



TUNNELLING IN ROCK BY DRILLING & BLASTING

A.T. SPATHIS & R.N. GUPTA EDITORS

 **CRC Press**
Taylor & Francis Group
A BALKEMA BOOK

TUNNELLING IN ROCK BY DRILLING AND BLASTING

This page intentionally left blank

WORKSHOP HOSTED BY FRAGBLAST 10 — THE 10TH INTERNATIONAL SYMPOSIUM ON
ROCK FRAGMENTATION BY BLASTING, NEW DELHI, INDIA, 24–25 NOVEMBER 2012

Tunnelling in Rock by Drilling and Blasting

Editors

A.T. Spathis

Orica, Australia

R.N. Gupta

Geotechnical & Rock Engineering Consultant,

Former Director, NIRM, KGF, India



CRC Press

Taylor & Francis Group

Boca Raton London New York Leiden

CRC Press is an imprint of the
Taylor & Francis Group, an **informa** business

A BALKEMA BOOK

CRC Press
Taylor & Francis Group
6000 Broken Sound Parkway NW, Suite 300
Boca Raton, FL 33487-2742

© 2013 by Taylor & Francis Group, LLC
CRC Press is an imprint of Taylor & Francis Group, an Informa business

No claim to original U.S. Government works
Version Date: 20130321

International Standard Book Number-13: 978-0-203-38749-8 (eBook - PDF)

This book contains information obtained from authentic and highly regarded sources. Reasonable efforts have been made to publish reliable data and information, but the author and publisher cannot assume responsibility for the validity of all materials or the consequences of their use. The authors and publishers have attempted to trace the copyright holders of all material reproduced in this publication and apologize to copyright holders if permission to publish in this form has not been obtained. If any copyright material has not been acknowledged please write and let us know so we may rectify in any future reprint.

Except as permitted under U.S. Copyright Law, no part of this book may be reprinted, reproduced, transmitted, or utilized in any form by any electronic, mechanical, or other means, now known or hereafter invented, including photocopying, microfilming, and recording, or in any information storage or retrieval system, without written permission from the publishers.

For permission to photocopy or use material electronically from this work, please access www.copyright.com (<http://www.copyright.com/>) or contact the Copyright Clearance Center, Inc. (CCC), 222 Rosewood Drive, Danvers, MA 01923, 978-750-8400. CCC is a not-for-profit organization that provides licenses and registration for a variety of users. For organizations that have been granted a photocopy license by the CCC, a separate system of payment has been arranged.

Trademark Notice: Product or corporate names may be trademarks or registered trademarks, and are used only for identification and explanation without intent to infringe.

Visit the Taylor & Francis Web site at
<http://www.taylorandfrancis.com>

and the CRC Press Web site at
<http://www.crcpress.com>

Table of contents

Preface	vii
Organising Institution	ix
Committees	xi
Sponsors	xiii
High precision drilling <i>A. Östberg</i>	1
Improved tunneling performance through smarter drilling and design <i>M.B. Lovitt & A.H. Collins</i>	7
Rapid excavation of tunnels using innovative drilling and blasting techniques <i>A.K. Mishra & R.N. Gupta</i>	15
Blasting works in urban areas—A Singapore case study <i>F.I. Manolas & T. Arusu</i>	23
Tunnelling through adverse geological condition: A case study <i>B.M. Gupta, A.N. Sreekumar & S.K. Tripathi</i>	31
Controlled blasting for a new tunnel near an existing railway tunnel <i>R.N. Gupta & A.K. Raina</i>	37
Introducing specialized blasting techniques and sequences of excavation in tunneling works under critical conditions <i>M.M. Singh, N.K. Bhagat & S.K. Mandal</i>	41
Controlling shock waves and vibrations during large and intensive blasting operations under Stockholm City <i>D. Jonson</i>	49
Vibration measurements and modelling for blasting in a hard rock tunnel <i>A.T. Spathis & M. Rothery</i>	59
Multiple seed blast vibration modeling for tunnel blasting in urban environments <i>R. Yang & D.B. Kay</i>	73
Geometric assessment of perimeter control blasting in tunnels <i>A.T. Spathis</i>	79
Controlled blasting for underground hydroelectric projects—NIRM experience <i>H.S. Venkatesh, R. Balachander, G. Gopinath & A.I. Theresraj</i>	91
Investigation of cracks in domestic houses near construction project in the Himalaya, India: A case study <i>H.K. Verma, R.K. Goel, V.V.R. Prasad, S. Dutta, A. Bhardwaj & K.C. Upadhyay</i>	101
IT & its role in underground blasting—an overview & future insights <i>A.K. Raina</i>	107
Author index	117

This page intentionally left blank

Preface

The world is going underground and a manifestation of that is the growth in tunnelling and underground space in and around our cities, the expansion in mines seeking underground resources, and the increase in hydroelectric power where man can build on the opportunities provided by nature. The present workshop brings together those involved globally in the construction of tunnels in rock, underground caverns, and underground space technology using the drilling and blasting method. Tunnel construction project managers and operators, mining and geotechnical engineers, underground space operators, government and regulatory authorities and end users and owners of the infrastructure created can review current and future technologies and benefit from the shared experience included in the proceedings.

The topics covered in the workshop include drilling equipment, explosives and delivery systems used in tunnelling, and initiation systems including those based on electronic delay detonators. Modern methods of blast design for safe and rapid tunnelling given the challenges of the geological setting are discussed. Methods of assessing a tunnel blast outcome are canvassed with case studies that consider excavation and geotechnical issues based on the experience of the authors and presenters. Software is used in various parts of a tunnel construction and the workshop covers the current state of the art in this important and growing area. The workshop describes tools such as MWD (measurement while drilling) designed to aid the assessment of rock mass conditions ahead and around the tunnel heading. A significant consideration is the environmental effects of the tunnelling process and a number of approaches to assessing and predicting ground vibration from tunnel blasting are presented.

The workshop has the benefit of experienced researchers, academicians, and practitioners from across the world. The workshop provides a forum for interaction and sharing of decades of experience with the key authors and speakers and provides information useful for the construction of future projects in India and elsewhere. The intended audience ranges from those with little or no knowledge of tunnelling in rocks, through to practitioners involved in day to day construction of such tunnels.

We thank the International Organising Committee of the Rock Fragmentation by Blasting Symposia (Fragblast) for their commitment and support of this and other workshops held in conjunction with Fragblast 10. The National Organising Committee for the Fragblast 10 Symposium in New Delhi, India provided generous support throughout. We thank our anonymous referees for their review of the papers presented at the workshop. Finally, we thank our employers for the opportunity to bring together this snapshot of the current status of aspects of tunnelling in rock using the drilling and blasting method.

A.T. Spathis
Orica, Australia

R.N. Gupta
*Geotechnical & Rock Engineering Consultant,
Former Director, NIRM, KGF, India*

This page intentionally left blank

Organising Institution



CSIR - Central Institute of Mining & Fuel Research
(Council of Scientific & Industrial Research)
Dhanbad, India

This page intentionally left blank

Committees

PATRONS

- Prof. Samir K. Brahmachari, *Director General, CSIR and Secretary, DSIR, New Delhi*
- Mr. Partho S. Bhattacharyya, *Chairman, CSIR-CIMFR, Research Council, Dhanbad*
- Mr. Satish Puri, *Director General of Mines Safety, DGMS, Dhanbad*
- Mr. S. Narsing Rao, *Chairman-cum-Managing Director, Coal India Limited, Kolkata*

CHAIRMAN ORGANISING COMMITTEE

- Dr. Amalendu Sinha, *Director, CSIR-CIMFR, Dhanbad*

ORGANISING SECRETARY & CONVENOR

- Dr. Pradeep K. Singh, *Senior Principal Scientist, CSIR-CIMFR, Dhanbad*

INTERNATIONAL ORGANISING COMMITTEE

Prof. W.L. Fourney	<i>University of Maryland, USA</i>
Prof. José A. Sanchidrián	<i>Universidad Politecnica de Madrid, Spain</i>
Docent Agne Rustan	<i>Retired from Luleå University of Technology, Sweden</i>
Prof. Hans Peter Rossmannith	<i>Technical University, Vienna, Austria</i>
Prof. Sushil Bhandari	<i>Earth Resource Technology Consultants, India</i>
Dr. Cameron K. McKenzie	<i>Blastotechnology, Australia</i>
Prof. Bibhu Mohanty	<i>University of Toronto, Canada</i>
Prof. Xuguang Wang	<i>Beijing General Research Institute of Mining & Metallurgy, China</i>
Mr. R. Frank Chiappetta	<i>Blasting Analysis International, USA</i>
Mr. Carlos P. Orlandi	<i>Enaex Servicios S.A., Chile</i>
Prof. Finn Ouchterlony	<i>Montanuniversitaet Leoben, Austria</i>
Prof. Kunihiya Katsuyama	<i>(Retired from) Ehime University, Japan</i>
Dr. William Robert Adamson	<i>Davey Bickford, Chile</i>
Prof. Panagiotis D. Katsabanis	<i>Queen's University, Canada</i>
Prof. Peter Moser	<i>Montanuniversitaet Leoben, Austria</i>
Dr. Ken Qian Liu	<i>Xstrata Nickel, Canada</i>
Dr. Ewan Sellers	<i>African Explosives, South Africa</i>
Dr. A.T. Spathis	<i>Orica, Australia</i>
Dr. Dale S. Preece	<i>Orica Mining Services, USA</i>

REVIEW COMMITTEE

Prof. W.L. Fourney	<i>University of Maryland, USA</i>
Prof. José A. Sanchidrián	<i>Universidad Politecnica de Madrid, Spain</i>
Docent Agne Rustan	<i>Retired from Luleå University of Technology, Sweden</i>
Prof. Sushil Bhandari	<i>Earth Resource Technology Consultants, India</i>

Dr. Cameron K. McKenzie	<i>Blastotechnology, Australia</i>
Prof. Bibhu Mohanty	<i>University of Toronto, Canada</i>
Prof. Xuguang Wang	<i>Beijing General Research Institute of Mining & Metallurgy, China</i>
Mr. R. Frank Chiappetta	<i>Blasting Analysis International, USA</i>
Mr. Carlos P. Orlandi	<i>EnaexServicios S.A., Chile</i>
Prof. Finn Ouchterlony	<i>Montanuniversitaet Leoben, Austria</i>
Dr. William Robert Adamson	<i>Davey Bickford, Chile</i>
Prof. Panagiotis D. Katsabanis	<i>Queen's University, Canada</i>
Prof. Peter Moser	<i>Montanuniversitaet Leoben, Austria</i>
Dr. Ken Qian Liu	<i>Xstrata Nickel, Canada</i>
Dr. Ewan Sellers	<i>African Explosives, South Africa</i>
Dr. A.T. Spathis	<i>Orica, Australia</i>
Dr. Dale S. Preece	<i>Orica Mining Services, USA</i>
Dr. Pradeep K. Singh	<i>CSIR-Central Institute of Mining & Fuel Research, India</i>
Dr. Amalendu Sinha	<i>CSIR-Central Institute of Mining & Fuel Research, India</i>
Dr. Alastair Torrance	<i>Kilmorie Consulting, Australia</i>
Dr. Alexander Hennig	<i>RWTH Aachen University, Germany</i>
Prof. Ali Mortazavi	<i>Amirkabir University of Technology, Iran</i>
Prof. Ajoy K. Ghose	<i>Formerly, Indian School of Mines, India</i>
Mr. Akhilesh Joshi	<i>Hindustan Zinc Ltd, India</i>
Mr. Ashok Kumar Singh	<i>Central Mine Planning & Design Institute, India</i>
Dr. AymanTawadrous	<i>Orica Mining Services, USA</i>
Prof. C. Niemann-Delius	<i>RWTH Aachen University, Germany</i>
Prof. Carsten Drebenstedt	<i>Technical University, Freiberg, Germany</i>
Dr. Catherine T. Aimone-Martin	<i>New Mexico Tech, USA</i>
Prof. Charles H. Dowding	<i>Northwestern University, USA</i>
Prof. Claude Cunningham	<i>Blasting Investigations and Consultancy, South Africa</i>
Dr. Essaieb Hamdi	<i>Ecole Nationale D'Ingénieurs, Tunisia</i>
Dr. Geoff F. Brent	<i>Orica Research and Development, Australia</i>
Dr. Italo Andres Onederra	<i>CRC Mining – The University of Queensland, Australia</i>
Prof. John Kemeny	<i>University of Arizona, USA</i>
Dr. Lina M. López	<i>Universidad Politécnica de Madrid – E.T.S.I. Minas, Spain</i>
Dr. Michael Noy	<i>Orica, Australia</i>
Dr. Pablo Segarra	<i>Universidad Politécnica de Madrid – E.T.S.I. Minas, Spain</i>
Dr. Pijush Pal Roy	<i>CSIR-Central Institute of Mining & Fuel Research, India</i>
Prof. R.N. Gupta	<i>Consultant in Geotechnical/Rock Engineering, India</i>
Dr. Roger Holmberg	<i>Secretary General, EFEE, Malta</i>
Dr. Ruilin Yang	<i>Orica USA Inc, USA</i>
Prof. S.P. Singh	<i>School of Engineering, Laurentian University, Canada</i>
Prof. Stanley Vitton	<i>Michigan Technological University, USA</i>
Mr. Vinay Kumar Singh	<i>Northern Coalfields Limited, India</i>
Dr. William Birch	<i>Blastlog Ltd, United Kingdom</i>

Sponsors

Diamond Sponsor

Coal India Limited



Platinum Sponsors

Solar Industries India Limited



Orica



Deepak Fertilisers & Petrochemicals Corporation Ltd.



Hindustan Zinc Limited
(Vedanta Group Company)



HINDUSTAN ZINC

Tata Steel



Gold Sponsors

Singareni Collieries Company Limited



Jindal Steel & Power Limited



Silver Sponsors

NMDC Ltd.



Essel Mining & Industries Limited

National Aluminium Company Limited



Jaiprakash Industries Limited



Manganese Ore (India) Limited



Uranium Corporation of India Limited



EMTA Group of Companies



Sarda Mines Pvt. Ltd.



Bronze Sponsors

Gujarat Mineral
Development Corporation



IDL Explosives Limited



J.K. Cement



Hutti Gold Mines Limited



V.V. Mineral (VVM)



Navbharat Group of Companies



JSW Bengal Steel Ltd.



Neyveli Lignite Corporation Limited



Lunch Sponsor

Ganesh Explosive Pvt. Ltd.



This page intentionally left blank

High precision drilling

Anders Östberg

Atlas Copco Rock Drills AB, Örebro, Sweden

ABSTRACT: In order for an underground project to run with good quality and profitability there must be good control of all activities in the tunnel cycle. It is important to understand each activity individually but especially how they affect each other. All activities can affect each other, for example bad scaling affects the safety in drilling, bad charging affects the mucking etc. One of the crucial factors to have a successful project is to have good control of the drilling.

Why do we need to have good control of the drilling? It doesn't matter if the project is located remotely or in urban areas, whether it is a hydro power project or infrastructure project, they all need drilling application such as drilling for blasting, pre grouting, probe hole, forepoling, spiling etc, and all this equal with precision drilling. Examples of what bad drilling and blasting can effect include: short pulls of the rounds, more rock reinforcement due to damaged rock mass, longer scaling and mucking time, more concrete in lining due to over break, bad control of grouting etc. All these effects are quality and cost related.

At underground works in urban areas we often get vibration problems from blasting when the tunnels are located close to existing houses, tunnels and other sensitive objects. To be able to blast in hard competent rock close to sensitive areas we need to have a very good control on the amount of explosives and the location of the explosives. For smooth blasting that uses small amounts of explosives in an efficient way we must have good control of the drilling. If drilling or blasting fails in vibration sensitive areas it can have a significant negative impact on the project.

Computerized drill rigs can provide high precision drilling. The benefits with these types of rigs are that you know exactly where you are and where and how to drill. During the last few years the focus has been on raising the quality and precision on the drilling rigs. Today we can use total station navigation for positioning the drill rig, pre made drill pattern, full automation of the drilling, forecast the rock with MWD (Measure While Drilling) analysis, use rig mounted profiler for scanning the perimeter etc. All these applications contribute to raising the quality and productivity of the project.

In order to be able to use and get the benefits from the new technology, the users from operator to project management and clients must be trained and informed in how to use the equipment to get good quality and profitability on their projects.

1 INTRODUCTION

1.1 Why do we need high precision drilling?

There are lots of drilling applications in tunnel works, for example drilling for blast holes, pre grouting, bolting, fore poling etc. Each type of drilling application has its own demands on precision and accuracy (Fig. 1). In a tunnel these involve the void holes, production holes, contour holes and rock support holes for grouting, bolting and meshing, for example.

2 DEMANDS ON THE DRILLING APPLICATION

2.1 Blast hole drilling

We know that the vibrations from blasting can be deleterious for the surrounding buildings and



Figure 1. Drilling application.

plants. Therefore it is crucial to have control of the blasting so the allowed limitation of vibration is not exceeded. To achieve low vibration blasting, it is required to use smooth blasting. Smooth blasting can be used in different applications. If the

goal is to get a nice and sustainable contour it's important to use the right amount of explosives per hole, so the surrounding rock is less damaged. If the requirement is low vibration and sustainable contour the amount of explosives per hole must be calculated for the vibration limitations and be adjusted for the contour. If very sensitive blasting is required it is very important to use an ignition pattern that ensures single hole blasting. To achieve single hole blasting there are two common techniques, non electric in the hole detonators combined with or without surface delay connector or electronic detonator.

To be able to use the full capacity of smooth blasting technique it requires high precision drilling. The fraction on the blasted rock is directly linked to the drilling and blasting result. With good control on the drilling and blasting it is possible to get a good result of the size fractions.

2.2 Pre grouting and probe hole drilling

Pre grouting: the purpose with pre grouting is to seal and stabilize the rock mass in front of the face. The sealing can have different kinds of purpose depending on type of project and requirements, for example, prevent influence of the water table, prevent water leakage on roads and rail way track etc.

One key factor when grouting is to know the location of the hole, and especially the hole bottom, this requires high precision drilling.

2.3 Drilling for rock reinforcement

There are different kinds of rock reinforcement: there is permanent rock reinforcement, it normally includes shotcrete and rock bolts and there is temporary reinforcement, it normally includes spot bolting, forepoling or spiling. To get the permanent rock reinforcement to work properly, if it is systematic bolting, it is important to know where to install the rock bolts, this job can be done manually or by drill pattern in the drill rig. The function of the temporary rock reinforcement is to make a safe progress through the weak rock, and afterwards install the permanent rock reinforcement. When drilling for spiling or fore poling it's very important to know where and how to drill to be able to make a safe passage of the weak rock.

2.4 Probe drilling

There can be several purposes to do probe drilling for example forecast rock quality, forecast water leakage, find different rock levels etc. The common thing with all probe drilling is to have good control of the drill hole location and collect data from

the hole. Example of data collected from probe holes is, color on flushing water, quality of cuttings, rock hardness, rock fracture and water leakage.

3 DRILL HOLE DEVIATION

3.1 Deviation

To be able to drill with high precision there is a number of variables in the drilling we have to cope with, (Fig. 2). If one of the variables fail, it will end up with a divergent hole.

3.2 Error in setting out

There is several ways of setting out for drilling and the most common way is still manual setting out. The manual setting out gives high accuracy of the collaring but is time consuming and difficult to get good precision of the alignment of the feed.

To get high precision navigation of the rig Atlas Copco has two options available, navigation by aligning the feeder in a laser beam, or use a total station navigation (Fig. 3). The laser navigation

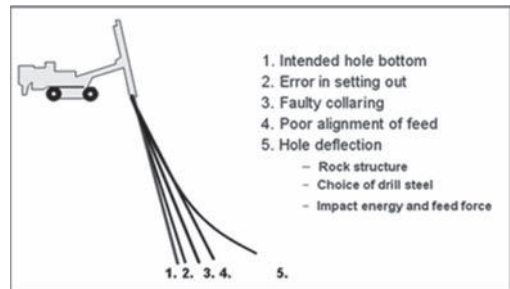

Figure 2. Factors that effects the drilling precision.

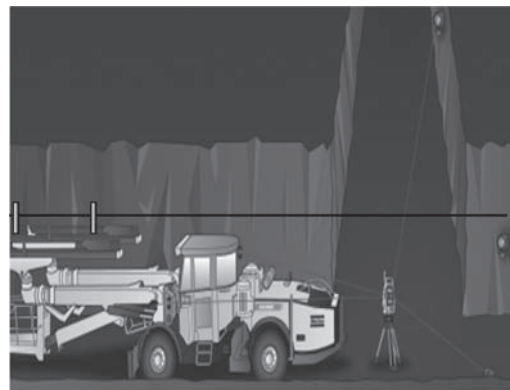

Figure 3. Navigation systems.

gives accuracy within 20 cm of the collaring if the rig is well calibrated and the operator aligns the feeder into the laser in a proper way.

The total station navigation gives a very high precision of the navigation, within 10 cm if the rig is well calibrated. The navigation is done with fixed prisms on the rig and at the tunnel walls, this means that the human error is minimized when navigating. The total station navigation is very suitable in curves and cross passes. Both types of navigation have a fast set up time, 10–15 min.

3.3 Faulty collaring and alignment

To get a good result from the drilling it is very important that the collaring and alignment is done properly. To get high precision, fast collaring and prevent bad alignment of the feed Atlas Copco drill rig is equipped with ABC system, (Advance Boom Control system), this system makes it easy for the operator to follow the pre designed drill pattern shown in the rig in a fast and accuracy way.

The ABC system has two levels of computerised aid systems ABC Regular (Fig. 4) and ABC Total (Fig. 5). In the ABC regular system the operator has to move the booms manually between the holes and in ABC total system it's possible to program the rig to drill fully automatically.



Figure 4. Collaring with ABC regular.



Figure 5. Automated collaring with ABC total.

The ABC system is a part of the overall control system of the rig, this system calls RCS (Rig Control System).

3.4 Hole deflection

To minimize the deflection of the hole, the right type of drilling equipment must be chosen and there must be correct settings on the drill machine or rock drill.

The drill steel should be as stiff as possible to avoid bending in the feeder and in the hole during drilling. A good example for blast hole drilling is 45–48 mm drill bit and 39 mm round drill steel, then you get a small gap between drill hole wall and drill steel to prevent bending but still big enough for the cuttings. When long hole drilling, the first rod should be a stiff guide tube for the same reason as for the blast hole drilling. To be able to drill straight holes the first 2–3 m are the most important part of the hole this gives the guide for the rest of the hole. To achieve a straight hole the feeder must be held still on the face and not sliding around during drilling. (Fig. 6.) The BUT 45 boom is built to keep the feeder on the face with a high force to prevent this. The rock drill must have the right settings to get smooth drilling in the first meters and be able to penetrate fault zones and cracks in a smooth way and also have well function anti jamming system. Those settings on the rock drill are controlled by the RCS system (Rig Control System).

3.5 Rock structure

The rock structure can have a big impact on the hole deviation. Even if everything is done right when it comes to drilling equipment, rock drill settings good trained operator etc. there can be large hole deviation due to the rock structure, especially in long hole drilling (Fig. 7).

In the Figure we can see the first 2–3 m of the holes are straight, the white lines are representing the joints in the rock, we can see how the holes strive to go perpendicular to the joints. In this case we can only minimize the deviation with the right drill equipment and settings and not eliminate the deviation.

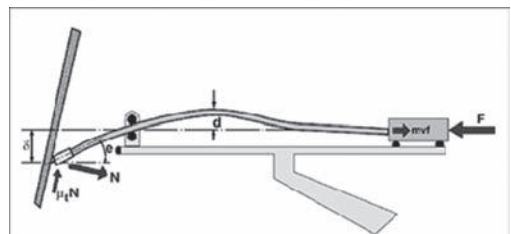

Figure 6. Drill hole deviation during drilling.

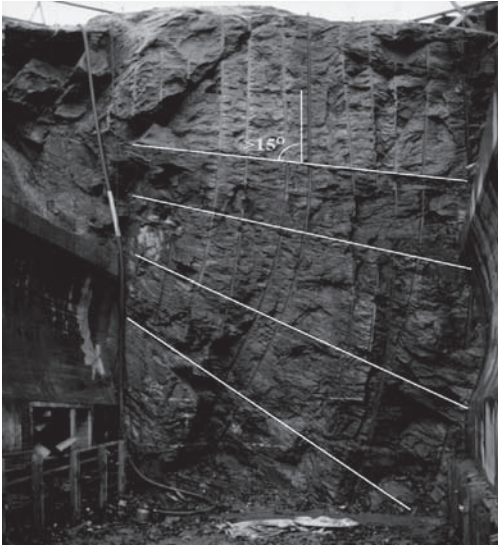

Figure 7. Hole deviation.

4 OPTIONS OF THE DRILLING EQUIPMENT

- MWD (Measure While Drilling)
- Communication and information systems
- Drill support software (Tunnel Manager)
- RHS (Rod Handling System)
- Profiler

4.1 MWD

In underground infrastructure projects, where the design and location are defined in advance, the excavation technique and reinforcement method are strongly influenced by the expected conditions of the surrounding rock mass. However, even with a well-conducted preliminary site investigation, only a rough estimation of the rock mass properties is achieved. Unexpected variations and surprises of different magnitudes will normally occur during the construction period. This is especially important for tunneling projects where cars or trains will make up the traffic and where the safety and maintenance responsibility may exceed 100 years.

One solution to these problems is, of course, better and more detailed geological and geomechanical data collection. This can be accomplished only by denser sampling of data, i.e. more site investigation holes. The traditional way to extract geo-data is often expensive and will therefore rarely be used for large scale sampling of a rock mass.

This lack of information in many rock excavation projects would be substantially improved if a

method was available to extract information directly from production drilling. This may reduce the cost of drilling test holes and would therefore reduce the cost of site investigation to a minimum.

One technique for extracting rock mass properties while drilling is called MWD. This technique is a method for collecting data during production drilling, and is often an option on modern computerized drill rigs. The major advantages of MWD are:

- Very high data resolution, data is extracted at an interval of a few cm in all the production holes.
- Very low cost, monitoring of data is conducted automatically during normal production drilling.
- Very low data risk, monitoring is performed during the drilling of the hole, and no instruments have to be inserted after the drilling is completed.
- Minimal disturbance of production, MWD will require very limited extra work from the operator.

In infrastructure and tunneling projects, the long broom-shaped injection or probing fans can be of interest for MWD usage. These holes provide detailed information on the rock mass 20–25 m beyond the face, and this data arrives in time for modification of the excavation, pre-reinforcement procedure or pre grouting geometry, if necessary. In this respect MWD also serves as a very important warning system for unexpected rock features or variations that can jeopardize the time schedule, cost estimation or even the safety of personnel. Rock mass variations undefined in the preliminary investigation for the project can also be detected and handled accordingly.

MWD also provides detailed rock mass information up to five meters outside of the final tunnel wall, see Figure 6. This information on fracture zones, water flow, rock discontinuities, etc., can be extremely important for the long-term maintenance of the tunnel. In tunnels where shotcrete is used shortly after excavation, MWD can also be a very strong support for the geological and geomechanical mapping and documentation of the tunnel. Figures 8–10 show some examples of MWD data integrated in a modern drill rig support system Tunnel Manager.

4.2 Communication and information system

Efficient communication and data transfer are vital for all kinds of automation systems. The transfer of data (drill plans, log files, etc.) to the rig and back to the office can be conducted manually with diskettes, USB sticks or other forms of mobile memories. However, this will constrain the

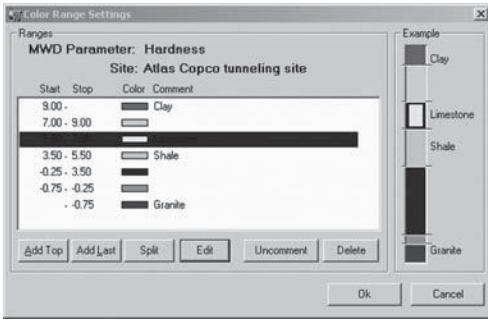

Figure 8. Site customisations done by adapting colours to specific geological or geomechanical formations.

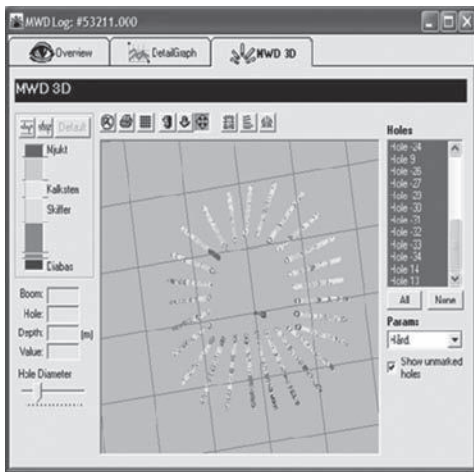

Figure 9. Three dimensional presentation of calibrated MWD data from an injection fan in a subway tunneling project.

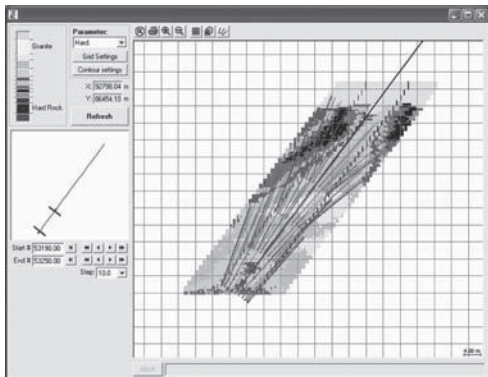

Figure 10. Tunnel mapping of a 50 m section in a subway tunneling project, including four injection.

technical possibilities for a modern drilling system. In many projects the manual transfer of data and the responsibility for this have been one of the largest obstacles.

Log files generated during the completion of the round (such as Measure While Drilling (MWD) files or quality files including documentation of the conducted round) must, in order to be used in the decision process, be transferred fast and efficiently back to the office for evaluation.

More and more effort is today being made to develop efficient underground communication systems. Often the system is based on a fixed backbone system and a linked wireless system out to the operational areas, for an example, see Figure 11. Sometimes commercially available “office” networks are available on the work site, even if this restricts the functionality to only remote access for data transfer.

4.3 Drill support software

Today’s drill support software includes all the design data, such as tunnel lines, sections, tunnel profiles and planned rock reinforcement, etc., which is integrated in one common data structure. On top of this, navigation tools such as laser lines and total station are used to connect the designed drill plans to the correct position in the tunnel. To end up with the final tunnel design specified by the buyer, the section, the tunnel line and the specified tunnel profile are all used as input to drill plan design modules. In this process the entire round, including all the holes, is designed in terms of the collar position, hole direction, hole diameter, hole length or final depth etc. (Fig. 12). Once the drill plan is designed, it will be transferred to the rig computer, where it defines the round to be drilled. Today different rig automation levels define the procedure for completing the round.

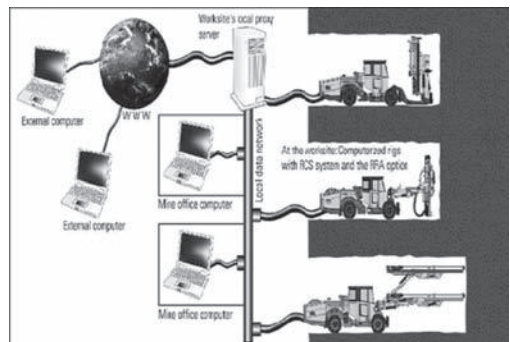

Figure 11. Communication system, for rigs with Atlas Copco’s RRA communication system.

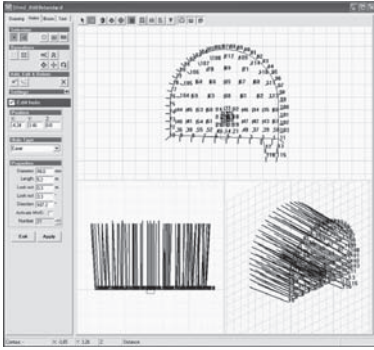

Figure 12. Design tool for drill plan generation.

4.4 RHS

The new BUT 45 boom is designed to carry more load than the old one, this means that it is possible to mount a rod handling system for long hole drilling on the boom. The big benefits with the RHS (Rod Handling System) (Fig. 13) are:

- Safety, no one needs to stand in the basket and be exposed to falling rock, moving machine parts and manually handle heavy extension rods.
- Productivity, when using RHS auto the capacity has increased with 40% compared with manually rod adding system.
- Accuracy, when adding rods manually the feeder must be placed in a way so the labor can reach the feed and assemble/disassemble the extension rods, this feed position can be a disadvantage to get straight holes. With the RHS system the feed can be placed in the most suitable way for the drilling, and therefore get higher precision on the drilling.
- Cost efficiency, in stand of two operators (one in the rig and one in the basket), one operator can manage the whole drilling process with a higher capacity.

4.5 Profiler

The Atlas Copco Tunnel Profiler is an onboard surveying system designed to enable the excavation of an optimum contour at minimal cost. By quickly comparing the tunnel's actual profile to the design plan, any remedial action can be taken before costly corrections are required (Fig. 14).

Tunnel Profiler provides fast, accurate, three dimensional scanning of tunnel sections. By using the system to monitor over- and underbreak, as well as shotcrete thickness at an early stage in the tunneling cycle, costs can be reduced. Tunnel Profiler presents the results from the scan immediately on a screen inside the drill rig cabin. The system is a fully integrated, proven, in-house technology that



Figure 13. The Rod Handling System, RHS.

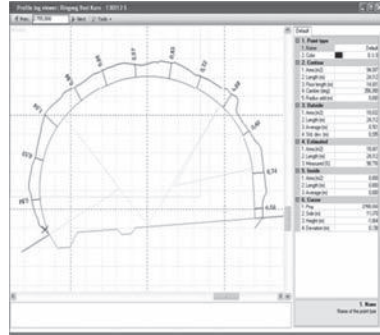

Figure 14. Section of scanned tunnel profile.

is able to scan a 65 m² face in around five minutes with a coordinate accuracy of +/- 2 cm.

5 SUMMARY

The trend is that the complexity and the demands of the projects get higher and higher. This means that the challenge for all involved in the projects increases for all involved including consultants, the client, contractors and different kinds of providers. To be able to utilize all new technology all sides must understand each others demands. To get an efficient utilization of the machines on the projects we already know that there has to be well trained operators and management.

There should be a close cooperation between all sides in an early stage, this gives the clients and consultant's knowledge what they can expect from the existing machines and give input to the provider what the demands will be in the future.

6 ACKNOWLEDGEMENTS

The author thanks his employer for permission to publish this work and also acknowledges the various clients, contractors and other providers involved in the range of projects that have helped deliver high precision drilling.

Improved tunneling performance through smarter drilling and design

M.B. Lovitt & A.H. Collins

Orica Mining Services, Subiaco, WA, Australia

ABSTRACT: Drill and Blast is a common construction method for the excavation of tunnels in rock. Much has been written about the use of explosives and sequencing to attain an excavation for access/egress, but not enough emphasis has been placed on the drill design and assistance available for the tunnel (or jumbo) driller. The role of a tunnel driller is a complex and important one which requires skill and experience. The need for holes to be drilled both parallel and sub-parallel is an ability that needs computer support to be carried out with reliability and efficiency, especially where the length of the hole exceeds 4 m. This paper identifies the key design aspects required in the design of long rounds and the reasons why more assistance should be supplied to tunnel drillers to increase their effectiveness. Computer control systems for tunnel drills do exist but the lack of understanding of impact, cost and maintenance issues (from having alternate duties such as bolting and scaling) have limited their ongoing use. This, compounded by a reduction in experienced tunnel drillers, is impacting negatively on the efficiency and cost of drill and blast as a tunnel excavation process.

This paper discusses the design aspects of tunnel designing along with a commentary on the explosive charging and sequencing. Jumbo operators will always be required to control the drilling rigs as exception decision-making is needed. Geological conditions, misfires, drill butts (sockets/bootlegs), services, poor blasting outcomes, etc. will provide a computer controlled drilling rig with exceptions it cannot deal with. At present these exceptions are handled by operators, but it is assistance in determining the toe position of a hole that is over 15 m away from the operator, to an accuracy of within 0.1 m that is needed by the operator. This ability to accurately place the toe will affect the advance rate, variance from design and overall tunneling costs. Explosive makers and users have products targeted to improve these performance indicators however fundamental to their performance are the holes drilled to design. More emphasis needs to be put on supporting the drilling cycle of the tunneling process.

1 INTRODUCTION

Drill and Blast is the main method of excavating mine tunnels and a significant part of construction tunnels. Drilling manufacturers are developing drill rigs that can drill larger and longer holes to take a longer cut length, but this places more emphasis on the drill pattern and the ability to drill parallel and sub-parallel holes. New drilling rigs have computer aided or fully automated drilling functions, but due to exceptions encountered operators are unable to fully utilise this function. Computer aided drills use their automation to drill the centre of the round and the operator drills the perimeter holes, which are the hardest to align from the cab.

Most mine development uses a “burn cut” to establish a free face for blasting. There are other alternatives such as “wedge” and cratering methods which are used more extensively in construction and shaft excavations, but this paper will deal exclusively with the burn cut. The key for the burn

cut is the use of large diameter void-holes (although some old patterns used holes of similar diameter to the blast hole) and closely spaced holes to establish the length of the cut, to which the remainder of the round is blasted.

The drill design and placement of the cut is dependant on many factors and a compromise will be made in relation to these. Normal short term usage development will require a different design to rapid capital development. Ore/waste separation tunnelling will require different design to decline development on a 30 m radius of curvature. The drill design should always take into account the explosive types being used.

The advance of any tunneling/drift/development round (referred hereafter as a development round) is a major component when determining the cost per meter and efficiency of a development round. Failure to pull the full round length means that a portion of the drilled meters have been wasted and the development schedule is being threatened. It may also be an indication

that the following aspects have been insufficiently controlled:

- Drill pattern is poorly matched for the ground.
- Explosives strength is not correctly matched for the application.
- Insufficient explosive charge at the toe
 - Poor hose handling.
 - Insufficient primer strength.
- Poor timing
 - Insufficient breakout angle and burden relief.
 - Poor accuracy of the detonators.
- Drilling accuracy is altering designs, mainly toe burdens.

Tunnel excavation costs can account for over half of the operating cost of a mine. The cost of advance is determined by summing up all the expenses incurred during the process of developing the opening. These costs are not necessarily incurred in the interest of maximising advance. Perimeter control should always be a major concern of any tunneling operation as the remaining ground needs to be supported to form the work area. Perimeter control (also known as contour blasting) is the reduction of damage to the remaining rock post blasting. This damage may be measured by overbreak or underbreak volume, percentage of half barrels remaining, scaling time, collaring of subsequent holes or degree of fracturing, the last being hard to measure. The degree of damage to the perimeter will be a large factor in the ground support selection and the safety of the working environment.

2 DRILLING DESIGN

2.1 General

The “Burn Cut” design will be the main method examined in this paper for establishing a void in a long round cut. By its nature the burn cut method is a high powder factor method working on small free faces and as such will have a large damage radius. Keeping this cut away from perimeters will reduce perimeter damage.

The drill design and placement of the cut is dependant on

- The requirement of the tunnel
- The tunnel service life
- The geological makeup of rock
- Support mechanisms
- Inclination and curvature
- Drill hole sizes available
- Explosive types used
- Explosive initiation systems used

Drilling and ground support are the two major costs of development mining. The drilling cost is

determined by round length and number of holes. As the number of holes increase, the work required of the blastholes decreases. A feature of good drill design is a pattern that makes holes work to their optimal efficiency. If a hole works too hard in or around the perimeter it will influence the damage to areas outside the blast. A trade-off between the number of drill holes and the blast performance must be made in order to optimize the drill and blast procedure. Reduction of perimeter hole burden can improve the tunnel profile, however if this burden reduction increases the burden of the stopping holes by too much the blast may freeze.

Measuring the burdens at the face can give an indication of drilling accuracy however the toe burdens are the most important parameter. The quality of the drilled round will depend on the geology, drill rig specifications and the skill of the operator. If the toe burdens are too great then the full round length will not be pulled and butts will remain post blast. Butts are evidence of poor blasting and must be immediately addressed in order to reduce cost per meter and reduce the threat of misfires and difficulty in drilling the next cut.

2.2 Burn cut

There are many burn cut designs and it would be difficult to describe even most of them. Burn cuts are a close pattern of parallel holes to create a free face to use to develop the tunnel proper. Those pictured in this paper are a small subset of the designs most used. Fundamentally, the burn cut provides

- a free face for blasting of charged holes,
- a void for rock to swell into and
- they provide a shielding mechanism to minimise the chance of sympathetic detonation or desensitization

The last of these factors is a subject that is not taken into account enough, and so designs have a percentage of holes that are wasted through the explosives, or the initiation system, being interrupted during the blasting process. This can result in misfired explosive products remaining after the blast. Usually this is accepted as the price for a robust design but it may prove to be an area of improvement on the way to gaining greater efficiency in tunneling as well as improving safety.

The void ratio needed for a burn cut to function efficiently has been covered in other papers, but fundamentally the swell of rock broken must be allowed to fit into the volume of the void or reamer hole before the explosive gases eject the broken rock. This calculation is best done on individual blast holes to individual void holes. The requirement is for the volume of rock which is to be broken between the first firing hole and a void hole to be greater than

40% (BDE course notes), due to the high swell factor for high powder factor. This is to say that there must be more than 40% void in addition to the volume of rock that is to be broken. In Figure 2 a basic burn pattern, using four 102 mm (4 inch) reamer holes and five 45 mm (1.75 inch) blast holes, is shown with the calculation of void ratio.

From the above calculation it can be seen that it is not necessary to use multiple reamers for the calculation. The use of multiple reamers in this calculation renders the calculation meaningless as shown in Figure 1. Using extra reamers in a burn cut allows for inaccuracy in drilling as it gives more options for the first hole to break to. It is possible with inaccuracy that the centre blast hole may only break efficiently to some of the available void holes.

The burn holes will be inclined above horizontal by 2 degrees to allow for the efficient clearing of cuttings and water. While many mines are using bulk emulsions so water can be ejected from blast holes, the void holes are far less efficient when they contain water. Initial charges can eject this water from void holes in shaft operations; however most operations drill inclined holes to freely drain the water. This can offer inefficiency in declining operations where the lifters holes are declining at over 10° down and the burn holes are inclined at

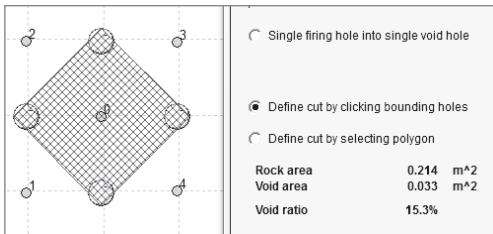

Figure 1. Burn cut showing meaningless void calculation.

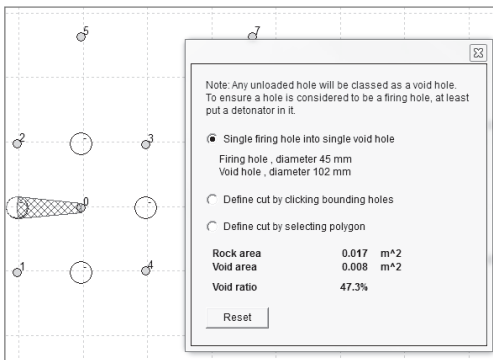

Figure 2. Burn cut design on 300 mm grid showing void ratio.

2 degrees up as any change in inclination requires holes to be sub-parallel which is not ideal. The burdens at the toe of the hole are at the optimum burden and therefore the burden defined by geometry will be smaller or larger following the hole to the collar, and therefore becoming sub-optimal.

Figure 3 shows the change in angle for a 1 in 7 decline. The red lines show the design outline.

2.3 Shoulder and perimeter holes

The perimeter holes define the profile of the tunnel and by their nature must be drilled close to the wall of the tunnel. They must be drilled with a “look-out” angle to allow the drifter rail and drill to have room to drill, but also such that the excavation blasted is large enough to conform to the design size. This starts another compromise which can be seen in Figure 4. The requirement would ideally be a hole that defines the perimeter (C), but as the drifting equipment has to fit inside the tunnel the start of the hole must be drilled slightly inside the design profile (100–200 mm (4–8”) depending on the rock and explosives used (B). The hole must be drilled with a look-out angle such that the hole breaks to the design at the collar and breaks slightly outside the design at the toe (0.2–0.3 m or 4–6”). Inexperienced drillers start on the perimeter and drill with a large look-out angle (A in Fig. 4) as the drifter cannot get close enough to the wall and blasting results in a large amount of overbreak. This results in a large saw tooth effect which can only be minimized with good drilling.

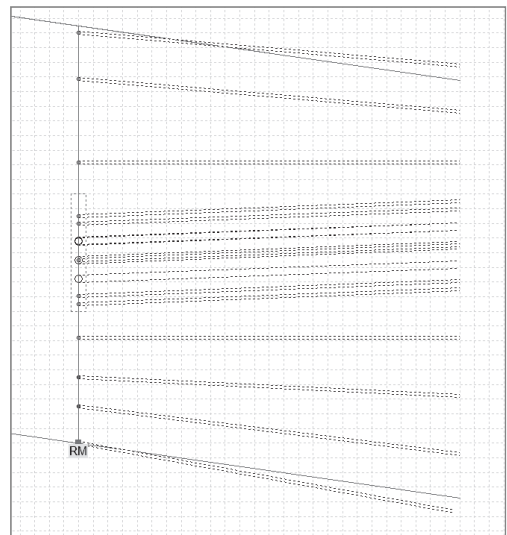

Figure 3. Long section of decline showing change in angles.

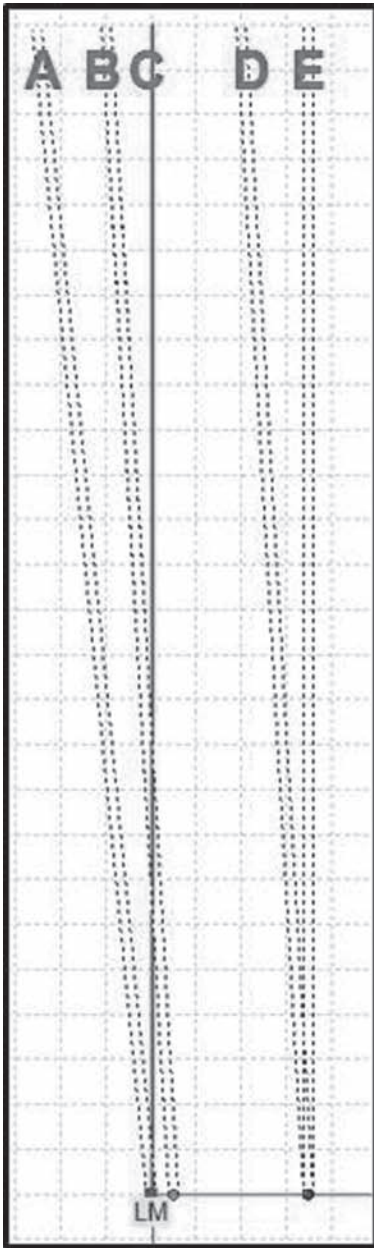

Figure 4. Plan of perimeter drill options on a 5.2 m round.

The key to good designing is for the perimeter holes to be as parallel to the perimeter as is possible. The next consideration is what explosives will be used.

It is the norm to use a specific perimeter charging product, which means that the energy level is down

on full strength explosives. To protect the perimeter, the burdens and spacings are reduced which reduces the work to be done by the explosives. The burden again should be measured at the toe and not at the collar. Many studies (Mohanty et al. 1998 and others) have identified that between 0.6 and 0.9 m (2–3') of a perimeter hole collar region is cratered off during the firing of the shoulder row (D and E in Fig. 4) and as such the uncharged collars of any perimeter product should not be less than that.

As specific perimeter products are being used it is vital that these shoulder holes are drilled parallel to the perimeter holes (such as D). Inexperienced drillers drill these shoulder holes parallel to the main cut (E) which over burdens the perimeter and gives the perimeter hole a variable burden. The explosive product used in the shoulder hole is also important as, if it is full strength, it is likely the damage can extend outside the profile of the tunnel resulting in a double damage area. Bulk explosives can be slightly reduced in strength to reduce their damage envelope so it does not extend outside the designed development envelope. Due to the energy in the shoulder row it is best to stagger the holes in between the perimeter holes to reduce the chance of the shoulder holes interfering with the perimeter hole charges.

The ability to get perimeter and shoulder holes parallel and on design is very achievable with computer assistance. Lifter (floor) holes are typically poorly drilled resulting in poor road surfaces and ongoing road building, haulage and drainage issues.

2.4 Size of blasthole

Drilling manufacturers are developing new drill sizes and rod options to increase the penetration rates and straightness of tunnel blast holes. This is good, as drilling is the largest and most significant factor in tunnel cycle times and costs. The larger hole size comes with extra costs however, with the use of a burn cut as a method of establishing a starting void, the chance to use the increased energy of these large hole sizes is not realized until the blast has progressed to outside the outer box of the burn.

Consider a standard 45 mm burn cut using 102 mm reamers, the geometry of the burn cut is dictated by the size of the free face, which is the diameter of the reamer. The next ring of holes is dependent on that “inner box” size and so due to the small free face the increased energy is limited in its influence to enlarge the pattern. The blast has now progressed to a 2×2 m free face with this outer box complete. Very few of these dimensions would be able to be increased with a 53 mm (2.1”) bit size.

The next set of holes is now able to better use the increase in burden afforded by the larger hole

size, as there exists a large free face to fire to and thus capitalise on the extra energy. However, this set of holes make up the shoulder row, which are the holes that are parallel to the perimeter holes that we are trying to reduce the impact on the perimeter, in a 5×5 m (16.4') development face.

Development rounds larger than 5×5 m may be able to use the benefits of a larger blast holes, but as it stands, larger blast holes do not have a cost benefit in this size tunnel or smaller. A cost benefit would be present if the total number of holes could be reduced. As a negative impact of large hole sizes, depending on the explosive options used, the damage radius can be increased.

2.5 Complexity of design

The design for declines and corners can be quite complex. Allowances for the length of round and radius of curvature need to be allowed for in designs. The ability of drill feeds to fit into the tunnel excavations is required. The attention to detail requires that the sockets or butts of the hole have a radius of around two times so that the collar position of the next hole is not impacted.

Figure 6 shows the need to position the burn on the outer part of a 30 m radius of curvature decline and also that the outside wall is longer than the burn round. Therefore the burdens on the outside of the bend need to be small to allow for the ground to be made up. The ability to accurately control the drill hole length to finish on the right plane ensures free faces are maintained. The perimeter charging options are difficult when the outside corner needs to be made up of two rows of holes. The drifters are 6.2 m long to drill a 5.2 m hole so enough room

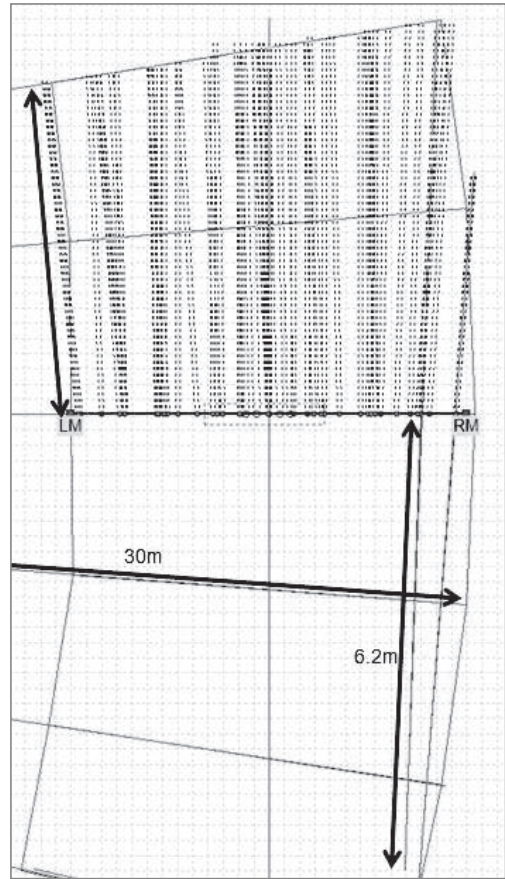

Figure 6. Plan of a 5.2 m decline turning left on a 30 m radius of curvature.

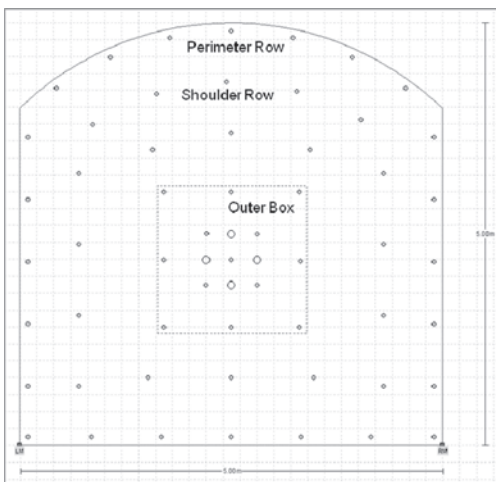

Figure 5. Face pattern showing areas of drilling.

must be allowed to fit the drifter into the tunnel excavation. Corner lifters need to be inclined to a greater depth to allow for drainage. Camber allowance for bends particularly in haulage-ways.

Thankfully the computer aided jumbos allow for some of these complexities, but not for all. Computer design is the start and the ability for this design to be transferred via an IREDES (International Rock Excavation Data Exchange Standard) format to the jumbo drilling machines can give the jumbo operator the design. IREDES is an industry standard to unify routines for the data exchange between mining equipment (machines) and office computer system. The jumbo drilling program determines a sequence of drilling to enable the jumbo to be as productive as possible. The operator now assesses the design and determines if the program can be carried out as per the plan. If the program cannot be followed the operator overrides the plan to work around the problem. The jumbo

computer systems then record what is drilled such that the record can be analysed.

If computers are not available many other aids are available to the drilling operator. There are guide sticks and paint marks, and these assist the operator to align a hole to be drilled with a hole already drilled but they require the operator to get out of the operators cab. This represents an increased hazard of climbing up and down and still does not guarantee correct orientation of holes.

2.6 Measured drilling accuracy

These are some rare results of actual measurements of hole length and spacings that give a flavor for the degree of accuracy that affects the standard designs. The accuracy of designs may be modified because the driller knew that the patterns would be measured and more care is taken. When analyzing the results of actual drilling accuracy measurements, mainly the hole length and spacing, the accuracy is often far from exact. Worthy of note is the fact that the accuracy of drilling varied greatly between when the driller was aware and unaware that the drilling was going to be audited.

Figures 7 and 8 show some data reported by Spathis et al. (2009). These box-whisker plots have the centre of the box at the median value with the two adjacent quartiles as the box and with the extreme values shown. In this case, the drilling lengths are reasonable, while the spacings are somewhat poor, especially for the toes. The data suggests a potential for a poor blast result. The main point of note is that the toes are of far worse accuracy than the collars and this relates to the availability of aids to assist the operator to determine the toe and where the hole finishes.

There is no measurement of burdens; however from this data an assumption of similar errors could be suggested. Of particular note is the variance of hole length. The face may not be able to

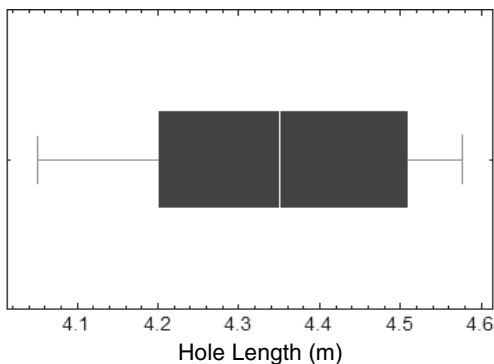

Figure 7. Drilling accuracy of hole length box-whisker plot (Spathis et al. 2009).

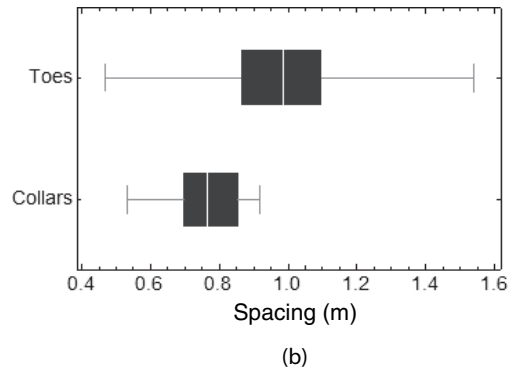

Figure 8. Drilling accuracy of collar and toe spacing box-whisker plots (Spathis et al. 2009).

make up ground once the shorter holes have blasted and so this would represent 0.2–0.3 m of butt or socket—and depending on where it is, could limit the advance of the face or cause the face to be more concave. When the dishing of the face gets too bad the jumbo operator will have to square the face up, requiring costs and lack of productivity.

3 EXPLOSIVES AND INITIATION

3.1 Detonators

The sole purpose of a detonator is to apply an explosive force after a set delay period. The strength of this force may vary depending on the blast requirements however the accuracy of the delay should be as close to nominal as is possible. There are a wide range of detonators to suit most budgets available to the development mining community. These detonators vary greatly from one another and can produce very different results depending on their accuracy. Broadly, these detonators are divided into the categories; pyrotechnic and electronic.

3.1.1 Pyrotechnic detonators

Pyrotechnic detonators achieve various delays by combining different compositions of pyrotechnic substances. The accuracy of these detonators is dependent on the duration of the delay and the quality of the delay element.

The main method of applying delays to blast holes using pyrotechnic delays is with a range of in-hole delays, for example delay numbers 0 to 15 with delays ranging from 25 ms to 9600 ms. This product range offers 16 individual delay times which is ample for development faces of around 30 m². However for larger civil tunnels a wider range of delays may be required to maintain good breakout angles and to keep the number of charges

on the same nominal delay down. An alternative is to drill an additional burn cut to increase void area earlier on in the blast.

The accuracy of pyrotechnic detonators is the main concern when low delay variances and long delays are concerned. The difference from the nominal firing time to the actual time is referred to as scatter, and for a 9600 ms delay the scatter may exceed 300 ms. The cost effectiveness and simplicity of pyrotechnics are the main advantages over electronics. There is however no guarantee that pyrotechnic detonators will go off exactly on their nominal delay. The time variances between sequential delay numbers does affect the scatter so that if large scatter does occur, the detonators will at least fire sequentially.

3.1.2 *Electronic detonators*

Electronic detonators have the same base charge as a pyrotechnic detonator of equal strength however the delay applied to the base charge is controlled by a computer chip capable of higher accuracy. This electronic control capability allows a huge range of individual delays to be applied to the detonators. This delay flexibility means that regardless of the size of the face and number of holes, the breakout angle does not need to be compromised. Because of the increased accuracy and two-way communication, electronic timing has proven itself to have numerous advantages over pyrotechnic. This includes

- Easier muck-pile shaping
- Excellent ore-waste separation (resue cuts)
- Vibration control
- Reduction in over-break
- Increase in advance
- P and S wave interaction
- Misfire reduction/identification

Due to the high velocity of P and S waves and the gas creation rate of bulk explosives, if interaction between blast holes is desired then the initiation must be very close to millisecond accurate. Numerous trials have been completed and have observed the benefits of true 'instantaneous' initiation, of special note is the work of Olsson and Bergqvist (1996a and 1996b) at Vånga in southern Sweden.

3.2 *Bulk explosives*

The commercially available bulk explosives used in development mining are predominantly either ANFO or Ammonium Nitrate Emulsions (ANE). Typically, ANFO is blow loaded into development holes and the critical collars are maintained by having tape on the hose at set lengths. This is only recommended for use in dry holes as AN prill is water soluble.

ANE is now able to be accurately loaded via use of computer controlled pumps and can have variable final in-hole densities. Depending on the required strength and coupling of ANE it is able to be manipulated to meet certain requirements. Different series of emulsions will have different density ranges, however most series of ANE can vary the RBS from between roughly 70 to 145. Varying these final densities allows for some perimeter to be applied easily and without the need for specialized packaged products. Because the gel perimeter product has no tensile strength, if an adjacent hole craters and breaks into the explosive product, the remainder of the explosive charge will not be ripped out of the hole. This prevents impact sensitive explosives ending up in the muckpile and reduces misfires.

The use of the computer controlled pump allows for the quick and accurate loading of holes. Pre-set amounts of emulsion can be programmed to be pumped repeatedly and all the operator has to do is push the hose and primer to the toe of the hole and push the start button. The ANE pump will deliver the required amount of explosives in the hole, maintaining critical collars without.

A 'swell and quell' ANE product has been developed specifically for tunneling. The perimeter holes are charged the same way as the other holes in the face, however the charge weight is less due to the greater expansion. The ANE gasses down to a sufficiently low density that it begins to coalesce. Once gassing has completed, the emulsion collapses to a higher density, causing a partial decoupling. This reduction in coupling ratio greatly reduces the pressure exerted on the blast-hole and as the decoupling ratio increases, the crack lengths are reduced from the blast hole with decoupling advantages demonstrated by Olsson and Bergqvist (1996a, 1996b).

3.3 *Packaged explosives*

Packaged explosives are used as primer charges or as the whole length of charge in blast holes (in the case of wet holes where ANE is not available). The cost per meter of packaged explosives is much higher than most bulk products however the benefits often make them worthwhile.

The primers used in development are usually heavy ANFO 'sausages' or alternatively high explosive cast primers. Pentolite and other ratios of TNT and PETN are usually the contents of these cast primers due to their high detonation pressure, detonator sensitivity and cost effectiveness. In many Australian development rounds, 25 g Pentolite primers are preferred to 200 g HANFO sausages. The initiation and VOD of the bulk explosive was not adversely affected and fewer butts were observed using a high explosive primer.

These smaller HE primers are lighter and easier to use than the HANFO alternatives and are slowly becoming more popular.

3.3.1 *Specialized perimeter products*

Perimeter control is a major concern in underground excavations and therefore reducing the damage incurred by the surrounding rock mass is very important. This can be achieved by decoupling the explosive charge and reducing the strength of the explosive. The best results are achieved by implementing both. The increased cost of packaged products is a major deterrent to their use, and the misfire rate is much greater than bulk products. The main reasons for packaged explosives misfiring are an insufficient collar length and not enough toe charge holding it in place.

Various combinations of low strength detonating cord, ANE, crushed ANFO, coal dust and aluminum have been packaged and sold as perimeter products. These products are generally decoupled and low energy; however their rope-like characteristic often causes them to be ripped from the blast hole by adjacent cratering holes. Their higher cost, labor demands and failure rate usually sees them replaced with either a low strength ANFO + Polystyrene bulk charge or a weak ANE product. Alternatively it is often decided that perimeter control is simply too hard or not worthwhile for an operation to pursue.

4 CONCLUSIONS

Long round tunnel development is becoming common place. The emphasis on blasthole alignment is paramount to ensure the efficiency of blasts. The weak link in the process is the amount of support the drilling operators have to ensure that blast holes have the required conformance to design. Computer aided devices in-built in the drill rigs are the solution to this variance from design. Drilling manufacturers are striving to develop systems that are robust enough to survive the harsh conditions present in the tunneling environment where such conditions are greater than in most other excavation operations.

Fundamental to the burn cut methodology of creating a free face to blast to, is the need for closely spaced parallel holes. This is the efficiency driver of the process. Computer aids can take the place of guide sticks and take the guess work out of drill alignment.

Perimeter hole alignment is one of the drivers for under and over break in tunnels as is the drilling of shoulder holes parallel to the perimeter holes. Again, this is very difficult to do accurately without computer-aided drilling.

The design of tunneling rounds is straight forward and software is readily available to assist this.

The challenge is to implement these designs with the least variation to effect a reduction in the variability of blasting outcomes. Explosive products and systems are developed to work under specific conditions, and if these conditions are poorly controlled and produce drill hole variance, then the blasts will not perform to design.

Better initiation systems have found their way into the development market allowing for greater flexibility, improved safety and increased accuracy. This increase in timing accuracy provided by electronic delay detonators has reduced or even removed the unknown factor from the time of energy release of the explosive that is present with pyrotechnic delays. Precision timing which allows for shockwave and gas interaction is improving advance rates and specialized perimeter products are protecting the backs better than was previously being achieved. The technology being used in the industry is finally able to apply the theories which have been trialed in software and proven in controlled conditions.

ACKNOWLEDGEMENTS

The authors would like to thank their colleagues from Orica and customer sites for the opportunity to study this subject over a number of years.

REFERENCES

- Blast Design Engineering for Underground Mines, Orica Mining Services Training Course Notes.
- Hamilton, C., DeGay, B., Resue Mining with eDev™ Electronics Detonators at Stawell Gold Mines (SGM), 2011, AusIMM Underground Operators Conference, Canberra.
- IREDES white paper, www.iredes.org.
- Mohanty, B. & Ludwig, G. 1998. Optimization of Development Drilling in an Underground Mine. Proceedings of International Society of Explosives Engineers.
- Olsson, M. and Bergqvist, I. 1996a. Crack lengths from explosives in multiple hole blasting, Proceedings of the 5th Intl Symp. Rock Fragmentation by Blasting: 187-91. Rotterdam.
- Olsson, M. & Bergqvist, I. 1996b. Crack growth during multiple hole blasting. SveBeFo report 18. Stockholm: Swedish Rock Engineering.
- Rosenstock, W., Chappuis, M., Henning, W. & Woolcott, P., 2000. Staggered parallel cut in small headings the most cost-reducing alternative to all other cuts in mechanized drifting, Proceedings from International Society of Explosives Engineers, Shotplus Tunnel Software, Orica Software.
- Spathis, A.T., Yuill, G. & Stow D. 2009. Proceedings of the 1st International Seminar on Safe and Rapid Development Mining, Perth, May 6-7, 2009.
- Wall, J. Case study at Mt Wright 2010. www.oricamining-services.com.

Rapid excavation of tunnels using innovative drilling and blasting techniques

A.K. Mishra

Department of Mining Engineering, Indian School of Mines, Dhanbad, India

R.N. Gupta

Ex-Director, NIRM, Kolar, India

ABSTRACT: Infrastructure development has been gaining importance over the years both from the economic perspective and as an area of sustained growth. Presently, the infrastructure sector in India accounts for 26.7% of India's industrial output and is therefore an effective tool to balance the economy. Over the last four years the infrastructure industry in India recorded a growth rate of almost 8.5%. Now the Indian government has announced further investment in infrastructure in their 12th five year plan (2012–2017), with which substantial growth has grown in the planning of tunnels, hydroelectric projects, storage caverns, metro projects and underground projects within the rail, road, sewage and hydropower sectors. To achieve time bound programmes of construction of mega projects in a period of four to five years, modern methods of rapid tunnel driving are being considered as only solution to achieve a high rate of progress.

We now have bigger and faster drill machines and excavators. In Explosives technology too significant progress has been made towards having safer explosives and accurate initiating systems that have increased overall control over blasting in terms of vibration, fragmentation, throw of basted muckpile and overall blast economics.

The developments have been mainly done in automation and precise drilling techniques. These include automation of the drill rigs, improved design of bits, rods, bit inserts, and the bailing systems.

Underground blasting in India has traditionally been done with packaged explosives. Though packaged explosives have served the industry for decades, they possess safety hazards, slow charging, manual handling, no product flexibility and partial energy utilization due to decoupling. This had compelled blasting engineers and researchers of the eighties to initiate a thought process in search of a system, which would lead to a paradigm shift in underground blasting technology. In the late eighties a few explosives manufacturers came up with their charging systems for underground. These systems had inherent advantages of pumped emulsion explosives like speed and safety, besides introducing a concept of flexibility of product. Product flexibility leads to greater rate of advance and lower damage at the backs for better roof stability.

The electronic detonators specifically designed for tunneling provide the accuracy and flexibility of electronic timing at a reasonable price with rapid and easy operations at the tunnel face.

In this paper, the authors discuss the latest developments which have taken place in explosives, initiating systems and drilling technology for tunneling at a few tunneling and cavern excavation sites for enhanced rate of excavation.

1 INTRODUCTION

Drilling and blasting has been used for centuries to excavate all types of tunnels, whether mining or civil. The drill and blast method of tunneling is preferred over mechanical excavation due to various reasons, like, if the shape of the tunnel is not circular, utilization coefficient of the machines is reduced in cases of poor tunnel stability, high investment costs of the machines and the long

setting up and dismantling times hinder their economic use in short tunnels, in large-diameter tunnels, TBM cannot achieve the same rate of advancement as in small or medium diameter tunnels, and in poor quality ground, the over break caused by the machine is of the same order of magnitude as that caused by explosives.

With fast depleting mineral resources at lower depths and increased demand for alternative resources of power, underground mining and

hydroelectric tunneling activity is expected to experience a boom in the times to come. In both the activities speed is of utmost priority. Any method to increase rate of advance will always be a welcome. With increasing production pressure in underground mines and ambitious commissioning targets for hyro-projects it becomes imperative to search for methods to increase advance rates.

Mechanization had already been introduced in all activities of the excavation cycle like mucking, supporting and surveying but drilling and blasting continued to be done with conventional methods. Thereafter drilling was mechanized with the aid of jumbos with up to three booms that helped drilling longer rounds accurately and quickly with significant manpower reduction. But charging with conventional packaged explosives made it an excessively labor intensive process besides consuming a large part of the cycle time. Though introduction of non-electric initiation systems in the 70s led to faster hook-up, technology uplift in the charging process was long overdue to get a more efficient charging system (Law et al., 2000).

Although bulk explosives in opencast projects in not a new concept, the successful adaptation of the same for blasting in underground excavation was not an easy task. The equipment as well as the product had to be developed to cater to the tough conditions existing underground. The charging equipment had to be compact, robust, reliable and efficient whereas the product had to be high-energy pumpable booster sensitive emulsion. Several explosive manufacturers made an effort develop their own system. But a few succeeded in their ventures. Key problems faced in the initial stages revolved around product stability and equipment reliability. The pioneer in this field was Orica Explosives of Australia (then ICI Australia). Today Orica is the largest and the most experienced supplier of underground bulk emulsion explosives in the world. The advantages of underground bulk system are varied; some inherent while others are application oriented (Ngai, et al., 1997).

2 RECENT DEVELOPMENTS IN DRILLING TECHNOLOGY

Drilling is the first unit operation in mining or excavation process. Basically we have three methods of production drilling namely rotary, percussive and down the hole (DTH) drilling. There are few other innovative methods as well but their applications have been restricted to few areas or are still in experimental stage, like laser drilling, water jet drilling etc.

The developments have been mainly done in automation of the drill rigs, improved design of

bits, rods, bit inserts, and the bailing systems. The following paragraphs will briefly discuss the automation and developments in surface and underground drill rigs.

2.1 *Rapid development*

The rapid development of excavations has been achieved traditionally using latest equipments and techniques in drilling, blasting and ground support. Innovative underground bulk explosives with automated precise drill equipments and faster bolting systems have compelled the construction companies to compete with each other over productivity. They are using the latest in mucking and hauling as well. Presently the rapid development is buzz word in construction community as it provides the advantage of following:

- Less time to complete the project
- Early beginning/mobilisation of excavation
- Time makes or breaks a project
- Reduce fixed cost expenses of project.

Drilling equipment is at its most productive when drilling, hence where geological conditions allow, it is recommended to use longer feeds than are traditionally used in excavations. The longer feeds when coupled with computer control systems, onboard drill plans and accurate positioning systems ensure that a face round achieves maximum pull length. Consistent accurate drilling also contributes to better blast fragmentation, less damage to the surrounding rock mass, potential to fine-tune drill patterns and ultimately safer-faster advance rates. To further improve drilling accuracy there have been several innovations in drill steel design. The traditional HEX 35 rods are losing popularity to round 39 mm steels which provide a much stiffer drill string, of high importance to reduce in-hole deviation when drilling longer rounds. Thread design has also been improved with options allowing longer life and better transfer of percussion energy from the rock drill to the drill bit.

Underground bulk emulsion explosives (Site sensitised emulsion explosives) with its water resistance and reduced noxious gases along with electronics detonators provide flexibility and automation in blasting for faster development. The mucking has been made easy with deployment of large capacity loaders with matching haulage equipment which are having high speed on grade, easy manoeuvring and minimised cycle time. The ground supporting has also been made faster with the use of purpose built mechanised and automated equipment having navigation and logging system.

With the automation of drill rigs it is now possible to make drill pattern and drilling sequence created on the PC in the office and transferred to

the rig using a USB flash drive/stick. If the operator puts the boom in automatic mode it moves to the next hole in sequence, collars and drills the hole automatically. The drill hole data is logged on the USB stick which can be uploaded back in office PC (Mishra & Sen, 2010). Even manual drilling of difficult holes can be done effectively (Sometimes perimeter holes are required to be drilled manually depending on the rock conditions and profile).

The software has been developed by Atlas Copco which has made the job of mining/excavation engineer easy. This software (Tunnel Manager®, a registered trade mark of Atlas Copco.) can be used to design the drill pattern required to match the rock properties, profile of the development heading and explosive properties (Figure 1). The drill plan can be effectively designed along with bolt plan design, tunnel line definition, tunnel laser definition, drill round reports, Measurement While Drilling (MWD).

This software offers various advantages over traditional system of design and implementation. With this Advanced Boom Control (ABC) is achieved. It makes easy boom navigation, good profile, less over break/under break, higher productivity, less time in completion of project, no cost overrun, and of the last project cost savings.

2.2 Measurement while drilling

The technique to extract rock mass properties while drilling is called “Measure While Drilling” (MWD), which can record up to 8 parameters, namely penetration rate, feed force, percussive pressure, rotation pressure, rotation speed, damp pressure, water pressure, and water flow. Today Atlas Copco offers a system for both registration and evaluation while most of the other suppliers provide registered data but do not offer any evaluation. By evaluation of the data we can get an inferred picture of the geological conditions. MWD does not have much of an application for a face blast, as not many people have the time to do a MWD analysis of a drilled

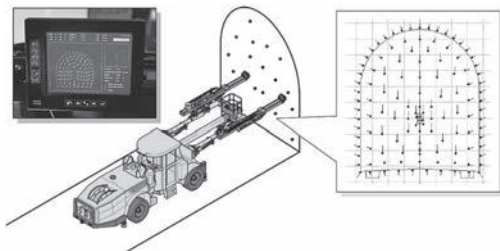

Figure 1. Application of Tunnel Manager® (photo provided by Atlas Copco).

face and then make an adjustment of blast design to take the MWD findings into account. MWD is best employed for probe-hole drilling ahead of a face in order to gain understanding of upcoming geological conditions. This is most useful in tunnelling where we think there could be bad ground—e.g. once bad ground is identified using MWD, the engineers can order pipe-roofing to pre-support the ground before the tunnel face reaches the poor area.

For mining, MWD has applications for long hole production drilling in order to help define ore body boundaries. Hence blast design can be adjusted in order to reduce dilution.

It also reduces the chances of unexpected decrease in pull and over break, hence improves the working safety at the site apart from reducing the extra cost of, loading-hauling, scaling and supporting. This further helps in avoiding the unexpected encounter of difficult rock conditions which can hamper the progress rate or the site safety.

2.3 Rig remote access

Rig remote access is another feature which is gaining popularity. In this system the rig is connected on line with the mine control room and even can be connected to the manufacturer or head office via internet and diagnosis is done before getting down the mine (Figure 2). The rig can also get an update of drill plans without any delay. It offers the following advantages:

- Production planning—The drill rig is always on line
- The drill rig operator has always access to the latest production planning
- Operator—You do not need to update PC-cards before each shift
- Log files will automatically be saved to the planning department
- There is no need for PC-card handling, what so ever
- Maintenance—Service technician can diagnose the problem before travelling to the drill rig

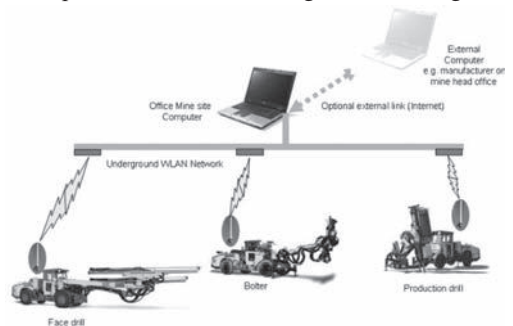

Figure 2. Rig remote access system (photo supplied by Atlas Copco).

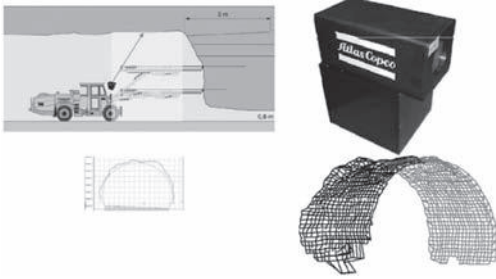

Figure 3. Tunnel Profiler (photo supplied by Atlas Copco).

- Fault diagnoses are easily done on line
- You can plan service based on actual needs.

2.4 Tunnel profiler

Automatic tunnel profiler is also available on the drill rigs which offer great advantage over conventional system of profiling (Figure 3). This presents the following advantages:

- Fast profiling, 5 minutes to scan a 65 m² roof
- Result data, profile and drill log, all combined
- One set-up and navigation only
- Operator is advised about under breaks
- Over break is calculated/presented to the operator
- Reduced need for surveying work
- Scanning while drilling next round and so time is saved
- Change in design of blast round depending on the feedback of profile.

3 RECENT DEVELOPMENTS IN EXPLOSIVES AND ACCESSORIES

3.1 Underground bulk explosives

The concept of bulk explosives started in the 1960s. In India bulk started replacing large diameter packaged emulsion explosives in open-cut mines in the early nineties. Today majority of the explosives used in open-cut mining (coal/non-coal) is bulk emulsion explosives. Total consumption of bulk emulsion in India would be more than 300000 MT. Speed and flexibility is the key benefits associated with mechanized explosives delivery as in the case of bulk explosives.

While the concept of bulk emulsion was becoming increasingly popular in the open-cut projects, its introduction in the tunnelling and Underground Hard rock mining applications stayed a challenge for explosives research scientists all over the world. Orica, Australia (then ICI, Australia) put in a lot of effort in this direction and finally in the mid-1990s came up with a product and delivery system that changed

the way underground blasting was perceived. Like all emulsion explosives this too was an ammonium nitrate based formulation but more robust to perform under tough underground conditions.

3.2 Advantages of underground bulk system

Underground Bulk system has various advantages over the conventional system of underground blasting. These benefits have been established at various underground mines globally. Some of these benefits are listed below:

1. **Faster Charging Rate**—The average charging rate is 30 seconds/hole. This is much faster than the conventional system.
2. **Better Advance**—With Underground Bulk system we can vary the energy over the face area by changing the density. This enables better energy utilization for achieving higher advance per round.
3. **Over-break Control**—Periphery holes are charged with low density, low energy bulk. This results in reducing the over-break.
4. **Better Fragmentation**—Underground bulk explosives is fully coupled inside the hole. This results in better transmission of shock energy and hence better fragmentation which improves the productivity of excavator.
5. **Safer Handling**—Underground bulk is non-explosive in nature until it is charged in the hole. Hence, only non-explosive components are transported, stored and handled before & during the charging operation, which is much safer.
6. **Reduced Drilling**—Due to the fact that Underground Bulk is fully coupled the drill pattern (burden & spacing) can be expanded. This may result in reduction of blast-hole drilling by 10%, which will save on drill factor and cost of drilling.
7. **Less Labor Intensive**—The charging operation is less labour intensive compared to conventional system. Only one blaster & 2 labors are required for charging and blasting.

3.3 Underground bulk emulsion explosive

The technical specifications of typical Underground Bulk Emulsion Explosives manufactured by Orica Mining Services are enumerated below:

Underground Bulk basically consists of two non-explosive components. The primary component is bulk premix (emulsion) that is manufactured at mother plant and transferred through tankers to the site. It is carried to the face where it is mixed with sensitizing solution. This sensitizing solution when mixed with the premix produces gas bubbles that lend the sensitivity to the explosive (Nagai et al., 1997, Ong et al., 2000). The concentration of this solution determines the final density of the bulk explosive.

Table 1. Typical priorities of UG Bulk explosive of Orica mining services (TDS of Civec™ Drive).

Properties	Civec™ Drive				
Density (g/cm ³)	0.8	0.9	1.0	1.1	1.2
Minimum Blast hole dia (mm)	38	38	38	38	42
Typical VOD (Km/s)	4.5	4.9	5.3	5.7	6.2
Relative effective energy					
Relative weight Strength	72	78	85	92	98
Relative Bulk Strength	72	89	106	127	147
Sleep time	7 days				

* REE is the Effective Energy relative to ANFO at a density of 0.8 g/cm³. ANFO has an effective energy of 2.30 MJ/kg. Energies quoted are based on ideal detonation calculations with a 100 MPa cut off pressure.

Hence, by simply varying the concentration of the sensitizing solution we can change the final density of the product. This eases of control over the density of the product & hence over its VOD & Relative Weight Strength allows it to be used for smooth blasting purpose (No et al., 2004).

Underground Bulk can be initiated in blast holes by the means of a small cartridge of packaged emulsion, which in turn is initiated by a detonator.

3.4 Charging equipments

3.4.1 Explosives pump unit

It is basically an assembly of storage bins for the emulsion, sensitizing solutions and water along with two pumps that pump the emulsion and sensitizer at a definite rate & pressure. The unit being used has a storage capacity of 1200 kg of emulsion and 2 sensitizing solution tanks of 40 liters each. The pump has a discharge rate of 80 kg/min with an accuracy of 625 grams. The amount of explosive being loaded can be easily calculated by counting the number of strokes of the pump. Each stroke gives 625 grams. The emulsion and the sensitizing solution being pumped individually pass through a charging hose. Its external diameter and internal diameter are 25 mm and 18 mm respectively. The sensitizing solution forms an outer layer in the hose while the emulsion flows concentrically in the middle. The former also acts as a lubricant for the flow of latter. At the end of the charging hose there is a specially designed nozzle in which both of these products are intimately mixed (Mishra, et al., 2009).

The pump unit can run on compressed air or hydraulically. The required air pressure for the effective operation of the pump is 6 kg/cm³.



Figure 4. UG Bulk charging unit of Orica Mining Services at the face.

Compressed air can be supplied externally as well as by compressor mounted on the charging unit. The compressor mounted on charging unit needs electrical connection to run so it should not be used with electrical detonators. Some water (about 40 liters) is also required for flushing the charging hose before & after actual charging operation.

3.4.2 Information system and integrated control system (ICIS)™

ICIS is registered trade mark of Orica. Basically it acts as the brain of the charging system. Powered by a separate battery it controls the whole system. It records all the pumping and charging information, viz., amount per hole, number of holes loaded, total quantity of explosives loaded, calibration data, etc.

It is housed in a rugged case and has a backlit LCD display that shows critical data of charging & pumping operation. It is provided with buttons that have definite functions.

Prior to the beginning of charging operation data about the charging going to be done is fed. Henceforth, a remote control can be used to control the ISIC & hence the pump.

4 USE OF UG BULK AT VIZAG—A CASE STUDY

Underground (UG) Bulk Explosives was introduced in India by Indian Explosives Ltd at Vizag cavern project in 2005. UG Bulk as expected had beaten all expectations at the site. Not only the system provided a more reliable and safe means of blasting, which is an absolute necessity at the site, but had also helped construction house in significantly crashing the charging time, which was of immense help in significantly reducing the total project completion time.

1. Advance Per Round: The average percentage advance per round in around 450 blasts that had been conducted with UG Bulk had been around 95%, this is in comparison to around 70% average advance which was being achieved with conventional system before introduction of UG Bulk at the site.
2. Charging Time: Average charging time had been reduced by 60% with UG Bulk as compared to the conventional system.
3. Half- Barrel Factor: A half-barrel factor of more than 75% had continuously being achieved not only in the cavern heading but also in the water curtain galleries, which enabled in effectively meeting the stringent project requirement while with conventional system it used to be around 25%.

5 DEVELOPMENTS IN INITIATING SYSTEM

5.1 Introduction

The history of developments in explosives initiation systems are described in Table 2. The first initiation system was a trail of gunpowder filled in goose quills. This was the precursor of safety fuse. First detonator was patented by Alfred Nobel in 1861. Plain detonator with safety fuse gave a degree of control in blasting but that was not enough. The blaster had to light the fuse and run—not knowing exactly when the shot would go off.

Electric fuse head inside the detonator provided safety and improved control; the blaster could go to safety of a shelter and knew the shot would go off as soon as he pressed the fire button. Blasters soon realized that firing all the rows together in a multi-row blast was not a good idea. This led them to put a small piece of safety fuse between electric fusehead and the primary charge in an electric detonator. That was the first delay detonator. Multiple rows in a blast could now be connected together but fired in sequence depending on the length of safety fuse inside the electric detonators. However it only ensured a sequence in firing. There was no real control on delay time. Blasters by now had realized that rock breaking was a very fast phenomenon and real control required delays of only a few milliseconds. So the safety fuse inside delay detonators was replaced by a fast burning chemical powder column enclosed in a lead tube.

Pyrotechnic powder delay technology has improved very little since then. All delay detonators today contain a column of pyrotechnic powder enclosed in a lead tube, placed between the fuse head (or shock tube) and the primary charge in a detonator. Delay interval is determined by the speed of burning of the powder and its length. Attempts at improving the accuracy of delay timing has led to manufactur-

Table 2. Summary of initiator developments of Explosives.

Initiation system	Year of Introduction
Goose quills	Prior to 1831
Safety fuse	1830's
Plain detonators	1861
Instant electrics	1870's
Delay electric detonators	1900's
Detonating cord	1907
Signal tube	1970's
Electronic delays	1980's

ing techniques which provide more control on length and burning speed of the delay element. But the technology has inherent limitation. Best of manufacturing practices anywhere in the world have not made pyrotechnic delay detonators of better than + or – 1% accuracy on commercial scale consistently.

In the meanwhile digital electronics technology has gone through a revolution. Control of events with microsecond accuracy is easy and common using digital electronics. The real challenge for developers of explosives initiation systems lay in incorporating suitable digital electronics in the small space in a detonator and making it work safely and reliably in the harsh environment of use. Several attempts at electronic detonators were made in late eighties. However it was only during mid-nineties that the commercial electronic detonators became available to the blasting community. Today there are several manufacturers of electronic detonators worldwide. The technology of electronic detonators is still evolving. There are many variants available today—not all are same (Worsey & Lawson, 1983. Watson, 2002, Ruston, 2002).

5.2 Construction of electronic detonator

Figure 5 shows the basic components and design of a typical shock tube detonator, electric detonator and an electronic detonator. Note the location of the igniter (bridge) in the electronic detonator versus the location in the electric or shock tube device. The igniter in the electronic design is positioned below the delay (timing) module, whereas both the shock tube detonator and the electric detonator utilize the igniter ahead of the delay module (shock tube functions as the igniter in the shock tube device). The electronic detonator design also differs from the other two with the use of some type of stored (electrical) energy device, typically a capacitor, in the delay module(s).

The basic design differences of an electronic detonator, coupled with the system level differences from one manufacturer to the other, make it essential that users of these products become fully educated on the specific detonator, equipment, operational

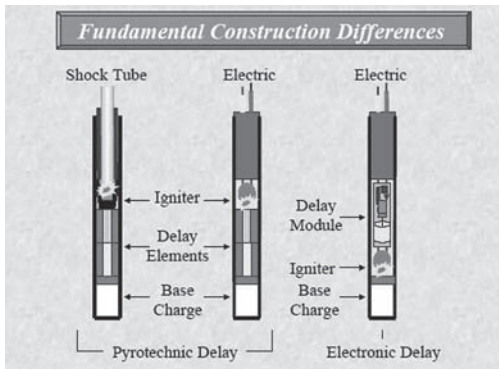

Figure 5. Construction of Electric, Shock-tube & Electronic Detonators © IME 2002.

limits, procedures, applications and guidelines outlined by each manufacturer prior to use.

5.3 Benefits of electronic detonators

It has been found that electronic detonators offer the following advantages:

- Inherent safety—with built in protection from static electricity, stray currents, radio frequency and high voltage (Cunningham, 2004).
- Electronic detonators can be programmed to fire at any time from 0 ms to 8000 ms in steps of 1 ms, which makes it possible to select the best delay time between holes and rows to suit the particular characteristics of each blast, rather than having to choose from set numbers such as 17 ms or 25 ms.
- A factory-programmed security code unique to the operator that will provide more security and prevent unauthorized use.
- Interactive facilities with full two way communication ability—as well as being programmed and armed by the system for checking the status of the detonator and making a circuit check before firing.
- The reduced delay and accuracy of the electronic detonators result in improving the fragmentation in surface mining with a reduction in the upper size classes (oversized material) and the fines, which in turn slash down the power consumption significantly in the primary and secondary crushers as well as total throughput, (Bosman et al., 1997).
- Electronic detonators improve face advance and provide safe working environment as it reduces the over break in tunnelling.
- The possibility of having a presplit effect in the blasts if delay timing between holes using the shock tube initiation system below 11 ms can be overcome with the availability of short delay electronic detonators (Grobler, 2003).

- Reduced stock management—as electronic detonators are programmable, only one type of detonator is required to be stored in the magazine.
- The absolute accuracy of electronic detonators ensures each blast hole fires exactly when it is supposed to fire. All mines, which have used electronic detonator, have witnessed 10% or more relative improvement in casting.
- By selection of proper delay timings, blast vibration energy can be channeled such that predominant energy falls into higher frequency range and so it offers a tool for vibration control and frequency channeling (Song & Kay, 2007).
- The flexibility of selecting the timing of holes offers blast designer to create separate muckpile of different grades to get ore and waste separation by re-establishing relief at any stage of progression of blast (Brace, 2004).

5.4 Electronic detonator for tunneling

The eDev™ system is an electronic blasting system developed by Orica Mining Services specifically designed for tunneling; providing the accuracy and flexibility of electronic timing at a reasonable price with rapid and easy operations at the tunnel face (TDS of eDev) which is available in India.

The new “time by numbers” feature and SHOTPlus®-T software allows blasters to operate in a familiar way with the great convenience of all detonators being the same. eDev™ offers the users significant reduction in inventory logistics and costs.

Electronic timing has been shown to drastically reduce vibration in tunnels, allowing as much as twice the mass of explosive per delay or per hole. This can lead to great increases in advance per round.

Advance per round is also improved simply due to (a) better accuracy (b) a wider choice of delay schemes, and (c) guaranteed in-sequence firing.

In some circumstances overbreak control—limiting the amount of material to be hauled and/or limiting the amount of concrete lining needed, can be the most significant benefit.

The System components include

- eDev™ Detonator
- eDev™ MC9090 Scanner
- Network Tester
- Blast Box BB310 and BB610
- Harness wire.

Features of the system include following:

- Simple and easy to operate
- Easy to learn
- Fully programmable detonators, in 1 ms increments upto 10 seconds
- Accurate electronic delay timing
- Rugged construction.

Advantages of the system are as following:

- Better control of blast induced vibrations
- Better overbreak control
- Enhanced pull
- Easy inventory control
- Design, simulate and optimise tunnel blast designs using software.

6 CONCLUSION

Globally Drilling and blasting technology has been an area of keen interest and is improving very fast. Products like digital drilling and drill navigation systems have given mining companies the space to operate for better productivity and efficiency. Rapid development is buzz word among the mine operators and construction companies. The emphasis is on technological up gradation and automation of drilling and blasting. Blasting is an integral part of tunneling and construction industry. Apart from the performance, the blasting should also satisfy the requirements of environmental thresholds set by organizations in terms of reduction in ground vibration, air blast etc. With the efforts of many researchers and scientists at last a flexible and accurate underground bulk delivery system is available with blasting engineer. It has been observed that UG Bulk improves the blasting performance for underground operations. The accuracy, precision, flexibility and methodology of UG Bulk offer enhanced safety and improved productivity. Here, the flexible UG Bulk delivery system allows for the development of flexible operations with solutions to the mining and construction industry. With underground bulk explosives introduced in the Indian construction industry, underground blasting has been redefined. It is proven that when bulk explosives replace both packaged explosives as well as ANFO there are significant production benefits that cannot be ignored. The leading edge electronic detonators are additional armour available with blasting engineer to harness the benefits of flexibility, productivity and ease of operation. Now the ball is in the court of the Indian mining and civil construction community to reap the benefits of this well established technology.

REFERENCES

- Bosman, H.G., Bedser, G. & Cunningham, C.V.B. 1997. Production Blasting with Electronic Delay Detonators at Peak Quarry, Institute of Quarrying of South Africa, South Africa.
- Brace, S. 2004. Electronic Detonator and Initiation Systems—Implications of the Dominant Design for Widespread Acceptance and Sales of this ‘New’ Technology, Proceedings of the Thirtieth Annual Conference on Explosives and Blasting Technique, New Orleans, Louisiana, USA, 1–4, February, 2004:International Society of Explosives Engineers, Ohio, USA.
- Cunningham, C. 2004. Electronic Detonators: Growing Success in Transforming Rock breaking, Proc of Intl Conf on Expl & Blasting Tech, ISEE.
- Grobler, H.P. 2003. Using Electronic Detonators to Improve All-Round Blasting Performance—Fragblast, 7(1):1–12.
- Law, T.M., May, J., Spathis, A.T., du Plessis, A.T. & Palmer, T. 2000. Blast damage and blast dilution control: The application of bulk emulsion systems at the WMC St Ives Junction Mine. Int. J. Rock Frag. Blasting, 5, No 1–2: 1–20.
- Mishra, A.K., Rao, K.V.R. & Tripathi, A. 2009. An Innovative tool for Rapid Excavation of Tunnels and Caverns—Underground Bulk Explosives, Proc. Of International Symposium on Rock Mechanics & Geo-Environment in Mining and Allied Industries, IT, BHU, Varanasi, 12–14th Feb, 2009: 200–207.
- Mishra, A.K. & Sen, A. 2010. Innovations in Production drilling Technology, Proc. of National Seminar on Drills & Drilling—An Update, September, 23–24, ISM.
- Ngai, W.C.T., Scovira, D.S. & Kennedy, B.J. 1997. Chemically sensitised bulk emulsions and pump systems used in Hong Kong civil works. Proc. 13th Ann. Symp. Expl. Blasting Res., February 2–5: Las Vegas.
- No, S.L., Moon, S.H., Jo, Y.C., Lee, S.P. & Yu, J.Y. 2004. The construction of long and large tunnel using bulk explosives’ Journal of Korean Society & Blasting Engineering, Vol.22 No.3: 65–70.
- Ong, P.F., Myklatun, M., Yeung, C. & Labriola, A. 2000. The use of bulk emulsion explosives at the Mandai underground storage caverns. Int. Conf. on Tunnels & Underground Structures, November 26–29: Singapore.
- Ruston, P.A. 2002. Blasting Technology Research and Development in the 21st Century, Proceedings of Seventh International Symposium on Rock Fragmentation by Blasting, Beijing, China, Metallurgical Industry Press.11–15, August,2002:10–16.
- Song, Y.S. & Kay D. 2007. Civil tunnelling with electronic blasting systems—Early experience. Underground Space—the 4th Dimension of Metropolises. Taylor & Francis Group, London, ISBN 978-0-415-40807-3: 1071–1077.
- Technical Data Sheet of eDev™ Detonator, eDev™ Electronic Tunneling System, www.Oricaminingservices.com.
- Technical Data Sheet of Civec™ Drive, www.Oricaminingservices.com.
- Watson, J.T. 2002. Developments with Electronic Detonators, Proc. of Intl Conf on Expl & Blasting Tech, ISEE.
- Worsley, P.N. & Lawson, J.T. 1983. The Development Concept of the Integrated Electronic Detonator, Proceedings of the First International Symposium on Rock Fragmentation by Blasting, Lulea, Sweden: 251–258.

Blasting works in urban areas—A Singapore case study

F.I. Manolas & T. Arusu

Asia Tunnelling & Construction Pte Ltd., Singapore

ABSTRACT: The Downtown Line (DTL) Stage 2 Project is a fully underground Mass Rapid Transit line (MRT) currently under construction in Singapore since mid-2009. When completed, the DTL will connect the north-western regions of Singapore to the city centre. It totals 16.6 kilometers in length and includes 12 underground stations, running under some of the busiest urban corridors within the city and densely populated residential areas. The majority of the line was constructed using Tunnel Boring Machines (TBMs) whilst Drill and Blast (D&B) method was employed in some areas. The project sites generally presented numerous challenges, not least in the great variability of the ground, with tunnelling carried out in all the geological strata present in Singapore, ranging from soft marine clay, through tropically weathered rocks, to fresh granite.

Employed by main contractors for most of the station contracts, Asia Tunnelling Construction Pte Ltd's (ATC) role in this project was to carry out blasting of the rock profile in the access shafts and the train stations. This paper discusses the rock blasting process followed by the evaluation of blast performance at two sites which was key to managing vibration levels and eliminating/minimizing fly rock incidents in such sensitive areas. In this paper, the risk management strategies of the blasting process are examined in detail and key success factors are highlighted.

1 INTRODUCTION

Singapore, a modern city-state with small footprint, has been rapidly developing in recent years. Residential areas are growing around at fast pace away from the crowded city centre and are connected mainly by expressways which are often bogged down by heavy traffic congestion at peak hours at interchanges near the city centre fringes. Providing the people with safe, efficient and comfortable means of public transportation has been the cornerstone of Singapore Government's land transport strategy (LTA, 2010). It is the Government's vision to make the rail network the backbone of Singapore's public transport system. The need for better connectivity and faster and effective public transportation around the island led to expansion of the MRT network (see Fig. 1). The MRT lines going underground are the most viable option for Singapore.

The Downtown Line (DTL) will be built in three stages, with Stage 1 to be completed in 2013, Stage 2 to be completed in 2015 and Stage 3 in 2017. When fully completed, the DTL will enhance the connectivity of the MRT System network and facilitates direct travel from the north-western and eastern areas of the island to the Central Business

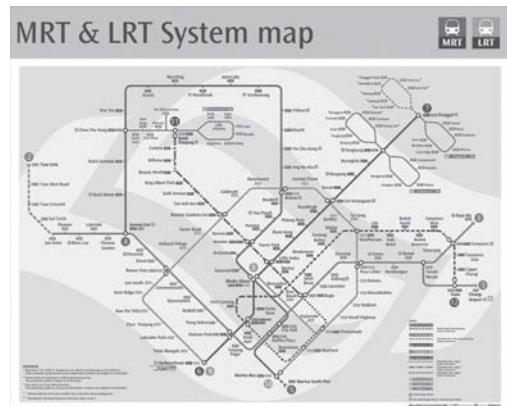

Figure 1. Map of Singapore's Rail System Network (LTA, 2010).

District and the Marina Bay. The DTL is projected to see a daily ridership of more than half a million when in full operation. For commuters, the DTL will offer significant savings in travelling time.

From geological approach Singapore has the ability to take advantage of the good underground conditions seen at the island, especially at the

center and North-western end of the island where the rock mass is characterized as good or very good due to the presence of granite and gabbro. The majority of the Downtown line runs into the Bukit Timah granite which is excavated mostly by Tunnel Boring Machines (TBMs) and secondary means by Drill and Blast (D&B) method. However, for the access shafts and the stations, which most of them are lying on bedrock, are excavated by D&B. The mechanical properties of the Bukit Timah granite are mentioned in Table 1.

The Land and Transport Authority of Singapore (LTA) awarded several construction contracts that required considerable amounts of blasting to excavate rock along the DTL. These blasting works are in both commercial and residential environments where the ground vibrations and fly rock could not only be a nuisance, but could also cause damage to facilities if blast charges and delay timing were such as to cause ground vibrations in excess of acceptable limits or any fly rock incident.

Table 1. Mechanical properties of the Bukit Timah granite.

Type	Description	Cohesion (kPa)	Friction angle (°)	UCS MPa
G-I	Fresh	500	50	92
G-II	Slightly weathered	500	50	85
G-III	Moderately weathered	300	45	55
G-IV	Completely weathered	50	40	12
G-V	Completely weathered	3	31	–
G-VI	Residual soil	3	30	–



Figure 2. Singapore's residential areas are highlighted. The DTL Stage 2 line stations are shown on the map.

2 BACKGROUND—TUNNELLING IN URBAN AREAS

Ground vibrations are a significant factor when considering tunneling, shaft and stations construction activities such as rock blasting operations, especially in urban areas. These activities create the potential for real damage to surrounding building structures and facilities, as well as a perceived damage from human sensitivities to detectable yet non-damaging ground motions. LTA practice has typically involved the use of specifications requiring the contractor to monitor the vibrations around the construction site.

The main object of this paper is to present the risk management of blasting process in an urban area by evaluating the blast performance in residential areas by case studies carried out by Asia Tunnelling and Construction Pte Ltd. Vibration levels were kept within strict low levels and fly rock incidents were minimized to minimum while the blasting activities produced the required excavation per day successfully and within the tight construction schedule.

2.1 Drill and blast method

Tunnelling can be carried out by mechanical methods, such as tunnel boring machines and road headers, or the conventional drill-and-blast method. The choice of method depends on site geology and project-specific conditions, such as the length and cross-section of the tunnel. The drill-and-blast (D&B) approach is suited for hard rock and complex geometric layout of the facility such as shafts, train station and cross passages.

D&B is still considered to be the most economical method for rock excavation either on surface or underground. The explosive energy, which breaks the rock mass, is not fully utilized for this purpose. Only part of explosive energy is utilized for fragmenting the rock mass and the rest is wasted in the form of ground vibration, air blast, noise, fly rock, back breaks, etc.

2.1.1 Ground vibration

Ground vibration is considered to have the most damaging effect by causing damage or being objectionable to the public. Ground vibration control is particularly important in urban environments but prediction is difficult to accomplish because it is influenced by a number of parameters. These parameters are either controllable (blast geometry, explosives types, etc.) or non-controllable (rock properties, joint patterns, distance from blast to source, etc.).

Ground vibration is directly related to the quantity of explosive used and distance between blast

area to monitoring point as well as geological and geotechnical conditions of the rock units in excavation area. Blast geometry plays a very crucial role for control of ground vibration. As rock is a non-homogeneous medium, it is hard to predict vibration measurements.

With a given explosive charge and a given distance, the intensity of vibration can be estimated using scaling laws. Most commonly, the square-root scaling law is used, which says that the intensity of the vibration is a function of the square root of the charge, W . The most important vibration parameter is the Peak Particle Velocity, V (PPV).

$$PPV = Kx \left(\frac{D}{\sqrt{w}} \right)^{-n} \quad (1)$$

where PPV = predicted peak particle velocity (mm/s); D = distance from explosive source to point of interest (m); W = instantaneous charge weight (kg); K and n = site-specific constants defined by regression.

The quantity D/\sqrt{W} is called the scaled distance and K is the peak velocity at a scaled distance of one. The quantity K varies with blast characteristics, confinement and geologic environment. A typical range for K is 100 to 800. The power n can vary from 0.75 to 1.75; it is often taken as 1.60.

Causes of ground vibration and prevention measures are summarized in Table 2.

2.1.2 Fly rock

Also, among the main and direct effects of blasting operations, fly rock is the most serious safety hazard, which can cause injuries or even death to those being inside, near or in the wider area of the blasting site without neglecting the hazards due to damages, malfunctions and disorders that fly rock might cause to structures, facilities, equipment, etc. Such hazards are caused by mostly controllable

Table 2. Causes of ground vibration and prevention measures.

<i>Causes</i>	
Maximum charge per delay	
Distance between blasting site and monitoring point	
Geological conditions (ground compact, rock properties)	
Blast design parameters (stemming, spacing, free face)	
Site conditions	
<i>Measures</i>	
Proper delay pattern	
Apply control measures (relief holes, line drilling)	
Proper blast design and implementation	
Sufficient stemming length	
Well trained and skilled staff	

Table 3. Causes of fly rock and prevention measures.

<i>Causes</i>	
Geometry of blast design	
Type of explosive and charge weight per delay	
Method of charging technique (location of primers)	
Drilling of blast hole (angle, accuracy)	
Inadequate stemming (material, length of stemming)	
Insufficient delay timing and pattern design	
Geological conditions (rock mass properties)	
<i>Measures</i>	
Proper delay pattern	
Proper stemming	
Proper blast design and implementation	
Safety zone area marked before blasting	
Covering and protecting (overburden, rubber mats, etc.)	
Well trained and skilled staff	

parameters (blasting face, stemming, charge weight per hole, blast protection system, etc.) and non-controllable (rock properties, site conditions, joint patterns etc.).

Fly rock mainly depends on the blast design parameters and secondary on geological conditions. Flying rock can either come from the face or the stemming of the blast hole or even from both at the same time. Causes of fly rock and prevention measures are in Table 3.

3 CASE STUDY 1

3.1 Blasting operation at DTL 2—C918 site

This case study is about the construction of the TBM launching shaft for Tan Tah Kee Station, Singapore (Contract 918) by drill & blast operation. Tan Tah Kee Station is one of the 12 stations of the MRT Downtown line 2 projects and Alpine Bau GmbH is the main contractor.

Upon completion of the S4 strutting works which constitutes part of the Earth Retaining Stabilizing Structures (ERSS), bedrock which was already anticipated had to be removed by controlled drill & blast operation in order for the TBM to launch its journey towards contract C919. The launching shaft excavation had hit rock at a depth of 13 m below the ground level and another 10 m had to be excavated in order to reach the final depth. Some earlier delays of the project made the urge for quick construction of the shaft a necessity, so the options of rock splitting or chemical breaking were quickly eliminated.

The blasting area was located in close proximity to a junior College and Bukit Timah road with Duchess Road, sub-station and canal situation just outside the boundary of the construction site. Blasting a large volume of rock in such a sensitive

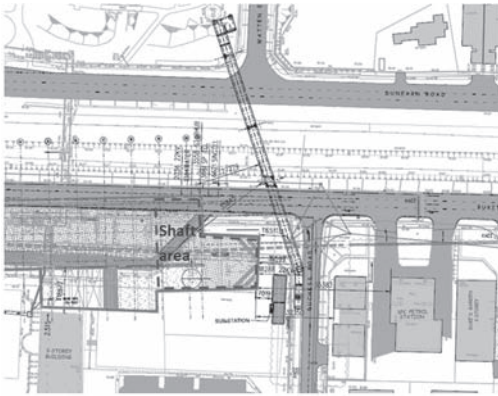

Figure 3. Plan view of Tan Tah Kee TBM launching shaft.

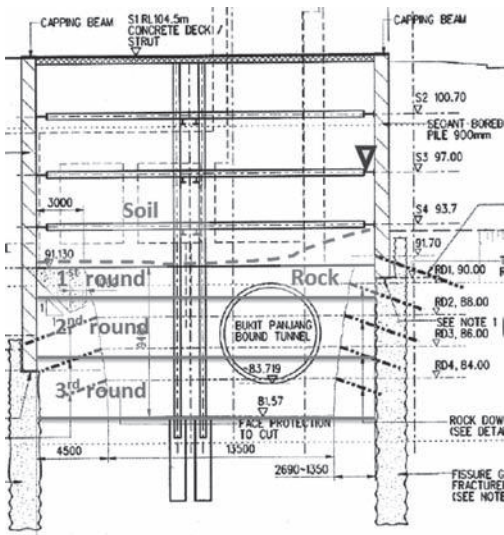

Figure 4. Section view of the shaft.

area in a short period of time whilst ensuring public safety had its risk. Nevertheless the challenge was undertaken after an extensive risk analysis study and trial blast.

The concerns about ground vibration and fly rock due to limited distances from the roads, the pedestrian side walk, the buildings and structures were a challenge for safe and efficient blasting. Of course, the ERSS had to be taken under account as the secant bored pile wall, kingpost and the struts that support the shaft construction could not afford to be affected by the blasting procedure.

The main objectives were to keep the vibration levels below the limit of 15 mm/sec and eliminate

any fly rock incidents which could result in traffic discontinuation and even possibly cause damages on the road deck. In addition the rock fragmentation had to be sufficient and easy to muck without further actions like rock splitting which would delay the whole blasting cycle and the shaft excavation in general.

3.2 Blast design

The total excavation volume was in a range of 7000 m³; the rock excavation depth being 12–14 m.

The total blasting area was divided into smaller blasting areas which would have maximum 30 blast holes each depending on the location of each blast. The main aim is to keep the blast at each excavation level to a minimum so that the maximum charge weight per delay is within acceptable limits to avoid high vibrations to surrounding structures and buildings. Furthermore, to ensure that the structures are not subjected to heavy impact from the blasting, the blast direction was designed away from these structures of concern. In other words, the direction of blast should always be facing away from the temporary structure. By allocating the delay sequence of the initiation, we can allow the blasting to be directed away from the structures. Thus, it minimizes the stress induced on the temporary structures. We incorporated the last line of defense with the relief hole drilling and the minimum separation distance from the structures.

The mucking starts concurrently after 2–3 rounds of blasting for the proposed excavation level. This facilitates the overburden backfilling to be recycled as the site conditions usually do not allow the import of soil due to lack of space and time. Using the recycled soil backfill from the previous blast is more practical and time saving. This sequence facilitates the mucking works without hindering the flow of the blasting cycle.

The drilling was done mainly by pneumatic rigs vertically with a small angle towards the free face and the spacing between blast holes was 1.2–1.4 m. The blast hole diameter was 64 mm (or 32 mm depending on locality and constraint for the drill rigs to maneuver) and the blast hole depth would be 2.7 meters for a start and has since progressed to 4 m per round. The blasting column charge was between 0.9 m to 1.1 m and the rest of the hole was stemmed. The powder factor was between 0.45–0.60 with a usual charge weight around 2.5 kg using both primers and ANFO. An electrical circuit was used for initiating the charges. The blast design differed depending on locality but was generally under the same plan taking always in mind the rock fragmentation and the shaping of the shaft without damaging the secant bored piles. (Ref to Fig. 5 & Table 4)

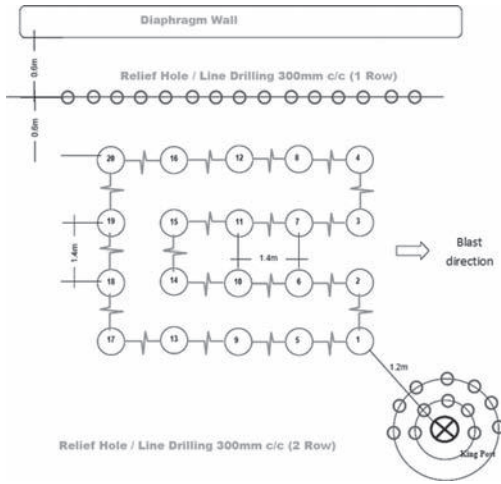

Figure 5. Typical blast design pattern.

Table 4. Blasting design details used in C918 project site.

Blast details	Round 1	Round 2 & 3
Number of blastholes	20	20
Diameter	64 mm	64 mm
Spacing	1.4 m	1.4 m
Depth	2.7 m	4.0 m
Stemming length	1.6 m	2.0 m
Charging column length	1.0 m	2.3 m
Charge weight per delay	2.5 kg	6.0 kg
Blast volume	95 m ³	165 m ³
Powder factor	0.53	0.70

3.3 Monitoring & instrumentation

3.3.1 Ground vibration monitoring

To collect and analyze the blast vibration data, three blasting seismographs and analysis software were acquired. Each seismograph consisted of a 3-axis velocity transducer, an air over-pressure transducer, a data acquisition and storage device. The blasting analysis software provided features for graphical output of the wave forms in each of the three axes and comparison of the measured peak particle velocities and frequency content with various accepted standards. Each transducer measured velocities on three mutually perpendicular axes (V_x , V_y , V_z) corresponding to a longitudinal, transverse and vertical component. The data acquisition equipment simultaneously recorded each geophone, in digital format, time-domain data for each of the three mutually perpendicular axes at each of the four radial distances.

3.3.2 Fly rock monitoring

Fly rock monitoring can only be done by video recording and post-blast facts and findings. A video camera was used to record all the blasts at the site.

3.4 Additional measures

Additional measures such as line drilling, overburden backfilling and electric detonator circuit system were adopted for better results and safety reasons.

3.4.1 Line drilling

To prevent damaging the earth retaining stabilizing structures and avoid high vibration values, line drilling (relief holes) were drilled in areas close to the ERSS which is usually 0.6 m away from the secant bored piles. The drill length was 10% more than the blast holes or similar with a diameter of

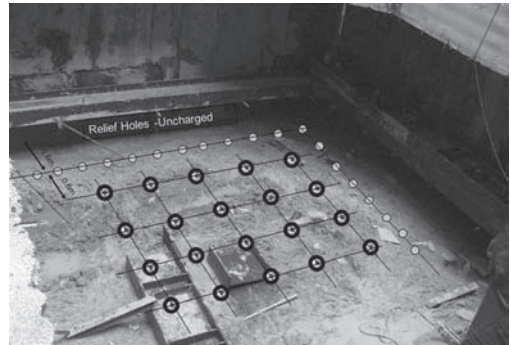

Figure 6. Schematic view of blasting design with relief holes close to diaphragm wall and struts in a TBM shaft.



Figure 7. Overburden, geotextile and rubber mats as additional measures for fly rock prevention.

Table 5. Pre-blast predicted PPV vibration levels.

Distance from blast	Explosive charge weight				
	1.0 kg	2.5 kg	3.5 kg	5.0 kg	6.0 kg
	Predicted vibration levels PPV (mm/s)*				
2.5 m	161.58	336.31	440.20	585.56	677.51
5.0 m	53.30	110.94	145.21	193.16	223.49
10.0 m	17.58	36.60	47.90	63.72	73.73
15.0 m	9.19	19.13	25.04	33.31	38.54
20.0 m	5.80	12.07	15.80	21.02	24.32
25.0 m	4.06	8.45	11.06	14.71	17.02
30.0 m	3.03	6.31	8.26	10.99	12.71

*The calculations are based on a K value of 700.

64–76 mm. The use of line drilling has been effectively used in several blasting projects and the main functions of these relief holes are to act a buffer or vacuum to deter and control the percentage of back-break from a blast detonation. These holes are drilled to act as isolation point from the main blast and will not be charged with explosives and merely act as a separation point from the main blast area. On completion of these relief holes, the production blast holes are drilled away from the line drilling holes. In theory, we have approximately 1.2 to 1.5 m of no blast-zone from the key structures.

3.4.2 Overburden/backfilling

Fly rock prevention was dealt with by backfilling the blasting area with earth creating an overburden (1.5 m to 1.8 m) and covering it with rubber mats and geo-textile material. With this measure blast fragments are contained within the intended area using soil or blast debris from previous blasts as a safety shield and also to control blast overpressure, which is usually muffled within the overburden during the blast.

3.4.3 Electric detonator system

Using an electrical circuit benefited in the long term as all blasts were fired without problems like misfires. All charged boreholes were wired up in series and tested with an ohm meter. The blasting initiation was given by an electrical circuit for two reasons. To make sure that the circuit would not be cut while adding the overburden over the blasting area and to control and identify any misfires.

3.4.4 Pre-blast estimations-expectations

All Downtown line projects have very strict blasting regulations. Unused explosives cannot be stored at site and therefore the correct amount explosives

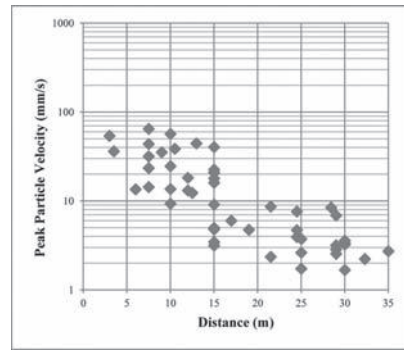

Figure 8. Recorded PPV values.

and detonators have to be ordered at least two days before. This practically means that blasting operations are only allowed between 10am to 6 pm. The allowable Peak Particle Velocity (PPV) is 300 mm/sec for the ERSS and 15 mm/sec for residential buildings and buried utilities. Before each blast an estimation of the expected vibration was calculated. Due to the flexibility of the K constant, the vibration is estimated by using a value of 700 which is a reasonable and accepted value for the area based on experience from previous blasts in the area.

3.4.5 Results

The blast reports proved the adoption good blasting design and prevention measures. The actual vibration values were smaller than the estimated ones and no fly rock incidents occurred through the blasting procedure. The blast fragmentation was also in acceptable sizes and the whole operation was carried out successfully.

4 CASE STUDY 2

4.1 Blasting operation in DTL 2—C916 site

This contract is for the design and construction of beauty world station and associated tunnels, and the station will also double up as a civil defense shelter. The main contractor on this project is McConnel Dowell SEA P/L.

Located along upper Bt Timah Rd (off Jalan Jurong Kechil), this site (see Fig. 9) sits amidst one of the most congested environment with popular local eating retreats and busy shopping centers, condominiums and continuous flow of human traffic.

Drilling and blasting beneath this urban jungle was no easy feat taking into consideration that the rock volume to be removed is nearly 60,000 m³. To make matters even challenging, blasting was required just beneath the twin storm water



Figure 9. Beauty world station location.

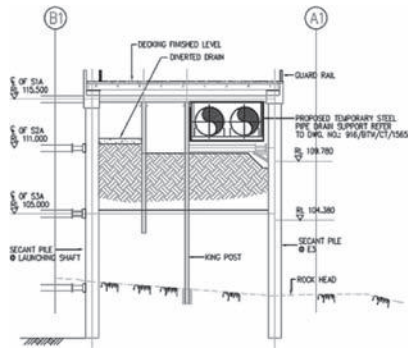

Figure 10. Section view of the shaft.

diversion pipes which runs through the station box (See Figs. 10 & 11).

The other challenges were the proximity of blasting to the existing kingpost, secant bored piles, struts and other existing services running parallel to the station box (see Fig. 12), not to mention the heavy human & vehicular traffic just above the blasting area.

Safety was the topmost priority during the blast and public awareness on the blasting program was made known to residents and tenants to keep them informed on the daily blasting activity. With traffic and pedestrian control well managed during the blast, no incidents have thus been recorded.

4.2 Blasting design

The total excavation volume was in a range of 60,000 m³; the rock excavation depth ranged from 6–15 m.

The total blasting area was excavated by bench blasting technique to reach the final depth. The need for maintaining the good schedule by the main contractor led to 3 to 4 blasts per day resulting to over 8,000 cubic meters per month in a high residential and populated area.

The blasting design used was similar to that discussed in the previous section. In this case, emphasis

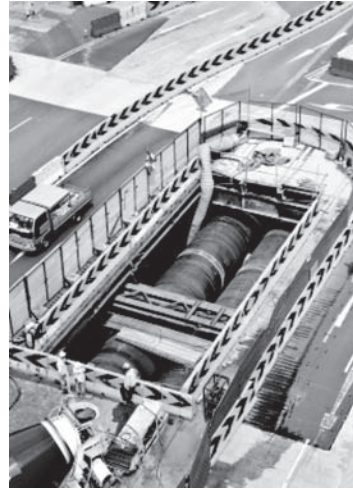

Figure 11. The twin storm water diversion pipes (aerial view).



Figure 12. The twin water pipes just above the blasting area.

is given to the blasting details for the rock excavation near the twin water pipes (see Figs. 11 & 12). The blast details were generally as the ones used in C918 and are shown in Table 4 under round 1.

5 DISCUSSION

It is important to understand that blasting risk management starts before the blasting works take place on site. Engineers and planners must ensure that the blast design is practical. Generally, despite the challenging nature of the blasting works in the urban areas, the rock blasting works were carried out safely and efficiently. A huge amount of rock was excavated and transported off in a very short time.

Following the successful completion of this Drill & Blast works mentioned in the case studies

for the DTL projects, some of the lessons or conclusions may be summarized as follows:

- The design process was generally successful and effective in addressing the concerns of all parties involved in the project. The blast designs adopted for the respective sites were reasonably suitable for the actual ground encountered during construction with some modifications as expected.
- Blasting operations in urban areas can be effective and safe given a well prepared blast design and blast safety system.
- The developed design of incorporating the additional measures of line drilling and overburden enabled safe blasting and restricted environmental hazards as fly rock and lower vibration with minimal disruption to the residents' daily routine and undisturbed traffic flow.
- The instrumentation and monitoring plan was necessary for this kind of blasting works where the impact on the live traffic is critical. The monitoring results indicated that the ground movements were within the acceptable range.
- Vibration values are kept low and within limits when suitable precautionary measures in place and the explosives distribution per round is strictly followed.
- Relief holes near structures prevented damages by vacuuming the blasting energy and controlling the vibration levels.
- Deeper holes were drilled with increased charge weight to determine the parameters of blast vibration and to reduce the number of blast per round of excavation. The outcome of the vibration results showed that the actual readings were far lesser than the predicted values. With the trial blast results, deeper holes were drilled which resulted in better production and cycle times.
- Trials are imperative to determine the K values (site constant), which is always a subject of great discussion. Without trials and numbers based on estimation of site constant can result in lost time and longer cycles for blasting.
- Blasting towards a free face or towards an unmucked blasted zone has a great influence on the vibration as well.

6 CONCLUSION

The paper discussed the rock blasting process of 2 DTL case studies followed by the detailed evaluation of the blast design and performance which was pivotal in managing vibration levels and eliminating/minimizing fly rock incidents in such sensitive areas. It also examined the risk management strategies of the blasting process and highlighted the key success factors.

All proposed stations along the DTL 2 had a lot of similarities coming to the rock excavation part. Having practically the same geological formation and most of them a significant amount of rock volume it was expected to have more or less the same blasting design in all sites with small differences depending on site conditions and challenges. Another common point among the stations was the locality as all of them were in residential areas, under or next to the Bukit Timah Road and buildings were usually in close range. Therefore, the risk management was on the same basis for all the sites.

The challenges faced in this project were multi-faceted due to the scale and complexity of the project, with numerous stakeholders involved. Opportunities for overall improvements in efficiency and process optimization were seized through innovation and active collaboration established among stakeholders of the project. Thanks to the fact that the improved basis for planning is incorporated in the blasting process, risks of damage and other potential dangers were identified prior to their occurrence and the construction measures were further optimized. With proper planning and blast design consideration as well as stringent control measures, the rock blasting works were completed with little impact to the nearby infrastructure.

ACKNOWLEDGEMENTS

ALPINE Bau GmbH (Singapore Branch); McCONNELL DOWELL South East Asia Pte Ltd (Singapore Branch); Land and Transport Authority of Singapore (LTA_P918); Land and Transport Authority of Singapore (LTA_P916).

REFERENCES

- Blasters' Handbook, Orica Mining Services Australia/Asia, July 2010. Department of the army U.S. Army Corps of Engineers "Engineering and Design Tunnels and Shafts in Rock" Chapter 5 EM 110-2-2901.
- Baliktsis, E. and A. Baliktsis "Flyrock risk prevention – from theory and ideas to a perfectly applied blasting project.
- Egan, J., Kermod, J., Skyrman, M. and L. Turner "Ground vibration monitoring for construction blasting in urban areas", CALTRANS, Apr. 2001.
- Nicholls, H.R., Johnson, C.F., and Duvall, W. I. "Blasting Vibrations And Their Effects on Structures," U.S. Bureau of Mines Bulletin 656, 1971.
- Oriard, Lewis L. "The Effects of Vibrations and Environmental Forces (A Guide for the Investigation of Structures)." International Society of Explosives Engineers, 1999.
- Wiss, John F. "Construction Vibrations: State-of-the-Art," *Journal of the Geotechnical Engineering Division*, ASCE, Vol.107, GT2, Feb. 1981, pp.167–181. <http://www.lta.gov.sg>

Tunnelling through adverse geological condition: A case study

B.M. Gupta, A.N. Sreekumar & S.K. Tripathi
H.C.C. Limited, Pare HEP, Arunachal Pradesh, India

ABSTRACT: Case History of Himalayan tunnel reveals that Barton's and Bieniawski's classification systems provide better assessment of the rock mass behaviour. The design and shear strength parameters derived from these classifications provided a preliminary design of the tunnel, which has been critically evaluate with the design adopted at site. Based on the structural features and ground water conditions, a number of tunnelling conditions have been predicted. Various tunnelling problems in the Himalayan rocks at depth are discussed. A study on various tunnel failures in squeezing rocks is presented. The studies indicated the loosening rock pressures would be occurring at the site, with the problems of roof collapse, flowing ground condition and cavity formation that may occur during excavation.

1 INTRODUCTION

The Pare Hydroelectric Project is proposed on river Pare in Arunachal Pradesh. The project envisages construction of 78 m height Concrete Gravity dam and a surface powerhouse to house 2 units of turbines of 55MW each to generate 110 MW of power.

The brief description of the project layout is presented in Figure 1.

1.1 *Underground excavation*

Tunneling is an essential part of any hydroelectric project, located in the Himalayan for the transfer of water from one basin to other. Due to the rugged and inhospitable nature of the terrain, it is usually not possible to conduct through investigations along the tunnel alignments. The use of rock mass classification systems for the tunnels under such condition serves better purpose for their preliminary design. Thus many regions of Himalaya lack sufficient design data. The present case study is of a typical Himalayan tunnel, where the application of rock mass classification systems formed a major part of the geotechnical studies conducted for the evaluation of tunneling conditions.

This case history is about the Head Race Tunnel at Pare Hydro Electric project, located in the North East region of India in Arunachal Pradesh. This 7.5 m finished diameter tunnel with 300 mm concrete lining is under construction for a length of about 2855 m in the single litho unit of sedimentary rock which is sandstone.

1.2 *Geology of the project site*

The regional geology of the area in the state of Arunachal Pradesh is divisible into four distinct physiographic domains: Himalayan Ranges, Mishi Hills, Naga-Patkoil Ranges and Brahmaputra plains. The Himalayan regions consist of rocks ranging in age from Proterozoic to Quaternary and have attained the present height during different phases of orogenic movement. Technically the area is in a complex domain of several tectonic features. The major tectonic features are Main Central Thrust (MCT), Main Boundary Thrust (MBT), Main Frontal Thrust (MFT), Mishi Thrust, Lohit Thrust, Bomdila lineament and Brahmaputra lineament, which seems to be tectonically active. The area has experienced several phases of deformation which is exhibited by multiple orientations of the deformation features.

The regional geological succession as worked out by the geological survey of India is given above in Table 1.

The project area falls in the upper Siwalik formation (Tertiary group) comprising brownish and grey coloured, fine to medium grained concretionary, soft and friable, pebble impregnated, salt pepper textured sandstone, sand rock and pebble beds which are moderately jointed. The regional strikes of the rocks are NE-SW with dips varying from 55°-75° towards NW. However in the project area with strike remain the same but the amount of dip and the direction changes from 50°-30° towards SE. some NE dipping beds have also been identified. At places, the Siwaliks contain impersistent bands/lances of coal which are thrust over the Gondwanas.

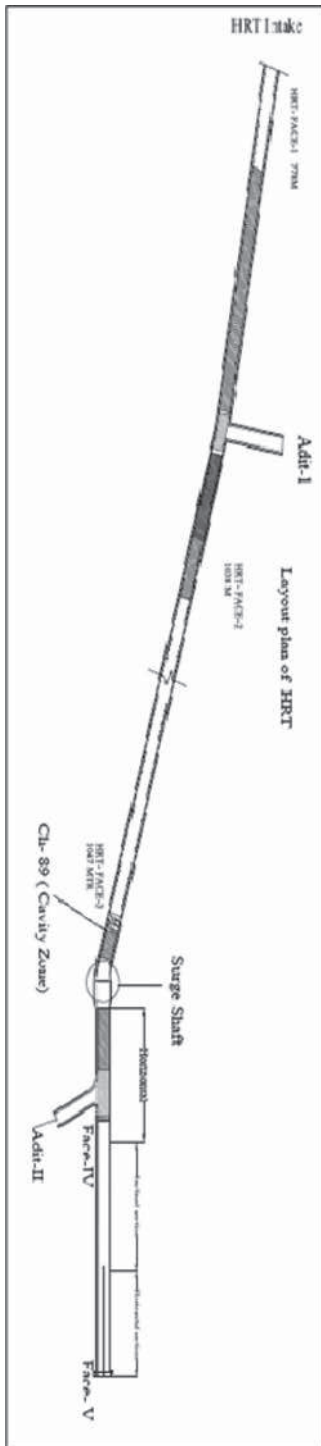

Figure 1. Layout plan for head race tunnel (HRT).

1.3 Geology of the Head Race Tunnel

The 2855 m long and 7.5 m finished diameter head race tunnel from intake area to the surge shaft points has been aligned in N24°E–S24°W direction. The modified horse shoe shaped tunnel enters in to upper Siwalik rocks comprising soft, friable, grey, fresh, moderately jointed pebbly sandstone, pebble beds. The rocks in the initial reaches of the tunnel strike N55°E–S55°W, dipping 12° towards SE direction with a prominent joint set striking N30°W–S30°E dipping 60°–65° towards NE. Approach to HRT alignment is difficult because of its inaccessibility. The salient have been made from the small reentrants and nallas descending down the hill range. The entire hill range is anticipated to be covered by minimum 5–6 m of overburden. The HRT is merging at surge shaft and intersecting brownish coloured, medium-grained highly weathered sandstone on

Table 1. Regional geologic setting.

Geological period	Super group/ group	Formation	Lithological description
Recent to sub-recent		Quaternary & Recent	Alluvium & river terraces
<i>Himalyan frontal thrust</i>			
Tertiary	Siwalik	Upper & middle	Soft, friable, sandstone with concretionary pebbles. Occasional clay bands and streaks of coal
<i>Thrust</i>			
Permian	Gondwanas	Upper	Argillaceous sandstones, calcareous shales, volcanic and metabasites, white quartzites & coal bands with marine fossils
<i>Thrust</i>			
		Khetabari formation	Slates, limestones, calcareous quartzites, graphite schists, black cherty quartzites, gneissic granite
Paleozoic to protozoic	Bomdila	Potini formation	Semi-pelitic schist (chlorite and garnet schist), mgmatites, gneisses with schistose enclaves (ziro gneisses)

the surface. The exploration proved around 15 m depth of weathered rock along HRT at places.

2 TUNNELING CONDITION

The tunneling in the soft rocks of Himalaya with adverse geo-hydrological condition poses a number of problems such as squeezing condition, flowing ground condition, cavity or chimney formation and roof collapse etc. in absence of subsurface investigation, the extent of such problems cannot be assessed even if the problems are known to occur prior to excavation.

2.1 *Development of various zones around a tunnel in squeezing ground condition*

2.1.1 *Running ground condition*

The running ground condition is water soaked fragmented rocks often containing larger rock fragments embedded in a matrix of finer grained material that has almost no strength and flow in to tunnel as slurry. The running ground is quite a common feature found associated with faults, thick shear zone, thrusts, and buried fossil valleys in the Himalayan region. The initial pressures generated by running ground may be high to cause failure of very heavy supports.

2.1.2 *Gasses in rocks*

A variety of natural gases namely carbon dioxide, methane, sulphur dioxide and hydrogen sulphide etc have been encountered in the tunnels excavated in civil section, in Loktak Hydrel Project in North-Eastern region of Himalaya. The methane (Marsh gas) was encountered in abundant in the tunnel located in the formations of sedimentary environments. Some 15 persons were killed and many had burn injuries of high degree due to explosion and fire near the heading. Similar case was found in the Ranganadi Project in the same region where the tunnel will pass through Gondwana Sandstone (known for coal deposits apart from granitic gneisses, schists etc.).

2.2 *Layout plan for head race tunnel (HRT)*

The squeezing and flowing ground conditions cause delay in fast completion of the tunnel and adversely affects the cost of the project. It is thus essential to conduct thorough investigations to get exact information on sub-surface geology so that proper excavation strategy and design of the underground structure can be planned. Most often the detailed geological exploration and investigation plan are not materialized because mostly these structures in the river valley projects of Himalayan

region are located in deep gorges with steep slopes and have no accessibility for any kind of detailed investigation.

Thus underground openings are aligned mostly based on the surface mapping and scanty borehole data. The total length of the tunnel is 2855 m being executed by two adits from Adit-1 divided into Face-01 of 778 m length and Face-02 of 1038 m, and from Adit-2, Face-03 of 1047 m length and Face-04 & 05 of 200.7 m. The main problem of cavitations is in Face-03, which is about 89 m from the surge shaft location. The layout plan clearly represents the cavity location during excavation with the help of wedge-shaped blasting pattern.

2.3 *Construction stage instrumentation*

The construction stage monitoring should consist of the following:

1. Measurement of support pressure.
2. Measurement of tunnel Closure.
3. Measurement of size of broken zone.
4. Estimation of coefficient of volumetric expansion of failed rock mass.
5. Refinement of predicted values of support pressure and tunnel closure (of pre-construction stage).
6. Revision of support system.

The measurement and estimation of first steps are carried out in the tunnel by implementing a scheme of instrumentation consisting of load cells, contact pressure cells, tape extensometer and bore hole extensometer.

3 DISCUSSION AND REMEDIAL MEASURES FOR CAVITY ZONE

3.1 *Pre-preventative measures*

After the formation of cavity from RD: 87.50 m, it was observed that the geology of the Face was getting poorer at RD: 87.50 m. The lithological description of face was very weak, soft friable, moderately weathered, medium grained, grey coloured, blocky sandstone with carbonaceous clay bands.

3.2 *Steps taken to prevent cavity*

The following steps were taken to prevent the formation of a cavity:

- Firstly we started with shotcreting on face and crown to prevent the loose fall but we are unable to present it by shotcrete, then we started the umbrella roofing by placing the 100 mm channel of 6.0 m length on crown above left SPL and

placed the steel plates above channels and backfill the portion with backfill concrete.

- Grouting through Mai-anchors the sum of 1100 bags in two rounds.
- The forepolling (36 mm diameter 6 m long @ 100 c/c) from crown to left SPL level.
- Then erection of Ribs 200 × 100 spacing @ 500 mm, steel lagging and backfill the annular space with backfill concrete.
- This process was started from 24th of June to 29th of August'11.

But at the later stage the fresh heavy loose fall over the fore poles observed, and automatically the load transfer to already erected Ribs from RD: 89.50 m to RD: 95.50 m. in the previous attempt we are unable to prevent the cavity zone. In previous attempt we used the drilling rig named Two Boom drill Jumbo which works on rotary drilling technique, in such technique we used the circulating fluid water for drilling further for inserting the fore poling of 36 mm steel rod for protecting the loose fall from both SPL level and crown as we had faced from RD: 89 m.

3.3 Dress methodology

After these remedial measures, further advance of HRT was done through drainage reinforcement, excavation, and support solution (DRESS) methodology which comprises the following procedures

1. Drainage in advance of rock mass by installation of long pipe forepoles of 12–15 m length followed by intensive grouting to create an umbrella arch as pre excavation support.
2. Excavation of tunnel with varying diameter and,
3. Support system by installation of steel ribs 200 × 100 at a spacing of about 500 mm, and of varying diameter or other rock support like shotcrete, concrete etc.

The placement of pipe forepole umbrella was carried out with a special drilling machine (CA-SAGRANDE PG 175) from Italy by ODEX method. Later stage we used the CASAGRANDE hydraulic drilling rig which works on pneumatic drilling technique which was useful for this type of strata at the project site. With the help of this technique we have inserted 114 mm perforated steel pipe by drilling the hole with 900 CFT compressor which generate a pressure of about 10 Kb attached with the air pipe with drilling rig, which circulated from drill stem (consist of Hammer and drilling bit) for proceeding further. By this pneumatic drilling technique the rock chips comes through the annular space between drill stem and 114 mm perforated steel pipe when we proceed further and the hammer

pushed the steel pipe further in the rockmass. With this technique we inserted the perforated steel pipe at a spacing of about 250–300 mm of length of about 12.00 m at an angle of about 5° to 7° having the overlap in each round 6–7 m, then grouted the pipe forepoles with grout mix of a ratio of 1:3 to 1:1, started from the end of each pipe and coming towards the beginning of the pipe using a mechanical packer to stabilize the rockmass to fall. After grouting in completed pipe forepoles excavation will be done in 0.5 m to 0.75 m at a time then rib will be erected and fixed at the excavated portion. Erected ribs will be embedded in shotcrete layer of 50–75 mm at a time. In one cycle of forepole 6 to 7 m of tunnel will be excavated. Once 6–7 m of tunnel was excavated next pipe forepoling will be carried out again. A typical figure of pipe forepoling is given below.



Figure 2. Loose fall from left SPL to crown.



Figure 3. Forepoling with 36 mm steel rod using Boomer.

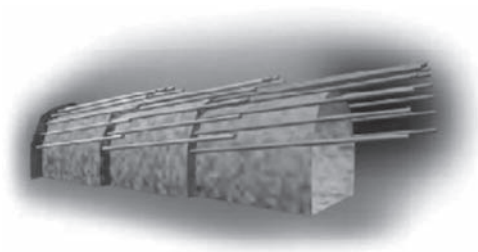

Figure 4. 3D view of pipe forepoling.



Figure 5. Casagrande PG 175 drilling rig at work.



Figure 6. Full face of modified horse shoe shape.

3.4 Post-preventative measures

- Firstly we started with Pipe forepoling (Umbrella roofing) with 114 mm dia pipe with the help of CASAGRANDE pneumatic drilling rig @ a pressure of about 5 Kb, of a length of about 12 mtr c/c.

- We did this process in four rounds from RD: 87.00 m to RD: 111.00 m.
- First round of pipe forepoling started on dated 06/01/2012 and completed on 19/01/2012 @ RD: 87.00 m, the length of the pipe forepoles varies from 7.5 m to 12.00 m because of encountering of steel rods, Self Drilling Rock bolts (SDR) and ISMC 100 used earlier for umbrella roofing, then grouted the pipe forepole with sum of 33 MT cement.
- Second round of pipe forepoling started on dated 12/02/2012 and completed on 24/02/2012 @ RD: 92.00 m of an average length of about 9.00 m, then grouted the pipe forepoles with sum of 8 MT cement.
- Third round of pipe forepoling started on dated 06/03/2012 and completed on 17/03/2012 @ RD: 95.00 m of an average length of pipe forepoles about 9.00 m, the pipe forepoles grouted with sum of 6 MT cement.
- Fourth round of pipe forepoling started on dated 31/03/2012 and completed on 05/04/2012 @ RD: 102 m of an average length of pipe forepoles about 9.00 m, then the pipe forepoles grouted with sum of 14 MT cement.

In each round of face excavation through hydraulic breaker with 1.00 m length and placed box Rib of 200 × 100, and backfilled the space with shotcrete. The total sum of 338 m³ shotcrete was consumed in cavity treatment.

4 CONCLUSION

The geomechanics studies conducted for the tunnel indicates that the rock pressures to be borne by the supports are of loosening type. Highly fractured and sheared rock mass charged with water, under the high rock cover may give rise to squeezing condition. Minor seepage to profuse water flowing condition may occur. Roof collapse, cavity formation, and flowing ground may be met during the excavation in the poor rock. Bieniawski and Barton's methods provide better assessment of the rock mass behaviour for the Himalayan tunnels under adverse conditions. The rock pressure range obtained can be used for the preliminary design as well as for the modification of the supports. However, these are short term rock pressure. heading and bench method of excavation is most suitable for the tunnel. Multiple drift method can be employed for the extremely poor condition of Sandstone. Providing of drainage holes and use of forepoling at the tunnel face, can be useful for improving the tunnel progress in the poor rock condition. With the help of instrumentation data, some simple and reliable empirical relations and

theories have developed. These may not be perfect but provide guideline for tunnel support design during construction stage.

REFERENCES

- Barton, N., Lein, R. and Lunde, J. 1975. Engineering Classification of Rock Masses for the Design of Tunnel Support. Rock Mechanics, Springer Verlag, Vol.6, pp. 1b9–236.
- Bieniawski, Z.T. 1973. Engineering Classification of Jointed Rock Masses. The Civil Engineer in South Africa, Dec. 1973, pp. 335–342.
- Varshney, R.S. 1988. Tunneling in Squeezing Rocks. Int. Symp. On Tunneling for Water Resources and Power Project. Jan 188. New Delhi, India.

Controlled blasting for a new tunnel near an existing railway tunnel

R.N. Gupta

National Institute of Rock Mechanics, KGF, Karnataka, India

A.K. Raina

CIMFR, Nagpur, India

ABSTRACT: The paper describes a controlled blasting strategy adopted to excavate open cut (for tunnel portal) and a new tunnel near an existing railway tunnel with a parting/barrier of about 16 m. The area lies in highly populated vicinity, with an operational railway track passing through an old tunnel with brick lining, high tension electric traction and small hutments. The objective of the study was to prevent any fly rock from the surface blasting and damage to the existing tunnel from the blasting for the new tunnel.

1 INTRODUCTION

A railway tunnel for Mumbai sub-urban was to be excavated using controlled blasting method. For this purpose blasting had to be conducted to create a face for the portal and further excavate the proposed tunnel using blasting. The details of the critical features from the blasting point of view, existing in the vicinity of the proposed tunnel include:

1. An existing tunnel with brick lining from which the average radial distance of the proposed tunnel is 16 m,
2. Railway tractions with high voltage,
3. Existing railway lines passing through the tunnel,
4. Hutments of iron sheets about 80 m from the location of the surface blasts.

The objective of this study was to prevent any incident of:

1. Fly rock that could hit the hutments and residents as it was not possible to evacuate people living in the adjoining hutments. Fly rock could also hit the high voltage railway traction about 35 m from the blast site or block the existing tracks about 25 m distance for which there are heavy penalties.
2. Prevent any damage to the existing railway tunnel, particularly the brick lining while blasting for the tunnel.

2 METHODOLOGY

Keeping in view the extremely critical nature of the nearby objects, a careful strategy was evolved

for both surface and underground blasting. This involved:

1. Creating a wire mesh and iron sheet barricade towards the exiting railway track (Fig. 1).
2. Working out of maximum charge per delay for control of ground vibrations and subsequent



Figure 1. Barricade for preventing flyrock for railway track & traction.



Figure 2. Arrangement of muffling for control of flyrock.

damage to the said structures. This was done by taking trial blasts and measuring the vibrations at different locations by varying charge per delay (See section 3).

3. Minimizing the charge per hole and maximizing the stemming to control flyrock in surface blasting. 3-tier muffling was also applied to control the flyrock as shown in Figure 2. The arrangement of muffling was as follows:

- a. Sandbags over the hole collars
- b. Conveyor belts over the rows
- c. Wire-mesh covering the whole blast, and
- d. Further sandbags over the complete wire mesh.

3 VIBRATION CONTROL

Trial blasts were conducted to evolve a blast vibration predictor equation. The following (Table 1) blast design parameters were used.

Sixteen (16) blast vibration events were recorded for analysis. Vibrations attenuate with distance (d) of the point of interest (here monitoring station) from blast site and have a relationship with the maximum charge per delay (Q_{max}). The relationship between distance and Q_{max} is expressed in terms of Scaled Distance (SD) which is given by

$V_{max} = K[D/(\sqrt{Q_{max}})]^{-\alpha}$ which in our case works out as:

$$V_{max} = 774(SD)^{-1.49} \dots 1 \text{ (at 75\% confidence interval)}$$

The general vibration equation worked from the blast data is also shown in Figure 3.

In addition the frequency of the blasts observed was also determined and plotted to assess the dominant frequency (Fig. 4).

Based on the standard method of DGMS India, the maximum charge per delay for the future blasts was worked out keeping in view the proximity of the structures (Table 2).

4 TUNNEL BLAST DESIGN

The following considerations were taken to evolve a proper blast design for tunneling.

The maximum allowable vibration considering the safety of brick lining of the existing tunnel is 15 mm/s.

Regression equation for vibration as given in Eq. 1; $V_{max} = 774(SD)^{-1.49}$ is used for prediction of maximum charge per delay (Table 2). A confidence interval of 75% has been used over the mean equation as the higher ranges of vibrations fall within this interval.

Table 1. Blast design parameters for trial blasts.

Blast location	Portal area open excavation	Drill diameter	32 mm
Explosive diameter	25 mm	Length of cartridge	20 cm
Burden	0.6–0.8 m	Spacing	0.9–1.0 m
Depth of holes	1.0 to 2.8 m	Stemming	0.7 to 1.2 m
Stemming material	Sand mild tamping	Surface connections	NONEL Twindet Relays 25 ms
Mode of initiation	NONEL-shock-tube	Flyrock control	Through use of 3 tier muffling system (see Figure ... also)
Specific charge	0.4–0.6 kg/m ³		

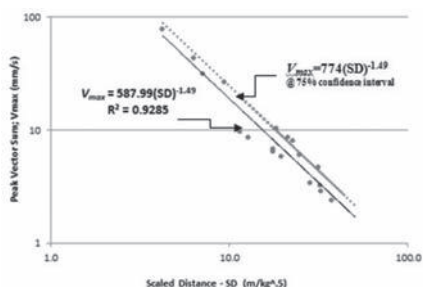

Figure 3. Vibration attenuation equation for the trial blasts.

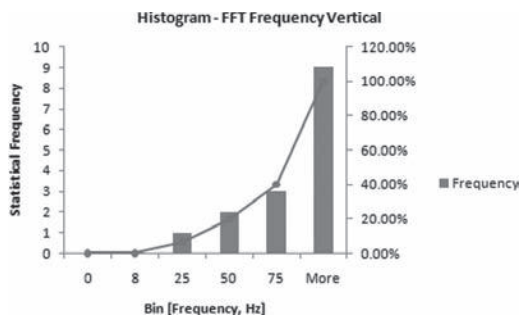

Figure 4. Dominant frequency of the vibrations.

Table 2. Maximum charge per delay for future blasts.

SL	Distance from cut (m)	Q_{max} (kg @ 15 mm/s)
1	21	2.2
2	20.3	2.1
3	19.6	1.9
4	18.9	1.8

Table 3. Input parameters for evolving tunnel blast design.

Parameter	Unit	Value
Hole diameter	mm	32
RWS of explosive		1.1
Density of rock	g/cc	2.5–3
Average Jt spacing	m	0.3–0.4
Compressive strength of rock	MPa	200
Explosive dia	mm	25
Explosive density	g/cc	1.1
Wt./cartridge	g	125
Cartridge length	cm	20

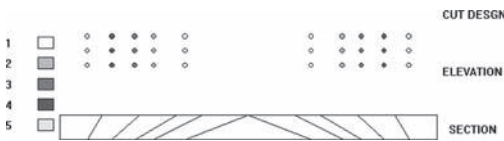

Figure 5. Design of the cut.

The distance from the tunnel-2 to tunnel-1 is 16.5 m from the blast holes.

Other properties necessary for evolving a tunnel blast design are provided in Table 3.

Based on the above a tunnel blast design was worked as given in Figures 5 and 6.

Keeping in view the size of the tunnel, blasting in the tunnel was designed to be conducted in 3 phases:

1. Excavation sequence 1 (ES 01, Fig. 6): this included the central portion of the tunnel and was blasted first.
2. Excavation sequence 2 (ES 02, Fig. 6): this included side portions of the tunnel which were slashed after implementing ES 01.
3. Benching: The balance portion of the tunnel was removed by benching (Benching portion, Fig. 6).

Vibrations were monitored parallel to the blasts in the adjacent operational tunnel in each blast.

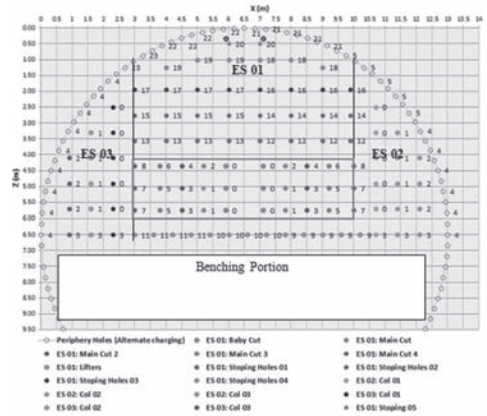

Figure 6. Design of the tunnel blast.

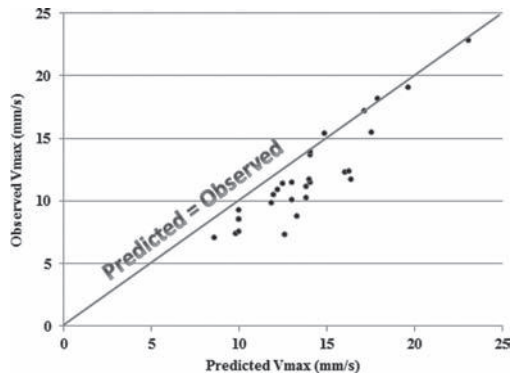

Figure 7. Validation of the blast vibration results.

Additionally the condition of the lining of the existing tunnel was also monitored daily. The observed vibrations thus are presented in Figure 7.

It is evident from the Figure 7 that the prediction of the vibration has been in tune with the predictor equation 1. Accordingly no damage to the lining of the existing tunnel was observed. By end of May'12 +65 m full face length of the tunnel has been successfully excavated.

ACKNOWLEDGEMENT

The authors of this paper are grateful to the management of Mumbai Rail Vikas Corporation Ltd. (MRVCL) and M/s D. Thakkar Construction Pvt. Ltd. for giving an opportunity for conducting blast trials. The views expressed in this paper are that of authors.

This page intentionally left blank

Introducing specialized blasting techniques and sequences of excavation in tunneling works under critical conditions

M.M. Singh, N.K. Bhagat & S.K. Mandal

Blasting Department, Central Institute of Mining & Fuel Research, Dhanbad, India

ABSTRACT: Construction of tunnels for hydroelectric power generation or diversion of roads for faster public transportation and avoid road congestion is increasingly becoming important. Depending upon topographical condition and local site geology, such tunnels are sometimes constructed under low cover zone or through rock having high inherent temperature (above 90 °C). The paper presents three different typical case studies where tunnels were driven under these difficult situations in our physical presence by drilling and blasting method. Considering the unique situation for each site, the paper presents the optimal solution and the methodologies adopted for drivage of such tunnels.

1 INTRODUCTION

The excavation of tunnels using drill & blast system requires an optimal set of design parameters so as to get higher advance ensuring minimal over break (Mandal & Singh, 2009). In case of tunnel excavation the major point of worry is the economics related to the cost of concreting to generate a smooth profile. The above fact leaves important consideration about the blast pattern being used (Singh et al., 2008 & 2011). The extent of overbreak using drilling & blasting is mainly controlled by lookout angle (except use of TBM) and several other parameters like geological disturbance, deviation of drill hole governed by rock properties, changes in structural alignment, blast induced overbreaks (Singh & Bhagat 2011). The unwanted overbreak extending the blast induced cracks towards the sidewall as well as crown sufficiently dilute the overall quality of immediate roof. This becomes significant when we have very low cover above the tunnel. A successful drivage of tunnel requires complete elimination of such blast induced cracks in a way that the required height is maintained free from any cracks. At a number of sites in such cases particularly under low cover zone and poor rock condition, drilling and blasting was prohibited along the periphery of the crown. In a few cases, mechanical rock breaker was used to clear off of the crown to erect the recommended support at their specified height & location (Singh et al., 2008 & 2012). Two tunnels having low cover zone, (cover varying between 0.6 to 0.95 times the width of the tunnel) were studied in detail.

However, a tunnel was also driven for about 350 m length where temperature varied between 70 to 98°C (Singh et al., 2011). In this case, an attempt

was made to find the reason of heating and it could be found that this was not a heating generated due to sulfur band nearby as apprehended (Chandrasekharam, 2001, Chandrasekharam et al. 2005 & Singh et al. 2011). The paper elaborately discusses the reason of this hot zone and the remedial measures to drive the tunnel in such conditions with specialized sequences of excavation.

2 SITE INFORMATION

2.1 Site A

The twin transport tunnels of Ghat-ki-Guni project (Jaipur), lying between Latitude 26°53'38.36" and Longitude 75°51'26.20", were constructed as a bypass route to existing National Highway very close to the old historical forts/temples of Jaipur in Rajasthan, India (Fig. 1). The rock exposed at the site was quartzite belonging to Delhi group. It showed a wide variation in quality and color. The barrier between them was 12 m. The total length of the each tunnel was 960 m with a finished width of 11.9 m and a height of 8.2 m. The left tube had a



Figure 1. Twin tunnels at Ghat-ki-Guni, Jaipur.

cover of 0.65 times the width, & right tube covering 0.95 times the width). Four sets of joints could be traced on the out crop with a joint spacing varying between 10 and 60 cm. The dip/dip directions of the joint sets were 80°/SW; 70°/NW; 40°/SSW and 20°/N125°. The rock mass quality (Q) assessed in this zone varied between fair to good quality. RQD of surface rock, upto 3–5 m depth, was within 30% and the quality of it increased to 80–90% with an increase in depth.

2.2 Site B

An existing PWD road of narrow width at Jaypee Himachal Cement Plant, Solan district of Himachal Pradesh, was found to be insufficient for movement of heavy motor vehicles. The widening of this road was at a very high risk as the villages were existing down the slopes where the road was to be widened. To ensure the safety of the human life, it became a serious matter to think for it and to search some other alternative so as to void any disaster due to falling of the blasted fragment and their rolling along the slope. For this purpose, a tunnel of 362 m long, 8 m width and 8.25 m height was proposed to be constructed to bypass the existing villages. Here also, the depth of the immediate cover was not more than 12 m. The proposed diverted route through a tunnel is shown in Figure 2.

The tunnel was to be excavated through thinly bedded dolomitic limestone. This rock had 3 sets of joints and a few shear zones. The site topography and geological conditions made alignment of tunnel almost parallel to bedding strike with a maximum variation of 10 to 20°. The Q value of the rock ranged between 0.1 and 1.66 *i.e.*, extremely poor to poor category under Barton's Q- system rock mass classification (Barton et al, 1974).

2.3 Site C

A 1000 MW Karcham Wangtoo Hydro-electric Project (KWHEP), run-off the river scheme project

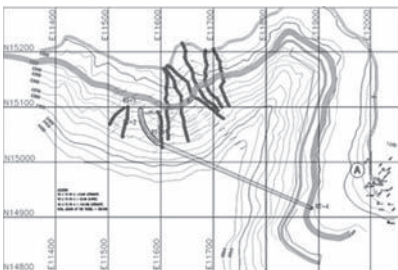

Figure 2. Tunnel alignment & existing road.

on the river Satluj, is located in Kinnaur district of Himachal Pradesh, India. Within 17.2 km long Head Race Tunnel (HRT), the upstream face of Adit-4, between Chainage 1063 to 1360 m, encountered hot zone where the temperature of rock surface varied between 70 and 98°C. Investigation into such cause revealed that it was due to geo-thermal heating and not due to sulfur heating. The rock strata exposed at site was granite gneiss with occasional biotite schist bands. The strike of foliation was between N20°W and S20°E with dip amount of 25 to 30° in North East direction. A few minor structural features *viz.*, fault or shear was also encountered in this zone ranging 0.3 to 1 m thick. Face was also completely dry and devoid of any water seepage. Under 'Q' system of classification, the strata were classified as poor to fair.

3 EXPERIMENTAL BLAST WITH SEQUENCE OF EXCAVATION

The blasting methodology and sequences of excavation adopted at Site A aimed at restricting propagation of blast-induced cracks and deterioration of surrounding rock strata due to sudden creation of void during blasting. At the initial stage pilot drivage of dimension 2 × 3 m² was driven per blast. Maximum depth of blastholes for such dimension was restricted to 2 m to contain total charge and maximum charge per delay well within control. To prevent extension of cracks beyond the tunnel profile, line drilling spaced at 20 cm was drilled along the perimeter. After every two pilot blasts, widening was carried out. Maximum depth of holes for widening was also restricted to 2 m. Protection of tunnel portal was thereafter implemented by rib supports spaced at 0.7 m and backfilling the void area (between ribs & tunnel profile) with concrete. The procedure and sequence of excavation adopted at site A is detailed below:

1. Within the low cover zone, excavation was carried out with piloting and widening sequence within the heading portion, Figure 3. Creation of small voids (piloting and widening within the heading section) by blasting resulted into minimum disturbance of in-situ stress and propagation of cracks within peripheral rock strata;
2. Use of minimum explosive in the pilot zone;
3. Implementation of line drilling at very close spacing along the perimeter;
4. To avoid cooperation of charges and minimize magnitude of vibration and overbreaks, long delays were implemented (Fig. 4);
5. Leaving the line drill holes un-charged controlled the tunnel profile with an average overbreak of 10 cm, Figure 5;

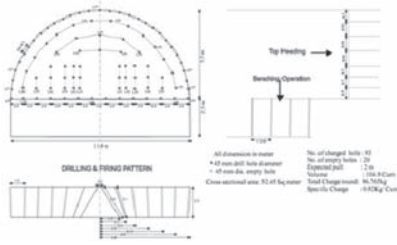

Figure 3. Drilling, charging & firing patterns of holes in heading, widening & benching portion.

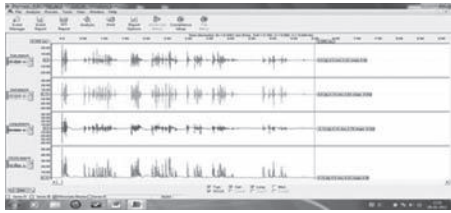

Figure 4. Seismic record of vibration showing segmental effect of it which does not allow interference of one charge in a delay to another.

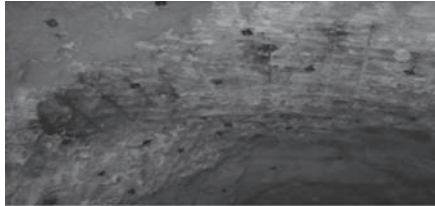
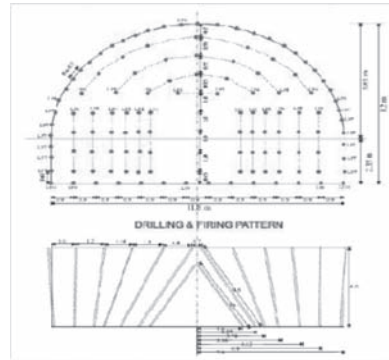

Figure 5. Hole markings achieved at crown.

6. Proper implementation of support system like SFRS (15 cm thick) along the rock surface, steel arch at 1 m c/c & 5 m long fully grouted bolts within alternate ribs at 1.5 m spacing;
7. Full face blasting was adopted when the cover was more than 2D and when competent rock to sustain the load was observed, Figure 6; and
8. Considering 15 mm/s as safe level of vibration for civil structures (DGMS Technical Circular, 1997) and 250 mm/s for competent rock (Bauer and Calder, 1971), the blast pattern was designed.

At Site B, tunnel was to be excavated through a hill running close to the existing road to avoid road congestion and easy traffic flow for transport of cement and clinkers. Since, the surface rock was weathered and highly fractured, competent rock was exposed by excavator and the periphery was trimmed by rock breaker to give its shape (Fig. 7).



Blast Type	Diameter (mm)	Depth (mm)	Holes	Volume (m ³)	Explosives Details		Charge (kg)
					45 mm	52 mm	
Cap 1	EP-1	1.6	8	20.8	0	14	27.8
Cap 2	EP-2	4.6	8	76.8	0	17	24
Cap Bench	EP-3	4.5	22	177.8	0	13	43.4
Increase	EP-4	4.0	24	96	0	13	42.4
Side Walls	EP-5	4.0	12	48	0	1	14
Centre	EP-6	4.0	24	96	0	1	14
Bottom	AP-08 (2)	4.0	18	72	0	13	24
Total			132	703.2	0	64	162.75
Hole diameter 45 mm		No. of holes 47		Equivalent dia. 75 mm		Volume 1.04 K.Cum	
		Specific charge 1.99 kg/m ³		Expected P.P.S. 1.8 m		Volume 308.56 m ³	
		Specific charge 1.83 kg/m ³					

Figure 6. Drilling, charging and firing pattern of holes for full face blasting at Site A.



Figure 7. Tunnel portal excavation by excavator.

Experimental blasts were conducted at Shalughat side face. Considering geology and rock mass characteristics, wedge-cut pattern was implemented for piloting with a cross-sectional area of about 15 m² (Fig. 8).

The pattern being very flexible with optimal cycle time yielded minimum overbreak and smooth peripheral rock wall near the portal area (Fig. 9). The total number of holes for this pattern varied between 30 and 38. To minimize deviation of blast-holes and achieve optimum breakage, depth of blastholes was restricted to 2.5 m. This also led to maximization of progress per blast. This was implemented for initial 15 m length until competent rock was encountered and the cover was more than 3D. Vibration was also measured to evaluate the impact of blasting on the surrounding strata. Maximum magnitude of vibration measures at a distance of 12 m above the crown of tunnel was 27.9 mm/s for

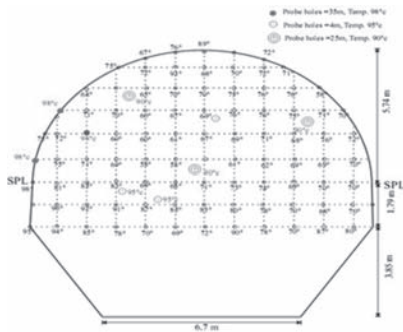

Figure 12. Temperature log of the face at Chainage 1068, Adit-4 (Upstream, HRT, KWHEP), dated 23/02/2009.



Figure 13. Hottest point (Sp1) temperature observed 96.6 C on rise sidewall of tunnel at 1350.

Table 1. Test results of explosive & accessories.

Sr. no.	Material tested	Approximate temperature (°C)	Procedure of testing	Results
1	Nonel detonator	60	Heating of water with the help of immersion rod in a steel tub	No detonation, heating continued for 30 minutes
2	Nonel detonator	80	Heating of water with the help of immersion rod in a steel tub	No detonation, heating continued for 45 minutes
3	Emulsion explosive (40 mm dia.)	90–100	Heating of water with the help of immersion rod in a steel tub	The detonator got fired immediately when received the blazing fire
4	Nonel detonator	More than 200	Detonator exposed to a blazing fire by burning dry wood after spraying liquid petrol over it. The distance between the wooden material and detonator was less than 5 cm	No detonation
5	Emulsion explosive (40 mm dia.)	60	Heating of water with the help of immersion rod in a steel tub	No detonation
6	Emulsion explosive (40 mm dia.)	100	Heating of water with the help of immersion rod in a steel tub	No detonation
7	Emulsion explosive (40 mm dia.)	More than 200	Explosive cartridge along with detonating cord was exposed to blazing fire by burning dry wood. The cartridge was just in touch with fire	Explosive and D-cord burnt completely. No detonation

aspects for handling and usage of explosives, full face blasting was very difficult. Furthermore, usage of NONEL or electric detonators had to be completely stopped. So, after carrying out some tests to understand the characteristics behavior of explosives and its accessories with temperature, and following the regulations stipulated by Directorate General of Mines Safety (DGMS), planning was made to drill and blast in four phases by restricting the depth of blastholes to 2 m (Table 1). Charging of holes was to be carried out with detonating cord and the delays were placed on surface of tunnel face.

The excavation sequence was divided into three to four sections *viz.*, piloting and widening in three sections (left wall, right wall and crown). The drilling pattern for both piloting and widening is shown in Figure 14. The face temperature data log generated during excavation of hot zone is shown in Figure 15. The general steps adopted for drivage of tunnel in hot zone are as follows:

- a. Complete charging & firing were to be carried out well within 45 minutes to avoid deflagration & immature detonation;

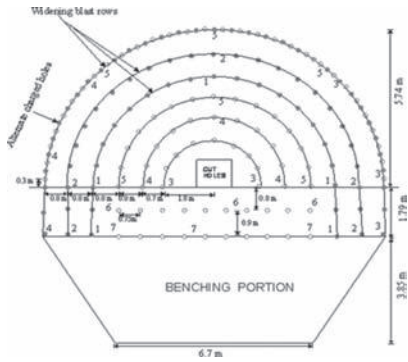

Figure 14. Sequences of excavation, drilling, firing and charging pattern of holes during hot temperature zone.

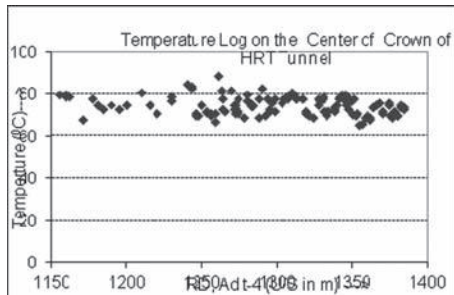

Figure 15. Temperature log recorded at different Reduced Distance (RD) in HRT, KWHEP.

- b. Stemming of blastholes should be carried out at end of charging of all blastholes;
- c. To accomplish total charging and firing within stipulated time, the initial cut was for a dimension of $3 \times 4 \text{ m}^2$. Number of blastholes for charging was restricted to 25 and depth of holes to 2 m;
- d. After initial pilot blast, tunnel face was quenched by spraying chilled water. Quenching of tunnel face was also carried out periodically *i.e.*, before widening, during drilling for widening and before charging of blast holes so as to bring the temperature of strata well below 80°C before charging;
- e. Detonating cord along with explosive was inserted within blast holes;
- f. To achieve delayed firing time as per the design, detonators or NONELs were connected to detonating cord and placed at the surface of tunnel face. To avoid direct contact between detonator and hot tunnel face, padding of either wet cloth or paper board were placed between detonator and tunnel face; and
- g. Periphery holes were drilled at 30 cm spacing *c/c* and alternate holes were charged.

4 CONCLUSIONS

In highly stressed zone or in low cover zone *i.e.*, where the cover is less than $2D$, excavation of tunnels should be carried out by piloting and widening in stages. This enables the in-situ rock to sustain the re-distribution of stress due to sudden creation of void during blasting. Depth of blastholes should also be restricted to a maximum of 2.5 m. Long delays should be used for both production blasts and in buffer zones to restrict cooperation of charge, amplification of vibration and control magnitude of overbreak. In hot temperature zone, blasting should be carried out by restricting number of holes per blast so that the total time taken for charging and firing is completed well within 2 hours. Detonating cord, capable to sustain 120°C , should be implemented as initiation device. Cord relays or detonators should be placed on surface and connected to detonating cord with padding of either moist cloth or asbestos between tunnel face and detonator to achieve delayed initiation and avoid immature detonation.

ACKNOWLEDGEMENT

The authors of paper sincerely express their thanks to the officials of Karcham Wangtoo Hydroelectric Project, Jaypee Himachal Cement Project of M/s Jaiprakash Associated Limited, M/s Rohan Rajdeep Rajasthan Infra Projects Limited, Jaipur Development Authority & M/s Dongah Geotechnical Engineering India Pvt. Ltd. for providing necessary facility and continuous support during the field investigations. The permission of Director, Central Institute of Mining & Fuel Research, Dhanbad, India to publish the paper is thankfully acknowledged. The special thanks are due to Prof. R.N. Gupta for technical guidance on this issue.

REFERENCES

- Barton, N., Lien, L., Lunde, J., 1974: Analysis of rock mass quality and support practices in tunneling and a guide for stemming support requirement, Internal report of Norwegian geotechnical Institute, Oslo, Norway, pp. 6-9.
- Chandrasekharam, D. 2001: HDR prospects of Himalaya geothermal province. "In K. Popovski and B. Sanner (eds) Proceeding, International Geothermal Days y 2001"—International Summer School on Direct Application of Geothermal Energy, Bad Urach, Germany, 269-273.
- Chandrasekharam, D. Alam, M.A. and Minissale, A. 2005: Thermal discharge at Manilaran, Himachal Pradesh, India, Proceeding World Geothermal Congress, Antalya, Turkey.

- DGMS Technical Circular No. 7, 1997: Standards of safe level of blast induced ground vibration for safety of structures, Ministry of Labour, Government of India.
- Jimeno, C.L., Jimeno, E.L. & Carcedo, F.J.A.: *Drilling and Blasting of Rocks*, 1995, pages 217–230.
- Kuzu, C. and Guclu, E.: The problem of human response to blast induced vibrations in tunnel construction and mitigation of vibration effects using cautious blasting in half-face blasting rounds. *Tunneling and underground space technology* 24 (2009) 53–61.
- Langefors, U. and Khilstrom, B. 1973. *The modern technique of rock blasting*. 2nd edn. New York Wiley. 405 pages.
- Mandal, S.K. and Singh, M.M.: Evaluating extent and causes of overbreak in tunnels, *Tunneling and Underground Space Technology*, 2009, Vol. 24 (1). pp. 22–36.
- Singh, M.M. and Bhagat, N.K.: Recent developments in designing of burn-cut method of blasting in tunnelling for higher productivity and special emphasis on the prevention of overbreaks, *Journal of Mines, Metals & Fuels, Mining Industry Annual Review*, Vol. 59, No.(10) October 2011, pp. 332–339.
- Singh, M.M., Mandal, S.K., Bhagat, N.K., Pal Roy P. and Sinha, A.: A CIMFR Investigation Report on “Study and advice to evolve optimum blast pattern for safe construction of new approach road & tunnel at JHCP (H.P.)”, GC/41/2007-08, 2008.
- Singh, M.M., Bhagat, N.K., Mandal, S.K., Pal Roy P. and Sinha, A.: A CIMFR Investigation Report on “Optimization of blast design to enhance overall blasting efficiency at various Tunnels & other structures and to safe guard the adjoining structures at Karcham Wangtoo Hydro-Electric Project, H.P.”, CNP-2360/09-10, 2011.
- Singh, M.M., Bhagat, N.K., Mandal, S.K., Pal Roy P. and Sinha, A.: A CIMFR Investigation Report on “Advice on blast pattern for the excavation of Ghat- Ki- Guni tunnel through Jhalana Hills to connect NH-11(Agra Road) Jaipur”, CNP-2591/2010-11, 2012.

This page intentionally left blank

Controlling shock waves and vibrations during large and intensive blasting operations under Stockholm City

Donald Jonson

Nitro Consult AB, Stockholm, Sweden

ABSTRACT: Plans to route more road and rail traffic underneath Stockholm City have resulted in a series of enormous projects that include constructing many large tunnels beneath sensitive urban infrastructures and environments. One such project is the 5-km Northern Link, which will contain 11 km of tunnels and become part of the long-planned Stockholm Inner Orbital Expressway. Another is the Stockholm City Line (Citybanan), a bold plan to route overground commuter trains right under the city center to interface directly with the city's underground metro network. In both projects, there are stringent controls on blasting, and Nitro Consult has been appointed to measure all associated vibration, noise and structure-borne sound. We are also responsible for surveying buildings and other infrastructure both before and after the rock excavation works.

1 STOCKHOLM GEOLOGY

The Stockholm bedrock consists mainly of veined gneiss, gneiss-granite and granite, mostly overlain by a thin layer of glaciogenic deposits. Amphibolitic and deformed dykes intersect the bedrock frequently. Doleritic dykes, too, occur in places.

The bedrock is considered generally to be of good geo-engineering quality. However, joints and joint sets occur frequently, and this can have a major effect on underground construction processes.

Outcropping in Stockholm is common, and it is not unusual to see buildings constructed directly on rock. However, there is much variety. For example, on the edges of Lake Mälaren's outlet to the Baltic Sea, around which old Stockholm is built, there are significant alluvial deposits in which many old and impressive buildings have their foundations. Most often, these consist of substantial wooden piles driven into the alluvial deposits. Taken together—and considering the already-well-developed underground infrastructure in Stockholm, with which any new developments must co-exist—the foregoing presents engineers with a variety of geotechnical challenges.

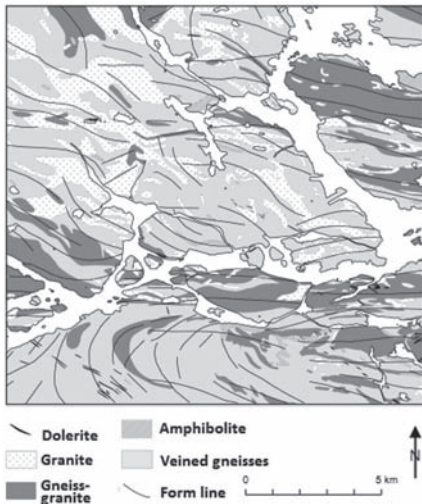

Figure 1. Main rock types in Stockholm bedrock, and structural trends (Persson 1998).

2 REAL ESTATE AND INFRASTRUCTURE

Stockholm city is home to over a million people and receives or transits hundreds of thousands of commuters each day from surrounding suburbs and nearby towns. Its real estate consists generally of low-rise buildings (4–8 stories), although a few relative skyscrapers have been built since the 1960s, mostly away from the city center. In the Old Town, many buildings are ancient (150–700 years), constructed of brick and stone, and preserved and protected as important national heritage assets. The oldest parts of the city can be described as compact in the medieval fashion, with narrow alleys and cobbled streets. Moving away from the old parts, which surround Lake Mälaren's outlet to the sea, the streets become broader and straighter, with buildings more widely spaced and more modern. There is quite a lot of impressive modern archi-

ecture in Stockholm. Moreover, the city is famous for its extensive district heating systems, which carry hot water (mostly underground) to residential and commercial properties. Owing partly to the good quality of its bedrock, Stockholm has a long tradition of underground construction and today overlies some 100–200 kilometers of tunnels, storage chambers and even large municipal facilities such as sewage treatment plants.

3 CURRENT UNDERGROUND CONSTRUCTION PROJECTS

Several major infrastructure projects are currently underway in and around the city. Most are products of the multi-billion dollar Dennis Agreement, a political compact signed in 1992 and named after Bengt Dennis, a former governor of the Bank of Sweden. Intended to make major and radical improvements to both traffic-flow and public transport in and around Stockholm, the goals of the agreement are being achieved in stages. Several times, key projects in the ‘grand scheme’ have been cancelled or abandoned due to opposition from local groups or revised political decisions at cabinet level. One by one, though, they are being reinstated, and there is today a high probability that all or most of the plans in the Dennis Agreement will be realized. Two major components we shall exemplify in this paper are the Northern Link (Norra Länken), a ring-road project (see section 6), and the Stockholm City Line (Citybanan), an undercity railway project (7).

4 RISK ANALYSIS

In any urban construction project that requires major blasting work to be done, the control of shock waves and vibrations is one of the most important factors governing both safety and productivity. In undercity tunneling in particular, in which geological and overlying environmental conditions vary from zone to zone along the route of the tunnel, it is vibration control that frequently sets the agenda. When the permissible values are set correctly, everyone is happy. People are safe and assured, and can carry on with their lives quite normally. Discomfort and disruption are minimal, and there is no structural damage to buildings or infrastructure. Contractors are able to maintain optimal productivity, the job is finished on schedule and the client is able to put his or her vision into operation on time. Finally, the right parties—those who have invested their time, skills, effort, courage and money—are able to earn a profit. But if the calculated permissible vibration values are wrong

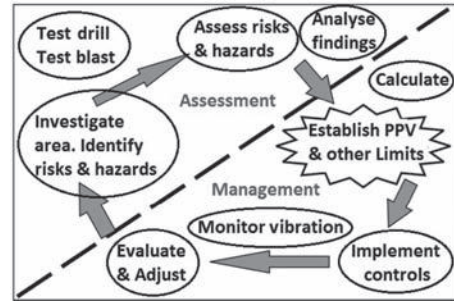

Figure 2. Vibration-oriented risk-analysis cycle for blasting.

in either direction, then one or more (or even all) of the foregoing satisfaction factors spiral out of control.

If the values are set too high, lives are put at risk, buildings and infrastructure are damaged, the environment can be ruined, delays are crippling, costs rise sharply, relationships deteriorate and no-one is happy. If they are set too low—because we have been overcautious through either ignorance or fear—then round lengths are too short, productivity falls, the job drags on, costs escalate and profits evaporate. Therefore, it is essential to strike the right balance, i.e. to set the vibration and noise limits at values that protect life and property, create minimal nuisance, respect the natural environment and—at the same time—enable contractors to achieve optimal productivity. The best way to achieve this is to conduct a full and thorough risk analysis before putting the project plan into action. It is the best investment the client and contractors can make.

Investing early in a comprehensive risk analysis will save considerable sums of money. The value of having intelligence about the whole environment surrounding the blasting site is key to achieving safe and effective results that meet optimally the demands of all stakeholders. It is essential to have correct information about the geology, geotechnical conditions, groundwater, buildings and their foundations, infrastructure and the environment. Good knowledge about buildings’ foundations, structural designs and constituent structural materials is vital. Equally important is to know what human activities take place in the area, including any scientific, medical, commercial and industrial processes that might be especially sensitive to vibration.

The blastability of the rock or ground formation must also be known as well as its vibration-dampening characteristics. This enables zone-specific transmission factors to be applied with greater certainty, so that maximum simultaneous charge weights can be calculated in advance. The foregoing requires

careful site investigations to be carried out at an early stage. Ideally, they should include test blasting, whose measured results can enable engineers to begin early to design and dimension future blasts. This in turn enables contractors to calculate more accurately the probable advance rates and overall production rates, before submitting their tenders. Test blasting can also help the client and other interested parties to understand better the technicalities associated with the blasting work.

5 SWEDISH GUIDELINES FOR PPV VALUES

When calculating vibration limit values, contractors in Sweden can consult the Swedish Standard *SS 4604866: Vibration and shock—Guidance levels for blasting-induced vibrations in buildings and other structures*. The standard gives guideline values and circumstance-factor-based methodology for calculating vibration limit values to avoid damaging buildings during urban blasting. It asserts Peak Particle Velocity (PPV) in the vertical direction to be the vector quantity of interest. This is based on extensive experience of the relationship between vertical PPV values and verified damage to buildings constructed on all types of substrata in Sweden.

The standard directs the user to calculate maximum permissible vertical PPV values (v) at building foundation level according to the formula:

$$v = v_0 \cdot F_b \cdot F_m \cdot F_d \cdot F_t$$

v_0 —Uncorrected PPV in the vertical axis, depending on the substrata

F_b —Building factor based on the type of building and its sensitivity to vibration

F_m —Material factor based on the vibration sensitivity of the weakest material in the building

F_d —Distance factor based on the distance between the blast and the measuring point

F_t —Blasting-work duration factor, which considers for how long the project carries on.

5.1 Uncorrected Peak Particle Velocity (PPV), v_0

Table 1 shows the uncorrected PPV, v_0 , guideline limits applicable to different ground conditions in Sweden. For combination foundations, the v_0 values for all substrata conditions that apply are considered.

5.2 Building factor, F_b

Buildings are classified into one of the five construction classes per Table 2 according to their sensitivity to vibrations.

Table 1. Guideline limits for vertical PPV in different substrata.

Substrata	Substratum	Vertical PPV, v_0 mm/s
Loosely layered moraine, sand gravel, clay	Clay	18
Compactly layered moraine, schist, soft limestone	Moraine	35
Granite, gneiss, hard limestone, quartzitic sandstone, diabase	Rock	70

Table 2. Vibration sensitivity factors for different buildings.

Class	Building	Building factor, F_b
1	Heavy constructions such as bridges, quays, defense installations, etc.	1.70
2	Industrial and office buildings consisting mainly of prefabricated elements	1.20
3	Normal residential buildings	1.00
4	Especially sensitive buildings and buildings with high vaults or constructions with large spans	0.65
5	Guideline values for especially sensitive heritage buildings, installations or environments identified in the investigation shall be determined separately. (Per special investigation.)	$F_b \leq 0.5$

5.3 Material factors, F_m

Building materials are classified into four classes, depending on their sensitivity to vibration. Factor F_m applies to the weakest material in the building.

5.4 Distance factor, F_d

The distance factor F_d as a function of the shortest distance between the blast and each affected building can be found in the diagram below.

The following equations are applicable to this relationship:

- $F_d = 1.91 \cdot d^{-0.28}$

- $F_d = 1.56 \cdot d^{-0.19}$

- $F_d = 1.91 \cdot d^{-0.29}$

- $F_d = 2.57 \cdot d^{-0.42}$

- The distance factors $F_d = 0.22$ and $F_d = 0.35$ and $F_d = 0.50$ for distances greater than 350 m are calculated in such a way that the combined factor $v_0 \cdot F_d$ for $v_0 = 70, 35$ and 18 mm/s

Table 3. Vibration sensitivity factors for different materials.

Class	Material	Material factor, F_m
1	Reinforced concrete, steel, wood	1.20
2	Plain concrete, brick, concrete hollow blocks, lightweight-aggregate concrete	1.00
3	Autoclaved aerated concrete, plaster, lath-and-plaster, stucco, render, etc.	0.75
4	Sand-lime brick, tiled oven with sensitive joints	0.65

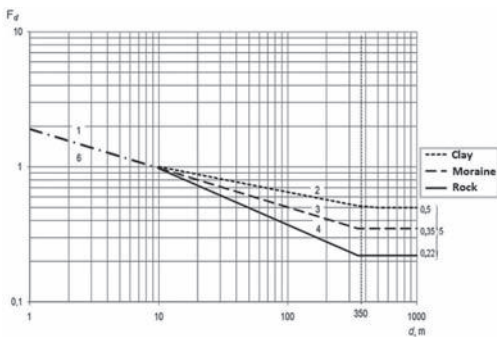

Figure 3. Uncorrected vertical PPV as a function of distance, d .

becomes 15 mm/s for rock, 12 mm/s for moraine and 9 mm/s for clay.

- When blasting in the immediate surroundings of a building, structure or installation ($10 \text{ m} \leq d$), special problems can arise. For example, unfavorable ground conditions such as the occurrence of horizontal joints can cause large displacements. Also the occurrence of high frequencies can demand both greater attention to the vibrations' amplitude and frequency content, and more detailed documenting of the blast.

5.4.1 *Blasting-work duration factor, F_t*

The blasting-work duration factor F_t is depends on for how long the blasting project will carry on.

5.5 *Calculating the maximum simultaneous charge*

There are various formulae for calculating the relationship between simultaneous charge energy and the magnitude of the detonation-shock-generated vibration waves that propagate through the ground toward an object of interest. In Sweden, blasters commonly

Table 4. Duration factors for different types of blasting works.

Class	Blasting-work duration factor, F_t
For the construction of tunnels, rock chambers, road cuttings, foundations, etc.	1.0
For permanent works such as rock quarries and mines	1.0–0.75

use the formula from Langefors & Kihlström's "The Modern Technique of Rock Blasting":

$$V = K (Q/R)^{1.5} 0.5$$

K = A specific constant (20–400) for the site in question. It has a higher value if blasting is closer to a building and/or if the building is founded on rock. It has a lower value if blasting is further away from the building and/or if the building is founded on softer rock or soil.

R = Distance (m) between blasting and the object of interest.

Q = Maximum charge per interval (kg) [max. simultaneously detonating charge weight].

v = Peak particle velocity, PPV (mm/s).

For experienced blasters, this formula offers an easy way to calculate the likely level of vibration. Its disadvantage is that the K -factor has to be calculated or guessed before each blast.

5.5.1 *Regression analysis of data from test blasting and/or routine blasting*

Another method used is linear regression analysis, which enables us to log mathematically the values from several test blasts (or from production rounds) using the following scaled distance formula:

$$V = A (R/Q^{0.5})^B$$

A, B = site-specific constants.

The constants A and B are calculated by linear regression analysis. This gives, in a double logarithmic diagram, a centroidal straight-line graph with 50% of the values above the line and 50% below it. The level of safety can then be raised by multiplying the A factor with one or two standard deviations that give confidence levels of 84% and 98% respectively. The formula can be updated easily with new blast data. The worksite constants A and B vary significantly between different worksites and the type of blasting. Typical values can be:

$A = 200\text{--}3000$

$B = -2.0\text{--}1.0$ (the gradient)

Bench blasting normally gives lower A and B values than tunnel blasting. Tunnel blasting gives a steeper line, so has a higher intersection on the y-axis compared with bench blasting.

In test blasting, the use of regression analysis together with vibration prediction formulae enables blasters to determine safe values and optimize future blasts. This methodology is also used during production in order to maintain optimally safe and optimally productive blasting.

6 NORTHERN LINK PROJECT

The Stockholm Northern Link project is a SEK 14-billion (USD 2 billion) scheme to build a 5-km, mostly underground expressway, which will become the third completed quadrant of the city's long-planned inner orbital expressway, locally called "The Ring". Consisting of twin, parallel 3-lane main tunnels and a complex of junctions, inlets and exits, it includes a total of 11 km of tunnels, 9 km of which are in rock. Excavated by drill-and-blast, they have cross-sections of 70, 90, 120 and 260 m² for 1, 2, 3 and 4-lane tunnels respectively. Including ramps and other surface cuts, over one million m³ of rock have been blasted in this project. Scheduled to open to traffic in 2015, the Northern Link's tunnels run beneath a variety of urban environments, including public institutions, residential and commercial properties, and an important city-state park.

In addition to serving the Stockholm region, the Northern Link will connect European highways E20 and E4 with the Värtan-Frihamn port, Sweden's most important port for passenger traffic to Finland, the Baltic States and Russia. In doing so, it will also become the eastern extremity of the Swedish leg of the E20, which, interspersed



Figure 4. Stockholm inner orbital expressway per 1992 Dennis Agreement.



Figure 5. The Northern Link is the eastern extremity of the Swedish leg of the E20, which runs through seven countries.

by 3 seas, runs from Shannon Airport in the west of Ireland to St Petersburg in Russia via England, Denmark, Sweden and Estonia.

6.1 *Vibration dampers, extreme caution and 100 active measuring points daily*

Much of the blasting work has had to be carried out with extreme caution. For example, five of the tunnels pass directly under (or very close to) the AlbaNova University Center, at one point just 7 m below it. As Stockholm's main research and education center for physics, astronomy and biotechnology, the AlbaNova center contains expensive, extremely sensitive instruments whose resistance to vibration is measured in $\mu\text{m/s}$. A short distance away, six of the tunnels cross a just few meters under or over existing tunnels in the Stockholm metro. Moreover, at certain places on the route, there was little or no rock cover, so the rock there had to be reinforced before tunnel excavation.

Throughout the works, the safety of passengers on the metro, which has continued to operate, has had to be guaranteed, while disturbance of researchers, residents, workers and road traffic has had to be kept to a minimum. To prevent blast-induced vibration from damaging vibration-sensitive equipment that works at nano-precision, Nitro Consult also devised and installed vibration isolators where needed. This enabled research activities to proceed normally during the rock excavation phase.

Together, these circumstances have presented great technical and organizational challenges. Added to this, project economics have required blasting to be carried out every day in five or six tunnels simultaneously in order to maintain high productivity with minimal disturbance. All these demands have been met through a combination of knowledge, experience, digital technology and advanced mathematics.

6.2 *Consulting and construction management*

Nitro Consult assisted with ground investigations and helped to solve design issues and draft con-

struction documents for the rock tunnels. We also conducted a series of test blasts to obtain basic data about vibration transmission through the rock, which contractors were then able to use during the bidding stage. We posted construction managers on six of the Northern-Link (NL) contracts.

In all NL contracts, we have been responsible for measuring vibration, airblast, noise and structure-born sound in buildings, objects, equipment and the underground railways. Approximately 100 measuring points have been active daily. All measured values are reported via GSM links to NCVIB, the online reporting, monitoring and evaluation system developed by Nitro Consult. With the aid of NCVIB, events such as vibration, airblast, noise, pore pressure and crack extension can be analyzed, evaluated and compared with instantaneous charge weights.

We have been taking the structure-borne and airborne sound-level measurements 24 hours a day. The client, contractors and other authorized parties can read these measurements continually online via the NCVIB portal. The portal has also been used by contractors to post the scheduled blasting times every morning, which has enabled researchers in the AlbaNova University Center and Royal Institute of Technology (KTH) to plan their vibration-sensitive activities accordingly.

Before the vibration-generating works began, we surveyed about 200 objects, which we are now resurveying to inspect for any related damage.

6.3 Introduction of electronic blast initiation

The complex geological, geotechnical, environmental, constructional and logistical relationships in the Northern Link project induced some interesting insights and developments regarding the current integration statuses of the various digital design, control and reporting technologies used in drilling and blasting operations.

Of particular interest was the decision in Contract NL35—where tunnel cross-sections ranged from 15 to 320 m²—to use a fully programmable Electronic Blast Initiation (EBI) system to try to raise productivity in difficult areas without exceeding prescribed PPVs. The aim was to use EBI to get better control over PPVs and maximize the advance per round.

The attraction of EBI—in this case the Orica i-kon™ VS system—was its programmability and its capacity to give each hole in the round a unique and precisely effected delay time of up to 8000 ms. Another attraction was that Orica SHOTPlus-T, the blast design software in use, had a degree of integration with the i-kon VS system and could also interface with the NCVIB vibration reporting and evaluation system. This gave significant ben-

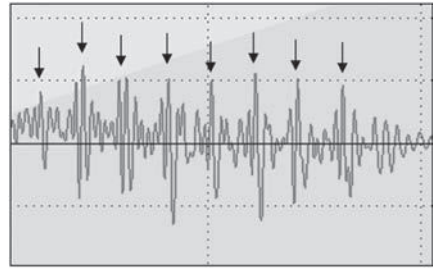

Figure 6. Waveform showing individual shotholes detonating.

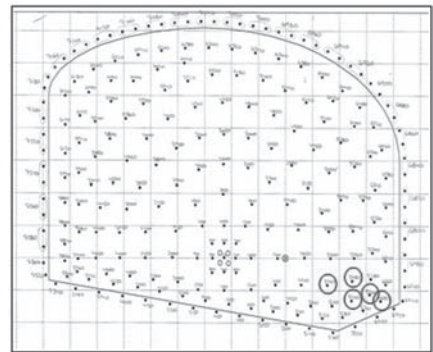

Figure 7. Correlating PPVs with shotholes the blast plan.

efits, for it was possible not only to read quickly online each blast's PPV values but also to identify in the recorded waveforms the individual shotholes detonating.

Additionally it was possible to match each PPV with its correlate shothole in the initiation plan and to view in the recorded charging data the hole's explosive-charge weight. This made it easier to control PPV by quickly adapting the drilling pattern, charging plan and/or initiation sequence to give compliantly the maximum advance per round.

EBI was, for example, used along a project-time-critical 250-m section of a 110–125 m² tunnel that had to be driven parallel to and 10 m distant from an existing heating-supply tunnel, which was subject to a PPV limit of 100 mm/s in any direction. This value had been prescribed in the tender documents, which also gave guideline values for Maximum Instantaneous Charge Weights (MICs) in various sections of the tunnel. (These values had been determined on the basis of earlier test blasting done by Nitro Consult.)

To achieve PPV compliance by resorting to traditional solutions like reducing the MICs or

7 STOCKHOLM CITY LINE

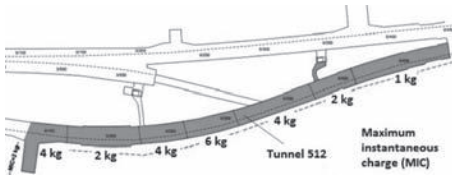

Figure 8. Instantaneous charge weight restrictions in tunnel 512.

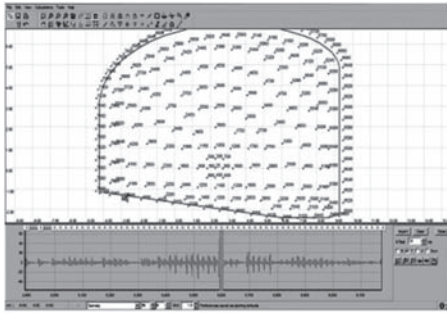

Figure 9. Using SHOTPlus-T and the NCVIB system to compare the recorded waveform with the initiation sequence.

segmenting the face would never have given the target advance rate of 6 m/blast. Another solution—extending the pyrotechnic detonator delay range using surface offset (blocking) delays—was tested and found to be effective, but still could not guarantee single hole firing. Moreover, its deployment over >250 holes was both complex and labor-intensive.

By introducing the i-kon VS EBI system and exploiting what interactive possibilities there were with the SHOTPlus-T blast design software, drill-rig navigation system and NCVIB, the contractor, JV Hochtief-Oden Tunnelling, was able to both maintain the desired full-face advance rate of 6 m/blast and comply with the prescribed PPV limit. As a result, the tunnels were completed 2 months ahead of schedule.

In spite of this success, the experience in Contract NL35 exposed the need for more integration between the various digital technologies used in drilling and blasting. Both Orica and Nitro Consult believe development in this area should be prioritized, since it contains many possibilities to further optimize the efficiency of the drill-and-blast tunneling method, especially in more complex environments. Add to this the ever-safer and more eco-friendly bulk emulsion systems we use today, and the method's applicability will continue to grow.

The Stockholm City Line (Citybanan) will be a 6-km, double-track underground railway running north-south beneath central Stockholm 10–45 meters below street level, underneath the existing metro network. It is intended to enable normally overland commuter trains to traverse the city swiftly and quietly underground, and will include three new stations, Stockholm City, Stockholm Odenplan and Stockholm South. The platforms for the two central stations are being excavated below the existing underground metro stations, T-Centralen and Odenplan. With excavated dimensions of 260-m × 220 m, they will enable passengers from outlying suburbs and towns to transfer easily on to the metro and bus networks, right under the heart of the city.

The excavated cross-section of the main tunnel is 130 m², splitting into 2 × 80 m² tunnels at platform approaches. There are 4 works-access tunnels, and the entire scheme requires about 1.5 million m³ of rock to be excavated by drill-and-blast.

The new high-capacity line will double the city's north-south-commuter railway capacity. This will relieve greatly the congested 1200-m central-bridge known locally as the “wasp waist” of Stockholm.

With an estimated construction cost of SEK 17 billion (USD 2.4 billion), it represents the biggest investment in the Swedish capital's railways since the Stockholm Metro in the 1950s. Construction proper started in January 2009, and the City Line is scheduled to open in 2017. The scheme includes also a parallel service tunnel, two underwater concrete tunnels and a 1.5 km railway bridge.

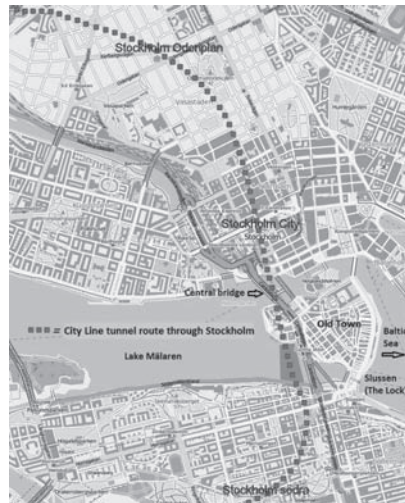

Figure 10. City Line tunnel route under central Stockholm.

Because the City Line will run underneath public, residential and commercial properties of many ages and types—and through a variety of both natural and artificial geotechnical conditions—cautious blasting frequently is necessary. Excavation methods, strategy and round-lengths are pre-designed, and adjusted continually during the construction process.



Figure 11. Main contractors on the City Line project.



Figure 12. The City Line will run under Riddarholmen, the islet and ancient seat of power on the west side of the central bridge.



Figure 13. There is often little rock cover between new and existing tunnels.

Nitro Consult has been involved in the project from the outset, starting with ground investigations, a risk assessment for the vibration-generating works and assisting in the design and drafting of construction documents for the Vasa Tunnel, which runs between the northern portal and Odenplan Station. Additionally, our vibration team performed a series of test blasts to determine vibration limit-values for vulnerable buildings such as the Gustav Vasa Church at Odenplan, and other sensitive installations in the metro and elsewhere.

In joint venture with Ansvarsbesiktning AB, we are responsible for measuring vibrations, noise and structure-borne sound along the entire route of the tunnel, which we are doing via about 500 active measuring points daily. We are also doing structural surveys of all buildings and other facilities within the risk zone (a 300 meter-wide corridor along the tunnel route) both before and after the works. The handling of all related questions and enquiries from neighbors and other third parties is also down to us.

7.1 Stockholm City Station

Most of the tunnel excavation for the scheme is now complete. So too are the vast and extremely challenging rock excavations for Stockholm City Station, which is being constructed under and over T-Centralen, the central underground metro station.

The approach tunnels here have had to cross under existing metro tunnels in an area of high horizontal rock stress with as little as 3 m of rock cover, extremely close to sensitive installations. Excavation strategy and vibration control were therefore critical. Tunnel excavation in this area was divided into very short sections, each of which was prescribed to be permanently reinforced before starting the next. Here too, electronic blast initiation was introduced to better control blast-induced vibration by giving each shothole a unique firing time.

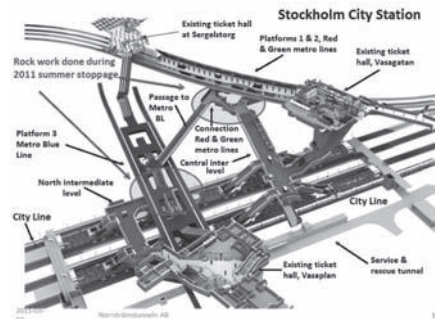

Figure 14. About 470 000 m³ of rock was excavated to make space for Stockholm City Station, a multi-modal interchange.

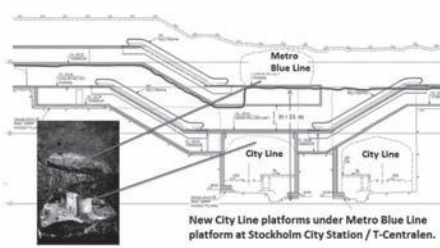

Figure 15. Excavating the 57, 200 m³ City Line platform chambers directly under the metro.

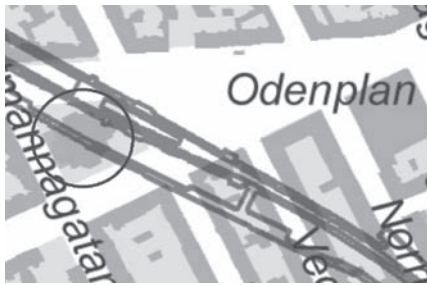

Figure 16. Gustav Vasa Church (encircled) above tunnel route.

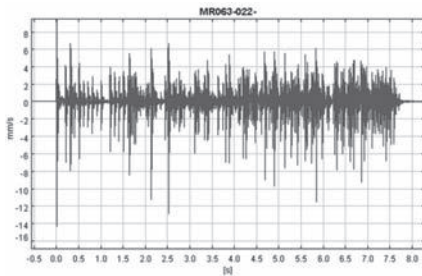

Figure 17. NCVIB: Example of blast vibration time history.

This enabled the contractor, NCC, to maintain advance rates of 3 m per round, keeping PPV values at 50–60 mm/s. In some zones, however, even cautious blasting had to be abandoned. For example, 3 meters before a City-Line breakthrough very close to an existing metro platform, the contractor decided to crack and break up the face mechanically. It took 10 days (140 h) to excavate the last 3 m in this way.

7.2 Stockholm Odenplan Station

Similarly challenging conditions face contractors at Stockholm Odenplan Station, which is about to

be excavated below Odenplan underground metro station. Among other valuable buildings and infrastructure in the area, the tunnels here will pass directly under Gustav Vasa Church, a conservation landmark. Since its foundations are in rock, this building is especially vulnerable to blast-induced vibrations.

Their PPV limits at the church foundations are just 18 mm/s, with an “alarm” level of 13 mm/s. In practice, the PPV values in the service & rescue tunnel (Fig. 18) are 13–17 mm/s during almost every blast. Here too, electronic blast initiation is being used by contractor Bilfinger Berger to give each hole a unique firing time, and NCVIB is being relied on intensively to provide virtually real-time blast intelligence.

The measured values are analyzed continually by regression analysis, the results of which NCVIB converts into a raft of useful and executable data, including a calculated MIC weight for the next round.

7.3 Controversy

The City Line project has not been without controversy, however. Several hundred complaints about vibration, noise and even damage have been received. But in fact, human over-perceptions of



Figure 18. NCVIB: Green X symbols show active measuring points in, under and around Gustav Vasa Church. (Yellow dynamite symbols show blasts and progression.)

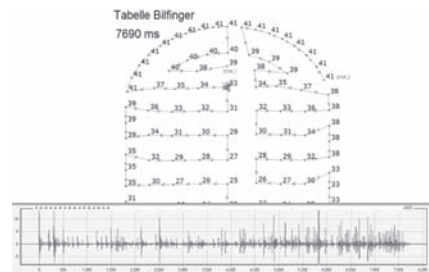
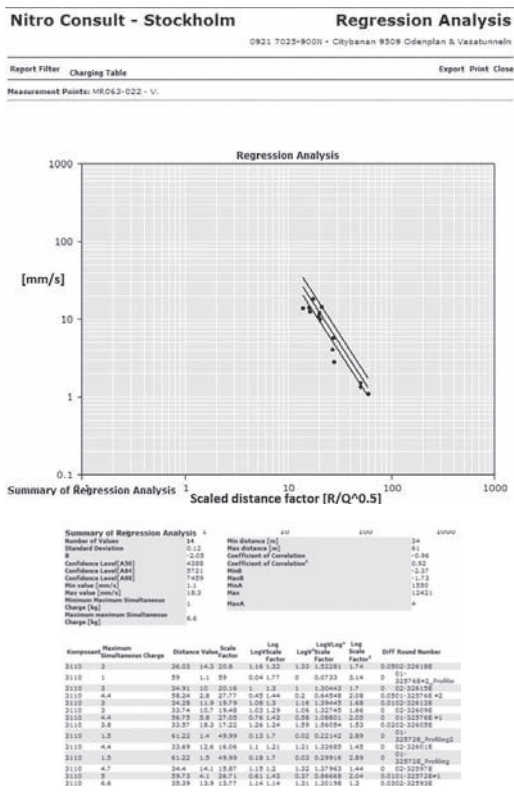

Figure 19. Using SHOTplus-T and the NCVIB system to compare the recorded waveform with the initiation sequence.



Figures 20–21. A regression analysis and summary enable rapid blast diagnosis and are used to calculate subsequent MICs.

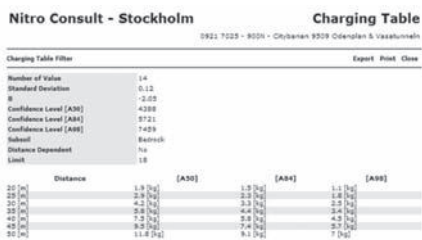

Figure 22. Calculated MIC weights for confidence levels 50, 84 and 98% give perspective and facilitate decision making.

blast vibration values are mostly fear-based and seldom reflect any real danger or discomfort. Similarly, only a very small proportion of the damage claims could be shown to be due to blasting.

However, there has been one major damage event. In November 2011, the Maria Magdalena Church graveyard sunk and collapsed into the tunnel during excavation under Södermalm in the

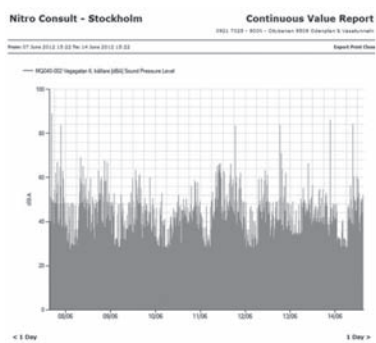

Figure 23. Both structure-borne and airborne noise are measured, analyzed and controlled 24 hours a day.

South. There were no injuries, but the event caused great alarm and months of delay while an investigation was carried out and reinforcements made. The overlying rock had been reinforced prior to excavation.

8 CONCLUSION

Drill-and-blast is not always possible, regardless of rock integrity and hardness. At some points in the depths of the Stockholm City Station, for example, the contractor had to resort even to wire sawing. But by perfecting the science of vibration control and exploiting valuable new technologies like the NCVIB suite of reporting functions and electronic initiation systems, the drill-and-blast method can be extended into ever-more complex environments, where many of today's tunnels must be constructed. For this, clear and reliable guidelines and standards are essential. While revising Swedish Standard SS 4604866, which has been consulted widely during these projects, the aim was not only to facilitate safe and effective vibration control but also to enable productivity to be optimized. What we shall continue striving to achieve is seamless integration of the respective digital technologies used in rock excavation to enable control, monitoring and reporting of the full cycle with ever-higher levels of confidence.

REFERENCES

Eriksson, Per; Nord, Gunnar & Kay, Dave 2010. Opportunities to optimise project economics through application of digital drill and blast technologies.
 Persson, Lars 1998. Engineering Geology of Stockholm, Sweden. *Bulletin of Engineering Geology and the Environment* Volume 57 (Number 1): 79–90.

Vibration measurements and modelling for blasting in a hard rock tunnel

A.T. Spathis & M. Rothery

Orica Mining Services Technical Centre, Kurri Kurri, NSW, Australia

ABSTRACT: Orica Mining Services was contracted by Macmahon and Bouygues Travaux Public to conduct a blast evaluation along the proposed Northern Link tunnel route in Brisbane, Australia. The field work conducted at three sites along the proposed tunnel line involved the firing of 46 individual charges below the ground and had masses between approximately 400 grams to 1600 grams. The ground vibrations produced by the charges resulted in 468 triaxial recordings at distances between approximately 15 to 288 metres. Charge weight scaling laws were derived for each site and also from the combined data. Based on the 95% charge weight scaling regression line for the combined data, it was found that the maximum advance in a horizontal blasting round can lie between 3.0 and 5.3 metres depending on the hole diameter and density of the explosive used. In order to examine interaction effects between multiple charges a Monte Carlo waveform superposition model was used and this showed little evidence of vibration overlap from different blastholes for typical timing intervals greater than 100 milliseconds. Reduction of the timing interval to (say) 25 ms that may be controlled accurately by electronic delay detonators predicted some overlap but a shorter duration blast.

1 INTRODUCTION

Orica Mining Services (OMS) was contracted by Macmahon and Bouygues Travaux Public to conduct a blast evaluation along the proposed Northern Link tunnel route in Brisbane, Australia. The work was designed to give information on the vibration levels likely from drilling and blasting activities. OMS proposed that a series of single hole charges be fired at horizons in the vicinity of potential underground workings and that the vibrations produced be measured over a range of distances. Such studies are common in forming so-called charge weight scaling laws that may be used in vibration prediction. It was also proposed that the work consider the application of waveform superposition modelling to examine the effect of delayed sequence blasting and its effect on the likely vibration levels.

Key assumptions of the work are that:

- charges are representative of those in a tunnel blast including such factors as
 - the coupling and disposition of the charges in the rock mass
 - the quantity of charge
 - the horizon of the charge with respect to the surface
 - the rock type and hydrology in which they were fired

- minimal influence of the free surface created by the tunnel
- charges fired produced limited localised damage so that later firing charges used in the study had similar vibration output
- vibrations monitored from the charges may be used as signature waveforms for waveform modelling.

The assumptions above are tested to some extent by the experimental work conducted. The study was conducted at three blasting locations along the proposed tunnel line: Thorpe Street, Hume Street and Plunkett Street.

The paper presents the information collected as two distinct parts: an analysis of the raw data to produce charge weight scaling laws for probabilistic design curves; a waveform modelling approach using a statistical linear superposition technique. The regression analysis used for the charge weight scaling laws is described in the Appendix. The method of fitting and the quality of the fit are discussed, including the use of a percentile limit that includes a given percentage of the data assuming that the mean residual error applies across the whole span of data.

2 EXPERIMENTAL WORK

2.1 Overview

Figure 1 shows a plan view of the proposed tunnel route and also the approximate location of

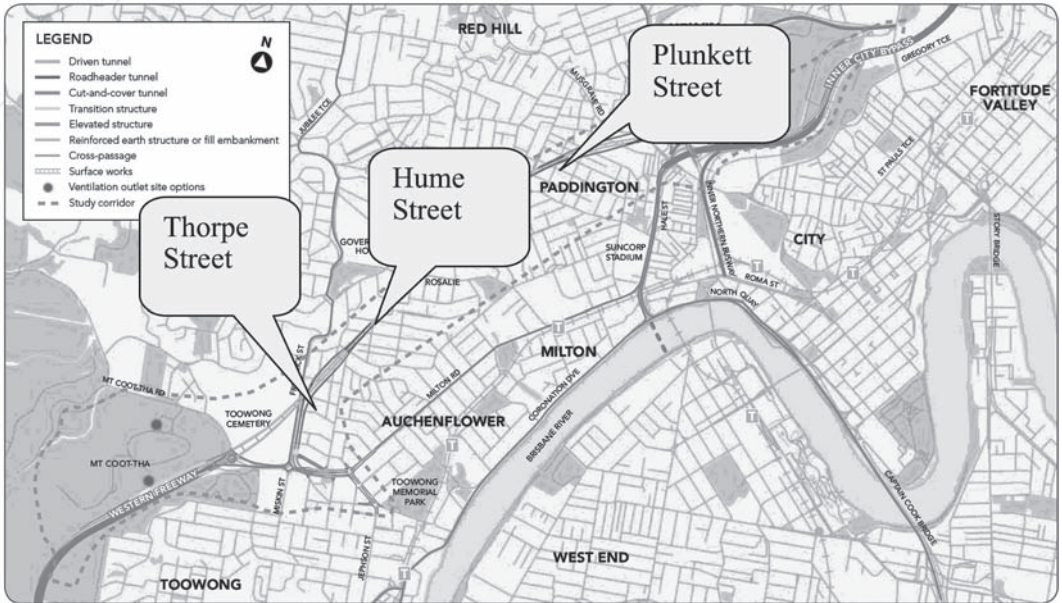

Figure 1. Approximate location of the three sites used for the test blasts.

the three test blast locations for the present study. It is clear that the first two of the sites chosen are close together (within approximately 700 m) and that the other site is some 1.4 km further on. Our information suggests that all three sites are in the phyllite rock mass.

At each site multiple holes were drilled although not all could be used as some holes collapsed. Several independent charges were fired in each of the blastholes and at different horizons within them. Each charge used a high-strength, detonator-sensitive packaged explosive Senatel™ Powerfrag™ with a standard cartridge size being 55 mm diameter and 300 mm length and nominal mass of 830 grams. The charges were weighed and fired individually. The charges had nominal masses of approximately 400, 800, 1200 and 1600 grams to give a good spread of scaled distances. The charge details are provided in Appendix A. Each charge used two iKon™ detonators to provide some redundancy in the initiation. Charges were generally fired in the lowest horizon first, followed by subsequent charges in the same hole but at decreasing depths down the hole. Charge weights usually commenced with the smallest charge followed by increasing charge weights but with the last charge in each hole usually being small. Using the smallest charge at the bottom cleared the hole of any water that might have been present and created a better spread of scaled distances. The details of the number of blast events and number of triaxial vibration recordings is summarised in Table 1.

Table 1. Data collection summary.

Site	Number of test charges	Number of triaxial recordings
Thorpe Street	15	72
Hume Street	12	223
Plunkett Street	19	173

The charges were placed into a given hole and located at the desired horizon. Each charge was covered with three metres of stemming material (gravel sub-10 mm). This ensured effective coupling of the charge to the rock mass and also minimised the risk of stemming ejection. Standard shot-firing procedures were followed before firing each blast-hole. This included satisfactory protection over the blasthole collar and adequate warning before firing, followed by an all clear at completion of each blast event. It was observed that most of the holes were water-filled and that the water was pumped to the surface by the high-pressure gasses produced by the explosive action. All blasts fired according to plan.

The vibrations were monitored using a range of equipment and transducers. The majority of the data was recorded on Kelunji Echo 24 bit, 2 kHz digital acquisition systems or on Startek 24 bit, 50 kHz digital acquisition systems. These systems record continuously and are not hampered by unwanted trigger signals that may arise from local activities such as traffic or other cultural noise.

They can also use traditional triggering methods such as threshold levels or the ratio of the short term to long term average. The transducers were PCB Piezotronics triaxial accelerometers with 0.5 g, 5 g or 10 g maximum range. The recorded data was integrated in the post-processing to produce the traditional particle velocity data used in the Australian Standard AS 2187-2006 that includes guidelines for blast vibration monitoring and vibration limits. A number of compliance monitoring systems were deployed and these used standard triaxial geophone sensors and Instatel Blastmate recorders with 16 bit, 2 kHz digital acquisition systems with threshold trigger.

Special care was taken to couple the transducers at each monitoring location. The preferred method for surfaces thought to accurately replicate ground motion is to secure the transducer to a metal plate which in turn is glued with brittle epoxy resin cement (Plastibond™). Some transducers were coupled to soil and this required the excavation of a small hole about 200 mm diameter and 150 mm deep into which a circular cylindrical block was inserted and the soil tamped around it to ensure solid and firm coupling to the surrounding soil mass. The transducer was bolted to the top of the buried cylinder.

The careful blast implementation and deployment of the measurement systems ensured the best prospect for good quality recordings.

2.2 Charge weight scaling

The Appendix gives an overview of the method of data analysis applied to the raw charge weight scaling data. Briefly, the vibration data is recorded at various monitors on the surface for each blast and the distance between the charge and each monitor is calculated from survey data and combined with the charge weight to produce a so-called scaled distance. The data is assumed to follow a charge weight scaling law of the form,

$$ppv = K \left(\frac{x}{\sqrt{W}} \right)^n \quad (1)$$

where ppv is the peak particle velocity recorded, x is the distance between the charge and a given monitor and W is the charge weight. K is the scale factor and n is the attenuation factor, both of which are found from a linear regression curve fit to Equation 1 after it has been linearised by taking logarithms of both sides. The term in brackets is termed the scaled distance (SD). Details may be found in the Appendix. It should be noted that for the purposes of this report, it is the vector peak particle velocities (VPPV) that are presented as

these provide a conservative estimate of the vibration levels observed for any one component. The components are used in the Australian Standard AS 2187-2006 as the relevant threshold limit so the results presented here are conservative, typically of the order of 10–30%.

In the analysis that follows, the data is presented individually for each blasting site and for the aggregate of all data. Charge weight scaling laws are found for each of these data sets and the adequacy of the assumptions for such a fit are presented as well. Finally, design charts are produced for the charge weights that will restrict exceedances based on the overall results and certain confidence levels drawn from the peak particle velocity data alone. The reader is directed to the Appendix that gives the concepts used in the data analysis and presentation that follow.

2.3 Thorpe Street results

The Thorpe Street site was the first test site in the study. Our procedures were fine tuned but followed the original plan in the sequence of blasting, the conduct of the blasting and the layout of the monitoring stations. As with all the sites the local terrain, traffic patterns and disposition of residences in the vicinity were considered.

Figure 2 shows the raw vector peak particle velocity data versus the scaled distance for Thorpe Street on a log-log plot. The spread of scaled distances is good. We fit a straight line to the transformed data and then check the strength of the assumptions that such a fit is well-founded statistically. The summary data in Table 2 gives information

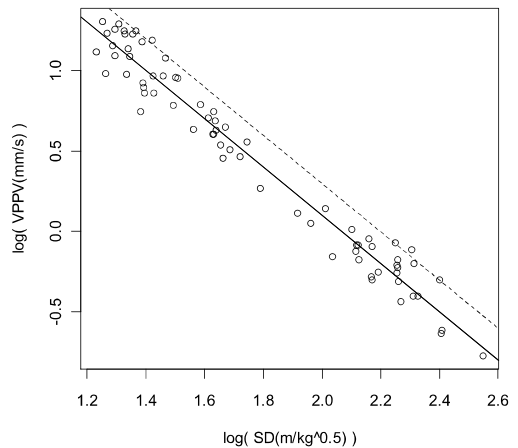

Figure 2. Thorpe Street vibration data with linear regression fit to transformed data. The dashed line is estimated from the mean standard error of the residuals at a 95% confidence level.

about the straight line fit to the Thorpe Street data. Figure 2 also shows the data, the fit and the line that includes the data assuming the mean standard error of the residuals applies across the complete data set at a 95% confidence level.

Figure 3 (a) and (b) show plots of the fit residuals and a probability plot, respectively, and confirm the normality assumptions for the estimate of the linear regression line.

2.4 Hume Street results

The Hume Street results are given in Table 3. Again the data quality is good (Figures 4) and examination of the residuals shows no disturbing trends (Figure 5 (a)). The normal probability plot (Figure 5 (b)) supports the assumption for the linear regression line albeit with some deviations at the smaller and larger quantiles.

2.5 Plunkett Street results

Plunkett Street was the third site used in the study. The work was conducted a week after the previous two sites. The data quality is good (Figures 6), the residuals (Figure 7 (a)) show no trends and the normal probability plot (Figure 7 (b)) is good. Table 4 gives the fit parameters.

2.6 Combined results

The results from the three sites are combined in this section. While there is some variation in the charge weight scaling law parameters from each site, the authors understand that the rock type is similar so it is prudent to look at the data as a whole. Figure 8 shows the transformed data, the linear regression line, and the line estimated from the mean standard error of the residuals at a 95% confidence level. Table 5 summarises the regression line data. There does not appear to be any trend in the residuals (Figure 9 (a)) and the probability plot (Figure 9 (b)) is quite linear with some deviation at the smaller and larger values.

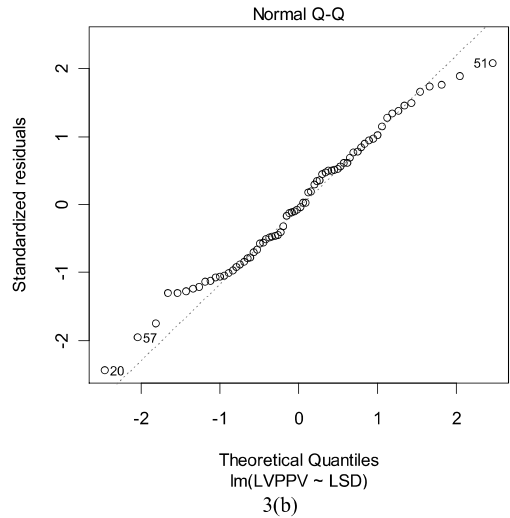
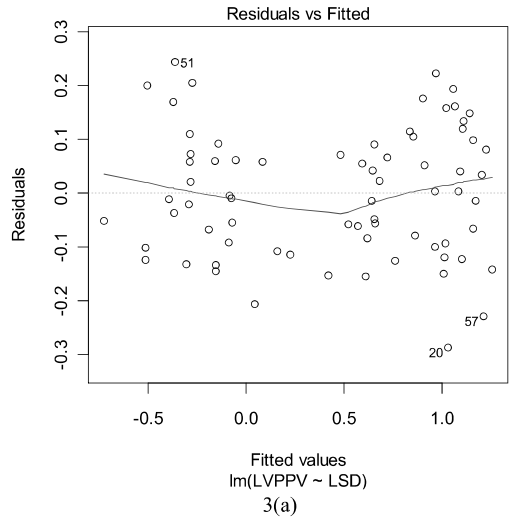

Figure 3. Thorpe Street (a) Plot of the residuals of the fit versus the fitted points (b) Probability plot for the regression fit.

Table 2. Linear regression parameters for Thorpe Street.

Parameter	Mean	Standard error	95% lower	95% upper
Log10 (K)	3.10	0.064	2.97	3.23
n	-1.50	0.035	-1.57	-1.43
Log10 (K*)	3.30			
MSE = 0.119 for 70 degrees of freedom $r^2 = 0.962$				

Table 3. Linear regression parameters for Hume Street.

Parameter	Mean	Standard error	95% lower	95% upper
Log10 (K)	2.84	0.053	2.74	2.95
N	-1.37	0.029	-1.42	-1.31
Log10 (K*)	3.13			
MSE = 0.171 for 221 degrees of freedom $r^2 = 0.912$				

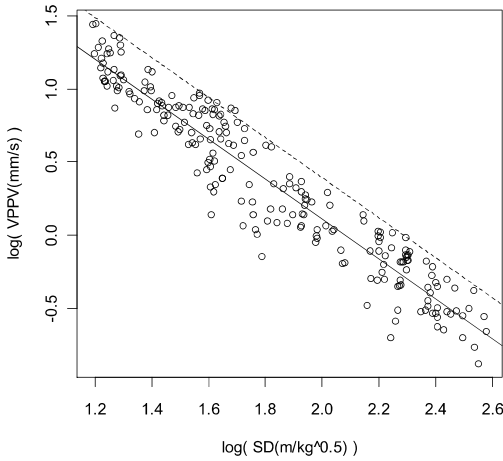

Figure 4. Hume Street vibration data with linear regression fit to transformed data plus a line estimated from the mean standard error of the residuals at a 95% confidence level.

2.7 Discussion

The data from the three sites show good consistency within each site and also when grouped as a single entity. The assumption of a normal distribution of the residuals for each site is supported generally by plots of the residuals from the linear regression line and by the associated probability plots. The linear regression data yield the charge weight scaling equations (Equation 1) for each of the sites and for the combined data and these are given in Table 6.

Also shown are the charge weight scaling equations for the line estimated from the mean standard error of the residuals at an upper 95% confidence level.

The regression lines estimate the vector peak particle velocity at each of the sites. As these lines predict the vector peak levels, they are conservative in terms of the component peak levels (radial, transverse and vertical) by perhaps 10–30%. That is, they are likely to overestimate any one component peak level and it is these latter levels that form the basis of the Australian Standard AS 2187-2006.

If we wish to be even more conservative in our estimates, then it is possible to use the 95% regression lines given in Table 6. These lines have assumed the same slope as the mean lines but include all the data by using the mean standard error of the residuals to estimate the intercept of the line which provides an estimate of the scaling coefficient, K , in Equation 1.

The K values of the individual sites span a factor of three (697 to 2158), while the slopes range from just under 1.4 to just over 1.6. A feature of

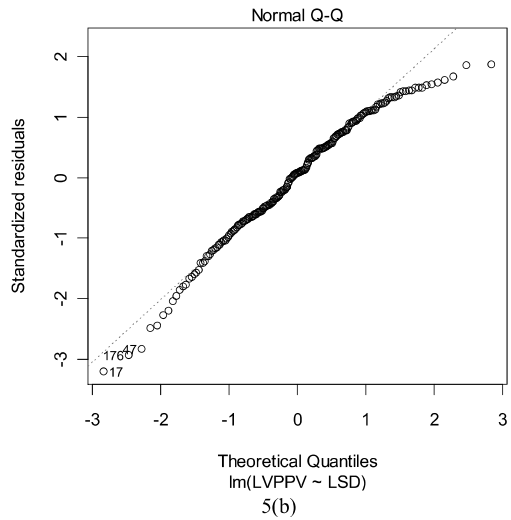
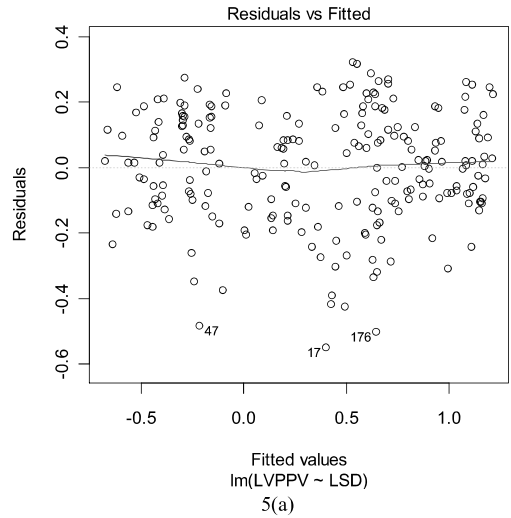

Figure 5. Hume Street (a) Plot of the residuals of the fit versus the fitted points (b) Probability plot for the regression fit.

the regression lines is that the larger K values are associated with larger absolute values of the slope, n . This means that in the regression of the data, the sites that had more attenuation with scaled distance also had the larger scaling coefficient.

Australian Standard AS 2197-2006 suggests various peak vibration levels for the components of the ground vibration. Threshold levels are suggested for the onset of cosmetic damage and are given in the form of charts that rely on frequency information. For example the vertical component at the nearest location to the firing of a 1657 gram charge in Plunkett Street is shown in Figure 10.

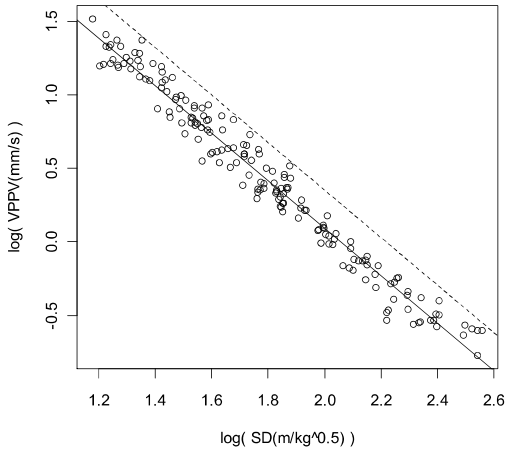

Figure 6. Plunkett Street vibration data with linear regression fit to transformed data plus a line estimated from the mean standard error of the residuals at a 95% confidence level.

The mean frequency content of the waveform, where the average is over the three components is shown in Figure 11 and the percent cumulative power in Figure 12.

Little energy (less than say 10%) exists in frequencies below about 20 Hz in the vibration shown in Figure 12. If we chart the component vibration data against the British Standard as given in AS 2187-2006, we see that the data lies well below the residential threshold across the entire frequency range (Figure 13). So for the largest recorded vibrations from all three blasting sites we see no prospect of an exceedance against the requisite vibration standards for cosmetic damage.

In order to predict the size of a single charge in any one blasthole in a tunnelling round, it is possible to use the charge weight scaling law and plot the peak particle velocity. Figure 14 shows the results where we have used the charge weight scaling law for the combined data based on a 95% confidence level. Curves are shown for a 1, 2 and 3 kg charge together with an AS 2187-2006 vibration component limit of 25 mm/s. The plots show the vector peak particle velocity versus the distance between the charge and the point of interest. It is important to recall that the components may be 10% to 30% lower and hence the information in Figure 14 is conservative. The curves suggest that for any of the charges shown there is no exceedance of the 25 mm/s limit at 40 m distance. Indeed, the charge weight scaling law predicts that a charge of 4.3 kg is required to produce a 25 mm/s vibration at 40 m.

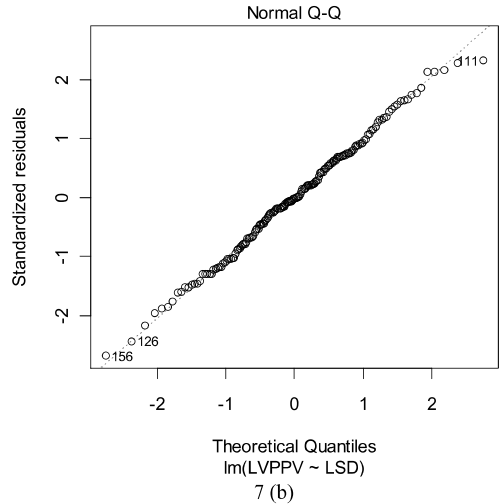
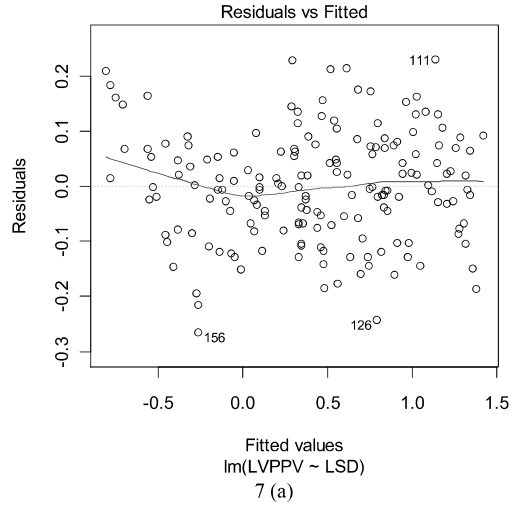

Figure 7. Plunkett Street (a) Plot of the residuals of the fit versus the fitted points (b) Probability plot for the regression fit.

Table 4. Linear regression parameters for Plunkett Street.

Parameter	Mean	Standard error	95% lower	95% upper
Log10 (K)	3.33	0.039	3.26	3.41
N	-1.62	0.022	-1.66	-1.58
Log10 (K^*)	3.50			
MSE = 0.100 for 171 degrees of freedom $r^2 = 0.970$				

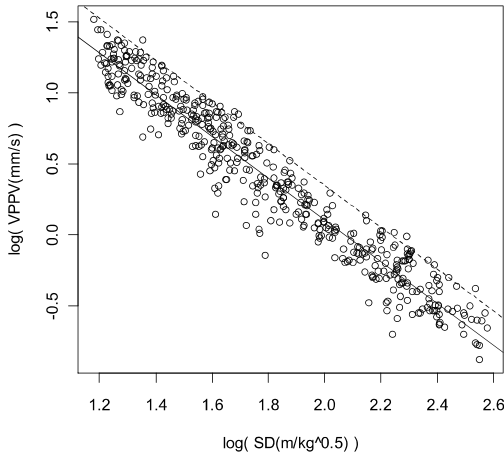

Figure 8. Combined vibration data with linear regression fit to transformed data plus a line estimated from the mean standard error of the residuals at a 95% confidence level.

Table 5. Linear regression parameters for combined data.

Parameter	Mean	Standard error	95% lower	95% upper
Log10 (K)	3.04	0.033	2.98	3.11
N	-1.47	0.018	-1.50	-1.43
Log10 (K^*)	3.13			
MSE = 0.148 for 466 degrees of freedom $r^2 = 0.936$				

Table 7 summarises some simple estimates of the tunnel advance possible for a round assuming vertical cover of 40 m and a set vibration limit of 25 mm/s for the vector peak particle velocity limit for two densities of explosive and hole diameter. It is assumed that the charged length is 90% of the advance.

The advance (m) in Table 7 may be calculated as,

$$Advance = \frac{4}{0.9\pi\rho} \frac{x^2}{d^2} \left(\frac{K}{ppv_{lim}} \right)^{2/n} \quad (2)$$

where ppv_{lim} is the required limit, d is the hole diameter, ρ is the density of the explosive and it is assumed that the charge length is 90% of the advance. All units are SI except for the parameter K which is scaled to yield mm/s in Equation 1 and ppv_{lim} is in mm/s.

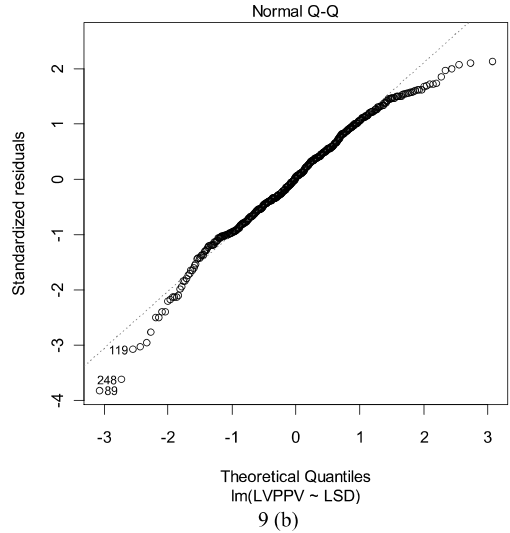
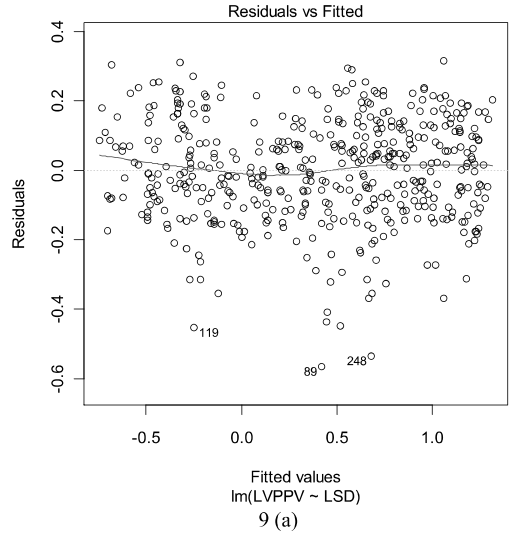

Figure 9. Combined data (a) Plot of the residuals of the fit versus the fitted points (b) Probability plot for the regression fit.

Table 6. Summary of charge weight scaling laws.

	Mean regression line		95% regression line	
	K	n	K	n
Blast				
Thorpe Street	1258	-1.50	1986	-1.50
Hume Street	697	-1.37	1336	-1.37
Plunkett Street	2158	-1.62	3156	-1.62
Combined data	1105	-1.47	1935	-1.47

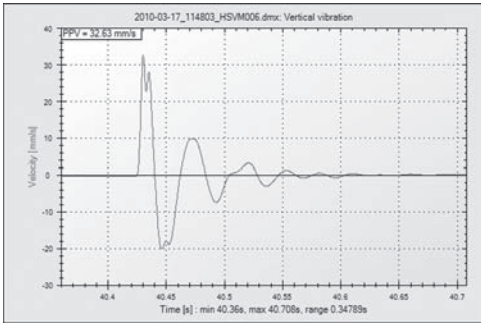

Figure 10. Vertical component of the vibration recorded at the nearest site to a 1657 gram charge fired in Plunkett Street.

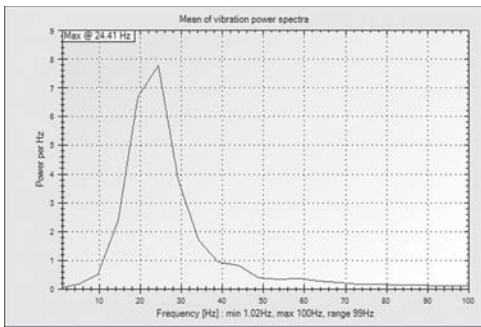

Figure 11. Mean vibration power spectrum for the vibration recorded nearest a 1657 gram charge in Plunkett Street.

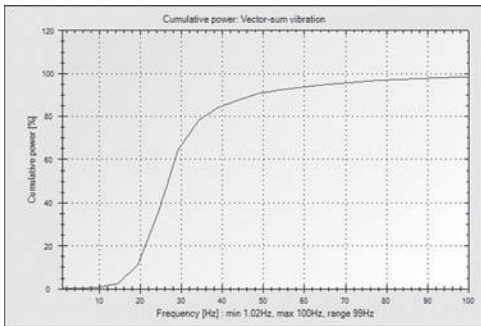

Figure 12. Percent cumulative power for the vibration recorded nearest a 1657 gram charge in Plunkett Street.

3 MONTE CARLO MODELLING

3.1 Waveform superposition model

Orica Mining Services Monte Carlo model uses linear waveform superposition to produce probabilistic blast vibration predictions. The model can be summarised in a few simple steps. Firstly, the

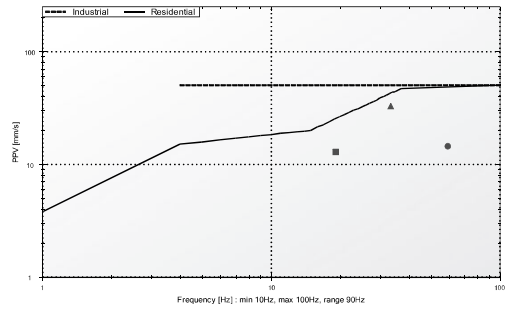

Figure 13. Plot of the component vibrations (□ transverse, ▲ vertical, ● radial) obtained for the largest vibration recorded nearest a 1657 gram charge in Plunkett Street. The threshold lines are those taken from the relevant British Standard and referred to in AS 2187-2006.

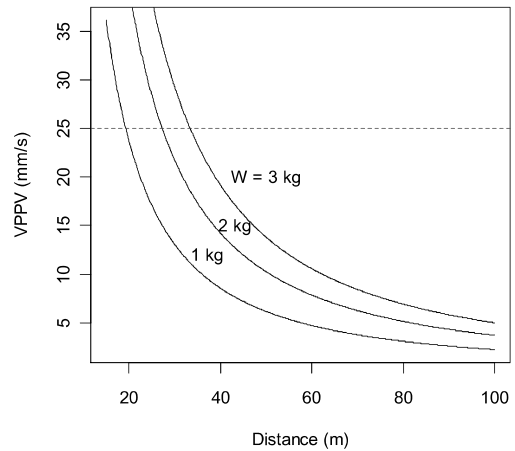

Figure 14. Vector peak particle velocity versus distance for a charge weight of 1, 2 and 3 kg. The plot is based on the 95% regression line for the combined data (Table 6). The AS 2187-2006 limit for human comfort for a component peak value is 25 mm/s (dashed line).

vibration from a single charge is used to quantify the vibration propagation characteristics at a specific site for a defined range of scaled distances. A seed wave is then selected to best represent the ray path taken by holes within the modelled blast. The distance, geology and geometry of the ray path all need to be similar between the seed wave and the holes in the production blast in order for the best results to be achieved. Usually, the final step is calibration of the model by adjusting the model parameters based on measured full-scale blasts.

The model requires as input the charge weight scaling law parameters (Equation 1) obtained from field measurements, an assessment of the ground velocity as this introduces relative time delays

Table 7. Predicted advance per round assuming 40 m cover and 25 mm/s limit.

Diameter (mm)	Density (g/cc)	Charged length (m)	Advance (m)
38	0.8	4.7	5.3
38	1.0	3.8	4.2
45	0.8	3.4	3.8
45	1.0	2.7	3.0

between charges at different locations, and an estimate of the coefficient of variation (COV) in the measured vibration data that encapsulates the variations from the mean regression line. The model also incorporates the statistical scatter of the delay times of the initiating system which is generally ten times lower for electronic delay detonators. It also can include the effects of local damage around a blasthole and also the reduction of vibration from a currently firing charge that has earlier firing holes between it and the point of interest. This last effect is termed screening and has been determined experimentally in surface blasting.

Monte Carlo modelling has primarily been developed and used in open cut mining and quarrying operations. There is one prior use of the Monte Carlo model in tunnelling at the Eastlink tunnel in Melbourne (Lesberg and Yuill, 2005, Blair, 2006). However, in that instance the model was not calibrated and applied to a site 1.5 km from where the site law was established. As a result the model over-predicted the expected vibration levels. This highlights two important criteria to achieve the predictive power of the model: it must be calibrated to provide accurate vibration predictions and the ground needs to be characterised over the length of the tunnel in case of variation. Whilst the model produced by this report is uncalibrated, it can easily be calibrated by the initial blasts during tunnel development. In any case, the model can still identify relative advantages between blast designs to help control ground vibrations while maintaining the desired advance.

3.2 Determination of Monte Carlo model parameters

Good consistency is evident in the charge weight scaling law data between the three sites used in the blasting study (Figure 8). This implies consistent geology. Despite the uniformity of the combined dataset, it was decided that the most accurate results would be obtained by treating each site individually. Scatter within the scaled distance datasets was then characterised for each site by calculating the coefficient of variation (COV) shown in

Figures 20 to 22. The estimate is determined iteratively by computer generation of simulated data that covers the observed field data variability.

P-wave velocity was determined based on the difference in arrival times between the closest sensor to the blast and each subsequent receiver. This method is based on the assumption that the wavefront expands uniformly outward from the seismic source. From the data each site was observed to have its own distinct P-wave velocity, (see also Table 8) with the velocity increasing towards the eastern end of the planned tunnel line. A lateral velocity gradient is not unusual and could be due to a number of geological factors such as difference in sedimentation, mineralogy, burial depth, temperature or pressure exposure etc. Minimal scatter in the data suggests once more that the geology is reasonably homogeneous which confirms the assumption of velocity uniformity near each site.

Site properties to be used as inputs for the model can now be accrued (Table 8). It should be noted that the model is uncalibrated. It is normal for an uncalibrated model to vary noticeably from reality and typically over predict ground vibrations generated by a blast (Blair, 2004). This was also the case when the model was applied to the Eastlink tunnel (Blair, 2006).

The last remaining input for the model is the seed wave. Selection of the seed wave depends entirely on the location of the modelled blast relative to the trial sites and the distance at which it is monitored. The seed wave selection is important as it encodes many factors such as wave separation, ray-path geometry, and frequency response that are not encompassed in the model parameters. Seed waves were chosen with the appropriate scaled distance.

As there are distinct but minor differences between the sites the best approach to calibration is likely to use a shifting calibration. With a shifting calibration every blast would be recorded, the calibration factor would be determined on a set of the most recent blasts. In this way gradual trends in the site law can be taken into consideration. For a shifting calibration to work effectively the accuracy of survey and loading information for the project would need to be kept to a very high level.

4 HYPOTHETICAL BLAST DESIGNS

Nine hypothetical blast designs were created using the same advance (3.1 m) to help optimise blast practices. Optimisation of blast designs is desirable in order to control ground vibrations while maintaining the desired advance. Variables tested include initiating system, trim blast timing and the presence of the slot which would have previously

Table 8. Model parameters for uncalibrated waveform superposition model based on single hole data.

Test site	K	n	COV	P -wave velocity (m/s)
Thorpe St	1258	-1.50	0.29	4330
Hume St	697	-1.37	0.37	4520
Plunkett St	2158	-1.62	0.25	4810

been excavated by a roadheader. Modelling was run for each site as changes to the charge weight scaling attenuation parameter or n value can alter the relative differences between models. Appropriate seed waves were also extracted from the data recorded at each site.

Evaluation of the performance of each design within the Monte Carlo model was based on the uncalibrated mean prediction and standard deviation. Results from each design are tabulated below in Table 9 with a brief design description in Table 10.

It is important to note that the scenarios with the slot are not comparable to designs that use the entire face and are likely to be conservative. This is because the Monte Carlo model cannot model the effect of introduced free surfaces and only accounts for those encoded in the selected seed wave. Transmission of vibration through the slot produced by the roadheader cannot occur in reality, and would contribute significantly to the prediction.

Within the models the coordinate scheme was rotated 90° from normal, with the Y and Z-axes switched. This was necessary as the model is only embedded within the Shotplus-i blast design program, used for designing surface blasts. Predictions may be affected due to this change as the blasthole screening algorithm was developed from surface data (Noy and Blair, 2009).

Increases in vibration levels due to waveform superposition are not a major factor in the majority of designs. Timing of the order of 100 ms or greater is sufficient to ensure minimal waveform superposition (Figure 15) due to the transmission properties of the rock. At less than 50 ms initiation separation notable waveform superposition can be observed (Figure 16). Electronic delay detonators offer the best control of the timing due to their inherent accuracy.

Designs 4 and 5 were identical with the exception of the style of perimeter blast. It can be seen that the presplit noticeably reduces the average peak vibration. Out of each set of models the ones using a presplit are observed to give some of the lowest values, despite various design differences. It is worth noting that such presplits are rarely used in tunnel blasting.

Table 9. Designs tested for a distance of 40 m to top of the centre of the face.

Design	Slot	Initiation type	Perimeter blast	Blast window (s)
1	Yes	Non-electric	Trim	3.3
2	Yes	Non-electric	Presplit	2.9
3	Yes	Non-electric	Trim	3.1
4	Yes	Electronic	Presplit	1.45
5	Yes	Electronic	Trim	1.45
6	Yes	Electronic	Trim	0.725
7	No	Electronic	Trim	2.811
8	No	Electronic	Trim	13.33
9	No	Electronic	Presplit	2.825

Table 10. Results from uncalibrated Monte Carlo model for nine designs.

Design	Thorpe St		Hume St		Plunkett St	
	Mean (mm/s)	SD	Mean (mm/s)	SD	Mean (mm/s)	SD
1	19.0	2.5	15.4	2.7	22.2	3.8
2	18.7	3.0	14.7	2.2	20.7	3.0
3	18.4	2.8	14.0	2.1	21.0	3.9
4	17.5	2.4	13.9	1.9	20.1	3.0
5	18.5	2.7	14.4	2.1	22.2	3.9
6	18.7	2.4	16.3	1.8	23.0	3.4
7	21.2	2.3	17.3	2.1	27.3	3.5
8	20.9	2.0	17.2	2.0	25.2	3.9
9	21.0	2.3	17.5	2.1	26.7	3.7

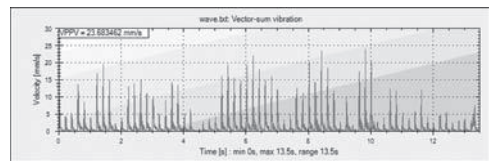

Figure 15. The first predicted waveform produced by the uncalibrated model for design 8 at Plunkett St. Minimal interference can be observed. 200 ms delay between production holes.

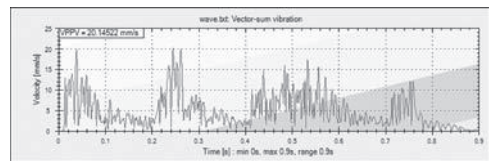

Figure 16. The first predicted waveform produced by the uncalibrated model for design 6 at Plunkett St. Waveform superposition is significant. 25 ms delay between production holes.

Designs that use electronic initiation were observed to produce slightly higher vibration in many cases. This is not inherent in the initiating system itself but rather is the consequence of the greater accuracy and flexibility afforded by it. Blast durations for the designs using the slot and electronic initiation were designed to be half to a quarter of their non-electric counterparts. This shortening of the blast duration with tight initiation control offered by the electronic delay detonators would be expected to cause the observed increases in vibration levels. However, reduced blast duration has two main advantages: fragmentation is likely to be finer which may enhance productivity, and often neighbours prefer shorter blasts rather than long ones.

5 CONCLUSIONS AND RECOMMENDATIONS

The vibration measurements and modelling conducted in this blast evaluation project suggest the following:

- charge weight scaling laws at each site are similar, including when the data from the three sites are combined. This may indicate a uniform geology along the tunnel line as far as vibrations are concerned.
- the charge weight scaling laws showed approximately a factor of three in the scale parameter, K , and that the attenuation factor, n , is similar across all sites
- probabilistic analysis using the combined data and a 95% upper confidence level indicates that a charge of 4.3 kg would produce a vector peak particle velocity of 25 mm/s at a distance of 40 m. This would enable quite reasonable tunnel round lengths without exceeding Australian Standard AS 2187-2006.
- both waveform models indicate that for the typical tunnel round timing (>100 ms), there is relatively small interaction and potential for waveform overlap at close distances.
- hypothetical blast designs using electronic delay detonators enable shorter blast durations without a significant impact on peak vibration levels.
- the waveform models indicate that full-face blasting is viable from a vibration perspective.

We recommend that the work here be reviewed in the light of any measurements of vibration from full-scale blasted tunnel rounds.

ACKNOWLEDGEMENTS

The authors thank the following Orica staff from Quarry Services and Construction: Rohan Stevens, Rick Macmaster, Mark Della Sabina, Ross Oldman

and Marty Adam for their planning, conduct and assistance with the blast vibration measurements. We also thank the Beenleigh plant operators and staff who assisted on many of the day to day activities. Finally, we thank Tony D'Alessandro from Macmahon for championing the work described here.

REFERENCES

- Anscombe, F.J. 1973. Graphs in statistical analysis. *American Statistician*, 27, 17–21.
- Blair, D.P. 2004. Charge weight scaling laws and the superposition of blast vibration waves. *Int. J. Blasting and Fragmentation*, 8(4):221–239.
- Blair, D.P. 2006. Probabilistic Vibration Analysis of Seven Blasts in the EastLink Freeway Tunnel Construction. Orica Internal Report 58754.
- Blair, D.P. & Minchinton, A. 2006. Near-field blast vibration models. 8th Int. Symposium Rock Fragmentation by Blasting, 152–159.
- Draper, N.R. & Smith, H. Applied regression analysis (2nd edition), 1981. John Wiley and Sons, New York.
- Lesberg, P., Yuill, G. 2005. Monte Carlo Vibration Prediction for the Eastlink Freeway Tunnel Construction. Orica Internal Report 58732.
- Noy, M.J., Blair, D.P. 2009. The development and implementation of a new ground vibration-screening algorithm. Orica Internal Report 58835B.
- R Development Core Team, 2008. R—A language and environment for statistical computing. R Foundation for Statistical Computing, Vienna.
- Weisstein, Eric W. 2010. Least Squares Fitting. From *MathWorld—A Wolfram Web Resource*. <http://mathworld.wolfram.com/LeastSquaresFitting.html>

APPENDIX: SUMMARY OF LINEAR REGRESSION FIT TO DATA

The fit

The production of charge weight scaling laws relies typically on a linear regression fit to vibration data. Such an approach assumes a simple expression for the curve fit to the measured data expressed as,

$$ppv = K \left(\frac{x}{\sqrt{W}} \right)^n \quad (A1)$$

where ppv is the peak particle velocity and x is the distance between a given charge of mass W and the measurement location. The coefficient K is the scale factor and n is the attenuation factor, both of which are site-dependent constants obtained from the regression curve as shown below. It should be noted that the term in brackets is known as the scaled distance (SD) and here it has been assumed that the square root of the charge mass is appropriate. It is

possible to introduce another model parameter in place of the square root although this is rarely used or needed given the variability in the field vibration data.

Usually Equation (A1) is linearised by taking logarithms (here to base 10) to become:

$$\log(ppv) = \log K + n \log(SD) \quad (A2)$$

The typical linear model assumed for a linear curve fit to the data is,

$$y = \alpha + \beta x + \varepsilon \quad (A3)$$

where we have the usual expression for a straight line with added noise represented by ε . It is assumed that the noise comes from a normal distribution over the range of x values in the data. It is important to test that assumption in order to use some of the confidence intervals described below. The noise represents the residual error between the actual measured data and the curve fit to the data.

The estimation of the two linear regression line (A3) parameters (α and β) depend on the data spread both within the (given) independent x values and the observed dependent y values. Some readers will know the approach as the estimation of a least squares curve fit to the data whereby it is the vertical deviations between the measured data and the curve fit (the residual error in Equation A3) that are to be minimised. An excellent textbook reference to the approaches described here is Draper and Smith (1981) or for an internet source, Weisstein (2010). It is worth noting that most statistical software can produce the information described below to various degrees (see, for example, R Development Core Team, 2008). Care is required in using such software and the author (ATS) has observed some limitations in that capability included in Microsoft Excel for example.

Following Weisstein (2010) and without the derivations he provides, we define the following sum of squares (SS) terms before giving the expressions for the linear regression line parameters:

$$\begin{aligned} SS_{xx} &= \sum_{i=1}^n (x_i - \bar{x})^2 \\ &= \left(\sum_{i=1}^n x_i^2 \right) - n(\bar{x})^2 \end{aligned} \quad (A4)$$

$$\begin{aligned} SS_{yy} &= \sum_{i=1}^n (y_i - \bar{y})^2 \\ &= \left(\sum_{i=1}^n y_i^2 \right) - n(\bar{y})^2 \end{aligned} \quad (A5)$$

$$\begin{aligned} SS_{xy} &= \sum_{i=1}^n (x_i - \bar{x})(y_i - \bar{y}) \\ &= \left(\sum_{i=1}^n x_i y_i \right) - n\bar{x}\bar{y} \end{aligned} \quad (A6)$$

where \bar{x} and \bar{y} are the average values of the independent and dependent values of the data. The subscript i refers to the i th data point and n is the number of data points.

The estimates for the linear regression line parameters in terms of the sum of squares defined above are,

$$b = \frac{SS_{xy}}{SS_{xx}} \quad (A7)$$

for the slope of the regression line, β , and,

$$a = \bar{y} - b\bar{x} \quad (A8)$$

for the intercept of the regression line, α . A measure of the amount of the variance in the data accounted for by the regression is given by the unadjusted squared correlation coefficient:

$$r^2 = \frac{SS_{xy}^2}{SS_{yy}SS_{xx}} \quad (A9)$$

So we now have the least squares straight line fit to the data, $y = a + bx$ and from this we may obtain the charge weight scaling law parameters as,

$$K = 10^a \quad (A10)$$

and,

$$n = b \quad (A11)$$

The question that arises is ‘‘How good a fit is the line to our data?’’.

Quality of the fit

Perhaps the most important approach to address this question is to plot the data and the regression line and examine their differences visually! A blind application of the curve fit is fraught with danger as is the simple expedient of using the correlation coefficient (derived from Equation A9) as an indicator of satisfactory quality (Anscombe, 1973). It is also important to use the curve fit only in the region spanned by the independent variable values of the data set. That is, interpolated values are acceptable whereas extrapolated values are not.

Apart from a direct examination of the residuals, it is useful to determine the estimates of the variances or their square root (known as their standard error or an estimate of their standard deviation) for each of the model parameters and also for the residuals themselves. These provide a means to estimate confidence levels for various features of the data and the curve fit. It is important to test that the residuals follow a normal distribution as the various confidence intervals expect that it does. This is best done by plotting the residuals and also using a normal probability plot also called a Q-Q plot that is described below.

The mean standard error of the residuals is given by,

$$MSE = \sqrt{\frac{\sum_{i=1}^n \varepsilon_i^2}{n-2}}$$

$$= \sqrt{\frac{SS_{yy} - \frac{SS_{xy}^2}{SS_{xx}}}{n-2}} \quad (A12)$$

and has $(n-2)$ degrees of freedom. The standard errors of the regression parameters, a and b , are given by,

$$SE(a) = MSE \sqrt{\frac{1}{n} + \frac{\bar{x}^2}{SS_{xx}}} \quad (A13)$$

and,

$$SE(b) = \frac{MSE}{\sqrt{SS_{xx}}} \quad (A14)$$

A line that is expected to lie above the data at a $(100 - \gamma)$ percent confidence level may be defined by,

$$y = a + t(\gamma/2, n-2)MSE + bx \quad (A15)$$

where the assumption is that the mean standard error is a reasonable value to use across the whole data set. In fact, below a more accurate approach is given for the confidence and prediction intervals that apply for known input values and for new input values. The confidence level curves in the main body of the paper used Equation A15.

We can now form confidence levels for the regression parameters. Confidence levels define a region in which we may expect a certain percentage of the population values to lie. For example if we set the confidence level at 95% and estimate a lower confidence value of lcv and an upper confidence value of

ucv , then we can expect that 95% of the population values will lie between lcv and ucv , and that 2.5% will lie below lcv and 2.5% will lie above ucv .

A $(100 - \gamma)$ percent confidence level on the regression parameter b is given by,

$$b \pm t(\gamma/2, n-2)SE(b) \quad (A16)$$

and for the regression parameter a is given by,

$$a \pm t(\gamma/2, n-2)SE(a) \quad (A17)$$

where $t(\gamma/2, n-2)$ is the Student t distribution with $(n-2)$ degrees of freedom. In the case of large n , the t -distribution may be replaced by the normal distribution. For example, for a 95% confidence interval, the multiplying factor of the standard errors in Equations A16 and A17 will be 1.96 obtained from a normal distribution with a mean of zero and standard deviation of unity for an area of $\gamma/2$.

The response axis of the regression line represents the mean prediction for any given independent value of input data. We can form confidence intervals for the input independent values of the data used to form the regression line. We can also form prediction intervals for input independent values not in the original data. These intervals are regions in which we expect to find the mean value of the response.

A $(100-\gamma)$ percent confidence level interval of the known response value for a known input independent value (x_i) in the original data is,

$$y_i \pm t(\gamma/2, n-2) \sqrt{MSE^2 \left[\frac{1}{n} + \frac{(x_i - \bar{x})^2}{\sum_{i=1}^n (x_i - \bar{x})^2} \right]} \quad (A18)$$

and the interval for a predicted response for a new input independent value (x_p) not in the original data is,

$$y_p \pm t(\gamma/2, n-2) \sqrt{MSE^2 \left[1 + \frac{1}{n} + \frac{(x_p - \bar{x})^2}{\sum_{i=1}^n (x_p - \bar{x})^2} \right]} \quad (A19)$$

In both cases of a fitted independent value and a new independent value, the minimum interval occurs when that value equals the mean independent value. As we move away from that mean value, the confidence/prediction intervals increase in size. The prediction interval for a new input independent value is greater than that for a fitted independent value in the original data.

This page intentionally left blank

Multiple seed blast vibration modeling for tunnel blasting in urban environments

R. Yang

Orica USA Inc., Watkins, USA

D.B. Kay

Orica, Matraville, NSW, Australia

ABSTRACT: Blast vibration control is of vital importance for tunnel blasting in urban environments. Due to the expensive nature of urban tunnelling projects, it is always necessary to maximize excavation productivity while controlling the blast vibration under prescribed limits. Using field tests to explore various design scenarios is time consuming and costly. It is worthwhile to use a reliable computer model of blast vibration to assist in selection of blast design options to maximize each blasting opportunity.

A project was conducted to test a blast vibration prediction model for tunnel blast vibration. A series of tunnel blast rounds were fired and tri-axial vibration waveforms from the blasts were recorded with several seismographs at distances ranging from 10 to 100 metres from the blasts. Seed waveforms were obtained from the cut holes in each round. Over 60 seed waveforms were collected and the charge weight scaling law for the signature hole PPV was established. A vibration model with Multiple Seed Waveforms (MSW) as input for a point of interest was developed in recent years by the present authors. The MSW blast vibration model has been applied successfully in open cut and quarry blasting situations. From the literature, it appears that there may not be any seed wave based vibration modeling work for tunnel blasting. In this paper the MSW model is applied to tunnel blasting and some specific issues associated with tunnel blast modelling are addressed. The capability of the model in terms of the PPV and frequency prediction is demonstrated in the paper.

The paper demonstrates the MSW blast vibration model is a useful tool for managing tunnel blast vibration with the potential to optimize round by round design. A few of the design scenarios were modelled and the results are discussed in terms of managing the vibration below the limit while maximizing tunnel advance rate.

1 INTRODUCTION¹

Tunneling is an important underground operations in construction and in underground mining. Today, many subways or highways are built underground or going through mountains by tunneling. In addition, in underground mining much development of the underground structure is accomplished through tunneling. Most economical method of tunneling is by drilling and blasting. Construction of tunnels is expensive and costly. Maximizing the tunneling rate (productivity) is always desirable for minimizing tunneling cost. However, in many cases tunnels have to go through regions close to residential houses or sensitive structures, such as hospitals, museums, or other underground tunnels or structures requiring careful

protection. In such cases, blast vibration from tunneling must be controlled. One of simplest methods is to reduce blast vibration is reducing the charge weight. However, if the vibration reduction only relies on reducing the charge weight, the productivity of tunneling cannot be maximized and therefore cost of tunneling is not minimized under given constraints. In order to maximize the productivity and reduce the cost, it is important to improve the blast design with blast vibration modeling through modeling various scenarios of blast designs to select improved design parameters that control blast vibration while maximize the tunneling productivity.

From the literature, it appears that there may not be any seed wave based vibration modelling work used routinely for tunnel blasting. In this paper the MSW model is applied to tunnel blasting and some specific issues associated with tunnel blast modelling are addressed. The capability of the model in terms of the PPV and frequency prediction is demonstrated in the paper.

¹This paper is an edited version of a paper presented at the EFEE World Conference, Lisbon, 18–20 September 2011.

2 MULTIPLE SEED WAVEFORM VIBRATION MODEL

The MSW blast vibration model differs from most existing blast vibration models in several aspects.

Firstly, the MSW model (Yang and Kay, 2011) uses multiple seed waveforms recorded at different distances as input to the model (Fig. 1). For modeling a production blast with multiple blast holes, a different seed waveform may be selected for a different blast hole according to the relative location of the blast hole to the point of interest (Fig. 2). Then the selected seed waveforms are extrapolated using a transfer function from the distance where they were measured to the distances to the monitor location (in Fig. 2, transfer for distances δd_1 , δd_2 , δd_3). By employing multiple seed waveforms recorded at different distances, p-, s-, and surface waves from charges at different distances can be assessed in the model. Waveform changes that are due to the mixture of wave types and frequency attenuation over the distance are automatically taken into account. In addition, the geological effect encoded in different seed waveforms is input into the model via the multiple seed waveforms. The concept of the model is suitable for both the near and the far field vibrations (Yang and Scovira, 2010).

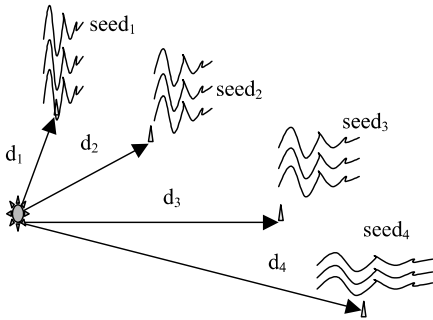

Figure 1. A sketch of multiple sets of seed waveforms measured at different distances from a signature hole.

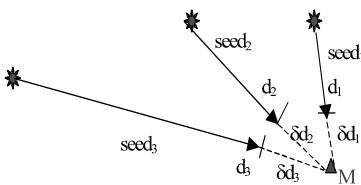

Figure 2. A set of signature waveforms is selected for each charge according to the distance match—multiple sets of seed waves used at a point of interest.

Secondly, the model simulates propagation and superposition of three tri-axial vibration components from each blast hole. It also models the change of the ratio of the longitudinal over the vertical component with distance that improves the modeling accuracy for both near and far field vibration. The MSW model is a three dimensional blast vibration model. Additionally, in some applications, the vibration limit is often specified against an individual component, such as the vertical component to be below a certain limit. The present model is suitable to model an individual component of tri-axial blast vibration.

At present, the MSW model has been applied successfully to open pit and quarry blasts. However, it has not been used for prediction of tunnel blast vibrations. For prediction of tunnel blast vibration, the algorithm of the broken ground screening is further refined from a previous algorithm (Yang and Scovira, 2008).

3 MODELLING EFFECTS OF BROKEN GROUND, VOIDS, AND CONFINEMENT

Earlier firing holes can cause ground damage in the vibration wave path of subsequent holes. The damaged path will result in more attenuation than the undamaged case in both amplitude and frequency. In the screen algorithm described in previous papers by the authors (Yang and Scovira, 2008), the total charge weight of the earlier fired blast-holes in the path area (shown in Fig. 3) was taken into account. The amplitude reduction as well as the change in the waveform is then a simple function of this ratio. However, the screen algorithm described previously (Yang and Scovira, 2008) sums all earlier firing charges within the path area (Fig. 3) without a weighting function to any of the charges. For earlier firing holes within the path area, the previous algorithm does not take into account the relative location (d_i and c_i in Fig. 3) and firing timing (Δt_i in Fig. 3) to the presently-firing charge (Fig. 3).

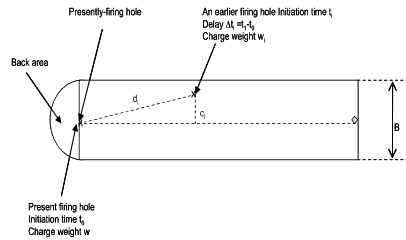

Figure 3. Path area where the earlier firing charges are accounted for screening the blast vibration from the presently-firing hole.

Recently, the screen algorithm has been further improved to model effects of the delay time and relative location of an earlier fired hole to the presently-firing hole. The improved algorithm allows the MSW model to be suitable to model tunnel blast rounds, as well as to model the screening effects more accurately for other blasts in open pit and underground.

3.1 Improved screening functions to model broken ground, void, and confinement

The improvement over the previous screening algorithm is the introduction of weighting functions to calculate the total effective charge weight in earlier fired blast holes in the path area.

As in the previous algorithm, the improved algorithm assumes that the vibration amplitude A_1 is reduced by a screening factor s to A_2 , $A_2 = sA_1$, where s is an exponential function:

$$s(\phi) = \lambda^\phi$$

$$\phi = \frac{w_{ie}}{w} \quad (1)$$

w_{ie} is the total effective charge weight in earlier fired blast holes in the path area and w is the weight of the presently-firing charge. The previous algorithm obtained the total effective charge weight by simple summation of the weights of earlier firing charges within the path area without a weighting function to any single charge. Whereas, the improved algorithm employs a weighting function to each charge weight within the path area according to its relative location (d_i and c_i in Fig. 3) and timing (Δt_i in Fig. 3) to the present firing charge, i.e.

$$w_{ie} = \sum_m f_1(d_i) f_2(\Delta t_i) f_3(c_i) \cdot w_i \quad (2)$$

where $f_1(d_i)$, $f_2(\Delta t_i)$, $f_3(c_i)$ are weighting functions for the i th previously fired charge w_i , m is the total number of the previously fired charges in the path area. The weighting functions are described below, which are incorporated into the previous screening algorithm.

Weighting functions are used to model the effects:

1. distance from the present charge to the earlier firing charger (d_i)—an earlier firing charge closer to the presently-firing charge yields more reduction in amplitude and more change in waveform to the vibration from the presently-firing charge.
2. advance time (Δt_i) of an earlier firing hole to the present hole—the smaller the advanced time, the less screening to the vibration of the presently-firing charge.

3. location deviation of an earlier firing hole to the center line (c_i)—the smaller the deviation, the more screening to the vibration of the presently-firing charge.

Simple functions to model the major trends of the effects are proposed as:

$$f_1(d_i) = \kappa e^{-\frac{\gamma d_i}{B}}$$

$$f_2(\Delta t_i) = 1 - e^{-\frac{\eta \Delta t_i}{T d_i}}$$

$$f_3(c_i) = \cos\left(\frac{\pi c_i}{B}\right) \quad (3)$$

where $f_1(d_i)$ is the weighting function accounting for the distance (d_i) from the present firing hole to the earlier firing hole. When $d_i = 0$, the coefficient of the earlier firing hole for screening is κ (e.g. assuming $\kappa = 2$) and when $d_i = B$ (nominal design burden), the coefficient is κ/e^γ . Assuming $\kappa/e^\gamma = 1$, $\gamma = \ln \kappa$, therefore,

$$f_1(d_i) = \kappa e^{-\frac{d_i \ln \kappa}{B}} \quad (4)$$

The function above provides negligible screening when the distance from an earlier firing hole to the present one is large. For example, when $d_i = 3B$,

$$f_1(d_i) = \frac{1}{\kappa^2}$$

Since a radius of a half burden at the back of the presently-firing hole (i.e. at the opposite direction of the presently-firing charge to the monitor) is included in the screening area (refer to Fig. 3), the function (4) also models the effect of variable burden to different holes during a tunnel blast round. The graph of the function (4) is displayed in Figure 4a.

$f_2(\Delta t_i)$ is the coefficient accounting for delay time (Δt_i) of the present firing hole from the earlier firing hole. T is the delay time per unit distance required for the sufficient relief of the overburden in the blast design, for example, for large open pit blast with soft rock, 20 ms/m is regarded as sufficient time relief. At the sufficient relief:

$$\frac{\Delta t_i}{T d_i} = 1$$

it is assumed that $f_2(\Delta t_i) \approx 0.98$, then $\eta = 4$. Therefore,

$$f_2(\Delta t_i) = 1 - e^{-\frac{4 \Delta t_i}{T d_i}} \quad (5)$$

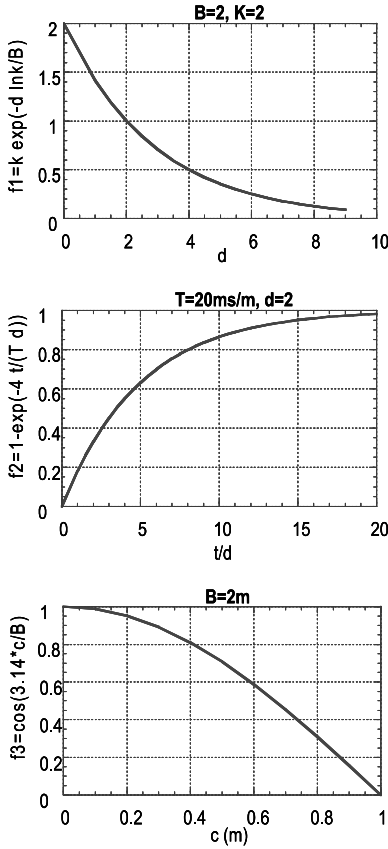

Figure 4. Graphs of three weighting functions.

The function above also assumes that there is no screening effect if an earlier firing hole is fired very close to the present hole in time ($\Delta t_i = 0$, $f_2(\Delta t_i) = 0$). The graph of the function (5) is displayed in Figure 4b.

$f_3(c_i)$ is the coefficient accounting for the deviation distance (c_i) from the line joining the charge center to the monitor.

$$f_3(c_i) = \cos\left(\frac{\pi c_i}{B}\right) \quad (6)$$

It is assumed that the coefficient equals 1 if the earlier firing charge is at the joining line and the coefficient equals 0 if the earlier firing hole is at the edge of the path area in Figure 3. The graph of the function (6) is displayed in Figure 4c.

As described above the functions (4), (5), and (6) models major trends of the blast hole screening phenomenon. However, future field data is necessary to refine the functions and their parameters. The improvement over the previous screen

algorithm has been incorporated into the framework of the previous screen algorithm.

4 MODELING CASE STUDY

A project was conducted during an urban tunneling environment in Sweden to test the MSW blast vibration model for tunnel blast vibration prediction. Three tunnel blast rounds were fired and tri-axial vibration waveforms from the blasts were recorded with several seismographs at distances ranging from 10 to 100 metres from the blasts. Vibration recorded from cut holes in the rounds were used as signature hole blasts for seed waveforms. Over 60 seed waveforms were collected at different distances and the charge weight scaling law for the signature hole PPV were established. The modeling results from the MSW model were compared with vibration recorded for the blast rounds.

The blast holes were 4.2 m deep on average and 48 mm in diameter. The rock is competent hard granite. Figure 5 shows the pattern for the three test blast rounds. The cross section of the tunnel is 7.5 m in width and 7.9 m in height. The delay among the cut holes was 150 ms. All holes were designed to fire on unique delay times. All shot-holes were primed each with an electronic detonator and a Pentax primer (25 g 15 × 150 mm).

Generically the timing was designed to give 150 ms in the cut with 100 ms in the box then uniform 40 ms timing within the remainder of the face. The perimeter (through earlier experience) was designed to fire on 5 ms increments to help control vibration, with the right side first then the left side meeting at the crown.

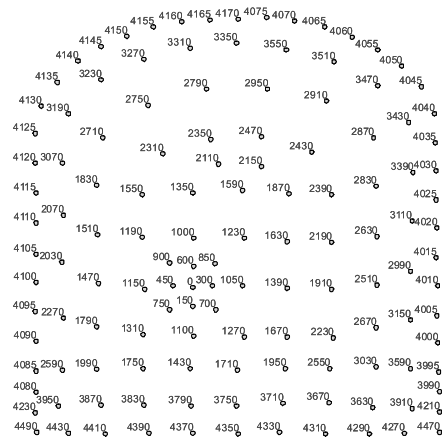

Figure 5. Blast holes and timing in a complete blast round.

Loading was conducted with string charging throughout the face. Three different string types were used dependent on location in the face with floor holes fully charged.

Figure 6 is a vibration trace recorded from a blast round. It can be seen that the vibration from each individual cut hole at the beginning of the blast can be clearly identified. As it is stated before, the vibration traces from cut holes are used as signature hole vibrations for the MSW modeling. The Peak Particle Velocity (PPV) of the blast vibration from the rest of the blast holes as shown in the trace in Figure 6 is used to compare with the model prediction.

Figure 7 shows a comparison of the waveforms recorded at different distances from cut holes in the hard granite of the site. It can be seen that even in the hard granite of the site the waveform change with distance (e.g. at 33 m, 40 m, and 48 m) is significant. It is important to include the waveform change with distance in the blast vibration modeling. The MSW model is designed to take this waveform change into account to model the amplitude and frequency of the blast vibration more accurately.

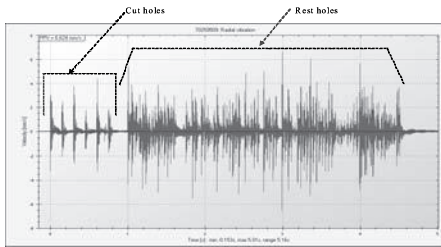

Figure 6. Vibration trace from a complete blast round.

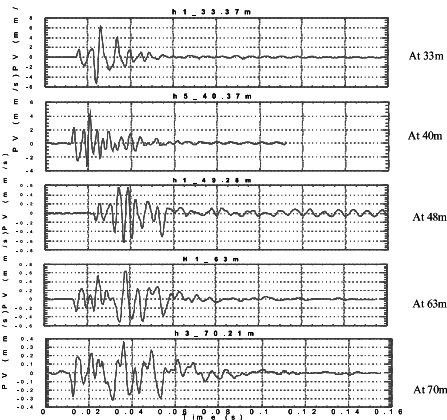

Figure 7. Waveform changes at different distance from a signature hole in the hard granite of the site.

In Figure 8 PPV's from different cut holes are plotted against the charge weight scaled distances. The graph shows that PPV from different cut holes have no significant difference for such a hard rock although the confinement to each cut blast hole may vary. A total of 64 signature hole waveforms was collected with monitors from three production blasts. Figure 8 displays the regression of the signature holes data in Figure 7. The regression parameters from the signature hole vibration are used without alteration as input to the MSW model for predictions of production blasts.

Figure 9 shows the modeled PPV comparing with the measured from the blast rounds. It demonstrates that with parameters from signature hole blast vibration and multiple waveforms at different distances the MSW model provides reliable predictions.

Figure 10 compares the measured and predicted power spectra. It can be seen that both spectra

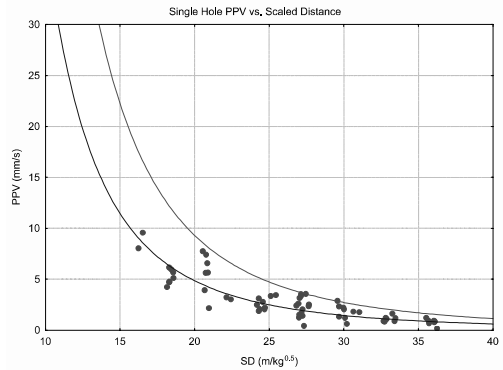

Figure 8. The regression of the cut hole vibration the parameters of which are input to MSW model.

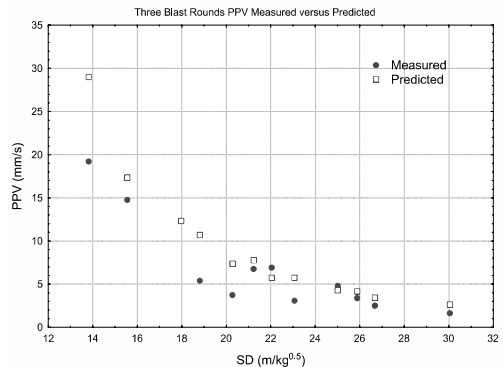

Figure 9. The modeled PPV comparing with the measured from the blast rounds.

5 CONCLUSIONS AND DISCUSSIONS

This paper represents a first attempt to model tunnel blast vibration with seed waves. The MSW model models propagation of tri-axial components of blast vibration, uses multiple seed waveforms to represent blast hole contributions, and models the effect of broken ground, voids, and confinement by taking into account the delay time, and relative hole locations. It shows that the MSW model provides reasonable predictions with seed waveforms and parameters from signature hole vibration as input.

The improved screening algorithm allows the MSW model to be suitable to model tunnel blast rounds, as well as to model other types of blasts in open pit and underground more accurately. As described above the screen functions model major trends of the blast hole screening and interaction phenomenon. However, future field data is necessary to refine the functions and their parameters.

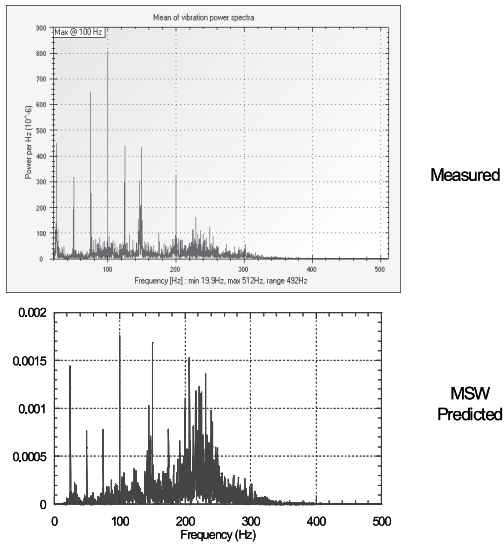

Figure 10. Comparison between the measured power spectrum and the predicted spectrum.

indicate 100 Hz is the dominant frequency and no vibration energy beyond exists above about 380 Hz. In addition, both spectra show 33 Hz interval from 0 Hz to 150 Hz, which is dictated by the 30 ms delay interval in the blast round. The blast rounds were initiated with electronic detonators. Therefore, the signature from the delay time interval is clearly shown in the measured power spectrum and is consistent with the model prediction.

Figures 9 and 10 demonstrated the capability of the model in terms of the PPV and frequency prediction.

As demonstrated in Figure 9, with the input of the signature hole vibration information, the model yields reliable predictions of the production blast vibration. The model could provide reliable predictions for different design scenarios. Comparison of prediction results could assist to identify improved blast design parameters for control of blast vibration while maximizing the productivity.

REFERENCES

- Kay D. 2010, Summary of three eDev™ blasts fired at the Citybanan cross city railway project, Stockholm.
- Yang R. and Scovira D.S., 2010, A model for near and far-field blast vibration based on multiple seed waveforms and transfer functions, *Blasting and Fragmentation*, 4(2), 91–116.
- Yang, R. and Kay, D.B. (2011). Multiple seed blast vibration modeling for tunnel blasting in urban environments. EFEE, World Conference, Lisbon, 18–20 September, pp. 361–372.

Geometric assessment of perimeter control blasting in tunnels

A.T. Spathis

Orica Mining Services Technical Centre, Kurri Kurri, NSW, Australia

ABSTRACT: Underground tunnels in hard rock are formed typically using the drilling and blasting method. A mix of different drill patterns, explosives, and timing regimes is used to control the tunnel perimeter. A tunnel assessment methodology is described that uses three geometric objects of varying complexity: the as-designed tunnel round, the as-drilled tunnel round, and the as-blasted tunnel round. A method for estimating advance per round is proposed. Comparisons are made between the as-designed round versus the as-drilled round for evaluating drilling accuracy, and between the as-drilled round versus the as-blasted round for evaluating the effectiveness of any given blast design. The data is collected using 3D laser survey or digital photogrammetry and goes beyond the use of counting the number of visible half-barrels in the crown and walls of the tunnel. It complements the information obtained in panoramic images of tunnel surfaces. Typical data from previous projects are used to demonstrate the approach using Boolean operations on the volumes and these operations also apply to the cross-sectional areas of the three geometric objects. Finally, in evaluating perimeter control blasting, a robust experimental design is warranted and a method for determining the number of trials needed is provided with a re-assessment of some previous work.

1 INTRODUCTION

Tunnels in civil engineering and mining have some common objectives for their construction by drilling and blasting. These include:

- Control of environmental effects such as ground vibrations, airblast, dust and fumes
- Speed of advance
- Conformance to designed profile
- Reliability with minimum down time within the overall excavation cycle
- Reduction in support costs that may improve advance rate
- Systems that meet regulatory constraints

Of particular interest here are the measurements that relate to the geometry of the excavation: advance per blasting round and conformance to the designed profile. As with the other factors above, these geometric ones affect the cost of constructing the tunnel and the time to its completion.

Spathis et al. (2006) discuss various data obtained in excavating a tunnel of small cross-section (~12 m²) including the geometric parameters. They implemented a methodology that required three geometric objects to be constructed for robust analysis: an as-designed round, an as-drilled round, and an as-blasted round. They focused on the last two in evaluating the efficacy of two different methods of blasting versus the standard approach. They noted that a comparison

between the as-designed round and the as-drilled round gave information of drilling accuracy while a comparison between the as-drilled round and the as-blasted round gave information about the influence of a given blast design. Wetherelt & Williams (2006) describe similar measurement procedures but focused on the drilling accuracy alone. A similar approach was used in a larger tunnel (~36 m²) by Spathis et al. (2009).

Boolean operations are made on the pairs of Three Dimensional (3D) objects or their Two Dimensional (2D) cross-sections to produce data on the overbreak (excavation larger than desired) and the underbreak (excavation smaller than desired). These influence decisions on the amount of ground support required and on the need for any remediation. Significant roughness of the tunnel surface can also influence ventilation in unlined tunnels used for access and transport, and also the head pressures in tunnels used for fluid transport such as in head races used in hydroelectric power schemes.

The paper discusses the methods of obtaining the necessary survey data to construct the 3D and 2D geometric objects, presents the use of panoramic images as a simple tool to support the survey data, describes the method of analysis of the geometric data, reviews data obtained at some sites and the experimental design advocated, and, finally, suggests the number of field trials required when making comparisons between different blast designs.

2 MEASUREMENT METHODS OF TUNNEL GEOMETRY

2.1 General

In mining and civil construction applications 3D survey data and visual images of pre-mining and post-mining conditions are often used for documentation. Quantitative information is most often provided from total station surveys and includes volumes, surface areas, perimeters, slopes and orientations of critical structures. Such information is augmented by visual images including both motion pictures (video) and still photographs. Recent developments have combined both such data types by producing photo-realistic images where each pixel is associated with its 3D coordinates. The most common, and often the most powerful, is the use of still photographs. These capture present conditions in full colour and provide a useful historical record of the condition of the excavation when combined with a suitable annotation. Methods for obtaining the 3D coordinates of the geometry of interest and a visual representation of it are presented below. We should anticipate that the combination of full 3D coordinates with photorealism will be the norm rather than the exception and many systems are combining the two data sets. Current technology for obtaining both such data separately in tunnels is described here. Of course the methods have general application in other mining and civil construction areas.

2.2 Survey data in tunnels

There are many commercial systems for creating 3D surveys of a tunnel. These tend to fall into two categories: laser scanners or digital photogrammetry. Both technologies provide high density point clouds. These point clouds are meshed and a digital terrain model is produced from which various analyses may be conducted. Quite apart from simple geometry information, the data may be analysed for data such as the spacing, persistence and distribution of joint sets (Tonon & Kottenstette 2006). Shan & Toth (2009) provide an in-depth look at various laser surveying instruments and their principles. A summary of some specifications of the two survey systems is given in Tables 1 and 2. Note that the data in the tables are indicative of the specifications of systems available at the time of writing and there are other systems available. The focus is on underground applications and specifically for tunnels although the various systems or their variants are relevant to surface mining applications and for larger ranges. The lidar systems (Fig. 1) scan in a relatively slow rate in a 360 degree nominal horizontal plane with a rapid vertical scan at each step of the horizontal rotation. The Optech system (Fig. 2) is different in that it steps out from

Table 1. Underground LIDAR system specifications.

Feature	Brand (no endorsement implied)			
	Optech	Leica	Riegl	Callidus
Range (m)	350	25/50	100/300	~32
Resolution (mm)	10	6@25 m	6@50 m	5
Vert. angle (deg)	290	330	0–80	40–180
Hor. angle (deg)	360	360	360	360
Data rate (pts/s)	145	555	8000	1750
Scan time (min)	6	6	6	6
Max. points (k)	~50	~400	~400	~400

Table 2. Photogrammetric system specifications.

Feature	Specification depends on range and camera
Range (m)	~300 (surface), ~20 (tunnel)
Resolution (mm)	1 (tunnel)
Image acquisition time (min)	15 (typ)
Processing time (min)	20 (typ)
Max. points	~20 megapixel



Figure 1. Laser scanning the wall of a tunnel (here the Callidus unit). Lighting is used for photographs and is not needed for acquiring the point cloud data alone.

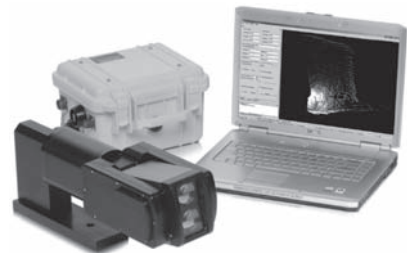

Figure 2. Optech laser scanning head (foreground).

a central point and then performs a further full circle rotation—both of these actions are relatively slow mechanical movements.

The photogrammetric method relies on a set of images taken from different but known positions to help create the stereo images required for post-processing. The analysis software identifies common features in the overlapped images that help the creation of the full digital terrain map of the surfaces imaged. Atkinson (2001) contains a thorough survey of the various methods used in photogrammetry, particularly at close range. A significant development in recent decades is the automated analysis using software procedures with commercial systems available. Of course, digital cameras are the norm and these now have over ten megapixel sensors that increase the density of points mapped. The specifications given in Table 2 are dependent on the distance from the camera, the number of pixels in its sensor, and the calibration of the camera lens.

For measurement purposes the point cloud data must be referred to the global coordinate system relevant to the project rather than the local coordinate system. It is usual to include reference points that are mapped at the time of the point cloud data acquisition but these may be surveyed after an excavation event or tunnel blast. However, the reference points may not be available due to such factors as damage from blasting, mine equipment dislodgement, ground support activities (bolting or shotcreting), or simply being obscured due to dust settling on the mined surface over time. For the lidar systems it is also possible to survey the instrument location at the time of data collection which enables the point cloud data to be placed in the global coordinate system.

The point cloud for the lidar system is collected from one scanning location. Multiple scans of data are possible but usually a single scan is done for a single blasting round in a tunnel. The images for the photogrammetry method are taken from multiple locations and require lighting. Birch (2008) describes the approach. Figure 3 shows a schematic of the image acquisition recommended by him. Two pairs of images are taken at each location shown: a left and right image with the first pair taken with the camera level, and the second pair with the camera pointing upwards to include the upper wall region and roof of the tunnel (Gothard 2012). A special bracket for the camera makes the process robust. The lighting used is typically LED arrays that are compact and light-weight. In the tunnel three lights are used along the axis of the tunnel between the four image locations shown in Figure 3. A standard professional 35 mm SLR camera may be used with a 20 mm lens. Images are best obtained using a remote release to avoid

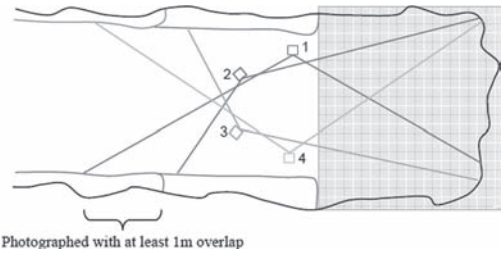

Figure 3. Four images are taken at each of the four numbered locations. These sixteen images are processed using the processing algorithm to produce the 3D point cloud (after Birch 2008).

movement, aperture priority, an ISO setting of 200, and automatic white balance.

2.3 Panoramic images of a tunnel excavation

The visual documentation of an excavation can be important during the construction phase but also for future historical purposes. The combination of a point cloud and associated visual image is the most desirable manifestation of such a record. However, at times, it is useful to have a rapid and simple record and one way of achieving it is to take a series of photos to form a panorama. Digital cameras have made this a relatively trivial task while the photogrammetric methods described above are becoming quite accessible. In this section we restrict ourselves to the most basic methods of creating a panoramic record of a tunnel wall and roof.

The panoramas may be formed by a combination of several still photographs that are stitched together based on common content in adjacent, overlapping images. The images are usually obtained by panning across a scene of interest with an overlap of approximately 30%–50%. Geometric corrections are made within the stitching software for such factors as lens distortion and field of view. The most common form of panorama is a so-called flat panorama, where each image is taken along a horizontal plane, usually over a span of 180 degrees or more. The vertical field of view is determined by the nature of the lens used to take the images. A wide angle lens is used for a large vertical field of view, and for maximum field of view but also maximum distortion, a so-called fish-eye lens (a very wide angle lens) is used.

The wider the lens angle, the fewer the number of photographs required in forming the panorama. Common types of panoramas are illustrated in Figure 4.

The actual panning of the camera to obtain the overlapping image sequence can be done without any aids, just careful use of the viewfinder to



Figure 4. Various forms of panoramas may be created. Typically, they consist of images projected onto various types of surfaces (a) flat (b) cylindrical (c) spherical (d) cubic. (©James Rigg/panoguide.com—reproduced with permission).

ensure sufficient overlap of identifiable features in adjacent images. However, there are both manual and automated tripod attachments that facilitate the panning and image overlap with greater accuracy and that lend them to routine and speedy field application. Figure 5 shows an automated panoramic head. A stitching feature often comes with the software for consumer digital cameras. Again, slightly more sophisticated software expedites some of the process for difficult images that resist rote application of the standard software.

The creation of a panorama in a tunnel follows these basic steps:

- Position the camera mounted on the panoramic head approximately on the axis of the tunnel with the rotation about that axis and with the camera facing the tunnel wall
- Rotate the camera head in equal angular steps ensuring about 30% overlap in the adjacent images, taking images using the in-built flash at each increment of rotation. Ensure labeled reference points are included in the panorama
- Process the images in a panoramic stitching software
- Conduct the field process from a position of safety.

Figure 6 shows some software that enables user interaction with the stitching of the images to create the final panorama. The panorama can



Figure 5. An automated panoramic head suitable for both horizontal and vertical panoramas (Gigapan Epic Pro).

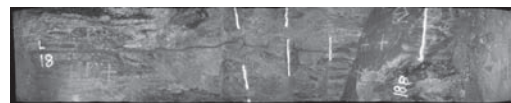
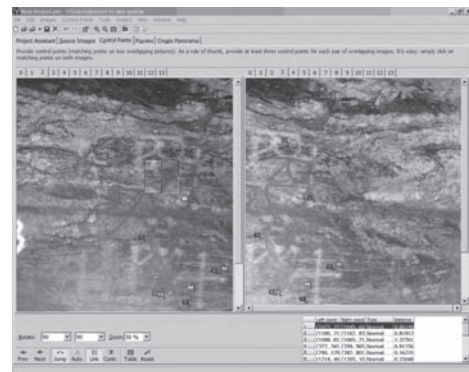
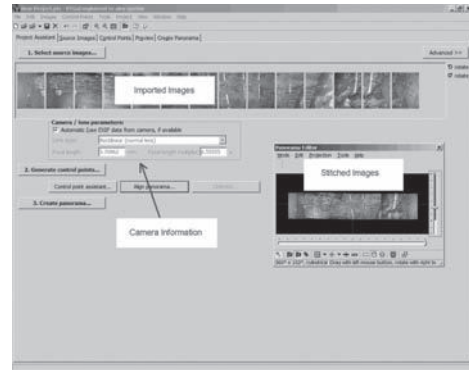

Figure 6. Panorama creation (a) overview of workflow (b) close-up of two adjacent images (c) unwrapped final panorama of tunnel wall and roof with half-barrels highlighted in white.

be a large file and it is sometimes useful to allow “immersion” of the viewer in the image by using virtual reality. The visual immersion is difficult to illustrate without a live demonstration, but it is essentially a method for the user to view different parts of the panorama by moving a cursor in any planar direction (up, down, left, right or anywhere in between). It is also possible to zoom in or out to view the panorama in more detail and this can be useful for identifying geological features and blast-induced damage or half-barrels.

3 GEOMETRIC PARAMETERS FOR TUNNEL ASSESSMENT

3.1 General

The basic geometric parameters of interest in assessing a tunnel are the advance and the conformance to the desired profile. Two other features are worth considering: the flatness of the face prior to drilling, and the accuracy of the drilling in terms of the collar and toe positions of each blasthole and each void hole. The advance refers to the distance the face is progressed in the direction of tunneling for a given blast round. The conformance to the desired profile refers to the extent to which any pair of three objects, the as-designed round, as-drilled round, and as-blasted round overlay with each other. The terms overbreak and underbreak refer to regions where one object is outside or inside the reference object, respectively. The overbreak and underbreak are strictly a 3D volume but they may be examined using cross-sections along the axis of the tunnel and be a 2D area.

3.2 Dead-end of tunnel and face flatness

The drilling of a tunnel blasting round requires accurate location of the collars of the blastholes and the correct drill orientation, typically slightly above horizontal for the main production holes, slightly outward for holes along the perimeter, and downward for holes at the base of the faces to enable lifting of the muckpile for easier digging. Flatness of the face enables accurate location of the collar positions with the drill acting normally to the face and after engagement any usually small adjustment in the hole direction may be made. Figure 7 illustrates two types of effects that need to be considered.

Figure 7(a) shows the actual idealized face as a rotated and tilted plane with respect to the nominal vertical face with its normal in the direction of the axis of the tunnel. Here a strategy is to fit a plane to the point cloud data of the face and examine the two orientation angles with respect to the normal plane to the tunnel axis. Figure 7(b) shows the

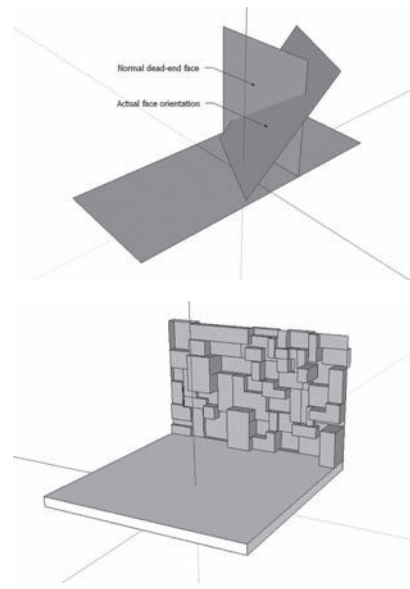

Figure 7. (a) Angled face from normal—the sketch is exaggerated to show both a tilt and rotation with respect to a vertical normal plane (b) Idealised vertical rough face with flat spots.

issue of the roughness of the face itself. Flat spots normal to the tunnel axis may still exist in good circumstances and may not cause difficulty to the drill. An actual face will have perturbations about the normal plane but if a hole collar crosses multiple adjacent flat spots, then the accurate location of that collar may be compromised. A measure of the percentage of flat area may be a useful index.

An actual face will combine both these effects in a complex manner—a common situation is that the face may be dished with the perimeter of the face sitting proud of the inner parts of the face, perhaps approximated by the shell of the upper quarter of various solids with different cross-sections. Figure 8 shows an ellipsoidal shape that may be used for fitting. The fitting of more complex shell-like shapes to portions of a point cloud is an active area of research (see, for example, Ong et al. 2011).

3.3 Advance per round

The time to completion for the construction of a tunnel for a road, rail, service, or mine is a significant measure of the overall cost of the project. In the civil construction domain it determines income for a toll road, for example, and for a mine, it influences the time to access the valuable minerals. The time to completion is affected by many variables but one of these is the advance per round. An obvious

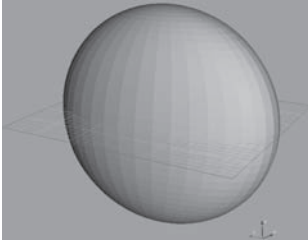

Figure 8. Ellipsoid shape whose upper quarter may be used for fitting to the dead-end of a dished tunnel face. Other shapes are possible such as an ovoid, for example.

choice for the advance per round is the distance between the mean coordinates of a plane fitted to the dead-end faces of adjacent blasted rounds.

3.4 Drilling accuracy

Drilling accuracy involves a comparison between the as-designed round to the as-drilled round. The actual locations of the collars and the toes of the blastholes versus the planned locations is a useful measure. A simple box-whisker plot of the differences in actual versus designed is a reasonable measure of drilling accuracy. In some cases, the as-designed locations may not be available, notably in mine development tunnels where the contractor has flexibility and may alter each round. In such cases a box-whisker plot of differences between the collar locations and the toe locations along (say) the perimeter may be a useful indicator of drilling accuracy.

Figure 9 shows some data reported by Spathis et al. (2009). These box-whisker plots have the centre of the box at the median value with the two adjacent quartiles as the box and with the extreme values shown. In this case, the drilling lengths are reasonable, while the spacings are somewhat poor, especially for the toes. The data suggests the potential for a poor blast result.

An alternative method for assessing the drilling accuracy for the perimeter blastholes is discussed below.

3.5 Conformance to as-designed/as-drilled rounds

Boolean operations in either 3D or 2D between the as-drilled versus as-designed rounds, and between the as-blasted versus as-drilled rounds provide information on the conformance to the designed profile or the drilled profile, respectively. The first pair offers an assessment of the drilling accuracy while the second pair indicates the extent that a blast design has managed to follow the boundary defined by the perimeter blastholes.

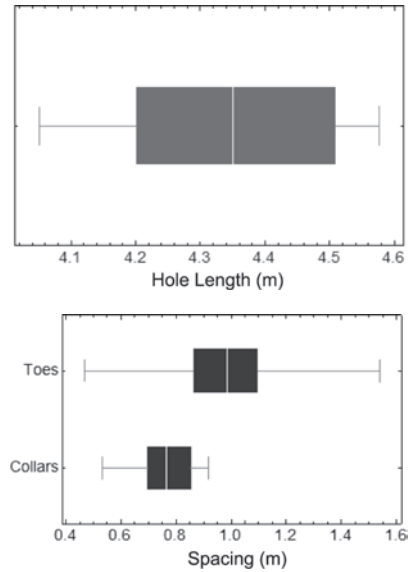

Figure 9. Drilling accuracy (a) Hole length box-whisker plot (b) Collar and toe spacing box-whisker plots (Spathis et al. 2009).

The tunnel designer commences with a cross-sectional profile that is usually uniform for the majority of the length of the tunnel. Typical profiles include circular, oval, rectangular, amongst others (Fig. 10).

The process for performing the required Boolean operations on the reference round and the as-drilled or as-blasted round is illustrated in Figure 11. Firstly, the union of the two objects is formed. This includes the areas occupied by either of the two objects including those areas where they intersect or overlay each other. The overbreak is found by forming the difference between the union and the reference object. The underbreak is found by forming the difference between the union and the non-reference object. The reference shape may be the as—designed round or the as-drilled round that are compared to the as-drilled round and as-blasted round, respectively. It is assumed that both types of rounds are placed in the global coordinate system so that the necessary comparisons are possible. The process is applicable to both 2D and 3D data. There are a number of software tools that enable such calculations, including some mine design packages.

The first step in the process is to form each individual object. The as-designed object is an idealised shape and relatively straight-forward to construct. The as-drilled round is built by using the surveyed perimeter blastholes. Each pair of adjacent blastholes are used as edges to form planar facets

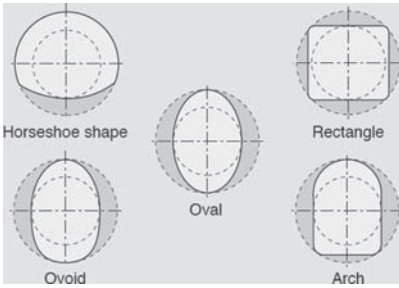

Figure 10. Typical tunnel cross-sections.

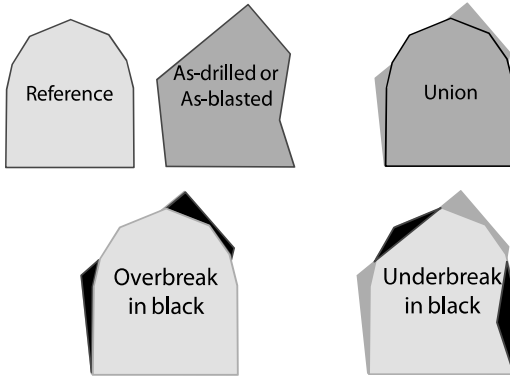

Figure 11. Boolean operations in 2D (a) approximate horseshoe profile is the reference object and the irregular polygon is the as-drilled round or as-blasted round. (b) Union of the reference object and the as-drilled or as-blasted object (c) Union minus the reference object gives the overbreak (in black) (d) Union minus the as-drilled or as-blasted object gives the underbreak (in black). Typically the reference object is either the as-designed round or the as-drilled round.

of a shell. The as-drilled round stitches these facets to form a closed perimeter shell (Fig. 12 (a)).

The as-blasted object starts as a point cloud with between perhaps 50 000 to 10^6 points. For a typical mine development round of say five metres length and with a diameter of five metres, the number of points required on a $1\text{ cm} \times 1\text{ cm}$ grid is approximately 7.5×10^5 points and this is likely to be the maximum necessary. Figure 12 shows the as-drilled and as-blasted rounds overlaid with the perimeter blasthole locations and indicates some overbreak and underbreak regions. Note that the two rounds have been truncated vertically at the front and rear of the round to remove edge effects in the calculation of conformance. Similarly, the floor has been truncated to remove effects such as poor mucking of the broken material after the blast that would artificially influence the conformance assessment.

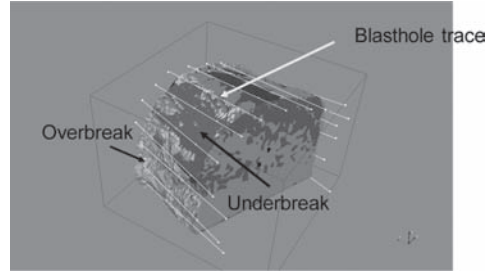
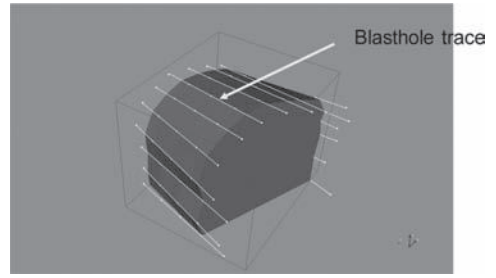

Figure 12. Boolean operation for as-drilled and as-blasted rounds (a) the as-drilled round formed by joining adjacent perimeter blastholes (b) overlay of the as-blasted round on the as-drilled round with some underbreak and overbreak areas indicated.

4 EXPERIMENTAL DESIGN CONSIDERATIONS

4.1 General

Randomised paired comparisons is a robust method for conducting field work to determine the benefit or otherwise of a treatment (Box et al. 1978). It essentially relies on blocking for variables under the control of the experimenter and randomizing across those variables over which no control is possible. Noy and Brent (2003) and Brent and Noy (2005) have demonstrated the method in work at mine sites, particularly for blasting trials.

4.2 Paired comparisons in tunnel blasting

Spathis et al. (2006) and Spathis et al. (2009) describe the challenge of conducting randomized paired comparisons in a tunnel. The intent is to have a single blast, half of which uses the reference blast design and the other half that uses the modified blast design. A tunnel blast consists of the cut region which contains a number of void holes that enables the expansion of the early breaking rock, followed by the production holes in the body of the round, followed by sub-contour and contour blastholes near the perimeter, usually followed by the lifters at the base of the blast.

The treatments applied in the modified blast design are many and varied and include such things as number of blastholes, their disposition and timing, all of this in the different regions of the tunnel blast. Spathis et al. (2009) argue that the ideal choice of using a single round with both the reference and modified blast design in each half of the round can be difficult from an operational perspective, let alone from the potential effects of earlier firing holes in one half affecting or potentially masking the effects of the other half. However, Yamamoto et al. (1995) is an example where a single blast was used successfully although they did not report a formal statistical analysis. The next best alternative is to use pairs of blasts adjacent to each other. There remains scope to investigate the two distinct methods further.

4.3 Number of trials required

It is desirable to have sufficient pairs of data for a statistical comparison. The question that arises is: how many pairs are required? If we are examining differences in the mean values between a reference blast design and a modified blast design then we may speak about the significance level and the power of the experiment. Table 3 shows how these standard parameters fit into a decision system based on estimates using sample data compared to the population data. The decisions are made using statistical hypothesis testing with the two errors known as Type 1 and Type 2. The significance level, α , the power, $1-\beta$, and the effect size (ratio of the minimum actual difference worth identifying normalized by the standard deviation of the sample differences), determine the minimum sample size.

The Appendix shows some figures that illustrate the interaction of these four parameters. The smaller the significance level, the larger the power, and the smaller the effect size, the larger is the number of trials required for the given parameters. As illustrated in the Appendix, it is usually necessary to conduct more than a handful of paired comparisons. For example, given a significance level of 0.2, a power of 0.8, and an effect size of 0.8, the minimum number of paired comparisons is 8.

Table 3. Type 1 and 2 errors: significance level and power.

Decision from sample	Population null hypothesis of equal means TRUE	Population null hypothesis of equal means FALSE
Reject	Type 1 error	Correct decision
Accept	Correct decision	Type 2 error
Decision	Significance level α	β , power = $1-\beta$,

In practical terms, the minimum number of paired comparisons required for studies in tunnel blasting can be a significant challenge from a logistical viewpoint but also in terms of the cost to conduct a given study. The effect size may need to be quite large and if not observed in the first few paired comparisons, the study may be curtailed and alternative and more promising treatments sought.

An advantage of using a single tunnel round with both the reference and treatment blast design included is that one obtains a single pair of data in a single blast. It avoids the logistics of swapping between, say, different products in adjacent rounds or ensuring that a matching pair of rounds are fired adjacently, particularly if there are several headings being used in the experiments. The latter is not unusual in a mine where mining may occur at different locations on different levels.

Irrespective of these challenges, it is important to follow the main principles of paired comparisons and ensure that all controllable variables are managed and blocked against while randomizing over the uncontrollable variables.

5 DISCUSSION AND CONCLUSIONS

A number of geometric parameters have been proposed in the present paper that assists the assessment of perimeter control blasting in tunnels. The emphasis has been on the perimeter as that influences heavily the integrity of the tunnel and the amount and cost of rock support. Simple approaches have been suggested for the advance per round and also for assessing drilling conformance. The methods are summarized in Table 4.

Table 4. Geometric measurement methods.

Parameter	Measure	Comment
Face orientation	Tilt and dip angles	Fit plane or shape to dead-end cloud point data
Face flatness	Percentage flat area	Use standard deviation
Advance/round	Distance between adjacent faces	Use mean of fit to adjacent dead-ends
Drilling accuracy	Mean & standard deviation of collar and toe errors	Use spacing of toes & collars as alternative
Perimeter conformance	Boolean difference between reference & alternative	Volumes for 3D, areas for 2D

The methods focus separately on the condition of the dead-end of a tunneling round, the advance per round, the quality of the drilling, and the conformance to a given profile as assessed in terms of overbreak and underbreak.

The 3D coordinate data needed for the analysis can come from laser scanners or digital photogrammetry. These are not exclusive means for obtaining such data and Franklin et al. (1989) describe an elegant method that uses light sectioning to obtain the 2D profile in a tunnel. Wang et al. (2010) describe a similar method using more recent laser-lit profiles. An issue in acquiring the coordinate data is the real possibility of shadow zones, that is, parts of the surface are obscured from the line of sight of the laser scanner or the camera used to take the measurements. One approach to deal with this is to use a rail aligned in the direction of the tunnel axis and take measurements essentially perpendicular to it. Safety issues are paramount in all such data acquisition and work should be undertaken from a position where no harm to the operator is possible. One might expect that robotic collection of this information will become routine.

In some recent work a tunnel contour quality index was proposed by Kim & Bruland (2008) and modified in Kim & Bruland (2009). They considered the effects of drilling and geological parameters in Kim et al. (2009). The index uses a weighted sum of three effects and a constant for range adjustment to help normalise the index for a given tunnel based on actual measurements. The three effects are the overbreak area, the perimeter length of a cross-section, and the longitudinal overbreak for five or greater rounds in a tunnel. They appear to make no distinction between overbreak versus underbreak apart from ignoring it, but this is appropriate for some actual blasting situations where underbreak is not present. The relative weights for the three effects are in the ratio 4.5:4.5:1, respectively. The authors identify that an issue with the index is the interaction between the three effects.

In making the sorts of geometric comparisons described in this paper, it is apparent that the number of trials demanded for a statistically significant conclusion is more than five (see Appendix). Figure 13 shows some data reported by Spathis et al. (2006) that shows the type of variation in actual randomized paired comparisons. The data are for two distinct treatments: firstly, the effect of precise timing produced by higher accuracy electronic delay detonators compared to standard pyrotechnic detonators with both blasts using ANFO, and secondly, the effect of precise timing, with faster timing using bulk emulsions versus standard timing using pyrotechnic detonators and

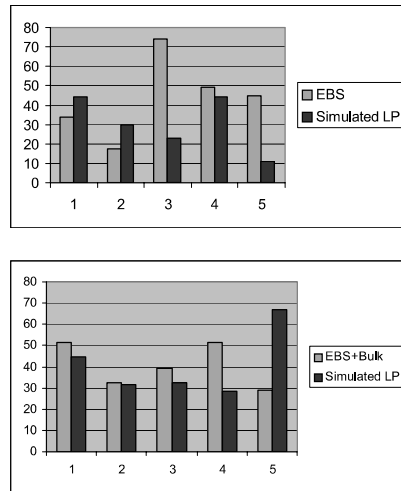

Figure 13. Randomised paired comparisons (a) effect of precise timing (b) effect of precise, faster timing and bulk emulsions (after Spathis et al. 2006).

ANFO. The actual p-values for the two treatments are 0.535 and 0.019, respectively. The first treatment indicates no difference while the second treatment supports a difference. Spathis et al. (2006) indicated incorrectly the former treatment was statistically significant. They also made the same comments for treatments assessed using half-barrel measurements and throw. These were incorrect due to an arithmetic error, although careful observation of their plots should have alerted them to the error. In any case, the statistical power of these experiments was low due to the relatively small number of trials, the variability in the data and the effect size as identified in the Appendix. The more recent data of Spathis et al. (2009) identified these limitations when a few trials are conducted. The clear need is for more paired comparisons. Furthermore, the strength of the randomized paired comparison approach is that more pairs may be added to the data set over time to enable a stronger statistical assessment.

The geometric assessment of perimeter control blasting in tunnels presented here offers a vehicle to guide better blasting strategies for tunnels.

ACKNOWLEDGEMENTS

The author would like to thank his colleagues Les Armstrong, Paul Lesberg, David Stow, Gavin Yuill, Michael Noy, and Geoff Brent variously retired, still there or moved on from Orica Australia. Some of the initial fieldwork in mine tunnels was conducted at the Edgar Mine through

the Colorado School of Mines and thanks are due to Vilem Petr, Bob Cooper and Tibor Rozganyi for their support. Stephen Boyce and Steve Thomson have provided ongoing support over a number of years in our efforts to quantify what type of blasting products, systems and designs produce a better tunnel.

REFERENCES

- Atkinson, K.B. 2001. Close range photogrammetry and machine vision. Whittles Publishing, Caithness.
- Birch, J.S. 2008. Using 3DM analyst mine mapping suite for underground mapping. Proc. Laser and Photogrammetric Methods for Rock Tunnel Characterization (F. Tonon, ed.), June 28–29, San Francisco.
- Box, G.E.P., Hunter, W.G. and Hunter, J.S. 1978 Statistics for Experimenters, John Wiley and Sons, New York, pp. 93–106.
- Brent, G.F. and Noy, M.J. 2005 Matched pairs blasting technique to quantify the benefits of the i-kon™ electronic initiation system, Proceedings Third EFEE World Conference on Explosives and Blasting, Brighton, September 13–16, pp. 481–492.
- Dalgaard, P. 2008. Introductory statistics with R (2nd Edition). Springer, New York.
- Franklin, J.A., Barra, J. & N.H. Maerz (1989). Blast over-break measurement by light sectioning. Int. J. Mining and Geological Engineering, 7, pp. 323–331.
- Gothard, J. 2012. AdamTech: How to take photos underground ! Orica Mining Services Technical Note.
- Kabacoff, R.I. 2011. www.statmethods.net/stats/power.html. Accessed 23 November 2011.
- Noy, M.J. and Brent, G.F. 2003 Mine site trialling—experimental design and measurement methods, Orica Technical Report No. 58635.
- Ong, W.E., Beetson, R.K. & C.J. Price 2011. Reconstruction with blobby shapes. ANZIAM J. 52 (CTAC 2010), pp. C596–C611.
- R Development Core Team, 2008. R—A language and environment for statistical computing. R Foundation for Statistical Computing, Vienna.
- Shan, J. & C.K. Toth 2009. Topographic laser ranging and scanning: principles and processing. CRC Press, Boca Raton.
- Spathis, A.T., Armstrong, L.W. and Lesberg, P.L. 2006. Tunnel blasting using precise electronic delay detonators and bulk emulsions, Proceedings Eighth International Symposium on Rock Fragmentation by Blasting, May 7–11, Santiago, Chile, pp. 411–416.
- Spathis, A.T., Yuill, G. & D. Stow 2009. Proceedings of the 1st International Seminar on Safe and Rapid Development Mining, Perth, May 6–7, 2009.
- Tonon, F. & J.T. Kottenstette 2006. Laser and photogrammetric methods for rock face characterization. Proc. Workshop held in conjunction with US Rock Mechanics Symposium, 18–19 June, Golden.
- Wang, T.-T., Jaw, J.-J., Hsu, C.-H., & F.-S. Jeng 2010. Profile-image method for measuring tunnel profile—improvements and procedures. Tunnelling and UndergroundSpace, 25, pp. 78–90.
- Wetherelt, A. and Williams, D.C. 2006. Using high definition surveying (HDS) to quantify tunnel hole burdens and fragmentation, Proceedings Eighth International Symposium on Rock Fragmentation by Blasting, May 7–11. Santiago, Chile, pp. 55–60.
- Yamamoto, M., Ichijo, T. and Tanaka, Y. 1995. Smooth blasting with electronic delay detonator, Proceedings Eleventh Annual Symposium on Explosives and Blasting Research, Nashville, February 5–9, pp. 144–156.

APPENDIX: NUMBER OF TRIALS IN RANDOMISED PAIRED COMPARISONS

Box et al. (1978) describe the method of randomized paired comparisons. Dalggaard (2008) discusses the use of the statistical software package R (R Development Core Team 2008) and includes a description of the use of the significance level, power, and the effect size to estimate the minimum number of paired comparisons required. He provides an approximate formula for the minimum number of paired comparisons assuming known population standard deviation so that the normal distribution may be used. The formula given is

$$n = \left(\frac{Z_{1-\beta} + Z_{\alpha/2}}{\delta / \sigma} \right)^2 \tag{A1}$$

where the z terms are quantiles from the normal distribution, α is the significance level assuming a two-sided test, $1-\beta$ is the power, δ is the minimum meaningful difference of interest and σ is the standard deviation of the population. The approximation tends to underestimate the number of pairs when the number is small.

Figures A1 to A3 give the results for the number of paired comparisons for different significance levels, power and normalized effect sizes (denominator in Equation A1 and denoted as d in the figures). They have been calculated using a modified R script obtained from Kabacoff (2011).

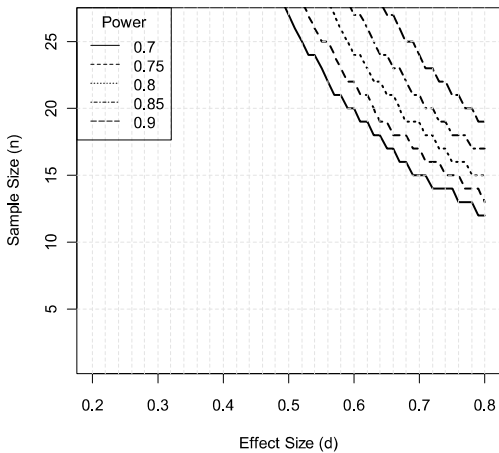

Figure A1. Sample size for significance level of 0.05.

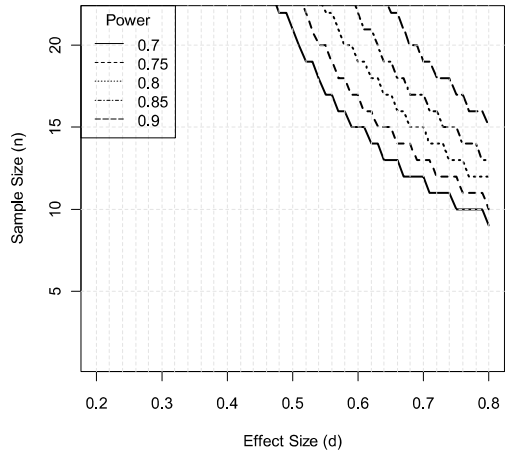

Figure A2. Sample size for significance level of 0.1.

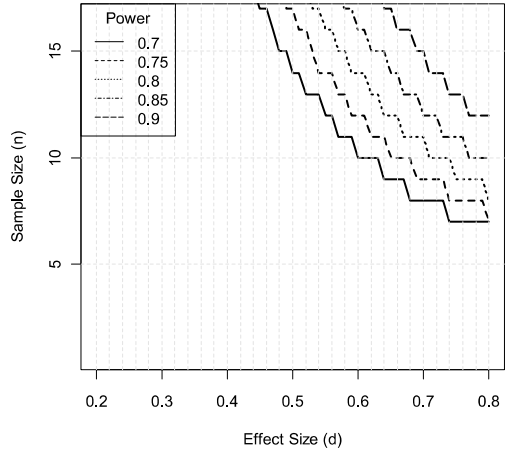

Figure A3. Sample size for significance level of 0.2.

This page intentionally left blank

Controlled blasting for underground hydroelectric projects— NIRM experience

H.S. Venkatesh, R. Balachander, G. Gopinath & A.I. Theresraj

National Institute of Rock Mechanics, Bangalore, India

ABSTRACT: The National Institute of Rock Mechanics (NIRM) has been associated with many hydroelectric projects during their planning and construction for over two decades. Though the excavation of caverns, tunnels, shafts etc have common features in many of the projects, the problems associated with these excavations can be quite different. In general the blasting problems in tunnels, caverns and shafts are related to overbreak/under-break, poor advance, rock mass damage. This paper deals with the problems and solution evolved during the blasting studies at three major hydroelectric projects which are geographically separated.

1 INTRODUCTION

India is bestowed with a huge water resource for harnessing power from sites that has been continuing over a period of time. National Institute of Rock Mechanics (NIRM) has been associated with many of these projects in planning the blast designs and even their execution in the field. At Sardar Sarovar Project (India), distress problem was encountered in the power house due to limited cover and shear zones. As cracks were observed on the cavern walls excavation was suspended and walls were additionally supported. A construction ramp on the downstream wall was to be excavated by drilling and blasting without causing further damage. The excavation of the ramp was critical as it was providing restraint to the movement of the downstream wall, which was intersected by large openings for six draft tube tunnels below the ramp.

While excavating the power house at Tala Hydroelectric Project (Bhutan), it was reported that roof collapse occurred at RD 95. The bearing plates and the end anchors were intact but the rock mass in between the bolts fell down. High frequency geophones were used to monitor near field vibrations and the permissible vibration levels were found to control rock mass damage. The Head Race Tunnels (HRT) at Chuzachen Hydro Electric Project (India), were being excavated in different rockmass conditions. There were undercuts and over breaks in the tunnel excavation leading to project delay and cost escalation in terms of shotcreting and support. Suitable blast designs for the tunnel faces were suggested and implemented so as to minimise the adverse impacts. This paper

deals with the problems and solution evolved during the blasting studies at three major hydroelectric projects which are geographically separated.

2 STUDY AT SARDAR SAROVAR PROJECT

The Sardar Sarovar (Narmada) project is one of the largest river valley projects in the state of Gujarat, India. For this project, a dam of 128 m high and 1210 m long was constructed across the river Narmada. The underground power house complex comprised six pressure shafts, power house cavern with six turbine units with an installed capacity of 6×200 MW, six draft tube tunnels, collection pool and exit tunnels.

2.1 *Background of the study*

During excavation of the power house cavern (23 m wide, 56.6 m high and 212 m long) at Sardar Sarovar Project, distress problem was encountered due to the limited amount of cover and the presence of shear zones. After cracks were observed on the cavern walls, further excavation was suspended and additional treatments to the walls were provided. A construction ramp on the downstream wall was to be excavated by drilling and blasting without causing further damage (Fig. 1).

The support provided in this cavern consisted of pattern rock bolting together with 38 mm layers of shotcrete with a welded wire mesh in between. Unfortunately, the 6 to 7.5 m long rock bolts provided for the sidewalls of the cavern were too short and could not provide adequate restraint to prevent the development of cracks (Hoek 1995). The first

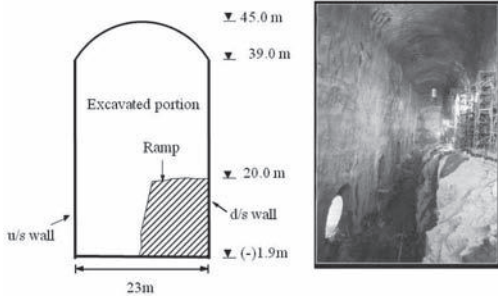

Figure 1. Position of the ramp and view of the underground power house cavern before excavation of the ramp.

crack was observed along upstream wall in the area of shear zones in March 1991. Subsequently cracks were also observed on downstream wall and bus galleries (Dasgupta et al. 1995). As remedial measures for the distress, additional treatments for upstream wall, downstream wall, bus galleries and for the junction of pressure shafts, bus galleries and draft tube tunnels with power house walls were evolved and the treatment was completed in 1994 (Mittal et al. 1999).

The construction ramp left along the downstream wall from EL 20 m at the service bay to the floor level at EL (-) 2 m of the cavern on the river side was the only access to the floor level of the cavern till the draft tube tunnel 1 was through to the cavern. The width of the ramp was approximately 8 m on the top or nearly 12 m at the bottom. The estimated volume to be excavated was 15000 m³.

The overall stability of the power house cavern was a matter of great concern because the ramp, which was temporarily supporting the downstream wall, was to be finally excavated. The rock mass in the downstream wall was weakened by the intersection of several large openings including six openings for draft tube tunnels and three for bus galleries. Although the magnitude of the deformation recorded after the treatment was small and no alarming signals were discernible, excavation of the ramp by drilling and blasting was considered as risky.

It was felt that a very conservative blast design would delay the excavation process and increase the cost of excavation. A liberal blast design, on the other hand, should not be permitted for safety reasons. Therefore an optimum controlled blast design had to be evolved. The controlled blasting should be followed with immediate support/reinforcement of the exposed wall to minimise rock mass movement.

Ramp blasting had an additional free face compared to the blasts conducted earlier which had only two free faces. The ramp blasting for the same amount of charge per delay was expected

to produce lower vibration and hence less damage to the adjoining rock. For safety, the ramp was divided into two parts as main (Stage 1) and bark (Stage 2). The major part of the ramp was blasted as bench blasting while controlling ground vibration. Smooth blasting was also required for the bark portion of the ramp to reduce the damage on the downstream wall of the cavern. Therefore two blast designs were made; one for the main and another for bark. Stage 1 was advanced by about 6 m before taking Stage 2. The damage to the downstream wall was assessed by taking multipoint extensometer readings and by observing cracks in the glass plate installed at a critical location, by vibration monitoring and observing drill hole impressions on the wall.

Ramp blasting in two stages (leaving the bark of 1.5 to 2.0 m) was expected to give better results compared to blasting in a single stage (full width of the ramp). Though the loading and hauling equipment were to be deployed under a congested condition, this option was safer.

The blasted muck was removed through draft tube tunnel 1, loop and access tunnels. Movement of rock through this route was possible throughout the year. As the ramp was divided into layers of 2.0 m, a total of 11 layers had to be removed. The ramp blasting progressed from the river side towards the service bay by vertical benching leaving a bark of 1.5 m to 2.0 m wide. After removing the third layer, the muck was also removed through draft tube tunnel 6 after it was broken through with the downstream wall of the cavern.

Superdyne, a cap sensitive small diameter aluminised slurry explosive, manufactured by IDL Industries Limited, was used. Each cartridge of explosive was 25 mm in diameter, 200 mm long, weighing 0.125 kg. The density of the explosive was 1.15 to 1.25 gm/cc and the velocity of detonation was 3400 to 4000 m/s.

Short delay electric detonators had delay numbers ranging from zero to ten, with a nominal time interval of 25 ms between successive delay numbers from 1 to 6, 50 ms for 7 and 8, and 75 ms for 9 and 10 was used. Long delay electric detonators had delay numbers ranging from zero to ten, with a nominal time interval of 500 ms between each successive delay number. These detonators were manufactured by IDL Industries Limited, India. The delay periods of either short or long delay detonators were not sufficient. Hence, a combination of short and long delay series was used for the blast design to restrict the maximum charge per delay to 4.5 kg.

2.2 Blast design for main

The hole diameter deployed for drilling was 51 mm using Ingersol Rand CM 341 mounted on EVL

130 wagon drills. The same wagon drills were also used for the purpose of rock bolting and cable anchoring. It was extremely important that the excavation and support go concurrently. Therefore, all necessary arrangements for treatment of downstream wall after removal of bark were made ready so as to provide treatment without any delay. Vertical holes were drilled to a depth of about 2.2 m on a pattern of 1 m × 1 m and charged with Superdyne. The charge per hole was 0.750 kg. The maximum charge per delay was restricted to 4.5 kg to avoid damage to the rock mass due to blasting. This charge was less than 7.54 kg used earlier for horizontal bench blasting and much less than 10.1 kg used in vertical benching with 76 mm diameter holes. Either V-cut or diagonal cut pattern was used depending on the desired direction of throw and other site conditions.

The design specific charge for the ramp blasting was 0.30 to 0.35 kg/m³, which was lower compared to those used earlier because of the availability of an additional free face (Adhikari et al. 2001). The actual specific charge calculated from the consumption of explosives and the volume of mucking was 0.23 kg/m³.

The 51 mm dia drill hole and 25 mm dia explosive cartridge were not matching. Six cartridges of explosives loaded in the hole settled at the bottom, leading to an increased stemming length of about 1.5 m. Because of this, fragmentation was not uniform but the longer stemming column controlled the occurrence of flyrock reducing the risk of equipment damage.

2.3 Blast design for bark

With the drilling and charging pattern for bark blasting, the bark portion of the ramp was removed by drilling jack hammer holes of 2.0 m deep. The suggested design consisted of production holes and perimeter holes. The perimeter holes were drilled at a spacing of 0.2 m and the production holes were drilled 0.5 m apart from the perimeter holes at the spacing of 0.8 m. The production holes were charged with 0.25 to 0.375 kg per hole while the perimeter holes were charged with 0.25 kg using PVC spacers. However, in the shear zones the charge was reduced to 0.25 kg in production holes and 0.125 kg in perimeter holes. Trials were made leaving two dummy holes and one dummy hole in between the charged holes. The result was found to be better by leaving one dummy hole.

2.4 Monitoring blast vibration

During excavation of the ramp, blast vibrations were monitored at different locations in the powerhouse. The vibration levels were compared with

the computed values from Equation 1, which was derived for excavation of the same cavern (Gupta, et al. 1987).

$$V = 64.23(D/\sqrt{Q})^{-0.80}, r = -0.86 \quad (1)$$

V = peak particle velocity (mm/s); D = radial distance from blast to monitoring station (m); Q = maximum charge per delay (kg) and r = correlation coefficient.

The measured peak particle velocities were very much less than those computed from equation 1. As the ground vibrations generated by ramp blasting were lower, the damage to the surrounding rock mass was considered controlled.

2.5 Monitoring movements

Single/Multipoint borehole extensometers were installed at various locations around the cavern to regularly monitor the behaviour of the surrounding rock mass in the cavern. The instrumentation readings did not indicate any considerable change in the rock mass response during and after removal of the ramp. This shows that damage to the surrounding rock mass was controlled.

A glass plate was fixed on the river side wall of the bus gallery 1 before commencing the removal of the ramp. It was at this location where the distress was maximum. After each blast, the glass plate was observed for formation of cracks in it. No cracks were found till the completion of the excavation, confirming that the blasting damage was controlled.

During removal of ramp, even though the over break was negligible on the downstream wall of the cavern, the drill hole impressions obtained were not satisfactory. This may be due to the unfavourable joint orientations on the downstream wall. However the profile of the downstream wall, as confirmed by the survey, was satisfactory and there was no noticeable damage to the wall rock.

3 STUDY AT TALA HYDROELECTRIC PROJECT

A 1020 MW (170 × 6 units) hydroelectric project at Tala in Bhutan was under construction, as a joint venture project between the Royal Government of Bhutan and the Government of India. Apart from other components of the project, the underground powerhouse was 206 m long, 20.4 m wide and 44.5 m high. The rock mass consists mainly of jointed, foliated and folded phyllites, phyllitic quartzite, and quartzite bands. The rock mass is classified as class III and IV according to Q system. The uniaxial compressive strength of the rock

based on the laboratory test happens to be 63 MPa and the Young's modulus 'E' based on Q value and recomputed by in-situ test results happens to be 5 GPa. The measured P-Wave velocity in the rock mass is about 1200 m/s (Venkatesh et al. 2004).

The excavation method adopted uses a central gullet 7 m wide, excavated by first making a box cut 10 m long and 3 m deep. The entire gullet is excavated across the free face by benching. Subsequently, the upstream and downstream benches are excavated. On average, 75 vertical holes are drilled using crawler mounted pneumatic drills. Forty-five of the holes are of production holes, while 30 are for smooth wall. The hole depth was 3 m and the hole diameter was 41 mm. The average burden and spacing was 1.0 m × 1.2 m while the spacing in the smooth wall holes was restricted to 30 cm centre to centre. For the above pattern the charge per hole in the production holes varied between 1.0 kg and 1.6 kg (i.e., 5 to 8–200 gram cartridges of 32 mm diameter or 4 to 5–300 gram cartridges of 40 mm diameter) depending on the rock type. Holes were initiated using 10 g/m detonating cord and the delay was given by long period surface shock tube initiators. The smoothwall holes were charged with 0.12 kg/m to 0.2 kg/m (i.e., 3 to 5–125 gram cartridges of 25 mm diameter, distributed along the hole depth). A linear charge of 0.12 kg/m was used in shear zone areas and in all other cases it was maintained at about 0.2 kg/m. In the shear area, the charge in the buffer row was restricted to 1 kg per hole.

3.1 Assessment of wall rock damage

Different methods of damage assessment such as visual inspection, scan line surveys, scaling time, empirical rockmass rating systems, sounding of roof and walls, geophysical methods, vibration analysis, P-Wave velocity measurements, half cast factor etc are available. In order to ascertain the efficacy of the controlled blasting, half casts were measured. Controlled blasting techniques when effective, will leave part of the perimeter blast holes intact, referred to as "half-casts" or "half barrels." The Half Cast Factor (HCF) is computed as the total length of visible half-casts divided by the total length of perimeter holes drilled, expressed as a percentage. This method does not measure damage directly, but gives a qualitative assessment. Post blast inspections revealed that where the hole spacing was less than 30 cm, the HCF fell below 50% (most of the bottom third of the hole was not visible as it got crushed) where the spacing was between 30 cm and 50 cm, the HCF was about 70 to 80%. In those cases where the spacing was above 50 cm, the HCF was also about 80% but the wall needed scaling of rock projections between the

holes and removal of under cuts at hole bottoms. It was thus decided to maintain the spacing between 30 and 50 cm.

Similarly, vibration analysis to assess and control rock mass damage has been quite popular but specific damage criteria related to vibration levels are not universally established. Combining the near field vibration measurements/site specific prediction with the pre-and post blast P-wave measurements, assessment of rock damage using particle velocity levels could be established (Venkatesh et al. 2005). This technique was used to arrive at a damage threshold limit at this project.

3.2 Vibration monitoring in the near field zone

In order to minimise the damage to rock mass in the powerhouse cavern, detailed field studies were conducted. Ground vibrations were measured so as to establish the vibration threshold limit to control the rock mass damage. However it is to be understood that the frequency of the seismic wave is dependent on the transmitting medium. The closest zone from the blast is termed as the near field zone (within 30 m from the blast) as the maximum frequency carrying the highest energy in this zone would be in general beyond 100 Hz and the vibration intensity could be as high as 1500 mm/s. Unlike normal vibration monitoring instruments, near field vibration monitoring instruments need high frequency range sensors capable of measuring very high velocities with high sampling rates.

Ground vibrations were monitored in the near field zone using InstanTel's Minimate Plus Seismograph (8 channels, 8192 samples/s sampling rate). High frequency vertical geophones (28 Hz to 2 KHz) were used for monitoring. The sensors were anchored to the rock mass by drilling 16 mm diameter, 254 mm (10 inch) deep holes within the rock mass. Threaded 12 mm diameter, 279.4 mm (11 inch) long MS bolts were inserted into the hole which were anchored to the rock by resin capsules. The sensor was screwed to a mounting block which was threaded to the anchor bolt as recommended by the instrument manufacturer (Fig. 2). In total 25 bolts were permanently anchored in the drainage gallery which were used depending on the blast location. In other words, if the blast happens to be closer to bolt set number V, then these anchors were used to mount the geophones. Similarly when the blast was closer to set number IV, then these anchors were used to mount the geophones to monitor near field vibrations. The arrangement to drill holes in the rock mass in the drainage gallery was difficult due to water logging at some locations, non availability of illuminated sections and electric power cables for operating



Figure 2. High frequency geophone used for near field monitoring.

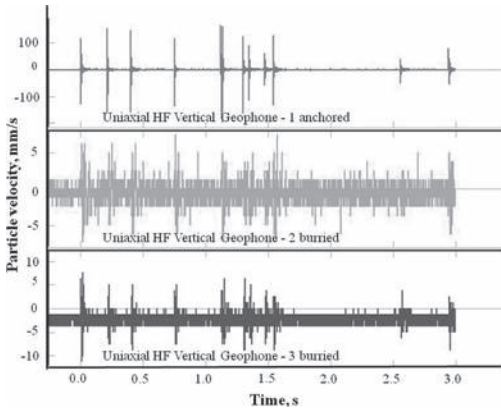

Figure 3. Signals obtained by different methods of coupling.

hand held 16" diameter drill machine. Considering these field constraints it was thought to check if buried sensors could give results on par with those anchored.

An experiment was conducted to check the efficacy of the mounting system. Three sensors were deployed, while two were buried and the third was anchored to the rock as described above. The signals picked up are shown in Figure 3. It can be seen that the sensor #1 which was anchored to the rock, has given a correct response when compared with the other two buried sensors. Hence it could be established that anchored sensors give proper results. In no case sensors were buried except during the above single experiment.

Vibration monitoring stations were established in the Drainage Gallery (DG), which surrounds the powerhouse cavern, in the Construction Adit (CA) and on the cavern walls and floor, close to the blasting face (Fig. 4).

The maximum charge per delay during the experimental blasts varied from 3.69 to 17.22 kg.

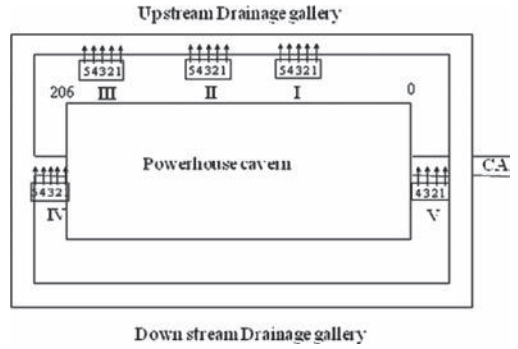

Figure 4. Location of vibration monitoring stations.

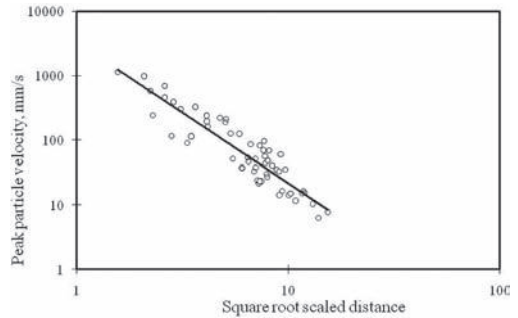

Figure 5. Peak particle velocity versus scaled distance.

The measured vibration levels varied from 6.35 mm/s to 1138 mm/s, and the measurements were carried out at distances between 3 m to 32 m from the blasts. The radial distances from the blasts to the sensor stations were established based on total station surveys that were conducted.

Fifty eight sets of data points were used for regression analysis. The site specific predictor equation 2, was derived at a confidence level of 50 percent with a correlation coefficient of -0.91.

$$V = 3325(D/\sqrt{Q})^{-2.18} \quad (2)$$

where, V = peak particle velocity (mm/s); D = distance between the blast site and the instrument station (m) and Q = maximum charge weight per delay (kg).

Figure 5 shows the plot between the square root scaled distance and particle velocity. Ground vibration for a known value of maximum charge weight per delay and distance of the point from the blast site can be estimated using equation 2 or from Figure 5.

3.3 *Effect of vibration on rock mass and support system*

Ground vibrations having sufficient energy can cause damage to the rock mass. The extent of damage is not solely a function of vibration level but is also related to site-specific parameters such as rock strength, geological features, ground support system, etc. As the severity of blast vibration increases, the damage done to the rock mass also increases. Various codes and standards have been prescribed for ground vibration limits in different countries for surface structures. There are no universally recognized standards for blast vibration for underground structures. Various researchers have carried out site-specific investigations and have correlated vibration levels through damage to underground structures.

Oriard (1982) observed that most rock masses suffer some damage at a particle velocity above 635 mm/s. Liu et al. (1998) reported that new fractures were created at a particle velocity of 1350 mm/s, while the existing fractures opened up at a particle velocity of 420 mm/s. In the case of reinforced shotcrete, McCreath et al. (1994) states that, shotcrete maintains its functionality and sustains only minor damage when exposed to particle velocities of 1500 to 2000 mm/s due to nearby blasting. Shotcrete thus is able to survive well beyond the threshold values of particle velocity at which rock fracturing would be anticipated. According to Stjern and Myrvang (1998), the mechanical performance of fully grouted rock bolts subjected to close proximity blasting is not influenced by blast vibrations and that blasting can be carried out close to fully grouted rock bolts.

The breakage effect of blasting in benches as well as in rock masses in general, is limited to the round itself and in a worst case, a few dozen blast-hole diameters into the rock mass (over break). Studies by USBM (USBM R1 7901, 1974) as quoted in Siskind, (2000), have shown that damage to rock structure extends only a few dozen blasthole diameters into intact rock, and about two burdens, at the most, in rock structures with free faces. That is why, generally, a mine drift can be mined adjacent to an earlier one without causing collapse. Some other researchers have also concluded that the extension of existing cracks in the rock mass is limited to a distance of 80 to 108 blasthole diameters (charge diameters) or 4.5 m at the most. Particle velocities at this distance were 300 to 400 mm/s. In an underground tunnel blasting project in the USA, a limit of 500 mm/s was set to protect duct banks. This was established based on site-specific experiments conducted and measurements of strain and vibration intensities (Jack Burke, 2003).

3.4 *Correlation of rock mass damage with vibration intensity*

As already mentioned, different researchers have observed the threshold of rock mass alteration at different vibration levels depending upon the rock mass they have encountered, the geology, the blasting techniques, and the blast damage assessment methods they have adopted. However, most correlate damage with particle velocity. Researchers at other sites have reported that there has been no fracturing of intact rock within a particle velocity of 250 mm/s and that particle velocity between 254 mm/s and 635 mm/s resulted in minor tensile slabbing. In Tala hydroelectric project, it was observed that vibration levels above 212 mm/s have resulted in minor spalling of the rock mass in the drainage galleries and the construction adit. This spalling might have been due to the rock mass, which could have been already dilated/deteriorated over a period of time. However, based on the above observations, it was decided to limit permissible vibration levels to 212 mm/s. It has to be understood that the vibration limit for rock mass should be a range, but the lowest of the range is considered for estimating the charge weight per delay. Unlike surface blasting, in underground blasting, the wall rock needs to be protected from damage. However, the rock mass which is abutting the perimeter holes does get weakened to a certain depth which was discussed in detail earlier. In order to control wall rock convergence, support is provided by shotcreting, and installing rock bolts. It is essential that these bolts are anchored into a competent rock. The lengths for installation of rock bolts is determined by a support engineer considering the stresses and it becomes the responsibility of the blasting engineer not to disturb the zone where the bolts are anchored. In the present case, 12 m long end anchored (4 m) bolts were being installed. It was decided to control vibration to a safe limit in this area, and a critical distance of 10 m was set. The maximum charge per delay for this distance computed from the site specific predictor equation was 8 kg. Vibrations monitored from time to time have confirmed that the vibration levels were well within the threshold limit of 212 mm/s at a distance of 10 m.

Some researchers have tried to correlate induced tensile stress developed by particle velocity with that of the tensile strength of the rock mass. Richards and Moore (2002) observed in a coal mine that strain induced by blast vibrations leading to damage was about 10 percent of the tensile failure strain of the rock. They further reported that this limit correlated with the observations of other research made in coal mines. As a cross check, in the present case, the induced strain at the threshold level was computed and compared with the tensile

failure strain. Strain induced by the particle velocity at a threshold of 212 mm/s can be calculated by using equation 3.

$$\epsilon = V/C \quad (3)$$

where ϵ = Strain induced; V = Particle velocity, (m/s) and C = Sonic velocity, (m/s).

Substituting the following value of 212 mm/s (threshold particle velocity) and 1200 m/s (the measured sonic velocity) in equation 3, the induced strain happens to be 176 μ s.

The tensile failure strain can be computed by equation 4.

$$\epsilon_t = \sigma_t/E \quad (4)$$

where ϵ_t = tensile failure strain; σ_t = tensile strength of the rock (MPa) and E = Elastic modulus (MPa).

On substituting the appropriate values for the cavern rock mass (6.3 MPa/5 GPa) the tensile failure strain happens to be 1260 μ s. The induced strain at the threshold level is 14 percent of the tensile failure strain, which is in conformity with other researchers. It can be summarized that near field vibration monitoring in conjunction with physical observation of rock mass alteration at critical locations, leads to a safe threshold limit for those site conditions. While rock mass damage criteria established for other sites may be taken as a guideline, it needs to be ascertained for the specific field condition. When site specific studies are not possible, the threshold limit may be computed from the tensile failure strain.

4 STUDY AT CHUZACHEN HYDROELECTRIC PROJECT

The project comprises of two dams, the Rangpo dam and the Rongli dam. The Rangpo dam is 48 m high concrete gravity dam with four spill ways. The Rongli dam is 41 m high concrete gravity dam with four spill ways. The water from both the dams is used to generate 99 MW (49.5 \times 2) of power from a surface power house. HRT consists of a separate HRT from Rangpo dam, a separate HRT from Rongli dam and both meet at a common point and form a combined HRT. To excavate this combined HRT, four adits were driven at different locations with different lengths and the complete HRT was excavated with eight working faces.

The Rangpo HRT is located on the left side of Rangpo River and has a length of 2604 m and it is excavated by two working faces (face 1 and face 2). The face 1 is accessible by adit 3 (96 m long) and face 2 is accessible by adit 2 (744.5 m length). The tunnel is located beneath a gently undulat-

ing topography and a maximum cover of 556 m is found at the junction of Rangpo Rongli HRT. The Rangpo tunnel route comprises of gneiss and schist of the Kachengjunga and Darjeeling formations. Four sets of main joints were observed with different dip and dip direction. The tunnel is being excavated by drilling and blasting.

In tunnel faces that were being excavated by drill and blast method, boomers drill machine were used to drill 45 mm diameter holes. Number of holes in a round was slightly varied depending on the rock type. They were charged with doped emulsion (40 mm diameter, 300 mm long and 385 g per cartridge). Blast holes were sequenced using the available long delay electric detonators. Though pull is the main concern in tunnelling projects, geological surprises like water inflow, flowing condition of the face, cavities etc are common in Himalayan geology and under these conditions stability becomes more important than the progress. In difficult rock conditions, the expected/desired progress is rarely achieved and invariably slow and steady progress enabling the safe completion of tunnel becomes the most important element.

4.1 Rangpo HRT face-1

The average pull obtained at this face was 2.0 m for a drilled depth of 3.0 m. On analysing the design, it was observed that the delay sequencing was not proper. A suitable blast design (Fig. 6) and charging

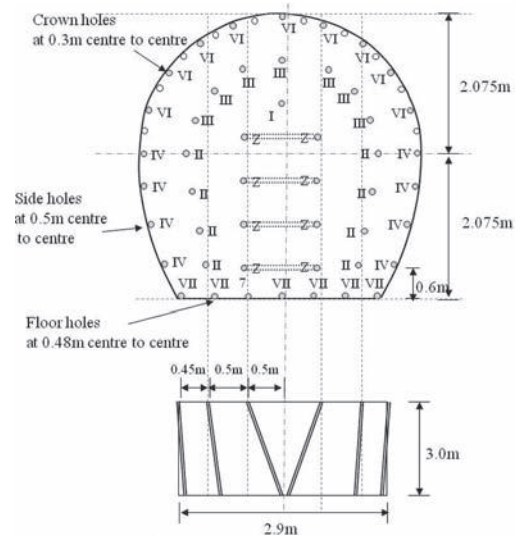

Figure Not to Scale
Use long electric delay detonators
Alternate holes in the perimeter only to be charged

Figure 6. Suggested blast design for face-1.

pattern (Table 1) was suggested with a drill hole depth of 3.0 m. In order to minimise the over break the design incorporated the smooth wall blasting technique. The results obtained at face 1 were satisfactory in terms of pull and profile. The suggested blast design gave a consistent pull of 3.0 m, and minimal over break and the tunnel was completed successfully.

In case of excessive overbreak use of pre-fabricated charge as shown in Figure 7 was suggested.

4.2 Rangpo HRT face-2

The rock mass at face 2 was highly jointed and in order to minimise instability in the tunnel excavation, holes were being drilled to a depth of 2.0 m only. It was observed from the design being used at this face that in order to control over break in the crown and the walls, the practice was not to charge the perimeter and adjacent row to perimeter holes. It was observed that the face after the blast was undulating and uneven at the portion of uncharged area. Often the drilled holes could be seen in the crown leading to under cuttings.

Table 1. Charging pattern for face-1.

	Delay no.	No. of holes	CPH (cartridges)	CPD, kg
Cut holes	Z	8	8	25.0
Addl. hole (above cut holes)	I	1	8	3.0
Cut spreader (side)	II	8	7	21.0
Stoper (top)	III	7	7	21.0
Wall (side)	IV	8	5	15.0
Crown (periphery)	V	9	4	14.0
Floor	VII	7	7	19.0

CPH: Charge per hole. CPD: Charge per delay.
 Cartridge: 40 mm dia, 300 mm long and 0.385 kg wt.
 Uncharged holes: 9, For perimeter holes (crown), after charging the explosives, air gap of about 1.0 m has to be maintained and remaining 0.8 m shall be stemmed.

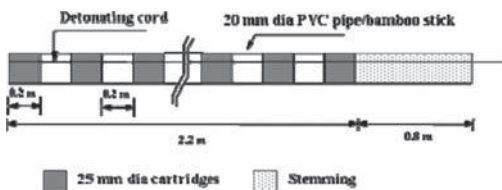

Figure 7. Prefabricated charge for perimeter holes.

After every advance of 2.0 m, the tunnel was supported by steel ribs and back filled with concrete by steel shuttering.

Considering the above and especially to minimise the undercut, a suitable controlled blast design (Fig. 8) and charging pattern (Table 2) was recommended. It is appropriate to mention that holes drilled need to be charged by explosives to break and displace the rock mass in the tunnel.

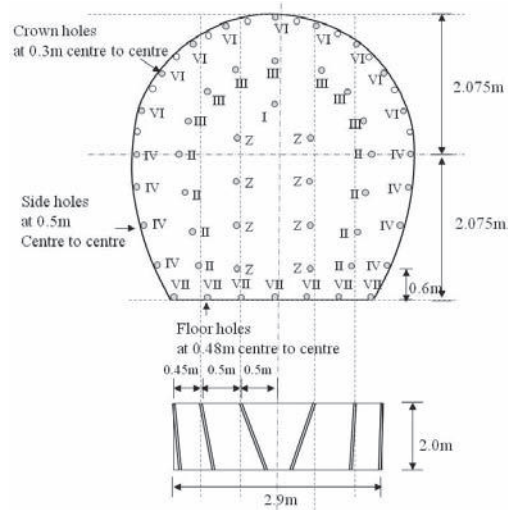

Figure Not to Scale
 Use long electric delay detonators.
 Alternate holes in the perimeter only to be charged.
 If the rock condition is very poor, one hole can be charged leaving two uncharged holes in the perimeter.
 If the rock condition is improved, the design suggested for face 1 can be followed for face 2 also.

Figure 8. Suggested blast design for face-2.

Table 2. Charging pattern for face-2.

	Delay no.	No. of holes	CPH (cartridges)	CPD, kg
Cut holes	Z	8	7	12.0
Addl. hole (above cut holes)	I	1	4	1.5
Cut spreader (side)	II	8	5	15.0
Stoper (top)	III	7	3	8.0
Wall (side)	IV	8	3	9.0
Crown (periphery)	V	9	1	3.5
Floor	VII	7	7	19.0

Uncharged holes: 9, For perimeter holes, after charging the explosive, air gap of about 0.7 m has to be maintained and remaining 0.8 m shall be stemmed.

In the suggested design, the above drawback was overcome by lightly charging all the penultimate row holes and alternate perimeter holes. The alternate perimeter holes were charged with only one cartridge and stemmed to a length of 1.0 m leaving an air gap of 0.7 m.

The delay sequencing was also appropriately modified and the maximum charge per delay was also reduced. The blast results improved and failure along the joints was controlled. The undulations in the crown were minimised and the under cuts were totally eliminated. As the suggested design yielded satisfactory results, it was continued till the successful completion of this face.

4.3 Combined Chuzachen HRT

The combined HRT is of 4245 m in length and is excavated by four faces (face 5, 6, 7 and 8). The balance of excavation during the start of the investigation was 53 m at face 5 of the combined HRT and this was accessible from adit 2. Similarly, the balance of excavation at face 6 having the access by adit 1 was 51 m. In case of the tunnel face 7, the balance was 161 m and this face is also accessible by adit 1. The balance excavation at face 8 was 62 m and this face is accessible from adit 4.

The cover of the tunnel is approximately 500 m at the junction and steadily reduces to 218 m at the surge shaft location. Above the tunnel alignment a number of small streams are flowing from the upper portions of the slope. There are also a number of small springs. Based on the above information, it appears that the ground water along the tunnel alignment generally follows the topographic contours during the initial part of the tunnel. As the ridges pitches laterally and vertically towards the confluence of the rivers the ground water table may be deeper. This was informed by the project authorities that during drilling of borehole BH9 from the surface, near the surge shaft area, water was not encountered even at a depth of 70 m.

4.4 Combined HRT face-6

The face condition was good, except for little over break due to blasting in the crown region. A pull of 3.0 m was consistently obtained in each blast. However, in order to minimise over break in the crown portion suitable blast design was suggested and implemented at this face (Fig. 9, Table 3). The perimeter holes were charged lightly and decoupled. The blast was successful in minimising the over break.

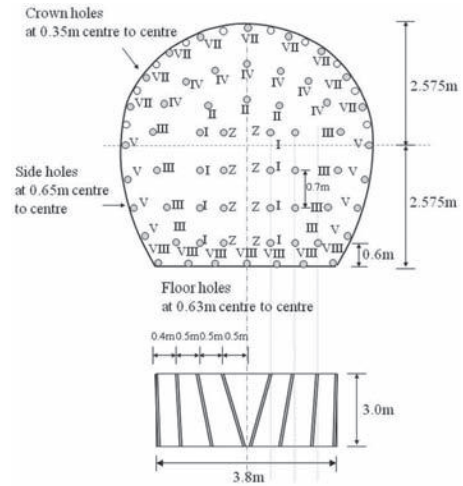

Figure Not to Scale
Use long electric delay detonators.
Alternate holes in the perimeter only to be charged.

Figure 9. Suggested blast design for face-6.

Table 3. Charging pattern for face-6.

	Delay no.	No. of holes	CPH (cartridges)	CPD, kg
Cut holes	Z	8	8	25.0
Cut spreader (side)	I	8	7	21.0
Cut spreader (top)	II	3	7	8.0
Stoper (side)	III	8	6	18.0
Stoper (top)	IV	7	3	16.0
Wall	V	8	5	15.0
Crown (periphery)	VII	9	3	10.0
Floor	VIII	7	7	19.0

Uncharged holes: 9, for crown perimeter holes, after charging three cartridges, air gap of about 1.0 m has to be maintained and remaining 1.1 m shall be stemmed.

5 CONCLUSIONS

In general controlled blasting and providing immediate support/reinforcement to exposed walls ensure safety and progress. Controlled blast designs lead to better wall rock profiles and half cast factors. Sometimes half cast factors could be cosmetic manifestations, and hence control of damage to rock within is equally essential. In order to minimise damage to the rock mass, a combination of vibration monitoring and controlled blast designs yield the desired results.

ACKNOWLEDGEMENTS

The authors are thankful to the project authorities for providing necessary facilities during field investigation. We are thankful to the Director, NIRM for his kind permission to publish this paper.

REFERENCES

- Adhikari, G.R., Balachander, R., Theresraj, A.I. & Gupta, R.N. 2001. All under control, *Tunnels & Tunneling International*, September, pp. 20–22.
- Dasgupta, B., Dham, R. & Lorig, L.J. 1995. Three dimensional discontinuum analysis of the underground power house for Sardar Sarovar Project, India, *Proc. 8th International Congress on Rock Mechanics*, Tokyo, Japan, Vol 2, pp. 551–554.
- Gupta, R.N., Singh, M.M. & Singh, B. 1987. Application of presplitting and smooth blasting for excavation of a large power house cavern. *Proc. 28th US Symp. on Rock Mechanics*, Tucson, 29 June–1 July, pp. 909–917.
- Hoek, E. 1995. Review of river bed power house design, Sardar Sarovar Hydroelectric Project, 13th December.
- Jack Burke. 2003. Working together produces results in Weehawken, *World Tunneling*, pp. 401–408.
- Liu, Q., Hung Trann, Dave Counter, & Patric, A. 1998. A case study of blast damage evaluation in open stope mining at Kid Creek mines, *Proc. of the 24th Ann. Conf. on Explosives and Blasting Technique*, ISEE.
- McCreath, D.R., Tennant, D.D. & Langille, C.C. 1994. Survivability of shotcrete near blasts, *Rock Mechanics, Nelson & Laubach (eds.)*, Balkema, Rotterdam.
- Mittal, B.K., Menon, K.K.M & Pal, A.K. 1999. Distress in the cavern of Sardar Sarovar power house and remedial measures. *Proc. of the Int. Conf. on Rock Engineering Techniques for Site Characterisation*, Bangalore, December 6–8, pp. 109–115.
- Oriard, L.L. 1982. Blasting effects and their control, *Underground mining methods handbook, SME/AIME*, New York.
- Richards, A.B. & Moore, A.J. 2002. Ground vibration and air blast, *Indian Conf.—INDOROCK*, New Delhi, India.
- Siskind, D.E. 2000. Vibrations from blasting, *ISEE*.
- Stjern, G. & Myrvang, A. 1998. The influence of blasting on grouted rockbolts, *Tunneling and Underground Space Technology*, Vol. 13, No. 1.
- Venkatesh, H.S., Balachander, R. & Gupta, R.N. 2005. Near field vibration monitoring for rock mass damage control, *The Journal of Explosives Engineering*, July–Aug.
- Venkatesh, H.S., Balachander, R., Gupta, R.N., Adhikari, G.R. & Theresraj, A.I. 2004. Final Report on Optimisation of Blast Design Parameters for Power House Complex at Tala Hydroelectric Project, Bhutan, *NIRM report No. RB0203C and RB0302C (Unpublished)*, September.

Investigation of cracks in domestic houses near construction project in the Himalaya, India: A case study

H.K. Verma, R.K. Goel & V.V.R. Prasad
CIMFR Regional Centre, CBRI Campus, Roorkee, India

S. Dutta, A. Bhardwaj & K.C. Upadhyay
L&T-Uttaranchal Hydro Power Development Co. (Pvt.) Ltd., Rudraprayag, India

ABSTRACT: Blast induced cracks in domestic houses has been matter of concern for mining and civil industry for many years. Practicing engineers, researchers and regulatory bodies have debated the issue for a long time to establish the threshold value of damage to domestic houses. In India, large numbers of hydro power projects are under construction in the Himalayan region. Problems of false claims and frequent stopping of work due to blasting vibration and air overpressure is seen in many construction projects. House building practices, mild seismic activities and geological formation of Himalaya pose special challenges for the engineer to combat the construction blast vibration related issues. Investigation of cracks in domestic houses in Singoli-Bhatwari Hydro Power Project reveals that in hilly terrain like Himalaya, the effect of meteorological conditions, house building practices and the differential settlement due to mild seismic activities have a pronounced effect in crack formation in the houses rather than the blasting vibration.

1 INTRODUCTION

M/s Larsen & Toubro (L&T) is developing 99 MW Singoli-Bhatwari Hydroelectric Power Project (SBHEPP) in Rudrapryag district of Uttarakhand state in India. The project envisages construction of 11.2 km long, 4.9 m finished diameter, D-shaped Head Race Tunnel (HRT) to divert water from Mandakini river. The proposed HRT is passing below thickly populated villages. Cover below the villages ranges from as low as 100 m to as high as 350 m. Some of the domestic houses are located close to the construction area and also along the tunnel alignment.

Full face drilling and blasting method is used for excavation using emulsion explosive and shock tube initiation system. The drilling and blasting method, although being flexible and less capital intensive, has certain disadvantages such as blast induced vibration, air-overpressure, flyrock and human annoyance.

The villagers protested and stopped the work on account of the observed cracks in their houses. They claimed that the blasting vibration and air-overpressure has induced cracks in their houses and they should be adequately compensated.

Central Institute of Mining and Fuel Research (CIMFR) Regional Centre, Roorkee investigated house construction practices, vibration in various locations, effect of differential settlement in some

of the houses along the tunnel alignment. Although the Peak Particle Velocity (PPV) remained less than 2.0 mm/s, it is observed that most of the houses have cracks in walls, ceilings and at foundation level. As per Indian standard (DGMS, 1973) permissible PPV is 5.00 mm/s for the corresponding case.

Further investigations reveal that the variation in temperature, humidity, rainfall along with frequent mild seismic tremors and construction practices are the main cause of cracks in the houses. Geological formation of the project area further aggravates the crack formation due to differential settlement under influence of seismic activities. This paper gives a detailed account of the investigations and recommendation which are applicable to various projects in Himalayan terrain.

2 GEOLOGY OF THE PROJECT AREA

Geologically, the site of SBHEPP (Singoli-Bhatwari Hydroelectric Power Project) is located in the seismically active zone (Seismic zone-V) of the Gharwal Block of Main Himalayan region. The Main Central Thrust (MCT) area is near Ukhi-math Tehsil, which is also the Barrage area of the project. More than 36 seismic events of magnitude more than 6 is recorded in one and half century in Garhwal division alone. About 24 earthquakes of

magnitude greater than 5.5 is recorded in the vicinity of MCT. Uttarkashi earthquake in 1991 and Chamoli earthquake in 1999 are the recent ones with heavy causality. The initial damage assessment of Chamoli earthquake revealed that 12306 houses were completely damaged and another 71333 were partially damaged in Chamoli district. Approximately 7104 houses were totally destroyed and 14677 houses were partially damaged in Rudraprayag district alone (Chamoli Earthquake report, 1999).

The HRT runs below number of rivulets and therefore more seepage is anticipated in these areas of the tunnel. The whole regional geology have been instigated with sludge/debris movement in early sixties. Dadua village in the project area was completely buried in the past due to sludge/debris movement induced by seismic activities (L&T, 2005).

Various rock types around the project are under the class of muscovite-biotite-quartz schist with its different variations like biotite-schist, sericite schist, granite gneiss, amphibolite etc. The major discontinuities in the area include general foliation dipping in different directions. The discontinuity orientation is ... dipping 30° – 35° in $N55^{\circ}$ to $N8^{\circ}$, whereas the HRT axis orientation is $S13^{\circ}$ W.

Rock types in HRT are granite gneiss, thinly foliated mica schist and quartz-biotite schist. Average strength of rock is approximately 50 MPa. The rock cover above various adits and HRT varied from 20 m to 400 m. Top 10 m–25 m of the cover constitute mainly alluvium interspersed with outcrop. This top alluvium has been compacted over the years.

The geological map of the HRT depicts that the terrain above tunnel alignment mainly comprises of colluviums deposits with intervening scanty and scattered outcrop of the rocks. Geological face log of HRT reveal that predominantly three sets of joint/discontinuity are present in the face with average spacing of discontinuities ranging from 200 mm to 600 mm. The condition of discontinuity is smooth to slight rough. Face condition is damp. Rock mass classification parameters Q and RMR values of HRT during monitoring of vibration is found to be about 5 and 40 respectively. Approximately 50% of excavation in HRT is through fair quality of rock mass having Q values close to 5.

3 HOUSE CONSTRUCTION PRACTICES

It is important to investigate the house construction practices while evaluating influence of the blast vibration on housing structures. Many villages which are in the alignment of the HRT (Table 1)

Table 1. Details of the villages along the HRT.

S. no.	Name of village	Vertical depth, m	Horizontal distance from tunnel alignment, m
1	Basti	158.5	445.79
2	Udaipur	40.0	691.5
3	Rari	198.0	550.0
4	Arkund	157.5	213.0
5	Dhankot	306.0	152.0
6	Haat	-19.0	995.0
7	Falai	76.0	870.0



Figure 1. A house built using stone blocks & clay in study area.

were inspected for their construction practices and following are the observation of the investigation in this regard.

- i. In Himalayan region, lands are generally developed in steps in the hills. General practices are to cut from the higher step and fill in the lower step for leveling foundation area bounded with stone walls. Thus creating area which is not compacted homogeneously throughout. This can lead to differential settlement under weight of the constructed house. Most of the houses were built of mud/clay stone type and few brick mortar structures were also built. The sized stones were stacked-up using mud/clay as cementing material between stones as shown in Figure 1.
- ii. While preparing and leveling foundation, embedded bigger boulders are removed, which also make foundation area to be differentially compacted. Foundations are shallow and therefore not resting on the firm ground/rock mass and constructed with stone and mud only. Such practice with

weaker foundations does not allow load distribution of the constructed house to greater depth.

- iii. Houses are surrounded by cultivation lands which are repeatedly inundated with water due to irrigation and rains. The water retained in these lands also affects the stability of the area and thereby destabilize the shallow founded houses as shown in Figure 2.
- iv. Footings of columns are not generally provided, so point load through beam, when loaded, is exerted towards the foundation and hence results in differential settlement.
- v. Houses which are built in steeper slope near natural drainage are vulnerable to differential settlement. In case of heavy rain, significant erosion of materials from the slope can take place along such drainage.
- vi. In stone masonry, interlocking in wall joints is not given. At such locations separations are observed after some time due to absence of key structuring.
- vii. The slope in the area is already under influence of natural forces. This is corroborated by the fact that most of the trees are bent at root level as shown in Figure 3. The houses situ-



Figure 2. A house surrounded by the cultivation land without appropriate foundation works.



Figure 3. Photograph of sludge/debris movement as depicted by inclination of trees.

ated on or near the bank of a steeply sloping hill suffered much more damage as compared to the houses, which were at some distance from the steep portion or on the gentle sloping part of the same hill due to differential settlement.

- viii. No anchorage or any other mechanism is used for integrity of walls, floors or roofs. As a result the building components are poorly connected and behave as if they are stacks of building materials under lateral loads.

Most of residential units in the affected area relied on load bearing masonry walls for seismic resistance. On first observations it seems that much of the damage could be attributed to ageing, inferior constructions materials, inadequate support of the roof and roof trusses, poor wall-to-wall connections, poor detailing work, weak in plane wall due to large openings, out-of-plane instability of walls, and lack of integrity or robustness and asymmetric floor plans.

4 DRILLING AND BLASTING PRACTICE

Full face drilling and blasting using burn-cut is followed for excavation of HRT as well as adits in the Singoli-Bhatwari project site. Figure 4 shows blasting pattern being followed in the HRT. Excavated area of the tunnel face is approximately 29 m². As mentioned earlier, about 50% of excavation in HRT passes through fair class of rock mass with compressive strength about 50 MPa and Q value close to 5. Full face blasting is adopted with 3.2 m

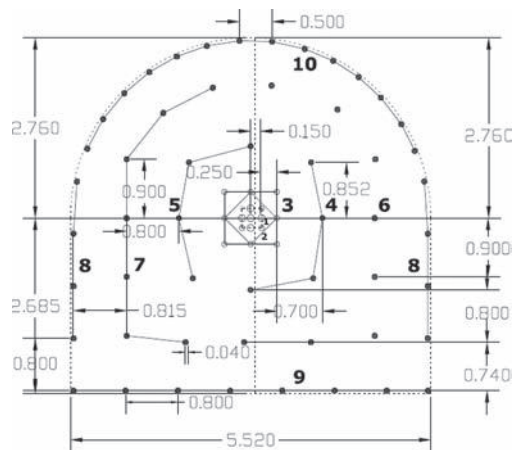

Figure 4. Blast design used in the excavation of HR tunnel.

hole depth and 45 mm hole diameter drilled using double-boom drill machine. Emulsion explosive, 80 per cent strength with non-electric initiation system is used to get average face advancement of 3.0 m in each blast. Total charge and Maximum Charge per Delay (MCD) is 140 kg and 20 kg respectively. Specific charge achieved is 1.6 kg/m³. Overbreak in tunnel periphery is controlled using smooth wall blasting techniques. Alternate holes are charged using low strength explosives. Burn-cut blast pattern using four 76 mm of reamer holes in the centre give more than 2.8 m of pull consistently. Use of shock tube initiation system assisted in controlling vibration and air overpressure. Figure 4 shows the blast pattern used in the SBHEPP for excavation of HRT.

5 ASSESSMENT OF BLAST VIBRATION

Blast induced ground vibration is monitored in different villages along the alignment. While monitoring the blast vibrations, it has been ensured to monitor the vibrations simultaneously at two locations, one in the filled material (filled to level the ground while the construction of houses) and other on compacted alluvium at the floor level of the house. This was mainly to study the variation in the vibrations in the filled material during and the compacted alluvium. Study shows that the vibrations at both places are almost practically same, which indicates that there is no settlement of filled-up material because of tunnel blast. Table 2 gives details of observed values of the blast vibration and other associated parameters.

It is clear from the Table 1 that the observed values of peak particle velocity of blast vibrations is very less and possess no damage potential to the housing structures along the alignment. The dominant frequency of the vibration also remained in higher ranges. This ruled out the possibility of

development of cracks in the houses due to tunnel blasting.

As per Indian standard (DGMS, 1973), the permissible Peak Particle Velocity (PPV) of vibration in the frequency range higher than 25 Hz for the domestic houses is greater than 15 mm/s. Looking into both National as well as International Standards, the PPV of blast vibrations observed were very low to cause any type of damage to the dwelling units along the HRT alignment.

Air Over-Pressure (AOP) monitoring is also carried out and found to be less than 120 Hz in most of the locations of measurement. Any possibilities of wave front reinforcement were examined by monitoring air velocity and direction at the time of blast. Such monitoring of AOP, wind velocity and direction also could not lead to phenomenon of wave front reinforcement.

Blast vibration velocity and AOP are too low to cause damage. But, the houses have cracks of different shapes, sizes and at different locations. The cracks are not limited to places of stress concentration as found in case of blast vibration induced cracks. Cracks were found in ceiling, along the beam and at many locations these cracks have step like shapes. Most of the cracks were wedge shaped.

Although the villagers around the excavation could perceive the blast vibration and air overpressure but it is established that the cracks are not developed by blast vibration. Villagers were correlating the pre-existing cracks with blasting due to negligence, communication gaps and lack of pre-blast inspection survey. Vested interest of the villagers further aggravated the problems which led to frequent stoppage of the work. Non-blasting causes were the main reason behind cracks in the houses. Pre-blast inspection survey with proper documentation using photographic and video records may be helpful in preventing undue blasting claims.

Table 2. Details of Peak Particle Velocity (PPV) values monitored in some of the locations along the tunnel alignment.

Blast ch. (m)	Total charge (kg)	MCD (kg)	Distance (m)	PPV (mm/s)	Frequency (Hz)
69.4	132	18.0	173	1.52	85
172.5	138	21	162	1.02	73
175.3	116	20.0	283	0.6	>100
180.6	108	17.0	114	1.65	>100
175.3	116	20.0	142	1.03	73
183.2	106	16.4	150	1.35	57
186.3	110	17.2	148	1.19	37
188.9	112	16.8	148	0.95	73

6 OBSERVATIONS ON CRACKS

Himalayan geology and environmental condition provide a special case for tunneling professionals. Seasonal variation in temperature, humidity, rainfall, wind direction and speed is high in this hilly terrain. These factors influence response of cracks in the houses. In project area, temperature variation is in the range of -5°C to 30°C , humidity varies from 40–95% and wind speed increases upto 100 kmph.

Many researcher such as Corkery and Wing (1993), Hutchison and Hutchison (1995) and Dowding (1985) have established that variation in temperature and humidity have profound effect on the response of the cracks compared to the blast phenomenon over a long-term period. Dowding (1996) in a study of crack response due to environmental conditions found that long-term weather-induced crack response correlates best with wall shear strains. The response of cracks due to environmental condition is more than equivalent blast induced ground motions of 2.5 mm/s. He also observed that long-term response of the cosmetic cracks monitored in these case studies is at least 4–5 times larger than the vibratory response at maximum measured peak particle velocities and more than 7–10 times larger than vibratory response at low but noticeable levels.

Dowding and McKenna (2005) observed in a study that extreme events such as rain storms in desert climates, long and intense changes in humidity, and seasonal heating can cause permanent and/or extreme crack responses that are much larger than those induced by typical daily and weekly weather change. Figure 5 shows the crack response with change in temperature.

Vibratory crack response induced by household activities can approach or exceed the vibratory response to low but noticeable peak particle

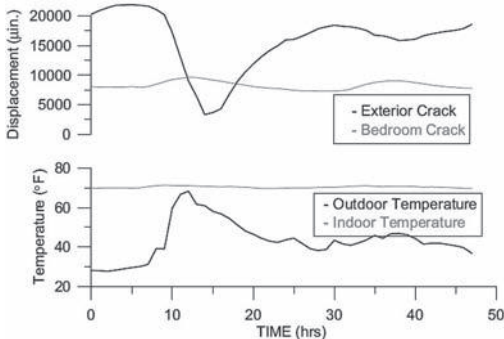

Figure 5. Response of crack with change in temperature (Dowding and McKenna, 2005).

velocities. Crack displacements induced by typical changes in weather and distinctly perceptible vibrations are far smaller than the width of the cosmetic cracks.

Uneven settlement is a common non-blast related cause for cracks observed in the hilly terrain of Himalaya. The strength of the supporting soil changes due to seasonal and annual changes in rainfall and other factors that cause changes in surface and underground water drainage paths and variations in the water table level. Most often an uneven settlement crack in a masonry wall appears as a wedged shape crack wider at one end than the other. Initially the cracking starts at the top or bottom of a wall and does not extend all the way up or down. The cracking will occur in the part of the wall with the least strength which may be the mortar, the brick, or both which is subject to stressing because the support for part of the wall is less than the other parts of the wall.

Underground water stream exists in hilly terrain. Variation in rainfall produce water streams nearer the surface which can shift and change the strength of soil that supports the weight of various parts of a house or structure. Such changes allow uneven settlement which can begin at the time or sometime after the change in the streams or after these dry up due to lack of rainfall.

In most of the houses along the tunnel alignment, cracks were observed but cracks did not match with the characteristics of the blast vibration induced cracks. Investigations reveal that such cracks are induced due to differential settlement of the top debris materials on which the houses are constructed. The observations of sludge/debris movements are corroborated by the tilted trees. Therefore, slope movement monitoring has also been planned. Differential settlement induces cracks that are vertical, horizontal or parallel to



Figure 6. Crack in the stone clay structures due to differential settlement.

slope movement and are not necessarily present at stress corners. Only a few cracks had the characteristics of blast induced cracks. Most of the cracks were originated from the debris movement and poor construction practices. The measured Peak Particle Velocity (PPV) values induced by blasting were found to be less than 5.0 mm/s. The frequency of the observed vibrations was found to be more than 25 Hz. As per DGMS standard, the safe permissible limit of PPV is more than 10 mm/s and hence it can be inferred that blast induced vibrations were within safe permissible limits.

7 CONCLUSIONS

Unscientific blasting practices producing high magnitude of ground motion and air overpressure damage surrounding structures. Cracks in the houses near construction projects may easily be associated to low magnitude perceptible level of blast vibration due to lack of communication gaps and improper liaising. It is established that a host of reasons such as weather condition, repeated seismic loading of structures, and poor construction practices can affect the health of the structures adversely.

In Indian Himalaya where most of the construction projects are located constitute similar conditions. Extreme variation in temperature, rainfall, humidity and poor house building practices together with mild earthquake tremors are the main causes of the crack in the dwelling units. The slope movement is continuous under influence of the seismic activities. This is reflected by the inclination of the trees along the slope. Cracks are found not only in the nearby houses but are also present in the houses where blasting vibration is too small to perceive.

Over the years, numerous non-blasting causes have been identified as main causes of damage in

the houses in hilly terrain. Due to lack of proper documentation and scientific investigations, these natural phenomena as proof of the actual causes has not been well established. One way of establishing non-blasting causes of property damage is to have effective pre-blast inspections and continuous monitoring of the property during excavation. Such inspections with photographs and diagrams of damages before any blasting are very effective in preventing undue claims.

REFERENCES

- Chamoli Earthquake Report (2000). Reconnaissance Report Chamoli Earthquake of 29th March, 1999, India, Joint Study by NSET-Nepal and DEQ-UOR, India.
- Corkery, D. and Wing, R. (1993). Controlled study of the effects of temperature and humidity vs blast vibrations on homes, Proc. Intl. Con. Explosive and Blasting Techniques, pp. 347–357.
- DGMS (1973). Damage of structures due to blast induced ground vibrations in the mining areas, DGMS (Tech) (S&T) Circular No.7 of 1997 dated 29.08.1997.
- Dowding, C.H. and McKenna L.M. (2005). Crack response to long-term environmental and blast vibration effects. Intl. Jr of Geotechnical and Geoenvironmental Engineering, Vol. 131, No. 9, September 1, ASCE, ISSN 1090-0241/2005/9 pp. 1151–1161.
- Dowding, C.H. (1985). Blast Vibration Monitoring and control, Prentice Hall, Englewood Cliffs, NJ, USA, 297p.
- Dowding, C.H. (1996). Construction vibrations, Prentice Hall, Englewood Cliffs, NJ, USA, 620p.
- Hutchison, E.C. and Hutchison W.C. (1995). Natural causes vs blasting damage, Proc. Intl. Con. Explosive and Blasting Techniques, in ISEE CD-ROM (1998) Explosives reference database on CD-ROM, Int Soc Explosive Eng, Ohio, USA, pp. 81–104.
- L&T (2005). Detailed Project Report of Singoli-Bhatwari Hydroelectric Power Project, L&T, India.

IT & its role in underground blasting—an overview & future insights

Avtar K. Raina

CSIR-Central Institute of Mining & Fuel Research, Seminary Hills, Nagpur, India

ABSTRACT: Information technology (IT) has played a great role in different aspects of mining. Blasting has received its due share and IT has played a role in designing underground blasts. There are ample cases to justify the use of software(s) for making blasting in underground (UG) easy to design and evaluate. Ample examples exist on the internet and public domain about claims of better blast design through software(s). This however, needs to be augmented by well documented case studies and peer-reviews. An attempt is made through this presentation to document the role of IT, the development of software(s) for tunnel/UG blasting, their rationale and specific features available for an UG blasting engineer. With the advent of modern technologies, higher and intelligent computing capabilities the future is going to see a sea change in the underground mining/excavations. This includes intelligent blast designs, tele-operated blasting and comprehensive and integrated blasting systems in which cloud based computations can assume a greater role. A universal database hub is conceived which can have a great degree of impact in introspection and evolution of near perfect blast designs.

1 INTRODUCTION

Rock excavation is principal to the mining and other civil works. Away from the blasts that take place in surface mines, we will be focusing on underground workings that utilize the blasting technique to excavate the rock to create room or extract ore from the ore body. There are lot of places where blasting cannot be done away with for the simple reason that it is still the cheapest method of rock breakage and mechanical methods have their own economic and operational constraints. The problem in underground blasting is more complicated since in many instances only one free face is available. Figure 1 introduces the places in where blasting is essential or dominant.

Blasting is primarily a three stage process:

1. Pre-blast designing & planning
2. Implementation of planned design & firing
3. Post blast results

The fundamentals of blasting techniques are similar, but the methodologies may differ depending on the requirements. A singular solution to these is probably a difficult proposition. The requirement in different excavations varies that in turn define the objectives of blasting.

1.1 Objectives of blasting

The basic premise of blasting remains the same—to excavate the rock at minimal cost. This can be achieved while other ancillary parameters are favorable. However, in case of places of vital and sensitive nature the objectives achieve different dimensions. A basic thesis of blasting revolves around the following rules:

1. Fragmentation is accomplished at minimal cost i.e. achieving an optimum K_{50} and uniformity of the broken material—assuming that there are no constraints on production.
2. An optimum muck profile is attained which aides quick loading of the material.
3. Ground vibrations and air-overpressure are minimized—this is aimed to prevent damage to the nearby structures and damage to the parent rock mass. However, if this constraint becomes a priority it can have a negative effect on fragmentation.
4. Minimize dust, fumes, ore dilution.

In totality the objectives have to follow a process of optimization which is defined in Figure 2.

An optimization process brings in a strong case for the 'IT' as it has multiple capabilities in contrast to the manual methods. There are several IT packages available that claim to present a better solution to UG blast design and consequent problems.

A brief look into the published domain is helpful in addressing the task here.

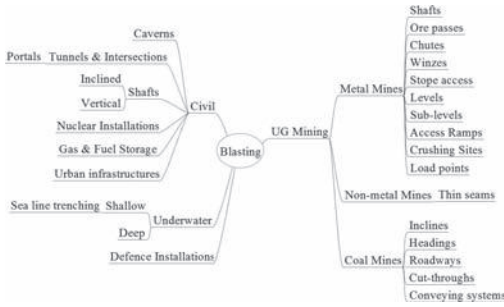

Figure 1. Different working where blasting is a dominant excavation method.

2 LITERATURE AT A GLANCE

A summary of the literature cited or published in the blasting domain is given in Table 1.

There are very insignificant publications after 2008 probably because of the fact that many of the software(s) are now available on commercial scale. A summary of the software(s) developed for underground blasting is given in Figure 3.

3 RATIONALE FOR BLAST DESIGN SOFTWARE

Any blast design should be able to address 3 major issues

1. Rock mass properties
2. Explosive & its properties
3. Post blast scenario & reporting

In addition it should be adaptable & appealing to the user along with different features as defined in Figure 4.

Modern day technology is aiming at productivity and safety that calls for intelligent designs while empowering the blasting engineers to achieve the objectives of their blasts.

3.1 Basis of blast design

A holistic blasting regime demands for a meticulous effort of the engineer who caters to blasting & above all involves lot of combinatory units/techniques that should be a part of universal software. Some important ones are identified in Figure 5 and 6. These involve

1. Estimation of rock mass properties
 - a. Structural details—whether these are favorable to blasting or not. These however require further investigations as to whether the role of such features is perfectly understood or not.

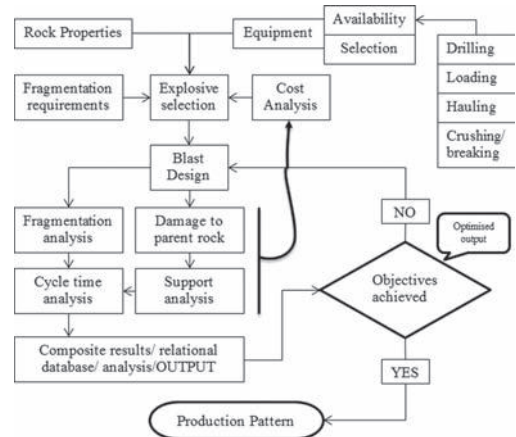

Figure 2. Objectives of blasting & basis for optimization.

- b. Laboratory geo-physical properties of the rocks—these provide a basis for a design, although such properties may present a significant departure from the in-situ conditions.
 - c. The dynamic properties of the rockmass which have a direct bearing on the design procedure. It needs to be stressed that we still have to zero in into a regime where the fundamental rock properties effecting blasting output need to be estimated & used for design & analysis.
2. Estimation of the explosive properties
 - a. These may primarily revolve around the VOD observed in field. The same is difficult to ascertain in practical conditions as actual VOD measurements in multi-hole, multi-row blasting is a difficult procedure & can present contrasting values for a single explosive.
 - b. Other properties like density are easy to measure but may pose other problems related to differential density due to loading delays between the holes particularly in deep holes.
 - c. Since the basic composition of the explosives is rarely conveyed it is difficult to evaluate the properties of explosive based on the composition with the help of detonation codes. These demands for an easy method of finding the explosive properties.
 3. Blast design (tools)

These are mostly relying on the empirical criterion which is quite substantiated with the field observations. Experience based systems are available and can be applied but these have a limitations that these can be applied in local domain only.
 4. Decision of mode of initiation is mostly determined by the costs of such accessories. Despite of the fact that better initiating devices like electronic detonators are available, it prohibitive costs & the market pressures still makes it less usable.

Table 1. Summary of cited works on blast design software systems.

Year	Author(s)	Summary
1990	Myers et al.	Customized program, AutoCAD, ring-hole blasting, multiple designs evaluation, re-design flexibility [change in drill diameter, variation in ore density, changes in explosive]. Use of such software to achieve K_{opt} at minimum cost.
1990	Rholl & Stag	Two computer programs, efficient blast design criteria evaluation [improved fragmentation]. Calculation a) overlap of ms initiators probability [Monte-Carlo simulation, Rholl et al. 1992], any shot size, multi-hole & multi-decked blasts (randomization), 2) K_{50} evaluation from blast design parameters (multiple regression).
1991	Andrieux & Sprot	Combination of many software(s) into 3-D UG blast design software (BLASTCAD). Empirical blast calculator, q analysis, delay scatter analysis, blast-hole deviation, blast breakage simulator & cost analysis modules. Discussed two sections viz. layout & assessment of the program that work with AutoCAD.
1991	Chiapetta	Use of IT to eliminate trial & error methods in blasting i.e. evaluation of blast designs in particular environment & explosive performance, optimum delay profiling (for high-wall, burden, muck volumes etc.), estimate swell & simulate ground vibrations. Stressed implementation of such programs in a holistic manner.
1991	Konya	Application of blasting software system for 1) Vibration control, 2) Blasting database 3) Explosive inventory control 4) retrieval & sorting.
1991	Smith & Hautala	Application of an expert system approach to integrate both symbolic model of the blasting engineer (trouble free blast) & a numeric optimization model that relates fragmentation to unit operations in a Mine-Mill system.
1992	Chung & Burchell	A computer based analysis system which can be used to create 3-D images before, during & after of a blast.
1993	Chenoweth & Duffy	Implemented Statistical Process Control (SPC) in a limestone mine & reported improvements in overall performance.
1993	Jethwa & Chakraborty	Illustrated DETBLAST software for tunnel & mine roadway blast design. The software incorporates different rock, drilling & explosive parameters to produce a blast design & expected output.
1994	Agreda	Developed MCMARB software for calculating burden & spacing of a blast based on comminution theory.
1994	Kundsen & Preece	Developed a Distinct Motion Code (DMC) to simulate blast induced rock motion (GUI based).
1995	Cameron et al.	Described the objectives & the necessity of blast design software in detail. They stressed that such software should be GUI based & able to design & predict results. They provided a list of available tools in this regard.
1995	Cocklin & Patz	Illustrated ExEx1000 & Computer Aided Blasting (CAB) with different modules; Blast Commander (for blast design) & Blast Programmer (Test programming & firing of detonators).
1995	Simons et al.	Introduced BFRACT, a finite element based computer model for determination of fragmentation.
1995	Wheeler	Described COMPU-BLAST for analysis of blast vibration data, frequency control, waveform analysis, simulation & evaluation of blast design timings.
1996	LeBlanc et al	Used USBM's NUTSA software to predict the envelope of damage in VCR method & to prevent ore dilution.
1997	Bernard	Introduced QUALITIR program which is a decision aided design tool for miners. The tools included therein are blast design, blasting sequence, fragmentation & vibration.
1997	Brown & Tidman	Illustrated a GUI based blast designer software suite that included ShotPlus (for layout & initiation), SurveyPlus (for face survey & bench geometry) & SABREX (for advance modeling of blasts & reporting).
1997	Dowding	Described software—NUVIB, which digitizes, analyses, displays plots of time histories of blasting & construction vibrations. The software is a collection of linked programs with GUI & calculates FFT, SDF relative displacement & pseudo velocity response time histories of vibration & air overpressure.

(Continued)

Table 1. Continued.

Year	Author(s)	Summary
1997	Higgins	Gives a list of 12 software modules developed at JKMR & further development of JKSimblast with focus on design, analysis, optimization, monitoring, assessment, evaluation, management & integration of blasts data.
1997	Hutchings	Described an integrated explosive, management, blast design, & loading system with automated control of the explosive loading & customer report options.
1997	Labuschagne & Uys	Explained MasterBlaster that is an online Mining Information System aimed to reduce the reporting time & also benefits from blast management.
1998	Bosman et al.	Introduced WinBlast system & ExEx EDD system.
1998	Boucher et al.	Described the use of Blast Design Editor 3 × 30-PRO & fragmentation & cost analysis module QFRAG.
1998	Comeau & Jannoulakis	Introduced blasting efficiency descriptor (BED) which is a product of vector sum & scaled distance.
1999	Harris	Stressed on the drilling accuracy (positioning, depth, borehole path) concluded that the objectives of advanced blast design software(s) & other precision equipment are nullified if the drill holes are not in their intended pattern/position & angle.
2000	Annon	Described AELRing2000 while giving cost comparison by evaluating the use of ANFO & emulsion explosives. The software allows for different permutations of mining variations & evaluation of their effect on blast costs.
2000	Persson	Introduced TIGERWIN software that determines the detonation & expansion state (velocity, pressure, temperature & density) of an explosive from its known chemical composition. The software also provides expansion work, reaction products composition with flexibility of keeping some ingredients in partially unreacted state.
2001	Keller & Ryan	Demonstrated the successful use of QED program to estimate near field vibration & blast damage. The iterative methodology in blasting (design, evaluation & confirmation) is suggested by them.
2001	Lee et al.	Reported computer software for tunneling.
2001	Paventi et al.	Reported the development of robotic mining equipment under Mining Automation Program (MAP) & presented the challenges of Teleminig™. They introduced DynaRem ED1 (electronic detonator programming system), DynaCAD (blast modeling software), & its use with AutoCAD while demonstrating tele-monitored drifting is possible.
2001	Ryu et al.	Used KIESSI & FLAC numerical codes for comparison of dynamic response of ground to blasting. Other such applications can be found in Zhao et al. (2009), Yang et al. (2010).
2003	Barkley	Stressed on importance of the drilling in blasting & attaining better results with laser based equipment & software.
2004	Hummel & Reinders	Describe a digital Central Blasting System (CBS) that uses the electronic detonator system & mine radio communications network to remotely conduct blasting & enhance safety.
2004	Kecojevic & Wilkinson	Discussed the steps involved in 3D CAD for drilling & blasting & consequent benefits of such system when used in conjunction with GPS & drill monitoring system. However, GPS has its own limitations in underground workings.
2004	Reinders & Hammelman	Described the history of blast management in light of modern trends of electronic blasting. The two way data exchange between blast design software & field equipment is discussed & stress on an expert blast data management system for planning, documentation, analysis, measurement & prediction.
2006	Ferrero	Discussed the importance of computerized blast inventory management system to accurately record all explosive transactions & blast documentation. The author detailed the justification & challenges of such system.
2006	Kahriman	Describes the use of Tunnel2000 software for blasting in sensitive urban environments for a waste water tunnel excavation.
2007	Santis	Introduced IMESA FR, a software for managing risk associated with commercial explosives.
2008	Jamshidi et al	Concluded that software based design & analysis can lead to accurate answers to different problems associated with underground blasting.

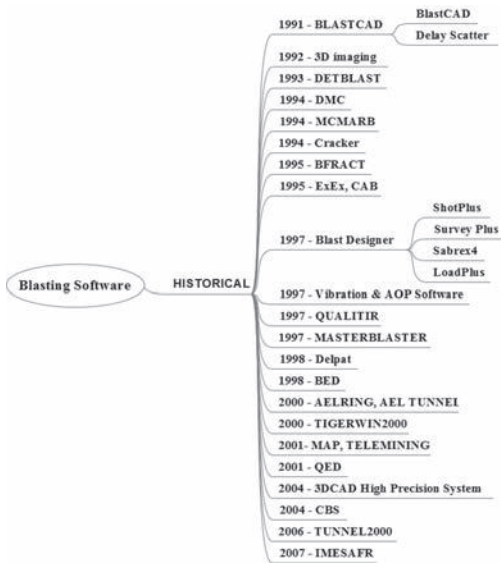

Figure 3. History of development of blasting software(s).

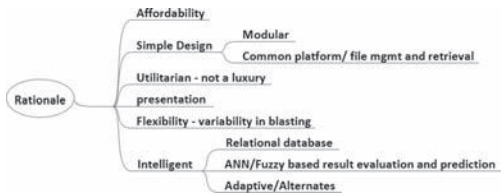

Figure 4. The rationale for blasting software(s).



Figure 5. Underground blasting considerations 1.

- Profiling & its data is valuable & need to be integrated into the solution. Many software(s) have such routines but since the domain of Laser based equipment is greater than blasting, the suppliers tend to supply a part of the system which does not work in tandem with comprehensive software(s).
- Post blast data—this is one of the important considerations as for a continuous improvement not only meticulous monitoring & logging of post blast data is essential, but a detailed analysis is of equal importance, also. An integrated approach to logging of such techniques is still not common & will be a demand of the future.
- A comprehensive database is essential with features that can be vital in decision making in future blasts. Such systems are available individually or in tandem but their capabilities are still in the low level.
- A cloud based computing can be quite beneficial along with a universal database hub which can provide sufficient cases for a blasting engineer to decide on a blasting strategy. The facility can be used to off-load some analysis/work to relatively cheaper destinations on the cloud.

4 MODERN DAY SOFTWARE(S)

With the advent of latest programming domains, effective interfaces & graphical outputs in 3D, the modern software(s) are gaining ground in a focused manner. Some of the software(s) available presently are given in Figure 6 and some of them are discussed below.

- AlphaBlast** and **Blastware** have Signature hole Analysis & Vibration Simulation routines that can be used to control the frequencies by determining the best possible delays using electronic detonators.
- BLASPA** blast design simulators uses explosive & rock properties to predict blasting results, at your mine or construction site.
- DelPat** is aimed at minimizing design time & maximize the cost-effectiveness of future blasts.
- DNA-Blast Technology** (Software) is a Decision Aid Tool that simulates possible initiation sequences in blast configuration & pinpoints the sequences that best optimize the energy inside the blast.
- Drift** uses Holmberg algorithm for tunnel blast design with inputs of tunnel geometry, blast hole diameter, explosive properties, charging strategies for smooth blasting. The output includes hole locations & amount of various explosives required. Blast damage is assessed using different methods for near field vibration prediction.

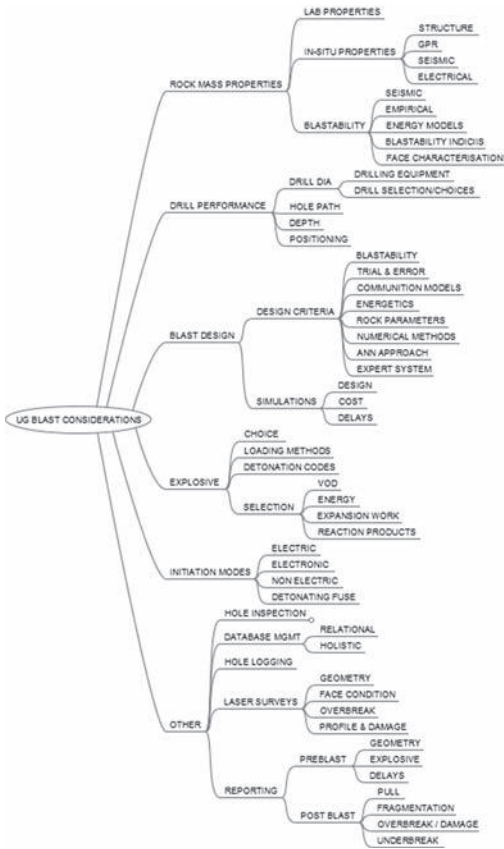

Figure 6. Underground blasting considerations 2.

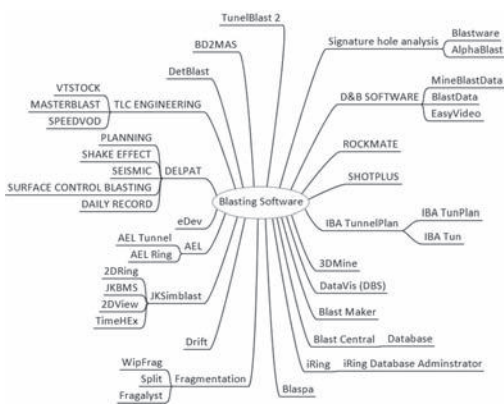

Figure 7. Blast design software(s).

with excavation results in terms of round bottom and profile control, drilled meters, powder factor, pull-out rate, vibration control, tunnel advance and costs.

8. **Master Blast**, is an 'inventory management software system', that is designed to improve documentation accuracy, minimize paperwork, & for rapid search & retrieval of blast documentation.
9. **JKSimBlast**, is a software system for blast design, analysis & management. SoftBlast uses the JKMRC developed SimBlast packages under its banner which include 2-D Face and 2-D Ring that are aimed at tunnel blast design and ring hole blast design. The package for underground includes 2DRing, JKbMS, 2DView & TimeHEX.
10. **iRing** is a software package primarily used in the mining industry for planning underground blasting operations. Designed & developed in collaboration with a major *intern*. mining corporation, this intelligent tool logically assists planners through the ring planning & blasting process, automating a time consuming, manual task which allows "planners to do planning".
11. **IBATun** is a program package contains different modules for making blast design for drill and blast tunneling. The platform for the program package is the blast design application which includes drilling-, charging- and firing-patterns. **IBA TUNNVIB** is a tool for calculating and controlling blast vibrations for blast designs.
12. **Tunnel 2000** enables blasting engineers to design and optimize tunnel blast layouts in mining and civil engineering applications with options to examine what-if situations by changing blasting parameters such as blast-hole size, explosive type, initiating system type, etc. and see the effect of the total rock breaking costs. The software supports five different tunnel shapes: rectangular, top-round, rounded corner, circular tunnels and circular shafts. The rock properties and drilling details can be defined; stand-off parameter definition; smooth blasting parameters; hole type definition; initiator selection can be made.
13. **TunnelBlast 2** (CSIR-CIMFR) is a simple program that considers the drill diameter, tunnel dimensions and rock properties to design a tunnel blast with options of selecting a wedge or parallel cut for D-Shaped tunnels of around 6.0 m width. The cut design provided by the software has been demonstrated to be quite accurate.
14. **TunnPlan** software helps in generation of sectional drawings, positioning of holes on the line (e.g. contour, 2nd contour and bottom hole), generation of blast designs including drilling, charging and firing patterns, construction of charging and firing patterns, estimation of

limit values for vibration based on Norwegian standards, estimate vibrations based on blast designs and uses measured vibrations to optimize blast designs.

15. **SHOTPlus-T** is a product oriented software & can design a blast in mining and civil tunnels, shaft sinking, long-hole rises and winzes. The program assists the tunnel blast designer to draft shot-hole layouts, angles and bearings in relation to the desired tunnel perimeter along with design of initiation sequences. The software has a graphic displays (3D) and option to calculate performance parameters.
16. **BD2MAS** is a universal blast design and output evaluation program with features for surface and UG blast designs developed by CSIR-CIMFR. The UG module incorporates blast designs for 'D', rectangular and circular tunnel shapes and provides detailed report of charging. Blast damage is predicted using near-field vibrations and Blast Damage Index.
17. **Split, WipFrag, WipJoint & Fragalyst 4.0** are fragmentation analysis software(s).

5 FUTURE TRENDS

5.1 Automated blasting systems

The future of the blasting is going to see a wide change in its domain. With the ever increasing capabilities of IT and analytical methods, the development of intelligent methods has started to flow-in. These systems will be based on learning and high level analysis for estimation of Rock-Explosive interaction and to maximize the effective energy utilization and minimize the unwanted byproducts of the blasting. Technological advances will however depend on the amount of investment mining fraternity puts in for the R&D and development of intelligent systems.

5.2 Remotely monitored mining

There are some instances where remotely monitored underground blasts have been reported. This is one of the areas of blasting which will be on forefront in mines which are very deep and or have severe mining hazards that impede the excavation process.

5.3 Future insight

It is expected that with the power of internet, things will shape differently for blasting also. The cloud based computing concept will also arise. Figure 8 is an attempt to make the things clear about the same.

The process once in place is going to be one of the cheapest methods in so far as the data collection, compilation and analysis of blasting go. This

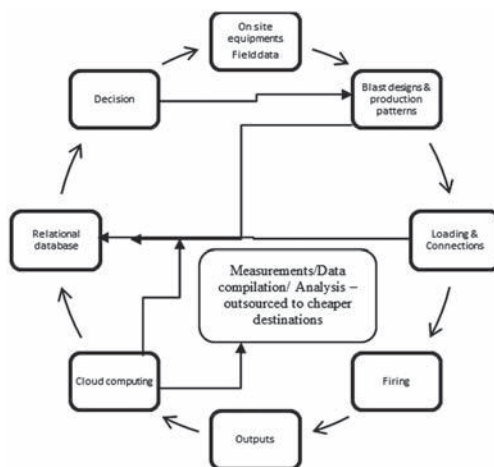

Figure 8. Cloud based computing system for blasting.

can have significant consequences for blasting in underground mines in particular and other blasting in general.

ACKNOWLEDGEMENTS

The author is thankful to the Director CSIR-CIMFR for allowing publishing the manuscript. Thanks are due to Prof. R.N. Gupta for his guidance and advice at different stages of preparation of the MS. Thanks are due to my family for their support.

REFERENCES

- Agreda, C. 1994. The comminution theory applied to rock blasting. *Res. Proc. 20th Ann. Conf. of ISEE on Expl. & Blasting Tech., Austin, January 30–February 3*: 245–256.
- Andrieux, P. & Sprott, D. 1991. BLASTCAD—three dimensional underground blast design software. *Res. Proc. 17th Ann. Conf. of ISEE on Expl. & Blasting Tech., Las Vegas, February 3–7*:115–127.
- Anonn, 2000. AEL RING 2000 & AEL TUNNEL 2000 (BAI—cf. *ISEE Reference database CDROM*):19p.
- Barkley, T.L. 2003. Measuring underground face drilling & blasting. *Gen. Proc. 29th Ann. Conf. of ISEE on Expl. & Blasting Tech., Nashville, February 2–5*, 2:11p.
- Bernard, M.T. 1997. Qualitr Software Suite, computer aided blast design. *7th Annual High-Tech Seminar—State-of-the-Art Blasting Technology Instrumentation & Explosives Applications, Orlando, July 28–August 1*, 1:427–435.
- Bosman, H.G., Bedser, G. & Cunningham, C.V.B. 1998. Production blasting with electronic delay detonators at Peak Quarry. *8th Annual High-Tech Seminar of BAI—State-of-the-Art Blasting Technology*

- Instrumentation & Explosives Applications, Nashville, July 20–24*:93–104.
- Boucher, G., McBride, N. & Williams, S. 1998. The use of computer based blasting models in mine feasibility analysis. *8th Annual High-Tech Seminar of BAI—State-of-the-Art Blasting Technology Instrumentation & Explosives Applications, Nashville, July 20–24*, 147–167.
- Brown, B.H.A. & Tidman, J.P. 1997. SHOTPlus—blast designs in a Windows environment. *7th Annual High-Tech Seminar—State-of-the-Art Blasting Technology Instrumentation & Explosives Applications, Orlando, July 28–August 1*, 1:27–35.
- Cameron, A.R., Kleine, T.H. & Forsyth, W.W. 1995. Computer assisted blast design & assessment tools. *Res. Proc. 21st Ann. Conf. of ISEE on Expl. & Blasting Tech., Nashville, February 5–9*:334–343.
- Celikisirt, M.C. & Erkan, V. 1998. Possibility of organizing & analyzing drilling-blasting with a computer program (DelPat). *Gen. Proc. 24th Ann. Conf. of ISEE on Expl. & Blasting Tech., New Orleans, February 2–5*: 645–654.
- Chakraborty, A.K., Murthy, VMSR, Jhanwar, J.C., Raina, A.K., Ramulu, M. & Jethwa J.L. 1998. Final Report on Development of Rock Mass Classification for Computer Aided Tunnel Blast Design, CSIR-CIMFR (India). *Grant-in-Aid Project funded by Ministry of Water Resources, Govt. of India*: 136p.
- Chenoweth, M.W. & Duffy, M.D. 1993. Implementation of a statistical process control (SPC) program to evaluate and improve blast performance. *Gen. Proc. 19th Ann. Conf. of ISEE on Expl. & Blasting Tech., San Diego, January 31–February 4*: 473–483.
- Chiapetta, F. 1991. Generating site specific blast designs with state-of-the-art blast monitoring instrumentation & PC based analytical techniques. *Gen. Proc. 17th Ann. Conf. of ISEE on Expl. & Blasting Tech., Las Vegas, February 3–7*, 1:79–95.
- Chung, S.H. & Burchell, S. 1992. Computer based 3-D blasting analysis system. *Res. Proc. 18th Ann. Conf. of ISEE on Expl. & Blasting Tech., Orlando, January 19–23*:141–147.
- Cocklin, R.L. & Patz, V. 1995. The ExEx 1000 computer aided blasting (CAB) system. *6th Annual High-Tech Seminar—State-of-the-Art Blasting Technology Instrumentation & Explosives Applications, Boston, July 8–13*, 2:907–939.
- Comeau, W. & Jannoulakis, E. 1998. A blasting efficiency descriptor “BED”. *Gen. Proc. 24th Ann. Conf. of ISEE on Expl. & Blasting Tech., New Orleans, February 2–5*: 669–681.
- Dowding, C.H. 1997. Vibration analysis software. *Gen. Proc. 23rd Ann. Conf. of ISEE on Expl. & Blasting Tech., Las Vegas, February 2–5*:121–131.
- Downing, P. J. 2001. The power of information. *Gen. Proc. 27th Ann. Conf. of ISEE on Expl. & Blasting Tech., Orlando, January 28–31*, 1:153–164.
- Ferrero, M. & Wilder, F. 2006. The importance of computerized blast & inventory management systems for the explosives industry. *Gen. Proc. 32nd Ann. Conf. of ISEE on Expl. & Blasting Tech., Grapevine, January 29–February*, 1:11p.
- Harris, J.E. 1999. Drill accuracy. *J. Explosives Engineering*, 16(2):18–20.
- Higgins, M. 1997. JK Simblast—new software for the design, simulation & analysis of blasting. *7th Annual High-Tech Seminar—State-of-the-Art Blasting Technology Instrumentation & Explosives Applications, Orlando, July 28–August 1*, 2:641–656.
- Hummel, D. & Reinders, P. 2004. A new digital centralized blasting system. *Gen. Proc. 30th Ann. Conf. of ISEE on Expl. & Blasting Tech., New Orleans, February 1–4*, 1:7p.
- Hutchings, J., Lindahl, O. & Irving, M. 1997. An integrated explosive management, blast design & loading system. *7th Annual High-Tech Seminar—State-of-the-Art Blasting Technology Instrumentation & Explosives Applications, Orlando, July 28–August 1*, 1:361–377.
- Jamshidi, M., Ataei, M. & Nasir Abad, H.M. 2008. Blasting pattern design with a new developed software for Bajgirani Tunnel, Iran. *8th Intern. Scientific Conference—SGEM2008, Bulgaria, June 16–20*, 1:385–396.
- Jensen, R.P. & Preece, D.S. 1999. Modelling explosive/rock interaction during presplitting using ALE computational method. *Proc. 6th Intern. Symp. for Rock Fragmentation by Blasting, The South African Inst. of Mining & Metall., Johannesburg, Aug. 8–12*: 199–202.
- Jethwa, J.L., Chakraborty, A.K. & Paithankar, A.G. 1993. Computer aided blast design for tunnels. *Res. Proc. 19th Ann. Conf. of ISEE on Expl. & Blasting Tech., San Diego, January 31–February 4*:41–52.
- Kahriman, A. 2006. Evaluation of environmental effects induced by blasting around a waste water tunnel project in high-urbanized area in Turkey. *Gen. Proc. 32nd Ann. Conf. of ISEE on Expl. & Blasting Tech., Grapevine, January 29–February 1*:10p.
- Kecojevic, V.J. & Wilkinson, W.A. 2004. Computer-aided design & high-precision systems in drilling & blasting. *J. Explosives Engineering*, 20(5):1–4.
- Keller, R. & Ryan, J. 2001. Considerations for the excavation of subsurface facilities by drill blast methods. *Gen. Proc. 27th Ann. Conf. of ISEE on Expl. & Blasting Tech., Orlando, January 28–31*, 2:39–68.
- Knudsen, S. & Preece, D.S. 1994. Blasting, graphical interfaces & Unix. *Res. Proc. 20th Ann. Conf. of ISEE on Expl. & Blasting Tech., Austin, January 30–February 3*:209–214.
- Konya, C.J. 1991. Blasting databases: a unique method for saving and retrieving blasting data. *Gen. Proc. 17th Ann. Conf. of ISEE on Expl. & Blasting Tech., Las Vegas, February 3–7*, 2:201–204.
- Labuschagne, J. & Uys, C. 1997. Masterblaster blasting management system. *7th Annual High-Tech Seminar—State-of-the-Art Blasting Technology Instrumentation & Explosives Applications, Orlando, July 28–August 1*, 2:629–640.
- LeBlanc, T.M., Ryan, J.M. & Heilig, J.H. 1996. Predicting the envelope of damage from the detonation of a confined charge. *Gen. Proc. 2nd Ann. Conf. of ISEE on Expl. & Blasting Tech., Louisville, January 28–30*:11–35.
- Leu, S.S., Lin, S.-F. Chen, C.-K. & Wang, S.-W. 1998. Analysis of powder factors for tunnel blasting using neural networks. *Fragblast - Intern. J. Blasting & Fragmentation*, 2(4): 433–448.
- Liu, L. & Katsabanis, P.D. 1996. Numerical modelling of the effects of air-decking/decoupling in production

- and controlled blasting. *Proc. 5th Intern. Symp. on Rock Fragmentation by Blasting, FRAGBLAST-5, Montreal, August 25–29*: 319–330.
- McKenzie, C.K., Geddes, P., Grohs, K. & Morrish, M. 1998. Blasting trials to control & monitor displacement of narrow vein gold ore. *Gen. Proc. 24th Ann. Conf. of ISEE on Expl. & Blasting Tech., New Orleans, February 2–5*: 145–163.
- Murthy, V.M.S.R., Dey, K. & Chimankar, R.R. 2006. Tunnel blast design using artificial neural network: a case study. *Institution of Engineers (India) J(MN)*, 86(February): 39–45.
- Myers, T.R., Lundquist, R. & Konya, C. 1990. Computer aided design of ring blasts. *Gen. Proc. 16th Ann. Conf. of ISEE on Expl. & Blasting Tech., Orlando, FL, February 4–9*: 43–52.
- Paventi, M., Lidkea, W. & Mirabelli, L.J. 2001. Mine automation program: drill & blast analysis. *Gen. Proc. 27th Ann. Conf. of ISEE on Expl. & Blasting Tech., Orlando, January 28–31*, 2:237–249.
- Persson, P.-A. 2000. TIGERWIN—a Windows PC code for computing explosives performance & thermodynamic properties. (BAI—cf. *ISEE Reference database CDRom*): 59p.
- Pusch, R. & Stanfors, R. 1992. The zone of disturbance around blasted tunnels at depth. *Intern. J. Rock Mech. Mining Sci. & Geomech. Abstr.*, 29(5): 447–456.
- Reinders, P. & Hammelmann, F. 2004. Electronic blasting & blast management past, present & future. *Gen. Proc. 30th Ann. Conf. of ISEE on Expl. & Blasting Tech., New Orleans, February 1–4*, 1: 9p.
- Rholl, S.A. & Stagg, M.S. 1990. Blast design software. *Gen. Proc. 16th Ann. Conf. of ISEE on Expl. & Blasting Tech., Orlando, FL, February 4–9*: 59–69.
- Rholl, S.A., Otterness, R.E. & Stagg, M.S. 1992. Computer simulations to determine the effects of firing time scatter. *Gen. Proc. 18th Ann. Conf. of ISEE on Expl. & Blasting Tech., Orlando, January 19–23*: 213–221.
- Rusilo, L.C., Sansone, E.C., Hennies, W.T. & Ayres Da Silva, L.A. 1994. Design and optimization of tunnel blasting operations. *Proc. 3rd Intern. Symp. on Mine Planning & Equipment Selection, Istanbul, Turkey, Oct 18–20*: 651–655.
- Ryu, C.-H., Cho, S.-H. & Yang, H.-S. 2001. Prediction of dynamic responses of ground due to blast loading. *Gen. Proc. 27th Ann. Conf. of ISEE on Expl. & Blasting Tech., Orlando, January 28–31*, 1:361–371.
- Santis, L., Hardwick, M., Leidel, D. & Tatom, J. 2007. A new tool for managing risk associated with commercial explosives operations. *Gen. Proc. 33rd Ann. Conf. of ISEE on Expl. & Blasting Tech., Nashville, January 28–31*, 2:14p.
- Simons, J.W., Curran, D.R. & Antoun, T.H. 1995. A computer model for explosively induced rock fragmentation during mining operations. *6th Annual High-Tech Seminar—State-of-the-Art Blasting Technology Instrumentation & Explosives Applications, Boston, July 8–13*, 2:733–749.
- Smith, M.L. & Hautala, R.L. 1991. Coupling numeric & symbolic modeling in blast design. *Gen. Proc. 17th Ann. Conf. of ISEE on Expl. & Blasting Tech., Las Vegas, February 3–7*: 125–133.
- Wheeler R.M. 1995. Windows software for the analysis of blast vibration data, controlling frequency, & simulating waveforms & evaluating blast design timing, *6th Annual High-Tech Seminar—State-of-the-Art Blasting Technology Instrumentation & Explosives Applications, Boston, July 8–13*, 2:1015–1060.
- Wolf, R.L. & Bellenie, R.W. 1994. Strategy, innovation and change—challenging the future at the Gregg River mine. *Gen. Proc. 20th Ann. Conf. of ISEE on Expl. & Blasting Tech., Austin, January 30–February 3*: 89–107.
- Yang, Y., Xie, X. & Wang, R. 2010. Numerical simulation of dynamic response of operating metro tunnel induced by ground explosion. *J. Rock Mech. & Geotech. Engg.* 2 (4): 373–384.
- Zhao, Z., Zhang, Y. & Wei, X. 2009. Analysis of Discontinuous Deformation, New Developments & Applications, Guowei, M.A. & Zhou, Y. (eds.), *Research Publishing Services, Singapore*: 169–176.

This page intentionally left blank

This page intentionally left blank

Tunnelling in Rock by Drilling and Blasting presents the latest developments in the excavation of tunnels using the drilling and blasting method. Examples of work conducted throughout the world including the Indian sub-continent, Australia, and Sweden amongst others are discussed. These tunnel projects serve to illustrate the challenges and importance of drilling accuracy, the effect of geology, methods of vibration prediction and control, and techniques for assessing tunnel performance in terms of overbreak and underbreak, advance and rock mass damage. A number of case studies demonstrate the ingenuity required to successfully excavate tunnels in demanding circumstances. Finally, an overview is provided of the software tools and IT, and the explosives and initiation products used to implement tunnel blast designs.

Tunnelling in Rock by Drilling and Blasting is the outcome of the workshop, Tunnelling in Rock by Drilling and Blasting, hosted by the 10th International Symposium on Rock Fragmentation by Blasting (Fragblast 10, November 2010, New Delhi, India), and is essential reading for researchers and practitioners in tunnelling in rock by drilling and blasting.



www.crcpress.com

6000 Broken Sound Parkway, NW
Suite 300, Boca Raton, FL 33487
Schipholweg 107C
2316 XC Leiden, NL
2 Park Square, Milton Park
Abingdon, Oxon OX14 4RN, UK

