

THE ELEMENTS OF

SURVEYING AND GEODESY



3 1761 06706420 4

BY JOHN H. FENNER

THE ELEMENTS OF
SURVEYING AND GEODESY



Digitized by the Internet Archive
in 2007 with funding from
Microsoft Corporation

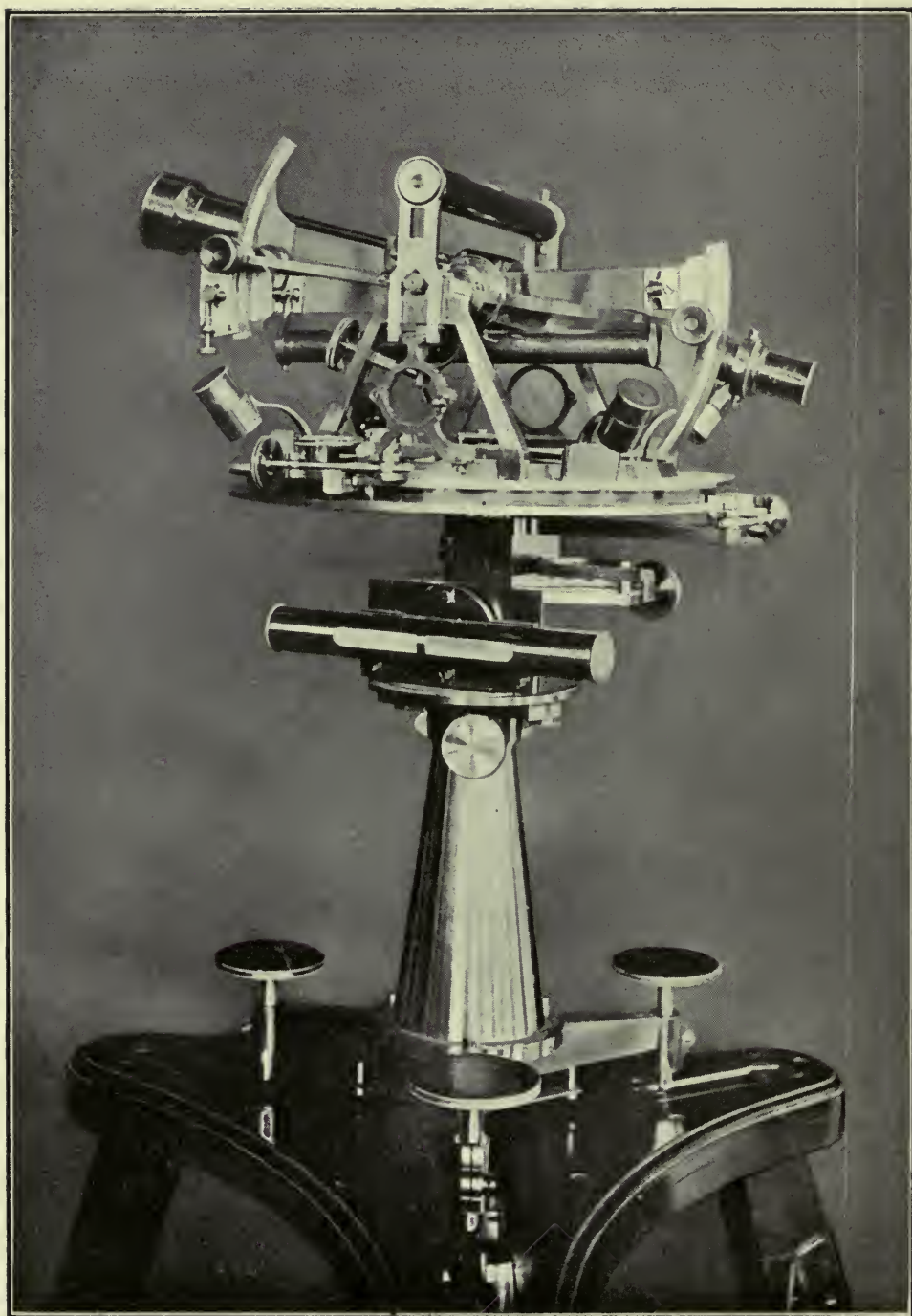

Old 10-inch Theodolite of Everest design, used on the early Indian Survey.

This has an arrangement for disconnecting from and reattaching to the pillar with the horizontal circle vertical so as to enable vertical angles beyond the range of the vertical segments of arc to be taken when required.

TE
Pop

THE ELEMENTS OF SURVEYING AND GEODESY

BY
WILLIAM CHARLES POPPLEWELL, M.Sc.
ASSOC. MEM. INST. C.E.

FORMERLY ASSISTANT TO THE PROFESSOR OF ENGINEERING IN THE UNIVERSITY OF
EDINBURGH; AND SENIOR ASSISTANT LECTURER IN ENGINEERING AT
THE YORKSHIRE COLLEGE, LEEDS; NOW LECTURER IN THE
UNIVERSITY OF MANCHESTER, FACULTY
OF TECHNOLOGY



WITH DIAGRAMS

163629
10/8/21

LONGMANS, GREEN AND CO.
39 PATERNOSTER ROW, LONDON
FOURTH AVENUE & 30TH STREET, NEW YORK
BOMBAY, CALCUTTA, AND MADRAS

1915

All rights reserved

PREFACE

AN attempt is made in the following pages to present a comprehensive view of the subject of geodesy in its wider sense, in order to provide students and others with such information as may lead to a sound knowledge of the fundamental ideas involved. A full knowledge of all the details of any one particular branch of surveying can only be acquired through experience. As leading towards this end the author has always advocated personal instruction in the use and adjustment of instruments, as well as the useful practice which may be obtained in a students' survey camp. But before either of these is possible the student must have mastered the bedrock principles, and the author hopes that a careful perusal of these pages may help him to do this.

Worked-out examples have been inserted where they seemed to be desirable, and a few examination questions are added at the end of the book. A list of references is also given to enable readers to consult authorities on specified branches of the subject.

The author desires to take this opportunity of thanking Messrs. W. F. Stanley & Co., Ltd., for the loan of many blocks of representative instruments and for much helpful advice; and also Messrs. C. F. Casella & Co., Ltd., and Messrs. J. H. Steward, Ltd.

W. C. P.

CONTENTS

CHAPTER I

SURVEYING BY DIRECT MEASUREMENT—CHAIN SURVEYING

	PAGE
Chains—Errors in chains—Standardising chains—Tapes and steel bands— Arrows—Ranging poles—Instruments for determining right angles—Geo- metrical methods—Carrying out chain surveys—Reconnaissance—Arrange- ment of triangulation—Ranging a base—Use of the chain—Offsets— Chaining on sloping ground—Accuracy—Ranging over undulating ground —Keeping the field book—Obstacles in chain lines—Determination of areas—Example of calculation	I

CHAPTER II

NEEDLE SURVEYS AND TRAVERSING

Traversing with the chain and tape—Needle traverses—Surveyor's compass, circumferentor, or dial—Errors of needles—Variation of the magnetic needle—Prismatic compass—Carrying out a needle survey—Working out and plotting—Rectangular co-ordinates—Methods of tabulation—Area enclosed—Notes on needle traverses	38
---	----

CHAPTER III

THE PLANE TABLE

Method of intersection—Traversing with the plane table—The instrument— The alidade or straight edge—Alidade with telescope—Adjustments of plane table—Use of the plane table—Radiation with tacheometer— Military plane table—Accuracy attainable	60
--	----

CHAPTER IV

INSTRUMENTS USED IN THE MEASUREMENT OF ANGLES

The surveying telescope—The sextant—The box sextant—Adjustments and use of the sextant	74
---	----

CHAPTER V

INSTRUMENTS USED IN THE MEASUREMENT OF ANGLES

(continued)

	PAGE
The theodolite—Description of a transit theodolite—Plain theodolite—Everest's theodolite—Adjustments and examination for constructional defects . . .	85

CHAPTER VI

CALCULATIONS OF DISTANCES AND HEIGHTS

Solution of plane triangles—Examples of solution of triangles and of problems relating to determination of heights	102
--	-----

CHAPTER VII

LEVELLING AND CONTOURING

Curvature of the earth—Correction for refraction—General principles of levelling—Instruments used—Water level—Dumpy spirit level—Y level—Levelling staves—Manipulation of level—Adjustments of level—Taking a set of levels—Booking—Working out the level book—Reciprocal levelling—Bench marks—Flying levels—Precise levelling—Contour lines—Fixing contours—Fixing of heights by the barometer—The hypsometer	109
---	-----

CHAPTER VIII

TACHEOMETRY OR RAPID SURVEYING

Surveying by visual angle and staff—Using ordinary theodolite telescope—Line of observation inclined—Staff inclined—Staff vertical—Porro's telescope—Surveying by vertical angles—Bar-subtense system—General hints—Accuracy—Rangefinders—Two-observer and single-observer rangefinders	139
---	-----

CHAPTER IX

GEODETIC OR TRIGONOMETRICAL SURVEYING

General—Measurements of base lines—Measuring bars—Extending the base—Measurement of the angles—Signals—Ordnance surveys of Great Britain and of India—Reduction to sea-level—Solution of spherical triangles . . .	163
--	-----

CHAPTER X

GEODETIC ASTRONOMY

Finding the true meridian—Observations by day and night—Observations for latitude—Determination of longitude	177
--	-----

CONTENTS

CHAPTER XI

HYDROGRAPHIC SURVEYING

	PAGE
Location of a point on the surface of water—Two angles observed on the land —Two angles read at the point—Points on known line—Soundings— Gauging of streams	194

CHAPTER XII

UNDERGROUND SURVEYING

Connection of surface with underground survey—Instruments used in under- ground work—Angle measuring instruments—Chains—Observation marks	201
--	-----

CHAPTER XIII

SETTING OUT—RAILWAY CURVES

Setting out in general—Ranging straight lines—Railway curves—Preliminary calculations—Setting out a curve with chain and tape—With chain and one theodolite—By two theodolites—By successive bisection of arcs— Reverse curves—Superelevation of outer rail—Transition curves— Example of transition curve	210
--	-----

CHAPTER XIV

EARTHWORK CALCULATIONS

Table of natural slopes of different earths—Table of weights of different earths —Details of calculations	226
EXAMINATION QUESTIONS	231
BIBLIOGRAPHY	233
TRAVERSE TABLE	234
TABLES OF LOGARITHMS AND ANGLES	236
INDEX	241

*The Tables on pages 236-240 are included by kind
permission of the Controller of His Majesty's
Stationery Office.*



THE ELEMENTS OF SURVEYING AND GEODESY

CHAPTER I

SURVEYING BY DIRECT MEASUREMENT—CHAIN SURVEYING

THIS is the simplest branch of survey work. The necessary measurements on the ground are made with the chain and tape, and the subsequent plotting requires the use of scales and compasses only. Measurements of angles are not essential, though sometimes found useful for purposes of checking; nor is a knowledge of trigonometry absolutely necessary.

It is possible to carry out complete surveys by the use of the chain alone so long as the areas covered are small. In larger surveys, where trigonometrical methods are used, chain surveying is useful for filling in the details.

Simple Example of the use of the Chain as a Surveying Instrument.—The wavy line on Fig. 1 represents the boundary of a small field. It is necessary to prepare a plan of the field on paper so as to have a record of its shape and, possibly, to ascertain the area also.

In doing this the surveyor, after an inspection of the ground, places three ranging poles at points A, B, and C, so that they form the angular points of a triangle, as nearly as possible equilateral. The lengths of these lines are now measured by a chain stretched on the ground. As each line is being chained perpendicular measurements, called "offsets," are taken from a number of points on the chain lines to the boundary, the distances of these points from the commencement of their lines being noted at the same time. On the line AB these are shown as *ha*, *gb*, *fc*, and *ed*. All measurements are noted in a book as they are made. The surveyor can now go into his office and lay down the line AC to a suitable scale

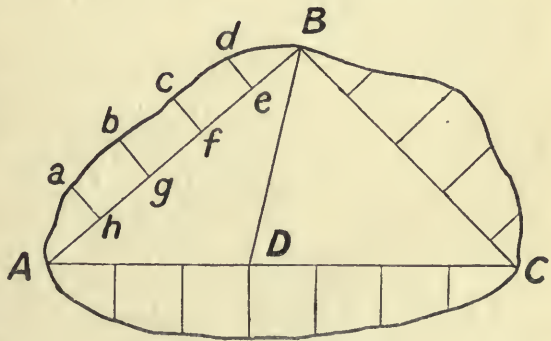

FIG. 1.—Simple survey.

on paper. Then, taking the length AB in his compasses, he strikes an arc from A, and in a like manner cuts this with a second one struck from C with the distance CB. This will fix the relative positions of the three points on the paper. He now goes along the lines AC, AB, and CB again, and plots the offsets from their respective points. A smooth curved line joining the ends of the offsets will then represent the true form of the given field, and the area enclosed will be proportional to the true area of the field, the ratio depending on the scale used in the plotting.

It is often desirable, for reasons of greater accuracy, to employ a fourth chain line DB, measured from some point D in the line AC across the triangle to B. In the plotting, the arcs struck from A, D, and C should pass through the same point.

Larger Areas and more intricate boundaries need a greater number of triangles, but the plan of operation is essentially the same in all chain work—offsets taken to boundaries from chain lines which themselves form the sides of triangles.

Details of Chain Surveying Work. The Instruments used.—Chains.—The chief horizontal measurements required in chain surveying are usually made with chains of either steel or iron, consisting of 100 main links joined together by sets of two or three short links or rings.

The principal lengths of the chains used in Great Britain are as follows :—

Gunter's Chain.—66 feet in total length, divided into 100 links, each 7.92 inches long.

Engineers' Chain.—100 feet total length, divided into 100 links, each 12 inches long.

Fifty-Foot Chain.—50 feet total length, divided into 50 links, each 12 inches long.

The first of these, the "Gunter's" chain, has a length of 22 yards and is one-eightieth part of a mile. This is especially useful for land surveying work, both on account of its length being a simple fraction of a mile, and also because a square chain is a fraction of an acre.

Thus, 1 acre is made up of 4840 square yards; one-tenth of this is 484 square yards or the square of one chain = $(22)^2$. If, therefore, a survey is made with a Gunter's chain and is plotted to a scale of so many chains to an inch, one square inch will represent so many square chains. For instance, to take a simple case—a survey is made with a Gunter's chain and is plotted to a scale of 2 chains to 1 inch. Here one square inch will represent $2 \times 2 = 4$ square chains, so that, if the area of a field on this plan is found to be so many square inches, it only becomes necessary to multiply by 4, in order to bring the result to square chains, and to divide this by 10 to get acres. Or, if the area is calculated direct from the chain measurements and the result obtained in square chains, the decimal point is to be moved one place to the left in order to obtain the result in acres.

The peculiar manner of division of the Gunter chain, therefore, makes it particularly suitable for land survey work; the 100-foot chain is used chiefly by civil engineers, especially in the United States; while

the 50-foot chain is used for the same work as the 100-foot chain, but is chosen where lightness is an advantage.

The link of a surveying chain consists of a piece of iron or steel wire with loops formed on it at the two ends. The loop at the beginning of one main link is connected to the corresponding loop at the end of the adjacent one by means of two or three short links, which are either circular or elliptical in shape.

The extreme ends of the chain are fitted with brass handles, which are held by the surveyor and his chainman when carrying out their work.

It is important to note that the length of a chain is taken as the distance between the outsides of the two handles.

After division into the 100 links a chain is again subdivided into 10 lengths of 10 links each. The points of division are marked by brass

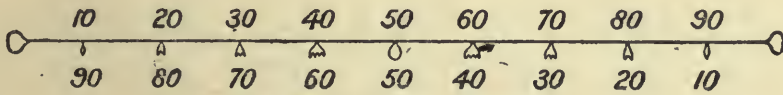

FIG. 2.—Division of chain.

tags or labels attached to the small link midway between the ends of two of the main links. These tags have points cut on their lower edges, the number of these corresponding to the position on the chain. Starting from one end, the tag at the end of the first 10 links has 1 point; that at the end of 20 links, 2 points; and so on as far as the fifth, which has a tag of circular shape to make it clearly distinguishable from the others. The chain is quite symmetrical about the centre, so that the sixth ten is marked by a tag of 4 points, the seventh by one of 3 points, and so forth.

This method of subdividing is indicated on Fig. 2.

The beginner will soon find out that some care is required in reading the length of a portion of a chain, confusion sometimes arising between the 60 and the 40, and between the 70 and the 30.

When not in use the chain should be folded as shown on Fig. 3. This folding is commenced by first bringing the handles together and starting from the centre. As they are brought into position the centres of the links should be kept close together, metal to metal, and the ends allowed to spread out as they like. If this is done the chain can be tightly fastened up by a strap as shown in the illustration.

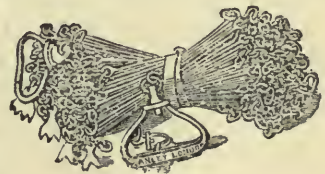

FIG. 3.

When the chain is to be used again the strap is taken off, the two handles clasped firmly and the chain thrown out and away, and afterwards pulled straight.

Errors to which Chains are Liable.—All chains, both by reason of their construction and the manner of their use, are liable to small variations in length, and these lead to errors in the work.

The error may be one of shortening or one of lengthening.

The Shortening of a Chain may be due to several causes.

(a) If the chain is made of soft steel or iron, some or all the links may become slightly bent in the ordinary course of the work, by being trodden upon, having cart-wheels pass over them, or by being roughly pulled round corners. There are 100 links to be affected in this way, and if each link is bent even to a minute extent the effect on the total length may be considerable.

(b) A second cause of shortening in the course of the work is the accumulation of dirt or mud or ice in the joints of the links. This effect is most marked when the lines are being chained across muddy roads or ploughed land.

The best cure is to place the chain after use in a bucket of water, when the mud will be washed out by the water and settle to the bottom of the bucket.

Lengthening of the Chain, which is more frequent than the shortening, is caused by—

(c) The opening of the joints of the links. Where the joints are not brazed and the metal is soft, a chain may easily be stretched a couple of inches in the course of a fortnight's work. It must be remembered that in a chain there are roughly 400 joints to give way, and a very small amount of yield in each one will result in a considerable stretch of the chain as a whole.

(d) The pulling or elongation of the links when the metal is too soft, and consequently not sufficiently rigid.

Standardising and Correcting Chains.—Every surveyor or engineer who uses surveying chains should either possess a standard chain which is only to be used for purposes of comparison, or he should have the correct length permanently marked out on some level surface which is not likely to be disturbed. A suitable place for this is the coping of a wall, the floor of a cement or tiled corridor, or a flagged footpath, and the correct length should be marked upon it from a standard steel chain or tape. When this has been done the chains in use can be frequently brought and compared with the standard measurement, and if found incorrect can be adjusted. In making this comparison the chain should be laid out perfectly straight along the standard distance and carefully inspected to make sure that there are no kinks or twists. It should then be pulled straight with about the same tension as is applied in the ordinary course of the work, and the error, if any, noted. The chain must now be adjusted as follows:—

Chain too Short.—When the chain has been shortened by the accumulation of dirt the defect is soon remedied in the manner already described.

When, however, the shortening is of a more permanent nature it is often found that by carefully going over each link and straightening it with a hammer, the necessary length may be attained. If it is still short, an additional link must be put into the chain at its middle point, the link being made of the proper length to secure the necessary adjustment.

The Chain too Long.—The opening of the links may be prevented in two ways. They may be made either of hardened steel in which no appreciable permanent set is possible, or the joints may be brazed together instead of being left open. The latter adds to the cost of the chain, but is a distinct advantage.

The elongating of the links may be also prevented by making them of harder steel. Many modern chains are made of steel just hardened sufficiently to prevent the taking of any appreciable permanent set. By using hardened steel in this way the chain is made much lighter. There is a great saving in using a light chain, and this advantage becomes apparent when the chain is one of the longer ones and has to be dragged over miles of rough country in the course of a day's work. At the same time, a heavy steel chain is very serviceable, and does not require so much attention as does a lighter one. In steel chains the great fear is that in places the steel may be over-hardened. Steel links, especially the lighter ones, often snap when subjected to rough usage, such as being left lying on a road when a cart is passing along.

When the chain is found to be too long, it must be carefully inspected so as to find out whether there is any local defect. If the link joints appear to have been pulled open, and the metal is sufficiently soft to allow of it, the chain must be examined in detail and all open links closed. If this fails to effect the desired result, or the links are too hard to admit of being hammered together, then the only remedy is to take one of the small links out of the chain, or perhaps two if necessary. Where links are removed or inserted it is best done in the middle of the chain, so that the total length may be correctly adjusted and the intermediate lengths not affected. If the chain, when found to be inaccurate, is not adjusted, a note must be made of the error and allowance made for it in plotting, but, though this can be done in an emergency, it is tedious and should be avoided.

Some chains are provided with screw adjustments at the handles, as in Fig. 4, so that the total length may be varied

without there being any need to insert or remove links. In some cases the screw adjustment is at the centre.

It is well to bestow some care in the selection of a chain. A light steel chain is the best, but should not be too light. The sizes in which these are made varies from No. 8 B.W.G. (equal to 0.165 in. diam.), to No. 12 B.W.G. (equal to 0.109 in. diam.). Care should be taken to ascertain if the links have been properly hardened and tempered.

Pit Chains.—For underground work where there is much moisture, chains are often made entirely of brass; others are made of steel with 10 feet of brass at each end.

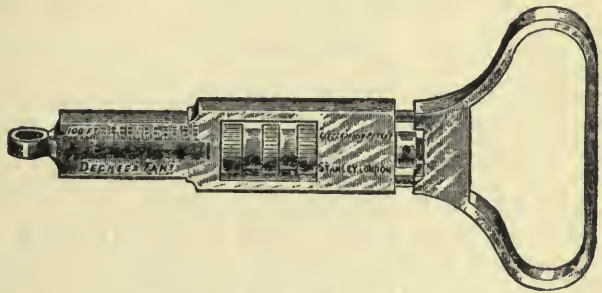

FIG. 4.

Effect of Temperature on Chains.—Variations in temperature affect the length of a chain, but not to any extent appreciable in ordinary surveying work, errors due to differences in the tension being relatively greater.

In cases, however, where standard steel chains of heavy design or steel tapes are used for such purposes as setting out important bases, the temperature must be constantly noted and allowance made for differences in length. The following may be used for steel :—

Let t = the temperature at which the chain or tape was standardised,
 T = the temperature at which measurement was made,
 l = length of line measured ; then

$$\text{Correction for temperature} = l \times 0.000065(T - t)$$

The correction must be added or subtracted according as the working temperature was above or below the standard temperature.

Tapes.—These are made both in steel and linen. Where great accuracy is required and where the persons using the tape are experienced and careful workers, a steel tape may be used for the offsetting and may often take the place of a chain ; it is reliable in that it does

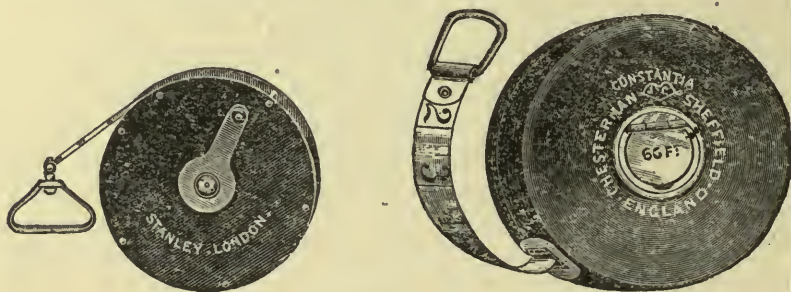

FIG. 5.

not vary appreciably in length, and it is very light and therefore easy both to carry about and to work with. But a steel tape has the disadvantage of being easily broken, and, if not nickel plated, of soon becoming so rusty that it is difficult to read the figures. In any case a 100-foot steel tape is a useful addition to the stock-in-trade of any engineer who has surveying to do. On account of its constant length it is always useful for checking and standardising the chains.

A steel tape is simply a ribband of a very high quality steel, varying in width from $\frac{1}{4}$ inch to $\frac{5}{8}$ inch, and in length between 33 feet, or half a chain, and 100 feet. The steel is polished and the divisions are etched so as to appear white on a dark ground. A common way of marking is to have feet and inches on one side and Gunter's links on the other.

Steel Band and Measuring Chain.—It is possible to procure steel tapes specially adapted for use as chains. They are provided with brass handles and divided into links or feet as may be desired. The

lengths in which these are made are 50, 66, and 100 feet. A general view of one of these is shown on the left of Fig. 5.

Fibrous Tapes.—These are too well known to need a special description. Perhaps the most serviceable tape for offset work is one marked in feet and inches on one side and in links on the other. For some purposes it may be convenient to have the tape divided in a similar manner to a chain—that is, into feet and tenths of a foot—but the former plan is most suitable for ordinary work, especially where measurements of buildings have to be made. These tapes can be obtained in lengths of 33, 50, 66, and 100 feet (see Fig. 5).

Many of the best tapes are provided with thin metallic strips interwoven with the linen and running from end to end, the object being to make the tape harder and to prevent stretching. There is no doubt it has this effect, especially when the tape is comparatively new and the metal has not been broken by wear.

The life of a tape may be prolonged by taking a reasonable amount of care. The chief thing to remember is that a tape should never be wound up when wet. In such a case it is best to lightly wipe it over and to hang it up in loose folds to dry before being rolled up. The part of a tape which wears out soonest is about 12 inches from the brass ring, and it is well to have this made of, or covered with, leather.

Arrows.—These are used in conjunction with the chain for marking points on the ground. They simply consist of pieces of steel wire or skewers about 12 to 15 inches long, pointed at one end and formed into a loop at the other. They are used in sets of ten, one such set being

required for each chain. It is advisable to have these of the strongest make, and it is also well to have tags of white or scarlet cloth tied on to the ring end of each arrow. This may seem a somewhat



FIG. 6.

useless precaution, but as a matter of fact arrows are very easily lost by being left in the ground, and, if the work is being done in grass country, it is most difficult to find an arrow which has been stuck into the ground among the grass. By adopting this simple precaution, much time will be saved as well as many arrows (Fig. 6).

Ranging Poles or Pickets.—These are made of wood, and are either circular or polygonal in section. They are usually made of straight-grained pine and provided with pointed steel shoes, as shown in the illustration Fig. 7. In some cases these poles are made of ash,



FIG. 7.—Pole or picket.

for greater strength and durability. The usual lengths as sold are 6, 7, 8, and 10 feet. The most useful length will be found to be the 7 or 8 feet. For very long sights and for marking important station points 10-foot poles will be found serviceable. In all cases where the distances are great, the poles should be provided with bunting or cotton

flags. These are best made white, though scarlet shows well where there is much foliage. It is a good plan to use flags which are half white and half red.

The poles themselves are divided into lengths by being painted in different colours. There is some difference of opinion as to the best colours to adopt. This is really a much more important point than would appear at first sight, and is especially true in instrumental work, where poles are often quite invisible to the naked eye, and have to be found through the telescope. The poles should be painted of such colours as will best be seen at a distance. Of the different colours, black shows best against a light background, and red is certainly the best colour to be seen among foliage. The author has found that poles painted in alternate lengths of black, white, and red (beginning from the bottom) are the best under all conditions. Some engineers advocate alternate black and white lengths, without the red. In open country poles of this kind are good enough, but are most difficult to see where they are partially obscured by trees.

The lengths of the divisions may be either feet or links according to the chain which is being used. These poles will be found useful in taking short offsets.

Ordinary laths with pointed ends are often useful in ranging out lines, being used to assist in fixing the lines for spaces between successive poles.

Also small pegs or twigs, pointed at one end and having slips of paper fixed in splits at the other, are extremely useful in denoting subsidiary and temporary stations, as well as for contour points.

Pegs.—These are used as permanent marks for “station points,” as the chief points in a triangulation are called. They should be fairly substantial in section, say 2 inches square. They are about 12 inches long with pointed ends, and are driven into the ground at the station points.

Surveyors' Rods.—Thin lancewood rods 5 or 6 feet long, divided into feet and inches by red and white figures on a black ground, are useful for taking short measurements, especially on buildings or where there is much detail.

Instruments for determining Right Angles.—These include cross-staff-heads and optical squares.

Old Form of Cross-Staff-head.—On Fig. 8 is shown the original and most simple form of this instrument. It can be made for a few pence and used on work in which great accuracy is not essential. It consists of a cubical piece of wood, mounted on the top of a short ranging pole about 5 feet high. In the figure (*a*) is the elevation and (*b*) the plan. Two saw cuts are made for some depth into the top of the block as shown, care being taken that these intersect truly at right angles. The slits are made sufficiently wide to allow a clear sight through. To use the cross-staff place the pole in the main line (xy) in such a way that, looking through from (x), a pole in the line at (y) some distance away, appears in the middle of the slit. On looking through the second slit, in the direction indicated by the arrow, any point (Z)

which appears in the centre of the slit, is in a line which is perpendicular to (xy) at the centre of the cross-staff pole.

Metallic Cross-Staff-heads.—The above form is crude and only suitable for rough work. In the more modern form the head is often made in the form of an octagonal box, as shown in the accompanying Fig. 9. On each pair of opposite faces are two slits, one continuous with the other. Half of this slit forms the opening into which the eye looks, and in front of this on the opposite face is a wider slit with a vertical wire, the latter forming the sight. Sights can be taken at angles of 45° as well as 90° .

Another form which is very convenient for some classes of work is shown on Fig. 10. The box in this case is circular and is made in two halves, of which the upper is capable of rotating on the lower. The top edge of the lower half is divided into degrees and fractions of a

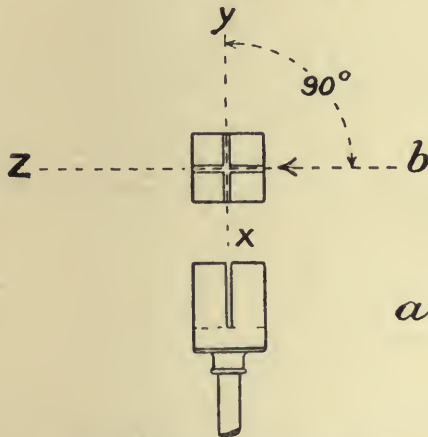

FIG. 8.—Simple cross-staff.



FIG. 9.



FIG. 10.

degree, and the upper half carries a vernier which moves over this. It is possible, therefore, not only to set out right angles with this instrument, but also to roughly measure the angle between two existing lines, or to set out a line making a given angle with an existing line. It is often provided with a compass.

The Optical Square.—This is a simple instrument of the reflecting kind, and possesses the advantage that it can be used when held in the hand of the observer and need not be fixed upon the top of a pole or tripod. A general view of the outside of the instrument is shown on Fig. 11. It will be seen that it consists of a small brass box about 3 inches in diameter and $\frac{3}{4}$ inch deep. The principle on which it works is indicated on the accompanying Fig. 12. At the bottom of the box, and at right angles to it, are fixed two mirrors, X and Y. Of these, X is silvered only on its lower half, being left clear on its upper half. The second mirror, Y, is silvered over the whole of its surface. The faces of these mirrors are set so as to make an angle of 45° with one another. The accuracy of the working of



FIG. 11.

the instrument depends on this setting. In the side of the box is an eye-hole at O , and two fairly large openings at P and Q . To illustrate the working of the instrument, take two perpendicular lines on the ground CA and CB , the angle ACB being a true right angle. Stand so that the centre of the instrument is vertically over C , having previously placed poles at A and B . On looking through the sight-hole O and through the clear upper part of the mirror, the pole at A will be seen, and in the lower or silvered part the second pole B will be seen to coincide with A , that is to say, the two poles appear to form a continuous line. The reason of this is as follows: The rays of light coming from B strike the mirror Y , and are reflected to the second mirror X , and thence back to the eye, following the course indicated by the dotted lines. It can be shown that when a ray of light is doubly reflected in this way, the angle between its original and its ultimate direction is

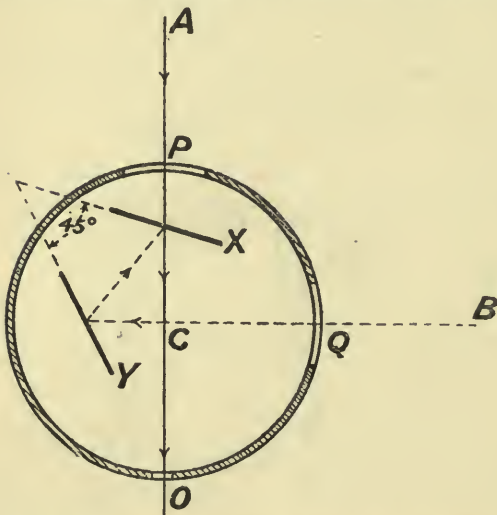

FIG. 12.—Optical square with two mirrors.

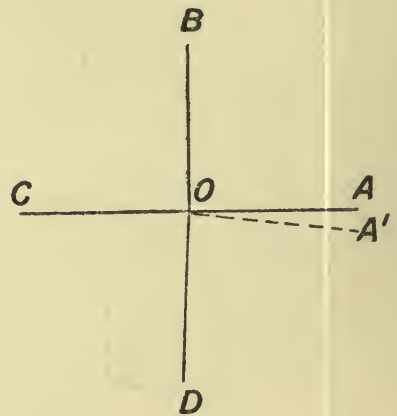

FIG. 13.

twice the angle between the reflecting surfaces. The proof of this is given in the paragraph relating to the sextant.

If, therefore, the observer stands on a line and look towards a pole placed in the line some distance away through the clear part of the first mirror, and an assistant places a pole in the ground in such a position that its image coincides with that of the direct view of the first pole, it will have been placed in a line making an angle of 90° with the first. The instrument is very convenient to use, and may be carried about in the pocket.

As the accuracy of the right angle depends on the angle between the mirrors being 45° , and the mirrors may sometimes get slightly displaced, it is desirable occasionally to test the instrument to make sure that the adjustment is correct. To do this, select a level and fairly large piece of ground (Fig. 13). Stand at some point O , and place a pole, A' , anywhere in the ground. Stand at O , and set out a right angle from A' as marked by a second pole D . The angle

A'OD is, according to the instrument, a right angle. Next, set out a third line OC at right angles to OD. In a similar way establish a fourth point B. If now the observer looks to B, A should coincide with B in the mirrors. In the figure this coincidence does not take place, which goes to prove that in this instance the angle set out by the optical square is less than 90° ; as otherwise the last line would have coincided with the first, the whole circle being made up of 360° , or four right angles. If means of adjustment are provided, the angle between the mirrors must be increased or diminished, until, on again testing, the first line and the last are found to coincide. A second form of optical square is sometimes used, consisting of a box as before, provided with two sight-holes, at an angle of 90° . One of these is a small sight-hole, while the other is a larger one provided with a vertical sight wire. One mirror is used in this case, set in such

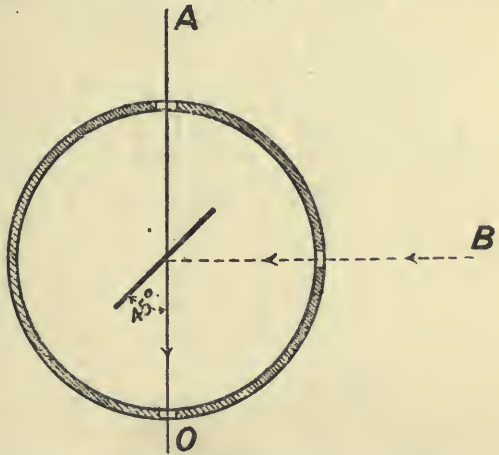

FIG. 14.—Optical square with one mirror.

a position that a ray of light striking it from the centre of the sight-hole is reflected through the centre of the sight, the incident and the reflected ray making an angle of 90° . See Fig. 14.

The accuracy of this depends upon the position of the mirror.

Geometrical Methods of Setting Out a Right Angle on the Ground.

—It is often necessary to set out a line making a right angle with an existing line without an optical instrument.

In such a case the difficulty may be got over by using a chain or tape in one of two ways (Fig. 15).

1st Method.—It is required to set off a line at right angles to a chain

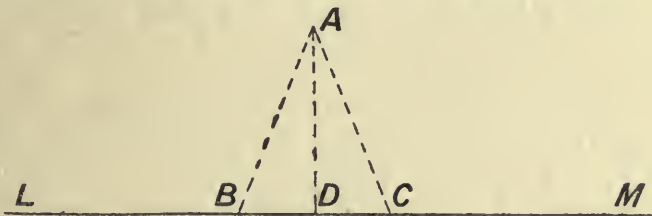

FIG. 15.

line LM at a point D in the line. If there is plenty of room along the line on each side of the point the first method may be used.

From D mark off two equal distances, DB and DC, on either side. Then take the chain or part of it—this will depend upon the length of BC—roughly double the length of BC. Hold one end at B and the other at C, take the middle point and pull the chain tight. This will give the point A, and AD will be at right angles to LM as required. If

the point A is given, and a perpendicular line has to be dropped from it to LM, then A must be taken as centre, and, with a length of chain as radius, two points, C and B, must be touched on the line equidistant from A. The middle of this length BC will be the foot of the required perpendicular.

2nd Method.—In cases where there is not sufficient space on one side of B (Fig. 16) the geometrical fact expressed in the forty-seventh proposition in the first book of Euclid may be made use of in the following way:—

This proposition says that in any right-angled triangle the square on the hypotenuse is equal to the sum of the squares on the remaining sides. So that if a triangle be taken whose sides are in the ratio of 3, 4 and 5, the angle opposite the 5 side will be a right angle. The square

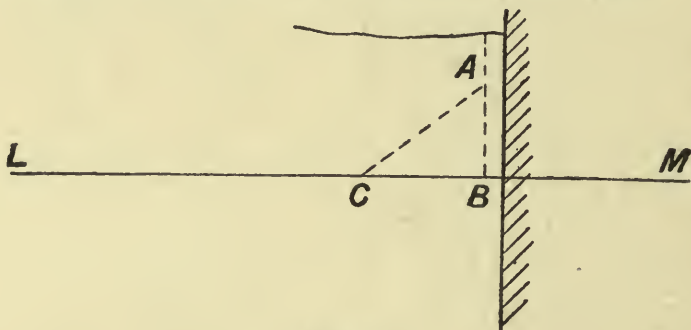

FIG. 16.

of 3 is 9, that of 4 is 16, and these added together make 25, which is the square of 5.

Mark off from B to C, 4 units. These may be feet, tens of feet, or other suitable number of feet, which must be settled according to the judgment of the surveyor, the one thing to remember being that the lines should be as long as possible.

Now with 8 of the same units on the chain, and holding one end at B and the other at C, take the point A, 3 units from B; taking hold of this point and pulling the chain tight, ABC will be the necessary right angle.

Larger Surveys. Reconnaissance, Arrangement of Triangulation.—In any chain survey the first thing to be determined is the base line. It is always well, if possible, to make the whole survey dependent upon one long line, which is made the reference line for all points. Generally speaking, the base line should be made as long as possible, passing right through the middle of the ground, and so forming a backbone upon which all the remaining lines and triangles are made to depend. In some cases it is necessary to place the line along one side of the land, as, for instance, where the main part of the ground lies on one side of a valley and the only level ground suitable for a base line is near a river-bank. In others it may be necessary, owing to the impossibility of getting one long uninterrupted line, to make use of two or more bases.

In selecting a suitable base a great deal of care must be taken. It

is not sufficient that the ground is suitable for the measurement of the base; its position must be such that good triangles can be obtained from points on the base. Before deciding upon its position, the ground must be carefully inspected and the principal station points selected, care being taken that these can be seen from the chief points on the base line.

All triangles should be "well-conditioned," that is to say, as nearly as possible equilateral, with no very obtuse or very acute angles.

Tie lines should be employed wherever possible. In every main triangle having a portion of the base line for one of its sides each point must be clearly visible from the other two. Also, it will be well if more than two points on the base line can be seen from each point of the other main stations, so that, if necessary, tie lines can be obtained.

It is important in choosing the main stations of the triangulation to see that the main lines are as far as possible placed so as to run near a boundary line or some points which have to be taken into the survey. By doing this many subsidiary lines will be saved and no time wasted in chaining two lines where one could have been made to suffice.

A short time spent in making a careful preliminary inspection of the ground will often save a much greater amount of time later on. Nothing is more annoying and disappointing than to have completed a part of the work and to discover that a tree or some other obstacle comes in the direct line of an important sight; that some station is invisible from some other station from which it is desirable to range a line; or to find that where one line might have been made to suffice, another has to be put in at the last moment in order to reach a boundary.

In a preliminary inspection of this kind it is often a great help to put temporary poles at what are intended to be the chief stations, and walk from station to station and see that all the lines are satisfactory. Lines should be placed so that the offsets may be as short as possible.

The general arrangement of the main triangulation ought to be as simple as it is possible to make it. A glance at the plotting of a survey will show at once whether it has been well or badly arranged. All the main triangles ought to be "well conditioned," all smaller triangles which are placed to take in details which could not otherwise be reached, should be made to depend entirely on the main triangulation, and not form part of a second triangulation of their own. A badly arranged survey presents a confused network of small triangles, the lines often crossing one another in hopeless confusion. When this is the case the minor triangulation has been patched together out of small parts instead of as it were "growing upon" the main triangulation. The aim in all survey work should be to work from the greater to the less, getting the main triangulation fixed before any attempt is made at putting in details. The converse of this should never be attempted. Such always leads to confusion and it is impossible to carry it out with accuracy.

If a long base can be chosen and a series of large triangles built upon it, with plenty of check lines, a stiff triangulation will be obtained to serve as a framework on which to build the lesser detail which comes afterwards.

Ranging out the Base.—When the preliminary inspection has been made and all the chief points decided upon, these should be marked by pegs driven into the ground, so that it will always be possible to return to any point, even some time after the survey has been completed. The first actual operation in making the survey is to range out the base. The manner of doing this will depend on its length and on the nature of the ground. If it is only, say, 500 or 600 feet in length it will generally be sufficiently accurate to range it out by eye; when it is much longer than this it is best to use a theodolite. If a theodolite is not available the line must be ranged out by eye with the help of a telescope or field glass.

At each end of the line a pole should be placed. These poles should be high and such as can be easily seen. For instance, for a half-mile base the writer has found two 10-foot poles with white flags suitable. The flags are very useful, especially where the sights are long and there is much foliage about. At a long distance it is often only by the flutter of the flag that the position of a point can be found. When a theodolite is used for ranging it must be placed at or beyond one of the end points, if possible slightly elevated, so that the whole of the line is plainly visible. It is also an advantage to have the two end poles elevated. When the instrument has been set up on the line at or just beyond one end, the pole at the other end is sighted, the cross-hairs being made to cut the centre of the pole where it enters the ground. The line of sight of the telescope will now coincide with the vertical plane of the base line at all points, and the observer can direct an assistant in placing his intermediate poles. It will already have been roughly decided where to place these poles. The assistant holds one just touching the ground, as near as he can judge in the line, and the observer at the telescope signals to him to move it from or towards him until the centre of the pole exactly coincides with the cross-hairs of the theodolite. This is done for each successive pole, it being remembered that the assistant must commence with that pole furthest from the observer so that there may be no intermediate poles to obstruct the view. This is also true when the ranging is carried out by eye without the aid of a theodolite. For a survey of any importance there should be an uninterrupted view from one end of the base line to the other, and if the line has necessarily to cross any hedge or wall a gap must be cut.

Chaining the Base and the Main Triangulation.—When the ranging of the base is complete, the chaining may begin. A base line should be chained two or three times, so that no error may be due to inaccuracy in the lengths of the different parts of the base line. The remaining lines of the triangulation may now be ranged out and chained. It is well to run over these principal lines twice, especially where the ground is rough or sloping. During one of these chainings the offsets can be taken when there are any points or boundaries to be noted.

Plotting the Main Triangulation.—When the main triangulation or any part of it has been chained it is best to plot the lines at once, and no further detail should be attempted until the main triangulation is complete and has been inked in with fine red lines. This is most important.

The surveyor may have gone over the ground and chained all the lines, the booking may be very complete and everything so far gone on without a hitch. But when the lines come to be put on paper the surveyor, especially if he be a beginner, may be astonished to find how far from fitting are the various triangles. It is easy to get an error of 5 or 10 feet in a long line. A chain may have been missed, what should have been read as 60 may have been booked as 40, and if the ground is sloping or undulating there may be an accumulation of small errors.

Example of Small Survey.—The simple case which has been given does not often occur in practice in so simple a form. The plan shown on Fig. 17, consisting of a plot of land divided into four irregular fields, is a more typical example of a small survey. Here AB, the base line, was found to be on fairly level ground with a clear view from A to B, and as it was also the longest line on the ground it was selected as being the most suitable for the base. The principal station points are at A, B, C, D, E, F, G, H, J; and AC, CH, EH, EJ, JF, CB, AD, GJ, JD, DB, and

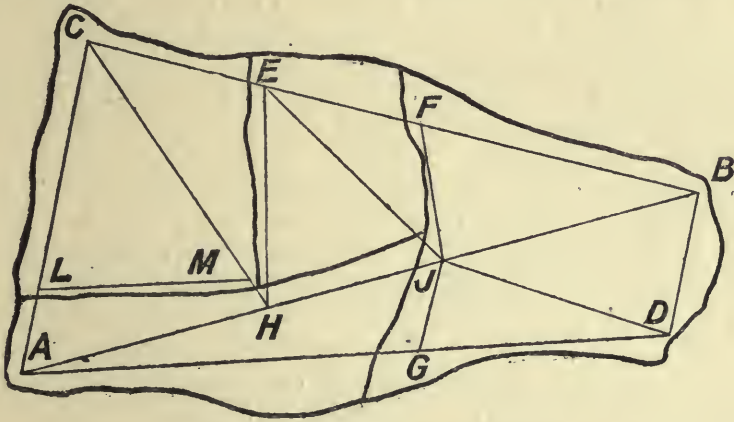

FIG. 17.—Several chain survey.

AD are the lines of the principal triangles. It will be seen that on the upper side of the base the vertices C, E, F, and B of main triangles happen to lie on a straight line. It is always well to keep a look-out for chances of this kind occurring, as setting points in a straight line stiffens the triangulation, gives an extra check on the accuracy of the work, and is a material help in plotting. It will be seen also that the main lines are so selected that they lie near boundary walls, and the only extra line it is necessary to take is the line LM.

How the Chain is used.—Although a very simple instrument in itself, the chain requires a considerable amount of care and experience in its use in order to produce accurate work. In chaining a line, there must be two persons to manipulate the chain and tape, and one of these may book the results. In some cases a third man enters the results in the field book, while the remaining two devote themselves entirely to the work of measurement.

The two men who manipulate the chain are called respectively the "leader" and the "follower" or "driver." The leader is usually the

chain-man whose duty it is to pull the chain from point to point, as he is directed; the driver is the man in charge of the chaining and directs the work as it proceeds. In measuring a simple chain line the following is the plan generally adopted:—

The driver takes the back end of the chain and stands close to the point from which the measurements are to be taken. The chain-man goes on in front and pulls the chain after him in the direction in which the line is to be measured. In his hand is a complete set of ten arrows.

It is assumed that previously the line has been ranged out and poles placed at frequent intervals. As a general rule fewer poles are required in an open level country than where the land undulates and where there are many small obstacles.

The driver kneels or stoops behind the pole which marks the beginning of the line, the leader having gone on before and pulled out the chain in the approximate direction of the line. The driver holds the handle of the chain firmly against the side of the pole. Strictly speaking, the end of a line must be taken as the centre of the pole which marks the point, and in measuring the line the end of the chain ought properly to be held opposite the centre of the pole. For rough measurements this is not always observed, the handle of the chain being held hard against the front of the pole.

The leader now stoops in such a position that his body does not interfere with the line of sight, and pulls the chain tight as nearly as he can judge in the right direction. The driver then directs him to move the hand which is holding the forward end of the chain to the right or left, until it lies in a direct line between the first pole and the next one in the line. In giving his directions the driver shouts either "to you" or "from you," as the case may be, or indicates the direction with a movement of his hand or by a side swing of his head.

When the leader has got the proper direction he gives the chain an upward shake so as to get it clear of the ground and then pulls it tight. When he commenced the line he had the complete set of ten arrows in his possession. One of these he puts into the ground against the extreme end of the handle.

The process is now repeated, the leader going on and pulling the chain after him, and leaving the arrow in the ground so as to mark the end of the first chain, and as a record of the fact that one chain length has been measured. In measuring the second chain the arrow instead of the pole is taken as the initial point. When this second chain length has been laid down, the leader leaves another arrow to mark the point, and the driver picks up the first arrow.

So the work proceeds, the number of arrows which the driver has in his possession at any moment being an indication of the number of complete chains laid down. If the line is more than ten chains in length the leader comes back to the driver at the end of the tenth chain and takes over the arrows again, a note being made in the field book that the ten chains have been completed. When the leader takes over the ten arrows the driver will have nothing wherewith to mark the end of the tenth

chain, and it is sometimes customary to carry eleven instead of ten arrows, so that the driver always has the spare arrow in his possession, and hands over ten only at the completion of ten chains.

No notice is taken of ranging poles when they are simply used for indicating the direction, but any station points which may come in the line are to be noted, it always being remembered that the position is given as being so many chains and fractions of a chain from the commencement of the line.

Offsets.—Where there is a boundary of any kind lying alongside the chain line, measurements must be taken to this from the chain line as the work proceeds.

A very simple example of this is given on Fig. 18.

Here a main chain line, AB, is being measured. On this line is a third

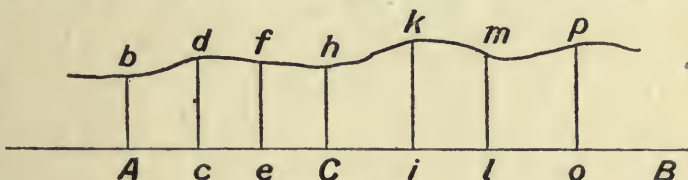

FIG. 18.

main station point, C, whose position must be noted in passing. At the same time there is a boundary fence, bp , on the ground, and offsets must be taken to this. A number of rectangular offsets are taken at frequent intervals. The first of these is at A, and the distance Ab is measured with a tape. The next is at c . Here the length of the offset cd is measured, and at the same time the distance of c from the commencement of the line is noted. The number or frequency of the offsets taken depends entirely on the nature of the boundary. In a perfectly straight wall it will be sufficient to take a careful offset at each end, and perhaps one about the middle to serve as a check. On the other hand, where the curves are many and sharp, offsets must be taken more frequently. Where several offsets come in one chain length, it is usual to pull the chain tight in its correct position, put the arrow in the leading end, and then allow the chain to lie along the ground in that position and measure the various offsets from it, noting their lengths and positions.

Swinging-in Long Offsets.—When putting in isolated points of importance, such as gate-posts or corners of buildings, rectangular offsets are not as a rule sufficiently accurate, as so much depends on the proper setting

out of the right angle. In such cases, what is called "swinging-in" is made use of. This is shown on Fig. 19.

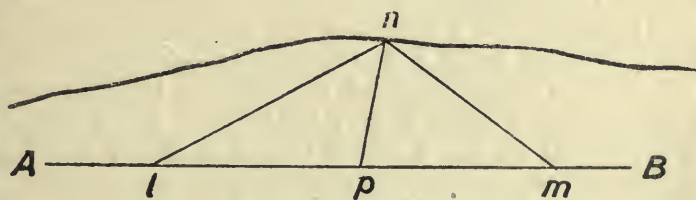

FIG. 19.—Swinging-in.

Here AB is the chain line as before, and n is the point which is to be fixed. Two points are taken in the chain line, such as l and m , and the distances ln and mn are measured with the tape or chain, usually the

former. This gives a small triangle of which the three sides are measured, and, the points l and m being fixed, the third point n can be determined. The triangle should be of good shape or be "well conditioned," having neither very acute nor very obtuse angles. Where special accuracy is required a third line, pn , can be taken as a check. This is a convenient way of putting in very long offsets.

Chaining on Sloping Ground.—A surveyor is lucky if all his work is on the level. In most cases some part, if not the whole of it, will be on undulating ground. The survey as plotted is intended to represent the projection on a horizontal plane of the lines and boundaries, and therefore all the lines and measurements as entered in the field book must refer to horizontal measurements and not to measurements on the slope.

Where the slope of the line is very slight, the error introduced by trying to determine the horizontal distance will possibly be greater than the difference between the horizontal distance and the length on the slope, and the distance on the slope must be taken, but this must only be done when the slope is very slight.

On Fig. 20 the line AB represents a section of the sloping ground down or up which a line is being run. The distance AB is the length



FIG. 20.



FIG. 21.

along the slope. BC is a vertical line set up from B . Then a horizontal line drawn from A to this line, or AC , is the horizontal projection of AB required.

Therefore, if A and B are two points on the ground, and it is necessary to find the horizontal projection of AB , the usual plan is to stretch the chain tight and horizontal, and to hold a plumb line so that the point of the bob just touches B , the upper end being at C . Then AC is what is required.

If the slope is a long one the work will have to be carried out in a series of steps as in Fig. 21. The number of steps depends upon the steepness of the slope and its length. If the slope is not very steep then half-chain lengths may be taken. Even where the slope is small it is difficult to use a whole length of chain without any intermediate supports. The chain will sag down in the middle. Even with half-a-chain it will be found useful to get a third man to hold it up in the middle so as to relieve the weight. Another reason why a long step cannot be taken on steep ground is that the vertical BC becomes considerably greater than the height of a man.

In Stepping Up or Down Slopes the chief points to remember are : that the number of steps taken be as small as is compatible with

accurate working in other respects: the chain should be held horizontal and without sag; and the end of the chain should be vertically above the corresponding point on the ground. These last two conditions are the most difficult to attain. It is not easy for a man holding one end of the chain to tell whether the chain is horizontal by simply looking along it, and in order to be quite certain on this point a third man ought to stand facing the chain and at some little distance away. Even then the natural slope of the ground is apt to be somewhat disconcerting. The best means of getting the point on the ground correctly under the end of the chain is by means of an ordinary plumb line and bob. This is a very simple piece of apparatus and can easily be carried in the pocket. In lieu of a plumb line an ordinary ranging pole may be used stuck vertically in the ground and the chain taken to the top of it, and then (if going downhill) at the next step the measurement taken from the lower end: the accuracy of this method depends on the uprightness of the pole, and this can only be ascertained by means of a plumb line or by an observer standing a little away from the line and opposite the pole. This is at best only an approximate method.

Sometimes if nothing better is available the end of the chain itself may be used as a plumb line with the handle hanging downwards.



Or again, an arrow may be held in the hand at the end C of the chain, then dropped, and the point where it strikes the ground noted. For this purpose a special arrow has been used. This is shown on Fig. 22. The arrow consists of a thin spindle of steel with a heavy bob near its lower end, and below this bob is a short spike which is really a prolongation of the spindle. When it is dropped from the end of the chain it travels vertically downwards, penetrates the ground, and remains there until plucked out. This might be much more used than it is.

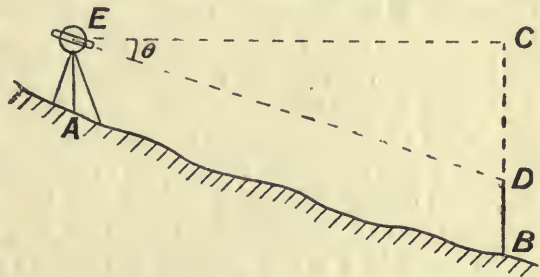

FIG. 23.

Getting the Horizontal Distance by the Angle of Slope.—

In some cases it is possible to ascertain the horizontal

distance by measuring the angle of slope and the distance along the slope, and multiplying the length of the slope by the cosine of the angle which the slope makes with the horizontal. This is shown on Fig. 23. It is required to find the horizontal distance between two points on a slope, A and B. A pole is put in at B. Some kind of angular instrument—the most convenient for this purpose is a theodolite, as in the figure, or an Abney level—is held at E, and the angle is measured between the horizontal and a line parallel to the slope. This

line is from E to D on the lower pole, BD being taken equal in height to AE. Then

$$\frac{EC}{ED} = \text{cosine of the angle DEC}$$

and the horizontal distance required

$$EC = ED \times \cos (\text{DEC})$$

This method can obviously be used only where the slope is a fairly long and uniform one, such as a line down the centre of a long hill on a turnpike road or a main chain line on the side of a hill.

Where the general formation of the ground is level and there are occasional dips which have to be crossed by the chain, either the chain or the half-chain may be stretched across the hollows and held up in the centre to get rid of much of the sag.

Although many surveyors use the ordinary chain for stepping, it will always be found much more convenient to use a tape, preferably a steel tape, as it is very much lighter and longer steps can be taken with greater accuracy.

In all chaining work great care must be taken in the proper counting of the chain lengths which have been measured, and a rigid adherence to the ten-arrow system should be cultivated. A long line may often be spoiled by the missing of a chain length, and although the total length may be correct the details may be all wrong if the point where the chain has been slipped cannot be traced. This slipping of chains and parts of chains occurs most often in stepping work, where it is sometimes forgotten whether the last point on the ground was the end of a chain or the middle.

Accuracy in Chaining.—The degree of accuracy attainable in the measurement of chain lines depends upon the conditions under which the work is being carried out. Assuming the chain to be of the correct length, errors may arise owing to the chain not being straight, to kinks in the chain, errors may be caused by the follower not setting his end precisely where the previous chain ended, by the leader not placing his arrow so as to coincide with the leading end of the chain, and—what is perhaps the greatest source of error—by the point on the ground in a step not being vertically below the end of the stretched chain. Many of the errors are compensating, and may tend towards a reduction of the total error in a given length, but others are cumulative.

In ordinary country where there is not a great deal of stepping the error in the length of a line should not exceed 1 in 1000, where an ordinary link chain is used. With a steel band, which is generally made of oval section about $\frac{3}{16}$ inch wide and $\frac{1}{8}$ inch thick, a higher degree of accuracy is attainable.

Ranging across Undulating Ground.—It is often found that lines have to be ranged over hills or across shallow valleys. Of the former case an illustration is given on Fig. 24. Here are two points, A and B, between which a line is to be chained. Between these two points the ground rises to such an extent that B cannot be seen from A, and A cannot in

the same way be seen from B. It will therefore be necessary, in order to know which way to go when starting from A, to have some intermediate points marked which will serve to show the direction. A single pole on the highest point which could be seen from both sides might be sufficient, but in general at least two points are wanted. The question arises as to how these are to be placed so that they both lie in the line. The problem can be solved by using a theodolite, and moving it about

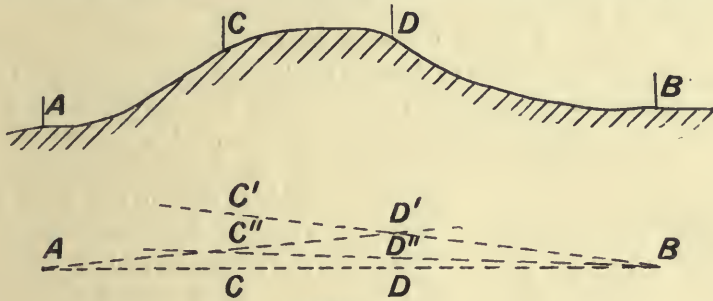

FIG. 24.

until it stands directly in the line. But this is a tedious process with a theodolite as ordinarily constructed, and for the purposes of chain surveying it is sufficient to make use of a "trial and error" method as follows:—

Take two poles to the high part of the hill, and place them in the ground, as nearly as can be estimated, in a straight line between A and B. It will be impossible to place them correctly at once, but they may be roughly in the line. Call these poles C and D.

Start at C', and as B can be seen from C', range D so as to be exactly in the line of C' and B. This is shown as D'.

Next, go to D' and range C so as to be in line with A and D'. This will be C'' in the plan.

Again cross over to C'' and put D in a straight line between C'' and B. This will be D'', and will have brought D nearer to the required line.

By this repetition process the two points are brought nearer and

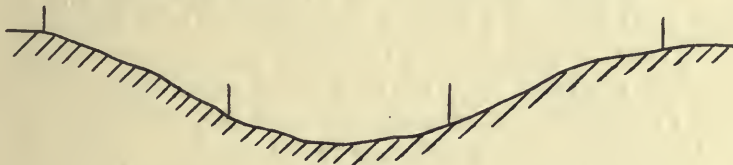

FIG. 25.

nearer to the line until a point is reached, when D will appear to be in the line as seen from C, and C will be in the line as seen from D.

When the obstacle is a depression instead of a rise, a similar plan may be adopted, but this is a much easier case, because the whole of the intervening ground can be seen from the two ends; this is shown on Fig. 25.

Keeping the Field Book.—There are several points regarding the manner in which the measurements are entered in the field book about

which surveyors differ, but these are not essential. What is of importance for accurate work is, first, to adopt a sound system of booking, and then to adhere rigidly to it in all subsequent work. Careless booking leads to far more errors and waste of time than slips in the actual measurement. A beginner is apt to rely on his memory for points which are a little out of the common. For instance, offsets may be taken to a river-bank, and the surveyor has to decide in his own mind whether he shall take the measurements to the top of the bank, where it begins to shelve away, or to the point reached by the average high water mark. He takes his measurements to one of these, but makes no note of which. If he plots the work immediately after doing the survey he will be quite clear on the point, and no harm will be done. But if the plotting has

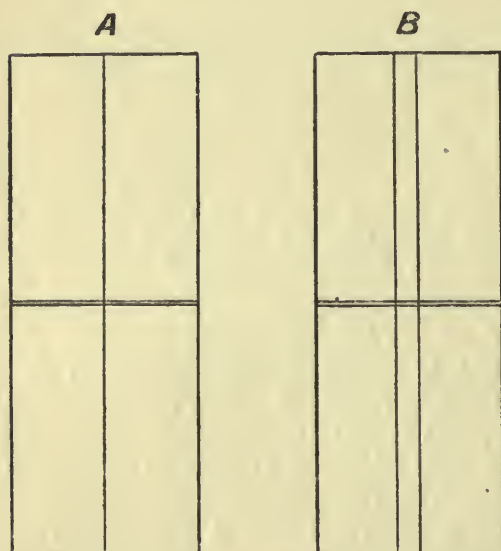

FIG. 26.

to be carried out some months afterwards, or the work has to be revised for some purpose, and the memory of the surveyor does not carry him back far enough, the work may have to be re-surveyed. In such a case as this both measurements should have been taken and entered in the book. Every point which may possibly be of use afterwards should be noted, and nothing left to chance or to memory. Bookings should be made on a uniform system, so that there can never be any possible doubt as to the meaning of an entry. Very often work is surveyed by one person and plotted some time afterwards by another. In

such a case it is obvious that the booking must be of the clearest. The best criterion of good surveying and booking is that it may be possible to send the field book to a strange draughtsman who has never seen the ground, and that he may be able to plot it at once without error.

If a surveyor always keeps the idea in his mind that the work is going to be plotted by another person with whom no communication can be made, it will help towards care and accuracy in his work.

This insistence on accurate booking is not merely fanciful, for it must be remembered that good surveying and booking make the plotting quicker and more straightforward, and in this way repetition is avoided and much time and money saved.

An ordinary surveying field book should have its pages not less in size than 6 inches \times 4 inches, a larger size being preferable. The pages open lengthwise, and a line or a pair of lines run up the whole length of both pages. The appearance of a blank double page of a typical field book is shown on Fig. 26. Two views are given, one provided with a single and the other with double lines,

The line up the middle of the page is supposed to represent the chain line along which the surveyor is proceeding. As he works along the line he takes measurements to various points in the line, and possibly also offsets from these points. The page of the field book is supposed to be a rough facsimile of the features on the ground. The line up the centre of the page represents the chain line itself, and the figures written upon it are the measurements to the various points, all taken from the beginning of the line. A rough sketch of any boundary or other feature lying to one side or the other of the line is drawn on the page, and the lengths of the offsets from the various points in the line to this boundary are written between the boundary and the chain line opposite the points from which they have been measured.

The booking begins at the bottom of the page. It is a disputed point as to whether the line should be a single one or a double one. If it is a single, the analogy with the actual line is the better preserved, but by having a double line there is no possibility of confusion between the chain distances and the offsets.

To make these points clear a small survey is given on the four sample pages annexed. The plan as plotted from the notes is shown on Fig. 27.

By following out the lettering on the plan and comparing the lines and details in the entries in the field book, the reader will appreciate the

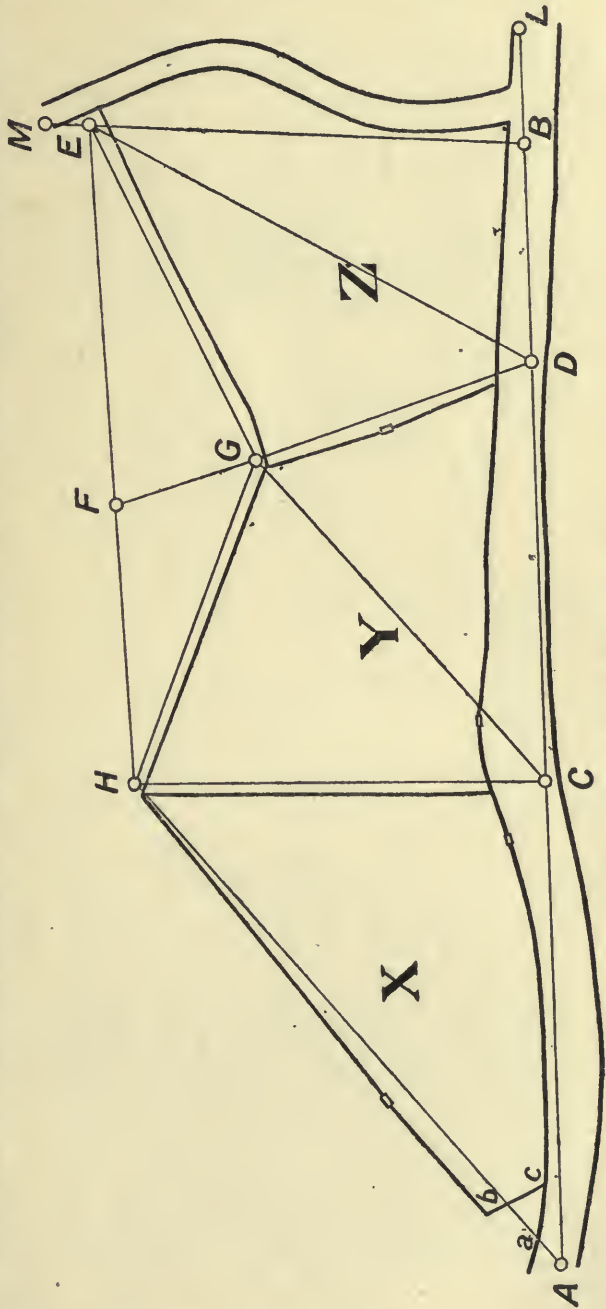

FIG. 27.—Small survey.

10	1600	L	50	L
10	1570		45	
12.5	1530		45	
15	1481		45	
20	(1450)	B	42	
27.5	1400		37	
42.5	1300		24	
45	(1170)	D	20	
45	1145		17	
50	1100		12	
60	1000		4	
65	900		10	
67.5	800		7.5	
80	700		12.5	
	(632)		17.5	C
70	615		20	
65	550		30	
45	500		42.5	
32.5	400		57.5	
15	300		65	
10	200		60	
15	105		40	
17.5	(000)		20	A
40				

ROAD

FENCE

GATE

FENCE

GATE

ROAD FENCE

ROAD FENCE

(643)	E	FENCE	E
596		ROAD FENCE	
47			
(000)	D		D
(552)	G		G
530			
180			
(000)		ROAD FENCE C	
(850)	E		E
(358)	F		F
(000)	H		H
(823)	H		H
810			
700			
600			
500			
400			
300			
200			
110			
102			
45			
(000)		A	A

FENCE

ROAD FENCE

FENCE

ROAD FENCE

GATE

FENCE

ROAD FENCE

method of booking. The offset figures should refer to the distance of each boundary from the chain line and not from the boundary next to it. In the example the rule has been transgressed by the road widths being given directly.

When one line is completed and a new one is to be commenced, a double line should be drawn across the page. Each station point—that is, a point in the main triangulation—must be indicated in the field book by surrounding the corresponding figure with a closed line. Also the number or letter corresponding to the point in question should be noted opposite its distance number. When commencing and planning out a survey all stations must be given either letters or numbers. In a small survey letters, such as English capitals, small English, or the two Greek alphabets, may be used. If the survey is a large one a point may be denoted by its position on a line of certain length, as it is very unlikely that there will be two lines of exactly the same length on the same survey. Thus, instead of calling a point A or *a*, it may be called $\frac{238}{1476}$, the meaning being that the point is at a distance of 238 links from the beginning of the line which has a total length of 1476 links. This method is rather cumbrous, and it is not so easy to remember a line by its length as by the more distinctive reference letters of its two ends. To use ordinary numerals would lead to confusion with other figures in the field book. Roman numerals do not possess any of these defects. Where the survey is a large one and the work is divided between two or more parties, an arrangement must be made with regard to the lettering of the points. Thus, if there were two parties, one might start numbering from 0 and the other from 100 (in Roman numerals), or one might use the English and the other the Greek alphabet. Although field books can be bought with the lines already ruled, some surveyors prefer to buy blank books and to rule their own lines. One advantage of this is that sometimes all the offsets come on one side of the line, and the chain line can be placed near one side of the page, thus leaving more room for the details and the offsets. This is especially useful when buildings come into the survey.

Obstacles in Chain Lines.—It frequently happens that for some unavoidable reason a chain line goes through an intervening obstacle such as a building, a wood, or a piece of water, and it becomes necessary to adopt a special method for ranging the line through the obstacle, and at the same time finding the distance across the gap in the line formed by the obstacle.

Cases of this kind naturally divide themselves into three classes, and it will generally be found that if an obstacle has to be overcome one of the following methods will be found to fit the case in question:—

Case I.—*An obstacle which can be seen across as well as chained round.*
—Instances of this class are to be found in pieces of water, small fields, and gardens. Three ways of dealing with this case are given.

(a) Fig. 28 (a).—The obstacle is shown by the irregular boundary, and is in this case taken as a pond. As the obstacle does not obstruct the view across there is no difficulty in ranging the line. In each of the following cases the chain line is shown as XY. Poles are placed at A

and B on opposite sides of the obstacle. It is required to find the distance AB. By the first method, set up at A and B lines at right angles to the chain line and of equal length, this being such that a line CD joining the ends of these two perpendiculars will lie clear of the

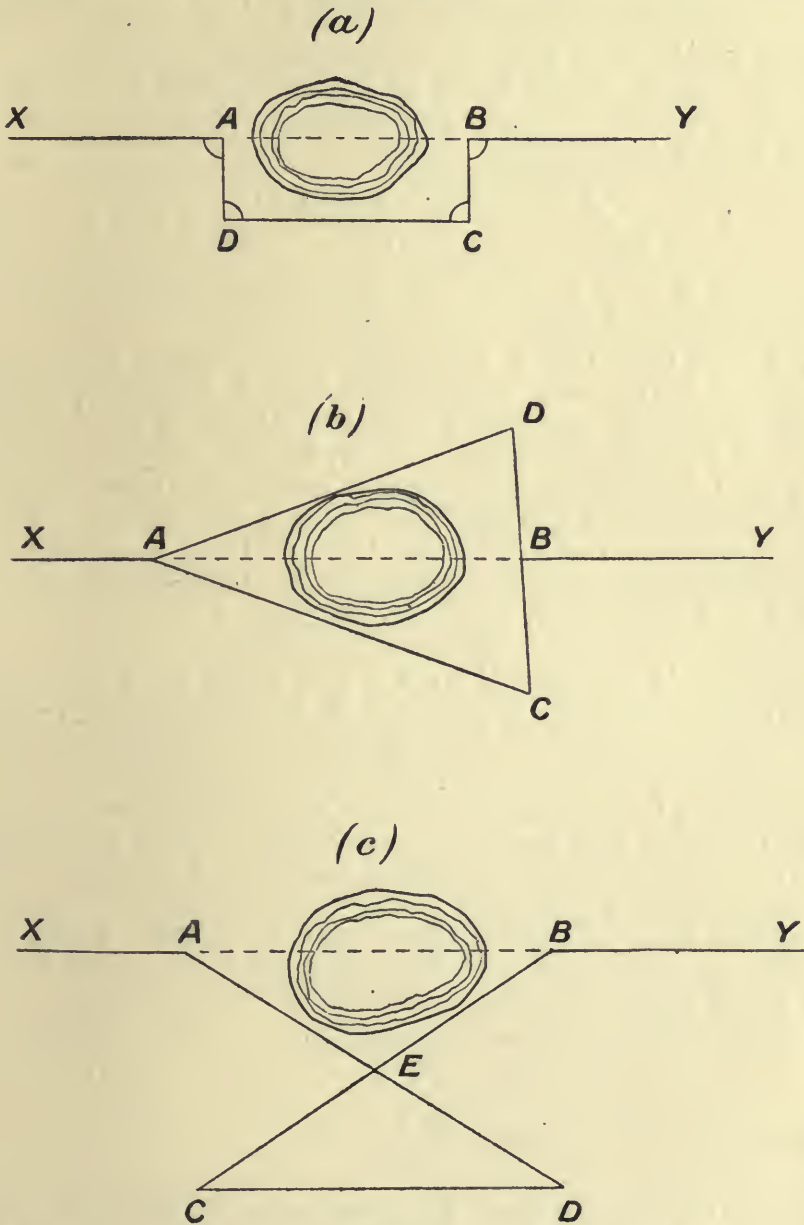

FIG. 28.

obstacle. It is then easy to chain CD, which is obviously equal to the required distance AB.

This method is simple, but its accuracy is dependent on the correctness of the two right angles CBY and DAX, and it will be clear that where

the perpendiculars are long very small inaccuracies in the angles may mean a considerable error in the linear measurement of AB.

(b) Fig. 28 (b).—Here, as before, XABY is the chain line. First, a line is set out on the ground in some such position as shown at CD, this line forming any angle with the chain line, the only proviso being that C and D be taken sufficiently far away from the chain line that lines joining C and D to the point A on the opposite side shall lie clear of the obstacle. Also C, B, and D are in a straight line. Now chain AD, AC, DB, and BC. Then the length AB may be calculated from the formula already given, that is to say,

$$AB = \sqrt{\frac{AD^2 \times CB + AC^2 \times BD}{DC} - DB \times BC}$$

This method is more accurate than the last, but requires greater care, and some time is taken up in calculation.

(c) Fig. 28 (c).—This is a convenient and accurate way of solving the problem, but can only be used when there is a considerable stretch of open land on one side of the obstacle. Having fixed A and B as before, but not too close to the obstacle, select a point E so that lines joining E to A and B clear the obstacle as shown. Then range BEC, making EC equal to EB, which has previously been chained. Similarly range AED with ED = EA. Then AEB and DEC will be similar and equal triangles, and consequently CD = AB. In order therefore to find AB, it is only necessary to chain CD, to which it has previously been made equal.

Case II.—*An obstacle which can be seen across but which cannot be chained round.*—Instances of obstacles of this type are to be found in rivers and deep narrow valleys or ravines. Two methods will be given.

(a) Fig. 29 (a).—Here the distance across a river has to be found and at the same time the line ranged across. There is no difficulty about the latter, as there is nothing to obstruct the view. Range a point, B, on the near side, and a second point, D, on the far side. From B set up a perpendicular, BC, as shown. Then, looking towards D from C, find a point A on the chain line, making the angle ACD a right angle. This can be done with an optical square. Then, ABC and CBD being similar triangles,

$$BD : BC :: BC : AB$$

and therefore
$$BD = \frac{BC^2}{AB}$$

from which the distance across the obstacle may be obtained.

(b) Fig. 29 (b).—As before range the two points, B and D, on opposite sides of the obstacle. Set out a perpendicular, BE, and also one from a third point, A, on the chain line, at the same time ranging the three points C, E, and D so as to be in the same straight line. Then DBE and EFC are similar triangles, EF being taken parallel to the chain line.

But $FC = AC - BE$,
 so that in the two similar triangles

$$DB : BE :: FE : FC,$$

$$DB : BE :: AB : (AC - BE)$$

that is to say

$$DB = \frac{BE \times AB}{(AC - BE)}$$

Therefore

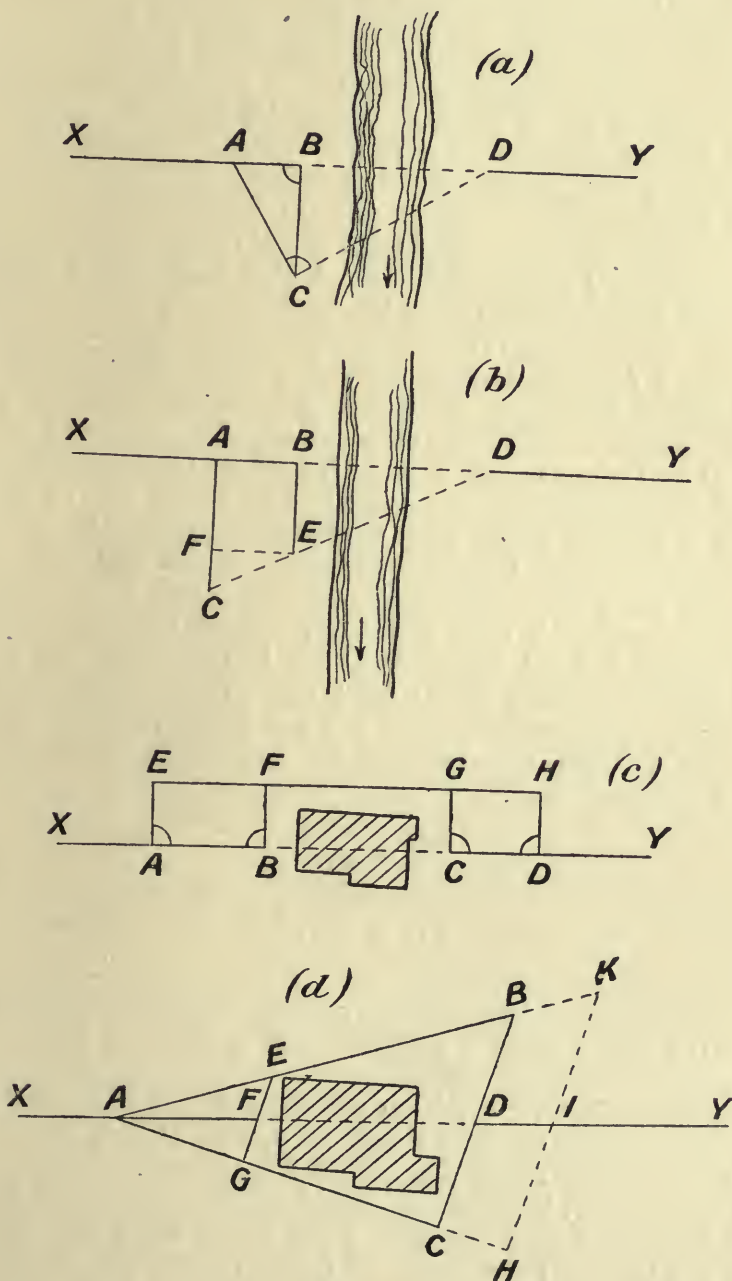

FIG. 29.

In this case, as in the last, all the chain lines given in the formula can be measured, so that it is only necessary to follow out the construction, chain the lines, and then calculate the distance BD from the expressions given.

Case III.—*An obstacle which cannot be seen across but which can be chained round.*—Such a case is to be found in a building or a thick coppice. Two solutions are given.

(a) Fig. 29 (c).—In this method of solution rectangular offsets are made use of. Here the chain line has been carried to a point, B, short of the obstacle, and the difficulty is to continue it beyond the obstacle and at the same time measure its length. At A and B, some considerable distance apart, set up perpendiculars, AE and BF, making these sufficiently long to clear the obstacle and of equal length. Next from E and F range a line, EFGH, where H is beyond the obstacle and G and H are about the same distance apart as E and F.

Then set down perpendiculars GC and HD from G and H, making these the *same length* as EA and FB. A line now ranged through C and D will be a continuation of XAB, and the length of the gap BC will be given by chaining FG.

(b) Fig. 29 (d).—A second way of solving the problem is by means of similar triangles. As before XAF is the chain line, to be continued towards Y. The two points A and F having been fixed, set up poles at two other points E and G, so that lines ranged through these from A will pass clear of the obstacle as shown, and E, F, and G will lie in a straight line. Now continue the lines AE and AG by ranging towards K and H respectively. Chain AE and AG so as to find the ratio AE : AG. Then fix the points B and K, and also C and H, so that the ratios AB : AC and AK : AH are the same as the one already found, AE : AG. Also fix D and I in the lines BC and KH so that AK : KI = AB : BD = AE : EF. Then D and I will be in a continuation of the original chain line and the line may be ranged on towards Y. To find the distance FD across the gap; by similar triangles it is known that

$$\frac{FD}{AF} = \frac{EB}{AE}$$

Therefore

$$FD = AF \cdot \frac{EB}{AE}$$

This is a somewhat long process, and the rectangular method will be found better and quicker if sufficient care is taken in setting out the right angles.

Plotting.—It has already been pointed out that in a survey of any importance the larger triangles should be plotted as they are measured, so that any necessary re chaining can be done at once.

In plotting these, the first line should be set down on the paper and carefully marked off from a plotting scale placed along it. This forms the base of a triangle; the lengths of the two remaining sides are taken in a pair of compasses and arcs struck from the two ends; where these

arcs intersect will be the third point of the triangle. The scale must now be laid along these two sides in order to see if the lengths have been set off correctly. When the first triangle has been satisfactorily plotted, the second may be built on one of its sides, and so on until the whole of the main triangulation is complete. Check lines are to be used whenever possible. It is the practice with many surveyors to ink in the main triangulation in red or blue when it has been completed and before the plotting of any detail is attempted. In doing this it is well to show the main stations, as the centre of small circles. Where a number of lines intersect at one station confusion is avoided by stopping the lines short of the actual point.

Subsidiary triangles are to be plotted in the same way.

In putting in the detail which is given by the offsets the plan is to lay the main scale along the line in question, with its zero coinciding with the zero of the line, and then to work the offset scale along it as a set square, moving it to its proper position along the line where the particular offset was taken and then marking off the length of the offset. When doing this the plotting scale may be held in position by two weights.

The manner of doing this is shown on Fig. 30.

It will be found useful in most cases to make a hand sketch of the

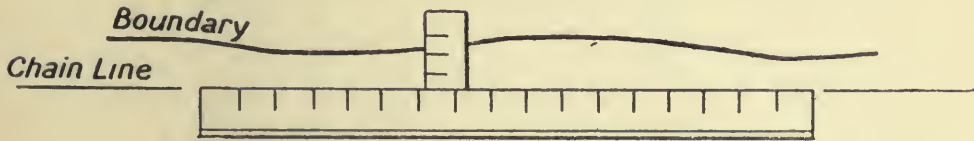

FIG. 30.

survey, very roughly to scale, as a preliminary and to serve as a guide in the actual plotting.

When the individual points at the ends of the offset distances have been pricked on the paper or marked with the point of a fine pencil, curved lines, including these points, such as occur in boundaries, may be sketched in by hand or drawn with a French curve.

The scale to which the survey is to be plotted should be drawn on the paper before commencing the plotting so that any variation in the size of the paper, and consequently of the lines, will affect the scale to the same extent.

It will generally be found convenient for purposes of comparison to plot the survey with the North at the top of the paper.

The scale to be adopted in the plotting depends on the size of the survey. For very small areas a scale of 1 chain to the inch will often suffice. Where the survey is not so small the scale of 2 chains to the inch may be used: this is probably the most useful all round for use in chain surveys. Other scales are 3, 4, 5, 6, 8, and 10 chains to the inch. It is useful for a surveyor to be provided with a set of these scales in a box, each plotting scale being provided with a corresponding offset scale.

Determination of Areas.—When a survey has been completed it often becomes necessary to find the area of the ground enclosed by the outer boundary or of some of the smaller plots. In many cases the determination of these areas is the chief reason for making the survey.

The area enclosed by a boundary may be found from the survey as plotted on paper, or directly from the notes in the field-book without plotting.

For the purpose of what follows it may be useful here to note the following facts with regard to the areas of some regular figures. Fig. 31. The area of the triangle ABC, is given by the square root of the product of the semi-perimeter into the differences between the semi-perimeter and each of the other sides. Or if $s = \frac{a + b + c}{2}$, where a, b, c , are the lengths of the three respective sides, then

$$\text{area} = \sqrt{s(s - a)(s - b)(s - c)}$$

This makes it possible to calculate the area of a triangle when the lengths of the three sides are known.

If the length of one side, such as AC, be known, as well as the

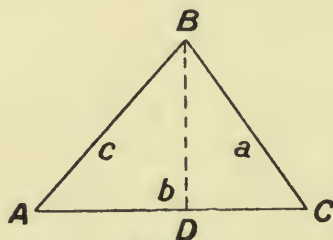

FIG. 31.

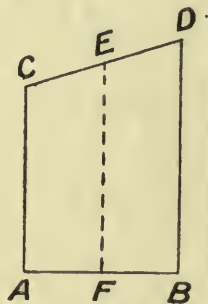

FIG. 32.

length of the perpendicular to this side from the opposite angle, BD, then

$$\text{area} = \frac{AC \cdot BD}{2}$$

Fig. 32. In the figure ABCD, where AC, FE, BD are perpendicular to AB, the area is given by the product of the base AB, and the mean height EF, or

$$\text{area} = AB \cdot EF = AB \left(\frac{AC + BD}{2} \right)$$

Equalisation of Boundaries.—In Fig. 33 a strip of land is bounded by a chain line EF, a curved boundary AB, and two rectangular offsets EA and BF. By “equalising the boundaries,” or, as it is sometimes called, using the “give and take method,” a straight line, CD, can be drawn in such a position that the area enclosed by the curve on its outside is equal to that on the inside. The precise position of this line depends on the skill and judgment of the draughtsman, and should

make the area ECDF equal to the area EABF. The area of the strip then becomes

$$\text{area} = EF \cdot \left(\frac{EC + FD}{2} \right)$$

All the curved lines are to be treated in the same way, a straight-line boundary taking the place of a curved boundary. After some practice a draughtsman soon

becomes skilful in equalising boundaries in this way, and a very fair approximation to accuracy can be obtained. An



FIG. 33.

enclosed area may be treated in the same way, and the total area reduced to a number of triangles whose areas can easily be computed.

Method of Mean Ordinates.—In Fig. 34 it is required to calculate the area of a strip of land enclosed by a chain line AB and an irregular boundary *ab*. The area is divided into a number of strips of equal width by rectangular ordinates, Aa, Cc, Dd, etc.

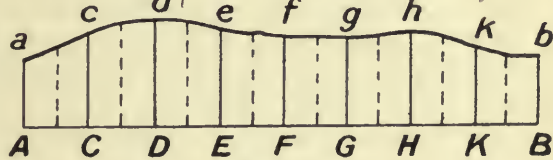

FIG. 34.

Assuming the boundary to be made up of a number of straight lines, *ac, cd, de,* and so on, then, as in Fig. 32 above, the area of the first strip will be

$AC \left(\frac{Aa + Cc}{2} \right)$; the area of the second strip will be $CD \left(\frac{Cc + Dd}{2} \right)$, and so on. Where, as in this case, the strips have a common width (*a*), and the lengths of the ordinates are $h_1, h_2, h_3, h_4,$ etc., the area may be written as

$$\begin{aligned} \text{area} &= a \left(\frac{h_1 + h_2}{2} \right) + a \left(\frac{h_2 + h_3}{2} \right) + a \left(\frac{h_3 + h_4}{2} \right) + \text{etc.} \\ &= a \left(\frac{h_1}{2} + h_2 + h_3 + \dots + \frac{h_n}{2} \right) \end{aligned}$$

Simpson's Rule.—Fig. 35. In the case of an area completely inclosed by an irregular curved boundary the last method will give a result somewhat below the true value. A nearer approximation will be given by using Simpson's rule, in

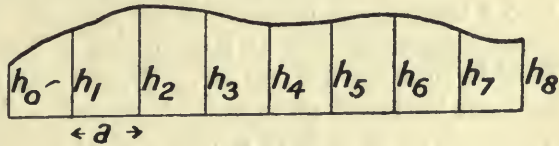

FIG. 35.

which, for a strip divided into an even number of strips of uniform width *a*, the area is given by the following formula :

$$\text{Area of strip} = \frac{a}{3} [(h_0 + h_8) + 4(h_1 + h_3 + h_5 + h_7) + 2(h_2 + h_4 + h_6)]$$

Calculations direct from Field Book.—The area of a plot of ground may be calculated direct from the notes in the field book. In doing this, first calculate the areas of the triangles enclosed by the main chain lines by the means of the formula already given. Then calculate the areas of the irregular strips lying along the outside chain lines, by using the method of ordinates, though the bases AC, CD, DE, etc., are not necessarily equal. Here the ordinates h_1, h_2, h_3 are the offsets measured in the field, and the bases of the strips AC, CD, DE, etc., are the distances along the chain line between the successive offsets. The areas of the separate parts when added together will give the area of the whole plot. Where the survey has been made with a Gunter chain the calculated area will be given in square chains, and it is only necessary to divide the result by ten to obtain the area in acres.

Computing Scale.—In measuring the area of a piece of ground inclosed by an irregular boundary by means of the computing scale, it is

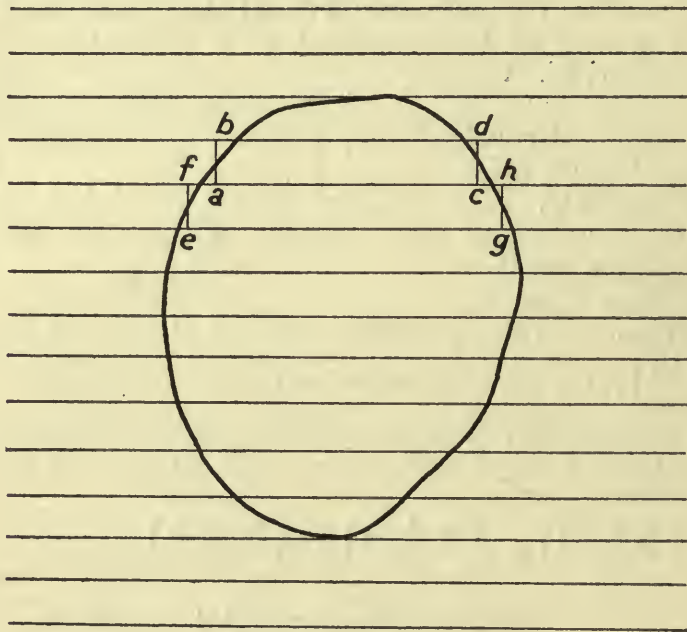

FIG. 36.

first necessary carefully to plot the survey on paper. It is then divided into a number of horizontal strips, each strip being in width equal to one chain, a fraction of a chain, or a multiple of a chain, to the scale used in plotting the survey. A suitable width of strip is a quarter-of-an-inch for small plots and about half-an-inch for large plots. A convenient way is to have a number of parallel lines drawn the requisite distance apart on a sheet of tracing paper. This is placed over the survey and turned about until two of the lines are just tangent to the curved boundary, as shown in Fig. 36. The computing scale itself is graduated in such a manner that measurements along it give the acres, roods, and poles included in a strip of the given width. For example, if the survey has been plotted to a scale of 4 chains to the inch, and the

distance between the horizontal lines is one-quarter of an inch, then one acre of this strip will be given by a distance along the scale of two-and-a-half inches. On the scale is a movable slide with a vertical cross wire. In using the scale it is placed horizontally below the strip in question, with the slide which is at zero placed at one end of the strip (*ab*). Keeping the scale fixed, the slide is moved along to the other end of the strip (*cd*). The scale is now lowered to the next strip with the slide resting at (*ef*); it is then moved along to (*gh*). The areas

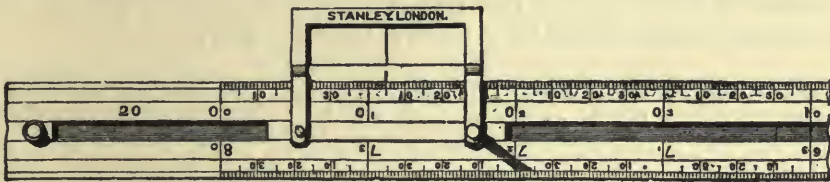

FIG. 36A.

included in the two strips will now be registered on the scale. This is repeated for all the strips. When the end of the scale has been reached the number of acres, etc., can be noted, and a fresh start made until the area of the whole plot has been computed. A view of Stanley's computing scale is shown on Fig. 36A. For the various scales used in plotting suitable loose scales are supplied and can be fitted into the main scale.

The Amsler Planimeter.—This is a convenient instrument which can be used for measuring areas of plots which have been carefully laid down on paper. It consists of two jointed bars, and at the end of one there is a fixed point which is stuck into the paper, while the end of the other one is a tracing point which the operator moves round the boundary so as to completely encompass it. Attached to the second lever is a small wheel or roller having its axis in the line of the bar. As the operator moves the tracing point round the boundary the wheel partly rotates and partly slides in conformity with the movement of the

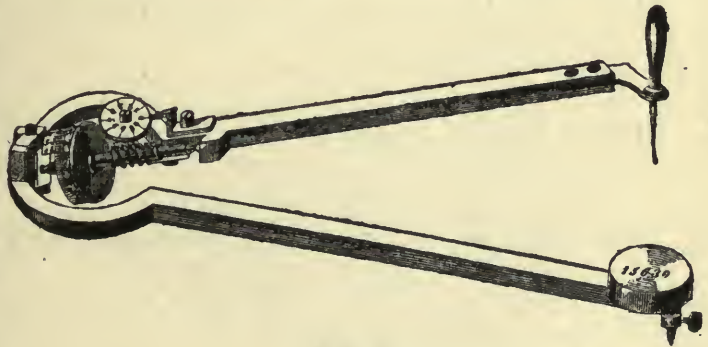

FIG. 37.

bar. The edge of the wheel is divided into ten equal parts, each part being again divided into ten. As the wheel rotates its divisions move past a fixed vernier, and it is the extent of this movement which provides a measure of the enclosed area. It is not necessary here to go into the theory of the instrument. In its ordinary form, one rotation of the wheel means ten square inches, but modified forms are constructed in

which the length of one of the arms can be varied at will, so that one revolution of the wheel may mean so many acres in the given scale to which the survey has been plotted. In order to obtain accurate results it is best to start with the wheel in any position, note the reading in this position, and subtract it from the reading given on the completion of the circuit. It is best also to take the average of three or more pairs of readings. A general view of the planimeter in operation is shown on Fig. 37.

Inaccurate Chain.—If a line has been measured with a chain which is known to be inaccurate by a known amount, then

$$\left(\begin{array}{c} \text{accurate length} \\ \text{of line} \end{array} \right) = \left(\begin{array}{c} \text{length of line} \\ \text{as measured} \end{array} \right) \times \left(\frac{\text{true length of chain}}{\text{supposed length of chain}} \right)$$

Also the true area of a plot measured with an inaccurate chain is given by

$$(\text{accurate area}) = (\text{calculated area}) \times \left(\frac{\text{true length of chain}}{\text{supposed length of chain}} \right)^2$$

Calculation of areas of plots X, Y, Z on Fig. 27 from the field-book notes already given (p. 24).

The required areas are made up of the areas of the triangles plus or minus the areas of the irregular strips alongside the chain lines.

First, to get the areas of the triangles :—

Triangle.	Sides.	$s = \frac{a+b+c}{2}$	$\sqrt{s(s-a)(s-b)(s-c)} = \text{square feet.}$	
AHC	$a = 823'$ $b = 535'$ $c = 632'$	995'	$\sqrt{995 \times 172 \times 460 \times 363}$	169,000
CHG	$a = 535'$ $b = 454'$ $c = 552'$	770.5'	$\sqrt{770.5 \times 235.5 \times 316.5 \times 218.5}$	112,000
CGD	$a = 538'$ $b = 552'$ $c = 383'$	736.5'	$\sqrt{736.5 \times 198.5 \times 184.5 \times 353.5}$	97,680
				<u>209,680</u>
DGE	$a = 383'$ $b = 473'$ $c = 643'$	749.5'	$\sqrt{749.5 \times 366.5 \times 276.5 \times 106.5}$	89,950
DEB	$a = 643'$ $b = 564'$ $c = 280'$	743.5'	$\sqrt{743.5 \times 100.5 \times 179.5 \times 463.5}$	78,840
				<u>168,790</u>

TOTAL AREAS OF PLOTS.

Plot.	Areas of triangles. sq. ft.	+ strips. sq. ft.	- strips. sq. ft.	Other areas. sq. ft.	Area of plot. sq. ft.
X	AHC = 169,000 sq. ft.	along AH = 13,986	along AC = 14,950 along CH = 7,502 <hr/> 22,452	triangle abc - 1530	158,004 = 3.627 acres
Y	GHG = 112,000 CGD = 97,680 <hr/> 209,680	along CH = 7502	along HG = 5,852 along GD = 4,620 along CD = 33,797 <hr/> 44,269		172,913 = 3.969 acres
Z	DGE = 89,950 DEB = 78,840 <hr/> 168,790	along DG = 4,610 along EB = 19,825 <hr/> 24,435	along GE = 11,119 along DB = 9,490 <hr/> 20,609		172,616 = 3.963 acres

The calculations of the strip along the chain line from the figures taken from the field book are given below:—

FROM FIELD BOOK.

	(823)	H
o	810	$110 \times \frac{1}{2}(0 + 14) = 770$
14	700	$100 \times \frac{1}{2}(14 + 11) = 1,250$
11	600	$100 \times \frac{1}{2}(11 + 21) = 1,600$
21	500	$100 \times \frac{1}{2}(21 + 26) = 2,350$
26	400	$100 \times \frac{1}{2}(26 + 22) = 2,400$
22	300	$100 \times \frac{1}{2}(22 + 30) = 2,600$
30	200	$90 \times \frac{1}{2}(30 + 34) = 2,880$
34	110	$8 \times \frac{1}{2}(34 + 0) = 136$
o	102	
o	45	<hr/> 13,986 sq. feet.
A	(000)	

$$13,986 \text{ sq. ft.} = \frac{13,986}{9} = 1554 \text{ sq. yards}$$

$$= \frac{1554}{4840} = 0.321 \text{ acre.}$$

CHAPTER II

NEEDLE SURVEYS AND TRAVERSING

THE satisfactory completion of an ordinary survey depends largely on the possibility of being able to cover the ground with a complete and closed network of triangles. In many cases it is impossible to do this, on account of peculiarities in the tract of country to be surveyed. For instance, if the precise shape of the boundary of a large pond or reservoir be required, it is impossible, without the employment of a theodolite or other angular instrument, to form a suitable system of triangulation having several lines crossing the water. A more difficult case is that of a thick wood, through which

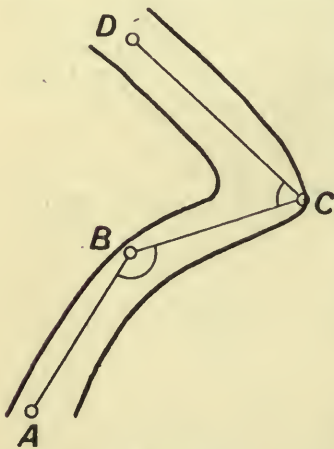

FIG. 38.

it is impossible either to chain lines or take sights with an angle measuring instrument. In cases such as these, the boundary may be determined by what is known as "traversing," which consists essentially in carrying a zig-zag line round the outside of the area to be surveyed and measuring the lengths and directions of the respective lines. Traversing is also used in surveying long narrow strips of land such as are to be found in lines of communication, rivers, and so forth.

Three lines of a simple traverse are shown on Fig. 38. The curved double line represents a road which is to be surveyed by traversing. To do this, successive lines, AB, BC, CD, and so on, are chained, and at the same time the angles measured between each successive pair of lines. This having been done, it will be possible to reproduce the chain lines on paper by setting off the successive lines to scale, each one being placed on the paper so as to lie at the proper angle with the one which it follows. As the chain lines and the angles are being measured, offsets are taken to the boundaries.

It will be seen that the essential difference between this and surveying with the chain alone is that the relative positions of any three successive points such as A, B, and C are here found by measuring the lengths of the two sides AB and BC as well as the angle ABC; whereas, in surveying with the chain alone, the lengths of the three sides AB, BC, and CA have to be measured.

A traverse may be open, that is, the end of the last line may not

coincide with the beginning of the first line ; or it may be closed, in which case the successive lines of the traverse form a closed polygon. These two cases are shown on Figs. 39 and 40. Whenever possible a traverse should be made closed, as the fact of the last point closing in on the first, when plotting, forms the best possible check on the accuracy of the measurements of the angles and lines. It will readily be seen that in a traverse, the correct location of any given point is to a large extent dependent on the accuracy of all the preceding work, as the position of

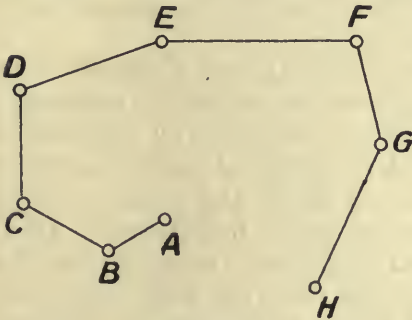

FIG. 39.

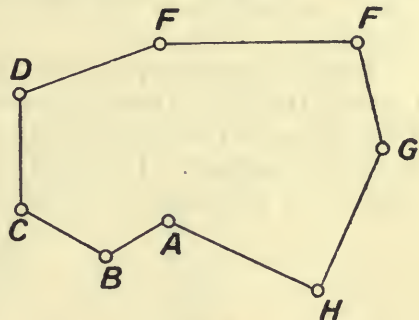

FIG. 40.

each point is only fixed with respect to the one that has gone before it, and any error that may arise is carried on throughout the rest of the traverse. This points to the necessity of using great care both in the measurement of the lines and the angles, and especially of the latter.

Four methods are employed in traverse work, namely—

- (a) With the chain alone.
- (b) With the chain and compass.
- (c) With the chain and sextant.
- (d) With the chain and theodolite.

Traversing with the Chain alone.—This, the least important of the four methods, is rarely used, and cannot be relied upon to give very

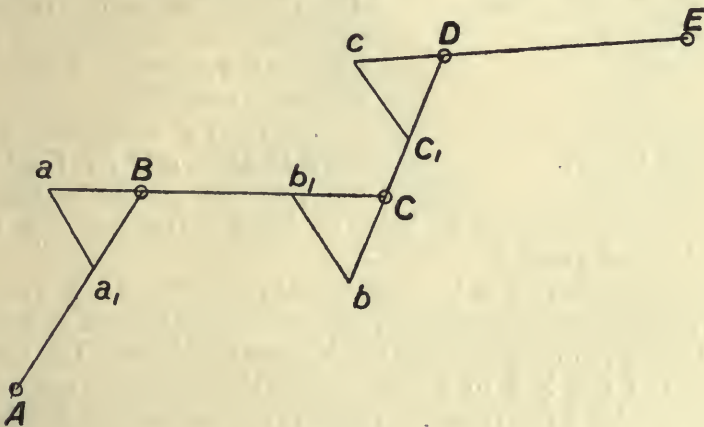

FIG. 41.

accurate results. The manner of carrying it out is shown on Fig. 41. In the traverse A, B, C, D, E, AB is first chained. Then the next line,

BC, before being chained is carried backwards some little distance to a , the same distance Ba_1 being set off along BA, aBa_1 thus forming an isosceles triangle whose base aa_1 is now measured. This enables the angle aBa_1 to be plotted, and so fix the direction of BC on the plan. The process is repeated for each succeeding line, the angle in all cases being fixed by measuring the sides of an isosceles triangle. Unless the equal sides of the triangles are made very long it is not easy to determine the angles with any fair degree of accuracy, and for this reason the method is not often used unless an angular instrument is not available.

Needle Traverses, or Traversing with the Chain and Compass.—By a needle traverse is meant one in which the angles which the successive lines make with each other, or their directions, are found by means of a magnetic compass. It is well known that a suspended magnetic needle points in a direction which is approximately North and South. In all

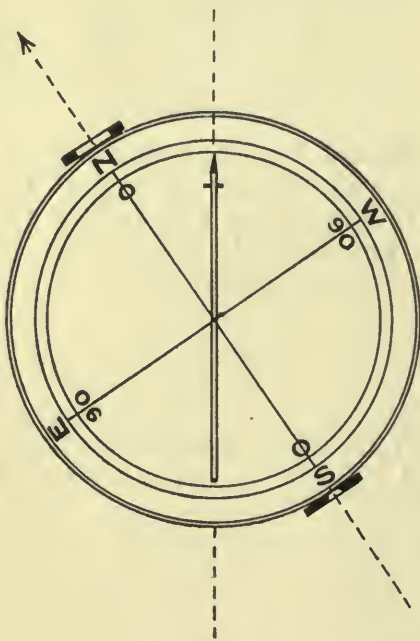

FIG. 42.

angle-measuring instruments which depend for their working on the magnetic needle, the angle measured is that between the line of sight and the longitudinal axis of the needle, which is taken as a fixed line of reference. Two distinct types of needle instruments are in use for surveying, namely, that in which the needle is free and the scale upon which the angles are read is fixed to the box which carries the sights; and the other type, in which the needle carries a graduated circular card moving over a fixed point, coinciding with one of the sights upon the box. The former are of the *circumferentor* or *mining dial* class, and the latter include the *prismatic compass* and the *mariners' compass*.

Surveyor's Compass, Circumferentor or Dial, and its Uses.—This is the form of needle instrument best

suited for systematic work, both in land surveying and traversing above and below ground.

A diagrammatic view of the instrument is shown on Fig. 42. Here the needle is shown as the double vertical line having a cross to mark the end which is always pointing towards the Magnetic North. The circle represents a plan of the box in whose centre the needle is supported on a point about which it can rotate. The box containing the needle is placed so that it lies in a horizontal plane, with its axis vertical; on turning it round about this vertical axis the needle remains stationary, and a line of sight taken through the centre and having its direction fixed by a pair of sights on the box, forms an angle with the centre line of the needle.

The sights are attached to the box of the instrument in such a way that the line of sight passes through the North and South points as marked on the graduated dial, which, it will be remembered, is in this case attached to the box and moves with it. The sights themselves are brass plates which fold down upon its face when the instrument is not in use. Generally there are two pairs of sights, one pair placed above the other. When using the sights the observer looks through a narrow vertical slit in the near plate and sees a fine vertical wire stretched vertically across

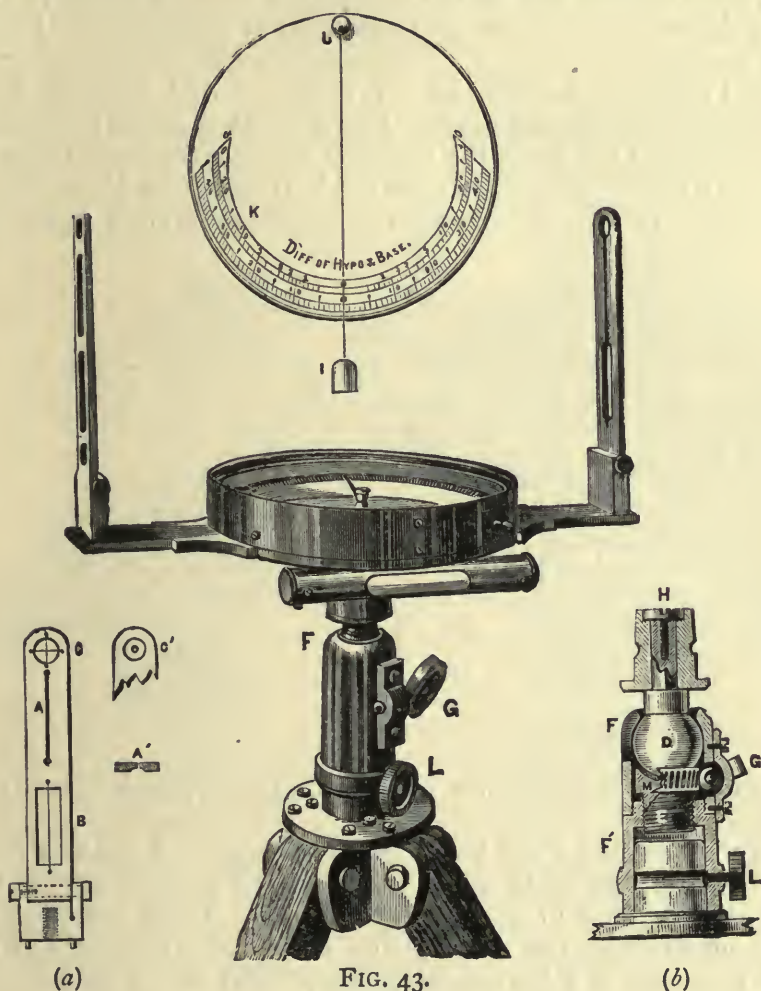

FIG. 43.

a wide slit in the further plate. In taking the observation he turns the instrument about its vertical axis until the wire coincides with the point which is being observed. Then the angular difference between the North point or South point and the pointed end of the needle gives the amount the line of sight is pointing to the East or West of the centre line of the needle. This centre line of the needle coincides with the Magnetic Meridian, which is a line passing through the centre of the instrument and the Magnetic North pole.

In this way a line is established passing through the point of observation and towards the point observed, and this line is found either to coincide with the magnetic meridian or to deviate from it to the East or West by a certain angle which is given by the reading on the dial.

This is called the "bearing" of the line. In the more usual practice the eye of the observer is placed at the sight near the South point on the dial and looks towards the North point. Then, the reading being taken at the North-seeking end of the needle, the bearing is always given as so many degrees to the West of North, East of North, West of South, or East of South.

Fig. 43 shows a view of an ordinary dial suitable for land surveying or underground work. The graduated circle is divided into four quadrants of 90° each, the numbers reading from 0° at the N. and S. to 90° at the E. and W., so that the bearings from N. or S. may be read direct. This is the common manner of dividing the graduated

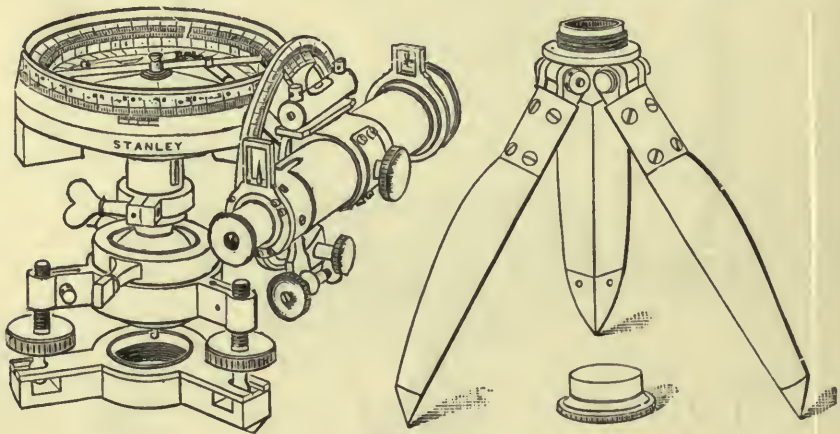

FIG. 44.

circle on needle instruments of the dial class, and offers obvious advantages.

There is a simple spirit level fixed to one side of the box ; in most cases there are two small spirit levels placed at right angles to each other and imbedded in the face of the dial. These are used for the purpose of levelling the dial so that the needle turns about a truly vertical axis and in a horizontal plane parallel to the face of the dial. This adjustment is made by hand and with the help of the two levels by moving the instrument about the ball and socket joint shown at (b). When it has been satisfactorily adjusted it is locked in position by turning the clamp screw. In taking observations the box is turned by hand and set in the right position. Allowance is made for the line of sight being inclined by having the slits and wires of sufficient length. The sight plate is shown at (a).

On Fig. 44 is shown a dial designed for mining survey work with a telescope and vertical circle attached at the side.

In some dials, as the one shown on Fig. 45, a second arc is added for the purpose of measuring the inclination of the line as well as its bearing. This also requires an additional pair of holes in the sight plates, these being circular in shape and a horizontal wire used.

In some instruments a telescope is added. One instrument of this kind is shown on Fig. 46.¹

Needle instruments of the dial type are always used mounted upon light wooden tripods. For use underground these tripods must needs be short, but they can be made of any convenient height for ordinary surface work.

The more ordinary kinds of dials are graduated in half degrees or quarter degrees. In some cases verniers are added, making it

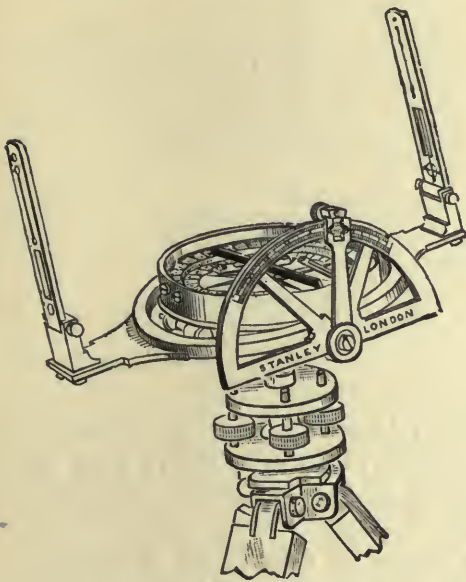

FIG. 45.—Hedley's dial.

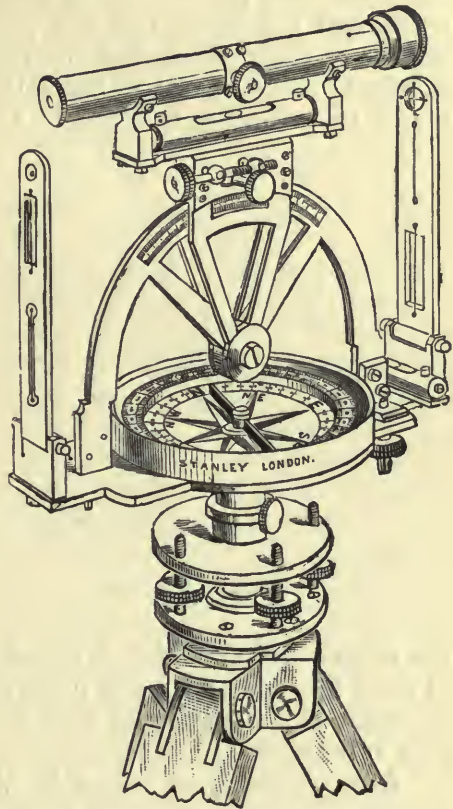

FIG. 46.

possible to obtain finer readings. Another refinement sometimes added consists of a tangent screw for adjusting the line of sight exactly on the object.

Errors to which Needle Instruments are Liable.—*Needle not Straight.*—It is important that the two ends of the needle should read angles which are 180° apart. If on examination it is found that this is not the case, that the angular difference is a little more or a little less than two right angles, and that this error is the same at all parts of the circle, then the needle is slightly curved and should be straightened by an instrument maker or the error carefully ascertained and noted. This is shown on Fig. 47.

Centre of Needle not in Centre of Dial.—When in testing the last adjustment it be found that there is an error which varies at different parts of the circle, being a maximum in one position of the needle and diminishing to zero in a second position at right angles to the first, then the needle has been placed eccentrically in the box and should be carefully reset. Being variable this is a much worse kind of error than the last. This is shown on Fig. 48.

Friction, Sluggish Needle.—The needle is usually supported by means of a small agate cup let into the needle and resting upon a hardened steel point. If the work of construction is well and carefully performed the friction of this joint will be very small. The effect of wear is to cause the end of the supporting point to become dull and the needle to come to rest in more than one position. This can easily be tested by swinging the needle and seeing if it always comes back to

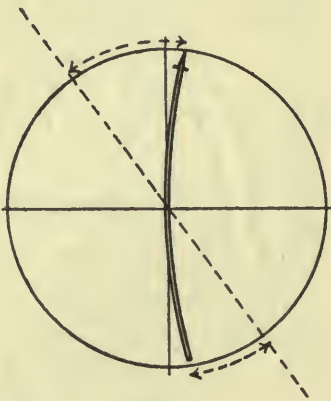

FIG. 47.

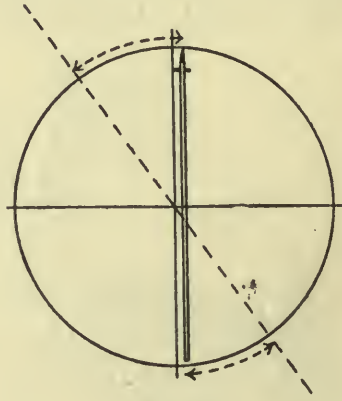

FIG. 48.

the same position. If it is found not to do so, the instrument must be at once overhauled, as it is quite impossible to do satisfactory work with a needle which is sluggish and which has an unknown error, sometimes plus and at others minus.

Local Disturbance caused by the Presence of Local Iron or Nickel.—A frequent cause of error is due to the presence of iron or nickel, causing the needle to be deflected for the moment from its true position. It is therefore necessary that the greatest care be taken to avoid anything of the kind. Two of the most usual causes of this error are to be found in surveying chains and railway lines. In view of the fact that under the best conditions surveying with the compass is greatly lacking in precision as compared with some other methods, especial care should be taken to reduce all sources of error to a minimum, as far as it is possible to do so.

Variation of the Magnetic Needle.—The direction taken by the centre line of the magnetic needle does not coincide with the true Meridian or great circle passing through the North Pole, but deviates from it to the extent of an angle of several degrees. This deviation is called the Declination or Variation of the Needle. - It changes from time to time.

TABLE OF MEAN MAGNETIC DECLINATIONS WEST OF THE MERIDIAN THROUGH GREENWICH.

Year.	Declination West.
1898	16° 39'0"
1899	16° 34'2"
1900	16° 29'0"
1901	16° 26'0"
1902	16° 22'8"
1903	16° 19'1"
1904	16° 15'0"
1905	16° 9'9"
1906	16° 3'0"
1907	15° 59'8"
1908	15° 53'5"
1909	15° 47'6"
1910	15° 41'2"
1911	15° 33'0"
1912	15° 24'3"
1913	15° 17'0"
1914	15° 12'0"

Secular Variation.—This represents the extent to which the declination changes from year to year. It has been observed that the secular changes take place in a cycle of from 150 to 180 years, the direction passing from a maximum declination Westwards to a maximum declination Eastwards and back again. At the present time the Magnetic meridian is swinging towards the true meridian. The magnetic declination for any year may be found in *Whitaker's Almanack*. It is obviously very necessary to know the declination at the time a needle survey is made, because the Magnetic Meridian for that time is taken as the principal line of reference, and everything depends upon it. This is especially true of mining surveys. A needle survey or a portion of it may have to be resurveyed in some future year or a new part may have to be added to the old survey and it is necessary to have a common line of reference. This must be the true meridian.

Annual Variation.—Besides the variation in the mean declination from year to year there is a variation of about half a minute from the mean position during the year.

Diurnal Variation.—There is also a variation in the position of the needle which follows a cycle of twenty-four hours' duration. It is very small in amount and need not be taken account of for ordinary work.

Magnetic Storms.—Besides those which have been mentioned the magnetic needle is subject to sudden and unexpected variations caused by disturbances in the terrestrial magnetic conditions.

As will be shown later it is always possible to find the true meridian by star or sun observations, and this should be done where an important needle survey is being carried out, in order to find the declination for the time in question.

Prismatic Compass.—This instrument is used for rapid preliminary surveys, for military surveying, route surveying in new countries, and generally for work where speed counts for more than rigid precision.

It is light and small, and, consequently, easily portable; and in most cases it is used without a stand or tripod, being simply held in the hand when the observation is being taken. The essential difference between this and needle instruments of the dial class is that the *graduated card is attached to the needle and moves with it*. The method of dividing the circle is also different.

A general view is shown on Fig. 49. Here the instrument is open. It consists first of a shallow metallic box about 3 to 6 inches in diameter. The needle is supported in the usual manner on a fine point of hardened steel; the card is fixed to the needle and turns with it. At the left-hand side in the figure is a sight plate, having a narrow slit at the upper edge and terminating in a small round hole. Attached to the plate in front of this hole is a small totally reflecting prism with the surface nearest the eye of the observer made concave. On the side

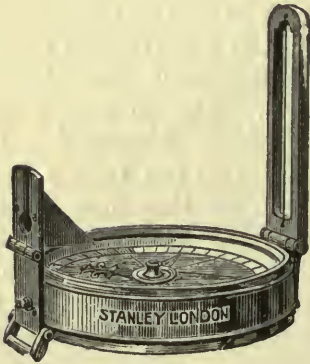

FIG. 49.

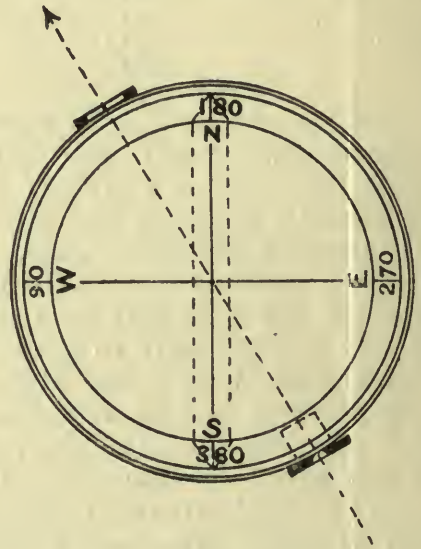

FIG. 50.

of the box opposite the prism is a light frame carrying the sight wire. When taking a bearing, the box is held horizontally with the eye of the observer opposite the round hole in the sight. Looking through this the observer sees the opposite wire through the slit, and in the round hole sees a view of the edge of the graduated card reflected by the prism. The prism may be raised or lowered to get the right degree of magnification of the figures on the card. When everything is in adjustment, the fine black line of the sight wire appears to cut into the graduated edge of the card, and this gives the bearing required.

The method of graduating the card in this case is shown on Fig. 50. It will be seen that the numbering starts from the South end of the needle and goes from 0, at this point, to 90 at W., 180 at N., 270 at E., and 360 at S. again. So that all bearings are read as so many degrees West of South, though it must be remembered that the observer is looking East of North. This manner of dividing the circle is somewhat inconvenient

when bearings are required East and West of the meridian, as described in the last case, but for more general work, where all the plotting is done from the meridian with a protractor, the plan offers great advantages. When not in use the prism and sights may be folded down against the box, and there is usually an arrangement whereby the needle is lifted from its point of suspension by the act of shutting down the long sight. This prevents any wear on the point when the instrument is not in use, and tends to minimise friction.

When using the prismatic compass care must be taken to hold the box in a horizontal position so that the card may be floating freely. Some trouble may be experienced at first by the vibration of the card about its position of rest, and an arrangement is generally supplied whereby these vibrations can be damped and the card brought to rest more quickly.

Where greater accuracy is desired and time and other conditions allow of it, the compass may with advantage be set on the end of a short surveying pole, and in this way held steady in a horizontal position. Some instruments are made with a short tube or ferrule for this purpose. It is still better if the instrument can be mounted on a light tripod. This is frequently done in the case of prismatic compasses of larger size.

The card is usually divided into either degrees, half degrees, or quarter degrees according to the size.

It should be obvious that the angle between two lines radiating from the point of observation will be the difference between the readings taken when observing these.

It will also be noted that the figures and letters are reversed as printed so that they may present their normal appearance when reflected.

Traversing with the Dial and Chain.—The following description, with reference to the diagram on Fig. 51, will serve to indicate the more usual manner of carrying out a needle traverse with the compass and chain.

Station poles are set up at suitable points on the line to be surveyed, such as A, B, C, D. Starting from the first point, A, the observer sets up his dial over the point on the ground, and, having carefully levelled it, turns it so that its sights exactly bear on the next point, B. He then reads the angle given by the North end of the needle, which is the angle BAL, or, as it is called, the "bearing" of the line AB. In the present case this bearing will be booked as so many degrees East of North. Having taken the bearing of the line, its length is now to be measured with the chain in the usual way, offsets being taken to any boundaries or isolated points which have to be taken account of. As in ordinary chain surveying, the usual allowances are made for sloping ground. When the end of the first line has been reached the dial is again set up, now at B. Before taking the bearing of the second line BC, an observation must be taken back to A, and the bearing noted. This is called a "reverse bearing," and is taken with the object of checking the forward bearing taken from A. It will be evident that

the reverse bearing QBA should be equal in amount to the forward bearing LAB, the only difference being that if the latter is East of North, the former will be West of South. If, on taking the reverse bearing in this way, it be found that there is a discrepancy in the angles, then the original bearing must be repeated until a satisfactory agreement is arrived at. By doing this it should be possible, with ordinary instruments to ascertain the bearing to within one-quarter of one degree.

Each successive line is to be dealt with in the same way.

Working Out and Plotting.—The simpler though less accurate way of plotting is to draw a vertical line XY on the paper to represent the meridian, and to set off from a point A an angle LAB with a protractor, equal in amount to the bearing of this first line. The chained distance AB is then set off to scale along the line so plotted. Then, a second meridian, MQ, is drawn through B parallel to the first and the second line BC set down in the same way, and so on. This plan suffers from the disadvantage that any inaccuracy, however small, in the plotting of AB, will give a wrong position to the point B, and this error will be repeated with each successive line and will be carried on throughout the traverse.

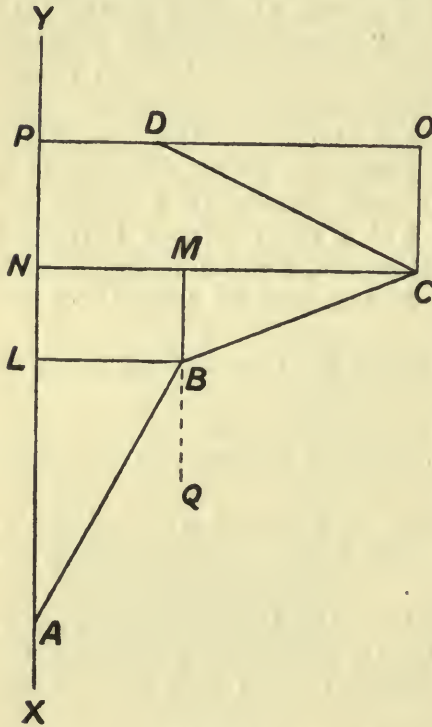

FIG. 51.

Another plan, which is no more accurate than the last, but probably less so, is to obtain the angle between each succeeding pair of chain lines by subtracting the bearing of the one from that of the other, and to plot the direction of the second line of a pair by setting off

this angle from the former line and then proceed as before. Where a prismatic compass is used this plan has certainly the advantage that it is more easy to obtain the angle between the lines by a simple subtraction than to deduce the bearing. But the most accurate method of plotting, and one which can be carried out very quickly when the work is systematically carried out, is by means of rectangular co-ordinates.

Plotting a Needle Survey by Rectangular Co-ordinates.—Again referring to Fig. 51, it will be seen that in going from A to B—so many degrees to the East of North and so far along the line—the movement can be resolved into two movements at right angles. That is to say, in order to get from A to B, it is possible to go a distance AL to the North, and then move Eastward a distance LB at right angles to the first direction. It is this latter plan which is made use of when plotting by rectangular

co-ordinates. The bearings and distances are taken with the dial as already described; then, knowing the angles such as \overline{LAB} , and the distances as AB , it is easy to calculate the rectangular co-ordinates AL and LB . For

$$AL = AB \cos \overline{LAB}, \text{ and } LB = AB \sin \overline{LAB}$$

The distance along the meridian is called the "difference of latitude," or, more shortly, "latitude;" and the distance moved to the East or West of this is called the "departure" of the point in question.

Next, in going from B to C , a further difference of latitude is attained, BM , and a further departure, MC , this last being taken from the new meridian drawn through B .

The algebraic sum of the latitudes, AN , is called the "total latitude," and, in the same way, the algebraic sum of the departure, NC , is called the "total departure." If, therefore, the latitudes and departures of the two lines AB and BC be calculated from the field notes and added algebraically so as to obtain the total latitudes and departures, it will be possible to plot the positions of the points B and C , by drawing the meridian on the paper and setting off first along this the total latitudes AL and AN , and then the total departures LB and NC along lines at right angles to the first meridian at L and N .

The result is that the positions of the directions of the two lines having been found independently with reference to a fixed direction, namely, the magnetic meridian, their lengths chained, and then their total latitudes and departures calculated, the positions of the points on the plan will have been obtained quite independently, and there is no accumulation of error and no possibility of carrying an error on from one line to another.

That is to say, B is found and plotted with reference to A , C is also obtained and plotted with reference to A , and so on, for all the other points in the traverse.

This system of rectangular plotting has many advantages which are especially evident in the case of closed traverses. Where the traverse is open each point is plotted independently, and the position of the last point is obtained with a smaller chance of error than when each line is plotted with reference to the one preceding it.

Where the traverse is a closed one there are two ways in which the accuracy of the work may be checked.

In the first place, it will be remembered that in a closed polygon the sum of all the internal angles bears a definite relation to the number of sides. Stated precisely, "*the sum of all the internal angles of a closed polygon plus four right angles is equal to twice as many right angles as the figure has sides.*" So that it is easy from the field notes to find the internal angle at each corner of the figure, and when these are all added, together with four right angles, it can at once be seen whether there has been any error in the measurement of the angles. This forms the first check on the field-work.

Secondly, the latitudes are divided into two classes, namely, those in which the line has been taken further North, and those in which the line

has travelled in a Southerly direction. The former of these are called "Northings" and the latter "Southings." In following round a closed traverse, where the end of the last line coincides with the first point of the first line, the total distance travelled Northwards must be equal

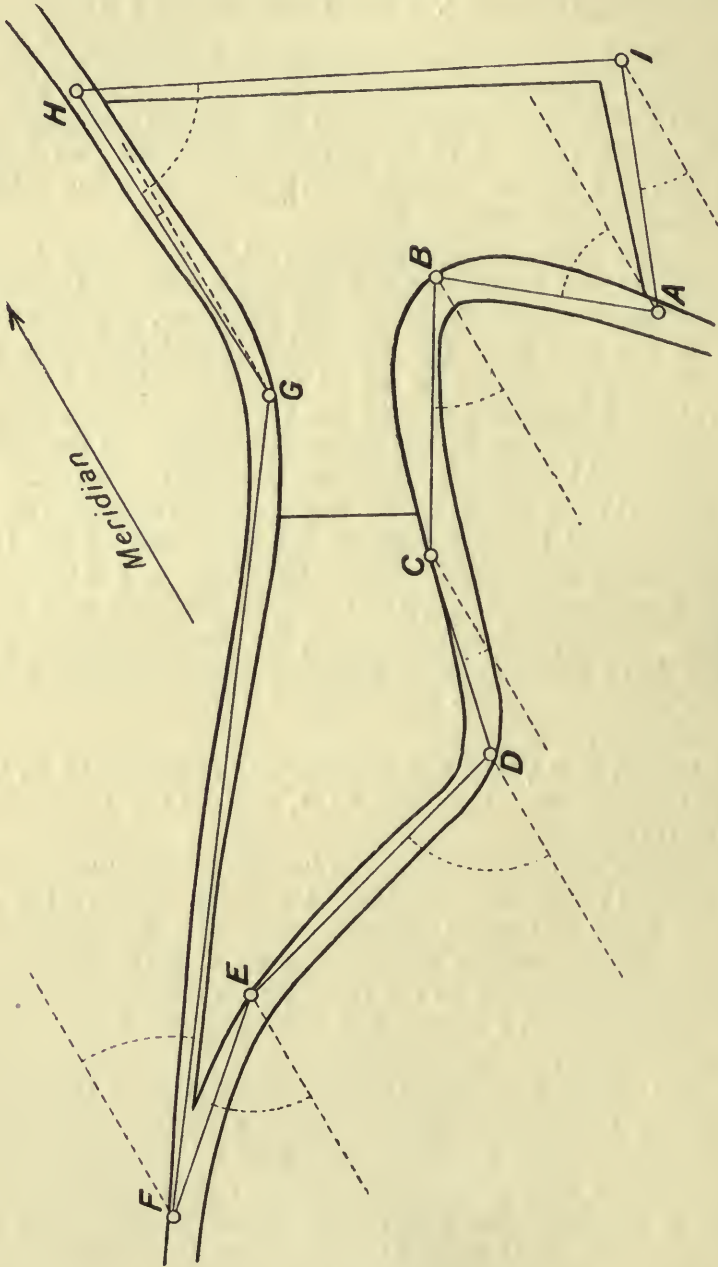

FIG. 52.

to the total distance travelled towards the South. This provides a second check on the accuracy of both field-work and the calculations; that is to say, the sum of the Northings must equal the sum of the Southings.

In a similar way the sum of the departures West, or "Westings," must be equal to the sum of the departures East, or the "Eastings."

In order to show how the field notes and calculations are to be tabulated a concrete example is given. This is a needle traverse (Fig. 52), forming part of the more complete survey made by the writer's students. First the figures in the given Table I. have been taken from the pages of the field book.

The balancing of the angles is done in the following way:—

$$\begin{aligned}
 B &= 360 - 50 - 30\frac{1}{2} = 279\frac{1}{2} \text{ degrees} \\
 C &= 180 + 30\frac{1}{2} - 13\frac{1}{2} = 197 \quad \text{,,} \\
 D &= 180 + 13\frac{1}{2} - 75 = 118\frac{1}{2} \quad \text{,,} \\
 E &= 180 + 75 - 50 = 205 \quad \text{,,} \\
 F &= 50 - 37\frac{1}{2} = 12\frac{1}{2} \quad \text{,,} \\
 G &= 180 + 37\frac{1}{2} + 2 = 219\frac{1}{2} \quad \text{,,} \\
 H &= 63 - 2 = 61 \quad \text{,,} \\
 I &= 180 - 63 - 22\frac{1}{2} = 94\frac{1}{2} \quad \text{,,} \\
 A &= 22\frac{1}{2} + 50 = 72\frac{1}{2} \quad \text{,,}
 \end{aligned}$$

$$\begin{array}{r}
 \phantom{+ \text{ four right angles}} \quad 1260 \\
 + \text{ four right angles} \quad 360 \\
 \hline
 1620 \text{ degrees}
 \end{array}$$

$$\text{Twice as many right angles as the } \left. \begin{array}{l} \text{figure has sides} \\ = 180 \times 9 \end{array} \right\} = 1620 \text{ degrees}$$

So that in this case the angles balance.

It is generally useful to make up four complete tables. The headings for the first of these are given in Table I. In the first three columns are put the figures as obtained straight from the field book. First comes the station at the end of the line referred to; then its bearing as taken from the preceding station; and, after this, the length of the line as measured. From the figures in the first three columns are calculated those which are placed in the four columns of Table II. This may be done in several ways. In using logarithms the log of the distance is found, and afterwards the logarithmic cosines and sines of the respective bearings; these are added together and the numbers corresponding to the resulting logarithms looked out in a log table. The results so obtained are to be placed in their proper places in the four columns. These logarithms of angles and distances are taken from some suitable table, such as Chamber's Mathematical Tables, or the tables at the end of this book. In some cases additional columns are made use of for the logarithms, so as to have the whole of the calculation in a tabular form.

The work may be much more quickly performed by means of a slide rule used in conjunction with the tables. A 20-inch slide rule is

preferable to a smaller one. If this be done the latitudes and departures can be written down straight away.

Another way of reducing the latitudes and departures from the

ROAD FENCE B	30	(236)	2	ROAD FENCE FIELD ROAD FENCE WALL C	
	22	200	15		
	12	150	27		
	8	100	24		
	6	50	30		
		(0.00)	5		Bearing S 30½° W
ROAD FENCE A	20	(181)	2	ROAD FENCE FIELD ROAD FENCE WALL B	
	14	170	20		
	11	150	26		
	16	100	25		
	16	50	18		
	25	(0.00)	7		Bearing N 50° W
ROAD FENCE D	25	(287.5)	5	ROAD FENCE FIELD ROAD FENCE WALL E	
	20	250	6		
	15	200	10		
	14	150	14		
	14	100	12		
	13	50	10		
	3	(0.00)	30		Bearing S 75° W
ROAD FENCE C	3	(176)	32	ROAD FENCE FIELD ROAD FENCE WALL D	
	15	150	15		
	22	100	5		
	25	50	4		
	30	(0.00)	2		Bearing S 13½° W
ROAD FENCE FGG	22	(700)	63	ROAD FENCE FIELD ROAD FENCE WALL G	
	5	600	10		
	7	500	18		
	10	400	12		
	15	300	7		
	15	200	6		
	12	100	8		Bearing N 37½° E
4	(0.00)				
ROAD FENCE E	21	(200)	4	ROAD FENCE FIELD ROAD FENCE WALL H	
	15	150	20		
	13	100	15		
	13	50	11		
	25	(0.00)	5		Bearing S 50° W
ROAD FENCE H		(214)		ROAD FENCE FIELD ROAD FENCE WALL I	
		200	10		
		14	20		
		(0.00)			Bearing S 22½° W
		(459)			
		440	10		
		25	13		Bearing S 63° E
	20				
	(0.00)				
ROAD FENCE G	12	(304)	16	ROAD FENCE FIELD ROAD FENCE WALL J	
	11	280	80		
	14	210	17		
	8	100	22		
	10	50	15		
	23	(0.00)	3		Bearing N 20° W

Pages of Field Book in Sample Needle Traverse.

bearings and distances is by using a Traverse Table, which will be found to give at once the latitude and the departure for a given bearing and distance. Generally tables of this kind are constructed to give

TABLE I.

TABLE II.

TABLE III.

TABLE IV.

TOTAL LATITUDE AND DEPARTURE.

CORRECTED.

Station observed.	Bearing.	Distance (feet).	Latitude.		Departure.		Latitude.		Departure.		Total latitude.		Total departure.	
			N.	S.	E.	W.	N.	S.	E.	W.	N.	S.	E.	W.
B from A	N. 50° W.	181	114	204	139	139	114	204	139	139	901	139	901	139
C "	S. 30½° W.	236		117	117			204	116		262	255	262	255
D "	S. 13½° W.	176		172	38			172	38		336	293	336	293
E "	S. 75° W.	287.5		74	278			74	278		467	571	467	571
F "	S. 50° W.	200		131	151			131	151			722		722
G "	N. 37½° E.	700	553		428	428	552		15	429		85		293
H "	N. 2° W.	304	306		413	413	305		15	413		390		293
I "	S. 63° E.	459		189	105			201	105			189		308
A "	S. 22½° W.	214						189						
	Total . .	2757.5	973	970	841	841	971	971	842	842		105		105
			970		841	841	971	971	842	842				
			3 error		error 2	error 2								

All the above are taken from the station A as origin.

results for the nearest degree, but as the bearings themselves can be read to the nearest quarter degree, or even finer than *this* in some cases, the results would hardly be sufficiently precise for any but comparatively rough work or for checking other and more precise calculations.

Methods of Tabulation.—The way in which the first table is to be constructed and the calculations made has been sufficiently indicated.

Having made the necessary entries and calculations for the first two tables (I. and II.), the column of Northings and Southings must be added up and the resulting sums compared. The same is to be done for the Eastings and Westings.

If the Northings are found not to equal the Southings, the difference represents the error in latitude, and that for the Eastings and Westings the error in departure. These are dealt with as follows:—

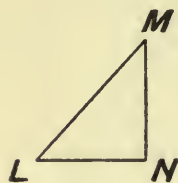

FIG. 53.

In the right-angled triangle on Fig. 53 the vertical line represents the error in latitude and the horizontal line the error in departure. Then the length of the hypotenuse, LM, is the distance by which the end of the last line of the traverse fails to coincide with the beginning of the first line, and is called the *error of closure*. It may be readily calculated as

$$(\text{Error of closure}) = \sqrt{(\text{latitude error})^2 + (\text{departure error})^2}$$

The ratio of this error of closure to the total length of all the chain lines should not be greater than 1 in 300 to 400 in average work and ordinary country, and not more than 1 in 1000 to 1 in 1200 when working under the best conditions in very level ground.

When the error of closure, as found in the manner just described, exceeds the limits of error allowed, then the cause of the error must be ascertained as far as possible, and any of the measurements which may appear to be doubtful must be repeated. It is difficult and almost impossible to say precisely what is to be done to correct an excessive error. Everything will depend on the special circumstances surrounding the case in question. It is sometimes not at all difficult to locate an error by a careful inspection of the table, especially where the discrepancy is the result of one fairly large error rather than an accumulation of small ones. In all cases it will be found that a rough plotting of the work by angles and distances is of the very greatest help, both in forming a correct idea as to the general form of the survey and in locating errors. If the resultant error is not very great but still too large to be passed, it will often be necessary to remeasure a part of the work until the causes of error have been located. In performing a check of this kind it will generally be found advantageous to go over the chaining first, because there will already have been a check on the angles in the shape of the reversed bearings, and these ought not to allow any considerable error to creep in. When the angles are being checked, if found necessary, it is well to remember that an error in the bearing of a long line causes a greater ultimate inaccuracy than it does

in the case of a shorter one. Occasionally it may happen that some one bearing is hopelessly wrong and is causing all the trouble by reason of some unsuspected local attraction. Another kind of mistake that must be looked out for is the missing of a chain or part of a chain.

When the accuracy is found to be within the necessary limits or has been made so by revising some of the work, it will probably be found that some error still remains, and the next thing to be done is to distribute this error, so that by spreading it over the different lines this small error will have less effect in changing the general form of the traverse than if concentrated at one point.

In distributing the error in this way what is usually done is to allow the various lines to take their share of the error according to their lengths. In the example given in Table II. it will be seen that the difference in latitude only amounts to 3 links, and that of departures, 2 links. The square root of the sum of the squares of these is

$$(\text{Error of closure}) = \sqrt{9 + 4} = 3.6 \text{ links}$$

The total length of all the lines is 2757.5 links, so that the total error, expressed as a ratio, is

$$\frac{3.6}{2757.5} = \frac{1}{765}$$

The distribution is carried out in the following way. Taking the first Northing in the present survey, the correction must be proportional to the length of the line in question. This length is 181 links, so that the correction will be that part of the three links total difference between Northings and Southings that 181 is of 2757. This may be written

$$\text{Correction} = \frac{181}{2757} \times 3 = 181 \times 0.0011$$

As this ratio of the difference to the total length is the same for every line, when considering the latitude, it will be sufficient to multiply the length of each line by this constant ratio. Or, putting these corrections in tabular form, they become : corrections for latitude

AB	181	$\times 0.0011$	$= 0.26$	link
BC	176	"	$= 0.19$	"
CD	287.5	"	$= 0.32$	"
DE	200	"	$= 0.22$	"
EF	700	"	$= 0.77$	"
FG	304	"	$= 0.33$	"
GH	459	"	$= 0.50$	"
HI	214	"	$= 0.20$	"

It will be seen that all these corrections are fractions of one link, and as it is not usual to add or subtract corrections to less than the

nearest link, the three largest corrections in the present case must be taken, assumed to be one link and the remainder neglected. If the plotting is to be to a large scale, the correction may be to the nearest half-link or even less if necessary. As a matter of fact the total error is small in the present instance, and the corrections appear more insignificant than is often the case. In making the necessary additions and subtractions, it must be noted which are larger, Northings or Southings. In the present case the Northings are too great, therefore in the case of the line from E, or EF, the Northing 553 is too large, and must be diminished by the one link, so becoming 552. The next line where a correction is to be supplied is the line from H; the Northing 306 must be diminished to 305, and the remaining one in the next line from I, which in this case is a Southing, and therefore must be increased from 200 to 201. The links here referred to are feet.

The corrections for the departures are dealt with in a precisely similar manner, and there is no need to go through all the details again. It is sufficient to notice that here the Westings are the greater, and must therefore have their corrections subtracted while the Eastings are correspondingly to be increased.

The figures as amended are given on Table III.

The fourth table required is the final one which is prepared for plotting, and called the table of Total Latitudes and Departures. It is best to plot all points from two lines only, drawn at right angles through any convenient point on the traverse. In most cases it is convenient to select a point in such a position that all other points lie North or all South, and also all to the West or all to the East. In the present instance such a point would be F, when all other points are North and East. However, as this particular traverse was made from a known point, A, on the main survey, it is convenient to work from this point alone.

The construction of this table is easy, and only consists of additions and subtractions as may be required. Take the latitudes. The second point B is the first point on the table. This lies 114 links to the North of A. Therefore, its total latitude with respect to A is 114. The next point C has a Southing with respect to B of 204 links, and therefore it lies to the South of A to the extent of $(204 - 114) = 90$ links. This is its total latitude. And so on for all the remaining points. Where the latitude of a line has the same sense as the total latitude of the previous line, it must be added to the last. Where, however, it has the opposite sense the smaller must be subtracted from the greater, and the difference placed in the same column as the greater.

Calculation of the Area enclosed in a Needle Traverse.—When the traverse is a closed one it is not difficult to calculate the contents by making use of the figures in the table of total latitudes and departures.

In the case of the example already given (Fig. 52), the figures in Table IV. are calculated for plotting from station A, and all the measurements are reckoned as from that point. For greater convenience in making the computations a new table (V.) has been constructed

in which the total latitudes and departures are again given, but reckoned from the most south-westerly station, F, so that all the measurements will be to the North and to the East of F.

The chain lines of this traverse are again plotted on Fig. 54, Fh being the meridian through F.

The enclosed area, $HiABCDEF$, is made up of the algebraic sum of the series of quadrilaterals such as hHi , and it will be seen that this has an area which consists of the product of hi and the mean of hH and ii , or $= ih \times \frac{1}{2}(hH + ii)$.

Of the quantities ih is called the difference of latitude for the line or

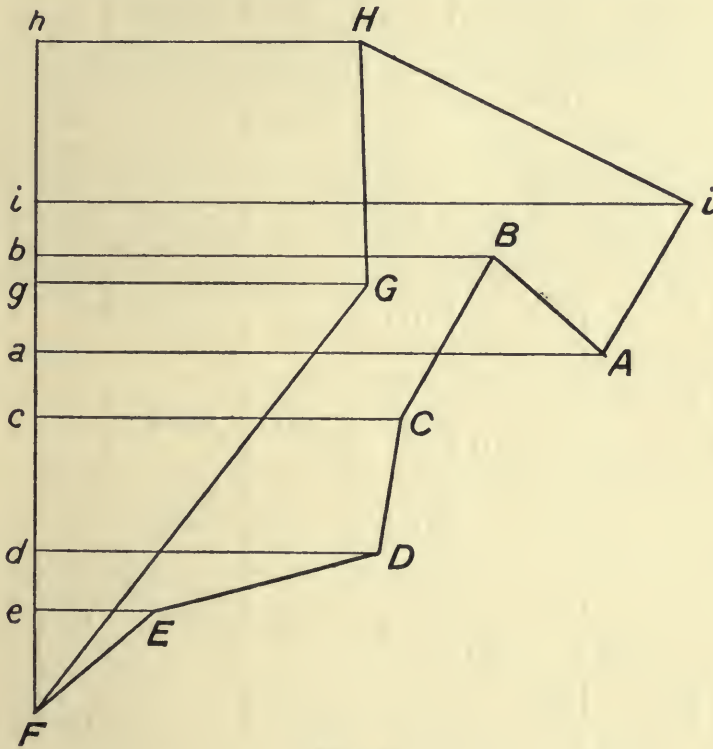

FIG. 54.

“course” in question, and is simply obtained by subtracting the total latitude of I from the total latitude of H.

The total departure hH is for the present purpose called the “meridian distance” of the station H, and ii the meridian distance of i . The quantity $(hH + ii)$ is called the “double meridian distance” for the line or course Hi , and is referred to in the table as D.M.D.

In Table V. are given all the figures required for the calculation of the areas and the results of the computations. Here

$$\begin{aligned} \text{Area } HiABCDEF &= hHiABCDEF - FGHh, \\ &= hHi + iiAa - bBAa + bBcc + cCDd + dDEe + eEF - gGF - gGHh \end{aligned}$$

TABLE V.—CALCULATIONS OF AREA ENCLOSED BY CHAIN LINES IN NEEDLE TRAVERSE (FIGS. 52 and 54).

Line or course.	Total latitude. N.	Total departure. E.	Difference of latitude.	D.M.D.	+ Area.	- Area.	Total.
H	857	414					
I	656	827	201	1241	124,720·5		
I	656	827	189	1549	146,380·5		
A	467	722					
B	581	583	114	1305		74,385	
B	581	583					
C	377	467	204	1050	109,100		
C	377	467	172	896	77,056		
D	205	429					
E	131	151	74	580	21,460		
E	131	151	131	151	9,890·5		
F	—	—					
G	552	429	582	429		118,404	
G	552	429					
H	857	414	305	843		128,507·5	sq. feet.
					488,607·5	321,296·5	167,311

The above calculations give the area enclosed by the chain lines ; where the area of the fields enclosed by the walls is required, the offset strips on the right hand of the chain lines will have to be subtracted.

Notes on Needle Traverses.—From what has been said about needle traversing, it is not difficult to see that the method is not one which admits of a very high degree of precision, but in hands of skilled and careful observers very good work may be done. Where the traverse is above ground and there are suitable points which can be used for the purpose, it is well to take occasional bearings of isolated and well-established stations not in the line of the traverse. These will

serve as most useful checks, and will help to tie the traverse to the main survey.

The disadvantages of the needle for surveying work of any kind are its want of accuracy and its lack of precision. The causes of these two have already been pointed out, the former being principally the secular diurnal and annual variation of the needle as well as the effect of the near proximity of masses of iron, while the precision is limited by the comparative coarseness of the divisions on the card. It may be pointed out here that an error of bearing of one-quarter of one degree yields linear error of a little over 5 inches at a distance of 100 feet, $4\frac{1}{2}$ feet at 1000 feet, and nearly 24 feet at one mile distance.

On the other hand, the compass is an instrument which is easy to use on account of its simplicity, the work done with it is very quick on account of the rapidity with which it may be set up and read, and the instrument is light and easy to move from place to place.

It may be well to point out here that besides its use for the purpose of traversing, a compass may be used to establish a number of points by the Radial method, all the observations being taken from one point, or by the method of intersection. These two methods will be described more in detail when discussing the plane table.

CHAPTER III

THE PLANE TABLE

THE plane table is an instrument which has been little used in Great Britain up to the present time, except for military purposes. Its chief merits are its simplicity, lightness, the rapidity with which work can be done, and its comparatively small cost. In its more ordinary forms it is not capable of a high degree of accuracy, but by reason of its rapidity it

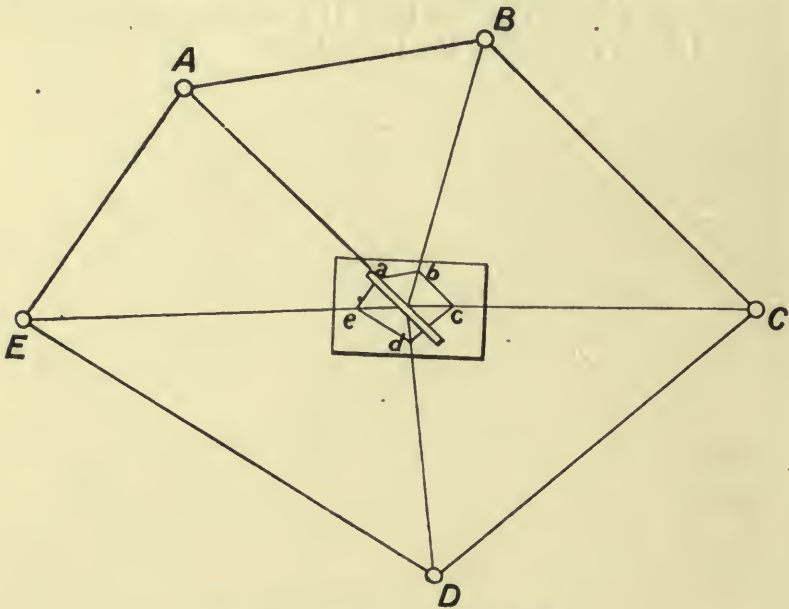

FIG. 55.—Plane table—Radiation.

is very suitable for use where preliminary or pioneer surveys have to be made in a limited time.

It is not surprising, therefore, that the use of the plane table has been largely developed in America, where it has been brought to a state of perfection scarcely to be credited by those who regard it as one of the cruder forms of surveying appliances, and one only suitable for the roughest kind of work.

The general scheme of the instrument and its use will best be made clear by describing its application to a simple surveying problem.

Referring to Fig. 55, A, B, C, D, and E are five points on the ground whose relative positions are to be determined. The plane table is set up, with its centre placed immediately over a known point on the ground. In the present instance the most convenient position is somewhere in the centre of the figure formed by the five points.

The instrument itself consists of a drawing board supported on a tripod and set perfectly level. On it is stretched a sheet of drawing paper. A long straight-edge, called the "alidade," rests on the table. At the ends of the ruling edge, and forming a line which coincides with it, are a pair of sights. A pin or needle is stuck vertically in the board over the point on the ground, F. The straight-edge is now moved upon the table so that its ruling edge touches the needle, and the observer, looking through the sights, ranges the line with one of the points on the ground, A. A line is now ruled with a hard pencil along the straight-edge with the alidade in this position.

In this way a line is established on the paper which radiates from F above the corresponding point on the ground and points directly towards A. Still keeping the table in the same position, the sights are successively directed towards B, C, D, and E, and the corresponding lines ruled as before. The distances FA, FB, FC, FD, and FE are now chained in the usual way, and their lengths plotted to some suitable scale along the corresponding lines on the paper from F. The result will be a facsimile on the paper to a reduced scale of the figure on the ground.

This is an example of the use of the plane table in its simplest form, and will serve to introduce its essential features. The process described is what is called the method of "Radiation." What the plane table does here is to establish the angles between a number of lines radiating from a known point, while the linear distances from this point to the other points on the ground are measured directly.

Method of Intersection.—A second method of using the plane table, and one which is largely used for rapid topographical surveying, is that called "intersection." This is shown on Fig. 56 as applied to the same problem as the last.

Two suitable points on the ground, X and Y, are selected, and the horizontal distance between them very carefully measured by chaining or taping. This line is now plotted on the board so as to roughly occupy about the same position as the line on the ground. The points on the ground are X and Y; the corresponding points on the paper are x and y . The table is now set up on the ground with its surface level, the point x on the paper exactly over X on the ground, and with the straight-edge so placed that the observer, on looking through the sight at x , sees the other sight coinciding with Y on the ground. Still keeping the table in the same position and the straight-edge pressed against the needle at x , the line of sight is directed successively towards A, B, C, D, and E, and lines drawn along the edge of the alidade when in these positions. This operation will constitute a graphical record of the respective angles YXA, YXB, YXC, YXD, and YXE.

The instrument is now moved to the second station Y, and is set up as before, with the difference that now the point *y* on the paper must

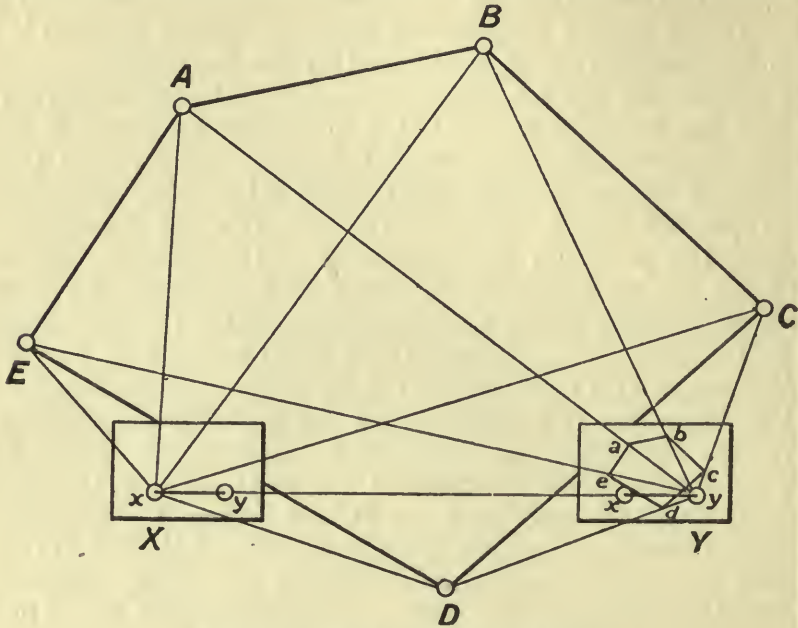

FIG. 56.—Plane table—Intersection.

be placed directly over Y on the ground. It is also necessary that when the alidade is placed along *xy*, the observer on looking through

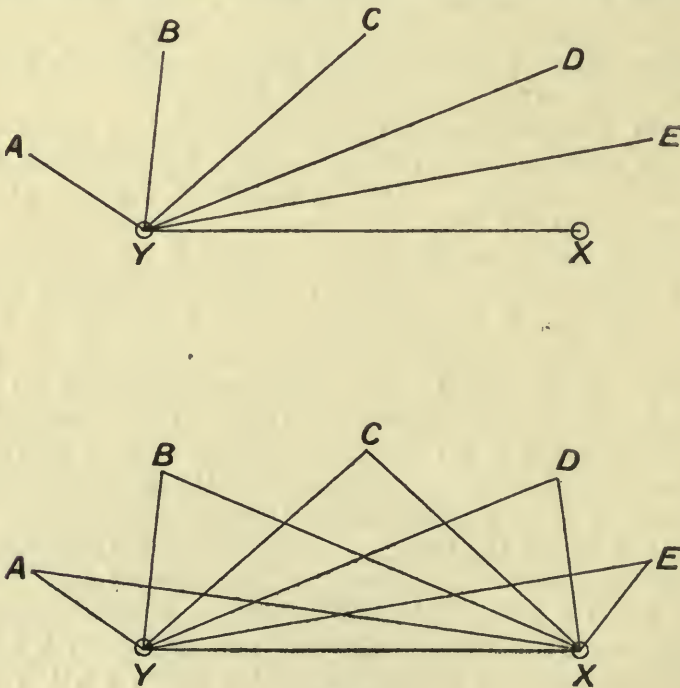

FIG. 57.

the sight at y shall see the cross wire in coincidence with X on the ground. The needle must now be fixed in the board at y , the alidade placed against it, and the sights successively pointed to $A, B, C, D,$ and E . When the alidade is in these positions lines are ruled along its edge, and where these lines cut the corresponding lines drawn from x towards the same points will determine the required positions of the points on the paper. Both those lines actually drawn and the directions of the lines of sight are shown on the figure. The principles of the two methods are shown compared on Fig. 57.

Traversing with the Plane Table (Fig. 58).—A process called "progression," analogous to traversing with the needle and chain is sometimes carried out with the plane table. The instrument used for this

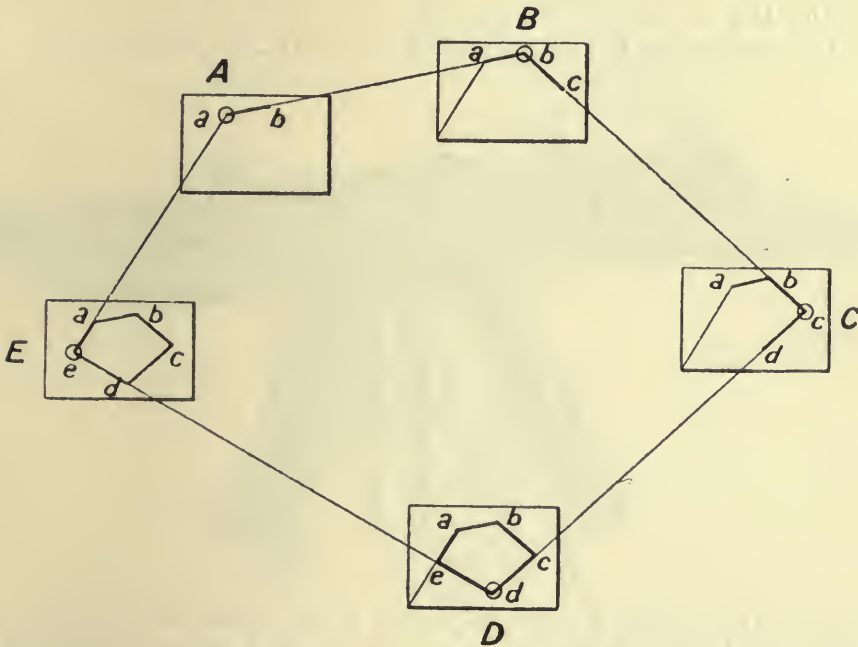

FIG. 58.—Plane table—Traversing.

purpose must be of an easily portable and light construction. It is to be set up on each point successively. First set it up over A , the corresponding point on the paper being marked a ; a line is ruled on the paper from a towards B by means of the alidade. The table is now moved to b , and the linear distance AB chained and plotted on the paper to a suitable scale. When B is reached the instrument is set up there, the point b on the paper being set over B , and the line ba pointing precisely back to A . The alidade is now set on b , directed onwards towards C , and the line drawn. This second line is chained and plotted from b to c , and so the work progresses, each line having its length directly measured by a chain or tape, and its relative direction found by means of the sights on the alidade.

The three methods of using the plane table which have been

described are the principal ones in use. There are several others, but in them the processes mentioned are only combined or further elaborated.

The Instrument (Figs. 59 and 60).—The plane table itself as used for topographical surveying and the filling in of details is very simple in construction. It consists essentially of a rigid board about 2 feet by $2\frac{1}{2}$ feet in size, attached to the top of a tripod which may be of much lighter construction than is common in the case of the level or theodolite. The precise height at which the top surface of the board is set depends upon the height of the observer, it being borne in mind that the observer must be able conveniently to take observations through the sights or telescope and at the same time be able to draw and write on the board. Within certain limits the lower the table is placed the better for the work.

The manner of fixing the paper on the board varies greatly. In

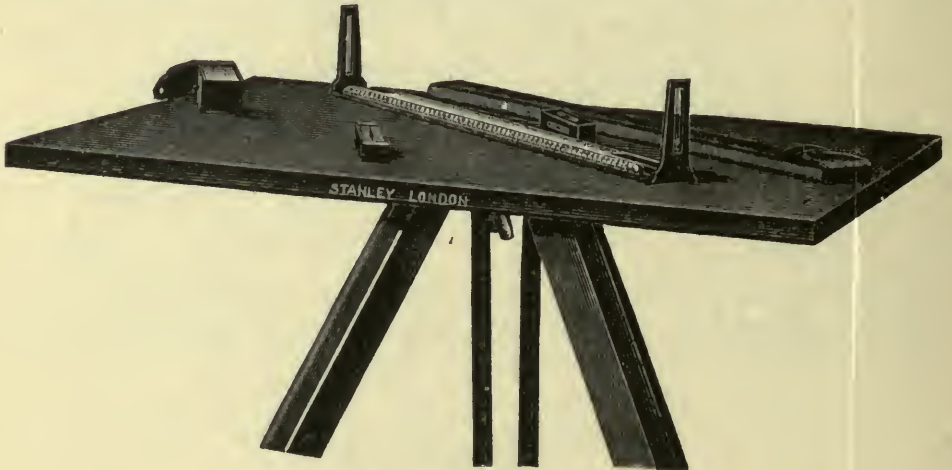

FIG. 59.

some cases the board is provided with a frame which fits closely round its edges, and when the sheet of paper has been placed in position the frame is pressed down so as to hold the paper tightly between itself and the edges of the board, a light ledge or beading being provided to allow the frame to be pressed down so that its surface is level with the top of the board. Or, the paper may be carried on two rollers, one at each end of the board; when the board is filled the paper can be rolled up at one end and a clean sheet exposed ready for use. In other cases the paper is doubled over the edges and held with drawing pins, or, again, it may be pasted on the board. Probably the first method, if the board and frame are properly made, is the most suitable for all-round work, though the writer has found considerable trouble to arise though the frame not being sufficiently stiff and so allowing the paper to spring loose.

Whatever method is used it must always be remembered that there must be no projections from the top surface of the board.

The connection between the board and its tripod is usually made

through a ball and socket joint and a set of levelling screws working from a large base. The most suitable number of screws is three.

If desired a clamp and tangent screw may be added, and will be found convenient in adjusting the sights in azimuth.

For the purpose of setting the top surface horizontal a spirit level is required; this may be carried loose, imbedded in the surface of the table, or affixed to the side.

In some plane tables a small compass is set in the top of the table at one end, giving at all times the bearing of a fixed line on the top of the table.

The Alidade or Straight-Edge.—The straight-edge may be 18 or 20 inches in length by about $2\frac{1}{2}$ inches wide. Two types are in use, namely, a wooden or metal straight-edge provided with a pair of sights; or a

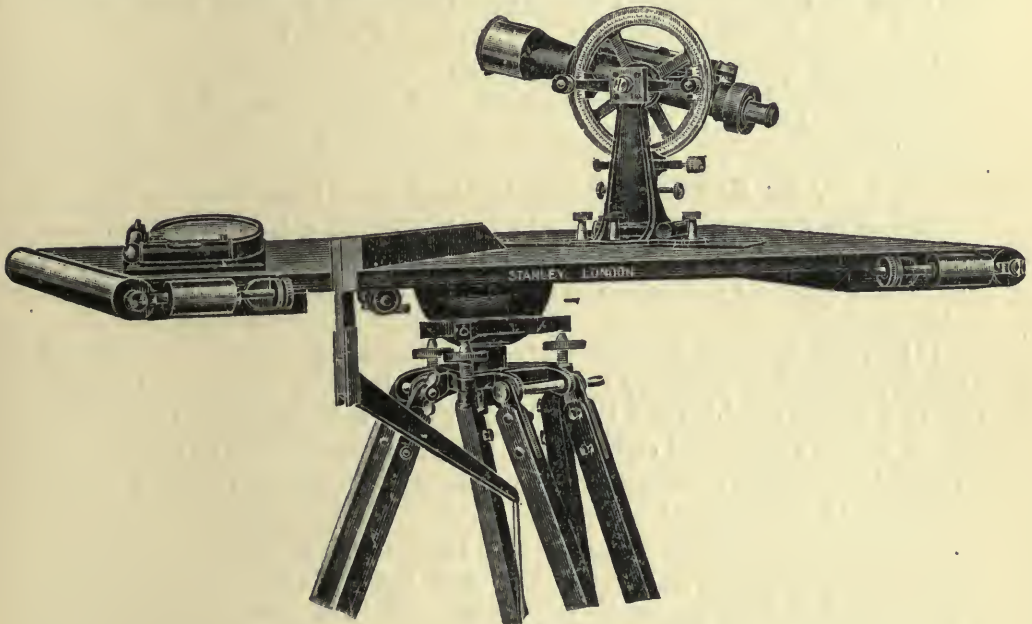

FIG. 60.

similar straight-edge on which is mounted a frame forming the supports for the horizontal axis of a theodolite telescope.

Of these, the former kind has the ends of a straight-edge fitted with vertical pieces of thin brass in which slits are cut to form the sights. One of these slits must be made narrow as in the near sight of a mining dial, while the other is wider, and down the middle of this is stretched a vertical wire, which is to be brought into coincidence with the object when taking an observation. It is desirable, though not necessary, that the sight plates be made to overhang towards the ruling edge or the edge be cut away, so that the edge of the ruler lies in the vertical plane of the sights. For doing the best work with a plane table a telescope is necessary, although with practice and care fairly accurate work can be done with plain sights: the author has found it possible to put in a large number of contour points with fairly satisfactory results by using an

extemporised wooden straight-edge fitted with sights cut out of tinplate and having a fine wire stretched across the open sight.

Alidade with Telescope.—The method of mounting shown on Fig. 60 may be adopted. In this the support is placed rather nearer one end of the straight-edge so as to make it easier for the observer to take his sights without being hampered by the free end of the straight-edge. The frame is overhung so as to allow the vertical plane swept out by the revolution of the line of collimation to pass through the ruling edge.

In the American type the telescope is set rather higher, the bearings for the trunnions being carried at the top of a round pillar which forms a convenient handle to be used for the purpose of adjusting the position of the straight-edge. The telescope cannot be turned completely over, but may be depressed or elevated through a small angle, and a vertical arc is added to allow of small vertical angles being read. On the top of the telescope is a bubble tube.

Adjustments of the Plane Table.—In order that the work done with plane table shall be accurate, the following conditions must be satisfied :—

Surface of the Board.—(1) The top surface of the table must not be warped or in any way distorted. It must present a true plane surface. This may be tested by placing a long straight-edge across its surface and seeing whether it touches the board all along its length when held in any position.

(2) When in use the upper surface of the table must be horizontal. This adjustment is made by means of a spirit level or pair of levels. Where a single bubble tube is used, and this is the more usual plan, it is placed with its length at right angles to a line joining one of the pairs of screws, and similarly for another pair until the bubble remains in the centre for all positions of the level.

Straight-Edge.—The edge of the ruler must give a straight line. This can be tested by ruling a line and then reversing the straight-edge, end for end, so as to rule a second line on the top of the first. If the first coincides with the second the edge may be regarded as true. There is certainly one form of uniform double curvature where coincidence could be obtained after reversal, but the chances against this occurring are very great.

Alidade and Sights.—(1) The sights must be vertical, and at right angles to the under surface of the straight-edge. It will be sufficiently accurate to test these with an ordinary square, or they may be tested by carefully levelling the table and sighting on to a plumb line.

(2) It is desirable that the vertical plane of the sights coincide with the straight-edge, but this is not absolutely necessary so long as they are parallel to or form a constant angle with it, and provided that the sights are always taken in the same direction along the straight-edge.

Telescope.—Where a telescope is used instead of sights the adjustments are made in a similar manner to that adopted for the theodolite,

and there is no need to recapitulate them here. Any one who is familiar with the theodolite will have no difficulty. The errors to be tested for are—

- (1) Line of sight at right angles to horizontal axis.
- (2) Horizontal axis parallel to plane of board.
- (3) Plane of line of sight to coincide with edge of ruler. This is not necessary but convenient.

Using the Plane Table.—The operations necessary in taking a set of observations with the plane table are as follows :—

(1) The table must be firmly set on its tripod, with the point on the paper from which the observations are to be taken placed immediately above the corresponding point on the ground. There are two ways of placing a point on the paper over a point on the ground.

The simple but more tedious is to have two double plumb lines hung over the board as shown in Fig. 61. These consist of pieces of thin cord with a weight attached at each end. These are hung across the board so as to be roughly at right angles to one another, with the bobs nearly touching the ground, and intersecting at the point in question on the paper. The point on the ground is marked by a peg, A, and (a) is to be placed vertically above A. The observer stands a little way from the instrument until he gets the two hanging portions of one of the lines to coincide, thus forming a vertical plane. The table must be moved until the plane so fixed appears to cut into the middle of the peg.

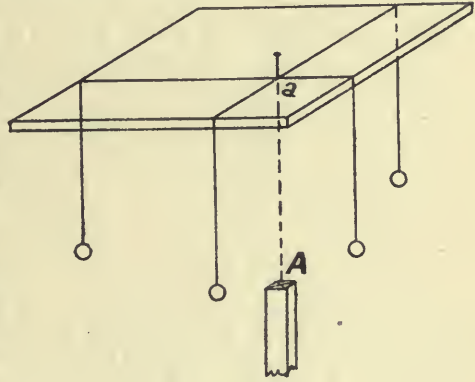

FIG. 61.

The second line is now tried and the table again shifted. This goes on until both pairs of lines appear to coincide with the peg. Where the point on the paper does not happen to coincide with the centre of the table and at the same time a given line on the paper has to be set so as to point in a given direction, the series of operations necessary may be found somewhat slow and tedious, as each translational movement of the table must be made by shifting the legs of the tripod. A double sliding movement allowing the board to be moved to a small extent backwards and forwards and sideways would be an extremely useful addition to the instrument for some kinds of work.

The other method is to use a light frame as shown in Fig. 60. The frame carries a point which rests on the paper on the lower side of its upper arm. A plumb bob hangs from near the end of the lower arm, and the frame is so balanced that the point of the plumb bob is vertically below the point which touches the paper. It is obvious that a device of this kind will render the setting of the table in the desired position a much quicker and easier operation than where two plumb lines have to be manipulated. It is important that the upper arm of the

frame, which is best made of light wood, shall be considerably longer than one-half the greatest length of the board.

(2) *Levelling the Table.*—After the instrument has been set in the correct position on the ground, it having during this operation been roughly levelled, it must be accurately levelled by means of the bubble tube and the three levelling screws.

(3) *Taking the Observations.*—For any given position of the plane table there is only one point from which the direction lines radiate. It is convenient to mark this point on the paper by inserting vertically a needle, which should be as fine as possible. The observer now places the alidade so that its fiducial edge rests against the needle, and directs his sights or telescope to the first point which has to be observed, care being taken that the end of the straight-edge farthest from the observer projects slightly beyond the edge of the table. When the observer is satisfied with his coincidence, he rules a line from the needle or near it to the edge of the paper. A hard pencil with a fine chisel point should be used. The point observed must be denoted by a number or letter of the alphabet, and when a line is ranged towards it and ruled on the



FIG. 62.

paper, the reference number or letter should be at once written close to the line itself. The best way of doing this is shown on Fig. 62. Here it will be seen that the reference number is enclosed in a rectangle lying close to the line itself. These numbers should be placed as near the edge

of the paper as possible as the lines radiate from points, and the nearer they are to the edge of the paper the further from each other they will be. This lettering of the lines is most important, especially where there are many points on the survey in question. When perhaps a hundred lines have been drawn from one station, and the plane table is moved to a second station and another hundred lines drawn each to intersect one of the first set, the greatest care is required to make sure that the points are fixed upon the paper by the intersection of the proper lines. Usually it will be found most convenient to mark each point as its second or intersecting line is drawn: this will be found much quicker than drawing all the lines from the two points and then hunting for the intersections afterwards. Another reason why it is better to complete the fixing of the points as the work proceeds is that if there is any doubt about the identification of any line drawn from the first point the uncertainty is more easily cleared up in the field than afterwards.

Putting in Contour Lines with the Plane Table.—Under some conditions it will be found that a plane table is very useful for putting in contour points rapidly and with a fair amount of accuracy. Such a piece of work is indicated on Fig. 63. This refers to a number of contours which were set out by the author's students as part of their work. The contours were set out at differences of height of 10 feet and run along part of one side of the valley, the individual points being marked by small pegs driven into the ground as the points were

found. On each peg was a slip of paper containing the number of the contour and the number of the point on that contour. After the points had been fixed with the level and marked on the ground the plane table was set up successively at several of the principal stations on the main base line. From each of these points as large a number of observations as possible were taken and the corresponding lines drawn, care being taken that the triangles formed were well conditioned. When starting from the station nearest one end of the base line, all points clearly visible from it were observed, the lines drawn, and the number corresponding to each point clearly marked in the manner described. On this being completed from one station the instrument was moved on to the next station and observations taken to these same points so as to fix them. Further observations were also taken to those points which came next in order but had not yet been observed, and so on until the lines were completed.

The actual observations were taken to a surveying pole held on each peg successively. The man held the pole vertically on the peg and

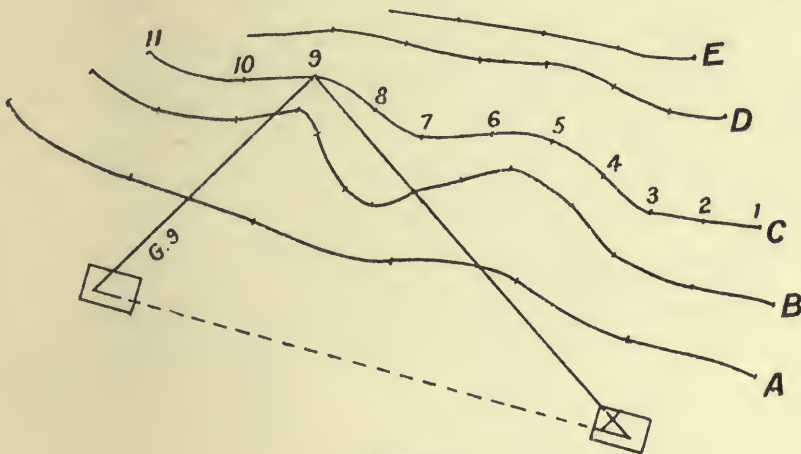

FIG. 63.

the observer at the plane table moved his telescope on to it and ruled his line. When this was done the man at the peg shouted or signalled—where the distance was too great for the sound to be heard—the reference number of the point, which was then written down against the line. In the cases of the more important points and where a clear view could be obtained, observations were taken from a third point so as to provide a check on the first two lines.

By pursuing systematically a plan of this kind the points can be put in very quickly and the contour lines completed as the work proceeds. Where the area is a large one extending some distance along a valley, the work of fixing the points with the level can be going on at the same time as the plane table observations, so long as the level keeps sufficiently ahead of the plane table.

In work of this kind it is well to ink in the contours soon after they have been fixed, so as to prevent any possibility of their being rubbed or washed out.

Radiation with the Tacheometer.—A large part of the time taken up in doing plane table work is used in setting up and levelling the instrument. It is at best not a very rapid operation, and it is always necessary that it be well and correctly carried out, as the accuracy of the later work depends upon it. For this reason the favourite method to be employed for ordinary topographical work is the “method of intersection” where one is able to take the maximum number of observations with the minimum amount of shifting the instrument, and this is why the “method of radiation” is less suitable. But the increasing use of tacheometric methods has brought about a change. By having stadia hairs fitted to the telescope a large number of points may be put in from one point by fixing the directions in the usual way and at the same time taking stadia readings from which the distances may be determined and plotted direct on the paper from the points in question.

Military Plane Table (Fig. 64).—The kind of plane table used for military purposes and for route surveying is made much smaller and

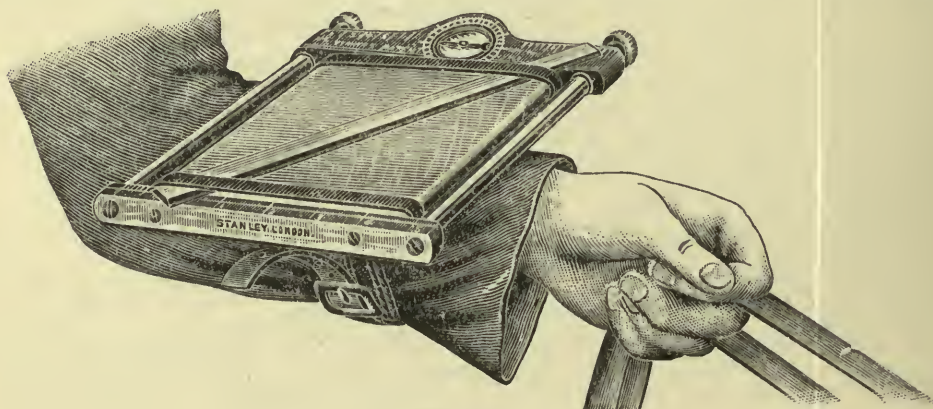

FIG. 64.

lighter than the one described: no telescope is used. Where the instrument is to be used on horseback the instrument is held horizontally in the hands or strapped on the wrist. Of course, in such a work a high degree of precision is not possible, accuracy being sacrificed to speed.

Hints.—To prevent the paper getting wet during sudden showers of rain it is always advisable to carry a bicycle cape or special mackintosh sheet to throw over the instrument when the need arises.

The intense white of the paper will sometimes be found troublesome in bright sunlight, and dark glasses should be worn by the operator.

The following rules should be observed in order to ensure the greatest possible accuracy:—

- (a) The point from which the lines are drawn should be placed exactly over the point on the ground.
- (b) The board must be placed with its plane horizontal.
- (c) The base line (where one is made use of) must be very accurately measured and scaled off on the paper.
- (d) The line of sight must be set correctly on the point observed.

- (e) The line ruled must be a fine clear line passing through the point of observation on the paper.
- (f) The paper should be kept as dry as possible in order to avoid the effects of expansion due to moisture.



FIG. 64A.—Bridges-Lee Photo-theodolite.

Accuracy attainable.—Baker gives the average error in finding areas with a plain sight alidade as about 1 in 800 in “traversing” and 1 in 600 in radiation.

Photographic Methods used in Topography.—Of late years considerable advance has been made in the use of the camera as a means of recording detail and establishing the positions of points of minor importance. The principle involved is similar to that of the plane table. One of the best known cameras used in work of this kind is the Bridges-Lee Photo-theodolite (Fig. 64A). In using the camera, which is mounted on the horizontal circle of a theodolite, it is set up and levelled at a station whose position on the map has been fixed previously by



FIG. 64B.—Picture from Bridges-Lee Photo-theodolite.

triangulation. The line of sight is directed to some well-defined point on the landscape and the plate exposed. The appearance of the kind of print obtained from the negative is shown in Fig. 64B. It will be seen that the rectangle is intersected by a horizontal and a vertical line which cross in the centre; the line of collimation of the camera lens passes through this point of intersection of the lines. The lines themselves are given by two hairs stretched across the focal plane of the instrument. Near the top of the print is a horizontal scale showing angular distances of objects in the view to the right or left of the centre line; this is given by a transparent scale, also fixed in the focal plane.

The curved scale close to the top edge is obtained from a vertical cylindrical transparent scale carried by the magnetic needle of the compass which is fixed in the bottom of the camera.

From the camera station, therefore, the bearing of the main line of sight is given by the intersection of the vertical hair line with the curved scale. A line having this bearing can be laid down on the map from the known station, and the angular position of any salient feature to the right or left of this line, as shown by the point where a vertical from this feature cuts the horizontal scale, may be set off from the main line of sight.

If views of the same region are taken from two (or more) known stations, intersecting lines from these stations to all clearly defined objects will be obtained, precisely as in the case of the plane table, and these intersections can be marked on the map and the points fixed. If thought necessary, the direction of the line of sight may be checked by taking a reading on the horizontal circle of the theodolite.

The use of the camera as a help to, or in place of, the plane table, has been made chiefly in Canada and Italy; it has also been tried in India. In the opinion of those who have had experience in its use, it possesses great advantages in that it provides general views of the country and that a great deal of detail can be got on one plate; as the greater part of the work is carried out indoors the process is relatively cheap. On the other hand, the results for purely topographical work are believed to be less accurate than those given by the plane table.

CHAPTER IV

INSTRUMENTS USED IN THE MEASUREMENT OF ANGLES

THE SURVEYING TELESCOPE—THE SEXTANT

Surveying Telescope.—The telescope forms an important part of all optical instruments of precision used in surveying. It will be convenient to examine its principles and construction in some detail before going on to consider the instruments in connection with which it is used.

The surveying telescope has two main functions to perform, namely, to create an image of the distant object on a fixed plane within its tube, and, at the same time, to enable the observer to see this image with

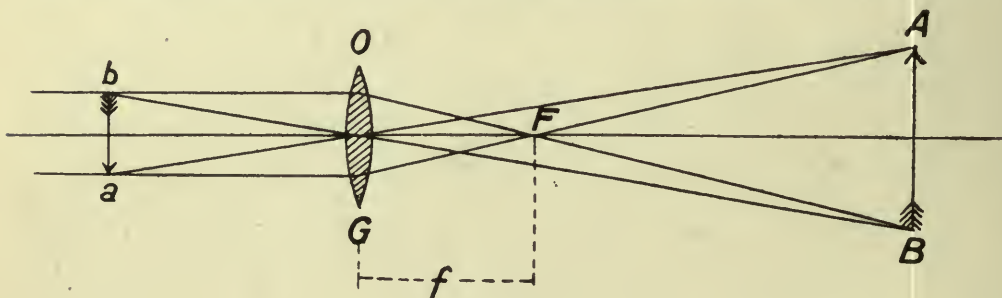

FIG. 65.

clear definition. The first of these functions is performed by a double convex lens called the "object glass," and the second by means of a combination of small lenses called the "eyepiece."

The manner in which the image is formed by a double convex lens is represented on Fig. 65. Here the lens is OG , the object whose image is to be formed is AB , and the image so formed is ab . Such an image might be thrown on a screen as in the case of a camera; in the present case it is formed in a plane which is at the same time at the focus of the eyepiece through which it can be observed. In considering the formation of the image, it will be seen that from the top A of the object two rays of light are shown by lines, one of which passes through the centre of the lens OG , and the other, in passing through the lens, is deflected and passes down the tube parallel to its axis. These two rays meet at a , which is in the focal plane of the lens for this particular

position of AB. There must be an infinite number of rays passing from A and meeting in a after traversing the lens. The point a will be the image of A. Similarly an image of B is formed at b , and so for all intermediate points, until a complete inverted image of the object is formed. The position of the focal plane wherein the image lies will vary according to the distance of the object from the lens. The further the object is removed the nearer is the focus to the lens. When the object is at an infinite distance, so that its rays are parallel

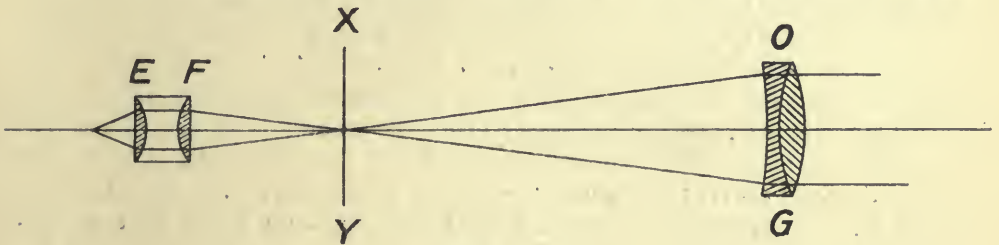

FIG. 66.

as they strike the lens, the image will be formed at the principal focus. This occurs in the case of light from the sun and the principal focus is sometimes called the "solar focus." In the case of the present lens the principal focus, on the side of the object, where parallel rays from ab are brought to a focus, is marked F, at a distance from the lens f .

The arrangement of the lenses in a surveying telescope is shown in Fig. 66. Here OG is the "object glass" consisting of an achromatic double convex lens. The principal focus is in the plane XY. The eyepiece, whose focal plane coincides with that of the object glass, is

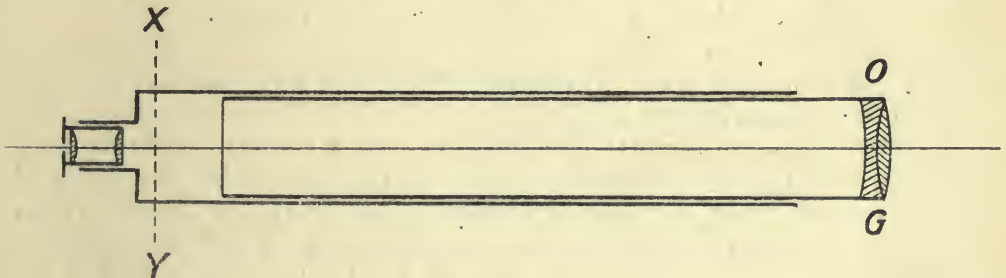

FIG. 67.

marked EF, and consists of two plano-convex lenses of which E is spoken of as the "eye glass" and F as the "field glass." In the Ramsden eyepiece, which is the one most generally used in surveying instruments, the distance apart of the two glasses is two-thirds of the focal length of either lens, the convex surfaces facing one another.

The body of the telescope (Fig. 67) consists of an outer tube which is rigidly held to the frame of the instrument, an inner tube carrying the object glass or objective OG, which slides into the outer tube and which is controlled by a rack and pinion, and the eyepiece which is built in a third tube also arranged to slide relatively to the main tube. The focal

plane XY is stationary and is defined by spider webs (or other substitute) affixed to a frame within the tube. These constitute what is known as the "diaphragm" of the telescope.

When using the telescope the observer begins by focussing the eyepiece on the webs until they are seen with great distinctness. He next focuses the object on the webs by racking the tube which carries the objective in and out until he can see the object with absolute clearness. When this has been done the image will have been formed in the common focus of the eyepiece and the objective.

If either the eyepiece, the object glass, or both have been improperly focussed there will exist what is called "parallax." This is seen when the observer, on looking through the eyepiece and at the same time moving his head slowly from side to side or up and down, notices that the webs appear to move with respect to the image of the object. When there is correct focussing the image formed by the objective, the plane formed by the webs of the diaphragm, and the focus of the eyepiece should coincide. When these conditions are not attained there must be parallax, and the lenses should be adjusted again until the

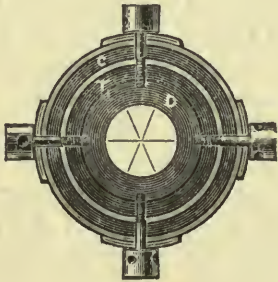

FIG. 68.

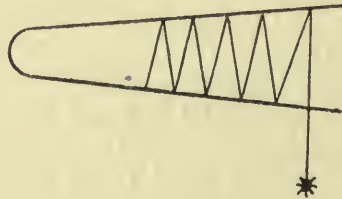

FIG. 68A.

image of the object appears to be perfectly steady on the webs, no matter how the observer's head is moved.

The diaphragm plate (Fig 68) is attached to a stout brass ring concentric with the telescope tube and held in position by two pairs of screws which pass through a thickening of the main tube. These screws, besides holding the plate in position, can be used for adjusting the position of the webs so that the centre of the diaphragm may be set in the centre of the tube.

The "cross-hairs" or "cross-wires" or "webs" are made of several materials. Spider webs are good, but very delicate and easily destroyed. The web should be spun by a live spider on to a wire frame (Fig. 68A). On the diaphragm plate are generally marks showing where the webs are to be placed. When the webs have to be renewed the wire (Fig. 68) is held above the frame so that a web is just over one of the lines. It is then gently lowered until the web touches the plate and a drop of shellac varnish put on each of its ends and the loose ends cut away.

In such a way the webs can be fixed on the diaphragm plate, one at a time. Great care and a considerable amount of practice are

needed before the work can be done quite satisfactorily. In cases of emergency and in places where the help of an instrument maker cannot be called upon, the surveyor may be thrown on his own resources and compelled to replace webs when they have been broken. If he can catch a small garden spider and persuade it to spin a web from the wire frame which he has prepared, he may not have much difficulty in replacing his webs. But if a live spider cannot be found he may be compelled to use such unsatisfactory substitutes as pieces cut from the old webs which are found in barns and old buildings generally, or pieces of fibre taken from the cloth of his own coat. Of these, the old web is nearly always dirty and covered with small specks of dust, and the wool fibre is as a rule too coarse. It is said that old webs may be cleaned by placing them in warm water, but the writer cannot speak from experience on this point. He has used old webs, and has found that by placing the cleaner bits so as to come on the essential parts of the image a very satisfactory substitute is obtained. The coarser fibre may be used in a level if the reading is always taken on the edge of the web.

On Fig. 69 are shown four examples of the arrangement of webs in surveying telescopes.

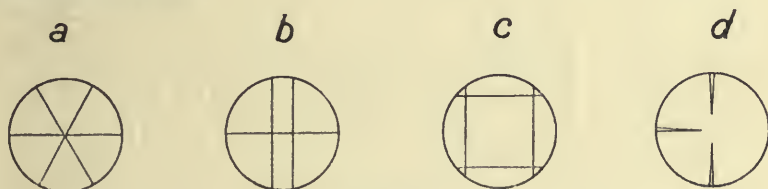

FIG. 69.

(a) Shows the most usual arrangement of webs in a surveying theodolite—one horizontal and two inclined. The intersecting point of the three webs should coincide with the axis of the telescope tube.

(b) Shows the arrangement of the webs in a level—one horizontal web, on which the readings are taken, and two vertical webs which serve as a guide in focussing the telescope on the levelling staff.

In the third case (c), which is that of a sextant telescope, the webs are placed so as to form a square.

The arrangement (d) is one known as Stanley's Point Diaphragm, in which webs are done away with altogether and points substituted. These are practically indestructible and are said to give very satisfactory results. The metal used in the manufacture of these points is an alloy of platinum and iridium, which resists the attacks of moisture and acids in the atmosphere.

As being more lasting than spider webs, fine webs of silk have been used with success.

A very durable form of diaphragm is a thin glass plate upon which lines are scratched with a diamond and blackened. This device provides very fine lines which are practically everlasting. The writer has made these from microscopic cover glasses, scribing the lines with

a scratching diamond. After preparing the glass it can be fixed in place with Canada balsam. Any one who attempts to make these line glasses for the first time will probably destroy a few before he gets one that is entirely satisfactory, but when once obtained the result is excellent. It is sometimes objected that these glasses cut off some of the light passing through the telescope and that they easily get fogged by moisture in the air, but these troubles are easily overcome, and are hardly sufficient to militate against the use of glass diaphragms.

Very good webs have been made with platinum wires. These are drawn very fine and then covered with silver. The combined wire is now drawn out as before and the silver eaten away with acid, leaving an extremely fine platinum wire which may be fixed on the diaphragm plate.

The Sextant.—The sextant may be used for measuring angles between lines in any plane, whether horizontal, inclined, or vertical. The angle measured is that made by lines of sight radiating from the observer and cutting two distant objects. In instruments of the theodolite type, such an angle is measured by first setting the line of sight on one of the points and then setting it on to the other point and noting the angle turned through by that part

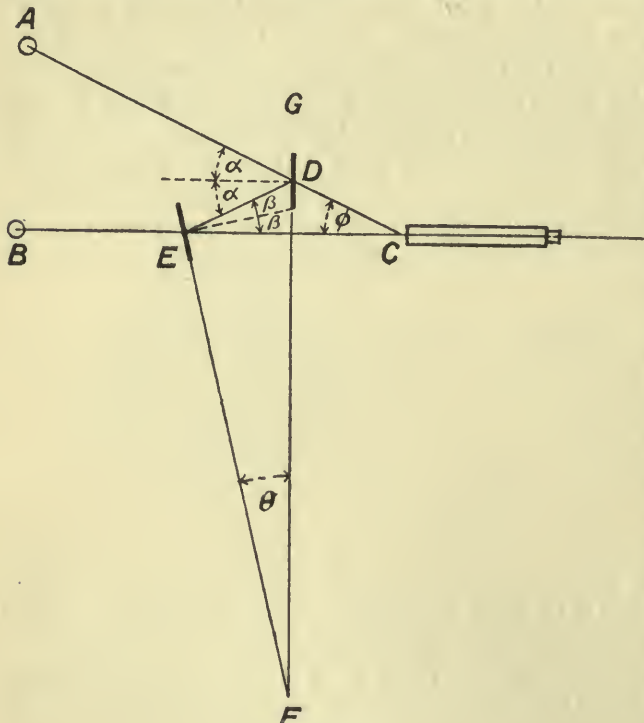

FIG. 70.

of the instrument which has been moved, that is, three operations are required to measure the angle.

In the sextant, the angle is measured in two operations, by one of the lines of sight coming straight to the eye of the observer and the other reaching the eye after being reflected from two mirrors. The angle between these mirrors can be measured and from it the angle between the lines ascertained.

The principle upon which the sextant depends is represented on Fig. 70. Here A is one of the points observed and B is the other, while the observer is at C. The problem is to measure the angle ACB. The two mirrors are placed one at D and the other at E. The mirror at D is completely silvered, while that at E has its lower half silvered, the upper half being left clear. Suppose the stations A and B to be

marked on the ground by vertical poles. The observer, looking towards B through the unsilvered part of the mirror E, sees a direct image of the pole. At the same time he sees an image of A by reflection first from the mirror D and then from the silvered portion of E. This is on the supposition that the mirrors have been set at the correct angle.

In the case of double reflection of this kind the angle formed by the lines of sight from the objects is twice the angle between the planes of the mirrors.

This depends on the well-known fact that where a ray of light is reflected from a plane surface, the angle which the ray makes with the normal to the plane at the point where it strikes the surface is equal to the angle which it makes with the same normal after reflection.

Referring to Fig. 70, it will be seen that the angle between the lines of sight is marked ϕ , and that between the faces of the mirrors is θ . Also, the angles of incidence and reflection at D are marked α , and the corresponding angles at the mirror E are marked β .

To prove that $\phi = 2\theta$, in the triangle EDC

$$\text{the exterior angle ADE} = \text{DEC} + \text{DCE}$$

$$\begin{aligned} \text{that is,} & \quad 2\alpha = 2\beta + \phi \\ \text{or,} & \quad \phi = 2(\alpha - \beta) \end{aligned}$$

Again, in the triangle DEF,

$$\text{the exterior angle GDE} = \text{DEF} + \text{DFE}$$

$$\begin{aligned} \text{or,} & \quad (90 + \alpha) = (90 + \beta) + \theta \\ \text{that is,} & \quad \theta = (\alpha - \beta) \\ \text{But} & \quad \phi = 2(\alpha - \beta) \\ \text{therefore} & \quad \phi = 2\theta \end{aligned}$$

The mirror E is fixed to the frame of the instrument, and D is fixed on a pivot in such a way that after the radial arm has been set so that there is coincidence between the direct and the reflected images, the angle at F, which is one-half the required angle at C, can be read off on a graduated arc. The divisions are so numbered that the doubling is done in the graduation and the angle ϕ can be read off directly. In the case of the two poles mentioned above the appearance of the direct and reflected images would be that of one continuous pole.

A general view of a sextant of the ordinary type is shown on Fig. 71. The various parts are carried by a rigid brass frame, whose shape is roughly that of one-sixth of the arc of a circle, to which are attached two radial pieces. At the junction of these, which is the centre of the circle, is pivoted a rotating arm carrying over the centre the silvered mirror, and at its outer end a vernier moving over the graduated arc.

The fixed half-silvered mirror is called the "horizon glass," and that attached to the arm is called the "index glass."

A telescope is fixed to the frame opposite the horizon glass, and dark sun glasses are provided for use when taking solar readings. The vernier at the end of the arm can be clamped and set to its exact position by means of a tangent screw; there is also provided a

microscope for reading the vernier. The telescope is not an absolutely necessary part of the sextant, and readings on objects not very far away can be taken without it.

Adjustments of the Sextant.—In order that the sextant may give accurate readings within its intended limits of precision the following conditions must be satisfied, and to ensure these a number of tests have to be applied and suitable adjustments made. The adjustments which

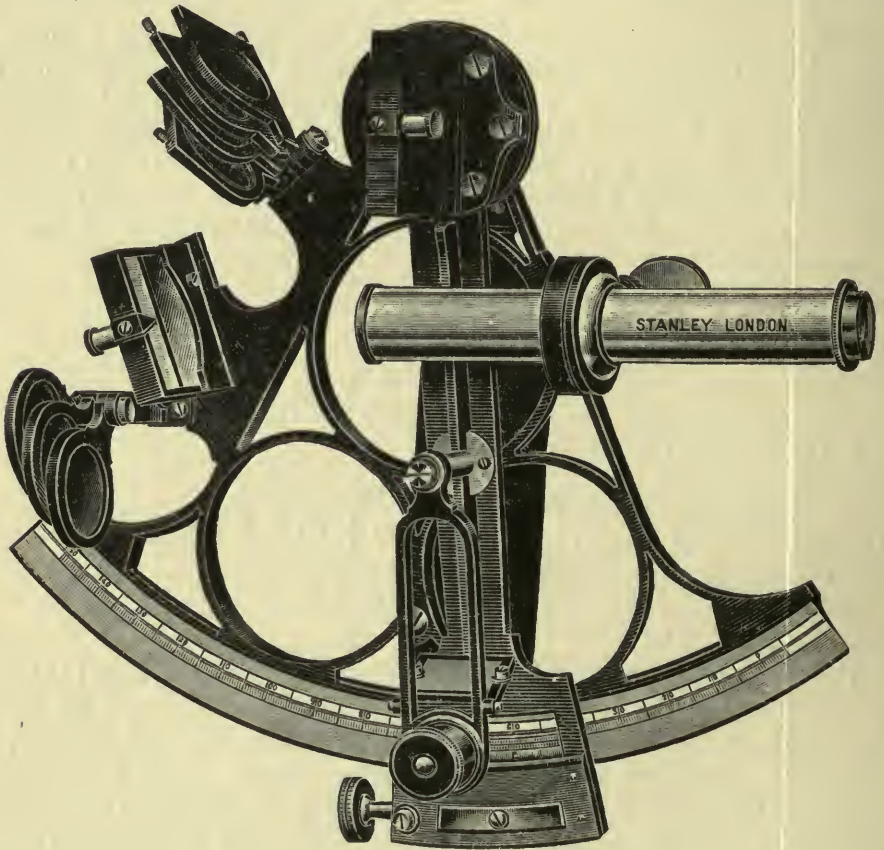

FIG. 71.

the surveyor himself may make are the following ; others of a more permanent nature must be made by an instrument maker.

In most optical measuring instruments the adjustments can be divided into temporary and permanent adjustments. The temporary adjustments are those which are needed each time the instrument is used. The permanent adjustments are those which have to be made from time to time in order to ensure the accuracy of the work done with the instrument. In the sextant the only temporary adjustment is that of the telescope, which is to be so set that the cross wires are seen distinctly through the eyepiece, and the object glass focused so that the observed object is seen clearly. The reason for these telescope adjustments will be explained in greater detail when the telescopes of the theodolite and level are discussed.

Permanent Adjustments.—(a) Index glass should be perpendicular to the plane of the instrument. The plane of the instrument is perpendicular to the axis about which the index arm rotates; the reflecting surface of the index mirror must be perpendicular to this or parallel to the axis of rotation.

Set the vernier to read somewhere about 40° , and looking into the index glass, see whether the graduated arc and its image in the glass appear to be continuous. If they are not continuous the above condition does not hold, and the mirror must be tilted until continuity is attained. It will be seen that three small screws are provided for the purpose of making this adjustment, the one further from the mirror for raising the foot, and the remaining two for drawing the foot down to the plane of the instrument.

(b) The horizon glass should be perpendicular to the plane of the instrument.

Set the index to zero, and, looking at a distant object, such as the horizon, see whether the direct image appears at the same height as the reflected image. If not so, adjust as before.

(c) Horizon glass and index glass should be parallel when the vernier reads zero. If not, there will be an index error. Sight on to a vertical line, such as is provided by a surveying pole or the corner of a building, and bring the direct and reflected images into coincidence, so that the line appears unbroken. The index should then read zero. If this is not so, the horizon glass is to be adjusted about its vertical axis until continuity is attained. There is usually a small screw supplied for making this adjustment. Another way of testing this adjustment and ascertaining the index error is to put the sun glasses in place and set the telescope on the sun, so that its upper and lower limbs appear to just touch (see Fig. 72), first on one side, then on the other. Here the correct diameter of the sun subtends the angle ϕ , but in one position is given by α , and in the other position by θ . The index error is $\alpha - \phi$ for one position, and $\phi - \theta$ for the other. Then

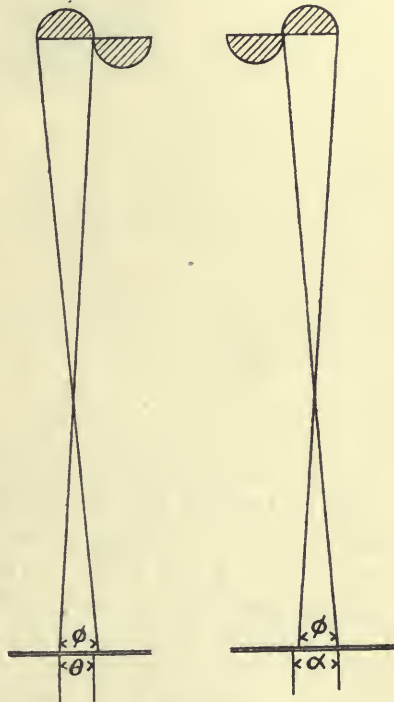

FIG. 72.

$$\text{Twice the index error} = (\alpha - \phi) + (\phi - \theta)$$

or
$$\text{Index error} = \frac{\alpha - \theta}{2}$$

Where no provision is made for altering the position of the mirror this index error must be taken into account when making calculations;

where means of adjustment are provided the mirror must be set in position as before.

(d) The line of collimation is to be parallel to the plane of the instrument.

To test for this, set the instrument so as to bring into coincidence two objects whose directions are about 90° apart, then move the instrument slightly about an axis through the object which is seen by reflection. If the adjustment is correct the coincidence will remain intact.

When using the sextant it must not be forgotten that the angles measured lie in the plane of the instrument or in planes parallel to it,

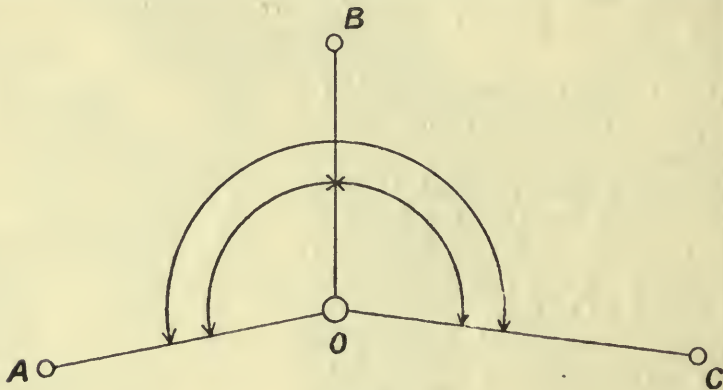

FIG. 73.

so that to measure the horizontal angle between two points the instrument must be held so that its plane is horizontal. There is some difficulty in measuring the horizontal angle between the vertical planes traversing two points of which one lies below the other, and the possibility of doing this is limited by the size of the glasses.

An angle which is much greater than 100° can only be measured with a sextant by splitting it up into two or more angles, measuring each of these separately and adding them together. Thus on Fig. 73 the angle AOC is too large to be measured in one observation. A subsidiary station is taken at B and marked with a surveying pole placed vertically in the ground. The observer then measures AOB and BOC, each in turn, and the whole angle

$$AOC = AOB + BOC$$

Ordinary surveying sextants are generally divided to read with the vernier to the nearest 20 seconds of arc or $\frac{1}{180}$ th part of one degree. The Admiralty pattern reads to the nearest 10 seconds. The graduations are generally on silver and marked up to 120° , but it is not often easy to actually bring into satisfactory coincidence two objects at so great an angular distance apart as this.

For use in topographical work the most useful form is that of the **Box Sextant**, which is similar in all essentials to the one already described, but is smaller and more compact. A general view is

shown on Fig. 74. The body of the instrument consists of a circular brass box. The arm which carries the vernier is seen moving over the graduated arc on the top of the box, being moved over this arc by the larger of the two milled heads. A lens is provided for reading the divisions. These give a reading to the nearest minute of arc. A telescope is sometimes provided, though observations are generally taken through a small hole in the side of the box, the line from the reflected object coming in through a larger opening opposite the index glass. What appears as the lower part of the box in the figure is really the cover,

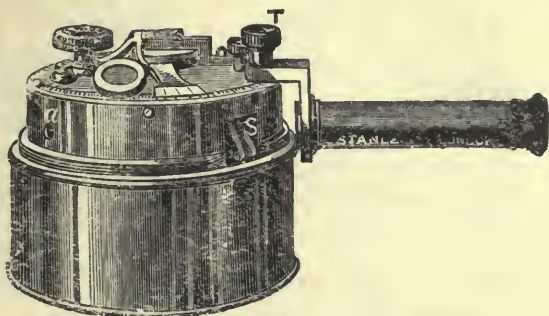

FIG. 74.

which can be unscrewed from the position shown and screwed down to the instrument so as to completely cover it. The diameter of a box sextant is generally about 3 inches.

When taking an angle of elevation with a sextant the angle must be that between the object and the edge of the distant horizon, allowance being made for the height of the observer, or an **Artificial Horizon** must be employed.

In Fig. 75 the eye of the observer is at E, and he is looking towards a distant object, as the sun, at O. Rays from a distant object to the

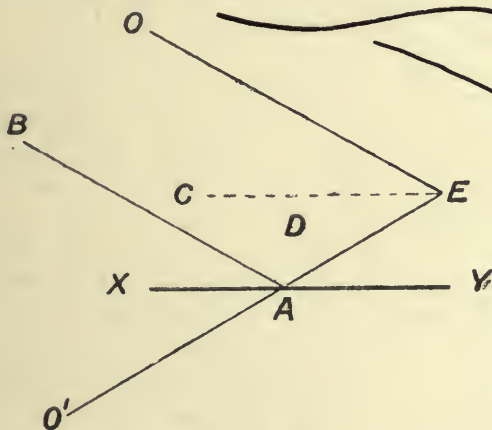

FIG. 75.

immediate neighbourhood of the observer will be sensibly parallel, that is, in the figure, BA will be parallel to OE. The ray from B striking the reflecting surface at A will have equal angles of incidence and reflection, that is, $BAX = EAY = OEC = CEA = XAO'$, where O' is the reflected image of O as it appears to the observer. The observer measures with his sextant OEO' or the angle between O and its

reflection; this is double of OEC or BAX , which are the angles of elevation required. So that the observer, after measuring OEO' , has only to halve this angle and his angle of elevation is obtained.

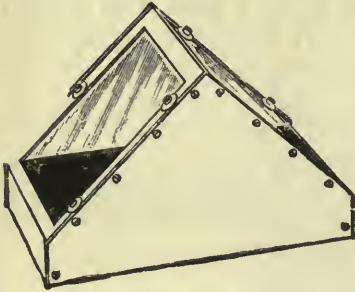

FIG. 76.

The artificial horizon itself consists either of a trough of mercury or a sheet of blackened glass which has been fixed in a perfectly horizontal position. The former is shown on Fig. 76, and consists of a shallow vessel into which mercury is poured from its containing bottle. Its size is about 6 inches \times 3 inches. A more portable form is made with the

mercury vessel attached to the small circular dish with which it can be connected.

The blackened glass horizons are more portable than the mercury ones, but their efficiency depends on their being set in a truly horizontal position.

CHAPTER V

INSTRUMENTS USED IN THE MEASUREMENT OF ANGLES (Continued)

THE THEODOLITE

THE theodolite is used for the purpose of measuring angles between lines in a horizontal plane, or "in azimuth," or between intersecting vertical planes; and for measuring the angles of elevation or depression of points above or below the horizontal. It has other uses of a subsidiary nature, but the above are the chief ones for which the theodolite is designed.

A diagrammatic sketch of a theodolite is shown on Fig. 77. Commencing from the top of the instrument, the line LC represents the "line of collimation" or "line of sight" established by the lenses and diaphragm of the telescope. This telescope is attached to the horizontal axis HH, about which it can turn so as to rotate in a vertical plane. The line of sight is placed perpendicular to the axis about which it rotates.

The horizontal axis turns in bearings carried by a frame fixed to the vernier plate VP, which rotates in a horizontal plane about the vertical axis VV; the horizontal axis should be placed at right angles to the vertical axis.

It is absolutely essential to the proper working of the instrument that the conditions named, namely, *the line of collimation at right angles to the horizontal axis*, and that *the horizontal axis at right angles to the vertical axis*, be maintained.

The lower end of VV is ultimately attached to the tripod which carries the instrument. Connected with this is the "horizontal limb" or "horizontal circle," HL, down the centre of which is the bearing in which turns the axis of the vernier plate VP, and, as this carries the

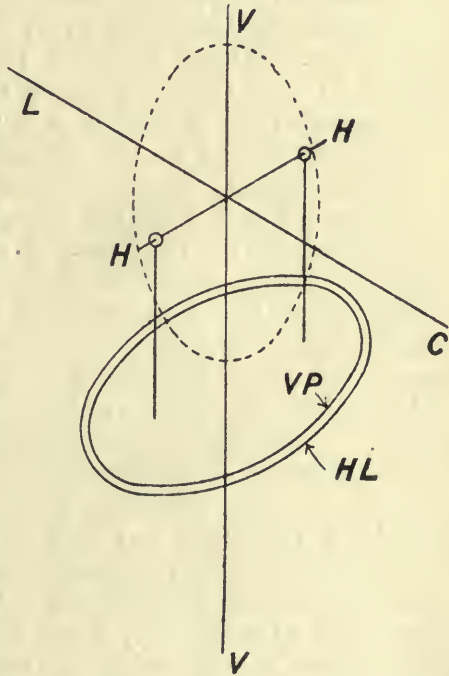

FIG. 77.

brackets which support the horizontal axis, everything which is above HL is able to revolve in this bearing. There are in fact two vertical bearings, one within the other. These are, (*a*) the bearing of the horizontal circle in the upper parallel plate which forms part of the upper end of the tripod; and (*b*) the bearing, formed on the horizontal limb, in which turns the axis of the vernier plate.

The axes of these two vertical bearings should be coincident.

In measuring a horizontal angle with the theodolite, the observer first sets his line of sight so as to cut the left-hand station point of the two between which the angle lies, and takes the reading of the verniers on the horizontal circle. He next turns the vernier plate and sets his line of sight on the right-hand station point, and again reads the same vernier in this second position. The difference between the two vernier readings will be the angle required.

Theodolites are made in various sizes to suit the kind of work for which they are intended to be used. The two commonest sizes used for survey work are probably the 5-inch and 6-inch, these numbers referring to the diameters of the graduated circles. In some instruments the telescope is supported in such a way that it may be rotated completely about the horizontal axis; while, in others, a partial rotation only is permitted. Where complete rotation is possible the instrument is called a "transit theodolite," and the turning of the telescope end for end, through 180° , is spoken of as "transiting."

The details of a 6-inch transit theodolite are shown on Fig. 78. It will be seen that the view is partially in section.

Here the lower "parallel plate," N, is screwed to the top of the supporting tripod. On the inside of this lower parallel plate is formed a spherical bearing against which fits part of the prolongation of the upper parallel plate L. The whole is kept in position by four plate screws which fit into nuts fixed in the upper plate and whose free ends rest against the lower plate, their turning being effected by means of the milled heads, M. There are four screws, placed at the four corners of a square. These are worked in pairs to place the body of the instrument in a horizontal position. The whole weight of that part of the instrument above the lower plate is supported on the four screws, and these should be tightened just sufficiently to keep the upper plate piece resting against its bearing surface on the lower plate and to prevent any shake or looseness between the bottom surfaces of the screws and the lower plate on which they rest. It is important to remember that the plate screws should never be screwed up hard or some permanent straining of the instrument may result.

The "body piece," marked T and T' in the figure, terminates at its lower end in a long cone which finds a bearing in a corresponding coned hole in the upper parallel plate, and in which bearing it can turn completely round. This is the vertical axis.

The clamp collar K fits round the body piece and can be made to grip it by turning the clamp screw shown. A screw marked P turns in a bearing fixed to the upper parallel plate and screws into a nut attached to the axis clamp.

When the clamp screw K is tightened the clamp is practically part of the body piece T, and this can be turned through a small angle relatively to the upper plate L by means of the tangent screw P. If the

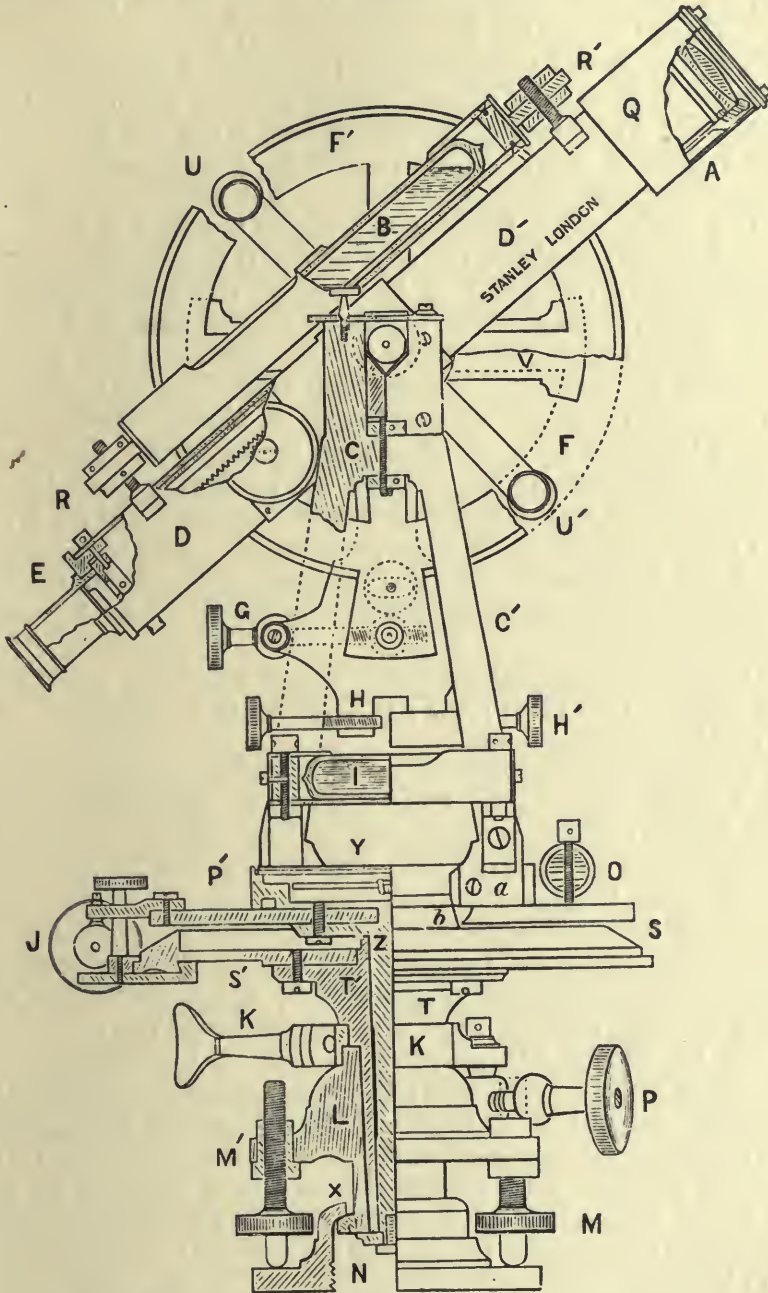

FIG. 78.—Details of 6-inch transit theodolite.

vernier plate is clamped to the horizontal circle, the telescope may be set on a station point by loosening the clamp K, and then setting the telescope roughly in the right direction. The clamp is now tightened

and the cross-webs placed exactly on the station by making use of the controlled slow motion given by the screw P. The "central axis" is marked Z and is shown in half-section. This axis, which carries the vernier plate, is seen to turn in a coned bearing inside the body piece already referred to. As the horizontal circle is attached to this body piece the central axis is the one which rotates when the vernier plate is turned upon the horizontal circle. There is also a slow motion given to this movement by means of the tangent screw marked J. This screw turns in a bearing fixed to the vernier plate and passes into a nut attached to the clamp which takes hold of the edge of the horizontal limb. The screw which tightens this clamp is shown in the figure, its milled head being just above the edge of the vernier plate.

Assuming the vertical axis to be clamped and the horizontal circle to be unclamped, it is clear that the vernier plate can be turned with respect to the horizontal circle quite freely. After rotating the vernier plate by hand, the brackets C' being taken hold of, so that the telescope is nearly on its point, the tangent screw is clamped and the screw J turned until the cross-webs are exactly on the required station.

These movements may be summed up by saying that *the vernier plate can rotate with respect to the horizontal circle*, and that *the horizontal circle can rotate relatively to the upper parallel plate*, and, consequently, to the tripod and the ground; and that for each of these two there is an arrangement whereby the movement can be clamped and controlled by a screw.

The *Compass* which forms a part of every theodolite is contained in a box of brass. This (Fig. 78, Y) is fastened to the plate which forms the body of the horizontal circle.

The suspended needle points to a circle which is generally graduated in modern instruments, from 0 to 360, North being 0°, East 90°, South 180°, and West 270°. Sometimes the division of the circle is made similar to that of a circumferentor or dial, so as to enable bearings to be taken, or this may be done on an additional circle.

The needle itself is suspended on a hardened steel point, the "cup," which rests on the point, being formed out of agate or some similar hard stone. Means are always provided by which the needle may be lifted from its point of suspension when not in actual use.

On the top of the vernier plate are screwed the standards, or "A frames," which are used to support the bearings of the horizontal axis. These bearings consist of Vs in which rest the ends of the trunnions or pivots projecting from the sides of the telescope. At the top of one of the A frames there is an arrangement by means of which the bearing may be raised or lowered to a small extent. This provision is made for the purpose of adjusting the horizontal axis that it may be perpendicular to the vertical axis.

To one of the trunnions or pivots is fixed the vertical circle FF', which turns with the telescope and moves over two fixed verniers marked V. These verniers turn freely on the trunnion, but can be fixed in any position relatively to the A frame by means of two screws H, H'.

The vertical circle can be clamped to this frame which carries the verniers, and a slow motion given to it through a tangent screw.

The "readers" or reading microscopes of a theodolite are simply small microscopes which can be focused on the verniers by sliding in and out of brackets attached to arms which turn easily about the vertical axis. One is provided for each vernier, and, at the commencement of the measurement of a series of angles, the readers can be focused once for all. The observer after setting his verniers has only to look through the readers, after moving them into their right positions so as to be able to read the part of the circle he is particularly concerned with. Readers are provided for both horizontal and vertical circles.

On the top of the telescope tube is fixed the "principal level," which is used when the telescope has to be set in a horizontal position. The level tube is mounted on the telescope through two screws attached to the latter. These screws pass through two plates projecting beyond the ends of the level tube, and these are held in place by a pair of capstan nuts at each end.

Besides this principal level there are usually provided a pair of smaller levels, O and I, placed at right angles to one another; one of these is often attached to one of the A frames and the other to the top of the vernier plate.

The telescope itself is similar to the one described in the last chapter. The diaphragm is provided with three cross-webs, one horizontal and two inclined at about 60° to the horizontal. In instruments which are to be used for stadia work an extra pair of horizontal webs is supplied. Their use will be described when discussing tacheometry.

The manner in which the circles are divided largely depends on the size of the instrument. The numbering of the horizontal circle is always from 0° to 360° , taken from left to right as seen from the centre of the instrument, or "clockwise" when looking vertically down from above the circle.

The vertical circle is divided into four quadrants and reads from 0° to 90° , upwards and downwards.

In 6-inch theodolites the circles are divided directly to the nearest $30'$, or sometimes the nearest $20'$. A further subdivision is attained by means of the vernier of 60 divisions enabling the angle ultimately to be read to the nearest $30''$ or $20''$. In the smaller instruments the subdivision is not so fine, while in the larger theodolites used in geodetic work the ultimate subdivision may be to the nearest 10, 5, or even 1 second of arc. In many of these larger instruments the verniers are replaced by micrometers.

The use of the vernier itself is explained by reference to Fig. 79. Here the vernier is shown in two positions, at (A) and (B). In both these the main or parent scale is marked PS and the sliding vernier which moves along it is VV. In the scales shown the main subdivision is into degrees and half-degrees, the smallest division being one-half degree or 30 minutes. The length of the vernier consists of 29 of the small divisions of the parent scale, and this is subdivided into 30 equal

parts, each of which is $\frac{1}{30}$ th of a division shorter than the smallest division on the parent scale. On Fig. 79 (B) it will be seen that the zero or arrow of the vernier is between divisions 53 and 54 on the parent scale. It is a little more than one half-degree to the left of division 53, that is to say, it is little beyond ($53^\circ + 30'$). The amount by which the reading exceeds $53^\circ + 30'$ is given by inspection of the vernier. On looking along this it will be seen that, say, division 21 of the vernier coincides with a division of the parent scale. This means that the distance between the last division on the parent scale and the zero of the vernier is $\frac{21}{30}$ ths of a division or 21 minutes, because each of

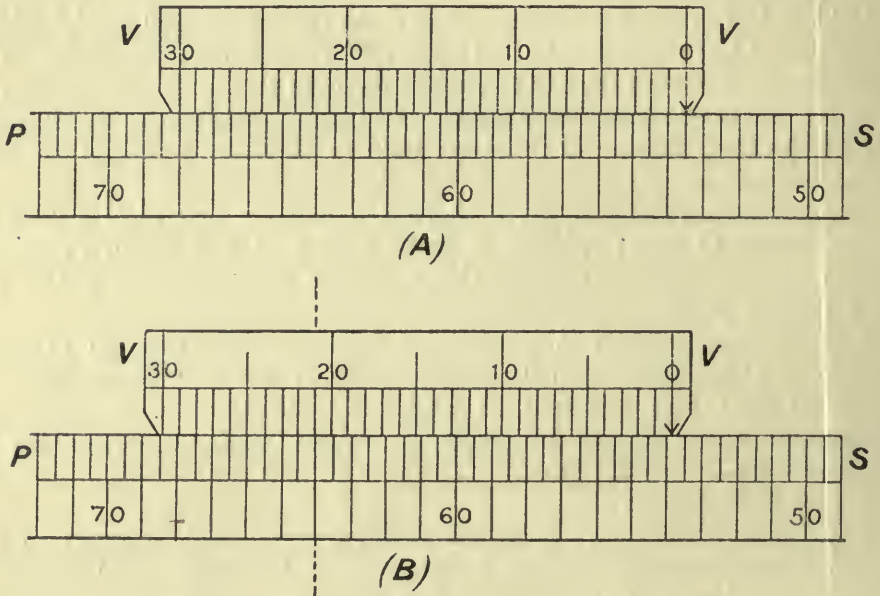

FIG. 79.

the vernier divisions is $\frac{1}{30}$ th less than a division on the parent scale, and there are 21 of these. So that the reading is

$$\begin{array}{r}
 53^\circ \quad 0' \quad 0'' \\
 30' \quad 0'' \\
 21' \quad 0'' \\
 \hline
 53^\circ \quad 51' \quad 0''
 \end{array}$$

In cases where the ultimate subdivision is to $30''$ and $20''$ the parent scale is divided into half-degrees and one-third degrees and the vernier has 60 subdivisions. So that in reading the angle all that the observer has to do is first to note the number of whole degrees up to the zero of the vernier, then the number of subdivisions of the next degree, if there are any intervening between the last main division line and the vernier zero. This last amount may be $30'$, as in the example just given, or it may be $20'$, or twice $20' = 40'$. The remaining number of the smallest subdivisions is then to be found by noting where a line

on the vernier coincides with a line on the parent scale, noting the number on the vernier and adding this to the reading already obtained. After a little practice this angle reading becomes an almost mechanical process.

On Fig. 80 is shown a general view of one of Stanley's old-type 5-inch transit theodolites with four screws; and one of a newer type, in

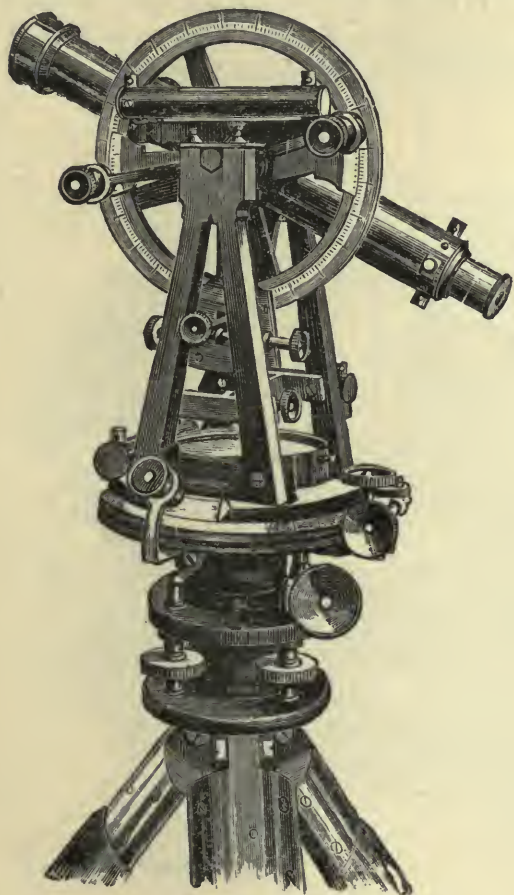

FIG. 80.

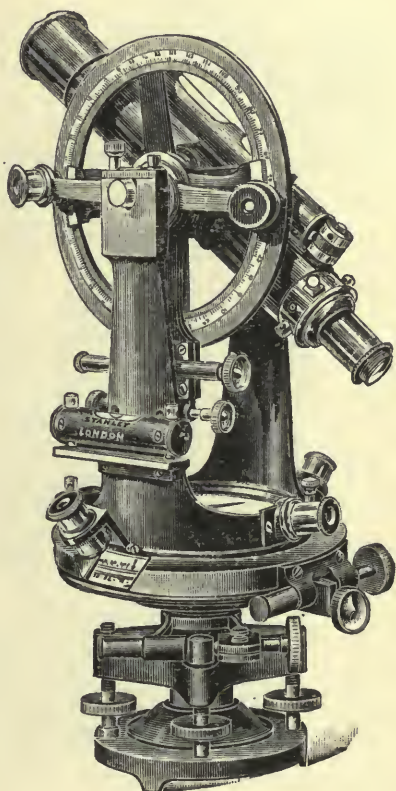

FIG. 81.

which the A frames are replaced by solid standards, is shown on Fig. 81.

A modification which has been introduced in recent years is the substitution of three levelling screws for the old four. A 6-inch transit instrument fitted with this arrangement is shown on Fig. 82. Where three screws are used to carry the weight of the instrument the system is kinematically sound, there being equal pressures on all screws when the instrument is level. Also, there is no possibility of tight screwing and consequent straining of the instrument. The levelling is effected by the turning of one screw instead of two together. The three-screw arrangement gives a more rigid base than the four-screw plan as usually constructed, as the screws work in arms which project further from the

centre than the parallel plates. It should be mentioned, however, that some makers do construct four-screw instruments in which the screws are set further from the centre than in the old-fashioned type (see Fig. 82).

The theodolites referred to so far have been of the transit type, in which the telescope can be rotated through 180° . Two others of the many special theodolites constructed ought to be mentioned.

The Plain Theodolite.—One of these is the “plain theodolite” (Fig. 83). In this instrument it will be seen that the telescope is placed above the vertical limb, which forms part only of a complete circle.

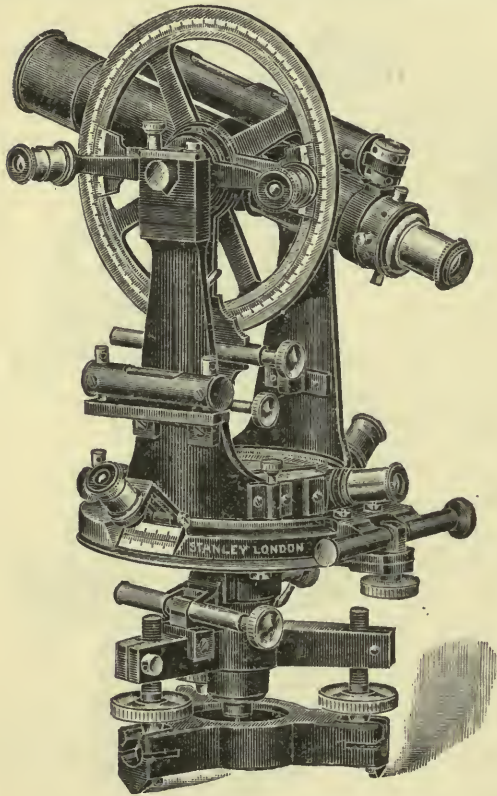

FIG. 82.

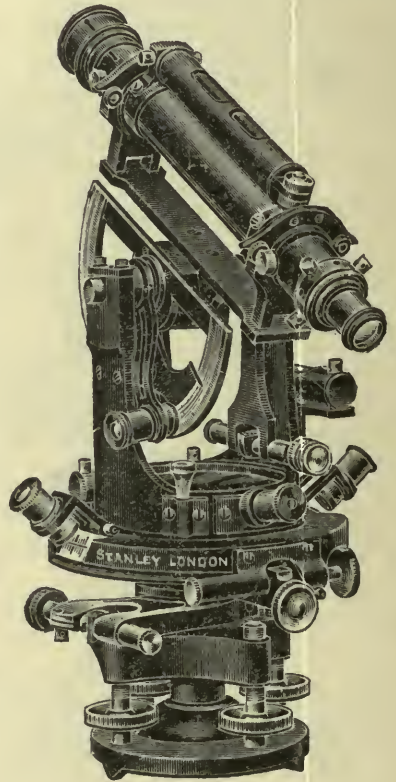

FIG. 83.

This vertical circle is read by means of one vernier only, and the horizontal circle has two verniers.

The main difference between the plain theodolite and the transit theodolite is that in the former the telescope cannot be transited or turned completely round, and that the telescope of the plain theodolite is so placed in V-seatings that it can be rotated about its own axis. The former renders it less useful than the transit for ranging purposes as well as making one of the adjustments less easy; while the second difference makes the collimation adjustment easier.

Everest's Theodolite.—A general view of this instrument is shown on Fig. 84. It was originally designed by Colonel Everest for use in the detail work of the trigonometrical survey of India. Like the plain

theodolite, the vertical limb is not a complete circle, but in this case consists of two arcs attached to the telescope and each having its own vernier. The telescope has trunnions which rest in Vs on brackets attached to the top of a central pillar. The telescope is placed low down and cannot be transited. The horizontal circle is formed in silver near the edge of the limb. Three verniers are used, each one of which is fixed to the end of an arm projecting from the central pillar.

A noteworthy feature of this instrument is the "tribrach" arrangement through which the body of the instrument is supported. It will

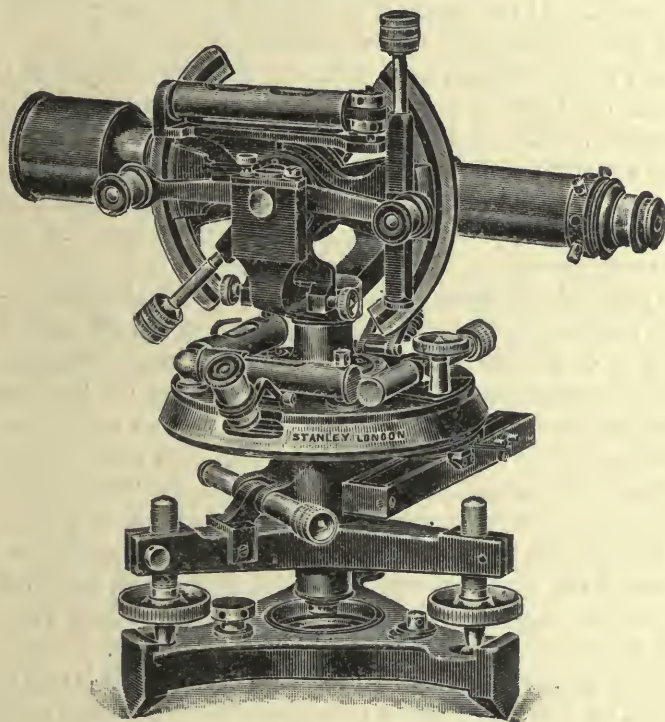

FIG. 84.

be seen that three arms project from the body piece in which the vertical axis turns. Near the ends of these are three levelling screws, turned by milled heads, and whose lower extremities terminate in spherical ends which rest in V grooves cut in the top of the tripod plate. One of the earlier Everest theodolites is shown in the frontispiece.

Although the Everest theodolite is still used by the Royal Engineers for military survey work it has never become popular with civil engineers, chiefly because of its open construction and liability to collect dirt, and also because it lacks the convenient transit arrangement.

Adjustments of the Theodolite.—*Temporary Adjustments.*—These have to be made each time the instrument is used.

(1) *Setting the Instrument over the Station Point.*—There is generally a hook provided below the levelling plates from which a plumb bob may be hung, and, if the hook is properly placed, the plumb line will form a

continuation of the vertical axis. The instrument should be so placed, when it is to be used for measuring an angle at a given station, that the point of the plumb bob points directly to the centre of the hole in the ground which represents the station, or to the intersection of the diagonals of the square head of the peg placed to mark the station. In most cases this has to be done by moving the legs of the tripod. The tripod itself should be so placed that the telescope is at a convenient height for readings to be taken by the observer; the legs should be set so far apart as to give the maximum of stability; and, at the same time, the horizontal limb should be approximately horizontal, as shown by the small levels. If the ground is at all of a soft or yielding nature the feet should be pressed firmly downwards.

Messrs. Troughton and also Messrs. Stanley supply a sliding stage arrangement by means of which the vertical axis of the theodolite may be moved bodily to a small extent in any direction. This is very useful when setting the instrument over the point, as the plumb bob can be placed first near its proper position by moving the legs, and then adjusted to its exact position by the sliding stage. A great deal of time is thereby saved.

(2) *To place the Vertical Axis in a truly Vertical Position.*—This may be done by making use of the two small spirit levels which are set at right angles to one another. First, clamp the vertical axis, leaving the vernier plate unclamped. Turn this until one of the two levels is parallel to the line through two of the plate screws which are diagonally opposite to one another. These screws are then turned, one to the left and the other to the right until the bubble is in the middle of its run. The other pair of screws are to be manipulated in a similar manner until the bubble of the second level has been brought to the centre. This last may have slightly disturbed the first level, and this must now be put right. By repeating this process once or twice the bubbles of both levels may be brought to their centre positions.

The same result can be reached by using the large level on the telescope. The vernier plate is turned until this level is above one pair of diagonally placed plate screws, the reading of the vertical circle having previously been set to zero. The screws are now turned until the bubble is at the centre, and the telescope is completely reversed by turning the vernier plate through 180° . If the bubble remains in the centre the second pair of screws may be attended to; if not, correct half the error by the vertical tangent screw and the remainder by means of the plate screws. The same is to be done for the other pair of screws, and both operations will have to be repeated several times before the bubble remains stationary in its central position as the vernier plate is slowly rotated. The vertical axis may now be considered to be vertical and the next adjustment proceeded with.

(3) *Parallax.*—This has been referred to when describing the telescope. It is sufficient to say again that first the eyepiece is to be focused and then the object glass, these being so adjusted that the image appears to the observer quite stationary on the webs, as, when looking into the telescope, he moves his head slowly from side to side.

Permanent Adjustments.—In order that it may be possible to carry out accurate work with the theodolite the following adjustments must be made. Having once been made an adjustment is supposed to remain intact, but it will be necessary to carry out the tests from time to time, as the mere fact of using the instrument tends gradually to disturb the adjustments. In describing the following tests and adjustments it is assumed that the instrument has been properly set up and all the temporary adjustments made, so that the theodolite is standing with its vertical axis truly vertical.

(1) *Level Parallel to the Line of Collimation.*—If this adjustment has been made correctly the line of collimation will be parallel to the main level, that is to say, when the bubble of this level is in its central position the line of collimation is truly horizontal.

As this is also the chief adjustment of the “level,” it will be fully discussed when dealing with that instrument. Unless the theodolite is to be used for levelling work this adjustment is of less importance than those which follow.

(2) *The Vertical Circle should read Zero when the Bubble is in its Central Position, that is, when the Line of Collimation is Horizontal.*
Index Error.—To find the “index error,” bring the bubble to its central position, having previously set the vertical axis truly vertical. The verniers should now read zero; if they are found not to be at zero the angular difference between zero and the reading given is the “index error.” This index error must be taken into account when measuring vertical angles.

Instead of finding the index error in this way and allowing for it in calculations, a better plan is to first clamp the vertical circle and set the verniers to zero by means of the tangent screw, and afterwards bring the bubble to the centre by means of the screws which give a rotary motion to the vernier plate. The reading will then be zero and the bubble will be in the centre—that is, the index error is eliminated.

(3) *The Line of Collimation at Right Angles to the Horizontal Axis.*—Having placed the telescope approximately horizontal, focus on a distant object and set the intersection of the cross-webs on a clearly defined vertical line, such as the edge of a building, a vertical pole or mast, or a suspended line. The vertical axis and the horizontal vernier plate are clamped. Now remove the caps from the horizontal axis Vs, lift the telescope out of its bearings, and replace with the ends of the horizontal axis reversed. The telescope will now be turned over, with the level below. If the observer now looks through the telescope, the intersection of the cross-webs should cut the same vertical line as before. If they do not so coincide, one-half the distance between the cross-webs and the line represents the angular error by which the line of collimation fails to be perpendicular to the horizontal axis. This is shown diagrammatically on Fig. 85. Here HA is the horizontal axis, FC the line of collimation as it should be, C_1 is the object on which it is sighted, and C_2 is the position of the cross-webs as they appear after the reversal of the telescope. C_1C_2 is the observed difference, and the actual error is CC or CC_2 .

In correcting the error, by means of the horizontal diaphragm screws, the webs are to be brought from C'' halfway towards C' , that is, to C , and the other half corrected by moving the horizontal tangent screw. If the adjustment has been performed correctly the line of collimation will

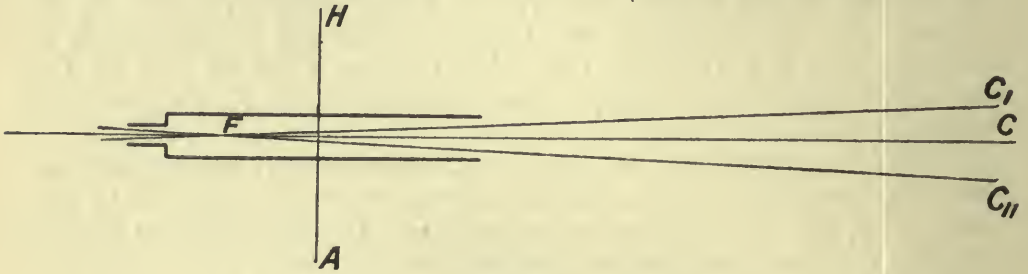

FIG. 85.

now cut the point C , or be truly perpendicular to HA . It is generally necessary to repeat this test and adjustment two or three times before the result is satisfactory.

Another way of carrying out this test, in the case of the transit theodolite, is to set the cross-webs on a well-defined point, transit the telescope through 180° , and turn the horizontal vernier plate through 180° . This will have the same effect as in the former way of carrying it out. The adjustment is made as before.

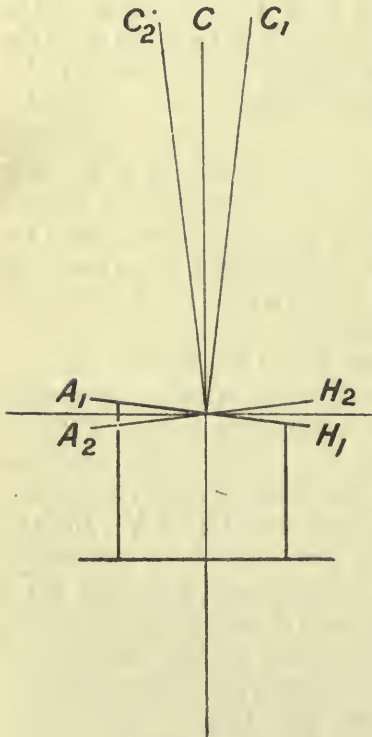

FIG. 86.

In the case of the plain theodolite, the telescope cannot be reversed in its bearings, neither can it be turned over by transiting. The telescope tube, however, rests in Vs , and can be rotated about its own axis. To make the test in this case, focus on a distant point or vertical line, and then slowly rotate the telescope about its own axis in the Vs through 180° . If after this semi-rotation the intersection of the cross-webs still cuts the same point or vertical line, the adjustment is correct. If not, one-half the error must be corrected by the diaphragm screws and one-half by the horizontal tangent screw.

(4) *The Horizontal Axis at Right Angles to the Vertical Axis.*—The principle upon which the test for this depends is similar to the last, but the error occurs in a vertical or nearly vertical instead of a horizontal

plane. It is obviously impossible to take actual vertical readings, but the cross-webs can be placed on a well-defined point at as high an altitude as will permit convenient readings being taken. The telescope is turned under until the eyepiece is at the same angle on the other side

of the vertical, and the horizontal vernier plate turned through 180° . The line of collimation should now traverse the same point. One-half the discrepancy is to be corrected for by the adjustment which allows one of the bearings to be lowered or raised. This should be clear from Fig. 86.

Another way of testing for this same adjustment is to select a long vertical line, such as the edge of the corner of a building or, better still, a wire suspended with a heavy weight at its bottom end. If, now, the line of collimation, in a horizontal position, is set on the line somewhere near its lower end, and the telescope moved slowly upwards, the cross-webs should remain in coincidence with the line throughout.

For convenience the adjustments of the theodolite may be summarised as below :—

Adjustment of Theodolite.

Temporary.—(1) *Setting the Instrument on the Station.*—Plumb bob below vertical axis placed over mark on ground by moving legs of tripod, at the same time keeping vertical axis approximately vertical.

(2) *Placing Vertical Axis truly Vertical.*—Roughly by means of two small levels and the plate screws; finishing with telescope level, first over one pair of plate screws, then, at right angles, over other pair, until bubble remains in centre when telescope is completely rotated in a horizontal plane.

(3) *Parallax.*—Focus eyepiece until webs are quite distinct. Then focus objective. Image should appear stationary on webs as head of observer is moved.

Permanent.—(1) *Level parallel to Line of Collimation.*—As described in adjustments of level.

(2) *Index Error.*—Clamp vertical circle and bring bubble of telescope level to central position. Difference between the vernier reading and zero is "index error." Can be avoided by clamping vertical circle, setting to zero and bringing bubble to centre by adjusting screws of clipping arm of vernier frame.

(3) *Line of Collimation perpendicular to Horizontal Axis.*—Focus webs on distant point, approximately on same level as instrument. Lift telescope out of bearings and replace with bottom uppermost, so that pivots are reversed. Webs should still cut the distant point. If not, correct half discrepancy by diaphragm screws and half by horizontal tangent screw.

(4) *Horizontal Axis perpendicular to Vertical Axis.*—Set webs on highly elevated point with horizontal circle clamped. Turn telescope and horizontal vernier plate through 180° , and point telescope towards same point. Webs should still cut point. If not, correct one-half error by vertical adjustment of one of telescope bearings. Same may be tested by setting webs on bottom of vertical line and seeing if they remain on it as telescope is swung upwards.

Examination to discover Constructional Defects.—In the tests which have been described the necessary adjustments may be made with the means specially provided for the purpose. There are, however, a

number of possible causes of inaccuracy in taking readings which may be discovered, but which can only be remedied by rebuilding the instrument or by making very radical changes in its construction. The surveyor cannot make these adjustments nor can the instrument-maker without involving the user in considerable expense, but it is possible to find out if they do exist and to what extent. It is further possible, in most cases, to so carry out the work with the particular instrument in question that the errors to which they give rise may be reduced to a minimum.

Eccentricity of Horizontal Circle and its Vernier Plate.—Assuming the subdivision of the circle to be perfectly uniform there should be a difference of 180° between the readings given by the two verniers. But if the axis about which the horizontal circle rotates does not coincide with that of the inner bearing of the vernier plate the readings given by the two verniers may differ by more or less than 180° .

The effect of this eccentricity is shown in an exaggerated form in the diagram on Fig. 87. Here A and B are the two centres, which do not coincide as they should. The vernier plate in rotating turns about A instead of B, and the angle FAH, which is equal to the required angle GBH, is given on one vernier by the arc FH and upon the other by CD. The two lines FAD and GBE are drawn parallel, and give the amounts by which the given arcs HF and DC respectively exceed and fall short of the two arc values HG and CE. It is evident that the true

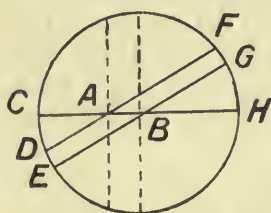

FIG. 87.

value will be obtained by taking the arithmetic mean of the two, that is, $CE = GH = \frac{1}{2}(CD + FH)$. There is no error when DF coincides with CH, and it has a maximum value when DF is at right angles to CH.

Reading the Angles.—Elimination of Instrumental Errors.—When a horizontal angle is to be read at any given station the instrument is first to be set up over the mark on the ground which represents the station, care being taken that the continuation of the vertical axis cuts the mark and that the tripod legs are well pressed into the ground so as to make the theodolite quite stable. The setting of the vertical axis truly vertical is completed by means of the telescope level. The vernier plate is now set to zero and clamped. The vertical axis is unclamped and the telescope directed towards the first station to be observed and the axis again clamped. The telescope is then precisely focused on the station and the horizontal circle slowly rotated by the vertical axis tangent screw until the X of the webs coincides with the centre of the mark. The point observed may be a surveying pole or picket stuck in the ground, a vane or flagstaff on a building, or some other convenient mark. Where the mark is a pole in the ground, the cross-webs must be placed on the centre where it enters the ground, if that point can be seen. This precaution is necessary to eliminate errors due to the pole not being truly vertical. Where intervening objects prevent the part of the pole entering the ground from being seen, great

care should be taken to place the pole as nearly as possible vertical. This may be done with a plumb line.

Having set the webs on the left-hand station, the vernier plate must be unclamped and the telescope directed towards the second station. The vernier plate is again clamped, the telescope focused, and the webs set precisely on the station mark. The angle through which the vernier plate has been turned can now be read on the two verniers through the reading microscopes, and booked.

This is the process of reading a simple horizontal angle made by two distant points at the point of observation.

The given result may be in error from one of several causes.

(a) Inaccuracy in the original fixing of the verniers, by which they do not give two readings whose difference is 180° . If the error is due to this cause it will be found, by taking pairs of readings at a number of different parts of the circle, that the difference has a constant value.

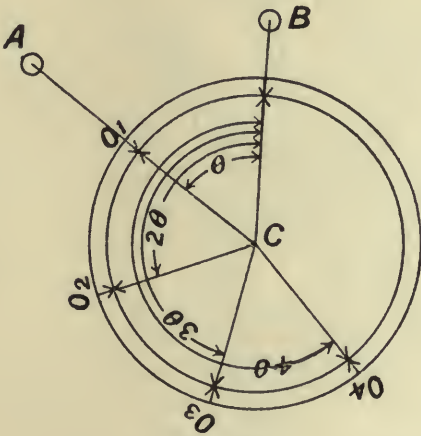

FIG. 88.

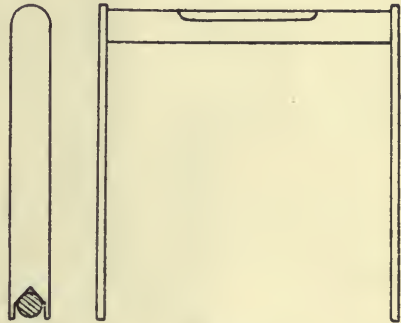

FIG. 89.

Though this error may be found to exist it is not likely to do any particular harm in ordinary work.

(b) If, on trying the differences in reading of the two verniers at different parts of the circle, it is found that the difference changes from a maximum value to zero, and to maximum again in passing through 180° , the error is due to the cause already referred to, namely, eccentricity of the vernier plate and horizontal circle. To eliminate this error the mean value of the two vernier readings must always be taken.

(c) Uneven graduation of the circle. This error, as shown by a difference in the reading of the two verniers, is one whose variation does not obey any particular law. The only way in which its effects can be combated is by reading the angles by the method of "repetition." This means that the angle is read on every part of the scale with the result that the plus and minus errors compensate.

The manner of reading angles by "repetition" is as follows (Fig. 88): Set the vernier plate to read zero and clamp in that position. Unclamp the vertical axis and set the webs on the left-hand point of observation A,

keeping the circle still clamped. Now unclamp the vernier plate and turn the telescope on to the right-hand station B; clamp again, and set webs precisely by the tangent screw. The angle has now been measured

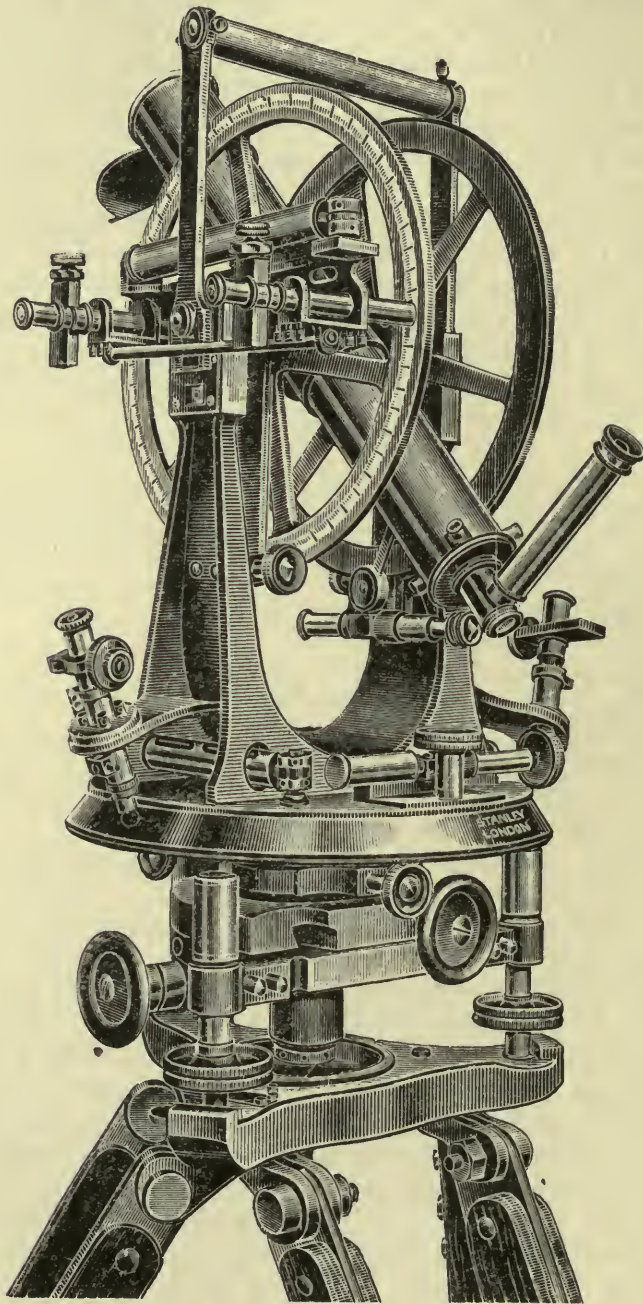

FIG. 90.

once. Next, keeping the vernier plate clamped, unclamp the vertical axis and turn back to A again; clamp vertical axis and set the webs on the station by means of its tangent screw. Unclamp the vernier plate and

turn the telescope to B station a second time ; clamp the vernier plate and set the webs on the station by the tangent screw. The reading should now give an angle which is double of the first. This operation may be repeated n times, and the total reading divided by n will give the mean value. As the total of the interior angles of any triangle adds up to 180° , the average interior angle must be one of 60° . If, therefore, the measurement of an angle be repeated six times, the average total should be 360° . This number of 6 is a convenient number of repetitions, and, on the average, enables the observer to cover the complete circle and so reduce the errors, both instrumental and due to incorrect setting, to a minimum value. A smaller number of repetitions may be employed.

A way of obviating some of the instrumental errors is to read single angles by "changing face." In doing this, the angle is read in the usual way, with the vernier plate tangent screw on the observer's near side with its milled head convenient to his right hand ; then the vernier plate is turned round through 180° with the tangent screw on the far side, and the angle again measured with the transited telescope upside down. An average value is taken. A plan sometimes adopted, for the purpose of ensuring all parts of the circle being used and enabling the errors to tie, is to place the zero of the circle always at the magnetic north of the needle, when setting the telescope on the left-hand station previous to the taking of any angle. This does not mean that magnetic bearings are to be taken, but simply that the horizontal circle is kept in the same place for all angles and only the vernier plate changes its position.

It should be observed when taking angles, that it is not necessary to set the vernier plate to zero when sighting the left-hand station, but the reading for each of the two positions may be taken and the angle obtained by subtraction.

Striding Level.—This is a convenient adjunct to a theodolite, and is used for setting the horizontal axis truly perpendicular to the vertical axis in a manner more direct than that already described. It consists of a very delicate level fixed in a horizontal tube, to the ends of which are attached two legs of the same length (see Fig. 89). The lower ends of these legs terminate in Vs, and the dimensions are such that they can be allowed to rest on the pivots of the horizontal axis, and at the same time the level is clear of the telescope and vertical circle. After placing the striding level in this position the horizontal axis may be adjusted until the bubble is in the middle of its run.

A view of a 10-inch theodolite with a striding level in position is shown on Fig. 90. This has a right-angled eyepiece, and the circles are read with micrometers.

CHAPTER VI

CALCULATIONS OF DISTANCES AND HEIGHTS

It is assumed that the reader has some knowledge of plane trigonometry, but the following summary of the chief formulæ may be useful for reference:—

In Fig. 91, where

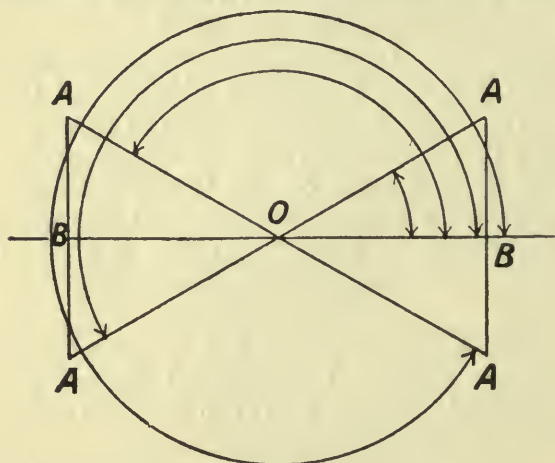

$$\theta = \text{AOB}$$

$$\text{Sine } \theta = \frac{AB}{OA}$$

$$\text{Cosine } \theta = \frac{OB}{OA}$$

$$\text{Tangent } \theta = \frac{AB}{OB}$$

$$\text{Cotangent } \theta = \frac{OB}{AB}$$

FIG. 91.

Measurements to the right of O and upwards from O are + ; to the left of O and downwards from O are - ; the hypotenuse OA is always +.

$$\text{Sin } \theta = \text{cos } (90 - \theta) = \text{sin } (180 - \theta) ; \text{cos } (180 - \theta) = - \text{cos } \theta.$$

$$\begin{aligned} \text{Sin } (\theta \pm \phi) &= \text{sin } \theta \text{ cos } \phi \pm \text{cos } \theta \text{ sin } \phi \\ \text{Cos } (\theta \pm \phi) &= \text{cos } \theta \text{ cos } \phi \pm \text{sin } \theta \text{ sin } \phi \end{aligned}$$

$$\text{Sin } \theta + \text{sin } \phi = 2 \text{ sin } \frac{\theta + \phi}{2} \text{ cos } \frac{\theta - \phi}{2}$$

$$\text{Sin } \theta - \text{sin } \phi = 2 \text{ cos } \frac{\theta + \phi}{2} \text{ sin } \frac{\theta - \phi}{2}$$

$$\text{Cos } \theta + \text{cos } \phi = 2 \text{ cos } \frac{\theta + \phi}{2} \text{ cos } \frac{\theta - \phi}{2}$$

$$\text{Cos } \theta - \text{cos } \phi = 2 \text{ sin } \frac{\theta + \phi}{2} \text{ sin } \frac{\theta - \phi}{2}$$

$$\text{Sin}^2 \theta + \text{cos}^2 \theta = 1$$

In any plane triangle, A, B, C (Fig. 92)

$$a : b : c :: \sin A : \sin B : \sin C$$

$$\sin \frac{A}{2} = \sqrt{\frac{(s-b)(s-c)}{bc}}, \text{ where } s = \frac{a+b+c}{2},$$

and similarly for the sines of $\frac{B}{2}$ and $\frac{C}{2}$.

The area of A, B, C = $\frac{1}{2}bc \sin A = \sqrt{s(s-a)(s-b)(s-c)}$.

In a right-angled triangle, where C is the right angle,

$$c^2 = a^2 + b^2$$

where C is not a right angle,

$$c^2 = a^2 + b^2 - 2ab \cos C$$

Solution of Plane Triangles.—Four cases may arise, as below—

(i) Two angles and one side being known.

In Fig. 92 this might mean that A, B, and a are known. Then C, b , and c may be found by

$$C = 180 - (A + B)$$

$$b = a \cdot \frac{\sin B}{\sin A}$$

$$c = a \cdot \frac{\sin C}{\sin A}$$

(ii) Two sides and the included angle being known.

In Fig. 92 this might mean that a , b , and C are known. Then $c^2 = a^2 + b^2 - 2ab \cos C$, and $\sin A = a \cdot \frac{\sin C}{c}$, from which A can

be found and $B = 180 - (A + C)$.

(iii) The three sides being known.

Using the equation employed in (ii),

$$c^2 = a^2 + b^2 - 2ab \cos C$$

we have

$$\cos C = \frac{a^2 + b^2 - c^2}{2ab}$$

and the rest follows from (ii).

(iv) Two sides and the angle opposite to one of them are known.

In Fig. 93 there might be a , b , and A.

In this case, if B should be a right angle,

$$c = b \cos A$$

and the complete solution follows from (ii).

If A is an obtuse angle, then for solution a must be greater than b .

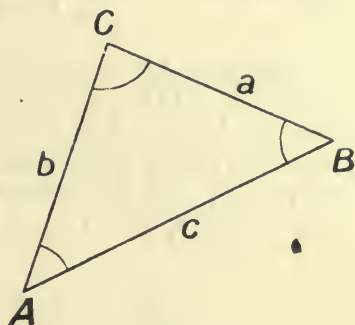

FIG. 92.

If A is an acute angle and a is less than the perpendicular CB_1 there is no solution.

If A is an acute angle and a is greater than b , there is only one solution, $c = AB$.

If A is an acute angle and a is less than b but greater than CB_1 , there must be two solutions, as follows, where $a = CB_2 = CB_3$,

$$a^2 = b^2 + c^2 - 2bc \cos A$$

from which $c^2 - (2bc \cos A) = a^2 - b^2$

and $c = b \cos A \pm \sqrt{a^2 - b^2 + b^2 \cos^2 A}$

The case to which the above-mentioned formulæ are most often applicable is the calculation of one or two unknown sides of a triangle when the length of the third side is known, either from direct measurement or when calculated as the side of another triangle. Again referring to Fig. 92, A and B are two points marked on the ground as station points, and the distance AB has been either found by direct

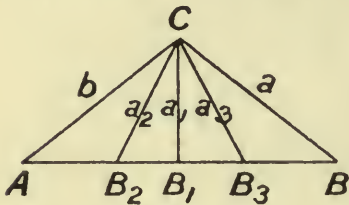

FIG. 93.

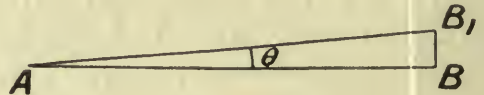

FIG. 94.

measurement or it may have been calculated as one side of another triangle. C is a third point at some distance away, and it is required to know the horizontal distances AC and BC . In the first place A and B should be nearly as possible on the same level. If they are not, then their difference in level must be found (see Chapter VII.), and the horizontal projection of the measured line calculated as in Fig. 94. Here AB_1 is the length of the line measured on the slope, and BB_1 is the vertical difference in level. Then the horizontal equivalent, AB , of AB_1 is

$$AB = \sqrt{(AB_1)^2 - (BB_1)^2}$$

or $AB = AB_1 \cos \theta$

if the angle of slope, θ , has been measured.

In carrying the work further, the theodolite is set up at the point A (Fig. 92), and the horizontal angle, BAC , very carefully measured, the angles being found by "repetition." The theodolite is now moved to the point B , and the angle ABC found. Care should be taken to place the instrument at the same height from the ground in both positions. The angle of slope, θ , which has just been mentioned may be found when the theodolite is at A or at B . For example, if the angle θ is to be found from A a staff must be set up at B , and a mark placed upon it at the same height from the ground as is the centre of the theodolite telescope. The third angle ACB can be found by setting

up the instrument at C and sighting on to B and A. When these three angles have been measured in this way, their sum should be equal to 180° . If it is found that there is an appreciable discrepancy, it will be necessary to measure the angles a second time.

Where it is not possible to measure the third angle directly, it must be found by difference. As, calling the angles A, B, C, and the sides opposite to these a, b, c , $C = 180 - (A + B)$, and the lengths of the two opposite sides are found from

$$a = c \frac{\sin A}{\sin C} \text{ and } b = c \frac{\sin B}{\sin C}$$

As illustrating the above method, the following worked-out example is given :—

Example.—In a plane horizontal triangle formed by three points on the ground, A, B, C, the following measurements were made :—

$$\begin{aligned} \text{Side AB} &= 2762 \text{ feet} \\ \text{Angle BAC} &= 41^\circ 12' \\ \text{Angle ABC} &= 81^\circ 6' \end{aligned}$$

Calculate the lengths of the unknown sides BC and AC.

To find the angle ACB,

$$\begin{aligned} \text{ACB} &= 180^\circ - (41^\circ 12' + 81^\circ 6') \\ &= \underline{57^\circ 42'} \end{aligned}$$

$$b = AC = AB \frac{\sin (81^\circ 6')}{\sin (57^\circ 42')}$$

$$\begin{aligned} \log AC &= \log AB + \log \sin (81^\circ 6') - \log \sin (57^\circ 42') \\ &= 3.44122 + 9.99474 - 9.92700 \\ &= 3.50896 \end{aligned}$$

$$AC = \underline{3228.2 \text{ feet}}$$

$$a = BC = AB \frac{\sin (41^\circ 12')}{\sin (57^\circ 42')}$$

$$\begin{aligned} \log BC &= \log AB + \log \sin (41^\circ 12') - \log \sin (57^\circ 42') \\ &= 3.44122 + 9.81868 - 9.92700 \\ &= 3.33290 \end{aligned}$$

$$BC = \underline{2152.3 \text{ feet}}$$

Determination of Heights.—The simpler cases occur where the points in question are all in the same vertical plane.

* CASE I. (Fig. 95).—The height of the point X above a second point A is required.

A horizontal line AB is measured to a point B immediately below X; also the angle of elevation of C above AB is observed.

The height $h = XB$ is to be calculated. Here

$$h = l \tan \theta$$

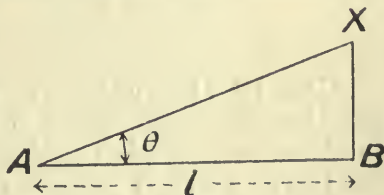

FIG. 95.

CASE II. (Fig. 96).—Where B is not vertically below X, but ABX are still in the same vertical plane. AB is measured; also angles of elevation XAD = θ and XBD = ϕ . $h = XD$. Here

$$h = AD \tan \theta = AB \tan \theta + BD \tan \theta$$

$$h = BD \tan \phi, \text{ from which}$$

also,
$$BD = AB \frac{\tan \theta}{\tan \phi - \tan \theta}$$

and
$$h = AB \frac{\tan \phi \tan \theta}{\tan \phi - \tan \theta}$$

$$= l \frac{\tan \phi \tan \theta}{\tan \phi - \tan \theta} = \frac{l}{\cot \theta - \cot \phi}$$

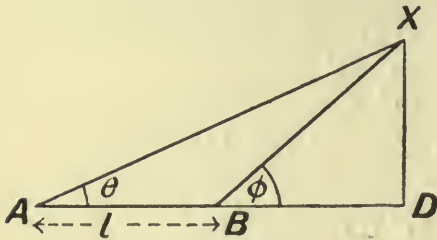

FIG. 96.

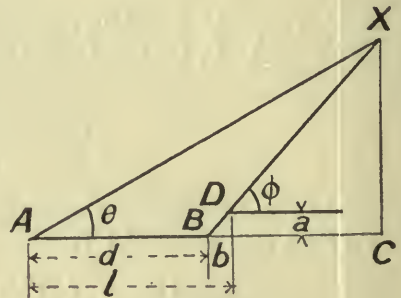

FIG. 97.

CASE III. (Fig. 97).—

$$b = \frac{a}{\tan \phi}$$

$$h = (l - b) \frac{\tan \phi \tan \theta}{\tan \phi - \tan \theta}$$

$$= \left(l - \frac{a}{\tan \phi} \right) \frac{\tan \phi \tan \theta}{\tan \phi - \tan \theta}$$

$$= \frac{l \tan \phi - a}{\frac{\cot \theta}{\cot \phi} - 1}$$

$$= \frac{l \tan \phi - a}{\frac{\tan \phi}{\tan \theta} - 1}$$

CASE IV. (Fig. 98).—The problem represented on Fig. 98 is really the most important one which is likely to present itself. When finding the height of a very high building or the altitude of a marked point on the top of a hill, it generally happens that it is difficult or impossible to find a base line which is perfectly horizontal, which is in the same vertical plane with the point in question, and, at the same time, of sufficient length to lead to reliable results. More often it is convenient to take the base line AB in a direction which makes a considerable

angle with the line from A to the elevated point. The writer remembers one such case when the height of a hill had to be determined; it was found that there was a stretch of nearly quite straight macadam road which was also level and at a known height above sea-level. The base line was ranged along this road, and as it was on a flat hard surface it was possible to measure it with a steel tape with a minimum of error.

At the top of the hill in question was erected a pole to which had been fixed a cross-piece. This mark was in full view of the stations at the two ends of the road base. The theodolite was set up successively at the two base-line stations and horizontal angles and angles of elevation read, the vertical angles

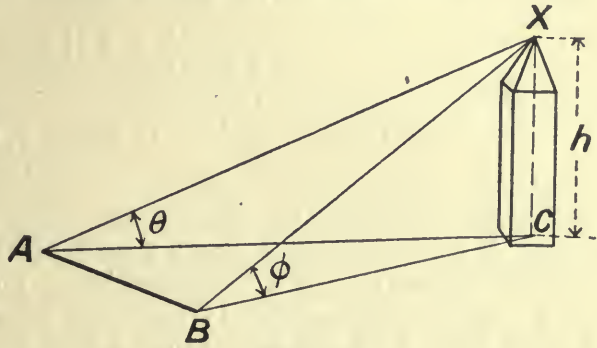

FIG. 98.

being taken to the cross-bar of the pole, and its height from the ground afterwards subtracted from the determined height. The following examples deal with a case such as this.

In Fig. 98 a perpendicular from the highest point X cuts the horizontal plane of A and B at C.

The theodolite is first placed at A and the angles CAB and CAX read. Then CBA and CBX are observed from B.

The angle ACB is obtained by subtraction. Then

$$AC = AB \frac{\sin ABC}{\sin ACB}$$

and, similarly,

$$BC = AB \frac{\sin BAC}{\sin ACB}$$

From these

$$h = AC \tan \theta,$$

and, also

$$h = BC \tan \phi$$

These two values of h should be the same if the work has been carried out correctly. The following are two worked-out problems.

Example of Calculation of Height of a Mountain.—A base line AB is 2000 feet in length and 750 feet above sea-level. A theodolite is set at each of the stations A and B and observations are taken on the station X which is on the top of a hill. The following results were booked: Horizontal angle, $XAB = 43^\circ 15'$; horizontal angle, $XBA = 72^\circ 30'$; angle of elevation of station X = $13^\circ 20'$ above A. Find the vertical height of X above sea-level.

In Fig. 98,
$$AC = AB \frac{\sin B}{\sin C}$$

To find C, subtract $A + B$ from 180° ,

$$\text{that is, } C = 180^\circ - 43^\circ 15' - 72^\circ 30' = 64^\circ 15'.$$

$$\begin{aligned} \text{Then } \log AC &= \log AB + \log \sin B - \log \sin C \\ &= 3.30103 + 9.97940 - 9.95460 = 3.32580 \\ \text{and } AC &= 2117 \text{ feet} \end{aligned}$$

And the height of the hill $CX = h$ is

$$\begin{aligned} h &= AC \tan (13^\circ 20') \\ \log h &= \log AC + \log \tan (13^\circ 20') \\ &= 3.32580 + 9.37475 \\ &= 2.70055 \end{aligned}$$

from which

$$\begin{aligned} h &= 501.9 \text{ feet} \\ \text{and total height above sea} &= 501.9 + 750 \\ &= 1251.9 \text{ feet} \end{aligned}$$

Second Example of finding the Height of a Mountain.—On a map A and B are two points 1 mile apart and 380 feet above the level of the sea; C is a mountain-top. The horizontal angle $CAB = 77^\circ 30'$ and $CBA = 78^\circ 15'$; and the angle of elevation of C above A is $6^\circ 32'$. Find the height of the mountain above the level of the sea, making due allowance for the curvature of the earth.

To find the third angle at C.

$$\text{Angle at } C = 180^\circ - 78^\circ 15' - 77^\circ 30' = 24^\circ 15'$$

$$\text{Horizontal side } AC = AB \frac{\sin 78^\circ 15'}{\sin 24^\circ 15'}$$

$$\begin{aligned} \text{or } \log AC &= \log 5280 + \log \sin (78^\circ 15') - \log \sin (24^\circ 15') \\ &= 3.7226 + 9.9908 - 9.6135 \\ &= 4.0999 \end{aligned}$$

$$\text{and } AC = 12,586 \text{ feet}$$

The height

$$\begin{aligned} h &= AC \tan (6^\circ 32') \\ \log h &= \log AC + \log \tan (6^\circ 32') \\ &= 4.0999 + 9.0589 \\ &= 3.1588 \end{aligned}$$

from which

$$h = 1441.5$$

The correction for curvature at end of AC works out to 3.2 feet (see Chap. VII.), and this must be added. Therefore

$$\begin{aligned} \text{total height above sea} &= 1441.5 + 3.2 + 380 \\ &= 1824.7 \text{ feet} \end{aligned}$$

CHAPTER VII

LEVELLING AND CONTOURING

THAT part of surveying called "Levelling" is concerned with the measurements necessary to determine the relative heights or depressions of points above or below some standard surface of reference. All measurements are vertical, or in the direction of gravity.

If a survey is to be made of a portion of the Earth's surface sufficiently complete to make it possible to reproduce to scale all the features of the country, it will be necessary to find not only the horizontal position of every point with respect to the others, but also to determine its relative vertical position.

Just in the same way that in chain surveying horizontal boundaries are fixed by taking a number of isolated measurements from an established chain line which is perfectly straight and rigid, so it is customary to fix the respective heights of a number of points, of which the plan is a straight line, by referring them to an assumed reference line. Such a line may be a "level" line, that is, one which at all points cuts the direction of gravity at right angles; or it may be merely a "horizontal" line, or one which is straight and at right angles to the direction of gravity at one point. If the earth were a true sphere a level line at the surface of the earth would form part of a great circle of this sphere. As the earth is not a perfect sphere a level line is more nearly part of an ellipse than of a circle. The difference is so extremely small that for most purposes it may be neglected. In surveys of such magnitude as the Ordnance Survey of Great Britain and similar surveys of other countries, where some of the lines may be hundreds of miles in length, the departure from the form of a true sphere is not only taken account of, but is made use of. Careful measurements of meridional arcs, combined with the determination of the latitude of the two ends has been the means of ascertaining the form of the earth and the extent to which this varies from that of a true sphere.

From most points of view the level line may be taken as being part of a great circle struck from the centre of the earth. The actual height of this line—that is to say, its distance from the centre of the earth—may be quite arbitrary, and may be taken anywhere, as it is found most convenient. But for many purposes it is convenient to know the height of this reference line with respect to some standard height which has been rigidly fixed, and which may be used as a reference height for all other levels.

In this country, the mean level of the sea is taken as the absolute standard, and all heights on the Ordnance maps are referred to it. This mean level has been determined once for all, and is marked as a fixed point on some permanent object. Where a spherical surface passing through this is not in itself used as the surface of reference, the actual one that is used, or the "datum," as it is called, is generally spoken of as being at such a height above the sea-level. It is convenient to know this in order to be able to compare the heights with others in adjacent works. In some cases, such as in waterworks, the plan of referring everything to one datum is imperative.

There is little difficulty in establishing a connection between the levels which are being taken and the Ordnance levels, because permanent stations or "Bench Marks" are left at frequent intervals in all districts, and a reference to the Ordnance map of the district will enable a surveyor to ascertain the height of any Ordnance bench mark above sea-level.

Curvature of the Earth.—It is therefore assumed that the line or surface of reference lies on a sphere, having for its radius the mean radius of the Earth. It may be a few feet above this, and in some few cases below, but it will be convenient to take it as being coincident with a great circle drawn at the mean radius of the earth.

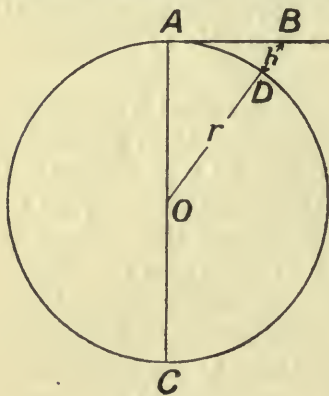

FIG. 99.

On Fig. 99 is drawn a circle ADC to represent a great circle of the earth, OA, OD, and OC being radii.

Here let A be a point on the earth's surface, AD an arc of the great circle drawn through this point, and AB a line also drawn from A tangentially to the arc, or at right angles to the radius $OA = r$. Then the further any point, B, on this tangential line is taken from A, the further will it be separated from the arc AD.

It is customary, in speaking of two such lines, to say that AD is the *level* line, and AB the *horizontal* line from A. These terms are often confused, and it is well to appreciate the difference.

The surface of still water is a level surface, and it is a matter of common observation that, as a ship departs from the land, the hull appears to fall below the horizon, then the masts, until the whole has disappeared.

In the accompanying figure, this case can be represented by assuming the eye of the observer, who is watching the ship depart, to be at A. Then, when the ship has reached the point D on the surface of the water, its mast can be represented by DB.

This height, DB, or the extent to which the horizontal line has departed from the level line in going from A to D on the Earth's surface is found in the following way :—

Polar diameter of the Earth is	7898 miles.
Equatorial " " "	7924 "
Mean " " "	7916 "

In the figure—

$$\begin{aligned} OB^2 &= OA^2 + AB^2 \\ (r + h)^2 &= r^2 + l^2 \\ r^2 + 2rh + h^2 &= r^2 + l^2 \\ 2rh + h^2 &= l^2 \end{aligned}$$

But in levelling work h is very small compared with $2r$, and therefore the square of h being an extremely small quantity may be neglected. So the equation can be written—

$$2rh = l^2$$

or

$$h = \frac{l^2}{2r}$$

The above is true when the h and l are taken in the same units. If, however,

L = the distance in miles of the object from the observer,
and h = dip due to the curvature of the earth in feet, then—

$$\begin{aligned} h \text{ (feet)} &= \frac{L^2(5280)^2}{7916 \times 5280} \\ &= 0.667L^2 \\ &= \frac{2}{3}L^2 \text{ (nearly)} \end{aligned}$$

This last gives results sufficiently near for most levelling work.

To illustrate the meaning of this, suppose the eye of the observer to be on a level with the surface of the water of a canal and looking horizontally; then at a distance of 1 mile the departure of the curved surface of the water from this line of sight will be $\frac{2}{3}(1)$, that is, two-thirds of one foot or 8 inches. At 2 miles this will be $\frac{2}{3}(4)$, or 32 inches. At 3 miles it will be $\frac{2}{3}(9)$, or two-thirds of 108 inches, that is, 72 inches. The figures show how rapidly the dip increases as the distance becomes greater.

The converse is true also. If the observer is at B (Fig. 99), then the distance he will be able to see a point, A, on the surface of the water will be BA. For instance, the following example may be taken: A man stands on the top of a cliff, which is of such a height that his eye is 180 feet above the surface of the water; he can just see a small floating buoy on the horizon: how many miles is he from the buoy?

$$\begin{aligned} L^2 &= \frac{3}{2}h \\ L &= \sqrt{\frac{3}{2}h} \\ &= \sqrt{\frac{3}{2} \cdot 180} \\ &= 5.2 \text{ miles} \end{aligned}$$

The equation is most often useful in the form in which the distance is in miles. Occasionally the distance is in feet as well as

the dip, and in such a case the equation may be used in the original form :—

$$\begin{aligned}
 h &= \frac{l^2}{2r} \\
 &= \frac{l^2}{7916 \times 5280} \\
 &= \frac{l^2}{41,800,000} \\
 \text{or} \quad l &= 6460\sqrt{h}
 \end{aligned}$$

Example.—The height of the summit of a certain hill is 1084 feet

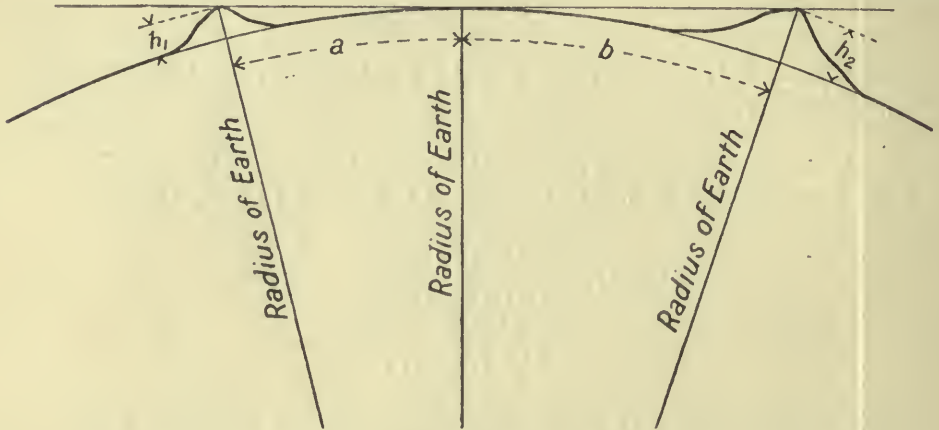

FIG. 100.

above sea-level. What is the height of a second hill whose summit can just be seen from that of the first at a *distance* of 85 miles ?

First, to find a (Fig. 100).

$$\begin{aligned}
 a &= L = \sqrt{\frac{3}{2}h_1} = \sqrt{\frac{3}{2}32} = 39.17 \\
 a + b &= 85 \\
 \therefore b &= 85 - 39.17 = 45.83
 \end{aligned}$$

Then

$$\begin{aligned}
 h_2 &= 0.667b^2 \\
 &= 0.667 \times (45.83)^2 \\
 &= 1434 \text{ feet}
 \end{aligned}$$

Correction for Refraction.—In no case does the line of sight follow a perfectly straight line when starting as a tangent to the earth's surface. A long line, which starts tangentially, rises eventually to a considerable height above the surface of the earth, and, in doing so, is continually passing from a medium of a certain density into one whose density is less. The result of this is that the line of sight, instead of being straight, as it would be if the atmosphere were one of uniform density, is made to curve slightly downwards towards the earth.

This is shown on Fig. 101. AB is a line of sight, while AE shows this as it actually is, curved towards the earth. The dip or correction for

curvature is not in this case DB but DE, which is something less, the tendency of the refraction of the line of sight being rather to correct the error than to increase it. This refraction is not always the same, much depending upon the condition of the atmosphere as to dampness, temperature, and pressure, but there is an approximate correction which can be applied, as follows :—

To correct for refraction, it is not very far wrong to assume that the line of sight follows the arc of a circle whose diameter is five to seven times that of the earth.

The dip for refraction, which is one-fifth to one-seventh that for curvature, is then—

$$h' = \frac{l^2}{2r} \times 7$$

$$= \frac{2}{3} \cdot \frac{l^2}{7}$$

or

in feet, where l is in miles.

The total correction is

$$H = h - h' - \frac{2}{3}l^2(1 - \frac{1}{7}) = \frac{4}{7}l^2$$

$$= 0.5717l^2$$

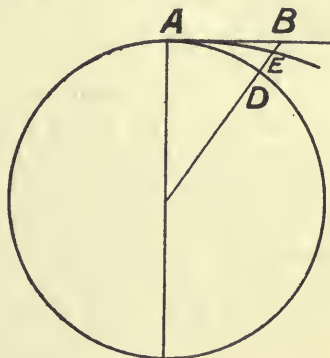

FIG. 101.

TABLE OF CORRECTIONS FOR CURVATURE AND REFRACTIONS.
(From Stanley's "Surveying Instruments.")

Distances in Gunter's chains.	Corrections for curvature minus refraction.
	Feet.
1	0.00028
2	0.00047
3	0.00090
4	0.0016
5	0.0026
6	0.0038
7	0.0051
8	0.0067
9	0.0084
10	0.010
11	0.013
14	0.02
17	0.03
20	0.04
22	0.05
24	0.06
26	0.07
28	0.08
30	0.09
40	0.14
60	0.31
80	0.56

General Principles of Levelling.—Differences of level or of elevation are determined by finding the relative heights above or depths below some given level line of reference.

In order to do this, an operation must be conducted which consists of two distinct parts.

In the first place, a level line must be established, from which the measurements to the two points can be taken.

The measurements from the two points to the line of reference must then be made; the difference between these is the difference of level required.

A process such as this constitutes the basis of most levelling operations. In some cases differences of height are found by totally different means, as, for instance, the heights of mountains, though they may be and are in some cases levelled in the ordinary way, are most frequently found by means of the barometer or hypsometer. The latter is a piece of apparatus for finding differences of atmospheric pressure by means of the temperature at which water boils. Also, differences of level are found in many cases by direct measurement, when the two

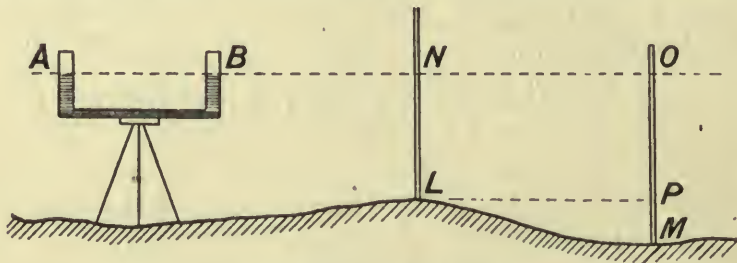

FIG. 102.—Water level.

points happen to be in the same vertical line or very nearly so: an instance of this is to be found in the finding of the depth of a shaft or vertical precipice.

Instruments used in Levelling.—First, as to the way in which the lines of reference are to be fixed. They are in almost every case lines of sight, whose directions are established by some form of instrument known as a “level.” These are in most cases dependent on the fact that the natural form taken by the free surface of a liquid is that of a level surface.

Water Level.—In the water level we have one of the simplest of levelling instruments. A view of one of these is shown on Fig. 102. On the top of a support or tripod are fixed, at the opposite ends of a cross-bar, two glass vessels, A and B, these being partially filled with water. The lower ends of these are connected by means of a small tube as shown, so that there is free communication between the fluid in the two vessels, and consequently their upper surfaces always stand at the same level. If, therefore, an observer looks across the top of the water at A, and keeps this in line with the upper surface at B, his line of sight, which is a line taken tangential to both surfaces, will be level. This is shown dotted in the figure.

To show the application of this to levelling operations, two points on the ground are marked L and M. It is required to find the difference in level of these two points. Hold a rod vertically on L, this rod being marked in feet and fractions of a foot. Looking across the water surfaces in the two tubes, the graduation on the rod at N, which is just seen over the surfaces of the water, will give the depth of the point L below the line of sight. Similarly the depth of M is given by the reading on the staff when held on M, the level instrument remaining stationary.

The difference in level between L and M is obviously the difference between the two readings LN and MO ; or

$$\text{Difference in level} = \text{MO} - \text{LN} = \text{MP}$$

This instrument is rarely used at the present day for any but very rough levelling, but it contains all the elements of the more perfect level which actually is used, and the manner of using it is similar.

The Dumpy Level.—This is the most usual form of level used in ordinary surveying and engineering work in this country. In levelling

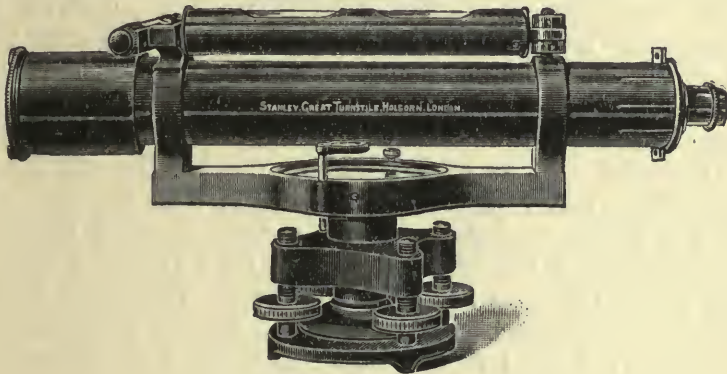

FIG. 103.

operations it serves the same purpose as the water level which has just been described, but in a much more perfect way. A general view of a "dumpy" level fitted with four plate screws is shown on Fig. 103. Remembering what was said in Chapter V. about the theodolite, the construction and use of the levelling instrument should not be difficult to understand. It will be seen that there are two screw plates, of which the lower one is screwed on to the top of the tripod stand. There is a bearing in the upper plate in which rotates the main bar or limb which supports the telescope. Above the telescope and attached to it is a long sensitive spirit level. The telescope of the level is generally a more powerful one than is used in the more common sizes of theodolite and has a larger aperture so as to admit plenty of light. The construction of the telescope is similar to the one already described, except that the diaphragm webs are arranged in a somewhat different manner. Often a compass-box is let into the cross-bar just under the centre of the telescope. There is in many levels a second, but much smaller, spirit level fixed on to the top of the telescope at right angles to the main level.

The objects and principles of working of this instrument are briefly as follows. The main object is to establish a level line from which the depths of points on the ground can be measured by means of a graduated staff. This line of reference is in reality the line of sight of the telescope, and the main and essential adjustment of the instrument is the parallelism of the line of sight and the spirit level, so that when the bubble of the latter is in its central position the line of sight shall be horizontal.

The most important part of the instrument and the one upon which the accuracy of the work largely depends is the spirit level itself which is attached to the telescope. This consists of a glass tube fixed inside a protecting brass tube. The glass tube is, in the best instruments, very carefully ground to a perfectly uniform and symmetrical shape and is made so as to be curved to the arc of a large circle. This may have a radius of from 30 feet in the more ordinary to 1000 feet in the case of the largest and most sensitive levels. The tube itself is partially filled with pure alcohol or, in the rougher instruments, commercial methylated spirit; for very delicate work the fluid is often sulphuric ether or chloroform, these being very mobile liquids. The tube after being partially filled with the fluid is sealed up. When this has been accomplished and the tube set in a horizontal position with the convex surface of the glass at the top, a long bubble will appear near the middle of its length. If either end be slightly raised the bubble will run towards that end. The greater the radius of curvature of the tube the more sensitive will be the bubble, and this sensitiveness of the bubble to vertical inclination of the tube is increased by a greater mobility of the fluid with which the tube has been supplied. The glass tube so prepared is set in the brass casing attached to the telescope, in the upper side of which is cut an elongated slot. A number of uniform divisions are engraved on the top of the bubble tube by means of which the observer is able to tell when the bubble is in its central position. Also marks are sometimes made on the brass tube for the same purpose.

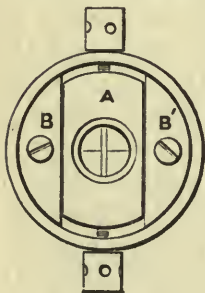

FIG. 104.

It can be seen on Fig. 103 that the brass casing of the bubble tube is attached to the top of the telescope by a hinge at one end and a pair of adjusting nuts working on a screw projecting from the telescope frame at the other. By this arrangement the angle of slope of the bubble tube relatively to the telescope may be adjusted.

The telescope itself has the usual objective and eyepiece as previously described. The diaphragm is arranged as shown on Fig. 104. The plate A which carries the webs is made to slide vertically in a frame, BB, and is controlled in so doing by the two capstan-headed screws shown. These are made use of in one of the permanent adjustments. The webs themselves are arranged as two vertical and one horizontal. The vertical webs are simply provided for the purpose of placing the centre of the horizontal web on the staff. The important web is the horizontal

one, and this should be very carefully considered. As in the theodolite material lines of spider web, silk, and wire are used as well as scratches on glass and metallic points. As a general rule it may be said that so long as the web can be seen clearly and distinctly through the eyepiece it cannot be too fine. Levelling staves are most often divided ultimately into hundredths of one foot, these being arranged so as to form alternate black and white bands. If the distance of the staff from the instrument is relatively great and the web is not very fine, it may often happen that the thickness of the web as seen through the eyepiece

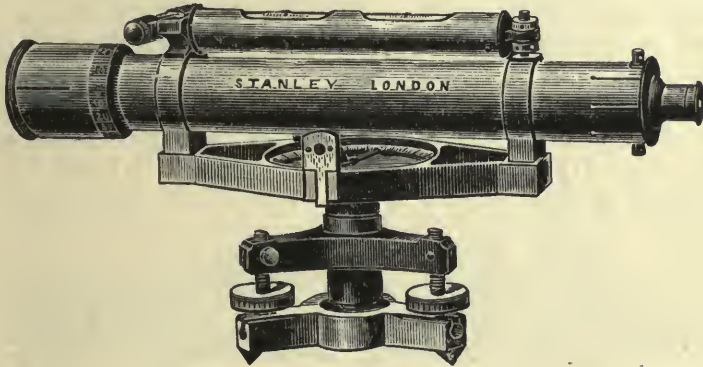

FIG. 105.

completely covers the width of the smallest division on the staff, and consequently the latter cannot be subdivided. With the staff nearer and the web very fine it is often possible to subdivide the smallest division on the staff. It is for the above reasons that metallic points are preferred to webs by some engineers. The writer has found lines

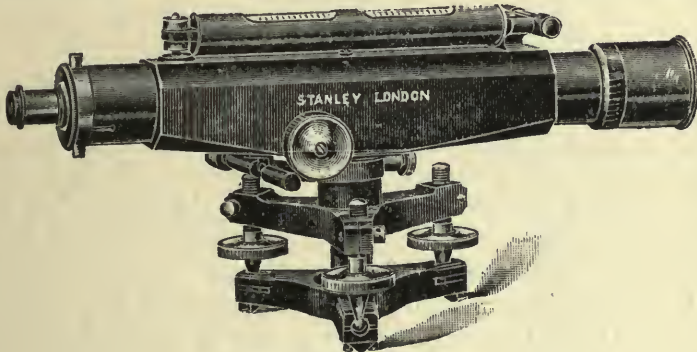

FIG. 106.

engraved on glass very good, but the glass cuts off some of the light and must be kept scrupulously clean.

A better form of dumpy level than that on Fig. 103 is shown on Fig. 105. It will be seen that in this instrument the four screw plates are replaced by the tribrach support. Another type, introduced by Messrs. Stanley, is on Fig. 106. In this the limb or body piece and the middle portion of the telescope are cast in one piece, by means of which great rigidity is attained.

The Y Level (Fig. 107).—This form of level is really of earlier design than the Dumpy, and the latter is only a modification of the Y level. The main characteristic of the Y level is the fact that the telescope, instead of being rigidly attached to the limb, rests in V pieces or Ys as they are called, one of which is fixed to each end of the limb. The telescope tube rests in these Ys, in which it may be rotated about its own axis, or, if necessary, taken out and replaced with the ends reversed. The telescope is kept in place when resting in the Ys by a pair of hinged caps or clips which fit over the top. The main bubble is sometimes attached to the top of the telescope, but in the original design it is slung below. It will be seen that there are capstan-headed nuts for adjusting the height of the Ys.

Levelling Staves.—These may be either of the “speaking” or the “target” class. Of these the one most commonly used for ordinary levelling work in this country is the “speaking” staff of the Sopwith

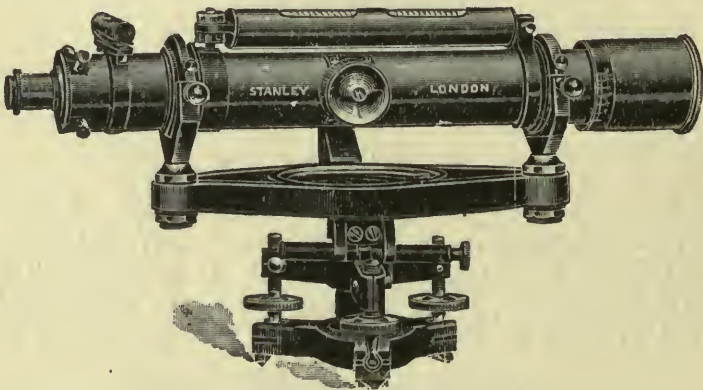

FIG. 107.

pattern, of which two views are given on Figs. 108 and 108A. These staves are telescopic and close up to have the appearance of the left-hand figure. When fully extended this Sopwith staff has a length of 14 feet, except in special cases. The right-hand view shows one foot of the ordinary Sopwith staff drawn to an enlarged scale. Here the large figures on the left of the staff refer to the feet into which it is divided, the top of each figure being the beginning or end of the foot in question. These large figures are generally marked in red, and the smaller figures in black. In the case represented in the figure the end of the third foot from the bottom of the staff is a horizontal line across the top of the large figure 3. This is also the beginning of the fourth foot which ends at the top of the figure 4. These feet are subdivided into ten parts, each tenth being represented by the length of one of the smaller figures. Only alternate tenths are numbered. The tenths are again subdivided into tenths of themselves or hundredths of a foot. These smallest subdivisions are represented by alternate lines and spaces, the breadth of a line or space being made equal to the hundredth of a foot. For example, a reading of 3.37 would be above

the large 3 at a point somewhere between the top of the small 3 and the bottom of the small V, the actual distance being 4 white bands and 3 black.

Target Staff.—This is less frequently used in this country than is the speaking staff. Two skilled observers are needed, one to manipulate the telescope, and the second to slide the target up or down the staff at the direction of the man at the telescope until it exactly coincides with his horizontal web, and afterwards to read the position of its vernier on the graduated scale. The graduations are generally arranged to give, by means of the vernier, readings to the nearest $\frac{1}{1000}$ of a foot. See Fig. 109.

Manipulation of the Level.—To use the level, first, having screwed it on to the top of the tripod, set the legs firmly on the ground, being sure that the feet stand as far apart as possible. The legs must be made to accommodate themselves to the inequalities of the ground, especially where the ground is on the slope. The telescope must be in such a position that the point which is being observed is clearly in view.

Where the ground is of a soft or spongy nature, the legs ought to be pressed down firmly. If in such a case they are only lightly placed on the ground, the weight of the observer as he moves about from one side to another, may be sufficient to throw the bubble entirely out of adjustment and seriously interfere with the accuracy of the readings.

When the instrument has been set up in this way with the lower screw plate approximately level, the next thing to do is to level the instrument. This is done, where there are four plate screws, by placing the centre line of the telescope over one pair of screws, care being taken that there is no shake in any of the screws. The operator brings the bubble to its central position by turning the two screws simultaneously in opposite directions. A little practice is required before the screws can be manipulated quickly and accurately. In order to prevent shake, the two screws must be worked together, one going down as the other comes up. They should be kept just tight enough to prevent

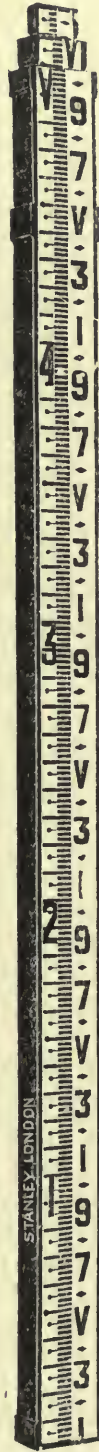

FIG. 108.

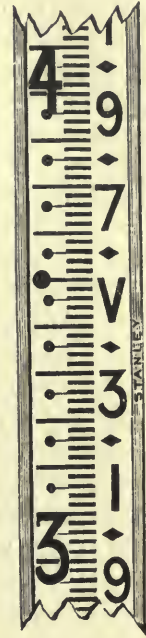

FIG. 108A.

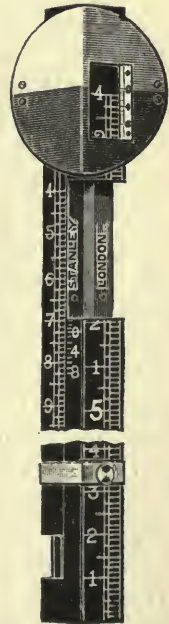

FIG. 109.

shake, but more than this will make it awkward to turn the screws, and at the same time will not improve the threads.

When the bubble has in this way been brought to the centre of its run, the telescope must be turned at right angles and the other pair of screws manipulated in the same way. The first position must be tried again, and so on, until at the end of two or three repetitions, the bubble remains perfectly stationary at the centre in whatever position the telescope is placed.

If the instrument is in good adjustment and the observer has attained the requisite amount of skill, the whole of this operation can be performed in a very short time.

Where there are three plate screws instead of four, only one is turned, the centre line of the telescope being meanwhile placed at right angles to the line formed by the other two.

In order that accurate work may be possible with the level the following tests and adjustments must be completed:—

Adjustments of the Level.—Temporary.—The temporary adjustments of the level are similar to those for the theodolite and may be as follows:—

(1) Set up the tripod firmly on level ground as described above.

(2) Focus the lenses. This is the same as in the theodolite.

Permanent Adjustments.—To appreciate the significance of these the reader must remember that the telescope turns about a vertical axis as it swings round; at right angles to this is a horizontal bubble tube, and that parallel to this—that is, also horizontal—is the line of collimation of the telescope or line of sight. The line of collimation should coincide with the axis of the telescope tube.

(1) *Line of Collimation or Line of Sight in Axis of Telescope.*—This can only be done by the surveyor himself in the case of the Y level. In doing this the horizontal web is focused on a distant horizontal line such as a division of the levelling staff. The telescope tube is then rotated about its own axis in the Ys through 180° . The web should still coincide with the line. If not, correct one-half the error by the diaphragm screws, and repeat until the adjustment is correct.

In the case of the dumpy level this adjustment can only be made by the instrument maker, who is generally supplied with a set of isolated Ys in which he can place his telescope tubes for testing. As a matter of fact, so long as the web has been carefully placed as near the centre of the tube as it is possible to estimate without making the above test, a slight deviation of the line of sight from the centre line of the tube does not greatly matter. This is fortunate, because obviously it would be impossible to make the adjustment after putting in a new web when carrying on work many miles from an instrument maker.

(2) *The Line of Collimation at Right Angles to the Vertical Axis.*—This means that the vertical axis being truly vertical, the line of sight should sweep out a horizontal plane when the telescope is turned completely round.

The manner of carrying out this test is shown on Fig. 110. Two points, E and F, are selected some 4 chains apart, having suitably hard ground on which to place the staff. The level is set up midway between these stations and carefully levelled. A staff is first held on E and a reading EA taken; the telescope is then swung round to face the second station and a reading FB taken. Then $FB - EA$ will give the true difference in level of the two stations, because, the instrument being placed midway between the two stations, any error AC caused by the line of sight not being perpendicular to the vertical axis will be the same as the error at the other station BD. The level is now placed in another position, P, in a straight line with F and E, but beyond the latter, and readings taken on the staff, EK and FG. If the difference of these is the same as the difference in the first position the adjustment is correct; if not, the line of sight will have to be brought down to H until the difference is the same as before. This adjustment is made by means of the screws which connect the telescope standards with the ends of the horizontal limb. At each of these points there are three screws, of which the outer pair are screwed into the telescope standard and pass freely through the limb, so that by tightening them the

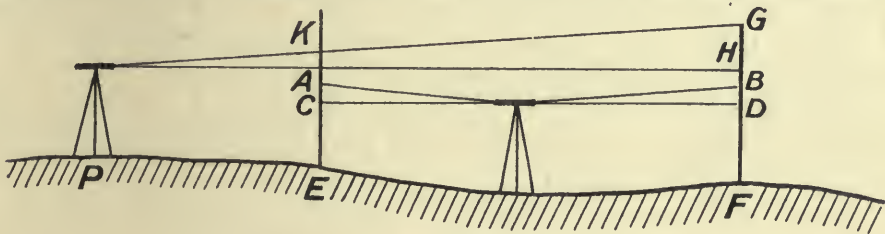

FIG. 110.

standard is drawn tight against the limb. The third or centre screw fits into a threaded hole in the limb, and its inward movement tends to raise the standard from the limb. In the Y level shown on Fig. 107 a similar adjustment is made with the capstan nuts.

(3) *The Bubble Tube at Right Angles to the Vertical Axis, that is, Parallel to the Line of Collimation.*—This is tested by setting up the level and bringing the bubble to the centre when at right angles to one pair of plate screws and turning the telescope through 180° . If the bubble now leaves its central position, correct one half the error by the plate screws and the rest by the adjusting nuts at the end of the bubble tube opposite to the hinge. When this adjustment has been correctly performed and the bubble remains in its central position as the telescope is rotated the level is said to “traverse.”

These permanent adjustments are not always made in quite the same way, although the manner of carrying them out and the order in which they have been taken are as they should be. Some surveyors prefer to leave intact the adjustment between the telescope and limb of the level, and, after first getting the bubble tube at right angles to the vertical axis by the hinge adjustment above or below the telescope, to set the

line of collimation parallel to the bubble tube or at right angles to the vertical axis by adjusting the diaphragm screws, after testing in the manner already described. This is quicker than the other way, but is not really correct, and where the line of collimation has been set in the centre line of the telescope by the maker it should not be disturbed. Where, however, the movement given to the diaphragm screws in making the adjustment in this way is only very small no harm will be done and the adjustment may be so made. The adjustments of the level may be summarised as follows:—

Temporary.—As in theodolite.

Permanent.—*Line of Collimation in Axis of Telescope.*—In Y level by rotating in Ys and adjusting by diaphragm screws.

In Dumpy level, this is done by maker.

Line of Collimation at Right Angles to Vertical Axis.—Set up level midway between two stations and get their true difference of level. Move level near to one staff and try again. Difference should be same as before. If not, correct by adjustment connecting telescope with limb of instrument.

Bubble Tube at Right Angles to Vertical Axis, that is, Parallel to Bubble. The Instrument should traverse.—Made by adjusting position of bubble tube about hinge until bubble remains in centre as the instrument is turned completely round about vertical axis.

Levelling Operations.—It has already been pointed out that levelling consists in finding the relative heights of a number of points on the



FIG. III.

ground so that they may be plotted and a section of the ground obtained on the line of staff positions. The simplest case is where there are two points only, A and B (Fig. III). The instrument is set up, for preference, midway between the points and properly levelled. Then, looking towards the graduated staff held on the ground at A, the observer sees the horizontal web of his telescope lying across a certain part of the staff at a , the height of the point from the ground being Aa . He then turns his telescope round so as again to face the staff, which has in the mean time been moved to B, and, again focusing on the staff in this position, takes the reading Bb . On the assumption that the instrument is in perfect adjustment and that ab is a truly horizontal line, the difference between Bb and Aa will be the difference in height between the two positions of the staff on the ground.

This is the simple operation of levelling as it applies to finding the difference in level between a single pair of points on the ground.

Before discussing the carrying out of more extended sets of levels and the more precise classes of the work, it will be well to consider several points in connection with the actual taking of the staff readings.

Reading the Staff.—After the telescope has been levelled and turned towards the staff, which is being held vertically on the point in question, the eyepiece being in focus, the objective is carefully focused so that the readings on the staff are distinctly visible. The image of the staff itself should appear as between the two vertical webs of the diaphragm, and the horizontal web should appear to be lying across the staff. The reason for placing the staff in the middle of the field of view is that the same part of the web may be used for all readings. The observer first notes the number of complete feet which intervene between the ground and the cross-web, as indicated by the nearest red figure which appears above the web. Some surveyors prefer to read the tenths and hundredths and book them before reading the feet, so as to avoid relying on the memory for the number of complete feet, but this is quite a personal matter. If the staff happens to be so near the telescope that the extent of the field of view is less than one foot of the staff image, it may be that no red figure is visible. In such a case the observer must signal to the staff man to slightly raise his staff, so that the next figure lower down the staff can be seen.

After the feet, then the tenths of feet, and, lastly, the hundredths.

The beginner will find that he is very liable to make mistakes owing to the fact that all the readings appear upside down, but this will come right after a little practice. In order to get over this difficulty some levels are made with erecting eyepieces similar to those of ordinary telescopes, but the simpler form is much to be preferred, on account of the better light and definition which is obtainable.

Where the sight is a long one, especially if the web is coarse, it is sometimes difficult to read to the hundredths of a foot, and in this case the fraction of a tenth at which the web stands must be estimated by eye.

Where a target staff is used, as in American practice, all the observer has to do is to see that the web coincides exactly with the horizontal mark on the target; and the staff man takes the reading at once, giving the height of the mark from the ground.

In reading the ordinary "speaking" staff, it is a good plan to look through the telescope and take the reading; then take the eye off, and look at the bubble to see that it is quite in the centre of its run; then, looking through the eyepiece, take the reading again. The two readings should, of course, coincide; if there is any divergence, a third can be taken.

When levels are being read, it is assumed that when the bubble is in the centre of its run, the line of collimation of the telescope is level. It is, therefore, most important that, at the moment the reading is being taken, the bubble shall be in the centre of its run. Unless the instrument is of heavy and rigid construction, it takes very little to disturb the bubble. The slightest pressure of a finger on the telescope, the alteration of the centre of gravity of the telescope caused by the process

of focusing, or the effect of wind or sun, are each of them sufficient to alter slightly the slope of the line of collimation.

This can be seen at once by focusing on the staff and lightly touching the telescope with the hand. It will be seen that it requires a very slight pressure to cause the movement of the cross-hair over several divisions of the staff, and at the same time to move the bubble from the centre. Many levels are provided with a mirror which is placed on the top of the telescope in such a way that the bubble can be seen by the observer without the necessity of moving his head. In this way, he can glance at the bubble just as he is about to take his reading. Where the readings taken are extremely important, it is sometimes advisable to requisition the services of a third person, whose business it is to stand by the instrument and keep the bubble in the centre of its run, and to be sure that this condition obtains just at the moment the reading is being taken.

With regard to the relative advantages of "speaking" and target staffs, there is the difficulty that we in Great Britain are not sufficiently familiar with the latter to be able to speak from knowledge born of long experience. But, so far as it is possible to make a fair comparison, the following may be put down as the respective advantages:—

Speaking Staff.—(a) Only one *skilled* observer necessary.

(b) The readings are taken directly without any setting of a target. The result of this is that greater speed is attained.

(c) The responsibility for the accuracy of the readings is in the hands of the one observer and there is no possibility of confusion or misunderstanding arising.

Target Staff.—(a) When the target has been "set," there is greater certainty in the reading being correctly taken.

(b) For long sights, the accuracy of target staff readings is probably greater than those of a speaking staff.

(c) Where a third man is employed in keeping the field book he can just as easily be at the staff and book the readings, when the staff man has set the target according to the instructions of the observer.

It is also to be remembered that the target staff has found much favour among surveyors in the United States of America, and this is evidence in its favour that cannot well be ignored.

Taking a Set of Levels.—The level has only been considered so far as regards the taking of a single observation. The series of operations which are made use of in determining sections will now be considered.

On the diagram shown on Fig. 112 a vertical section is represented as taken through a line AB on the ground. A section such as this is determined by taking a set of levels along the line in the manner indicated on the sketch, and so determining the heights of a number of successive points above an assumed datum line 300 feet above sea-level.

The successive points are marked A, *a*, *b*, *c*, *d*, and so on. Suppose the levelling to commence at the left-hand end of the line at A, and

proceed towards the right. It is further to be supposed that the height of the point A above the sea-level is known. It is generally convenient to start a set of levels from a point whose height is known, so that the heights of all other points which are connected with it by the series of levels can be given definite values. The datum line is generally taken at such a height that all points are well above it. This is much more convenient than taking it so that some points come above it, and others below. Suppose in this case that the datum is taken at the sea-level. Then the height of this point above the datum, in this case 312 feet, is called the "Reduced Level" of the point. Similarly the heights of all the other points above the datum are called their "reduced levels."

The first point should be of a permanent and immovable kind, so that it can be again referred to if desired. In commencing operations the level is set up in such a position that its line of collimation comes

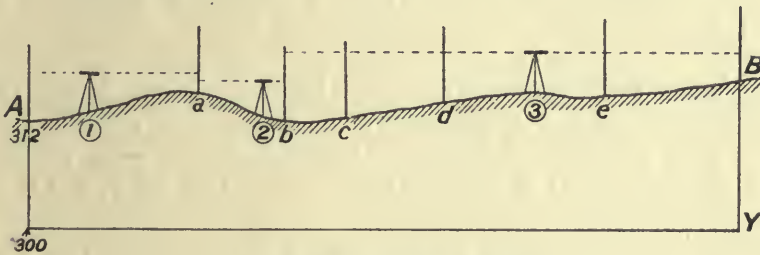

FIG. 112.—Series of levels.

well above the ground at A, and also so as to clear the ground at all points on the line intermediate between A and the position of the instrument.

The staff is now held on the point A, the staff holder standing behind the point and holding the staff quite vertical. The observer then reads the staff and books his reading. This first reading is called a "back sight," the term referring to a sight taken by the observer when he looks backward along the direction in which he has come.

The staff is next held on the second point *a*, whose height is required and the reading taken. This will be a "fore-sight."

The level is now moved and set up in a second position (2), and a "back sight" taken on the staff in the same position as for the last "fore sight," at *a*. The staff is now moved to *b* and a "fore sight" taken on this point. The level is now moved a second time and set up at (3), and a "back sight" taken on the staff at *b*. In this position, before reading the "fore sight" at B, the staff is held on a number of points *c*, *d*, *e* between *b* and B, and readings taken at these points. These are called "intermediate sights," or more shortly "inter sights." The fore sight on *a* should have been taken very carefully, with the staff held firmly upon some hard surface, such as a large piece of stone, part of a tree-trunk, or a peg driven in the ground. The readings taken in the first setting of the instrument will have made it possible to find the

reduced level of the point on the ground at a ; therefore, this will be a definite point from which to carry on the operations after the instrument has been shifted. In the second set of readings this point a is a "back sight," and is termed a change point—that is to say, its height forms the connecting link which makes the chain of levels complete.

A great deal of the accuracy of levelling operations depends on the correctness of the readings taken on these change points, and on the care with which the points on the ground are selected. These should be of such a nature that as the staff is turned round for the next back sight, the bottom face of the staff is at precisely the same height above the datum as it was in taking the previous fore sight.

And so the work proceeds, "back sights," "intermediate sights," and "fore sights" following each other in the same order as before.

The frequency with which intermediate sights are taken must be left to the judgment of the surveyor; generally speaking, uniform slopes require fewer of these than on more sharply undulating ground.

Also, it is a good rule to make the change points as few as possible, as each change means a possibility of error, and time is taken up in the setting of the instrument. In the present case it has been assumed that the level is set up always in the line itself, but this is not necessary.

Ordinary levelling work of the kind just described can easily be carried out by two persons. These are, first, the engineer or surveyor, who is responsible for the carrying out of the work; and, secondly, the staff-holder, whose duty it is to hold the staff on the points as directed, and also to act as chain man when the horizontal distances are being measured. The duties of the staff-holder are not difficult to carry out so long as a fair amount of care is taken.

In holding the staff for observation, the staff-holder should stand behind it facing the telescope, and hold it in position with one hand at each side, taking care not to get any part of either hand in front of the graduated face of the staff. The staff should be held quite vertical, and the holder may give it a slight backward and forward motion, so that if not permanently held quite vertically it will swing through its vertical position and show its lowest reading at this position. The staff-holder should be very careful to see that the particular spot of ground upon which the staff rests is fairly flat, and if the ground is of a soft or spongy nature the spot should be pressed down with the foot. A useful addition to the staff is a circular level fixed at the back so as to be in full view of the staff-holder. This is a small spirit level with a spherical container for the alcohol instead of a curved tube. In plan it appears as a circle, and the bubble, which is also circular, is in the centre when the staff is vertical.

A plate, Fig. 113, is sometimes used upon which to place the staff on soft ground. This is simply a triangular piece of plate iron with spikes at the corners to hold it in position and a chain and ring to carry it by.

The staff-holder should remember that when once he has held his staff in position he should never move it unless instructed or signalled to do so by his chief.

It must be remembered always that the change points are the points of real importance when carrying on a series of observations. These should be read with special care, because any error occurring in the reading of the staff when on a change point will remain throughout the series of observations. Whenever and wherever possible the level should be set up midway between two change points, so as to eliminate errors as far as possible. The reason for this will have been apparent from a consideration of the manner of carrying out the second of the permanent adjustments of the level.



FIG. 113.

Booking Levels.—As his observations are taken the observer records them in a levelling book. The pages of this book are ruled with vertical as well as horizontal lines so as to divide the figures into columns, and at the top of each column is a printed heading. The headings used vary according to the taste of the engineer and the class of work which is being carried out. Two of the most usual of these are given below, and the pages are filled with the observed quantities from which Fig. 112 was obtained.

The first of these tables is a sample of the most common way of booking the results. In the first column are placed the “intermediate distances,” these being the horizontal chainings between the successive staff positions. The second column contains the “total distances” from the beginning of the line of levels, made up of the sums of the quantities in the first column. The third, fourth, and fifth columns give respectively “back sights,” “intermediate sights,” and “fore sights.” The back sight is that obtained when the observer looks back at a change point, the fore sight is when he looks forward to the next change point, and the intermediate or inter. sights are all those staff readings taken in between the back and the fore sights. All the figures booked so far are taken from the observations. The next three columns contain worked-out results. These are “rise,” “fall,” and “reduced level.” Thus, in passing from the back sight 5.35 to the fore sight 2.15, the ground rises, and the difference between these two readings is booked in the “rise” column. In the next pair of sights the ground obviously falls, and so on. All these differences are taken and placed in their proper columns. The “reduced level” of the first point is known to be at 312 feet above sea-level, and this figure is placed in its proper column. As the second point has risen 3.20 feet, the reduced level of this will be $312.00 + 3.20 = 315.20$ feet. These rises and falls are added and subtracted from the preceding reduced level in each case. A check on the accuracy of the booking is obtained by subtracting the total fore sights from the total back sights and comparing this difference between the last and the first reduced level.

In the second table, whose columns and headings are arranged as in the first, the figures are not entered in quite the same way. In the first

table all readings obtained from one setting of the level are kept separate by being divided from those which precede and follow by lines drawn across the page. It will be seen that the last reading in the second setting is at a distance 138, and its reduced level is 312'4. In the next setting these figures have to be repeated below the line. In the second table the same figures are entered, but without the above repetition, each horizontal line of figures containing all the information obtained for a certain point on the ground, the distance, the fore sight for one setting and the back sight for the next setting being given in one line. This is really the simplest way of booking these results and the quickest, but in the plan in Table I. there is less chance of confusion. Very often the distances, which may be in links or feet, are placed in columns between the "reduced levels" and the "remarks."

In Table III. the "Line of Collimation" or "Height of Instrument" system, in which the height of the line of collimation is used for reference, is adopted for entering these same figures. Here the "height of the L.C." is obtained for the first setting by adding the first back sight to the known reduced level of the point, that is, $312'00 + 5'35 = 317'35$. To get the reduced level of the next point, subtract the fore sight from the height of the L.C., or $317'35 - 2'15 = 315'20$.

The height of the L.C. remains the same for all readings in one setting of the instrument, and the reduced levels are obtained by subtracting the staff readings from the height of the L.C. When the instrument is moved to a new position the height of its L.C. is obtained by adding its first back sight to the last reduced level. The balancing is done as before.

TABLE I.—EXAMPLE OF LEVELLING BOOK. RISE AND FALL SYSTEM.

Inter- mediate distances.	Total distances.	Back sight.	Inter. sight.	Fore sight.	Rise +	Fall -	Reduced level.	Remarks.
Feet.	Feet.	Feet.	Feet.	Feet.	Feet.	Feet.	Feet.	
91'0	0'0 91'0	5'35		2'15	3'2		312'00 315'20	Above sea-level
47'0	91'0 138'0	1'97		4'77		2'80	315'20 312'40	
33'0 54'0 86'0 74'0	138'0 171'0 225'0 311'0 385'0	7'46	7'21 5'41 4'90	3'23	0'25 1'80 0'51 1'67		312'40 312'65 314'45 314'96 316'63	
		14'78 10'15		10'15			316'63 312'00	
Total rise .		4'63			Total rise .		4'63	

TABLE II.—EXAMPLE OF LEVELLING BOOK. RISE AND FALL SYSTEM.

Inter- mediate distances.	Total distances.	Back sight.	Inter. sight.	Fore sight.	Rise +	Fall -	Reduced level.	Remarks.
Feet.	Feet.	Feet.	Feet.	Feet.	Feet.	Feet.	Feet.	
	0'0	5'35		2'15	3'20		312'00	Above sea-level
91'0	91'0	1'97		4'77		2'80	315'20	
47'0	138'0	7'46			0'25		312'40	
33'0	171'0		7'21		1'80		312'65	
54'0	225'0		5'41		0'51		314'45	
86'0	311'0		4'90		1'67		314'96	
74'0	385'0			3'23			316'63	
		14'78		10'15			316'63	
		10'15					312'00	
Total rise .		4'63			Total rise .		4'63	

TABLE III.—EXAMPLE OF LEVELLING BOOK. LINE OF COLLIMATION SYSTEM.

Inter- mediate distances.	Total distances.	Back sight.	Inter. sight.	Fore- sight.	Height of line of collimation.	Reduced level.	Remarks.
Feet.	Feet.	Feet.	Feet.	Feet.	Feet.	Feet.	
	0'0	5'35		2'15	317'35	312'00	Above sea-level
91'0	91'0				317'35	315'20	
	91'0	1'97			317'17	315'20	
47'0	138'0			4'77	317'17	312'40	
	138'0	7'46			319'86	312'40	
33'0	171'0		7'21		319'86	312'65	
54'0	225'0		5'41		319'86	314'45	
86'0	311'0		4'90		319'86	314'96	
74'0	385'0			3'23	319'86	316'63	
		14'78				316'63	
		10'15				312'00	
Total rise .		4'63			Total rise .	4'63	

Reciprocal Levelling.—Where a reading has to be taken on a more or less isolated point which is in such a position that the level cannot be set up halfway between this and the last back sight, by reason of a gap in the ground, the reciprocal method must be resorted to. Suppose the point whose height is known is A and the point whose height is desired is B, the instrument is set up near A, and a reading taken on a staff held on A and B. This gives a certain difference of level which may be incorrect by reason of instrumental errors such as the want of perpendicularity of the line of collimation and the vertical axis of the

level. The level is again set up near B, and a reading taken on the staff at B and A. This difference will be in error to the same extent, in the opposite direction, and the mean between the two differences, as determined, will be the true difference in level.

Bench Marks.—A bench mark is a permanent record of the height of the point above the sea-level or above some other datum. On the maps of the Ordnance Survey are to be found many of these Ordnance bench marks, which have been determined during the carrying out of the Ordnance Survey work. They are marked on the permanent parts of buildings, generally a few feet from the ground. Stone bridges are favourite positions for Ordnance bench marks, and also rock faces when they are available. The Ordnance marks are of the form shown on Fig. 114, cut deep in the face of the stone. The actual height referred to in the map is the height of the centre line of the top bar of the mark, and is at the bottom of a triangular groove. Surveyors often leave similar bench marks at convenient parts of their work to serve as permanent records from which the levels may subsequently be repeated or checked. The important thing to remember in leaving bench marks is that they should

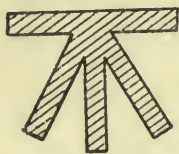

FIG. 114.

be placed on some object which is likely to remain undisturbed for many years. For instance, a mark on a substantial—not new—stone building is good, while a mark on a tree is likely to be continually changing in height.

If a surveyor wishes to establish the height above sea-level of any point on his survey he can generally find an Ordnance bench mark by consulting the Ordnance map of the district.

Flying Levels and Check Levels.—Flying levels are taken between isolated points at relatively great distances apart, in order to give the engineer some idea of the relative heights of a number of points with which his work is concerned. This kind of work is generally carried out rapidly, and long sights taken.

After completing a long line of levels, it is desirable to check the work in some way. This may be done by means of check levels, carried out by following the same line, and repeating the work with longer sights, or by coming back along the same line in the reverse direction. The best check is to determine the difference of level of the first and last points by taking long sights on a line which proceeds by a different route.

Precise Levelling.—This branch of levelling is carried out for such purposes as fixing the level of a point at some distance from the sea coast, establishing Ordnance bench marks from which other levelling operations may be started, finding the relative elevations of two sheets of water, and other similar purposes where differences in level of points at some distance apart are required to be known to a considerable degree of accuracy. The general plan of work in precise levelling is similar to that followed in ordinary levelling, but each instrument used is constructed with especial care, and each operation is carried out in such a way as to eliminate as far as possible all sources of error.

Besides the purposes which have been mentioned, precise levelling has to be made use of in carrying out such important engineering works as sets of locks, canals, and other similar hydraulic works. There are cases where lines of precise levels have been carried to distances as great as 1000 miles, but these are exceptional. In precise levelling all possible sources of error have to be considered, and no precaution is to be neglected. The principal causes of error are—

1. Want of perpendicularity of the line of collimation to the vertical axis of the levelling instrument.
2. Settling of the tripod in the ground.
3. Badly fitting staff joints.
4. Settling of the staff between the taking of successive readings on the change joints.
5. Atmospheric refraction.

Some of these give plus, others minus errors; some are cumulative, while others are compensating. No one of them is quite avoidable, but much can be done to minimise them and reduce the errors to their lowest possible values.

1. The levelling instruments used in this kind of work are generally larger than the ordinary dumpy level. The telescopes are more powerful, and the instruments are placed on tripods of heavy and rigid construction. In addition to the usual pair of vertical webs, three horizontal webs are provided, the centre one being for the staff readings, and the other two, which are placed equidistant from the centre one, are for the stadia work used in ascertaining the horizontal distances between the staff positions. The permanent adjustments are tested and made with great care, and the one which relates to the perpendicularity of the line of collimation and the vertical axis should be checked each morning previous to the day's work. Instruments used for precise levelling are often provided with tangent screw adjustments to allow of the telescope being rotated slowly. The telescope is generally supplied with a reflector to enable the observer to watch his bubble when taking readings; and an elevating screw is provided with which he can set the line of collimation exactly horizontal, by bringing the bubble to the centre, just as he takes his reading. The curvature of the bubble tube should be such that an inclination of the telescope which moves the bubble through one division should correspond to an angle of about 3 seconds of arc.

2. During the field-work great care is to be taken in selecting a stance for the tripod which will allow of the instrument being placed firmly on the ground with little possibility of settling downwards or of being disturbed by the weight of the observer as he moves about. The tripod legs should be covered with white cloth and the instrument itself protected from the sun's rays by means of an umbrella or other shade.

3. Errors due to badly fitting staff joints are eliminated by the simple plan of using jointless staves. These are generally about 10 feet in length, and divided into feet, tenths, and hundredths of a foot, the thousandths being read by estimation.

4. The settling of the staff between successive readings tends to give heights which are too great, and as this error is all in the same direction and cumulative, the final effect is to make the last point too high. The possibility of this error can be and is minimised by using a substantial foot-plate upon which to rest the staff. The bottom end of the staff is provided with a cylindrical piece of metal which fits into a corresponding hole in the foot-plate. The bottom of this hole has a convex surface upon which rests the flat end of the staff piece. Of course the points of contact must be kept scrupulously clean. There is generally a leveller and, following him, a check leveller who goes over the same ground as the leveller. Some levellers make a practice of taking observations on two change points for each setting of the level, there being in all four readings. The best way to counteract the cumulative error caused by settling of the staff is by repeating the set of levels from the opposite end of the line.

5. The effect of refraction depends a good deal on the condition of the atmosphere at the time the observations are taken and varies with the time of day. The best time in most cases is between the hours of ten and four, though, as a rule, it is not possible to get in more than about four hours' good work in the course of a day. In tropical countries, where the nights are cold and the days hot, the time of work is often reduced to one or two hours in a day. The average speed of working should be about 1 mile per hour.

In all possible cases the back sights should be of the same length as the fore sights, that is, the instrument should be set up midway between the staff positions. If this could be done in all cases the errors due to refraction and to the line of collimation not being quite horizontal would be almost eliminated. The sights should be as short as reasonably convenient and ought to be limited to 300 feet.

It is of course not possible to have a standard of absolute accuracy with which to compare any given determination, and the only possible way to get at the extent of an error is by comparing the result with a calculated mean value. The European International Geodetic Association have suggested the following standards for accuracy in precise levelling. Taking d_1, d_2, d_3, d_4, d_5 , etc., as the individual differences between given results and the mean of all the results, and n as the number of observations, the probable error may be taken as

$$= \pm 0.6745 \sqrt{\frac{\sum d^2}{n(n-1)}}$$

The standards are—

± 5 mm.	in one kilometre	is called	“large.”
± 3 mm.	“ ”	“ ”	“medium.”
± 2 mm.	“ ”	“ ”	“fair.”
± 1 mm.	“ ”	“ ”	“very precise.”

Results have been attained in some cases even better than the best of the above standards.

A study of the methods adopted and the precautions necessary to

ensure a reasonable degree of accuracy in precise levelling is worthy of the earnest consideration of any one who desires to carry out reliable work in any kind of levelling.

Contour Lines.—A contour line is a level line drawn upon the surface of the earth; or it may be defined as a line on the surface of the earth of which all points are at the same distance from its centre; or it is the boundary of a section cut by a level surface. The high-water line of a sea-coast and the water-line boundary of a lake are contour lines. Contour lines will be found marked on the larger-scale maps of the Ordnance Survey, and serve to indicate the forms of the valleys and ridges; where the lines are placed at equal vertical intervals their nearness to one another serves to indicate the steepness or flatness of the ground, for where the contour lines for equal vertical heights appear in the plan to be crowded together the ground is on a steep incline, and where they are far apart for the same vertical intervals the surface of the ground is relatively flat.

Contour lines are of use to the engineer in enabling him to plan out routes for railways and roads, and to select suitable courses for pipe lines and sewerage works. Also they provide data wherewith to calculate the contents of projected reservoirs.

In taking measurements which will enable him correctly to draw a series of contour lines on his plan, the engineer must first establish the points marking the contour lines on the ground, and afterwards take such observations as are necessary for the purpose of plotting them.

In order the better to explain how this is done a typical case will be described.

The wavy lines in Fig. 115 represent the contour lines of a valley across which is to be built a dam for the purpose of impounding the water which flows down the main stream of the valley for the purpose of forming a reservoir. The engineer wishes to know what volume of water the valley can hold, and also what amount will correspond to a rise or fall in the water level of so many feet above or below the mean.

First, to mark the contours on the ground or to "contour the valley." The manner of doing this will partly depend on the form or size of the valley. A convenient way which is applicable in most cases is that shown on the figure. Here it will be seen that lines of levels are taken, such as along AB and CD, from which cross-sections may be plotted if desired, and from which the contour lines can be "run." Suppose the contours are to be placed at vertical intervals of 10 feet. A point such as A is first established on the ground by levelling back from the nearest Ordnance bench mark. In this way a new bench mark can be fixed at a known reduced level. This point should be determined very carefully and its position permanently marked. Where there is no reason for fixing the contour lines at any particular heights the point *a* can be fixed arbitrarily. Having fixed the one point the engineer then works up the hill on one side of the valley, establishing points at *b*, *c*, *d*, and so on, each of these being 10 feet above the previous one. This is done by setting up the level approximately midway between *a* and where *b* is likely to come. Holding the 14-foot staff on *a* he takes a back

sight, which may be, say, 12.73 feet. He then subtracts 10.00 from this, obtaining 2.73. The staff-holder now moves up the slope in the direction of A (which should be marked by a picket), until the staff reading, which is now a fore sight, is 2.73. This will give a second point, *b*, which is 10 feet higher than *a*. As these successive stations are "change points," and as all the subsequent work depends on them for its accuracy, care must be taken to make them as permanent as possible. In doing this it is well to mark the initial point, *a*, on a large stone sunk in the ground, and the others, *b*, *c*, *d*, etc., are marked conveniently as the tops of substantial pegs driven into the ground, until the staff when held

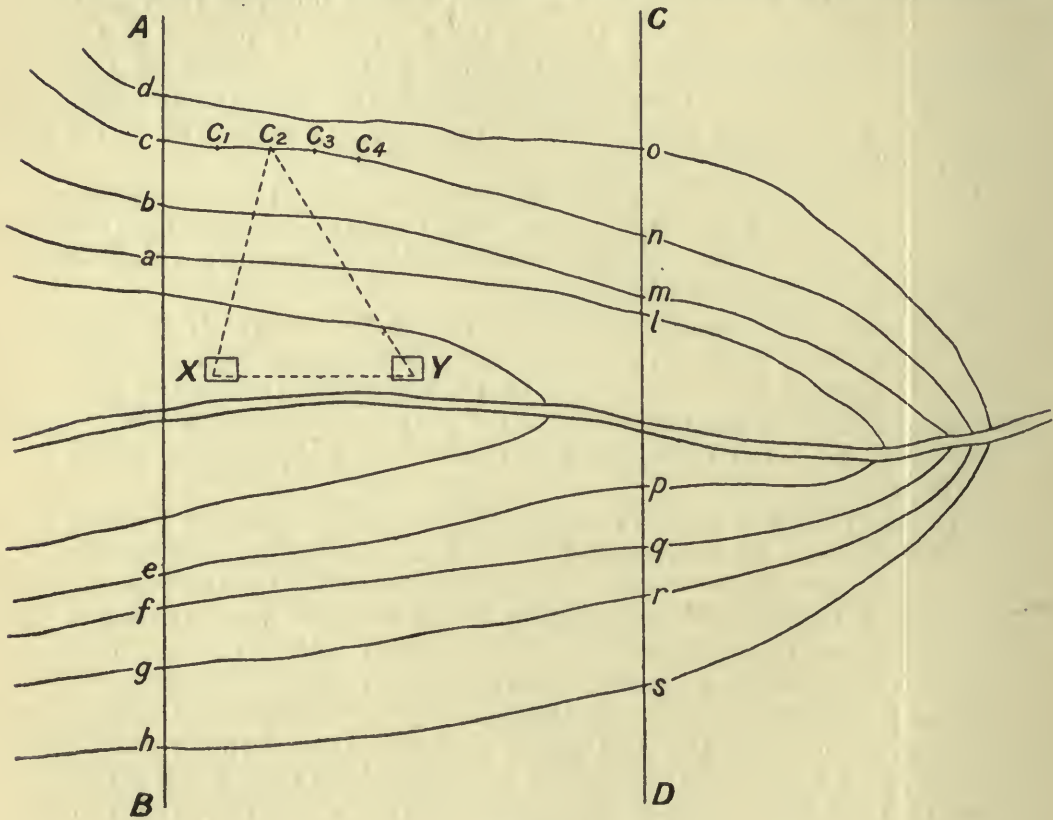

FIG. 115.

there gives precisely the correct reading. As *b* is established from *a*, so is *c* from *b*, and so forth, until all the points on one side of the valley are put in. The other side may now be approached, and *e*, *f*, *g*, *h*, and so on are established, *e* being at the same level as *a*, *f* as *b*, *g* as *c*, *h* as *d*. If the work has been carried out correctly a line of points will have been marked up both sides of the valley, each point being 10 feet higher than the one next below.

From these points *a*, *b*, *c*, *d*, *e*, *f*, *g*, *h*, etc., the corresponding contour lines can be run, both up and down the valley, as may be required. To do this from the point *c*, for example, the level is set up some little way from *c* at approximately the same level, a reading taken with the staff

held on the peg at c , and the reading noted. The staff-holder now moves to the neighbourhood of c_1 , and shifts his staff up or down the slope until the reading as seen by the man at the instrument is the same as at c . When this point is found the staff-holder receives a signal, and marks the point by inserting a small peg in which has been slipped a piece of paper marked c_1 . He then goes on to other points c_2, c_3, c_4 , etc., on the same contour, marking each in the same way as he leaves it. The number of these points which are necessary and their nearness to one another depends on the form of the ground. Where the slopes are flat and uniform it is only necessary to have a few marks, but when the ground is full of sharp curves around indentations and projecting ridges, the contours become sinuous and the points on the contour lines will need to be many and placed near together. When the staff gets out of convenient range of the instrument, the latter must be moved along and set up again, care being observed with the change point. The best chance of accurate work will be given if, in each setting of the instrument, the first back sight is at the same distance away from the instrument as the last fore sight, and a peg is driven into the ground for each change point. In some cases, where the difference in level between the contours is not greater than about 10 feet, it is possible to run two contours at the same time, with the same setting of the instrument and a constant difference between the staff readings for the points on the upper and the lower contour.

In a case such as the one described it may be convenient to have a second cross-section CD, the points l and p being carefully levelled up from the bench mark at a and the other points, m, n, o and q, r, p , being determined from l and p . This will give a check on the work as it proceeds, as the contour started from c should pass through n , and similarly for the others.

When contouring a wide valley it often happens that some of the contours prove to be closed lines. This happens where there is a depression in the flatter part of the bottom of the valley or where a mound occurs. As a matter of fact all contour lines form closed figures if carried far enough. Thus the high-water line at any part of our coast is in reality part of a closed line which runs round the whole of Great Britain, following the headlands out to sea and running up the estuaries and down again, until it comes back to its starting point. The process so far described will have enabled the engineer to mark the needed contour lines on the ground; it now remains for him to survey them so that they can be plotted.

There are several ways of doing this. In the case of long single contour lines, which may be necessary in connection with lines of communication, such as roads, railways, pipe lines, etc., it will be necessary to survey them by traversing with the theodolite and stiffening the traverse by observations taken on well-defined objects lying to one side of the line. Where there are many contours laid down in a confined space, as is the case on Fig. 115, it is quicker and more accurate to fix the points either by using a plane table or by stadia readings combined with horizontal angle readings with a theodolite.

In such a case as the one shown on Fig. 115, if the plane table is to be used, a base line will be set out in some position which will enable the telescope of the alidade to command all the contour points from both X and Y, the two ends of the line. After setting up the table over one of the points, the observer sends a man with a pole to be held successively on the various contour points. As there will be a great many of these, a carefully prearranged system of numbering and signalling will have to be adopted and rigidly adhered to. The contours may be denoted by the letters of the alphabet and the contour points by numbers. The point c_2 , or point number 2 on contour c , is shown as being fixed. Here the observer, standing at X, directs his telescope so as to cut the pole as held on the point, the picket-holder signalling its letter and number. As soon as the observer has properly sighted this point, drawn the line along the straight-edge, and marked the letter and number against this close to the edge of the paper, he lets the picket-holder know that he is satisfied, and the latter moves on to the next point, which is treated in the same way. All the points visible from X are marked for the one setting of the instrument, which can then be moved to Y, and the same process repeated from this end of the line. That is, when the observer comes to point c_2 , he directs his telescope so as to cut the picket and rules the corresponding line. He will note where this line cuts the line drawn from X and having the corresponding number c_2 . The intersection of these will give the position of c_2 on the paper. When this has been fixed to the satisfaction of the observer, the picket man can pull up the peg and go on to the next point. In this way, and in cases which happen to be suitable for plane-table work, the points can be put in very quickly. Some observers like to sketch in the contours as their points are fixed. When the plane-table sheet is completed, it can be removed from the table and the points transferred to the main plan by pricking through.

When fixing the contour points by the tacheometer (to be described in the next chapter), the theodolite, which is used for this purpose, is set up first at some convenient position X, and afterwards may be moved to a second position Y. The distance between these two points should be measured, and also their position relatively to the other points of the survey. At the position X the telescope must first be set on the point Y, after the horizontal circle has been clamped at zero. With the horizontal circle still clamped, the telescope, and with it the vernier plate, is successively adjusted on the staff when held at various contour points. At each point the horizontal angle which the line of sight makes with the line XY is read and booked, and also the staff reading subtended by the stadia hairs. The former will give the direction of the contour point relative to XY, and the latter observation will enable the distance of the point from X to be calculated. It is possible with a fair degree of accuracy to fix the points from one setting of the instrument, at Y, and the only reason for a second setting at Y is to give a check on the work if the engineer thinks this is necessary. With the readings taken and booked in the field in this way, the angles have to be plotted and the distances calculated and plotted in the office afterwards.

It would be possible to fix the points by the theodolite without any stadia readings if the angles alone were taken from the two stations. This would be similar to the plane-table scheme, but would involve a good deal more work, and could hardly be expected to be so accurate.

Determination of Differences of Height by means of the Barometer.

—It is well known that the reading of a barometer falls as it is carried to a greater elevation, where the atmospheric pressure is necessarily lower, and this fact is made use of when relatively great differences in level are required. The principal case to which this method is applied is in the determination of the heights of mountains which in most cases it is practically impossible to find by the ordinary direct methods of precise levelling. The difference in height of two stations is dependent not only on the fall in the mercury column, but is affected by differences in the temperature of the mercury at the two stations, differences in the air temperature, the condition of the atmosphere as to moisture, any difference in latitude of the stations, and the diminution of the force of gravity at the higher as compared with its value at the lower station. These influences are all taken into account in the more accurate formulas devised for the purpose of calculating heights, such as that of Rühlmann, but the extreme precision aimed at in these formulas is often more imaginary than real, and is often masked by obvious errors due to the manner of carrying out the work. In any case, they can only be used with any satisfaction by highly trained meteorological observers.

When the height of a mountain is to be found in this way, two barometers ought to be used. The readings of these are compared at the lower station, and one only is carried to the upper station. An observer remains at the lower station, and notes all the readings at small intervals of time, so that the readings at the upper station can be compared with those taken at the lower station at the same instant, and any variations in the conditions at the lower station, due to the lapse of time, are in this way taken account of. Temperatures of mercury and air are to be taken as well as pressures.

For the use of the engineer the following formula given by Rankine will be found to be sufficiently accurate :—

$$h = 60360[\log B - \log b - 0.000044(T - t)]\left(1 + \frac{T' + t' - 64}{986}\right)$$

where h is the difference in height of the two stations in feet ;

B is the height of the barometer at the lower station ;

b is the height of the barometer at the higher station ;

T is the temperature of the mercury in degrees Fahr. at the lower station ;

t is the temperature of the mercury in degrees Fahr. at the higher station ;

T' is the temperature of the air in degrees Fahr. at the lower station ;

t' is the temperature of the air in degrees Fahr. at the higher station.

Another formula, giving less precise results, is—

$$h = 56,300(\log B - \log b) \left(1 + \frac{T' + t'}{900} \right)$$

A couple of good aneroid barometers are far more convenient than mercury barometers, and, for the purposes of the engineer, sufficiently exact. When using these it is only necessary, in addition to the reading of the barometers themselves, to note the atmospheric temperatures.

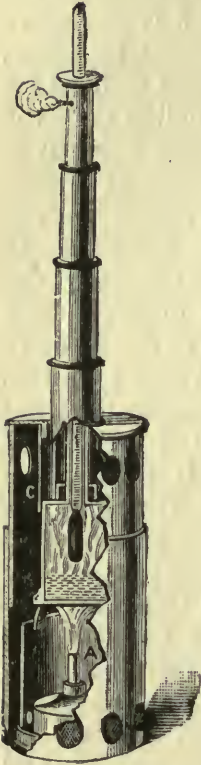

FIG. 116.

Cases have occurred of the heights of mountains in a ridge being found and where there is a sea-coast or flat land on both sides of the ridge, in which it has been necessary to have two lower station barometers, one on each side the ridge, on account of differences in the readings on the opposite sides caused by the air currents.

The Hypsometer.—The hypsometer, Fig. 116, is simply a specially arranged thermometer by which differences in the height of two stations can be determined by noting the difference between the temperatures at which pure water boils at the two stations. The temperature falls approximately 1° Fahr. for every 543 feet of difference in level. The following gives h in feet above the station where water boils at 212° , T being the actual temperature of boiling at the station in question. So that to find the difference in level between stations, first find the height of the lower station above the 212° station, and similarly for the upper station, and subtract the two results. The formula is—

$$h = 517(212 - T) + (212 - T)^2$$

and the difference in elevation in feet will be—

$$\begin{aligned} H &= h_1 - h_2 \\ &= [517(212 - T_1) + (212 - T_1)^2] - [517(212 - T_2) + (212 - T_2)^2] \end{aligned}$$

CHAPTER VIII

TACHEOMETRY OR RAPID SURVEYING

TACHEOMETRY has come to mean that particular form of surveying by which the relative positions of points upon the surface of the earth are determined by polar co-ordinates, where the directions are fixed in horizontal angles and the radial distances by readings taken through the telescope of the theodolite. In its broader sense it may be said also to include all methods in which distances are determined by single readings taken from one point, as in the various range-finders and telemeters. In all cases where tacheometric surveying is employed for topographical work, the angular direction of a line which is being measured is determined in the ordinary way, either by taking its magnetic bearing or by reading the angle which it makes with a known line. It is in the determination of the linear distance that the purely tacheometric methods come in.

The introduction of tacheometry into the everyday work of surveying was first made by Porro, an Italian engineer, about the year 1820. Since that time tacheometry has been largely employed by engineers and surveyors on the Continent of Europe, as well as in the United States of America, and in the Colonies, but, so far, engineers in this country have been very shy about adopting a method which would save them both time and money, and enable them to do their work as accurately as by the more direct chain measurements.

The determination of the linear distance between two points on the ground without the observer actually traversing the intervening space will be found in all cases to resolve itself into the solution of a triangle. It is a compact form of triangulation, in which the triangle is in most cases isosceles, and in which the base may be constant or variable.

On Fig. 117 is a diagram representing the more usual case met with in triangulation with the theodolite. Here AB is a base whose length is found by direct measurement. C is a third point whose position relatively to A and B is to be determined. The length of the base being known, the angles CAB and CBA are measured, and from the data so obtained it is possible to calculate AC or BC . This requires the completion of three distinct operations—namely, the measurement of the base and the two angular measurements. These

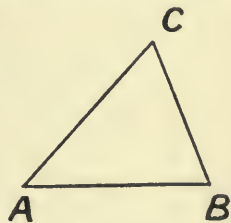

FIG. 117.

are necessary in the field, and to them must be added the calculation of the desired result.

In tacheometric work these four operations are reduced to either two or one. To do this, one angle of the triangle must be fixed, either by making the figure a right-angled triangle or an isosceles triangle. Thus in Fig. 118 AC can be found if AB and the angle BCA are known, ABC having previously been fixed as a right angle. Or, in Fig. 119, CD can be found if BA and the angle BCA are known,



FIG. 118.



FIG. 119.

the triangle being isosceles and CD the bisecting line. In both these cases the number of operations may be further reduced by giving either the base AB or the vertical angle ABC a constant value. In the case of the isosceles triangle on Fig. 119 it is usual to make the angle at the point C the visual angle of a theodolite telescope, of which the cross-webs intercept a certain length of a graduated rod held at D, the graduations being such that the intercept is a simple sub-multiple of the distance required.

The four principal tacheometric methods made use of in surveying are the following :—

- (a) Surveying by visual angle and graduated staff.
- (b) Surveying by vertical angles and graduated staff.
- (c) The "bar subtense" method, using a fixed base and reading horizontal angles.
- (d) Methods used in naval and military rangefinders.

Surveying by Visual Angle and Graduated Staff.—The principle involved in surveying by means of the visual angle and graduated rod

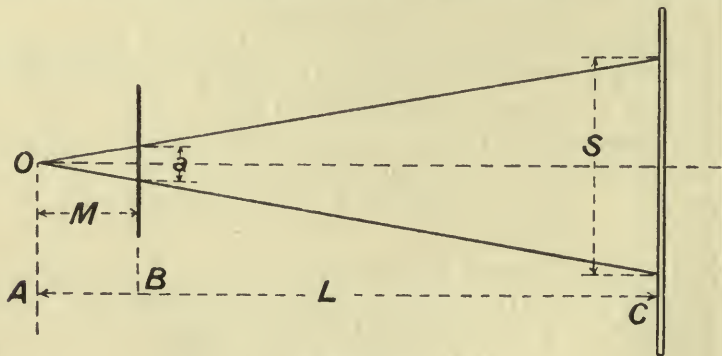

FIG. 120.

is shown graphically on Fig. 120. The observer is supposed to be looking horizontally from A through a screen at B, in which is a hole whose vertical height is (a). A graduated staff is held vertically at a third point C; the observer standing at A, and looking from O through

the screen at B, is only able to see a part of its length S by reason of the remainder being obscured by the screen. It is obvious that the further the staff is taken from A the greater will be the intercept S. In other words, S is proportional to the distance L, and may be used to measure it. Here there are two similar triangles in which

$$L : M = S : a$$

or

$$L = \frac{MS}{a}$$

In this case, if the ratio of M to a be made some simple ratio, such as 100 to 1, then, in order to ascertain any distance, L, between the position of the observer and that of the staff, it will only be necessary to look through the screen, note the length of the intercept S, multiply this intercept by the constant ratio, and the distance is given at once. If the ratio is made a multiple of 10, the multiplication can be performed mentally by moving the decimal point, and the measurement of L is reduced to one simple and rapidly performed operation.

This is the principle which is embodied in all the visual angle methods, but in actual practice the simple apparatus indicated would be useful only for very short distances, because the intercept could not be read if the staff were to be held more than a very few feet from the observer. Instead of a hole in a screen, the intercept is determined by two cross-webs in the diaphragm of a telescope appearing to the observer to lie across the staff; at the same time the visual angle or angle subtended by the intercept (S) and the distance (a) is fixed by the focal length of the object glass of the telescope.

There are two systems of this kind to be described, very similar in principle but differing in detail. The former of these is performed with an ordinary transit theodolite, which previously has been subjected to some slight modification. In the second case the telescope used is of a special design, known as an anallatic or Porro's telescope. This modified telescope may be used in an ordinary transit theodolite, or it may form part of a special theodolite and called a "tacheometer."

Tacheometry with an ordinary Theodolite Telescope.—On Fig. 121 is shown a diagrammatic view of the optical arrangement of a theodolite telescope. AB represents the vertical axis of the instrument, D the object glass, and the two cross-webs are marked l and m , the distance between them being a . The telescope is supposed to be focused on a levelling staff held vertically on the point whose distance L from A is to be found.

The only modification required in the telescope is the insertion of the two additional cross-webs, placed horizontally, and usually at equal distances on either side of the centre web. The appearance of the webs in an ordinary theodolite arranged in this way is shown on Fig. 122. The addition can be made once for all, and does not interfere in any way with the use of the instrument for other purposes.

The measurement of a horizontal distance by means of the additional tacheometer webs is carried out in the following way. The vertical axis

of the instrument is at AB, and the point whose distance is to be found is at EG; the problem is to find the horizontal distance L between these two lines. Suppose the telescope to be focused upon the staff, and suppose a ray of light to be traced from the cross-web l running parallel

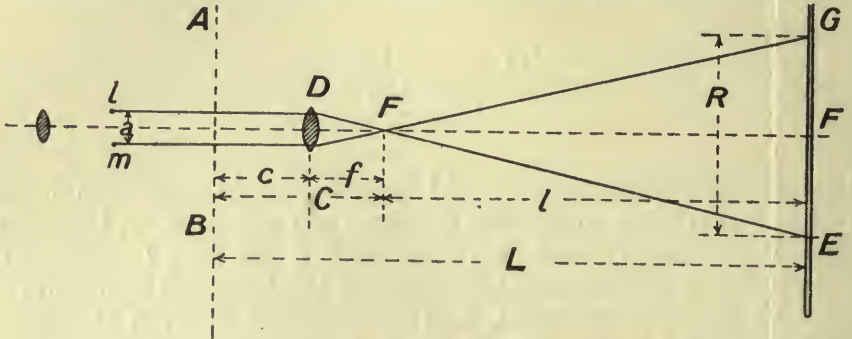

FIG. 121.—Theory of stadia measurements.

to the axis of the telescope. It will pass through the object glass at D and be deflected towards the centre line. It will pass through the principal focus of the object glass, and thence in a straight line to the point E, where the cross-web appears to the observer to traverse the staff. The same thing is true for the ray running parallel to the centre line from the second cross-web m . The angle GFE will be constant, and constitutes the measuring angle, distances from F to the staff being proportional to the intercept GE. As the observer looks through the telescope he will see the staff, and, lying across it, the two cross-webs l and m at E and G respectively. He will observe the reading of m at G, and that of l at E, and the difference between them will be the intercept GE or R. This is the only reading he will have to make in order to find L.

Now for the relation which exists between the intercept and the required distance L. In the figure the two triangles whose altitudes are f and l respectively are similar. Therefore,

$$l : f :: R : a$$

or
$$l = \frac{f}{a} R = kR$$

where k is the ratio between f and a . Of these two, f is the principal focal distance of the object glass and therefore constant, and a is the distance between the cross-webs in the diaphragm, and therefore also constant, so long as the webs are not disturbed. This will make k a constant.

But L is made up of l and f and c , of which f is constant, and c , the distance from the centre of the object glass to the vertical axis of the instrument, is only slightly variable, the extreme variation in the case of an ordinary 5-inch theodolite being not more than $\frac{5}{16}$ inch.



FIG. 122.

The average distance is considerably less than this, and may therefore be neglected in measurements of perhaps several hundred feet. So that if k , f , and c are found once for all for the instrument in question, then L minus a constant quantity, $C = (f + c)$, is directly proportional to R .

$$\text{Thus} \quad L = (f + c) + kR = C + kR$$

Before a given instrument can be used for the determination of distances these constants must be found.

To find k the best plan is to measure off several distances on a level piece of ground, driving in pegs at 100, 200, 300, 400, and 500 feet from the vertical axis of the instrument. The actual distances should be very carefully measured off with a steel tape and marked distinctly by black lines on the tops of the pegs. The staff is now to be held successively on each peg, with its graduated face coinciding with the line on the peg. At each position the telescope is focused on the staff, a reading for the top and bottom webs taken to give R , and the distance c measured. It is not difficult to locate the centre of the lens, and this point may be marked on the outside of the tube. The distance c will be given by measuring from this mark to the centre of the trunnion for each successive focusing.

The focal length may be found by focusing on a distant object so as to get the entering rays as nearly as possible parallel, and then measuring from the above-mentioned mark to the diaphragm screws, these being where the image is formed.

Then for each position of the staff c , f , R , and L will be known.

It is possible, therefore, to calculate the value of k as

$$k = \frac{L - (c + f)}{R}$$

The constant $(c + f)$ is only variable to a small extent. In order to obtain a reliable value for k the best plan is to take a number of observations at each distance, in every case observing R and measuring c , and from all the readings so obtained calculating a mean value for k to be used in all future operations.

In order to prevent possibilities of mistakes occurring, this value of k should be found from time to time, as it is quite possible for cross-webs to become displaced, and of course any new distance between the webs will mean a new value for k .

The cross-webs may be a fixed distance apart, or they may be so arranged that this distance is variable within small limits. If the latter plan is adopted the value of k may be made some simple multiple of 10, such as 100, in which case it is only necessary to shift the decimal point of the staff reading two places and add the constant, and the distance is determined at once without any tedious multiplication or reference to tables. For instance, it is obviously far better to make the constant 100 than to have, say, 98.72, which it may come to be if the webs have only been set approximately at the right distance apart. But if this plan of

having adjustable wires is used, every precaution must be taken that the adjustment is not disturbed.

The cross-webs may be spider webs, platinum wires, scratches on glass, or points. Some engineers prefer these last as being easy to read quickly, and at the same time being permanent.

In using this method in the field, with the intention of locating a number of points on the ground, the instrument must be placed in one or more positions, from each of which a clear view can be obtained of a large number of the points. When the instrument has been set up, the observer sights his telescope successively on each of the points to be located. At each point an assistant must hold the staff vertically, and upon it the observer notes the readings of the two horizontal cross-webs, in this way finding the intercept;

INCLINED TACHEOMETER SIGHTS.

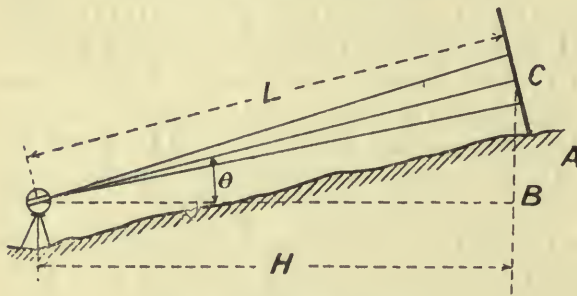

FIG. 123.—Staff inclined.

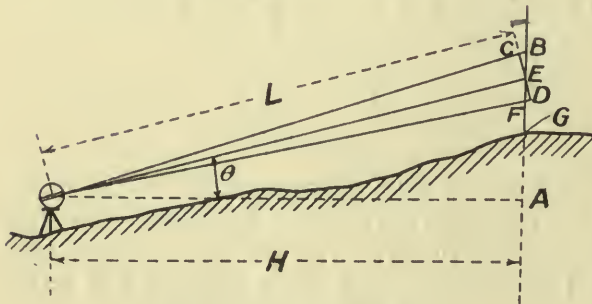

FIG. 124.—Staff vertical.

intercept. Either the distances may be calculated directly or obtained from tables or diagrams. It will be seen that the position of each point in any set is obtained quite independently of that of any other point of the same set. In this way there is no accumulation of error, and a mistake once made does not necessarily affect any other part of the work than the actual point in question.

Line of Observation Inclined.—What has been said up to the present refers to tacheometer measurements on level ground. On Fig. 123 will be seen a diagrammatic representation of the system which has been just described when used with the line of collimation inclined instead of horizontal. When this is the case the angle of elevation or depression, as shown by the central cross-web, must be observed and

at the same time he notes the bearing of his line of collimation, which is either the magnetic bearing or the angle which the line of sight makes with some line which has been previously established. For every point, therefore, two things are settled, namely, its direction relatively to a known line, and its distance from the known point of observation. In the office a number of lines must be set off radiating from the point of observation and making the directions given by the horizontal angles; along each of these must be set off a distance as obtained from the observed

noted as well as the staff intercept. The staff itself may be inclined as in Fig. 123, or held vertically as shown in Fig. 124.

Staff Inclined.—When inclined the staff must be held so as to be perpendicular to the line of collimation of the telescope; this is easily done by having either a telescope or a pair of sights fixed to the staff, about 5 feet from the ground and giving a line of sight which is perpendicular to the face of the staff. When holding the staff, the assistant inclines it so that when looking through the telescope or sights he gets the object glass of the tacheometer in this line of sight.

In this case the horizontal distance is

$$\begin{aligned} H &= L \cos \theta \\ &= (C + kR) \cos \theta \end{aligned}$$

it being remembered that the angle of elevation is observed at the same time as the intercept and horizontal angle.

Staff Vertical.—The holding of the staff so as to be perpendicular to the line of sight involves a certain amount of special care and is much more troublesome than when holding it upright. For this reason the latter plan is the one which is more usually adopted. This is shown in Fig. 124. Here CD is drawn perpendicular to the line of collimation and CD is R, the actual reading on the staff being BF = R'. Then, because

$$\begin{aligned} CE &= BE \cos \theta \text{ (nearly)} \\ ED &= EF \cos \theta \text{ (nearly)} \end{aligned}$$

and

the two errors are of opposite sign, and thus tend to neutralize one another—

$$\begin{aligned} R &= CE + ED \\ &= (BE + EF) \cos \theta \\ &= R' \cos \theta \end{aligned}$$

and

$$\begin{aligned} L &= C + kR \\ &= C + kR' \cos \theta \end{aligned}$$

But

$$\begin{aligned} H &= L \cos \theta \\ &= C \cos \theta + kR' \cos^2 \theta \end{aligned}$$

Surveying by Visual Angle, using a Special Telescope.—One objection to the method which has just been described is that there is always a constant to be added to the product of the staff intercept and the constant k . Moreover, this constant is not invariable, but depends for its absolute value on the focus of the instrument at the time. It is obvious that if this second constant can be done away with, the distance measured becomes directly proportional to the intercept on the staff. The consequence of this is that much of the office work can be done away with. The cross-webs may be set at such a distance apart that the distance measured is a simple multiple of the staff intercept; for, if they are at a fixed distance apart the staff may be redivided and painted in such a way that the staff intercept gives the distance as a direct reading.

A very usual plan is to so place the cross-webs that the intercept on an ordinary staff, or one specially prepared for the purpose, is one-hundredth of the measured distance from the face of the staff to the

vertical axis of the instrument. Thus, if the staff readings of the upper and lower webs were 6.72 and 3.35, or an intercept of 3.37, the decimal point would be moved two places and the distance required read off at once as 337 feet. This plan has obvious advantages.

The elimination of the second constant is made possible by the following device.

Referring to Fig. 125, S is the staff intercept which coincides with the cross-webs as seen through the eyepiece. O is the object glass, the eyepiece is near E, and between these two is placed a third lens, A, called the anallatic lens. g is the principal focal length of the anallatic lens. If x and y are the cross-webs, then rays emerging from them and passing parallel to the axis of the instrument must pass through the principal focus of the lens A at D, and traverse the staff at S.

The principal focal length of the object glass is greater than that of the anallatic lens, and is at a distance, f , beyond A. The distance, d , between O and A is fixed and cannot be changed by the ordinary

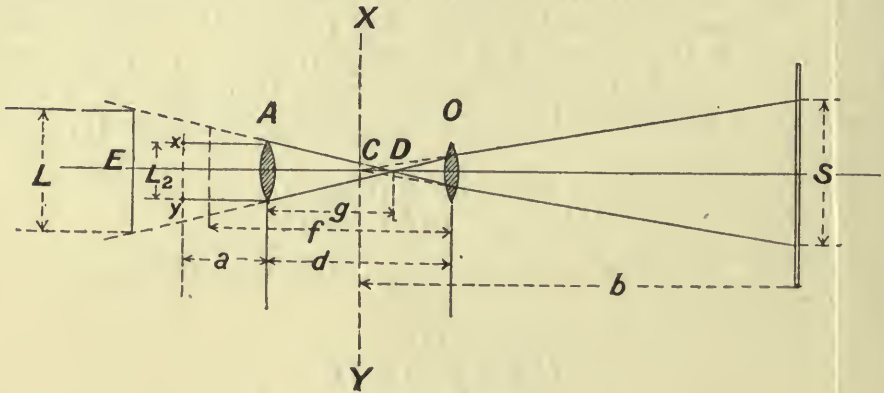

FIG. 125.

temporary adjustments. The lenses are so placed that the production of the limiting rays from the ends of the intercept pass always through the fixed point C, which is in the vertical axis of the instrument XY. These two rays themselves are refracted by the object glass, and meet at D, and, passing onwards through the anallatic lens A, emerge thence in parallel lines traversing the cross-webs x and y . This latter occurs because the point D is also the principal focus of A. It will be seen that D is the focus of O for the limiting rays making the reading angle, and is also the principal focus of A; also C and D are conjugate foci for the lens O.

By this arrangement the vertex of the reading angle is always at C in the vertical axis of the instrument, and the important result is attained that the distance b of the face of the staff from the vertical axis of the instrument is always proportional to the intercept S, and there is no constant to be added.

The lenses O and A, besides having their distance apart invariable, are also fixed with respect to the vertical axis of the instrument, focusing being effected by moving the eyepiece and diaphragm.

The arrangement just described is known as Porro's or the anallatic telescope, and was devised about the year 1823 by Porro, an officer in the Italian army and afterwards professor at Milan.

The method of using this tacheometer in the field is precisely similar to the one last described, the only difference being that the absence of the second constant makes the work simpler. When the staff is held vertically and the sight is of necessity inclined, a similar correction must be made in terms of the vertical angle made by the line of collimation of the instrument.

It may be added that it is not an uncommon thing for engineers to have anallatic telescopes fitted to their theodolites, even though they may not be intended for tacheometric work, a more powerful telescope being obtained. In this way, apart from obtaining the more powerful telescope, the tacheometric arrangements are ready for use if and when required.

Determination of Differences of Level.—Referring again to Fig. 124, it will be seen that the angle θ having been measured, it is only necessary to multiply the inclined distance L by the sine of this angle in order to obtain the vertical distance EA between the point A and the point E on the staff traversed by the central horizontal web. Then subtracting from this the reading on this central web, the difference of level between A and G will be obtained.

Surveying by Vertical Angles.—This system of rapid surveying is less frequently used, and is not so good as the visual angle methods

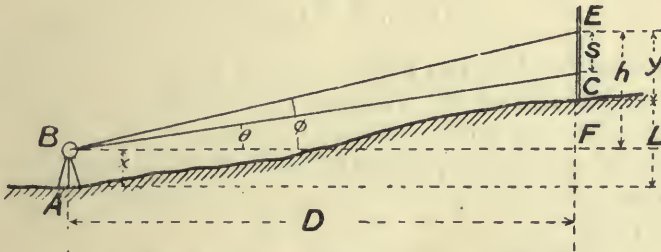

FIG. 126.—Surveying by vertical angles.

which have been described. It, however, possesses the advantage that it can be carried out with the aid of an ordinary 5 or 6-inch theodolite without any modification of the telescope and without the addition of any extra cross-webs. The general scheme of this method will be clear from an inspection of Fig. 126.

Here the theodolite is set up at a point on the ground A , and the graduated staff is held vertically upon a second point C , the problem being to find the horizontal distance between these two, and at the same time ascertain their difference in level.

$$\begin{aligned} \text{In this case} \quad & h = D \tan \phi \\ \text{also} \quad & h = D \tan \theta + S \\ \text{therefore,} \quad & D \tan \phi = D \tan \theta + S \\ \text{or} \quad & D = \frac{S}{\tan \phi - \tan \theta} \end{aligned}$$

In carrying out this method the instrument is set up on a known point, and the staff held vertically on each of the points to be determined. When the telescope has been directed to the centre of the staff and focused, the following readings are taken :—

(a) The reading of the horizontal circle, or the bearing by compass or both ; this will give the direction from the point of observation.

(b) The reading on the vertical circle when pointing towards the upper part of the staff, and the similar angle of elevation when pointing towards the lower part of the staff. These will be ϕ and θ . It is best to have the points a definite distance apart, which may with advantage be 10 feet or more. By having the ends of the intercept permanently marked on the staff by clear and easily distinguishable lines much time will be saved, and the length of the intercept S in the above formula becomes a constant quantity. When this is done the distance h from the upper reading to the ground will also be a constant. If the intercept is not kept constant the upper and lower staff readings will have to be taken as well as the angles.

(c) The height of the horizontal axis of the theodolite from the ground must also be measured.

The horizontal distance D between the two points will be given by the above formula from the data obtained with the help of a table of tangents.

The difference of level between A and C, or

$$L = h + x - y \\ = D \tan \phi + (\text{height of telescope}) - y$$

The number of observed points will as a rule be many, and will be taken from few points of observation, so that the height (x) need only to be measured a very small number of times.

The degree of accuracy obtainable in this system is given by Mr. Airey, who has thoroughly investigated it, as follows :—

Horizontal Errors.

At 5 chains . . .	1'13'	. . .	0'23	per cent.
„ 10 „ . . .	4'5'	. . .	0'45	„
„ 20 „ . . .	18'1'	. . .	0'90	„

Level Errors.

At 5 chains . . .	0'048'	. . .	0'009	per cent.
„ 10 „ . . .	0'096'	. . .	0'009	„
„ 20 „ . . .	0'192'	. . .	0'009	„

These are the estimated possible errors on level ground with a 14-foot intercept on the staff.

The advantages may be briefly stated thus: It is rapid, easy to understand, there is no special instrument required as an ordinary theodolite may be used, and, if a constant intercept be employed, there will be no staff readings to be taken.

The work will be greatly facilitated if a special staff be used provided with two white discs having distinct black lines drawn across.

Bar-Subtense System.—In the subtense method of rapid surveying a fixed horizontal base is held at the point to be fixed, and the horizontal angle which this base subtends is measured at the instrument ; from this, the distance between the base and instrument is found. It has been used on some of the Government survey work in India with marked success. In this case ordinary 6-inch theodolites were used, and were provided with only one vertical and one horizontal web in the diaphragm of the telescope. Instead of using ordinary levelling staves held horizontally rods of special design and construction were provided. These were of different lengths according to the distances sighted ; for distances up to three miles the rods were 20 feet long, and correspondingly shorter for the nearer sights.

Each bar was provided with a pair of circular discs, one at each end, the centre of the disc in each case being taken as the point to be intersected by the cross-webs of the instrument. A sight vane was fixed to the bar for the purpose of setting this at right angles to the line of sight of the theodolite.

The work in the field is carried out in the following manner : The theodolite, having been set up and levelled in the usual way, and the staff-holder being in position on the point to be observed, the line of sight is first directed to the left-hand disc, the rod at the same time being held perfectly horizontal and at right angles to the line of sight of the telescope.

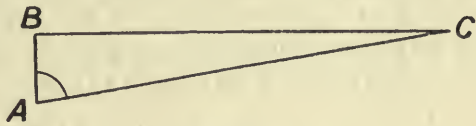

FIG. 127.

This latter end is attained by the staff-holder sighting his telescope on the centre of the theodolite. The sight vane or telescope is at the end B of the bar, and therefore the angle ABC is the right angle (see Fig. 127).

The observer, after directing his line of sight to the left-hand disc at A, fixes the lower clamp, and takes the left-hand reading. He then unfastens the upper clamp, directs his telescope to the centre of the right-hand disc at B, and reads the angle thus obtained. This angle should be found with the greatest accuracy by repeating the movements ten times, and dividing the total angle so obtained by 10. If this angle is called $\beta = \text{BCA}$

$$\begin{aligned} AC &= (\text{length of bar}) \times \text{cosec } \beta \\ &= AB \text{ cosec } \beta \end{aligned}$$

One great advantage of this system is that, the angle measured being a horizontal one contained between the two vertical planes swept out by the line of collimation of the instrument, the distance obtained is also horizontal, and no further reduction is required. By the tangential and visual angle methods the distance first found is on the slope and must be reduced to its horizontal projection.

A high degree of accuracy is possible and has been attained. It is stated that in India an error of only 6 feet was obtained at a distance of three miles, this being equivalent to 1 in 2640. As the work was

plotted to a scale of 1 in 1117 the above error was inappreciable. For shorter distances the errors will be relatively smaller.

Subtense Work in Small Surveys.—There appears to be no reason why a system based on the bar subtense method could not be made use of for the purpose of fixing the main points of smaller surveys. There are two points in its favour. One is that the horizontal distance is found at once and can be plotted as found, and the other is that greater accuracy may be expected than in other tacheometric systems, because the base subtended has a definite and fixed length, and is not made to depend upon direct readings on a graduated staff; and, further, this base

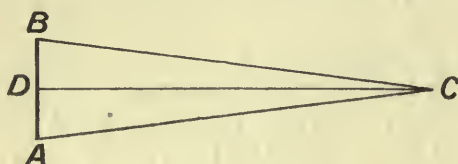

FIG. 128.

length can be and is increased to suit the length of readings that may be expected. In using the subtense system for smaller surveys a telescopic rod could easily be provided with a sight vane fixed in the centre at right angles to the axis of the rod. This arrangement would perhaps be more convenient than that of Fig. 127. In this case if AB is the length of the base, between the centres of the two discs, and α the observed horizontal angle subtended by this base, then the horizontal distance from the instrument to the centre of rod will be (Fig. 128)—

$$CD = \frac{AB}{2} \times \cot \frac{\alpha}{2}$$

To get the difference of height between the two points a small third disc with a horizontal line upon it could be placed in the centre of the bar, and the elevation or depression of this point read at the same time as the horizontal angle.

The accuracy of such a method can be fairly well estimated. For instance, suppose the average length of line to be 300 feet and the theodolite a 5-inch one reading to single minutes. In the angular reading a greater error than one minute ought not to occur. If the method of repetition were used it would be considerably less than this. With a base of 20 feet at a distance of 300 feet the error in the estimation of the distance would not be more than about 2 feet, and in the hands of very careful and practised workers the error would probably be much less.

General Hints on Tacheometric Work.—From what has been said it will be seen that there are a number of different ways of solving the main problem of tacheometry, which is, given a point on the ground, to determine the horizontal distance of a second point some distance away from the first, and at the same time to find its height above or depth below a level line drawn through the first point.

The actual system adopted depends upon the circumstances surrounding the particular case in question. For very long sights it will probably be found that the bar-subtense method, using horizontal bars of constant length, is the most accurate and convenient.

Surveying by vertical angles is simple as regards the field work, and does not require any special or modified appliances, but is tedious as regards the office or reduction work.

Those methods which depend upon the employment of the visual angle are slightly more accurate than the last, and are much easier to reduce to a state suitable for plotting. This is especially true where an anallatic lens is used along with a specially divided staff. This last may be regarded as the best suited for rapid and accurate topographical work.

In what classes of work are tacheometric methods to be employed? Speaking generally, it may be said that for detailed topographical surveying the chain and tape are superior to the tacheometer—that is to say, where the principal object is to secure a wealth of detail rather than to aim at a very high degree of accuracy. But for surveys extending over large tracts of new country, such as are to be met with in the Colonies, the tacheometer is undoubtedly superior to the chain, both in speed and accuracy.

One class of work for which the tacheometer is especially suitable is “contouring.” If, for instance, a portion of a valley is to be contoured for any special purpose, it is only necessary to mount the instrument on two or three prominent positions and run the contours, observing and booking the direction and length of each line of sight. With the tacheometer it is only necessary to observe each point on the contour from one point of observation; with the plane table two are necessary.

In recent years several accounts of their work have been given by engineers who have made use of tacheometric methods in carrying out surveys. Many of these have been in connection with railway work in the Colonies or in new countries which have previously not been surveyed in sufficient detail to render a resurvey necessary. One of the most interesting and instructive of these is by Mr. H. G. Dempster, A.M.I.C.E., who gives an account of the carrying out of the trial survey for a railway in South Africa; this is a typical case showing the methods adopted by him in carrying out all work of this kind.

After expressing the opinion that the tacheometer is likely to become the universal instrument for railway work, the author goes on to say that the success of a tacheometer survey depends largely on the care with which the whole plan of operations is mapped out, the proper apportionment of the work among the various members of the party, and the thorough training of each unit of the party in his own particular branch of the work. Or, as Mr. Dempster puts it, “the success of a tacheometer survey depends to a great extent on the systematic organization of the party.”

The tacheometer party engaged on a trial survey in rough country should consist of the surveyor in charge, a first assistant to run the traverse and take the tacheometer readings, a junior to enter the readings in the field book, a leveller to check-level the traverse stations and do plotting and drawing work, and a slide-rule man to work out the field books and help in the plotting. For such a party of engineers

SAMPLE HEADINGS FOR FIELD BOOKS IN TACHEOMETRY, USED BY DIFFERENT AUTHORITIES.

Authority, AIREY.

Theodolite station.	Object viewed.	Azimuth of object.	Compass reading.	Intercept on staff.	Vertical angle reading.		Height of telescope above ground.
					Upper.	Lower.	
II	12	180° 24'	81	2-16 feet	83° 3½'	91° 55½'	4-90 feet

Authority, KENNEDY.

Station.	Height of instrument.	No. of point.	Bearing.	Vertical angle.	Reading of wires.	Generating No.	Height of staff.	Horizontal distance.	Difference in feet.	Rise.	Fall.	Reduced level.
A	1'27	3	311° 48'	91° 42'	166	156	1'76	155'86	4'63	—	6'39	267'58

Authority, GRIBBLE.

Telemeter station.	Staff station.	Horizon- tal limit.	Vertical limit.	Stadia hairs.	Direct distance.	Horizontal component.	Vertical component.	Elevation of telemeter station.	Height of instru- ment.	Back sight.	Fore sight.	Elevation of staff station.	Elevation of line of colli- mation.
A	BM	—	+2'05	500 700	280	280	10'16	494'91	4'75	6'49	—	503'42	499'66

there should also be at least five tacheometer staff men, two level staff men, and also one or two extra men to drive pegs, carry apparatus, etc. In a colonial survey most of these manual assistants are natives. After making himself thoroughly conversant with the general features of the ground and matured his plan of operations, the work is begun.

A tacheometer with two horizontal stadia webs in addition to the central horizontal web was used, and the readings were taken on vertical levelling staves, divided into $\frac{1}{60}$ ths of a foot instead of $\frac{1}{100}$ ths.

The tacheometer theodolite was set up in a number of successive positions and a large number of observations taken from each position, the number varying, according to the nature of the ground, from 10 to 60 from each point.

The staff-holders held their staves on the various points whose position and height were to be determined with the object of getting a complete set of contours of the ground traversed by the proposed centre line of the railway.

After setting up the instrument the height of the centre of the instrument was measured with a small steel tape, and then the readings taken to the various points. The following are a list of the observations to be taken to each point and the results to be worked out from these:—

(a) The number of the station from which the readings are being taken.

(b) The height of the instrument as measured from the top of the peg in the ground to the centre point of the instrument. This is measured by means of a short steel pocket tape.

(c) The number of the point which is being observed is noted in the book.

(d) The horizontal angle is observed. At all stations the zero line is set so as to be in the same position, coinciding with the magnetic meridian. By doing this the angles can be referred to one pair of rectangular axes, and they can also be checked by compass readings.

(e) The vertical angle is taken as given by the reading on the vertical circle.

(f) The stadia readings are next taken, the upper and lower web being read separately and booked as such.

(g) In the next column of the complete book is the difference between the readings of the two webs, which is the length on the staff subtended by the visual angle.

(h) The reading of the axial web is next given; this gives the height of the point observed above the point on the ground where the staff is held.

(i) In the complete book, the horizontal distance from the observer to the staff is given next, being worked out, as described, by

$$H = KS \cos^2 \theta$$

K being the constant of the instrument and S the staff intercept, and θ the angle of elevation. This horizontal distance is given by a reference set of tables.

(j) After the horizontal distance comes the vertical height of the point above the observer.

(*k*) In the next column is entered the difference between the vertical height of the bottom of the staff above the observer. If the angle is one of depression this is a fall.

(*l*) In the next two columns are, first, the height of the instrument above the datum; and, secondly, the height of the point, also above datum.

(*m*) In the last column are entered special remarks having reference to points observed.

The heights were checked by ordinary levelling and the results compared. This served as an excellent check on the work, and made the results more reliable.

The theodolite stations were all levelled in the ordinary way by means of 12-inch dumpy levels, and these formed a check on the accuracy of the tacheometer readings. Besides the one 12-inch level there were used on this survey two 5-inch tacheometers, a prismatic compass, and seven levelling staffs.

This example shows very well how a tacheometer can be made use of for a rapid and sufficiently accurate determination of the contours of a strip of country along which it is intended to run a line of communication. There is little difference between the tacheometer determination of heights and the same when found by direct levelling. The author states that the level of a point could be found with the tacheometer at a distance of 800 feet from the observer to within 3 inches. The check levels might be dispensed with, but it saves time in the end to be certain about the figures.

Apart from its more extended use on large surveys, any engineer using a theodolite will find that the addition of a pair of stadia hairs to the diaphragm of his telescope most useful for the purpose of taking occasional observations in difficult places, such as finding the width of rivers or the distances apart of two isolated points situated on opposite sides of a ravine.

The use of tacheometric methods is a perfectly simple matter and requires no special training. One point that is very greatly in the favour of the tacheometer as compared with the chain is that the great bulk of the work is done in the office, and a very great deal can be done in the field in a day unless there is much detail work, in which case it would be better to abandon the tacheometer and use the chain.

For getting a rapid measurement of a considerable tract of land with as high a degree as can be obtained with a chain and tape, the tacheometer or the theodolite provided with stadia webs is invaluable, and it is a great pity that it is not more generally used.

Accuracy of Tacheometer Methods.—Taking the degree of accuracy of ordinary chain work as 1 in 400 for fairly good work in an undulating country, and as 1 in 1500 in surveying of the best kind, it will be seen from the following figures and results that tacheometry compares very well with chain surveying so far as accuracy is concerned. The actual degree of accuracy attained varies a good deal according to the method employed and upon the conditions of working. The following figures will be of use in giving the reader a definite idea of what has been attained.

These figures and results have been selected from various sources of information.

Geological Survey of the U.S.—The average error of ordinary stadia work over all kinds of country was found to be 1 in 700

Subtense Surveying in India.—The errors were so small that they were not appreciable when plotting to a scale of 1 in 1117

U.S. Lake Survey.—The mean result of surveying 140 lines, varying in length from 800 to 1000 feet, gave an error of 1 in 650

Also three measurements of a base line gave results of 1 in 1000
 1 in 1635
 and 1 in 1888

Topographical Survey of St. Louis, Mo.—The error of closure after correction for the error of graduation of the rods used was 1 in 800

Without this correction the error was 1 in 500

Baker's Measurements.—Three measurements of lengths varying from 50 to 500 feet showed an average error of 1 in 1100

Airey, from careful investigation of the subject of surveying by vertical angles, estimates the horizontal measurements at 500 feet to be to 1 in 440
 at 1000 „ „ 1 in 220
 and at 2000 „ „ 1 in 110

The above were for an intercept on a 14-foot staff on level ground.

Middleton, by laying out a very carefully executed theodolite triangulation, and going over the lines afterwards with a theodolite working on the tangential system of tacheometry found that the limit of reasonably accurate working was reached at sights of 1000 feet; and that the average error for distances up to 1000 feet was 1 in 860

For stadia work he found the limit reached at 800 feet with a degree of accuracy of 1 in 1200

The Author, by testing the stadia method on carefully measured level lines of lengths varying from 50 to 550 feet, in increments of 50 feet, found the average single line error at 50 feet 1 in 270
 to 550 feet 1 in 190

These errors are plus and minus, and when a number of measurements are taken they to some extent compensate. The error in this case would be called the Mean Resultant Error and was at
 50 feet 1 in 2000
 and at 550 feet 1 in 370

Rangefinders or Telemeters.—Rangefinders are only used in surveying to a very small extent, but as the principles involved bear a close relation to those used in tacheometry, it will be useful to consider briefly one or two of the standard rangefinders. Telemeters and rangefinders are practically identical, the former term being used when the instruments are especially adapted and used for land surveying, and the latter when referring to those used for naval and military purposes. The word “telemeter” is also used occasionally as meaning what has been described as “tacheometer.”

Speaking generally, telemeters or rangefinders are those instruments or devices employed for the determination of distances without making use of direct measurement and where the whole operation must be conducted at or close to the point of observation. For instance, in military operations, the distance required is that from the gun to the point which it is required to reach with the projectile, and as this point is in the hands of the enemy, it is obviously impossible for an assistant to go to the point for the purpose of holding up a graduated staff; for this reason a device must be adopted in which the whole operation can be conducted in the immediate neighbourhood of the observer. In the ordinary surveying tacheometer, some kind of staff must be held at the point of observation. It is in this respect that the real difference between tacheometers and telemeters or rangefinders consists.

Telemeters and rangefinders can themselves be divided into two distinct classes, namely, those in which the operation is conducted by two observers in one operation or one observer in two operations; and, secondly, those in which the whole determination is made in one observation.

General Principles adopted in all Rangefinders.—This has already been mentioned, but it will be well to refer to it again here. It is expressed by the diagram on Fig. 127. Here A is the observer and C is the observed point, it being required to find the horizontal distance AC without traversing the intervening space. AB is the base of a right-angled triangle in which ABC is the right angle. Then, if the length of the base AB is known and the angle BAC can be measured, sufficient data will be obtained to find the distance AC.

If the angle BAC were to be measured with an ordinary angle instrument, such as a theodolite, the desired result would be given by—

$$AC = AB \sec (\text{BAC})$$

As a matter of fact, this process is rarely followed out in all its details, some device being, in most cases, adopted by which the required range is given at once by a single reading on a linear scale.

Two Observation Telemeters or Rangefinders.—One of the best-known of instruments of this type is the **Steward Telemeter**. This can be used for both military purposes or for land surveying. The general principle upon which this instrument works is shown in Fig. 127. In the right-angled triangle CBA, the observer stands at A, and looking towards a point in AB or AB produced, sets his instrument so that by means of the mirror arrangement used the point C is brought into

coincidence with B, by turning the movable mirror through the requisite angle. The angular movement given to the mirror in order to effect this is, on its proper scale and with the known and fixed base, a measure of the required range.

The instrument itself is shown on Fig. 129, being in reality a modified form of sextant. In some cases where the ranges are long

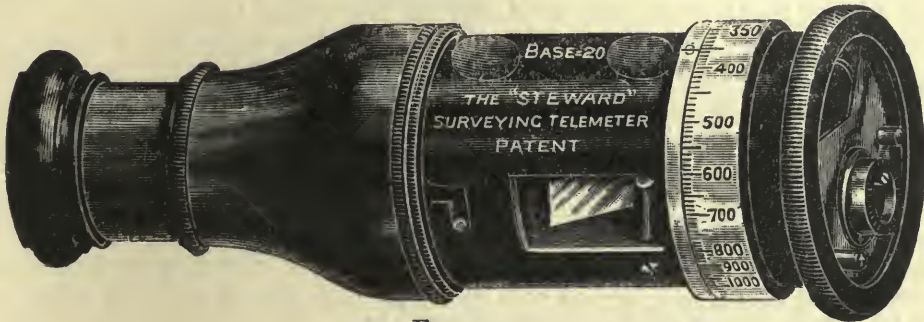

FIG. 129.

or the definition required is to be very great, a special telescope eyepiece can be attached to the end where the eye of the observer is placed.

When the range is to be rapidly found in a single operation, two observers are necessary. The position of these is shown in Fig. 130. The two observers stand, the right-hand one at the right angle B of the triangle and the other at the variable angle A. The base is a fixed one, and is determined by a piece of fishing line stretched between the two instruments used. The left-hand observer holds the telemeter (Fig. 129) in his hand, and the second observer holds an optical square in a similar way. The base line is fixed to the two instruments, and is to be kept tight during the operation. On the top of each instrument is fixed a sight vane.

The left-hand observer (No. 1) sets the two zeros of the telemeter together, and also sets the arrow on the toothed wheel so as to coincide with the fixed arrow. The line is now pulled tight, No. 2 retires or advances until the sight vane held by No. 1 coincides with the object sighted. No. 2 is then standing at a correct right angle. When this has been done, he calls "On," and

No. 1 has in the mean time been turning the milled head so as to keep the sight vane on No. 2 in coincidence with the object observed. At the moment when No. 2 shouts "On," No. 1 finally brings the points into exact coincidence, and reads off the range, which is given by the indication of the graduated ring.

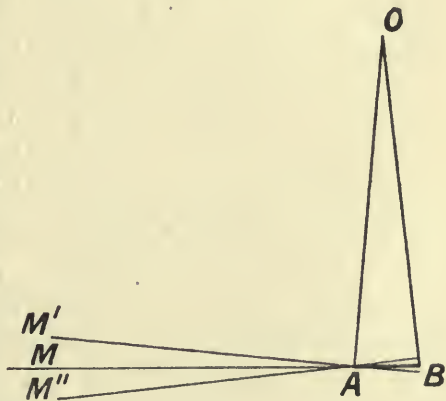

FIG. 130.

The graduated ring or drum serves to alter the angle of the movable mirror and so bring the points into coincidence. When this is set to zero, and at the same time the toothed wheel is set to zero also, the instrument is simply an optical square, and the angle between the two points is a right angle.

The above method is most suitable when the range has to be found in a very short time, and is of course best suited to the exigencies of military work. But where more time is available, the whole of the work can be performed by one observer, in the following way.

First set the instrument to zero, and at the same time set the arrow of the toothed wheel approximately to zero. Now let the observer stand at A (Fig. 130), look along AM and at right angles to the direction of the range to be measured. The reflected view of O will be seen in the lower glass, and above it will be seen the direct view of some object in the direction of M. If the object, which may be a tree, or other familiar object, be not exactly in coincidence, it must be made to coincide by turning the toothed wheel. Much depends on the accuracy with which this coincidence is made. When this has been done the observer places some object, such as a glove or stone, on the ground exactly under the position of his eye as he has taken his observation.

Having done this, he walks backwards in the continuation of the line formed by the mark M and the stone he has left on the ground. The distance he walks backwards must be either measured or paced, the former of these being of course the more accurate, but pacing can be made use of for approximate work.

The instrument is graduated in such a way that the length of this base must be 30 units in length. The units may be feet, yards, or metres.

Being now at the point B in a line with MA, AB being 30 units in length, the observer brings the mark and the object into coincidence once more by turning the milled drum, and the range may be read off directly. The range will be given by the reading on the divided edge of the drum in the same units which have been made use of for setting out the base. With a similarly divided drum, the range can be determined with a base having a larger or smaller number of units by

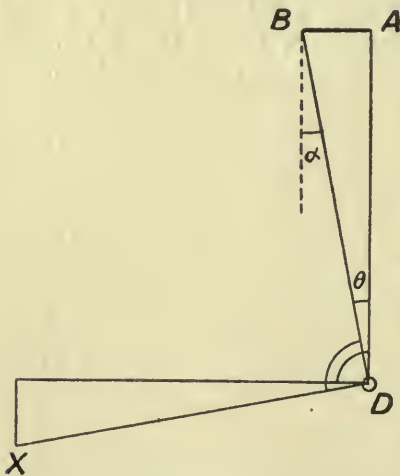

FIG. 131.

performing a simple operation in arithmetic. For instance, if the base were to be 60 units instead of 30, then the range would be got by dividing the result by 2 or the fraction which the original base was of the new base.

Similarly if the base is smaller instead of larger, the result must be multiplied instead of being divided.

On Fig. 131 is shown another way in which this telemeter may be

made use of. Here the base is held by an assistant at the point observed, as in the case of tacheometry. The observer stands at D, and sends the assistant to the point observed at AB. A convenient length for this base is 6 feet. The observer stands facing roughly at right angles to the range line and selects a point, X, which is as nearly as he can judge in a line at right angles to the range. Call this point the "mark."

The observer first brings the mark into coincidence with the end of the staff farthest away from the observed point by means of the cogged wheel, and then into coincidence with the other end by means of the milled drum. Then the figure given on the circle divided by 6 will be the required range. In this case the turning of the mirror simply measures the angle θ instead of the angle α , as in the former case. The staff should be held so as to be at right angles to the direction of the range.

It will be seen that this telemeter is nothing more or less than a compact form of sextant in which the rotation of the index glass is given on a divided scale, which is so calibrated that for a given base its readings yield the range direct.

Single Observer, Single Operation Rangefinder.—The best example of this type is the now well-known Barr and Stroud Rangefinder. This instrument was selected from a number submitted to the British Admiralty, after being subjected to severe and rigid tests, and has proved perfectly satisfactory in its working.

The standard Naval Rangefinder of Drs. Barr and Stroud has a fixed base of 4.5 feet, and is designed to comply with the Admiralty requirements, which insist upon a rangefinder being able to measure ranges up to 3000 yards with a maximum error of 3 per cent. In order that there may be a safe margin, even after all allowances have been made for the effects of the many disturbing influences, the makers of this rangefinder have aimed at a degree of accuracy represented by an error of 1 per cent. at 3000 yards. This error becomes less as the range diminishes.

The general scheme of all rangefinders of this type is shown on Fig. 132. Here AB is the fixed base, AO is the range, and the angle OAB is a right angle. The angle OBA varies with and forms the measure of the range.

A diagrammatic view of a rangefinder is shown in plan in Fig. 133. This is shown as a tube whose centre line forms the fixed base. This is AB. Near the two ends of the tube are placed inclined mirrors, in such a way that the line corresponding to OA (Fig. 132) enters the tube through the opening or window near the end L, strikes the mirror, and is reflected at right angles to its original direction, which is down the centre of the tube.

Here it strikes a second mirror O, and is again reflected at right angles to the eye of the observer who is looking through an eyepiece at E. If the object were at an infinite distance from the observer, the ray coming from it and entering the tube near M would strike the other mirror



FIG. 132.

B, suffer a double reflection through two right angles, and enter the eye in a direction which coincides with that of the first. But if the direction of this ray is as seen in the triangle AOB as OB (Fig. 132), then if the mirror B is in the same position as before, the reflected ray will follow the direction indicated by the upper dotted line, and will not enter the eye coincidently with the first.

This coincidence may be effected by altering the angle of the mirror B, and this angular movement of the mirror may be made eventually to form a measure of the range. The further the object is from the observer the less will the mirror need to be turned until the two images of the object as seen from the two ends of the base are seen to coincide.

This latter plan was adopted in the rangefinder made by Adie in 1860, the movable mirror being attached to the end of a long lever to which was given an angular movement by the turning of a fine thread-screw with a milled head having a graduated edge. By a suitable calibration the divisions on this milled head were made to give a direct

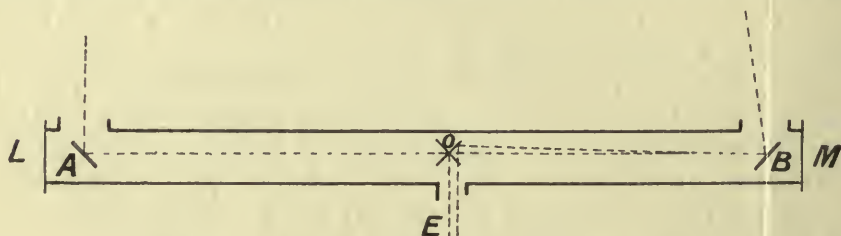

FIG. 133.—Rangefinder with movable reflector.

reading of the range when the images had been brought into coincidence. This was not, however, able to produce results which came up to the standard required by the British Admiralty.

In order to be able to work to the prescribed limits of accuracy, it is necessary to be able to detect a difference of angular direction of the second ray represented by one second of arc. In the Adie instrument the mechanical defects, caused by the inaccuracy of the screw, the distortion of the lever and the backlash of the screw gave rise to errors which made it impossible to detect the extremely small angle required. It may be interesting to note here that one second of arc is approximately the angle subtended by one-third of an inch at a distance of one mile, or $\frac{1}{100}$ of an inch at a distance of 170 feet.

Another device for effecting the same purpose was used in the rangefinder designed by Mr. W. H. M. Christie, Astronomer Royal. This consisted in interposing a lens between the mirror B which, in this case, was fixed, and the centre of the tube where the mirror for the second reflection was placed. This lens was capable of being moved laterally to the centre line of the tube, so as to move the ray of light bodily and bring it into coincidence. This plan, however, was not sufficient to ensure the desired accuracy.

In the Barr and Stroud rangefinder, which is based on the same general plan, a most ingenious device which has made it possible to

attain the desired degree of accuracy is made use of, and the instrument has been entirely successful. This success is not, however, due to the main device alone, but also to the very great care and ingenuity which has been displayed in overcoming small minor difficulties and possible sources of inaccuracy.

A diagrammatic plan of the Barr and Stroud rangefinder is shown on Fig. 134.

It will be seen that the rays pass inwards from the observed point as before and are reflected along the axis of the tube. If the rays are parallel they will be coincident after the first reflection, and after the second reflection will pass to the eye of the observer still in coincidence, so that the images from the two ends appear to be superposed. If the observed object comes nearer the instrument, the ray entering the right-hand end of the tube will not now run parallel to the other ray but strikes its reflector in a direction shown by the dotted lines. After its

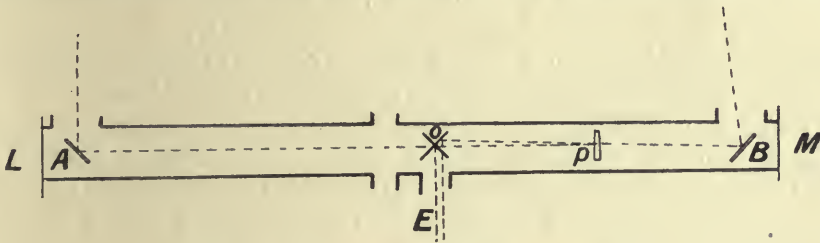

FIG. 134.—Barr and Stroud rangefinder.

reflection it inclines upwards, and, after passing through the object glass, follows a path which is parallel to its former one, but rather nearer the point observed. After the second reflection, the rays from the two ends will not coincide, and two distinct images will be seen.

In order to bring the two images into coincidence, a prism marked P is interposed between the objective and the central reflector. As the rays pass through this they are deflected towards the centre, and the angle of this deflection is always the same. The lateral displacement of the central ray, consequent on passing this prism, depends on the position of the latter as regards its distance from the end of the tube.

The movement of this prism from its zero position is made the means of measuring the range. The nearer the observed point comes to the instrument the more inclined will the right-hand ray be, and consequently the further the small-angle prism must be moved towards the end of the tube.

A pointer attached to this prism moves with it over a graduated scale, whose divisions are in yards of range, so that the position of the pointer on this scale indicates at once the distance of the observed point from the observer.

It must be understood that the instrument itself is supported upon a standard or pillar and can be swivelled about the vertical axis as well as turned about its own axis, which is horizontal. In addition to the eyepiece, in which the object is viewed and its two images brought into

coincidence, there is a second telescope placed at right angles to the axis of the main tube, and so arranged that as the observer stands and looks through the principal eyepiece with his right eye at E the eyepiece of the second telescope is exactly opposite his left eye. This second telescope is used simply as a finder, and is used when getting the object in view in the first instance. The telescope is so supported that the observer can bring it into position with very little effort. As soon as the object is brought into the middle of the field of the "finder" the observer concentrates his attention on the main eyepiece, and with his right hand turns the milled roller which is placed conveniently on the top of the tube. By doing this he brings the two images of the object into coincidence by the movement of the prism, and as soon as this has been done he at once looks at the reading given on the scale, which is seen through the second eyepiece, and this gives him the range at once. The whole operation only takes a few seconds and is complete in itself.

The two reflectors at the ends of the main tube are of speculum metal, and the reflection at the centre is effected by a combination of prisms so arranged that the image of the object as seen from the left-hand end of the base appears on the upper half of the field of the eyepiece, and that from the other end appears on the lower half.

For instance, if a flagstaff is the object sighted, when there is not proper coincidence, it appears to be broken. When this is so the milled roller must be turned until the lower part of the image moves to the left and comes into coincidence.

A special device is employed in the arrangement of the prisms by which the line of demarcation between the upper and lower halves of the field is a definite one.

When observations have to be taken at night, an astigmatizer is used by which a lamp or light of any kind appears to the observer as a vertical line, and a lamp is provided for the purpose of illuminating the scale.

For a full description of this instrument the reader is referred to a paper by Drs. Barr and Stroud, published in the *Proceedings of the Institution of Mechanical Engineers*, 1896.

CHAPTER IX

GEODETIC OR TRIGONOMETRICAL SURVEYING

GEODETIC surveying differs in several important respects from the plane surveying which has so far been described. It is used for the purpose of locating the relative positions of points over tracts of country much greater in extent than those in which ordinary plane surveying would be applicable; ordinary land surveys do not usually cover areas greater than one mile across, whereas geodetic surveys are used to measure tracts of country which may be several hundreds of miles across in any one direction. And, as the distances are relatively greater than in plane-surveying, the surface covered must be treated as what it really is, namely, part of the surface of a sphere or spheroid; this involves the use of spherical trigonometry. Lastly, in geodetic surveying the relative positions of the various points are fixed by making them the angular points of a series of triangles, in which, when the length of the side of one of them is known, the lengths of the sides of all the other triangles can be found by calculation when the angles have been measured. In other words, the ground is covered with a network of large triangles; the length of a side of one of these triangles is measured directly, and the remainder of the work consists in measuring angles and calculating lengths of sides.

In the more ordinary kind of geodetic survey, such as that of Great Britain, the whole of the ground to be so surveyed is first covered with a network of very large triangles, some of whose sides may be as long as 100 miles. The sides of the triangles will vary in size from, say, 100 miles to 15 miles, according to the locations of the naturally suitable main stations. A horizontal line, some miles in length, is measured directly, extreme care being taken to obtain the greatest possible accuracy under the existing conditions. This is the "base," and it is generally found convenient to extend this by triangulation, so that the working base may be more nearly comparable with the intended sides of the main triangles. The extended base is then linked up, by means of angle measurements, with one of the sides of a main triangle. From further angular measurements it now becomes possible to calculate the two remaining sides of this triangle. As each side of this first triangle forms also one side of a further triangle, it now becomes possible to completely determine four triangles. And if the lines joining the vertices of the last three triangles be taken as completing three more triangles, seven triangles will have been completely

determined. So the process goes on, the lengths of the sides of each triangle being dependent on three angle measurements, and on the previously calculated length of one of them.

It will thus be seen that for the complete determination of a system of triangulation three things are necessary, namely—

- (a) Measurement of a base with the greatest possible accuracy.
- (b) Measurement of the three angles of each triangle.
- (c) Calculation of the lengths of the undetermined sides of all the triangles.

Before the work of a trigonometrical survey can be commenced, a general reconnaissance of the country must be carried out, so that some definite idea may be obtained as to the arrangement of the general scheme of triangulation, and the main stations must be selected. The whole of the area to be surveyed is first to be covered with the network of the "main" or "primary" triangulation, consisting of triangles whose sides may be as great as 100 miles in length, and probably not less than 30 miles. The angular points of these main triangles must of necessity be situated on prominent and easily distinguishable stations, and are often placed at the tops of high mountains or hills. Interlinked with the "primary" is the "secondary" triangulation, which may be made up of triangles having sides from 10 to 15 miles in length. Inside this, again, is the "tertiary" triangulation, with lines of 1 or 2 miles in length. This last is used for the purpose of filling in the detail with the chain.

As in all other survey work, the best plan is to work from the greater to the less, the first aim being to get the relative positions of the main points correctly determined. Then the secondary points are fixed relatively to the main points, the tertiary triangles and the detail being put in last.

Measuring the Base.—As the correctness of all that follows in a trigonometrical survey depends on the accurate measuring of the base line, this will be taken first. For the purpose of carrying out the measurement it is necessary to select a suitable piece of ground. This must be level, with an uninterrupted view for several miles along the direction of the line. Also it should be placed so that the stations at the end of the line command a view of such of the main stations as are to be linked up with the base. The ground should be dry and not likely to be affected by floods. It is also desirable in many cases to have the tract of land considerably longer than the proposed measured base, and wide as well as long, so that if desired the base may be extended by triangulation. The line is first ranged out with a transit instrument (Fig. 134A), and a large number of stations marked on the line so ranged. When this has been done and the ground rendered as level as possible and free from obstacles, the actual work of measurement may be commenced. It is now generally recognised that short bases on perfectly level ground are better than longer extended bases on rough ground.

Several methods have been used for measuring bases, all the older bases being measured by the repeated and consecutive application of

short rods. However constructed or of whatever material, one of the chief qualifications in a measuring rod is that it shall be affected to the least possible extent by variations of temperature or by moisture in the atmosphere. Whatever the material or design of the measuring bars, the general plan of using them is the same. Fine lines or crosses are marked near their ends, the distance between the centres of these at the normal temperature being the stated length of the bar in question. Three bars are generally used, and these are supported on trestles in the true line, being placed end to end with a few inches between each

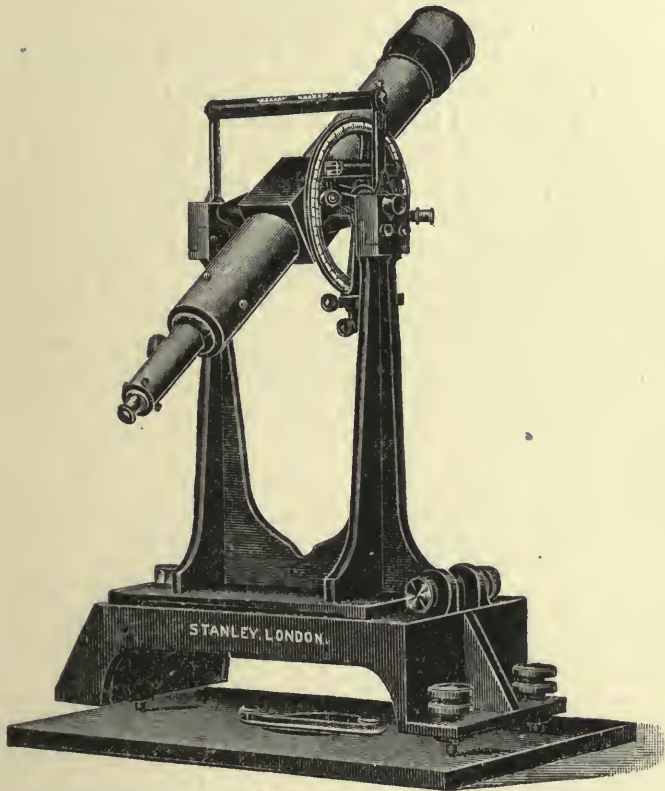

FIG. 134A.

pair, and carefully levelled. Above each of the two gaps are placed short subsidiary bars fitted with micrometer microscopes. The total length of this combination of bars = (the sum of the lengths of the three bars, properly corrected for temperature) + (the lengths of the two gaps as determined by the micrometers). When this has been completely determined, the measuring bar nearest the beginning of the line is removed and placed end to end with the third bar. Its length plus the width of the third gap is added to the former total. This process is continued, bar by bar, until the whole line has been completed. The bars are generally covered by a light tent roof or covering to protect them from the sun's rays and from rain. The process is a very tedious one, it requires the greatest care, and may take many

months to complete. It is well to repeat the measurement from the other end, so as to provide a check on the work.

Measuring Rods or Bars.—Deal rods have been used, but though these are little affected by variations in temperature, it has been found that their capacity for absorbing moisture from the atmosphere militates against constancy of length. Though temperature variations may be allowed for from data provided by previous experiment, the variation due to moisture is an unknown quantity and cannot be calculated.

Glass rods, in the form of tubes, have been tried with far better success than attended the use of the wooden rods.

Steel chains, 100 feet long and of heavy section, have been used with some success. These chains, whose links were one-quarter of a square inch in section, were laid in previously levelled wooden troughs and kept under a constant tension of about 56 pounds. Lines near the ends of these were made to coincide with the zero of a steel scale of known length. By using these longer units errors due to repetition are partly eliminated, and variations due to temperature changes can be calculated with a considerable degree of accuracy. Steel bands of heavier section than the ordinary steel tape and of lengths up to 500 feet are now frequently used.

Self-compensating Bars.—A measuring bar designed by Borda was first used in one of the Spanish trigonometrical surveys. This consisted of a composite bar of steel and brass, so proportioned that the

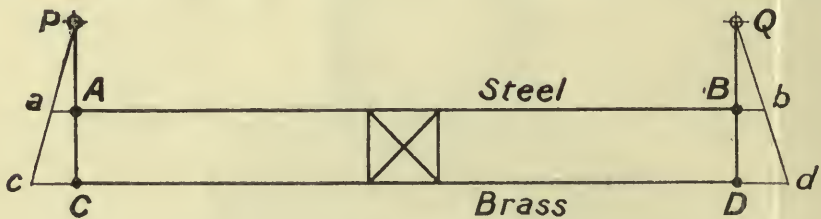

FIG. 135.

distance between a pair of crosses scratched near its ends remained constant whatever the temperature. A rise in temperature would tend to lengthen the bar as a whole, but this same rise in temperature would cause the bar to become curved by reason of the greater expansion of the brass than that of the steel. This curvature would bring the points nearer together by the same amount as that with which they had a tendency to separate by the linear expansion of the steel.

Besides Borda's bar two other bars designed with the intention of preserving a constant distance between the measuring points, whatever the temperature, may be described. The first of these is *Colby's Compensating Bar*. The scheme of this bar is shown in diagram on Fig. 135. Here the main part of the bar is AB, of steel, 10 feet long and $1\frac{1}{2}$ inches by $\frac{5}{8}$ inch in cross-section. Fixed in a position parallel to this is a brass bar of the same length, CD. The ends of these are connected by two short pieces, CAP and DBQ, by pin joints at A, B, C, and D. As the main bar AB expands by reason of a rise in temperature, the brass

bar CD expands to a greater extent by reason of the greater coefficient of expansion of the brass. The points P and Q are so placed that

$$Aa : Cc = (\text{coefficient of expansion of steel}) : (\text{coefficient of expansion of brass}).$$

This means that as the steel bar expands by amounts Aa and Bb , the brass bar will expand by Cc and Dd , corresponding proportionally to the coefficients of expansions of the two metals. The result is that the straight lines CAP and DBQ take up new positions, caP and dbQ , and whatever the amounts of these expansions, the lines ca and db will always pass through the same points P and Q. In other words, these points will remain stationary and PQ will have the same value for all temperatures. This bar was used successfully on the first Irish survey.

Bessel Bar.—In this bar the same result is attained as in the Colby bar but in a different way. The arrangement is shown diagrammatically on Fig. 136. The points between which the length is to remain constant under varying temperatures are marked on two platinum pieces at A and F. AB is of iron and EF also is of iron. Rigidly attached

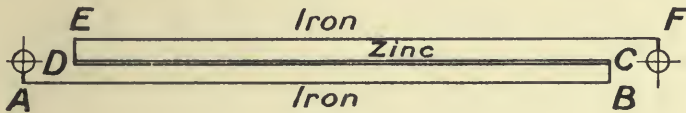

FIG. 136.

to B and E is a zinc rod CD. The coefficients of expansion of the two metals are as 292 for the zinc to 119 for the iron, so that if the lengths of the zinc and iron rods are made according to this ratio the lengthening of the iron bars will be compensated for by the expansion in the opposite direction of the zinc bar, and the distance between A and F will remain constant. A measuring bar of this design was used by Bessel for the measurement of a base on the shores of the Baltic as long ago as 1836.

Extending the Base.—It is often necessary and generally desirable to extend the base beyond the directly measured portion, and for this purpose points must be chosen beyond the sides of the base and angles measured. One plan is shown on Fig. 137. Here AB is the original base which has been measured directly in the manner described. Stations at C and D are chosen to the right and left of the base, and a point E ranged in a straight line with the base. These points must be selected so that the triangles ACB, ADB, ACE and ADE are “well conditioned.” Then, by measuring the angles CAB, CBA, DAB, DBA, ACE, ADE, CBE, BEC, BCE, DBE, DEB, and BDE it becomes possible to calculate the length of BE, and an extended base AE is obtained. If it is desired to extend the base further to a third point H, it may be necessary to select two further points F and G, and proceed as before.

Another mode of procedure is shown on Fig. 138. In this AB is the original measured base, and C and D are two points beyond the

sides of the base. By measuring angles as before it is possible to calculate the distance CD. Then stations E and F are taken, either in the same line as the original base or not, all the interior angles of this

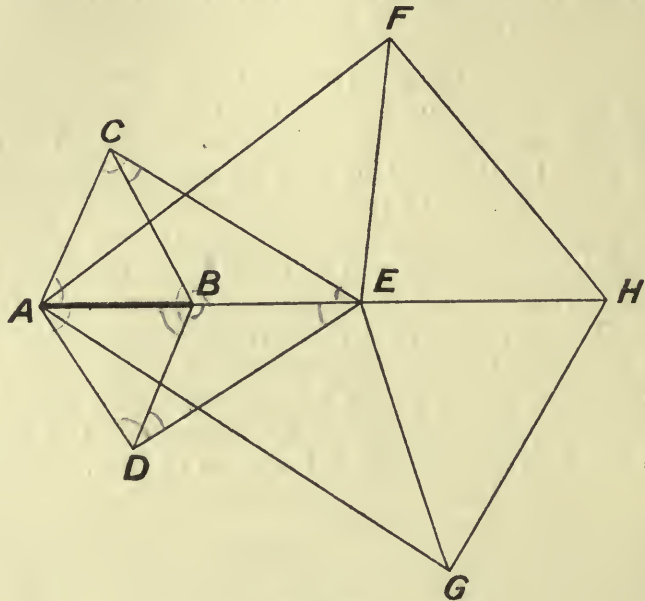

FIG. 137.

new figure measured, and the length EF calculated as the new base. In this case there must be room to spare at the sides and beyond the ends of the base.

Measurement of the Angles.—The instruments which are used for measuring the angles in a trigonometrical survey are designed mainly with the idea of attaining a high degree of precision and accuracy in the determination of the horizontal angles. The horizontal circles are therefore of large diameter and the divisions correspondingly small.

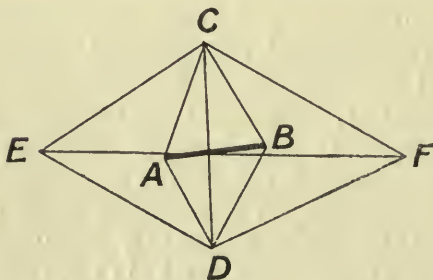

FIG. 138.

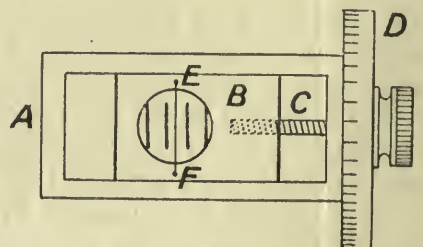

FIG. 139.

For the more ordinary trigonometrical survey work theodolites with horizontal circles 14, 12, and 10 inches diameter are sold by the instrument makers. These circles are usually divided into 5 minute spaces, and these are still further subdivided, by means of micrometer microscopes in place of verniers, into single seconds. Theodolites of these sizes are

the largest that can be looked upon as really portable. In cases where larger circles have been required, as in the Ordnance Survey of Great Britain, they have had to be set up on solid masonry pedestals where they might remain for some months (see Fig. 90, p. 100).

The micrometer microscopes used on these large theodolites are all designed on similar lines. One of these is shown on the sketch in Fig. 139. The microscope itself, which is not shown here, is held at the end of a fixed radial arm, so that the observer, by focussing the objective, can see the main divisions on the horizontal circle. In the focus of the microscope is fixed the frame marked A in the figure. This frame forms an integral part of the microscope. Attached to it is a sliding frame B, moved in a horizontal direction by a fine pitch screw C, which turns in bearings in the end of the frame A, and is rotated by means of a divided head attached to the graduated disc D. The fixed frame A has a number of lines or points—shown by the thick lines in the figure—which are the same distance apart as the divisions on the circle. The slide carries a web, EF, which when the milled head is turned move relatively to the large divisions on the frame and the divisions on the circle. In the largest instruments the webs are a pair placed a trifle further apart than the width of one of the thick lines.

When using the micrometer, the focuses are adjusted so that readings on the circle, the main divisions on the micrometer frame, and the webs are set in the same plane. The reading of the division on the circle which is nearest to the line on the frame which has been selected as the permanent line of reference is observed and noted. This will give the angle reading to the nearest 5'. The distance between this nearest line of the circle and the line of reference is ascertained by setting the web successively on these two and noting how many revolutions and parts of a revolution of the screw are required to effect the movement.

A good example of micrometer is that used in the largest theodolites ever made, namely, the two provided by Ramsden for use on the Ordnance Survey of Great Britain. In these the horizontal circles are 36 inches in diameter. The divisions are marked on silver, the finest being 5 minutes of arc. Five micrometer microscopes are situated at equal horizontal angles, and are arranged to subdivide the smallest division on the circle to tenths of a second. The micrometer screws are of such a pitch that ten revolutions of the screw head moves the webs over two divisions on the main circle or 10 minutes of arc. Therefore as the micrometer heads are divided into sixty equal parts, a movement of the head through one of these divisions means one-sixtieth of one-tenth of two divisions on the circle, or divides the circle into single seconds.

$$\begin{aligned}
 10 \text{ revolutions} &= 2 \text{ divisions} = 10 \text{ minutes} && 1 \text{ rev.} = 1' \\
 1 \text{ division} &= \frac{1}{60} \times \frac{1}{10} \times 10 \text{ minutes} && 1 \text{ div.} = 1'' \\
 &= \frac{1}{600} \times 600 \text{ seconds} \\
 &= 1 \text{ second}
 \end{aligned}$$

Moreover, as the divisions on the head are about one-tenth of an inch

apart, there is little difficulty in ultimately subdividing the circle into tenths of one second of arc.

In the larger sizes of theodolite, such as the 14-inch, 12-inch, and 10-inch, micrometers similar to the one described are used. These are generally arranged to subdivide ultimately into single seconds.

Signals.—Different kinds of signals have been used in trigonometrical survey work. The particular signal to be used for any kind of work depends upon the length of the sights and upon the condition of the atmosphere. For relatively short sights vertical poles placed on the station in question are quite suitable, so long as there are light backgrounds to show them up. But for very long sights, and in places where the atmosphere is less clear, the sight signals must be more easily distinguishable. For observations on distant stations night signals have been used in the form of Bengal lights, but these were ultimately abandoned in favour of sunlight reflected from a mirror at the station. In the great survey of India it was found ultimately that the atmospheric conditions were better at night than by day, and signals which consisted of powerful oil lights placed behind slits in screens were adopted with considerable success. The slit was placed vertically and exactly over the station in question. The telescope webs consisted of a pair of parallel vertical lines, and were set with the signal mark midway between them. It is easier to set such a pair of lines precisely on the observed line than is possible with a pair of crossed hairs of the ordinary kind.

THE ORDNANCE SURVEYS OF GREAT BRITAIN AND OF INDIA.

The following brief sketch of the work carried out in making these surveys will serve to give the reader some idea of the methods used when carrying out this kind of work in obtaining the highest possible degree of accuracy, and will show him the difficulties which have had to be met and overcome.

The Ordnance of Great Britain, which has resulted in the production of the marvellously complete set of maps obtainable at the present time, was first taken in hand in the year 1747, soon after the rebellion of 1745, in order to provide reliable maps of those tracts of country which were chiefly affected by the rising. The work was afterwards taken up on a larger scale by General Roy, who, in 1784, commenced the triangulation which was to connect England and France. For this purpose he measured the first important base on Hounslow Heath, its length being about $5\frac{1}{2}$ miles. This measurement was (as already mentioned) carried out, first with steel chains, 100 feet long, then with 20-foot deal rods, and afterwards with cased glass tubing. The mean of the measured lengths found by the glass tubes and the steel chains, namely, 27404·2 feet, was taken as the best result and used in the calculations which followed. The work of measuring this base took about $2\frac{1}{2}$ months. In the following table are given some details relating to the principal bases measured for the purposes of the Ordnance Survey of Great Britain.

PRINCIPAL BRITISH BASE LINES FROM 1787 TO 1849.

Year.	Location.	Method.	Length.	Time taken.
			Miles.	
1784	Hounslow Heath	{ Steel chains } { Glass tubes } { Deal rods }	5½	2½ months
1787	Base of verification on Romney Marsh	—	5½	7 weeks
1791	Hounslow base remeasured	Steel chains	—	
1794	Base of verification on Salisbury Plain	—	7	
1798	Sedgemoor, Somerset	—	5¼	
1806	Base of verification on Rhuddlan Marsh, St. Asaph	Steel chains	5	
1817	Base of verification on Belhousie Links, Aberdeenshire	—	—	
1827-8	Lough Foyle shore	Colby bars	8	
1849	Salisbury base remeasured	Colby bars	—	

In the work of connecting France and England by triangulation General Roy used the 36-inch Ramsden theodolite already referred to. The principal readings were taken from Dover Castle and a station on Fairlight Down, the signals being white lights or reflectors, which necessitated the operations being carried out at night. Soon after measuring the verification base on Romney Marsh, Roy died in 1788, and the work which he had commenced with such success was brought to a standstill and was not recommenced until 1791. After this the work was steadily carried on and the triangulation gradually extended to other parts of the country. After the Salisbury base had been measured in 1794 the triangulation was pushed further into Dorset, Devonshire, and Cornwall. In 1798 another base was measured at Sedgemoor and the triangulation carried into Somerset, and about the same time it was extended in an opposite direction into Kent, then into Essex and Suffolk and the nearer midland counties. During the first few years of the nineteenth century the principal triangulation was further extended into Wales and the northern counties and the Isle of Man, and also up through the eastern counties until the greater part of England and Wales had been included. Thence it was carried into Scotland up the east coast as far as Fifeshire. After this a good deal of steady work was done in extending the triangulation to further parts of Scotland and in taking in many of the outlying islands.

As a check on this work in Scotland the verification base in Aberdeenshire was measured in 1817.

The Lough Foyle base was measured in 1827-8 and the principal triangulation of Ireland proceeded with.

The primary triangulation for Great Britain and Ireland was complete in 1852, having taken between 60 and 70 years to complete. The work had been carried out with wonderful care and accuracy.

This is shown by the fact that from the directly measured base at Lough Foyle in the North of Ireland the length of the Salisbury base was computed from the angle measurements of the intervening triangulation. The distance between the two bases is about 350 miles, partly across the Irish Sea. It was found that the difference between the measured length of the Salisbury base and the computed length was less than 5 inches. An even more striking result was in the difference between the measured length of the Belhousie base and its length as computed from the Salisbury base 422 miles away, which was only a few inches.

In the triangulation of Great Britain the whole of the country was covered with a network of triangles, these being arranged in no particular way and being of no special shape beyond being as far as possible well conditioned. The plan adopted in India and in parts of the continent of Europe, is to cover the ground with a number of parallel bands of triangles intersecting at right angles and coinciding approximately with meridians and with parallels of latitude. Such an arrangement is shown on Fig. 140. In the Indian survey these bands were approximately 150 miles apart and the triangles had sides of 11 to 30 miles in length. When the bands of triangles had been completely fixed, the interiors of the quadrilaterals enclosed were filled in.

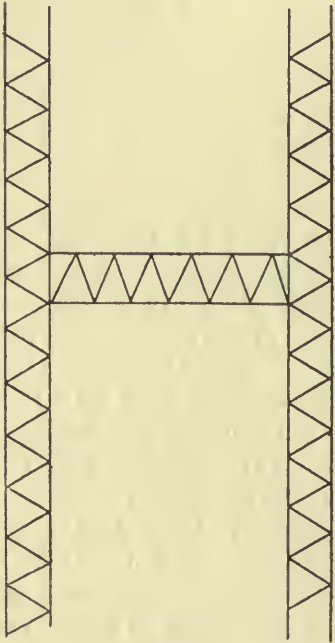

FIG. 140.

In the principal triangulation of Great Britain the longest line was one from Scafell Pike in Cumberland to Slieve Donard, one of the Mourne Mountains in the North of Ireland, whose length is a distance of 111 miles. This principal triangulation included about 250 main stations, many of them at the summits of mountains and all in positions which commanded extensive views and which could be seen from several other points. The average length of side in this main triangulation was 35 miles. The angles were measured with 36-inch, 24-inch, and 18-inch theodolites.

In the secondary triangulation which filled in the triangles of the primary, the sides were from 10 to 15 miles in length, and the angular measurements were taken with 12-inch theodolites.

The triangles of the tertiary triangulation had sides from 1 to 2 miles in length. The angles were measured with 7-inch theodolites, and the interiors of the triangles so determined were afterwards filled in with the chain and tape.

The points on which observations were taken in this survey were marked by poles or staves with flags for the shorter distances, and in some cases night readings were taken, illuminated slits in brass plates

being used. For the longer distances Bengal Lights were used at night, to be afterwards replaced by slits illuminated by argand lamps, and later by the oxyalcoholic light. These night observations were abandoned ultimately in favour of sunlight reflected from heliostats. Great difficulties were experienced in taking the long distance observations on account of the condition of the atmosphere, and in some cases days and weeks had to be allowed to go by before a reading could be taken. In order to facilitate the work a system of premiums or bonuses was instituted which had the effect of stimulating the vigilance of the watchers for heliostat flashes and the care with which the flashes were directed to the points of observation. For instance, of the men who were looking out for the heliostat on a distant observed station, the one who first spotted the heliostat received 1s. Then the men whose business it was to direct the heliostat towards the theodolite station got 6d. for each time it was seen for 10-mile distances, 1s. each time for distances between 10 and 20 miles, and in increasing amounts according to distance until he received 15s. for distances from 90 to 100 miles. The main stations or "trig points," where the signal has been fixed and over which the theodolite has been set, are as far as possible marked by square holes cut in blocks of stone, the actual point being the intersection of the diagonal of the square. In open country these are sunk 2 feet below the surface of the ground. By making these permanent records it is always possible to remeasure the angles at the points.

Reduction to Sea-level.—In a geodetic survey when a line AB (Fig. 141) has been measured directly or by calculation, and is found to be at a height of h feet above the mean sea-level, it is necessary to reduce it to its equivalent length at the mean sea-level. The mean diameter of the earth, regarded as a sphere, may be taken as $7912\frac{1}{2}$ miles or 41,778,000 feet, the radius being half of this or 20,889,000 feet = r .

In the figure, C is the centre of the earth, AB is the measured line, CA and CB are radii drawn from the earth's centre. Then the reduced length of AB, that is

$$DE = \frac{AB \cdot EC}{BC} = AB \frac{r}{r+h}$$

Spherical Triangles.—In engineering geodesy it is sufficiently accurate to regard the triangles as being drawn on the surface of the sphere whose diameter, r , has just been given. In Fig. 142 ABC is such a spherical triangle. The relations between sides and angles in a spherical

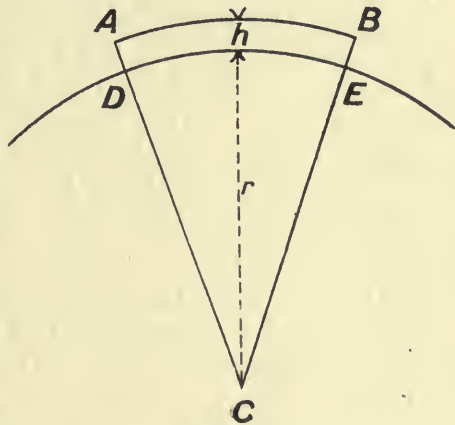

FIG. 141:

triangle differ from similar relations in the case of a plane triangle. In a spherical triangle the angles are measured, not between straight lines joining the points, but between the planes of the great circles of which the lines form parts. The sum of the three triangles in a spherical triangle is equal to an angle greater than 180° , the difference being called the "spherical excess." The solution of problems relating to spherical triangles depends on the following two principles:—

(1) The sum of the three angles of a spherical triangle exceeds two right angles by an angle which bears the same proportion to four right angles that the area of the triangle bears to the surface of the hemisphere.

(2) The sines of the angles of a spherical triangle are proportional to the sines of the angles subtended at the centre of the sphere by the sides to which they are respectively opposite.

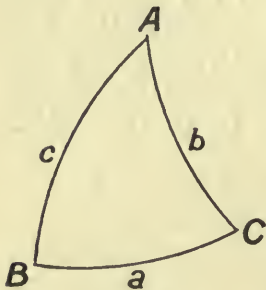

FIG. 142.

This second principle is only applicable in the case of strict spherical trigonometry and will not be applied here.

Remembering that in trigonometrical surveying the lines are rarely more than 100 miles in length and generally less, and that consequently the areas of the triangles are very small fractions of the earth's surface, it is not necessary to follow rigidly the rules of spherical trigonometry, but

it is accurate enough to make use of formulas which are sufficiently approximate.

Rule I.—To find the angle A in a spherical triangle when the other angles B and C are given and also the length of the side, a.

First, taking the triangle as plane, calculate the approximate area from

$$\text{Area} = \frac{a^2}{2} \cdot \frac{\sin C \cdot \sin B}{\sin A} = S$$

Second, taking this area, S, as the true value, calculate the spherical excess, X, by

$$X = 360 \frac{S}{2\pi r^2}$$

where r is the earth's radius

$$\begin{aligned} X \text{ (seconds)} &= \frac{206,264 \cdot 8S}{436,350,321,000,000} \\ &= \frac{S(\text{in sq. feet})}{2,115,500,000} \end{aligned}$$

The required angle

$$A = 180 + X - C - B$$

Rule II.—To find the remaining sides of the triangle, b and c . The three angles are now known. From each of them subtract $\frac{X}{3}$, and with the remaining angles so obtained proceed as follows:—

$$c = a \frac{\sin\left(C - \frac{X}{3}\right)}{\sin\left(A - \frac{X}{3}\right)}$$

and

$$b = a \frac{\sin\left(B - \frac{X}{3}\right)}{\sin\left(A - \frac{X}{3}\right)}$$

Rule III.—Given sides b and c and included angle A , to find remaining side, a , and the two angles, B and C .

First, calculate the approximate area as for a plane triangle, thus—

$$S = \frac{bc \sin A}{2}$$

Then calculate the spherical excess, X , as in Rule I.; allowing for this

$$A' = A - \frac{X}{3}$$

To find the third side, a , make

$$\sin D = \frac{2\sqrt{bc}}{b+c} \cos \frac{A}{2}$$

from which

$$a = (b+c) \cos D$$

To get B' and C' , suppose the triangle to be plane, then

$$\sin B' = \frac{b}{c} \sin A'$$

$$\sin C' = \frac{c}{a} \sin A'$$

and

$$B = B' + \frac{X}{3}$$

$$C = C' + \frac{X}{3}$$

Rule IV.—Reduction of small error in angular measurement. Call total error in measurement, E .

Then $A' + B' + C' = 180 + X \pm E$

and the probable values of the angles will be

$$A = A' \mp \frac{E}{3}$$

$$B = B' \mp \frac{E}{3}$$

$$C = C' \mp \frac{E}{3}$$

making the correction for each angle one-third of E and of the opposite sign.

CHAPTER X

GEODETTIC ASTRONOMY

THE operations comprised under this heading are—

Determination of the direction of the true meridian through a station.

Finding of the latitude of a station.

Finding the longitude of a station.

Of these three the most important to the ordinary engineer is the first, which may often become necessary for the purpose of fixing the amount of variation of the magnetic needle when carrying out compass surveys. The remaining two may occasionally be necessary when carrying out surveys over large tracts of country, especially where the country is unknown. The bare principles involved may not be out of place here.

Before going further, it will be well for the reader to have some distinct idea as to the relative positions and movements of the several celestial bodies which are made use of for the purpose of these determinations, namely, the fixed stars around the Pole and the sun.

It is well known that the earth rotates on its own axis once in each twenty-four hours, and revolves round the sun once in the course of a year. The axis about which the earth rotates has an approximately fixed direction in space, pointing always to a place in the heavens which in our hemisphere we call the North Pole.

The imaginary point so called is stationary, and all the celestial bodies which are visible to us, with the exception of the planets, appear to move round it in circles; the actual movement is that of the earth, and the various bodies remain stationary relatively to the Pole. Thus, on a clear night, if an observer stands facing in a Northerly direction and looking along a line at an elevation of about 52° (in Great Britain) above the horizon, he will be looking towards the Pole, and, by carefully watching them, he will see that all the visible stars appear to revolve round this point. Further, he will see that those stars which are nearer the Pole appear to move in complete circles, without dipping below the horizon; while the others which are further from the Pole rise from below the horizon, traverse their paths, and again set below it. Those which make complete circles are called "circumpolar stars," and it is with these that we are chiefly concerned. When such a circumpolar star attains the highest or lowest point in its apparent path, it is said to have reached its upper or lower "culmination." Similarly,

its most easterly or westerly position is spoken of as its greatest "elongation," east or west.

The earth in its course round the sun travels in an ellipse whose plane is inclined to the axis of the earth. Viewed from a point on the earth's surface, the sun (in the Northern hemisphere) appears to rise above the eastern horizon, to traverse a curved path in the sky, moving from east to west, and then to set again below the horizon. By reason of the rotation of the earth on its own axis simultaneously with its movement round the sun, the apparent path of the sun is continually changing. This will be discussed in more detail later.

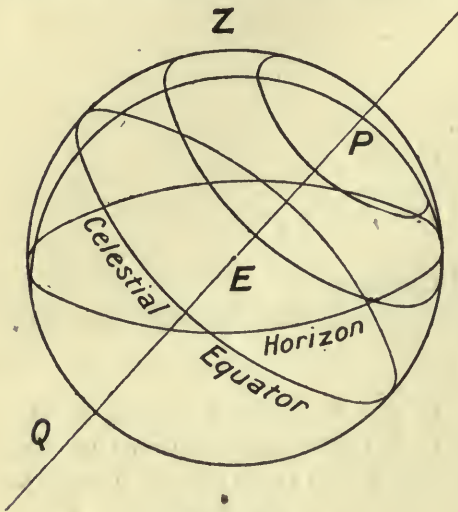

FIG. 143.

Some idea of the movements of the circumpolar stars around the Pole is given on Fig. 143. Here P is the celestial Pole, and the inclined line is one passing through the centre of the earth, E, and traversing the Pole. Z is the zenith, the part of the sky immediately above the observer. The inclined ellipses whose centres are in the line PEQ represent the apparent paths of a number of circumpolar stars, which, when viewed from a point on the earth, E, appear as circles with the Pole as centre. The celestial Pole is not marked by any visible point, and

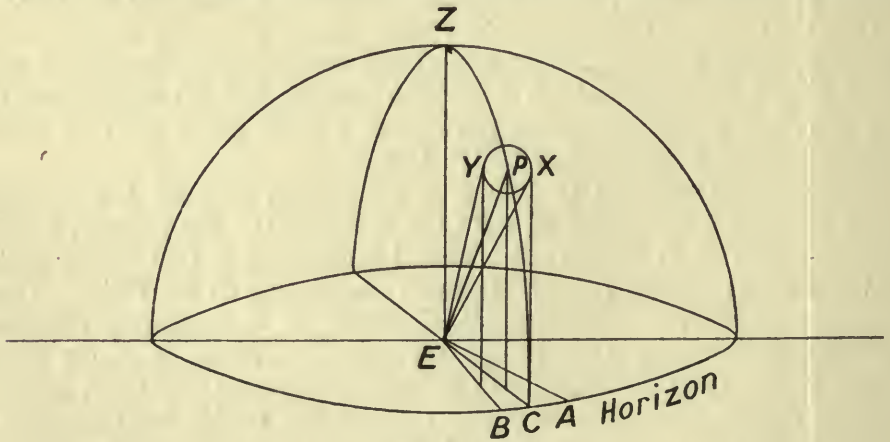

FIG. 144.

is located as the imaginary centre about which the stars revolve. The well-known Pole Star, or Polaris, occupies a position so near the true Pole that for very rough purposes it may be taken as the Pole. But Polaris, like the other circumpolar stars, makes its small circle round the Pole. The path of a circumpolar star which is near the Pole is again shown on Fig. 144.

Finding the True Meridian.—This is the most important of the astronomical determinations which under ordinary circumstances an engineer is likely to be called upon to make. When using any kind of needle instrument it is desirable to have some means of finding directly the variation of the needle from the true meridian. The methods employed are—

Operations involving observations by Night.

1. By equal altitudes of a circumpolar star.
2. By greatest elongations of a circumpolar star.
3. By a vertical through Polaris and one of the stars in Ursa Major.

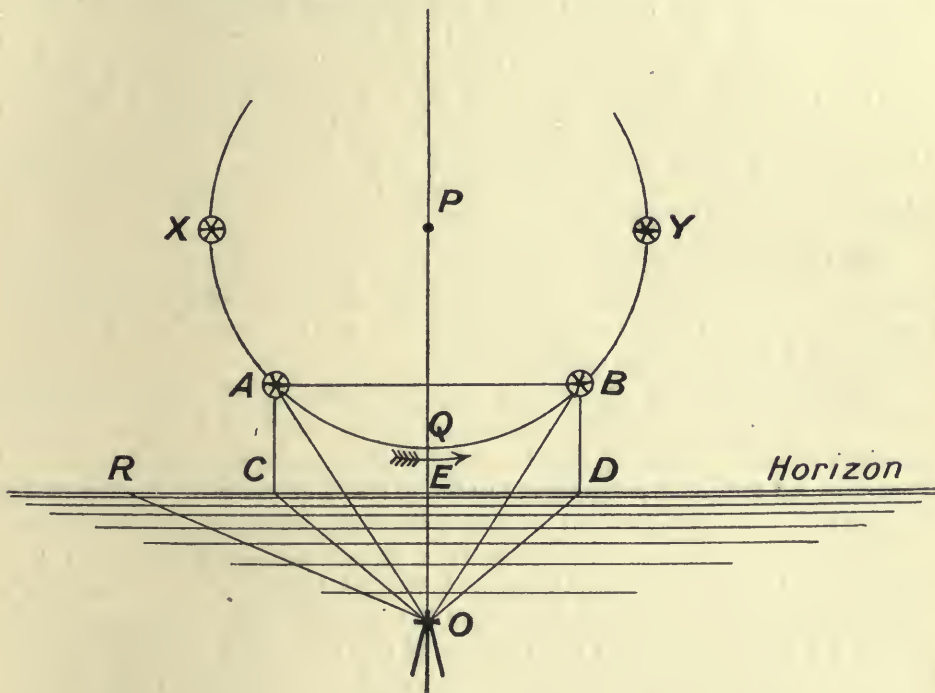

FIG. 145.

Operations carried out in Daylight.

4. By equal altitudes of the sun.
5. By sun shadows.
6. Rough approximation by means of the hands of a watch.

The true meridian lies in a plane which passes through the point of observation, the centre of the earth and the celestial Pole, or more simply is a line passing from the observer in a direction towards the Pole.

(1) *Finding the Meridian by Equal Altitudes of a Circumpolar Star.*—On Fig. 145 P is the Pole as viewed by the observer, and the partial circle is the path of a circumpolar star. At one instant the star is at A, and thence, travelling in the direction shown by the arrow, reaches after some time a point, Q, vertically below P and therefore in the

meridian. After the lapse of an equal interval of time it arrives at a third point, B, which is at the same elevation as A.

The observer being at O, and the arc AQ being equal to the arc QB, because the star is travelling at a uniform rate, the horizontal angle between the projections of the lines of observation will be bisected by the projection of the meridian line OQ, and this bisecting line is the meridian required.

In the present method of finding the meridian, the line of collimation of the theodolite telescope is set on a circumpolar star when on its downward path, say at A, the vertical circle clamped, and the reading on the horizontal circle noted. In the figure this horizontal angle would be ROC. With the vertical circle still clamped, the telescope is moved in azimuth from the left towards the right until the star is again seen to coincide with the cross-webs. The horizontal angle is again read as ROD. Then the difference between the two horizontal angles measured will be DOC, and the line bisecting this will be the meridian required. Also the angle ROE is the angle between the meridian and the point of reference, R, and is equal to $\frac{ROC + ROD}{2}$.

For this determination the theodolite used should be as large as possible, and should be provided with a lamp and reflector for illuminating the cross-webs. It may be convenient also to have it fitted with a right-angled eyepiece.

The instrument is to be set up in daylight, and after carefully levelling, the vernier of the horizontal circle must be set to zero and clamped there. Keeping the horizontal circle clamped, the telescope must now be set on a pole placed in the ground, preferably a little to the west of the general direction of the telescope during the observations. The ground on which the instrument is set up must be as level as possible and quite free from obstacles which might get in the way of the sights or impede the feet of the observer in the dark. After carefully setting the line of sight on the bottom of the reference pole, which may be about 200 feet from the instrument, and clamping the vertical axis, the instrument may be covered with a mackintosh sheet and left until such time as it is sufficiently dark to take observations.

For star observations the night must be clear. The observer must now select a bright, easily recognised star which is approaching the meridian on its downward course, and about 3 or 4 hours away from it. The illumination of the cross-webs must now be completed, the horizontal circle unclamped, and the cross-webs set on the star. The vertical circle is then clamped, and must be allowed to remain so until the determination is complete. At the same moment that the vertical circle is clamped and the cross-webs set on the star, the reading of the horizontal circle must be taken and noted. This will be the angle ROC referred to above.

The observer must now wait until the star has again reached the same altitude on its upward path to the east of the meridian. The time that is likely to elapse before this occurs can be estimated roughly by hanging a plumb line so that it appears to pass through Polaris, and

noting how long it takes the star to reach it. The time taken will be approximately equal to the time which will be taken between the plumb line and the second position of the star. As the instant of the second coincidence approaches, the observer must be on the watch, keeping the star in sight and noting when it begins to get near the line of sight. This can be done without disturbing the vertical circle by looking along the top of the telescope.

As soon as the star comes into the field of vision the horizontal circle must be clamped and the star followed by means of the tangent screw, care being taken to keep the centre of the cross-webs vertically below the star. When the star coincides exactly with the intersection of the cross-webs, the horizontal vernier is read and the angle noted. This is ROD in Fig. 145.

The two angles made by the line of collimation with the reference point R will now have been found, and their mean value will be the angle between the true meridian and the line of reference. Assuming that the theodolite has been set up with a plumb bob over the centre of a peg in the ground, then a line through this and the centre of the reference pole will provide a permanent record of the line which forms the determined angle with the meridian.

If the theodolite is allowed to remain in its position until daylight again appears and the line of collimation set so as to make the ascertained angle with the reference line, the magnetic declination can be read off directly at the end of the needle in the theodolite.

This way of finding the meridian has the advantage of simplicity and involves practically no calculation, and if the observations are made with care, the results are likely to be more than sufficiently accurate for the purpose of finding the declination of a compass needle. But it has several disadvantages which are likely to militate against its frequent use. The result depends upon the accuracy of two, or perhaps more, observations taken in the dark at long intervals of time. If the first observation is taken soon after the elongation of the star, nearly twelve hours will have to elapse before the time comes round for the second reading; this means that, where long time intervals are to be used, the method can only be employed on winter nights. Also, there is always the possibility of the sky becoming overcast before the second reading, and the determination in this way spoilt. If the first reading is taken on a star which is, say, 30° or 45° from the vertical through the pole, the total interval will, of course, be shorter, but it must be remembered that the shorter the time interval the less is the accuracy of the result likely to be. The reason is that the nearer the star is to its elongation the more nearly vertical is its path, and therefore the easier it is to set the intersection of the cross-webs upon it for the measurement of a horizontal angle. For instance, when the star is at 45° from a vertical through the pole, it is seen approaching the intersection of the wires at 45° , and under these conditions it is more difficult to tell when it has arrived at the right height than if it were travelling more nearly vertically. The observer must choose a star for the first reading which is not so far away from the meridian that the

interval between the readings will be a long one, and at the same a star which is moving as nearly as possible vertically. It is also important to select a star which is bright and easily followed.

In order to have more than one pair of readings for the purpose of determining the meridian and to provide some check on the work, it is sometimes the practice to bring the star into coincidence with the webs at several points before it reaches the meridian, and to read the angles at these points and to book them. Then, as the star comes round in its path the telescope is successively set at the same vertical angles as before and when coincidence has been obtained at these altitudes the corresponding angles are read and booked. In this case it is necessary to read both the horizontal and vertical angles. The calculations are made as before on the respective pairs of sights and a mean taken. An advantage of doing this is that the chances of interference by cloud are lessened as there are several second readings to depend upon instead of one only. Against this it may be urged that the vertical circle has to be disturbed and there is the possibility of inaccuracy owing to the vertical circle having to be set in its second positions instead of remaining as it was first set.

Where the telescope has not been provided by the maker with an arrangement for the illumination of the webs, a reflector must be

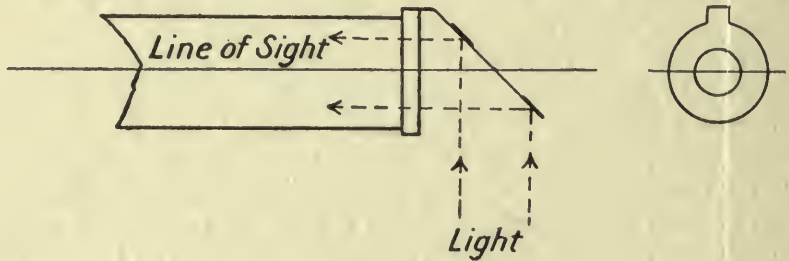

FIG. 146.

extemporised by cutting out a piece of tinplate or, if this is not available, stiff paper of the form shown on Fig. 146. When fixed on the objective end of the telescope it really resolves itself into a ring placed at an angle of 45° with the axis of the telescope. A lamp is held at the side of the telescope so that the light from it is reflected down the telescope tube from the surface of the ring, and at the same time there remains the clear hole in the centre to allow of the star being seen by the observer when looking through the telescope. In this and all cases where the cross-webs have to be illuminated, care must be taken that the light is modified so far as not to kill the light from the star. A balance can be reached with a little practice, by which the star is seen with the maximum of distinctness and at the same time the cross-webs can be seen clearly. The author has had to make use of the above temporary reflector fitted on to an ordinary 5-inch theodolite, when finding the meridian and latitude, and has found it to work perfectly well. Of course it means an extra assistant to hold the lamp in the right position. This simple part is not so easy

to play as would appear at first sight, and a great deal of annoyance may be caused by an assistant who will persist in holding the light so that little of it is deflected down the tube.

In operations of this kind special care should be taken that every possible piece of apparatus that may be required is prepared before the sun goes down, so that the whole attention of the observer may be concentrated on his readings. The fewer assistants the observer has the better, so long as they thoroughly understand what they have to do. Too many are liable to get in each other's way and too many feet near the theodolite are likely to be the cause of a disturbance to the tripod legs.

(2) *Meridian by Greatest Elongation of a Circumpolar Star.*—The manner of carrying out this determination should not be difficult to understand after a consideration of the last case. Referring to Fig. 145 it will be seen that the star in question is at its most Westerly point at X and at its most Easterly position at Y. When at either of these points the star is at one or other of its greatest elongations. When at one of these points it is obvious that, as seen by an observer, the star appears to be moving in a vertical direction. As the apparent rate of movement of the star is relatively slow it appears to remain travelling in a vertical direction at its elongation for quite a considerable space of time, and it is easy to set the cross-webs of the telescope on the star for the measurement of a horizontal angle. In finding the meridian by this method there are two ways of proceeding.

In the former of these, the instrument is to be set up as in the last case, and early in the evening the cross-webs are to be set on a star which has nearly reached one of its elongations. The horizontal circle being clamped, the tangent screws are worked so as to follow the star to its furthest position in one direction, until it begins to move back. This maximum position in one direction is read and noted, and the observer must now wait for twelve hours until the star is nearing its opposite elongation.

The greatest angle in this direction is then read on the horizontal circle. Then the difference between the two readings will be the angle subtended by XY, and the meridian will be the bisecting line of this angle. The disadvantage of this method is that twelve hours must elapse between the readings and this is only possible with an ordinary theodolite telescope in the middle of winter. In other respects it is the most accurate way of finding the meridian.

In the Second Method, the angle between a fixed point on the ground and the star at one of its elongations is taken. For example, suppose the reference line to be as in Fig. 145 to the left of the meridian, and a reading on a star is taken when at its Westerly greatest elongation. Then the meridian will be East of this by an amount equal to CEA (Fig. 144), which is the angle made by the star when at its greatest elongation. If the observation had been taken at the Easterly elongation the angle CEB would have had to be subtracted to give the position of the meridian. These angles for the best known stars can be obtained from the Nautical Almanack.

(3) *Meridian by Vertical through Pole Star and one of the Stars in Ursa Major or the Great Bear.*—It happens that a line joining the Pole Star and the star in the constellation of the Great Bear, marked A in Fig. 147, passes very nearly through the Pole which lies between the two. So that if these two stars are taken when they are in the same



FIG. 147.

vertical straight line, the plane including this line and the point of observation will pass through the Pole. This is a very convenient method of finding the meridian, as it is quickly carried out and is sufficiently accurate for most purposes. Either a theodolite or a plumb line can be used, the former of course yielding the more reliable result.

In using the theodolite, set up the instrument in daylight as already described and wait until the two stars are very nearly in the same vertical. This may be noted approximately by sighting across a plumb line. When near the required position the horizontal circle and vertical axis of the instrument must be clamped and the telescope turned slowly in azimuth by the tangent screw. The cross-webs are to be kept very nearly on a vertical through one of the stars, and the telescope constantly turned on its horizontal axis to the altitude of

the second star, until the intersection of the cross-webs passes through both stars as the line of collimation is rotated in a vertical plane. When this is attained the line of collimation is in the meridian and the reading of the horizontal circle can be taken. If the vernier had been set to zero when the needle was also at zero, that is, with the line of collimation lying in the magnetic meridian, the reading of the horizontal vernier when the stars were in the same vertical would give at once the declination of the needle.

Where a plumb line is used for the same purpose, it must be suspended from a high point and sufficient light supplied as will enable the line to be seen without rendering the stars invisible. A movable sight must be placed some little way behind the line so that a sight taken from this point through the plumb line cuts both stars at the same time, and the observer will then be looking along the true meridian; and he can range out a line on the ground.

The star Alioth (A, Fig. 147) is a great deal further from the Pole

than is Polaris, so that if possible the observation ought to be taken when Alioth appears to be below Polaris. If the opposite position has to be used, with Polaris below, it means that the telescope must be pointed to a very high altitude, which is not convenient.

There is only one observation to be taken in this case, but it may happen that the proper time is somewhere in the middle of the night. By going to look at the sky soon after sundown, when the stars become visible, the observer will be able to form an idea as to when his two stars are likely to come into the same vertical. This is probably the most easily carried out of the more accurate methods.

(4) *Meridian by Equal Altitudes of the Sun.*—The sun must be clearly visible and not even partially obscured by cloud during the observations. The plan adopted is similar to that used in finding the meridian by equal altitudes of a circumpolar star, with differences in detail. The sun is at all times when visible to us travelling along the upper portion of its path. The stars are simply spots or points, with very little appreciable size, as far as can be seen through a theodolite telescope, whereas the sun appears to be very much larger; and, as it is not possible to take observations of its centre, it becomes necessary to set the sight lines on one of its edges and make due allowance for its radius. The path of the circumpolar stars is very nearly circular, with little variation in declination, whereas the sun's declination, or angular height above the celestial horizon when at meridian, is changing constantly and to an extent which must be taken into account.

On Fig. 148 the sun is on a vertical through S_1 on a certain day and at several hours before noon; it attains its highest point at M when in the meridian at noon; and sets again at B_1 , B , or B_2 according to the time of the year. Its angular distance from the meridian, as seen by the observer NOD is not necessarily equal to NOD_1 . In the early part of the year, from December 21 to June 21, the sun sets further and further to the west on each succeeding evening, that is to say, the distance along the horizon intervening between sunrise and sunset is continually increasing during this period. The path of the sun on such a day would be CM_1E . Conversely, in the second half of the year its path would be FM_2G . In the case in question at the time of the first observation the sun is at S_1 at a certain time interval before meridian or noon; and is at S_2 at the end of the same time interval after noon, during the first half of the year; and at S_3 during the second half of the year. In other words, D_2ON is greater than D_1ON ; and conversely, D_3ON is less than D_1ON . If there were no correction the meridian would lie in the bisecting line of the angle D_1OD . In the first half of the year the meridian lies in the bisecting line of the angle D_2OD_1 less the excess D_2OD ; and in the second half it is in the bisecting line of D_3OD_1 plus D_3OD .

To find the meridian by this method, set up the theodolite with the zero of its horizontal circle in a known position, that is to say, the line of collimation in some known position when the vernier of the horizontal is at zero. This may be pointing along some fixed line in the survey, or it may be in the magnetic meridian. Two or three hours before meridian is a convenient time for the first observation, say at 9.30.

The cross-webs should lie against one side, and either the top or bottom of the sun's disc as shown in Fig. 149. When this coincidence has been attained the vertical circle is left clamped and the reading of the

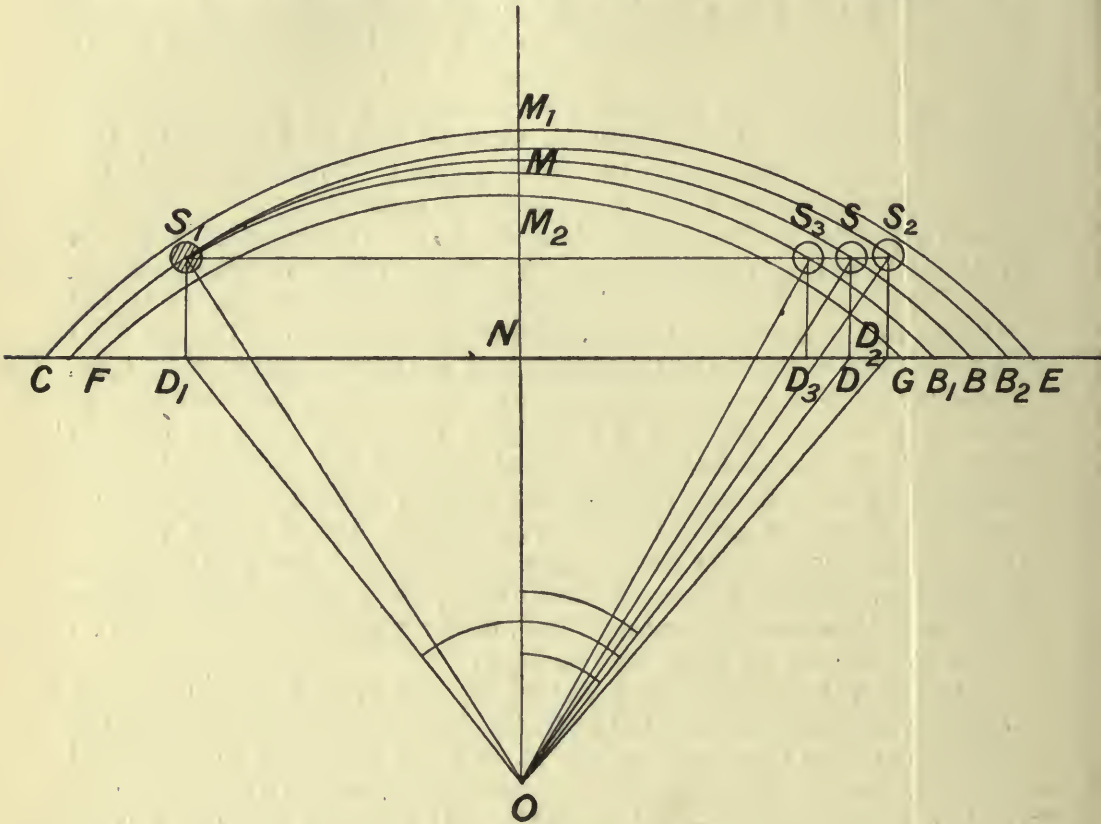

FIG. 148.

horizontal circle taken. This first observation is at S_1 . At a little less than $2\frac{1}{2}$ hours after meridian, the telescope is pointed towards the sun, with the vertical circle still clamped and the circle slowly revolved in azimuth until the lower edge of the disc again just touches the horizontal web and the left-hand edge touches the vertical line. This horizontal angle is noted and booked. If there were no variation in the declination, half the difference between the angles of the two observations would give the position of the meridian. On June 21 and December 21 the line obtained in this way will give the meridian directly without any correction. At other times of the year a correction has to be made, which is subtracted in the spring of the year and added in the autumn.



FIG. 149.

The correction is one half D_2OD or D_3OD on Fig. 148, and is given by—

$$\text{Correction} = \left(\frac{1}{2} \text{ change of Sun's declination}\right) \times (\text{secant latitude}) \times (\text{cosec } \frac{1}{2} \text{ angle } D_2OD_1 \text{ or } D_3OD_1)$$

After meridian it begins to lengthen again, and at equal intervals of time after meridian it has approximately the same length as for similar intervals before meridian.

At 10.30 the shadow is OA ; mark the point A , and draw an arc of a circle with centre at O , having the radius OA . After the sun has passed the meridian and the shadow is lengthening, there comes a time when the outer end of the shadow just lies on the circular arc drawn through A . That is OA' . A line drawn to bisect the angle AOA' will pass approximately through the meridian. In order to reduce the chances of the observations being spoiled by clouds coming over the sun, a number of similar shadows are marked at equal intervals of time, and circular arcs drawn through them as before. In this way an average value is obtained of a number of bisecting lines, thus to some extent cancelling errors of observation.

Instead of using a table and needle, the operation may be performed on a smooth piece of ground in which a surveying pole has been set vertically. The arcs in this case are to be struck with a tape and arrow, one end of the tape being fastened to the pole. The shadows are less well marked than those of a needle on white paper, but a rough approximation may be obtained.

In either case there is still the error due to change of declination, and this cannot be eliminated unless the usual correction is applied, but the combined error of observation will in most cases be greater than the necessary correction for change of declination.

(6) *Rough Method by the Hands of a Watch.*—In order to get a rough idea as to where the north and south lie in an unknown locality, it is useful sometimes to remember that if the bisecting line of the angle between the hour-hand and XII. be pointed towards the sun, the XII. or ring of the watch will point south.

Observations for Latitude.—The latitude of a point on the earth's surface may conveniently be found by—

1. Observation of a star at its meridian.
2. Observation of the sun at its meridian.

The latitude of a point on the earth's surface is the angular distance of the point from the plane of the equator, as ACB in Fig. 151. If AP_1 is a line from the point of observation A to the pole P , then it is not difficult to see that HAP_1 is equal to ACB , where HAB represents the plane tangent to the earth's surface at the point of observation. Therefore if the observer measures HAP_1 , which appears as the altitude of the pole, he will obtain the required latitude. As the pole has no mark or point to distinguish it, it will be necessary to measure the altitude of a circumpolar star when at its highest or lowest point, or its upper or lower culmination, and subtract or add the known angular distance of the star from the pole when at its culminations. It has already been shown that Polaris, the Pole and Alioth are nearly on a straight line, so that when this line is vertical with Alioth below, Polaris must be at its upper culmination. In the figure Polaris is Q , and if the angle QAH be measured and QAP_1 added, PAH will be given. The following example of a latitude determination by means of the Pole

Star carried out by the author will serve to indicate the plan to be followed.

Example of Latitude determination by Pole Star.—Unlike the case of Fig. 151, the star was observed at its lower culmination, that is, when it was in its lowest apparent position. The cross-webs were brought into coincidence with the star when near its lower culmination, and it was kept in sight until it appeared to have passed the meridian and had begun its upward path. The reading of the vertical circle was that corresponding to its lowest position. In Fig. 151 the altitude measured is

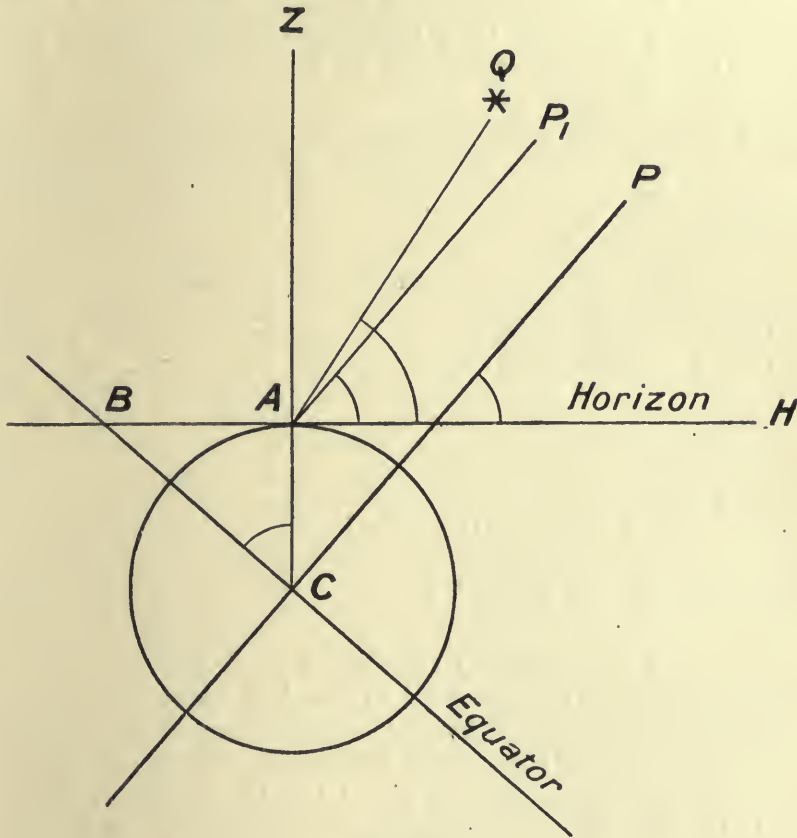

FIG. 151.

shown by the angle QAH, this being the angle between the horizontal line at the earth's surface and the line of sight from the observer to the star. The angle of latitude required is P_1AH , the difference between this and the observed angle being the angle QAP_1 . This is the "polar distance," or the angular distance of the star from the pole at its culmination. It is also called the "co-declination," being the difference between 90° and the declination when the "declination" is the angular distance of the star from the celestial equator, corresponding to latitude on the earth.

Hence, in order to find the altitude of the pole, which is the same as the latitude of the point of observation on the surface of the earth,

it is necessary in this case to add to the observed angle the co-declination QAP_1 , this latter being found by subtracting from 90° the "declination" as obtained from the Nautical Almanack for the date in question.

A correction must be subtracted for refraction. The line of sight from the star must pass through the earth's atmosphere before reaching the observer, and in doing so is traversing a medium of increasing density, being therefore curved towards the earth. The consequence is that the line of sight as seen from the observer's end is pointing higher than it should do, and a subtraction must be made. This correction may conveniently be taken from Chambers' Tables, in which a page is devoted to the angles of refraction to be subtracted for observations at different altitudes.

It may be that there is also an instrumental error to be added or subtracted. This is so in the example given, the vertical circle not reading zero when the line of collimation was horizontal. The actual figures were as follows:—

Determination of Latitude of a Station.

Observed altitude of Polaris	52° 51' 30''
Index error of instrument (to be subtracted)	0° 4' 0''
	52° 47' 30''
Correction from refraction (from Tables)	0° 0' 44''
	52° 46' 46''
Corrected altitude	52° 46' 46''
Co-declination of Polaris = ($90^\circ 0' 0''$) — ($88^\circ 45' 56''$)	1° 14' 4''
	54° 0' 50''

(II.) *Latitude by Altitude of the Sun at its Meridian.*—The general plan of operations is the same as in the last case. It must be remembered, however, that the declination of the sun is always changing, and therefore it must be taken from the Nautical Almanack for the day in question. This declination is given for 12 o'clock at Greenwich, and where the latitude is being found at any point which is not in the same longitude as Greenwich a correction (also from the Nautical Almanack) must be made for the number of degrees of difference in longitude between the station in question and Greenwich, 1° of longitude corresponding to 4' of time. As before, a correction must be made for refraction. The observation will be taken on the upper or lower edge of the sun's disc, so that its semidiameter must be added or subtracted to reduce the observation to the sun's centre.

Where the observation is taken with a sextant, as at sea, allowance must be made for the dip of the horizon.

Observations for the Determination of Longitude.—As the latitude of a place on the earth's surface is its angular distance from the plane of the equator, so the longitude is the angle measured on a plane normal to the axis of the earth between the plane of a great

circle through the point in question and that of a great circle passing through Greenwich. The earth revolves about its axis once in twenty-four hours, and as it revolves at a uniform rate there will be 360° of longitude passed over in one day. Longitude has, therefore, its equivalent in time. Thus if a certain star appears to attain its upper culmination at a certain time in one place and appears to similarly culminate at some other place 6 hours, or one-quarter of 24 hours, later, there will be a difference of longitude between the two places of 90° or one-quarter of 360° . The stars appear to move round the pole, from East to West above and from West to East below. A point on the surface of the earth is really moving from West to East. If, therefore, a certain star appears to cross the meridian, or attain its upper culmination, when observed from a certain point on the earth, later than the same star appears to culminate when seen from Greenwich, the point must lie on the surface of the earth to the West of Greenwich. And the converse is true also.

A "mean solar day" is a day of average length, representing the average length of time between two successive passages of the sun across the meridian at the place in question. The "apparent time" is that obtained from the passage of the sun across the meridian on some one particular day. According to "local mean time" the sun crosses the meridian at 12 noon. On the particular day the transit may be a little before or a little after noon, according to "mean time." The difference between the "apparent time" and the "mean time" is called the "equation of time," and is given in the Nautical Almanack for each day in the year at the different latitudes.

If the observer at a given place has some means of knowing Greenwich time at any moment, either by means of a chronometer or a telegraphic message, he can find the longitude by comparing the Greenwich time with the local mean time which he may have found. Thus, to take a simple example, he may have found that the sun crossed the meridian at a certain moment, which in "apparent time" would be twelve o'clock, and that, after applying the "equation of time" for the day and latitude, the hour was $12\frac{1}{6}$, and that the Greenwich mean time was $3\frac{5}{8}$ hours after twelve o'clock. The difference in mean time would be $3\frac{4}{6}$ hours or $3\frac{2}{3}$ hours. As 24 hours correspond to 360° , the difference of longitude would here be $\frac{3\frac{2}{3}}{24} \times 360$ or 55° West of Greenwich.

To get the time of the sun's transit the most accurate way is to note the time of the passage of the centre of the sun across the webs of a transit instrument which has been set in the true meridian, found from a previous determination. This gives apparent noon, and may be reduced to local mean noon by applying the equation of time.

The time referred to in the Nautical Almanack is "astronomical time," which is the same as "mean time," but is measured from a different datum. Astronomical time is measured in one period of 24 hours, reckoned from noon. "Mean time," which is the same as "civil time," is divided into two 12-hours periods in the same way, and

is 12 hours in advance of "astronomical time." "Nautical time" is 12 hours in advance of "civil time," that is, 24 hours in advance of "astronomical time."

As "solar time" depends on the apparent transit of the sun across the meridian, so "sidereal time" depends upon the movement of the celestial bodies across the celestial meridian, which is an arbitrarily chosen plane passing through Aries. And in the same way that angular distance of a point on the earth from the meridian through Greenwich is called "longitude," so the angular distance of a celestial body from Aries is its "right ascension."

Where the longitude of a fixed station has been found by sun observations the result may be checked from star transits by using the Nautical Almanack, and remembering that 23 hours 56 minutes 4.092 seconds "mean solar time" corresponds to 24 hours "sidereal time."

Thus, to find the longitude of a place by time, 1st, ascertain the Greenwich time at the place in question by means of a chronometer or good watch, making the necessary corrections for the gaining or losing of this according to the known rate; 2nd, find the local mean time of the place by the transit of the sun or a star, correction being made according to the equation of time. The difference between the times thus found will be the difference between the longitude of the place and that of Greenwich, in time. Convert this difference in time into the difference in angle by multiplying the difference in time in hours by fifteen. This will be in minutes of arc.

It may be noted here that Greenwich time can now be picked up by "wireless" in almost any part of the world.

Direct Method of Finding the Longitude by the Transit of Moon-culminating Stars.—There are a number of stars situated near the moon whose times of transit at Greenwich, as well as the times of transit of the moon at Greenwich, are given in the Nautical Almanack for every day in the year.

At the place in question the time of transit of one of these stars is observed, and also the time of transit of the centre of the moon. The difference between these times is then found by subtraction. Call this the "interval" at the place in question. The corresponding times of transit at Greenwich are then taken from the Nautical Almanack, and the "interval" for Greenwich found. The difference between the two "intervals" is now taken, and this is proportional to the longitude of the place, in time. The difference in arc can be found by means of a constant taken from the Nautical Almanack.

The following definitions may be found useful for reference :—

Altitude.—Is the vertical angle between a line from the observer to the centre of a celestial body, and a horizontal plane through the observer.

Azimuth.—Is the angle between the plane of a great circle passing through the observer and the meridian, measured on a plane normal to the intersection of the great circle plane and the meridian plane.

Co-altitude.—Is the angle between zenith and pole or (90 - altitude).

Co-declination.—Is the distance from the pole to the observed body, or is equal to ($90 - \text{declination}$).

Declination.—Is the angular distance of a celestial body from the celestial equator measured on a meridian.

Equator.—Is a great circle whose plane is normal to the axis of the earth. This is the terrestrial equator. The celestial equator is the intersection of the plane of the terrestrial equator with the celestial sphere.

Great Circle.—Is the circle on a sphere formed by the intersection of the surface of the sphere with a plane passing through its centre.

Horizon.—By this term is meant a tangent plane at the surface of the earth at the point of observation. In its broader sense it refers to a plane parallel to the above and passing through the centre of the earth.

Meridian.—The celestial meridian is the great circle passing through the celestial poles and the point of observation. In a terrestrial sense the meridian is a great circle on the earth's surface which passes through the observer and the pole.

Zenith.—Is the point on the celestial sphere directly above the observer. Consequently the "zenith distance" is the distance expressed as an angle between the pole and the observed body, or, in other words, the same as the co-latitude.

CHAPTER XI

HYDROGRAPHIC SURVEYING

HYDROGRAPHIC surveying includes Marine or Nautical Surveying, which is used for the purpose of locating one or more points on the surface of water not far from the land, generally soundings, and the Gauging of Streams.

Marine or Nautical Surveying.—For any one point plotted in a nautical survey two determinations are generally required, namely, the fixing of the position of the point relative to the positions of known stations on the land, and the measurement of the depth of the water at the point. As a rule the operations are all carried out from a boat, which proceeds to the point in question and remains there until the readings are taken and booked. In the case of isolated points, such as rocks, all the observations may be taken on shore.

Location of a Point on the Surface of Water.—In doing this direct measurements are not possible, and the point must be fixed either by angle readings from known points on the land or by angle observations, taken from a boat, of known points on shore. The manner of fixing the point depends largely on the character of the coast in question. The different methods may be classified as follows:—

1. Angles observed on the land at two known stations and taken from the line joining them.
2. Where three points on shore are known, by means of angles read in the boat.
3. By one angle read in the boat, which is kept in a known straight line by means of fixed points on shore.
4. By time intervals when the boat is moving at a uniform speed along a range or line fixed by points on shore.

The Land Survey.—In the operations which have been mentioned it is necessary in the first place that a number of points on the land shall be known. In the case of a country where there is an existing survey, as in the case of the Ordnance Survey of Great Britain, the points on shore can be taken from this, but in new or little-known countries a simple trigonometrical survey must be carried out near the coast, so as to fix such points as may be necessary for the required observations. In doing this, first the ground near the coast must be carefully inspected and a number of stations selected, which can be easily seen from such points on the water as may require to be fixed.

These must then be surveyed by measuring a base and taking angular measurements. Such a base is often measured with long steel bands, from 300 to 500 feet in length. Where the land is flat many of the lines may be measured directly with the steel bands, and in any case one or two should be measured in this way so as to form check bases.

The actual points to be observed from the water must be easily distinguishable, and may take the form of long poles or pickets with flags at their tops, vertical lines painted on the faces of cliffs, or bushes covered with canvas. Where the coast is thickly wooded clearings must be made around stations, and if the land is flat as well as covered with dense forest, masts must be erected sufficiently high to enable their tops to be seen above the wood. When such points as may be necessary have been fixed on shore in this way, the real hydrographic work may begin.

1. *Two Angles observed on the Land* (Fig. 152).—Here A and C are on shore, their position is known relatively to the survey of the

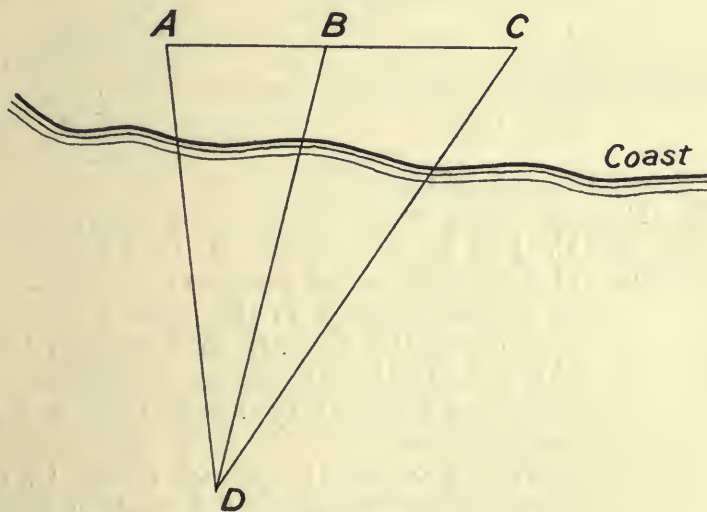

FIG. 152.

land, and AC is known. Therefore, if CAD and ACD are read, the position of the point on the water D can be fixed relatively to A and C, and therefore to the other points on the land.

The angles are measured with either theodolites or sextants at the points A and C, and the distance AC being known, it becomes easy to plot D. It is better to have a third point, say B, to provide a check on the work. This case most often occurs when D is on an isolated point, such as a submerged or visible rock. If it is to be used for a series of points, there will have to be observers at A, C, and D, and a complete system of signals arranged.

2. *Two Angles read at the Point in Question*.—The difficulties which this case presents will perhaps most easily be appreciated by following the operations represented on Fig. 153. Here A, B, and C are the three points on the land, and D a point on the water whose

position is to be fixed with respect to A, B, and C, all of which must be clearly visible from D. The observer in the boat at D reads the angles BDA and BDC; if the boat is stationary the angles may be read with a sextant by one observer; if the boat is in any way moving,

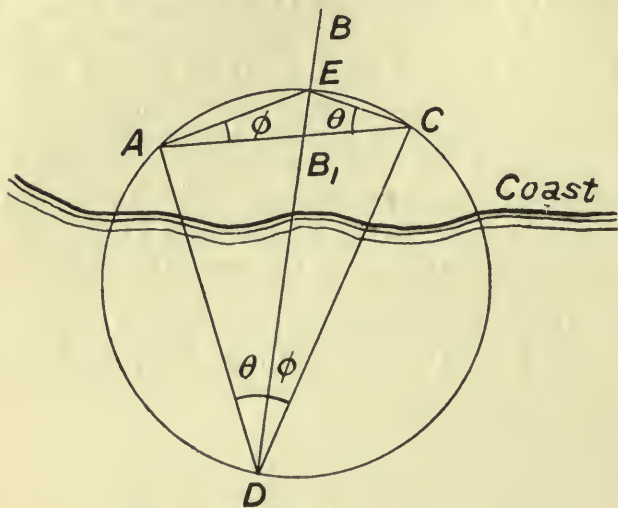

FIG. 153.

the two angles must be read simultaneously by two observers, each with a sextant, or by one observer using a double sextant, with which he is able to sight the two pairs of points almost at once, and read the angles afterwards. Having found the angles BDA and BDC, the problem is to plot D. This may be done geometrically by joining AC on the chart and setting off angles from AC at A and C, equal

respectively to BDC and BDA. The lines thus set off will meet in a point E. Draw a circle, either geometrically or by trial, to pass through A, E, and C. Join BE and produce it to cut the circle in some point D. This will give the required position; for ACE and ADE are angles inscribed in the same segment and are therefore equal. Similarly for CDE and CAE. But CAE and ACE have been made equal to the measured angles, and therefore the angles CDE and ADE are equal to these.

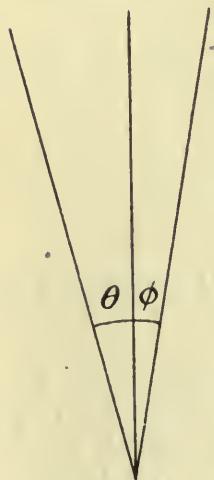

FIG. 154.

This geometrical way of fixing D, from the recorded observations, is not used in practice, but the description of it may help to make clear the conditions surrounding the problem. In practice one of two methods is employed for plotting.

One way is to set out the two angles θ and ϕ on a piece of tracing paper, as in Fig. 154, and to place it over the chart which has the known points A, B, C marked upon it. The tracing paper is moved about over the chart until the three indefinite lines pass through the three known points.

A quicker way, and one which is used on most important nautical surveys, is to employ a "station pointer," shown on Fig. 155. This consists of a graduated circle and three movable arms which can be set at the required angles. It will be seen that the upper edge of the centre arm and the inner edges of the other two pass through the centre of the circle. In using it the arms are set so that their edges include the given angles, and it is then

moved about, like the piece of tracing paper, until the three edges pass through the three points on the chart. The mark in the centre of the circle will be the point whose position is to be fixed. The station pointer here illustrated is the pattern used by the British Admiralty.

Referring to Fig. 153, the fixing of D depends on the production of the short line BE until it cuts the circle. It is evident that the longer BE is, the more certain will be the direction of the line drawn through these points, and consequently the more accurate the fixing of D. Conversely, as BE gets shorter the direction of BD becomes less definite; and when B and E coincide, that is when A, B, E, and C all lie on the circle, the problem becomes wholly indeterminate. It is therefore desirable that B be far enough away from the circle to give definiteness to

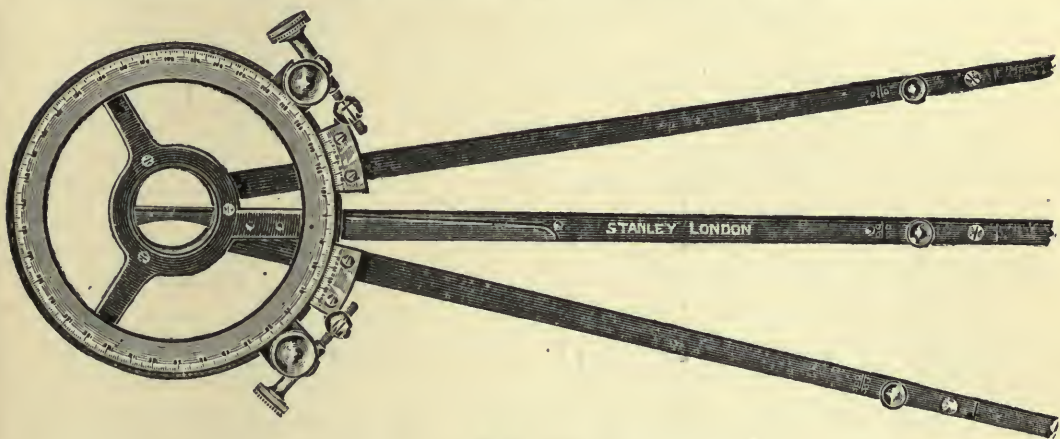

FIG. 155.

the direction of BD. The point B may be outside or inside the circle at B_1 . Of the two the latter position is the better.

In order to obtain a good "fix," as it is called, it is a good rule to choose the three points for observation so that one of the outside points is far from the observer and the remaining two are relatively near; and also that the angle between the nearer points is not greater than 140° or less than 30° ; the size of the other angle does not matter. It is not desirable that the middle point of the three be far away unless *very far*. A good fix may be obtained if the three points are in the same straight line, so long as neither angle is greater than 30° . The point of observation may be within the triangle formed by the other three points.

3. *Points lying in a known Line from the Shore and determined by the Reading of One Angle* (Fig. 156).—Here A and B are two clearly visible stations on shore, and the boat is kept stationary and in the line. It is rowed away from or towards the shore and soundings taken at a, b, c, d , and so on. At each point where a sounding is taken the angle is observed between the line through AB and a third station on shore, C, that is, the angles CaA, CbA, CcA, CdA , etc. No one of these angles should be less than 30° , and the position of C must be chosen accordingly. When plotting it is only necessary to draw a

line CX parallel to AB , and from it to set off the observed angles; in the case shown $XC\alpha$ is equal to $C\alpha A$, and so for the rest.

It is sometimes convenient, when the position of a dangerous sunken rock is to be located permanently, to establish two fixed

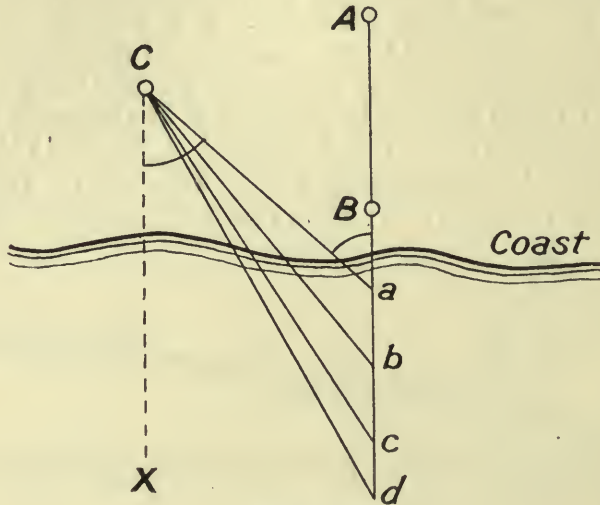

FIG. 156.

ranges, AB and EF (Fig. 157), whose intersection is the point in question.

Soundings.—The object of nautical surveying is mainly to fix on a chart the positions of a number of soundings. These may be taken on a fixed line (Fig. 156) so as to provide a section of the shore on the line; or a number of these may be taken and from them lines of equal depth determined, which are similar to contour lines, or the soundings may be taken at points along these lines parallel to the shore.

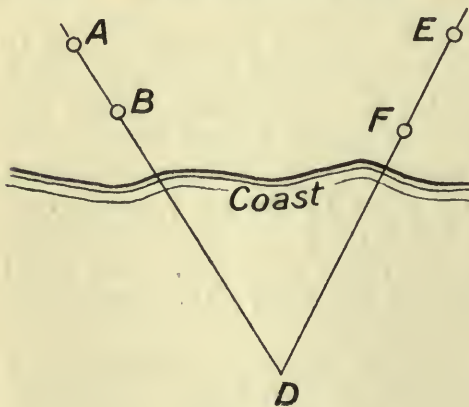

FIG. 157.

In making the soundings the lead used should be of elongated form so that it will sink easily, and should weigh from about 5 lbs. for use in shallow still water to 20 lbs. for deep moving water.

The sounding lines to which the leads are attached should be made of Italian hemp, and should be marked by means of tags in fathoms and feet. When wet they

should be well stretched, and it is absolutely necessary for them frequently to be compared with standard measures.

Sounding poles for shallow water are made of timber and weighted to make them sink. They can be used for depths of less than 15 feet, and are conveniently graduated in feet and inches.

When making soundings in running water, a strong boat's crew is necessary to keep the boat stationary; the lead should be thrown well in front of the bows of the boat. The lead will come back with the stream, and the sounding is to be taken when the line is just vertical.

In taking a series of soundings and angle observations from a boat, the following records must be made in the book:—

Date.

Names of persons taking the observations.

General description of the line which is being sounded.

{ The two angles.

{ The three stations observed.

{ Depth of sounding.

{ Time.

All soundings must afterwards be worked out as from a known datum or surface of reference. On a sea-coast this is taken as the height of the mean tide, in lakes the datum is usually the lowest height recorded, and in rivers it is either the lowest recorded or the mean. In order that the surveyor may know the height of the water surface above or below the datum at any moment, a tide gauge should be employed. Such a gauge is installed in a convenient place near the shore and free from waves or eddies. A float carrying a pointer gives the height of the water surface on a graduated scale. The most convenient arrangement is to have the height automatically recorded on a rotating drum. For each sounding the height of the water surface at the moment of taking the sounding below or above the datum must be added or subtracted, as the case may be. This is the only really accurate way of proceeding. Formulas are sometimes employed, but these are only approximate, and the movements of a tide are affected largely by the local conditions, especially in estuaries.

The Gauging of Streams.—In gauging streams the information sought is the number of cubic feet of water per second passing a given section of the stream at a given moment. The method used largely depends on the size of the stream.

Two quantities have to be determined, namely, the mean velocity of the water across the given section, and the area of that section.

In any stream the velocity on a horizontal section is greatest in the centre and gradually diminishes towards the sides, and on a vertical section it is greatest near the surface and gradually slows down towards the bed, the maximum velocity being a little below the surface.

In large streams the mean velocity is sometimes found by noting the speed of surface floats travelling at different distances from the banks, and empirically estimating the means; but this only gives very approximate results.

A better plan is to use "sub-surface floats," and so get the velocities at a number of points not only across the stream, but from surface to bed. These sub-surface floats generally consist of two rectangular pieces of galvanised iron fixed at right angles and suspended with the joint vertical from small hollow metal floats. They can be set at any

depth below the surface, and as they travel down their own part of the stream they carry the floats as well, whose velocity can be observed. Weighted rods are also used for the same purpose.

For very large streams current meters are used (Fig. 158).

The actual velocity of a surface float or of the surface portion of a sub-surface float, is obtained by noting the time taken for it to pass at right angles to a pair of lines across the stream, these being established either by pairs of pickets or by two theodolites.

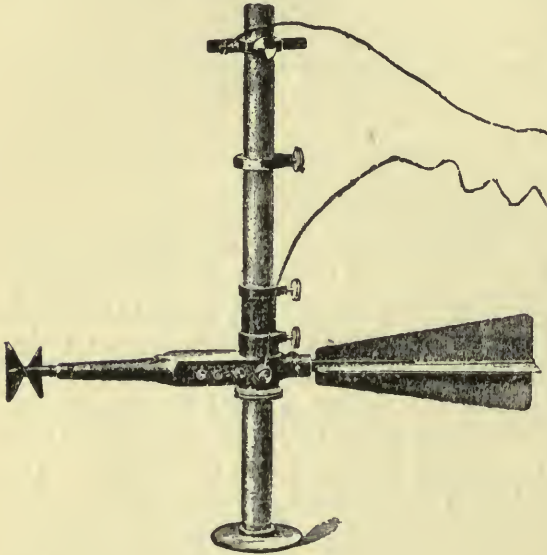

FIG. 158.

The area of the cross-section is found by taking depths at a number of known positions across the stream and calculating by Simpson's Rule, or by plotting and measuring with a planimeter. In small rivers the depths may be measured by weighted poles, but in larger rivers sounding leads must be used from a boat. The positions of these soundings may be fixed as in Fig. 156.

In the smaller streams the positions of the soundings may be fixed by stretching a wire across and marking the points with tags. In streams of uniform section, such as culverts, the best plan is to divide the stream section into a number of squares, and to take the velocity by means of a current meter of the anemometer type, fixed to the end of a staff and held successively in each of the squares. Having obtained these two values the quantity flowing down the stream in cubic feet per second,

$$Q = V \times A$$

where V is the mean velocity in feet per second, and A the area of the cross-section in square feet.

CHAPTER XII

UNDERGROUND SURVEYING

UNDERGROUND surveying presents greater difficulties than similar work carried out upon the surface of the ground, and the methods which can be made use of are far more restricted. In the first place, there is no sunlight and everything has to be done by means of artificial light. In most cases sights can be taken only in directions which are limited to within a few feet on either side, with the result that not only can intersecting sights not be taken in the ordinary way, but the use of check sights and check lines is almost entirely done away with. The result of this limitation of the range of vision laterally is that great reliance has to be placed upon angles, as chain surveying in the ordinary sense is practically done away with.

Connection of Surface with Underground Survey.—A survey underground, whether it be a mine survey or a tunnel forming part of a line of communication, must always be intimately related to the survey of the ground above it, and it is necessary in all cases to establish a connection between the two. This forms one of the most difficult problems in this branch of surveying. Connection may have to be effected under one of the following conditions:—

- I. Where there are two shafts connected below.
- II. One shaft only.
- III. A sloping heading in one direction.
- IV. Two headings coming from opposite directions.

I. Two Shafts connected below Ground.—The difficulty under these conditions increases with the nearness of the shafts to one another. Suppose they are half a mile apart, as often happens in the case of a mine. There may or may not be a direct connection between the two shafts. In the former case the problem is comparatively easy. A plumb line in the form of a fine wire is dropped down each shaft. This is suspended from a timber framework above the top of the shaft and carries at the lower end a heavy plumb bob which nearly touches the ground. The distance apart of the portions of the wires above ground can be measured, and their positions determined relative to the other points of the surface survey. The precise manner of doing this will depend on the configuration of the ground and on the presence of obstacles or buildings, but in most cases the positions of the top ends of the wires can be established with a high degree of accuracy. The method is indicated in Fig. 159.

If the wires hang vertically the horizontal line joining them at the bottoms of the shafts will be of the same length and will be vertically below the corresponding line joining their upper ends. Where the shafts are joined by a gallery a theodolite may be placed first at the bottom of one shaft, then in the other, and the angles which the line joining the two wires makes with two or more lines running along other galleries can be measured accurately. In this way the direction of the line with respect to the underground survey can be rigidly fixed and the survey of the workings underground plotted on the surface plan by starting from the line which is common to both surveys.

Where the shafts are not directly connected below, a theodolite traverse must be made through the mine, starting from one of the wires

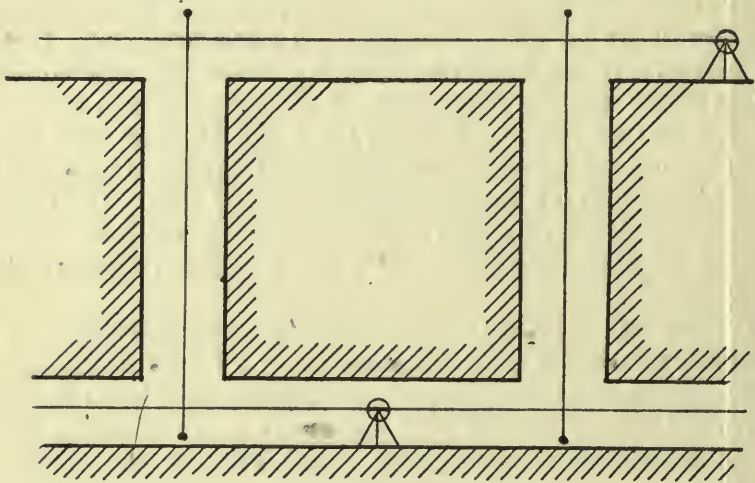

FIG. 159.

and finishing at the other. The shortest course should be taken. In this way the relative positions of the first and last points are determined, but with far less accuracy than before.

Where the shafts are near together, say 100 feet apart, the line above ground through the wires must be extended by ranging through the wires and this longer line used for linking up to the surface survey.

II. One Shaft only.—Where there is only one shaft connecting the underground and surface surveys the difficulty is greatly increased, and the very utmost care must be taken in order to attain to anything like respectable accuracy.

There are at least three ways of making the connection when there is only one shaft, namely, by means of two wires, by a transit instrument or theodolite placed at the bottom, and thirdly, by a similar instrument placed at the top of the shaft.

Where two wires are used they must be suspended (see Fig. 160) as before from a timber framework above the top of the shaft and support heavy plumb bobs at the bottom. The wires are best made of steel pianoforte wire. Fine readings can be taken on this, and it will support heavy weights. A difficulty which is met with in all cases

of suspended wires carrying weights arises from the fact that they act as pendulums and persist in swinging if they are disturbed in the slightest degree. It is difficult to avoid slight disturbances, and as the wires are usually very long the time of swing of the pendulum is correspondingly slow, and it is often almost impossible to tell whether or no the bob is swinging unless the bottom end of the wire is held in front of a finely divided scale so that its movement can be seen. To damp these vibrations the bob should be hung in a tank or bucket of water, or better still of some more viscous fluid such as oil, glycerine or treacle. By doing this and at the same time protecting the wire as far as possible from air currents and allowing plenty of time for the weight to come to rest, a fairly steady wire can be obtained.

The two wires must be hung as far apart as convenient, as the distance between them constitutes the base of the triangulation below ground, and the accuracy of the work increases with the length of base.

When the wires are in position a large theodolite or transit instrument (see Fig. 134A) is to be set up on the surface of the ground as nearly as may be judged by eye in the line of the two wires. It should be fixed

on a traversing table by which a small lateral motion can be given to it by means of a fine screw. It is then carefully levelled and set precisely in line with the wires, as may be seen by the two wires appearing to coincide when brought into line with the cross webs of the telescope. If the wires are fine, say 0.03 inch diameter, and the instrument is placed at about 50 feet beyond the nearest wire, the probable error in the position of the instrument will not be great. That there will be a small error is apparent when it is remembered that the further wire is hidden behind the nearer one, and that there is a small range in the position of the instrument which will make this possible.

When the line of sight has been brought into line with the wires the telescope may be transited and the line ranged out on the ground. Two points should be marked permanently at the two ends of a fairly long line set out in this way. One of these points may be near the shaft and the other beyond the instrument. These will form permanent records of a line on the surface which coincides with a known line below ground or makes a known angle with it. Where extreme accuracy is required the operation may be repeated on the other side of the shaft and the two lines set out should then be continuous.

In the same way the theodolite may be used at the bottom of the shaft to establish a line in which the wires form two points and the angle

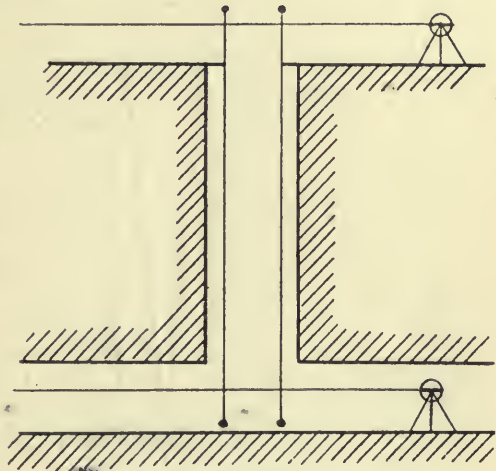

FIG. 160.

made by this line with some other known direction may be found and recorded.

Theodolite or Transit Instrument without Wires.—This method may be used either with the instrument at the bottom of the shaft or at the top. Of these two the former is simpler and can be performed with an ordinary transit theodolite, but it is probably less accurate.

The general scheme of transferring a line underground to the surface by using a theodolite placed at the bottom of the shaft is shown on Fig. 161. The theodolite used must have a powerful telescope, and this must be fitted with a right-angled eyepiece, as two of the directions taken by the line of sight are nearly vertical.

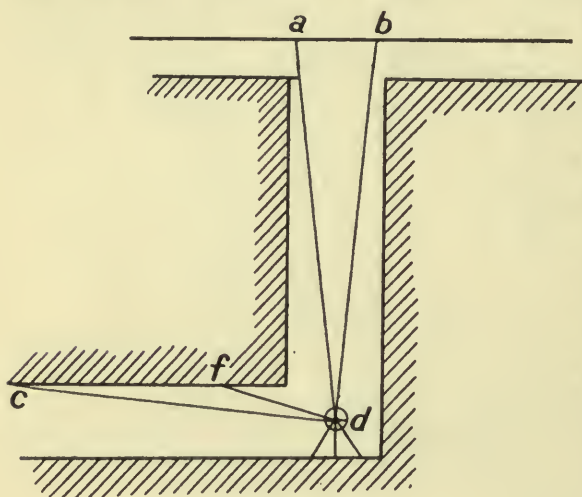

FIG. 161.

The instrument is set up on firm ground near the centre of the bottom of the shaft and very carefully levelled and adjusted. In work of this kind it is very necessary that the permanent adjustments are correct, because the accuracy of the method depends very largely on being able to establish a truly vertical plane by the rotation of the line of collimation. Of these adjustments that by which the horizontal axis of the telescope is set truly horizontal, and the one by which the

line of collimation is set truly at right angles to the horizontal axis are the most important.

The instrument being set up at *d*, the telescope is directed along the centre of a gallery leading from the bottom of the shaft and set upon some well-defined permanent mark. Probably this latter will be a station in the underground survey, and the point upon which the theodolite stands may be another. Or the line of sight may be focussed on one point (*c*) far away, and then a point nearer the instrument (at *f*) adjusted until it is exactly cut by the line of sight. (*c*) and (*f*) will now be two points forming a line which lies in the vertical plane swept out by the rotation of the line of sight.

The telescope is now directed upwards, and two marks, *a* and *b*, are adjusted near the edge of the shaft mouth until they are also cut by the line of sight. The actual form of sight, or mark, adopted depends upon the depth of the shaft and the power of the telescope. It should be something like the arrangement shown on Fig. 162. This is a glass plate or frame inclined to the horizontal at 45° and having two lines marked upon it, or wires stretched across. The points of intersection of the lines will be seen from below, and they can equally well be seen for the purpose of ranging out a horizontal line on the surface.

It will be necessary to have the theodolite diaphragm artificially illuminated. Where the voice cannot be heard directly a telephone may be used, so that the observer at the telescope can instruct his assistant at the shaft mouth as to the moving of *a* and *b* until they are in coincidence with his diaphragm lines, or a system of signalling will have to be

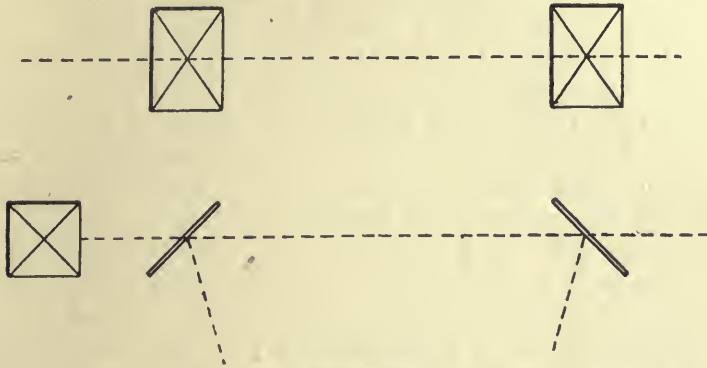

FIG. 162.

devised. If the work has been carefully carried out with an accurately adjusted instrument, *a*, *b*, *c*, *f*, and *d* will be in the same vertical plane, and a line ranged through *c*, *f*, and *d* will have the same horizontal direction as one through *a* and *b* on the surface.

Another plan is to have the instrument supported on a platform above the top of the shaft and take observations by looking downwards. The plan is simply a reversal of the one just described, with differences in detail. See Fig. 163.

As it is impossible to use an ordinary transit theodolite with the telescope pointing downwards, a transit instrument, or its equivalent, must be used. It is necessary in the present case that a hole be provided in the base plate immediately below the telescope so that sights can be taken vertically downwards and at small angles with the vertical. The instrument should be set upon a very rigid framework built over the mouth of the shaft or attached to some of the existing timbering. If the instrument can be carried upon a support which is quite independent of the platform upon which the observer stands, so much the better for the accuracy of the work. The instrument must be set up as before with its horizontal axis truly horizontal, and the line of collimation must make a true right angle with the horizontal axis.

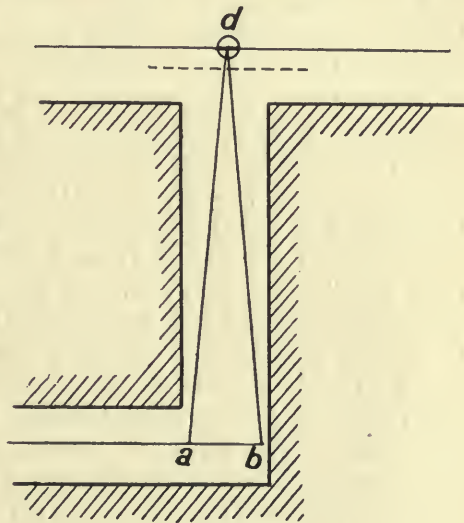

FIG. 163.

When the instrument has been fixed up in this way a line on the

surface of the ground can be set out with great accuracy. When this has been done the telescope is turned downwards, and two points are adjusted at the bottom of the shaft so as to be cut by the line of collimation. The precise arrangement of these sights forms one of the difficulties of the present method. Some observers have used sight vanes similar to those on Fig. 162, but illuminated with powerful lights reflected upwards by mirrors placed below, all light beyond that required for illumining the wires being carefully excluded. When these points have been set perfectly in the plane of the instrument it is not difficult to fix a theodolite in a gallery leading to the bottom of the shaft in such a position that its line of sight intersects the two marks. This will establish a line below in the same vertical plane as the one already set out on the surface of the ground.

Another plan is to use a pair of incandescent electric lamps, having filaments formed in a single loop. The lamps are so placed that their filaments lie in one vertical plane which is made to coincide with the vertical plane of the line of collimation of the transit telescope. When illuminated these filaments will appear from above as two short bright lines pointing in the same direction, and when viewed below in a horizontal direction will appear to coincide as one vertical line.

III. Sloping Heading leading Underground.—The connection of the surface work with the underground survey is far easier when there is a passage leading directly from the surface to the workings than in the cases already mentioned. The connection can be made by setting a transit theodolite close to the entrance to the heading, so that a sight can be obtained down the sloping passage in one direction and across the open ground behind by transiting the telescope. The two lines are then ranged out, and the line in the heading will be a continuation of that set out on the ground, and if permanent marks are placed on the line in the heading, the theodolite can now be set at the bottom of the slope, and the line either continued, if the direction of the underground passages admits, or the angle it makes with some line underground can easily be determined.

IV. Two Headings from Opposite Directions.—This is the case that usually occurs in tunnel works for lines of communication. In most instances the line underground is to be straight. Where the tunnel is a long one, and the ground under which it passes is suitable, it is usual to sink several shafts at uniform intervals along the line, and, at the same time, to set out the line on the surface of the ground above the tunnel. The work of alignment is in this way greatly facilitated, as connection can be made from the surface line to the underground line at a number of points. A general idea of the course adopted is indicated on Fig. 164. Here a tunnel is to be driven through the piece of high ground shown, and is to follow the direction of the arrows at A and D. The centre line is carefully set out in both directions leading to the tunnel mouths and is carried over the ground above. The line is ranged inwards at A and D, as shown by the arrows; and is continued further along as the tunnelling work proceeds by using a transit theodolite inside and looking backwards at carefully determined permanent marks

and carrying the line forward by transiting the telescope with the horizontal plate clamped.

The line is at the same time transferred to the bottom of the two shafts by one of the methods already described, the most usual one being the two-wire method. The line is again carried along the headings in both directions as shown, so as to meet the line coming in the opposite directions. The lines follow the work as it proceeds, the direction of the tunnelling being fixed in accordance with the direction indicated by the theodolite. Shafts sunk in this way, besides helping in the alignment, make it possible to carry on the working at a greater number of points, and so gain time.

Besides the horizontal direction of the centre line of the tunnel, the levels have to be attended to, so that when two portions meet they will be at the same height.

By very careful observations and with the best instruments available a high degree of accuracy is generally obtained in work of this kind. The following are a few examples of the accuracy attained.

In the Nepean Tunnel in New South Wales the total length was

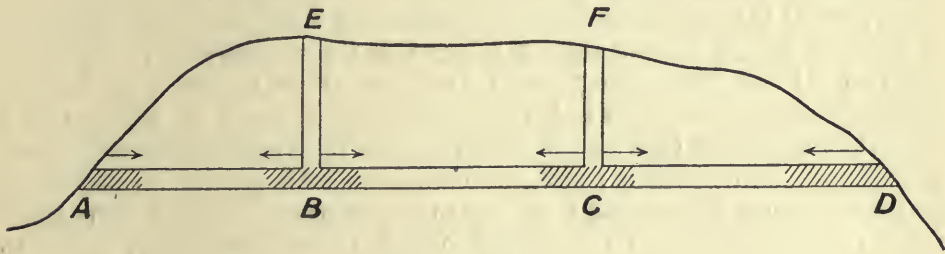

FIG. 164.

4·35 miles, and six shafts were sunk. The error in alignment for one pair of tunnels was not more than $\frac{5}{8}$ inch.

Hoosac Tunnel, Mass. Total length, 4·75 miles. Worked from the two ends and from a shaft sunk in the middle. For one pair of headings the error in alignment was 0·30 inch, and for the other 0·50 inch.

Croton Aqueduct Tunnel, New York. 1·21 mile long with no shafts. The error in alignment was about 1 inch.

In the Mont Cenis Tunnel, 6 miles long with no shafts, the two workings met with practically no error in alignment; and in the St. Gothard Tunnel, which was 3 miles longer—9 miles in all, there was an error of little more than 12 inches.

Instruments used in Underground Work.—The reader will have formed some idea from what has already been said as to the kind of instruments most suitable for survey work underground.

Instruments for measuring Angles.—In the case of a mine survey, when the work has once commenced underground it resolves itself into one long traverse or series of traverses with only occasional opportunities for checking by means of cross lines. Triangulation as usually understood is impossible, and much of the accuracy of the work is made to

depend upon the measurement of the angles. The best instrument for doing the work of highest precision is a theodolite with a transiting telescope. Where a theodolite is to be used in a mine the tripod is often made with the legs much shorter than usual on account of the small amount of head room available. For ranging the centre line of long tunnels the theodolite should have a horizontal circle of 7 or 8 inches.

Where the theodolite is to be used for transferring a line on the surface to the underground survey the telescope must be provided with a right-angled eyepiece; and where the sights are intended to be taken down the shaft from the top, either a transit instrument is to be used or the theodolite telescope mounted upon a specially constructed frame which will allow a clear sight downwards. For this purpose a special form of theodolite has been constructed with the lower part of the telescope stand consisting of a tube.

The other instrument used for getting the directions of lines is the *mining dial*, which is similar to the circumferentor or dial already described for use in needle surveys above ground. Great care is necessary in using this, as there are always possibilities of magnetic disturbances being set up by the presence of the rails in the mine.

The dial is used in the mine both with the needle "loose" and with it "fast." In the former case it is used in the ordinary way, the directions of all the lines being taken as bearings or angles with a fixed magnetic meridian. This is a very convenient manner of working in a mine, because each line that is surveyed is only dependent on one point, the station from which it starts, its direction and length being measured and being quite independent of any previous work. At the same time, what the method gains in convenience it lacks in accuracy, owing to want of precision in the readings taken and in the possibility of unknown magnetic influences being at work.

By working with the "fast" needle is meant simply raising the needle from its centre point so as to put it out of action and using the dial as a theodolite by reading on the "horizontal circle" provided in most instruments, and taking the angles made by successive lines with one another instead of reading the magnetic bearings. This is often done in making the more important surveys of the main lines in a mine.

A very useful instrument for tunnelling and other underground work is that in Fig. 44.

Instruments for measuring Distances.—Chains and tapes of similar construction to those used above ground are used. In mining work the 66-foot chain is more usual than a longer one on account of its greater lightness. In Cornwall a 60-foot chain is used. Great care should be observed that the lengths of the chains are frequently checked and also that they be kept clean and free from the rust which they are liable to in damp mines.

Instruments for marking Stations.—Surveying poles cannot very well be used underground, and arrows are also impossible when chaining, owing to the hardness of the ground. Chain lengths or parts of chains are generally marked by chalk lines on the ground or rail or other convenient point, with the number of the chains chalked alongside.

For sights used in measuring angles candle flames are used in needle traverse work. The candle is set on the top of a short tripod and the sight line of the instrument is made to intersect the centre of the flame. The candle is a simple and easily seen kind of sight and does very well for needle work. A suspended lamp is shown on Fig. 165.

But where a theodolite is used or where greater accuracy is aimed at the sight must take the form of a vertical wire hung from the roof. The wire must carry a weight to steady it, and must be illuminated by a piece of white paper held behind it with a lamp behind the paper.

This latter is the method adopted in tunnel work, the wire being suspended from a steel staple fixed to a plug driven into a hole in the roof. The lower end of the staple ends in a sharp angle where the wire is fixed so that it will always hang in the same vertical line. As the work proceeds the centre line of the tunnel is ranged forward to near the working face, and a sight wire is set in line with extreme care and its position permanently fixed in the manner described. When the line is to be carried on to another permanent station, a wire is again hung from the bracket and used for ranging forward.

Where the roof is bad and crumbly the ranging wire may be suspended from the centre of a horizontal chain which is hung from two plugs driven in the opposite sides of the tunnel.

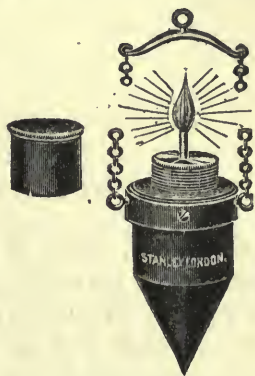

FIG. 165.

CHAPTER XIII

SETTING OUT—RAILWAY CURVES

IN general, what is spoken of as "setting out" is a reversal of the process of surveying. That is to say, instead of taking such measurements on the land as will enable the engineer to draw an accurate representation of its main features on a plan, in "setting out" the form and position of the proposed works are first fixed on the plan, and then the engineer has to mark the position of their main points on the ground so as to enable the works to be completed. Setting out is needed in connection with lines of communication, such as roads, railways, and canals, lines of water-pipes and sewers; and such other works as bridges and docks.

In setting out lines of communication the main problem is to mark the centre line on the ground, then the width of the strip which forms the main part of the work, and also the boundary of the extra land required for cuttings and embankments. When the centre line has been set out and the total width is known at each point along the line, it is not difficult to measure this total width on either side of the centre line and mark its boundary with pegs driven into the ground.

The setting out or ranging of long, straight lines which is often necessary in connection with roads, railways, pipe and conduit lines, is generally effected by means of a large transit theodolite set up on a specially prepared station, or, in more important cases, a transit instrument is used. This may be set up on a masonry foundation placed on an eminence which commands the line in both directions, or where it is necessary to raise the instrument to a suitable height a special tower or platform may have to be built.

When the centre line has been laid down on the ground according to the plan, the levels of the formation surface of a road or railway or the bottom of the trench of a line of pipes will have to be fixed. When the general scheme of the work is planned out, the course taken by the line will have been arranged so as to give, as far as possible, either level surfaces or lines of uniform slope. Surfaces of uniform slope are best determined by a theodolite whose line of sight is set at the required angle of slope, and pegs or other marks placed in the ground all at the same distance below this sloping line of sight, as shown by a marked staff. A level can also be used for this purpose, but the lengths of the sights are more limited.

In the laying of pipes boning rods are made use of (Fig. 166). The heights of the two ends of a certain length of the pipe having been accurately fixed, a T-shaped piece of timber is fixed at each end of the length in such a position that the height from the top of the crosspiece to the centre of the pipe is the same at both ends. All the length of pipe lying intermediate between these ends is set so that the cross-pieces of boning rods placed on the top of the pipe coincide with a line of sight fixed by the two rods at the ends, and in this way a uniform slope obtained.

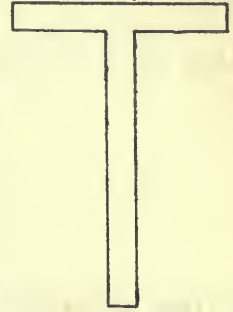

FIG. 166.—Boning rod.

Railway Curves.—The problem involved in the setting out of a railway curve is represented in its simplest form in the diagram of Fig. 167. Here are shown two straight lengths of railway, AB and CB, meeting in the point B. It is required to connect these by a circular curve of a given radius of curvature r . To do this, it is first necessary to find the points where the curve begins and ends, that is, the two tangent points. For this it is necessary to know the value of the angle at the centre of curvature D,

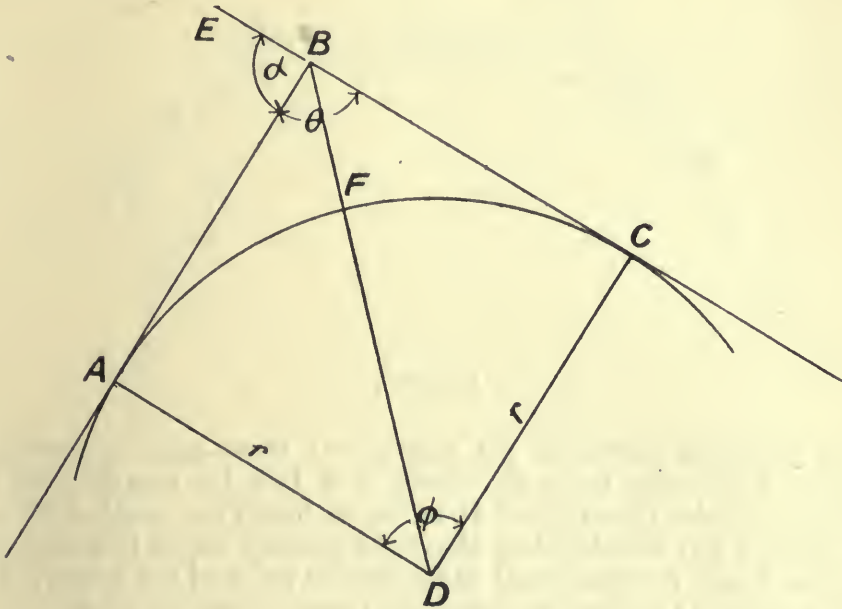

FIG. 167.

or $\phi = ADC$. If the point of meeting, B, is accessible, a theodolite may be set there, and either the interior angle ABC or the exterior angle EBA measured in the ordinary way. As DAB and DCB are right angles, and $DA = DC = r$, and

$$\frac{\phi}{2} = \frac{180^\circ}{2} - \frac{\theta}{2} \quad \text{or} \quad \phi = 180^\circ - \theta$$

And as $\alpha = \text{EBA} = 180^\circ - \theta$

$$\therefore \phi = \alpha$$

and $\text{BA} = \text{BC} = \text{AD} \tan \frac{\phi}{2} = r \tan \frac{\alpha}{2}$

Also, it is sometimes useful to know the position of F, and

$$\begin{aligned} \text{BF} &= \text{BD} - r \\ &= r \sec \frac{\alpha}{2} - r \\ &= r \left(\sec \frac{\alpha}{2} - 1 \right) \end{aligned}$$

So that the exterior angle, α , made by the intersecting lines being found, and the radius of curvature r having been assumed, it becomes possible to calculate the distances BA and BC from the intersection

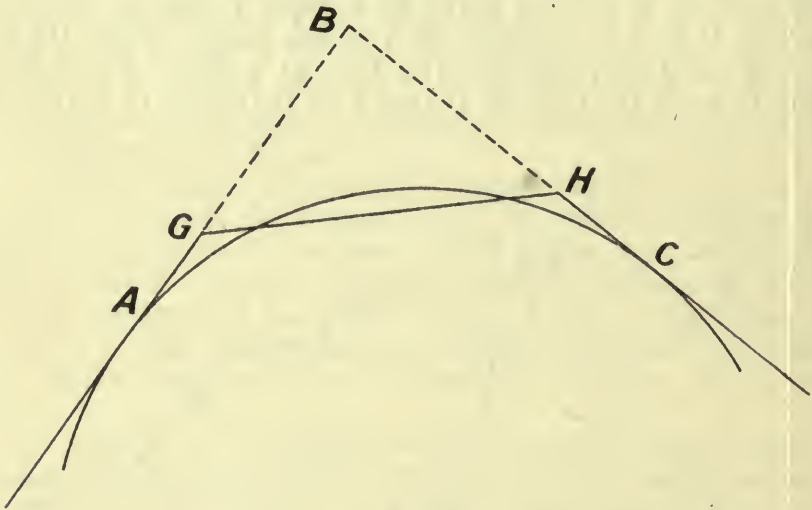

FIG. 168.

to the springing points of the curve, and these may be found by chaining backwards from B. Also, if a line be ranged with the theodolite in the direction of D, so as to bisect the angle ABC and the distance BF, calculated as above, be chained off in this direction, the point F will be established as the middle point of the curve. This point is useful as a check on the work of setting out the curve from A towards C or from C towards A.

Point of Intersection not Accessible.—When the actual point of intersection of the straight portions cannot be reached by reason of some obstacle coming in the way, such as a projecting hill or a wood or a building, it becomes necessary to follow out the plan indicated on Fig. 168. Two points, G and H, are taken in the straight portions of the line, as near the intersection as is convenient, and between which it is possible to range and measure a straight line. The angle AGH is

read with the theodolite, and also CHG. From these it is possible to calculate ABC or θ . For

$$\begin{aligned} & \text{BGH} = 180 - \text{AGH}, \text{ and } \text{BHG} = 180 - \text{CHG} \\ \text{and } & \text{ABC} = \theta = 180 - \text{BGH} - \text{BHG} \\ & = 180 - 180 + \text{AGH} - 180 + \text{CHG} \\ \therefore & \theta = \text{AGH} + \text{CHG} - 180 \end{aligned}$$

And the angle at the centre of curvature

$$\begin{aligned} \phi &= 180^\circ - \theta \\ &= 180^\circ - \text{AGH} - \text{CHG} + 180 \\ &= 360^\circ - \text{AGH} - \text{CHG} \end{aligned}$$

GH is to be chained.

$$\text{Then } \text{BG} = \text{GH} \frac{\sin^2 \text{BHG}}{\sin \theta}, \text{ and } \text{BH} = \text{GH} \frac{\sin \text{BGH}}{\sin \theta}$$

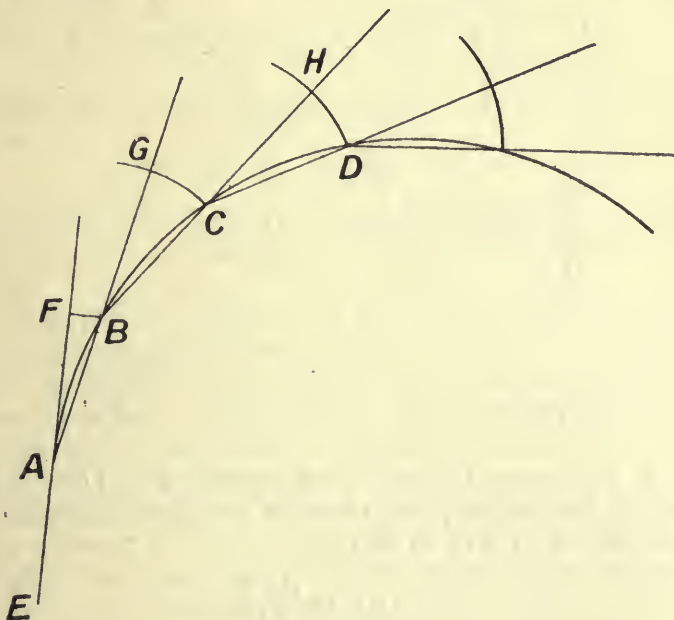

FIG. 169.

As θ and the radius r are known, BA and BC can be calculated as before.

Then

$$\begin{aligned} \text{GA} &= \text{BA} - \text{BG} \\ \text{HC} &= \text{BC} - \text{BH} \end{aligned}$$

So that now it is only necessary to chain the calculated distances GA and HC back from G and H to fix A and C.

Having calculated the position of the springing points of the curve and marked them on the ground by pegs, and possibly also the middle point of the curve, it now becomes necessary to mark the actual curved

line on the ground. So far this is assumed to be a circular arc. There are several ways of setting out a circular arc on the ground, as follows :—

- (a) By means of the chain and tape alone.
- (b) By means of chain and one theodolite.
- (c) With two theodolites.
- (d) By the successive bisection of arcs.

(a) *Setting out a Circular Curve on the Ground with a Chain and a Tape.*—In Fig. 169, from E to A is a length of straight line, and A, B, C, D, etc., are pegs on a circular curve whose springing point is at A. To find the first point on the curve beyond A, place pickets

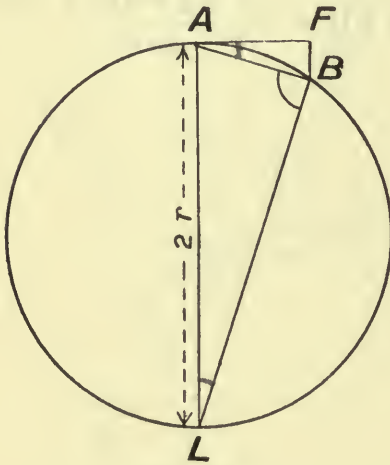

FIG. 170.

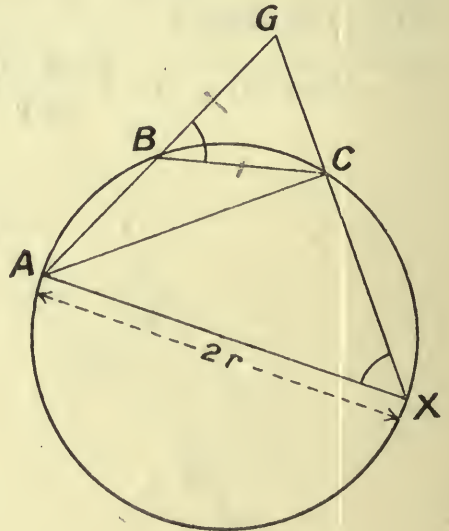

FIG. 171.

at E and A, and range through them towards F. Then if AB is made some definite distance, say one chain or one half-chain, FB is to be set out at right angles to AF, so that

$$FB = \frac{AB^2}{2r}$$

where r is the radius of the curve. This will give B as a point on a circular curve of radius r and tangent at A.

In Fig. 170 AL is a diameter $= 2r$.

The triangles BFA and ABL are similar, so that

$$\frac{FB}{AB} = \frac{AB}{AL}$$

or

$$FB = \frac{AB^2}{AL} = \frac{AB^2}{2r}$$

This gives the first point B, beyond A. To fix C, range from A through

B to G, making ABG a straight line and BG = AB. Then C will be a second point on the arc if BC is made = BG, and

$$GC = \frac{AG \cdot BC}{2r}$$

For, in Fig. 171, BG = BC, and as AXC is an angle about the chord AC in a segment of the circle, and GBC is the external angle in the segment on the other side of the same chord, the angle GBC = the angle AXC, and

∴ triangle GCB is similar to the triangle GXA

$$\therefore \frac{GC}{BC} = \frac{AG}{AX}$$

or

$$GC = \frac{AG \cdot BC}{AX} = \frac{AG \cdot BC}{2r}$$

Where AB, BC, CD, etc., are made equal, the above expression becomes (Fig. 169)

$$CG = DH = \text{etc.} = \frac{2BC^2}{2r} = \frac{BC^2}{r}$$

In marking the points on the ground, the distance AF is first calculated as

$$AF = \sqrt{AB^2 - FB^2}$$

and F marked at this distance along EA produced. Then FB is marked off at its proper distance from F at right angles to AF. This gives B.

Then G is ranged in the line of AB, and BG is made = AB.

Next, an observer holds one end of the chain of length = BG, at B, and the length BG is swung round B as centre until C is distant from G, the calculated distance GC. The distance GC is fixed by means of a length of the tape. This gives C, and similarly for the other points D and those beyond.

The process of setting out circular curves by the use of the chain and tape is affected by two sources of inaccuracy, namely, want of precision in the actual operations themselves, and the constant accumulation of error as the process goes on. Each step is dependent on all previous steps, and an error which creeps into the location of one of the earlier points is not only repeated during each successive stage but it tends to increase in magnitude. It is found when ranging a curve by this method that however much care may be taken a curve starting from one springing point rarely happens to arrive anywhere near the second tangent point. For these reasons the method cannot be relied upon for accurate work in setting out long curves, and is really only suitable for very short arcs and for filling in detail where several points have already been fixed by other means.

(b) *Using the Chain and One Theodolite.*—This case represents the system which is most convenient and at the same time reasonably accurate. The method depends upon the following geometrical facts.

1. In any segment ACB of a circle (Fig. 172) all angles at the circumference, such as ACB, are equal and have a value which is one-half the angle ADB subtended by the same chord AB at the centre of the circle.

2. The exterior angles such as FEB, formed on the other side of the chord, are also equal to ACB.

3. The angle made by the tangent with the chord, or HAB, is again equal to ACB.

The above may be summed up by saying that

$$\frac{ADB}{2} = ACB = FEB = HAB = \alpha$$

And as
$$ADB = \frac{\text{arc (AEB)}}{2\pi r} \times 360$$

$$\alpha = \frac{\text{arc}}{4\pi r} \cdot 360 \text{ degrees}$$

$$= \frac{21,600}{4\pi} \cdot \frac{\text{arc}}{r} \text{ minutes}$$

$$= 1718.873 \cdot \frac{\text{arc}}{r} \text{ minutes}$$

And the length of the arc AB is

$$= 0.00058187\alpha r$$

where α is in minutes.

In setting out a curve according to this plan, the engineer having decided what distance is to separate the successive pegs on his curve

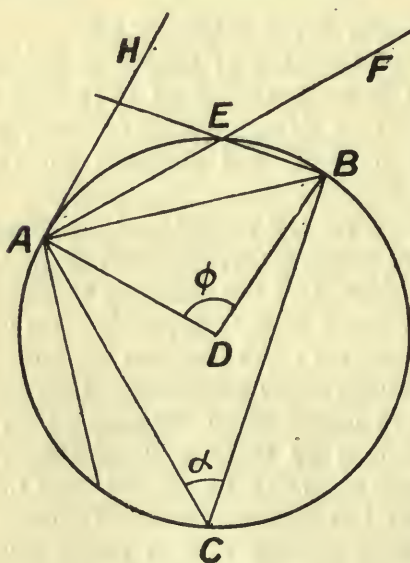

FIG. 172.

(Fig. 173), and knowing the radius of curvature, r , calculates the angle α by the above formula. Assuming that the springing points A and Z have been fixed, in the manner already indicated, he sets up his theodolite at one of these, say A. With the vernier plate at zero and the telescope pointing along the straight in the direction of X, he moves the vernier, and with it the telescope through the calculated angle α . The line of sight is now pointing in the direction Aa. A length of chain or steel tape is to be stretched from A until its free end at a is just cut by the line of sight. Then a will be on the required arc. The telescope is now turned further through the same angle, α , until it points in the direction of b , and the same length

chain stretched now from a so as to give b as the point where its end coincides with the line of collimation. And so on for each successive point, the arcs being assumed equal to the chords.

This process is simple and straightforward, and as the direction of each succeeding point is absolutely fixed by the line of sight of the telescope, the only possibility of serious error is in the lengths of the arcs Aa , ab , bc , cd , etc. When the curve does not quite close in on the second springing point X , it is not difficult to trace the cause of the error and adjust it.

If the angle α has been carefully calculated, the total angle which the direction of any point makes with the tangent is simply a multiple of α , and the direction of any one point is in a direction which is fixed independently of the other points, and there is no accumulated error due to this cause.

(c) *By using Two Theodolites.*—A higher degree of accuracy than is possible in the last case can be obtained in setting out a circular arc by using two theodolites instead of one theodolite and a chain. Referring

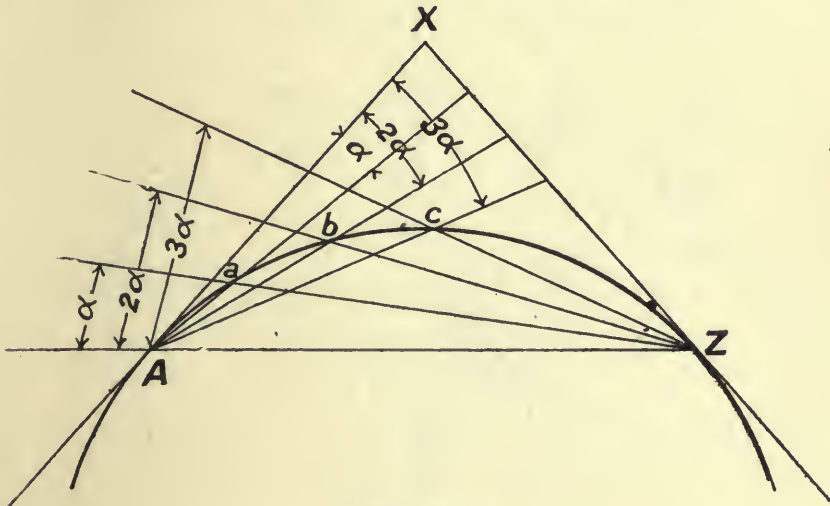

FIG. 173.

to Fig. 173, and imagining one theodolite set up at A , as before, and the other at the second tangent point Z . The first point in the curve from A is in the line of sight from A , which makes an angle α with AX ; it is also in a line of sight taken from Z and making an angle α with the chord ZA . In this way all the points of the curve may be set out. Two observers and a chain man are required. For example, in fixing the second point of the curve b , the observer at A directs the chain man, who is holding a picket somewhere about b , until his picket is in the line which makes the angle 2α with AX . At the same time the observer at Z , having set his telescope to point along a line making 2α with ZA , gives directions to the chain man until the picket is in this line of sight. By a series of adjustments the chain man eventually gets his picket into such a position that each observer is satisfied that it lies in his line of sight. It will then be on the required circular arc. This process is somewhat tedious, and is really not very often employed; but it has the unquestionable advantage of making it possible to fix

each point independently of all the others, and there is no cumulative error.

(d) *By the Successive Bisection of Arcs* (Fig. 174).—This is not very often employed in setting out a curve; but, like the last case, it has the advantage of accuracy. The springing points having been found as before, the line joining them, AZ, is chained and bisected at the point E. Then F, the first point on the curve, is found by setting up the perpendicular, EF, from E, where

$$EF = r - r \cos \frac{\phi}{2} = r \left(1 - \cos \frac{\phi}{2} \right)$$

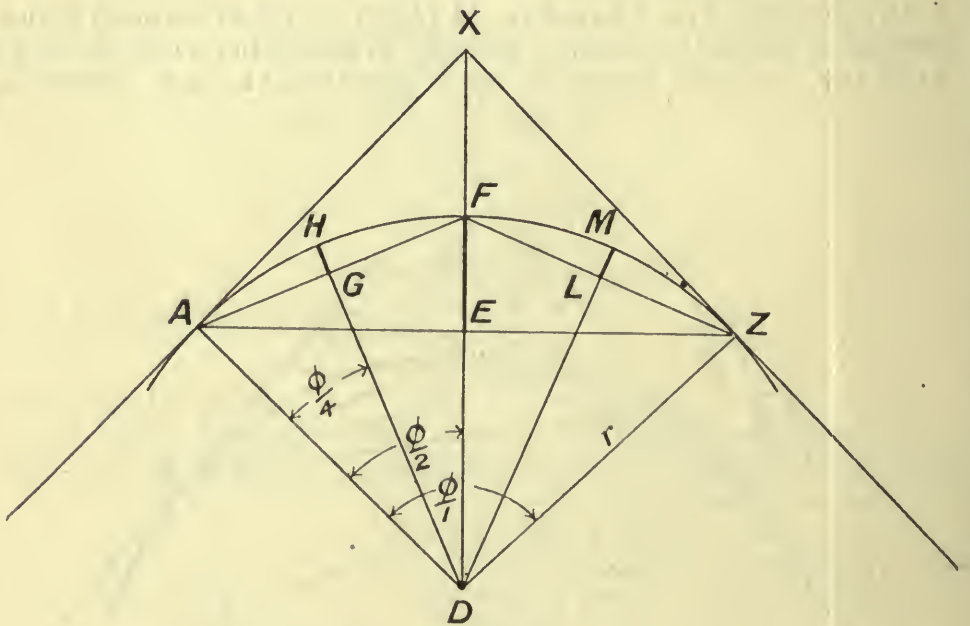

FIG. 174.

Next AF and FZ are joined and these chords bisected; perpendiculars GH and LM are set up from their middle points, where

$$GH = LM = r - r \cos \frac{\phi}{4} = r \left(1 - \cos \frac{\phi}{4} \right)$$

This gives five points on the arc, including A and Z. Further points may be obtained by bisecting AH, HF, FM, and MZ, and setting up perpendiculars whose lengths are equal to

$$r \left(1 - \cos \frac{\phi}{8} \right)$$

This successive bisection can be carried on until the required number of points are fixed.

Reverse Curves.—Cases sometimes arise (see Fig. 175) where two straight portions of a railway have to be joined by a double curve, CDF, having a point of contrary flexure, D. The common tangent,

BE, is called the "subtangent." The conditions in the general case, where the radii of curvature R_1 and R_2 are unequal, are given below. Here the angle between the two straight portions is α , and the angles which the subtangent makes with these, are respectively β and γ .

In Fig. 175—

$$\alpha = \beta - \gamma$$

also $BE = AB \frac{\sin \alpha}{\sin \gamma} = \text{subtangent}$

Again $BC = BD = R_1 \cotan \frac{\pi - \beta}{2}$

and $EF = ED = R_2 \cotan \frac{\pi - \gamma}{2}$

$$BE = BD + ED$$

$$= R_1 \cotan \frac{\pi - \beta}{2} + R_2 \cotan \frac{\pi - \gamma}{2}$$

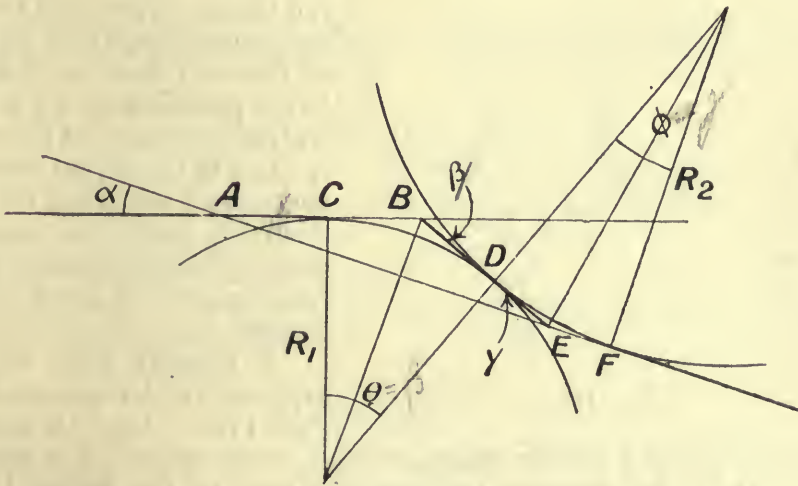

FIG. 175.

Now

$$AC = AB - BC$$

$$= BE \frac{\sin \gamma}{\sin \alpha} - R_1 \cotan \frac{\pi - \beta}{2}$$

$$= \frac{\sin \gamma}{\sin \alpha} \left(R_1 \cotan \frac{\pi - \beta}{2} + R_2 \cotan \frac{\pi - \gamma}{2} \right) - R_1 \cotan \frac{\pi - \beta}{2}$$

$$= R_1 \cotan \frac{\pi - \beta}{2} \left(\frac{\sin \gamma}{\sin \alpha} - 1 \right) + R_2 \cotan \frac{\pi - \gamma}{2} \cdot \frac{\sin \gamma}{\sin \alpha}$$

In this equation there are two unknown quantities, AC and β , so that one of these must be assumed, and the engineer must decide either where the starting point, C, of the curves is to be, or he must choose the angle which the subtangent makes with one of the original straight lengths.

When the lines are parallel, $\alpha = 0$, and $\beta = \gamma$, and it follows that BE, which may be placed anywhere,

$$= BD + DE$$

$$= \cotan \frac{\pi - \beta}{2} (R_1 + R_2)$$

It sometimes happens that there is no need for continuity in the curves; in this case the subtangent may be placed at any angle with the main line and the two curves inserted in the usual way.

Superelevation of the Outer Rail on a Curve.—When a train or other vehicle on rails is running round a curve, the effect of the centrifugal acceleration is to increase the wheel pressure on the outer rail and correspondingly lessen that on the inner rail. It also sets up a pressure of the wheel flanges against the inside edges of the rail heads. Where the radius of curvature is large and the speed of the train slow, the difference in the pressures on the two rails will not be great and little harm is likely to follow, but where the curvature is sharp and the speed relatively great, the conditions become dangerous and the train runs a chance of being derailed or upset.

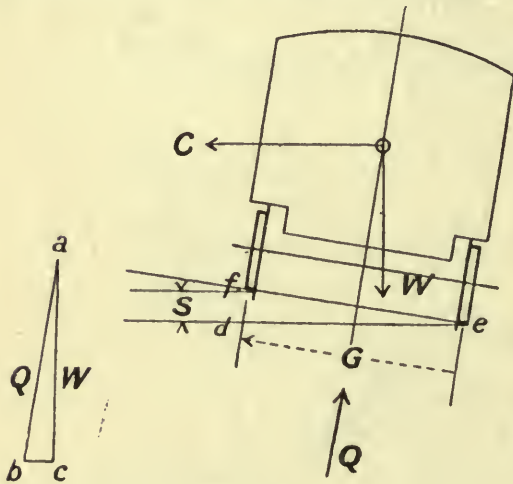

FIG. 176.

A general idea of what happens will be gathered from Fig. 176. Here is shown a skeleton view of a vehicle going round a sharp curve. The centre of gravity is O, the distance between the rails or the gauge, G, and the weight of the vehicle, W. The centrifugal force is marked C. As the vehicle runs round the curved rails, it is under the action of three forces, namely, its weight W, the centrifugal force C, and the resultant of the pressures of the rails on the wheels. If the outer rail is raised or elevated to such an extent that the resultant of W and C, passes down at right angles to the wheel axle and midway between the two rails, then the pressure on the rails will be equal, and equilibrium maintained. The amount by which the outer rail is raised is called the "superelevation," and is fixed by the maximum speed v , allowed on the curve and on the radius of curvature, r .

In the triangle of forces shown, abc ,

W = weight of vehicle

$cb = C =$ centrifugal force $= \frac{Wv^2}{gr}$, where v is the speed

Q = total pressure on the rails

The triangle abc is similar to edf , consequently

$$\frac{fd}{fe} = \frac{bc}{ba}$$

But $fd =$ superelevation, S , nearly

and $fe =$ gauge, G

$$\therefore S = \frac{bc}{ba} fe$$

or, approximately, the superelevation

$$S = \frac{C \times G}{W} = \frac{v^2 G}{gr}$$

where v is in feet per second

G is in feet

$$g = 32.2$$

r is in feet.

As 1 mile per hour = 1.46 feet per second, and in English railways $G = 4' 8\frac{1}{2}'' = 4.7'$, the superelevation

$$S = \frac{(1.46)^2 \cdot m^2 \cdot 4.7 \cdot 12}{32.2 \cdot r}$$

$$= \frac{3.73 \cdot m^2}{r} \text{ inches, or more precisely } = \frac{3.77m^2}{r}$$

where m is the speed in miles per hour.

For example, if the limiting speed is 50 miles per hour, and the curve has a radius of 2000 feet,

$$S = \frac{3.73 \cdot (50)^2}{2000}$$

$$= 4.67 \text{ inches}$$

Transition Curves.—The above formula, using the proper speed and radius of curvature, makes it possible to calculate the height of the superelevation for the main part of the curve. As soon as the train has passed the tangent point, in the case of a simple circular curve touching a straight length, it is subject to the full effect of the centrifugal action, and as it is obviously impossible to jump on to the elevated rail at once, some arrangement must be adopted by which the outer wheels mount to their full superelevation gradually, and at the same time the curve can gradually attain its minimum radius of curvature. For this purpose what are called "transition curves" are interposed between the straight and the circular arc. There are several ways of setting these out and various forms of curve are used; the following will serve to show how a transition curve is set out according to the most recent practice. In Fig. 177, AB and CB are two lengths of straight meeting at B , and AFC is a circular arc set out as already described.

The first thing to decide is the length of the transition curve. This should be from 500 to 700 times the superelevation of the main curve, so as to allow of a sufficiently gradual attainment of that height and at the same time sufficient length to admit of a gradual approach to the normal curvature. One-half this transition length is set off behind the tangent point, as AL in the figure. The transition curve extends from L until it touches the circular curve at M. It is clear that the part of the circular arc between the two ends of the transition curves will have to be moved bodily towards the centre of curvature. This is called the "shift," which is found by the rule

$$AN = \text{shift} = \frac{(\text{length of curve of adjustment})^2}{24r} = \text{corr. projection}$$

All points on the circular arc from A to C are moved inwards towards the centre of curvature, until a new arc, NOP, is obtained. The

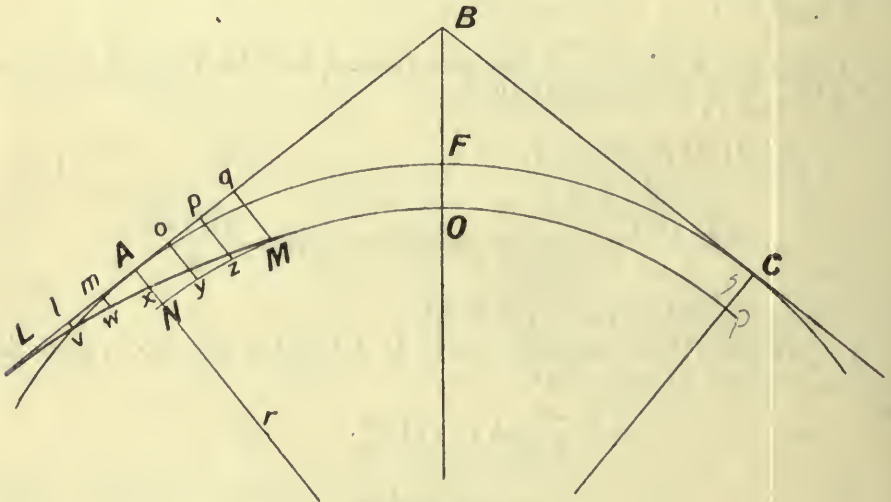

FIG. 177.

transition curve leaves the straight at L and joins the arc at M, passing through the middle point of AN. Afterwards the remaining points are put in by the rule of Mr. Froude, according to which whose curve of adjustment approximates to a cubic parabola. The following example will illustrate the way in which the calculations are made and the field work carried out for a circular arc which is afterwards connected to the straight part of the line by Froude's curves.

Example.—Two straight portions of a railway are inclined to one another, but do not meet on accessible ground. They are to be joined by a circular curve of fifteen chains (1500') radius. They are intercepted by a line eight chains (800') in length which makes angles with them of 140° and 150° respectively. After the necessary calculations have been made and the circular arc set out on the ground the two curves of adjustment must be put in. (See Fig. 178.)

The speed round the curve must not exceed 45 miles per hour.

It is assumed that the points X and Y are marked by pegs and that there are others marking the straight portions towards A and C, and further that the theodolite has been placed at X and Y in order to measure the angles AXY and CYX, which are 140° and 150° respectively, making the interior angles 40° and 30° .

In what follows, $r = 1500'$
 and $m = 45$ miles per hour.
 $\theta = 180^\circ - 40^\circ - 30^\circ = 110^\circ$ and $\phi = 180^\circ - \theta = 70^\circ$

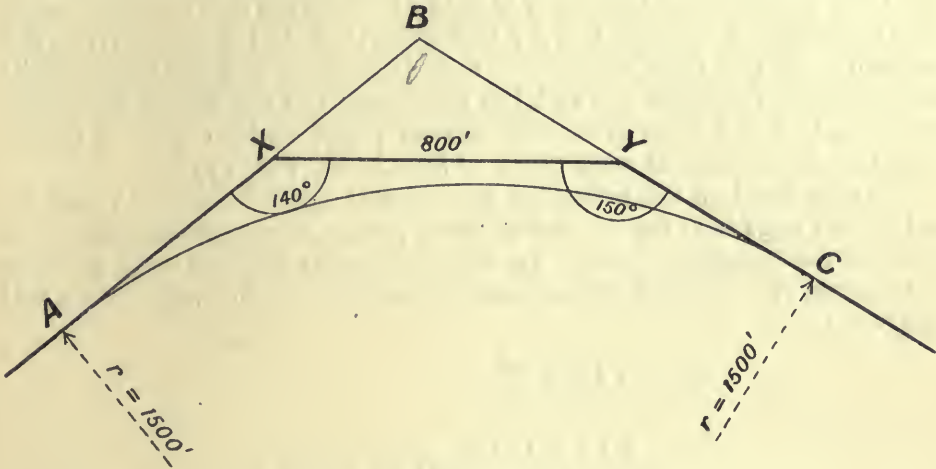

FIG. 178.

In the triangle BXY,

$$BX = XY \frac{\sin BYX}{\sin XBY}$$

$$= 800 \frac{\sin 30^\circ}{\sin 110^\circ} = 800 \times \frac{0.5000}{0.9397} = 425.7'$$

and $BY = XY \frac{\sin BXY}{\sin XBY} = 800 \frac{\sin 40^\circ}{\sin 110^\circ} = 800 \times \frac{0.6428}{0.9397} = 547.3'$

Also $AB = BC = r \tan \frac{\phi}{2} = 1500 \tan 35^\circ = 1500 \times 0.7002 = 1050.3'$

so that $XA = BA - BX = 1050.3 - 425.7 = 624.6'$

and $YC = BC - BY = 1050.3 - 547.3 = 503.0'$

It is now possible to fix the springing points A and C. In doing this the engineer chains back from the points where the intercept meets the straight lines at X and Y, towards A and C, making $XA = 624.6'$ and $YC = 503.0'$.

He then drives in pegs at A and C.

The following calculation is to be made for use in setting out the curve with a theodolite at A and a steel tape, the distances between the pegs on the arc being half-chains or 50 feet.

The angle at the instrument subtended by each 50 feet will be given by

$$\begin{aligned} \alpha &= \frac{(\text{arc})360}{2\pi r} \\ &= \frac{1718.873 \times (\text{arc})}{r} = \frac{1718.873 \times 50}{1500} = 57' 18'' \end{aligned}$$

With the theodolite at A, and using a 50-foot steel tape, the engineer finds the intersecting point of the line of sight and the end of the chain, when the beginning of the chain is held at A and the line of sight makes $57' 18''$ with the direction AX; this gives the first point. With the beginning of the tape moved to this first point and the line of sight turned through another $57' 18''$, the intersection of the line of sight with the far end of the tape gives the second point, and so on. A peg is driven in the ground at each point so found (see Fig. 173).

Having fixed all the points on the circular curve between A and C, and driven pegs into the ground at these points, the engineer must next consider the transition curve. In this connection the first thing to do is to ascertain the value of the superelevation of the outer rail. This will be given by—

$$\begin{aligned} S &= \frac{3.73 \times m^2}{r} \\ &= \frac{3.73 \times (45)^2}{1500} = 5.03 \text{ inches} \end{aligned}$$

Calling this 5 inches and making the length of the transition curve 300 feet, the slope of the outer rail will be 1 in 720, which is quite reasonable. Calling this length l , and the "shift" y , then

$$\text{the shift} = y = \frac{l^2}{24r} = \frac{(300)^2}{24 \times 1500} = 2\frac{1}{2} \text{ feet}$$

This is AN in Fig. 177, and the transition curve will bisect its middle point at x . The other ordinates are given by—

$$\begin{aligned} lv &= 1.25 \times \frac{1^3}{3^3} = 0.046 \text{ feet} \\ mw &= 1.25 \times \frac{2^3}{3^3} = 0.373 \text{ ,,} \\ Ax &= \text{the half-shift} = 1.250 \text{ ,,} \\ oy &= 1.25 \times \frac{4^3}{3^3} = 2.960 \text{ ,,} \\ pz &= 1.25 \times \frac{5^3}{3^3} = 5.780 \text{ ,,} \\ qM &= 1.25 \times \frac{6^3}{3^3} = 10.000 \text{ ,,} \end{aligned}$$

At L the transition curve is tangential to the straight line and at M is continuous with the shifted circular arc, and it passes through the middle point x of the shift AN. The ordinates are set off at right angles to the tangent, and in length are proportional to the cubes of the distances measured along the transition curve. The same process is gone through at the other end of the arc.

This curve of Froude's is probably the most suitable for the purpose, as both the required calculations and the fieldwork are simple.

For purposes of transition Mr. Gravatt suggested doing away with the circular arc altogether and making the whole length of the curve one long curve of sines. This would give the middle portion as something approximating to a circular arc, and towards the ends the radius of curvature would be continually increasing. The chief objection to a curve of sines is the difficulty in setting out.

CHAPTER XIV

EARTHWORK CALCULATIONS

Earthwork Calculations.—In completing schemes for the construction of lines of communication it is in nearly all cases necessary to make calculations of the quantity of earth or rock to be removed from a cutting of given dimensions or the quantity required in building up an embankment, or it may be the quantity of earth to be removed when driving a tunnel. These are the chief cases, and the present discussion will be limited to them and not extended to the more special cases which arise in connection with dock and harbour construction.

A piece of earthwork is, as a rule, bounded by four surfaces, which appear as lines in the transverse sections. These are:—

- (a) The “formation” surface, which occurs at the top of an embankment or the bottom of a cutting. This is always either nearly or quite horizontal.
- (b) The natural surface of the ground. This may be horizontal or it may be sloping, often it is curved. It forms the tops of cuttings before the earth is removed, and the bottoms of embankments.
- (c) The “slopes” which form the sides. These are generally flat surfaces of uniform slope. The angle of slope is chosen as the steepest which at the same time is consistent with the stability of the earth.

The following are the slopes at which certain typical kinds of earth naturally lie. If any given earth is cut or formed at a steeper angle it ultimately slides down until the slopes make the natural angle with the horizontal.

TABLE OF NATURAL SLOPES OF EARTH. (Angles with the horizontal.)

Compact earth	50°
Rubble	45°
Well-drained clay	45°
Gravel	40°
Dry sand	38°
Shingle	39°
Vegetable earth	28°
Damp sand	22°
Wet clay	16°

Of course every kind of earth does not necessarily come within any one of the above classes, but the figures will serve to indicate the sort

of angle to be expected in any given case. The natural angle of repose can be found experimentally by piling up a large heap and allowing the earth to run down the sides until it has settled to a definite slope. In profile such a slope will appear as a straight line whose angle with the horizontal can easily be measured.

The following also may be found useful.

TABLE OF WEIGHTS OF DIFFERENT EARTHS, ETC.

Slate	43 cwt. in 1 cubic yard
Trap rock	42 " " "
Granite	42 " " "
Quartz	41 " " "
Shale	40 " " "
Sandstone	39 " " "
Chalk	36 " " "
Clay	31 " " "
Marl	26 " " "
Mud	25 " " "
Gravel and sand	30 " " "

It is usual to calculate the volume of earthwork quantities as so many cubic yards, so that where the measurements are in feet (or links, which are capable of being converted into feet), and the calculations made in these units, it is necessary to divide the volumes in cubic feet so found by 27 to convert them to cubic yards.

In Fig. 179 are shown at (a), (b), (c) three typical cases of earthwork sections.

In (a) the natural surface of the ground is level across; in (b) this natural surface lies at a uniform slope of r horizontal to 1 vertical.

In the third case, (c), the natural surface is again at a uniform slope, but part of it intersects the base or formation, so that the upper part is "cutting" and the lower part "embankment."

In all these cases the natural surface of the ground is represented by OS, the formation level is FL, and the side slopes are OF and LS, and lie at angles of s horizontal to 1 vertical.

As (a) and (b) are shown they represent sections of cuttings. If they are turned the other way up they may be taken as representing sections of embankments.

From these figures the first thing to be found is the "half breadth" and "total breadth" of the ground required by the constructors of the embankment or the cutting. When found these can be pegged out on the two sides of the centre line.

In Fig. 179 (a), (b), and (c),

- the central depth = MN = h
- „ half-breadth of formation = NF = NL = b
- „ half-breadth of slope = BS = AO in (a)
- = DO and YS in (b) and (c)
- = a_1 and a_2

The slope or sidelong declivity of } = r (horizontal) to 1 (vertical)
 the natural surface }
 „ slope of the earthwork = s (horizontal) to 1 (vertical)

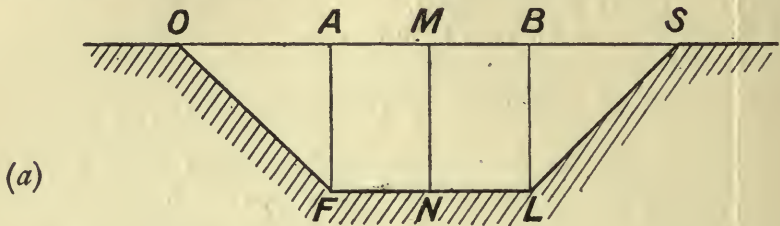

(a)

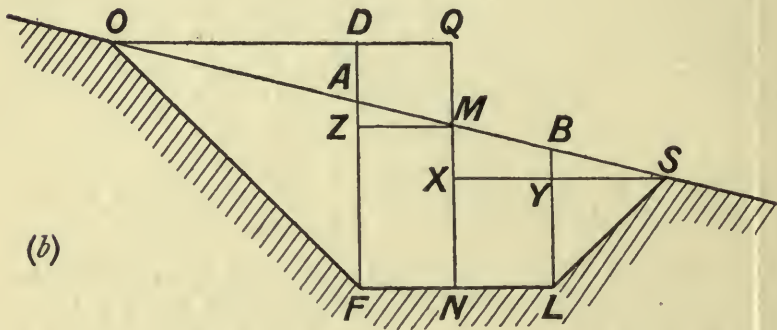

(b)

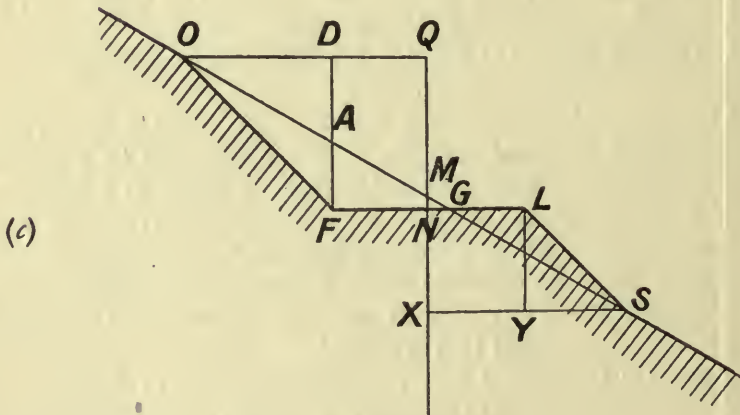

(c)

FIG. 179.

To find the Total Breadth of Land required at any Given Section.

CASE (a).—

$$\begin{aligned}
 \text{Total breadth} &= 2 \left(\begin{array}{l} \text{half-breadth} \\ \text{of formation} \end{array} \right) + 2 \left(\begin{array}{l} \text{half-breadth} \\ \text{of slope} \end{array} \right) \\
 &= 2b + 2a \\
 &= 2(b + sh) \\
 &= 2MB + 2BS \\
 &= OS, \text{ in the figure.}
 \end{aligned}$$

CASE (b).—In the figure,

$$\begin{aligned} \text{The total breadth} &= (\text{NL} + \text{NF}) + (\text{YS} + \text{DO}) \\ &= 2b + a_1 + a_2 \\ &= 2b + \frac{rs}{r+s} \left(h - \frac{b}{r} \right) + \frac{rs}{r-s} \left(h + \frac{b}{r} \right) \end{aligned}$$

Because—

$$\begin{aligned} \text{MN} = h &= \text{MX} + \text{XN} = \frac{b + a_1}{r} + \frac{a_1}{s} \\ \therefore a_1 &= \frac{rs}{r+s} \left(h - \frac{b}{r} \right) \end{aligned}$$

and similarly for DO or a_2 .

CASE (c).—In the figure,

$$\begin{aligned} \text{The total breadth} &= (\text{NL} + \text{NF}) + (\text{YS} + \text{DO}) \\ &= 2b + a_1 + a_2 \\ &= 2b + \frac{rs}{r-s} \left(\frac{b}{r} - h \right) + \frac{rs}{r+s} \left(\frac{b}{r} + h \right) \end{aligned}$$

To calculate the Sectional Areas enclosed by the Boundaries OSLF.

CASE (a).—Enclosed area

$$\begin{aligned} \text{OSLF} &= \text{MN} \cdot \frac{1}{2}(\text{OS} + \text{FL}) \\ &= \frac{h}{2} \{ 2(b + sh) + 2b \} \\ &= h(2b + sh) \\ &= 2bh + sh^2 \end{aligned}$$

CASE (b).—Enclosed area

$$\begin{aligned} \text{OSLF} &= \text{OAF} + \text{FABL} + \text{LBS} \\ &= \frac{1}{2} \text{AF} \cdot \text{OD} + \text{FL} \cdot \text{MN} + \frac{1}{2} \text{BL} \cdot \text{YS} \\ &= \frac{1}{2} \left\{ \left(h + \frac{b}{r} \right) \frac{rs}{r-s} \left(h - \frac{b}{r} \right) \right\} + 2 \cdot b \cdot h + \frac{1}{2} \left\{ \left(h - \frac{b}{r} \right) \frac{rs}{r+s} \left(h - \frac{b}{r} \right) \right\} \\ &= 2 \cdot b \cdot h + \frac{rs}{2(r-s)} \left(h + \frac{b}{r} \right)^2 + \frac{rs}{2(r+s)} \left(h - \frac{b}{r} \right)^2 \end{aligned}$$

CASE (c).—Total enclosed area

$$\begin{aligned} &= \text{FOG} + \text{GLS} \\ &= \frac{1}{2} \text{FG} \cdot \text{QN} + \frac{1}{2} \text{GL} \cdot \text{LY} \\ &= \frac{1}{2} (b + rh) \frac{b + rh}{r-s} + \frac{1}{2} (b - rh) \frac{b - rh}{r-s} \\ &= \frac{(b + rh)^2}{2(r-s)} + \frac{(b - rh)^2}{2(r-s)} \end{aligned}$$

To calculate the Volumes.

1ST CASE.—Given the areas of two cross-sections, A_1 and A_2 , and the longitudinal distance between them, l .

The volume enclosed is given, very approximately, by

$$V = l \frac{A_1 + A_2}{2}$$

A clearer approximation is given where there are three equidistant sections, A_0 , A_1 , A_2 , by Simpson's rule,

$$V = \frac{l}{6} (A_0 + 4A_1 + A_2)$$

l being the total length.

3RD CASE.—*Prismoidal Formula.*

Here the ground is level across; the two end sections are given and the middle one calculated.

Let h_0 = central depth at A_0 .
 „ h_2 = „ „ „ A_2 .

Then $h_1 = \frac{h_0 + h_2}{2}$, and, as the area of any section, $A = 2bh + sh^2$, and by Simpson's rule,

$$\begin{aligned} V &= \frac{l}{6} (A_0 + 4A_1 + A_2) \\ &= \frac{l}{6} \left\{ (2bh_0 + sh_0^2) + 4 \left(2b \frac{(h_0 + h_2)}{2} + s \frac{(h_0 + h_2)^2}{4} \right) + (2bh_2 + sh_2^2) \right\} \\ &= l \left\{ b(h_0 + h_2) + \frac{s}{3} (h_0^2 + h_0h_2 + h_2^2) \right\} \end{aligned}$$

This may be written in another form as

$$= l \left\{ b(h_0 + h_2) + s \left(\frac{(h_0 + h_2)^2}{4} + \frac{(h_0 - h_2)^2}{12} \right) \right\}$$

EXAMINATION QUESTIONS

(1) Show that, in tacheometer measurements, $D = \frac{f}{i} \cdot s + c + f$, where

D = distance of vertical axis of instrument from staff,

f = principal focal distance of object glass,

i = distance between stadia hairs,

c = distance from the vertical axis to the centre of the object glass,

and s = the staff reading.

(2) Describe the principles and advantages of the arrangement known as Porro's telescope, and explain how it may be used to determine linear distances on the ground.

(3) Describe minutely the process of setting out a base line 5 miles long with great accuracy, for instance, along the coast of Lincolnshire; and point out how this could be utilised for the purpose of determining the distance between London and Leeds.

(4) Describe the method of measuring a base line with great accuracy by means of Col. Colby's compensation bars, and explain the principle upon which these bars depend.

(5) Explain in detail how the latitude of a place is determined by observations of a circumpolar star through a transit theodolite, and point out how refraction tends to affect the result.

(6) The north declination of "Polaris" in 1865 was $88^{\circ} 35' 23''$. In that year the altitude of "Polaris" was observed from a certain place to be $48^{\circ} 32' 20''$, when at its upper culmination. Neglecting refraction, find the latitude of this place.

(7) A, B, C are three fixed points on shore; $AB = 725$ feet; $BC = 910$ feet; angle $ABC = 160^{\circ}$. D is a sunken rock whose position has to be determined. The angles ADB and BDC are read by means of a double sextant, and are found to be 19° and 27° . Show how the point D can be plotted by making use of a geometrical construction.

(8) If a river is 96 feet wide and soundings are taken at every 12 feet across, as follows— $0'$, $2'1$, $4'2$, $5'38$, $5'57$, $6'07$, $5'98$, $3'21$, and $0'$ —and the mean velocity of the water is 2.19 feet per second, find the number of gallons per hour passing the section.

(9) Given a river 100 feet wide and 6 feet mean depth at a given cross-section. Explain fully a method of determining the number of cubic feet of water passing the section per minute.

(10) How can a single observer locate the position of a point on the surface of water with respect to three fixed points on the land? Under what conditions does this method fail?

(11) Point out how you would proceed to connect a survey on a surface of the ground with an underground survey, (a) when the connecting shaft is 45 feet deep, and (b) when it is 1000 feet deep, the shaft in each case having a diameter of 20 feet.

(12) Two straight portions of a railway intersect at an angle of 120° , and they are to be joined by a curve of 15 chains radius. The chainage to the point of intersection is 2433 links. Find the chainage at the beginning and end of the curve, and make such preliminary calculations as are necessary for the purpose of setting out the curve with a theodolite and chain. The pegs marking the centre line to be 50 feet apart.

(13) Find the superelevation of the outer rail of a railway on a curve of 2000 feet radius, when the limiting speed is 44 miles an hour, and the gauge 7 feet. What should be the length of the curve of adjustment, and why?

(14) The speed of a train travelling round a circular curve of 18 chains radius is 40 miles per hour, the gauge of the rails is $4' 8\frac{1}{2}''$. Find the necessary superelevation of the outer rail.

(15) Two straight portions of a railway are inclined to one another, but do not meet on accessible ground. They are to be joined by a circular curve of 15 chains radius. They are intercepted by a line AB of 8 chains in length, which makes angles of 140° and 150° respectively with them. Describe how you would proceed to set out the curve and make all the necessary preliminary calculations.

(16) A circular curve of 14 chains (1400 feet) radius has two tangents making an angle of 115° with each other. Make all the necessary calculations for setting this curve out on the ground with two theodolites, the pegs on the centre line being placed 50 feet apart. Also describe in detail the process of setting out the curve.

(17) Calculate the maximum elevation of the outer rail on the above curve on the supposition that the maximum speed of the train is 55 miles an hour.

(18) The tangents to a circular railway curve of 10 chains radius meet at an angle of 130° . Set out this curve on paper—(a) by means of an angle and a linear measurement; (b) by means of two angles; (c) by means of two linear measurements. Scale for setting out—1 inch = 1 chain. The successive points on the curve are to be 1 chain apart. Give all the preliminary calculations in detail.

(19) Calculate the half-widths at the 100-foot pegs, also the volume of earthwork to be removed in making a cutting of the following dimensions: length, 400 feet; slopes, 1 to 1; width at formation level, 36 feet.

No. of peg . . .	3100	3200	3300	3400	3500
Depth (feet) . . .	0	18	24	16	0

(20) The width of the bed of a canal is to be 80 feet; the slopes 2 to 1; the natural surface of the ground is flat, and at two alternate sections, 200 feet apart, the central depths are 38 and 27 feet respectively. Find the number of cubic yards of earth to be excavated between the two sections.

(21) Calculate at what depth a cutting 32 feet wide at formation level, with slopes of $1\frac{1}{2}$ to 1, becomes of equal cost with tunnelling, when the cutting costs 1s. 6d. per cubic yard and tunnelling is £30 per lineal yard.

(22) A cutting has a base of 32 feet, and slopes of $2\frac{1}{2}$ to 1. Find the volume in cubic yards contained in a chain length (66') of this cutting, the central depths of the two ends being respectively 42 and 31 feet. The surface of the ground is level across.

(23) The width of a base of a railway cutting is 30'; the slopes of the cutting are $1\frac{1}{2}$ to 1; the distance between two sections is 2 chains (Gunter's), and the central depth at the sections is 39' and 47' respectively. Find the number of cubic yards of earth in the cutting between the two sections.

(24) The depth of a cutting at a point on the centre line of a railway is 23.6 feet, the half-breadth of the base 15 feet, slopes 2 to 1, and the ground surface has a side-long declivity of 13 to 1. Find the horizontal distance from the centre line to the top of each slope.

(25) If a tunnel costs £56 per yard run, and an open cutting costs 8d. per cubic yard excavated, find the depth of cutting which would cost the same as the tunnel. Width of formation base = 40'; slopes 2 to 1. The surface ground is level.

BIBLIOGRAPHY

- Stanley's "Surveying Instruments." W. F. Stanley & Co.
"Preliminary Survey and Estimates." Gribble. Longmans, Green & Co.
"Mine Surveying." Lupton. Longmans, Green & Co.
"Practical Mensuration." Nesbit. Longmans, Green & Co.
"Civil Engineering." Rankine. Chas. Griffin & Co.
"Aid to Survey Practice." Jackson. Crosby Lockwood & Co.
"Practical Surveying." Usill. Crosby Lockwood & Co.
"Surveying with the Tacheometer." Kennedy. Crosby Lockwood & Co.
"Trigonometrical Surveying." Frome. Crosby Lockwood & Co.
"Levelling." Sims. Crosby Lockwood & Co.
"Earthwork Tables." Broadbent and Campin. Crosby Lockwood & Co.
"Field and Colliery Surveying." O'Donahue. Macmillan & Co.
"Marine Surveying." Robinson. Macmillan & Co.
"Navigation and Nautical Astronomy." Stebbing. Macmillan & Co.
"Field Engineer's Handbook." Wells & Clay. Edward Arnold.
"Traverse Tables." Louis & Gaunt. Edward Arnold.
"Geodesy." Clarke. London.
"Hints to Travellers." Grant. London.
"Hydrographic Surveying." Wharton. London.
"Nautical Surveying." Shortland. London.
"Surveying Instruments." Baker. Wiley & Sons, New York.
"Field Astronomy for Engineers." Comstock. Wiley & Sons, New York.
"Geodetic Astronomy." Hayford. Wiley & Sons, New York.
"Theory and Practice of Surveying." Johnson. Wiley & Sons, New York.
"Precise Surveying and Geodesy." Merriman. John Wiley & Sons.
"Topographical Surveying." Wilson. John Wiley & Sons.
"Transition Curves." Crandall. John Wiley & Sons.
"Transition Curves." Howard. John Wiley & Sons.
"Trial Survey for a Railway." Stewart. Min. Proc. Inst. C.E., vol. cxxi.
"Survey of Danube Delta." Vernon Harcourt. Min. Proc. Inst. C.E.,
vol. cxxii.
"Rapid Preliminary Surveys." Poole. Min. Proc. Inst. C.E., vol. cxxxix.
"Railway Surveying on the Pipli Ghat." Min. Proc. Inst. C.E., vol. cxlviii.
"Longitude in Land Surveying." Downes. Min. Proc. Inst. C.E., vol.
cxxxiii.
"Transition Curves." Robinson. Min. Proc. Inst. C.E., vol. cxxxiii.
"Long Distance Levelling." Bagnall. Min. Proc. Inst. C.E., vol. cxxi.
"Railway Surveying in Tropical Forests." Shelford. Min. Proc. Inst.
C.E., vol. cxxxiii.
"Railway Surveying with the Tacheometer." Demster. Min. Proc. Inst.
C.E., vol. cxxxix.
"Notes on Railway Surveying." Albrecht. Min. Proc. Inst. C.E., vol. cliv.
"Meridian Diagrams." Barnes. Min. Proc. Inst. C.E., vol. clxiv.
"Note on Traverse Surveying." Crosthwaite. Min. Proc. Inst. C.E., vol.
clviii.
"Surveying with the Aneroid." Gribble. Min. Proc. Inst. C.E., vol. clxxi.
"Survey of Inaccessible Places by Tacheometry." Cuffe. Min. Proc. Inst.
C.E., vol. clxx.

TRAVERSE TABLE

TRAVERSE TABLE.

For angles up to 45° read downwards, and for angles over 45° read upwards.

Dis- tance.	10 feet.		20 feet.		30 feet.		40 feet.		50 feet.		60 feet.		70 feet.		80 feet.		90 feet.		100 feet.		Dis- tance.
	Lat.	Dep.	Lat.	Dep.	Lat.	Dep.	Lat.	Dep.	Lat.	Dep.	Lat.	Dep.	Lat.	Dep.	Lat.	Dep.	Lat.	Dep.	Lat.	Dep.	
1°	10°	00.2	20°	00.3	30°	00.5	40°	00.7	50°	00.9	60°	01.0	70°	01.2	80°	01.4	90°	01.6	100°	01.7	89°
2°	10°	00.3	20°	00.7	30°	01.0	40°	01.4	50°	01.7	60°	02.1	70°	02.4	80°	02.8	90°	03.1	99.9	03.5	88°
3°	10°	00.5	20°	01.0	30°	01.6	39.9	02.1	49.9	02.6	59.9	03.1	69.9	03.7	79.9	04.2	89.9	04.7	99.9	05.2	87°
4°	10°	00.7	20°	01.4	29.9	02.1	39.9	02.8	49.9	03.5	59.9	04.2	69.8	04.9	79.8	05.6	89.8	06.3	99.8	07.0	86°
5°	10°	00.9	19.9	01.7	29.9	02.6	39.8	03.5	49.8	04.4	59.8	05.2	69.7	06.1	79.7	07.0	89.7	07.8	99.6	08.7	85°
6°	09.9	01.0	19.9	02.1	29.8	03.1	39.8	04.2	49.7	05.2	59.7	06.3	69.6	07.3	79.6	08.4	89.5	09.4	99.5	10.5	84°
7°	09.9	01.2	19.9	02.4	29.8	03.7	39.7	04.9	49.6	06.1	59.6	07.3	69.5	08.5	79.4	09.7	89.3	11.0	99.3	12.2	83°
8°	09.9	01.4	19.8	02.8	29.7	04.2	39.6	05.6	49.5	07.0	59.4	08.4	69.3	09.7	79.2	11.1	89.1	12.5	99.0	13.9	82°
9°	09.9	01.6	19.8	03.1	29.6	04.7	39.5	06.3	49.4	07.8	59.3	09.4	69.1	11.0	79.0	12.5	88.9	14.1	98.8	15.6	81°
10°	09.8	01.7	19.7	03.5	29.5	05.2	39.4	06.9	49.2	08.7	59.1	10.4	68.9	12.2	78.8	13.9	88.6	15.6	98.5	17.4	80°
11°	09.8	01.9	19.6	03.8	29.4	05.7	39.3	07.6	49.1	09.5	58.9	11.4	68.7	13.4	78.5	15.3	88.3	17.2	98.2	19.1	79°
12°	09.8	02.1	19.6	04.2	29.3	06.2	39.1	08.3	48.9	10.4	58.7	12.5	68.5	14.6	78.3	16.6	88.0	18.7	97.8	20.8	78°
13°	09.7	02.2	19.5	04.5	29.2	06.7	39.0	09.0	48.7	11.2	58.5	13.5	68.2	15.7	77.9	18.0	87.7	20.2	97.4	22.5	77°
14°	09.7	02.4	19.4	04.8	29.1	07.3	38.8	09.7	48.5	12.1	58.2	14.5	67.9	16.9	77.6	19.4	87.3	21.8	97.0	24.2	76°
15°	09.7	02.6	19.3	05.2	29.0	07.8	38.6	10.4	48.3	12.9	58.0	15.5	67.6	18.1	77.3	20.7	86.9	23.3	96.6	25.9	75°
16°	09.6	02.8	19.2	05.5	28.8	08.3	38.5	11.0	48.1	13.8	57.7	16.5	67.3	19.3	76.9	22.1	86.5	24.8	96.1	27.6	74°
17°	09.6	02.9	19.1	05.8	28.7	08.8	38.3	11.7	47.8	14.6	57.4	17.5	66.9	20.5	76.5	23.4	86.1	26.3	95.6	29.2	73°
18°	09.5	03.1	19.0	06.2	28.5	09.3	38.0	12.4	47.6	15.5	57.1	18.5	66.6	21.6	76.1	24.7	85.6	27.8	95.1	30.9	72°
19°	09.5	03.3	18.9	06.5	28.4	09.8	37.8	13.0	47.3	16.3	56.7	19.5	66.2	22.8	75.6	26.0	85.1	29.3	94.6	32.6	71°

TRAVERSE TABLE

Angle.	Dep.	Lat.	Dep.	Lat.	Dep.	Lat.	Dep.	Lat.	Dep.	Lat.	Dep.	Lat.	Dep.	Lat.	Dep.	Lat.	Dep.	Lat.	Dep.	Lat.	Dep.	Lat.	Angle.
20°	09.4	03.4	18.8	06.8	28.2	10.3	37.6	13.7	47.0	17.1	56.4	20.5	65.8	23.9	75.2	27.4	84.6	30.8	94.0	34.2	70°		
21°	09.3	03.6	18.7	07.2	28.0	10.8	37.3	14.3	46.7	17.9	56.0	21.5	65.4	25.1	74.7	28.7	84.0	32.3	93.4	35.8	69°		
22°	09.3	03.7	18.5	07.5	27.8	11.2	37.1	15.0	46.4	18.7	55.6	22.5	64.9	26.2	74.2	30.0	83.4	33.7	92.7	37.5	68°		
23°	09.2	03.9	18.4	07.8	27.6	11.7	36.8	15.6	46.0	19.5	55.2	23.4	64.4	27.4	73.6	31.3	82.8	35.2	92.1	39.1	67°		
24°	09.1	04.1	18.3	08.1	27.4	12.2	36.5	16.3	45.7	20.3	54.8	24.4	63.9	28.5	73.1	32.5	82.2	36.6	91.4	40.7	66°		
25°	09.1	04.2	18.1	08.5	27.2	12.7	36.3	16.9	45.3	21.1	54.4	25.4	63.4	29.6	72.5	33.8	81.6	38.0	90.6	42.3	65°		
26°	09.0	04.4	18.0	08.8	27.0	13.2	36.0	17.5	44.9	21.9	53.9	26.3	62.9	30.7	71.9	35.1	80.9	39.5	89.9	43.8	64°		
27°	08.9	04.5	17.8	09.1	26.7	13.6	35.6	18.2	44.6	22.7	53.5	27.2	62.4	31.8	71.3	36.3	80.2	40.9	89.1	45.4	63°		
28°	08.8	04.7	17.7	09.4	26.5	14.1	35.3	18.8	44.1	23.5	53.0	28.2	61.8	32.9	70.6	37.8	79.5	42.3	88.3	46.9	62°		
29°	08.7	04.8	17.5	09.7	26.2	14.5	35.0	19.4	43.7	24.2	52.5	29.1	61.2	33.9	70.0	38.8	78.7	43.6	87.5	48.5	61°		
30°	08.7	05.0	17.3	10.0	26.0	15.0	34.6	20.0	43.3	25.0	52.0	30.0	60.6	35.0	69.3	40.0	77.9	45.0	86.6	50.5	60°		
31°	08.6	05.2	17.1	10.3	25.7	15.5	34.3	20.6	42.9	25.8	51.4	30.9	60.0	36.1	68.6	41.2	77.1	46.4	85.7	51.5	59°		
32°	08.5	05.3	17.0	10.6	25.4	15.9	33.9	21.2	42.4	26.5	50.9	31.8	59.4	37.1	67.8	42.4	76.3	47.7	84.8	53.0	58°		
33°	08.4	05.4	16.8	10.9	25.2	16.3	33.5	21.8	41.9	27.2	50.3	32.7	58.7	38.1	67.1	43.6	75.5	49.0	83.9	54.5	57°		
34°	08.3	05.6	16.6	11.2	24.9	16.8	33.2	22.4	41.5	28.0	49.7	33.6	58.0	39.1	66.3	44.7	74.6	50.3	82.9	55.9	56°		
35°	08.2	05.7	16.4	11.5	24.6	17.2	32.8	22.9	41.0	28.7	49.1	34.4	57.3	40.2	65.5	45.9	73.7	51.6	81.9	57.4	55°		
36°	08.1	05.9	16.2	11.8	24.3	17.6	32.4	23.5	40.5	29.4	48.5	35.3	56.6	41.1	64.7	47.0	72.8	52.9	80.9	58.8	54°		
37°	08.0	06.0	16.0	12.0	24.0	18.1	31.9	24.1	39.9	30.1	47.9	36.1	55.9	42.1	63.9	48.1	71.9	54.2	79.9	60.2	53°		
38°	07.9	06.2	15.8	12.3	23.6	18.5	31.5	24.6	39.4	30.8	47.3	36.9	55.2	43.1	63.0	49.3	70.9	55.4	78.8	61.6	52°		
39°	07.8	06.3	15.5	12.6	23.3	18.9	31.1	25.2	38.9	31.5	46.6	37.8	54.4	44.1	62.2	50.3	69.9	56.6	77.7	62.9	51°		
40°	07.7	06.4	15.3	12.9	23.0	19.3	30.6	25.7	38.3	32.1	46.0	38.6	53.6	45.0	61.3	51.4	68.9	57.9	76.6	64.3	50°		
41°	07.5	06.6	15.1	13.1	22.6	19.7	30.2	26.2	37.7	32.8	45.3	39.4	52.8	45.9	60.4	52.5	67.9	59.0	75.5	65.6	49°		
42°	07.4	06.7	14.9	13.4	22.3	20.1	29.7	26.8	37.2	33.5	44.6	40.1	52.0	46.8	59.5	53.5	66.9	60.2	74.3	66.9	48°		
43°	07.3	06.8	14.6	13.6	21.9	20.5	29.3	27.3	36.6	34.1	43.9	40.9	51.2	47.7	58.5	54.6	65.8	61.4	73.1	68.2	47°		
44°	07.2	06.9	14.4	13.9	21.6	20.8	28.8	27.8	36.0	34.7	43.2	41.7	50.4	48.6	57.5	55.6	64.7	62.5	71.9	69.5	46°		
45°	07.1	07.1	14.1	14.1	21.2	21.2	28.3	28.3	35.4	35.4	42.4	42.4	49.5	49.5	56.6	56.6	63.6	63.6	70.7	70.7	45°		

	0	1	2	3	4	5	6	7	8	9	1234	5	6789
10	0000	0043	0086	0128	0170	0212	0253	0294	0334	0374	4 9 13 17 4 8 12 16	21 20	25 30 34 38 24 28 32 37
11	0414	0453	0492	0531	0569	0607	0645	0682	0719	0755	4 8 12 15 4 7 11 15	19 19	23 27 31 35 22 26 30 33
12	0792	0828	0864	0899	0934	0969	1004	1038	1072	1106	3 7 11 14 3 7 10 14	18 17	21 25 28 32 20 24 27 31
13	1139	1173	1206	1239	1271	1303	1335	1367	1399	1430	3 7 10 13 3 7 10 12	16 16	20 23 26 30 19 22 25 29
14	1461	1492	1523	1553	1584	1614	1644	1673	1703	1732	3 6 9 12 3 6 9 12	15 15	18 21 24 28 17 20 23 26
15	1761	1790	1818	1847	1875	1903	1931	1959	1987	2014	3 6 9 11 3 5 8 11	14 14	17 20 23 26 16 19 22 25
16	2041	2068	2095	2122	2148	2175	2201	2227	2253	2279	3 5 8 11 3 5 8 10	14 13	16 19 22 24 15 18 21 23
17	2304	2330	2355	2380	2405	2430	2455	2480	2504	2529	3 5 8 10 2 5 7 10	13 12	15 18 20 23 15 17 19 22
18	2553	2577	2601	2625	2648	2672	2695	2718	2742	2765	2 5 7 9 2 5 7 9	12 11	14 16 19 21 14 16 18 21
19	2788	2810	2833	2856	2878	2900	2923	2945	2967	2989	2 4 7 9 2 4 6 8	11 11	13 16 18 20 13 15 17 19
20	3010	3032	3054	3075	3096	3118	3139	3160	3181	3201	2 4 6 8	11	13 15 17 19
21	3222	3243	3263	3284	3304	3324	3345	3365	3385	3404	2 4 6 8	10	12 14 16 18
22	3424	3444	3464	3483	3502	3522	3541	3560	3579	3598	2 4 6 8	10	12 14 15 17
23	3617	3636	3655	3674	3692	3711	3729	3747	3766	3784	2 4 6 7	9	11 13 15 17
24	3802	3820	3838	3856	3874	3892	3909	3927	3945	3962	2 4 5 7	9	11 12 14 16
25	3979	3997	4014	4031	4048	4065	4082	4099	4116	4133	2 3 5 7	9	10 12 14 15
26	4150	4166	4183	4200	4216	4232	4249	4265	4281	4298	2 3 5 7	8	10 11 13 15
27	4314	4330	4346	4362	4378	4393	4409	4425	4440	4456	2 3 5 6	8	9 11 13 14
28	4472	4487	4502	4518	4533	4548	4564	4579	4594	4609	2 3 5 6	8	9 11 12 14
29	4624	4639	4654	4669	4683	4698	4713	4728	4742	4757	1 3 4 6	7	9 10 12 13
30	4771	4786	4800	4814	4829	4843	4857	4871	4886	4900	1 3 4 6	7	9 10 11 13
31	4914	4928	4942	4955	4969	4983	4997	5011	5024	5038	1 3 4 6	7	8 10 11 12
32	5051	5065	5079	5092	5105	5119	5132	5145	5159	5172	1 3 4 5	7	8 9 11 12
33	5185	5198	5211	5224	5237	5250	5263	5276	5289	5302	1 3 4 5	6	8 9 10 12
34	5315	5328	5340	5353	5366	5378	5391	5403	5416	5428	1 3 4 5	6	8 9 10 11
35	5441	5453	5465	5478	5490	5502	5514	5527	5539	5551	1 2 4 5	6	7 9 10 11
36	5563	5575	5587	5599	5611	5623	5635	5647	5658	5670	1 2 4 5	6	7 8 10 11
37	5682	5694	5705	5717	5729	5740	5752	5763	5775	5786	1 2 3 5	6	7 8 9 10
38	5795	5809	5821	5832	5843	5855	5866	5877	5888	5899	1 2 3 5	6	7 8 9 10
39	5911	5922	5933	5944	5955	5966	5977	5988	5999	6010	1 2 3 4	5	7 8 9 10
40	6021	6031	6042	6053	6064	6075	6085	6096	6107	6117	1 2 3 4	5	6 8 9 10
41	6128	6138	6149	6160	6170	6180	6191	6201	6212	6222	1 2 3 4	5	6 7 8 9
42	6232	6243	6253	6263	6274	6284	6294	6304	6314	6325	1 2 3 4	5	6 7 8 9
43	6335	6345	6355	6365	6375	6385	6395	6405	6415	6425	1 2 3 4	5	6 7 8 9
44	6435	6444	6454	6464	6474	6484	6493	6503	6513	6522	1 2 3 4	5	6 7 8 9
45	6532	6542	6551	6561	6571	6580	6590	6599	6609	6618	1 2 3 4	5	6 7 8 9
46	6628	6637	6646	6656	6665	6675	6684	6693	6702	6712	1 2 3 4	5	6 7 7 8
47	6721	6730	6739	6749	6758	6767	6776	6785	6794	6803	1 2 3 4	5	5 6 7 8
48	6812	6821	6830	6839	6848	6857	6866	6875	6884	6893	1 2 3 4	4	5 6 7 8
49	6902	6911	6920	6928	6937	6946	6955	6964	6972	6981	1 2 3 4	4	5 6 7 8
50	6990	6998	7007	7016	7024	7033	7042	7050	7059	7067	1 2 3 3	4	5 6 7 8

	0	1	2	3	4	5	6	7	8	9	1234	5	6789
51	7076	7084	7093	7101	7110	7118	7126	7135	7143	7152	1 2 3 3	4	5 6 7 8
52	7160	7168	7177	7185	7193	7202	7210	7218	7226	7235	1 2 2 3	4	5 6 7 7
53	7243	7251	7259	7267	7275	7284	7292	7300	7308	7316	1 2 2 3	4	5 6 6 7
54	7324	7332	7340	7348	7356	7364	7372	7380	7388	7396	1 2 2 3	4	5 6 6 7
55	7404	7412	7419	7427	7435	7443	7451	7459	7466	7474	1 2 2 3	4	5 5 6 7
56	7482	7490	7497	7505	7513	7520	7528	7536	7543	7551	1 2 2 3	4	5 5 6 7
57	7559	7566	7574	7582	7589	7597	7604	7612	7619	7627	1 2 2 3	4	5 5 6 7
58	7634	7642	7649	7657	7664	7672	7679	7686	7694	7701	1 1 2 3	4	4 5 6 7
59	7709	7716	7723	7731	7738	7745	7752	7760	7767	7774	1 1 2 3	4	4 5 6 7
60	7782	7789	7796	7803	7810	7818	7825	7832	7839	7846	1 1 2 3	4	4 5 6 6
61	7853	7860	7868	7875	7882	7889	7896	7903	7910	7917	1 1 2 3	4	4 5 6 6
62	7924	7931	7938	7945	7952	7959	7966	7973	7980	7987	1 1 2 3	3	4 5 6 6
63	7993	8000	8007	8014	8021	8028	8035	8041	8048	8055	1 1 2 3	3	4 5 5 6
64	8062	8069	8075	8082	8089	8096	8102	8109	8116	8122	1 1 2 3	3	4 5 5 6
65	8129	8136	8142	8149	8156	8162	8169	8176	8182	8189	1 1 2 3	3	4 5 5 6
66	8195	8202	8209	8215	8222	8228	8235	8241	8248	8254	1 1 2 3	3	4 5 5 6
67	8261	8267	8274	8280	8287	8293	8299	8306	8312	8319	1 1 2 3	3	4 5 5 6
68	8325	8331	8338	8344	8351	8357	8363	8370	8376	8382	1 1 2 3	3	4 4 5 6
69	8383	8395	8401	8407	8414	8420	8426	8432	8439	8445	1 1 2 2	3	4 4 5 6
70	8451	8457	8463	8470	8476	8482	8488	8494	8500	8506	1 1 2 2	3	4 4 5 6
71	8513	8519	8525	8531	8537	8543	8549	8555	8561	8567	1 1 2 2	3	4 4 5 5
72	8573	8579	8585	8591	8597	8603	8609	8615	8621	8627	1 1 2 2	3	4 4 5 5
73	8633	8639	8645	8651	8657	8663	8669	8675	8681	8686	1 1 2 2	3	4 4 5 5
74	8692	8698	8704	8710	8716	8722	8727	8733	8739	8745	1 1 2 2	3	4 4 5 5
75	8751	8756	8762	8768	8774	8779	8785	8791	8797	8802	1 1 2 2	3	3 4 5 5
76	8808	8814	8820	8825	8831	8837	8842	8848	8854	8859	1 1 2 2	3	3 4 5 5
77	8865	8871	8876	8882	8887	8893	8899	8904	8910	8915	1 1 2 2	3	3 4 4 5
78	8921	8927	8932	8938	8943	8949	8954	8960	8965	8971	1 1 2 2	3	3 4 4 5
79	8976	8982	8987	8993	8998	9004	9009	9015	9020	9025	1 1 2 2	3	3 4 4 5
80	9031	9036	9042	9047	9053	9058	9063	9069	9074	9079	1 1 2 2	3	3 4 4 5
81	9085	9090	9096	9101	9106	9112	9117	9122	9128	9133	1 1 2 2	3	3 4 4 5
82	9138	9143	9149	9154	9159	9165	9170	9175	9180	9186	1 1 2 2	3	3 4 4 5
83	9191	9196	9201	9206	9212	9217	9222	9227	9232	9238	1 1 2 2	3	3 4 4 5
84	9243	9248	9253	9258	9263	9269	9274	9279	9284	9289	1 1 2 2	3	3 4 4 5
85	9294	9299	9304	9309	9315	9320	9325	9330	9335	9340	1 1 2 2	3	3 4 4 5
86	9345	9350	9355	9360	9365	9370	9375	9380	9385	9390	1 1 2 2	3	3 4 4 5
87	9395	9400	9405	9410	9415	9420	9425	9430	9435	9440	0 1 1 2	2	3 3 4 4
88	9445	9450	9455	9460	9465	9469	9474	9479	9484	9489	0 1 1 2	2	3 3 4 4
89	9494	9499	9504	9509	9513	9518	9523	9528	9533	9538	0 1 1 2	2	3 3 4 4
90	9542	9547	9552	9557	9562	9566	9571	9576	9581	9586	0 1 1 2	2	3 3 4 4
91	9590	9595	9600	9605	9609	9614	9619	9624	9628	9633	0 1 1 2	2	3 3 4 4
92	9638	9643	9647	9652	9657	9661	9666	9671	9675	9680	0 1 1 2	2	3 3 4 4
93	9685	9689	9694	9699	9703	9708	9713	9717	9722	9727	0 1 1 2	2	3 3 4 4
94	9731	9736	9741	9745	9750	9754	9759	9763	9768	9773	0 1 1 2	2	3 3 4 4
95	9777	9782	9786	9791	9795	9800	9805	9809	9814	9818	0 1 1 2	2	3 3 4 4
96	9823	9827	9832	9836	9841	9845	9850	9854	9859	9863	0 1 1 2	2	3 3 4 4
97	9868	9872	9877	9881	9886	9890	9894	9899	9903	9908	0 1 1 2	2	3 3 4 4
98	9912	9917	9921	9926	9930	9934	9939	9943	9948	9952	0 1 1 2	2	3 3 4 4
99	9956	9961	9965	9969	9974	9978	9983	9987	9991	9996	0 1 1 2	2	3 3 3 4

	0	1	2	3	4	5	6	7	8	9	1	2	3	4	5	6	7	8	9
·00	1000	1002	1005	1007	1009	1012	1014	1016	1019	1021	0	0	1	1	1	1	2	2	2
·01	1023	1026	1028	1030	1033	1035	1038	1040	1042	1045	0	0	1	1	1	1	2	2	2
·02	1047	1050	1052	1054	1057	1059	1062	1064	1067	1069	0	0	1	1	1	1	2	2	2
·03	1072	1074	1076	1079	1081	1084	1086	1089	1091	1094	0	0	1	1	1	1	2	2	2
·04	1096	1099	1102	1104	1107	1109	1112	1114	1117	1119	0	1	1	1	1	1	2	2	2
·05	1122	1125	1127	1130	1132	1135	1138	1140	1143	1146	0	1	1	1	1	1	2	2	2
·06	1148	1151	1153	1156	1159	1161	1164	1167	1169	1172	0	1	1	1	1	1	2	2	2
·07	1175	1178	1180	1183	1186	1189	1191	1194	1197	1199	0	1	1	1	1	1	2	2	2
·08	1202	1205	1208	1211	1213	1216	1219	1222	1225	1227	0	1	1	1	1	1	2	2	2
·09	1230	1233	1236	1239	1242	1245	1247	1250	1253	1256	0	1	1	1	1	1	2	2	2
·10	1259	1262	1265	1268	1271	1274	1276	1279	1282	1285	0	1	1	1	1	1	2	2	2
·11	1288	1291	1294	1297	1300	1303	1306	1309	1312	1315	0	1	1	1	1	1	2	2	2
·12	1318	1321	1324	1327	1330	1334	1337	1340	1343	1346	0	1	1	1	1	1	2	2	2
·13	1349	1352	1355	1358	1361	1365	1368	1371	1374	1377	0	1	1	1	1	1	2	2	2
·14	1380	1384	1387	1390	1393	1396	1400	1403	1406	1409	0	1	1	1	1	1	2	2	2
·15	1413	1416	1419	1422	1426	1429	1432	1435	1439	1442	0	1	1	1	1	1	2	2	2
·16	1445	1449	1452	1455	1459	1462	1466	1469	1472	1476	0	1	1	1	1	1	2	2	2
·17	1479	1483	1486	1489	1493	1496	1500	1503	1507	1510	0	1	1	1	1	1	2	2	2
·18	1514	1517	1521	1524	1528	1531	1535	1538	1542	1545	0	1	1	1	1	1	2	2	2
·19	1549	1552	1556	1560	1563	1567	1570	1574	1578	1581	0	1	1	1	1	1	2	2	2
·20	1585	1589	1592	1596	1600	1603	1607	1611	1614	1618	0	1	1	1	1	1	2	2	2
·21	1622	1626	1629	1633	1637	1641	1644	1648	1652	1656	0	1	1	2	2	2	2	2	2
·22	1660	1663	1667	1671	1675	1679	1683	1687	1690	1694	0	1	1	2	2	2	2	2	2
·23	1698	1702	1706	1710	1714	1718	1722	1726	1730	1734	0	1	1	2	2	2	2	2	2
·24	1738	1742	1746	1750	1754	1758	1762	1766	1770	1774	0	1	1	2	2	2	2	2	2
·25	1778	1782	1786	1791	1795	1799	1803	1807	1811	1816	0	1	1	2	2	2	2	2	2
·26	1820	1824	1828	1832	1837	1841	1845	1849	1854	1858	0	1	1	2	2	2	2	2	2
·27	1862	1866	1871	1875	1879	1884	1888	1892	1897	1901	0	1	1	2	2	2	2	2	2
·28	1905	1910	1914	1919	1923	1928	1932	1936	1941	1945	0	1	1	2	2	2	2	2	2
·29	1950	1954	1959	1963	1968	1972	1977	1982	1986	1991	0	1	1	2	2	2	2	2	2
·30	1995	2000	2004	2009	2014	2018	2023	2028	2032	2037	0	1	1	2	2	2	2	2	2
·31	2042	2046	2051	2056	2061	2065	2070	2075	2080	2084	0	1	1	2	2	2	2	2	2
·32	2089	2094	2099	2104	2109	2113	2118	2123	2128	2133	0	1	1	2	2	2	2	2	2
·33	2138	2143	2148	2153	2158	2163	2168	2173	2178	2183	0	1	1	2	2	2	2	2	2
·34	2188	2193	2198	2203	2208	2213	2218	2223	2228	2234	1	1	2	2	2	2	2	2	2
·35	2239	2244	2249	2254	2259	2265	2270	2275	2280	2286	1	1	2	2	2	2	2	2	2
·36	2291	2296	2301	2307	2312	2317	2323	2328	2333	2339	1	1	2	2	2	2	2	2	2
·37	2344	2350	2355	2360	2366	2371	2377	2382	2388	2393	1	1	2	2	2	2	2	2	2
·38	2399	2404	2410	2415	2421	2427	2432	2438	2443	2449	1	1	2	2	2	2	2	2	2
·39	2455	2460	2466	2472	2477	2483	2489	2495	2500	2506	1	1	2	2	2	2	2	2	2
·40	2512	2518	2523	2529	2535	2541	2547	2553	2559	2564	1	1	2	2	2	2	2	2	2
·41	2570	2576	2582	2588	2594	2600	2606	2612	2618	2624	1	1	2	2	2	2	2	2	2
·42	2630	2636	2642	2649	2655	2661	2667	2673	2679	2685	1	1	2	2	2	2	2	2	2
·43	2692	2698	2704	2710	2716	2723	2729	2735	2742	2748	1	1	2	2	2	2	2	2	2
·44	2754	2761	2767	2773	2780	2786	2793	2799	2805	2812	1	1	2	2	2	2	2	2	2
·45	2818	2825	2831	2838	2844	2851	2858	2864	2871	2877	1	1	2	2	2	2	2	2	2
·46	2884	2891	2897	2904	2911	2917	2924	2931	2938	2944	1	1	2	2	2	2	2	2	2
·47	2951	2958	2965	2972	2979	2985	2992	2999	3006	3013	1	1	2	2	2	2	2	2	2
·48	3020	3027	3034	3041	3048	3055	3062	3069	3076	3083	1	1	2	2	2	2	2	2	2
·49	3090	3097	3105	3112	3119	3126	3133	3141	3148	3155	1	1	2	2	2	2	2	2	2

	0	1	2	3	4	5	6	7	8	9	1	2	3	4	5	6	7	8	9	
·50	3162	3170	3177	3184	3192	3199	3206	3214	3221	3228	1	1	2	3	4	4	4	5	6	7
·51	3236	3243	3251	3258	3266	3273	3281	3289	3296	3304	1	2	2	3	4	4	5	5	6	7
·52	3311	3319	3327	3334	3342	3350	3357	3365	3373	3381	1	2	2	3	4	4	5	5	6	7
·53	3388	3396	3404	3412	3420	3428	3436	3443	3451	3459	1	2	2	3	4	4	5	6	6	7
·54	3467	3475	3483	3491	3499	3508	3516	3524	3532	3540	1	2	2	3	4	4	5	6	6	7
·55	3548	3556	3565	3573	3581	3589	3597	3606	3614	3622	1	2	2	3	4	4	5	6	7	7
·56	3631	3639	3648	3656	3664	3673	3681	3690	3698	3707	1	2	3	3	4	4	5	6	7	8
·57	3715	3724	3733	3741	3750	3758	3767	3776	3784	3793	1	2	3	3	4	4	5	6	7	8
·58	3802	3811	3819	3828	3837	3846	3855	3864	3873	3882	1	2	3	4	4	4	5	6	7	8
·59	3890	3899	3908	3917	3926	3936	3945	3954	3963	3972	1	2	3	4	5	5	6	6	7	8
·60	3981	3990	3999	4009	4018	4027	4036	4046	4055	4064	1	2	3	4	5	5	6	6	7	8
·61	4074	4083	4093	4102	4111	4121	4130	4140	4150	4159	1	2	3	4	5	5	6	7	8	9
·62	4169	4178	4188	4198	4207	4217	4227	4236	4246	4256	1	2	3	4	5	5	6	7	8	9
·63	4266	4276	4285	4295	4305	4315	4325	4335	4345	4355	1	2	3	4	5	5	6	7	8	9
·64	4365	4375	4385	4395	4406	4416	4426	4436	4446	4457	1	2	3	4	5	5	6	7	8	9
·65	4467	4477	4487	4498	4508	4519	4529	4539	4550	4560	1	2	3	4	5	5	6	7	8	9
·66	4571	4581	4592	4603	4613	4624	4634	4645	4656	4667	1	2	3	4	5	5	6	7	9	10
·67	4677	4688	4699	4710	4721	4732	4742	4753	4764	4775	1	2	3	4	5	5	7	8	9	10
·68	4786	4797	4808	4819	4831	4842	4853	4864	4875	4887	1	2	3	4	6	6	7	8	9	10
·69	4898	4909	4920	4932	4943	4955	4966	4977	4989	5000	1	2	3	5	6	6	7	8	9	10
·70	5012	5023	5035	5047	5058	5070	5082	5093	5105	5117	1	2	4	5	6	6	7	8	9	11
·71	5129	5140	5152	5164	5176	5188	5200	5212	5224	5236	1	2	4	5	6	6	7	8	10	11
·72	5248	5260	5272	5284	5297	5309	5321	5333	5346	5358	1	2	4	5	6	6	7	9	10	11
·73	5370	5383	5395	5408	5420	5433	5445	5458	5470	5483	1	3	4	5	6	6	8	9	10	11
·74	5495	5508	5521	5534	5546	5559	5572	5585	5598	5610	1	3	4	5	6	6	8	9	10	12
·75	5623	5636	5649	5662	5675	5689	5702	5715	5728	5741	1	3	4	5	7	7	8	9	10	12
·76	5754	5768	5781	5794	5808	5821	5834	5848	5861	5875	1	3	4	5	7	7	8	9	11	12
·77	5888	5902	5916	5929	5943	5957	5970	5984	5998	6012	1	3	4	5	7	7	8	10	11	12
·78	6026	6039	6053	6067	6081	6095	6109	6124	6138	6152	1	3	4	6	7	7	8	10	11	13
·79	6166	6180	6194	6209	6223	6237	6252	6266	6281	6295	1	3	4	6	7	7	9	10	11	13
·80	6310	6324	6339	6353	6368	6383	6397	6412	6427	6442	1	3	4	6	7	7	9	10	12	13
·81	6457	6471	6486	6501	6516	6531	6546	6561	6577	6592	2	3	5	6	8	8	9	11	12	14
·82	6607	6622	6637	6653	6668	6683	6699	6714	6730	6745	2	3	5	6	8	8	9	11	12	14
·83	6761	6776	6792	6808	6823	6839	6855	6871	6887	6902	2	3	5	6	8	8	9	11	13	14
·84	6918	6934	6950	6966	6982	6998	7015	7031	7047	7063	2	3	5	6	8	8	10	11	13	15
·85	7079	7096	7112	7129	7145	7161	7178	7194	7211	7228	2	3	5	7	8	8	10	12	13	15
·86	7244	7261	7278	7295	7311	7328	7345	7362	7379	7396	2	3	5	7	8	8	10	12	13	15
·87	7413	7430	7447	7464	7482	7499	7516	7534	7551	7568	2	3	5	7	9	9	10	12	14	16
·88	7586	7603	7621	7638	7656	7674	7691	7709	7727	7745	2	4	5	7	9	9	11	12	14	16
·89	7762	7780	7798	7816	7834	7852	7870	7889	7907	7925	2	4	5	7	9	9	11	13	14	16
·90	7943	7962	7980	7998	8017	8035	8054	8072	8091	8110	2	4	6	7	9	9	11	13	15	17
·91	8128	8147	8166	8185	8204	8222	8241	8260	8279	8299	2	4	6	8	9	9	11	13	15	17
·92	8318	8337	8356	8375	8395	8414	8433	8453	8472	8492	2	4	6	8	10	10	12	14	15	17
·93	8511	8531	8551	8570	8590	8610	8630	8650	8670	8690	2	4	6	8	10	10	12	14	16	18
·94	8710	8730	8750	8770	8790	8810	8831	8851	8872	8892	2	4	6	8	10	10	12	14	16	18
·95	8913	8933	8954	8974	8995	9016	9036	9057	9078	9099	2	4	6	8	10	10	12	15	17	19
·96	9120	9141	9162	9183	9204	9226	9247	9268	9290	9311	2	4	6	8	11	11	13	15	17	19
·97	9333	9354	9376	9397	9419	9441	9462	9484	9506	9528	2	4	7	9	11	11	13	15	17	20
·98	9550	9572	9594	9616	9638	9661	9683	9705	9727	9750	2	4	7	9	11	11	13	16	18	20
·99	9772	9795	9817	9840	9863	9886	9908	9931	9954	9977	2	5	7	9	11	11	14	16	18	20

MATHEMATICAL TABLES

Angle.		Chord.	Sine.	Tangent.	Co-tangent.	Cosine.			
De-grees.	Radians.								
0°	0	000	0	0	∞	1	1.414	1.5708	90°
1	.0175	.017	.0175	.0175	57.2900	.9998	1.402	1.5533	89
2	.0349	.035	.0349	.0349	28.6363	.9994	1.389	1.5359	88
3	.0524	.052	.0523	.0524	19.0811	.9986	1.377	1.5184	87
4	.0698	.070	.0698	.0699	14.3007	.9976	1.364	1.5010	86
5	.0873	.087	.0872	.0875	11.4301	.9962	1.351	1.4835	85
6	.1047	.105	.1045	.1051	9.5144	.9945	1.338	1.4661	84
7	.1222	.122	.1219	.1228	8.1443	.9925	1.325	1.4486	83
8	.1396	.140	.1392	.1405	7.1154	.9903	1.312	1.4312	82
9	.1571	.157	.1564	.1584	6.3138	.9877	1.299	1.4137	81
10	.1745	.174	.1736	.1763	5.6713	.9848	1.286	1.3963	80
11	.1920	.192	.1908	.1944	5.1446	.9816	1.272	1.3788	79
12	.2094	.209	.2079	.2126	4.7046	.9781	1.259	1.3614	78
13	.2269	.226	.2250	.2309	4.3315	.9744	1.245	1.3439	77
14	.2443	.244	.2419	.2493	4.0108	.9703	1.231	1.3265	76
15	.2618	.261	.2588	.2679	3.7321	.9659	1.218	1.3090	75
16	.2793	.278	.2756	.2867	3.4874	.9613	1.204	1.2915	74
17	.2967	.296	.2924	.3057	3.2709	.9563	1.190	1.2741	73
18	.3142	.313	.3090	.3249	3.0777	.9511	1.176	1.2566	72
19	.3316	.330	.3256	.3443	2.9042	.9455	1.161	1.2392	71
20	.3491	.347	.3420	.3640	2.7475	.9397	1.147	1.2217	70
21	.3665	.364	.3584	.3839	2.6051	.9336	1.133	1.2043	69
22	.3840	.382	.3746	.4040	2.4751	.9272	1.118	1.1868	68
23	.4014	.399	.3907	.4245	2.3559	.9205	1.104	1.1694	67
24	.4188	.416	.4067	.4452	2.2460	.9135	1.089	1.1519	66
25	.4363	.433	.4226	.4663	2.1445	.9063	1.075	1.1345	65
26	.4538	.450	.4384	.4877	2.0503	.8988	1.060	1.1170	64
27	.4712	.467	.4540	.5095	1.9626	.8910	1.045	1.0996	63
28	.4887	.484	.4695	.5317	1.8807	.8829	1.030	1.0821	62
29	.5061	.501	.4848	.5543	1.8040	.8746	1.015	1.0647	61
30	.5236	.518	.5000	.5774	1.7321	.8660	1.000	1.0472	60
31	.5411	.534	.5150	.6009	1.6643	.8572	.985	1.0297	59
32	.5585	.551	.5299	.6249	1.6003	.8480	.970	1.0123	58
33	.5760	.568	.5446	.6494	1.5399	.8387	.954	.9948	57
34	.5934	.585	.5592	.6745	1.4826	.8290	.939	.9774	56
35	.6109	.601	.5736	.7002	1.4281	.8192	.923	.9599	55
36	.6283	.618	.5878	.7265	1.3764	.8090	.908	.9425	54
37	.6458	.635	.6018	.7536	1.3270	.7986	.892	.9250	53
38	.6632	.651	.6157	.7813	1.2799	.7880	.877	.9076	52
39	.6807	.668	.6293	.8098	1.2349	.7771	.861	.8901	51
40	.6981	.684	.6428	.8391	1.1918	.7660	.845	.8727	50
41	.7156	.700	.6561	.8693	1.1504	.7547	.829	.8552	49
42	.7330	.717	.6691	.9004	1.1106	.7431	.813	.8378	48
43	.7505	.733	.6820	.9325	1.0724	.7314	.797	.8203	47
44	.7679	.749	.6947	.9657	1.0355	.7193	.781	.8029	46
45°	.7854	.765	.7071	1.0000	1.0000	.7071	.765	.7854	45°
			Cosine.	Co-tangent.	Tangent.	Sine.	Chord.	Radians.	De-grees.
Angle.									

INDEX

A

- Accuracy in tacheometer methods, 154
- Adjustments of chains, 4
 - of level, 120
 - of plane table, 66
 - of sextant, 80
 - of theodolite, 93
- Alidade, ordinary, 65
 - , with telescope, 66
- Altitude, definition of, 192
- Angle, of slope, 19
 - , instruments for the measurement of, 74
- Anti-logarithms, 238, 239
- Areas, calculation of, 32
 - , of cross sections, 229
- Arrows, 7
- Artificial horizon, 83
- Astronomy, geodetic, 177
- Azimuth, definition of, 192

B

- Balancing of needle survey, 52
- Bar-subtense system, 149
- Barometer, heights by, 137
- Barr & Stroud rangefinder, 161
- Base lines, measurement of, 164
 - —, principal British, 171
- Bench marks, 130
- Bessel compensating bar, 167
- Bibliography, 233
- Boning rod, 211
- Booking levels, 127
- Borda's compensating bar, 166
- Boundaries, equalisation of, 32
- Box sextant, 82
- Breadths and half-breadths of land, 228

C

- Calculation of areas, 32
 - of distances, 102
 - of heights, 105
 - , earthwork, 226

- Chain surveying, 1
- Chaining, of base, 14
 - , accuracy in, 20
- Chains, 2
 - , adjustments of, 4
 - , engineers', 2
 - , errors of, 3
 - , Gunter's, 2
 - , inaccurate, 36
 - , pit, 5
 - , standardising of, 4
 - , temperature effect on, 6
- Check levels, 130
- Circular curve, 214
 - —, setting out by successive bisection of arcs, 218
 - —, — with chain and tape, 214
 - —, — — and one theodolite, 215
 - —, — — and two theodolites, 217
- Circumferentor, uses of, 40
- Closure, error of, 54
- Co-altitude, 192
- Co-declination, 193
- Colby's compensating bar, 166
- Compass errors, 43-45
 - on theodolite, 88
 - —, constructional defects of, 97
 - , prismatic, 45
 - , surveyors', 40
 - surveys, 40
- Compensating bars, 166
- Computing scale, 34
- Connecting underground surveys with surface, 201
- Contour lines, 133
- Contouring, 109
- Cross staff-head, 8
- Current meter, 200
- Curvature of earth, 110
 - table for correction for, 113

D

- Declination of magnetic needle, 45
 - , definition of, 193

Dial, mining, 42
 —, uses of, 40
 Direct measurement, surveying by, 1
 Drop arrow, 19
 Dumpy level, 115

E

Earthwork calculations, 226
 Engineers' chain, 2
 Equalisation of boundaries, 32
 Equator, definition of, 193
 Errors in tacheometry, 148
 — of chains, 3
 — of closure, 54
 Everest's theodolite, 92
 Examination questions, 231
 Example of survey, 23-25
 Extending the base, 167

F

Field book, calculations from, 34, 36,
 37
 — — in tacheometry, headings, 152
 — —, keeping of, 21
 Flying levels, 130

G

Gauging of streams, 199
 Geodetic astronomy, 177
 — surveying, 163
 Great Britain, Ordnance Surveys of, 170
 Great circle, 193
 Gunter's chain, 2

H

Hedley's dial, 43
 Height by barometer, 137
 — of mountain, 107
 Horizon, artificial, 83
 —, definition of, 193
 Hydrographic surveying, 194
 Hypsometer, 138

I

Inaccurate chain, 36
 Inclined line of observation, 144
 Inclined tacheometer sights, 144
 Indian survey, 170
 Instrumental errors, elimination of, 98
 Instruments for underground work, 207

L

Latitude, by Pole star, example, 189
 —, by sun at meridian, 190
 —, determination of, 190
 —, observations for, 188
 Level, adjustments of, 120
 —, dumpy, 115
 —, manipulation of, 119
 —, water, 114
 Levelling, 109
 —, book tables, 128-129
 —, general principles of, 114
 —, instruments used in, 114
 — operations, 122
 —, precise, 130
 —, reciprocal, 129
 — staves, 118
 Levels, booking, 127
 —, check, 130
 —, flying, 130
 —, taking a set of, 124
 Logarithms, 236, 237
 Longitude, by moon culminating stars,
 192
 —, observations for, 190

M

Magnetic needle, declination of, 45
 — —, variation of, 44
 Marine surveying, 194
 Mean ordinates, 33
 Measurement of base, 14
 — of base line, 164
 Measuring bars, 166
 Meridian, by equal altitudes of circum-
 polar star, 179
 —, — — — of the sun, 185
 —, by greatest elongation of circum-
 polar stars, 183
 —, by hands of watch, 188
 —, by stars in Great Bear, 184
 —, by sun shadows, 187
 —, definition of, 193
 —, finding of, 179
 Military plane table, 70
 Mining dial, 42

N

Nautical surveying, 194
 Needle surveys, 38
 — —, example, 51
 — — traverses, 40
 — —, notes on, 58
 — —, calculations of, 56-58

O

- Observations, for latitude, 188
- , for longitude, 190
- Obstacles in chain lines, 26
- Off-sets, 17
- Optical square, 9
- Ordnance Surveys, 170

P

- Parallax, 94, 97
- Pegs, 8
- Photo-theodolite, 71
- Photographic surveying, 72
- Pickets, 7
- Pit chains, 5
- Plain theodolite, 92
- Plane table, 60, 64
 - —, adjustments of, 66
 - —, alidade or straightedge, 65
 - — and contour lines, 68
 - —, intersection, 61, 62
 - —, radiation, 60
 - —, traversing with, 63
 - triangles, solution of, 103
- Planimeter, 35
- Plotting, 30
- Porro's telescope, 145
- Precise levelling, 130
- Prismatic compass, 45
- Prismoidal formula, 230

R

- Radiation with tachometer, 70
- Railway curves, 211
- Rangefinders, 156
 - of Barr & Stroud, 161
 - , general principles, 156
 - , single operation, 159
 - , two-observation, 156
- Ranging across undulating ground, 20
 - poles, 7
- Rapid surveying, 139
- Reciprocal levelling, 129
- Reconnaissance, 12
- Rectangular co-ordinates, plotting by, 48
- Refraction, correction for, 112
 - , table for correction for, 113
- Reverse curves, 218
- Right angles, instruments for, 8
 - —, setting out, 11

S

- Sea-level, reduction to, 173
- Setting out, in general, 210

- Setting out of circular curves, 214
- Sextant, 78
 - , adjustments of, 80
 - box, 82
- Signals, 170
- Simpson's rule, 33
- Single observer, 159
 - operation rangefinder, 159
- Sloping ground, 18
- Solution of plane triangles, 103
- Soundings, 198
- Speaking staff, 124
- Spherical triangles, 173
- Stadia measurements, 142
- Staff, speaking, 124
 - , reading the, 123
 - , target, 119 and 124
- Standardising chains, 4
- Station-pointer, 196
- Staves, levelling, 118
- Steward telemeter, 156
- Straightedge, 65
- Striding level, 101
- Subtense work in small surveys, 150
- Superelevation, 220
- Surveying, by direct measurement, 1
 - , by graduated staff, 140
 - , by vertical angle, 147
 - , by visual angle, 140
 - , geodetic, 163
 - , hydrographic, 194
 - , marine, 194
 - , nautical, 194
 - , rapid, 137
 - telescope, 74
 - , trigonometrical, 163
 - , underground, 201
 - with chain, 1
- Suspended lamp, 209
- Swinging in, 17

T

- Tables, anti-logarithms, 238, 239
 - , balancing of needle survey, I. to IV., 53
 - , — — —, V., 58
 - , corrections for curvature and refractions, 113
 - , declination of magnetic needle, 45
 - , levelling book systems—
 - I., Rise and fall system, 128
 - II., " " " " 129
 - III., Collimation system, 129
 - , logarithms, 236-237
 - , mathematical tables, 240
 - , natural slope of earth, 226
 - , traverse table, 234, 235
 - , weights of different earths, 227

- Tabulation, methods of, 54
 Tacheometer, inclined sights, 144
 —, radiation with, 70
 Tacheometry, 139
 —, headings of field books, 152
 — with theodolite telescope, 141
 Tapes, steel, 6
 —, fibrous, 7
 Target staff, 119
 Telemeters, 156
 Telescope, Porro's, 145
 — used in surveying instruments, 74
 Temperature, effect on chains, 6
 Theodolite, 71, 85
 —, adjustments of, 93
 — compass, 88
 —, constructional defects of, 97
 —, Everest's, 92
 —, plain, 92
 —, reading the angles, 98
 — telescope, tacheometry with, 141
 — transit, 86
 Transit instrument, 164
 — theodolite, 86
 Transition curves, 221
 — —, example, 222
 Traverse table, 52, 234, 235
 Traversing, 38
 — with chain or tape, 39
 — — and compass, 40
 — — dial and chain, 47
 Traversing with plane table, 63
 Triangulation, arrangement of, 12
 Trigonometrical surveying, 163
 Two observation telemeters, 156
- U
- Underground surveying, 201
 — —, instruments for, 207
 Undulating ground, ranging across, 21
- V
- Variation of magnetic needle, 44
 Vernier plate, 88, 98
 Vertical angle, 147
 Visual angle, surveying by, 140, 145
 Volumes, circulation of, 230
- W
- Water level, 114
- Z
- Zenith, definition of, 193

THE END

