

DOE/NASA/3194-1
NASA CR-168088



Stirling Engine Design Manual

Second Edition

(NASA-CR-158088) STIRLING ENGINE DESIGN
MANUAL, 2ND EDITION (Martini Engineering)
412 p HC A18/MF A01 CSEL 15F

N83-30328

Unclas
G3/85 28223

William R. Martini
Martini Engineering

January 1983

Prepared for
NATIONAL AERONAUTICS AND SPACE ADMINISTRATION
Lewis Research Center
Under Grant NSG-3194

for
U.S. DEPARTMENT OF ENERGY
Conservation and Renewable Energy
Office of Vehicle and Engine R&D

DOE/NASA/3194-1
NASA CR-168088

Stirling Engine Design Manual

Second Edition

William R. Martini
Martini Engineering
Richland, Washington 99352

January 1983

Prepared for
National Aeronautics and Space Administration
Lewis Research Center
Cleveland, Ohio 44135
Under Grant NSG-3194

for
U.S. DEPARTMENT OF ENERGY
Conservation and Renewable Energy
Office of Vehicle and Engine R&D
Washington, D.C. 20545
Under Interagency Agreement DE-AI01-77CS51040

TABLE OF CONTENTS

	<u>Page</u>
1. Summary	1
2. Introduction.	3
2.1 Why Stirling?.	3
2.2 What Is a Stirling Engine?	4
2.3 Major Types of Stirling Engines.	7
2.4 Overview of Report	10
3. Fully Described Stirling Engines.	12
3.1 The GPU-3 Engine	12
3.2 The 4L23 Engine.	27
4. Partially Described Stirling Engines.	42
4.1 The Philips 1-98 Engine.	42
4.2 Miscellaneous Engines.	46
4.3 Early Philips Air Engines.	46
4.4 The P75 Engine	58
4.5 The P40 Engine	58
5. Review of Stirling Engine Design Methods.	60
5.1 Stirling Engine Cycle Analysis	61
5.1.1 Stirling Cycle, Zero Dead Volume, Perfect Regeneration.	62
5.1.2 Stirling Cycle, Zero Dead Volume, Imperfect Regeneration.	66
5.1.3 Otto Cycle, Zero Dead Volume, Perfect or Imperfect Regeneration.	68
5.1.4 Stirling Cycle, Dead Volume, Perfect or Imperfect Regeneration.	69
5.1.5 Schmidt Cycle	71
5.1.6 Finkelstein Adiabatic Cycle	87
5.1.7 Philips Semi-Adiabatic Cycle.	92
5.2 First-Order Design Methods	98
5.2.1 Definition.	98
5.2.2 Efficiency Prediction	98
5.2.3 Power Estimation by First-Order Design Methods.	99
5.2.4 Conclusion for First-Order Methods.	100
5.3 Second-Order Design Methods.	101
5.3.1 Definition.	101
5.3.2 Philips Second-Order Design Method.	101
5.3.3 Power Losses.	105
5.3.4 Heat Losses	109
5.3.5 First Round Engine Performance Summary.	122
5.3.6 Heat Exchanger Evaluation	123
5.3.7 Martini Isothermal Second-Order Analysis.	123
5.3.8 Rios Adiabatic Second-Order Analysis.	124
5.3.9 Conclusion for Second-Order Methods	124

TABLE OF CONTENTS (continued)

	<u>Page</u>
5.4 Third-Order Design Methods	124
5.4.1 Basic Design Methods.	125
5.4.2 Fundamental Differential Equations.	125
5.4.3 Comparison of Third-Order Design Methods.	128
5.4.4 Conclusions on Third-Order Design Methods	133
6. References.	134
6.1 Introductions.	134
6.2 Interest in Stirling Engines	134
6.3 References	134
7. Personal Author Index	237
8. Corporate Author Index.	256
9. Directory	265
9.1 Company List	265
9.2 Contact Person	265
9.3 Country and Persons Working.	265
9.4 Service of Product	265
9.5 Transcription of Questionnaires.	265
Appendices	
A. Property Values	293
B. Nomenclature for Body of Report	307
C. Isothermal Second-Order Design Program.	327
D. Adiabatic Second-Order Design Program (Rios).	355
E. Adiabatic Cycle Analysis by the Martini Method.	389
F. Non-Automotive Present Applications and Future Applications of Stirling Engines.	399

1. SUMMARY

The DOE Office of Conservation, Division of Transportation Energy Conservation, has established a number of broad programs aimed at reducing highway vehicle fuel consumption. The DOE Stirling Engine Highway Vehicle Systems Program is one such program. This program is directed at the development of the Stirling engine as a possible alternative to the spark-ignition engine.

Project Management responsibility for this project has been delegated by DOE to the NASA-Lewis Research Center. Support for the generation of this report was provided by a grant from the Lewis Research Center Stirling Engine Project Office.

For Stirling engines to enjoy widespread application and acceptance, not only must the fundamental operation of such engines be widely understood, but the requisite analytic tools for the simulation, design, evaluation and optimization of Stirling engine hardware must be readily available.

The purpose of this design manual is to provide an introduction to Stirling cycle heat engines, to organize and identify the available Stirling engine literature, and to identify, organize, evaluate and, in so far as possible, compare non-proprietary Stirling engine design methodologies. As such, the manual then represents another step in the long process of making available comprehensive, well verified, economic-to-use, Stirling engine analytic programs.

Two different fully described Stirling engines are presented. These not only have full engine dimensions and operating conditions but also have power outputs and efficiencies for a range of operating conditions. The results of these two engine tests can be used for evaluation of non-proprietary computation procedures.

Evaluation of partially described Stirling engines begins to reveal that some of the early but modern air engines have an interesting combination of simplicity and efficiency. These show more attractive possibilities in today's world of uncertain fuel oil supply than they did 20 years ago when they were developed.

The theory of Stirling engine is presented starting from simple cycle analysis. Important conclusions from cycle analysis are: 1) compared to an engine with zero unswept gas volume (dead volume), the power available from an engine with dead volume is reduced proportional to the ratio of the dead volume to the maximum gas volume, and 2) the more realistic adiabatic spaces can result in as much as a 40% reduction in power over the idealized isothermal spaces.

Engine design methods are organized as first order, second order and third order with increased order number indicating increased complexity.

First order design methods are principally useful in preliminary systems studies to evaluate how well-optimized engines may perform in a given heat engine application.

Second order design methods start with a cycle analysis and incorporate engine loss relationships that apply generally for the full engine cycle. This method assumes that the different processes going on in the engine interact very little.

A FORTRAN program is presented for both an isothermal second-order design program and an adiabatic second-order design program. Both of these are adapted to a modern four-piston Siemens type of heat engine.

Third-order methods are explained and enumerated. This method solves the equations expressing the conservation of energy, mass and momentum using numerical methods. The engine is divided into many nodes and short time steps are required for a stable solution. Both second- and third-order methods must be validated by agreement with measurement of the performance of an actual engine.

In this second edition of the Stirling Engine Design Manual the references have been brought up-to-date. There is a continual rapid acceleration of interest in Stirling engines as evidenced by the number of papers on the subject. A revised personal and corporate author index is also presented to aid in locating a particular reference. An expanded directory lists over 80 individuals and companies active in Stirling engines and details what each company does within the limits of the contributed information. About 800 people are active in Stirling engine development worldwide.

2. INTRODUCTION

2.1 Why Stirling?

Development of Stirling engines is proceeding world-wide in spite of their admittedly higher cost because of their high efficiency, particularly at part load, their ability to use any source of heat, their quiet operation, their long life and their non-polluting character.

For many years during the last century, Stirling engines occupied a relatively unimportant role among the kinds of engines used during that period. They were generally called air engines and were characterized by high reliability and safety, but low specific power. They lost out in the dollars-per-horsepower race with other competing machines. In the 1930's some researchers employed by the Philips Company, in Holland, recognized some possibilities in this old engine, provided modern engineering techniques could be applied. Since then, this company has invested millions of dollars and has created a very commanding position in Stirling engine technology. Their developments have led to smooth and quiet-running demonstration engines which have very high efficiency and can use any source of heat. They may be used for vehicle propulsion to produce a zero or low level of pollution. A great variety of experimental Stirling engines have been built from the same general principles to directly pump blood, generate electricity, or directly generate hydraulic power. Many are used as heat pumps and some can be used as both heat pumps and heat engines depending upon the adjustment. With a few notable exceptions of independent individuals who have done very good work, most of the work on Stirling engines has been done by teams of engineers funded by the giant companies of the world. The vital details of this work are generally not available. The United States government is beginning to sponsor the development of an open technology on Stirling engines and is beginning to spend large sums of money in this area. As part of this open technology, this design manual is offered to review all the design methods available in the open literature.

Consider the following developments which show that interest in Stirling engines is growing not just as a popular subject for research, but as a product that can be sold at a profit.

United Stirling of Sweden is committed to quantity production of their P-75, 75 kw truck engine.

Mechanical Technology, Inc., United Stirling and American Motors have teamed up to develop and evaluate Stirling engines for automobiles. The sponsor is the U.S. Department of Energy, via NASA-Lewis, at 4 million dollars per year.

- The Harwell thermo-mechanical generator, a type of super-reliable Stirling with three times the efficiency of thermo-electric generators has now operated continuously for four years.
- A Japanese government-industry team is designing and building a 800 hp marine engine. Funding is 5 million dollars for 5 years. A 10 kw and a 50 kw engine of reasonable performance have been built independently by Japanese firms.

ORIGINAL PAGE IS
OF POOR QUALITY

- Work has started by three organizations using the talents of long time Dutch, Swedish and German Stirling engine developers to design and eventually build a 500 to 2000 horsepower coal-fired Stirling engine for neighborhood heat and power generation.
- Stirling Power Systems has equipped eight Winnebago motor homes with an almost silent and very reliable total energy system based upon a 6.5 kw Stirling engine generator. These systems are now ready for manufacture and sale.
- Solar Engines of Phoenix, Arizona, have sold 20,000 model Stirling engines.
- Sunpower of Athens, Ohio, has demonstrated an atmospheric air engine that produces 850 watts instead of 50 watts for an antique machine.

2.2 What Is A Stirling Engine?

Like any heat engine, the Stirling engine goes through the four basic processes of compression, heating, expansion, and cooling (See Figure 2-1). A couple of examples from every day life may make this clearer. For instance, Figure 2-2 shows how an automobile internal combustion engine works. In this engine a gas-air mixture is compressed using work stored in the mechanical flywheel from a previous cycle. Then the gas mixture is heated by igniting it and allowing it to burn. The higher pressure gas mixture now is expanded which does more work than was required for the compression and results in net work output. In this particular engine, the gas mixture is cooled very little. Nevertheless, the exhaust is discarded and a cool gas mixture is brought in through the carburetor.

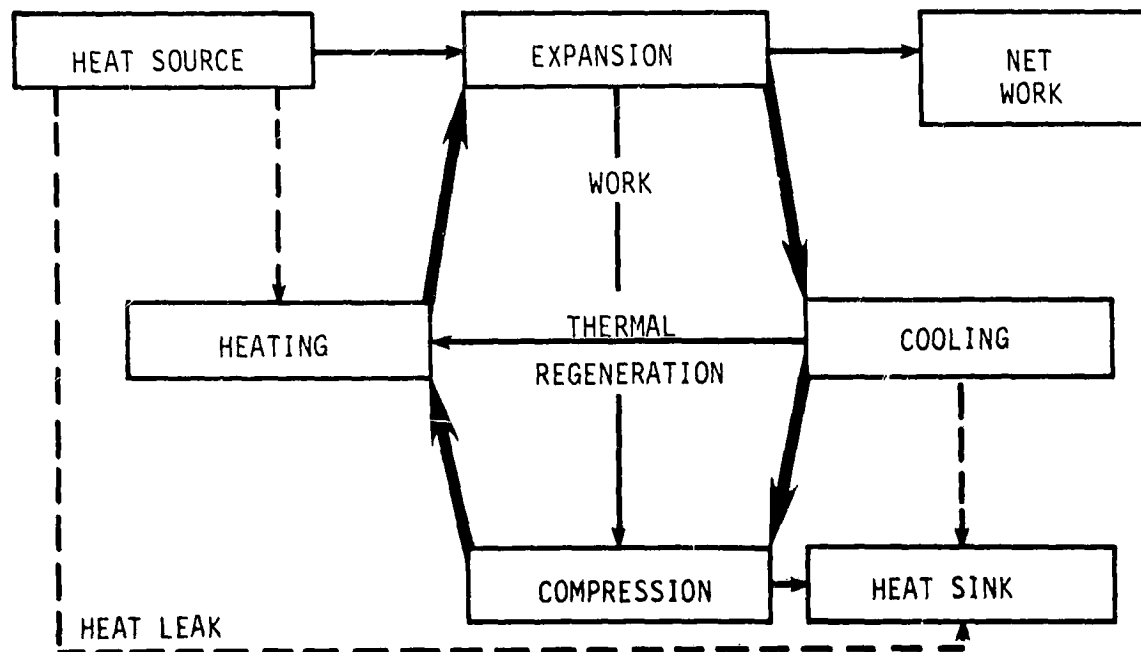

Figure 2-1. Common Process for all Heat Engines.

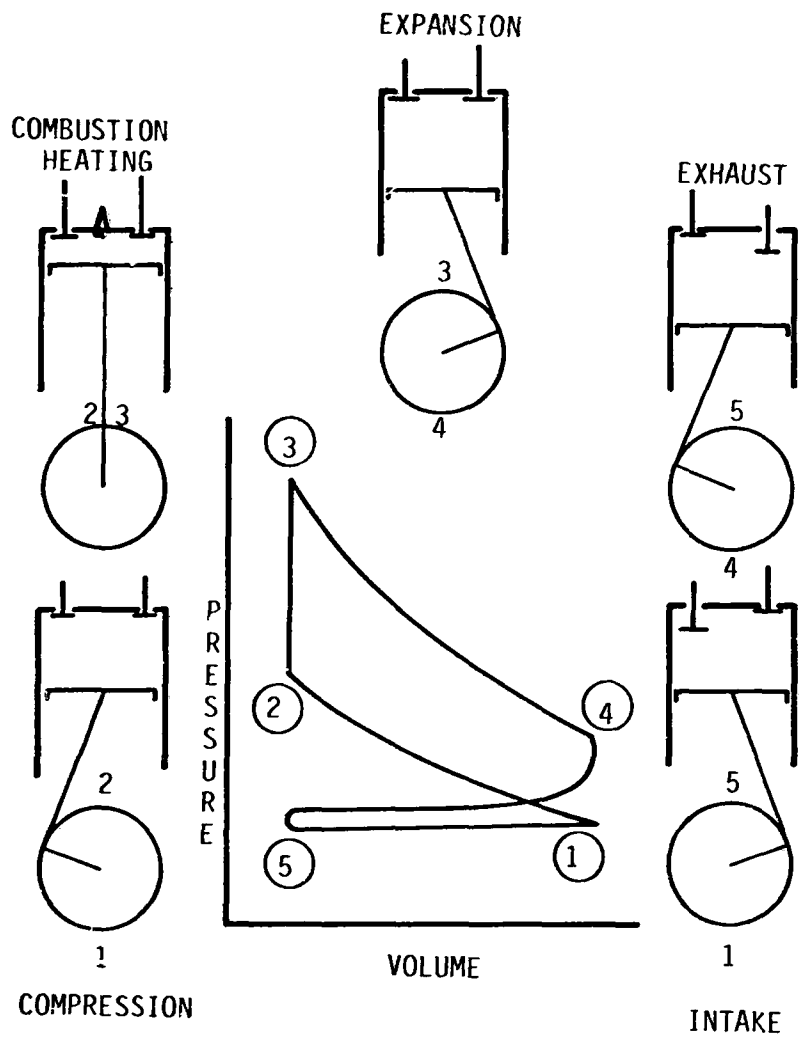

Figure 2-2. Example of Internal Combustion Engine.

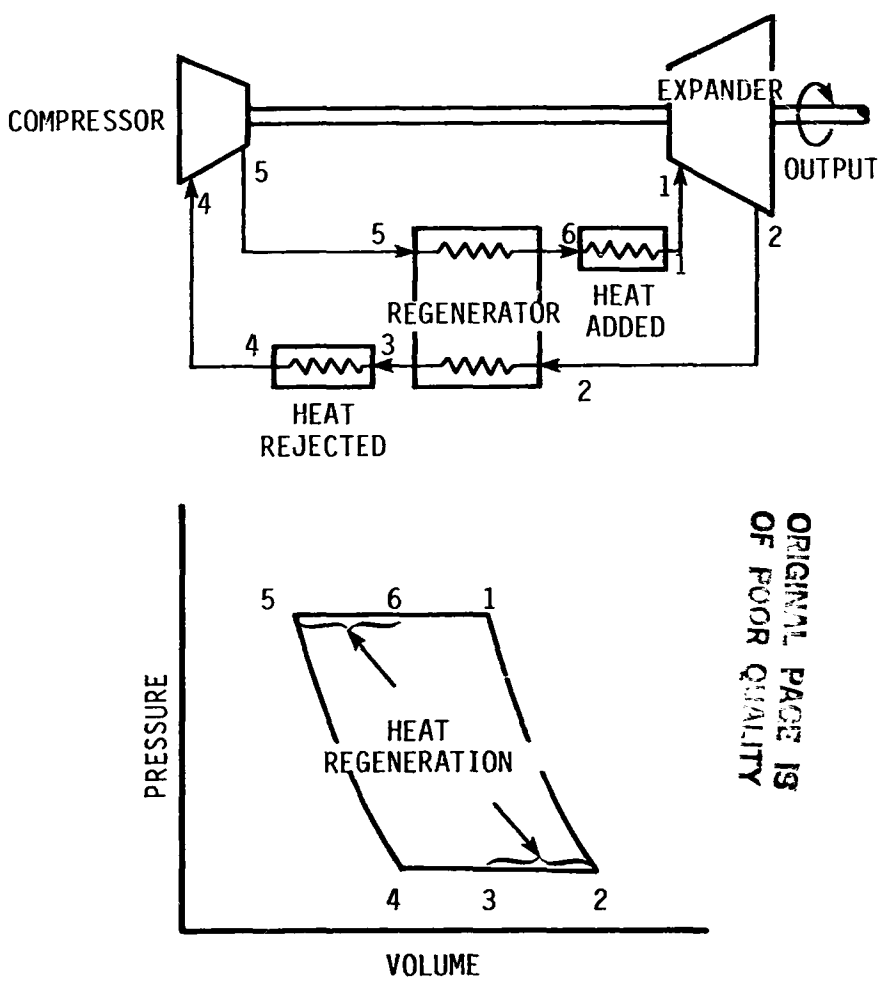

Figure 2-3. Example of Closed Cycle Gas Turbine Engine.

ORIGINAL PAGE IS
OF POOR QUALITY

Another example of the general process shown in Figure 2-1 is the closed cycle gas turbine engine (See Figure 2-3). The working gas is compressed, then it passes through a steady-flow regenerative heat exchanger to exchange heat with the hot expanded gases. More heat is added in the gas heater. The hot compressed gas is expanded which generates more energy than is required by the compressor and creates net work. To complete the cycle, the expanded gas is cooled first by the steady flow regenerative heat exchanger and then the additional cooling to the heat sink.

In the first example (Figure 2-2), the processes occur essentially in one place, one after the other in time. In the second example (Figure 2-3), these four processes all occur simultaneously in different parts of the machine. In the Stirling machine, the processes occur sequentially but partially overlapping in time. Also the processes occur in different parts of the machine but the boundaries are blurred. One of the problems which has delayed the realization of the potential of this kind of thermal machine is the difficulty in calculating with any real degree of confidence the complex processes which go on inside of a practical Stirling engine. The author has the assignment to present as much help on this subject as is presently freely available.

A heat engine is a Stirling engine for the purpose of this book when:

1. The working fluid is contained in one body at nearly a common pressure at each instant during the cycle.
2. The working fluid is manipulated so that it is generally compressed in the colder portion of the engine and expanded generally in the hot portion of the engine.
3. Transfer of the compressed fluid from the cold to the hot portion of the engine is done by manipulating the fluid boundaries without valves or real pumps. Transfer of the expanded hot fluid back to the cold portion of the engine is done the same way.
4. A reversing flow regenerator (regenerative heat exchanger) may be used to increase efficiency.

The general process shown in Figure 2-1 converts heat into mechanical energy. The reverse of this process can take place in which mechanical energy is converted into heat pumping. The Stirling engine is potentially a better cycle than other cycles because it has the potential for higher efficiency, low noise and no pollution.

Figure 2-4 shows a generalized Stirling engine machine as described above. That is, a hot and a cold gas space is connected by a gas heater and cooler and regenerator. As the process proceeds to produce power, the working fluid is compressed in the cold space, transferred as a compressed fluid into the hot space where it is expanded again, and then transferred back again to the cold space. Net work is generated during each cycle equal to the area of the enclosed curve.

ORIGINAL PAGE IS
OF POOR QUALITY

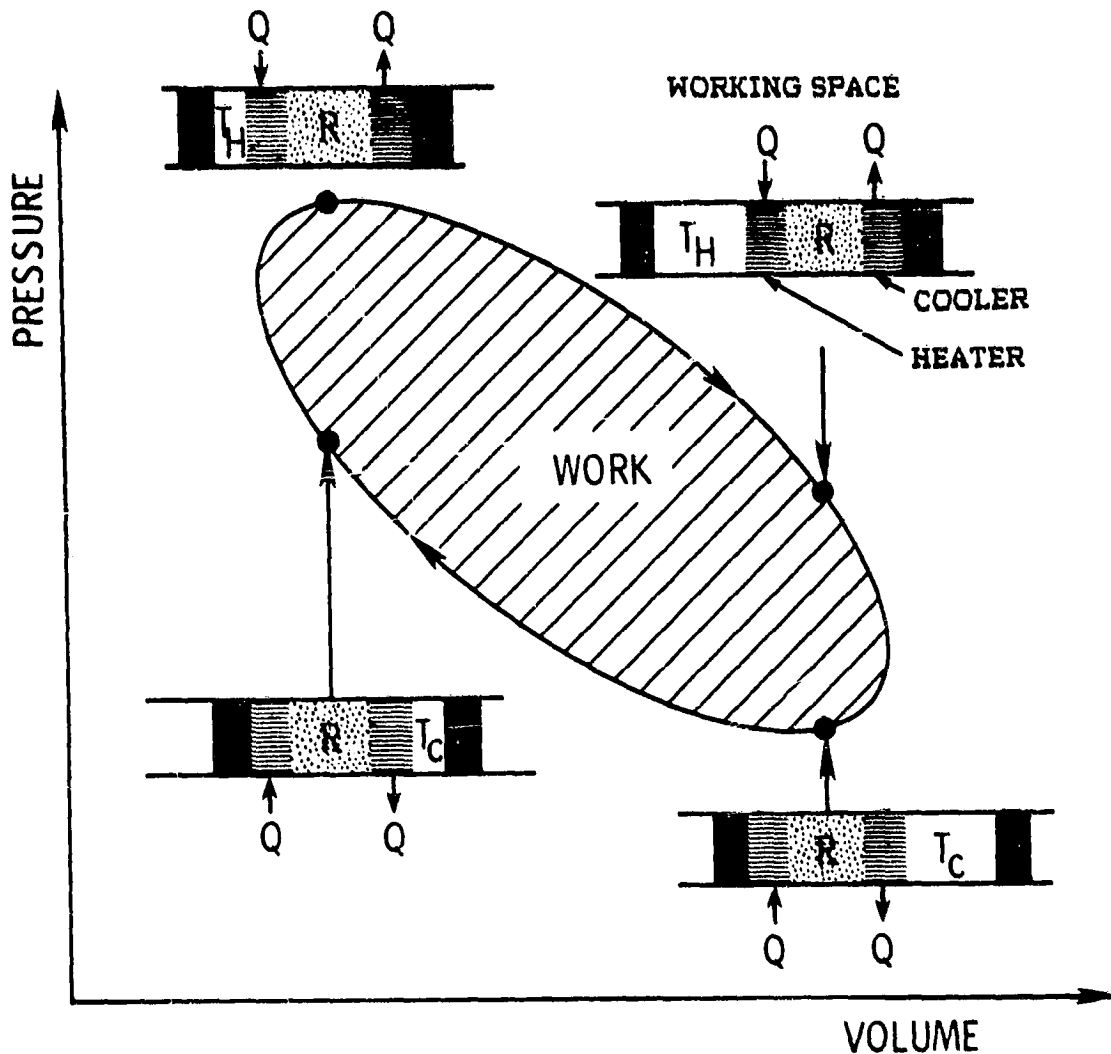

Figure 2-4. Essential Character of a Stirling Engine.

2.3 Major Types of Stirling Engines

In this publication the author would like to consider the classification of Stirling engines from a more basic standpoint. Figure 2-5 shows the various design areas that must be addressed before a particular kind of Stirling engine emerges. First some type of external heat source must be determined. Heat must then be transferred through a solid into a working fluid. There must be a means of cycling this fluid between the hot and cold portion of the engine and of compressing and expanding it. A regenerator is needed to improve efficiency. Power control is obviously needed as are seals to separate the working gas from the environment. Expansion and compression of the gas creates net indicated power which must be transformed by some type of linkage to create useful power. Also the waste heat from the engine must be rejected to a suitable sink.

ORIGINAL PAGE IS
OF POOR QUALITY

by a heater, regenerator and cooler, as in the alpha-type of Figure 2-6. In the Siemens arrangement there are 4 alpha-arrangement working spaces with each piston double-acting, thus the name. This arrangement has fewer parts than any of the others and is, therefore, favored for larger automotive scale machines. Figure 2-9 shows an implementation of the Siemens arrangement used by United Stirling. United Stirling places 4 cylinders parallel to each other in a square. The heater tubes are in a ring fired by one burner. The regenerators and coolers are in between but outside the cylinders. Two pistons are driven by one crank shaft and two pistons are given by the other. These two crank shafts are geared to a single drive shaft. One end of the drive shaft is used for auxiliaries and one for the main output power.

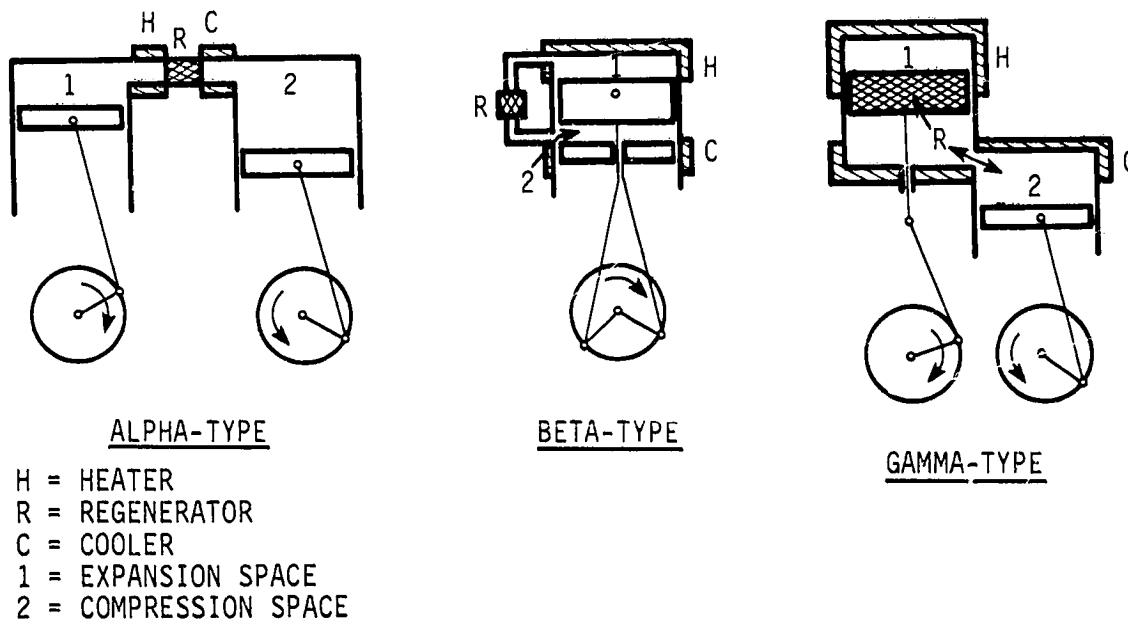

Figure 2-6. Main Types of Stirling Engine Arrangements.

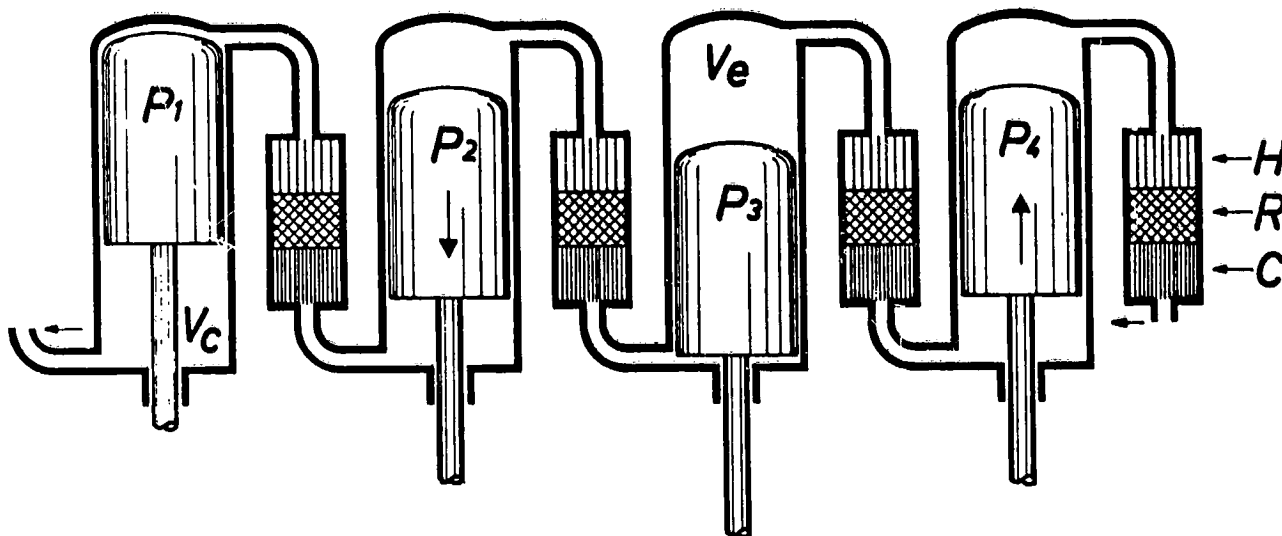

Figure 2-7. A Rinia, Siemens or Double-Acting Arrangement.

ORIGINAL PAGE IS
OF POOR QUALITY

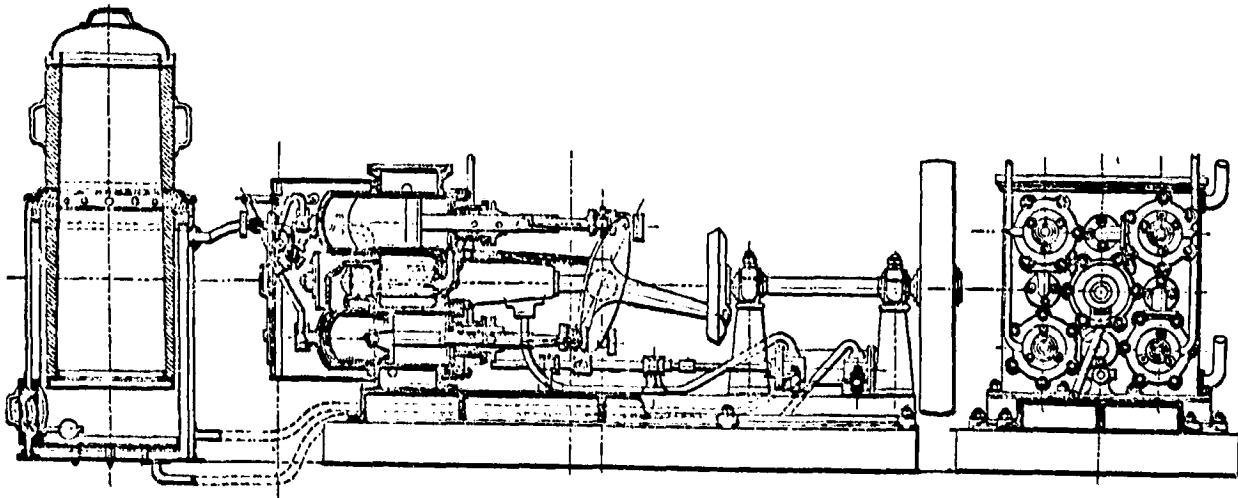

Figure 2-8. Four-Cylinder Double-Acting Engine Invented by Sir William Siemens in 1863 (after Babcock (1885 a)).

2.4 Overview of Report

The chief aim of this design manual is to teach people how to design Stirling engines, particularly those aspects that are unique to Stirling engines. To this end in Section 3, two engines have performance data and all pertinent dimensions given (fully described). In Section 4 automotive scale engines, for which only some information is available, are presented. Section 5 is the heart of the report. All design methods are reviewed. A full list of references on Stirling engines to April 1980 is given in Section 7. Sections 8 and 9 are personal and corporate author indices to the references which are arranged according to year of publication. Section 10 is a directory of people and companies active in Stirling engines.

Appendix A gives all the property values for the materials most commonly used in Stirling engine design. The units employed are international units because of the worldwide character of Stirling engine development. Appendix B gives the nomenclature for the body of the report. The nomenclature was changed from the first edition to fit almost all computers. Appendices C, D and E contain three original computer programs. Appendix F presents a discussion of non-automotive present and future applications of Stirling engines.

OF THE UNITED STATES
OF AMERICA

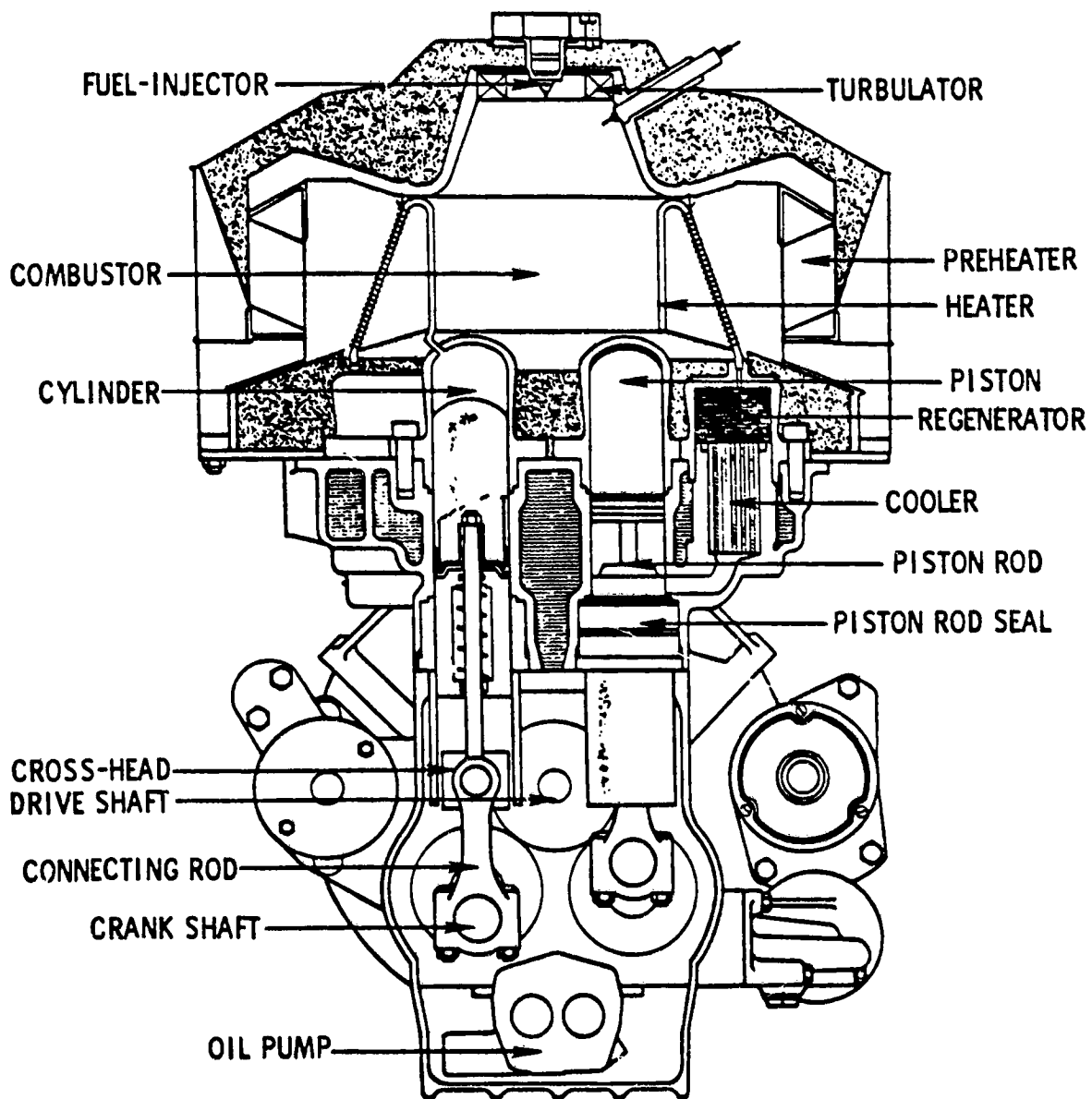

Figure 2-9. Concept for United Stirling Production Engines.

3. FULLY DESCRIBED STIRLING ENGINES

Definition of Term "Fully Described"

Fully described does not mean that there is a complete set of prints and assembly instruction in hand so that an engine can be built just from this information. However, it is a lot more than is usually available which is power output and efficiency at a particular speed. Sometimes the displacement of the power piston and the operating pressure and the gas used in the engine are also given. What is meant by "Fully Described" is that enough is revealed so that the dimensions and operating conditions that the calculation procedure needs for input can be supplied. Also required is at least the reliably measured power output and efficiency for a number of points. If experimental measurements are not available, then calculated power output and efficiency are acceptable if they are done by an experimentally validated method. It is not necessary that this method be available for examination.

Two engines are presently well enough known in the open literature and of general interest to be "fully described." These are:

- 1) The General Motors GPU-3
- 2) The General Motors 4L23

All the necessary information for each engine will now be given.

3.1 The GPU-3 Engine

General Motors Research Corporation built the Ground Power Unit #3 (GPU-3) as a culmination of a program lasting from 1960 to 1966 with the U.S. Army. Although the program met its goals, quantity production was not authorized. Two of the last model GPU-3's were preserved and have now been tested by NASA-Lewis. One of the GPU-3's as delivered to the Army is shown in Figure 3-1.

3.1.1 Engine Dimensions

Figure 3-2 shows a cross section of the entire engine showing how the parts all fit together. The measurements for this engine (78 ad, pages 45-51; 78 o) have been superceded by later information (79 a). The following tables and figures are from this latter source. Table 3-1 gives the GPU-3 engine dimensions that are needed to input the computer program. Since dead volume is not only in the heater and cooler tubes and in the regenerator matrix, but is also in many odd places throughout the engine, the engine was very carefully measured and the dead volumes added up (see Table 3-2.) The total volume inside the engine was also measured accurately by the volume displacement method. By this method Table 3-2 shows an internal volume of 236 cc. Measurements accounted for 232.3 cc. In addition to the information given in Table 3-1 and 3-2, more information is needed to calculate heat conduction. This is given in Figure 3-3.

ORIGINAL PAGE IS
OF POOR QUALITY

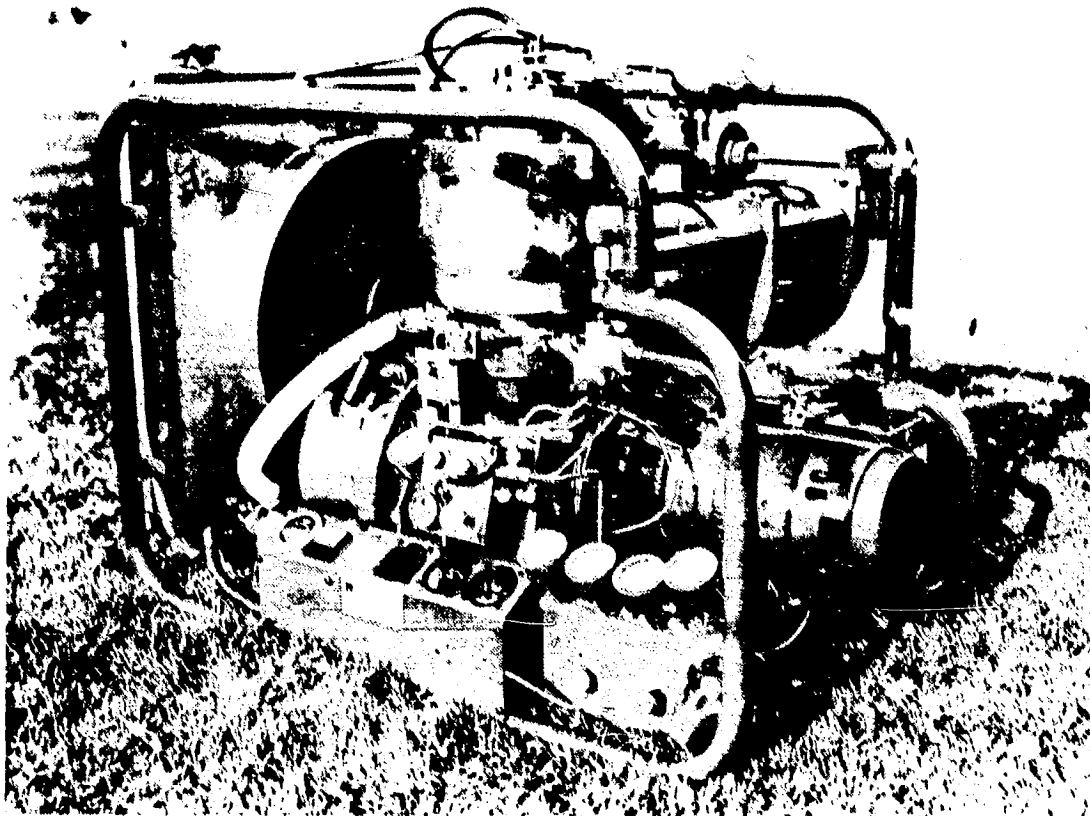

Figure 3-1. The General Motors GPU-3-2 Stirling Electric Ground Power Unit for Near Silent Operation (ref. 68 p.) Picture courtesy General Motors research.

Figure 3-4 defines the geometric relationship between piston position and crankshaft angle, which occurs in a rhombic drive machine.

3.1.2 Engine Performance

Besides engine dimensions, a fully described engine has information available on engine performance. The original performance data was obtained from NASA-Lewis by private communication (78 q) to meet the operating point published in the first edition (78 ad, page 47.) Table 3-3 shows the measured performance for these eight points. In addition, NASA-Lewis did some additional tests which were compared with the NASA-Lewis computation method. Tabular

ORIGINAL PAGE IS
OF POOR QUALITY

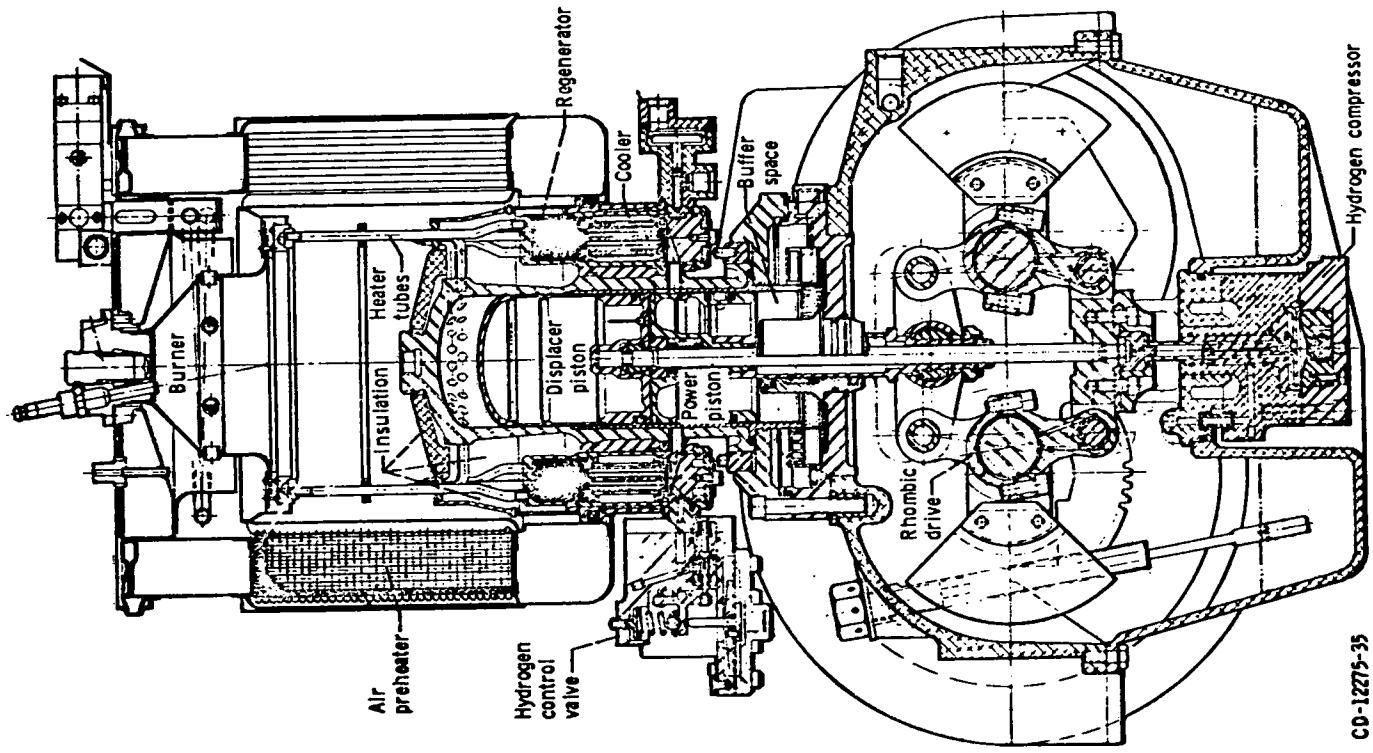

Figure 3-2 Cross Section of GPU-3 Engine
(78 cd)

Table 3-1 GPU-3-2 Engine Dimensions and Parameters (79 a)

Cylinder bore at liner, cm (in.)	6.99 (2.751)
Cylinder bore above liner,* cm (in.)	7.01 (2.76)
<u>Cooler</u>	
Tube length, cm (in.)	4.61 (1.813)
Heat transfer length, cm (in.)	3.55 (1.399)
Tube inside diameter, cm (in.)	0.108 (0.0425)
Tube outside diameter, cm (in.)	0.159 (0.0625)
Number of tubes per cylinder (or number of tubes per regenerator)	312 (39)
<u>Heater</u>	
Mean tube length, cm (in.)	24.53 (9.658)
Heat transfer length, cm (in.)	15.54 (6.12)
Cylinder tube, cm (in.)	11.64 (4.583)
Regenerator tube, cm (in.)	12.89 (5.075)
Tube inside diameter, cm (in.)	0.302 (0.119)
Tube outside diameter, cm (in.)	0.483 (0.19)
Number of tubes per cylinder (or number of tubes per regenerator)	40 (5)
<u>Cold end connecting ducts</u>	
Length, cm (in.)	1.59 (0.625)
Duct inside diameter, cm (in.)	0.597 (0.235)
Number of ducts per cylinder	8
Cooler end cap, cm ³ (in ³)	0.279 (0.0170)
<u>Regenerators</u>	
Length (inside), cm (in.)	2.26 (0.89)
Diameter (inside), cm (in.)	2.26 (0.89)
Number per cylinder	8
Material	Stainless steel wire cloth
Number of wires, per cm (per in.)	79x79 (200x200)
Wire diameter, cm (in.)	0.004 (0.0016)
Number of layers	308
Filler factor, percent	30.3
Angle of rotation between adjacent screens, deg	5
<u>Drive</u>	
Connecting rod length, cm (in.)	4.60 (1.810)
Crank - radius, cm (in.)	1.38 (0.543)
Eccentricity, cm (in.)	2.08 (0.820)
<u>Miscellaneous</u>	
Displacer rod diameter, cm (in.)	0.952 (0.375)
Piston rod diameter, cm (in.)	2.22 (0.875)
Displacer diameter, cm (in.)	6.96 (2.740)
Displacer wall thickness, cm (in.)	0.159 (0.0625)
Displacer stroke, cm (in.)	3.12 (1.23)
Expansion space clearance, cm (in.)	0.163 (0.064)
Compression space clearance, cm (in.)	0.030 (0.012)
Buffer space maximum volume, cm ³ (in ³)	521 (31.78)
Total working space minimum volume, cm (in)	233.5 (14.25)

*Top of displacer seal is at top of liner at displacer TDC.

Table 3-2 GPU-3 Stirling Engine Dead Volumes (79 a)

Volumes are given in cu cm (cu in.)

<u>I. Expansion space clearance volume</u>	
Displacer clearance (around displacer)	3.34 (0.204)
Clearance volume above displacer	7.41 (0.452)
Volume from end of heater tubes into cylinder	1.74 (0.106)
Total	12.5 (0.762)
<u>II. Heater dead volume</u>	
Insulated portion of heater tubes next to expansion space	9.68 (0.591)
Heated portion of heater tubes	47.46 (2.896)
Insulated portion of heater tubes next to regenerator	13.29 (0.811)
Additional volume in four heater tubes used for instrumentation	2.74 (0.167)
Volume in header	7.67 (0.468)
Total	80.8 (4.933)
<u>III. Regenerator dead volume</u>	
Entrance volume into regenerators	7.36 (0.449)
Volume within matrix and retaining disks	53.4 (3.258)
Volume between regenerators and coolers	2.59 (0.158)
Volume in snap ring grooves at end of coolers	2.18 (0.133)
Total	65.5 (3.998)
<u>IV. Cooler dead volume</u>	
Volume in cooler tubes	13.13 (0.801)
<u>V. Compression in space clearance volume</u>	
Exit volume from cooler	3.92 (0.239)
Volume in cooler end caps	2.77 (0.169)
Volume in cold end connecting ducts	3.56 (0.217)
Power piston clearance (around power piston)	7.29 (0.445)
Clearance volume between displacer and power piston	1.14 (0.070)
Volume at connections to cooler end caps	2.33 (0.142)
Volume in piston "notches"	0.06 (0.004)
Volume around rod in bottom of displacer	0.11 (0.007)
Total	21.18 (1.293)
Total dead volume	193.15 (11.787)
Minimum live volume	39.18 (2.391)
Calculated minimum total working space Volume	232.3 (14.178)
Measured value of minimum total working space volume (by volume displacement)	232.5 (14.25)
Change in working space volume due to minor engine modification	2.5 (0.15)
	36.0 (14.40)

ORIGINAL PAGE IS
OF POOR QUALITY

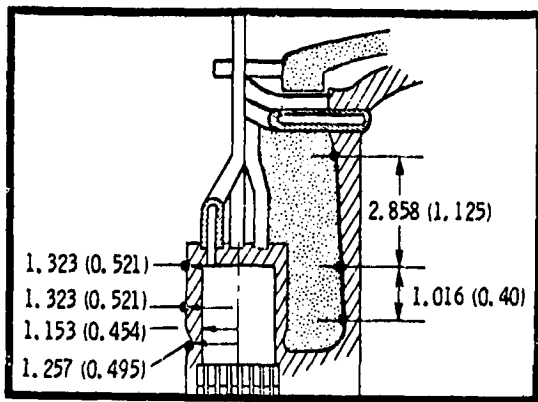

ORIGINAL PAGE IS
OF POOR QUALITY

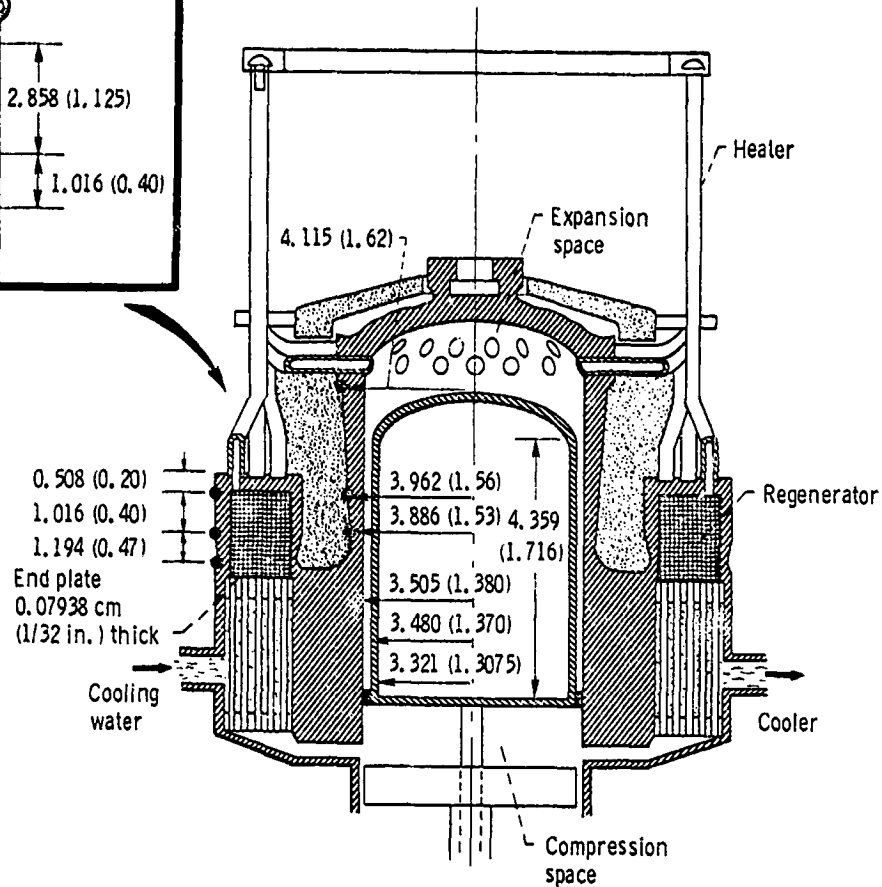

Figure 3-3. Schematic Showing Dimensions of GPU-3 Needed for Calculating Heat Conduction. (Regenerator, housing, cylinder, and displacer are 310 stainless steel. Dimensions are in cm (in.).)

information as in Table 3-3 has not been released. Tables 3-4 to 3-8 give approximate and incomplete information by reading the graphs (79 a). If brake efficiency is given, it is not calculated by dividing the brake power by the heat input, but is determined by reading a separate graph. Since this work was done, a complete test report was published (79 b1) which includes 7 microfiche sheets of all the test data. The reader is referred to this report (79 b1) for more exact information.

NASA-Lewis also determined mechanical losses due to seal and bearing friction and similar effects. Figure 3-4 shows these losses for hydrogen working gas and Figure 3-6 shows the same losses for helium.

Percival (74 bc) gives two sets of curves for the power output and efficiency for the "best" GPU-3 engine tested in late 1969 (see Figures 3-7 and 3-8).

ORIGINAL PAGE IS
OF POOR QUALITY

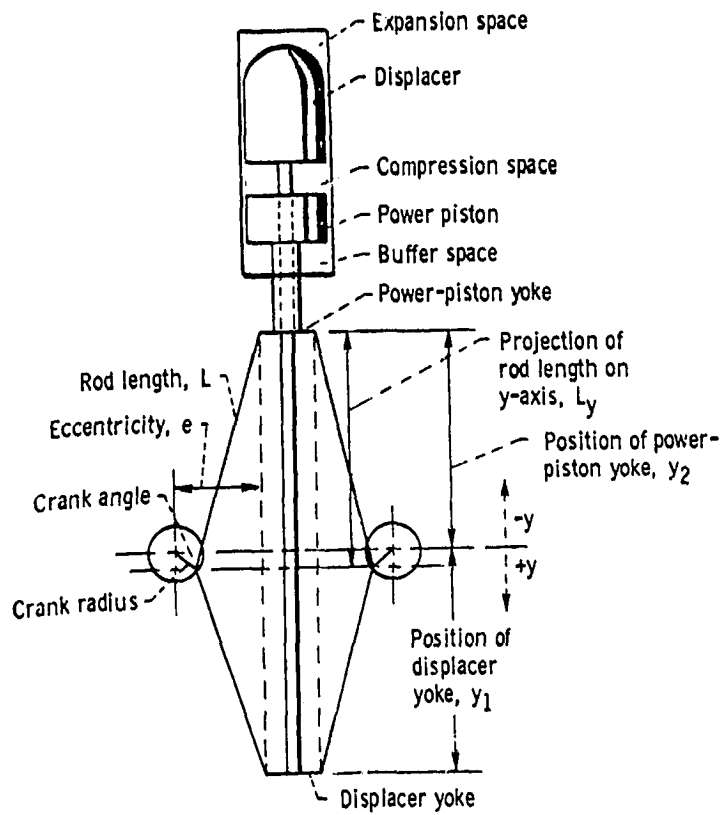

Figure 3-4 Schematic Showing Geometric Relations Between Piston Positions and Crankshaft Angle

Table 3-3 Measured Performance of the GPU-3 Engine Under Test at NASA-Lewis

Measurements

Table 3-4 Measurements of GPU-3 Engine Performance
 by NASA-Lewis - Part I (79a)
 Hydrogen Gas, 704C (1300F) Heater Gas Temperature,
 15C (59F) Inlet Cooling Water Temperature

Pt	Mean Press		Engine SP		Ind. Power		Brake Power		Heat Input*		Brake Eff.* %
	MPa	PSIa	HZ	RPM	KW	HP	KW	HP	KW	HP	
1	1.38	200	16.67	1000			0.39	0.52	2.46	3.30	15.6
2	1.38	200	25	1500			0.58	0.78	3.06	4.10	17.5
3	1.38	200	33.33	2000			0.71	0.55	3.69	4.95	18.1
4	1.38	200	41.67	2500			0.78	1.05	3.97	5.32	19.1
5	1.38	200	50	3000			0.82	1.10	4.51	6.05	17.2
6	1.38	200	58.33	3500			0.56	0.75	4.83	6.48	11.0
7	2.76	400	16.67	1000	1.57	2.1	1.13	1.52	4.47	6.0	24.4
8	2.76	400	25	1500	2.05	2.75	1.49	2.00	5.64	7.57	25.7
9	2.76	400	33.33	2000	2.57	3.45	1.95	2.62	7.08	9.50	27.2
10	2.76	400	41.67	2500	3.13	4.2	2.39	3.20	8.58	11.50	27.0
11	2.76	400	50	3000	3.47	4.65	2.61	3.50	9.88	13.25	25.7
12	2.76	400	58.33	3500	3.65	4.90	2.70	3.62	11.00	14.75	23.9
13	4.14	600	58.33	3500			4.47	6.0	16.18	21.70	27.0

*Based upon energy balance at cold end.

ORIGINAL PHOTO
 OF POOR QUALITY

Table 3-5 Measurements of GPU-3 Engine Performance
by NASA-Lewis - Part II (79a)

Hydrogen Gas, 15C (59F) Cooling Water Inlet Temperature,
2.76 MPa (400 psia) Mean Pressure

Pt	Heater Gas Temp.		Engine Speed		Brake Power	
	°C	°F	HZ	RPM	KW	HP
1	704	1300	16.67	1000	1.13	1.52
2	704	1300	25	1500	1.49	2.00
3	704	1300	33.33	2000	1.95	2.62
4	704	1300	41.67	2500	2.35	3.15
5	704	1300	50	3000	2.61	3.50
6	704	1300	58.33	3500	2.70	3.62
7	649	1200	16.67	1000	0.89	1.20
8	649	1200	25	1500	1.34	1.80
9	649	1200	33.33	2000	1.85	2.48
10	649	1200	41.67	2500	2.24	3.00
11	649	1200	50	3000	2.42	3.25
12	649	1200	58.33	3500	2.44	3.27
13	593	1100	16.67	1000	0.86	1.15
14	593	1100	25	1500	1.36	1.82
15	593	1100	33.33	2000	1.72	2.30
16	593	1100	41.67	2500	2.07	2.77
17	593	1100	50	3000	2.13	2.85
18	593	1100	58.33	3500	2.09	2.80

ORIGINAL FROM
OF HIGH QUALITY

Table 3-6 Measurements of GPU-3 Engine Performance
 by NASA-Lewis - Part III (79a)
 Helium Gas, 704C (1300F) Nominal Heater Gas Temperature
 13C (56F) Cooling Water Inlet Temperature

Pt	Mean Press		Engine Speed		Ind. Power		Brake Power	
	MPa	Psia	HZ	RPM	KW	HP	KW	HP
1	2.76	400	16.67	1000	1.34	1.8	0.88	1.18
2	2.76	400	25	1500	1.83	2.45	1.21	1.62
3	2.76	400	33.33	2000	2.15	2.88	1.40	1.88
4	2.76	400	41.67	2500	2.42	3.25	1.53	2.05
5	2.76	400	50	3000	2.50	3.35	1.42	1.90
6	2.76	400	58.33	3500	2.10	2.82	0.89	1.20
7	1.38	200	16.67	1000			0.25	0.34
8	1.38	200	25	1500			0.26	0.35
9	1.38	200	33.33	2000			0.37	0.50
10	1.38	200	41.67	2500			0.15	0.20
11	4.14	600	33.33	2000			2.35	3.15
12	4.14	600	41.67	2500			2.65	3.55
13	4.14	600	50	3000			2.55	3.42
14	4.14	600	58.33	3500			2.01	2.70
15	5.52	800	50	3000			3.77	5.05
16	5.52	800	58.33	3500			3.39	4.55

ORIGINAL PAGE IS
 OF POOR QUALITY

Table 3-7 Measurements of GPU-3 Engine Performance
 by NASA-Lewis - Part IV (79a)
 Helium Gas, 395C (1100F) Nominal Heater Gas Temperature
 13C (56F) Cooling Water Inlet Temperature

Pt	Mean Press		Engine Speed		Brake Power	
	MPa	PSia	HZ	RPM	KW	HP
1	2.76	400	16.67	1000	0.69	0.93
2	2.76	400	25	1500	0.93	1.25
3	2.76	400	33.33	2000	1.01	1.35
4	2.76	400	41.67	2500	0.94	1.26
5	2.76	400	50	3000	0.70	0.94
6	2.76	400	58.33	3500	0.27	0.36
7	5.52	800	33.33	2000	2.59	3.47
8	5.52	800	41.67	2500	2.96	3.97
9	5.52	800	50	3000	2.73	3.66
10	5.52	800	58.33	3500	1.80	2.42

ORIGINAL FROM IS
 OF POOR QUALITY

Table 3-8 Measurements of GPU-3 Engine Performance
 by NASA-Lewis - Part V (79a)
 Helium Gas, 649C (1200F) Nominal Heater Gas Temperature,
 13C (56F) Cooling Water Inlet Temperature

Pt	Mean Pressure		Engine Speed		Brake Power		Heat Input*		Brake Eff.* %
	MPa	PSIa	HZ	RPM	KW	HP	KW	HP	
1	2.76	400	16.67	1000	0.82	1.10	3.95	5.3	20.5
2	2.76	400	25	1500	1.12	1.50	5.41	7.25	20.7
3	2.76	400	33.33	2000	1.21	1.62	6.64	8.9	18.0
4	2.76	400	41.67	2500	1.21	1.62	7.64	10.25	15.2
5	2.76	400	50	3000	1.04	1.40	8.95	12.00	11.8
6	2.76	400	58.33	3500	0.56	0.75	9.88	13.25	5.4
7	4.14	600	25	1500	1.79	2.40	7.23	9.70	24.8
8	4.14	600	33.33	2000	2.20	2.95	9.17	12.30	23.9
9	4.14	600	41.67	2500	2.42	3.25	11.33	15.20	21.3
10	4.14	600	50	3000	2.35	3.15	12.83	17.20	18.2
11	4.14	600	58.33	3500	1.73	2.32	14.32	19.20	12.0
12	5.52	800	41.67	2500	3.28	4.40	14.69	19.70	22.5
13	5.52	800	50	3000	3.28	4.40	17.45	23.40	18.8
14	5.52	800	58.33	3500	2.76	3.70	19.18	25.72	14.2
15	6.9	1000	50	3000	3.93	5.27	20.88	28.0	18.7
16	6.9	1000	58.33	3500	3.37	4.52	23.15	31.05	14.2

*Based upon energy balance at cold end.

ORIGINAL MODEL IS
 OF POOR QUALITY

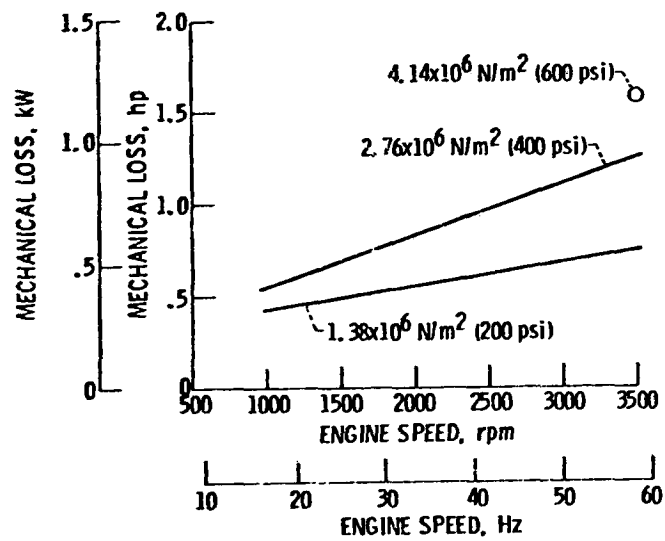

Figure 3-5 Mechanical Loss As a Function of Engine Speed for Hydrogen Working Gas (Determined from Experimental Heat Balance)

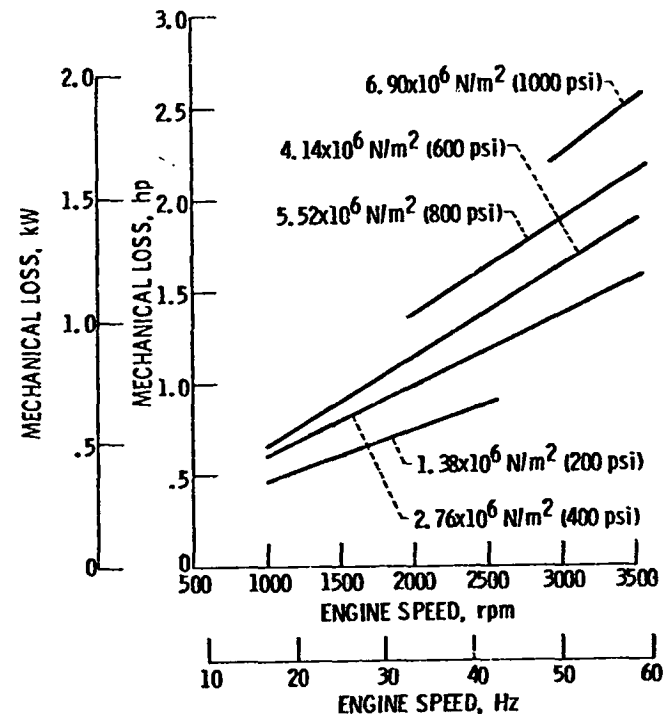

Figure 3-6 Mechanical Loss As a Function of Engine Speed for Helium Working Gas (Determined from experimental heat balance.)

ORIGINAL PAGE IS
OF POOR QUALITY

Figure 3-7: GPU-3 STIRLING THERMAL ENGINE PERFORMANCE - PRESSURE RUNS

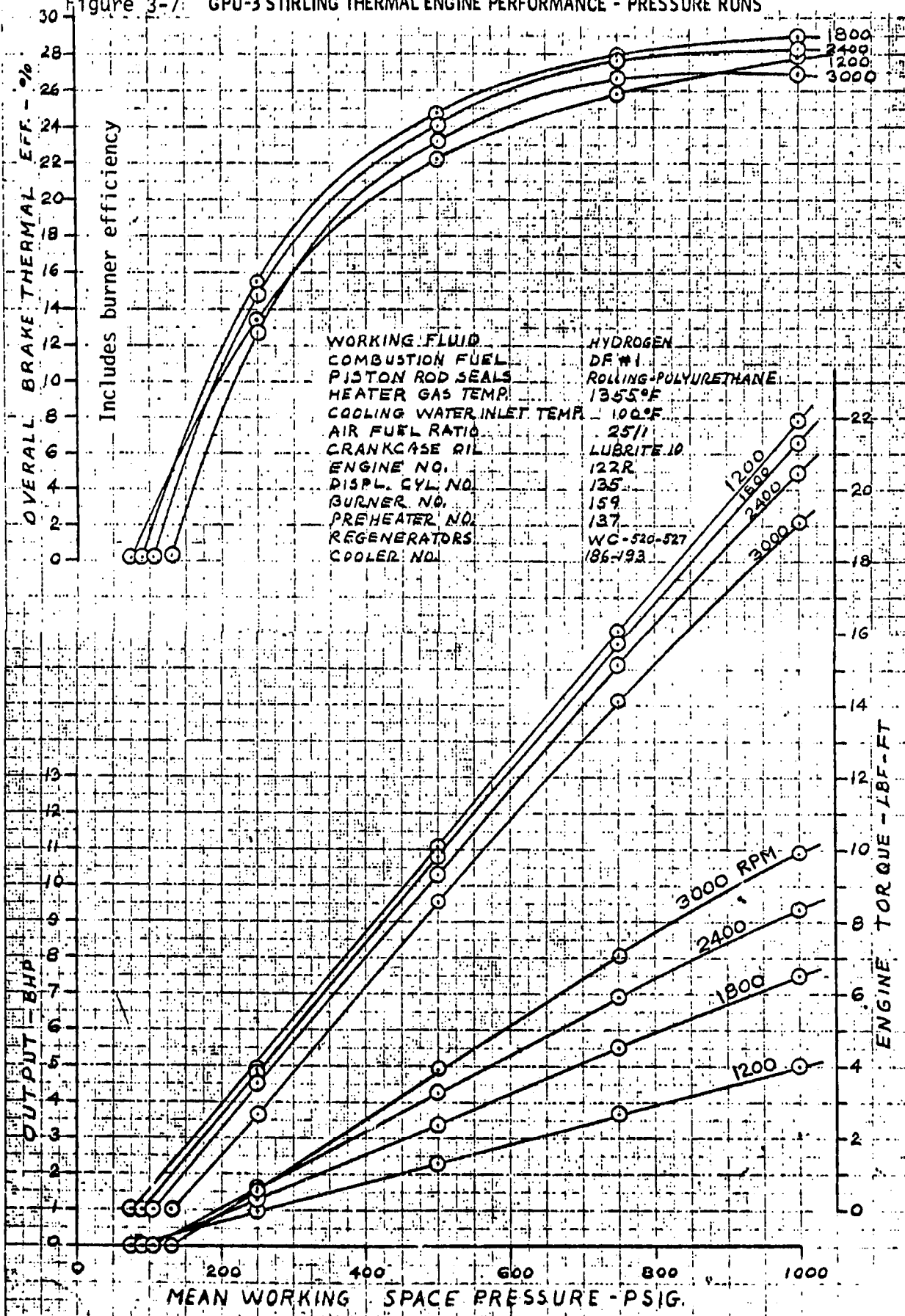
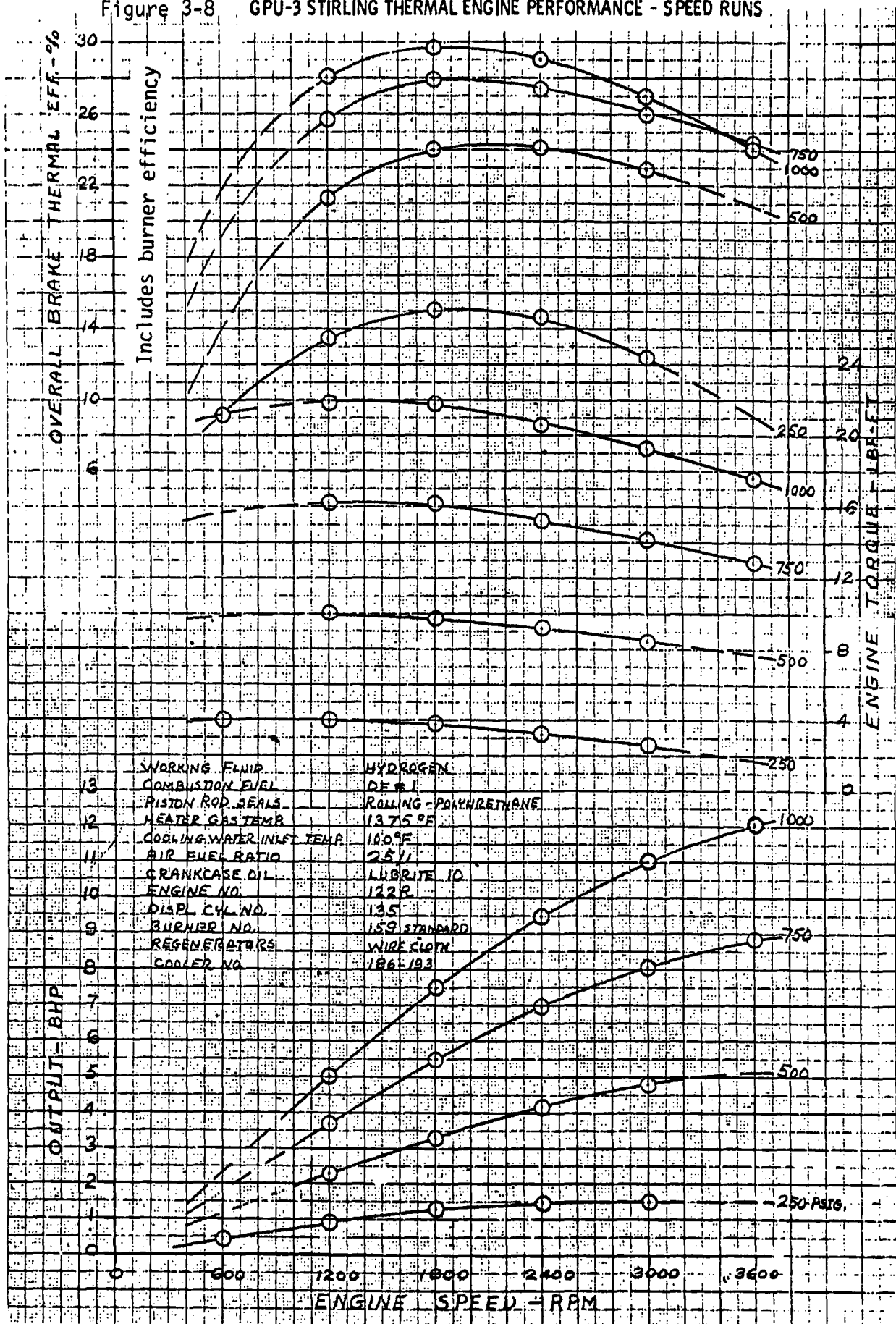

Figure 3-8 GPU-3 STIRLING THERMAL ENGINE PERFORMANCE - SPEED RUNS



ORIGINAL PAGE IS
OF POOR QUALITY

CALCULATED PERFORMANCE

GPU-3 STIRLING ENGINE

BHP, TORQUE AND EFFICIENCY VS. ENGINE SPEED
AT VARIOUS MEAN WORKING PRESSURES

10 GPM COOLING WATER FLOW
100°F COOLING WATER INLET TEMPERATURE
1400°F INSIDE HEATER TUBE WALL TEMPERATURE
80% FURNACE EFFICIENCY
82.5% MECHANICAL EFFICIENCY (AT 3000 RPM AND 1000 PSI)

● Design Point

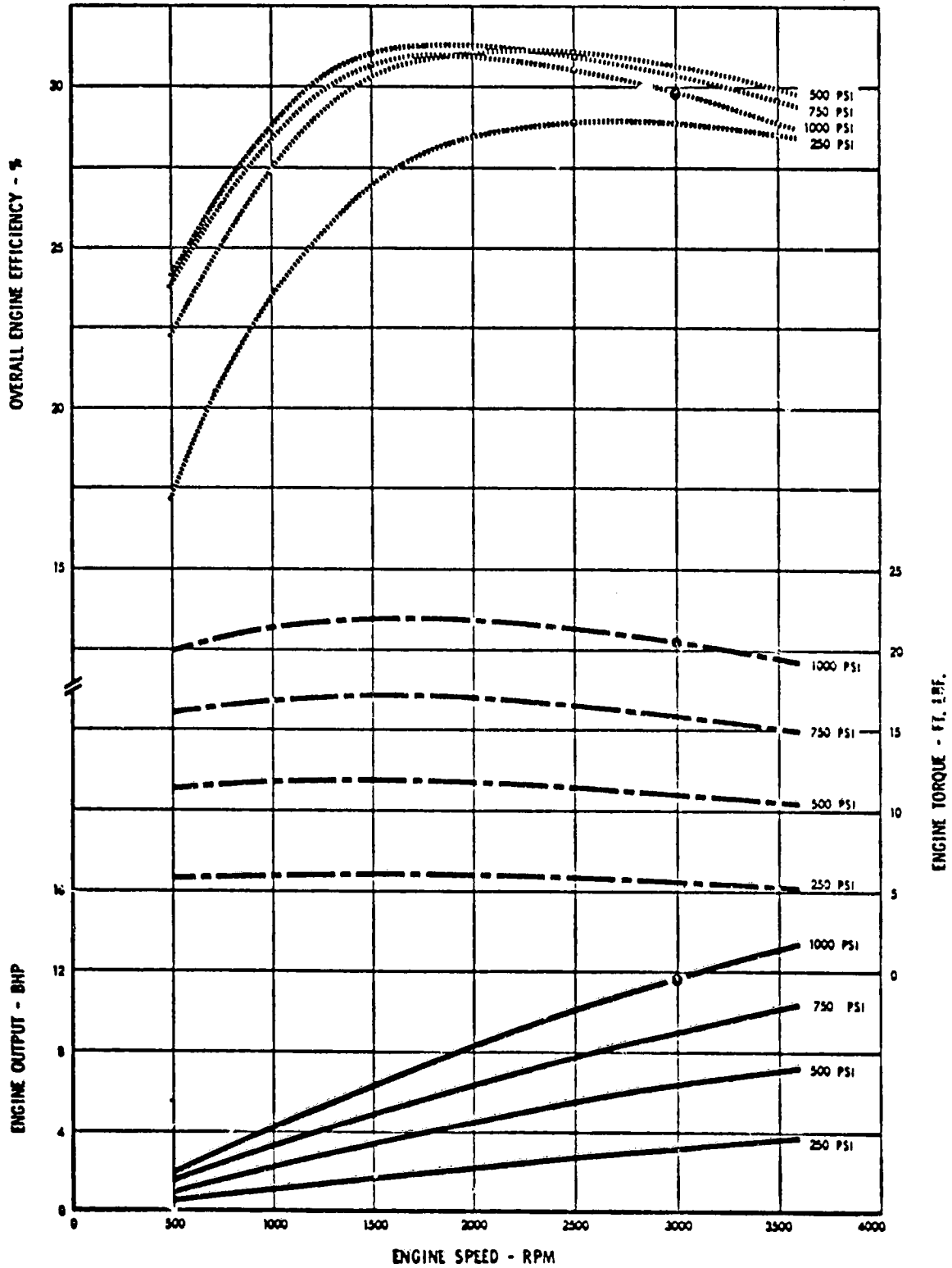

Figure 3-9.

Later in the General Motors papers on Stirling engines released in 1978, a graph giving the calculated performance for the GPU-3 engine was published (78 bh, section 2.116, page 6, March 1970). (See Figure 3-9.) Furnace and mechanical efficiency are stated so the indicated power and efficiency calculated by most design methods can be compared with the unpublished method used by General Motors. Examinations show that Figures 3-7 and 3-8 agree well and are probably different plots of the same experimental measurements. Figure 3-9 agrees fairly well with measurement near the design point of 3000 rpm 1000 psia.

	G.M. Calculation Figure 3-9	G.M. Measurement Figure 3-8
Output BHP	11.6	11
Overall Efficiency	29.8	26

However, at 3000 rpm and 250 psi, the calculated power is 3.3 hp, but the measured is only 1.5 hp.

The GPU-3 engine now has considerable data on it. It is not completely understood but the engine has been thoroughly measured and carefully run. A full test report on this is available (79 bl).

3.2 The 4L23 Engine

According to Percival (74 bc), design for a four-cylinder double-acting engine was started in 1968. Eventually, the goal was to demonstrate an advanced Stirling engine of about 150 hp. The engine became known as the 4L23 because of the piston displacement of 23 cubic inches and having four cylinders in a line. A single crankshaft was used with cross heads and only one piston per cylinder was needed. Figure 3-10 shows a cross section through one of these cylinders. In this Rinia, or Siemens, arrangement, the gas leaves the hot space and goes through a series of tubes arranged in a circle similar to the way the GPU-3 engine is designed. The tubes go from the hot space up to a manifold at the top and then other tubes come down and enter one of six regenerator cans grouped around each engine cylinder. Figure 3-11 shows a top view of this engine showing the four cylinders and the 24 regenerator cans that were used. Below each porous regenerator is the tubular gas cooler. As in the GPU-3, the regenerator and gas cooler were made as a unit and slipped into place. From the bottom of the gas cooler the gas is not inducted into the same cylinder as in the GPU-3, but into another cylinder in the line. Figure 3-11 and 3-12 show the arrangement of these conducting ducts. Figure 3-11 shows how the cold space of cylinder 1 is connected to the gas coolers of cylinder 3. The cold space of cylinder 3 is connected to the gas coolers of cylinder 4. The cold space of cylinder 4 is connected to the gas coolers of cylinder 2; and finally, the cold space of cylinder 2 is connected to the gas coolers of cylinder 1 to complete the circuit. This particular arrangement is done for the purpose of balancing the engine. In addition to this "firing order" arrangement and the counter-weights shown in Figure 3-10, engine 4L23 had two balance shafts on either side of the main crankshaft which has weights on them that rotated in such a way as to attain essentially perfect balance. This made the crankcase wider at the bottom. Also from the drawings sent to NASA-Lewis from General Motors (1978 dk) the crankcase was much less compact than that shown in Figure 3-10. Also the corrugated metal air preheater sketched in Figure 3-10 turned

ORIGINAL PAGE IS
OF POOR QUALITY

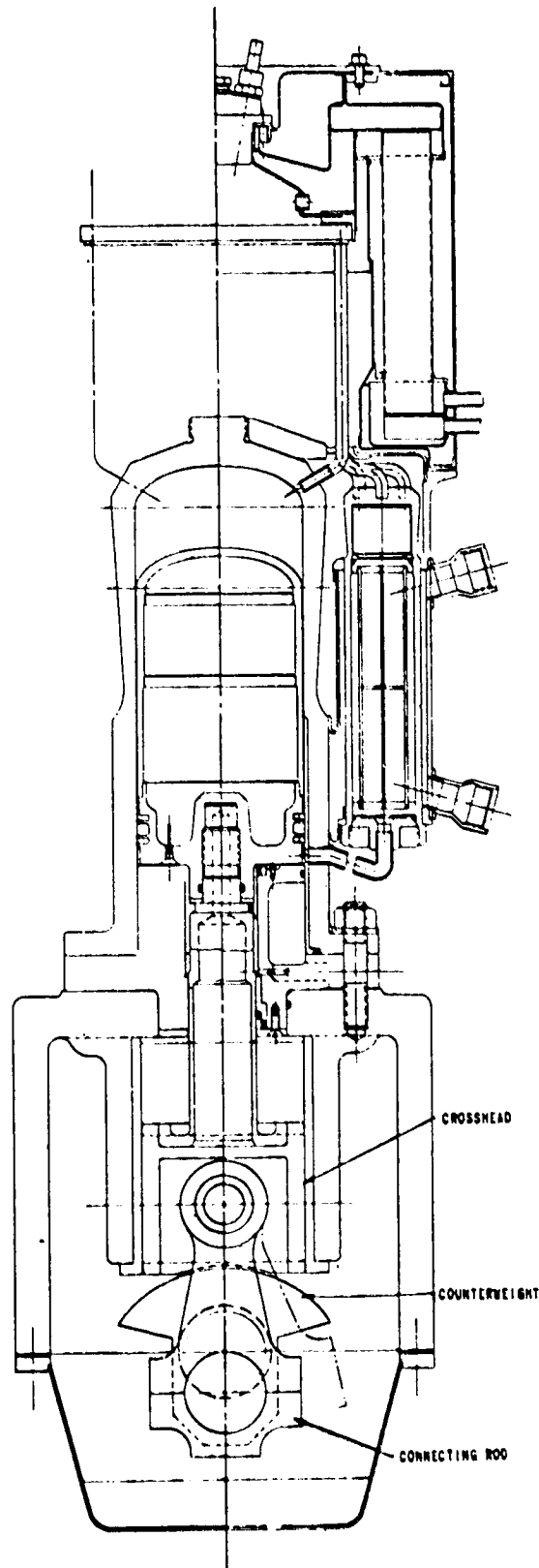

Figure 3-10. Cross Section of Single Crank In-Line Engine.

ORIGINAL PAGE IS
OF POOR QUALITY

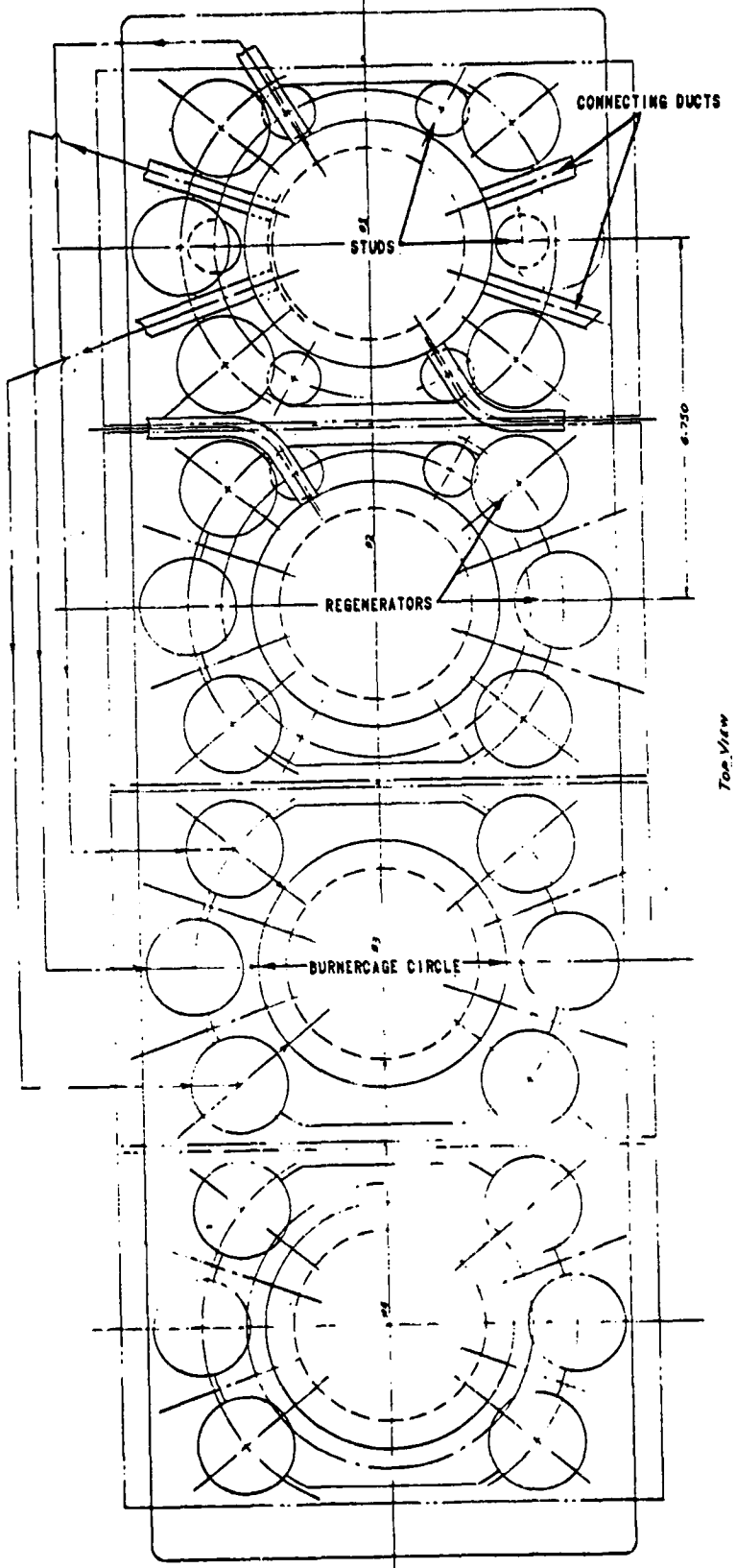
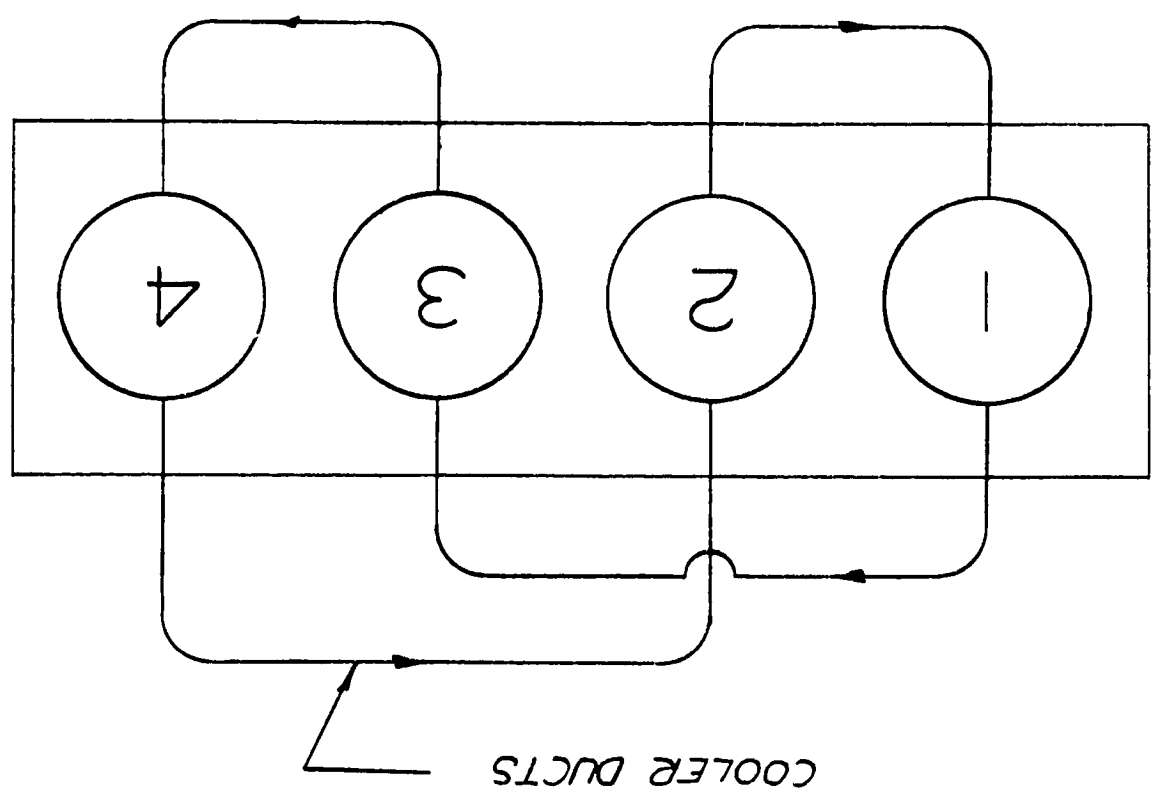

Figure 3-11. Arrangement of Regenerators and Hold Down Studs for In-Line Crankcase.

Figure 3-12. Diagram of Connecting Ducts for In-Line Engines.

"FIRING ORDER" 1-3-4-2-1



ORIGINAL SOURCE
OF FIGURE 3-12

out to be a shell and tube heat exchanger about three times as large. No report quality cross sections or artists' renderings or pictures of hardware were ever released on this engine. Nevertheless this engine is important today because it is of a very modern design and has an adequate description as to dimensions and calculated performance. It is very similar to the P-40 or P-75 engine that United Stirling is now building and testing. In order to provide for future engine upgrading, the combustion system and crankcase, crankshaft and bearings were designed to accept 3000 psi mean pressure. The 4L23 was General Motors Research's first computer design (optimized engine.) The 4L23 was the first engine with the sealed piston. In other engines a small capillary tube allowed the inside of the piston to be pressurized at the mean pressure of the engine working gas. This was done in order to minimize the inventory of hydrogen gas and also to reduce heat leak by having air instead of hydrogen in the piston dome. The 4L23 was optimized for the use of Met Net regenerator material which was found by General Motors to be considerably less expensive to produce than the woven wire regenerator material which had been used up until that time.

Table 3-9 gives all the engine dimensions necessary to calculate the power output and efficiency of the 4L23. Most of these numbers come from GMR-2690 section 2.115 (78 bh) report dated 19 January 1970. Some come from additional drawings sent to NASA-Lewis from General Motors Research (78 dk). The list given by Martini (79 ad) has been revised somewhat. The final list is given in Table 3-9.

3.2.2 Engine Performance

Insufficient data is given in the General Motors reports to calculate static heat loss through the engine. Second order theory indicates that if the engine heat inputs are plotted against frequency the extrapolation to zero frequency should give the static heat loss. This process was done for the data given by Diepenhorst (see Figures 3-13 to 3-15.) It was found that the heat inputs were exactly proportional to frequency, but that the zero intercept was not consistent (see Figure 3-16.) Since the heat input was so perfectly proportional to frequency of operation, it was a shock that the zero intercepts did not follow any particular pattern. One would expect that the zero intercepts for hot tube temperature of 1400 F would be always higher than those for 1200 F, which would always be higher than those for 1000 F. There is also no reason for a dependence on average pressure because metal thermal conductivity is not affected by this, and gas thermal conductivity is almost not affected. This problem is only discussed in this section because there should be some information given from which the static thermal conductivity can be calculated. Table 3-10 gives the information needed to calculate static thermal conductivity. The engine cylinder and the regenerator cases are tapered to have a smaller wall thickness at the cold end. However, at this level of detail only an average wall thickness and an average thermal conductivity for the entire wall is desired.

Percival gives a somewhat different calculated performance for the 4L23 engine (see Figure 3-17.) Figure 3-15 and Figure 3-17 have the same operating conditions and engine specifications, but the power output and efficiency are slightly different. Figure 3-17 quotes 25 GPM cooling water flow which is for

Table 3-9 - Specifications for the General Motors 4L23 Stirling Engine Type:
4 cylinder, single crank drive with double acting pistons

<u>Working Fluid:</u>	Hydrogen	<u>Regenerators (per cyl.)</u>	
<u>Design Speed:</u>	2000 RPM	Length	2.5 cm (0.98 in.)
<u>Design Pressure:</u>	1500 psia	Diameter	3.5 cm (1.38 in.)
<u>Cylinders per engine:</u>	4	Number	6
<u>Bore:</u>	10.16 cm (4.0 in.)	Material	Met Net .05-.20
<u>Stroke:</u>	4.65 cm (1.83 in.)	Filler Factor	20 percent
<u>Displacement (per cyl):</u>	377 cu. cm (23 c. in.)	Wire Diameter	.00432 cm (.0017 in.)
<u>Diameter of roll sock seal</u>	4.06 cm (1.6 in.)	<u>Drive</u>	
<u>Piston end clearance</u>	0.0406 cm. (0.016 in.)	Connecting Rod Length	13.65 cm (5.375 in.)
<u>Cooler (per cyl.)</u>		Crank Radius	2.325 cm (0.915 in.)
Tube Length	12.9 cm (5.08 in.)	<u>Cooling Water</u>	
Heat Transfer Length	12.02 cm (4.73 in.)	Flow	25 GPM/cyl. @2000 RPM
Tube I. D.	.115 cm (0.045 in.)	Inlet Temperature	1350F
Tube O. D.	.167 cm (0.065 in.)	<u>Mechanical Efficiency</u>	
Number of Tubes	312	For Bare Engine	90 percent
Water Flow	25 GPM	<u>Furnace Efficiency</u>	
Water Inlet Temp.	1350F	Burner + air preheater	80 percent
<u>Heater (per cyl.)</u>		<u>Hot Cap</u>	
Tube Length	41.8 cm (16.46 in.)	Length	6.40 cm (2.52 in.)
Heat Transfer Length	25.58 cm (10.18 in.)	Gap	0.0406 cm (0.016 in.)
Tube I.D.	.472 cm (0.18 in.)	Phase Angle	90°
Tube O.D.	.640 cm (0.25 in.)	<u>Velocity Heads due to</u>	
Number of Tubes	36	Entrance and Exit and Bends	
Inside Wall Temp.	1400°F	Heater	4.4
<u>Cold End Connecting Ducts (per cyl.)</u>		Cooler	1.5
Length	71 cm (27.95 in.)	Connecting T.	3.0
I.D.	.76 cm (0.30 in.)		
Number	6		
Isothermal Volume	5 percent		
Adiabatic Volume	95 percent		

ORIGINAL PAGE IS
OF POOR QUALITY

4L23 CALCULATED PERFORMANCE

BHP, TORQUE AND EFFICIENCY VS. ENGINE SPEED
AT VARIOUS MEAN WORKING PRESSURES

ORIGINAL PAGE IS
OF POOR QUALITY

100 GPM COOLING WATER FLOW (AT 2000 RPM)
135°F COOLING WATER INLET TEMPERATURE
80% FURNACE EFFICIENCY
90% MECHANICAL EFFICIENCY

1000°F INSIDE HEATER TUBE WALL TEMPERATURE

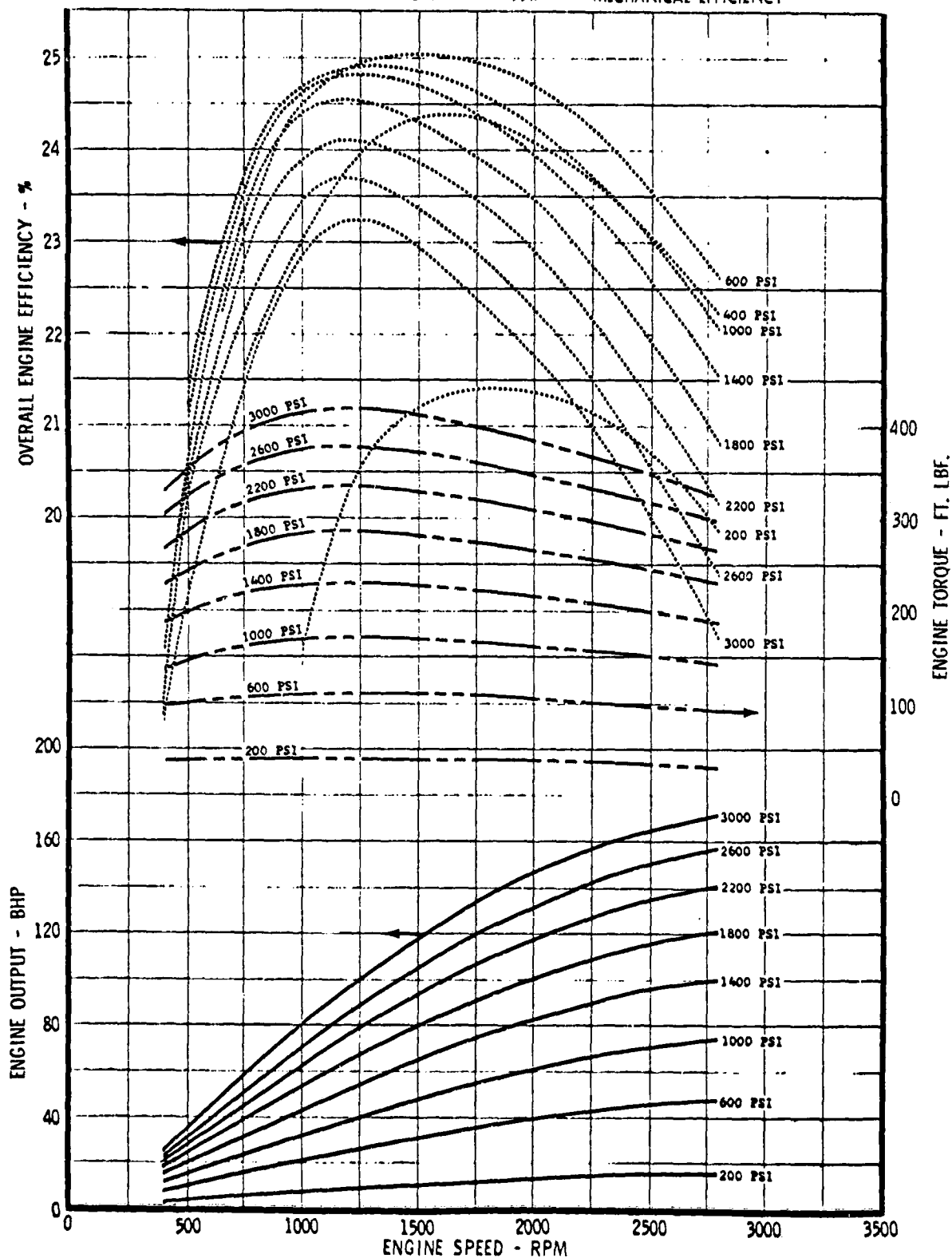

FIGURE 3-13.

4L23 CALCULATED PERFORMANCE
 BHP, TORQUE AND EFFICIENCY VS. ENGINE SPEED
 AT VARIOUS MEAN WORKING PRESSURES

ORIGINAL PAGE IS
 OF POOR QUALITY

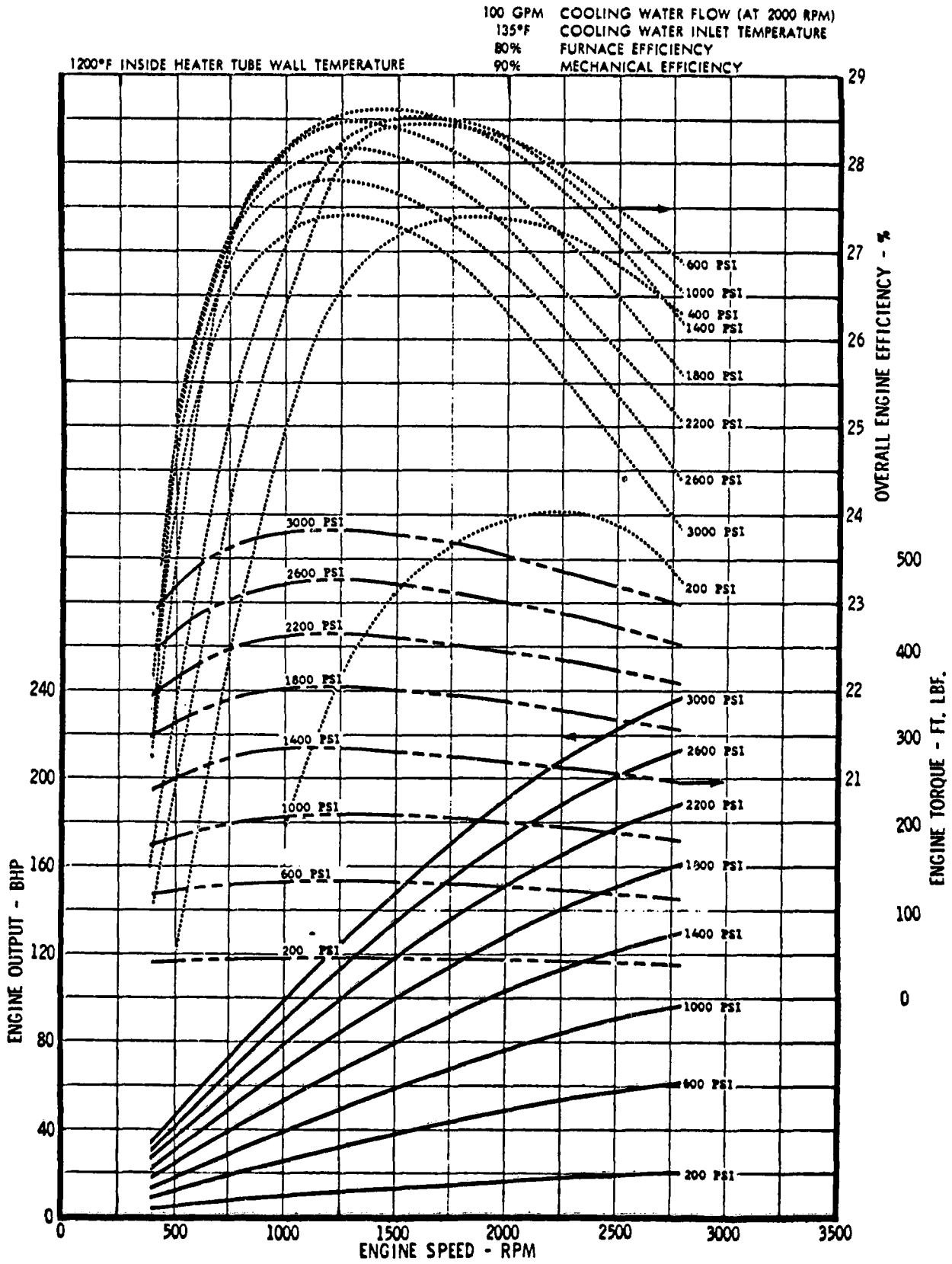

FIGURE 3-14.

4L23 CALCULATED PERFORMANCE

BHP, TORQUE AND EFFICIENCY VS. ENGINE SPEED
AT VARIOUS MEAN WORKING PRESSURES

OPTIMAL DESIGN
OF FOUR QUALITY

100 GPM COOLING WATER FLOW (AT 2000 RPM)
135°F COOLING WATER INLET TEMPERATURE
80% FURNACE EFFICIENCY
90% MECHANICAL EFFICIENCY

1400°F INSIDE HEATER TUBE WALL TEMPERATURE

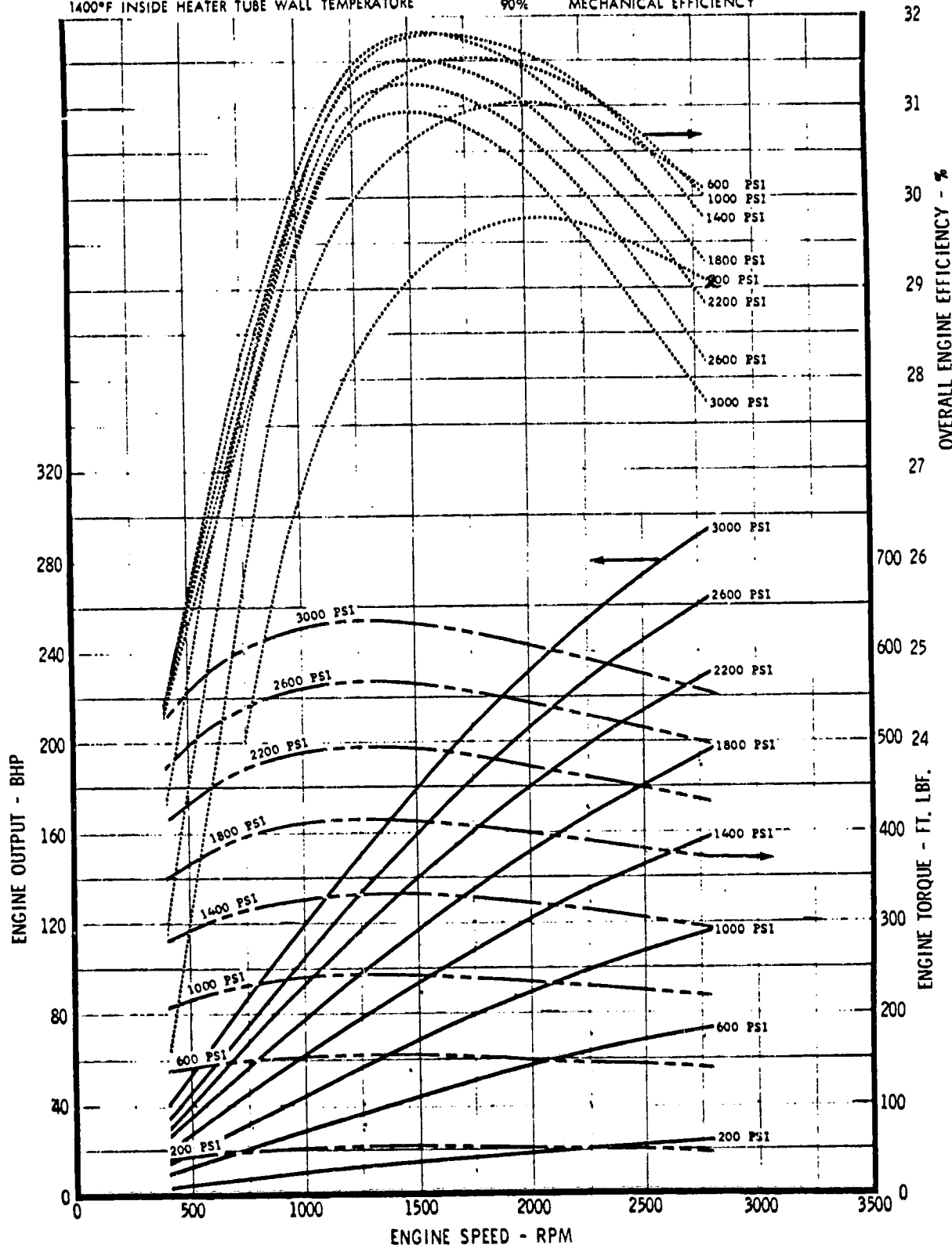

FIGURE 3-15.

ORIGINAL PRINTING
OF POOR QUALITY

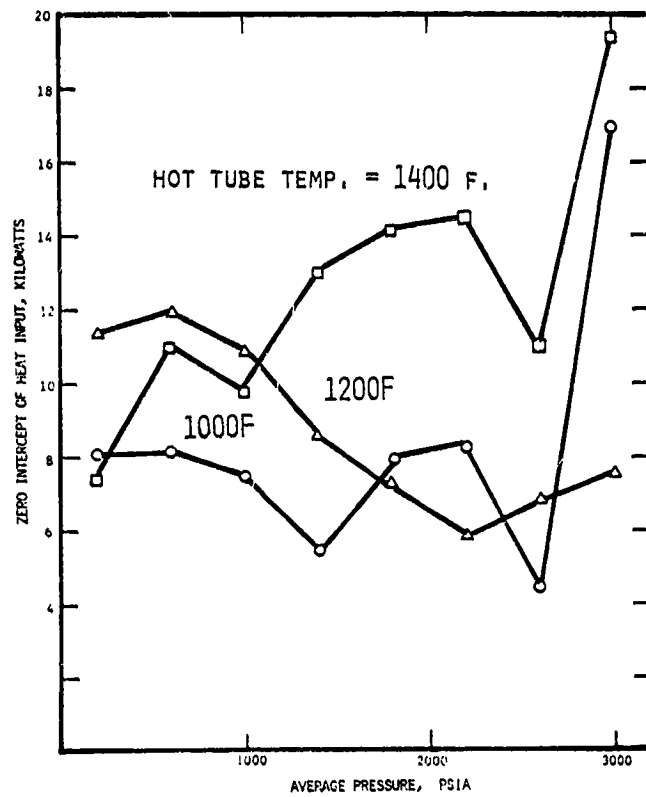
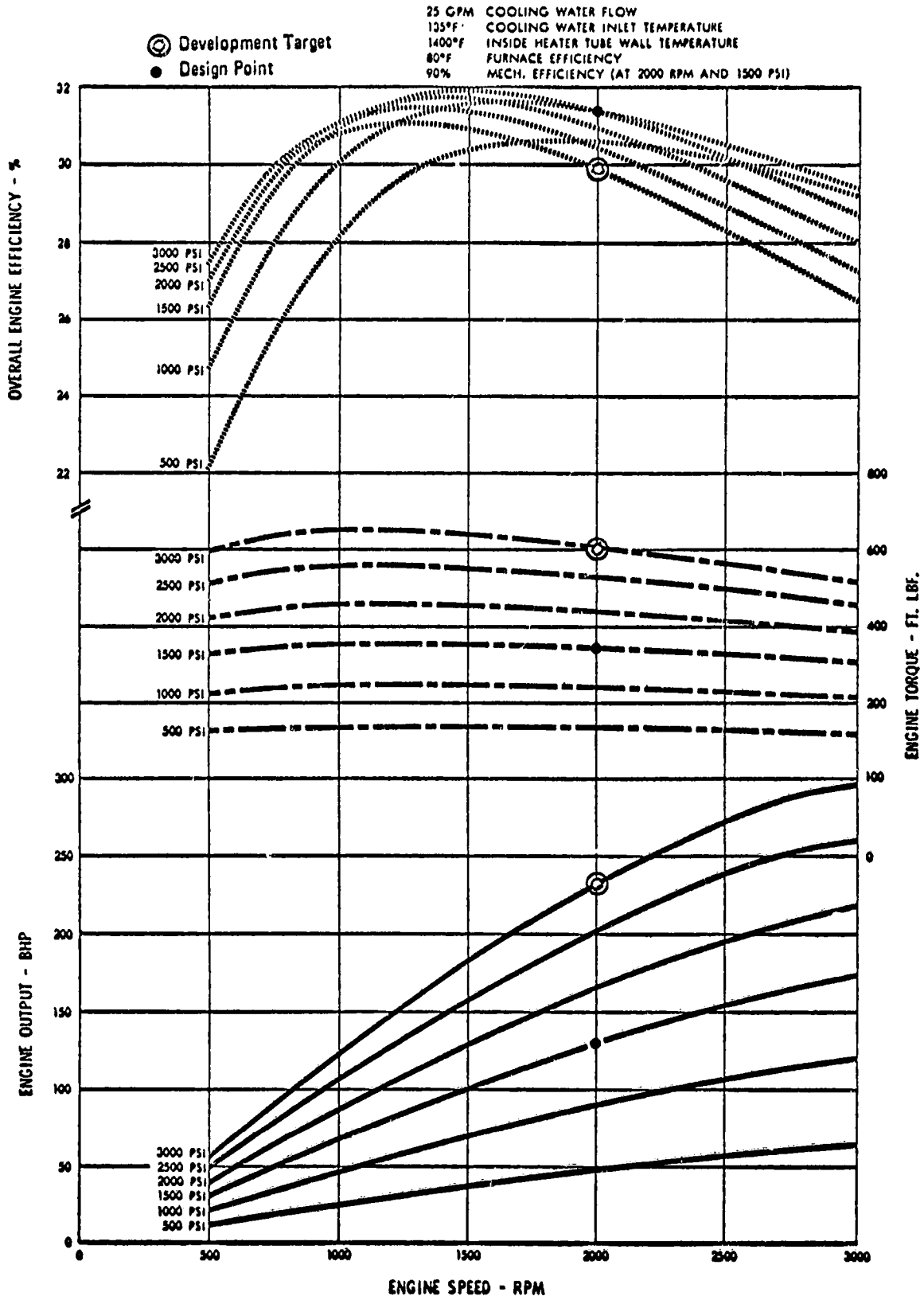

Figure 3-16. Calculated Zero Intercepts of Heat Input Vs. Frequency.

ORIGINAL PAGE 13
OF POOR QUALITY

CALCULATED PERFORMANCE COMPACT STIRLING RESEARCH ENGINE MODEL 4L23

Hydrogen Working Fluid at Various Mean Working Pressures



ENGINE SPEED - RPM

Figure 3-17

ORIGINAL PAGE IS
OF POOR QUALITY

Table 3-10. 4L23 Engine Dimension for the Purpose of Calculating Static Heat Conduction

Engine Cylinder

OD	=	~12.7 cm (5 in.)
ID	=	~10.2 cm (4 in.)
Length	=	22.6 cm (8.9 in.)
Number per engine	=	4

Hot Cap.

OD	=	10.211 cm (4.020 in.)
ID	=	9.45 cm (3.72 in.)
ΔT Length	=	10.03 cm (3.95 in.)
Number of Radiation Shields	=	3

Regenerator

Number per cylinder	=	6
Case Length (ΔT)	=	2.79 cm (1.1 in.)
Case ID	=	3.5 cm (1.38 in.)
Case OD (avg.)	=	4.32 cm (1.7 in.)
Matrix	=	Met Net .05 - .20
Thermal Conductivity of Matrix	=	0.017 w/cmC*

*78 bm, Section 6.006, page 7.

each cylinder. Figure 3-16 quotes 100 GPM cooling water flow which is for all 4 cylinders and is proportional to speed.

The same data given in Figures 3-13 to 3-15 are replotted in the form of "muschel" diagrams in Figures 3-18 to 3-20. These are included because this is the common way engines are described today.

ORIGINAL PAGE IS
OF POOR QUALITY

4L23 CALCULATED PERFORMANCE

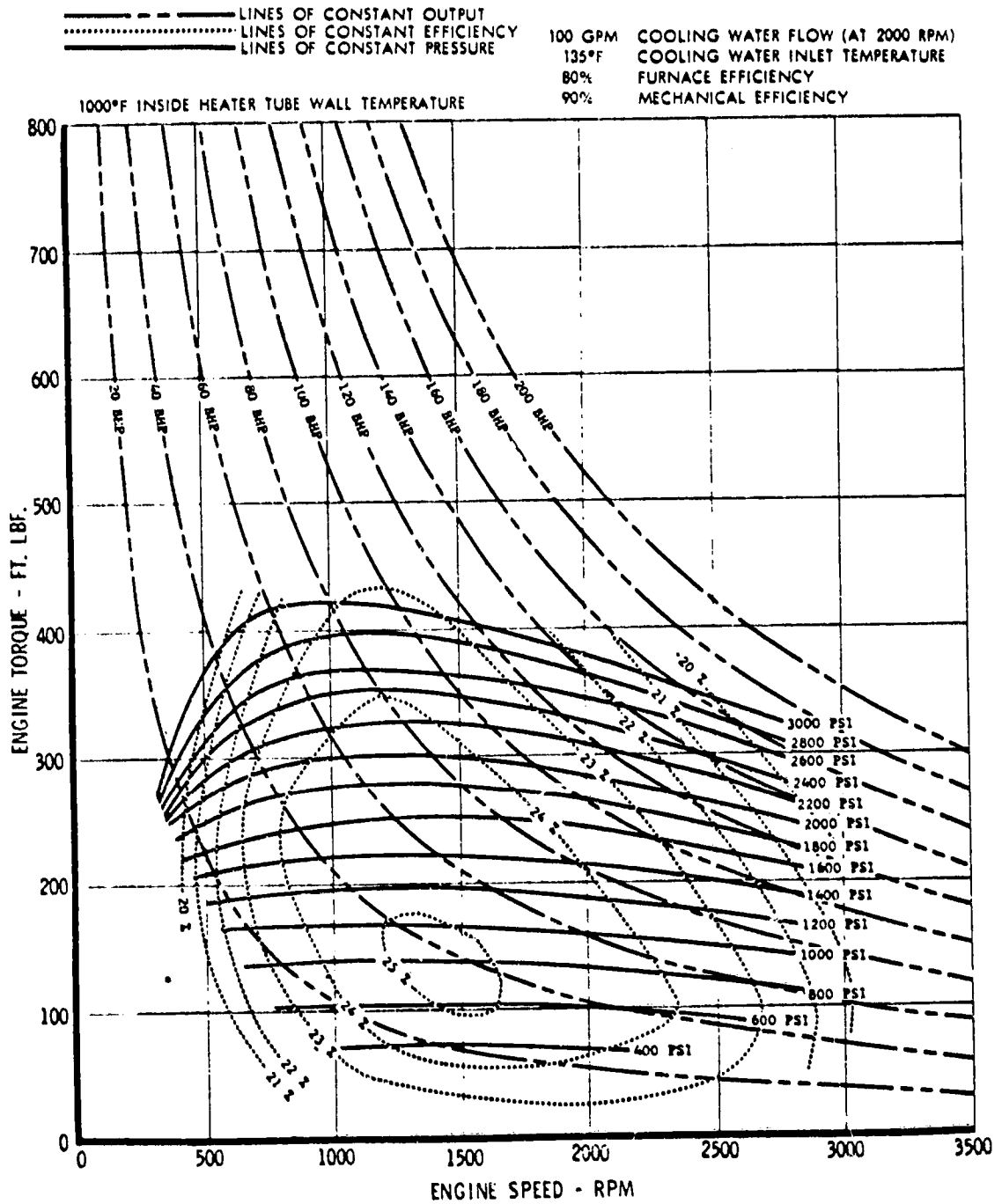

FIGURE 3-18

ORIGINAL PAGE IS
OF POOR QUALITY

4L23 CALCULATED PERFORMANCE

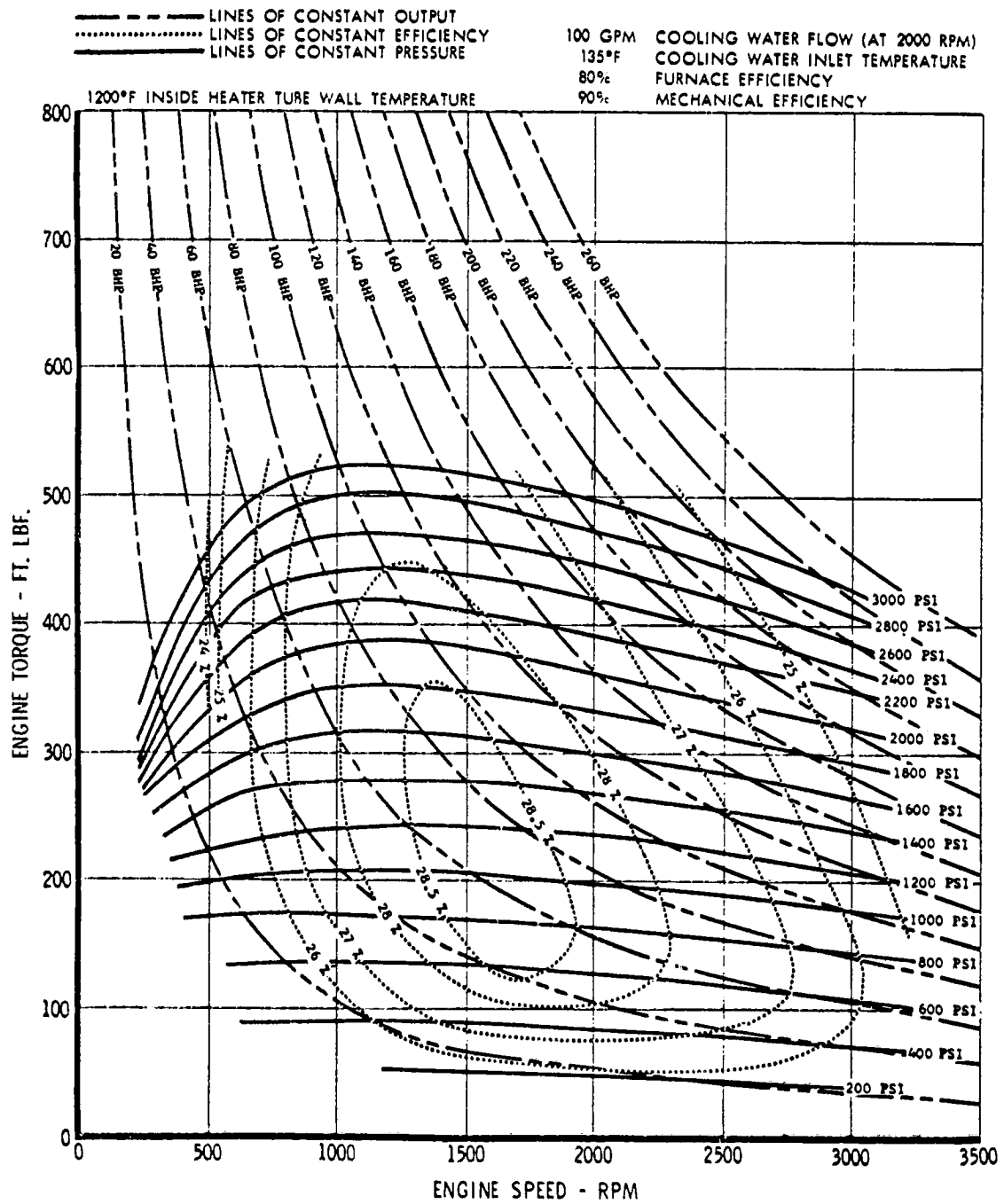

FIGURE 3-19

ORIGINAL QUALITY OF POOR QUALITY

4L23 CALCULATED PERFORMANCE

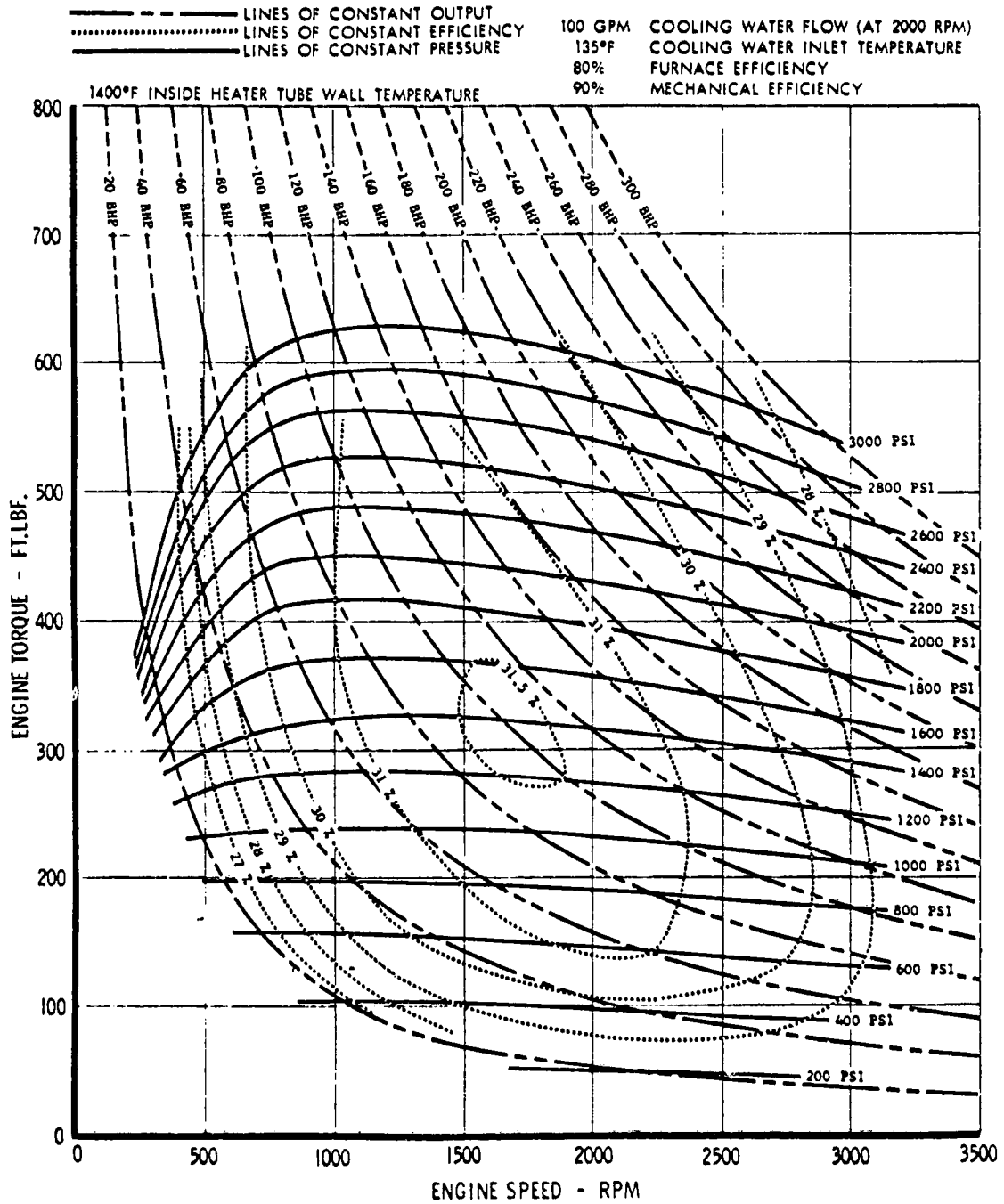

FIGURE 3-20

4. PARTIALLY DESCRIBED STIRLING ENGINES

In this section will be given as much information as available on complete well-engineered engines which have some information on displacement, operating speed, operating temperatures, power and efficiency, but not enough data so that they can be classified as fully described engines. Information given elsewhere in the Design Manual will be referred to instead of being duplicated. This information will inform the readers what the state-of-the-art of Stirling engines is.

4.1 The Philips 1-98 Engine

About 30 Philips engines of this type have been built. They are the Rhombic drive type with a single power piston and displacer. The power piston displacement is 98 cm^3 , and there is one power piston. Thus the name 1-98. The design of the heater, cooler and regenerator have not been disclosed. Probably there are many different kinds of 1-98 engines depending upon the intended use. Michels (76 e) has calculated the performance of the 1-98 engine for a variety of conditions. In each condition the heat exchangers of the engine are optimized for the best efficiency at each power point. Michels showed that for these optimized engines the indicated efficiency depends upon the heater temperature and cooler temperature and not upon the working gas used. Figure 4-1 shows this curve correctly labeled. Another way of describing the performance of the 1-98 engine is to relate the indicated efficiency to the Carnot efficiency for the particular heater and cooler temperature employed. Table 4-1 gives such information for the 1-98 engine. Table 4-2 gives similar computed information for the brake (shaft) efficiencies for the 1-98 Rhombic drive engine. These are correlated in Figure 4-2 in a way that might be applicable to other well-designed Stirling

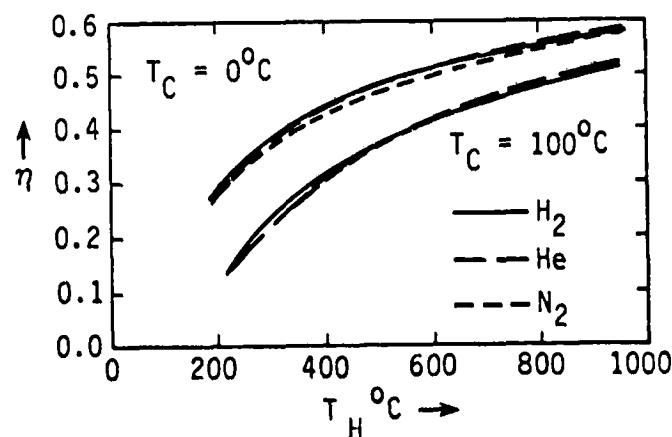

Figure 4-1. Indicated Efficiencies for Philips 1-98 Engine Vs. Heater Temperature T_H at Two Different Cooler Temperatures T_C . Engine Displacement 98 cm^3 .

ORIGINAL DESIGN
OF 1938 QUALITY

Table 4-1

Indicated Efficiencies of a
1-98 Rhombic Drive Philips Engine
(Reference 76 e)

Working Fluid	Heater Temp. C	Cooler Temp. C	Indicated Power at Maximum Efficiency Kilowatts	Indicated Efficiency %	Percent of Carnot Efficiency
H ₂	850	100	8	50	75
H ₂	400	100	1	32	72
H ₂	250	100	.35	18	63
He	850	100	6	50	75
He	400	100	1	30	67
He	250	100	.18	17	59
N ₂	850	100	1.5	49	73
N ₂	400	100	.35	31	70
N ₂	250	100	Negative	--	--
H ₂	850	0	10	57	75
H ₂	400	0	2.8	45	76
H ₂	250	0	1	34	71
He	850	0	8	58	77
He	400	0	2	42	71
He	250	0	.7	32	67
N ₂	850	0	2	55	73
N ₂	400	0	.48	42	71
N ₂	250	0	.18	33	69

Table 4-2

Computed Brake (Shaft) Efficiencies for
a 1-98 Rhombic Drive Phillips
Engine Optimized for Each Operating Point
(Reference 76 e)

Working Fluid	Heater Temp. C	Cooler Temp. C	Shaft Power at Max. Eff. K. watt	Brake* Eff. % $\frac{W_B}{Q}$	% of Carnot Eff. $\frac{\eta_B}{\eta_C}$	Mechanical Efficiency $\frac{W_B}{W_I}$
H ₂	850	100	4	40	60	0.80
H ₂	400	100	0.8	25	56	0.78
H ₂	250	100	0.12	12	42	0.67
He	850	100	4	40	60	0.80
He	400	100	0.4	24	54	0.80
He	250	100	0.1	12	42	0.71
N ₂	850	100	1.0	43	64	0.88
N ₂	400	100	0.2	26	58	0.84
N ₂	250	100	Negative	--	--	-----
H ₂	850	0	6	47	62	0.82
H ₂	400	0	1.8	36	61	0.80
H ₂	250	0	0.7	26	54	0.76
He	850	0	5	46	61	0.79
He	400	0	1.2	36	61	0.86
He	250	0	0.4	27	56	0.84
N ₂	850	0	1.3	49	65	0.89
N ₂	400	0	0.4	38	64	0.90
N ₂	250	0	0.17	29	61	0.88

*without auxiliaries

ORIGINAL PAGE IS
OF POOR QUALITY

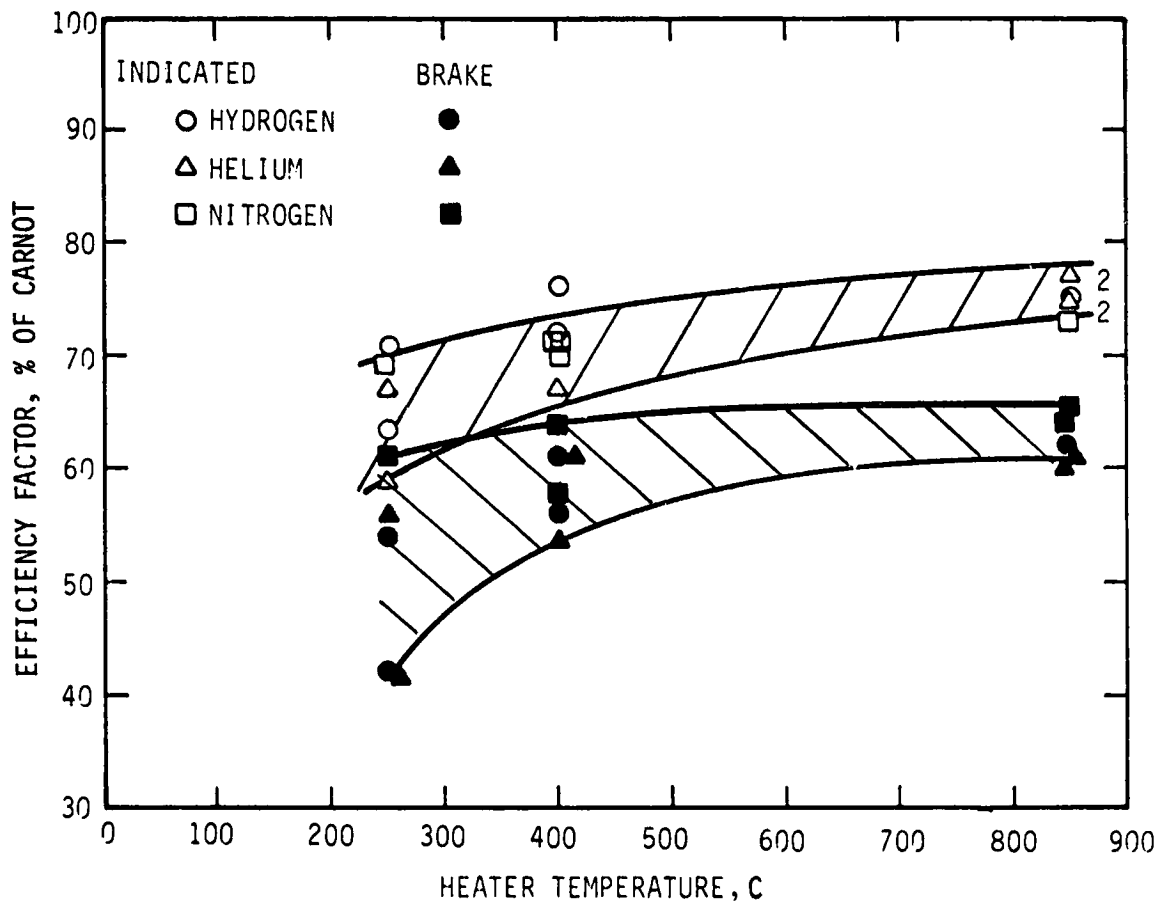

Figure 4-2. Indicated and Brake Efficiency Factors for Optimized Philips 1-98 Engines (76 e).

engines. Note that when the efficiency is related to the Carnot efficiency for the temperatures over which the engine operates, this fraction of Carnot goes from 65 ± 6 percent at 250 C heater temperature to 75 ± 2 percent at 800 C heater temperature for the indicated efficiency. Lower numbers are shown for the brake efficiency which shows that the mechanical efficiency for this machine is generally about 80 percent (See Table 4-2).

4.2 Miscellaneous Engines

The size, weight, power and efficiency for a number of other engines mentioned in the literature are presented in Tables 4-3 and 4-4. It should be emphasized that the powers given are the maximum efficiency operating point, not the maximum power operating point. Note that the brake efficiencies range from 46 to 69 percent of Carnot.

Finegold and Vanderbrug (77 ae) used the data from the Philips 4-215 engine to conclude that the maximum brake efficiency is 52 percent of the Carnot efficiency. This factor is based upon 1975 data. Improvements have been made since then.

Net brake efficiency--the information presented in Tables 4-3 and 4-4 is for engines without auxiliaries. In Table 4-5 the performance and efficiencies are given for the engine powering all auxiliaries needed to have the engine stand alone. This includes cooling fan, the blower, the atomizer, the fuel burner and the water pump for the radiator. Table 4-5 shows that the maximum net brake efficiency is 38 to 65 percent of Carnot.

4.3 Early Philips Air Engines

The early antique Stirling engines, which were called air engines, were very ponderous, operated at a slow speed and were very heavy for the amount of power that they produced. They were operated at or near 1 atm pressure. In the late forties and early fifties, Philips developed a high speed air engine which was very much better than the old machines, but still was not competitive for the times. Philips never published any information on their early air engines. However, quite a number of these early machines were made and they were submitted for evaluation by at least one external laboratory. Even though they were not considered by Philips to be competitive, in today's world where the multi-fuel capability of the Stirling is much more keenly appreciated, the simplicity, the reasonable size for small scale stationary power using solid fuel and the reasonable efficiency of these early Philips air engines are attractive. The best documented account of one of these early air engines is given by Walker, Ward and Slowley (79 ao).

In the early Philips program, development of Stirling engines was concentrated on small engines of 1 KW or less. One machine was sufficiently developed to be made in quantities of several hundred. It was never put into regular production, however, and in the late 1950's, Philips disposed of the entire stock, largely to universities and technical institutes throughout Europe. A cross section of this engine is shown in Figure 4-3. Scaling of this drawing shows that the power piston has a diameter of about 4.8 cm and a stroke of about 3 cm, giving a displacement for the power piston of about 50 cm^3 . Twin connecting rods run

Table 4-3

Maximum Brake Efficiencies for
Various Stirling Engines
(Reference 1975 t)

Engine Designation Manufacturer	Working Fluid	Mean Pressure	Heater Temp	Cooler Temp	Maximum Efficiency Operating Point			Dimension cm wt, kg	Engine Type No. of cylinders	
					MPa psia	C F	C F			KW BHP
Prototype United Stirling	H ₂	$\frac{14.5}{2100}$	$\frac{691}{1275}$	$\frac{71}{160}$	$\frac{35}{26}$	2000	30	47	---	$\frac{2 \text{ Piston}}{4}$
4-235 Prototype Philips	He	$\frac{22.1}{3200}$	$\frac{683}{1260}$	$\frac{43}{108}$	$\frac{175}{130}$	1800	31	46	$\frac{125 \times 52 \times 110}{557}$	$\frac{\text{Piston-Displ.}}{4}$
40 HP Prototype Philips	H ₂	$\frac{14.2}{2058}$	$\frac{649}{1200}$	$\frac{16}{60}$	$\frac{23}{17}$	725	38	55	---	$\frac{\text{Piston-Displ.}}{4}$
Anal. Ph. 1 United Stirling	H ₂	$\frac{14.5}{2100}$	$\frac{719}{1325}$	$\frac{71}{160}$	$\frac{76}{57}$	1200	35	54	$\frac{113 \times 82 \times 95}{651}$	$\frac{2 \text{ Piston}}{8}$
4-400 MAN-MWM	He	$\frac{10.8}{1570}$	$\frac{633}{1170}$	$\frac{41}{105}$	$\frac{88}{65}$	1000	32	49	$\frac{153 \times 70 \times 131}{---$	$\frac{\text{Piston-Displ.}}{4}$

*without auxiliaries

Table 4-4

Maximum Brake Efficiencies for
Various Stirling Engines

Engine Designation	Working Fluid	Mean Pressure	Heater Temp	Cooler Temp	Maximum Efficiency Operating Point			Dimension cm	Engine Type	
					KW BHP	RPM	Brake* Eff. %			
GPU-3 General Motors Research (Ref. 69 f)	H ₂	$\frac{6.9}{1000}$	$\frac{816}{1500}$	$\frac{10}{50}$	$\frac{8.1}{9.5}$	2000	39	53	28 x 29 x 27	$\frac{\text{Piston-Displ.}}{1}$
	H ₂	$\frac{4.1}{600}$	$\frac{816}{1500}$	$\frac{10}{50}$	$\frac{6.0}{8}$	2500	38.5	52	28 x 29 x 27	$\frac{\text{Piston-Displ.}}{1}$
	H ₂	$\frac{2.8}{400}$	$\frac{816}{1500}$	$\frac{10}{50}$	$\frac{4.5}{6}$	3000	37	50	28 x 29 x 27	$\frac{\text{Piston-Displ.}}{1}$
	H ₂	$\frac{1.4}{200}$	$\frac{816}{1500}$	$\frac{10}{50}$	$\frac{2.2}{3}$	3400	32.5	49	28 x 29 x 27	$\frac{\text{Piston-Displ.}}{1}$
30-15 Philips (Ref. 69 f)	H ₂	$\frac{10.3}{1500}$	$\frac{816}{1500}$	$\frac{10}{50}$	$\frac{19.4}{23}$	1100	51	69	44 x 43 x 86	$\frac{\text{Rinia}}{4}$
	H ₂	$\frac{8.3}{1200}$	$\frac{816}{1500}$	$\frac{10}{50}$	$\frac{17.2}{23}$	1200	50	68	44 x 43 x 86	$\frac{\text{Rinia}}{4}$
	H ₂	$\frac{6.2}{900}$	$\frac{816}{1500}$	$\frac{10}{50}$	$\frac{14.9}{20}$	1400	49	67	44 x 43 x 86	$\frac{\text{Rinia}}{4}$
	H ₂	$\frac{4.1}{600}$	$\frac{816}{1500}$	$\frac{10}{50}$	$\frac{11.2}{15}$	1450	48	65	44 x 43 x 86	$\frac{\text{Rinia}}{4}$
	H ₂	$\frac{2.1}{300}$	$\frac{816}{1500}$	$\frac{10}{50}$	$\frac{6.0}{8}$	1800	45	61	44 x 43 x 86	$\frac{\text{Rinia}}{4}$

* without auxiliaries

ORIGINAL PAGE IS
OF POOR QUALITY

Table 4-4 (continued)

Engine Designation Manufacturer	Working Fluid	Mean Pressure MPa psia	Heater	Cooler	Maximum Efficiency Operating Point			Dimension cm wt, kg	Engine Type No. of cylinders	
			Temp C F	Temp C F	KW BHP	RPM	Brake Eff. %			% of Carnot
150 HP General Motors Research (Ref. 69 f)	H ₂	$\frac{10.3}{1500}$	$\frac{816}{1500}$	$\frac{10}{50}$	$\frac{97}{130}$	1400	44	60	94 x 50 x 84	$\frac{\text{Rinia}}{4}$
	H ₂	$\frac{8.3}{1200}$	$\frac{816}{1500}$	$\frac{10}{50}$	$\frac{78}{105}$	1500	44	60	94 x 50 x 84	$\frac{\text{Rinia}}{4}$
	H ₂	$\frac{6.2}{900}$	$\frac{816}{1500}$	$\frac{10}{50}$	$\frac{75}{100}$	1800	44	60	94 x 50 x 84	$\frac{\text{Rinia}}{4}$
	H ₂	$\frac{4.1}{600}$	$\frac{816}{1500}$	$\frac{10}{50}$	$\frac{52}{70}$	2000	43	59	94 x 50 x 84	$\frac{\text{Rinia}}{4}$
	H ₂	$\frac{2.1}{300}$	$\frac{816}{1500}$	$\frac{10}{50}$	$\frac{30}{40}$	2000	40	54	94 x 50 x 84	$\frac{\text{Rinia}}{4}$
10-36 General Motors Research (Ref. 74 c)	H ₂	$\frac{6.9}{1000}$	$\frac{760}{1400}$	$\frac{24}{75}$	--	1800	26.3	28	$\frac{36 \times 36 \times 72}{58^*}$	$\frac{\text{---}}{1}$
4S1210 General Motors Research for Navy (Ref. 74 c)	H ₂	$\frac{10.3}{1500}$	$\frac{650}{1202}$	$\frac{33}{90}$	--	750	35	52	$\frac{188 \times 102 \times 193}{2300^{**}}$	$\frac{\text{---}}{4}$
1-S1050 General Motors Electro Motive Div. (Ref. 74 c)	H ₂	$\frac{9.9}{1436}$	$\frac{688}{1270}$	$\frac{38}{100}$	--	1200	28	30	$\frac{91 \times 70 \times 165}{1000^{**}}$	$\frac{\text{---}}{1}$
2W17A General Motors Electro Motive Div. (Ref. 74 c)	H ₂	$\frac{7.6}{1100}$	$\frac{593}{1100}$	$\frac{38}{100}$	--	900	28.4	31	$\frac{92 \times 158 \times 215}{1700^{**}}$	$\frac{\text{---}}{2}$

*Bare engine with preheater.

** Without flywheel.

ORIGINAL PAGE IS
OF POOR QUALITY

Table 4-5

Maximum Net Brake Efficiencies for
Various Stirling Engines

Engine Designation Manufacturer	Working Fluid	Mean Pressure MPa psia	Heater Temp C F	Cooler Temp C F	Maximum Efficiency Operating Point			Dimension cm wt, kg	Engine Type No. of cylinders	
					KW BHP	RPM	Brake* Eff. % % of Carnot			
4-215 Philips (Ref. 75 t)	H ₂	$\frac{19.6}{2850}$	$\frac{705}{1300}$	$\frac{80}{175}$	$\frac{56}{75}$	1100	32	50	--- 340	Rinia 4
Anal. Opt. Des. Philips (Ref. 75 T)	He	$\frac{22.1}{3200}$	$\frac{\sim 760}{\sim 1400}$	$\frac{71}{160}$	$\frac{75}{100}$	500	43	65	$\frac{149 \times 131 \times 67}{---}$	Piston-Displ. 4
GPU-3 General Motors (Ref. 75 t)	H ₂	$\frac{6.89}{1000}$	$\frac{760}{1400}$	$\frac{83}{180}$	$\frac{\sim 5.2}{\sim 7}$	1900	26.5	40	$\frac{40 \times 40 \times 73}{75}$	Piston-Displ. 1
P-40 United Stirling (Ref. 77 bj)	H ₂	$\frac{15.2}{2200}$	$\frac{721}{1330}$	$\frac{52}{125}$		1250	35	52	--- ---	Double Acting Dual Crank 4
Model IV M/I/Sunpower (Ref. 77 s)	He	$\frac{5.0}{725}$	$\frac{594}{1100}$	$\frac{23}{73}$		960	25	38	--- ---	Free Piston Free Displ.
TMG(D3) Farwell (Ref. 75 1)	He	$\frac{0.1}{14.5}$	$\frac{594}{1101}$	$\frac{40}{104}$	$\frac{0.0375}{0.05}$	6000 cycles per min.	16.9	26.5	--- ---	Oscillating diaphragm: sprung displacer 1

* with auxiliaries

QUALITY IS
OF YOUR QUALITY

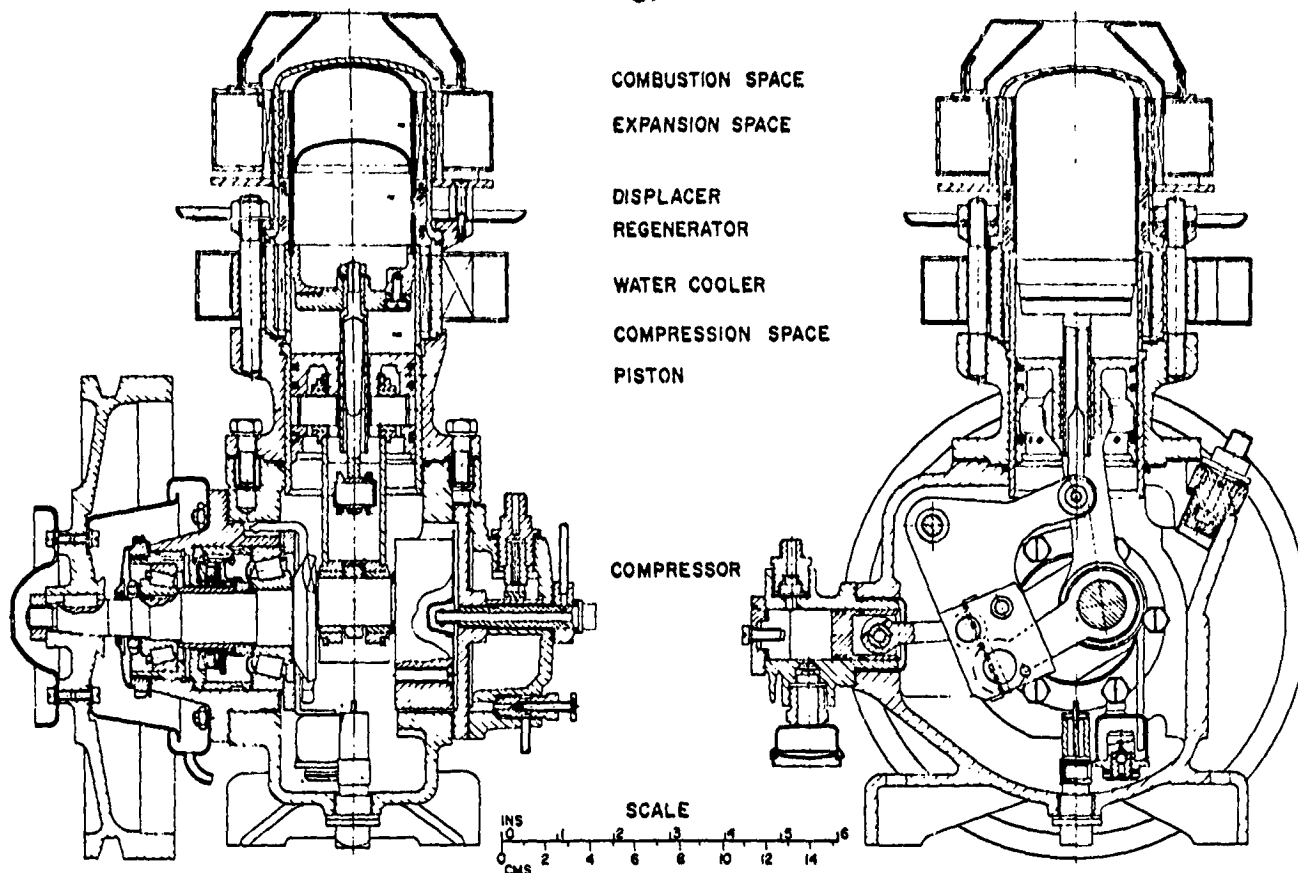

Figure 4-3. Cross-section of Philips Type MP 1002 C Stirling Cycle Air Engine.

from the power piston to the crank shaft. In between these rods a flexible connecting rod drives the displacer through a bell crank linkage to a connecting rod radiating from the crank at about 90° from the main power crank (See Figure 4-3). This bell crank also operates an air compressor needed to keep the engine pumped up. Figure 4-4 shows the same engine installed in an electric power generating package which was made in a self-contained unit designed for 200 W (e) output. This unit incorporated a gasoline or kerosene fuel tank, a cooling fan, and engine controls by mean pressure. In the tests done by Walker, Ward and Slowley at the University of Bath in Somerset, England, the engine was removed from the frame of the generator set and was mounted on a test rig. The engine was coupled to an electric swing-field dynamometer capable of acting as a generator or as a motor. The combustion equipment was modified to allow the use of liquified petroleum gas and air rather than the normal liquid kerosene or gasoline as fuels. Provision was made for accurate measurement of the gas-air consumption and engine shaft speed and brake power input or output of the engine.

The principle modification of the engine was to substitute water cooling for the original air cooling around the compression space of the cylinder. The

ORIGINAL PAGE IS
OF POOR QUALITY

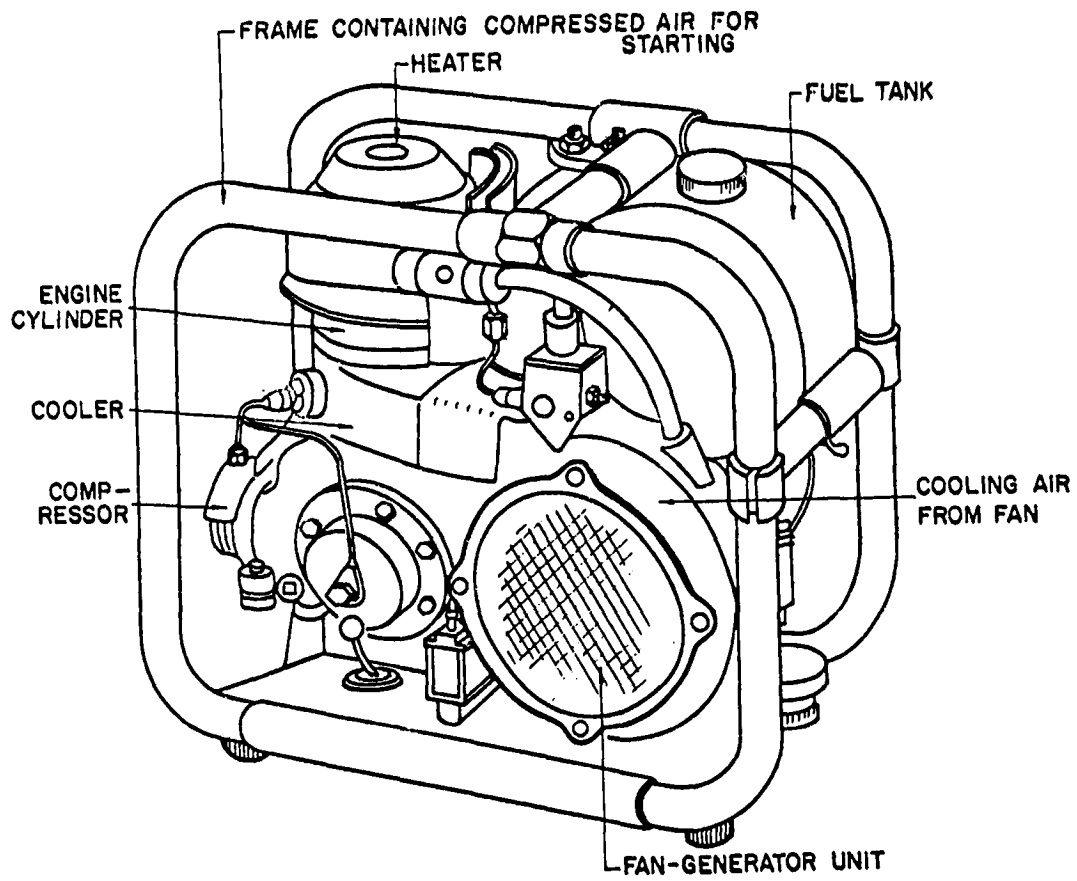

Figure 4-4. Stirling Cycle Air Engine/Generator Set.

temperature and flow rate of cooling water was measured. Chromel-alumel thermocouples were brazed to the engine cylinder head to measure the nominal cylinder heater head temperature. In normal practice the air acting as a working fluid is compressed by a small crank-driven air compressor before delivery to the working space. For the tests reported here provision was made for the air pressure to be supplied and controlled from laboratory air supplies.

In the motoring tests the working space was connected to a large tank thereby increasing the internal dead volume of the engine by a large factor. Therefore, during operation there was no substantial change in the pressure level of the working fluid throughout the cycle. Therefore, the work absorbed by the engine during these motoring tests was due to fluid friction and mechanical friction, the thermodynamic work being made essentially negligible by virtue of the large dead volume. Tests were run with this engine at 1200, 1400, 1600 and 1800 rpm. At each speed the engine performance was observed with cylinder head temperatures of 600, 700, 800 and 900 C with mean working space pressures of 4.14, 5.52, 6.90, 8.28, 9.66 and 12.41 bar. In the motoring tests measurements were made at 800, 1000, 1200 and 1400 rpm. Mean working space pressures of 1.00, 5.25, 8.28, 11.03 and 12.41 bar were made with the engine in all cases at ambient temperature. The results of some engine power tests are shown in Figures 4-5 and 4-6. The maximum power observed during these tests was approximately .48 KW. The specific fuel consumption was based upon the combustion of "Calor-Gas" with a lower heating value of 46,500 KJ/KG. A specific fuel consumption of 1 Kg/KW-hr is equivalent to an efficiency of 7.75 percent. It was claimed by the authors that at high cylinder head temperature, high working space pressure and low operating speed, an efficiency of about 10 percent was obtained. This efficiency was obtained with no attempt to preheat the incoming air with the hot exhaust gases. They felt that in many applications for small engines, efficiency is rarely as important as size, weight, reliability or capital costs.

The results of the motoring tests are given in Figure 4-7. This shows the motoring power required to drive the engine as a function of operating pressure at four different speeds. Figure 4-8 separates the data into mechanical friction loss, which is taken to be that at 0 operating pressure, and gaseous pumping power loss, which is seen to be proportional to gas pressure and only mildly dependent upon engine speed. By separating the losses in this way much of the seal drag which is dependent upon engine pressure is lumped with gaseous pumping power. Since the flow friction of the gas is proportional to the engine speed for laminar flow and to the engine speed squared for turbulent flow, much of the so-called gaseous pumping power is seal drag.

Tests of an even earlier Philips air engine are reported by Schrader of the U. S. Naval Experimenting Station (51 r). The engine is identified as a Philips model 1/4D external combustion engine, equipped as a portable generator set rated at 124.5 W or more. The engine was operated as continuously as possible for 1,015 hours. The engine had a bore of 2.5" and a stroke of the power piston of 1-7/32" and of the displacer 3/4". This gives a displacement of 98 cm³ for the power piston (the same as the later Philips 1-98 engine.) An external belt-operated air compressor was utilized. Sealing was with cast iron piston rings. Average specific fuel consumption was 4.66 lb/KW-hr (2.12Kg/KW-hr). The fuel was lead-free gasoline and the crank case was oil lubricated. The engine operated almost silently. A microphone installed 24 feet directly above

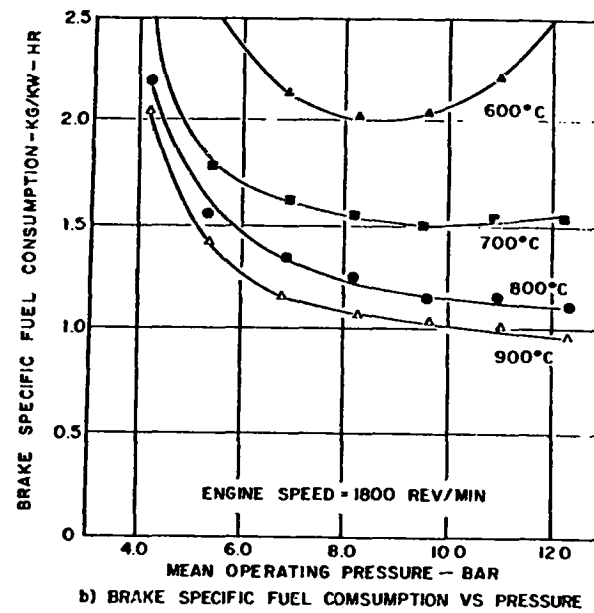
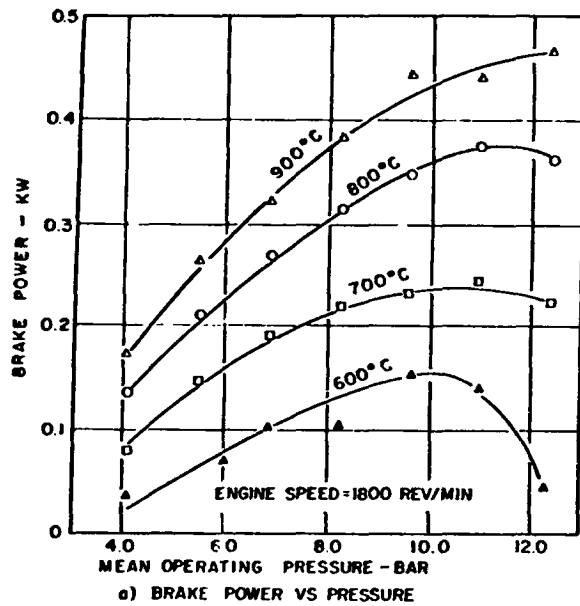

Figure 4-5. Brake Power and Brake Specific Fuel Consumption of Stirling Air Engine as a Function of Mean Operating Pressure at Four Different Cylinder Head Temperatures and a Constant Engine Speed of 1800 Revolutions per Minute.

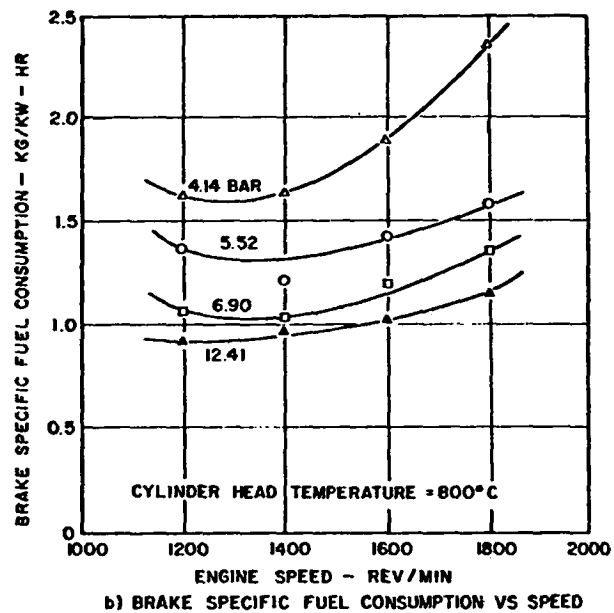
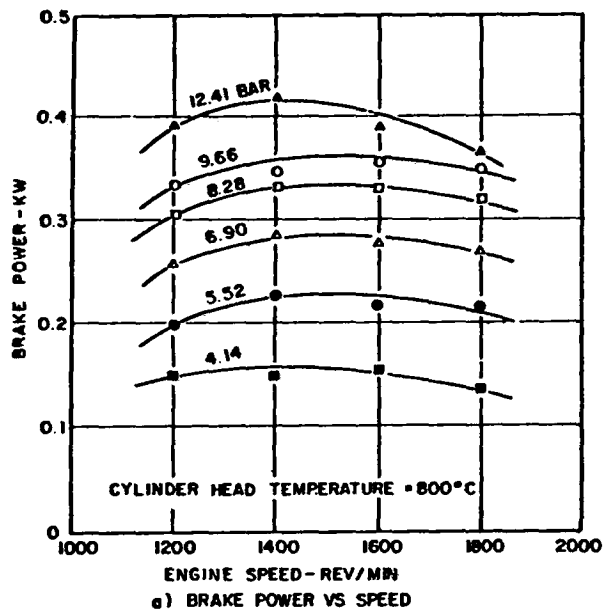

Figure 4-6. Brake Power and Brake Specific Fuel Consumption of Stirling Air Engine as a Function of Engine Speed at Different Mean Operating Pressures and a Constant Cylinder Head Temperature of 800°C.

ORIGINAL PAGE IS OF POOR QUALITY

ORIGINAL PAGE IS
OF POOR QUALITY

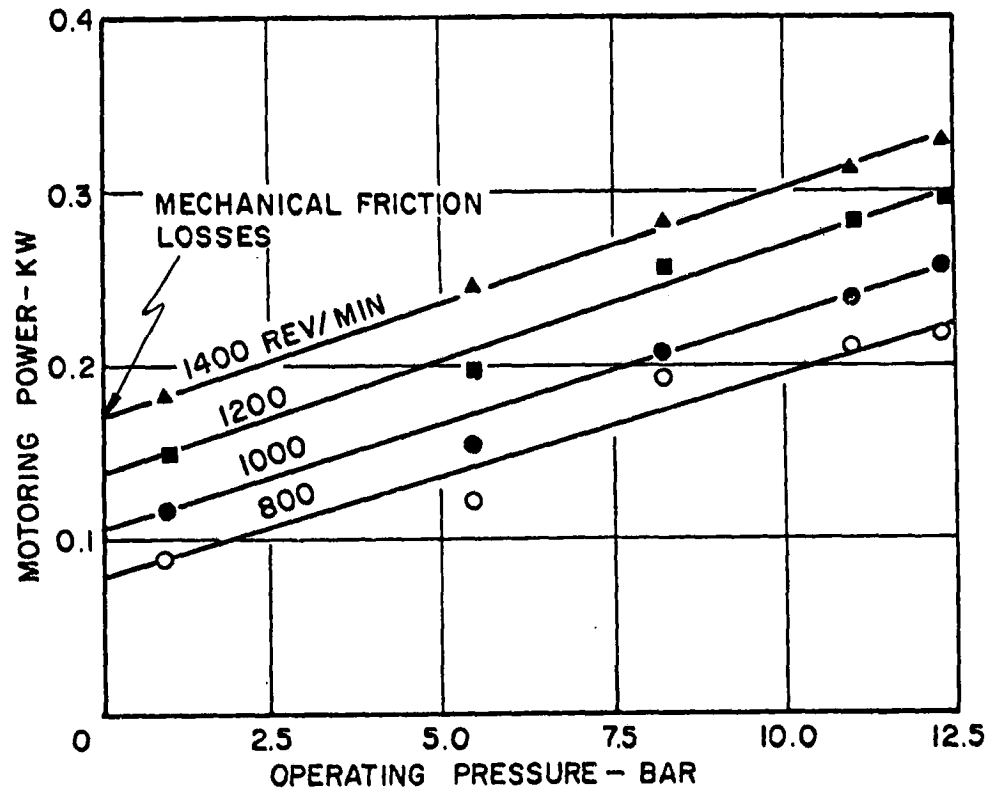
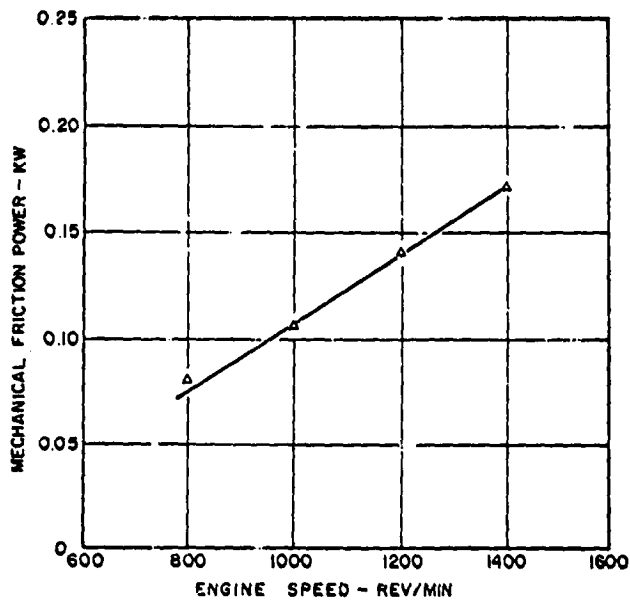
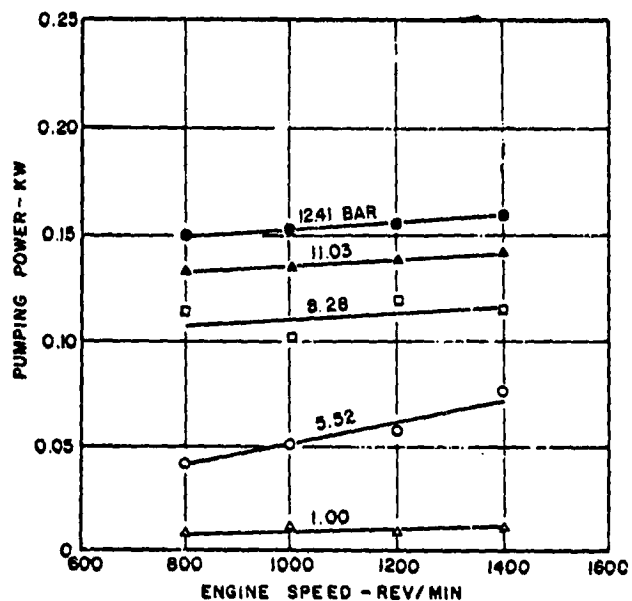

Figure 4-7. Required Motoring Power of Stirling Air Engine as a Function of Mean Operating Pressure at Four Different Speeds and With Engine Cylinder at Ambient Temperature.

ORIGINAL PAGE IS
OF POOR QUALITY



a) MECHANICAL FRICTION LOSS VS SPEED



b) GASEOUS PUMPING POWER VS SPEED

Figure 4-8. Possible Mechanical Friction and Gaseous Pumping Power of Stirling Air Engine as a Function of Engine Speed and Various Mean Operating Pressures.

the engine gave a rating of 58.9 db with the engine operating under load and 54.4 db with the engine off. The engine design was, as far as could be determined, similar to the one previously described in that the heat exchangers were multi-finned pressure vessels with many fins on the outside of the pressure vessel as well as on the inside. During the 1,015 hour endurance test the oil was scheduled to be changed and was changed every 150 hours. Chrome-plated piston rings were used for the 1,000 hour test. However, unplated rings had been used for a 600-hour test earlier and were also in good shape at the end of that period. Immediately prior to the post-trial disassembly inspection, a measurement of maximum power output was made. The heater head temperature was increased to 1150 F (nominal 1050 to 1075) and the crank case pressure was raised to 108 psi (nominal 85 to 88 psi). Under these conditions, the engine developed 185 W output as compared to the nominal 124.5 W rating. This was considered to be proof of the excellent condition of the engine at the time of the post-trial inspection. During the 1,015 hour test the engine had to be secured (stopped) many times for minor problems. Problems detailed in Reference 51 were heater head flameout, burner pressure cutout, air leaks, gasoline tube breakage, compressor suction valve failure, compressor discharge valve failure, crank case pressure regulator failure. These are all normal shake-down problems that could be fairly well eliminated with experience. The important thing to note is that the internal parts did not foul with decomposed oil deposits. Possibly these deposits burned off because of the pressurized air working fluid.

ORIGINAL PAGE IS
OF POOR QUALITY

4.4 The P75 Engine

United Stirling of Sweden (USS) plans to initiate limited production of their 75 kilowatt P-75 engine by 1981-82. They plan to reach production of 15,000 engines per year by the late 1980's (79 i). Figure 4-9 shows this engine. This engine has been installed in a light truck (78 aa). (See Figure 4-10.) The installation has been successful.

4.5 The P40 Engine

USS is planning a group of related engines--the P40, a 40 kw four cylinder double acting engine; the P75 (just mentioned), and the P150 which is a double P75. The P40 is not now scheduled for serial production; however, production of at least five is part of the DOE sponsored automobile engine programs administered by NASA-Lewis. Figure 4-11 shows the first one of these engines. Figure 4-12 shows this engine as it was installed in an Opel (78 cu). It has been a success as an initial demonstrator. Its drivability is good. It is quiet, but it shows no advantage in fuel economy because the engine, transmission and vehicle were not designed for one another (78 dt).

The second P40 engine has been tested by NASA-Lewis.

The third P40 is installed in a 1979 AMC Concord sedan. The sedan was modified by AMC. Installation of the engine was done by USS. The fourth P40 has been delivered to MTI for familiarization and evaluation. The fifth P40 is a spare.

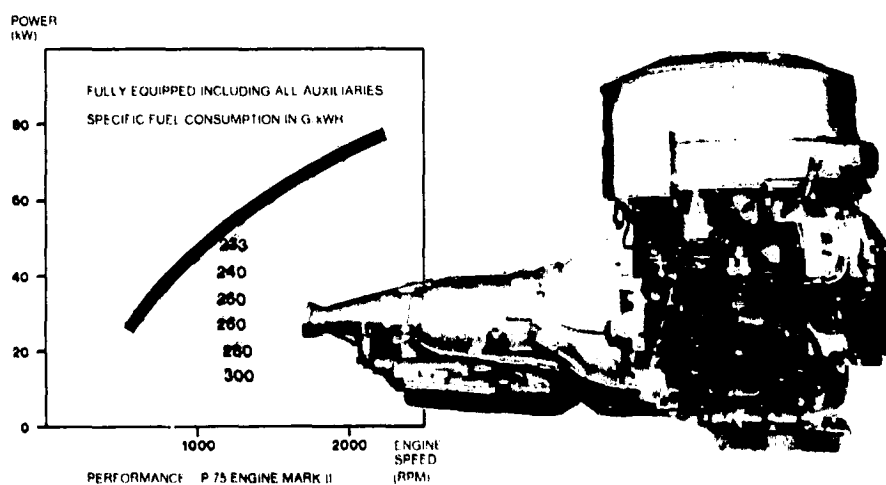

Figure 4-9. The United Stirling P75 Engine.

INSTALLATION IN VEHICLE

ORIGINAL PAGE IS
OF POOR QUALITY

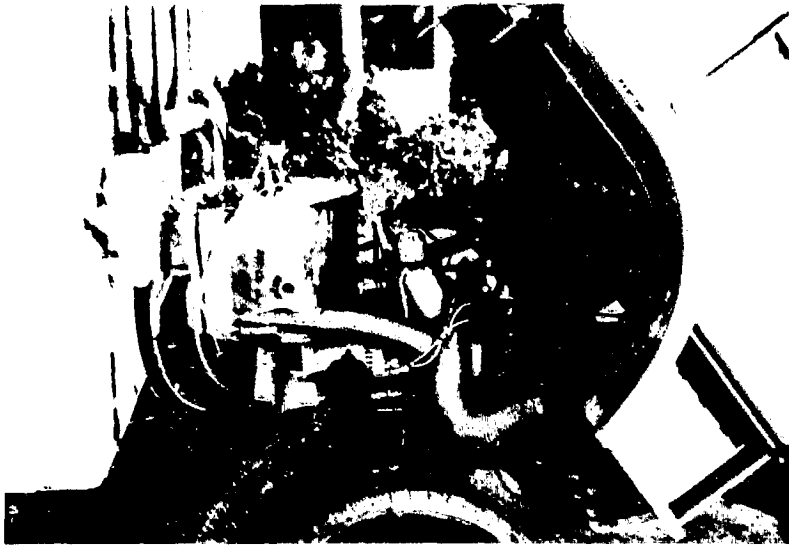

Figure 4-10. The P75 Engine Installed in a Light Truck.

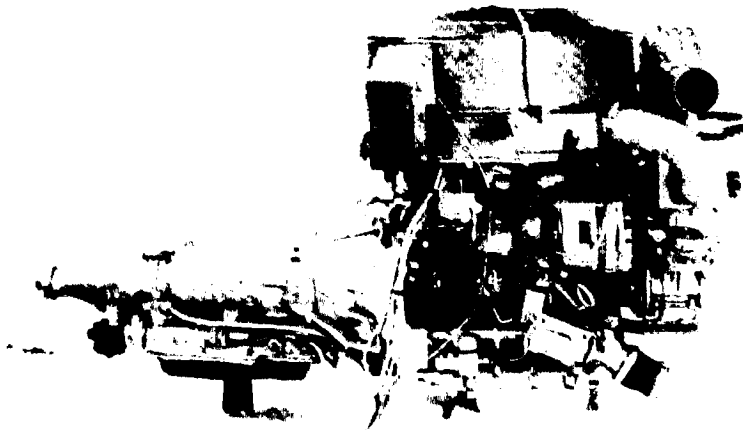

Figure 4-11. The P40 Engine.

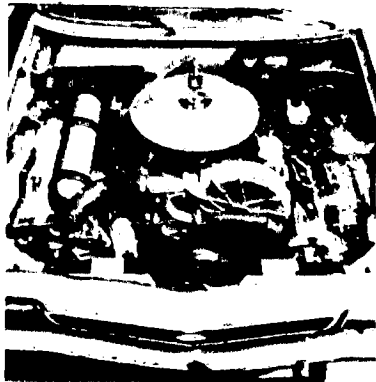

Figure 4-12. The P40 Engine Installed in an Opel.

5. REVIEW OF STIRLING ENGINE DESIGN METHODS

Other sections in this design manual describe what is going on in Stirling engines today. This section outlines the mathematics behind the Stirling engine process itself. Stirling engine cycle analysis will first be discussed. This subsection discusses what really goes on inside a Stirling engine starting out with the most simple assumptions and then progressing to more and more realistic assumptions. This subsection is the basis for the subsequent three subsections that discuss first-order design methods, second-order design methods and third-order design methods.

First-order design methods start with limited information and calculate power output and efficiency for a particular size engine. Use of the first-order method assumes that others have or will actually design the Stirling engine. First-order analysis is for systems engineers who want to quickly get a feeling for the capability of a Stirling engine.

Second-order design methods take all aspects of the Stirling engine into account and are for those who intend to design a new Stirling engine. A wide spectrum of methods falls under the heading of second-order analysis. In second-order analysis it is assumed that a relatively simple Stirling engine cycle analysis can be used to calculate the basic power output and heat input. It further assumes that various power losses can be deducted from the power output. These power losses are assumed to be calculable by simple formulas and do not interact with other processes. It is further assumed that the separate heat losses can be calculated by simple formula and are addable to the basic heat input. It is further assumed that each one of these heat losses is independent of the others and there is no interaction.

Third-order design analysis is what is generally called nodal analysis. The engine is simulated by dividing it up into a number of sections, called nodes. Equations are written which express the conservation of heat, mass, momentum for each node. These equations are programmed into a digital computer and the engine is simulated starting with an arbitrary initial condition and going until the cycle repeats with a desired degree of accuracy. For those designers who are embarking on the original design of a Stirling engine, the choice must be made between second- and third-order design methods. Generally, as the complexity and therefore the cost of computation increases, the accuracy and general applicability of the result should also increase. However, the state of information on Stirling engine design is still highly incomplete. One cannot draw a graph of computation costs versus accuracy of result and place the different computation methods upon it.

5.1 Stirling Engine Cycle Analysis

In this subsection on cycle analysis the basic thermodynamics of a Stirling engine will be explained and the effect of some necessary complications will be assessed. The thermodynamic definition of a Stirling cycle is isothermal compression and expansion and constant volume heating and cooling, 1, 2, 3, 4, 1 in Figure 5-1.

The thermodynamic definition of an Ericsson cycle is isothermal compression and expansion and constant pressure heating and cooling, 1, 2', 3, 4', 1 in Figure 5-1. This Ericsson cycle encompasses more area than the Stirling cycle and therefore produces more work. However, the volumetric displacement is larger, therefore, the engine is larger. There is a modern pumping engine concept which approximates this cycle (73 p). The early machines built by John Ericsson used valving to attain constant pressure heating and cooling (59 c), thus the cycle name.

The thermodynamic definition of the Otto cycle is adiabatic compression and expansion and constant volume heating and cooling, 1, 2'', 3, 4'', 1 in Figure 5-1. The reason this cycle is mentioned is that the variable volume spaces in a Stirling engine are usually of such size and shape that their compression and expansion is essentially adiabatic since little heat can be transferred to the walls during the process of compression or expansion. An internal combustion engine approximates the Otto cycle. In real Stirling machines, a large portion of the gas is in the dead volume which is compressed and expanded nearly isothermally so the loss of work per cycle is not as great as shown.

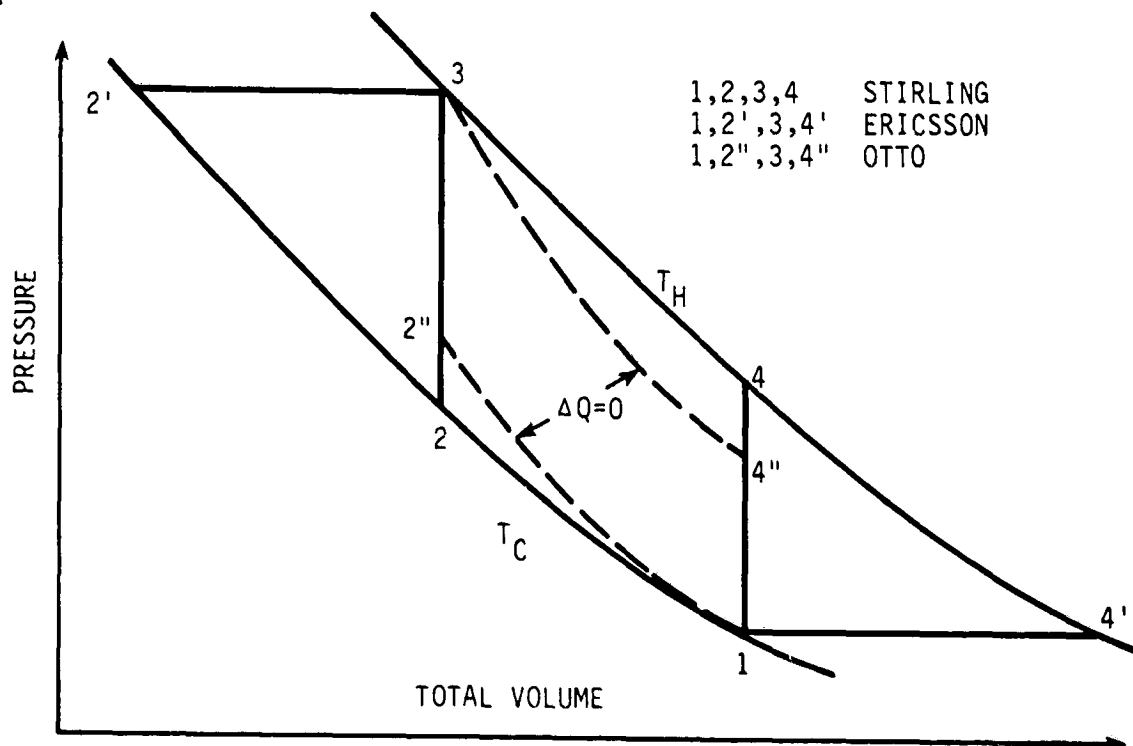

Figure 5-1. Theoretical Stirling, Ericsson and Otto Cycles.

ORIGINAL PAGE IS
OF POOR QUALITY

In Section 5.1 discrete processes of compression, heating, expansion and cooling will be considered first. Numerical examples will be used to make the processes clearer. The section starts with the simplest case and proceeds through some of the more complicated cases. In the later parts of Section 5.1 cycles will be considered where the discrete processes overlap as they do in a real engine.

5.1.1 Stirling Cycle, Zero Dead Volume, Perfect Regeneration

The Stirling cycle is defined as a heat power cycle using isothermal compression and expansion and constant volume heating and cooling. Figure 5-2 shows such a process. Specific numbers are being used to make the explanations easier to follow and allow the reader to check to see if he is really getting the idea. Let us take 100 cm³ of hydrogen at 10 MPa (~100 atm) and compress it isothermally to 50 cm³. The path taken by the compression is easily plotted because (P(N))(V(N)) is a constant. Thus, at 50 cm³ the pressure is 20 MPa (~200 atm). The area under this curve is the work required to compress the gas and it is also the heat output from the gas for the cycle. If the pressure is expressed in Pascals (Newton/sq. meter) (1 atm ≈ 10⁵ N/m²) and if the volume is expressed in m³, then the units of work are (N/m²)(m³) = N•m = Joules = watt seconds. For convenience, megapascals (MPa) and cm³ will be used to avoid very large and very small numbers.*

The equation of the line is

$$\begin{aligned} (P(N))(V(N)) &= 100 \times 10^5 \text{ Pa} (100 \times 10^{-6} \text{ m}^3) = 1000 \text{ Joules} \\ &= 10 \text{ MPa} (100 \text{ cm}^3) = 1000 \text{ Joules} \end{aligned}$$

The work increment is

$$d(W(N)) = P(N)(d(V(N))) = \frac{1000}{V(N)} d(V(N)) \quad (5-1)$$

Integrating

$$\begin{aligned} W(1) &= 1000 \int_{V(1)}^{V(2)} \frac{dV(N)}{V(N)} = 1000 \left[\ln V(N) \right]_{V(1)}^{V(2)} \\ &= 1000 \ln \left(\frac{V(2)}{V(1)} \right) \quad (5-2) \end{aligned}$$

Thus

$$W(1) = 1000 \ln \left(\frac{50}{100} \right) = -693.14 \text{ Joules}$$

The answer is negative because work is being supplied. Also by the perfect gas law,

$$P(N)(V(N)) = M(R)(TC(N))$$

*Note that the nomenclature is defined as it is introduced. A full list of nomenclature is given in Appendix B.

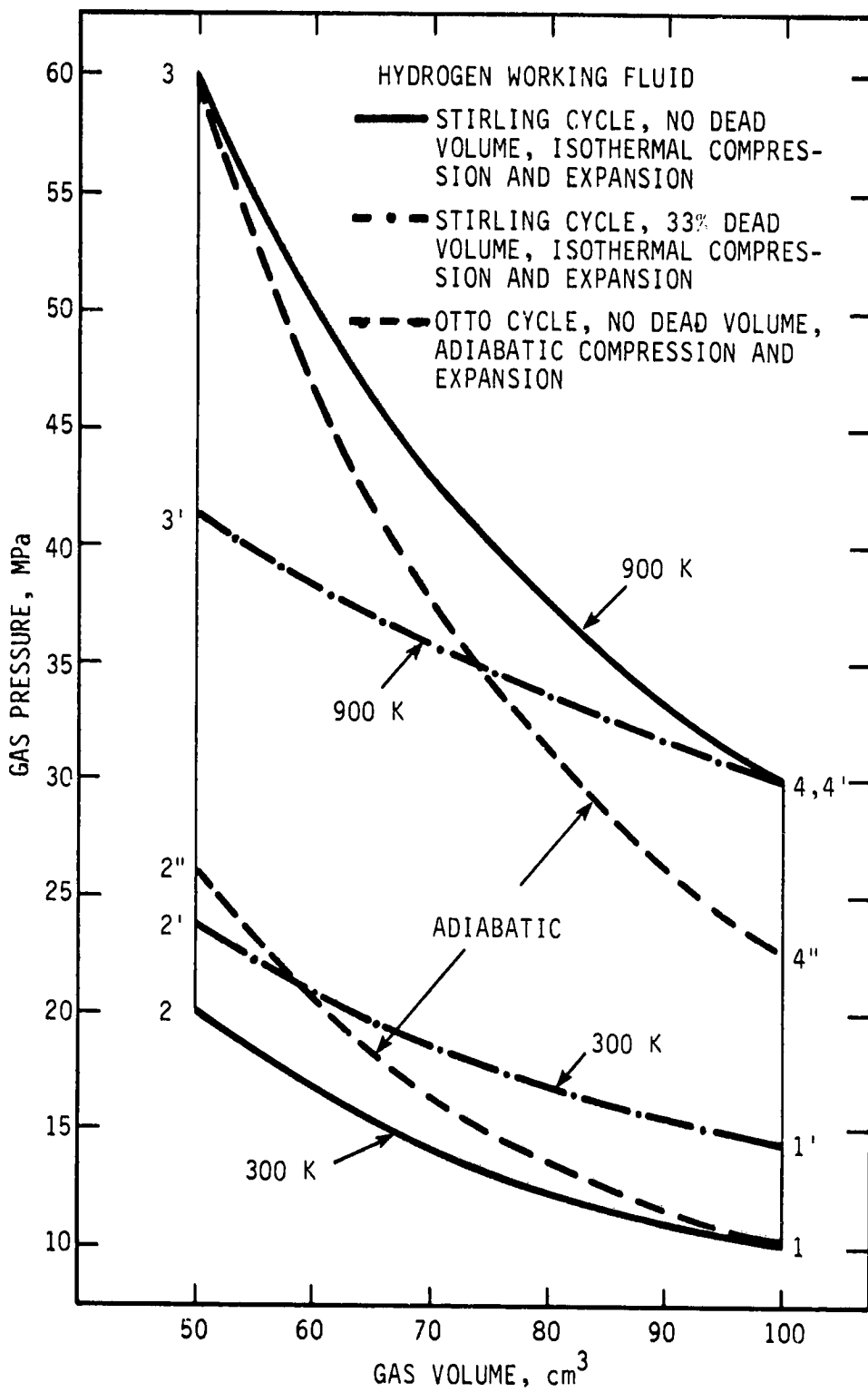

Figure 5-2. Theoretical Cycles.

ORIGINAL PAGE IS
OF POOR QUALITY

where $P(N)$ = gas pressure at point N, N/m^2 or MPa
 $V(N)$ = gas volume at point N, m^3 or cm^3
 M = number of moles, g mol
 R = universal gas constant
= 8.134 Joule/K (g mol)
 $TC(N)$ = cold side temperature at point N, K

Thus

$$(10 \text{ MPa})(100 \text{ cm}^3) = M(8.314)(300)$$

$$M = 0.4009 \text{ g mol}$$

Therefore, the formula for work normally given in text books is:*

$$W(1) = (M)(R)(TC(1)) * \ln\left(\frac{V(2)}{V(1)}\right) = -693.14 \text{ Joules} \quad (5-3)$$

This quantity is also the negative of heat of the compression of the gas or the heat removed from the cycle.

Next from state 2 to 3 the gas is heated at constant volume from 300 to, say, 900 K. Assume for the moment that the regenerator that supplies this heat has no dead volume and is 100% effective. The heat that must be supplied to the gas by the regenerator matrix is:

$$QR(2) = M(CV)(TH(3) - TC(2)) \quad (5-4)$$

where

CV = heat capacity at constant volume, j/K (g mol)

For hydrogen

$$CV = 21.030 \text{ at } 600 \text{ K average temperature}$$

Therefore

$$\begin{aligned} QR(2) &= 0.4009 (21.030)(900 - 300) \\ &= 5059 \text{ Joules} \end{aligned}$$

Note that the heat transfer required in the regenerator is 7.3 times more than the heat rejected as the gas is compressed.

The pressure at state 3 after all gas has attained 900 K is:

$$\begin{aligned} P(3) &= M(R)(TH(3))/V(2) \\ &= 0.4009(8.314)(900)/50 \\ &= 60 \text{ MPa} \end{aligned}$$

Sometimes for clarity the asterisk () is used for multiplication as it is in FORTRAN and BASIC.

ORIGINAL PAGE IS
OF POOR QUALITY

Isothermal expansion of the gas from state 3 to state 4 (Figure 6-1) is governed by the same laws as the compression.

$$\begin{aligned} W(3) &= M(R)(TH(3)) \ln\left(\frac{V(1)}{V(2)}\right) \\ &= .4009(8.314)(900) \ln \frac{100}{50} = 2079.4 \text{ Joules} \end{aligned}$$

This quantity is also the heat input to the engine. The expansion line is easily plotted when it is noted that $P(N)(V(N)) = (60 \text{ MPa})(50 \text{ cm}^3)$

$$= 3000.0 \text{ Joules}$$

Finally the return of the expanded gas from state 4 to state 1 back through the regenerator finishes the cycle. The same formula applies as for heating.

$$\begin{aligned} QR(4) &= M(CV)(TC(1) - TH(4)) \\ &= .4009(21.030)(-900 + 300) \text{ Joules} \\ &= -5059 \text{ Joules} \end{aligned}$$

Note that since heat capacity of the gas is not dependent on pressure and since the average temperature is the same, the heat transferred to and from the regenerator cancel.

The net work generated per cycle is:

$$\begin{aligned} W1 &= W(1) + W(3) \\ &= W(\text{in}) + W(\text{out}) = -693.14 + 2079.4 \\ &= 1386.3 \text{ Joules} \end{aligned}$$

The efficiency of the cycle therefore is:

$$EF = \frac{\text{net work}}{\text{heat in}} = \frac{W1}{W(3)} = \frac{1386.3}{2079.4} = 0.6667$$

In general the efficiency is:

$$EF = \frac{\text{work in} + \text{work out}}{\text{heat in}} = \frac{M(R)(TC(1))\ln\left(\frac{V(1)}{V(2)}\right) + M(R)(TH(3))\ln\left(\frac{V(1)}{V(2)}\right)}{M(R)(TH(3))\ln\left(\frac{V(1)}{V(2)}\right)} \quad (5-5)$$

$$EF = \frac{TH(3) - TC(1)}{TH(3)} = \frac{900 - 300}{900} = 0.6667 \quad (5-6)$$

This efficiency formula is recognized as the Carnot efficiency formula. Therefore, the limiting efficiency of the Stirling cycle is as high as is possible. We will consider the other cycles represented on Figure 5-2 after considering the effect of the regenerator.

5.1.2 Stirling Cycle, Zero Dead Volume, Imperfect Regenerator

Stirling engines require highly efficient regenerators. Consider an annular gap around the displacer which acts as gas heater, regenerator and cooler (see Figure 5-3). Assume that this engine operates in a stepwise manner and that this annular gap has negligible dead volume. Let E be the regenerator effectiveness during the transfer. For the transfer from cold space to hot space:

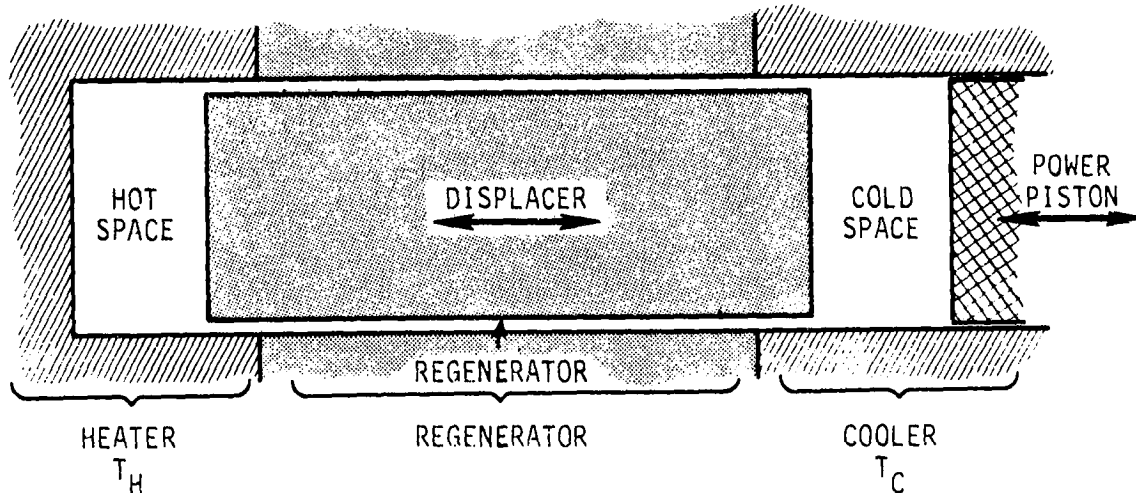

Figure 5-3. Simple Stirling Engine with Annular Gap Regenerator.

Let T_L = temperature of gas leaving regenerator
 $T_C = T_C(N)$ for any N
 $T_H = T_H(N)$ for any N

$$E = \frac{T_L - T_C}{T_H - T_C} \quad (5-7)$$

Now during transfer the heat from the regenerator is:

$$Q_R = M(CV)(T_L - T_C) \quad (5-8)$$

and the heat from the gas heater is:

$$Q_B = M(CV)(T_H - T_L) \quad (5-9)$$

Therefore, the efficiency becomes:

$$EF = \frac{M(R)(T_H) \ln \left(\frac{V(1)}{V(2)} \right) - M(R)(T_C) \ln \left(\frac{V(1)}{V(2)} \right)}{M(R)(T_H) \ln \left(\frac{V(1)}{V(2)} \right) + M(CV)(T_H - T_L)} \quad (5-10)$$

which reduces to:

$$EF = \frac{TH - TC}{TH + \frac{CV}{R} \left(\frac{(TH - TC)(1 - E)}{\ln\left(\frac{V(1)}{V(2)}\right)} \right)} \quad (5-11)$$

For the numerical example being used here:

$$EF = \frac{900 - 300}{900 + \frac{21.030 (900-300)}{8.314 \ln \frac{100}{50}} (1 - E)} = \frac{600}{900 + 2189.5 (1 - E)}$$

Figure 5-4 shows how the engine efficiency is affected by regenerator effectiveness for this numerical example. Some of the early Stirling engines worked with the regenerator removed. Figure 5-4 shows that at low regenerator effectiveness, the efficiency is still reasonable. How close it pays to approach 100% effectiveness depends on a trade-off which will be discussed under Section 5.3.

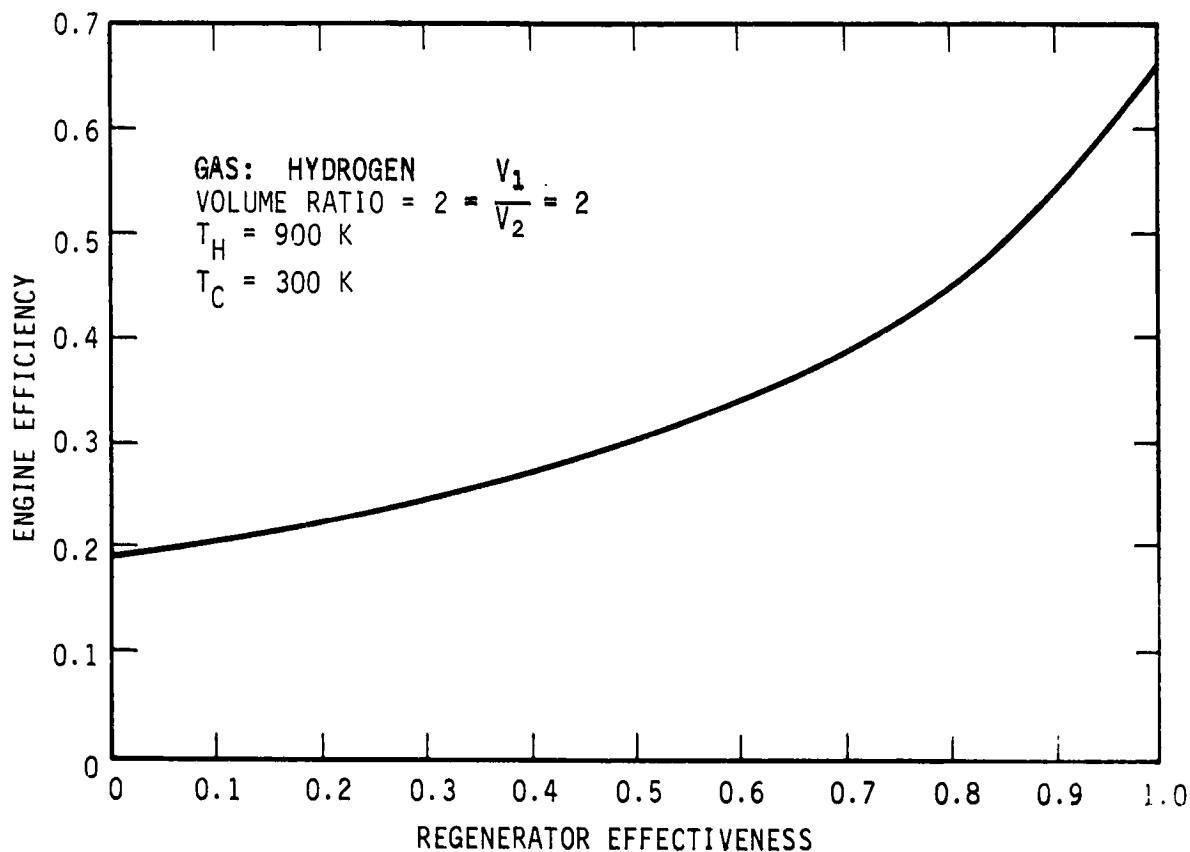

Figure 5-4. Effect of Regenerator Effectiveness on Efficiency.

Rallis (77 ay) has worked out a generalized cycle analysis in which the compression and expansion is isothermal but the heating and cooling can be at constant volume or at constant pressure or a combination. The heating process does not need to be the same as the cooling process. He assumes no dead volume, but allows for imperfect regeneration. For a Stirling cycle he derives the formula:

$$EF = \frac{(KK - 1)(TA - 1) \ln VR}{(1 - E)(TA - 1) + TA(KK - 1) \ln VR} \quad (5-12)$$

where

EF = cycle efficiency
 KK = CP/CV
 TA = TH/TC
 VR = V(1)/V(2)

ORIGINAL PAGE IS
 OF POOR QUALITY

Equations 5-12 and 5-11 are the same, just different nomenclature. Note that for E = 1, both Equations 5-11 and 5-12 reduce to the Carnot equation, Equation 5-6.

Rallis (77 ay) also derived a formula for the Ericsson cycle efficiency:

$$EF = \frac{(KK - 1)(TA - 1) \ln VR}{KK(1 - E)(TA - 1) + TA(KK - 1) \ln VR} \quad (5-13)$$

Equation 5-13 also reduces to Equation 5-6 when E = 1, that is, for perfect regeneration. To attain Carnot efficiency, the compression and expansion ratio must be the same. Rallis shows this using cycles which will not be treated here.

Rallis also gives a useful formula for the net work per cycle for the Stirling cycle:

$$\frac{W1}{(V(1) - V(2))(P(1))} = \frac{VR(TA - 1) \ln VR}{VR - 1} \quad (5-14)$$

For instance, for the numerical example being used here:

$$\begin{aligned} W1 &= (50 \text{ cc})(10 \text{ MPa})2(3 - 1) \ln(2/(2 - 1)) \\ &= 1386.3 \text{ Joules} \end{aligned}$$

which is the same as obtained previously.

5.1.3 Otto Cycle, Zero Dead Volume, Perfect or Imperfect Regeneration

The variable volume spaces in Stirling engines are usually shaped so that there is little heat transfer possible between the gas and the walls during the time the gas is expanded or compressed. Analyses have been made by Rallis (77 az) and also by Martini (69 a) which assume adiabatic compression and expansion with the starting points being the same as for the Stirling cycle. For instance for the numerical example in Figure 5-2, compression goes from 1 to 2" instead of from 1 to 2. Expansion goes from 3 to 4" instead of from 3 to 4. It appears that considerable area and therefore work per cycle is lost.

However, this process is not correct because the pressure at point 3 is not the same as for the isothermal case. For the numerical example after compression to point 2" the pressure of the gas is 26.39 MPa and the gas temperature is 396 K. As this gas moves into the hot space through a cooler, regenerator and heater, all of negligible dead volume, it is cooled to 300 K in the cooler, heated to 900 K in the heater. As the gas is transferred at zero total volume

ORIGINAL PAGE IS
OF POOR QUALITY

change from the cold space to the hot space the pressure rises. This pressure rise results in a temperature increase in the gas due to adiabatic compression. Therefore, at the end of the transfer process the mixed mean gas temperature in the hot space will be higher than 900 K. Point 3 is calculated for all the gas to be exactly 900 K. Adiabatic expansion then takes place. Then by the same process as just described, the transfer of the expanded gas back into the cold space results in a lower gas temperature than 300 K at the end of this stroke. The computational process must be carried through for a few cycles until this process repeats accurately enough. This effect will be discussed further in Section 5.1.6.

5.1.4 Stirling Cycle, Dead Volume, Perfect or Imperfect Regeneration

An inefficient regenerator backed up by an adequate gas heater and gas cooler will not change the work realized per cycle but will increase the heat required per cycle. It will now be shown that addition of dead volume which must be present in any real engine decreases the work available per cycle.

Assume that the annulus between displacer and cylinder wall (see Figure 5-3) has a dead volume of 50 cm³, that the temperature gradient from one end of the displacer to the other is uniform and that the pressure is essentially constant. The gas contained in this annulus is:

$$M = \frac{P(1)}{R} \int_{X=0}^{X=LR} \frac{d(VA)}{TZ} \quad (5-15)$$

where

- M = moles of gas
- VA = total volume of annulus
- $d(VA) = \frac{(VA)}{(LR)} dX$ = differential volume of the annulus
- X = distance along annulus
- LR = total length of annular regenerator
- TZ = temperature along regenerator

Now

$$TZ = TH - \frac{X}{LR} (TH - TC) \quad (5-16)$$

By substituting and integrating one obtains:

$$M = \frac{P(1)(VA)}{R} \frac{\ln(TH/TC)}{(TH - TC)} \quad (5-17)$$

Thus the effective gas temperature of the regenerator dead volume is:

$$TR = (TH - TC) / \ln(TH/TC) \quad (5-18)$$

which is the log mean temperature. Thus for the numerical example:

$$TR = \frac{900 - 300}{\ln \frac{900}{300}} = 546.1 \text{ K}$$

ORIGINAL PAGE IS
OF POOR QUALITY

Quite often it is assumed that $TR = \frac{TH + TC}{2} = \frac{900 + 300}{2} = 600$ K.

For the large dead volumes which will almost always result, it is important to have the right gas temperatures for the regenerator and heat exchangers.

Assume for the moment that the hot and cold gas spaces can be maintained at 900 K and 300 K and that the pressure at the end of the expansion stroke, (Point 4 of Figure 5-2) 30 MPa (~300 atm), is maintained. The gas inventory must be increased. It now is:

$$M = \frac{P(4)}{R} \left[\frac{VH}{TH} + \frac{VR}{TR} \right] \quad (5-19)$$

$$M = \frac{30}{8.314} \left[\frac{100}{900} + \frac{50}{546.1} \right]$$

$$= 0.7313 \text{ g mol.}$$

The equation for the gas expansion is:

$$P(N) = \frac{(M)(R)}{\frac{HL(N)}{TH} + \frac{VR}{TR}} = \frac{(0.7313)(8.314)}{\frac{HL(N)}{900} + \frac{50}{546.1}} \quad (5-20)$$

$$P(N) = \frac{A}{HL(N) + B} \text{ where } A = 5472; \quad B = 82.4$$

where

HL(N) = hot live volumes at point N

The work output by expanding from HL(1) = 50 cm³ to HL(2) = 100 cm³ is:

$$W(3) = \int_{HL(1)}^{HL(2)} P(N) d(HL(N)) = \int_{HL(1)}^{HL(2)} \frac{A d(HL(N))}{HL(N) + B} \quad (5-21)$$

$$= A \ln \left(\frac{HL(2) + B}{HL(1) + B} \right)$$

$$= 5472 \ln \left(\frac{100 + 82.4}{50 + 82.4} \right)$$

$$= 1753 \text{ Joules}$$

The equation for gas compression is:

$$P(N) = \frac{(M)(R)}{\frac{CL(N)}{TC} + \frac{VR}{TR}} = \frac{(0.7313)(8.314)}{\frac{CL(N)}{300} + \frac{50}{546.1}}$$

where $CL(N)$ = cold live volume at point N

$$P(N) = \frac{C}{CL(N) + D} \quad \text{where } C = 1824.02, D = 27.4$$

Analogously, the work of compression is:

$$\begin{aligned} W(1) &= C \ln\left(\frac{CL(2) + D}{CL(1) + D}\right) \\ &= 1824.02 \ln\left(\frac{50 + 27.4}{100 + 27.4}\right) \\ &= -908.37 \text{ Joules} \end{aligned}$$

Therefore the net work is:

$$\begin{aligned} W1 &= W(3) + W(1) \\ &= 1753.08 - 908.37 = 844.71 \text{ Joules} \end{aligned}$$

Figure 5-5 shows how dead volume as % of maximum total gas volume affects the work per cycle. For more generality the work per cycle is expressed as a % of the work per cycle at zero dead volume. Note that the relationship is almost linear. This curve differs from that published by Martini (77 h) in that in Figure 5-5 the pressure at the end of the expansion stroke was made the same (average pressure). In the previous Figure 2 of reference 77 h, the minimum pressure was made the same. This caused the average pressure to decrease more rapidly as dead volume increased. Figure 5-5 is more truly representative of the effect of dead volume on work per cycle.

5.1.5 Schmidt Cycle

The Schmidt cycle is defined here as a Stirling cycle in which the displacer and the power piston or the two power pistons move sinusoidally. It is the most complicated case that can be solved analytically. All cases with less restrictive assumptions have had to be solved numerically. The cycle gets its name from Gustaf Schmidt (1871 a) who first published the solution.

The assumptions upon which the Schmidt analysis is based are as follows:

1. Sinusoidal motion of parts.
2. Known and constant gas temperatures in all parts of the engine.
3. No gas leakage.
4. Working fluid obeys perfect gas law.
5. At each instant in the cycle the gas pressure is the same throughout the working gas.

Since Gustaf Schmidt did the analysis, a number of others have checked it through and re-derived it for specific cases. A more accessible paper for those who want to delve into the mathematics was written by Finkelstein (60 j). In this manual the Schmidt cycle will first be evaluated numerically because it is easier to understand this way. Also, the numerical method is easy to generalize to more nearly fit what a machine is actually doing. Piston-displacer engines will be discussed first and then dual-piston engines.

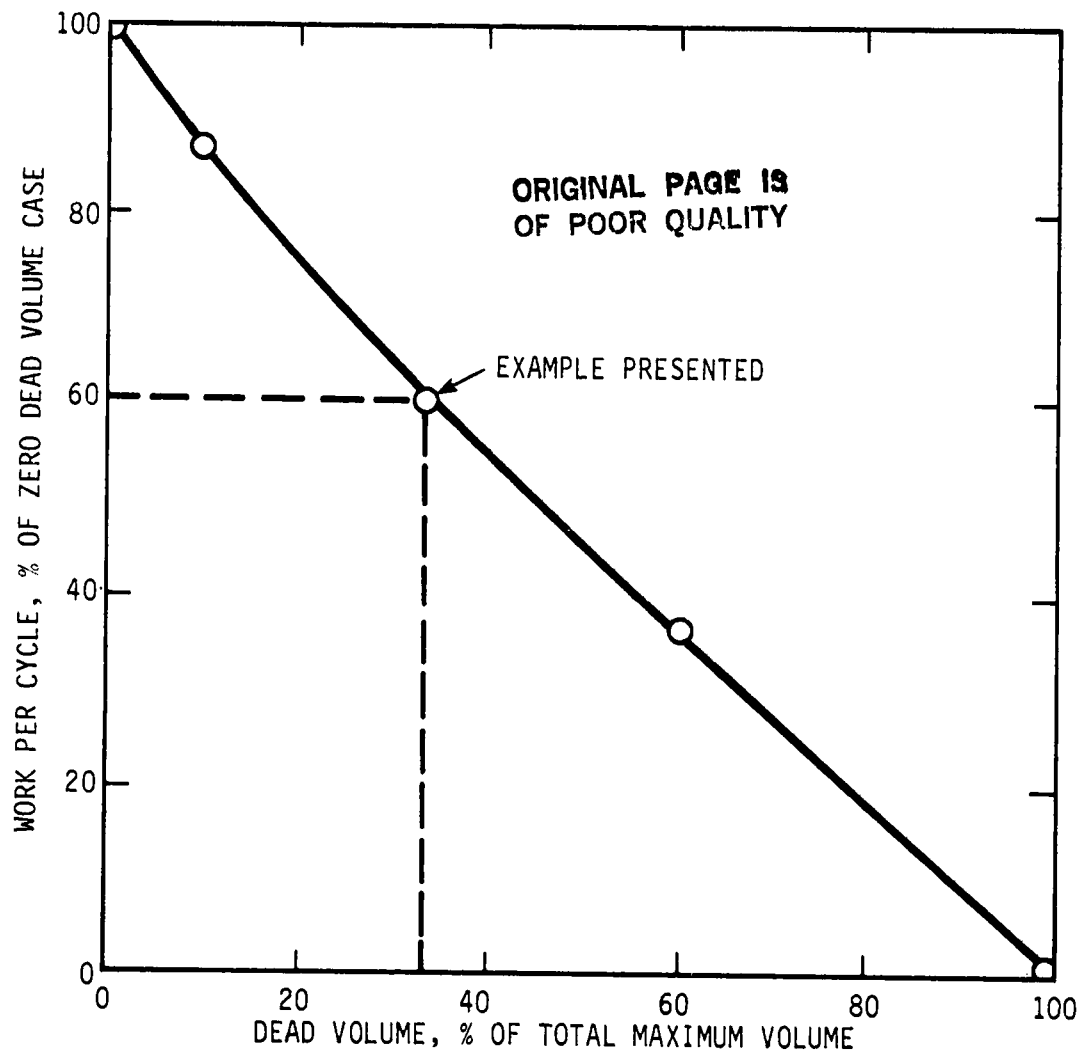

Figure 5-5. Effect of Dead Volume on Work Per Cycle for Isothermal Spaces and Constant Average Pressure.

5.1.5.1 Piston-Displacer Engines

5.1.5.1.1 Engine Definition

The nomenclature for engine internal volumes and motions is described in Figures 5-6 and 5-7. The following equations describe the volumes and pressures: The maximum hot, live volume is:*

$$V_L = 2(RC)(DB)^2(\pi/4) \quad (5-22)$$

The maximum cold, live volume associated with the displacer is:

$$V_K = 2(RC) \left[(DB)^2 - (DD)^2 \right] (\pi/4) \quad (5-23)$$

*In Equations 5-20 and 5-21, HL(N) is defined as an array of hot live volumes at N points during the cycle. VL is the maximum hot live volume.

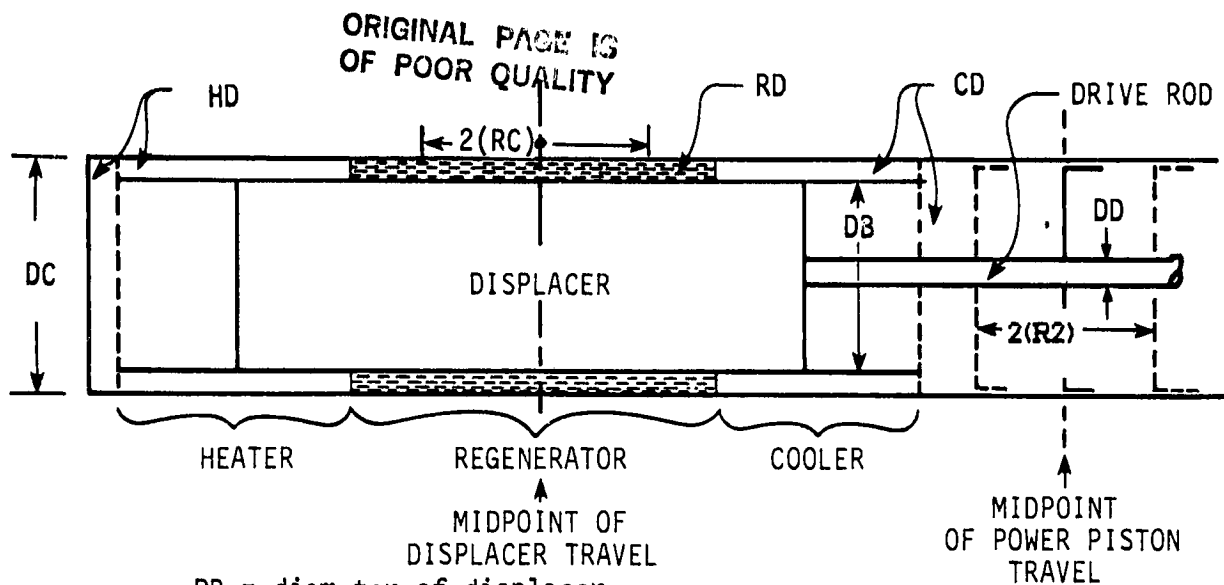

- DB = diameter of displacer
 DD = diameter of displacer drive rod
 DC = diameter inside engine cylinder
 HD = hot dead volume, cm³
 2(RC) = stroke of displacer
 RD = regenerator dead volume, cm³
 CD = cold dead volume, cm³
 2(R2) = stroke of power piston, cm
 TH = effective hot gas temperature, K
 TR = effective regenerator gas temperature, K
 TC = effective cold gas temperature, K
 M = engine gas inventory, g mol
 R = universal gas constant 8.314 J/g mol·K
 P(N) = common gas pressure at particular point in cycle, MPa
 F = angle of crank, degrees
 AL = angle of phase, degrees

Figure 5-6. Piston Displacer Engine Nomenclature.

The maximum cold, live volume associated with the power piston is:

$$VP = 2(R2) \left[(DC)^2 - (DD)^2 \right] (\pi/4) \quad (5-23a)$$

For any angle F, the array of hot volumes is:

$$H(N) = \frac{VL}{2} \left[1 - \cos(F) \right] + HD \quad (5-24)$$

For any angle F, the array of cold volumes is:

$$C(N) = \frac{VK}{2} \left[1 + \cos(F) \right] + CD + \frac{VP}{2} \left[1 - \cos(F - AL) \right] \quad (5-25)$$

Therefore, the total gas volume at any crank angle is:

$$V(N) = H(N) + C(N) + RD \quad (5-26)$$

Therefore, by the perfect gas law the pressure at any crank angle is:

$$P(N) = \frac{M(R)}{\frac{H(N)}{TH} + \frac{C(N)}{TC} + \frac{RD}{TR}} \quad (5-27)$$

ORIGINAL PAGE IS
OF POOR QUALITY

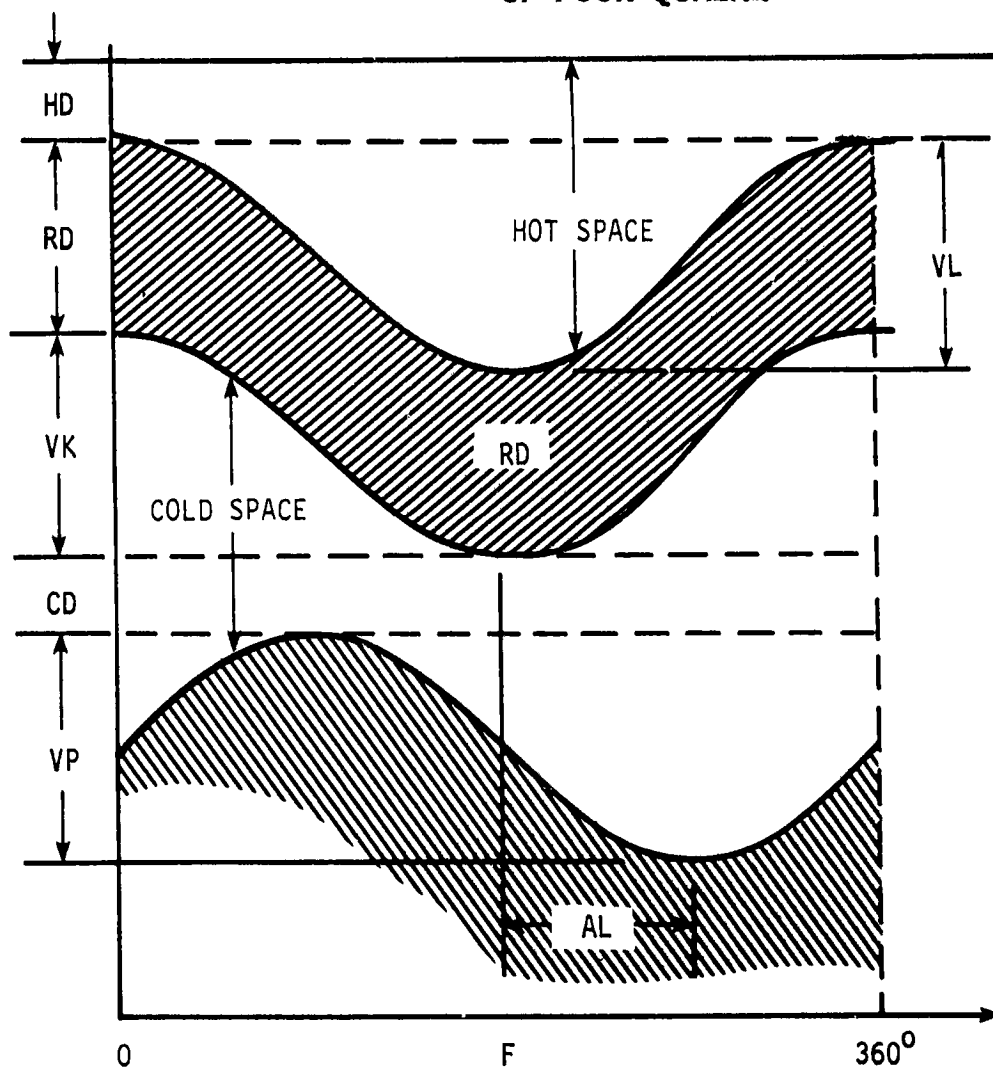

Figure 5-7. Phasing of Displacer and Power Piston.

The volume CD includes the dead volume in the cooler as well as the dead volume between the strokes of the displacer and the power piston. According to the classification of engines given in Figure 2-6, the gamma type machine must have some volume between the strokes to allow for clearance and the flow passages between. In the beta type engine the strokes of the displacer and the power piston should overlap so that they almost touch at one point in the cycle. This overlap volume is subtracted from the dead volume in the cold heat exchanger. For a beta type engine with this type of stroke overlap and $AL = 90^\circ$ and $VP = VK$, then $CD = VM - (VP/2)(2 - \sqrt{2}) = VM - VP(1 - (\sqrt{2}/2))$ where VM = cold dead volume in heat exchanger and clearances and ducts. For the more general case, one should determine the clearance between the displacer and power piston and adjust it to be as small as practical.

5.1.5.1.2 Sample Engine Specifications

In order to check equations which look quite different, it was decided to specify a particular engine and then determine if the work integral checks. The specification decided upon was:

$$\begin{aligned} M(R) &= 10.518 \text{ J/K} \\ TH &= 600 \text{ K} \\ TC &= 300 \text{ K} \\ VL &= VK = VP = RD = 40 \text{ cm}^3 \\ HD &= CD = 0 \\ AL &= 90^\circ \end{aligned}$$

TR is defined a number of ways, depending how it is defined in the analytical equation that is being checked. It may be:

- (1) Arithmetic mean (Walker)
 $TR = (TH + TC)/2 = 450 \text{ K}$
- (2) Log mean, most realistic
 $TR = (TH - TC)/\ln(TH/TC) = 432.8 \text{ K}$
- (3) Half volume hot, half volume cold (Mayer)
 $\frac{1}{TR} = \frac{1}{2(TH)} + \frac{1}{2(TC)}$
 $TR = 400 \text{ K}$

The above sample engine specification is for a gamma engine. For a beta engine assume in addition that $VM = 0$. Then:

$$CD = 0 - 40\left(1 - \frac{\sqrt{2}}{2}\right) = -11.715 \text{ cm}$$

5.1.5.1.3 Numerical Analysis

Using the numbers given in Section 5.1.5.1.2, Equations 5-22 to 5-27 can be evaluated for $F = 0, 30, 60 \dots 360$, $P(N)$ can be plotted against $V(N)$ and the resultant closed curve can be integrated graphically and the maximum and minimum gas pressure can be noted. The author's experience with a number of different examples gives a result which is 4.5% low when compared with valid analytical equations and with numerical calculations with very small crank angle increments. If the reader has access to a programmable calculator or a computer then the computation can be made with any degree of precision desired. Figure 5-8 shows the flow diagram which was used for programming. The author has used both an HP-65 and an HP-67 for this purpose. He has also used this method as part of a larger second-order calculation written in FORTRAN and in BASIC.

Using the 400 K effective regenerator temperature the following results were obtained for the numerical example.

Angle Increment, ND, degrees	Work Integral $\oint P(N)dV(N)$	% Error
30	314.36 Joules	-4.5
20	322.56	-2.0
10	327.53	-0.50
5	328.78	-0.13
0.25	329.1994570	-0.0003
Mayer Equation	329.2005026	0

ORIGINAL PAGE IS
OF POOR QUALITY

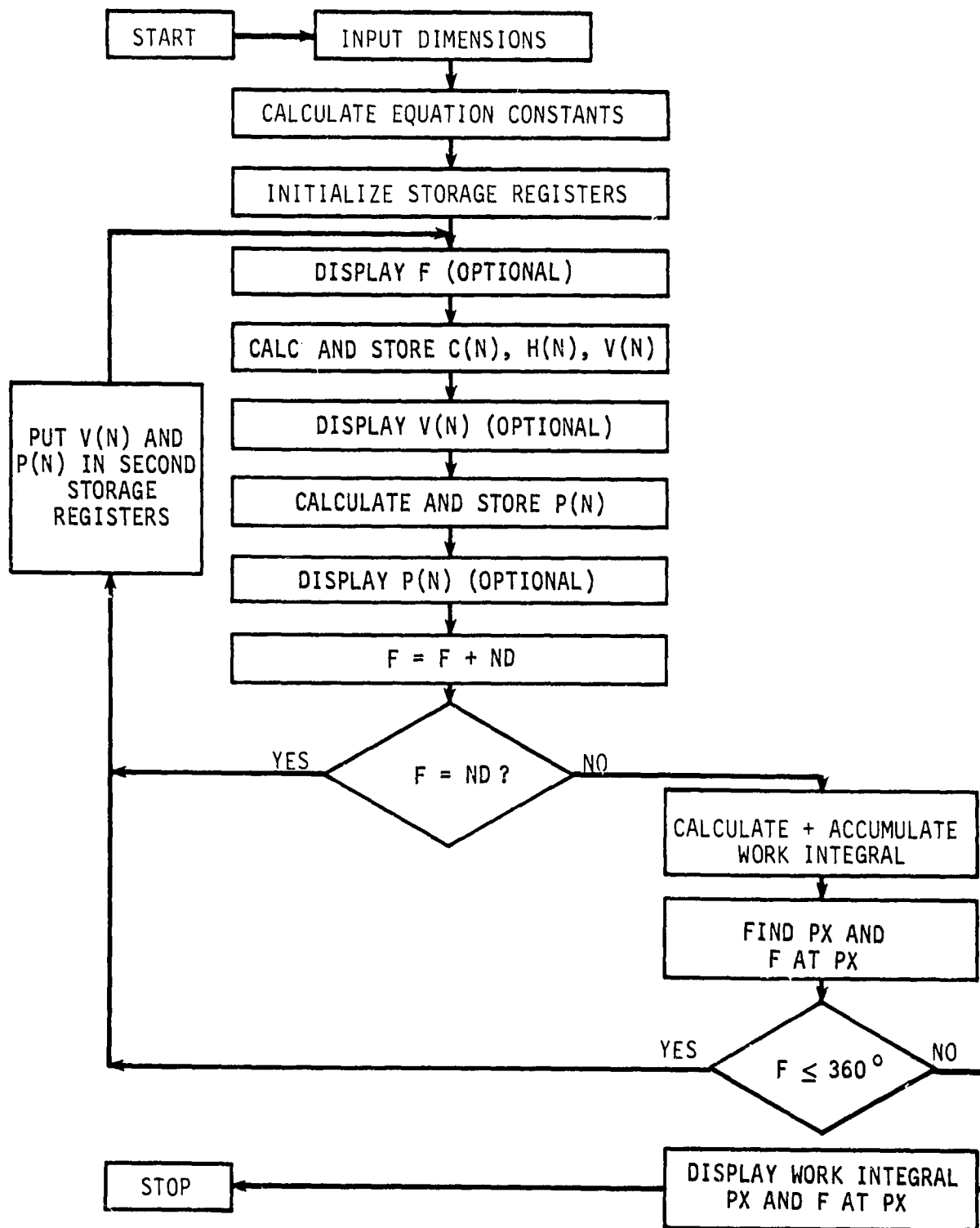

Figure 5-8. Flow Diagram for Work Integral Analysis.

ORIGINAL PAGE IS
OF POOR QUALITY

The Mayer equation will be given in Section 5.1.5.1.4 and discussed more fully there. It uses the same assumptions as were employed in the numerical analysis. One can see from the above table that the result by numerical analysis approaches the Mayer equation result as ND approaches zero. The two check.

If the arithmetic average is used TR = 450 K, then:

ND	$\oint PdV$	Maximum Pressure, PX	Crank Angle F at PX
1 degree	360.45 Joules	58.10 MPa	117 deg.

If the log mean average is used TR = 432.8 K, then:

ND	$\oint PdV$	PX	F at PX
1 degree	350.04 Joules	56.99 MPa	117 deg.

For the case of the beta engine with essentially touching displacer and power piston at one point in the cycle, CD = -11.715 cm³. For the arithmetic average dead volume temperature TR = 450 K, then:

ND	$\oint PdV$	PX	F at PX
1 degree	516.32 Joules	74.0862 MPa	117 deg.

Precision in calculating this work integral is mainly of academic interest because the result will be multiplied in first-order analysis by an experience factor like 0.5 or 0.6 (one figure precision). Even in second- or third-order analysis, no more than two figure accuracy in the final power output and efficiency should ever be expected. Thus errors less than 1% should be considered insignificant. Therefore, ND = 15° would be adequate for all practical purposes. This error in evaluating the work integral by using large angle increments seems to be insensitive to other engine dimensions. Therefore, one could evaluate the work integral using 30° increments and then make a correction of 4.5%.

5.1.5.1.4 Schmidt Equations

The literature was searched to find all the different Schmidt equations. Quite a large number were found which looked to be different. In this section and in Section 5.1.5.2.3 for the dual piston case these equations will be given and evaluated by determining whether they agree with the numerical analysis just described.

At McDonnell Douglas, Mort Mayer reduced the Schmidt equation to the following relatively simple form (68 c):

$$W1 = \frac{M(R)(TC)(\pi)Y(VP)}{Y^2 + Z^2} \left[\frac{X}{(X^2 - Y^2 - Z^2)^{1/2}} - 1 \right] \quad (5-28)$$

where:

ORIGINAL PAGE IS
OF POOR QUALITY

W1 = work per cycle, J

M = gas inventory, g mol

R = gas constant = 8.314 J/g mol·K

TC = effective cold gas temperature, K

TH = effective hot gas temperature, K

$$X = XX + \frac{TC}{TH} (XY)$$

$$XX = \frac{VP}{2} + CD + \frac{VK}{2} + \frac{RD}{2}$$

$$XY = HD + \frac{VL}{2} + \frac{RD}{2}$$

$$Y = \frac{VL}{2} \left(1 - \frac{TC}{TH}\right) \sin(AL)$$

$$Z = \left[VP - VL \left(1 - \frac{TC}{TH}\right) \cos(AL)\right] / 2$$

AL = phase angle between displacer and power piston, normally 90°

From the sample engine specifications:

$$XX = \frac{40}{2} + 0 + \frac{40}{2} + \frac{40}{2} = 60 \text{ cm}^3 = 60 \times 10^{-6} \text{ m}^3$$

$$XY = 0 + \frac{40}{2} + \frac{40}{2} = 40 \text{ cm}^3 = 40 \times 10^{-6} \text{ m}^3$$

$$X = 60 \times 10^{-6} + \frac{300}{600} (40 \times 10^{-6}) = 8 \times 10^{-5} \text{ m}^3$$

$$Y = \frac{40 \times 10^{-6}}{2} \left(1 - \frac{300}{600}\right) = 1 \times 10^{-5} \text{ m}^3$$

$$Z = \frac{40 \times 10^{-6}}{2} = 2 \times 10^{-5} \text{ m}^3$$

Using these inputs the Mayer equation gives:

$$W = 329.2005026 \text{ Joules}$$

The Mayer equation evaluates the integral exactly given the assumptions that were used in its derivation, like sinusoidal motion and half the dead space at hot temperature and half at cold temperature. The numerical method (Section 5.1.5.1.3) approaches this same value as the angle increment approaches zero. The Mayer equation must have VP = VK.

J. R. Senft (76 n) presents a Schmidt equation for finding the energy generated per cycle. He assumes that the temperature of the dead space gas has the arithmetic mean between the hot and cold gas spaces. This equation is for a beta type engine with the displacer and power piston essentially touching at one point during the cycle. His equation is:

$$W1 = \frac{\pi(1 - AU)PX(VL)(XY) \sin(AL)}{Y + (Y^2 - X^2)^{1/2}} \left[\frac{Y - X}{Y + X} \right]^{1/2} \quad (5-29)$$

where:

$$X = \left[(AU - 1)^2 + 2(AU - 1)(XY) \cos(AL) + (XY)^2 \right]^{\frac{1}{2}}$$

$$Y = AU + \frac{4(XX)(AU)}{1 + AU} + Z$$

$$Z = (1 + (XY)^2 - 2(XY) \cos(AL))^{\frac{1}{2}}$$

$$AU = TC/TH$$

GENERAL EQUATIONS
OF FOUR STROKE CYCLE

$$XX = \frac{RD + HD + CD}{VL}$$

$$VL = VK$$

$$XY = VP/VL$$

In order to illustrate and check this equation it is evaluated for a specific case previously computed by numerical methods. (See Section 5.1.5.1.3 for TR = 450 K and CK = -11.715 cm³.)

$$AU = \frac{300}{600} = 0.5$$

$$XX = 40/40 = 1$$

$$XY = 40/40 = 1$$

$$AL = 90^\circ$$

$$PX = \text{maximum pressure attained during each cycle} = 74.0862 \text{ MPa}$$

$$Z = (1 + 1 - 2(1) \cos 90^\circ)^{\frac{1}{2}} = \sqrt{2}$$

$$Y = 0.5 + \frac{4(1)(0.5)}{1.5} + \sqrt{2} = 3.247547$$

$$X = \left[(0.5 - 1)^2 + 2(0.5 - 1)(1)(\cos 90^\circ) + 1 \right]^{\frac{1}{2}} = 1.118034$$

$$\left[\frac{Y - X}{Y + X} \right]^{\frac{1}{2}} = 0.698424$$

$$Y + (Y^2 - X^2)^{\frac{1}{2}} = 6.296573$$

$$W1 = \frac{\pi(1 - 0.5)(74.08326)(40)(1) \sin(90^\circ)(0.698424)}{6.296573}$$

$$= 516.33 \text{ Joules}$$

This answer agrees very well with results obtained by numerical methods of 516.32 Joules. Senft (77 ak) also has adapted his equation for a gamma type engine (without stroke overlap). In this case the equations for W1 and X are the same and the equation for Y is:

$$Y = \frac{4(XX)(AU)}{1 + AU} + 1 + AU + XY$$

(5-30)

Therefore:

$$Y = \frac{4(1)(0.5)}{1.5} + 1 + 0.5 + 1 = 3.833333$$

$$\left[\frac{Y - X}{Y + X} \right]^{1/2} = 0.740518$$

$$Y + (Y^2 - X^2)^{1/2} = 7.5000$$

To agree with the numerical analysis of Section 5.1.5.1.3 for TR = 450 K,
PX = 58.10 MPa.

Thus:

$$W1 = \frac{\pi(1 - 0.5)(58.10)(40) \sin(90^\circ)(0.740518)}{7.50000}$$

$$W1 = 360.45 \text{ Joules}$$

This result agrees exactly with the numerical analysis for ND = 1°, TD = 450 K
and PX = 58.10 MPa. (See Section 5.1.5.1.3.)

This new Senft equation is also correct.

Cooke-Yarborough (74 i) has published a simplified expression for power output
which makes the approximation that not only the volume changes but also the
pressure changes are sinusoidal. The regenerator is treated as being half at
the hot volume temperature and half at the cold volume temperature. His
equation is:

$$W1 = \frac{\bar{P}(\pi)}{4} \frac{(VL)(VP)(TH - TC) \sin(AL)}{XX \left[TC + \frac{XY}{XX} (TH - TC) \right]} \quad (5-31)$$

where:

\bar{P} = mean pressure of working gas, or pressure with both displacer
and power piston at mid-stroke. (With the approximations
used, these two pressures can be regarded as identical.) If
the mean pressure is known, it can be used directly in
Equation 5-31. Otherwise, the mid-stroke pressure can be
calculated as follows:

$$\bar{P} = \frac{(M)(R)}{\frac{VL}{2(TH)} + \frac{RD}{TR} + \frac{VK}{2(TC)} + \frac{VP}{2(TC)}}$$

Substituting the assumed values,

$$\bar{P} = \frac{10.518}{\frac{20}{600} + \frac{40}{432.8} + \frac{20}{300} + \frac{20}{300}}$$

ORIGINAL PAGE IS
OF POOR QUALITY

$$\begin{aligned}P &= 40.59 \text{ MPa} \\V_L &= 40 \text{ cm}^3 \\V_P &= 40 \text{ cm}^3 \\XX &= \text{total gas volume of system when output piston is at midstroke} \\&= V_L + RD + (V_P/2) \\&= 40 + 40 + 20 = 100 \text{ cm}^3 \\TH - TC &= 600 - 300 = 300 \text{ K} \\AL &= 90^\circ \\XY &= \text{cold gas volume with both piston and displacer at midstroke} \\&\quad \text{and regenerator volume split between hot and cold volumes} \\&= \frac{RD}{2} + \frac{VK}{2} + \frac{V_P}{2} \\&= \frac{40}{2} + \frac{40}{2} + \frac{40}{2} = 60 \text{ cm}^3\end{aligned}$$

Therefore, substituting into Equation 6-31 we have:

$$\begin{aligned}W_1 &= \frac{40.59(\pi)}{4} \frac{40(40)}{100} \frac{(300)1}{300 + \frac{60}{100}(300)} \\&= 318.79 \text{ Joules}\end{aligned}$$

Because of how XY is determined this result should be compared to the Mayer equation, that is, to 329.20 Joules. Therefore, the Cooke-Yarborough equation appears to be a reasonably good approximation (3.2% error). The accuracy improves as the dead volume is increased because the pressure waveform is then more nearly sinusoidal.

5.1.5.2 Dual Piston Engines

5.1.5.2.1 Engine Definition and Sample Engine Specifications

The nomenclature for engine internal volumes and motions are described in Figure 5-9. Also given in Figure 5-9 are the assumed values for the sample case. The following equations describe the volumes and pressures.

Hot Volume

$$H(N) = \frac{V_L}{2} [1 - \sin(F)] + HD \quad (5-32)$$

Cold Volume

$$C(N) = \frac{V_K}{2} [1 - \sin(F - AL)] + CD \quad (5-33)$$

Total Volume

$$V(N) = H(N) + C(N) + RD \quad (5-34)$$

ORIGINAL PAGE IS
OF POOR QUALITY

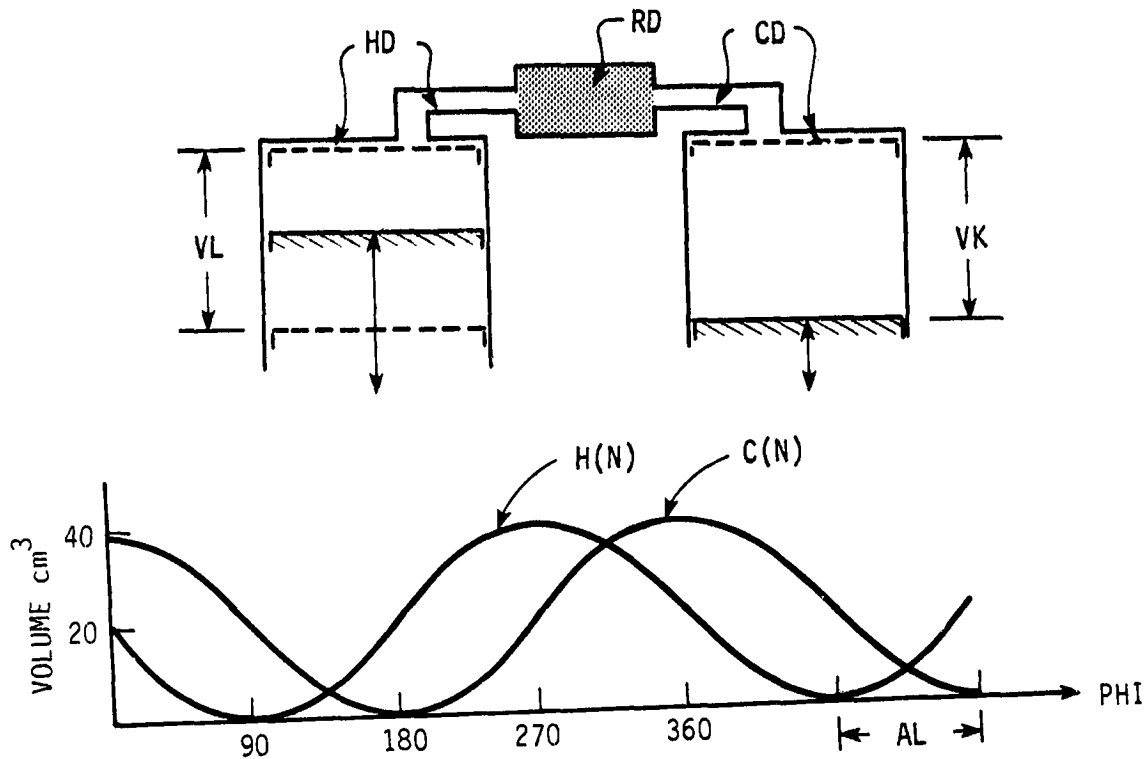

Symbol	Definition	Units	Assumed Values
HD	hot dead volume	cm ³	0
RD	regenerator dead volume	cm ³	40
CD	cold dead volume	cm ³	0
VL	hot piston live volume	cm ³	40
VK	cold piston live volume	cm ³	40
TH	effective hot gas temperature	K	600
TC	effective cold gas temperature	K	300
TR	effective regenerator gas temp.	K	450
M	engine gas inventory	g mol	1.265
R	gas constant	J/g mol·K	8.314
M(R)		J/K	10.518
P(N)	common gas pressure	MPa	to be calculated
F	crank angles	degrees	
ND	crank angle increment	degrees	(ND)(N) = 360
AL	phase angle	degrees	N = interger

Figure 5-9. Dual Piston Engine Nomenclature and Assumptions for Sample Case.

Engine Pressure

$$P(N) = \frac{(M)(R)}{\frac{H(N)}{T_H} + \frac{C(N)}{T_C} + \frac{RD}{T_R}}$$

(5-35)

5.1.5.2.2 Numerical Analysis

Using the assumed values given in Figure 5-9, Equations 5-32 to 5-35 were evaluated for $F = 0, 30, 60 \dots 360$. The results were:

F Degrees	V(N) cm ³	P(N) MPa
0	100.0	41.2
30	87.3	45.7
60	72.7	54.4
90	60.0	67.6
120	52.7	83.0
150	52.7	91.9
180	60.0	86.1
210	72.7	71.2
240	87.3	57.0
270	100.0	47.3
300	107.3	41.9
330	107.3	39.9
360	100.0	41.2

These data were graphed in Figure 5-10 and graphically integrated. A value of 695.3 J was obtained. As before, a numerical integration was carried along as the points were calculated. This was 668.8 Joules, a 3.8% error which indicates the accuracy of the graphical integration procedure. To approach the answer that should be obtained by valid Schmidt equations, ND should be reduced toward zero. The results obtained were:

Angle Increment, degrees	Work Integral, Joules	Maximum Pressure, MPa	Effective Regen. Temp. K	Error %
30	668.8	91.87	450	-4.5
10	696.8		450	-0.5
1	700.324	91.98	450	0
30	641.284	89.121	432.8	-4.5
1	671.517	89.220	432.8	0
30	587.9		400	-4.5
1	615.619	83.831	400	0

Note the difference in the result depending on what is used for the effective temperature of the gas in the regenerator. If the regenerator has a uniform temperature gradient from hot to cold, which it usually does, then the log mean temperature ($T_R = 432.8$ K) is correct. The arithmetic mean ($T_R = 450$ K) gives a result for this numerical example 4.3% high. The assumption that the regenerator is half hot and half cold ($T_R = 400$ K) gives a result 9.1% low.

ORIGINAL PAGE IS
OF POOR QUALITY

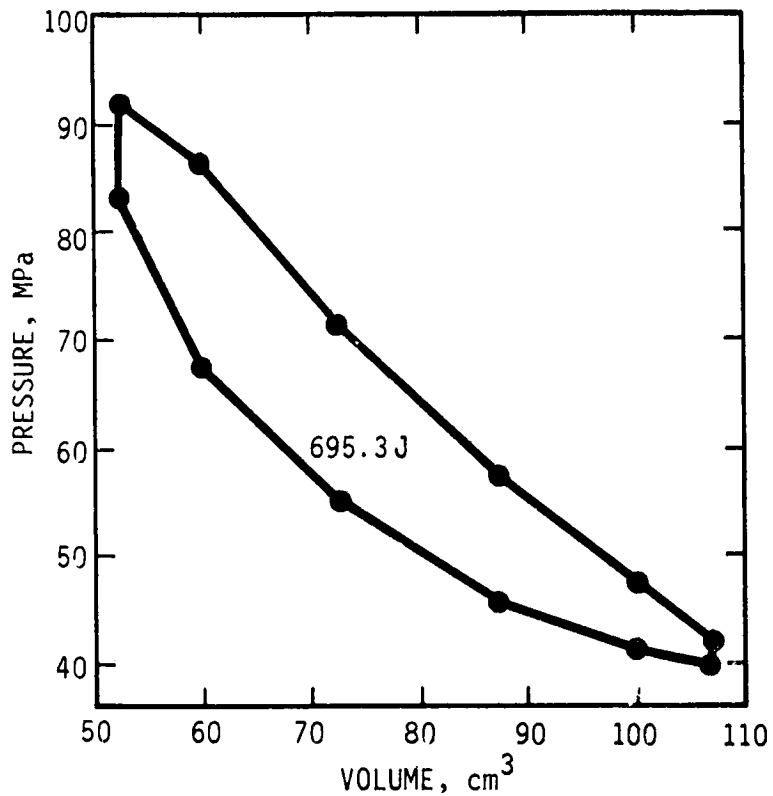

Figure 5-10. Work Diagram for Dual Piston Sample Case (ND = 30°).

5.1.5.2.3 Schmidt Equations

Walker (73 j, 78 dc) gives a Schmidt equation most adaptable to the two piston engine.

$$W1 = (PX)(VT) \frac{\pi(AU - 1)}{(K + 1)} \left(\frac{(1 - DL)}{(1 + DL)} \right)^{\frac{1}{2}} \frac{DL \sin(ET)}{1 + (1 - (DL)^2)^{\frac{1}{2}}} \quad (5-36)$$

where

- W1 = work per cycle, Joules
- PX = maximum pressure during cycle, MPa
- VT = VL + VK = (1 + K)VL
- VL = swept volume in expansion space
- VK = swept volume in compression space
- K = swept volume ratio = (VK)/(VL)
- AU = TC/TH
- TC = compression space gas temperature
- TH = expansion space gas temperature

ORIGINAL PAGE IS
OF POOR QUALITY

TR = dead space gas temperature
 $= (TC + TH)/2$
DL = $\left((AU)^2 + 2(AU)(K) \cos (AL) + K^2 \right)^{1/2} / (AU + K + 2S)$
AL = angle by which volume variations in expansion space lead those
in compression space, degrees
S = $2(RV)(AU)/(AU + 1)$ (This is where the arithmetic average
temperature for the regenerator enters.)
RV = VD/VL, dead volume ratio
VD = total dead volume, $cm^3 = HD + RD + CC$
ET = $\tan^{-1} (K \sin (AL) / (AU + K \cos (AL)))$ (Note that ET is defined
incorrectly in Walker's table of nomenclature and on page 36,
but is right on page 28 of reference 73 j.)

Now in order to check this equation against numerical analysis, it should give a
work per cycle of slightly greater than 700.324 Joules when 91.98 MPa is used as
the maximum pressure. TR = 450 K is the same assumption for both (see Section
5.1.5.2.2).

Therefore to evaluate:

VT = 40 + 40 = 80 cm^3
K = VK/VL = 40/40 = 1
PX = 91.98 MPa
AU = TC/TH = 300/600 = 0.5
RV = VD/VL = 40/40 = 1
S = $2(1)(0.5)/(0.5 + 1) = 2/3$
DL = $(0.5^2 + 1^2)^{1/2} / (0.5 + 1 + 2(2/3)) = 0.39460$
ET = $\tan^{-1} (1/0.5) = 63.43^\circ$
W1 = -700.37 Joules

Thus the formula checks to 4 figure accuracy except for the sign.

Walker obtained the above equation along with most of the nomenclature from the
published Philips literature. Meijer's thesis contains the same formula (see
page 12 of reference 60 c), except Meijer uses $(1 - AU)$ instead of $(AU - 1)$ and
a positive result would therefore be obtained.

In Meijer's thesis (60 c), the quantity S is defined so that dead spaces in
heaters, regenerator and coolers and clearance spaces in the compression and
expansion spaces, all of which have different temperatures associated with them,
can be accommodated.

Thus:

$$S = \sum_{s=1}^{s=n} \frac{V(S) TC}{VL T(S)} \quad (5-37)$$

where V(S) and T(S) are the volumes and absolute temperatures of the dead spaces.
Using this formula it would be possible to use the more correct log mean tempera-
ture for the regenerator. Thus:

ORIGINAL PAGE IS
OF POOR QUALITY

$$S = \frac{40(300)}{40(321.8)} = 0.693$$

The above equation then evaluates to:

$$P = 671.537 \text{ Joules}$$

This is within 0.003% of the value of 671.517 computed numerically for 1 degree increments (see Section 5.1.5.2.2).

Finkelstein (61 e, 60 j) independently of Meijer derived the following formula for the work per cycle:

$$W_1 = \frac{(2\pi)(K)(1 - AU)(\sin AL)(M)(R)(TC)}{(AU + K + (2)(S))^2 \sqrt{1 - (DL)^2} (1 + \sqrt{1 - (DL)^2})} \quad (5-38)$$

This equation looks quite different from Equation 5-36. It is somewhat simpler but requires the amount of gas in the engine to be specified instead of the maximum pressure.

Using the last numerical example:

$$S = \frac{40(300)}{40(432.8)} = 0.693$$

$$AU = 0.5$$

$$K = 1$$

$$AL = 90^\circ$$

$$(M)(R)(TC) = 10.518(300) = 3155.4$$

$$DL = \sqrt{1.25}/(1.5 + 2S) = 0.38735$$

Therefore, the work per cycle is:

$$W_1 = 671.55 \text{ Joules}$$

This result compares with 671.537 by the Meijer formula and with 671.517 by numerical analysis with 1 degree increments. Therefore, the above formula is correct and is also useful in computing the work output per cycle.

5.1.6 Finkelstein Adiabatic Cycle

The next step toward reality in cycle analysis beyond the Schmidt cycle is to assume that the hot and cold spaces of the engine have no heat transfer capability at all. That is, they are assumed to be adiabatic. For all but miniature engines this is a better assumption than assuming they are isothermal as the Schmidt analysis does. It is still assumed that the heat exchangers and the regenerator are perfect. The cycle has been named by Walker (78 dc) the Finkelstein adiabatic cycle because it was first calculated by Finkelstein (60 v) who was the first to compute it using a mechanical calculator (one case took 6 weeks). The assumptions Finkelstein used are as follows:

1. The working fluid is a perfect gas and the expression $pV = wRt$ applies.
2. The mass of the working fluid taking part in the cycle remains constant, i.e., there is no leakage.
3. The instantaneous pressure is the same throughout the system, i.e., pressure drops due to aerodynamic friction can be neglected.
4. The volume variations of the compression and expansion spaces are sinusoidal, and the clearances at top dead center are included in the constant volume of the adjacent heat exchangers.
5. The regenerator has a heat capacity which is large compared with that of the working fluid per pass, so that the local temperatures of the matrix remain unaltered. Its surface area and heat transfer coefficient are also assumed to be large enough to change the temperature of the working fluid passing through to the terminal value. Longitudinal and transverse heat conduction are zero.
6. The temperature of the boundary walls of each heat exchanger is constant and equal to one of the temperature limits. The heat exchangers are efficient enough to change the temperature of the working fluid to that of the boundary walls in the course of one complete transit.
7. The temperature of the internal surfaces of the cylinder walls and cylinder and piston heads associated with each working space is constant, and equal to one of the temperature limits. The overall heat transfer coefficient of these surfaces is also constant.
8. Local temperature variations inside the compression and expansion spaces are neglected--this assumes perfect mixing of cylinder contents at each instant.
9. The temperature of the respective portions of the working fluid in each of the ancillary spaces, such as heat exchangers, regenerators, ducts and clearances, is assumed to remain at one particular mean value in each case.
10. The rotational speed of the engine is constant.
11. Steady state conditions are assumed for the overall operation of the engine, so that pressures, temperatures, etc. are subject to cyclic variations only.

The analysis outlined by Finkelstein is very complicated (60 v). The results of this pioneering analysis are given below because they give some understanding of the effect the nearly adiabatic spaces of a real engine has on engine performance.

Finkelstein evaluated a specific case which happened to be a heat pump with a two-piston configuration (see Figure 5-9). The specific parameters were specified in dimensionless form as follows:

$$K = 1 = \frac{VK}{VL} = \text{swept volume ratio}$$

$$2S = 1 = \text{temperature corrected clearance ratio}$$

$$AL = 90^\circ = \text{phase angle}$$

$$AU = 2 = \frac{\text{temperature of heat rejection}}{\text{temperature of heat reception}}$$

Finkelstein gives results based upon a dimensionless heat transfer coefficient which is also called a number of transfer units. Where:

$$TU = \frac{(HY)(AH)}{(OM)(M)(MW)(CP)} \quad (5-40)$$

where

HY = heat transfer coefficient, watts/cm²K

AH = area of heat transfer, cm²

OM = speed of engine, radians/sec

(M)(MW) = mass of working gas, grams

CP = heat capacity at constant pressure, j/g K

Real engines can be built where TU in the hot and cold space is very low all the time. Also real engines can be built where TU is very high all the time. However, real engines can probably not be built where TU has a constant intermediate value during the cycle. Nevertheless, the results at these intermediate values calculated by Finkelstein are instructive to show where the breakpoint is between adiabatic-like and isothermal-like operation. Table 5-1 shows the results of this analysis. All the mechanical and heat energies are non-dimensionalized by dividing each by M(MW)(R)(TH). Note that for this particular numerical example the adiabatic cycle is only about half as efficient as the isothermal cycle in pumping heat. However, this example is for a lower than usual temperature corrected clearance ratio, S, of $\frac{1}{2}$. It is not uncommon for S to be much larger. For instance, in the GPU-3 engine, S could be evaluated as follows: (see Table 3-2)

$$\begin{aligned} S &= \frac{TC}{VL} \left(\frac{HD}{TH} + \frac{RD}{TR} + \frac{CD}{TC} \right) & (5-41) \\ &= \frac{330}{120.4} \left(\frac{93.3}{1000} + \frac{65.5}{604.3} + \frac{34.3}{300} \right) \\ &= 0.84 \end{aligned}$$

The larger S is, the less dramatic the effect of the adiabatic spaces.

Note that a small amount of heat transfer in the hot and cold space is worse than none at all. This gas spring hysteresis effect has been noted by others (78 as, 78 at). It also shows that if you want to gain all the advantages of heat transfer in the variable volume spaces, the heat transfer coefficient must be high.

Table 5-1

FINKELSTEIN ADIABATIC ANALYSIS

Dimensionless Quantities	Isothermal Regime	Limited Heat Transfer			Adiabatic Regime
Transfer units, TU	∞	1	0.5	0.1	0
Mechanical Energy Input to Expansion Space	-0.518	-0.455	-0.435	-0.443	-0.481
Mechanical Energy Input to Compression Space	1.036	1.107	1.166	1.310	1.367
Net Mechanical Energy Input	0.518	0.652	0.731	0.867	0.886
Heat to Gas in Expansion Space	0.518	0.478	0.438	0.228	0
Heat to Gas in Heat Exchanger Next to Expansion Space	0	-0.023	-0.003	0.215	0.481
Total Heat In	0.518	0.455	0.435	0.443	0.481
Heat from Gas in Compression Space	1.036	0.998	0.880	0.410	0
Heat from Gas in Heat Exchanger Next to Compression Space	0	0.109	0.278	0.900	1.367
Total Heat Out	1.036	1.107	1.158	1.310	1.367
<u>Heat In</u> Mech. Energy In	1.000	0.698	0.595	0.511	0.543

Finkelstein also shows how the engine pressure changes during the cycle for the cases shown in Table 5-1. (See Figure 5-11.) Note that the swing is largest as would be expected for the adiabatic case and least for the isothermal case and the other cases are in between. Figure 5-12 shows how the expansion space gas temperature varies during the cycle. The bottom curve is for η or TU = 0. The labeling on the left-hand side of curve 5-12 is incorrect. Note that as the heat transfer increases, the temperature generally gets close to the infinite heat transfer case which does not vary from 1; that is, the expansion space temperature remains infinitesimally close to the heat source temperature. For zero heat transfer in the expansion space there has to be a discontinuity at a crank angle of 180° because this is the point when the expansion space becomes zero in volume. After 180° the expansion space begins to fill again with gas which is, by definition, at the heat source temperature. In Figure 5-13 the

ORIGINAL PAGE IS
OF POOR QUALITY

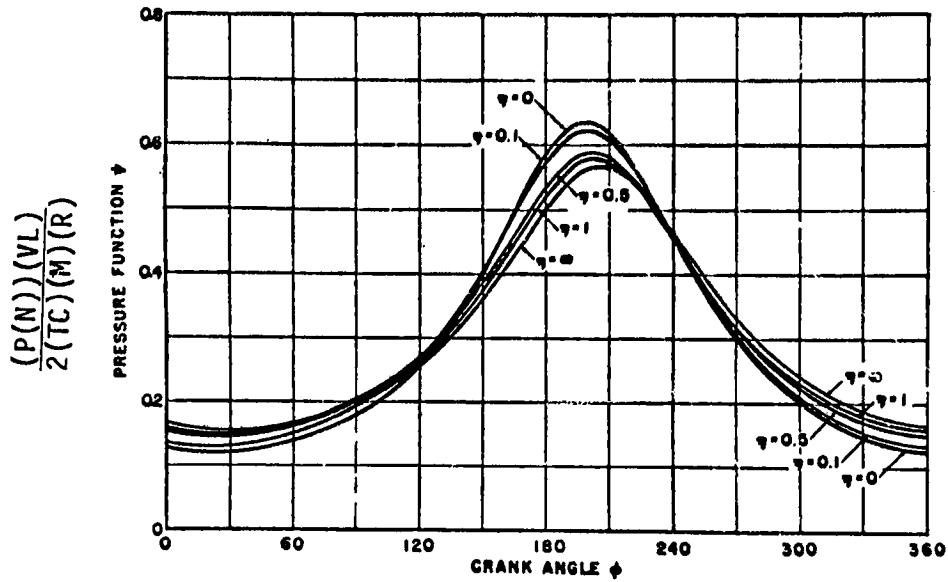

Figure 5-11. Pressure Variation for Cases Given in Table 5-1 (60 v).

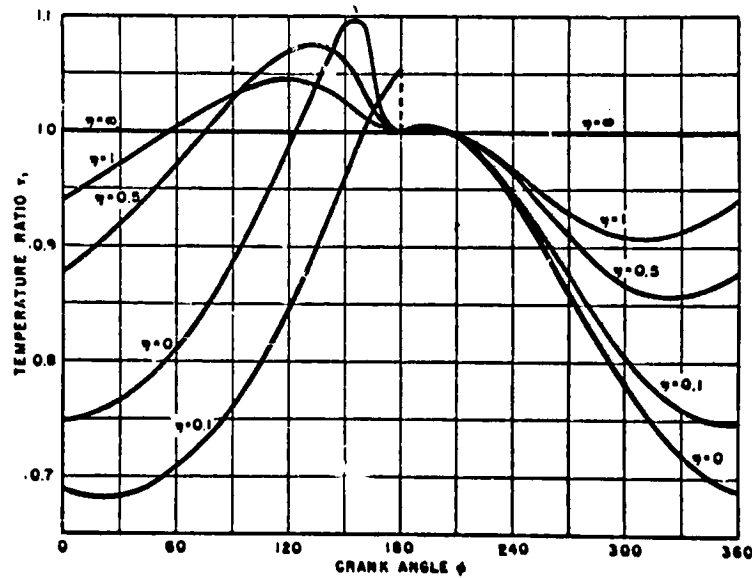

Figure 5-12. Expansion Space Gas Temperature Relative to the Heat Source Temperature in the Expansion Space for the Cases Given in Table 5-1 (60 v).

ORIGINAL PAGE IS
OF POOR QUALITY

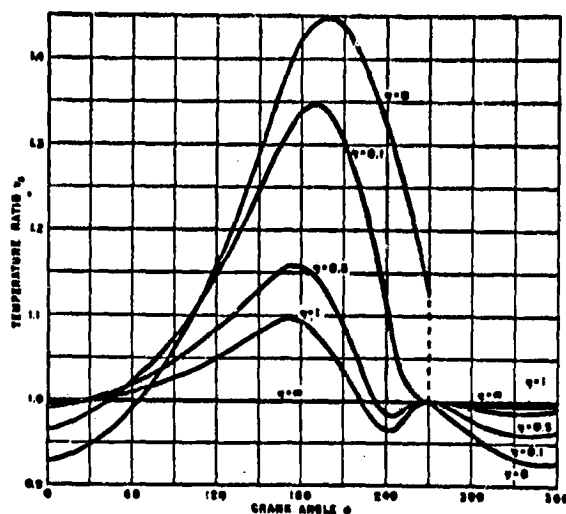

Figure 5-13. Compression Space Gas Temperature Relative to Heat Sink Temperature for the Cases Given in Table 5-1 (60 v).

same calculated information is given for the compression space. Here again the more the number of heat transfer units, η , or TU, the closer the gas temperature curve approaches to the perfect heat transfer curve which stays at a temperature ratio of 1. Here the compression space volume becomes zero at 270° crank angle. Thus, the discontinuity at this point for an entirely adiabatic case.

In reality the heat transfer coefficient in the compression space and the expansion space will get to be quite large when these spaces almost disappear each cycle. Then the number of transfer units will smoothly get to be very small during the rest of the cycle providing the engine is built in the conventional way.

Most of the design methods of first-, second- and third-order designs start out with some sort of cycle analysis to determine the basic power output and basic heat input and then make the necessary corrections to get the final prediction. One highly regarded method of doing this was published by Rios (69 am). The author spent a considerable amount of time getting this program which originally was supplied in punch card form to the author by Professor J. L. Smith of MIT into working order on his own computer. The Rios analysis uses the same assumptions as Finkelstein did but he does not require that the two pistons move in sinusoidal motion. He starts with arbitrary initial conditions and finds that the second cycle is convergent, that is, it starts at the same point that it ends at, providing the dead volumes are defined so that the clearance volume in the hot and cold spaces is lumped with the heat exchangers. Therefore, these volumes in these spaces go to zero at which point

ORIGINAL PAGE IS
OF POOR QUALITY

the gas temperature in these spaces can be re-initialized. Appendix D presents the Rios program which has been modified by the author to be for a heat engine instead of a heat pump as the original thesis gave it. By the nature of the assumptions the temperature of the gases in all parts of the engine except the hot and cold spaces is known in advance and it is also assumed that the pressure is uniform throughout the engine each instant of time. As in the Finkelstein solution just described the temperatures of both the hot and cold spaces are allowed to float. Also, similar to the Finkelstein analysis there are four possible cases. Each case requires a separate set of equations. The four cases are: 1) mass increasing in both hot and cold spaces, 2) mass decreasing in both hot and cold spaces, 3) mass decreasing in cold space and increasing in hot space and 4) mass increasing in cold space and decreasing in hot space. The program employs a simplified Runge-Kutta integration approach. For each of the four cases it calculates a pressure change based upon the conditions at the beginning of the increment. Based upon this pressure change it calculates the pressure at the middle of the increment and using this pressure, it calculates a better approximation of the pressure change for the increment using volumes that are true for the middle of the increment. This final pressure change is used to determine the pressure at the end of the increment and the mass changes during the increment. Based upon these mass changes the decision matrix is set up so that for the next increment the proper option will be selected of the four that are available. The analysis in Appendix D was done for one degree increments. Many modifications to the program would be necessary to do anything different than one degree increments.

Martini has checked the Finkelstein adiabatic analysis for the particular case published by Finkelstein (60 v). The computation procedure is quite different than any others and is explained in detail in Appendix E. It was found that the pressure wave as shown in Figures 5-11 and 5-14 could be duplicated for the adiabatic case with fairly large time steps, as large as 30° . However, at the point of maximum curvature the curve is not really too well defined. Using the Martini method the adiabatic curve from Figure 5-12 is duplicated on a larger scale in Figure 5-15. The calculated points for 15° , 30° and 2° angle increments are plotted. Note that degree increments of 15° and 30° , although adequate for determining the pressure-volume relationship, are not adequate for determining the temperature in the expansion space of the engine. However, 2° angle increments do determine the temperature almost exactly, probably as closely and as accurately as Figure 5-12 was drawn. Figure 5-16 gives a similar evaluation for the adiabatic temperature curve duplicate from Figure 5-13. Note that 15° angle increments and 30° angle increments give substantial errors in comparison to the more exact 2° angle increments. Appendix E gives the method of calculation and shows how accurate it is.

5.1.7 Philips Semi-Adiabatic Cycle

Extremely little has been published by the Philips Company on how they calculate their engines. However, one of their licensees, MAN/MWM, discussed quite generally their process in a lecture at the Von Karman Institute for Fluid Dynamics (73 aw). Mr. Feuerer discloses that one of the Philips processes for calculating a Stirling engine starts out with a semi-adiabatic cycle and then adds additional corrections in a second-order design method. This second-order method will be discussed in Section 5.3 and the semi-adiabatic cycle it

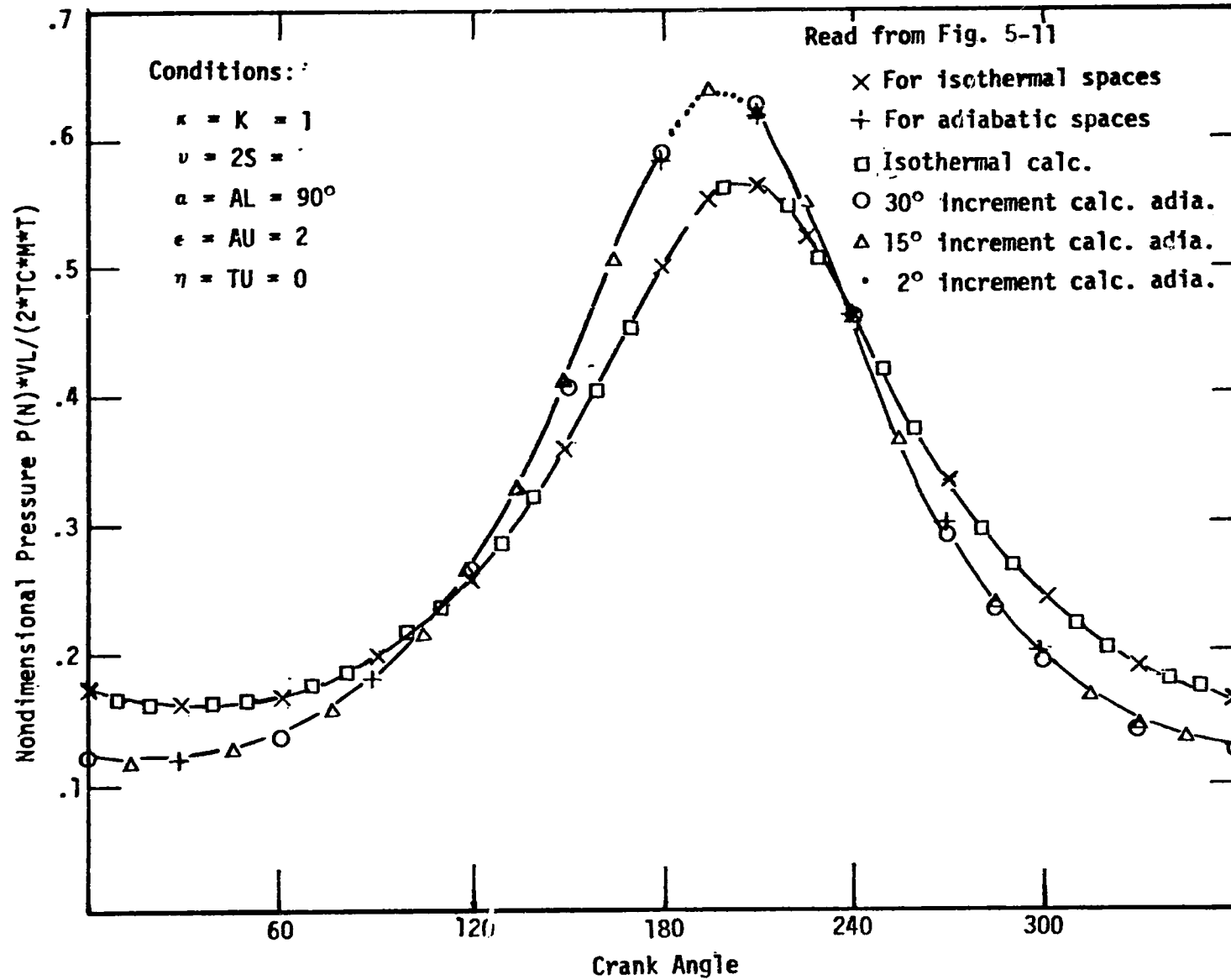

ORIGINAL PAGE IS
OF POOR QUALITY

Figure 5-14. Dimensionless Pressure vs Crank Angle Show Accuracy of Martini Method for Various Angle Increments.

ORIGINAL PAGE IS
OF POOR QUALITY

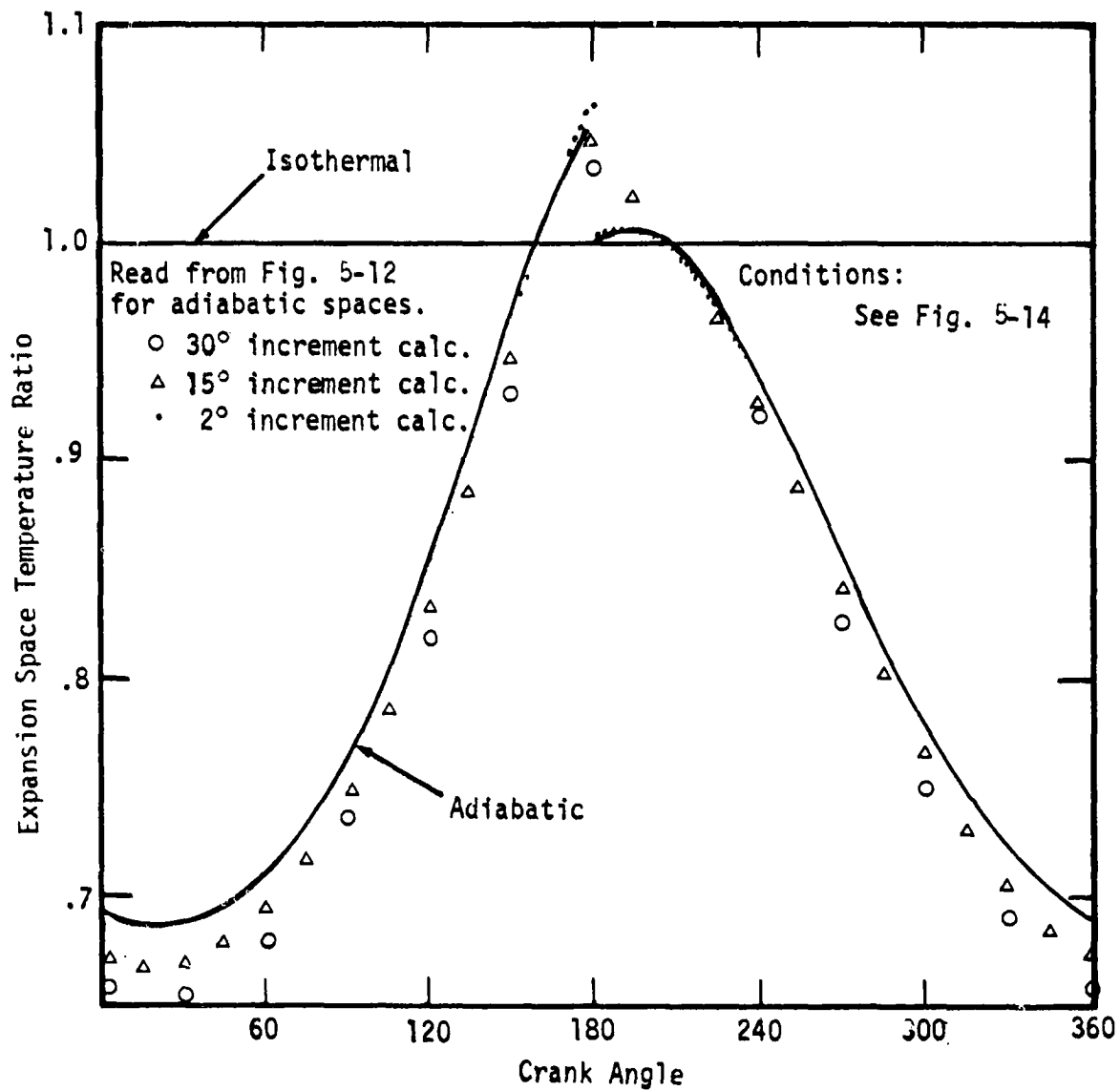

Figure 5-15. Expansion Space Temperature Ratio vs. Crank Angle Showing Accuracy of Martini Method for Various Angle Increments.

C-2

FIGURE 13
CRANK QUALITY

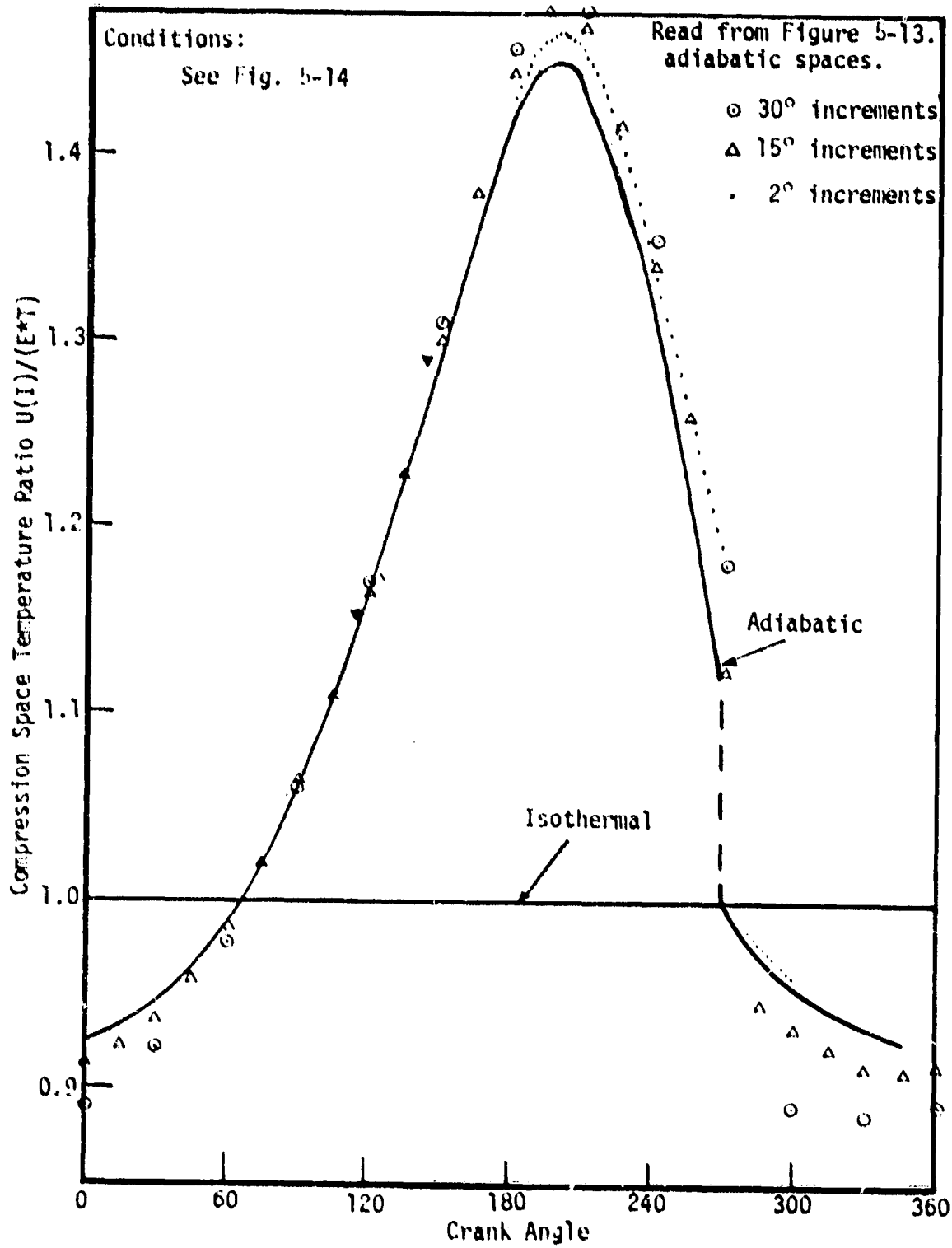

Figure 5-16. Compression Space Temperature Ratio vs. Crank Angle Showing Accuracy of Martini Method for Various Angle Increments.

is dependent upon will be discussed here. As opposed to the more ideal Finkelstein adiabatic cycle, the Philips semi-adiabatic cycle is an adiabatic process that allows for the fact that the gas properties and the heat transfer are not ideal, that is, 1) the compressibility factor must be taken into account and 2) both the heat exchangers and the cylinders have finite heat transfer coefficients. These heat transfer coefficients result in different gas temperatures throughout the cycle than were calculated in the Finkelstein adiabatic cycle. Taking these effects into account the Philips licensee people arrive at what they call the semi-adiabatic cycle. Feurer (73 aw) presents a number of efficiencies and power outputs for the cycle for the conditions given in Table 5-2. In addition he varied the phase angle from zero to 180° and gave results for additional dead volumes of 40, 100 and 200 cm³ and diameters for the connecting spaces which these additional dead volumes represented of 100, 50 and 20 mm. However, this information is not judged to be of general utility because the description of the heat exchangers and cylinders are not given and the heat transfer coefficients that pertain to these parts of the engine are not given. All of this information along with the compressibility factor which is known for a particular gas is needed to calculate the Philips semi-adiabatic cycle results.

It was surmised by Walker (78 dc, p. 4.16-4.17) that the Philips semi-adiabatic cycle is the same as the Finkelstein adiabatic cycle. Further investigation by Martini presented herein shows that that is not the case. The Martini formulation of the Finkelstein adiabatic cycle given in Appendix E was used to generate the information shown on Figure 5-17. Note that the indicated power or the indicated efficiency is plotted versus the phase angle between the two pistons of a dual piston Stirling engine. The Schmidt power given by Feurer is the same as that calculated by Martini using the applicable computer program. Also, the ideal efficiency is, of course, checked. Note that the Philips semi-adiabatic

Table 5-2

ENGINE CONDITIONS FOR THE
NUMERICAL EXAMPLE OF FEURER (73 aw)

Helium working gas
1500 rpm
120 atm mean pressure
75 C inside cooler tubes
750 C inside heater tubes
120.5 cm³ heater tube gas volume
56.5 cm³ cooler tube gas volume
145.3 cm³ regenerator gas volume
0 cm³ additional dead volume
100 mm pistons diameter
50 mm stroke
100 mm connecting rod length

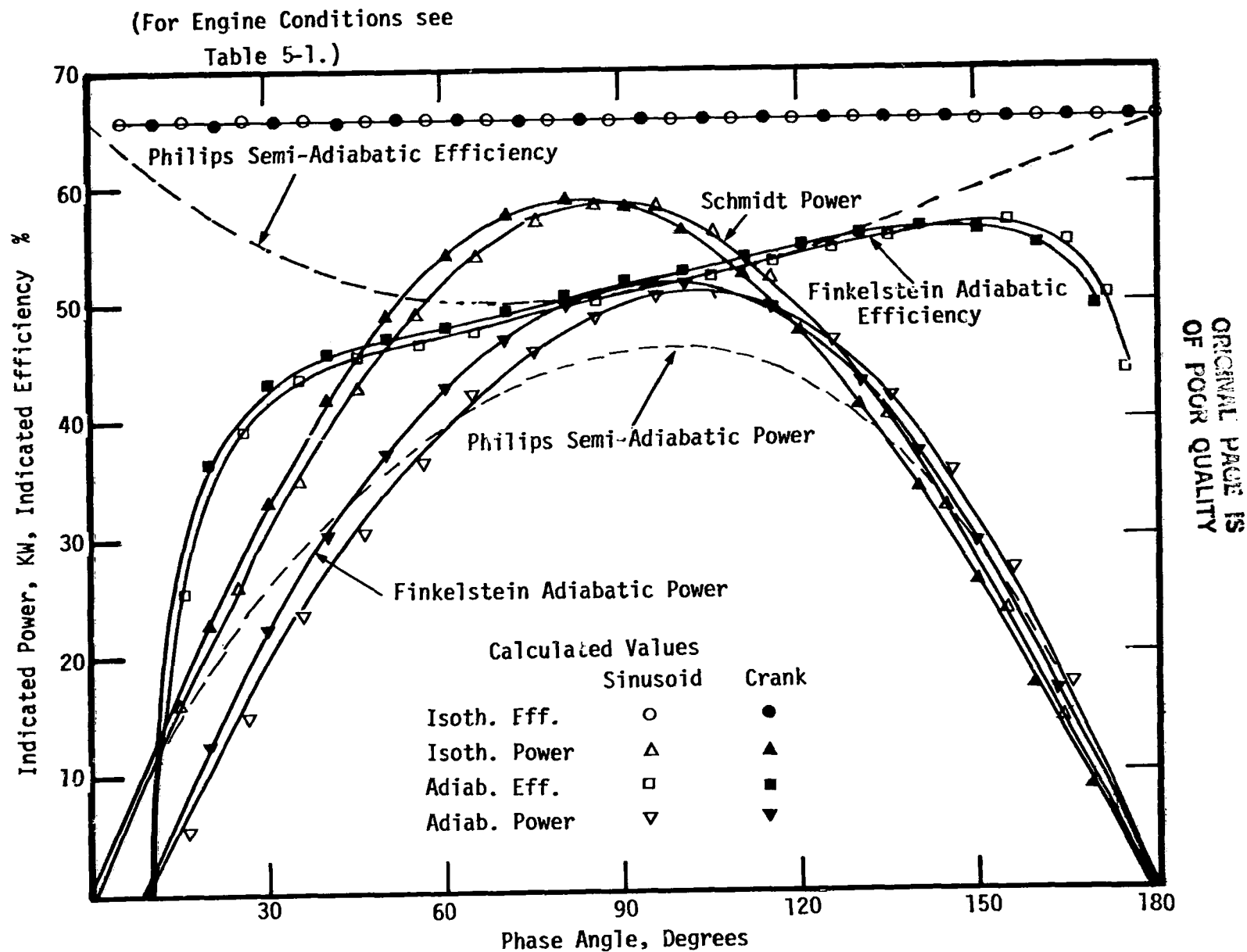

Figure 5-17. Comparison of Cycles using the Feurer Example (73 aw).

efficiency is the same as the ideal efficiency at a phase angle of 0 and 180°, but drops down to only 50% instead of the ideal 67% at about 70° phase angle. The cycle efficiency using the Finkelstein adiabatic analysis cycle is given by the squares on Figure 5-17. There is a small difference depending upon whether purely sinusoidal motion is assumed or whether the crank motion specified in Table 5-2 is employed. It is interesting to note that the Philips semi-adiabatic efficiency and the Finkelstein adiabatic efficiency agree in the region from 80° to 130° in phase angle. Beyond this region of agreement, which may be fortuitous, the Philips semi-adiabatic efficiency tends toward the ideal efficiency and the Finkelstein adiabatic efficiency tends toward zero efficiency.

Concerning the power, Figure 5-17 shows that the Finkelstein adiabatic power is usually less than the Schmidt power. In both cases the crank geometry tends to have the power peak at a lower phase angle than for the sinusoidal geometry. However, the effect at this particular crank ratio is not pronounced. Note that the Philips semi-adiabatic power is lower generally than the Finkelstein adiabatic power and that the Philips power goes to 0 at 0 and 180° phase angle, whereas the Finkelstein adiabatic power for this particular case goes to 0 at 10° and 180° phase angle.

It should be emphasized that this is not by any means a full disclosure of the Philips semi-adiabatic cycle, but it does give all the information that is available on it in the open literature.

5.2 First-Order Design Methods

5.2.1 Definition

A first-order design method is a simple method that can literally be done on the back of an envelope. It relates the power output and efficiency of a machine to the heater and cooler temperature, the engine displacement and the speed. There is no need to specify the engine in any more detail than this. Therefore, this method is good for preliminary system analysis. It is assumed that an experienced Stirling engine design and manufacture team will execute the engine. First-order methods are used to predict the efficiency as well as the power output.

5.2.2 Efficiency Prediction

Efficiency of a Stirling engine is related to the cycle efficiency of a Stirling engine which is the same as the Carnot efficiency, which of course is related to the heat source and heat sink temperatures specified. Section 4 gives all the information available on well-designed Stirling engines which have not been fully disclosed and shows how the quoted efficiencies of these engines relate to the Carnot efficiency.

Carlqvist, et. al (77 a1) give the following formula for well optimized engines operating on hydrogen at their maximum efficiency points.

$$\eta_{\text{eff}} = \frac{P_{\text{net}}}{E_F} = \left(1 - \frac{T_C}{T_H}\right) \cdot C \cdot \eta_H \cdot \eta_M \cdot f_A \quad (5-42)$$

where

η_{eff} = overall thermal or effective efficiency

P_{net} = net shaft power with all auxiliaries driven

E_F = fuel energy flow

T_C, T_H = compression - expansion gas temperature, K

C = Carnot efficiency ratio of indicated efficiency to Carnot efficiency, normally from 0.65 to 0.75. Under special conditions 0.80 can be reached.

η_H = heater efficiency, ratio between the energy flow to the heater and the fuel energy flow. Normally between 0.85 and 0.90.

η_M = mechanical efficiency, ratio of indicated to brake power. Now about 0.85 should go to 0.90.

f_A = auxiliary ratio. At maximum efficiency point $f_A = 0.95$.

Thus the most optimistic figures:

$$\eta_{\text{eff}} = \left(1 - \frac{T_C}{T_H}\right)(0.75)(.90)(.90)(.95) = \left(1 - \frac{T_C}{T_H}\right)(0.58)$$

5.2.3 Power Estimation by First-Order Design Methods

Some attempts have been made to relate the power actually realized in a Stirling engine to the power calculated from the dimensions and operating conditions of the engine using the applicable Schmidt equation. Usually, the actual power realized has been quoted to be 30-40% of the Schmidt power (78 ad, p.100). However, the recommended way of estimating the Stirling engine power output is to use the Beale number method as described by Walker (79 y). To quote from Walker, "William Beale of Sunpower, Inc. in Athens, Ohio, observed several years ago that the power output of many Stirling engines conformed approximately to the simple equation:_____

$$P = 0.015 p \times f \times V_0$$

where .

P = engine power, watts

p = mean cycle pressure, bar

f = cycle frequency of engine speed, hertz

V_0 = displacement of power piston, cm^3

"This can be rearranged as $P/(pfV_0) = \text{constant}$. The equation was found by Beale to be true approximately for all types and sizes of Stirling engines for which data were available including free piston machines and those with crank mechanisms. In most instances the engines operated with heater temperatures of 650 C and cooler temperatures of 65 C.

"The combination $P/(pfV_0)$ is a dimensionless group that may be called the Beale number. It is self-evident that the Beale number will be a function of both heater and cooler temperatures. Recent work suggests the relationship of Beale number to heater temperature may be of the form shown in Figure 5-18 by the full line. Although for the sake of clarity the relationship is shown as a single line, it must of course be understood that the relationship is a gross approximation and particular examples of engines that depart widely may be cited. Nevertheless, a surprisingly large number of engines will be found to lie within the bounds of the confidence limits (broken lines) drawn on either side of the proposed relationship. Well designed, high efficiency units with low cooler temperatures will be concentrated near the upper bound. Less well designed units of moderate efficiency with high cooler temperatures will be located at the lower extremity.

"It should be carefully noted that the abscissa of Figure 5-18 is absolute temperature, degrees Kelvin; engines with the hot parts made of conventional stainless steels (say 18-8) will be confined to operate at temperatures limited to the region indicated by the line A-A. High alloy steels for the hot parts will permit the elevation of heater temperature to the limit of B-B. Above this temperature ceramic components would likely be used in the heater assembly."

Figure 5-18 is the best information generated by Walker and his students based upon information available to them, both proprietary and non-proprietary.

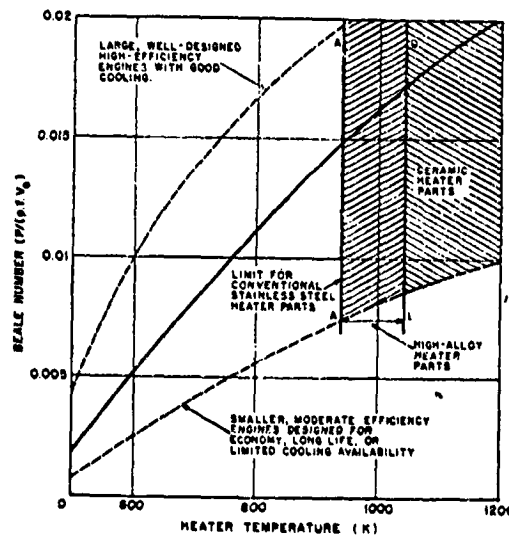

ORIGINAL PAGE IS
OF POOR QUALITY

Figure 5-18. Beale Number as a Function of Heater Temperature.

5.2.4 Conclusion for First-Order Methods

First-order design methods are recommended for those who would like to evaluate the possibility of the use of a Stirling engine.

5.3 Second-Order Design Methods

5.3.1 Definition

Second-order design methods are relatively simple computational procedures that are particularly useful for optimizing the design of a Stirling engine from scratch. An equation or brief computational procedure is used to determine the basic power output and heat input. The basic power output is then degraded by various identifiable loss terms and the heat input is added to by evaluating a variety of additional heat losses that are known to exist in real engines. Consequently, an estimate is made of the real power output and real heat input using relatively simple means and not resorting to full-blown engine simulations which are the domain of third-order design methods. In second-order analysis one of the Stirling engine cycles described in Section 5.1 is used as a basis.

What is known about the Philips second-order analysis (73 aw) will be given because although very little is known about this analysis procedure, very much has been done with it. Because of the practical successes of the Philips engines, any information that is known about their engine design methods is of importance. Next the equations that have been used to evaluate power losses and heat losses will be given in two separate subsections. It will be left for the designer to decide what power losses and what heat losses pertain to his particular design and to add them to the cycle analysis which is most realistic for this engine to come up with his own second-order design method.

5.3.2 Philips Second-Order Design Method

This method starts with the Philips semi-adiabatic cycle as its basic power output and efficiency and then makes corrections. The corrections in the order that they are applied are shown in Table 5-3. Feurer (73 aw) shows the effect of the non-sinusoidal motion of the crank by Figure 5-19. Note that this is essentially identical to a portion of Figure 5-17 for the white and black triangles. In Figure 5-20 the line labeled "0" is for the power output of the semi-adiabatic cycle. The curve labeled "I" is not drawn because it is so close to the curve labeled "0" and this is for the power output based on the semi-adiabatic cycle less the correction due to the crank motion. The curve labeled "II" has the additional correction of adiabatic residual losses. Note that this has a very large correction at low phase angles but none at phase angles approaching 180° . The final curve labeled "III" in Figure 5-20 shows the additional correction due to flow losses. Note that this correction is small at low phase angle and maximum at a phase angle of 180° . Note that for this case the phase angle of 90° is not necessarily optimum, but is reasonably close. Figure 5-21 shows the adiabatic residual losses that are subtracted from curve I in Figure 5-20 to get curve II. Figure 5-21 also shows the flow losses which are subtracted from curve II in Figure 5-20 to get curve III. In Figure 5-21 it is shown what happens to the efficiency of the engine as the various losses are considered. At the top of Figure 5-21 is the Carnot efficiency which of course only depends on the temperature input and output of the machine. By going from a strictly Schmidt cycle to a semi-adiabatic cycle the bow-shaped curve labeled "I" which has a minimum at 50% efficiency is obtained. Going from sinusoidal to crank motion apparently has little effect

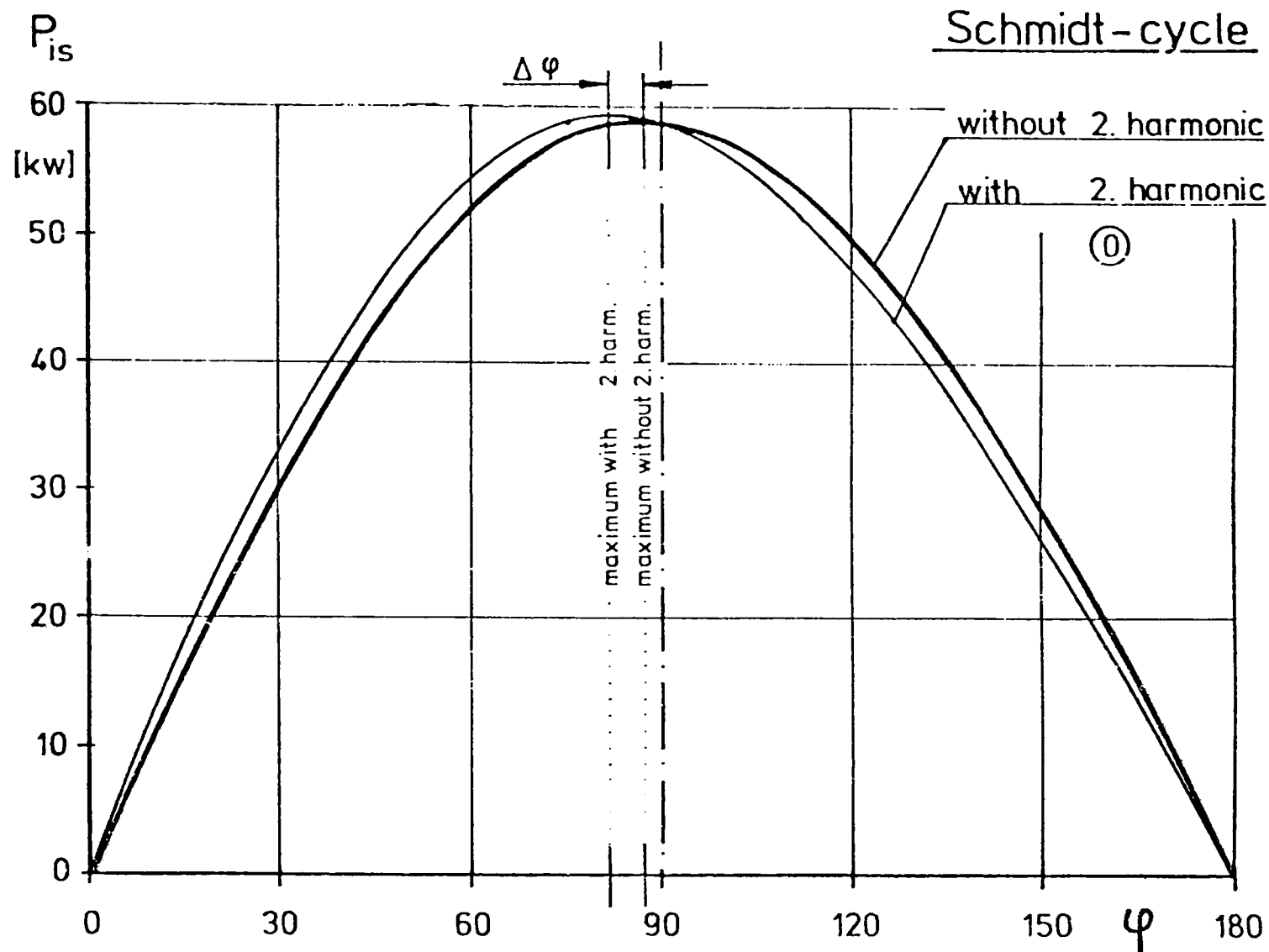
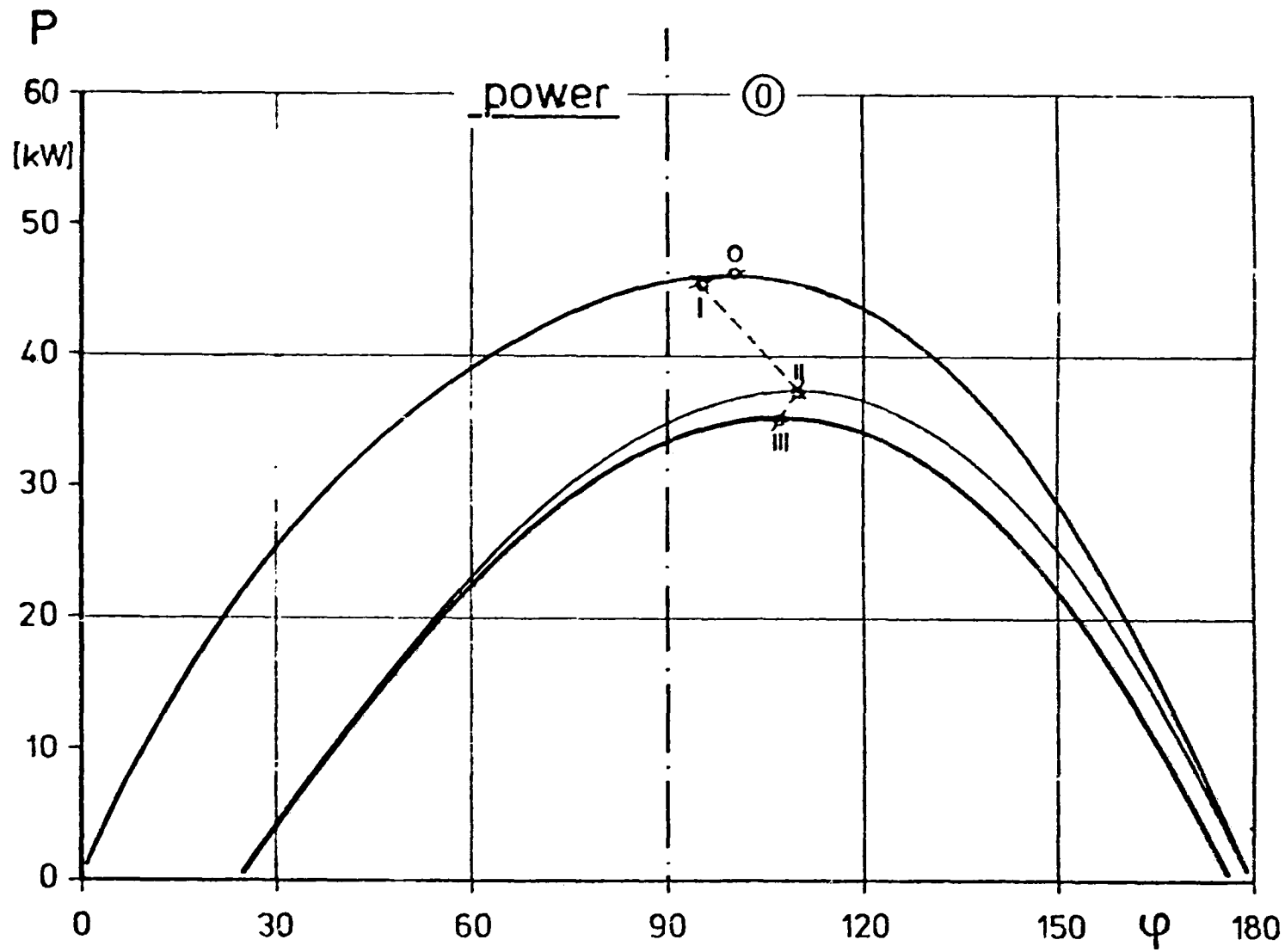

Figure 5-19. Effect of Two Harmonics on the Schmidt Cycle Power (Based upon Crank Specified In Table 5-2).

ORIGINAL PAGE IS
OF POOR QUALITY



ORIGINAL PAGE IS
 OF POOR QUALITY

Figure 5-20. Power Output Based Upon Conditions for Table 5-2 (73 aw).

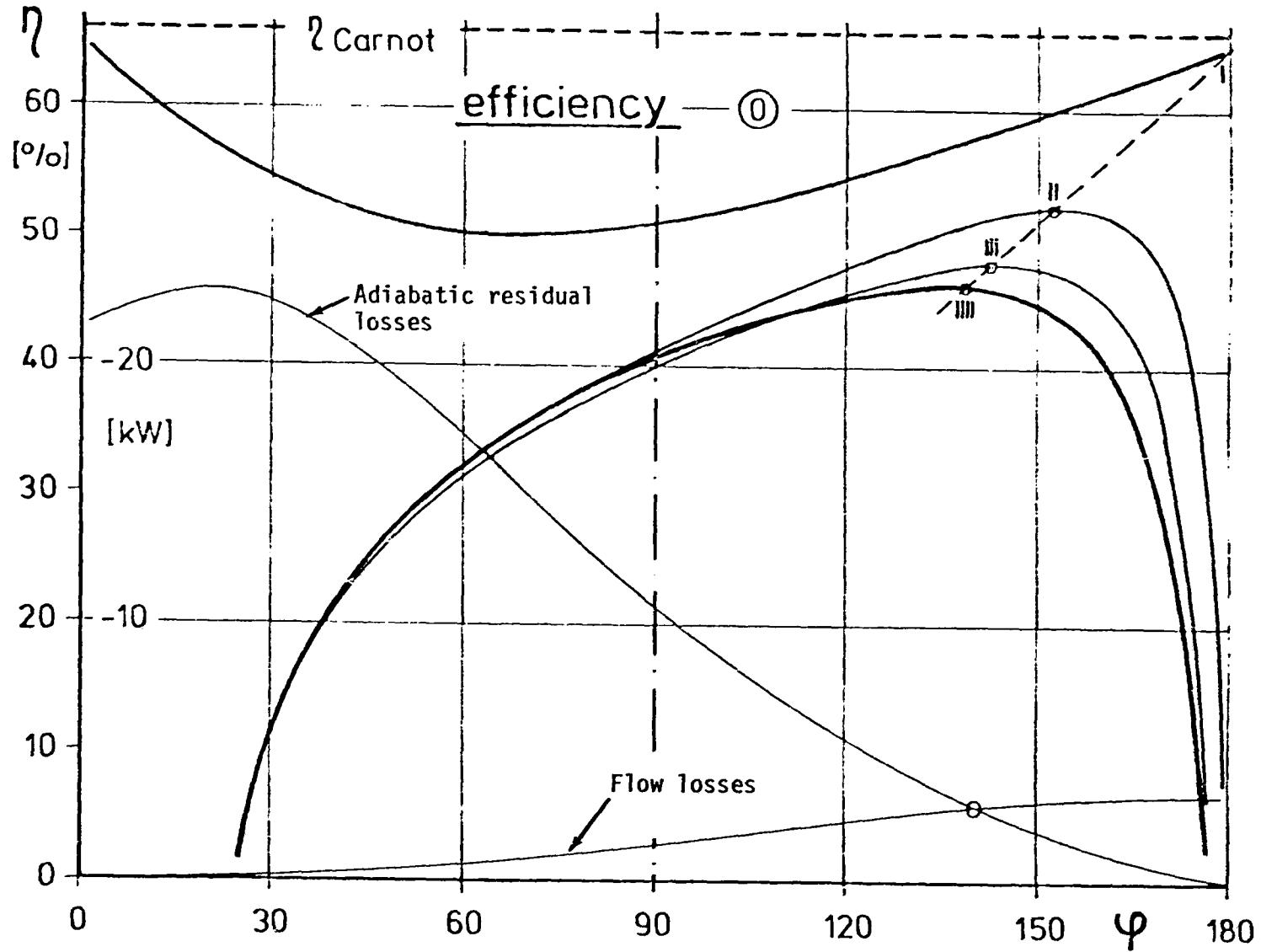

Figure 5-21. Engine Efficiencies Based upon Conditions Given in Table 5-2 (73 aw).

Table 5-3

OUTLINE OF PHILIPS SECOND-ORDER
POWER OUTPUT CALCULATION

Start with basic power output computed by semi-adiabatic cycle (Section 5.1.7).

Less: loss due to non-sinusoidal motion of cranks.

Less: adiabatic residual losses which is the difference between the ideal temperature in the cylinders, heat exchangers and connecting spaces on the one hand and the actual temperature in these components on the other which results in an additional power loss.

Less: flow losses due to flow friction and entrance and exit losses and additional losses.

Equals: indicated output.

Less: mechanical losses, seals, bearings, etc.

Less: power for auxiliaries.

Equals: net shaft output

on the efficiency. However, in adding in the effect of the adiabatic residual losses the efficiency curve becomes the one labeled "II" which is much different in shape which peaks at about 150° phase angle. (Compare curve II with the Finkelstein adiabatic efficiency shown in Figure 5-17.) Curve III is the efficiency after the addition of flow losses and curve IV is the final efficiency after the addition of heat conduction losses. Note that the maximum efficiency point when all losses are considered is at a larger phase angle than is the maximum power point. It would seem reasonable for this machine to settle on a phase angle of about 120° because this would be nearly the high point of the power curve as well as nearly the high point of the efficiency curve.

This gives about all that is known about the workings of the Philips second-order design program. There is probably a number of good second-order as well as third-order design programs available to Philips as well as speciality programs for particular parts of the machine. It should be pointed out that all this information is from one paper by Feuer of MAN/MWM, a Philips licensee. Nothing like this has been published directly from Philips.

5.3.3 Power Losses

It would seem reasonable that when isolated groups wrestle with the problem of analyzing a Stirling engine in a practical way, they would consider the various identifiable losses in different orders. The work that follows is chiefly

the result of the United States Air Force-sponsored work on cooling engines (70 ac, 75 ac) as well as HEW-sponsored work on the artificial heart machine (63 c). This work starts out usually with a Schmidt cycle analysis and then applies a number of corrections. Some work has started out with a Finkelstein adiabatic analysis and then applies the corrections to that. (See Section 5.3.5.) This section identifies a number of power losses and presents the published equations which describe them. Power losses fall under two headings: flow friction and mechanical friction. The adiabatic residual losses which were so important in the Philips second-order method described just previously have been either included in this cycle analysis at the start of the evaluation or have been added on the end as an experience factor.

5.3.3.1 Flow Friction Losses

The basic power is computed as if there is no fluid friction. Energy loss due to fluid friction is deducted from the basic power as a small perturbation on the main engine process. If fluid friction consumes a large fraction of the basic power the following methods will not be accurate but then one would not choose a design to be built unless the fluid friction were less than 10% of the basic power.

Fluid friction inside the engine can be computed by published correlations for fluid flow through porous media and in tubes. These flow friction correlations are applicable for steady, fully developed flow. If the fraction of the gas inventory found in the hot spaces and in the cold spaces is plotted against crank angle, it is apparent that to a good approximation this periodic flow can be approximated by (1) steady flow, in one direction, (2) no flow for a period of time, (3) then steady flow back in the other direction and (4) then no flow to complete the cycle. The mass flow into and out of the regenerator is not quite in phase due to accumulation and depletion of mass in the regenerator. Note that the mass flow at the cold end is much more than the mass flow at the hot end mostly due to gas density change. The average mass flow rate and the average fraction of the total cycle time that gas is flowing in one direction at the hot end of the regenerator is used for the heater flow friction and heat transfer calculations. The average mass flow rate and the average fraction of the total cycle time flowing in one direction at the cold end of the regenerator is used for the cooler flow friction and heat transfer calculations. For the regenerator the mean of the above two flows and of the above two fractions has been used successfully. (See Appendix C and 79 ad, 79 o.)

Although the above approximation has been found to work, in each case graph the fractions of the mass of gas in the hot and the cold space during the cycle to determine if the approximations listed above of a constant flow rate, a stationary time and another constant flow rate are really approximated. One should also be certain that the computer algorithm for determining the flow rates and the times of the assumed constant flows are properly evaluated.

It would be more certain to divide the regenerator and even the heater and cooler spaces into a number of sections and evaluate the mass flow rates and the temperatures in each one of these sections for each time step. Then if one can assume that steady-flow friction coefficients apply, the pressure drop and finally the flow loss in each element can be computed and summed to find the

ORIGINAL PAGE IS
OF POOR QUALITY

total flow loss for that increment. The flow friction correlations for each part of the engine taking into account the different geometries will now be given. The regenerator will be given first since it is the most important in terms of pressure drop and then the heat exchangers second.

5.3.3.1.1 Regenerator Pressure Drop -- Screens

Kays and London (64 1, p. 33) give the formula for pressure drop through a matrix as would be used for a regenerator:

$$DP = \frac{(GR)^2}{2(G1)(RO(1))} \left[\underbrace{\left(1 + \left(\frac{AF}{AM} \right)^2 \right) \left(\frac{RO(1)}{RO(2)} - 1 \right)}_{\text{Flow Acceleration}} + \underbrace{\frac{(CW)(LR)(RO(1))}{(HR)(RM)}}_{\text{Core Friction}} \right] \quad (5-43)$$

where

- DP = pressure, difference of, MPa
- GR = velocity, mass, in regenerator, g/sec cm²
- G1 = constant of conversion = 10⁷ g/(MPa·sec²·cm)
- RO(1), RO(2) = gas densities at entrance and exit, g/cm³
- AF = area of flow, cm²
- AM = area of face of matrix, cm²
- CW = factor of friction for matrix
- LR = length of regenerator, cm
- HR = radius, hydraulic, of matrix = PO/AS
- RM = density of gas at regenerator, g/cm³
- PO = porosity of matrix
- AS = ratio of heat transfer area to volume for matrix, cm⁻¹

The flow acceleration term can be ignored in computing windage loss for the full cycle because the flow acceleration for flow into the hot space very nearly cancels the flow acceleration for flow out of the hot space. However, the difference may be significant. One should really leave in the flow acceleration term until experience shows that it does not make any difference. Nevertheless, with this simplifying assumption, the pressure drop due to regenerator friction is:

$$DP = \frac{(CW)(GR)^2(LR)}{2(G1)(HR)(RM)} \quad (5-44)$$

In the above equation the friction factor CW is a function of the Reynolds number $RR = 4(HR)(GR)/\mu$. Figure A4 shows the correlation for stacked screens usually used in Stirling engines. Note that the relationship is dependent somewhat upon the porosity. Since this calculation is already an approximation, it is recommended that a simpler relationship be used more adapted to use in simple computer programs (see Figure A4). To use this correlation the Reynolds number must be evaluated correctly.

- HR = PO/AS (5-45)
- = hydraulic radius for matrix, cm
- PO = porosity of matrix
- AS = heat transfer area per unit volume, cm⁻¹

Also,

$$\begin{aligned} GR &= WR/(PO)(AM) && (5-46) \\ &= \text{mass velocity in matrix, g/sec cm}^2 \\ WR &= \text{flow through matrix, g/sec} \\ AM &= \text{frontal area of matrix, cm}^2 \end{aligned}$$

Finally, the viscosity is evaluated at the gas temperature in the matrix. (See Table A-6 for data on working gas viscosities.)

5.3.3.1.2 Heater and Cooler Pressure Drop

5.3.3.1.2.1 Tubular

Heater and cooler pressure drops are usually small in comparison with the regenerator. Heaters and coolers are usually small diameter, round tubes although an annular gap is practical for small engines. Pressure drop through these heaters and coolers is determined by Equations 5-47 or 5-48 with CW determined from the Fanning friction factor plot (see Figure A5) and densities DH or DK being evaluated at heat source or heat sink temperature and at average pressure. The length to diameter ratio is usually very large so for simple programs the equations shown with Figure A5 are:

$$DP = \frac{2(CW)(GH)^2(LH)}{(G1)(IH)(DH)} \quad \text{for heater} \quad (5-47)$$

$$DP = \frac{2(CW)(GC)^2(LC)}{(G1)(IC)(DK)} \quad \text{for cooler} \quad (5-48)$$

where in addition

CW = factor of frictions for tubes
GH = velocity, mass, in heater, g/sec cm²
GC = velocity, mass, in cooler, g/sec cm²
LH = length of heater tubes, cm
LC = length of cooler tubes, cm
IH = diameter, inside, of heater tubes, cm
IC = diameter, inside, of cooler tubes, cm
DH = density of gas in heater, g/cm³
DK = density of gas in cooler, g/cm³

5.3.3.1.2.2 Interleaving Fins (See Reference 77 h)

One of the advantages of this type of heat exchanger is that the gas flows into it rather than through it. Also, it is rather complicated because the flow passage area changes with the stroke. Experimental data are needed. One of the best types of interleaving fins is the nesting cone because the cone like the tube can have a thin wall and heat can be added and removed directly from the outside of the cone. In this type of filling and emptying process the flow

goes from maximum at the entrance to zero at the farthest point. This situation is equivalent to having all the flow flow half the distance volume-wise. Note that the equivalent diameter for this geometry is two times the separation distance between the cone surfaces. If the cone surfaces come close together and if the equivalent length along the cone is quite large, the flow resistance in a nesting cone isothermalizer can be large. There is no sure way of designing a Stirling engine. Each design concept has its good and bad points.

5.3.3.1.3 Heater, Cooler and Regenerator Windage Loss

Once the pressure drops are calculated, it should be noted that the product of the pressure drop in MPa and the volumetric flow rate in cm^3/sec is the flow loss in watts. Increment by increment, as the engine is calculated, the instantaneous flow loss as well as the average for the cycle should be calculated. A peak in the flow loss during the cycle may slow down or stop the engine depending upon the size of the effective flywheel.

5.3.3.2 Mechanical Friction Loss

Mechanical friction due to the seals and the bearings is hard to compute reliably. It essentially must be measured. However, if the engine itself were used, the losses due to mechanical friction would be combined with power required or delivered by the engine. If indicated and brake power are determined, then mechanical friction loss is the difference. The friction loss should be measured directly by having the engine operate at the design average pressure with a very large dead volume so that very little engine action is possible. The engine need not be heated but the seals and bearing need to be at design temperature.

5.3.4 Heat Losses

Power losses which need to be subtracted from the basic power output have just been discussed. In this next section heat losses are defined which must be added to the basic heat input. These are: reheat, shuttle, pumping, temperature swing, internal temperature swing and flow friction credit.

5.3.4.1 Reheat Loss

One way that extra heat is required at the heat source is due to the inefficiency of the regenerator. The regenerator reheats the gas as it returns to the hot space. The reheat not supplied by the regenerator must be supplied by the heater as extra heat input. Figure 5-22 shows how the gas temperatures vary in the heater, regenerator and cooler during flow out of the hot space as well as flow into it. Note that at inflow, the gas attains cooler temperature, then is heated up in the regenerator part-way. The temperature difference, A , between the heat source temperature and the gas entering from the regenerator is then multiplied by the heat capacity, the effective flow rate and the fraction of time that this gas is flowing to obtain the reheat loss. The methods derived from the literature and from the author's own practice are given below. The formula for reheat once used by the author is:

$$RH = \underbrace{FR}_{\substack{\text{Fraction Time} \\ \text{Flowing} \\ \text{Into Hot} \\ \text{Space}}} \underbrace{(WR)}_{\substack{\text{Effective} \\ \text{Flow Rate}}} \underbrace{(CV)}_{\substack{\text{Heat} \\ \text{Capacity}}} \underbrace{(TH - TC)}_{\substack{\text{Temp} \\ \Delta T}} \underbrace{\left(\frac{2}{NT + 2}\right)}_{\substack{\text{Regenerator} \\ \text{Ineffectiveness}}} \quad (5-49)$$

A

Each element in Equation 5-49 is a type of an approximation. The fraction of time flowing into the hot space is estimated by extrapolating the maximum cycle time that this process would occupy if the flow rate were always at its maximum value. This fraction, FR, turns out to be about one-third. FR will be taken as 1/3 if an analytical Schmidt equation is used. If a numerical procedure is used, FR may be computed when the flow resistances are calculated providing the approximation is found valid that regenerator flows can be approximated by two steady flows interspersed by two periods of no flow. The effective flow rate then is determined by the flow through the regenerator, WR. If these two periods of constant flow approximation are not used, then for every time step when flow is from the regenerator to the heater a partial reheat loss must be calculated for each such increment and summed for the cycle.

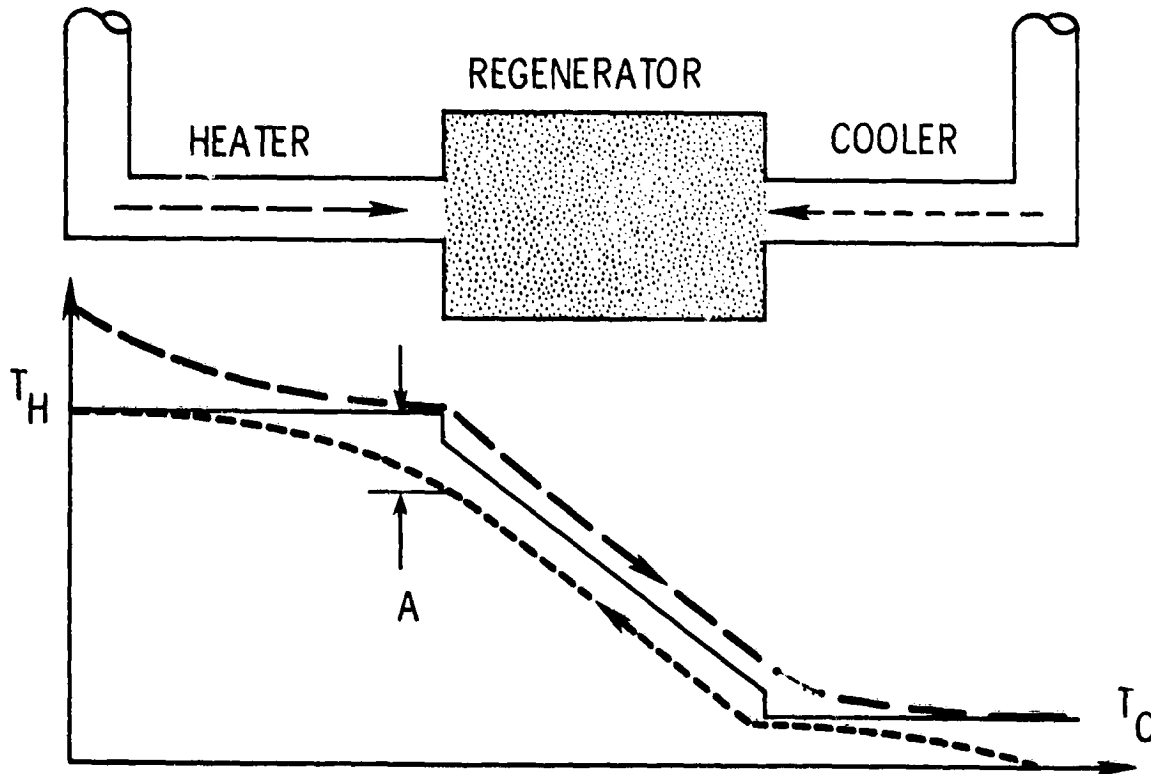

Figure 5-22. Reheat Loss.

Neither heat capacity CV or CP is strictly correct. More complicated analyses can take into account more rigorously the effect of pressure change during gas flow through the regenerator (75 ag, 77 bl). The rationale for using CV in Equation 5-49 is that the transfer of gas takes place when the total volume is relatively constant. However only a small amount of the total volume is in the regenerator at any one time. An equation suggested by Tew of LeRC (78 ad, p. 123) is:

$$RH = \left[\underbrace{FR(WR)(CP)(TH - TC)}_{\text{Flow Heat}} - \underbrace{\frac{RD(CV)(PX - PN)(NU)(MW)}{(R)}}_{\text{Pressure Change Heat}} \right] \underbrace{\left(\frac{2}{NT + 2} \right)}_{\text{Ineffec- tiveness}} \quad (5-50)$$

where

- RH = loss, reheat, watts
- FR = fraction of cycle time flow is into hot space
- WR = flow, mass, through regenerator, g/sec
- CP = capacity of heat of gas at constant pressure, j/g K
- TH = temperature, effective, of hot space, K
- TC = temperature, effective, of cold space, K
- RD = Volume, regenerator, dead, cm³
- CV = capacity of heat of gas at constant volume, j/g K
- PX = maximum pressure, MPa
- PN = minimum pressure, MPa
- NU = frequency of engine, Hz
- MW = molecular weight of gas, g/g mol
- R = constant, gas, universal = 8.314 j/g mol K
- NT = number of transfer units in regenerator
= (HY)(AH)/((CP)(WR))
- HY = coefficient of heat transfer, watts/cm²K
- AH = area of heat transfer, cm²

In Equation 5-50, the flow heat is watts needed on a continuous basis to raise the temperature of the gas passing into the hot space. The pressure change heat recognizes the fact that some of the heat required to raise the gas temperature can come from increasing the gas pressure which happens at nearly the same time. However, it can happen that the pressure change heat can be larger than the flow heat. In this case a more exact analysis should be employed. The net of the flow heat and the pressure change heat is multiplied by the ineffectiveness of the regenerator to obtain the reheat loss. Equation 5-50 is used in Appendix C to calculate reheat loss.

The temperature difference A in Figure 5-22 is represented by the total temperature difference between the hot metal and the cold metal times the regenerator ineffectiveness. This ineffectiveness is one minus the effectiveness of the regenerator material (see Equation 5-7). This formula for ineffectiveness agrees with the simple equations in earlier standard references on regenerators such as Saunders and Smoleniec (51 q).

The idea of separating power output and the heat losses into a number of superimposed processes has been used by a number of investigators of the Vuilleumier cycle. The details of this analysis have been given in a number of government reports. The Vuilleumier cycle is a heat operated refrigeration machine which

ORIGINAL PAGE IS
OF POOR QUALITY

uses helium gas and regenerators very similar to the way the Stirling engine is constructed. This superposition analysis has worked well in VM cycle machines. In an RCA report (69 aa, pp. 3-37) the measured cooling power using this method of analysis was found to be within 8.9% of that calculated. Crouthamel and Shelpuk (75 ac) give the following formula for the reheat loss after it is translated into the nomenclature used in this section.

$$RH = (\frac{1}{4})(WR)(CP)(TM - TW)(\frac{2}{NT + 2}) \quad (5-51)$$

Equation 5-51 is written in the same order as Equation 5-49 and therefore can be directly compared. The first term, one quarter, is specific for their particular machine and therefore needs to be evaluated for another type of machine. The flow rate is evaluated in the same way, but the heat capacity is different. Probably this can be justified to be CP instead of CV because the VM cycle machine undergoes a relatively small change in pressure during its cycle. Also, the distinction between metal temperatures and gas temperatures is also relatively small at this stage of analysis.

More elaborate equations for the calculation of reheat loss have been given in the literature. These are at least 10 times more complicated than those already given and no studies have yet been made to show that they are better. Bjorn Qvale (69 n, 78 ad, pp. 126-127) developed a formula which takes the pressure wave into account. He tested his equation against some experimental results from Rea (66 h) and found it to agree within $\pm 20\%$.

Rios (69 ar, 69 am) employed quite a different formulation to calculate reheat loss. It is also very complicated. It is included in the listing of the Rios program in Appendix D. The reheat loss is calculated on Line 430, but many lines preceding this line are required to calculate values leading up to this line.

5.3.4.2 Shuttle Conduction

Figure 5-23 shows how shuttle conduction works. Shuttle conduction happens anytime a displacer or a hot cap oscillates across a temperature gradient. It is usually not frequency-dependent for the speeds and materials used in Stirling engines. The displacer absorbs heat during the hot end of its stroke and gives off heat during the cold end of its stroke. Usually neither the displacer nor the cylinder wall change temperatures appreciably during the process. Shuttle conduction depends upon the area involved, the thickness of the gas filled gap, G, the temperature gradient (TH-TW)/LB, the gas thermal conductivity, KG, and the displacer stroke, SD. It is also dependent on the wave form of the motion and in some cases, upon the thermal properties of the displacer and of the cylinder wall. All formulas in the literature are of the form:

$$QS = \frac{(YK)(ZK)(SD)^2(KG)(TH - TW)(DC)}{(G)(LB)} \quad (5-52)$$

ORIGINAL PAGE IS
OF POOR QUALITY

where

- QS = shuttle heat loss (in this case for one cylinder)
- YK = wall properties and frequency factor
- ZK = wave form factor
- SD = stroke of displacer or hot cap, cm
- KG = gas thermal conductivity, w/cm K
- TH = effective temperature of hot space, K
- TW = temperature of inlet cooling water, K
- DC = inside diameter of engine cylinder
- G = clearance around hot cap or displacer, cm
- LB = length of displacer or hot cap, cm

The quantity ZK depends upon the type of displacer or hot cap motion, and YK depends upon the thermal properties of the walls and the frequency of operation. Table 5-4 shows the results of a literature survey for ZK. Note that there is a substantial disagreement about what ZK should be for the sinusoidal case. The author has derived the lower value and he would recommend it. This value, $\pi/8$, agrees with Rios but does not agree with Zimmerman. However, there are no data that would lay the matter to rest.

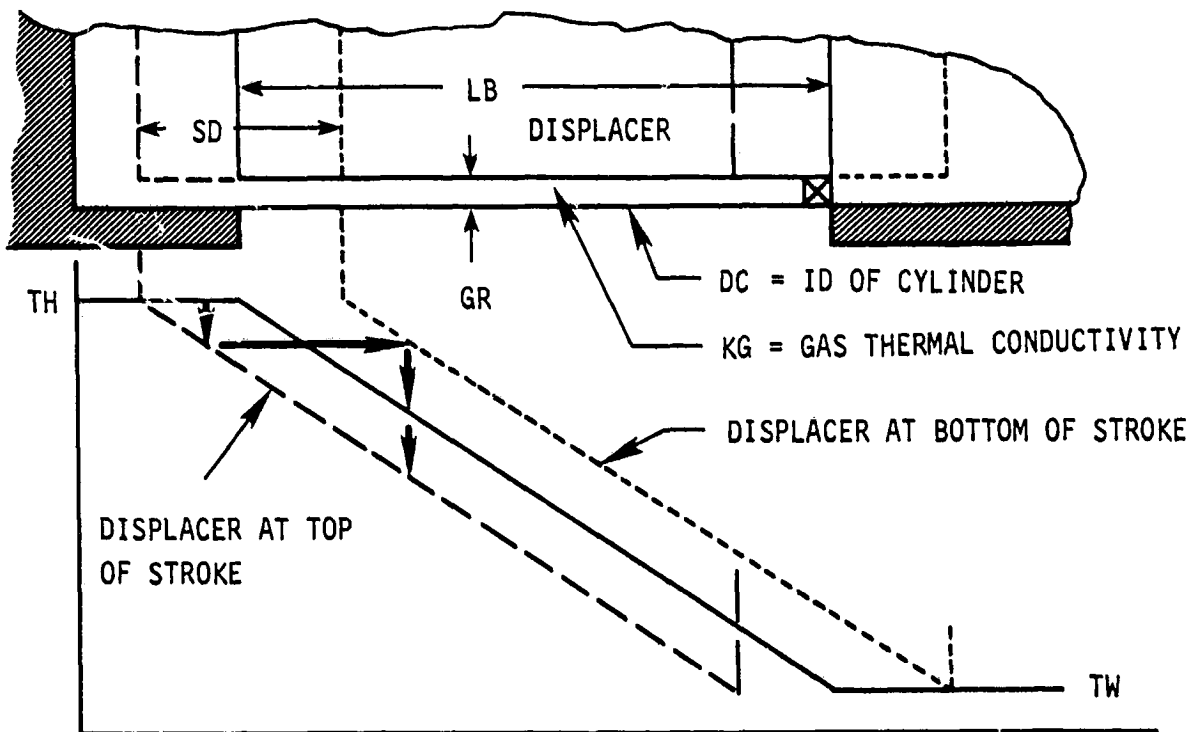

Figure 5-23. Shuttle Conduction.

ORIGINAL PAGE IS
OF POOR QUALITY

Table 5-4

COEFFICIENT FOR SHUTTLE
HEAT CONDUCTION EQUATION
(Ignoring Effect of Walls)

Motion	Investigator	Ref.	ZK
Square wave $\frac{1}{2}$ time at one end, $\frac{1}{2}$ time at other	Zimmerman	71 be	$\pi/4 = 0.785$
	Crouthamel & Shelpuk	75 ac	$\pi/4 = 0.785$
Sinusoidal (effect of walls ignored)	Martini	(1)	$\pi/8 = 0.393$
	Zimmerman	71 be	$\pi/5.4 = 0.582$
	Rios	71 an	$\pi/8 = 0.393$
	White	71 l	$.186\pi = 0.584$
	--	69 aa	$.186\pi = 0.584$

(1) McDonnell Douglas Reports, never published.

Rios has published values for YK to take into account the effect of frequency or wall thermal properties which are sometimes important. The most general Rios theory takes into account the thermal properties of the cylinder wall as well as the displacer or hot cap wall (71 an). His new theory gives:

$$YK = \frac{1 + XB}{1 + (XB)^2} \quad (5-53)$$

where in addition:

$$XB = 1 + \frac{1}{2\pi} \frac{KG}{G} \left(\frac{L4}{K1} + \frac{L5}{K2} \right)$$

L4 = temperature wavelength in displacer, cm

$$L4 = 2\pi \sqrt{\frac{2(D4)}{OM}}$$

D4 = thermal diffusivity in displacer, cm²/sec

OM = engine speed, radians/sec

D4 = $K1/((E4)(M4))$

E4 = density of displacer wall, g/cm³

M4 = heat capacity of displacer wall, j/g K

K1 = thermal conductivity of displacer, w/cm K

L5 = temperature wavelength in cylinder wall, cm

$$L5 = 2\pi \sqrt{\frac{2(D5)}{OM}}$$

ORIGINAL PAGE IS
OF POOR QUALITY

K2 = thermal conductivity of cylinder wall, w/cm K
 D5 = thermal diffusivity of cylinder wall, cm²/sec
 D5 = K2/((E5)(M5))
 E5 = density of cylinder wall, g/cm³
 M5 = heat capacity of cylinder wall, j/g K

The above factor applies for simple harmonic motion and for engines in which D4 is smaller than the thickness of the displacer wall and D5 is smaller than the thickness of the cylinder wall. Rios gives equations for solving the problem for any periodic motion by using Fourier series expansion. To help determine whether the above factor applies, Rios gives some typical values of temperature wavelength at room temperature (see Table 5-5).

Table 5-5

TYPICAL TEMPERATURE WAVELENGTHS
 AT ROOM TEMPERATURE CONDITIONS
 Reference: Rios, 71 an
 Centimeters

Material	Frequency, HZ					
	1	2	5	10	20	50
Mild Steel	1.21	0.86	0.54	0.38	0.27	0.17
Stainless Steel	0.74	0.53	0.33	0.24	0.17	0.11
Phenolic	0.85	0.60	0.38	0.27	0.19	0.12
Pyrex Glass	0.26	0.18	0.11	0.08	0.06	0.04

If the wall thickness is considerably smaller than the temperature wavelength, then it may be assumed that radial temperature distribution in the walls is uniform. Rios (71 an) proposes the following definition of YK for this case:

$$YK = \frac{1}{1 + (SG)^2} \quad (5-54)$$

where

$$SG = \frac{KG}{(G)(OM)} \left[\frac{1}{(E4)(M4)(SC)} + \frac{1}{(E5)(M5)(SE)} \right]$$

and

E4 = density of displacer wall, g/cm³
 E5 = density of cylinder wall, g/cm³
 SC = wall thickness of displacers, cm
 SE = wall thickness of cylinder wall, cm
 M4 = heat capacity of displacer wall, j/g K
 M5 = heat capacity of cylinder wall, j/g K

ORIGINAL PAGE IS
OF POOR QUALITY

Note that when the thermal properties of the wall do not matter, YK, whether evaluated by Equation 5-53 or 5-54, would evaluate to nearly 1. There is not any published formula that treats the case of cylinder and displacer wall thickness on the order of the temperature wavelength. There are also no published formulas for the case of a thick cylinder wall and a thin displacer or visa-versa. For horsepower size engines Equation 5-53 will apply. For model engines or artificial heart engines Equation 5-54 will apply. Therefore, for horsepower size, high pressure engines the recommended equation for shuttle heat conduction is:

$$QS = \frac{1 + XB}{1 + (XB)^2} \frac{\pi}{8} \frac{(SD)^2(KG)(TH - TC)(DC)}{G(LB)} \quad (5-55)$$

For model size engines using low gas pressure and very thin walls:

$$QS = \frac{1}{1 + (SG)^2} \frac{\pi}{8} \frac{(SD)^2(KG)(TH - TC)(DC)}{G(LB)} \quad (5-56)$$

It also should be emphasized that Equation 5-55 and 5-56 are for nearly sinusoidal motion of the displacer or hot cap. Square wave motion would double this result. Ramp motion should reduce this result some.

5.3.4.3 Gas and Solid Conduction

This heat loss continues while the engine is hot, independent of engine speed. It is simply the heat transferred through the different gas and solid members between the hot portion and the cold portion of the engine. Heat can be transferred by conduction or radiation. In the regenerator the gas moves, but under this heading the heat loss is computed as if the gas were stagnant. In Section 5.3.4.1, the reheat loss is computed assuming there is no longitudinal conduction.

The uncertainty about what thermal conductivities and what emissivities to use to evaluate this loss makes its measurement with the engine desirable. In some engines the hot and cold spaces are heated and cooled directly. In this case measuring the heat absorbed by the cooling water with the engine heated to temperature but stopped will give this heat loss. However, all the horsepower-size engines described in Sections 3 and 4 have indirectly heated and cooled hot and cold gas spaces. For this case the sum of the gas and solid conduction and the shuttle conduction can be determined by measuring the heat absorbed by the cooling water for a number of slow engine speeds with the engine heater at temperature and then extrapolating to zero engine speed.

Usually the following conduction paths are identified and should be evaluated for each engine:

<u>Path No.</u>	<u>Description</u>
1.	Engine cylinder wall.
2.	Displacer or hot cap wall.
3.	Gas annulus between cylinder and hot cap.
4.	Gas space inside displacer or hot cap. <ul style="list-style-type: none"> a. gas conduction b. radiation
5.	Regenerator cylinders.
6.	Regenerator packing.

The engine cylinder, the displacer and regenerator cylinders must be designed strong enough to withstand the gas pressure for the life of the engine without changing dimension appreciably. However, extra wall thickness contributes unnecessarily to the heat loss. For this reason the cylinder walls of most high powered engines are much thinner at the cold end where the creep strength is high than they are at the hot end. This, of course, complicates evaluation of this type of heat loss.

The following types of heat transfer problems need to be solved to evaluate these heat losses:

1. Steady, one dimensional conduction, constant area, variable thermal conductivity.
2. Steady, one dimensional conduction, variable area, variable thermal conductivity.
3. Steady, one dimensional conduction through a composite material (wire screens).
4. Radiation along a cylinder with radiation shields.

Solutions to each one of these problems will now be given.

5.3.4.3.1 Constant Area Conduction

Heat loss by conduction of this type is computed by the formula:

$$CQ = \frac{KG(AH)(T_H - T_C)}{LB} \quad (5-57)$$

where the thermal conductivities areas and lengths are german to Path 3 and 4a above, KG is evaluated at mid-point temperature. (See Table A2.)

5.3.4.3.2 Variable Area, Variable Thermal Conductivity

For one dimensional heat conduction where the heat transfer area varies continually and the thermal conductivity changes importantly, the heat conduction path is divided into a number of zones. The average heat conduction area for each zone is calculated. The temperature in each zone is estimated and from this estimate a thermal conductivity is assigned. Figure A-2 gives the thermal conductivities for some probable construction materials in the units used in this manual. It should be noted that there is quite a variability in some common materials like low carbon steel. Measured thermal conductivity different by a factor of 3 is shown. Differences are due to heat treatment and the exact composition. With commercial materials having considerable variability, it is strongly recommended that the static heat loss be checked by extrapolating the heat requirement for the engine to zero speed. This number would then need to be analyzed to determine how much shuttle heat loss is also being measured and how much is static heat loss.

For purposes of illustration, assume 3 zones are chosen along a tapered cylinder wall. (See Figure 5-24.) Temperatures MT(2) and MT(3) must be estimated between MT(1) and MT(4) to start. MT(1) is the hot metal temperature and MT(4)

ORIGINAL PAGE IS
OF POOR QUALITY

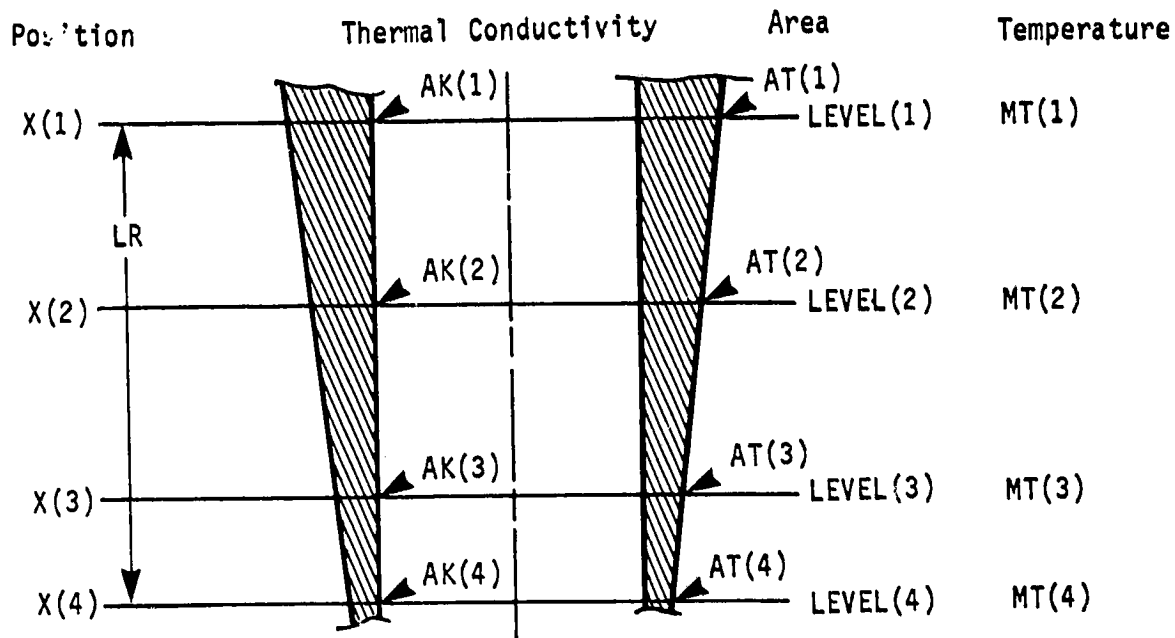

Figure 5-24. Computation of Tapered Cylinder Wall Conduction.

is the cold metal temperature. The heat transfer areas AT(1) to AT(4) are computed based upon engine dimensions. The heat through each segment is the same. Thus:

$$\begin{aligned}
 CQ &= \left(\frac{AK(1) + AK(2)}{2} \right) \left(\frac{AT(1) + AT(2)}{2} \right) \left(\frac{MT(1) - MT(2)}{X(2) - X(1)} \right) & (5-58) \\
 &= \left(\frac{AK(2) + AK(3)}{2} \right) \left(\frac{AT(2) + AT(3)}{2} \right) \left(\frac{MT(2) - MT(3)}{X(3) - X(2)} \right) \\
 &= \left(\frac{AK(3) + AK(4)}{2} \right) \left(\frac{AT(3) + AT(4)}{2} \right) \left(\frac{MT(3) - MT(4)}{X(4) - X(3)} \right)
 \end{aligned}$$

Let:

$$Y(1) = (X(2) - X(1)) / \left(\left(\frac{AK(1) + AK(2)}{2} \right) \left(\frac{AT(1) + AT(2)}{2} \right) \right) \quad (5-59)$$

$$Y(2) = (X(3) - X(2)) / \left(\left(\frac{AK(2) + AK(3)}{2} \right) \left(\frac{AT(2) + AT(3)}{2} \right) \right) \quad (5-60)$$

$$Y(3) = (X(4) - X(3)) / \left(\left(\frac{AK(3) + AK(4)}{2} \right) \left(\frac{AT(3) + AT(4)}{2} \right) \right) \quad (5-61)$$

Then:

$$CQ = \frac{MT(1) - MT(4)}{Y(1) + Y(2) + Y(3)} \quad (5-62)$$

Once CQ is computed then:

$$MT(2) = MT(1) - (Y(1))(CQ) \quad (5-63)$$

$$MT(3) = MT(2) - (Y(2))(CQ) \quad (5-64)$$

MT(2) and MT(3) are compared with the original guesses. If they are appreciably different so that the thermal conductivities would be different, then new thermal conductivities based upon these computed values of MT(2) and MT(3) would be determined and the process repeated. Once more is usually sufficient.

The same procedure is used for the engine cylinder and the displacer if the walls are tapered.

5.3.4.3.3 Conduction Through Regenerator Matrices

Usually the regenerator of a Stirling engine is made from many layers of fine screen that are lightly sintered together. The degree of sintering would have a big bearing on the thermal conductivity of the screen stack since the controlling resistance is the contact between adjacent wires. Some cryogenic regenerators use a bed of lead spheres.

In the absence of data, Gorring (61 n) gives the following formula for conduction through a square array of uniformly sized cylinders.

$$KX = KG \left(\frac{\left(\frac{1 + (KM/KG)}{1 - (KM/KG)} \right) - FF}{\left(\frac{1 + (KM/KG)}{1 - (KM/KG)} \right) + FF} \right) \quad (5-65)$$

where

KX = thermal conductivity of the matrix, w/cm K
 KG = thermal conductivity of the gas in the matrix, w/cm K
 KM = thermal conductivity of the metal in the matrix, w/cm K
 FF = fraction of matrix volume filled with solid

The thermal conductivity of the gas KG and the metal KM are evaluated at TR. The heat loss through the screens is then determined using an equation like Equation 5-57.

Sometimes the regenerator is made from slots in which metal foils run continuously from hot to cold ends. The conductivity of the matrix in this case is:

$$KX = \frac{(KG)(G) + (KM)(DW)}{G + DW} \quad (5-66)$$

Then the heat loss through the matrix is then determined using an equation like Equation 5-57.

ORIGINAL PAGE IS
OF POOR QUALITY

5.3.4.3.4 Radiation Along a Cylinder with Radiation Shields

The engine displacers or the hot cap for a dual piston machine is usually hollow. Heat transport across this gas space is by gas conduction and by radiation. Radiation heat transport follows the standard formula:

$$CQ = (FA)(FM)(FN)(\pi/4)(DB)^2(SI)((TH)^4 - TC)^4 \quad (5-67)$$

where

CQ = heat loss by radiation, watts
FA = area factor
FM = emissivity factor
FN = radiation shield factor
DB = diameter of cylinder, cm
LB = length of cylinder, cm
SI = Stefan-Boltzman constant
= 5.67×10^{-12} w/cm² K⁴
TH = hot surface temperature, K
TC = cold surface temperature, K

The area factor, FA, is usually determined by a graph computed by Hottel (McAdams, Heat Transmission, 3rd Ed., p. 69). For the case of two discs separated by non-conducting but reradiating walls, his curve is correlated by the simple formula:

$$FA = 0.50 + 0.20 \ln \frac{DB}{LB} \quad (5-68)$$

Equation 5-68 is good for values of DB/LB from 0.2 to 7. for (DB/LB) < 0.2 use:

$$FA = \frac{DB}{LB} \quad (5-69)$$

Emissivity factor, FM, is the product of the emissivity at the hot end and at the cold end. Thus:

$$FM = (EH)(EK) \quad (5-70)$$

The hot and cold emissivities can be obtained from any standard text on heat transfer. This emissivity depends upon the surface finish, the temperature and the material. There is a large uncertainty in handbook values.

If the emissivity of the radiation shields is intermediate between the emissivity of the hot and cold surfaces, then from the number of radiation shields, NS, the radiation shield factor, FN, is calculated approximately.

$$FN \approx 1/(1 + NS) \quad (5-71)$$

5.3.4.4 Pumping Loss

A displacer or a hot cap has a radial gap between the ID of the engine cylinder and the OD of the displacer. The gap is sealed at the cold end. As the engine is pressurized and depressurized, gas flows into and out of this gap. Since the closed end of the gap is cold, extra heat must be added to the gas as it comes back from this gap. Leo (70 ac) gives the formula:

ORIGINAL PAGE IS
OF POOR QUALITY

$$Q_P = \frac{2(\pi(DC))^{0.6}(LB)(P_X - P_N)^{1.6}(NU)^{1.6}(CP)^{1.6}(T_H - T_C)(G)^{2.6}}{1.5(Z_1)(R/MW)^{1.6}(KG)^{0.6}((T_H + T_C)/2)^{1.6}} \quad (5-72)$$

where

Q_P = pumping heat loss, watts (one cylinder)
 DC = diameter of cylinder, cm
 LB = length of hot cap, cm
 P_X = maximum pressure, MPa
 P_N = minimum pressure, MPa
 NU = engine frequency, Hz
 CP = heat capacity of gas at constant pressure, j/g K
 T_H = effective temperature of hot space, K
 T_C = effective temperature of cold space, K
 G = clearance around hot cap, cm
 Z_1 = compressibility factor of gas
 R = universal gas constant = 8.314 j/g mol K
 MW = molecular weight of the gas, g/g mol
 KG = thermal conductivity of the gas/ j/g K

5.3.4.5 Temperature Swing Loss

In computing the reheat loss (see Section 5.3.4.1) it was assumed that the regenerator matrix temperature oscillates during the cycle a negligible amount. In some cases the temperature oscillation of the matrix will not be negligible. The temperature swing loss is this additional heat that must be added by the gas heater due to the finite heat capacity of the regenerator. The temperature drop in the regenerator matrix temperature from one end to the other due to a single flow of gas into the hot space is:

$$TS = \frac{WR(CV)FR(T_H - T_C)}{NU(MX)(M6)} \quad (5-73)$$

where

TS = matrix temperature swing during one cycle, K
 WR = mass flow through regenerator, g/sec
 CV = gas heat capacity at constant volume, j/g K
 FR = fraction of cycle time flow is into hot space
 T_H = effective hot space temperature, K
 T_C = effective cold space temperature, K
 NU = engine frequency, Hz
 MX = mass of regenerator matrix, g
 $M6$ = heat capacity of regenerator metal, j/g K

Half of this, $(TS)/2$, is equivalent to A in Equation 5-49 and Figure 5-22 since TS starts at zero at the start of the flow and grows to TS . Thus the temperature swing loss is:

$$SL = FR(WR)(CV)(TS)/2 \quad (5-74)$$

Crouthamel and Shelpuk (75 ac) point out this loss but their equation is:

$$SL = FR(WR)(CP)(TS) \quad (5-75)$$

ORIGINAL PAGE IS
OF POOR QUALITY

Their equation substitutes CP for CV as was done also in Section 5.3.4.1. The reason for division by 2 seems to be recognized in their text but is not reflected in their formula. Based upon the discussion in Section 5.3.4.1, it is now recommended that an effective gas heat capacity based upon Equation 5-50 be used in Equations 5-73 and 5-74.

5.3.4.6 Internal Temperature Swing Loss

Some types of regenerator matrices could have such low thermal conductivity (for example, glass rods) that all the mass of the matrix would not undergo the same temperature swing. The interior would undergo less swing and the outside additional swing would result in an additional heat loss. Crouthamel and Shelpuk (75 ac) give this loss as:

$$Q1 = SL \left[C3 \left(\frac{(E6)(M6)}{KM} \right) \left(\frac{(DW/2)^2 NU}{FR} \right) \right] \quad (5-76)$$

where

Q1 = internal temperature swing loss, watts
SL = temperature swing loss, watts
C3 = geometry constant (see below)
E6 = density of matrix solid material, g/cm³
M6 = heat capacity of regenerator metal, j/g K
KM = thermal conductivity of regenerator metal, watts/cm K
DW = diameter of wire or thickness of foil in regenerator, cm
NU = engine frequency, Hz
FR = fraction of cycle time flow is into hot space

The geometry constant C3 is given as 0.32 by Crouthamel and Shelpuk (75 ac) who refer to page 112 of Carslaw and Jaeger (59 o). This constant is for a slab. The constant for a cylinder or a wire is 0.25 (59 o, p. 203).

5.3.4.7 Flow Friction Credit

The flow friction in the hot part of the engine is returned to this part of the engine as heat. It is assumed that

$$FZ = \frac{RW}{2} + HW \quad (5-76a)$$

where

FZ = flow friction credit, watts
RW = flow friction in regenerator, watts
HW = flow friction in heater, watts

5.3.5 First Round Engine Performance Summary

At this point it is necessary to take stock of the first estimate of the net power out and the total heat in based upon the first estimate of the effective hot and cold gas temperature. The total heat requirement will be used along with the characteristics of the heat exchangers to compute the effective hot

and cold gas temperatures. These new computed temperatures will be used to determine a better estimate of the basic output power and basic heat input. Heat losses and power losses will remain the same. The net power output is:

$$NP = BP - CF - HW - RW \quad (5-77)$$

The net heat input is:

$$QN = BH + RH + QS + CQ + QP + TS + QI - FZ \quad (5-78)$$

5.3.6 Heat Exchanger Evaluation

Once the first estimate of the net heat input, QN, is computed, the duty of the gas heater and gas cooler are determined:

$$QB = QN \quad (5-79)$$

$$QC = QN - NP \quad (5-80)$$

Next, the heat transfer coefficient for the gas heater and gas cooler is computed. The most common type is the tubular heat exchanger. Small machines can use an annular gap heat exchanger. Isothermalizer heat exchangers are possible.

5.3.7 Martini Isothermal Second-Order Analysis

So far in Sections 5.1.5 and 5.1.6, means for calculating the basic power output, BP, and the basic heat input, BH, have been given. Means for calculating flow losses CF, HW, and RW in the cooler, heater and regenerator are reviewed in Sections 5.3.3. Means for calculating heat losses which add to the basic heat input have been discussed in Section 5.3.4. Section 5.3.5 shows how the net heat input and power outputs are calculated, and Section 5.3.6 shows how the amount of heat that must be transferred by the heat exchangers is determined.

To bring this all together there must be a calculation procedure that will allow the performance of a particular engine design to be predicted. The Martini isothermal analysis uses the following method:

1. Using the given heat source and heat sink temperatures and the engine dimensions, find the basic power using a Schmidt cycle analysis.
2. Using the heat source and heat sink temperatures, calculate the basic heat input from the power output using the Carnot efficiency.
3. Evaluate net power, NP, by Equation 5-77, net heat input, QN, by Equation 5-78, gas heater duty by Equation 5-79, and gas cooler duty by Equation 5-80.
4. Using the flow rate and duration during the cycle of gas flowing through the heater, determine the temperature drop needed to allow the gas heater duty to be transferred. Deduct a percentage of this temperature drop based upon experience from the heat source temperature to obtain a first estimate of the effective hot space gas temperature.
5. Using the flow rate and duration during the cycle of gas flowing through the cooler, determine the temperature drop needed to allow the gas cooler duty to be transferred. Add a percentage of this temperature drop based upon experience to the heat sink temperature to obtain the effective cold space gas temperature.

6. Recalculate steps 1, 2, 3, 4 and 5 using the effective hot space temperature for the heat source temperature and the effective cold space temperature for the heat sink temperature. Do this several times till there is no appreciable change in these effective temperatures.

This method is very similar to that published previously by Martini (78 o, 78 ad, 79 ad). A FORTRAN computer program of this method is given in Appendix C.

5.3.8 Rios Adiabatic Second-Order Analysis

P.A. Rios (69 am) developed a computer code for cryogenic coolers which is highly regarded. This has been adapted to heat engine analysis. A full discussion and a FORTRAN listing are included as Appendix D. An outline of this method is now given.

1. Using the given heat source and heat sink temperatures and the engine dimensions, find the basic power using a Finkelstein adiabatic analysis. (The Rios equations are different and more general than Finkelstein used but the assumptions are the same.)
2. Use the adiabatic analysis to calculate basic heat input.
3. Evaluate net power, NP, by Equation 5-77, net heat input, QN, by Equation 5-78, gas heater duty by Equation 5-79 and gas cooler duty by Equation 5-80.
4. Calculate heater and cooler ineffectiveness. Based upon these, modify heat source and heat sink temperatures. Re-do steps 1, 2, 3 and 4 with new temperatures. Three iterations were always found to be enough for convergence.

5.3.9 Conclusion for Second-Order Methods

Second-order methods have the ability to take all engine dimensions and operating conditions into account in a realistic way without getting involved in much more laborious computer simulation routines employed in third-order analysis. The principles employed in second-order analysis have been described. Whether these principles are useful in real life design depends upon their accuracy over a broad range of applications.

5.4 Third-Order Design Methods

Third-order design methods start with the premise that the many different processes assumed to be going on simultaneously and independently in the second-order design method (see Section 5.3) do in reality importantly interact. Whether this premise is true or not is not known and no papers have been published in the open literature which will definitely answer the question. Qvale (68 m, 69 n) and Rios (70 z) have both published papers claiming good agreement between their advanced second-order design procedures and experimental measurements. Third-order design methods are an attempt to compute the complex process going on in a Stirling engine all of a piece. Finkelstein

pioneered this development (62 a, 64 b, 67 d, 75 a1) and in the last year or so a number of other people have taken up the work. If the third-order method is experimentally validated, then much can be learned about the workings of the machine that cannot be measured reliably.

Third-order design methods start by writing down the differential equations which express the ideas of conservation of energy, mass and momentum. These equations are too complex for a general analytical solution so they are solved numerically. The differential equations are reduced to their one dimensional form. Then depending on just what author's formulation is being used, additional simplifications are employed.

In this design manual the non-proprietary third-order design methods will be discussed. In this section it will not be possible to describe these methods in detail. However, the basic assumptions that go into each calculation procedure will be given.

5.4.1 Basic Design Method

In broad outline the basic design method is as follows (see Figure 5-25):

1. Specify dimensions and operating conditions, i.e., temperatures, charge pressure, motion of parts, etc. Divide engine into control volumes.
2. Convert the differential equations expressing the conservation of mass, momentum and energy into difference equations. Include the kinetic energy of gas. Include empirical formulas for the friction factor and the heat transfer coefficient.
3. Find a mathematically stable method of solution of the engine parameters after one time step given the conditions at the beginning of that time step.
4. Start at an arbitrary initial condition and proceed through several engine cycles until steady state is reached by noting that the work output per cycle does not change.
5. Calculate heat input.

5.4.2 Fundamental Differential Equations

Following the explanation of Urieli (77 d), there are 4 equations that must be satisfied for each element. They are:

1. Continuity
2. Momentum
3. Energy
4. Equation of state

These relationships will be given in words and then in the symbols used by Urieli using the generalized control volume shown on Figure 5-26.

Figure 5-26. The Control Volume for Third-Order Analysis.

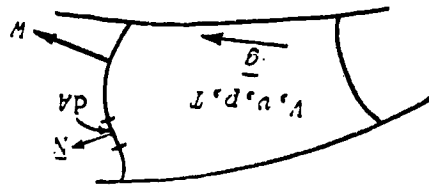
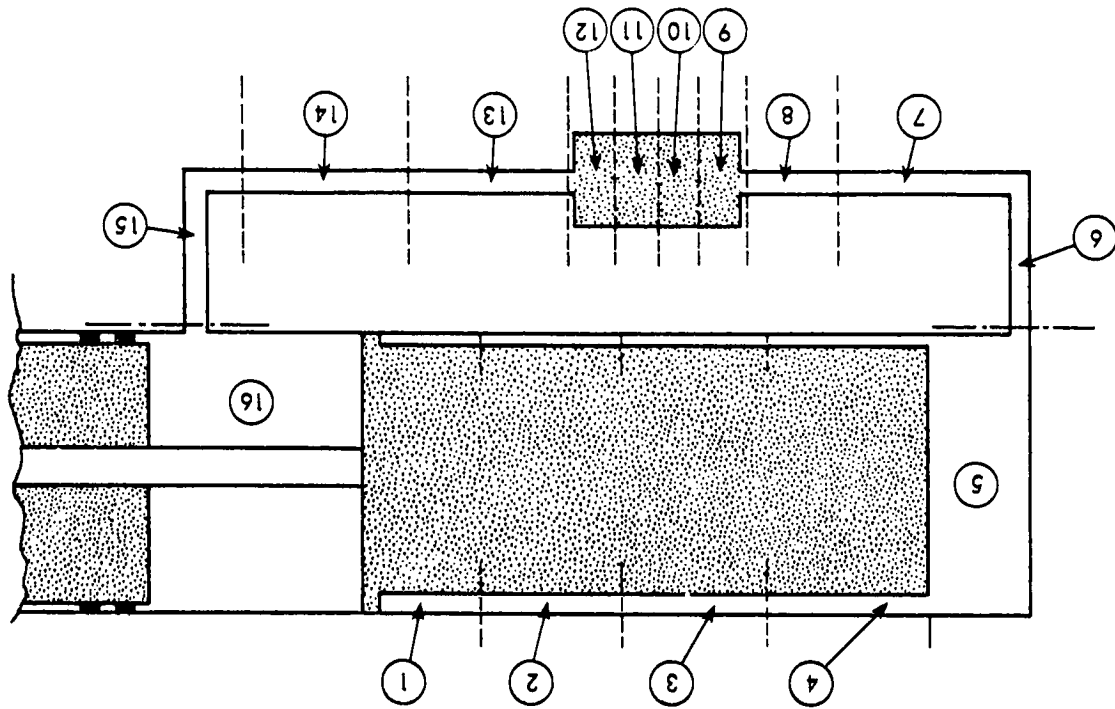

Figure 5-25. Sample Division of Engine Working Gas Space into Control Volumes for a Third-Order Design Method.



ORIGINAL PAGE IS
OF POOR QUALITY

ORIGINAL PAGE IS
OF POOR QUALITY

The continuity equation merely expresses the fact that matter can neither be created nor destroyed. Thus:

$$\left\{ \begin{array}{l} \text{rate of decrease of} \\ \text{mass in control volume} \end{array} \right\} = \left\{ \begin{array}{l} \text{net mass flux convected} \\ \text{outwards through surface} \\ \text{of control volume} \end{array} \right\} \quad (5-81)$$

Urieli (77 d) expresses this relationship as:

$$\frac{\partial m}{\partial t} + V \frac{\partial g}{\partial x} = 0 \quad (5-82)$$

where:

- $m = \tilde{m}/M$
- \tilde{m} = mass of gas in control volume, Kg
- M = mass of gas in engine, Kg
- t = time, seconds
- $V = \tilde{V}/V_s$
- \tilde{V} = volume of control volume, m^3
- V_s = total power stroke volume of machine, m^3
- $g = \tilde{g}/M\sqrt{R(T_k)}/V_s$
- \tilde{g} = mass flux density, $kg/m^2\text{sec}$
- R = gas constant for working gas, $J/Kg \cdot K$
- T_k = cold sink absolute temperature, K
- $x = \tilde{x}/(V_s)^{1/3}$
- \tilde{x} = distance, meters

5.4.2.2 Momentum Equation

$$\left\{ \begin{array}{l} \text{Rate of changes of} \\ \text{momentum within the} \\ \text{control volume V} \end{array} \right\} + \left\{ \begin{array}{l} \text{Net momentum flux con-} \\ \text{vected outwards through} \\ \text{control surface A} \end{array} \right\} = \left\{ \begin{array}{l} \text{Net surface force acting on} \\ \text{the fluid in the control} \\ \text{volume V} \end{array} \right\} \quad (5-83)$$

Urieli (77 d) expresses this relationship as:

$$\frac{\partial}{\partial t} (gV) + V \frac{\partial}{\partial x} (g^2v) + V \frac{\partial p}{\partial x} + F = 0 \quad (5-84)$$

where in addition:

- $v = \tilde{v}/(V_s/M)$
- \tilde{v} = specific volume, m^3/Kg
- $p = \tilde{p}/(M(R)T_k/V_s)$
- \tilde{p} = pressure, N/m^2
- $F = \tilde{F}/M(R)T_k/(V_s)^{1/3}$
- \tilde{F} = frictional drag force, N

5.4.2.3 Energy Equation

$$\begin{aligned}
 & \left\{ \begin{array}{l} \text{Rate of heat transfer} \\ \text{to the working gas} \\ \text{from the environment} \\ \text{through control surface A} \end{array} \right\} = \left\{ \begin{array}{l} \text{Rate of energy} \\ \text{accumulation} \\ \text{within the control} \\ \text{volume V} \end{array} \right\} \\
 + & \left\{ \begin{array}{l} \text{Net energy flux convected} \\ \text{outwards by the working} \\ \text{gas crossing the control} \\ \text{surface A} \end{array} \right\} + \left\{ \begin{array}{l} \text{Net rate of flow work} \\ \text{in pushing the mass of} \\ \text{working gas through} \\ \text{the control surface A} \end{array} \right\} \\
 + & \left\{ \begin{array}{l} \text{Net rate of mechanical work done by} \\ \text{the working gas on the environment} \\ \text{by virtue of the rate of change of} \\ \text{the magnitude of the control volume V} \end{array} \right\} \quad (5-85)
 \end{aligned}$$

Urieli (77 d) expresses this relationship finally as:

$$\frac{dQ}{dt} = \frac{\partial}{\partial t} \left(\frac{mT}{\gamma - 1} \right) + V \frac{\partial}{\partial x} \frac{\gamma T(g)}{\gamma - 1} - g(v) \left(v \frac{\partial p}{\partial x} + F \right) + \frac{DW}{dt} \quad (5-86)$$

where in addition:

$$\begin{aligned}
 Q &= \tilde{Q}/(MR(Tk)) \\
 \tilde{Q} &= \text{heat transferred, J} \\
 \gamma &= \text{ratio of specific heat capacity of working gas} = CP/CV \\
 T &= \tilde{T}/Tk \\
 \tilde{T} &= \text{working gas temperature in control volume, K} \\
 W &= \tilde{W}/(M(R)Tk) \\
 \tilde{W} &= \text{mechanical work done, J}
 \end{aligned}$$

5.4.2.4 Equation of State

Due to the normalizing parameters Urieli uses the equation of state merely as:

$$p(V) = m(T) \quad (5-87)$$

5.4.3 Comparison of Third-Order Design Methods

A number of third-order design methods will be described briefly.

5.4.3.1 Urieli

This design method is described fully in Israel Urieli's thesis (77 af). A good short explanation is given in his IECEC paper (77 d). He applies his method to an experimental Stirling engine of the two-piston type. The hot cylinder is connected to the cold cylinder by a number of tubes in parallel. Sections of each one of these tubes are heated, cooled or allowed to seek their

own temperature level in the regenerator part. This type of engine was chosen because of ease in programming, and because heat transfer and fluid flow correlations for tubes are well known. Also, an engine like this is built and is operating at the University of Witwatersrand in Johannesburg, South Africa. The intention is to obtain experimental confirmation of this design method. Urieli converts the above partial differential equations to a system of ordinary differential equations by converting all differentials to difference - quotients except for the time variable. (See Appendix A.) Then he solves these ordinary differential equations using the fourth order Runge-Kutta method starting from a stationary initial condition. The thesis contains the FORTRAN program. The first copies of this thesis has three errors in the main program. Urieli applied this program to the JPL test engine (78 ar). However, no data have yet come out to compare it with. The program is further discussed in general (79 ac).

5.4.3.2 Schock

Al Schock, Fairchild Industries, Germantown, Maryland, presented some results of calculations using his third-order design procedure at the Stirling Engine Seminar at the Joint Center for Graduate Study in Richland, Washington, August 1977. His calculation started with the same differential equations as Urieli but his method of computer modeling was different but undefined. He confirmed what Urieli had said at the same meeting that the time step must be smaller than the time it takes for sound to travel from one node to the next through the gas. Al Schock's assignment was to develop an improved computer program for the free displacer, free piston Stirling engine built by Sunpower for DOE. The engine had a very porous regenerator. Although the pressures in the expansion and compression space of the engine were different, they were not visibly different when the gas pressure versus time was plotted.

This program is as yet not publicly documented. Schock is awaiting good experimental data with which to correlate the model. Many results were presented at the 1978 IECEC (78 aq) and in the Journal of Energy (79 eh). Schock makes good use of computer-drawn graphics to show what is going on in a free piston machine that was simulated. The last reference states that a listing can be obtained by contacting Al Schock. The author has contacted Dr. Schock but has yet to receive the listing. The program is fully rigorous, but for economy it can be cut down to not include the effect of gas acceleration.

5.4.3.3 Vanderbrug

In reference 77 ae, Finegold and Vanderbrug present a general purpose Stirling engine systems and analysis program. The program is explained and listed in a 42-page appendix.

One paper (79 aa) presents some additional information on this program and shows how SCAM agrees with one experimental point so far published. Table 5-6 shows the comparison. Note that the simple Schmidt cycle predicts almost as well as the SCAM program. Many more data points are needed before SCAM will have a fair evaluation.

5.4.3.4 Finkelstein

Ted Finkelstein has made his computer analysis program (75 a1) available through Cybernet. Instructions and directions for use are obtainable from TCA, P. O. Box 643, Beverly Hills, California 90213. One must become skilled in the use of this program since as the engine is optimized it is important to adjust the temperature of some of the metal parts so that the metal temperature at the end of the cycle is nearly the same as at the beginning.

Table 5-6

SUMMARY OF EXPERIMENTAL AND
ANALYTICAL TEST RESULTS (79 aa)

	Engine Temp., °F, of		Working Press Avg. Psia		Indicated Power IHP		System Power	
	Cooler	Heater	Expand	Comp	Expand	Comp	IHP	BHP**
Experimental*	105	1300	326	310	8.98	-4.33	4.65	-1.9
Schmidt Cycle	105	1300	318	318	7.26	-2.33	4.93	--
SCAM	105	1300	326	310	7.64	-2.93	4.70	-1.3

* Test number 8 16-10

**Dynamometer measurement

Urieli and Finkelstein use the same method in handling the regenerator nodes in that the flow conductance from one node to the next depends upon the direction of flow. Finkelstein solves the same equations as Urieli presents but he neglects the kinetic energy of the flowing gas. By so doing, he is able to increase his time step substantially. Neglecting kinetic energy will cause errors in predicting pressures during the cycle. However, it is not clear what effect this simplifying assumption has upon power output and efficiency calculations. To make a comparison one would have to use the same correlations for friction factor and heat transfer coefficient and be certain that the geometries are identical.

Finkelstein claims that his program has been validated experimentally but the results are proprietary.

5.4.3.5 Lewis Research Center (LeRC)

The author has attempted to formulate a design procedure based upon some computation concepts originally used by M. Mayer at McDonnell Douglas. A simplified version was presented (75 ag). However, an attempt failed to extend the method to include a real regenerator with dead volume and heat transfer as a function of fluid flow. The procedure was computationally stable and approached a limiting value as the time step decreased. But when the heat transfer coefficients were set very high, there should have been no heat loss through the regenerator, but the computation procedure did not allow this to happen because gas was always entering the hot space at the temperature of the hottest regenerator element. There was also the problem of finding the proper metal temperature for the regenerator elements.

Parallel and independently of the author, Roy Tew, Kent Jefferies and Dave Miao at LeRC have developed a computer program which is very similar to the author's (77 b1). In addition, they have found a way of handling the regenerator which gets around the problem the author encountered.

The LeRC method assumes that the momentum equation need not be considered along with the equations for continuity, energy and equation of state. They assume that the pressure is uniform throughout the engine and varies with time during the engine cycle. LeRC combines the continuity, energy equation and equation of state into one equation.

$$\frac{dT}{dt} = \underbrace{\frac{hA}{mCp} (T_W - T)}_{\text{heat transfer}} + \underbrace{\frac{W_i}{m} (T_i - T)}_{\text{flow in}} + \underbrace{\frac{W_o}{m} (T_o - T)}_{\text{flow out}} + \underbrace{\frac{V}{mCp} \frac{dp}{dt}}_{\text{pressure change}} \quad (5-88)$$

This equation indicates that the temperature change in a control volume depends upon heat transfer, flow in and out and pressure change. Equation 5-88 could be solved by first-order numerical integration or by higher order techniques such as 4th order Runge Kutta. LeRC did not use this approach.

LeRC used an approach of separating the three effects and considering them successively instead of simultaneously. From a previous time step they have the masses, temperature and volumes for all 13 gas nodes used. From this they calculate a new common pressure. Using this new pressure and the old pressure and assuming no heat transfer during this stage, they calculate a new temperature for each gas node using the familiar adiabatic compression formula. Next, the volumes of nodes 1 and 13, the expansion and compression space, are changed to the new value based upon the rhombic drive. New masses are calculated for each control volume. Once the new mass distribution is known, the new flow rates between nodes are calculated from the old and new mass distributions. The new gas temperature is now modified to take into account the gas flow into and out of the control volumes during the time step. During this calculation it is assumed that each regenerator control volume has a temperature gradient across it equal to the parallel metal temperature gradient and that the temperature of the fluid that flows across the boundary is equal to the average temperature of the fluid before it crossed the boundary; heater and cooler control volumes are at the bulk or average temperature throughout. Next, local heat transfer coefficients are calculated based upon the flows. Temperature equilibration with

the metal walls and matrix is now calculated for the time of one time step and at constant pressure. An exponential equation is used so that no matter how large the heat transfer coefficient, the gas temperature cannot change more than the ΔT between the wall and the gas. Heat transfer during this equilibration is calculated. In the regenerator nodes heat transfer is used to change the temperature of the metal according to its heat capacity. In the other nodes where the temperature is controlled, the heat transfers are summed to give the basic heat input and heat output. This final temperature set after temperature equilibration along with the new masses and volumes calculated during this time step are now set to be the old ones to start the process for the next time step.

The model is set up to take into account leakage between the buffer space and the working gas volume. LeRC has developed an elaborate method of accelerating convergence of the metal nodes in the regenerator to the steady state temperature.

On the final cycle LeRC considers the effect of flow friction to make the pressure in the compression and expansion space different from each other in a way to reduce indicated work per cycle.

To quote Tew (77 b1):

Typically it takes about 10 cycles with regenerator temperature correction before the regenerator metal temperatures steady out. Due to the leakage between the working and buffer spaces, a number of cycles are required for the mass distribution between working and buffer space to settle out. The smaller the leakage rate, the longer the time required for the mass distribution to reach steady-state. For the range of leakage rates considered thus far it takes longer for the mass distribution to steady out than for the regenerator metal temperatures to settle out. Current procedure is to turn the metal temperature convergence scheme on at the 5th cycle and off at the 15th cycle. The model is then allowed to run for 15 to 25 more cycles to allow the mass distribution to settle out. When a sufficient number of cycles have been completed for steady operation to be achieved, the run is terminated.

Current computing time is about 5 minutes for 50 cycles on a UNIVAC 1100 or 0.1 minute per cycle. This is based on 1000 iterations per cycle or a time increment of 2×10^{-5} seconds when the engine frequency is 50 Hz. The number of iterations per cycle (and therefore computing time) can be reduced by at least a factor of 5 at the expense of accuracy of solution. On the order of 10% increase in power and efficiency results when iterations per cycle are reduced to 200 from 1000.

The agreement between the NASA-Lewis model and experiment is discussed in (79a). They got agreement between calculated results and measurements only after they multiplied the computed friction factor for the regenerator by a factor of 4 for hydrogen and by a factor of 2.6 for helium. In a different way this is the same order of magnitude correction that the best second-order analysis requires.

5.4.4 Conclusions on Third-Order Design Methods

1. A number of well constructed third-order design methods are available.
2. A choice is available between rigorous third-order (Urieli, Schock, Vanderbrug), third-order ignoring fluid inertia (Finkelstein), third-order assuming a common pressure (LeRC).
3. There is a spectrum of design methods reaching from the simplest first-order through simple and complex second-order culminating in rigorous third-order analysis. However, all these methods depend upon heat transfer and fluid flow correlations based upon steady flow instead of periodic flow, because correlations of periodic flow heat transfer and flow friction which should be used have not been generated.
4. Third-order analysis can be used to compute flows and temperatures inside the engine which cannot be measured in practice.
5. Third-order analysis can be used to develop simple equations to be used in second-order analysis.
6. Eventually when all calculation procedures are perfected to agree as well as possible with valid tests of Stirling engines, third-order design methods will be the most accurate and also the longest. The most rigorous formulations of third-order will be much longer and more accurate than the least rigorous formulations.

6. REFERENCES

6.1 Introduction

The references in this section are revised and extended from the first edition (78 ed). The authors own accumulation has been cataloged. Also extensive bibliographies by Walker (78 dc) and Aun (78 eb) were checked for additional references. Cataloging of references continues. The following list is as of April 1980.*

Each entry in the following reference list corresponds to a file folder in the author's file. If the author has an abstract or a copy of the paper an asterisk (*) appears at the end of the reference.

All personal authors are indexed (see Section 7).

All known corporate authors are indexed (see Section 8).

The subject index included in the first edition has been deleted because it was found not to be very useful. Possibly some day an index to the Stirling engine literature can be written.

6.2 Interest in Stirling Engines

Because of the way Stirling engine references are cataloged in this section it is easy to plot the rise in interest in Stirling engines by the number of references each year in the literature. Figure 6-1 shows the references per year for the last few years.

6.3 References

1807 a Cayley, G., Nicholson's Journal, November 1807, pg. 206 (letter).

1816 a Stirling, R., "Improvements for Diminishing the Consumption of Fuel and in Particular, an Engine Capable of Being Applied to the Moving of Machinery on a Principle Entirely New, " British Patent No. 4081, 1816.

1826 a Ericsson, J., British Patent No. 5398, 1826. *

1827 a Stirling, R., and Stirling, J., "Air Engines," British Patent No. 5456, 1827. B3. *

*Note in final preparation: The completion date of the second edition was July 1979. At the request of H. Valentine the references were updated to April 1980. A further update to October 1981 is now available.

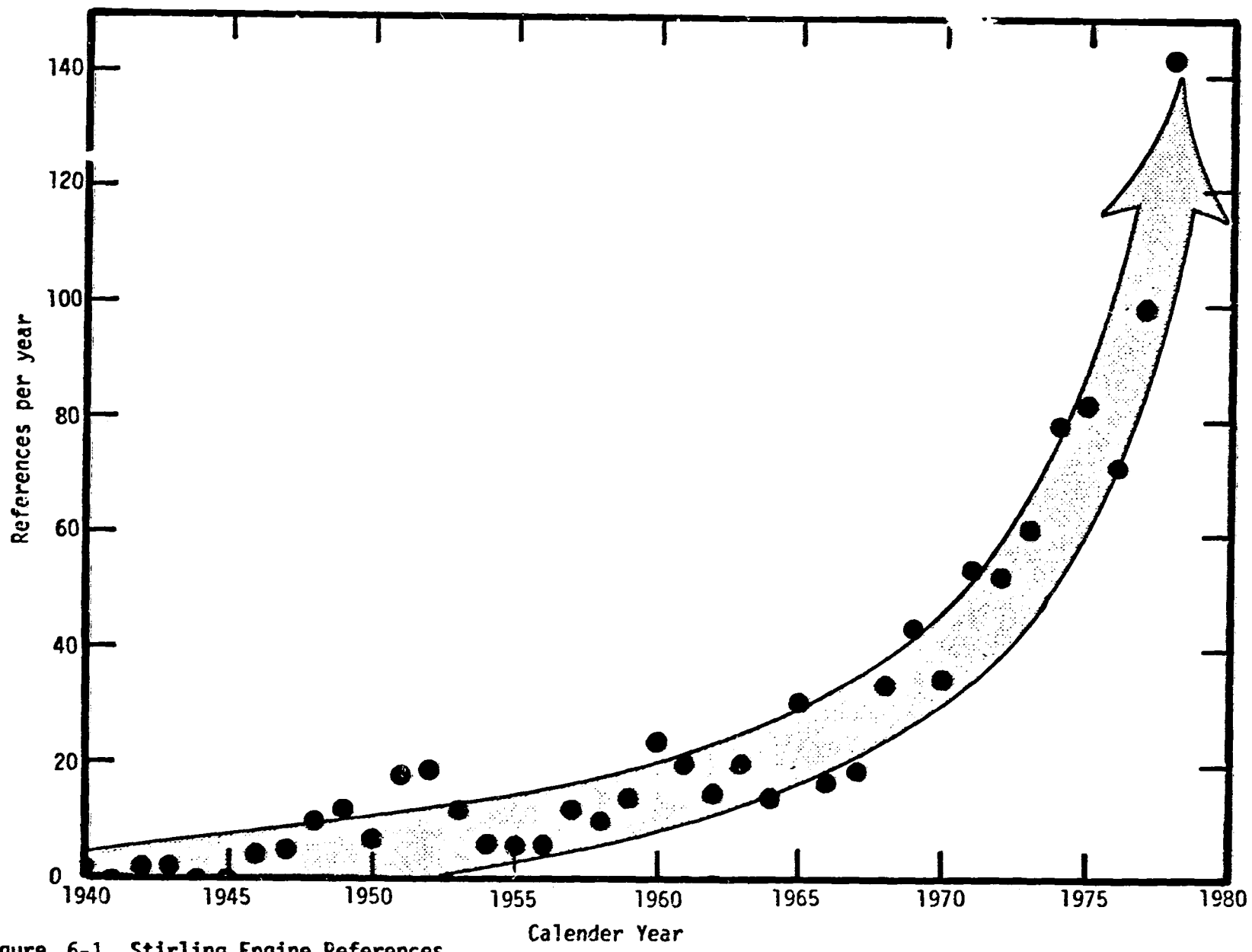

Figure 6-1. Stirling Engine References

Copyright © 1977
 by
 General Motors

- 1833 a Ericsson, J., "Air Engines," British Patent No. 6409, 1833. *
- 1840 a Stirling, J., and Stirling, R., "Air Engines," British Patent No. 8652, 1840. *
- 1845 a Poingdestre, W. W., "Descriptions of Sir George Cayley's Hot-Air Engine". Proceedings ICE, 9: 194-203, 1845.
- 1845 b Stirling, R., Proceedings ICE, 1845.
- 1845 c Stirling, J. "Description of Stirling's Improved Air Engine". Proc. ICE, 4: 348-61, 1845.
- 1850 a Herschel, J., "Making Ice," The Athenaeum, January 5, 1850, p. 22.
- 1852 a Joule, J.P. and Turin, R. A. , "On the Air Engine". Phil. Trans. R. Soc., No. 142, pp. 65-77. *
- 1852 b Cheverton, B., "Heated Air Engines". Proc. ICE. 12.
- 1853 a Combes, Par M., "Sur Des Documents Relatifs A La Machine A Air Chaud Du Capitaine Ericsson, " (Documents Relative to the Hot Air Machine of Captain Ericsson) Annalis des Mines, Vol. 3, 1853 *
- 1853 b Napier, J.R., and Rankine, W.J.M., British Patent No. 1416, 1853.
- 1854 a Rankine, M., "On the Means of Realizing the Advantages of Air Engines Proc. Br. Ass., September, 1854.
- 1854 b "Napier and Rankine's Patent Hot Air Engine," Mechanics Magazine, No. 1628, October 21, 1854. *
- 1861 a Schmidt, G., "Theorie der Geschlossenen Calorischen Maschine von Laubroy und Schwartzkopff in Berlin," Den. Pol. Journ., Vol. CLX, p. 401, 1871 or Zeitschrift des Oster. Ing. Ver., p. 79, 1861.

- 1864 a Dinglers Polytechnisches Journal, Vol. 172, p. 81, 1864.
- 1865 a Dinglers Polytechnisches Journal, Vol. 179, p. 345, 1865.
- 1869 a Delabar, G., Dinglers Polytechnisches Journal, Vol. 194, p. 257, 1869.
- 1869 b Eckerth, "Technische Blatter," 1, Jahrgang, Prague, 1869.
- 1870 a Ericsson, J. "Sun Power: The Solar Engine". Contributions to the Centennial. Philadelphia, 571-77, 1870.
- 1871 a Schmidt, Gustav, "Theory of Lehmanns Heat Machine". Journal of the German Engineers Union. Vol. XV, No. 1, pp. 1-12; No. 2, pp. 98-112.
- 1871 b Rider, A.K., "Improvement in Air-Engines," United States Patent 111,088, January 17, 1871.
- 1871 c The Roper Hot Air or Caloric Engine Co. Catalog., reprinted by Alan G. Phillips, P.O. Box 20511, Orlando, FL 32814. *
- 1874 a Kirk, A., "On the Mechanical Production of Cold," Proceedings of the Institution of Civil Engineers (London), Vol. 37, pp. 244-315, January 20, 1874. *
- 1874 b Slaby, A. "The Theory of Closed Air Engines". Proc. Inst. Civ. Eng. 56: 369-71, 1874.
- 1875 a Fritz, Prof. B., "Ueber die Ausnützung der Brennstoffe," (Utilization of Fuel), Dingler's Polytechnisches Journal, 1875. A5. *
- 1875 b "Air Engines," Editorial, Engineering, Vol. 19, Part 1 - March 12, 1875, pp. 200-201; Part 2 - March 26, 1875, pp. 241-242; Part 3 - April 9, 1875, pp. 287-289; Part 4 - April 30, 1875, pp. 355-356; Part 5 - May 21, 1875, pp. 417-418; Part 6 - June 18, 1875, pp. 504-505.
- 1876 a Ericsson, J., Contributions to the Centennial Exhibition, 1876.
- 1878 a Slaby, A., "Beitrage zur Theorie der Geschlossenen Luftmaschinen," Verh. des Ver. zur Bef. des Gewerbefleisses, Berlin, 1878.

- 1878 b Bourne, J., "Examples of Steam, Air and Gas Engines of the Most Recent Approved Type," Longmans, Green and Co., London, 1878
- 1879 a Slaby, A., "Die Luftmaschine von D.W. van Rennes," 1879. B4. *
- 1880 a Slaby, A., "Ueber Neuerungen an Luft- und Gasmaschinen," (Innovations of Air and Gas Machines), Dinglers Polyt. Journal, Bd 236, H. 1, 1880. *
- 1880 b Ericsson, J., "Air-Engine," United States Patent 226,052., March 30, 1880. *
- 1880 c Shaw, H. S. H. "Small Motive Power". Proc. ICE. 62: 290, 1880.
- 1881 a Schottler, R., "Uber die Heissluftmaschine von Rider, " Z.V.D.I., Vol. 25, 1881.
- 1884 a Ericsson, Ja. "The Sun Motor and the Sun's Temperature". Nature. 29: 217-19, 1884.
- 1885 a Babcock, G. H., "Substitutes for Steam," Trans ASME, Vol. 7, pp. 680-741, 1885.
- 1887 a Zeuner, G., "Technische Thermodynamik," Leipzig, Vol. 1, pp. 347-357, 1887.
- 1887 b "Improved Rider Compressing Pumping Engine," Reprinted by Alan G. Phillips, P. O. Box 20511, Orlando, FL 32814. *
- 1888 a Rontgen, R., "The Principles of Thermodynamics with Special Application to Hot Air, Gas and Steam Engines," Translation by Du Bois, New York, 1888.
- 1888 b Rider, T.J., "Hot-Air Engine," United States Patent 393,663. November 27, 1888. *
- 1888 c Rider, T. J., "Hot-Air Engine," United States Patent 393,723. November 27, 1888. *

- 1889 a Slaby, Prof. A., "Die Feuerluftmaschine," Zeitschrift des Vereines Deutscher Ingenieure, Band XXXIII, No. 5, Sonnabend, February 2, 1889. *
- 1889 b "Remarkable New Motor, A". Engineering News. Sept. 14: 242-6.
- 1890 a Grashof, F., "Theorie der Kraftmaschinen," Hamburg, 1890.
- 1890 b "The Improved Ericsson Hot-Air Pumping Engine", Reprinted by Alan G. Phillips, P. O. Box 20511, Orlando FL 32814. *
- 1897 a Anderson, G.A., and Ericksson, E.A., "Hot-Air Engine," United States Patent 579,670, March 30, 1897. *
- 1898 a Lanchester, F.W., "Improvements in Fluid Pressure Engines," British Patent 10836.
- 1899 a Appleton Cyclopaedia of Applied Mechanics. New York, 1899.
- 1899 b Knoke, J.O., "Die Kraftmaschine Des Kleinwerbes," Berlin, 1899. *
(Table of Contents Only.)
- 1903 a Essex, H., "Caloric Engine." United States Patent 723,660, March 24, 1903.
- 1905 a Smal, P., "Improved Motor Using Hot and Cold Compressed Air," British Patent 29,002., April 13, 1905. *
- 1906 a Rider-Ericsson Engine Co., "The Improved Rider and Ericsson Hot-Air Pumping Engines." Catalogue, 1906. *
- 1906 b Morse, F.W., and Hubbard, F.G., "Hot-Air Engine," United States Patent 822,463, June 5, 1906. *
- 1906 c "Directions for Running the Improved Reeco Ericsson Hot Air Pumping Engine." Reprinted by Alan G. Phillips, P.O. Box 20511, Orlando, FL 32814. *
- 1908 a "Hot Air Pumping Engines" Reprinted by Alan G. Phillips -
(see directory). *

- 1911 a Donkin, B., "A Text Book on Gas, Oil and Air Engines," London, 1911.
- 1913 a Anderson, L. and Engel, E.F., "Caloric Engine," United States Patent 1,073,065, September 9, 1913. *
- 1913 b "Illustrated Catalog of the Caloric Noiseless Engines and Water Systems," Bremen Mfg. Co., Bremen, OH, Reprinted by Alan G. Phillips, P.O. Box 20511, Orlando, FL 32814. *
- 1914 a Godoy, J. V., "Improvements Relating to Heat Engines," British Patent 1,872., May 28, 1914. B3. *
- 1917 a "The Centenary of the Heat Regenerator and the Stirling Air Engine," The Engineer, pp. 516-517, December 14, 1917.
- 1917 b "The Regenerator," The Engineer, p. 523, December 14, 1917.
- 1917 c "The Stirling Specifications," The Engineer, p. 567, December 28, 1917.
- 1917 d Prosses, "The Centenary of the Heat Regenerator and the Stirling Air Engine," The Engineer, p. 537, December 21, 1917.
- 1918 a Vuilleumier, R., "Method and Apparatus for Inducing Heat Changes," United States Patent 1,275,507., August 13, 1918. *
- 1919 a L'Air Liquide Societe Anonyme, "Improvements in or Relating to Heat Engines," British Patent 126,940 - Complete Not Accepted, January 6, 1919. *
- 1920 a Rees, T. A., "Improvements in Hot-Air Engines," British Patent 146,620, July 12, 1920. *
- 1926 a Anzelius, A., "Über Erwärmung Vermittels Durchstromender Medien," Z. Angew. Math. Mech. 6, pp. 291-294, 1926.
- 1927 a Nusselt, W., "Die Theorie des Winderhitzers," Z. Ver Dt. Ing., Vol. 71, p. 85, 1927.
- 1928 a Nusselt, W., "Der Beharrungszustand im Winderhitzer," Z. Ver. Dt. Ing., Vol. 72, pp. 1052, 1928.

- 1929 a Hausen, H., "Über die Theorie des Wärmeaustausches in Regeneratoren," Z. Angew. Math. Mech., Vol. 9, pp. 173-200, June 1929. *
- 1929 b Schumann, T.E.W., "Heat Transfer to a Liquid Flowing Through a Porous Prism," J. Franklin Inst., Vol. 208, pp. 405-416, 1929. *
- 1929 c Hausen, H., "Wärmeaustausch in Regeneratoren," Z. Ver. Dt. Ing., Vol. 73, p. 432, 1929.
- 1930 a Furnas, C.C., "Heat Transfer from a Gas Stream to a Bed of Broken Solids - I," Industrial Eng. Chemistry, Vol. 22, p. 26, 1930.
- 1930 b Hausen, H., "Über den Wärmeaustausch in Regeneratoren," Tech. Mech. u Thermodynam., Vol. I, pp. 219-224. *
- 1931 a Malone, J.F.J., "A New Prime Mover," The Engineer, July 24, 1931, pp. 97-101. *
- 1931 b Hausen, H., "Näherungsverfahren zur Berechnung des Wärmeaustausches in Regeneratoren," (An Approximate Method of Dimensioning Regenerative Heat-Exchangers), Z. Angew. Math. Mech., Vol. 11, pp. 105-114, April, 1931.
- 1932 a Furnas, C., "Heat Transfer from a Gas Stream to Bed of Broken Solids," Bulletin, U.S. Bureau of Mines, No. 361, 1932. *
- 1932 b Smith, H.F., "Heat Engine," United States Patent 1,879,563., September 27, 1932. *
- 1934 a Schumann, T.E.W. and Voss, V., "Heat Flow Through Granulated Material," Fuel, Vol. 13, pp. 249-256, 1934. *
- 1937 a Lee, R., "Heat Engine," United States Patent 2,067,453., January 12, 1937. *
- 1938 a Boestad, G., "Die Wärmeübertragung im Ljungstrom Luftwärmer," Feuerungstechnik, Vol. 26, p. 282, 1938.
- 1938 b Bush, V., "Apparatus for Transferring Heat," United States Patent 2,127,286., August 16, 1938. *
- 1939 a Bush, V., "Apparatus for Compressing Gases," United States Patent 2,157,229., May 1939. *

- 1940 a Saunders, O. and Ford, H., "Heat Transfer in the Flow of Gas Through a Bed of Solid Particles," J. Iron Steel Inst., No. 1,, p. 291, 1940.
- 1940 b Ackeret, J., and Keller, C. "Hot Air Power Plant". Engineer. 169: 373.
- 1942 a Hausen, H., "Vervollstandigte Berechnung des Warmaustausches in Regeneratoren," Z. Ver. Dt. Ing. Beiheft Verfahrenstechnik, No. 2, p. 31, 1942.
- 1942 b Smith, H.F., "Refrigerating Apparatus," United States Patent 2,272,925., February 10, 1942. *
- 1943 a Martinelli, R.C., Boelter, L.M.K., Winberge, E.B. and Yakahi, S., "Heat Transfer to a Fluid Flowing Periodically at Low Frequencies in a Vertical Tube," Trans. Amer. Soc. Mech. Engrs., No. 65, pp. 789-798, 1943.
- 1943 b Philips Co., "Improvements in or Relating to Hot-Gas Engines," British Patent 697, 157, August 25, 1943. D8. *
- 1946 a Rinia, H. and du Pré, F. K., "Air Engines," Philips Technical Review, Vol. 8, No. 5, pp. 129-136, 1946. *
- 1946 b Johnson, O., "Civilization, to John Ericsson, Debtor," The Scientific Monthly, pp. 101-106, January, 1946. *
- 1946 c Philips Co., "Improvements in or Relating to Hot-Gas Engines," British Patent 630,429, October 13, 1946. *
- 1946 d Rinia, H., "New Possibilities for the Air-Engine," Philips Gloeilampenfabrieken, Paper No. 1684, 1946 or Proceedings, Koninklijke Nederlandsche Akademie van Wetenschappen, pp. 150-155, February 1946, (published in English). *
- 1947 a Tipler, W., "A Simple Theory of the Heat Regenerator," Technical Report No. ICT/14, Shell Petroleum Co. Ltd., 1947
- 1947 b de Brey, H., Rinia, H., and van Weenen, F. L., "Fundamentals for the Development of the Philips Air Engine," Philips Technical Review, Vol. 9, No. 4, 1947. *
- 1947 c van Weenen, F.L., "The Construction of the Philips Air Engine," Philips Technical Review, Vol. 9, No. 5, pp. 125-134, 1947. *
- 1947 d "Caloric Engine," Auto Engr., Vol. 37, No. 493, pp. 372-376, October 1947.
- 1947 e "Philips Air-Engine," The Engineer, Vol. 184, No. 4794, December 12, 1947, pp. 549-550; and No. 4795, pp. 572-574, December 19, 1947. *

- 1948 a Vacant
- 1948 b Hahnemann, H., "Approximate Calculation of Thermal Ratios in Heat-Exchangers Including Heat Conduction in the Direction of Flow," National Gas Turbine Establishment Memorandum 36, 1948.
- 1948 c Iliffe, C.E., "Thermal Analysis of the Contra-Flow Regenerative Heat-Exchanger," Proc. Instn. Mech. Engrs., Vol. 159, pp. 363-372, 1948. *
- 1948 d Saunders, O.A., and Smoleniec, S., "Heat Regenerators," Proc. Int. Cong. of Appl. Mech., Vol. 3, pp. 91-105, 1948.
- 1948 e Tipler, W., "An Electrical Analogue to the Heat Regenerator," Proc. Int. Cong. of Appl. Mech., Vol. 3, pp. 196-210, 1948.
- 1948 f Wuolijoki, J. R., "Kuumailmakoneen Renessanssi," Teknillinen Aikakauslehti, Vol. 38, No. 9, pp. 241-246, Sept. 1948.
- 1948 g Bohr, E., "Den Moderna Varmluftsmotorn," Teknisk Tidskrift, No. 18, pp. 595-599, 1948.
- 1948 h "Inventor of Hot-Air Engine and Engine-Driven Air Pump," The Engineer, Vol. 186, No. 4829, pp. 168-169, August 13, 1948.
- 1948 i "Prime Movers in 1947," The Engineer, Vol. 185, Nos. 4798, January 9, 1948, pp. 44-46; 4799, January 16, 1948, pp. 71-72, 4800, January 23, 1948, p. 95.
- 1948 j Philips Co., "Improvements in or Relating to Closed Cycle Hot-Gas Engines," British Patent 606,753, August 19, 1948. *
- 1948 k Philips Co., "Improvements in or Relating to Hot-Gas Reciprocating Engines," British Patent 605,992, August 4, 1948. *
- 1948 l Armagnac, A. P., "Will the Old Hot-Air Engine Drive the New Cars?" Pop. Sci. Feb. 1948: 145-9.

- 1949 a Bush, V., "Thermal Apparatus for Compressing Gases," United States Patent, 2,461,032, February 8, 1949. *
- 1949 b "Old Hot-Air Engine," The Engineer, Vol. 187, No. 4862, pp. 365-366, April 1, 1949.
- 1949 c van Heeckeren, W. J., "Hot-Air Engine Actuated Refrigerating Apparatus," United States Patent 2,484,392, October 11, 1949. *
- 1949 d Philips Co., "Improvements in or Relating to Hot-Gas Reciprocating Engines," British Patent 632,669, November 28, 1949. *
- 1949 e Philips Co., "Improvements in Systems Comprising a Hot-Gas Reciprocating Engine," British Patent 623,090, May 12, 1949. *
- 1949 f Philips Co., "Improvements in or Relating to Hot-Gas Reciprocating Engines," British Patent 618,266, Feb. 18, 1949. *
- 1949 g Philips Co., "Improvements in or Relating to Hot-Gas Reciprocating Engines," British Patent 617,850, February 11, 1949. *
- 1949 h Philips Co., "Improvements in or Relating to Hot-Gas Engines," British Patent 619,277, March 7, 1949. *
- 1949 i Philips Co., "Improvements in or Relating to Cylinder Heads for Hot-Gas Engines," British Patent 615,260, January 4, 1949. *
- 1949 j Philips Co., "Improvements in or Relating to Hot-Gas Engines," British Patent 630,428, October 13, 1949. *
- 1949 k van Heeckeren, W. J., "Hot-Gas Engine Heater Head Arrangement," United States Patent 2,484,393, October 11, 1949. *
- 1949 l Schrader, Alan R., "Test of Philips Model 1/4 D External Combustion Engine" U.S. Naval Engineering Experimental Station, Annapolis, Md., N.E.E.S. Report C-3599-A (1) 25 March 1949.

- 1950 a Locke, G. L., "Heat-Transfer and Flow-Firction Characteristics of Porous Solids," Dept. of Mech Engr., Stanford University, U.S.A., Technical Report No. 10, 1950. *
- 1950 b Philips Co., "Improvements in or Relating to Hot-Gas Reciprocating Engines," British Patent 637,719, May 24, 1950. *
- 1950 c Philips Co., "Improvements in or Relating to Heat-Exchanging Apparatus," British Patent 635,691, April 12, 1950. *
- 1950 d Philips Co., "Improvements in or Relating to Hot-Gas Engines," British Patent 645, 934, Nov. 15, 1950. *
- 1950 e Pakula, A., "Kylmailmakoneet U U dessa Kchitysvaiheessa," Teknillien Aikakausleptie, Vol. 40, No. 6, pp. 123-127, March 25, 1950.
- 1950 f Schrader, Alan R., "1015 Hour Endurance Test of Philips Model 1/4 D External Combustion Engine," U.S. Naval Engineering Experiment Station, Annapolis, Md., N.E.E.S. Report C-3599-A (3) AD-494 926.
- 1950 g Keller, C. "Closed-Cycle Gas Turbine, Escher-Wyss-AK Development 1945-50". Trans. ASME. Aug: 835-50. 1950.

- 1951 a Davis, S.J., and Singham, J.R., "Experiments on a Small Thermal Regenerator," General Discussion on Heat Transfer, Inst. of Mech. Engr., London, pp. 434-435, 1951.
- 1951 b Hougen, J.O., and Piret, E.L., "Effective-Thermal Conductivity of Granular Solids through which Gases are Flowing," Chem. Engng. Prog., Vol. 47, pp. 295-303, 1951.
- 1951 c Schultz, B. H., "Regenerators with Longitudinal Heat Conduction," General Discussion on Heat Transfer, Inst. of Mech. Engr., London, 1951.
- 1951 d Denton, W. H., "The Heat Transfer and Flow Resistance for Fluid Flow through Randomly Packed Spheres," The Inst. of Mech. Engr., London, pp. 370-373, 1951.
- 1951 e Gamson, B.W., "Heat and Mass Transfer, Fluid Solid Systems," Chem. Engng. Prog., Vol. 47, No. 1, pp. 19-28, January 1951.
- 1951 f Dros, A.A., "Combination Comprising a Hot-Gas Engine and a Piston Machine Driven Thereby," United States Patent 2,558,481, June 26, 1951. *
- 1951 g Philips Co., "Improvements in and Relating to Thermal Regenerators," British Patent 657,472, September 19, 1951.*
- 1951 h Philips Co., "Improvements in or Relating to Multi-Cylinder Piston Machines," British Patent 656, 252, August 15, 1951. *
- 1951 i Philips Co., "Improvements in or Relating to Hot-Gas Reciprocating Engines and Reciprocating Refrigerators Operating According to the Reversed Hot-Gas Engine Principle," British Patent 656,250, August 15, 1951. *
- 1951 j Philips Co., "Improvements in and Relating to Hot-Gas Engines," British Patent 648,742, January 10, 1951. *
- 1951 k Philips Co., "Improvements in Hot-Gas Engines," British Patent 654,625, June 27, 1951. *
- 1951 l Philips Co., "Improvements in or Relating to Hot-Gas Reciprocating Engines, Including Refrigerating Engines Operating on the Reversed Hot-Gas Principle," British Patent 654,936, July 4, 1951. *
- 1951 m Philips Co., "Improvements in or Relating to Reciprocating Engines," British Patent 654,940, July 4, 1951. *
- 1951 n Philips Co., "Improvements in or Relating to Hot-Gas Reciprocating Engines," British Patent 655,565, July 25, 1951. *
- 1951 o Philips Co., "Improvements in Reciprocating Hot-Gas Engines," British Patent 658,743, September 26, 1951. *

- 1951 p Philips Co., "Improvements in or Relating to the Control of Hot-Gas Reciprocating Engines," British Patent 655,935, August 8, 1951.
- 1951 q Saunders, O. A., and Smoleniec, S., "Heat Transfer in Regenerators," General Discussion on Heat Transfer, Inst. of Mech. Eng. and ASME, 11-13 September 1951, pp. 443-445. *
- 1951 r Schrader, A.R. "1015 Hr. Endurance Test of Philips Model 1/4 D External Combustion Engine," Naval Eng. Experiment Station, EES Report No. C-3599-A(3), NTIS #494926, February 1, 1951. *

- 1952 a Coppage, J., "Heat-Transfer and Flow-Friction Characteristics of Porous Media," Thesis, Stanford University, U.S.A., 1952.
- 1952 b Finklestein, T., "Theory of Air Cycles with Special Reference to the Stirling Cycle," Ph.D. Thesis, University of London, 1952.
- 1952 c du Pre, F.K., "Hot-Gas Engine or Refrigerator," United States Patent 2,590,519, March 25, 1952. *
- 1952 d Koopmans, A., "Hot-Gas Reciprocating Engine," United States Patent 2,618,923, November 25, 1952. *
- 1952 e Yendall, E.F., "A Novel Refrigerating Machine," Advances in Cryogenic Engineering, Volume 2, 1952. *
- 1952 f Dros, A.A., and Koopmans, A., "Multitude Heater for Hot-Gas Reciprocating Engines," United States Patent 2,621,474, December 16, 1952. *
- 1952 g Yzer, J.A.L., "Cylinder Head for Hot-Gas Reciprocating Engines," United States Patent 2,616,250, November 4, 1952. *
- 1952 h van Heeckeren, W.J., "Hot-Gas Motor with Means for Controlling the Heat Supply Therefor," United States Patent 2,583,311, January 22, 1952. *
- 1952 i de Brey, H., "Hot-Gas Reciprocating Engine of the Kind Comprising One or More Closed Cycles," United States Patent 2,616,249, November 4, 1952. *
- 1952 j Philips Co., "Improvements in or Relating to Reciprocating Apparatus," British Patent 684,394, December 17, 1952.
- 1952 k Philips Co., "Improvements Relating to Hot-Gas Reciprocating Engines and Refrigerating Engines Operating on the Reversed Hot-Gas Reciprocating Engine Cycle," British Patent 665,989, February 6, 1952. *
- 1952 l Philips Co., "Improvements in or Relating to Hot-Gas Reciprocating Engines, and Refrigerating Engines Operating on the Reversed Hot-Gas Engine Principle," British Patent 684,600, December 24, 1952. *
- 1952 m Philips Co., "Improvements in or Relating to Hot-Gas Reciprocating Engines," British Patent 675,161, July 9, 1952. *
- 1952 n Philips Co., "Improvements in Refrigerating Systems," British Patent 680,241, October 8, 1952. *
- 1952 o Philips Co., "Improvements in or Relating to Hot-Gas Engines or Engines Operating on the Reverse Hot-Gas Engine Principle," British Patent 666,313, February 13, 1952. *

- 1952 p Philips Co., "Improvements in or Relating to Hot-Gas Engines,"
British Patent 662,061, March 12, 1952. *
- 1952 q Philips Co., "Improvements in or Relating to Hot-Gas Engines,"
British Patent 669,891, April 9, 1952. *
- 1952 r Philips Co., "Improvements in or Relating to Hot-Gas Engines,"
British Patent 665,735, January 30, 1952.*
- 1952 s Philips Co., "Improvements in or Relating to Refrigeration
Machines Operating on the Reversed Hot-Gas Engine Principle,"
British Patent 668,621, March 19, 1952. *

- 1953 a Coppage, J.E., and London, A.L., "The Periodic-Flow Regenerator--
A Summary of Design Theory," Trans. Am. Soc. Mech. Engrs., Vol.
75, pp. 779-787, 1953. *
- 1953 b Denham, F.R., "A Study of the Reciprocating Hot-Air Engine,"
Ph. D., Thesis, Durham University, 1953.
- 1953 c Finkelstein, T., "Self-Acting Cooling Cycles," D.I.C. Thesis,
Imperial College, London, 1953.
- 1953 d Philips Co., "Improvements in Hot-Gas Engines," British Patent
691,781, May 20, 1953. *
- 1953 e Schultz, B.H., "Approximate Formulae in the Theory of Thermal
Regenerators," Appl. Scient. Res. A., Vol. 3, pp. 165-173, 1953.
- 1953 f Philips Co., "Improvements in or Relating to Hot-Gas Reciprocating
Engines and Engines Operating on the Reversed Hot-Gas Engine
Principle," British Patent 690,026, April 8, 1953. *
- 1953 g Philips Co., "Improvements in Heat Regenerator Filling Material
Consisting of Wire Material," British Patent 695,271, August 5, 1953.
- 1953 h Philips Co., "Improvements in or Relating to Hot-Gas Engines,"
British Patent 697,082, September 16, 1953.*
- 1953 i Philips Co., "Improvements in Hot-Gas Reciprocating Engines,"
British Patent 691,785, May 20, 1953. *
- 1953 j Philips Co., "Improvements in Hot-Gas Engines," British Patent
691,784, May 20, 1953. *
- 1953 k Heywood, H. "Solar Energy: Past, Present and Future Applications".
Engineering. 176: 377-80, 1953.
- 1953 l Robinson, N. "A Report on the Design of Solar Energy Machines".
UNESCO. NS/AZ/141, 1953.

- 1954 a Havemann, H.A., and Narayan Rao, N., "Heat Transfer in Pulsating Flow," Nature, Vol. 174, No. 4418, p. 41, 1954. *
- 1954 b Köhler, J.W.L., and Jonkers, C.O., "De Kindagaskoelmachine," De Ingenieur, No. 49, December 3, 1954.
- 1954 c Jones, L.L. Jr., and Fax, D.H., "Perturbation Solutions for the Periodic-Flow Thermal Regenerator," A.S.M.E. Paper No. 54-A-130, 1954.
- 1954 d Philips Co., "Improvements in or Relating to Heat Exchangers," British Patent 702,132, January 13, 1954. *
- 1954 e Köhler, J.W.L., and Jonker, C.O., "Fundamentals of the Gas Refrigerating Machine," Philips Technical Review, Vol. 16, No. 3, pp. 69-78, September, 1954. *
- 1954 f Kohler, J. W. L., and Jonkers, C. O., "Construction of a Gas Refrigerating Machine". Philips Technical Review, Vol. 16, No. 4, pp. 105-115, October, 1954. *
- 1955 a Havemann, H.A., and Narayan Rao, N.N., "Studies for New Hot-Air Engine," J. Indian Inst. Sci., B37, p. 224, and 38 p. 172, 1955.
- 1955 b Brazeale, W.L., "State of the Art of Radioisotope Power Systems for Lunar Surface Vehicles," NASA CR-61055.*
- 1955 c Vacant
- 1955 d Lambeck, A.J.J., "Hot-Gas Reciprocating Engine and Refrigerator or Heat Pump Operating on the Reversed Hot-Gas Reciprocating Engine Principle," United States Patent 2,709,334, May 31, 1955.*
- 1955 e Köhler, J.W.L., "Principles of Gas Refrigeration Machines," Nature, pp. 623-626, October 1, 1955.
- 1955 f Condegone, C., "Sur le cycle Frigorifique Philips," Comtes Rendus du IX Congres International du Froid, Paris, pp. 3025-3031, August 31 to September 7, 1955.
- 1955 g Köhler, J.W.L., and ver der Steer, J., "A Small Liquid Nitrogen Plant, Using a Gas Refrigerating Machine," Comtes Rendus du IX Congres International du Froid, Paris, pp. 1057-1063, August 31 to September 7, 1955.

- 1956 a Coppage, J.E., and London, A.L., "Heat-Transfer and Flow-Friction Characteristics of Porous Media," Chem. Engng. Prog., Vol. 52, No. 2, pp. 56-57, February 1956.
- 1956 b Dros, A.A., Yzer, J.A.L., and Hellingman, E., "Hot-Gas Reciprocating Engine," United States Patent 2,746,241, May 22, 1956. *
- 1956 c Crandall, S.H., "Engineering Analysis," McGraw-Hill Book Company, New York, p. 177, 1956. *
- 1956 d Köhler, J.W.L., "Refrigerator Gas Liquification Device," United States Patent 2,734,354, February 14, 1956. *
- 1956 e Köhler, J.W.L., and Schalkwijk, W.F., "Cold Gas Refrigerator," United States Patent 2,750,765, June 19, 1956. *
- 1956 f de Lange, L., "Cooler Construction in a Hot-Gas Engine," United States Patent 2,765,879, October 2, 1956. *
- 1957 a Creswick, F.A., "A Digital Computer Solution of the Equation for Transient Heating of a Porous Solid, Including the Effects of Longitudinal Conduction," Ind. Math., Vol. 8, pp. 61-68, 1957.
- 1957 b Fabbri, S., "Hot-Air Engines and the Stirling Cycle," Metano., Vol. 11, pp. 1-9, 1957.
- 1957 c Meijer, R.J., "Device for Circulating a Medium in a Reciprocating Engine," United States Patent 2,781,632, February 19, 1957. *
- 1957 d "Air Engine and Air Motor," Colliers Encyclopedia, 1957 edition. *
- 1957 e "Air Engine," Britannica Encyclopedia, 1957 edition. *
- 1957 f Newton, A.B., "Refrigeration Compressor," United States Patent 2,803,951, August 27, 1957. *
- 1957 g Meijer, R.J., "Hot-Gas Reciprocating Apparatus," United States Patent 2,794,315, June 4, 1957. *
- 1957 h Köhler, J.W.L., and Bloem, A.T., "Cold-Gas Refrigerator," United States Patent 2,781,647, February 19, 1957. *
- 1957 i Schalwijk, W.F., de Lange, L., and Koopmans, A., "Regenerator Construction of a Cold-Gas Refrigerator," United States Patent 2,775,876, January 1, 1957. *
- 1957 j Köhler, J.W.L., "Hot-Gas Reciprocating Engine for Refrigerating," United States Patent 2,784,570, March 12, 1957. *
- 1957 k van Weenen, F.L., and Dros, A.A., "Hot-Gas Reciprocating Engine Construction," United States Patent 2,817,950, December 31, 1957. *
- 1957 l Yellott, Y. I. "Power from Solar Energy". Trans. ASME. 76n6 (Aug.). 1957.

- 1958 a Halley, J.A., "The Robinson-Type Air Engine," J. Stephenson Engng. Soc., King's Coll. Newcastle, Vol. 2, No. 2, p. 49, 1958.
- 1958 b Karavansky, I.I., and Meltser, L.Z., "Thermodynamic Investigations of the Working Cycle of the Philips Machine," Proc. 10th Int. Cong. on Refrig., 3-29, 209, 1958. *
- 1958 c Jonkers, C.O., "Hot-Gas Reciprocating Engine," United States Patent 2,857,220, October 21, 1958. *
- 1958 d Lambertson, T. J., "Performance Factors of a Periodic-Flow Heat-Exchanger," Trans. Am. Soc. Mech. Engrs., Vol. 80, pp. 586-592, 1958. *
- 1958 e Shuttleworth, P., "An Experimental Investigation of a Stirling Engine," M. Sc. Thesis, Durham University, 1958.
- 1958 f Yendall, E.F., "A Novel Refrigerating Machine," Advances in Cryogenic Engineering, Vol. 2, Plenum Press, New York, pp. 188-196, 1958.
- 1958 g Wolgemuth, C.H., "The Equilibrium Performance of the Theoretical Stirling Cycle with a Chemically Reactive Gas as the Working Fluid," Penn. State Univ., 1958. *
- 1958 h Meijer, H.M., "Hot-Gas Reciprocating Engine," United States Patent 2,828,601, April 1, 1958. *
- 1958 i den Haan, J.J.W., "Regenerator for Use in Hot-Gas Reciprocating Engine," United States Patent 2,833,523, May 6, 1958. *
- 1958 j Walker, G., "Stirling Cycle Engines," Jnl. Stephenson Soc., Newcastle, Vol. 2, No. 2.

- 1959-a Darling, G.B., "Heat Transfer to Liquids in Intermittent Flow," Petroleum, pp. 177-178, May, 1959.
- 1959 b Emerson, D. C., "Effect of Regenerator Matrix Arrangements on the Performance of a Gas Refrigerating Machine," B. Sc. Hons. Thesis, Durham University, 1959.
- 1959 c Finkelstein, T., "Air Engines," Engineer, Vol. 207, pp. 492-497, 522-527, 568-571, 720-723, 1959. *
- 1959 d van Heeckeren, W.J., "Hot-Gas Engine Comprising More than One Device for the Supply of Heat," United States Patent 2,894,368, July 14, 1959. *
- 1959 e Kirkley, D.W., "Continued Work on the Hot-Air Engine," B.Sc. Hons. Thesis, Durham University, 1959.
- 1959 f Meijer, R.J., "The Philips Hot-Gas Engine with Rhombic Drive Mechanism," Philips Tech. Rev., Vol. 20, No. 9, pp. 245-276. *
- 1959 g Schalwijk, W.E., "A Simplified Regenerator Theory," J. Engng. Pwr., Vol. A81, pp. 142-50, 1959. *
- 1959 h Köhler, J.W.L., "Single-Acting Hot-Gas Reciprocating Engine," United States Patent 2,872,779, February 10, 1959. *
- 1959 i Newton, A.B., "Hot Fluid Engine with Movable Regenerator," United States Patent 2,907,169, October 6, 1959. *
- 1959 j McMahon, H.O., and Gifford, W.E., "Fluid Expansion Refrigeration Method and Apparatus," United States Patent 2,906,101, Sept. 29, 1959. *
- 1959 k Havemann, H.A., Narayan Rao, N.N., Jayachandra, P., and Garg, G.C., "Studies for New Hot-Air Engine," J. Indian Inst. Sci., Sec. B., Vol. 38, No. 3, pp. 172-202, July, 1959.
- 1959 l Meijer, R.J., "Hot-Gas Reciprocating Machine of the Displacer-Piston Type," United States Patent 2,885,855, May 12, 1959. *
- 1959 m Meijer, R.J., "Hot-Gas Reciprocating Apparatus," United States Patent 2,867,973, January 13, 1959. *
- 1959 n Newton, A.B., "Refrigerant Engine and Work Device," United States Patent 2,909,902, October 27, 1959. *

- 1960 a Flynn, G., Percival, W.H., and Heffner, F.E., "The GMR Stirling Thermal Engine," SAE Paper 118A, 1960, also SAE Journal, pp.42-51, Ap.1960.*
- 1960 b Henderson, R.E., and Dresser, D.L., "Solar Concentration Associated with the Stirling Engine," Amer. Rocket Soc., Space Power Systems Corp., Santa Monica, California, September 1960.
- 1960 c Kohler, J.W.L., "The Gas Refrigerating Machine and its Position in Cryogenic Technique," Prog. in Cryogenics, Vol. 2, pp. 41-67, 1960 *
- 1960 d McMahon, H.D., and Gifford, W.E., "A New Low-Temperature Gas Expansion Cycle- Parts I and II," Advances in Cryogenic Engng., Vol. 5, Plenum Press, New York, pp. 354-372, 1960. *
- 1960 e Meijer, R.J., "The Philips Stirling Thermal Engine," Ph.D. Thesis, Technical University, Delft, 1960. *
- 1960 f Parker, M.D., and Smith, C.L., "Stirling Engine Development for Space Power," A.R.S. Space Power -Systems Conf., September 1960.
- 1960 g Rapley, C., "Heat Transfer in Thermal Regenerators," M.Sc. Thesis, Durham University, 1960.
- 1960 h van der Ster, J., "The Production of Liquid Nitrogen from Atmospheric Air using a Gas Refrigerating Machine," Delft Technische Hochschule Thesis, 1960.
- 1960 i "GMR Stirling Thermal Engine," Mechanical Engineering, Vol. 82, pp. 88-89, April, 1960. *
- 1960 j Finkelstein, T., "Optimization of Phase Angle and Volume Ratios in Stirling Engines," SAE Paper 118C, 1960. *
- 1960 k Stoddart, J.S., "An Analysis of the Stirling Cycle," Thesis, Durham University, 1960.
- 1960 l Stoddart, D., "Generalized Thermodynamic Analysis of Stirling Engines," Thesis, Durham University, 1960.
- 1960 m Garay, P.N., "Stirling Engine Betters Efficiency," Power, September, 1960. *
- 1960 n Wintringham, J.S., "Potential Passenger Car Powerplants," SAE Paper No. S275 for meeting November 9, 1960. *
- 1960 o Meijer, R.J., "Thermo-Dynamic Reciprocating Apparatus," United States Patent 2,951,334, September 6, 1960. D9. *
- 1960 p Meijer, R.J., "Thermo-Dynamic Reciprocating Apparatus," United States Patent 2,959,019, November 8, 1960. *

- 1960 q Meijer, R.J., "Hot-Gas Reciprocating Engine," United States Patent 2,963,854, December 13, 1960. *
- 1960 r Meijer, R.J., "Thermo-Dynamic Reciprocating Apparatus," United States Patent 2,963,871, December 13, 1960. *
- 1960 s Wile, D.D., and Brainard, D.S., "Control System for Winter Operation of Air-Cooled Condensers," United States Patent 2,943,457, July 5, 1960. *
- 1960 t Jonkers, C.O., and Kohler, J.W.L., "Gaseous Medium Leakage Prevention Arrangement for a Hot-Gas Reciprocating Machine," United States Patent 2,943,453, July 5, 1960. *
- 1960 u Jakeman, R.W., "The Construction and Testing of the Stirling Universal Research Engine," Durham University Thesis, 1960.
- 1960 v Finkelstein, T., "Generalized Thermodynamic Analysis of Stirling Engines," SAE Paper 118 B, January 1960. *
- 1960 w Stephens, C.W., Spies, R., Menetrey, W.R., "Dynamic Thermal Converters," Electro-Optical Systems, Inc., Pasadena, CA.
- 1960 x Utz, J.A., Braun, R.A. "Design and Initial Tests of a Stirling Engine for Solar Energy Applications," Univ. of Wisconsin, Dept. of Mech. Eng., WIS.

- 1961 a Bayley, F.J., Edwards, P.A., and Singh, P.P., "The Effect of Flow Pulsations on Heat Transfer by Forced Convection from a Flat Plate," Int. Heat Trans. Conf., ASME, Boulder, Colorado, pp. 499-509, 1961. *
- 1961 b Wintringham, J.S., Promising Methods of Generating Electricity, S A E, New York.
- 1961 c Newton, A.B., "Hot Gas Refrigeration System," United States Patent 2,993,341, July 25, 1961. *
- 1961 d Finkelstein, T., "Regenerative Thermal Machines," Battelle Tech. Review, May, 1961. *
- 1961 e Part I - Finkelstein, T., "Conversion of Solar Energy into Power," ASME Paper No. 61-WA-297, 1961.
Part II - Eibling, J.A., "Collection of Solar Radiation," ASME Paper No. 61-WA-297, 1961.
- 1961 f Meek, R.M.G., "The Measurement of Heat-Transfer Coefficients in Packed Beds by the Cyclic Method," Int. Heat-Trans. Conf., (ASME) Boulder, Colorado, pp. 770-780, 1961.
- 1961 g Murray, J.A., Martin, B.W., Bayley, F.J., and Rapley, C.W., "Performance of Thermal Regenerators Under Sinusoidal Flow Conditions," Int. Heat-Trans. Conf., (ASME) Boulder, Colorado, pp. 781-796, 1961. *
- 1961 h Chellis, F.F., and Hogan, W.H., "A Liquid-Nitrogen-Operated Refrigerator for Temperatures Below 77°K," Paper J-6, Advances in Cryogenic Eng., pp. 545-551. Vol. 3, 1961. *
- 1961 i Siegel, R., and Perlmutter, M., "Two-Dimensional Pulsating Laminar Flow in a Duct with a Constant Wall Temperature," Int. Heat-Trans. Conf., (ASME), Boulder, Colorado, pp. 517-535, 1961. *
- 1961 j Wadsworth, J., "An Experimental Investigation of the Local Packing and Heat-Transfer Processes in Packed Beds of Homogeneous Spheres," Int. Heat-Trans. Conf., (ASME, Boulder, Colorado, pp. 760-769. 1961. *
- 1961 k Walker, G., "The Operational Cycle of the Stirling Engine with Particular Reference to the Function of the Regenerator," J. Mech. Engng. Sci., Vol. 3, No. 4, pp. 394-408, 1961. *
- 1961 l Walker, G., "Some Aspects of the Design of Reversed Stirling-Cycle Machines," Ph.D. Thesis, Durham University, 1961.

- 1961 m Yagi, S.; Kunii, D.; and Wakao, N., "Radially Effective Thermal Conductivities in Packed Beds". Int. Heat-Trans. Conf., (ASME) Boulder, Colorado, pp. 742-749, 1961 *
- 1961 n Gorring, Robert L., Churchill, Stuart W., "Thermal Conductivity of Heterogeneous Materials". Chemical Engineering Progress, Vol. 57, No. 7, July 1961. *
- 1961 o Walker, G., "Machining Internal Fins in Components for Heat Exchangers". Machinery, London, Vol. 101, No. 2590.
- 1961 p Ferguson, E. S. "John Ericsson and the Age of Caloric". Contributions from the Museum of History and Technology Paper 20, pp. 41-60, Reprinted by Alan G. Phillips, P. O. Box 20511, Orlando, FL 32814. *
- 1961 q Eigling, J. A. "A Novel Engine Operating on Internally Focused Sunlight". U.N. Conf. on New Sources of Energy. 1961.
- 1961 r Finkelstein, T. "Internally Focusing Solar Power Systems". ASME. Annual Meeting, Paper 61-WA-297, 1961.
- 1961 s Tabor, H. "Use of Solar Energy for Mechanical Power and Electricity Production by Means of Piston Engines and Turbines". U.N. Conf. on New Sources of Energy. E35GR59, 1961.
- 1961 t Finkelstein, T. "Cyclic Processes in Closed Regenerative Gas Machines". Am. Soc. of Mech. Eng. Annual Meeting, Paper 61-SA-21, 1961.

ORIGINAL PAGE IS
OF POOR QUALITY

- 1962 a Finkelstein, T., "Cyclic Processes in Closed Regenerative Gas Machines Analyzed by a Digitag Computer, Simulating a Differential Analyzer," Trans. Am. Soc. Mech. Engr., Vol. 884, No. 1, February 1962. —
- 1962 b Fleming, R.B., "An Application of Thermal Regenerators to the Production of Very Low Temperatures," Sc.D. Thesis, M.I.T., 1962.
- 1962 c Glassford, A.P.M., "An Oil-Free Compressor, Based on the Stirling Cycle," M.Sc. Thesis, M.I.T., 1962. *
- 1962 d Vacant
- 1962 e Kirkley, D.W., "Determination of the Optimum Configuration for a Stirling Engine," J.Mech. Engng. Sci., Vol. 4, No. 3, pp. 204-212, 1962. *
- 1962 f Walker, G., "An Optimization of the Principal Design Parameters of Stirling-Cycle Machines," J. Mech. Engng. Sci., Vol. 4, No. 3, 1962. * —
- 1962 g Harold, R.J., and Johnston, R.D., "Power Plant Heat Storage Arrangement," United States Patent 3,029,596, April 17, 1962. *
- 1962 h Khan, M.I., "The Application of Computer Techniques to the General Analysis of the Stirling Cycle," Thesis, Durham University, 1962.
- 1962 i Monson, D.S., and Welsh, H.W., "Allison Adapting Stirling Engine to One-Year-In-Space Operation," SAE Journal No. 70, pp 44-51, 1962.
- 1962 j Vonk, G., "Regenerators for Stirling Machines," Philips Technical Review, Vol. 24, p. 406, 1962. *
- 1962 k Van Witteveen, R.A.J.O., "Experiments on High Power Hot Gas Engines," Philips Technical Review, Vol. 24, p. 409, 1962. *
- 1962 l Finkelstein, T., "Regenerative Thermal Machines," Int. Science and Tech., pp. 54-59 and 84, May, 1962. *
- 1962 m Creswick, F.A., and Mitchell, R.K., "Design and Construction of a Stirling-Cycle Engine to Drive a Gas-Furnace Circulating Blower," Battelle Research Report, December 28, 1962. *
- 1962 n Parker, M.D. and Malik, M.J., "Investigation of a 3kw Stirling Cycle Solar Power System -- Volumes I through X," General Motors Corp., Allison Div., No. 1767, WADD-TR-61-122, published 1962 and 1963.
- 1962 o "Potential Capabilities of the Stirling Engine for Space Power," Aeronautical Systems Division, Wright-Patterson AFB, Ohio, ASD-TDR-62-1099, 1962.
- 1962 p Walker, G., "Regeneration in Stirling Engines," Engineer, Vol 216, No. 5631, pp. 1097-1103, December, 1962. *

- 1963 a Finkelstein, T., "Analogue Simulation of Stirling Engines," Simulation, No. 2, March, 1963.
- 1963 b Gamson, B.W., Thodos, G., and Hougen, O.A., "Heat, Mass and Momentum Transfer in the Flow of Gases Through Granular Solids," Trans. Am. Inst. Chem. Engrs., Vol. 39, pp. 1-35, 1963.
- 1963 c Hogan, W.H., and Stuart, R.W., "Design Considerations for Cryogenic Refrigerators," ASME Paper No. 63-WA-292, 1963.
- 1963 d Howard, C.P., "Heat-Transfer and Flow-Friction Characteristics of Skewed-Passage and Glass-Ceramic Heat-Transfer Surfaces," ASME Paper No. 63-WA-115, 1963.
- 1963 e Prast, G., "A Philips Gas Refrigerating Machine for 20K," Cryogenics, pp. 156-160, September, 1963. *
- 1963 f Vacant
- 1963 g Walker, G., "Density and Frequency Effects on the Pressure Drop Across the Regenerator of a Stirling-Cycle Machine," Engineer, Vol. 216, No. 1063, December, 1963. *
- 1963 h Malaker, S.F., and Daunt, J.G., "Miniature Cryogenic Engine," United States Patent 2,074,244, January 22, 1963. *
- 1963 i Heffner, F.E., "Stirling Engine Ground Power Unit," General Motors Corp., Research Laboratories, 1963.
- 1963 j "Potential Capabilities of the Stirling Engine for Space Power," Aeronautical Systems Division, Air Force Systems Command, Technical Documentary Report No. ASK-TDR-62-1099, January, 1963.
- 1963 k Underwood, A., and Tsou, M.T., "Les Possibilitees du Motor Stirling," Ingenieurs de l'Automobile, Vol. 36, No. 12, pp. 655-664, 1963.
- 1963 l Weinhold, J., "Der Philips-Heissluftmotor," Motortechnische Zeitschrift, Vol. 24, No. 12, pp. 447-453, 1963.
- 1963 m "Mobility Engineers Test Stirling Cycle Engines," Automotive Industries, Vol. 129, No. 3, pp. 35-37, 1963.
- 1963 n Wolgemuth, C.H., "The Use of a Chemically Reactive Gas in a Closed Stirling Cycle," Ph.D. Thesis, Ohio St. University, 1963.
- 1963 o Kirkley, D.W., "An Investigation of the Losses Occuring in Reciprocating Hot Air Engines," Durham University, Ph.D. Thesis. *

- 1963 p Daunt, J.G., Rossi, R.A., Jakobsson, E.G., and Malaker, S.F., "Investigation of Gas Liquefiers for Space Operation," Malaker Labs Inc., Report - October, 1962-May, 1963. Contract AF 33-657-10133. Project 8169.
- 1963 q Gifford, W. E.; and Longworth, R. C. "Pulse-Tube Refrigeration". ASME Paper No. 63-WA-290, 1963.
- 1963 r Baas, H. B., and Veldhuijzen, E. J. J., "Hot-Gas Reciprocating Machine and System Composed of a Plurality of these Machines", United States Patent 3,074,229, January 22, 1963.*
- 1963 s Hogan, W. H., "Method and Apparatus for Employing Fluids in a Closed Cycle", United States Patent 3,115,014, December 24, 1963. *
- 1963 t Meijer, R. J. "Der Philips-Stirling Motor". Schweizerische Tech. Zeitschrift. 60, Nr 29 S. 561-578.
- 1963 u Jordan, R. C. "Conversion of Solar to Mechanical Energy". Introduction to the Utilization of Solar Energy. ed. A. M. Zarem and C. C. Erway, McGraw-Hill, New York, 125-52. 1963.

- 1964 a Bahnke, G.D., and Howard, C.P., "The Effect of Longitudinal Heat Conduction on Periodic-Flow Heat-Exchanger Performance," Journal of Engineering for Power, Vol. A86, pp. 105-120, 1964. *
- 1964 b Finkelstein, T., "Analysis of Practical Reversible Thermodynamic Cycles," Jt. AIChE and ASME Heat Trans. Conf., Paper No. 64-HT-37, Cleveland, Ohio, 1964. *
- 1964 c Finkelstein, T., "Specific Performance of Stirling Engines," The Journal of Applied Thermal Processes, presented at 3rd Conf. of Performance of High Temp. Systems, Pasadena, CA, 7-9 December 1964. *
- 1964 d Gifford, W.E., and Longworth, R.C., "Pulse-Tube Refrigeration Progress," Advances in Cryogenic Engng., Vol. 10, Section M-U, pp. 69-79, 1964. *
- 1964 e Howard, C.P., "The Single-Blow Problem Including the Effects of Longitudinal Conduction," ASME Paper No. 64-GIP-11, 1964. *
- 1964 f Hogan, W.H., "Closed-Cycle Cryogenic Refrigerator and Apparatus Embodying Same," United States Patent 3,151,466, October 6, 1964. *
- 1964 g Mondt, J.R., "Vehicular Gas Turbine Periodic-Flow Heat Exchanger Solid and Fluid Temperature Distributions," Journal of Engr. for Power, Trans. of ASME, Vol 86, Series A, pp. 121-126, April 1964. *
- 1964 h Eluklin, N.K., and Strarosvitskill, S.I., "Heat Exchange and Hydraulic Resistance in Dumped Packings of Regenerators," Int. Chemical Engng., Vol. 4, No. 1, pp. 114-118, January 1964. *
- 1964 i Prast, G., "A Modified Philips-Stirling Cycle for Very Low Temperatures," Int. Advances in Cryogenic Engng., Vol. 10, pp. 40-45, 1964.
- 1964 j "Feasibility of Isotopic Power for Manned Lunar Missions," Martin Marietta Corp., Volume 6, Stirling Cycle System, AT(30-1)-3296, May, 1964.
- 1964 k Arend, P.C., Chelton, D.G., and Mann, D.B., "Satellite Refrigeration Study," National Bureau of Standards, Part II - Technical Analysis No. NBS-8444, Sept. 1964.
- 1964 l Kays, W.M., and London, A.L., "Compact Heat Exchangers," McGraw-Hill, 1964. E7, E8, E9, E10, E11. *
- 1964 m Hazard, H.R., "Multifuel Thermal Energy Converters," Proc. 18th Ann. Power Sources Conf., Fort Monmouth, May 19-21, 1964.
- 1964 n Farber, E. A. and Prescott, F. L. "Quater-Horsepower Closed Cycle Solar Hot-Air Engine". ASME. Paper 64-WA/SOL-5. 1964.

- 1965 a Creswick, F.A., "Thermal Design of Stirling-Cycle Machines," SAE Paper No. 949C, 1965. *
- 1965 b Dros, A.A., "An Industrial Gas Refrigerating Machine with Hydraulic Piston Drive," Philips Technical Review, Vol. 26, pp. 297-308, 1965.*
- 1965 c Finkelstein, T., "Simulation of a Regenerative Reciprocating Machine on an Analog Computer," SAE Paper No. 949F, 1965. *
- 1965 d Gifford, W.E., and Longworth, R.C., "Surface Heat Pumping," Cryogenic Engineering Conference, Rice University, Houston, Texas, 1965.
- 1965 e Kirkley, D.W., "A Thermodynamic Analysis of the Stirling Cycle and a Comparison with Experiment," SAE Paper No. 949B, Int. Auto. Engng. Congress, Detroit, Michigan, 1965. * (Also Paper 650078)
- 1965 f Köhler, J.W.L., "The Stirling Refrigeration Cycle," Scientific Amer., Vol. 212, No. 4, pp. 119-127, 1965. *
- 1965 g Meijer, R.J., "Philips Stirling Engine Activities," SAE Paper No. 949E, Int. Auto, Engng. Congress, Detroit, Michigan, 1965. *
- 1965 h Rietdijk, J.A., Van Beukering, H.C.J., Van Der Aa, H.H.M., and Jeijer, R.J., "A Positive Rod or Piston Seal for Large Pressure Differences," Philips Tech. Rev. Vol. 26, No. 10, pp. 287-296, 1965.*
- 1965 i Walker, G., and Khan, M., "The Theoretical Performance of Stirling-Cycle Machines," SAE Paper No. 949A, Int. Auto. Engng. Congress, Detroit, Michigan, 1965. *
- 1965 j Walker, G., "Some Aspects of the Design of Reversed Stirling-Cycle Machines," ASHRAE Paper No. 231, Summer Meeting, Portland, 1965. *
- 1965 k Hanson, K.L., "Thermal Integration of Electrical Power and Life Support Systems for Manned Space Stations," General Electric Co., No. NASA-CR-316, Nov. 1965.
- 1965 l "Stirling Machine Developments," The Engineer, pp. 906-912, November 26, 1965. *
- 1965 m Dineen, J.J., "Heat Engine," United States Patent 3,220,178, November 30, 1965. *
- 1965 n Higa, W.A., "A Practical Philips Cycle for Low-Temperature Refrigeration," No. NASA-TR-32-712, 1965.
- 1965 o Farber, E., and P. Scott, F.L., "Closed-Cycle Solar Hot-Air Engines," "Part 1 - A 1/4 hp Engine," "Part 2-A 1/3 hp, Pressurized Engine," Solar Energy Vol. 9, No. 4, pp. 170-176, October-December 1965. *
- 1965 p Weissler, P., "GM's Amazing New 2-Piston Engine," Science and Mechanics, pp. 76-79, 104-105, March, 1965.

- 1965 q Zanzig, J., "Stirling Cycle Engine," SAE Paper No. 733B, 1965.
- 1965 r Barker, J.J., "Heat Transfer in Packed Bed," Industrial and Engineering Chemistry, Vol. 57, No. 4, pp. 43-51, April, 1965. *
- 1965 s Bayley, F.J., and Rapley, C., "Heat Transfer and Pressure Loss Characteristics of Matrices for Regenerative Heat Exchangers," ASME Paper No. 65-HT-35, August, 1965. E7. *
- 1965 t Heffner, F.E., "Highlights from 6500 Hours of Stirling Engine Operation," SAE Paper No. 949D, and GMR Publication No. GMR-456, 1965. *
- 1965 u Trayser, D.A., Bloemer, J.W., Thorson, J.R., and Eibling, J.A., "Feasibility of a 50-watt Portable Generator Using a Solar Powered Stirling-Cycle Engine," RACIC Report, Battelle, Jan. 12, 1965. *
- 1965 v Du Pre, F., and Daniels, A., "Miniature Refreigerator Opens New Possibilities for Cryo-Electronics," North Amer. Philips Co., reprinted from Signal Magazine, September, 1965. *
- 1965 w Nobrega, A.C., "A Harmonic Analysis of Stirling Engines," Thesis, M.I.T., 1965.
- 1965 x Prast, G., "A Gas Refrigerating Machine for Temperatures Down to 20°k and Lower," Philips Tech. Rev., Vol. 26, No. 1, pp. 1-11, January 1, 1965. *
- 1965 y Breazeale, W.L., "Apollo Extension System Studies. State of the Art of Radioisotope Power Systems for Lunar Surface Vehicles," Northrop Space Labs, No. NASA-CR-61055, May 1965.
- 1965 z Walker, G., "Reversed Stirling Cycle Refrigerating Machines -- Some Aspects of Design," Presented at ASHRAE, Portland, Oregon, July, 1965.
- 1965 aa Arthur, J., "Whispering Engine," Pop. Mech., pages 118-120, 210, January 1965.
- 1965 ab Walker, G., "Regenerative Thermal Machine - A Status Survey," Proc. 27th Am. Power Conf., pp. 530, Chicago, Ill.
- 1965 ac Walton, H., "Amazing No-Fuel "Space" Engine You Can Build," Pop. Sci., Vol. 176, pp. 106-110, July.
- 1965 ad Burstall, A. J. A History of Mechanical Engineering. MIT Press, Cambridge, Mass. pp. 274-7, 350-1, 437-8.
- 1965 ae Walton, H. "New Engine for Space Does Down-to-Earth Jobs". Pop. Sci. 196 (Jul.): 100-5, 174-5. 1965.

- 1966 a "Analytical Report on Six Studies Basic to Consideration of the Artificial Heart Program," Hittman Associates, Vol. I to III, PB 173050 to PB 173052, 1966. *
- 1966 b Romie, F.E., and Ambrosio, A., "Heat Transfer to Fluids Flowing with Velocity Pulsations in a Pipe," Heat Transfer, Thermodynamics and Education, pp. 273-294, McGraw-Hill, 1967.
- 1966 c Trayser, D.A., and Eibling, J.A., "A 50-watt Portable Generator Employing a Solar-Powered Stirling Engine," 1966 IECEC Record, Paper 669019, pp. 238-244, 1966. *
- 1966 d van Nederveen, H.B., "The Nuclear Stirling Engine," First Inter. Conf. on the use of Radioisotopes, Paper 35, 1966. *
- 1966 e Horton, J.H., "Military Engines for Ground Power," Automotive Industries, pp. 65-67, May 1, 1966. *
- 1966 f Van Witteveen, R.A.J.O., "The Stirling Engine, Present and Future," UKAEA/ENEA Symp. on Industrial Appl. for Isotopic Power Generators, Howell, England, September, 1966.
- 1966 g Meijer, R.J., "Philips Stirling Engine Activities," SAE Transactions, Paper 74, pp. 18-32, 1966.
- 1966 h Rea, S.N., "A Study of Thermal Regenerators Subjected to Rapid Pressure and Flow Cyclings," Ph.D. Thesis, M.I.T., February 1966. *
- 1966 i Longsworth, R.C., "An Analytical and Experimental Investigation of Pulse Tube Refrigeration," Ph.D. Thesis, Syracuse University, June, 1966.
- 1966 j Jakeman, R.W., "The Construction and Testing of the Stirling Universal Research Engine," Thesis, Durham University, 1966.
- 1966 k Dros, A.A., "Large-Capacity Industrial Stirling Machine," Inter. Advances in Cryogenic Engng., Vol. 10, 1966.
- 1966 l Daniels, A., and Du Pre, F.K., "Closed Cycle Cryogenic Refrigerators as Integrated Cold Sources for Infrared Detectors," Philips Co., Reprint from Applied Optics, Vol. 5, No. 9, pp. 1457-1460, Sept. 1966*
- 1966 m Ricardo, H. Sir, "Stirling Cycle Hot Air Engine," Engineer, Vol. 221, No. 5750, April 8, 1966. *
- 1966 n "Industrial Applications for Isotopic Power Generators," European Nuclear Energy Agency, September, 1966.
- 1966 o Morgenroth, H., "Stirling Cycle Engine Divided into a Pressure Generating Unit and Energy Converting Unit," United States Patent 3,248,870, May 3, 1966. *

- 1966 p Koenig, K., "An Investigation into a Means of Approaching Isothermal Processes Applicable to Stirling Cycle Machines," Mass. Inst. of Tech., M.Sc. Thesis, January 1966. *
- 1966 q "General Motors Looks to Future," Engineering, (London), Nov. 1966.

- 1967 a De Socio, L., and Pallabazzer, R., "Thermodynamical Analysis of Stirling Cycle Power Plants," Convegno Internazionale Delle Comunicazioni, 15th, Genoa, Italy, Oct. 12-15, 1967.
- 1967 b Trayser, D.A., and Eibling, J.A., "A 50-watt Portable Generator Employing a Solar Powered Stirling Engine," Solar Power, Vol. 11, No. 3 and 4, pp. 153-159, 1967. *
- 1967 c Finkelstein, T., "Thermophysics of Regenerative Energy Conversion," AIAA Paper No. 67-216, 1967. *
- 1967 d Finkelstein, T., "Thermodynamic Analysis of Stirling Engines," Journal of Spacecraft & Rockets, Vol. 4, No. 9, pp. 1184-1189. *
- 1967 e Lucek, R., Damsz, G., and Daniels, A., "Adaption of Rolling-Type Seal Diaphragms to Miniature Stirling-Cycle Refrigerators," Air Force Flight Development Laboratory Report No. AFFDL-TR-67-96, 1967.
- 1967 f Walker, G., "Stirling-Cycle Engines for Total-Energy Systems," Inst. Gas. Tech., August, 1967. *
- 1967 g van Beukering, H.C.J., and Van Der Aa, H.H.M., "A Rolling Diaphragm Seal for High Pressures and High Speeds," 3rd Inter. Conf. on Fluid Sealing, Paper G4, Cambridge, England, April, 1967.
- 1967 h Kovton, I.M., Naumov, A.M., and Nesterenko, V.B., "Stirling Cycle in Dissociating Gas," Int. Chem. Engng., Vol. 7, No. 4, pp. 608-610, October, 1967. *
- 1967 i Cooke-Yarborough, E.H., "A Proposal for a Heat-Powered Non-Rotating Electrical Alternator," AERE Report No. AERE - M 1881, 1967. *
- 1967 j Neelen, G.T.M., "De Philips-Stirling Motor," Van Klassiek Idee-Tot Modern Krachtbron, Ship en werf Vol. 17, 1967.
- 1967 k Tabor, H.Z., "Power for Remote Areas," Inter. Science and Tech., pp. 52-59, May, 1967. *
- 1967 l Rea, S.N., Smith, J.L. Jr., "The Influence of Pressure Cycling on Thermal Regenerators," Jour. of Engineering for Industry, Trans. of ASME, Vol. 89, No. 3, Series B., pp. 563-569, August 1967. *
- 1967 m Kohlmayer, G.F., "Extension of the Maximum Slope Method for Arbitrary Upstream Fluid Temperature Changes," ASME Paper No. 67-HT-79, Aug. 1967*
- 1967 n Qvale, E.B., "An Analytical Model of Stirling-Type Engines," M.I.T., Ph.D. Thesis, January, 1967.
- 1967 o Leybold-Heraeus, "Catalog information on model Stirling engines," West Germany. Personal Correspondence. *

- 1967 p Adams, W.E., Kerley, R.V., "The Next Decade for Piston Engines." SAE Paper 670685.
- 1967 q Kirkland, T.G., Hopkins, R.E., "U.S. Army Research in Electrical Propulsion," SAE Paper 670454.
- 1967 r Vernet-Lozet, M. "Thermodynamics of Piston Engines for Space Applications," Gordon and Breach, Science Publishers, Inc., New York.
- 1967 s "Small Scale Power Generation". 1967. United Nations, Dept. of Econ. and Soc. Affairs. 67.11.B.7.

- 1968 a Chironis, N.P., "Smogless Stirling Engine Promises New Versatility," Prod. Engr., Vol. 39, No. 5, pp. 30-33, Feb. 26, 1968. *
- 1968 b Patterson, D.J., and Bolt, J.A., "Low Pollution Heat Engines," 1968 IECEC Record, pp. 779-784, 1968. *
- 1968 c Martini, W.R., Johnston, R.P., Goranson, R.B., and White, M.A., Development of a Simplified Stirling Engine to Power Circulatory Assist Devices," 1968 IECEC Record 689102, pp. 833-749, 1968. *
- 1968 d Volger, J., "Superconductivity," Philips Technical Review, Vol. 29, No. 1, pp. 1-16, 1968. *
- 1968 e Buck, K.E., Forrest, D.L., and Tamai, H.W., "A Radioisotope-Powered Stirling Engine for Circulatory Support," 1968 IECEC Record, No. 689101, pp. 723-732, 1968. *
- 1968 f Reed, B., "Hot-Gas Engines," Gas and Oil Power, Vol. 64, No. 739, pp. 8-11, January, 1968. *
- 1968 g Rios, P.A., and Smith, J.L., Jr., "The Effect of Variable Specific Heat of the Matrix on the Performance of Thermal Regenerators," Advances in Cryogenic Engng., Vol. 13, pg. 566, Plenum Press, New York, 1968. *
- 1968 h Buck, K.E., "Conceptual Design of an Implantable Radioisotope Power Source for Circulatory Support Systems," Aerojet General Corp., Final Tech. Rept., No. AGN-8258, January 26, 1968.
- 1968 i Malik, M.J., "Stirling Cycle Drive for an Electrokinetic Transducer," United States Patent 3,400,281, September 3, 1968. *
- 1968 j Buck, K.E., "Experimental Efforts in Stirling Engine Development," ASME Paper No. 68-WA/Ener-3, 1968. *
- 1968 k Kolin, I., "The Stirling Cycle with Nuclear Fuel," Nuclear Engng., pp. 1027-1034, December, 1968. *
- 1968 l Martini, W.R., "A Stirling Engine Module to Power Circulatory-Assist Devices," ASME Paper No. 68-WA/Ener-2, 1968. *
- 1968 m Qvale, E.B., and Smith, J.L. Jr., "A Mathematical Model for Steady Operation of Stirling-Type Engines," Journal of Engng. Pwr., No. 1, pp. 45-50, January, 1968.*
- 1968 n Walker, G., "Military Applications of Stirling-Cycle Machines," 1968 IECEC Record No. 689135, pp. 1008-1016, 1968. *

- 1968 o Cheaney, E.S., Creswick, F.A., Fisher, R.D., Hoess, J.A., and Trayser, D.A., "Study of Unconventional Thermal, Mechanical, and Nuclear Low-Pollution-Potential Power Sources for Urban Vehicles" Summary Report to National Air Pollution Control Administration under Contract No. PH-86-67-109, March 15, 1968.
- 1968 p Lienesch, J.H., and Wade, W.R., "Stirling Engine Progress Report - Smoke, Odor, Noise and Exhaust Emissions," SAE Paper No. 680081, January 8-12, 1968. *
- 1968 q Meijer, R.J., "Der Philips-Stirlingmotor," Motortechnische Zeitschrift, Vol. 29, No. 7, pp. 284-298, 1968.
- 1968 r Rios, P.A., Qvale, E.B., and Smith, J.L. Jr., "An Analysis of the Stirling Cycle Refrigerator," Cryogenic Eng. Conf., Paper J1, pp. 332-342, 1968. *
- 1968 s Goranson, R.B., "Application of the Radioisotope-Fueled Stirling Engine to Circulatory Support Systems," MDAC Final Report, No. DAC-60742, June, 1968.
- 1968 t Vedin, B.A., "Stirlingmotorn," Ny Teknik, Vol. 2, No. 34, pp. 16-17, 20, 1968.
- 1968 u Martini, W.R., "Design and Development of the Stirling Cycle Energy Converter to Power Circulatory Support Systems," MDAC Annual Report, No. DAC-60763, July, 1968. *
- 1968 v "The General Motors Stirling Engine: Applications from Under the Sea to Outer Space," GMR Laboratories, December 2, 1968. *
- 1968 w Cowans, K.W., "Heat Powered Engine," United States Patent 3,379,026, April 23, 1968. *
- 1968 x Magee, F.N., and Doering, R.D., "Vuilleumier Cycle Cryogenic Refrigerator Development," Air Force Flight Dynamics Lab., Report No. AFFDL-TR-68-67, August, 1968. *
- 1968 y Leach, C.E., and Fryer, B.C., "Radioisotope Energized Undersea Stirling Engine," 1968 IECEC Record No. 689115, pp. 830-844, 1968. *
- 1968 z "Low Emission, Quiet Engines Highlight Advanced Powerplant Sessions at 1969 Annual Meeting," SAE Journal, pp. 81-82, October, 1968.
- 1968 aa "GM Stir-Lec I -- A Stirling Engine - Electric Hybrid Car," GMR Laboratories, November, 1968. *
- 1968 ab "Stirling Engine- Isotope Power Source," Isotopic Heat and Power Development, Isotopes and Radiation Tech., Vol. 6, No. 1, Fall, 1968.*

ORIGINAL
OF 1000 COPIES

- 1968 ac Kohler, J.W.L., "Computation of the Temperature Field of Regenerators with Temperature-Dependent Parameters," Brighton Cryogenics Conf. *
- 1968 ad Walker, G., "Dynamical Effects of the Rhombic Drive for Miniature Cooling Engines," Advances in Cryogenic Engng., Vol. 14, or Proc. of Cryogenic Engng. Conf., Paper J-5, pp. 370-377, August 19-21, 1968. *
- 1968 ae Dunne, J., "Test Driving GM's Hybrid Electric Car--A Stirling Engine and An Electric Motor Working Together--A Promising Idea on the Way to a Smog Free Car," Pop. Sci., pp. 116-119, December, 1968.
- 1968 af Ford, D.R., Green, C.F., "Performance and Part Load Testing of a Philips Air Cycle Engine," Project Rept. No. 125, Sch. Eng., Univ. of Bath, U.K.
- 1968 ag Starr, M.D., Hagey, G.L., "Navy Two-to-Ten KW(e) Radioisotope Power System for Undersea Applications," 1968 IECEC Record, pp. 805-810. *
- 1968 ah Wolgemuth, C.H., "The Equilibrium Performance of the Theoretical Stirling Cycle with a Chemically Reactive Gas as the Working Fluid," Ph.D. Thesis, Ohio St. University.

- 1969 a Martini, W.R., Johnston, R.P., and Noble, J.E., "Mechanical Engineering Problems in Energetics- Stirling Engines," ASME Paper No. 69-WA/Ener-15, or MDAC Paper WD 1109, 1970. *
- 1969 b Wolgemuth, C.H., "The Equilibrium Performance of the Theoretical Stirling Cycle with Chemically Reactive Gas as the Working Fluid," The Performance of High Temperature Systems, Vol. 2, Paper 20, pp. 371-387, 1969. *
- 1969 c Leeth, G.G., "Energy Conversion Devices for Ground Transportation," 1969 IECEC Record 699115, pp. 933-939, 1969. *
- 1969 d Hoess, J.A., and Stahman, R.C., "Unconventional Thermal Mechanical and Nuclear Low-Pollution-Potential Power Sources for Urban Vehicles," SAE Paper 690231, also SAE Transactions, Vol. 78. *
- 1969 e Meijer, R.J., "The Philips Stirling Engine," De Ingenieur, Jrg. 81, Nr. 18, May 2, 1969, pp. W69-W79, and Jrg. 81, nr 18, May 9, 1969, pp. W81-W93. *
- 1969 f Mattavi, J.N., Heffner, F.E., and Miklos, A.A., "The Stirling Engine for Underwater Vehicle Applications," SAE Paper No. 690731 or General Motors Research Publ. No. GMR-936, 1969. *
- 1969 g "Metal-Combustion Energy Drives Stirling Engines Under the Sea," Product Engineering, pp. 104-105, Dec. 15, 1969.*
- 1969 h Beale, W.T., "Free Piston Stirling Engines - Some Model Tests and Simulations," SAE Paper No. 690230, January 13-17, 1969. *
- 1969 i Buck, K.E., "An Implantable Artificial Heart," Mechanical Engng., pp. 20-25, Sept. 1969. *
- 1969 j Agarwal, P.D., Mooney, R.J., and Toepel, R.P., "Stirlec I, A Stirling Electric Hybrid Car," SAE Paper No. 690074, 1969. *
- 1969 k Lienesch, J.H., and Wade, W.R., "Stirling Engine Operating Quietly with Almost No Smoke and Odor, and with Little Exhaust Emissions," SAE Journal, pp. 40-44, January, 1969. *
- 1969 l Magee, P.R., and Datring R., "Vuilleumier-Cycle Cryogenic Refrigerator Development," Technical Report, Air Force Flight Dynamics Lab., No. TR 68-69, 1969.
- 1969 m Meijer, R.J., "Rebirth of the Stirling Engine," Science Journal, No. 2, pp. 31-39, August, 1969. *
- 1969 n Qvale, E.B., and Smith, J.L., Jr., "An Approximate Solution for the Thermal Performance of a Stirling Engine Regenerator," J. Engng. Power, pp. 109-112, April, 1969. *

- 1969 o Rios, P.A., and Smith, J.L., Jr. "An Analytical and Experimental Evaluation of the Pressure-Drop Losses in the Stirling Cycle," ASME Paper No. 69-WA/Ener-8, 1969. (same as 1970 z) *
- 1969 p Vashista, V., "Heat-Transfer and Flow-Friction Characteristics of Compact Matrix Surfaces for Stirling-Cycle Regenerators," M.Sc. Thesis, University of Calgary, 1969.
- 1969 q Walker, G., "Dynamical Aspects of the Rhombic Drive for Small Cooling Engines," Advances in Cryogenic Engineering, Vol. 14, pp. 370-377, 1969. *
- 1969 r ver Beek, H.J., "A Two-Stage Compressor with Rolling Diaphragm Seals," Philips Technical Review, Vol. 30, No. 2, pp. 51-54, 1969. *
- 1969 s Farber, E.A., "Supercharged and Water Injected Stirling Engine," ASME Paper No. 69-WA/Sol-3, 1969. * -- also in Eng. Prog. at the Univ. of Florida Vol. 24 no. 2, Jan. 1970.
- 1969 t Meijer, R.J., "Mit Elektro-Warme Speicher und Stirlingmotor - Eine Mechanische Antrieb-Alternative," Denkschrift, Teil 11/1969, pp. 143-164. Elektrofahrzeuge, Deutsche Forschungsgemeinschaft, 1969.
- 1969 u Meijer, R.J., "Philips Stirling-Motor-Varmgasmotor med Utvecklingsmøjligheter," Teknisk Tidsskrift, Vol. 99, No. 17, pp. 373-378, 1969.
- 1969 v "The New Stirling Engine 'Search'," General Motors Research Laboratories, 1969. *
- 1969 w "Stirling Engines Vie for Underwater-Vehicle Jobs," Product Engng., Vol. 40, No. 24, December, 1969. *
- 1969 x Martini, W.R., Johnson, R.P., and Noble, J.E., "The Thermocompressor and its Application to Artificial Heart Power," MDAC Paper 10.177, September, 1969. *
- 1969 y "Stirling Engine - A New Lease on Life," Mechanical Engng, p. 52, July, 1969. *
- 1969 z Meijer, R.J., "Combination of Electric Heat Battery and Stirling Engine - An Alternative Source of Mechanical Power," Denkschrift Elektrospeicherfahrzeuge, Vol. 11, 1969. *
- 1969 aa "ICICLE Feasibility Study," Advanced Technology Lab., Final Report, 1969. *
- 1969 ab "Stratos-Dined Stirling Cycle Engine (5 to 50 hp Range)," U.S. Government Interagency Advanced Power Group Project Brief, PIC No. 1762, May 1969. *

- 1969 ac Martini, W.R., "Development of an Implantable Artificial Heart Power Source Employing a Thermocompressor," 1969 IECEC Record pp. 107-114, Paper 699015 (same content as 1969 x). *
- 1969 ad "GMR Stirling Engine Generator Set," sales handout from GM Research, Warren, Michigan, 1969. *
- 1969 ae "GMR Stirling Engine Generator Set," sales handout from GM Research, Warren, Michigan, 1969. *
- 1969 af Buck, K.E., "Development of a Stirling Cycle Power System for Artificial Hearts," 1969 IECEC Record, Paper 699016, pp. 115-121, Sept. 1969.
- 1969 ag Wolgemuth, C.H., "Dynamic Performance of a Thermodynamic Cycle Using a Chemically Reactive Gas," 1969 IECEC Record, No. 699073, pp. 599-605, Sept. 1969. *
- 1969 ah Sadvskii, M.R., Maikov, V.P., and Elukhin, N.K., "Investigation of the Heat Transfer and Hydraulic Resistance of Gauze Packing," Int. Chem. Eng., Vol. 9, No. 4, pp. 592-595, Oct. 1969. *
- 1969 ai Meulenbergh, R.E., and Abell, T.W.D., "Marine Applications of Stirling Cycle Refrigerators," Inst. of Mar. Engrs.-Trans., Vol. 81, No. 7, pp. 225-248, July, 1969.
- 1969 aj Magladry, R., and Zindler, G.F., "Conceptual Design Studies of Two TURPS Using Stirling and Direct Energy Conversion Cycles," Isotopes, Inc., Tech. Rept., No. AFWL-TR-68-73, June 68-March 69.
- 1969 ak Buck, K.E., O'Keefe, R.J., Carney, H.C., and Tamai, H.W., "Development and 'In Vivo' Testing of an Implantable Stirling Cycle Heart Engine," Aerojet-General Corp., No. AN-1732, March-November, 1969.
- 1969 al Martini, W.R., "Implanted Energy Conversion System," MDAC Annual Report, No. MDC G2025, June 29, 1968 - June 28, 1969. *
- 1969 am Rios, P.A., "An Analytical and Experimental Investigation of the Stirling Cycle," Ph.D. Thesis, M.I.T., 1969. *
- 1969 an Rios, P.A., Smith, J.L., Jr., and Qvale, E.G., Advances in Cryogenic Engineering, Vol. 14, pg. 332, Plenum Press, New York, 1969.
- 1969 ao "Quiet Engine - Stirling Cycle, Vapour Cycle," General Motors Research Laboratories, May, 1969. *
- 1969 ap "Energy Storage Systems Complement the Stirling Engine," General Motors Research Laboratories, May, 1969. *
- 1969 aq Bush, Vannevar, "Hot Gas Engines Method and Apparatus," United States Patent 3,457,722, July 29, 1969. *

- 1970 a Underwood, A.F., "Requiem for the Piston Engine?" Machine Design, pp. 20-34, August 6, 1970. *
- 1970 b Fraize, W.E., and Lay, R.K., "A Survey of Propulsion Systems for Low-Emission Urban Vehicles," ASME Paper 70-Tran-49, 1970.*
- 1970 c "Dutch on the Road to a Pollution-Free Engine," Business Week, pp. 52-53, January 10, 1970. *
- 1970 d Meijer, R.J., "Prospects of the Stirling Engine for Vehicular Propulsion," Philips Tech. Review, Vol. 31, No. 5/6, pp. 168-185, 1970.*
- 1970 e Cooke-Yarborough, E.H., "Heat Engines," United States Patent 3,548,589, Dec. 22, 1970. *
- 1970 f Finkelstein, T., "Thermocompressors, Vuilleumier and Solvay Machines," 1970 IECEC Record 709025, p. 2-20 to 2-27, 1970. *
- 1970 g Finkelstein, T., Walker, G., and Joshi, T., "Design Optimization of Stirling-Cycle Cryogenic Cooling Engines, by Digital Simulation," Cryogenic Engineering Conf., Paper K4, June, 1970. *
- 1970 h Pitcher, G.K., and Du Pre, F.K., "Miniature Vuilleumier-Cycle Refrigerator," Proc. Cryogenic Engineering Conf., June, 1970.*
- 1970 i Kuhlmann, P., and Zapf, H., "Der Stirlingmotor eine neue Kraftmaschine Sonderdruck aus der MAN-Informationsschrift," Tooschen, Planen Bauen, 1970., 7 pp.
- 1970 j Meijer, R.J., "The Philips Stirling Engine as a Propulsion Engine," IECEC Record 709196, p. 16-8 to 16-17, 1970. *
- 1970 k Organ, A.J., "Stirling Engine Power and Transmission," Journal of Automotive Engineering, Vol. 1, No. 5, pp. 9-16, 1970.*
- 1970 l Kuhlman, P., and Zapf, H., "The Stirling Engine - A New Prime Mover," MAN Research Engng. Manuf., Sept., 1970, pp. 56-60.
- 1970 m Kim, J.C., "An Analytical and Experimental Study of Heat Transfer and Flow-Friction Characteristics for Periodically Reversing Flow through the Porous Matrix of Thermal Regenerators," Ph.D. Thesis, Purdue University, June, 1970. *
- 1970 n Bender, R.J., "Technical Briefs," Power Reader Service Section, March, 1970. Also, "No Air Pollution, No Noise with a Stirling Engine," Power, March, 1970. *
- 1970 o "The Stirling Engine," United Stirling, October 23, 1970. *
- 1970 p Prast, G., and Rietdijk, J.A., "Device for Converting Mechanical Energy into Heat Energy or Conversely," United States Patent 3,487,635, January 6, 1970. *

- 1970 q "Supercharged and Water Injected Solar Hot Air Engine," Engr. Prog., Univ. of Florida, Vol. 24, No. 2, pp. 1-16, January 1970.
- 1970 r Buck, K.E., Tamai, H.W., Rudnicki, M.I., and Faeser, R.J., "Test and Evaluation of a Breadboard Modified Stirling-Cycle Heart Engine," Aerojet Nuclear Systems Co., Annual Rept., No. 3968, June 1968-May 1969.
- 1970 s Bush, Vannevar, "Compound Stirling Cycle Engines," United States Patent 3,527,049, Sept. 8, 1970. *
- 1970 t Walters, S., "Free-Roaming Animal Carries Artificial Heart," Mechanical Engr., Vol. 92, No. 9, pp. 44-45, Sept. 1970. *
- 1970 u Neelen, G.T.M., "Vacuum Brazing of Complex Heat Exchangers for the Stirling Engine," Welding Journal, Vol. 49, No. 5, pp. 381-386, May, 1970.*
- 1970 v Martini, W.R., Johnston, R.P., Goranson, R.B., and White, M.A., "Development of a Simplified Stirling Engine to Power Circulatory-Assist Devices," Isotopes and RAdiation Tech., Vol. 7, No. 2, pp. 145-160, Winter, 1969-1970. *
- 1970 w "A Report on the Performance Characteristics of Power Sources for Remote Areas," Booz-Allen Applied Research Inc., Final Rept., No. DAAD05-68-C-178, April, 1970.
- 1970 x Holmgren, J.S., "Implanted Energy Conversion System," MDAC Annual Report, No. PH43-67-1408-3, June 29, 1969-July 7, 1970. *
- 1970 y Harris, W.S., "Regenerator Optimization for a Stirling Cycle Refrigerator," M.Sc. Thesis, M.I.T., January, 1970. *
- 1970 z Rios, P.A., and Smith, J.L., Jr., "An Analytical and Experimental Evaluation of the Pressure-Drop Losses in the Stirling Cycle," Transactions ASME, Jnl. Eng. for Power, pp. 182-188, April, 1970. (Same as 1969 o)
- 1970 aa Howlett, R., "A Digital Computer Simulation of the Thermo-Mechanical Generators," AERE Report, AERE-M 2294, April, 1970. *
- 1970 ab Howlett, R., "The Computed Performance of a Thermo-Mechanical Generator Undergoing Sinusoidal Motion," AERE Report, AERE-M 2345, April, 1970. *
- 1970 ac Leo, B., "Designer's Handbook for Spaceborne Two-Stage Vuilleumier Cryogenic Refrigerators," Air Force Flight Dynamics Laboratory, Report No. AFFDL-TR-70-54, June, 1970. *
- 1970 ad Kuhlmann, P., Zapf, H., "Kraftmaschine Stirling Motor," VDI Nachrichten Nr. 12, 25.3, 1970 S. 18.

- 1970 ae Vickers, P.T., "Unconventional Power Plants," Proc. Air Pollution Control Assoc., Conf., Harrisburg.
- 1970 af Westbury, E.T., "Robinson Type Hot Air Engine," Model Engineer, Vol. 136, No. 3387, p. 164, Feb. 20 (part I); Vol. 136, No. 3388, p. 216, Mar. 6, (Part II); Vol 136, No. 3389, p. 368, Mar. 20, (part III); Vol. 136, No. 3390, p. 320, April 3, (part IV); Vol. 136, No. 3391, p. 372, April 17, (part V).
- 1970 ag Zarichang, J., "Bibliography on Stirling Engines," I.T.D.G., London.
- 1970 ah Pitcher, G.K., "Energy Conversion by a Vuilleumier Cycle Engine/Refrigerator," 1970 IECEC Record 709024, pp. 2-17. *
- 1970 ai "Option of Solar Terrestrial Power Production Using Heat Engines". 1970. J. Eng. Power. 92 (Apr.): 197-81.

- 1971 a Huffman, F.N., Hagen, K., "Vapor Cycle Energy System for Implantable Circulatory Assist Devices," Annual Progress Report., No. TE 4100-6-72, August 1971.
- 1971 b Huffman, F.N., Coleman, S.J., Borhnorst, W.J., and Harmiston, L.T., "A Nuclear Powered Vapor Cycle Heart Assist System," 1971 IECEC Record, No.719039, pp. 277-287. *
- 1971 c Zimmerman, M.D., "A Piston Power Plant fights back - The Stirling Engine," Machine Design, Vol. 43, No. 13, pp. 21-25, May 27, 1971.*
- 1971 d Scott, D., "Amazing Hot-Gas Engine Powers Clean-Air Bus," Popular Science, pp. 54-56, June, 1971. *
- 1971 e de Wilde de Ligny, J.H., "Heavy Duty Stirling Engine, A Progress Report," Intersociety Energy Conver. Conf., Boston, August 5, 1971.* (Not in 1971 IECEC Record -- available from N.V. Philips.)
- 1971 f Michels, A.P.J., "The No-Content in the Exhaust Gases of a Stirling Engine," SAE Paper No. 719134, October, 1971. *
- 1971 g Beale, W., Rauch, J., Lewis, R., and Mulej, D., "Free Cylinder Stirling Engines for Solar-Powered Water Pumps," ASME Paper No.71-WA/Sol-11, August, 1971. *
- 1971 h Daniels, F., "Power Production with Assemblies of Small Solar Engines," ASME Paper No. 71-WA/Sol-5, November 28-December 2, 1971. *
- 1971 i Riggle, P., Noble, J., Emigh, S.G., Martini, W.R., and Harmison, L.T., "Development of a Stirling Engine Power Source for Artificial Heart Application," MDAC Paper No. WD 1610, September 1971, pp. 288-298. *
- 1971 j Gibson, B.M., Hornbeck, C.J., Longworth, R.C., and Harmison, L.T., "Bypass Gas Actuated Thermocompressor as an Implantable Artificial Heart Power Source," IECEC Record No.719043, pp. 310-316, 1971. *
- 1971 k Agbi, T., "The Beale Free-Piston Engine," M.Sc. Thesis, University of Calgary, 1971.
- 1971 l Daniels, A., and Du Pre, F.K., "Miniature Refrigerators for Electronic Devices," Philips Tech. Rev., Vol. 32, No. 2, pp. 49-56, 1971.*
- 1971 m Neelen, G.T.M., Ortegren, L.G.H., Kuhlmann, P., and Zacharias, F., "Stirling Engines in Traction Applications," C.I.M.A.C., 9th Int. Congress on Combust. Eng., A26, 1971.*
- 1971 n Walker, G., and Vasishta, V., "Heat-Transfer and Friction Characteristics of Dense-Mesh Wire-Screen Stirling-Cycle Regenerators," Advances in Cryogenic Engng., Vol. 16, pp. 324-332. 1971. *

- 1971 o Wan, W.K., "The Heat-Transfer and Friction-Flow Characteristics of Dense-Mesh Wire-Screen Regenerator Matrices," M.Sc. Thesis, University of Calgary, 1971.
- 1971 p Daniels, A. and Du Pre, F.K., "Triple-Expansion Stirling Cycle Refrigerator," Advances in Cryogenic Engng., Vol. 16, pp. 178-184, 1971. *
- 1971 q Davis, S.R., Henein, N.A., and Lundstrom, R.R., "Combustion and Emission Formation in the Stirling Engine with Exhaust Gas Recirculation," SAE Paper, No. 710824, 1971. *
- 1971 r Hamerak, K., "Der Heissgasmotor - eine Interassante Hubkolbenkraftmaschine mit Ausserer Verbrennung," Energie und Technik, Vol. 23, No. 5, pp. 175-178, 1971.
- 1971 s Harris, W.S., Rios, P.A., and Smith, J.L., "The Design of Thermal Regenerators for Stirling-Type Refrigerators," Advances in Cryogenic Engng., Vol. 16, pp. 312-323, 1971. *
- 1971 t Maki, E.R., and Dehart, A.O., "A New Look at Swash-Plate Drive Mechanism," SAE Paper No. 710829, 1971.
- 1971 u Organ, A.J., "Stirling Cycle Engine - A Possible Answer to Atmospheric Pollution," Env. Engng., pp. 9-15, September 1971. *
- 1971 v Storace, A., "A Miniature, Vibration-Free Rhombic-Drive Stirling Cycle Cooler," Advances in Cryogenic Engng., Vol. 16, pp. 185-194, 1971. *
- 1971 W Zacharias, F., "Betrachtungen zum ausseren Verbrennungssystem des Stirling Heissgasmotors," MTZ, Vol. 31, No. 1, pp. 1-5, 1971. *
- 1971 x Vacant
- 1971 y Ortegren, L., "Svensk Stirlingmotor I Produktion 1976," Teknisk Tidskrift, Vol. 101, No. 3, pp. 44-50, 1971.
- 1971 z Ortegren, L., Henriksson, L., and Lia, T., "Stirlingmotorn och dess Potential I Militara System," Mitlitarteknisk Tidskrift, Vol. 40, No. 2, pp. 5-19, 1971.
- 1971 aa Wilding, T., "Stirling-Engine Coach at Brussels," Commercial Motor, January 22, 1971.
- 1971 ab vacant

- 1971 ac Scott, D., "Stirling Engine Development Continues," Automotive Industries, pp. 22-23, July 15, 1971. *
- 1971 ad Scott, D., "European Roundup," Automotive Industries, p. 24, Feb. 15, 1971.*
- 1971 ae Walker, G., "Stirling Cycle Machines," Presentation Note to Stirling Cycle Machine Seminar, University of Bath, December 14, 1971. (early version of 1973 j).
- 1971 af Lia, T., "Stirlingmotoren-Miljoevnlig, Energibesparande-et Alternative Til Dagens Diesel - Og Ottomotorer," Masken, Norway, Vol. 42, pp. 23-27, November 18, 1971.
- 1971 ag van Witteveen, R.A.J.O., "The Stirling Cycle Engine," Technical Report of the Conf. on Low Pollution Power Systems Develop., Eindhoven, Netherlands, February, 1971, Chapter V.*
- 1971 ah Ortegren, L.G., "Stirling Engine Activities at United Stirling (Sweden)," Technical Report of the Conf. on Low Pollution Power Systems Develop., Eindhoven, Netherlands, February, 1971, Chapter VII.*
- 1971 ai "Developing the Stirling Engine," Automotive Design Engng., (British), pp. 57-58, October, 1971.
- 1971 aj Kim, J.C., and Qvale, E.B., "Analytical and Experimental Studies of Compact Wire-Screen Heat Exchanger," Advances in Cryogenic Engng., Vol. 16, pp. 302-311, 1971. *
- 1971 ak Kim, J.C., Qvale, E.B., and Helmer, W.A., "Apparatus for Studies of Regenerators and Heat Exchangers for Pulse Tube, Vuilleumier, and Stirling-Type Refrigerators," 8th International Congress of Refrigeration, Paper No. 1:46, August, 197.*
- 1971 al "Low Pollution Engines," Scientific American, pp. 80-81, Sept., 1971.*
- 1971 am Sherman, A., "Mathematical Analysis of a Vuilleumier Refrigerator," ASME Paper No. 71-WA/HT-33. *
- 1971 an Rios, P.A., "An Approximate Solution to the Shuttle Heat-Transfer Losses in a Reciprocating Machine," Journal of Engineering for Power, pp. 177-182, April, 1971. *
- 1971 ao Johnston, R.P., and White, M.A., "Simulation of An Artificial Heart System," MDAC Paper No. WD 1589, April, 1971. *
- 1971 ap West, C., "The Fluidyne Heat Engine," AERE Report No. AERE-R 6775, 1971*
- 1971 aq Beale, W.T., "Stirling Cycle Type Thermal Device," United States Patent 3,552,120, January 5, 1971.*

- 1971 ar Wilkins, G., "Hot Air Engine Runs Quietly and Cleanly," Mechanix Illustrated, pp. 68-71, October, 1971. *
- 1971 as Hinton, M.G., Jr., Iura, T., Roessler, W.U., and Sampson, H.T., "Exhaust Emission Characteristics of Hybrid Heat Engine/Electric Vehicles," SAE Paper 710825, October 26-29, 1971.*
- 1971 at Neelen, G.T.M., "Precision Castings Advance the Development of the Stirling Engine," Giesserei, Vol. 58, No. 7, pp. 166-170, April 8, 1971.
- 1971 au Zacharias, F., "Der Stirlingmotor fur Aufgaben der Meerestechnik," Sonderdruck aus der Zeitschrift Schiffstechnik heft 92, May, 1971, pp. 39-45. *
- 1971 av Organ, A.J., "The Stirling Cycle Regenerative Thermal Machine as a Low Pollution Prime Mover," Instituto Tecnologico de Aeronautica, Sao Jose dos Campos, Sao Paulo, Brasil, 1971.
- 1971 aw Vacant
- 1971 ax Vacant
- 1971 ay Buck, K.E., "Artificial Heart Pumping System Powered by a Modified Stirling Cycle Engine-Compressor Having a Freely Reciprocable Displacer Piston," United States Patent 3,597,766, August, 1971.*
- 1971 az Bazinet, G.D., Faeser, R.J., Hoffman, L.C., Mercer, S.D., and Rudnicki, M.I., "Development and Evaluation of a Modified Stirling-Cycle Engine," Aerojet Liquid Rocket Co., Semi-Annual Report, No. PHS-71-2488, June-November, 1971.
- 1971 ba Martini, W.R., "Implanted Energy Conversion System," MDAC Annual Report, No. PH43-67-1408-4, July 8, 1970-July 7, 1971. *
- 1971 bb Meltzer, J., and Lapedes, D., "Hybrid Heat Engine/Electric Systems Study," Aerospace Corp., Final Report, Volume 1: Sections 1 through 13, No. TOR-0059-(6769-01)-2-Vol.-1, June 1970-July 1971.
- 1971 bc "Developing the Stirling Engine," Automotive Design Engineering, pp. 57-58, October 1971.*
- 1971 bd "External Combustion Engines Cut Noise and Air Pollution," Design Engng., (London), pp. 66-68, April 1971.*
- 1971 be Zimmerman, F.J., and Longworth, R.C., "Shuttle Heat Transfer," Advances in Cryogenic Engineering, Vol. 16, pp. 342-351, Plenum Press, 1971.*
- 1971 bf Leo, B., "Vuilleumier Cycle Cryogenic Refrigeration System Technology Report," AFFDL-TR-71-85, DDC Number AD888992L, September, 1971.

- 1972 a Michels, A.P.J., "C.V.S. Test Simulation of a 128 kw Stirling Passenger Car Engine," 1972 IECEC Record No. 729133, pp. 875-886. *
- 1972 b White, M.A., Martini, W.R., and Gasper, K.A., "A Stirling Engine Piezoelectric (STEPZ) Power Source," 25th Power Sources Symposium, May, 1972, or MDAC Paper WD 1897. *
- 1972 c Hermans, M.L., Uhlemann, H., and Spigt, C.L., "The Combination of a Radioisotopic Heat Source and a Stirling Cycle Conversion System," Power from Radioisotopes, Proc., pp. 445-466, 1972.*
- 1972 d Harmison, L.T., Martini, W.R., Rudnicki, M.I., and Huffman, F.N., "Experience with Implanted Radioisotope-Fueled Artificial Hearts," Second International Symposium on Power for Radioisotopes, Paper EN/IB/10, May 29-June 1, 1972. *
- 1972 e Mott, W. E., Cole, D. W., Holman, W. S., "The U.S. Atomic Energy Commission Nuclear-Powered Artificial Heart Program". Second International Symposium on Power from Radioisotopes, Paper En/IB/57, May 20-June 1, 1972. *
- 1972 f "Isotopes Development Programs Research and Development - 1971," Division of Applied Technology, USAEC, Progress Reports and Sponsored Work, No. TID-4067, February, 1972.
- 1972 g Knoos, S., "Method and Device for Hot Gas Engine or Gas Refrigeration Machine," United States Patent 3,698,182, October 17, 1972.*
- 1972 h Harmison, L.T., "Totally Implantable Nuclear Heart Assist and Artificial Heart," National Heart and Lung Institute, National Institute of Health, February, 1972.
- 1972 i Walker, G., and Wan, W.K., "Heat-Transfer and Fluid-Friction Characteristics of Dense-Mesh Wire Screen at Cryogenic Temperatures," Proc. 4th Int. Cryogenic Engng. Conf., Eindhoven, Netherlands, 1972.
- 1972 j Walker, G., "Stirling Engines for Isotope Power Systems," Proc. 2nd Int. Conf. on Power from Radioisotopes, pp. 467-493, 1972. *
- 1972 k Andrus, S.R., Bazinet, G.D., Faeser, R.J., Hoffman, L.C., and Rudnicki, M.I., "Development and Evaluation of a Modified Stirling-Cycle Heart Engine," Aerojet Liquid Rocket Co., Semi-Annual Rept., No. PHS-71-2488, December 1971-May 1972.
- 1972 l Norman, J.C., Harmison, L.T. and Huffman, F.N., "Nuclear-Fueled Circulatory Support Systems," Arch. Surg., Vol. 105, October 1972.*
- 1972 m Martini, W.R., "Developments in Stirling Engines," ASME Paper No. 72-WA/Ener-9, or MDAC Paper WD 1833, November, 1972. *

- 1972 n Meijer, R.J., "Möglichkeiten des Stirling-Fahrzeugmotors in unserer künftigen Gesellschaft," Schweizerische Technische Zeitung, SZT 69 (1972): 31/32, pp. 649-660.
- 1972 o Moon, J.F., "European Progress With Stirling Engines," Diesel and Gas Turbine Progress, pp. 14-17, December, 1972. *
- 1972 p Viklund, G.D., "Ny Svensk Stirlingmotor Premiätkörd i Malmö," Ny Teknik, Vol. 5, No. 1, 1972. *
- 1972 q Gasparovic, N., "Engines with Rhombic Drive Mechanism," Marine Eng. Review, Vol. 77, pp. 25-27, 1972. *
- 1972 r Davis, S.R., Henein, N.A., Singh, T., "Emission Characteristics of The Stirling Engines," IECEC Record, Paper No. 729134, pp. 887-895, 1972. *
- 1972 s Ludvigsen, K., "The Stirling: Ford's Engine for the Eighties?" Motor, Week Ending September 9, 1972.
- 1972 t Morgan, N.E., "Analysis and Preliminary Design of Airborne Air Liquefiers," Air Force Flight Dynamics Laboratory, Report No. AFFDL-TR-71-171- February, 1972. *
- 1972 u Finkelstein, T., "Computer Analysis of Stirling Engines," Cryogenic Engineering Congress, Paper G-2, pp. 269-282, 1972. *
- 1972 v Bjerklie, J.W., "Comparison of Co₂ Cycles for Automotive Power Plants," 1972 IECEC Record, Paper No. 729135, pp. 896-904. *
- 1972 w Ward, E.J., Spriggs, J.O., and Varney, F.M., "New Prime Movers for Ground Transportation - Low Pollution, Low Fuel Consumption," 1972 IECEC Record, Paper No. 729148, pp. 1013-1021. *
- 1972 x Beale, W.T., "Stirling Cycle-Type Thermal Device Servo Pump," United States Patent 3,645,649, February 29, 1972. *
- 1972 y "Free Piston Engine Driven Gas Fired Air Conditioner," Ohio University, 1972. *
- 1972 z Riha, F.J., "Development of Long-Life, High-Capacity Vuilleumier Refrigeration System for Space Applications," "Part III - Refrigerator Design and Thermal Analyses," AFFDL Interim Report, August 1971-March 1972.
- 1972 aa "Ford Buys License for Old Stirling Engine, Eventual Use Is Possible to Fight Pollution," Wall Street Journal, about Aug. 9, 1972.*
- 1972 ab "Ford Signs Licensing Pact to Develop Stirling Engine," AMM/MN, August 14, 1972. *

- 1972 ac "Ford Will Develop 'Hot Air' Engines With Dutch Partner," L.A. Times, August 9, 1972. *
- 1972 ad Beale, W.T., Rauch, J.S., and Lewis, R.S., "Free-Piston Stirling Engine Driven Inertia Compressor for Gas Fired Air Conditioning," Conf. on Nat. Gas Res. and Technol., 2nd Proc., Session III, Paper 5, June 5-7, 1972.
- 1972 ae Kneuer, R., Persen, K., Stephan, A., Gass, J., Villard, J.C., Marinet, D., Solente, P., Wulff, H.W.L., Claudet, G., Verdier, J., Mihnheer, A., Danilov, I.B., Kovatchev, V.T., Parulekar, B.B., and Narayankhedkar, K.G., "Inter. Cryogenic Engineering Conference," 4th Proc., May 24-26, 1972.
- 1972 af Crouthamel, M.S., and Shelpuk, B., "A Combustion-Heated, Thermally Actuated Vuilleumier Refrigerator," Cryogenic Engng. Conf., pp. 339-351, August 9-11, 1972. *
- 1972 ag Schirmer, R. M., LaPointe, C.W., Schultz, W.L., Sawyer, R.F., Norster, E.R., Lefebvre, A.H., Grobman, J.S., Breen, B.P., Bahr, D.W., Wade, W.R., and Cornelius, W., "Emissions from Continuous Combustion Systems," Proc., Symp., Plenum Press, 1972.
- 1972 ah Asselman, G.A.A., Mulder, J., and Meijer, R.J., "A High Performance Radiator," 1972 IECEC Record 729132, pp. 865-874. *
- 1972 ai Gipps, G. de V., "Machine for Many Purposes," Australias Eng., 5 pages between page 8 and 13, March, 1972.
- 1972 aj Estes, E.M., "Alternative Power Plants for Automotive Purposes," Inst. Mech. Engng., (London), Proc. Vol. 186, Pap. 11/72 for meeting March 13, 1972.
- 1972 ak Martini, W.R., Riggle, P., Harmison, L.T., "Radioisotope-Fueled Stirling Engine Artificial Heart System," Nucl. Technol., Vol. 13, No. 2, pp. 194-208, February, 1972. *
- 1972 al Buck, K.E., "Modified Stirling Cycle Engine-Compressor Having a Freely Reciprocable Displacer Piston," United States Patent 3,678,686, July 25, 1972. *
- 1972 am "Final Engineering Report on the Design and Development of Two Miniature Cryogenic Refrigerators," Texas Instruments Inc., Rept. No. DAAK02-73-C-0495, June 1972.
- 1972 an Johnston, R.P., "Implanted Energy Conversion System," MDAC Annual Report, No. PH43-67-1408-5, July 8, 1971-July 7-1972. *

- 1972 ao "Transit Bus Propulsion Systems State-Of-The-Art," Booz-Allen Applied Research, Inc., Final Report., DOT-UT-10008, UMTA-IT-06-0025, August 10, 1972.
- 1972 ap Welsh, H.W., Harp, J.L., Yano, R.A., Oatway, T.P., and Riley, C.T., "Study of Low Emission Vehicle Power Plants Using Gaseous Working Fluids," Thermo Mech. Systems Co., Rept. SR-20-EPA-71-003, August 1972.*
- 1972 aq Ludvigsen, K., "Zukunftsmusik," ("Future Music"), Auto Motor Sport, H. 23, S:78-88.
- 1972 ar Fryer, B.C., "Design, Construction, and Testing of a New Valved, Hot-Gas Engine," D.Sc. Thesis, M.I.T., October, 1972.*
- 1972 as Uhlemann, H., Spigt., C.L., "Der Stirlingmotor Mit Isotope Wärmeguelle für die Meerestechnik," VDI Berichte 181, S. 41-44.
- 1972 at Ludvigsen, K., "The Engine of the 1980's--Stirling's 'Mr. Clean' Image Lies Behind Ford-Philips Deal," Ward's Auto World, pp. 41-44, September 1972.
- 1972 au Martini, W.R., White, M.A., Gasper, K.A., "The Stirling Engine Piezoelectric (STEPZ) Power Source Concept for Space Applications," Trans. Am. Nucl. Soc., Vol 15, No. 2, November 1972.*
- 1972 av Umarov, G. Ya., Tursenbaev, I.A. and Trukhov, V.S., "Influence of Heat Exchanger Inefficiency on the Efficiency and Power Characteristics of a Solar Powerplant Dynamic Converter," Applied Solar Energy, U.S.S.R., January/February. *
- 1972 aw Walker, G., "Stirling Engines - The Second Coming?," Chartered Mech. Eng. I., Mech. E., pp. 54-57, London, April.
- 1972 ax Ward, G.L., "Performance Characteristics of the Stirling Engine," M.Sc. Thesis, Sch. of Eng., Univ. of Bath, U.K.
- 1972 ay Umarov, G. Ya.; Tursunbaev, I. A.; Borisov, I. V.; Klyuchevskii, Y. E., Orda, E. P. "Dynamic Converter for Stirling Engines and Prospects for its Utilization in Autonomous Solar Power Plants", Reports of all Union Conference on Renewable Energy Sources. Tashkent 1972. (in Russian)*
- 1972 az Zarinchang, J. The Stirling Engine. Intermediate Technology Development Group, London. 1972.
- 1972 ba Kolin, Ivo. The Evolution of the Heat Engine. Thermodynamics Atlas 2. J. W. Arrowsmith Limited, Bristol. pp. 16-22, 55-69, 87-93, 98-101. 1972.

- 1973 a Alm, C.B.S., Carlqvist, S.G., Kuhlmann, P.F., Silverqvist, K.H., and Zacharias, F.A., "Environmental Characteristics of Stirling Engines and their Present State of Development in Germany and Sweden," 10th Inter. Cong. on Combustion Engines, Paper No. 28, April 5-9, 1973.*
- 1973 b Beale, W., Holmes, W., Lewis, S., and Cheng, E., "Free-Piston Stirling Engines -- A Progress Report," Soc. of Auto. Engrs., Paper No. 730647, June, 1973. *
- 1973 c van Beukering H.C.J., and Fokker, H., "Where Philips Stands on the Stirling Engine - 1," Automotive Engng, Vol. 81, No. 7, pp. 37-43, July, 1973. *
- 1973 d van Beukering, H.D.J., and Fokker, H., "Present State-of-the-art of the Philips Stirling Engine," Soc. of Auto. Engrs., Paper No. 730646, June, 1973. *
- 1973 e Lia, T., "The Stirling Engine," Combustion Engine Progress, pp. 44-47 1973.
- 1973 f William, C.G., "Alternative to the Motor Car - or Alternative Fuels," Natl. Soc. Clean Air, Brighton, England.
- 1973 g Norbye, J.P., and Dunne, J., "Ford's Gamble -- Stirling-Cycle Engine Promises Low Emissions Without Add-Ons," Popular Science, pp. 72-75, & 154, February 1973.*
- 1973 h Postma, N.P., van Giessel, R., and Reinink, F., "The Stirling Engine for Passenger Car Application," Soc. of Auto. Engrs., Paper No. 730648, June, 1973. *
- 1973 i Walker, G., "Stirling Engines," von Karmen Institute for Fluid Dynamics, Lecture Series 53, Brussels, 1973. (similar to 1973 j)
- 1973 j Walker, G., "Stirling Cycle Machines," Clarendon Press, Oxford, 156 pgs., 1973. *
- 1973 k Ludvigsen, K., "Stirling Engine - History and Current Development of Another Possible Alternative to the Internal Combustion Engine," Road & Track, Vol. 24, No. 7 pp. 83-91, March, 1973. *
- 1973 l Kim, J.C., "An Analytical and Experimental Study of Flow Friction Characteristics for Periodically Reversing Flow," ASME Paper, No. 73-WA/FE-13, pp. 1-8, 1973.*
- 1973 m Walker, G., Agbi, B., "Optimum Design Configuration for Stirling Engines with Two-Phase Two-Component Working Fluids". ASME Paper No. 73-WA/FE-13, pp. 1-8, 1973. *
- 1973 n Walker, G., "The Stirling Engine," Scientific American, Vol. 229, No. 2, pp. 80-87, August, 1973. *

- 1973 o "Ford is Readying Stirling Engine for Torino-II," Automotive Engineering, Vol. 81, No. 8, pp. 42-45, August, 1973. *
- 1973 p Benson, G.M., "Thermal Oscillators," 1973 IECEC Record No. 739076, pp. 182-189. *
- 1973 q White, M.A., "Proof-Of-Principle Investigation of 300 W(E) Stirling Engine Piezoelectric (Stepz) Generator," MDAC Final Report, No. MDC G4420, September, 1973. *
- 1973 r Moise, J.C., Rudnicki, M.I., and Faeser, R.J., "Development of a Thermocompressor Power System for Implantable Artificial Heart Application," 1973 IECEC Record No. 739152, pp. 511-535. *
- 1973 s Lia, T.A., and Lagerqvist, R.S.G., "Stirling Engine with Unconventional Heating System," 1973 IECEC Record No. 739073, pp. 165-173.*
- 1973 t Beale, W., Rauch, J., and Lewis, S., "Design Details and Performance Characteristics of Some Free-Piston Stirling Engines," 1973 IECEC Record No. 739077, pp. 190-193. *
- 1973 u Agbi, B., "Theoretical and Experimental Performance of the Beale Free Piston Stirling Engine," 1973 IECEC Record No. 739034, pp. 583-587. *
- 1973 v Walker, G., "Stirling Engine Power Supplies for Remote Unattended Sites," 1973 IECEC Record No. 739037, pp. 594-600. *
- 1973 w Feigenbutz, L. V., Griffith, W. R., Hinderman, J. D., Martini, W. R., Perrone, R. E., and Gasper, K. A., "A Stirling Engine Approach to an Implantable Nuclear Heart-Assist System". 1973 IECEC Record, Paper 739137, pp. 441-448. *
- 1973 x Jaspers, H.A., and Du Pre, F.K., "Stirling Engine Design Studies of an Underwater Power System and a Total Energy System," 1973 IECEC Record No. 739035, pp. 588-593. *
- 1973 y Zacharias, F.A., "Unique Requirements for the Cooperation of Computation and Design in the Development of Stirling Engines," von Karman Inst. for Fluid Dynamics, Lecture Series 53, Feb. 12-16, 1973.*
- 1973 z Umarov, G. Ya., Tursunbaev, I.A., Lashkareva, T.P., and Trukhov, V.S., "Influence of Regenerator Efficiency on the Thermal Efficiency of a Stirling Engine Dynamic Energy Converter," Gelictekhnika, Vol. 9, No. 3, pp. 58-61, 1973.*

- 1973 aa Medvedev, E.M., Murinets-Markevich, B.N., and Nosov, M.E., "Microrefrigerator with Opposed Compressor and Expander," Khim. and Neft. Mashinostr., (USSR), Vol. 9, No. 7, July, 1973.
- 1973 ab Hapke, H., "The Influence of Flow Pattern and Heat-Transfer in the Heat-Exchanger Unit of Stirling Machines on the Thermodynamic Cycle," Brennst.-Waerme-Kraft, (Germany), Vol. 25, No. 10, pp. 389, 392, 393, and 394, October, 1973.*
- 1973 ac Organ, A.J., "Stirling Engine Beats Pollutions' Threat," Design Engineer, Vol. 43, No. 6, May, 1973. *
- 1973 ad Kuhlmann, P., "Das Kennfeld des Stirlingmotors," ("Characteristic Diagrams of the Stirling Engine,") Motortech Z, Vol. 24, No. 5, pages 135-139, May 1973.*
- 1973 ae Daniels, A., "Stirling Engines -- Capabilities and Prospects," Cryog. Symp. and Expo - 6th Proc., Paper 13, pp. 190-210, October 2-4, 1973.
- 1973 af Ayres, R.V., "Alternative Means of Controlling Air Pollution from Vehicular Engines," Inova. 73, World Innov. Week Conf., Pap. 10, pp. 148-159, June 1973. *
- 1973 ag Walker, G., and Agbi, Babatunde, "Thermodynamic Aspects of Stirling Engines with Two-Phase, Two-Component Working Fluids," Trans. Can. Soc. Mech. Eng., Vol. 2, No. 1, pp. 1-8, 1973-1974.
- 1973 ah Serruys, M., "Concerning Ericssons and Stirling's Cycles," Rev. Gen. Therm., Vol. 12, No. 143, pp. 1125-1134, Nov. 1973
- 1973 ai Ross, M.A., "Speed Control Apparatus for Hot Gas Engine," United States Patent 3,724,206, April 3, 1973. *
- 1973 aj Asselman, G.A.A., and Green, D.B., "Heat Pipes--II. Applications." Philips Tech. Rev., Vol. 33, No. 5, pp. 138-148, 1973.*
- 1973 ak Brogan, J.J., "Alternative Powerplants," SAE Spec. Publ. No. SP-383, Paper No. 730519, pp. 31-36, July 1973. *
- 1973 al Baumgardner, A.R., Johnston, R.P., Martini, W.R., and White, M.A., "Stirling Cycle Machine with Self-Oscillating Regenerator," United States Patent 27,567, Reissued January 23, 1973. *
- 1973 am Lavigne, P., "Driving Device of the Stirling-Cycle Relaxation Type for an Implantable Artificial Heart," United States Patent 3,766,568, October 23, 1973. *
- 1973 an Johnston, R.P., "Implanted Energy Conversion System," MDAC Annual Report, No. PH43-67-1408-6, July 8, 1972-July 8, 1973. *

- 1973 ao Davis, S.R., and Henein, N.A., "Controlling Emissions with the Stirling Engine," Automot. Eng., Vol. 81, No. 4, pp. 32-35, April, 1973. *
- 1973 ap Daniels, A., and Du Pre, F.K., "Miniature Refrigerators for Electronic Devices," Cryogenics, Vol. 13, No. 3, pp. 134-140, March, 1973. *
- 1973 aq Guilfooy, R.F., Jr., "Refrigeration Systems for Transporting Frozen Foods," ASHRAE Jour., Vol. 15, No. 5, pp. 58-60, May 1973.
- 1973 ar Davis, S.R., and Henein, N.A., "Comparative Analysis of Stirling and Other Combustion Engines," SAE Spec. Publ. SP-379, Paper 730620, pp. 36-47, March, 1973. *
- 1973 as Horn, S.B., "Pneumatic Stirling Cycle Cooler with Non-Contaminating Compressor," United States Patent 3,765,187, October, 1973. *
- 1973 at Andrus, S., Faeser, R.J., Moise, J., Hoffman, L.O., and Rudnicki, M.I., "Development and Evaluation of a Stirling Cycle Energy Conversion System," Aerojet Liquid Rocket Co., Rept. PHS-73-2930, July, 1973.
- 1973 au Arkharov, A.M., Bondarenko, L.S., and Kuznetson, B.G., "The Calculation of (Piston) Gas Refrigerating Machines and Heat Engines," Foreign Tech. Div., Wright-Patterson AFB, No. FTD-HT-23-0360-73, June 5, 1973.
- 1973 av Sergeev, P.V., and Shmerelzon, Ya. F., "Synthesis of Mechanisms of Rhombic Drives for Machines Operating on the Stirling Cycle," Foreign Tech. Div., Wright-Patterson AFB, No. FTD-HT-23-533-73, May 24, 1973.
- 1973 aw Feurer, B., "Degrees of Freedom in the Layout of Stirling Engines," von Karman Inst. for Fluid Dynamics, Lecture Series 53, February 12-16, 1973. *
- 1973 ax "Evaluation of Practicability of a Radioisotope Thermal Converter for an Artificial Heart Device," Westinghouse Electric Corp., Phase I and II Final Reports, 1973. *
- 1973 ay Fryer, B.C., and Smith, J.L., Jr., "Design, Construction, and Testing of a New Valved, Hot-Gas Engine," 1973 IECEC Record 739074, pp. 174-181. *
- 1973 az "Evaluation of Alternative Power Sources for Low-Emission Automobiles," Nat. Acad. Sc., Washington, D.C., Ap. 1973.
- 1973 ba "Technological Feasibility of 1975-76 Motor Vehicle Emission Standards," Nat. Acad. Sc., Panel Rept., Washington D.C., Ap. 1973.

- 1973 bb "United Stirling--Stirling Air Cycle Engine Status," NATO, Bursseis, Belgium, June, 1973.
- 1973 bc Cole, D.W., Holeman, W.S., Mott, W.E., "Status of the U.S.A.E.C.'s Nuclear-Powered Artificial Heart," Trans. Soc. Artif. Int. Organs, Vol. 19, p. 537.
- 1973 bd Conlin, D.M., Reed, L.H.K., "The Performance of a Modified Stirling Engine with Exhaust Gas Recuperator," Project Report, Sch. of Eng., Univ. of Bath, U.K.
- 1973 be Mallett, T., "The Robinson Hot Air Engine," Model Engineer, Vol. 139, No. 3467, p. 610, June 15, 1973.
- 1973 bf Senft, J.R., "A Small Hot Air Fan," Model Engineering, Vol. 139, No. 3475, p. 1017, October 19.
- 1973 bg Sier, R., "Hot Air Engines," Model Engineer, Vol. 139, No. 3461, p. 298, Mar. 16, 1973, (part I); Vol. 139, No. 3463, p. 376, April 20, 1973, (part II); Vol. 139, No. 3464, p. 444, May 4, 1973, (part III).
- 1973 bh Slack, A., "A Hot Air Engine Suitable for Powering a Small Boat," Model Engineer, Vol. 139, No. 3476, p. 1072, Nov. 2.
- 1973 bi Walker, G., "Stirling Engines," Proc. 2nd Nat. Tech. Conf., Canadian Gas Assn., October 1973.

- 1974 a "A Stirling Performance," Time, p. 61, Sept. 9, 1974. *
- 1974 b Daniels, A., "The Stirling Engine as a Total Energy System Prime Mover," Philips Laboratories, 1974.*
- 1974 c Meijer, R.J., and Spigt, C.L., "The Potential of the Philips Stirling Engine for Pollution Reduction and Energy Conservation," Symposium on Low Pollution Power Sys. Devel., pp. 1-12, November 4-8, 1974.*
- 1974 d Waalwijk, J.M., and Wiedenhof, N., "The Ford-Philips Stirling Engine Programme," Philips Information No. 6519E. October, 1974.*
- 1974 e Scott, D., "New Stirling-Cycle Zero-Pollution Car Runs on Stored Heat," Popular Science, pp. 66-68, 148, June, 1974. *
- 1974 f Cooke-Yarborough, E.H., "A New Thermo-Mechanical Generator from Harwell," Scientific and Technical News Service, December, 1974.*
- 1974 g Cooke-Yarborough, E. H., Franklin, E., Geisow, J., Howlett, R., West, C. D., "Thermo-Mechanical Generator: An Efficient Means of Converting Heat to Electricity at Low Power Levels". Proc. ICE, Vol. 121, No. 7, pp. 749-751, July, 1974. *
- 1974 h Cooke-Yarborough, E.H., "Fatigue Characteristics of the Flexing Members of the Harwell Thermo-Mechanical Generator," Harwell, AERE-R-7693, March, 1974. *
- 1974 i Cooke-Yarborough, E.H., "Simplified Expressions for the Power Output of a Lossless Stirling Engine," Harwell, AERE-M2437, March, 1974. *
- 1974 j Cooke-Yarborough, E.H., Franklin, E., Geisow, J., Howlett, R., and West, C.D., "The Harwell Thermo-Mechanical Generator," Harwell, AERE-R7714, March, 1974. *
- 1974 k Cooke-Yarborough, E.H., Franklin, E., Geisow, J., Howlett, R., and West, C.D., "A New Electrical Power Source for Long-Term Unattended Operation," Harwell, AERE-R7753, May, 1974. *
- 1974 l Harkless, L.B., "Demonstration of Advanced Cryogenic Cooler-Infrared Dector Assembly," Air Force Flight Dynamics Lab., AFFDL-TR-74-15, March, 1974.*
- 1974 m Raetz, K., "Development and Application of a Stirling Heat Pump for Heating," Braunschweig, PTB-FMRB-57, September, 1974.*
- 1974 n Martini, W.R., Emigh, S.G., White, M.A., Griffith, W.R., Hinderman, J.D., Johnston, R.P., and Perrone, R.E., "Unconventional Stirling Engines for the Artificial Heart Application," MDAC Paper No. WD2337, August, 1974 or 1974 IECEC Record, Paper No. 749117, pp. 791-798. *

- 1974 o Martini, W.R., White, M.A., DeSteeze, J.G., "How Unconventional Stirling Engines Can Help Conserve Energy," MDAC Paper No. WD 2336, August, 1974 or 1974 IECEC Record, Paper No. 749151, pp. 1092-1099.*
- 1974 p Martini, W.R., "Development and Evaluation of a Modified Stirling-Cycle Engine," MDAC Quarterly Report, No. MDC G4438, April, 1974.*
- 1974 q Elrod, H.G., "The Fluidyne Heat Engine: How to Build One--How it Works," National Tech. Info. Serv., No. AD/A-006 367, December, 1974. *
- 1974 r Noble, J.E., Riggle, P., Emigh, S.G., and Martini, W.R., "Heat Engine," United States Patent 3,855,795, December, 1974. *
- 1974 s Morash, R.T., and Marshall, O.W., "The Roesel Closed Cycle Heat Engine," 1974 IECEC Record, Paper No. 749154, pp. 1117-1124. *
- 1974 t Lindsley, E.F., "Air-Conditioning Cold from any Source of Heat," Popular Science, Aug. 1974, pp. 60-61. *
- 1974 u Uhlemann, H., Spigt, C.L., and Hermans, M.L., "The Combination of a Stirling Engine with a Remotely Placed Heat Source," 1974 IECEC Record, Paper No. 749051, pp. 620-627. *
- 1974 v Frank, G., Keller, H., Plitz, W., Richter, C., Schmid, P., and von Reth, R.D., "An Implantable Thermal Converter as Power Source for an Artificial Heart," 1974 IECEC Record, Paper No. 749115, pp. 775-781. *
- 1974 w Pouchot, W.D., and Daniels, A., "Nuclear Artificial Heart Bench Model," 1974 IECEC Record, Paper No. 749116, pp. 782-790. *
- 1974 x Noise, J.C., Faeser, R.J., and Rudnicki, M.I., "Status of a Thermocompressor-Powered Implantable Artificial Heart System," 1974 IECEC Record, Paper No. 749118, pp. 799-804. *
- 1974 y Shelpuk, B., "A Solar Vuilleumier System," Workshop Proc. Solar Cooling for Buildings, NSF-RA-N-74-063, February 1974. *
- 1974 z Hakansson, S.A.S., "Heat Exchangers for Stirling Cycle Engines," United States Patent 3,834,455, September 10, 1974. *
- 1974 aa Stang, J.H., and Bush, J.E., "The Periodic Method for testing Compact Heat Exchanger Surfaces," Journal of Engineering for Power, pp. 87-94, April, 1974.*
- 1974 ab Andersen, N.E., and Qvale, B., "Model for Instationar Stromning I Varmveksler for Stirlingmotor," Laboratoriet for Energiteknik, Denmark, June 1974. *
- 1974 ac "New Thermo-Mechanical Generator form Harwell," Heat and Air Cond. Jour., Vol. 43, No. 515, October, 1974.

- 1974 ad Cooke-Yarborough, E., Franklin, E., Geisow, J., Howlett, R., and West, C., "The Thermo-Mechanical Generator," Proceedings of the Ninth Inter. Symposium, Brighton, Sussex, England, Research and Develop. in Non-Mechanical Electrical Power Sources, pp. 643-648, September 17-19, 1974.
- 1974 ae Hartley, J., "Stirling Set for 1980," Automotive Design Enng., Vol. 13, pp. 27 & 29, September 1974. *
- 1974 af "Thermo-Mechanical Generator," Engineering, Vol. 214, No. 9, September 1974. *
- 1974 ag Hartley, J., "Ford Leads in the Race to Find a Cleaner Yet Economic Engine," Engineer, Vol. 238, No. 6165, May, 1974.*
- 1974 ah Amann, C.A., "Why the Piston Engine Lives On," Mach. Des., Vol. 46, No. 5, February 21, 1974.*
- 1974 ai Boltz, C.L., "New Research Work Regarding an Old Machine", Antriebstechnik, Germany, Vol. 13, No. 3-4, March-April, 1974.
- 1974 aj Lefebvre, A.H., "Pollution Control in Continuous Combustion Engines," Symp. on Combust. - 15th Int. Proc., pp. 1169-1180, August 25-31, 1974.
- 1974 ak Blinov, I.G., and Minaichev, V.E., "Condensation Cryopump with Independent Cryogenerator," 6th Proc. Int. Vac. Congr., pp. 101-104, March 25-29, 1974.
- 1974 al Rochelle, P., and Andrejewski, J., "Optimizing Maximum Efficiency Cycles," Rev. Inst. Fr. Pet. Ann. Combust. Liq., Vol. 29, No. 5, pp. 731-749, September-October 1974.
- 1974 am Minaichev, V.E., and Zykov, V.M., "Cryocondensation Booster Pump," Instrum. Exp. Tech., Vol. 17, No. 3, Part 2, pp. 795-798, May-June, 1974.
- 1974 an Brogan, J.J., "Developments in Power Systems for Transportation," ASME Annual Symp., 14th Proc., pp. 45-57, February 28-March 1, 1974.*
- 1974 ao Walker, G., "Stirling Cycle Cooling Engine with Two-Phase, Two-Component Working Fluid," Cryogenics, Vol. 14, No. 8, pp. 459-462, August, 1974. *
- 1974 ap Penn, A.W., "Small Electrical Power Sources," Phys. Technol. Vol. 5, No. 2, pp. 115-140, 1974.
- 1974 aq Newhall, H.K., "Low Emissions Combustion Engines for Motor Vehicles," Am. Chem. Soc., Div. Fuel Chem., Prepr., Vol. 19, No. 1, pp. 15-37, 1974.*

- 1974 ar Richardson, R.W., "Automotive Engines for the 1980's," Am. Chem. Soc., Div. Fuel Chem., Prepr., Vol. 19, No. 1, pp. 40-4., 1974.*
- 1974 as Longworth, R.C., "Split Stirling Cycle Cryogenic Refrigerator," Air Products and Chemicals, Inc., Final Tech. Rept., No. DAAK02-72-C-0316, 1973-1974.
- 1974 at Lapedes, D.E., Hinton, M.G., and Meltzer, J., "Current Status of Alternative Automotive Power Systems and Fuels. Volume II - Alternative Automotive Engines," Aerospace Corp., No. 68-01-0417, July, 1974.
- 1974 au Andrus, S., Faeser, R.J., Moise, J., Hoffman, L.C., and Rudnicki, M.E., "Development and Evaluation of a Stirling Cycle Energy Conversion System," Aerojet Liquid Rocket Co., No. PHS-73-2930, May, 1974-July, 1974.
- 1974 av Johnston, R.P., Griffith, W.R., Perrone, R.E., Martini, W.R., and Emigh, S.G., "Implanted Energy Conversion System," MDAC Annual Report, No. No1-HV-4-2901-1, July 8, 1973-July 22, 1974. *
- 1974 aw Noble, J.E., and Johnston, R.P., "Energy Converter to Power Circulatory Support Systems," United States Patent 3,788,772, January 29, 1974. *
- 1974 ax "Nuclear-Powered Artificial Heart Prototype System Development Program. Phase IIIa-Conceptual Design Intermediate System," Westinghouse Electric Corp., No. AT(11-1)-3043, February 1, 1974.
- 1974 ay "Nuclear-Powered Artificial Heart Prototype System Development Program. Phase III," Westinghouse Electric Corp., Quarterly Reports, October-December, 1973; January-March, 1974; April-June, 1974; No. AT(11-1)
- 1974 az Smith, L.M., Sandquist, G.M., "Biomedical Engineering Support," Utah University, Third Quarterly Report., No. AT(11-1)-2155, February 16, May 15, 1974.
- 1974 ba Hagen, K.G., Ruggles, A.E., and Huffman, F.N., "Thermal Design of a Tidal Regenerator Engine for Circulatory Support Systems," ASME Paper No. 74-HT-2, AIAA Paper No. 74-657, July, 1974. *
- 1974 bb Umarov, G.Ya., Trukhov, V.S., and Tursenbaev, I.A., "Prospects for Using Dynamic Thermocompression Converter in Solar Power Plants," Applied Solar Energy, Vol. 10, No. 1-2, pp. 53-56, (translation), 1974.*
- 1974 bc Percival, W.H., "Historical Review of Stirling Engine Development in the United States from 1960 to 1970," ERDA, No. NASA CR-121097, July 1974. *

- 1974 bd Senft, J.R., "A 10-inch Stirling Engine Powered Fan," Live Steam Magazine, pp. 10 - 12, Part I, December, 1974. *
- 1974 be Zacharias, F.A., "Advanced Development on Stirling Engines at MWM " 2nd NATO-CCMS-Symposium, Low Pollution Power System Development, 4-8 November, 1974, Düsseldorf. *
- 1974 bf "Heat Regeneration by Thermal Wheel," Applegate, C.G. and Newberry Ltd., Energy Dig., Vol. 3, No. 6, pages 21-23, Dec., 1974.---
- 1974 bg Carlqvist, S.G., Ortegren, L.G.H., "The Potential Impact of the Stirling Engine on Environmental Issues," Inst. Road Transport Engines, p. 10, January 17, 1978.
- 1974 bh Cooke-Yarborough, E.H., Franklin, E., Geisow, J., Howlett, R., West, C.D., "The Harwell Thermo-Mechanical Generator," 1974 IECEC Record, pp. 1132 to 1136. *
- 1974 bi Crossland, J., "Cars, Fuel, and Pollution," Environment, March 1974.
- 1974 bj Daniels, A., "Stirling Engine, A Promising Power Source for Communications Equipment," Philips Labs, Briarcliff Manor, N.Y., May-June 1974.
- 1974 bk Harley, J., "Ford Leads in the Race to Find a Cleaner Yet Economic Engine," Engineer, Vol. 238, No. 6165, May 19, 1974.
- 1974 bl Harley, J., "Engines to Stretch the World's Oil," New Sci., Aug., 1974.
- 1974 bm Harley, J., "Stirling Set for 1980." Automotive Design Eng., Vol. 13, pp. 27-29, Sept. 1974.
- 1974 bn Harvey, D. C., Menchen, W.R., "The Automobile: Energy and the Environment," Hitman Associates Inc., Columbia, MD.
- 1974 bo Kuhlmann, P. "Stirling Engine for Vehicle Propulsion," VDI, Ber.
- 1974 bp Lapedes, D.E., Hinton, M.G., Meltzer, J., "Current Status of Alternative Automotive Power Systems and Fuels." Aerospace Corp., El Segundo, CA, July.
- 1974 bq Lapedes, D.E., Meltzer, J., "Status Review of Hybrid Heat Engine/ Battery and Heat Engine," Aerospace Corp., El Segundo, CA Sept., 1974.
- 1974 br Massa, D.J., "High Efficiency Compressors - Design and Application." Proc. Conf.: Improving Efficiency on HVAC Equipment, Purdue Univ., Oct. 7-8, 1974.
- 1974 bs Minaichev, V.E., Zykov, V.M., "Cryocondensation Booster Pump," Instrum. Exp. Tech., Vol. 17, No. 3, Part 2, pages 795-798, May-June 1974.

- 1974 bt Pedroso, R.I., "Control of Elongation in the Rolling Diaphragm Seal Under Cyclic Pressure Loading," Proc. Joint Automatic Control Conf., pp. 539-548, Univ. Texas, Austin, TX.
- 1974 bu Phillips, J.B., Reid, T.J., "An Investigation of the Effect of an Exhaust Gas Recuperator on the Performance of a Stirling Engine," Project Report No. 278, Sch. Engineering, Univ. of Bath, U.K.
- 1974 bv Schroeder, J., "Thermal Energy Storage and Control," ASME, Paper No. 74/WA/Oct-1, New York, Nov., 1978. *
- 1974 bw Sternlicht, B., "Which Automotive Engines in the Future," ASME, New York.
- 1974 bx Walker, G., "Optimization of Stirling Engines," The Big Byte, Vol. 7, No. 1, pp. 1-8, Univ. of Calgary, Jan.
- 1974 by Lindsley, E. F. "Revolutionary On-Site Energy Source for Your Home". Pop. Sci. 205 (Oct.): 83-5, 1962. 1974.
- 1974 bz "Stirling Engine Run On Stored Heat". Auto. Eng. 82: 18-20.
- 1974 ca Lamm, M. "Hot Air Fra: Ericsson's Hot Air Engine". Am. His. Illustrated. 9 (Oct.): 18-23.
- 1974 cc Rochelle, P., Andrejewski, J., "Optimisation des Cycles A Rendement Maximal". Revue de L'Institut Francais de Petrole. Sept.-Oct. 1974.

- 1975 a Doody, R.D., "Long Life, High Capacity Vuilleumier Refrigerator for Space Applications," Air Force Flight Dynamics Laboratory, No. AFFDL-TR-75-108, September, 1975. *
- 1975 b Pitcher, G.K., "Spacecraft Vuilleumier Cryogenic Refrigerator Development," Air Force Flight Dynamics Laboratory, No. AFFDL-TR-75-114, September, 1975. *
- 1975 c "Stirling Pump for India," Atom, No. 227, September, 1975. *
- 1975 d Zarinchang, J., "Some Considerations on Design of Stirling Engine," 1975 IECEC Record, Paper No. 759142, pp. 948-957.*
- 1975 e Wurm, J., "Assessment of Selected Engine-Driven Heat Pumps," Solar Energy Heat Pump Systems for Heating and Cooling Buildings, pp. 195-200, Con. No. 7506130-2560-1, June, 1975. *
- 1975 f Bierman, U.K.P., "The Lithium/Sulphurhexafluoride Heat Source in Combination with a Stirling Engine as an Environmental Independent Underwater Propulsion System," 1975 IECEC Record, Paper No. 759153, pp. 1023-1030. *
- 1975 g von Reth, R.D., Haerten, R., Nemsman, U., Henning, E., and Bucherl, E.S., "Development of Power Sources for Blood Pump Applications," 1975 IECEC Record, Paper No. 759180, pp. 1214 - 1222. *
- 1975 h van der Sluys, W.L.N., "A Lithium/Sodium/Sulphurhexafluoride Heat Source in Combination with a Stirling Engine as a Propulsion System for Small Submersibles," 1975 IECEC Record, Paper No. 759154, pp. 1031-1037. *
- 1975 i Organ, A.J., "The Concept of 'Critical Length Ratio' in Heat Exchangers for Stirling Cycle Machines," 1975 IECEC Record, Paper No. 759151, pp. 1012-1019. *
- 1975 j Gabrielsson, R.G., and Lia, T.A., "Low Emission Combustors for Stirling Engines," 1975 IECEC Record, Paper No. 759139, pp. 927-932. *
- 1975 k Dunn, P.D., Rice, G., and Thring, R.H., "Hydraulic and Rotary Drive Stirling Engines with Fluidised Bed Combustion/Heat Pipe System," 1975 IECEC Record, Paper No. 759141, pp. 942-947.*
- 1975 l Cooke-Yarborough, E.H., and Yeats, F.W., "Efficient Thermo-Mechanical Generation of Electricity from the Heat of Radioisotopes," 1975 IECEC Record, Paper No. 759150, pp. 1003-1011. *
- 1975 m Spigt, C.L., and Daniels, A., "The Phillips Stirling Engine: A Progress Report," 1975 IECEC Record, No. 759138, pp. 919-926. *

- 1975 n Beale, W.T., and Rankin, C.F., "A 100 Watt Stirling Electric Generator for Solar of Solid Fuel Heat Sources," 1975 IECEC Record, Paper No. 759152, pp. 1020-1022. *
- 1975 o Rauch, J.S., "Steady State Analysis of Free-Piston Stirling Engine Dynamics," 1975 IECEC Record, Paper No. 759144, pp. 961-965. *
- 1975 p Moise, J.C., Rudnicki, M.I., and Faeser, R.J., "Thermocompressor Powered Artificial Heart Assist System," 1975 IECEC Record, Paper No. 759183, pp. 1242-1245. *
- 1975 q Martini, W.R., "An Efficient Stirling Heat Engine-Heat Pump," Solar Energy Heat Pump Systems for Heating and Cooling Buildings, CON. No. 7506130-2560-1, pp. 201-206, June, 1975. *
- 1975 r Johnston, R.P., Noble, J.E., Emigh, S.G., White, M.A., Griffith, W.R., and Perrone, R.E., "A Stirling Engine with Hydraulic Power Output for Powering Artificial Hearts," 1975 IECEC Record, Paper No. 759212, pp. 1448-1455. *
- 1975 s Beale, W.T., "A Stirling-Hydrostatic Drive for Small Vehicles," 1975 IECEC Record, Paper No. 759143, pp. 958-960. *
- 1975 t Stephenson, R.R., "Should We Have a New Engine?" Jet Propulsion Lab., An Automobile Power Systems Evaluation, Volume II: Tech. Repts., October, 1975 or SAE Spec. Publ. SP399, SP400, Vol. I & II, August 1975*
- 1975 u Fisher, D. "Gas Turbine, Stirling Engine Favored," Los Angeles Times, September 4, 1975. *
- 1975 v Schuman, M., "Energy Converter Utilizing a Modified Stirling Cycle," April, 1975. *
- 1975 w Urieli, I., and Rallis, C.J., "Stirling Cycle Engine Development - A Review," University of Witwatersrand, Johannesburg, So. Africa, No. 61, July, 1975. *
- 1975 x vacant
- 1975 y Cooke-Yarborough, E.H., and Yeats, F.W., "Efficient Thermo-Mechanical Generation of Electricity from the Heat of Radioisotopes," Harwell, No. AERE-R 8036, May, 1975. *
- 1975 z Scott, D., "Flame-Powered Push-Pull Generator Runs a Year Without Maintenance, Refueling," Popular Science, Feb. 1975, pp. 82-82 & 134*
- 1975 aa "British Device Runs TV on Propane Gas," New York Times, June 12, 1975. *

- 1975 ab Pouchot, W. D., Bifano, N. J., Hanson, J. P., and Lehrfeld, D., "Artificial Heart System Thermal Converter and Blood Pump Component Research and Development". 1975 IECEC Record, Paper No. 759181, pp. 1223-1231. *
- 1975 ac Crouthamel, M.S., and Shelpuk, B., "Regenerative Gas Cycle Air Conditioning Using Solar Energy," Advanced Technology Laboratories, No. ATL-CR-75-10, August, 1975. *
- 1975 ad Scott, D., "Stirling-Cycle Liquid-Piston Engine with no Moving Parts," Popular Science, January, 1975, pp. 70-71 cont. *
- 1975 ae Kettler, J.R., "The Thermal Vehicle - A Pollution Free Concept," 1975 IECEC Record, Paper No. 759084, pp. 548-553. *
- 1975 af Summers, J.L., "Hot Gas Machine," United States Patent 3,879,945, April 29, 1975. *
- 1975 ag Martini, W.R., "The Free-Displacer, Free-Piston Stirling Engine-- Potential Energy Converter," 1975 IECEC Record, Paper No. 759149, pp. 995-1002. *
- 1975 ah Higa, W.H., "Stirling Cycle Engine and Refrigeration Systems," Patent Application, 5 May 1975 (NASA-NPO-13613-1).*
- 1975 ai Hagen, K.G., Ruggles, A.E., Fam, S.S., and Torti, V.A., "Annular Tidal Regenerator Engine for Nuclear Circulatory Support Systems," 1975 IECEC Record, Paper No. 759182, pp. 1232-1241. *
- 1975 aj Grigorenko, N.M., Savchenko, V.I., and Prusman, Yu. O., "Results of Test of a Heat-Using Cryogenic Machine," Khim. and Neft. Mashinostr, U.S.S.R., Vol. 11, No. 9, September, 1975.
- 1975 ak Lyapin, V.I., Prusman, Yu. O., and Bakhnev, V.G., "Effect of Efficiency of the End Heat Exchanger on the Start-Up Period of a Helium Cooler," Khim. and Neft. Mashinostr, U.S.S.R., Vol. 11, No. 9, September, 1975.
- 1975 al Finkelstein, T., "Computer Analysis of Stirling Engines," Advances in Cryogenic Engineering, Vol. 20, pp. 269-282, 1975 or 1975 IECEC Record, Paper No. 759140, pp. 933-941. *
- 1975 am Bjerklie, J.W., Cairns, E.J., Tobias, C.W., and Wilson, D.G., "Alternative Power Sources for Low Emission Automobiles," Automotive Eng., Vol. 83, No. 10, Oct., 1975, or SAE Paper 750929. *
- 1975 an Patterson, M.F., Webster, D.J., Spragge, J.O., "Improved Multilayer Insulation for Compact High Temperature Power Source," 1975 IECEC Record, pp. 1554 to 1557. *

- 1975 ao Garrett, K., "Stirling Engine is a Hot Contender for Car Powerplants," Engineer, Vol. 240, No. 6208, March, 1975. *
- 1975 ap Mortimer, J., "Low Cost, Long Life (Stirling) Engine May be Ideal for the Third World," Engineer, Vol. 240, No. 6208, March, 1975. *
- 1975 aq Wilson, S.S., "Possible Developments in Transportation," Aspects of Energy Conversion, Proc. of a Summer School, Lincoln Coll., Oxford, Engl., July 14-25, 1975.
- 1975 ar "Alternative Automotive Power Plants," Automotive Engineering, Vol. 83, No. 12, pp. 18-23, 57, Dec. 1975. *
- 1975 as Grigorenko, N.M., Savchenko, V.I., and Prusman, Yu. O., "Results of Test of a Heat-Using Cryogenic Machine," Chem. Pet. Eng., Vol. 11, No. 9-10, Sept.,-Oct., 1975.
- 1975 at Balkan, S., "Thermal Energy Storage Systems for Pollutant-Free Operation of Automobiles," Ver. Dsch. Ing., Vol. 117, No. 9, pp. 422-429 (in German). *
- 1975 au Andrus, S., Faeser, R.J., Moise, J., Hoffman, L.C., and Rudnicki, M.E., "Development and Evaluation of a Stirling Powered Cardiac Assist System," Aerojet Liquid Rocket Co., Annual Rept. No. N01-HV-3-2930, May, 1974-June, 1975.
- 1975 av Biryukov, V.I., and Sergeev, P.V., "Synthesis of Three-Parameter Mechanisms of the Rhombic Drive of a Stirling Engine," Izv Vyssh Uchevn Zaved Mashinostr, No. 11, pp. 70-76, 1975.
- 1975 aw Shah, R.K., "A Correlation for Longitudinal Heat Conduction Effects in Periodic-Flow Heat Exchangers," Journal of Engineering for Power, pp. 453-454, July, 1975. *
- 1975 ax Mott, W.E., "Nuclear Power for the Artificial Heart," Biomater. Med. Dev. Artif. Organs, Vol. 3, No. 2, pp. 181-191, 1975.
- 1975 ay Balas, C., Jr., "Design and Fabrication of a Rhombic Drive Stirling Cycle Cryogenic Refrigerator," Philips Labs, Final Rept. No. DAAK02-72-C-0224, April, 1975.
- 1975 az Carlqvist, S.G., Lia, T., and Lundholm, G.S.K., "Stirling Engines: Their Potential Use in Commercial Vehicles and Their Impact on Fuel Utilization," Inst. Mech. Eng., Paper C4/75, pp. 35-46, 1975. *
- 1975 ba Smith, L., Sandquist, G., Olsen, D.B., Arnett, G., Gentry, S., and Kolff, W.J., "Power Requirements for the A.E.C., Artificial Heart," Trans. Amer. Soc. Artif. Int. Organs, Vol. XXI, pp. 540-544, 1975.*

- 1975 bb Linden, L.H., Heywood, J.B., Jacoby, H.D., and Margolis, H., "Federal Support for the Development of Alternative Automotive Power Systems: The General Issue and the Stirling, Diesel, and Electric Cases," Mass. Inst. of Tech., Final Report No. MIT-EL-76-014, November, 1975.
- 1975 bc Bougard, J., "Importance of Kinematics in the Stirling Engines," Rev. M. Mec., Vol. 21, No. 2, June-July, 1975, pages 185-190 (Belgium).
- 1975 bd Mullins, P.J., "Progress on the Stirling Engine," Automot. Ind., Vol. 152, No. 3, pp. 32-34, February 1, 1975. *
- 1975 be Johnston, R.P., Emigh, S.G., Griffith, W.R., Noble, J.E., and Perrone, R.E., "Implanted Energy Conversion System," McDonnell Douglas Astronautics Co., Annual Rept. No. MDC-G4444, July 23, 1974-May 1, 1975. *
- 1975 bf Smith, J.L., Jr., "Development of the Valved Hot-Gas Engine," Department of Transportation, Final Report, No. DOT-TST-76-34, August, 1975. *
- 1975 bg Senft, J.R., "Moriya, A 10-inch Stirling Engine Powered Fan," Live Steam Magazine, pp. 28-29, January, 1975, Part II, pp. 8-10, February, 1975, Part III. *
- 1975 bh Beale, W. T., "Stirling Engines for Developing Countries." Appendix to "Energy for Rur Development" Published by National Academy of Science. (Appendix available from Sunpower, Inc.)*
- 1975 bi Dark, H.E., Auto Engines of Tomorrow: Power Alternatives for Cars to Come," Indiana Univer. Press, Bloomington, Ind.
- 1975 bj Debono, A.N., "A Swash-Plate Hot Air Engine," Model Engineer, Vol. 141, No. 3521, p. 905 et. seq., September 19, 1975.
- 1975 bk Hakansson, S.A.S., "Multicylinder Double-Acting Stirling Cycle Engines," U.S. Patent 3,927,529, December 23, 1975. *
- 1975 bl Hallare, B., "Stirlingmotorn i undervattenstjanst," Industriell. Teknik, Vol. 7-8, pp. 48-51.
- 1975 bm Harrewijne, A., Michels, A.P.J., Gasseling, F.W.E., "Device for Converting Heat Energy into Mechanical Energy," German Patent 2,427,819, Jan. 9, 1975.
- 1975 bn Jaspers, H.A., "Power-Control System for Stirling Engines," U.S. Patent 3,886,744, June 3, 1975.
- 1975 bo Laing, N., Weg, H., "Thermal Power Plant," U.S. Patent 3,894,395, July 15, 1975.*

- 1975 bp Leeder, W., "Simple and Cheap Heat Pump for Heating," German Patent No. 2,360,585.
- 1975 bq Liang, C.Y., Yang, W.J., "Modified Single-Blow Technique for Performance Evaluation on Heat Transfer Surfaces," J. Heat Transfer, Trans ASME, Vol. 97, Ser. C, No. 1, pp. 16-21, February, 1975.
- 1975 br Nystroem, P.H.G., "Method and System to Control the Output of a Stirling Motor," German Patent 2,449, 742, April 24, 1975.
- 1975 bs Postma, N.P., "Review of Ford/Philips Program," Highway Vehicle System Contractors Coordination Meeting, E.R.D.A., Washington, D.C.
- 1975 bt Raab, B., Schock A., King, W.G., "Nuclear Heat Source for Cryogenic Refrigerators in Space," 1975 IECEC Record, pp. 894-900. *
- 1975 bu Raetz, K., "Stirling Heat Pump for Heating," German Patent 2,400,256, July 17. *
- 1975 bv Automotive Power Systems Contractors Coordination Meeting, Ann Arbor, MI, May 6-8, 1975 (8th Summary Report), ERDA-64. *
- 1975 bw "What Price New Engine Designs," New Sci, Jan., 1975.
- 1975 bx Benson, G.M., "Thermal Oscillators," U.S. Patent No. 3,928,974, December 30, 1975. *
- 1975 by Bergman, U.C., "Stirling Engine Power Control Means," U.S. Patent 3,914,940, October 28, 1975. *
- 1975 bz Brogan, J.J., "United States Research and Development Program," NATO Committee on the Challenges of Modern Society (ERDA), Washington, D. C.
- 1975 ca Burwell, C.C., "Is the Energy Problem Solvable?" ORNL, Tenn.
- 1975 cb Svedberg, R.C., Buckman, R.W., Jr., "Artificial Heart System Thermal Insulation Component Development," 1975 IECEC Record, P. 1489-1495. *
- 1975 cc Tipler, W., "Energy Economics of Automotive Power Generation," Soc. of Auto Eng., Inc., New York.
- 1975 cd Urwick, W.D., "Hot Air Engines - The Regenerator," Model Engineer, Vol. 141, 3506, p. 140, February 7, (part I); Vol. 141, No. 3507, p. 179, February 21, (part II).
- 1975 ce Kim, J. D., "Heat Transfer and flow-friction Characteristics in periodically Reversing Flow for Thermal Regenerators," Paper HI1.7 pp. 185-189 (publication unknown). *
- 1975 cf Beale, W. T., "The Free Piston Stirling Engine" From Sunpower, Inc. (See directory). *

- 1976 a Ross, M.A., "Stirling Performance," The Columbus Dispatch Magazine, July 18, 1976. *
- 1976 b Ross, M.A., "A Rhombic Drive Stirling Engine," Model Engineer, pp. 760-762, 796-799, 820, August 6 and August 20, 1976. *
- 1976 c Polster, N.E., and Martini, W.R., "Self-Starting, Intrinsically Controlled Stirling Engine," 1976 IECEC Record pp. 1511-1518 Eratta from authors.*
- 1976 d Flint, J., "Stirling Engine: Can An Old Failure Spell Success?" New York Times, 1976. *
- 1976 e Michels, A.P.J., "The Philips Stirling Engine: A Study of Its Efficiency as a Function of Operating Temperatures and Working Fluids," 1976 IECEC Record 769258, pp. 1506-1510. *
- 1976 f Asselman, G.A.A., "Fluidised Bed Coal Combustion as a Heat Source for Stirling Engines," Presented as discussion at 1975 IECEC, not in record.*
- 1976 g "Ford Shows Latest Stirling," Machine Design, June, 1976. *
- 1976 h Organ, A.J., "Fluid Particle Trajectories in Stirling Cycle Machines," Private communication, January 1976. *
- 1976 i Ureili, I., and Rallis, C.J., "A New Regenerator Mod l for Stirling Cycle Machines," University of the Witwatersrand, School of Mechanical Engineering, Report No. 67, May, 1976. *
- 1976 j "Stirling Isotope Power System Program," General Electric Company, Document No. GESP-7130, June-December, 1976. *
- 1976 k West, C.D., "Solar Power and the Stirling Engine," Solar Energy Digest, pp. 4-6, March, 1976. *
- 1976 l White, R., "Vuilleumier Cycle Cryogenic Refrigeration," AFFDL-TR-76-17, April, 1976. *
- 1976 m "Stirling Cycle Applied to Water Pump," Solar Energy Digest, p. 8, September, 1976. *
- 1976 n Senft, J.R., "The Design of Stirling Cycle Engines," Live Steam Magazine, Part I, Pages 9-12, November, 1976, Part II pp. 9-12 December, 1976. *
- 1976 o Weimer, G.A., "Stirling Engine: Solution to the U.S. Auto Dilemma?" Iron Age, November 22, 1976. *
- 1976 p Polster, N.E., "Hot Gas Engine," United States Patent 3,994,136, November 30, 1976. *

- 1976 q Lowe, J.F., "Liquid Piston Oscillates Naturally," Design News, Vol. 32, February 23, 1976. *
- 1976 r Johnston, R.P., "System 6 Performance Test Report," McDonnell-Douglas Astronautics Co., Report No. MDC G4445, March, 1976. *
- 1976 s "Century-Old Engine Pumps Heart," New York Times, Sunday, December 5, 1976. *
- 1976 t Noble, J.E., Riggle, P., Emigh, S.G., and Martini, W.R., "Heat Engine," United States Patent 3,949,554, April 13, 1976, *
- 1976 u Noble, J.E., Riggle, P., Emigh, S.G., and Martini, W.R., "Heat Engine," United States Patent 3,956,895, May 18, 1976. *
- 1976 v Johnston, R.P., "Proposal to Continue Developing and Evaluating a Modified Stirling Cycle Engine," McDonnell Douglas Astronautics Co., Vol. 3, Annual Report Draft, No. MDC G4448P, May, 1976. *
- 1976 w Andersen, N.E., "Optimeringsmodel for Stirlingmotor," Laboratoriet for Energiteknik, November 1976. *
- 1976 x Kern, J., "On the Average Transfer Coefficient in Periodic Heat Exchange - I, II," Inst. J. Heat Mass Transfer, Vol. 19, pp. 869-892, 1976. *
- 1976 y Rallis, C.J. and Urieli, I., "Optimum Compression Ratios of Stirling Cycle Machines," University of Witwatersrand, Report No. 68, ISBN-0-85494-395-1, 17 p., June, 1976. *
- 1976 z "A Simplified Heat Engine (With Pneumatic System)," Compressed Air, Vol. 81, No. 9, Sept., 1976. *
- 1976 aa Janicki, E., "Which Auto Engine Next?" Automotive Engineer, Vol. 1, No. 7, October, November, 1976.
- 1976 ab Pron'ko, V.G., Ammamchyan, R.G., Guilman, I.I., and Raygorodsky, A.E., "Some Problems of Using Adsorbents as a Matrix Material for Low-Temperature Regenerators of Cryogenic Refrigerators," May, 1976.
- 1976 ac Koizumi, I., "Development of Stirling Engines," J. Jap. Soc. Mech. Eng., Vol. 79, No. 693, August, 1976.
- 1976 ad Mortimer, J., "Alternative Engines for Tomorrow's Car," Engineer, Vol. 242, No. 6269, May, 1976. *
- 1976 ae Fosdick, R.J., "Engine Development - No Overnight Happening," Automot. Ind., Vol. 154, No. 4, February, 1976. *

- 1976 af "Swedish Stirling Seen as Diesel Replacement". 1976 Auto. Eng. 84: 18-21.
- 1976 ag Schock, A., "Isotope Heat Source for Dynamic Power Systems," 1976 IECEC Record 769198, pp. 1136-1138. *
- 1976 ah Gratch, "Advanced Automotive Propulsion: An Overview," 1976 IECEC Record, Vol. 1, pp. 2-5. *
- 1976 ai Tomazic, W.A., "Alternative General-Aircraft Engines," Aircraft Piston Eng. Exhaust Emissions Symp., pp. 315-328, NASA, N77-17081, Sept. 1976. Also NASA-CP-2005. *
- 1976 aj Pouchot, W.D., Lehrfeld, D., "Nuclear-Powered Artificial Heart System," 1976 IECEC Record, pp. 157-162. *
- 1976 ak Byer, R.L., "Initial Experiments with a Laser Driven Stirling Engine," NASA-SP-395, Conf. on Laser Energy Conversion, pp. 181-188, 1976. *
- 1976 al Moise, J.C., Faeser, R.J., and Russo, V.F., "Thermocompressor Powered Artificial Heart Assist System," 1976 IECEC Record, Paper No. 769024, pp. 150-156. *
- 1976 am Pouchot, W.D., and Lehrfeld, D., "Nuclear-Powered Artificial Heart System," 1976 IECEC Record, Paper No. 769025, pp. 157-162. *
- 1976 an "Alternative Powerplants and Energy Conservation," Automotive Engr., Vol. 84, No. 3, March, 1976. *
- 1976 ao Garbuny, M., and Pechersky, M.J., "Laser Engines Operating by Resonance Absorption," Appl. Opt., Vol. 15, No. 5, May, 1976. *
- 1976 ap Garbuny, M., and Pechersky, M.J., "Optimization of Engines Operated Remotely by Laser Power," Conf. on Laser Energy Conversion, NASA SP-395, pp. 173-180, 1976.*
- 1976 aq Andrus, S., Carriker, W., Faeser, R.J., Helwig, J.W., and Hoffman, L.C., "Development and Evaluation of a Pneumatic Left Ventricle Assist System," Aerojet Liquid Rocket Co., Rept. No. 9280-430-76, May, 1976.
- 1976 ar Higa, W.H., Fletcher, J.C., "Stirling Cycle Engine and Refrigeration Systems". United States Patent 3,971,230, July 27, 1976. *
- 1976 as Johnston, R.P., Bakker, L.P., Bennett, A., Blair, C.R., and Emigh, S.G., "Implanted Energy Conversion System," McDonnell Douglas Astronautics Co., Annual Rept. No. MDC-G4448, May 1, 1975-June 30, 1976. *

- 1976 at Asselman, G.A.A., "Thermal Energy Storage Unit Based on Lithium Floride," Energy Conversion Vol. 16, pages 35-47, 1976. *
- 1976 au Kolff, J., Sandquist, G., Smith, L.M., and Olsen, D.B., "The Nuclear Heart," Resident & Staff Physician, December, 1976. *
- 1976 av Umarov, G. Ya., Trukhov, V.S., Tursenbaev, I.A., and Orunov, B.B., "Method of Optimizing Heat Exchangers for a Stirling Engine," Geliotekhnika, No. 6, pp. 18-23, (in Russian), 1976.*
- 1976 aw Umarov, G.Ya., Orunov, B.B., Kliuchevskii, Ya.E., Tursunbaev, I.A., and Trukhov, V.A., "Thermodynamic Analysis and Selection of Optimal Parameters of a Dynamic Converter for a Solar Energy Set-Up -- Utilizing Stirling Engine," Geliotekhnika, No. 5, pp. 31-34, (in Russian), 1976. *
- 1976 ax Burn, K.S., and Walker, G., "Exploratory Study of the Rainbow Variant Stirling Cycle Engine," 1976 IECEC Record, Paper No. 769262, pp. 1519-1522. *
- 1976 ay Johnston, R.P., Bennett, A., Emigh, S.G., Griffith, W.R., Noble, J.E., Perrone, R.E., White, M.A., Martini, W.R., and Niccoli, L.G., "Stirling/Hydraulic Power Source for Artificial Hearts," 1976 IECEC Record, Paper No. 769023, pp. 143-149. *
- 1976 az "Monthly Technical Progress Report," Mechanical Technology Inc., Nos. 16 & 17, November & December, 1976. *
- 1976 ba Pedroso, R.I., "The Stirling Engine -- Engineering Considerations in View of Future Needs," 1976 IECEC Record, Paper No. 769257, pp. 1498-1505. *
- 1976 bb Percival, W.H., "Stirling Cycle Engines," 1976 IECEC Record, pp. 1496-1497. *
- 1976 bc Watelet, R.P., Ruggles, A.E., and Torti, V., "Status of the Tidal Regenerator Engine for Nuclear Circulatory Support Systems," 1976 IECEC Record, Paper No. 769022, pp. 136-142. *
- 1976 bd Beale, W. T. "Free Piston Stirling Engines" Notes for UCLA Short Course - Stirling Engines. (Available from Sunpower, Inc., see directory.)*
- 1976 be Huebner, G.J., Jr., "Future Automotive Power Plants," SAE Publication No. SP-409.*
- 1976 bf Schultz, R.B., "Ceramics in the ERDA Highway Vehicle Heat Engine Systems Program," SAE Paper 760238. *

- 1976 bg Begg, W., "A Hot Air Engine with Rhombic Drive," Model Engineer, Vol. 142 No. 3533, page 296 et. seq., Mar. 19, 1976 (Part I), Vol. 142, No. 3334, page 349 et seq., April 2, 1976, (Part II).
- 1976 bh Chaddock, D.H., "The Hot Air Engine Competition," Model Engineer, Vol. 142, No. 3545, page 915 et seq. Sept. 17, 1976.
- 1976 bi Colosimo, D.D., "On-Site Heat Activated Heat Pumps," Tech. Opportunities for Energy Conservation in Appliances, Boston, Mass., May 11, 1976.
- 1976 bj Kelly, D.A., "Rotary Closed Parallel Cycle Engine Systems," U.S. Patent No. 3,958,421, May 25, 1976. *
- 1976 bk Kelly, D.A., "Rotary Stirling Cycle Engine Systems," U.S. Patent 3,958,422, May 25, 1976.*
- 1976 bl Lee, F.Y. Computer Simulation of Stirling Engines, M.Sc. Thesis, University of Calgary, Canada. *
- 1976 bm Lee, K., "Progress Report on Valved Hot Gas Engine," Private Communication from J.L. Smith, MIT, November, 1976. *
- 1976 bn Postma, N.P., "Stirling Engine Program," Highway Vehicle System Contractors Meeting, E.R.D.A., Washington, D.C.
- 1976 bo Redshaw, C.G., "Rotary Stirling Engine," U.S. Patent 3,984,981, October 12, 1978.
- 1976 bp Cummins, C. L. Jr. Internal Fire. Carnot Press, Lake Oswego, Ore. 14-27.
- 1976 bq Pedroso, R. I. "Stirling Cycle Solar Cooling System". From Solar Cooling and Heating Forum, Miami Beach, FL USA (13 Dec. 1976)
- 1976 br Thirring, H. Energy for Man. Harper and Row, New York. 93-112. 1976.
- 1976 bs "Variable Speed Stirling Engine Takes the Prize". The Engineer. 242 (Mar 11): 13. 1976.
- 1976 bt Van Beukering, H. C. J. "Stirling Engines for Passenger Cars: Modern Developments and Potential Future Applications". pp. 159-167 of Power plants and future fuels. London. England: Institution of Mechanical Engineers (1976).

- 1977 a Benson, G.M., "Thermal Oscillators," 1977 IECEC Record, Paper No. 779247, pp. 1478-1487. *
- 1977 b Goldwater, B., Piller, S., Rauch, J., and Cella, A., "Demonstration of a Free Piston Stirling Engine Driven Linear Alternator," Phase I Report No. 77TR40, Mechanical Technology, Inc., March 30, 1977. *
- 1977 c Goldberg, L.F., Rallis, C.J., Bell, A.J., and Urieli, I., "Some Experimental Results on Laboratory Model Fluidyne Engines," 1977 IECEC Record, Paper No. 779255, pp. 1528-1533. *
- 1977 d Urieli, I., Rallis, C.J., and Berchowicz, D.M., "Computer Simulation of Stirling Cycle Machines," 1977 IECEC Record, Paper No. 779252, pp. 1512-1521. *
- 1977 e Rallis, C.J., Urieli, I., and Berchowicz, D.M., "A New Ported Constant Volume External Heat Supply Regenerative Cycle," 1977 IECEC Record, Paper No. 779256, pp. 1534-1537. *
- 1977 f Lehrfeld, D., "Practicability Study of Stirling Total Energy Systems," 1977 IECEC Record, Paper No. 779251, pp. 1504-1511. *
- 1977 g Berchowicz, D.M., Rallis, C.J., and Urieli, I., "A New Mathematical Model for Stirling Cycle Machine," 1977 IECEC Record, Paper No. 779254, pp. 1522-1527. *
- 1977 h Martini, W.R., Hauser, S.G., and Martini, M.W., "Experimental and Computational Evaluations of Isothermalized Stirling Engines," 1977 IECEC Record, Paper No. 779250, pp. 1496-1503. *
- 1977 i Rosenqvist, N.K.G., Gummesson, S.G., and Lundholm, S.G.K., "The Development of a 150 kw (200 hp) Stirling Engine for Medium Duty Automotive Application -- A Status Report," SAE Paper No. 770081,*
- 1977 j "The Swedish Stirling Engine Development," Kommanditbolaget, United Stirling, BI.16.3000 12.76, 1977. *
- 1977 k Kitzner, E.W., "Stirling Engine Program," Automotive Propulsion Systems Symposium, 20 April, 1977. *
- 1977 l Rahnke, C.J., and Vallance, J.K., "Reliability and Durability of Ceramic Regenerators in a Gas Turbine." ASME Paper No. 77-GT-59. March 1977. *
- 1977 m "Monthly Technical Progress Report," Mechanical Technology, Inc., Nos. 18-29, January-December 1977. *
- 1977 n Varney, F.M., "Solar Dome House and Automobile with Self-Contained Energy System," January, 1977. Personal Communication.*

- 1977 o Grossman, D.G., and Lanning, J.G., "Aluminous Keatite -- An Improved Rotary Ceramic Regenerator Core Material," ASME Paper 77-GT-60, 1977.*
- 1977 p Blankenship, C.P., and Schulz, R.B., "Opportunities for Ceramics in the ERDA/NASA Continuous Combustion Propulsion Systems Program," NASA, Paper No. TM X-73597, January 1977. *
- 1977 q Davoud, J.G., and Burke, J.A., "D-Cycle Vapor Stirling Engine," Abstract, Fourth Inter. Symp. on Auto. Prop. Systems, Vol. 3, April 20, 1977. *
- 1977 r Sarkes, L.A., Nicholls, J.A., and Menzer, M.S., "Gas-Fired Heat Pumps: An Emerging Technology," ASHRAE Journal, March, 1977. *
- 1977 s Goldwater, B., and Morrow, R.B., "Demonstration of a Free-Piston Stirling Linear Alternator Power Conversion System," 1977 IECEC Record, Paper No. 779249, pp. 1488-1495. *
- 1977 t Cooke-Yarborough, E.H., "A Data Buoy Powered by a Thermo-Mechanical Generator: Results of a Year's Operation at Sea," 1977 IECEC Record, Paper No. 779230, pp. 1370-1377. * also AERE-M 2886.
- 1977 u Benson, G.M., "Free-Piston Heat Pumps," 1977 IECEC Record, Paper No. 779068, pp. 416-425. *
- 1977 v Goldowsky, M., and Lehrfeld, D., "Artificial Heart Thermal Converter Component Research and Development," 1977 IECEC Record, Paper No. 779019, pp. 126-133. *
- 1977 w Auxer, W.L., "Development of a Stirling Engine Powered Heat Activated Heat Pump," 1977 IECEC Record, Paper 779065, pp. 397-401. *
- 1977 x Johnston, R.P., Bennett, A., Emigh, S.G., Griffith, W.R., Noble, J.E., Perrone, R.E., White, M.A., Martini, W.R., and Alexander, J.E., "Stirling/Hydraulic Artificial Heart Power Source," 1977 IECEC Record, Paper No. 779016, pp. 104-111. *
- 1977 y Boser, O., "Safety Considerations for High Temperature Thermal Energy Storage in Fluoride Salts," 1977 IECEC Record, Paper No. 779092, pp. 575-582. *
- 1977 z Organ, A.J., "The Use of Bulk Coefficients of Convective Heat Transfer in the Simulation of the Practical Stirling Cycle by Digital Computer," Kings College, London, Research Report, 1977. *
- 1977 aa Martini, W.R., "Stirling Engine Research Institute Newsletter," No. 1, February 1977. *

- 1977 ab Tomazic, W.A., and Cairelli, J.E., "Ceramic Applications in the Advanced Stirling Automotive Engine," Fifth Army Materials Technology Conference, March 21-25, 1977 ERDA/NASA 1011/77/2, NASA TMX-73632. *
- 1977 ac Selcuk, M.K., Wu, Y.C., Moynihan, P.I., and Day, F.D., "Solar Stirling Power Generation; Systems Analysis and Preliminary Tests," Jet Propulsion Laboratory, International Solar Energy Society Solar World Conference, Orlando, Florida, June 6-9, 1977. *
- 1977 ad Didion, D., Maxwell, B., and Ward, D., "A Laboratory Investigation of a Stirling Engine Driven Heat Pump," 1977 International Seminar on Heat Transfer in Buildings, Dubrovnik, Yugoslavia. *
- 1977 ae Finegold, J.G., and Vandergrug, T.G., "Stirling Engines for Undersea Vehicles," Final Report No. 5030-63, Jet Propulsion Laboratory, March, 1977. *
- 1977 af Urieli, I., "A Computer Simulation of Stirling Cycle Machines," Ph.D. Thesis, University of the Witwatersrand, Johannesburg, South Africa, February, 1977. *
- 1977 ag Chaddock, D.H., "The Hot Air Engine Competition - at the Wembley Model Engineer Exhibition," Model Engineer, May 20, 1977. *
- 1977 ah "The Vintage Stirling Makes a Comeback," Business Week, p. 84, June 27, 1977. *
- 1977 ai "Second Stirling Engine Development Team," Commerce Business Daily, No. PSA-6921, September 28, 1977. *
- 1977 aj Bledsoe, J.A., "Stirling Isotope Power System," Monthly Letter Reports, 1977. *
- 1977 ak Senft, J.R., Personal Communication, August 28, 1977. *
- 1977 al Carlqvist, S.G., Rosenqvist, K.G., and Gummesson, S.G., "Developing the Stirling Engine for Fuel Economy in Marine, Industrial and Medium Duty Automotive Applications," 12th Inter. Congress on Combustion Engines, Tokyo, May 22 to June 1, 1977. *
- 1977 am "Swedish Stirling Engine Development," United Stirling, 1977.*
- 1977 an Organ, A.J., "The Isothermal Stirling Cycle with Arbitrary Equation of State," Personal Communication, August 30, 1977.*
- 1977 ao Martini, W.R., "Survey of Stirling Engine Analytical Design Methods," Paper Presented at ERDA Highway Vehicle Systems Contractors' Coordination Meeting, October 4, 5, 6, 1977, Dearborn, Michigan.*

- 1977 ap "Ford Motor, U.S. Set Program to Develop Stirling Car Engine," Wall Street Journal, October 3, 1977.*
- 1977 aq "Stirling Engine Program," Paper Presented at ERDA Highway Vehicle Systems Contractors' Coordination Meeting, October 4, 5, 6, 1977, Dearborn, Michigan. *
- 1977 ar Folsom, L.R., Artiles, A.A., and Joyce, J.P., "Thermal Energy Storage/Heat Engine for Highway Vehicle Propulsion," Paper Presented at ERDA Highway Vehicle Systems Contractors' Coordination Meeting, October 4, 5, 6, 1977, Dearborn, Michigan.*
- 1977 as Ragsdale, R.G., "Stirling Engine Project Status," Paper Presented at ERDA Highway Vehicle Systems Contractors' Coordination Meeting, October 4,5,6, 1977, Dearborn, Michigan. *
- 1977 at Stephens, J.R., Witzke, W.R., Watson, G.K., and Johnston, J.R., "Materials Technology Assessment for Stirling Engines," Paper Presented at ERDA Highway Vehicle Systems Contractors' Coordination Meeting, October 4, 5, 6, 1977, Dearborn, Michigan. *
- 1977 au "Evaluation of Reciprocating Seals for Stirling Cycle Engine Application," Boeing Commercial Airplane Company, Paper Presented at ERDA Highway Vehicle Systems Contractors' Coordination Meeting, October 4, 5, 6, 1977, Dearborn, Michigan. *
- 1977 av Cairelli, J.E., and Thieme, L.G., "Initial Test Results with a Single Cylinder Rhombic Drive Stirling Engine," Paper Presented at ERDA Highway Vehicle Systems Contractors' Coordination Meeting, October 4, 5, 6, 1977, Dearborn, Michigan. *
- 1977 aw Clapham, E., "Hot Air Engine," Model Engineer, Part I, August 5, 1977, pp. 852-856, Part II August 19, 1977, pp. 908-912.*
- 1977 ax Balas, C., Leffel, C.S., and Wingate, C.A., "The Stirling Cycle Cooler: Approaching One Year of Maintenance-Free Life," Cryogenic Engineering Conference, Boulder, Colorado, August 2-5, 1977. *
- 1977 ay Rallis, C.J., "General Regenerative Cycle With Isothermal Compression and Expansion," Personal Communication, 1977. *
- 1977 az Rallis, C.J., "General Regenerative Cycle With Adiabatic Compression and Expansion," Personal Communication, 1977. *
- 1977 ba Organ, A.J., "Latent Pressure Waves in Stirling Cycle Machines," Kings College London, Dept. Mech. Engng., Research Report, Part 1, September, 1977. *

- 1977 bb Asselman, G.A.A., Spigt, C.L., and Meijer, R.J., "Design Considerations on a Thermal Energy Storage Stirling Engine Automobile," SAE Paper No. 770080. *
- 1977 bc Meijer, R.J., "Stirling Engine: Dark Horse?" IECEC Panel Discussion, August 29, 1977. *
- 1977 bd Valentine, H., Letter from NASA-Lewis July 26, 1977 and corrections to letter October 7, 1977. *
- 1977 be Hoffman, L., Personal Communication, August 17, 1977. *
- 1977 bf Senft, J.R., Personal Communication, October 14, 1977.*
- 1977 bg Bourne, R.J., "A New Stirling Engine Design," Model Engineer, pp. 497-499, May 6, 1977. *
- 1977 bh Collins, F.M., "A Pressurised Hot Air Engine," Model Engineer, pp. 822-825, July 15, 1977. *
- 1977 bi Urwick, W.D., "Stirling Engines: More Research and Development," Model Engineer, pp. 220-226, February 18, 1977.*
- 1977 bj Hallare, B., and Rosenqvist, K., "The Development of 40-150 KW Stirling Engines in Sweden and Their Application in Mining Equipment, Total Energy Systems and Road Vehicles," Presented at Fourth Inter. Symp. on Auto Prop. Systems., April 20, 1977.*
- 1977 bk Ledger, T. "Veteran Heat-Engine". Energy Book 2. ed. J. Prentis, Running Press, Philadelphia, 110-11. 1970.
- 1977 bl Tew, R., Personal Communication, October 7, 1977. *
- 1977 bm "DOE, Ford Sign Cost-Sharing Pact for Development of Stirling Engine," Energy Users Report, Bureau of National Affairs, Inc., No. 218, p. 26, October 13, 1977. *
- 1977 bn "Gas-Fired Heat Pump: The Coming Home Heater/Air Conditioner?" Machine Design, p. 8, October 6, 1977. *
- 1977 bo "Will the Stirling Engine Finally Get Out of the Garage?" Chemical Engineering, page 57, April 25, 1977. *
- 1977 bp Valentine, H., Personal Communication, November 23, 1977. *
- 1977 bq Berchowitz, D.M., Rallis, C.J., "The Schmidt Analysis," Lecture, University of Witwatersrand, July, 1977. *

- 1977 br Ross, A., "Stirling Cycle Engines," Solar Engines, Phoenix, Arizona, 85017.*
- 1977 bs Hauser, S.G., "The Use of Off-Peak Electrical Energy for Powering Automobiles in Richland, Washington," Personal Communication. *
- 1977 bt Zacharias, F., "Weiterentwicklungen Am Stirlingmotor," Motortechnische Zeitschrift, 38, Teil 1: S.371-377, Teil 2: S. 565-569. *
- 1977 bu Ross, A., "A Wax Pattern Die for a Finned Stirling Engine Heater," Personal Communication.*
- 1977 bv Senft, J.R., "Delta," Model Engineer, November 18, 1977, p. 1292 to 1295.*
- 1977 bw Volger, J., "Cryogenics: A Critical Review," Philips Tech. Review, 37, 91-106, 1977, No. 4. *
- 1977 bx Lehrfeld, D., "Stirling Total Energy Systems Study," DOE Report HCP/T-2947-0001 UC-93, August, 1977. *
- 1977 by Ford Motor Company Engineering and Research Staff, "Stirling Engine Feasibility Study of an 80-100 HP Engine and of Improvement Potential for Emissions and Fuel Economy," Final Report C00/2631-22, November, 1977. *
- 1977 bz Giessel, R. van Reinink, F., "Design of the 4-215 D.A. Automotive Stirling Engine," SAE Paper 77082.*
- 1977 ca Benson, G.M., "Thermal Oscillators," U.S. Patent No. 4,044,558.*
- 1977 cb Krasicki, B.R., Pierce, B.L., "Heat Transport Research and Development for Nuclear Powered Artificial Heart," 1977 IECEC Record, p. 119 to 125. *
- 1977 cc Martini, W.R., "Biomedical Power--A Progress Summary," 1977 IECEC Record, pp. 102-103. *
- 1977 cd Moise, J.C., Faeser, R.J., "Thermocompressor Powered Artificial Heart Assist System," 1977 IECEC Record, pp. 112 to 118. *
- 1977 ce Ross, A., "A Rider Stirling Engine," Model Eng., Vol. 143, No. 143, No. 3554, page 160, February 4.
- 1977 cf Koefoed, J., "Thermal Energy and Its Storage," Energy, Vol. 2, pp. 55-101. *
- 1977 cg Metwally, M., Walker, G., "Stirling Engines with a Chemically Reactive Working Fluid - Some Thermodynamic Effects," Trans. ASME, Eng. for Power, Vol. 99, No. 2, pp. 284-287, April. *

- 1977 ch Martini, W.R., "Stirling Engine Research Institute Newsletter," No. 2, April 1977.*
- 1977 ci Martini, W.R., "Stirling Engine Research Institute Newsletter," No. 3, June 1977. *
- 1977 cj Schulz, R.B., Blankenship, C.P., "Opportunities for Ceramics in the ERDA/NASA Continuous Combustion Propulsion Systems Program," CONF-770110-pp. 27-31. *
- 1977 ck "Development and Demonstration of a Stirling/Rankine Gas Activated Heat Pump." COO-2911-1 DOE Div of Buildings & Community Systems. Semiannual Report, January-June 1977. *
- 1977 cl Holgersson, S., Lia, T., and Gummesson, S., "Prospects of Ceramics in Stirling Engines". Diesel Engineering. Winter 1977 *
- 1977 cm "Stirling Cycle Engine-Owners Manual Model 1". Solar Engines. 1977. *
- 1977 cn Umarov, G. Ya., Soatov, F., Avezov, R. R., Sigalov, Y. M., Koryagin, N. I., "Development and Testing of Solar Water-Heater Boilers Fabricated by Diffusion Welding". Geliotekhnika. Vol. 13, No. 2, pp. 68-70, 1977. *
- 1977 co Umarov, G. Ya., Akramov, Kh. T., Razykov, T. M., Teshabaev, A. T., "Effect of Base Doping on the electrical and Photoelectric Properties of the Thin-Film Cu_2S -CDS Heterojunction". Applied Solar Energy. Vol. 13, 1977. *
- 1977 cp Umarov, G. Ya., Rabbimov, R. T., Baibutaev, K. B., Niyazov, Sh. K., "Temperature Field in Protective Soil With Heating Layers". Applied Solar Energy. Vol. 13, 1977. *
- 1977 cq Umarov, G. Ya.; Trykhov, V. S.; Klyuchevskii, Yu. E.; Orda, E.P.; Tursunbaev, I. A.; Vogulkin, N. P.; "Some Results of an Experimental Investigation of a Stirling Engine". Applied Solar Energy. vol. 13, 1977. *
- 1977 cr Umarov, G. Ya.; Avezov, R. R.; Niyazov, Sh. K.; "Determining Soil Surface Temperature Oscillation Amplitude and Amount of Solar Heat Accumulated in Unheated Protected Ground". Applied Solar Energy. Vol. 13, 1977. *
- 1977 cs "Energy Conversion Alternatives Study (ECAS)". NASA-Lewis for ERDA and N.S.F. Sept. 1977. *
- 1977 ct Zimmerman, J. E.; Flynn, T.M. "Applications of Closed-Cycle Cryocoolers to Small Superconducting Devices", NBS Special Publication 508, Oct. 3-4, 1977. *

- 1977 cu Godin, M.; Piar, G. "Hot Air Motors For Thermal Conversion of Solar Energy", Rev. Gen. Therm. 16: No. 188-189, 609-625 (Aug - Sept. 1977).
- 1977 cv "Plans Laid for Development of Stirling Engine". Design News. 33 (Nov. 21): 15. 1977.
- 1977 cw Ishizake, Y., Kamiyama, S., Hirata, M., Akiyama, M., Someya, T., "Study on the Stirling Engines", Annual Report of the Engineering Research Institute, Faculty of Engineering.

- 1978 a Hoehn, F.W., "Description of JPL Stirling Laboratory Research Engine," Private Communication, 4 January 1978."
- 1978 b Hoehn, F.W., "Stirling Laboratory Research Engine: Report on the Design and Fabrication of the Pre-Prototype Configuration," JPL Report 5030-178, 15 January 1978. *
- 1978 c Glassford, A.P.M., "A Closed-Form Adiabatic Cycle Analysis of the Valved Thermal Compressor." ASME Journal of Engineering for Power, (to be published).
- 1978 d Bledsoe, J.A., "Stirling Isotope Power System," Monthly reports prepared for DOE by G.E. in 1978. *
- 1978 e Beale, W.T., Letter to Editor of Solar Energy Digest, March, 1978, page 3. *
- 1978 f Walker, G., "Seminar Notes: Stirling Engines," University of Bath, England, May, 1978. *
- 1978 g Hoagland, L.E., Percival, W.A., "A Technology Evaluation of the Stirling Engine for Stationary Power Generation in the 500 to 2000 Horsepower Range," Report No. 78-2, AMTECH, Inc., Jan. 5, 1978. *
- 1978 h "U.S. Gives Contract for Stirling Engine Adaption to Autos," Wall St. Journal, Monday, March 27, 1978, p. 26. *
- 1978 i Mechanical Tech., Inc., "Monthly Technical Progress Report," Numbers 30-42. in 1978. *
- 1978 j A Schock, "Nodal Analysis of Stirling Cycle Devices," Preliminary Draft. *
- 1978 k "Highway Vehicle Systems Contractors Coordination Meeting," October 4-6, 1977, CONF-771037, Published March 1978.
- 1978 l Martini, W.R., "A Stirling Engine Design Analysis Manual," Presented at DOE Highway Vehicle Systems Contractors' Coordination Meeting, May 9-12, 1978, Troy, Michigan. *
- 1978 m Waters, E.D., "Sigma Research Conceptual Design of Thermal Energy Storage for a Stirling Engine Highway Vehicle," DOE Highway Vehicle Systems Contractors Coordination Meeting, May 9-12, 1978, Troy, MI.*
- 1978 n Organ, A.J., "Transient Response of the Miniature, Reversed Stirling Cycle Cryogenic Cooling Machine--An Empirical Approach," Research Rept., Dept. of Mech. Eng., King's College, London.
- 1978 o Martini, W.R., "A Simple Method of Calculating Stirling Engines for Optimization," 1978 IECEC Record. p. 1753-1762. *

- 1978 p Martini, W.R., "Energy Conversion in the Long Run," 1978 IECEC Record p. 1390-1399. *
- 1978 q Valentine, H., "GPU-3 Test Data," Personal Communication, May 1978. *
- 1978 r Marshall, W.F., "The Stirling Engine--An Option for Underground Mines," BERC/RT-78, March 1978, U.S. Tech. Info. Center. *
- 1978 s Berchowitz, D.M., "A Computer and Experimental Simulation of Stirling Cycle Machines," Master's Thesis, U. of Witwatersrand, So. Africa, March 1978. *
- 1978 t Meijer, R.J., Michels, A.P.J., "Advanced Automotive Stirling Concept," DOE-HVSCCM, May 9-12, 1978, Dist. by NASA-Lewis. *
- 1978 u Shiferli, J.W., "The Present Philips Program on the 4-215 DA Stirling Engine," DOE-HVSCCM, May 11, 1978. *
- 1978 v Krauter, A.I., "Analysis of Rod Seal Lubrication for Stirling Engine Application," DOE-HVSCCM, May 11, 1978. *
- 1978 w "Ford Automotive Stirling Development Program," DOE-HVSCCM, May 11, 1978. *
- 1978 x "MIT Stirling Engine Powertrain Development," DOE-HVSCCM, May 9-12, 1978. *
- 1978 y Ford Motor Co., "Automotive Stirling Engine Development Program," CONS/4396-1 NASA CR-135331, Quarterly Report, October, 1977, December, 1977, January 1978. *
- 1978 z Tomazic, W.A., "Lewis Research Center Stirling Engine Test Program," DOE-HVSCCM, May 9-12, 1978. *
- 1978 aa Unites Stirling, "In-Vehicle Stirling Engine Operation Experience," DOE-HVSCCM, May 9-12, 1978. *
- 1978 ab Valentine, H.H., "Stirling Engine Performance Analysis Development," DOE-HVSCCM, May 9-12, 1978. *
- 1978 ac "Thermo Electron Conceptual Design Study of Thermal Energy Storage for a Stirling Car," DOE-HVSCCM, May 9-12, 1978. *
- 1978 ad Martini, W.R., "Stirling Engine Design Manual," DOE/NASA/3152-78/1, NASA CR-135382, April, 1978. * NTIS No N78-23999
- 1978 ae Lindsley, E.F., "Go-Cycle AC from Sunshine; Solar Stirling Engine," Pop. Sci., June, 1978, pp. 74-77 (plus cover). *

- 1978 af General Electric Co., "Design Study of a General Purpose Stirling Test Engine," DOE-HVSCCM, May 9-12, 1978. *
- 1978 ag Ragsdale, R.G., Beremand, D.G., "Stirling Engine Project Status," DOE-HVSCCM, May 9-12, 1978. *
- 1978 ah Boeing Co., "Evaluation of Reciprocating Seals for Stirling Cycle Engine Application," DOE-HVSCCM, May 9-12, 1978. *
- 1978 ai Keith, T.G., Smith, P.J., "Pumping Ring Analysis," DOE-HVSCCM, May 9-12, 1978. *
- 1978 aj Yates, D., "Hydrogen Permeability of Ceramics and Metals," DOE-HVSCCM, May 9-12, 1978. *
- 1978 ak Stephens, J.R., "Stirling Materials Technology Program," DOE-HVSCCM, May 9-12, 1978. *
- 1978 al Finkelstein, T., "Balanced Compounding of Stirling Machines," 1978 IECEC Record, pp. 1791-1797. *
- 1978 am Berchowitz, D.M., Rallis, C.J., "A Computer and Experimental Simulation of Stirling Cycle Machines," 1978 IECEC Record, pp. 1730-1738. *
- 1978 an Fokker, H., Van Eekelen, J.A.M., "The Description of the Stirling Cycle in a Vector Diagram," 1978 IECEC Record, pp. 1739-1745. *
- 1978 ao Fokker, H., Van Eekelen, J.A.M., "Typical Phenomena of the Stirling Cycle as Encountered in a Numerical Approach," 1978 IECEC Record, pp. 1746-1752. *
- 1978 ap Reader, G.T., "The Pseudo-Stirling Cycle--A Suitable Performance Criterion?" 1978 IECEC Record, pp. 1763-1770.
- 1978 aq Schock, A., "Nodal Analysis of Stirling Cycle Devices," 1978 IECEC Record, pp. 1771-1779. *
- 1978 ar Urieli, I., "A Computer Simulation of the JPL Stirling Research Engine," 1978 IECEC Record, 1780-1783. *
- 1978 as Gedeon, D.R., "The Optimization of Stirling Cycle Machines," 1978 IECEC Record, pp. 1784-1790. *
- 1978 at Lee, K.P., Smith, J.L., Jr., "Influence of Cyclic Wall-to-Gas Heat Transfer in the Cylinders of the Valved Hot Gas Engine," 1978 IECEC Record, pp. 1798-1804. *
- 1978 au Hoehn, F.W., McDougal, A.R., "Design of a Preprototype Stirling Laboratory Research Engine," 1978 IECEC Record, pp. 1812-1819. *

- 1978 av Marusak, T.H., Chiu, W.S., "The Performance of a Free Piston Stirling Engine Coupled with a Free Piston Linear Compressor for a Heat Pump Application," 1978 IECEC Record, pp. 1820-1825. *
- 1978 aw Prast, G., de Jonge, A.K., "A Free Piston Stirling Engine for Small Solar Power Plants," 1978 IECEC Record, pp. 1826-1829. *
- 1978 ax Hermans, M.L., Asselman, G.A.A., "The Stirling Engine in Heat Pump Systems," 1978 IECEC Record, pp. 1830-1833. *
- 1978 ay Rice, G., Buckingham, J.F., Jr., "Conversion of a Standard Single Cylinder I.C. Engine into a Configuration Air Charged Stirling Engine," 1978 IECEC Record, pp. 1805-1811. *
- 1978 az Meijer, R.J., Michels, A.P.J., "A Variable Displacement Stirling Engine for Automotive Propulsion," 1978 IECEC Record, pp. 1834-1840. *
- 1978 ba Rauch, J.S., "A Free-Piston Stirling/Linear Alternator Demonstrator Engine," 1978 IECEC Record, pp. 1853-1857. *
- 1978 bb Wiley, R.L., Lehrfeld, D., "Development of a 1KW(e) Isotope Fueled Stirling Cycle Power System," 1978 IECEC Record, pp. 1858-1864. *
- 1978 bc Hoagland, L.C., Percival, W.H., "Potential of the Stirling Engine for Stationary Power Applications in the 500-2000 HP Range," 1978 IECEC Record, pp. 1865-1871. *
- 1978 bd Piller, S.J., "Status of Free-Piston Stirling Engine/Linear Alternator Power Conversion System Development," 1978 IECEC Record, pp. 1872-1877. *
- 1978 be Organ, A.J., "Mechanical Efficiency of a Rhombic-Drive Stirling Cycle Machine," 1978 IECEC Record, pp. 1841-1852. *
- 1978 bf "A Collection of Stirling Engine Reports from General Motors' Research - 1958-1970: Part 1.1-Model 3 Ground Power Units Design, Construction & Testing - Gov. Cont. Reports," GMR-2690. *
- 1978 bg "A Collection of Stirling Engine Reports from General Motors' Research - 1958-1970: Part 1.2-Model 3 Ground Power Units Design, Construction & Testing - Gov. Cont. Reports," GMR-2690. *
- 1978 bh "A Collection of Stirling Engine Reports from General Motors' Research - 1958-1970: Part 2-Stirling Cycle Analysis and Engine Design Studies - Gov. Cont. Repts.," GMR-2690. *
- 1978 bi "A Collection of Stirling Engine Reports from General Motors' Research - 1958-1970: Part 3-Stirling Engine Materials and Stresses - Gov. Cont. Repts.," GMR-2690. *

- 1978 bj "A Collection of Stirling Engine Reports from General Motors' Research - 1958-1970: Part 4-Piston Rod Seals - Gov. Cont. Rept." GMR-2690. *
- 1978 bk "A Collection of Stirling Engine Reports from General Motors' Research - 1958-1970: Part 5-Piston Seals - Gov. Cont. Rept.," GMR-2690. *
- 1978 bl "A Collection of Stirling Engine Reports from General Motors' Research - 1958-1970: Part 6-Regenerators - Gov. Cont. Repts.," GMR-2690. *
- 1978 bm "A Collection of Stirling Engine Reports from General Motors' Research - 1958-1970: Part 7-Thermal Energy Storage and Publication List - Gov. Cont. Repts," GMR-2690. *
- 1978 bn "Application of Solar Technology to Today's Energy Needs," Office of Technology Assessment U.S. Congress, OTA-E-66, June 1978. *
- 1978 bo "Stirling Engine Development" Mechanical Engineering, July 1978, p. 49. *
- 1978 bp Organ, A.J., "Latent Pressure Waves in Stirling Cycle Machines, Part II Boundary Conditions and Discretization Scheme," Kings College London Research Report. *
- 1978 bq Tew, R., "Martini Method Program and Results," Private communication from LeRC, 29 June 1978. *
- 1978 br Wilson, D.G., "Alternative Automobile Engines," Scientific American, Vol. 239, No. 1, p. 39-49, July 1978. *
- 1978 bs Walker, G., Ward, G.L., Slowley, J., "Operating Characteristics of a Small Stirling Engine," Private Communication, August, 1978. *
- 1978 bt Johnston, R.P., "Develop and Evaluate a Modified Stirling Engine," Quarterly Report, JCGS/REL 7808-209, August 1978. *
- 1978 bu Finegold, J.G., Scerrett, R.H., "Stirling Engine Regenerators Literature Review," JPL Report 5030-230, 15 July 1978. *
- 1978 bv "HVSCCM Final Report," Troy, Mich., May 1978. *
- 1978 bw "Review of Automobile Technology Status and Projections Project," HVSCCM May 1978. *
- 1978 bx Criddle, E.E., Gardner, C.L., Wake, S.J., "New Power Sources for a 14 ton Submersible," 1978 IECEC Record, p. 1208-1214. *
- 1978 by Richards, W.D. C., Auxer, W.L., "Performance of a Stirling Engine Powered Heat Activated Heat Pump," 1978 IECEC Record, p. 823-830. *

- 1978 bz Johnston, R.P. et al, "Miniature Long-Life Stirling Engine to Power an Artificial Heart," 1978 IECEC Record, p. 255-260. *
- 1978 ca Moise, J.C., et al, "Thermal and Electric Energy Converters Utilizing Fluid Controls Logic," 1978 IECEC Record, p. 250-254. *
- 1978 cb Johnston, R.P. et al, "Implanted Energy Conversion System," Report No. 1-HV-4-2901-5.*
- 1978 cc "Automotive Stirling Engine Development Program," CONS/4369-2, NASA, CR-159435 (Quarterly report Jan-Mar 1978). *
- 1978 cd Cairelli, J.E., Thieme, L.G., Walter, R.J., "Initial Test Results With a Single-Cylinder Rhombic-Drive Stirling Engine," DOE/NASA/1040-78/1, NASA TM-78919, July. *
- 1978 ce Tew, R., Jefferies, K., Miao, D., "A Stirling Engine Computer Model for Performance Calculations," DOE/NASA/1011-78/24, NASA TM-78884, July. *
- 1978 cf "Automotive Stirling Engine Development Program," MTI Quarterly Report No. F8ASE16QT1, August. *
- 1978 cg Kitzner, E.W., "Automotive Stirling Engine Development Program," Quarterly Report Oct.-Dec. 1977 C00-4396-1 Jan 1978. * (same as 1978 y but different report no.)
- 1978 ch Bragg, J.H., "Winnebago Combines Stirling Technology With Unique Motor Home Design," SAE Paper 780694, August, 1978.*
- 1978 ci Johansson, L., "Stirling Technology Provides Quiet Non-Polluting, Efficient Energy for RV Use," SAE Paper 780693, August 1978.*
- 1978 cj "Stirling Power Reference Data Guide," Stirling Power Systems, Handout. *
- 1978 ck Martini, W.R., "A Simple Non-Proprietary Code for Stirling Engine Design," DOE HVSCCM, October, 1978. *
- 1978 cl Piller, S., "Demonstration of a Free Piston Stirling Engine Driven Linear Alternator System," C00-2764-002, 21 April 1978. *
- 1978 cm Beremand, D.G., Knoll, R.H., "Stirling Engine Fuel Economy Outlook," DOEHVSCCM, 17 October 1978. *
- 1978 cn Schultz, D.F., "Low Emission Combustors for Advanced Stirling Engines," DOE HVSCCM, 17 October 1978. *
- 1978 co Stephens, J.R., "Stirling Materials Technology Program," DOE HVSCCM, 17 October 1978. *

- 1978 cp Thieme, L.G., Tew, R.C., "Baseline Performance of the GPU 3 Stirling Engine," DOE HVSCCM, 17 October 1978. *
- 1978 cq General Electric, "Preliminary Design of a General Purpose Stirling Test Engine," DOE HVSCCM, 17 October 1978. *
- 1978 cr Jet Pro. Lab., "Stirling Engine Regenerators Literature Review," DOE HVSCCM, 17 October 1978. *
- 1978 cs Jet Pro. Lab., "Cost Analysis for Brayton and Stirling Engines," DOE HVSCCM, 17 October 1978. *
- 1978 ct Ragsdale, R.G., "Stirling Engine Project Status," DOE HVSCCM, 17 October 1978. *
- 1978 cu KB United Stirling (Sweden), "Summary Report of P-40 Opel," DOE HVSCCM, 17 October 1978. *
- 1978 cv Ford Motor Co., "Automotive Stirling Engine Development Program," DOE HVSCCM, 17 October 1978. *
- 1978 cw "MTI Automotive Stirling Engine Development Program," DOE HVSCCM, 17 October 1978.*
- 1978 cx Thermo Electron Co., "Conceptual Design Study of Thermal Energy Storage for a Stirling Car," DOE HVSCCM, 17 October 1978. *
- 1978 cy Boeing, "Evaluation of Reciprocating Seals for Stirling Engine Cycle Application," DOE HVSCCM, 17 October 1978. *
- 1978 cz Hughs, W.F., "Thermal Analysis of Reciprocating Rod Seals in the Stirling Engine," DOE HVSCCM, 17 October 1978. *
- 1978 da Krauter, A.I., "Analysis of Rod Seal Lubrication for Stirling Engine Application," DOE HVSCCM, 19 October 1978. *
- 1978 db Martini, W.R., "Stirling Engine Research Institute Newsletter," No. 4, March 1978. *
- 1978 dc Walker, G., "Stirling Engines," Univ. of Calgary, Vol. 1, Vol. 2. *
- 1978 dd Yates, D., Vesely, Jr., E.J., "Hydrogen Permeability of Metals and Ceramics," DOE HVSCCM, 17 October 1978. *
- 1978 de Skwira, G., "Ford Drops Research on Stirling Engine," Detroit Free Press, 18 October 1978., p. 110. *
- 1978 df "Ford Pulls Out of \$160 Million Project With U.S. to Develop Stirling Car Engine," Wall St. Journal, 19 October 1978, p. 12. *

- 1978 dg Hirschfeld, F., "The Resurrection of the Stirling Engine," Mechanical Engineering, October, 1978, pp. 38-44. *
- 1978 dh Morrison, A., "Great Increases in Conversion Efficiencies Predicted," Mechanical Engineering, October, 1978, pp. 62-64. *
- 1978 di Steitz, P., Mayo, G., "Assessment of the Role of Advanced Technologies in Small Utilities - Final Report," NTIS, PC A08/MFA01, May.
- 1978 dj Reams, L.A., Dunlap, T.F., Fenzan, R.K., "Compact Ceramic Recuperator Preheater for Stirling Engines," U.S. Patent, 4,007,215, 7 March 1978.
- 1978 dk Heffner, F.E., "Additional Dimensions of 4L23 Engine," Personal Communication, 30 October 1978. *
- 1978 dl Ford Motor Co., "Automotive Stirling Engine Development Program," Quarterly Report AP78-June 78, CONS/4396-3, NASA CR 159436. *
- 1978 dm Cooke-Yarborough, E.H., "Stirling Cycle Thermal Devices," U.S. Patent 4,007,216, 7 March 1978.
- 1978 dn "Preliminary and Conceptual Design of a Stirling General Purpose Test Engine" (Final Report NASA CR 159391 September 1978.)
- 1978 do Kroebig, H. L., "Vuillemier (VM) Cooler Compressor/Linear Drive". Hughes Aircraft Co. - Air Force Flight Dynamics Laboratory, AFFDL-TR-78-160.
- 1978 dp Martini, W.R., "Stirling Engine Newsletter" Pilot Issue, Martini Engineering. (See Directory)
- 1978 dq Thomas, W., "First Stirling Goes to Work." Mechanix Illustrated, December 1978, pp. 46, 47, 114.
- 1978 dr Beale, W. T., "Hermetically Sealed Stirling Engines" (Obtainable from Sunpower, Inc., See directory.)
- 1978 ds Noble, J. E., Riggle, P., Emigh, S. G., Martini, W. R., "Heat Engine" Russian Patent 626708.*
- 1978 dt Allen, M., "Automotive Stirling Engine Development Program" MTI Rept. 79ASE 32QT2 Quarterly Report of July 2 - September 30, 1978.
- 1978 du Beale, W. E., "Novel Design Stirling Engine for Classroom and Research". (Available from Sunpower Inc. - See Directory.)*
- 1978 dv Cooke-Yarborough, E. H. "Stirling Cycle Thermomechanical Power Sources for Remote or Inaccessible Communication Sites," International Telephone Conference 25-27 Oct. 1978. *

- 1978 dw Kazyak, L., "A Quarter-size Rider-Ericsson Hot Air Pumping Engine," Live Steam Oct. 1978, pp 6-15; Nov. 1978, pp 14-20; Dec. 1978, pp. 30-35.
- 1978 dx Johnston, R. P., "Develop and Evaluate A Modified Stirling Engine," Quarterly Report, NHLBI Contract No. N01-HV-4-2901, October 1978.
- 1978 dy Senft, J. R. "Sailing on Hot Air". Live Steam. July 1978. *
- 1978 dz Breckenridge, R.W., Parish, G. T., Stratton, L. J., Welz, A. W., "Development of a Rotary Reciprocating Refrigerator for Space Applications". Technical Report AFFDL-TR-78-166. Dec. 1978. *
- 1978 ea Dehne, A. G. "Air Force Standard Cryogenic Cooler". Hughes Aircraft Company. Nov. 1978. *
- 1978 eb Aun, T. "Hot Air Engine Primer". Tonu Aun. 1978. *
- 1978 ec Umarov, G. Ya.; Drabkin, L. M.; Trukhov, V. S. "Optimization and Design of Radiative Heat Discharge System for Energy Unit With Stirling Engine". Geliotekhnika. Vol. 14, No. 3, pp. 25-30, 1978. *
- 1978 ed Oshima, K.; Ishizaki, Y.; Kamiyama, S.; Akiyama, M.; Okuda, M. "The Utilization of LH₂ and LNG Cold for Generation of Electric Power by a Cryogenic Type Stirling Engine". Cryogenics. Nov. 1978. *
- 1978 ee Oshima, K., Ishizak, Y., "N₂ Refrigeration Technology in Japan". Fifth International Cryogenic Engineering Conference.*
- 1978 ef Ishizaki, Y., Kamiyama, S., "The Stirling Engine". Journal of Japan Society of Lubrication Engineers. Vol. 23, No. 7 (in Japanese)*
- 1978 eg Akiyama, M., Ishizaki, Y., Okuda, M., "Study on the Stirling Engine". (Journal unknown, in Japanese) 1978.*
- 1978 eh Schock, A. "Stirling Engine Nodal Analysis Program". Journal of Energy. Vol. 2, No. 6, Nov. - Dec. 1978, pp. 354-362. *
- 1978 ei "Point Focusing Distributed Receiver Tech. Project" Annual-Tech. Report. Jet Propulsion Lab. 1978. *

- 1978 ej Dobrosotskii, A. V. "Method of Calculation of the Main Characteristics of Stirling Engines". Energomashinostroenie. No. 3, 16-19 (1978). (in Russian).
- 1978 ek Thomas, F. B. "A Cooling Pump for a Hot-Air Engine" Model Engineering. Jan 20: 102-3. 1978.
- 1978 el Ross, A. "A Wax Pattern Die for a Finned Stirling Engine Heater". Model Engineer. 144 (June 16): 697-703. 1978.
- 1978 em Hartley, J. "United Stirling Goes Flat Out for Future Expansion". Engineer. 246 (Dec. 29/Jan 5): 24-9. 1978.
- 1978 en Maxwell, B.R., of Bucknell Univ., and Didion, D.A., of National Bureau of Standards, "An Experimental Evaluation of Engine-Driven Heat Pump Systems". Presented at 1978 ASME Winter Annual Meeting, Dec. 11-15, in San Francisco, CA. *
- 1978 eo "Program Agenda", Highway Vehicle Systems Contractors Coordination Meeting, Oct. 17-20, 1978, U.S. DOE, Division of Transportation Energy Conservation. *
- 1978 ep Theeuwes, G.J.A.: "Dynamic High Pressure Seals in Stirling engines". Proc. 8th International Conference on Fluid Sealing, paper J.1, organized by Brit. Hydromech. Res. Assoc., Durham, Sept. 1978.
- 1978 er Reader, G. T., "The Stirling Engine - A Suitable Case for Study." IJMEE, Vol. 6, No. 3, pg 143-147, January 30, 1978.*
- 1978 es Ceperley, P. H. "Traveling Wave Heat Engine", U. S. Patent 4,114,380, 19 Sept. 1978.

ORIGINAL PAGE IS
OF POOR QUALITY

- 1979 a Tew, R.C., Thieme, L.G., Miao, D., "Initial Comparison of Single Cylinder Stirling Engine Computer Model Predictions with Test Results." NASA-TM-79044. Also SAE Paper 790327 presented 1 March 1979. *
- 1979 b Martini, W. R., "Stirling Engine Newsletter," February 1979.*
- 1979 c Johnston, R. P., "Implanted Energy Conversion System," Report No. N01-HV-4-2901-5. *
- 1979 d Aronson, R. B. "Stirling Engine Goes Commercial," Machine Design, 8 February 1979.*
- 1979 e "Monthly Technical Progress Report," Mechanical Technology, Inc. Contract No. EY-76-C-02-2764, No. 42-53.*
- 1979 f Bledsoe, J. A., "Stirling Isotope Power System," Starting with 31st Monthly Technical Letter Report.*
- 1979 g Goldberg, I. F. "A Computer Simulation and Experimental Development of Liquid Piston Stirling Cycle Engines - Vol. I and II". Masters Paper for the U. of Witwatersrand, Johannesburg, S.Africa. March 1979. *
- 1979 h Vacant
- 1979 i Martini, W. R. "Stirling Engine Newsletter". May 1979. *
- 1979 j "Proceedings of Highway Vehicle Systems - Contractors' Coordination Meeting". U.S. Department of Energy. March 1979. *
- 1979 k King, J. "Solar Engines". Model Engineer. Vol. 145, No. 3605, 16-31 March 1979, pp. 354-357. *
- 1979 l Krauter, A. I.; Cheng, H. S. "Experimental and Analytical Tools for Evaluation of Stirling Engine Rod Seal Behavior". DOE/NASA 0022-79/1, NASA CR-159543 SRC-78TR-39, Feb. 1979.*
- 1979 m Walker, G. "Cryogenic Cooling Systems". University of Calgary, Calgary, Alberta, Canada, March 1979.*
- 1979 n "Thermal Power Systems Small Power Systems Applications Project Annual Technical Report". 5103-36, Vol. 1, Jan 15, 1979.*
- 1979 o Allen, M. "Topical Report: Pre-Developmental Demonstration of a Stirling-Powered Vehicle, Genesis-1". MTI Report No. 79ASE33T01. Prepared for NASA-Lewis.*
- 1979 p "Automotive Stirling Engine Development Program". MTI Report No. 79ASE430T3. NASA-Lewis Research Center.*

- 1979 q Johnston, R. P., "Proposal to Continue Development of a Thermal Energy Converter for Implantable Circulatory Support Devices". Vol. 3, Annual Report Draft. *
- 1979 r Rosenqvist, K.; Lia, T; Goldwater, B., "The Stirling Engine for the Automotive Application". Mechanical Technology Inc. (Permission -to reprint by SAE) 790329, Feb. 1979. *
- 1979 s "Feasibility Study of Automotive Stirling Engine Heaters". United Technologies Research Center, NASA-Lewis Research Center R77-719021, 1979. *
- 1979 t Ishizaki, Y.; Ogura, M.; Haramura, S., "The Study of the Gas Heat Pump System Driven by a Stirling Engine". 1979. *
- 1979 u Ishizaki, Yoshihiro, "Stirling Engine Technology in Japan". Univ. of Tokyo, to be presented IECEC (Aug. 5-10), 1979.*
- 1979 v Thomas, B. F. "A Horizontally Opposed Twin Cylinder Stirling Engine". Model Engineer. Vol. 145, No. 3608, pp. 522-27, 4 May 1979. *
- 1979 w "Rules for the 1980 Model Engineer Hot Air Engine Competition". Vol. 145, No. 3608, pp. 500-1, 4 May 1979. *
- 1979 x Chaddock, D. H. "48th Model Engineer Exhibition - The Hot Air Engine Competition". Model Engineer. Vol. 145, No. 3608, pp. 498-501, 4 May 1979. *
- 1979 y Walker, G., "Elementary Design Guidelines for Stirling Engines". University of Calgary, Alberta, Canada. 1979 IECEC Record, pp. 1066-1068. *
- 1979 z Reader, G. T., and Cross, M., "The Choice of Gas Exchange Model in Stirling Cycle Machine Analysis". Royal Naval Engineering College, 1979 IECEC Record, pp. 1069-1074. *
- 1979 aa Hoehn, F. W., Nguyen, B. D., Schmit, D. D., "Preliminary Test Results With a Stirling Laboratory Research Engine". Jet Propulsion Laboratory, 1979 IECEC Record, pp. 1075-1081. *
- 1979 ab Hooper, C., Reader, G. T., "The Effects of Higher Harmonics on the Preliminary Design of Rhombic Drive Stirling Engines". Royal Naval Engineering College. 1979 IECEC Record, pp. 1082-1085. *
- 1979 ac Urieli, I., "A Review of Stirling Cycle Machine Analysis". Ormat Turbines, Ltd., Israel. 1979 IECEC Record, pp. 1086-1090. *
- 1979 ad Martini, W. R., and Ross, B. A., "An Isothermal Second Order Stirling Engine Calculation Method". Joint Center For Graduate Study. 1979 IECEC Record, pp. 1091-1097. *

ORIGINAL PAGE IS
OF POOR QUALITY

- 1979 ae Reader, G. T., Royal Naval Engineering College, and Lewis, P. D., Wolf & Holland, Ltd., "Modes of Operation of a Jet-Stream Fluidyne". 1979 IECEC Record, pp. 1098-1102. *
- 1979 af Goldberg, L. F., and Rallis, C. J., "A Prototype Liquid-Piston Free-Displacer Stirling Engine". University of Witwatersrand. 1979 IECEC Record, pp. 1103-1108. *
- 1979 ag Bennet, A., and Martini, W. R., "Comparison of Measurements with Calculation of a 5-Watt Free-Displacer, Free-Power Piston Hydraulic Output Stirling Engine". University of Washington, Joint Center for Graduate Study. 1979 IECEC Record, pp. 1109-1113. *
- 1979 ah Berchowitz, D. M., and Wyatt-Mair, G., "Closed-Form Solutions for a Coupled Ideal Analysis of Free-Piston Stirling Engines". University of Witwatersrand, 1979 IECEC Record, pp. 1114-1119. *
- 1979 ai Facey, J., Bunker, W., U. S. Department of Energy, and Holtz, R. E., Uherka, K. L., Marciniak, T. J., Argonne National Laboratory, "DOE Stationary External Combustion Engine Program: Status Report". 1979 IECEC Record, pp. 1120-1123. *
- 1979 aj Uherka, K. L., Daley, J. G., Holtz, R. E., of Argonne National Laboratory, and Teagan, W. P., of Arthur D. Little, Inc., "Stirling Engine Combustion and Heat Transport System Design Alternatives for Stationary Power Generation". 1979 IECEC Record, pp. 1124-1130. *
- 1979 ak Pons, R. L., "A Solar-Stirling Small Power System". Ford Aerospace and Communications Corporation. 1979 IECEC Record, pp. 1131-1135. *
- 1979 al de Jonge, A. K., "A Small Free-Piston Stirling Refrigerator". Philips Research Laboratories. 1979 IECEC Record, pp. 1136-1141. *
- 1979 am Goldwater, B., "Free-Piston Stirling Engine Development Status and Application". Mechanical Technology, Inc., 1979 IECEC Record, pp. 1142-1151. *
- 1979 an Johnston, R. P., Bennett, A., Emigh, S. G., Martini W. R., Noble, J. E., Olan, R. W., White, M. A., of Joint Center for Graduate Study, University of Washington, and Alexander, J. E., of College of Veterinary Medicine, Washington State University. "Miniaturized Stirling Engine for Artificial Heart Power". 1979 IECEC Record, pp. 1152-1156. *
- 1979 ao Walker, G., of University of Calgary, and Ward, G. L., of Northern Alberta Institute of Technology, and Slowley, J., of University of Bath, "Operating Characteristics of a Small Stirling Engine". 1979 IECEC Record, pp. 1157-1161. *
- 1979 ap Johansson, L., and Lampert, W. B., "A Stirling Engine Powered Total Energy System: Recreational Vehicle Application". Stirling Power Systems. 1979 IECEC Record, pp. 1163-1168. *

ORIGINAL PAGE IS
OF POOR QUALITY

- 1979 aq Lehrfeld, D., Sereny, A., of Philips Laboratories, North American Philips Corp., and Bledsoe, J., of General Electric Company, "Predicted Performance and Testing of a Pre-Prototype, Small, Stirling Engine/Generator". 1979 IECEC Record, pp. 1169-1174. *
- 1979 ar Senft, J. R., "Advances in Stirling Engine Technology". Sunpower Incorporated. 1979 IECEC Record, pp. 1175-1180. *
- 1979 as Chiu, W. S., Carlson, W. B., "Performance of a Free-Piston Stirling Engine for a Heat Pump Application". General Electric Company, 1979 IECEC Record, pp. 1181-1185. *
- 1979 at van Eekelen, J. A. M., "State of a Stirling Engine Powered Heat Activated Heat Pump Development". Philips Research Laboratories, Eindhoven. 1979 IECEC Record, pp. 1186-1190. *
- 1979 au Voss, J., "Design Characteristics of an Advanced Stirling Engine Concept". Philips Research Laboratories, Eindhoven. 1979 IECEC Record, pp. 1191-1196. *
- 1979 av Meijer, R. J., Ziph, B., "A Variable Angle Wobble Plate Drive for a Stroke Controlled Stirling Engine". Philips Research Laboratories. 1979 IECEC Record, pp. 1197-1202. *
- 1979 aw Ishizaki, Y., of University of Tokyo, and Haramura, S., Tani, T., of Aisin Seiki, Co., "Experimental Study of the Stirling Engines". to be presented at the 57th Japan Society of Mechanical Engineers (JSME), October 1979.*
- 1979 ax Taniguchi, H., of National Space Development Agency of Japan, and Ishizaki, Y., of University of Tokyo, "Energy Balance of the Power Generation Systems With the Combined Cycles by the Cryogenic Fuels". presented June 1979 at the 22nd semi-annual meeting of the Cryogenic Association of Japan.*
- 1979 ay Saaski, E.W., Waters, E.D., "Review and Assessment of Heat Pipes and other High-Temperature Thermal Transport Systems for Powering Large Stationary Stirling Engines", Sigma Research, Inc., Richland, Wash., February 1979. *
- 1979 az Theeuwes, G.J.A., "Dynamic Seals in Stirling Engines", N.V. Philips Research Lab., Eindhoven, Netherlands, Presented at HVSCCM, April 24-26, 1979, Dearborn, Michigan. *
- 1979 ba "Conceptual Design Study of an Automotive Stirling Reference Engine System", June 1979, Mechanical Technology, Incorp., for DOE, Conservation and Solar Applications, DOE/NASA/0032-79/1. *

- 1979 bb Berchowitz, D.M., Rallis, C.J., University of the Witwatersrand, Urieli, I., Ormat Turbines, Ltd., "A Numerical Model for Stirling Cycle Machines", ASME 79-GT-ISR-16. Presented at the 1979 Israel Joint Gas Turbine Congress, Haifa, Israel, July 9-11, 1979. *
- 1979 bc Sherman, A., Gasser, M., Goddard Space Flight Center, Goldowsky, M., North American Philips Corp., Benson, G., Energy Research and Generation, Inc., McCormick, J., Mechanical Technology, Inc., "Progress on the Development of a 3-5 Year Lifetime Stirling Cycle Refrigerator for Space", July 1979, Goddard Space Flight Center, Greenbelt, Maryland. *
- 1979 bd "Summary of FY 79 Activity", DOE, Office of Energy Research, Office of Basic Energy Sciences, Division of Advanced Energy Projects. *
- 1979 be Choudhury, P.R., Parry, J.F.W., R & D Associates, "Energy Utilization of Evaporating LNG", 14th IECEC Paper No. 799421, Boston, Mass. *
- 1979 bf Beale, W.T., "A Free Cylinder Stirling Engine Solar Powered Water Pump", Sunpower Incorporated, 1979 ISES International Congress. *
- 1979 bg Hauser, S.G., "Experimental Measurements of Transient Heat Transfer to Gas Inside a Closed Space", University of Washington, 1979. *
- 1979 bh Ishizaki, Y., of Univ. of Tokyo, and Haramura, S., Tani, T., of Aisin Seiki, Co., "Experimental Study of the Stirling Engines", to be presented Oct. 1979 at 57th Japan Society of Mechanical Engineers (JSME). *
- 1979 bi Holtz, R.E., Uherka, K.L., "On the Role of External Combustion Engines for On-Site Power Generation", Argonne National Labs., Ill 1979, Dep. NTIS, PC A02/MF A01. *
- 1979 bj Martini, W.R., "Stirling Engine Newsletter", August 1979.*
- 1979 bk Waters, E.D., Saaski, E.W., of Sigma Research, Inc., and Martini, W.R., of Martinin Engineering, "A Thermal Energy Storage System for a Stirling Engine Powered Highway Vehicle", 1979 IECEC Record, paper number 799098, August 1979. * pp. 425-480.
- 1979 bl Thieme, L.G. "Low-Power Baseline Test Results for the GPU-3 Stirling Engine", DOE/NASA/1040-79/6, NASA TM-79103, Apr. 1979. *
- 1979 bm "Automotive Stirling Engine Development Program", Quarterly Technical Progress Report for Period 1 Jan to 31 Mar 1979. June 79 DOE/NASA/0032-79/2, NASA CR-159606, MTI 79 ASE 67QT4. *
- 1979 bn Das, R.S.L., Bahrami, K.A., Jet Propulsion Lab., "Dynamics and Control of Stirling Engines in a 15 kWe Solar Electric Generation Concept", IECEC Paper, no. 799023, August 1979. *

ORIGINAL PAGE IS
OF POOR QUALITY

- 1979 bo Richards, W.D., Chiu, W.S., General Electric Co., "System Performance of a Stirling Engine Powered Heat Activated Heat Pump", IECEC Report, Paper No. 799359, August 1979. *
- 1979 bp Anderson, J.W., Hoehn, F.W., "Stirling Laboratory Research Engine Survey Report", JPL Publication 79-86, Sept. 5, 1979. *
- 1979 bq Martini, W.R., "Stirling Engine Newsletter", Nov. 1979. *
- 1979 br Beremand, D.G., of NASA-Lewis Research Center, "Stirling Engine for Automobiles", DOE/NASA/1040-79/7, NASA TM-79222, 1979, *
- 1979 bs Collins, F.M., "Phoelix - A Stirling Engine/Generator", Model Engineer, pp. 882-886, August, 1979.*
- 1979 bt Berchowicz, D.M., Wyatt-Mair, G.F., "Closed-Form Analysis for a Coupled Ideal Analysis of Free Piston Machines of the Harwell Type", Research Report No. 78, University of the Witwatersrand, Johannesburg, South Africa, May, 1979. *
- 1979 bu Laity, W.W., et al, "Assessment of Solar Options for Small Power Systems Applications", Vol. 1, Sep. 1979, Prepared for DOE by Pacific Northwest Lab, Battelle Memorial Inst. *
- 1979 bv United Stirling Automotive Stirling Engine Component Development, DOE-HVSCCM 23-25 Oct. 1979. *
- 1979 bw U.S. Dept. of Energy "Sixteenth Summary Report Highway Vehicle Systems Contractors' Coordination Meeting", April 24, 25, 26, 1979. Dearborn, MI CONF-7904105.*
- 1979 bx Wheatley, J.C., "Personal Communication", 22 Oct. 1979. *
- 1979 by Allen, P.C., Knight, W.R., Paulson, D.N., and Wheatley, J.C., "Principles of Liquids working in Heat Engines", Manuscript to be published. *
- 1979 bz Mechanical Technology Inc., "MTI Automotive Stirling Engine Development Program - Stirling Engine Component and Development Status", Presented at DOE Automotive Tech. Dev. Contr. Coord. Meeting, 23 Oct. 1979. *
- 1979 ca Stephens, J.R., "Stirling Engine Materials Tech.", Presented at DOE Automotive Tech. Dev. Contr. Coord. Meeting, 23 Oct. 1979.*
- 1979 cb Jet Propulsion Laboratory, "Stirling Laboratory Research Engine", Presented at DOE Automotive Tech. Dev. Contr. Coord. Meeting, 23 Oct. 1979. *
- 1979 cc AM General Corporation "Stirling Engine Vehicle Integration", Presented at DOE Automotive Tech. Dev. Contr. Coord. Meeting, 23 Oct. 1979. *

- 1979 cd Crouch, A. R., Pope, V.C.H., Ricardo Consulting Engineers, LTD, "Stirling Engine Drive Systems Test Rig Progress Report", Highway Vehicle Systems Contractors Coordination Meeting, 23 Oct. 1979. *
- 1979 ce Hill, V.L. and Vesely, E.J.Jr., "Hydrogen Permiability in Uncoated-Coated Metals", Presented at DOE Highway Vehicle Systems Contr. Coord. Meeting, 22-25 Oct. 1979. *
- 1979 cf Reader, G. T., Lewis, P. D., "The Fluidyne - A Water in Glass Heat Engine", J. N. S., Vol. 5, No. 4, 1979.*
- 1979 cg Helms, H.E., "Advanced Gas Turbine Powertrain System Development Project", Presented at DOE Office of Transportation Programs, 23 Oct. 1979. *
- 1979 ch Curulla, J., "Evaluation of Reciprocating Seals for Stirling Cycle Engine Application", DOE Highway Vehicle System Contr. Coord. Meeting April 24-26, 1979. *
- 1979 ci Schulz, R.B., "Stirling Engine Project Status", DOE Highway Vehicle System Contr. Coord. Meeting, April 24-26, 1979. *
- 1979 cj Stephens, J.R. "Stirling Materials Development", DOE Highway Vehicle Systems Contr. Coord. Meeting, April 24-26, 1979. *
- 1979 ck Sjosteat, Lars, "Automotive Stirling Engine Conceptual Design Study", DOE Highway Systems Contr. Coord. Meeting, April 24-26, 1979. *
- 1979 cl Press Information, Automotive Technology Development Contractor Coordination Meeting, 23-25 Oct. 1979. *
- 1979 cm Theeuwes, G.J.A., Philips, N.V. "Dynamic Seals in Stirling Engines", Research Laboratories, DOE Highway Vehicle System Contr. Coord. Meeting, April 24-26, 1979. *
- 1979 cn Decker, O., "MTI Automotive Stirling Engine Development Program" Mechanical Technology Incorporated, DOE Highway Vehicle Systems Contr. Coord. Meeting, April 24-26, 1979. *
- 1979 co Dochat, G.C., "Design Study of a 15 kW Free-Piston Stirling Engine - Linear Alternator for Dispersed Solar Electric Power Systems", DOE/NASA/0056-79/1, NASA CR-159587, MTI 79TR47, Aug. 1979.*
- 1979 cp Ragsdale, R.G., "Panel Discussion on Stirling Program", NASA-Lewis Research Center, DOE Highway Vehicle Systems Contr. Coord. Meeting, April 24-26, 1979. *

- 1979 cr Final Report - Automotive Technology Development Contractor
Coordination Meeting. October 23-25, 1979 (Attendance List)*
- 1979 cs Ceperley, P. H., "A Pistonless Stirling Engine", J. Acoust. Soc. Am.,
Nov. 1979, pg 1508-1513.
- 1979 ct Assessment of the State of Technology of Automotive Stirling Engines,
Sept. 1979, DOE/NASA/0032-79/4, NASA CR-159631, MTI79ASE 77RE2.
- 1979 cu Finegold, Joseph G., "Small Electric Applications, Comparative
Ranking of 0.1 to 10 MWe Solar Thermal Electric Power Systems",
11 Dec. 1979, SERI Briefing.*
- 1979 cv The Dish-Stirling Solar Experiment, "Converting Solar Energy to
Electricity for Community Use", DOE-JPL Handout.*
- 1979 cw Dochat, G. R., "Design Study of a ISKW Free Piston Stirling Engine-
Linear Alternator for Dispersed Solar Electric Power Systems", NASA-
Lewis/DOE, August 1979*.
- 1979 cx Berchowitz, D. M., and Wyatt-Mair, G. F., "Closed-Form Solutions for
a Coupled Ideal Analysis of Free-Piston Stirling Engines", University
of the Witwatersrand, Johannesburg, Report No. 79, Oct. 1979.*
- 1979 cy Morgan, D. T., "Thermal Energy Storage for The Stirling Engine Powered
Automobile", ANL-K-78-4135-1, NASA CR-159561, March 1979.*
- 1979 cz Seventeenth Summary Report Highway Vehicle Systems Contractors
Coordination Meeting, 23-25 October 1979, Conf. 791082.*
- 1979 da "First Annual Report to Congress on the Automotive Technology Develop-
ment Program", DOE/CS-0069, 31 August 1979.*

ORIGINAL PAGE IS
OF POOR QUALITY

- 1980 a Bledsoe, J. A., "Stirling Isotope Power System" Starting with 42nd monthly technical letter report.*
- 1980 b Rochelle, P., "Simplified Theory of Free-displacer Stirling Machines" (abstract) Personal Communication.*
- 1980 c Walker, G., "Stirling Powered Regenerative Retarding Propulsion System for Automotive Application", April 14-18, 1980, 5th International Automotive Propulsion System Symposium.*
- 1980 d Walker, G. "Stirling Engines", Clarendon Press, Oxford.*
- 1980 e Martini, W. R., "International Developments in Stirling Engines", 5th International Automotive Propulsion System Symposium, 14-18 April 1980.
- 1980 f "Automotive Stirling Engine Development Program", Quarterly Technical Progress Report, 1 July - 30 Sept. 1979, June 1980, DOE/NASA/0032-79/5 NASA CR-159744 MTI 79ASE 101QT6.*
- 1980 g Martini, W. R., "Stirling Engine Newsletter", Feb. 1980.*
- 1980 h Martini, W. R. "Directory of the Stirling Engine Industry for 1979", April 1980, Martini Engineering.*
- 1980 i Martini, W. R., "Index to the Stirling Engine Literature", April 1980, Martini Engineering.
- 1980 j Aronson, Robert B., "Stirling Engine - Can Money Make it Work?" Machine Design. Volume 52, No. 9, April 24, 1980, pp. 20-27.*
- 1980 k "Conference Preprint Fifth International Symposium on Automotive Propulsion Systems", CONF-800419, (2 Volumes).*
- 1980 l West, C. D. "An Analytical Solution for a Stirling Machine With an Adiabatic Cylinder", 1980 IECEC Record.*
- 1980 m Urwick, D., "Stirling Engines-Still Research and Development", Model Engineer, 18 Jan. 1980, pp. 82-86, 25 Jan. 1980, pp. .*
- 1980 n Walker, G., "Regenerative Engines with Dense Phase Working Fluids - The Malone Cycle", 1980 IECEC Record.*
- 1980 o "Stirling Traction Motors with Regenerative Braking Capability", 1980 IECEC Record.*
- 1980 p JoHansson, L., Lampert, W. B. III, Alpkvist, J., Gimstedt, L., Altin, R., "V160 Stirling Engine--For a Total Energy System". Presented at 5th International Symposium on Automotive Propulsion Systems, 14-18 April 1980.*
- 1980 q "Automotive Stirling Engine Development Program", Presented at 5th International Symposium on Automotive Propulsion Systems, 16 April, 1980.*
- 1980 r Slaby, J. G., "Overview of a Stirling Engine Test Project", DOE/NASA/1040-80/12, NASA TM-81442.*

- 1980 s Tomazic, W. A., "Supporting Research and Technology for Automotive Stirling Engine Development", DOE/NASA/1040-80/13, NASA TM-81495.*
- 1980 t "ASE MOD 1 Engine Design", presented at 5th International Automotive Propulsion Systems Symposium, 14-18 April 1980.*
- 1980 u Press Information, 5th International Symposium on Automotive Propulsion Systems, 14-18 April 1980.*
- 1980 v Rosenqvist, K., Haland, Y., "United Stirling's P40 Engine - Three Years Experience of Testing, Evaluation and Improvements", presented at 5th International Automotive Propulsion Systems Symposium, 14-18 April 1980.*
- 1980 w Hughes, W. F., Yang, Y., "Thermal Analysis of Reciprocating Rod Seals in the Stirling Engine", Presented at 5th International Symposium on Automotive Propulsion Systems, 14-18 April 1980.*
- 1980 x Meijer, R. J., Ziph, B., "Variable Displacement Stirling Automotive Power Trains," presented at 5th International Symposium on Automotive Propulsion Systems, 14-18 April 1980.*

- 0000 a Vonk, G., "A New Type of Compact Heat Exchanger with a High Thermal Efficiency," Advances in Cryogenic Engng., K-3, pp. 582-589.*
- 0000 b "Applications of Cryogenic Equipment in Hydrocarbon Processing and Transport," Philips Corp.*
- 0000 c Mauel, K., "Technikgeschichte in Einzeldarstellung en NR 2," (Technical History in a Single Copy No. 2,") VDI Verlag.
- 0000 d "Cryogenic Equipment," Philips Corp. C3, C4. *

7. PERSONAL AUTHOR INDEX

- Abell, T. W. D., 69 ai
 Ackeret, J., 40 b
 Adams, W. E., 67 p
 Agarwal, P. D., 69 j
 Agbi, Babtunde, 71 k, 73 u, 73 ag
 Akiyama, M., 77 cw, 78 ed, 78 eg
 Akramov, Kh. T., 77 co
 Alexander, J. E., 77 x, 78 bz, 79 an
 Allen, M., 78 dt, 79 o
 Allen, P. C., 79 by
 Alm, C. B. S., 73 a
 Alpkvist, J., 80 p
 Altin, R., 80 p
 Amann, C. A., 74 ah
 Ambrosio, A., 66 b
 Ammamchyan, R. G., 76 ab
 Andersen, N. E., 74 ab, 76 w
 Anderson, G. A., 1897 a
 Anderson, J. W., 79 bp
 Anderson, Lars, 13 a
 Andrejewski, J., 74 al, 74 cc
 Andrus, S., 72 k, 73 at, 74 au, 75 au,
 76 aq, 78 ca
 Anzelius, A., 26 a
 Applegate, C. G., 74 bf
 Arend, P. C., 64 k
 Arkharov, A. M., 73 au
 Armagnac, A. P., 48 l
 Arnett, G., 75 ba
 Aronson, R. B., 79 d, 80 j
 Arthur, J., 65 aa
 Artiles, A. A., 77 ar
 Asselman, G. A. A., 72 ah, 73 aj, 76 f,
 76 at, 77 bb, 78 ax
 Aun, T., 78 eb
 Auxer, W. L., 77 w, 78 by
 Avezov, R. R., 77 cn, 77 cr
 Ayers, Robert V., 73 af
 Baas, H. B., 63 r
 Babcock, G. H., 1885 a
 Bahnke, G. D., 64 a
 Bahr, D. W., 72 ag
 Bahrami, K. A., 79 bn
 Baibutaev, K. B., 77 cp
 Bakhnev, V. G., 75 ak
 Bakker, L. P., 76 as

Balas, Charles, Jr., 75 ay, 77 ax
Balkan, S., 75 at
Barker, J. J., 65r
Baumgardner, A. R., 73 a1
Bayley, F. J., 61 a, 61 g, 65 s
Bazinet, G. D., 71 az, 72 k
Beale, William T., 69 h, 71 g, 71 aq,
72 x, 72 ad, 73 b, 73 t, 75 n,
75 s, 75 bh, 75 cf, 76 bd, 78 e,
78 dr, 78 du, 79 bf
Begg, W., 76 bg
Bell, Andrew J., 77 c
Bell, G. C., 79 cq
Bender, R. J., 70 n
Bennett, A., 76 as, 76 ay, 77 x, 78 bz
78 cb, 79 ag, 79 an
Benson, G. M., 73 p, 75 bx, 77 a, 77 u
77 ca
Berchowitz, David M., 77 d, 77 e, 77 g,
77 bq, 78 s, 78 am, 79 ah, 79 bb,
79 bt, 79 cx
Beremand, D. G., 78 ag, 78 cm, 79 br
Bergman, U. C., 75 by
Biermann, U. K. P., 75 f
Bifano, N. J., 75 ab
Biryukov, V. I., 75 av
Bjerklie, J. W., 72 v, 75 am
Blair, C. R., 76 as
Blankenship, Charles P., 77 p, 77 cj
Bledsoe, J. A., 77 aj, 78 d, 79 f,
79 aq, 80 a
Blinov, I. G., 74 ak
Bloem, A. T., 57 h
Bloemer, J. W., 65 u
Boelter, L. M. K., 43 a
Boestad, G., 38 a
Bohr, E., 48 g
Bolt, J. A., 68 b
Boltz, C. L., 74 ai
Bondarenko, L. S., 73 au
Borisov, I. V., 72 ay
Bornhorst, W. J., 71 b
Boser, O., 77 y
Bougard, J., 75 bc
Bourne, J., 1878 b
Bourne, R. J., 77 bg
Bragg, J. H., 78 ch
Brainard, D. S., 60 s
Braun, R. A., 60 x
Breazeale, W. L., 55 b, 65 y
Breckenridge, R. W., 78 dz
Breen, B. P., 72 ag
Brogan, John J., 73 ak, 74 an, 75 bz
Bucherl, E. S., 75.g

Buck, Keith E., 68 e, 68 h, 68 j,
69 i, 69 af, 69 ak, 70 r, 71 ay,
72 al
Buckingham, J. F., Jr., 78 ay
Buckman, R. W., Jr., 75 cd
Bunker, W., 79 ai
Burke, J. A., 77 q
Burn, K. S., 76 ax
Burwell, C. C., 75 ca
Burstall, A. J., 65 ad
Bush, J. E., 74 aa
Bush, Vennavar, 38 b, 39 a, 49 a, 69 aq
70 s
Butler, K. C., 78 ca
Byer, R. L., 76 ak
Cairelli, James E., 77 ab, 77 av, 78 cd
Cairns, Elton J., 75 am
Carlqvist, S. G., 73 a, 74 bg, 75 az,
77 al
Carlson, W. B., 79 as
Carney, H. C., 69 ak
Carriker, W., 76 aq, 78 ca
Cayley, G., 1807 a
Cella, Al, 77 b
Ceperley, P. H., 79 cs
Chaddock, D. H., 76 hh, 77 ag, 79 x
Cheaney, E. S., 68 o

Chellis, F. F., 61 h
Chelton, D. G., 64 k
Cheng, E., 73 b
Cheverton, B., 1852 b
Chironis, N. P., 68 a
Chiu, W. S., 78 av, 79 as, 79 bo
Choudhury, P. R., 79 be
Churchill, S. W., 61 n
Clapham, E., 77 aw
Claudet, G., 72 ae
Condegone, C., 55 f
Cole, D. W., 72 e, 73 bc
Coleman, S. J., 71 b
Collins, F. M., 77 bh, 79bs
Colosimo, D. D., 76 bi
Combes, Par M., 1853 a
Conlin, D. M., 73 bd
Cook-Yarborough, E. H., 67 i, 70 e,
74 f, 74 g, 74 h, 74 i, 74 j, 74 k,
74 ad, 74 bh, 75 l, 75 y, 77 t,
78 dm, 78 dv
Coppage, J. E., 52 a, 53 a, 56 a
Cornelius, W., 72 ag
Cowans, K. W., 68 w
Crandall, S. H., 56 c
Creswick, F. A., 57 a, 62 m, 65 a, 68 o
Criddle, E. E., 78 dx

THIS PAGE IS
OF POOR QUALITY

ORIGINAL PAGE IS
OF POOR QUALITY

- Cross, M., 79 z
Crossland, J., 74 bi
Crouch, A. R., 79 cd
Crouthamel, M. S., 72 af, 75 ac
Cummins, C. L., Jr., 76 bp
Curulla, J., 79 ch
Daley, J. G., 79 aj
Damsz, G., 67 e
Daniels, A., 65 v, 66 l, 67 e, 71 h,
71 l, 71 p, 73 ae, 73 ap, 74 b,
74 w, 74 bj 75 m
Danilov, I. B., 72 ae
Darling, G. B., 59 a
Das, R. S. L., 79 bn
Datring, R., 69 l
Daunt, John G., 63 h, 63 p
Davis, Stephen R., 51 a, 71 q, 72 r,
73 ao, 73 ar
Davoud, J. G., 77 q
Day, Federick D., 77ac
Debono, A. N., 75 bj
de Brey, H., 47 b, 52 i
Decker, O., 79 cn
Dehart, A. O., 71 t
Dehne, A. G., 78 ea
Delabar, G., 1869 a
de Jonge, A. K., 78 aw, 79 al
de Lange, Leendert, 56 f, 57 i
den Haan, Jose J. W., 58 i
Denham, F. R., 53 b
Denton, W. H., 51 d
de Socio, L., 67 a
de Steese, J. G., 74 o
de Wilde de Ligny, J. H., 71 e
Didion, David, 77 ad
Dineen, John J., 65 m
Dobrosotskii, A. V., 78 ej
Dochat, G. C., 79 co, 79 cw
Doering, R. D., 68 x
Donkin, Brian, 11 a
Doody, R. D., 75 a
Drabkin, L. M., 78 ec
Dresser, D. L., 60 b
Dros, A. A., 51 f, 52 f, 56 b, 57 k,
65 b, 66 k
Dunlap, T. F., 78 dj
Dunn, P. D., 75 k
Dunne, J., 68 ae, 73 g
Du Pre, Frits K., 46 a, 52 c, 65 v,
66 l, 70 h, 71 l, 71 p, 73 ap,
63 ap
Eckerth, 1869 b
Edwards, P. A., 61 a
Eibling, J. A., 61 e, 65 u, 66 c,
67 b, 61 q

CONTENTS (PAGE 13)
OF POOR QUALITY

- Elrod, H. G., 74 q
- Elukhin, N. K., 64 h, 69 ah
- Emerson, D. C., 59 b
- Emigh, S. G., 71 i, 74 n, 74 r, 74 av,
75 r, 75 be 76 t, 76 u, 76 as,
76 ay, 77 x, 78 bz, 78 cb, 78 ds,
79 an
- Engel, Edwin F., 13 a
- Englesby, G. M., 78 cb
- Ericksson, E. A., 1897 a
- Ericsson, John, 1826 a, 1833 a, 1870 a
1876 a, 1880 b, 1884 a
- Essex, H., 03 a
- Estes, E. M., 72 aj
- Fabbri, S., 57 b
- Facey, J., 79 ai
- Faeser, R. J., 70 r, 71 az, 72 k, 73
73 at, 74 x, 74 au, 75 p, 75 au,
76 al, 76 aq, 77 cd, 78 ca
- Fam, S. S., 75 ai
- Farber, E. A., 65 o, 69 s, 64 n
- Fax, D. H., 54 c
- Feigenbutz, L. V., 73 w
- Fenzan, R. K., 78 dj
- Ferguson, E. S., 61 p
- Feurer, B., 73 aw
- Finegold, Joseph G., 77 ae, 78 bu,
79 cu
- Finkelstein, Theodor, 52 b, 53 c, 59 c,
60 j, 60 v, 61 d, 61 e, 61 r,
61 t, 62 a, 62 l, 63 a, 64 b,
64 c, 65 c, 67 c, 67 d, 70 f,
70 g, 72 u, 75 al, 78 al
- Fisher, Dan, 68 o, 74 t, 75 u
- Fleming, R. B., 62 b
- Fletcher, J. C., 76 ar
- Flint, Jerry, 76 d
- Flynn, G., 60 a
- Flynn, T. M., 77 ct
- Fokker, H., 73 c, 73 d, 78 an, 78 ao
- Folsom, L. R., 77 ar
- Ford, D. R., 68 af
- Ford, H., 40 a
- Forrest, D. L., 68 e
- Fosdick, R. J., 76 ae
- Fraize, W. E., 70 b
- Frank, G., 74 v
- Franklin, E., 74 g, 74 j, 74 k, 74 ad,
74 bh
- Fritz, B., 1875 a
- Fryer, B. C., 68 y, 72 ar, 73 ay
- Furnas, C. C., 30 a, 32 a
- Gabrielsson, R. G., 75 j
- Gamson, B. W., 51 e, 63 b

ORIGINAL PAGE IS
OF POOR QUALITY

Garay, P. N., 60 m
Garbuny, M., 76 ao, 76 ap
Gardner, C. L., 78 bx
Garg, G. C., 59 k
Garrett, K., 75 ao
Gasparovic, N., 72 q
Gasper, K. A., 72 b, 72 au, 73 w
Gass, J., 72 ae
Gasseling, F. W. E., 75 bm
Gasser, M., 79 bc
Gedeon, D. R., 78 as
Geisow, J., 74 g, 74 j, 74 k, 74 ad,
74 bh, 76 bu
Gentry, S., 75 ba
Gibson, B. M., 71 j
Giessel, R., 77 az
Gimstedt, L., 80 p
Gifford, W. E., 59 j, 60 d, 63 q,
64 d, 65 d
Gipps, G., 72 ai
Glassford, A. P. M., 62 c, 78 c
Godin, M., 77 cu
Godoy, Juan Vilchez, 14 a
Goldberg, Louis F., 77 c, 79 g, 79 af
Goldowsky, M., 77 v
Goldwater, Bruce, 77 b, 77 s, 79 r, 79 am
Goranson, R. B., 68 c, 68 s, 70 v
Gorring, R. L., 61 n
Grashof, F., 1890 a
Gratch, Serge, 76 ah
Gray, D. H., 78 cb
Green, C. F., 68 af
Green, D. B., 73 aj
Griffith, W. R., 73 w, 74 n, 74 av,
75 r, 75 be, 76 ay, 77 x
Grigorenko, N. M., 75 aj, 75 as
Grobman, J. S., 72 ag
Grossman, D. G., 77 o
Guilfoy, Robert F. Jr., 73 aq
Guilman, I. I., 76 ab
Gummesson, Stig G., 77 i, 77 al, 77 cl
Haerten, R., 75 g
Hagen, K. G., 71 a, 74 ba, 75 ai
Hagey, G. L., 68 ag
Hahnemann, H., 48 b
Hakansson, Sven A. S., 74 z, 75 bk
Haland, Y., 80 v
Hallare, B., 75 bl, 77 bj
Halley, J. A., 58 a
Hamerak, K., 71 r
Hanold, R. J., 62 g
Hanson, J. P., 75 ab
Hanson, K. L., 65 k

CATALOGUE OF
OF POOR QUALITY

- Hapke, H., 73 ab
Haramura, S., 79 t, 79 aw, 79 bh
Harkless, Lloyd B., 74 l
Harley, J., 74 bk, 74 bl, 74 bm
Harmison, L. T., 71 b, 71 i, 71 j,
72 d, 72 h, 72 l, 72 ak
Harp, J. L., 72 ap
Harrewijne, A., 75 bm
Harris, W. S., 70 y, 71 s
Hartley, J., 74 ae, 74 ag, 78 em
Harvey, D. C., 74 bn
Hausen, H., 29 a, 29 c, 31 b, 30 b,
42 a
Hauser, S. G., 77 h, 77 bs, 79 bg
Havemann, H. A., 54 a, 55 a, 59 k
Hazard, H. R., 64 m
Heffner, F. E., 60 a, 63 i, 65 t, 69 f,
78 dk
Hellingman, Evert, 56 b
Helmer, W. A., 71 ak
Helms, H. E., 79 cg
Hellwig, J. W., 76 aq, 78 ca
Henderson, R. E., 60 b
Henein, Naeim A., 71 q, 72 r, 73 ao,
73 ar
Henning, E., 75 g
Henriksson, L., 71 z
Hermans, M. L., 72 c, 74 u, 78 ax
Herschel, J., 1850 a
Heywood, H., 53 k
Heywood, John B., 75 bb
Higa, W. H., 65 n, 75 ah, 76 ar
Hill, V. L., 79 ce
Hinderman, J. D., 73 w, 74 n
Hinton, M. G., 71 as, 74 at, 74 bp
Hirata, M., 78 cw
Hirschfeld, F. 78 dg
Hoagland, L. C., 78 g, 78 bc
Hoehn, F. W., 78 a, 78 b, 78 au, 79 aa, 79 bp
Hoess, J. A., 68 o, 69 d
Hoffman, L. C., 71 az, 72 k, 73 at,
74 au, 75 au, 76 aq, 77 be, 78 ca
Hogan, Walter H., 61 h, 63 c, 63 s, 64 f
Holgersson, S., 77 cl
Holman, W. S., 72 e, 73 bc
Holmes, W., 73 b
Holmgren, J. S., 70 x
Holtz, R. E., 79 ai, 79 aj, 79 bi
Hooper, C., 79 ab
Hornbeck, C. J., 71 j
Hopkins, R. E., 67 q
Horn, Stuart B., 73 as
Horton, J. H., 66 e

ORIGINAL PAGE IS
OF POOR QUALITY

Hougen, J. O., 51 b
Hougen, O. A., 63 b
Howard, C. P., 63 d, 64 a, 64 e
Howlett, R., 70 za, 70 ab, 74 j, 74 k,
74 ad, 74 bh, 74 g
Hubbard, F. B., 06 b
Huebner, G. T., Jr., 76 be
Huffman, F. N., 71 a, 71 b, 72 d,
72 l, 74 ba
Hughes, W. F., 78 cz, 80 w
Iliffe, C. E., 48 c
Ishizaki, Y., 77 cw, 78 ed, 78 ee,
78 ef, 78 eg, 79 t, 79 u, 79 aw,
79 ax, 79 bh
Iura, T., 71 as
Jacoby, H. D., 75 bb
Jakeman, R. W., 60 u, 66 j
Jakobsson, E. G., 63 p
Janicki, E., 76 aa
Jaspers, H. A., 73 x, 75 bn
Jayachandra, P., 59 k
Jeffries, K., 78 ce
Johansson, L., 78 ci, 79 ap, 80 p
Johnson, Owen, 46 b
Johnston, J. R., 77 at
Johnston, R. D., 62 g
Johnston, R. P., 68 c, 69 a, 69 x, 70 v,
Johnston, R. P.,
7i ao, 72 an, 73 al, 73 an, 74 n,
74 av, 74 aw, 75 r, 75 be, 76 r,
76 v, 76 as, 76 ay, 77 x, 78 cb,
78 bt, 78 bz, 78 dx, 79 c, 79 q,
79 an
Jones, L. L., 54 c
Jonkers, Cornelius Otto, 54 b, 54 e,
54 f, 58 c, 60 t
Jordan, R. C., 63 u
Joschi, J., 70 g
Joule, J., 1852 a
Joyce, J. P., 77 ar
Kamiyama, S., 77 cw, 78 ed, 78 ef
Karavansky, I. I., 58 b
Kays, W., 64 l
Kazyak, L., 78 dw
Keith, T. G., 78 ai
Keller, C., 40 b, 50 g
Keller, H., 74 v
Kelly, D. A., 76 bj, 76 bk
Kerley, R. V., 67 p
Kern, J., 76 x
Kettler, Jack R., 75 ae
Khan, M., 62 h, 65 i
Kim, J. C., 70 m, 71 aj, 71 ak, 73 l,
75 ce

ORIGINAL PAGE IS
OF POOR QUALITY

- King, J., 79 k
King, W. G., 75 bt
Kirk, A., 1874 a
Kirkland, T. G., 67 q
Kirkley, D. W., 59 e, 62 e, 63 o,
65 e
Kitzner, E. W., 77 k, 78 cg
Klyuchevskii, Yu. E., 72 ay, 76 aw,
77 cq
Kneuer, R., 72 ae
Knight, W. R., 79 by
Knoke, J. O., 1899 b
Knoll, R. H., 78 cm
Knoos, Stellan, 72 g
Koefoed, J., 77 cf
Koenig, K., 66 p
Kohler, J. W. L., 54 b, 54 e, 54 f,
55 e, 55 g, 56 d, 56 e, 57 h,
57 j, 59 h, 60 c, 60 t, 65 f,
68 ac
Kohlmayer, G. F., 67 m
Koizumi, I., 76 ac
Kolff, Jack, 75 ba, 76 au
Kolin, I., 68 k, 72 ba
Koopmans, 52 d, 52 f, 57 i
Koryagin, N. I., 77 cn
Kovatchev, V. T., 72 ae
Kovton, I. M., 67 h
Krauter, A. I., 78 v, 78 da, 79 l
Krasicki, B. R., 77 cb
Kroebig, H. L., 78 dd
Kuhlmann, Peter, 70 i, 70 ad, 71 m,
73 a, 73 ad, 74 bo, 70 l
Kunii, D., 61 m
Kuznetson, B. G., 73 au
Lagerqvist, R. S. G., 73 s
Laing, N., 75 bo
Laity, W. W., 79 bu
Lambeck, A. J. J., 55 d
Lambertson, T. J., 58 d
Lamm, M., 74 ca
Lampert, W. B., 79 ap, 80 p
Lanchester, F. W., 1898 a
Lanning, J. G., 77 o
Lapedes, D. E., 71 bb, 74 at, 74 bp,
74 bq
LaPoint, C. W., 72 ag
Lashkareve, T. P., 73 z
Lavigne, Pierre, 73 am
Lay, R. K., 70 b
Leach, Charles F., 68 y
Ledger, T., 77 bk
Lee, F. Y., 76 bl
Lee, K., 76 bp, 76 bm, 78 at

ORIGINAL PAGE IS
OF POOR QUALITY

- Lee, Royal, 37 a
- Leeder, W., 75 bp
- Leeth, G. G., 69 c
- Lefebvre, A. H., 72 ag, 74 aj
- Leffel, C. S., 77 ax
- Lehrfeld, D., 75 ab, 76 aj, 76 am, 77 f,
77 v, 77 bx, 78 bb, 79 aq
- Leo, B., 70 ac, 71 bf
- Lewis, P. D., 79 ae, 79 cf
- Lewis, R. S., 71 g, 72 ad
- Lewis, Stephen, 73 b, 73 t
- Lia, Torbjorn A., 71 z, 71 af, 73 e,
73 s, 75 j, 75 az, 77 cl, 79 r
- Liang, C. Y., 75 bq
- Lienesch, J. H., 68 p, 69 k
- Linden, Lawrence H., 75 bb
- Lindsley, E. F., 74 t, 74 by, 78 ae
- Locke, G. L., 50 a
- London, A. L., 53 a, 56 a, 64 l
- Longworth, Ralph C., 63 q, 64 d, 65 d,
66 i, 71 j, 71 be, 74 as
- Lowe, J. F., 76 q
- Lucek, R., 67 e
- Ludvigsen, Karl, 72 s, 72 aq, 72 at,
73 f, 73 k
- Lundholm, G. K. S., 77 i, 75 az
- Lundstrom, R. R., 71 q
- Lyapin, V. I., 75 ak
- Magee, F. N., 68 x, 69 l
- Magladry, R., 69 aj
- Maikov, V. P., 69 ah
- Maki, E. R., 71 t
- Malaker, Stephen F., 63 h, 63 p
- Mallett, T., 73 be
- Malik, M. J., 62 n, 68 i
- Malone, J. F. J., 31 a
- Mann, D. B., 64 k
- Marciniak, T. J., 79 ai
- Margolis, Howard, 75 bb
- Marinet, D., 72 ae
- Marshall, Otis W., 74 s
- Marshall, W. F., 78 r
- Martin, B. W., 61 g
- Martinelli, R. C., 43 a
- Martini, M. W., 77 h
- Martini, W. R., 68 c, 68 l, 68 u, 69 a,
69 x, 69 ac, 69 al, 70 v, 71 i,
71 ba, 72 b, 72 d, 72 m, 72 ak,
72 au, 73 w, 73 al, 74 n, 74 o,
74 p, 74 r, 74 av, 75 q, 75 ag,
76c, 76 t, 76 u, 76 ay, 77 h,
77 x, 77 aa, 77 ao, 77 cc, 77 ch,
77 ci, 78 l, 78 o, 78 p, 78 ad,
78 bz, 78 ck, 78 db, 78 dp, 78 ds,

- Martini, W. R., (con't.)
79 b, 79 h, 79 i, 79 ad, 79 ag,
79 an, 79 bj, 79 bk, 79 bq, 80 e,
80 g, 80 h, 80 i
- Marusak, T. H., 78 av
- Massa, D. J., 74 br
- Mattavi, J. N., 69 f
- Mauel, K., 00 c
- Maxwell, Barry, 77 ad, 78 cn
- Mayo, G., 78 di
- McDougal, A. B., 78 au
- McMahon, H. D., 59 j, 60 d
- Medvedev, E. M., 73 aa
- Meek, R. M. G., 61 f
- Meijer, R. J., 57 c, 57 g, 59 f, 59 l,
59 m, 60 e, 60 o, 60 p, 60 r, 63 t,
65 g, 65 h, 66 g, 68 q, 69 e, 69 m,
69 t, 69 u, 69 z, 70 d, 70 j, 72 n,
72 ah, 74 c, 77 bb, 77 bc, 78 t,
78 az, 79 av, 80 x
- Meijer, Hugo H. M., 58 h
- Meltser, L. Z., 58 b
- Meltzer Joseph, 71 bb, 74 at, 74 bp,
74 bq
- Menetrey, W. R., 60 w
- Menzer, M. S., 77 r
- Mercer, S. D., 71 az
- Metcalf, F., 69 ar
- Metwally, M., 77 cg
- Meulenberg, R. E., 69 ai
- Meyer, R. J., 69 z
- Miao, D., 78 ce, 79 a
- Nichols, A. P. J., 71 f, 72 a, 76 e,
75 bm, 78 t, 78 az
- Mihmheer, A., 72 ac
- Miklos, A. A., 69 f
- Minaichev, V. E., 74 ak, 74 am, 74 bs
- Mitchell, R. K., 62 m
- Moise, J. C., 73 r, 73 at, 74 x,
74 au, 75 p, 75 au, 76 al, 77 cd,
78 ca
- Mondt, J. R., 64 g
- Monson, D. S., 62 i
- Moon, J. F., 72 o
- Mooney, R. J., 69 j
- Morash, Richard T., 74 s
- Morgan, D. T., 79 cy
- Morgan, N. E., 72 t
- Morgenroth, Henri, 66 o
- Morrison, A., 78 dh
- Morrow, R. B., 77 s
- Morse, F. W., 06 b
- Mortimer, J., 75 ap, 76 ad
- Mott, William E., 72 e, 73 bc, 75 ax

- Moynihan, Philip I., 77 ac
Mulder, G. A. A., 72 ah
Mulej, P., 71 g
Mullins, Peter J., 75 bd
Murinets-Markevich, B. N., 73 aa
Murray, J. A., 61 g
Napier, James Robert, 1853 b, 1854 b
Narayan Rao, N. N., 54 a, 55 a, 59 k
Narayankhedkar, K. G., 72 ae
Naumov, A. M., 67 h
Neelen, G., 67 j, 70 u, 71 m, 71 at
Nemsmann, U., 75 g
Nesterenko, V. B., 67 h
Newhall, Henry K., 74 aq
Newton, A., 57 f, 59 i, 59 n, 61 c
Nguyen, B. D., 79 aa
Niccoli, L. G., 76 ay
Nicholls, J. A., 77 r
Niyazov, Sh. K., 77 cp, 77 cr
Noble, Jack E., 69 a, 69 x, 71 i, 74 r,
74 aw, 75 r, 75 be, 76 t, 76 u,
76 ay, 77 x, 78 bz, 78 cb, 78 ds,
79 an
Nobrega, A. C., 65 w
Norbye, J. B., 73 g
Norman, John C., 72 l
Norster, E. R., 72 ag
Nosov, M. E., 73 aa
Nusselt, W., 27 a, 28 a
Nystroem, P. H. G., 75 br
Oatway, T. D., 72 ap
Ogura, M., 79 t
O'Keefe, R. J., 69 ak
Okuda, M., 78 ed, 78 eg
Olan, R. W., 79 an
Olsen, Don B., 75 ba, 76 au
Orda, E. P., 72 ay, 77 cq
Organ, A. J., 70 k, 71 u, 71 av, 73 ac,
75 i, 76 h, 77 z, 77 an, 77 ba,
78 n, 78 be, 78 bp
Ortegren, Lars G. H., 71 m, 71 y, 71 z,
71 ah, 74 bg
Orunov, B. B., 76 av, 76 aw
Oshima, K., 78 ed, 78 ee
Oster, J. F., 78 cb
Pakula, A., 50 e
Pallbazzar, R., 67 a
Parish, G. T., 78 dz
Parker, M. D., 60 f, 62 n
Parry, J. F. W., 79 be
Parulekar, B. B., 72 ae
Patterson, D. J., 68 b

- Patterson, M. F., 75 an
 Paulson, D. N., 79 by
 Pechersky, M. J., 76 ao, 76 ap
 Pedroso, R. I., 74 bt, 76 ba, 76 bq
 Penn, A. W., 74 ap
 Percival, W. H., 60 a, 74 bc, 76 bb,
 78 g, 78 bc
 Perlmuter, M., 61 i
 Perrone, R. E., 73 w, 74 n, 74 av,
 75 r, 75 be, 76 ay, 77 x, 78 bz,
 78 cb
 Persen, K., 72 ae
 Phillips, J. B., 74 bu
 Piar, G., 77 cu
 Pierce, B. L., 77 cb
 Piller, Steven, 77 b, 78 bd, 78 cl
 Piret, E. L., 51 b
 Pitcher, Gerald K., 70 h, 70 ah, 75 b
 Plitz, W., 74 v
 Poingdestre, W. W., 1845 a
 Polster, N., 76 c, 76 p
 Pons, R. L., 79 ak
 Pope, V. C. H., 79 cd
 Postma, N. P., 73 h, 75 bs, 76 bn
 Pouchot, W. D., 74 w, 75 ab, 76 aj, 76 am
 Prast, G., 63 e, 64 i, 65 x, 70 p, 78 aw
 Prescott, F. L., 64 n, 65 o
 Pronko, V. G., 76 ab
 Prosses, 17 d
 Prusman, Yu. O., 75 aj, 75 ak, 75 as
 Qvale, Einer Bjorn, 67 n, 68 m, 68 r,
 69 n, 69 an, 71 aj, 71 ak, 74 ab
 Raab, B., 75 bt
 Rabbimov, R. T., 77 cp
 Raetz, K., 74 m, 75 bu
 Ragsdale, R. G., 77 as, 78 ag, 78 ct, 79 cp
 Rahnke, C. J., 77 l
 Rallis, Costa J., 75 w, 76 i, 76 y,
 77 d, 77 e, 77 g, 77 ay, 77 az,
 77 bq, 78 am, 79 af, 77 c, 79 bb
 Rankin, C., 75 n
 Rankine, M., 1853 b, 1854 a, 1854 b
 Rapley, C. W., 60 g, 61 g, 65 s
 Rauch, Jeff S., 71 g, 72 ad, 73 t,
 75 o, 77 b, 78 ba
 Raygorodsky, A. E., 76 ab
 Razykov, T. M., 77 co
 Rea, S. N., 66 h, 67 l
 Reader, G. T., 78 ap, 79 z, 79 ab,
 79 ae, 79 cf
 Reams, L. A., 78 dj
 Redshaw, C. G., 76 bo
 Reed, B., 68 f
 Reed, L. H. K., 73 bd
 Rees, T. A., 20 a

ORIGINAL PAGE IS
OF POOR QUALITY

- Reid, T. J., bu
Reinink, F., 73 h
Ricardo, Sir H., 66 m
Rice, G., 75 k, 78 ay
Richards, W. D. C., 78 by, 79 bo
Richardson, Robert W., 74 ar
Richter, C., 74 v
Rider, A. K., 1871 b
Rider, T. J., 1888 b, 1888 c
Rietdijk, J. A., 70 p, 65 h
Riggle, Peter, 71 i, 72 ak, 74 r, 76 t,
76 u, 78 ds
Riha, Frank J., 72 z
Riley, C. T., 72 ap
Rinia, H., 46 a, 46 d, 47 b
Rios, Pedro Agustin, 68 g, 68 r, 69 o,
69 am, 69 an, 70 z, 71 s, 71 an
Robinson, N., 53 l
Rochelle, P., 74 al, 74 cc, 80 b
Roessler, W. U., 71 as
Romie, F. E., 66 b
Rontgen, R., 1888 a
Rosenqvist, N., 77 i, 77 al, 77 bj,
79 r, 80 v
Ross, B. A., 79 h, 79 ad
Ross, M. Andrew, 73 ai, 76 a, 76 b,
77 br, 77 bu, 77 ce, 78 el
Rossi, R. A., 63 p
Rudnicki, M. I., 70 r, 71 az, 72 d,
72 k, 73 r, 73 at, 74 x, 74 au,
75 p, 75 au
Ruggles, A. E., 74 ba, 75 ai, 76 bc
Russo, V. E., 76 al
Saaski, E. W., 79 ay, 79 bk
Sadviskii, M. R., 69 ah
Sampson, H. T., 71 as
Sandquist, Gary, 74 az, 75 ba, 76 au
Sarkes, L. A., 77 r
Saunders, O. A., 40 a, 48 d, 51 q
Savchenko, V. I., 75 aj, 75 as
Sawyer, R. F., 72 ag
Schalkwijk, W. F., 56 e, 57 i, 59 g
Schiferli, J. W., 78 u
Schirmer, R. M., 72 ag
Schmid, P., 74 v
Schmit, D. D., 79 aa
Schmidt, Gustav, 1861 a, 1871 a
Schock, Alfred, 75 bt, 76 ag, 78 j,
78 aq, 78 eh
Schottler, R., 1881 a
Schrader, Alan R., 49 l, 50 f, 51 r
Schroeder, J., 74 bv

- Schulte, R. B., 76 bf, 77 cj
Schultz, B. H., 51 c, 53 e
Schultz, O. F., 78 cn
Schultz, Robert B., 77 p
Schultz, W. L., 72 ag
Schulz, R. B., 79 ci
Schuman, Mark, 75 v
Schumann, T. E. W., 29 b, 34 a
Scott, David, 71 d, 71 ac, 71 ad, 74 e,
75 z, 75 ad
Selcuk, M. Kudret, 77 ac
Senft, James R., 73 bf, 74 bd, 75 bg,
76 n, 77 ak, 77 bf, 77 bv, 78 dy,
79 ar
Sereny, A., 79 aq
Sergreev, P. V., 73 av, 75 av
Serruys, Max, 73 ah
Shah, R. K., 75 aw
Shaw, H. S. H., 1880 c
Shelpuk, Benjamin, 72 af, 74 y, 75 ac
Sherman, Allan, 71 am, 79 bc
Shiferli, J. W., 78 u
Shmerelzon, Ya. F., 73 av
Shuttleworth, P., 58 e
Siegel, R., 61 i
Sigalov, Yu. M., 77 cn
Sier, R., 73 bg
Silverqvist, K. H., 73 a
Singh, P. P. 61 a
Singh, T., 72 r
Singham, J. R., 51 a
Sjostedt, L., 79 ck
Skwira, G., 78 de
Slaby, A., 1878 a, 1879 a, 1880 a,
1889 a, 1874 b
Slaby, J. G., 80 r
Slack, A., 73 bh
Slowly, G., 78 bs
Slowly, J., 79 ao
Smal, Pierre, 05 a
Smith, C. L., 60 f
Smith, Harry F., 32 b, 42 b
Smith, J. L., Jr., 67 l, 68 g, 68 m,
68 r, 69 n, 69 o, 69 an, 70 z,
71 s, 73 ay, 75 bf, 78 at
Smith, Lee M., 74 az, 75 ba, 76 au
Smith, P. J., 78 ai
Smoleniec, S., 48 d, 51 q
Soatov, F., 77 cn
Solente, P., 72 ae
Spies, R., 60 w
Spigt, C. L., 72 c, 74 c, 74 u, 75 m,
77 bb, 72 as

ORIGINAL PAGE IS
OF POOR QUALITY

Spragge, J. O., 75 an
Spriggs, James O., 72 w
Stahman, R. C., 69 d
Stang, J. H., 74 aa
Starr, M. D., 68 ag
Steitz, P., 78 di
Stephan, A., 72 ae
Stephans, J. R., 77 at, 78 ak, 78 co,
79 ca 79 cj
Stephens, C. W., 60 w
Stephenson, R. P., 75 t
Sternlicht, B., 74 bw
Sterrett, R. H., 78 bu
Stirling, James, 1827 a, 1840 a, 1845 c
Stirling, Robert, 1816 a, 1827 a, 1840 a,
1845 b
Stoddard, D., 60 l
Stoddard, J. S., 60 k
Storace, A., 71 v
Strarosvitskill, S.I., 64 h
Stratton, L. J., 78 dz
Stuart, R. W., 63 c
Summers, J. L., 75 af
Svedberg, R. C., 75 cd
Tabor, H. Z., 61 s, 67 k
Tamai, H. W., 68 e, 69 ak, 70 r
Tani, T., 79 aw
Taniguchi, H., 79 ax
Teagan, W. P., 79 aj
Teshabaev, A. T., 77 co
Tew, R., 77 bl, 78 ce, 78 bq, 78 cp,
79 a
Theeuwes, G. J. A., 78 ep, 79 az, 79 cm
Thieme, L. G., 77 av, 78 cd, 78 cp,
79 a, 79 bl
Thodos, G., 63 b
Thomas, F. B., 78 ek, 79 v
Thomas, W., 78 dq
Thorson, J. R., 65 u
Thring, R. H., 75 k
Thirring, H., 76 br
Tipler, W., 47 a, 48 e, 75 cc
Tobias, Charles W., 75 am
Toepel, R. P., 69 j
Tomazic, William A., 76 ai, 77 ab, 78 z, 80 s
Torti, V. A., 75 ai, 76 bc
Trayser, D. A., 65 u, 66 c, 67 b, 68 o
Trukhov, V. S., 72 av, 73 z, 74 bb,
76 av, 76 aw, 77 cq, 78 ec
Tsou, M. T., 63 k
Turin, R. A., 1852 a
Tursenbaev, I. A., 72 av, 73 z, 74 bb,
76 av, 76 aw, 72 ay, 77 cq
Uherka, K. L., 79 ai, 79 aj, 79 bi

ORIGINAL PAGE IS
OF POOR QUALITY

- Uhlemann, H., 72 c, 72 as, 74 u
Umarov, G. Ia., 72 av, 72 ay, 73 z,
74 bb, 76 av, 76 aw, 77 cn, 77 co,
77 cp, 77 cq, 77 cr, 78 ec
Underwood, A. E., 63 k, 70 a
Urieli, Israel, 75 w, 76 i, 76 y, 77 c,
77 d, 77 e, 77 g, 77 af, 78 ar,
79 ac
Urwick, W. D., 75 cd, 77 bi, 80 m
Utz, J. A., 60 x
Valentine, H., 77 bd, 77 bp, 78 q,
78 ab
Vallance, J. K., 77 l
van Beukering, H. C. J., 65 h, 67 g,
73 c, 73 d, 76 bt
van der Aa, H. H. M., 65 h, 67 g
Vanderbrug, Tom G., 77 ae
van der Sluys, Willem L. N., 75 h
van der Ster, J., 55 g, 60 h
van Eekelen, J. A. M., 78 an, 78 ao,
79 at
van Giessel, R., 73 h
van Heeckeren, W. J., 49 c, 52 h, 59 d,
49 k
van Nederveen, H. B., 66 d
van Reinink, F., 77 az
van Weenen, F. L., 47 b, 47 c, 57 k
van Witteveen, R., 62 k, 66 f, 71 ag
Varney, Frederick M., 72 w, 77 n
Vasishta, V., 69 p, 71 n
Vedin, B. A., 68 t
Veldhuijzen, A. J. J., 63 r
ver Beek, H. J., 69 r
Verdier, J., 72 ae
Vernet-Lozet, M., 67 r
Vesely, E. J., Jr., 78 dd, 79 cc
Vickers, P. T., 70 ae
Vicklund, G. D., 72 p
Villard, J. C., 72 ae
Vogulkin, N. P., 77 cq
Volger, J., 68 d, 77 bw
von Reth, R. D., 74 v, 75 g
Vonk, G., 00 a, 62 j, 00 a
Voss, J., 79 au
Voss, V., 34 a
Vuilleumier, R., 18 a
Waalwijk, J. M., 74 d
Wade, W. R., 68 p, 69 k, 72 ag
Wadsworth, J., 61 j
Wakao, N., 61 m
Wake, S. J., 78 bx

Walker, G., 58 j, 61 k, 61 l, 61 o,
62 f, 62 p, 63 g, 65 i, 65 j,
65 z, 65 ab, 67 f, 68 n, 68 ad,
69 q, 70 g, 71 n, 71 ae, 72 i,
72 j, 72 aw, 73 i, 73 j, 73 m,
73 n, 73 v, 73 ag, 73 bi, 74 ao,
74 bx, 76 ax, 77 cg, 78 f, 78 bs,
78 dc, 79 m, 79 y, 79 ao, 80 c,
80 d, 80 n, 80 o

Walter, R. J., 78 cd

Walters, S., 70 t

Walton, H., 65 ac, 65 ae

Wan, W. K., 71 o, 72 i

Ward, David, 77 ad

Ward, Edward J., 72 w

Ward, G. L., 72 ax, 78 bs, 79 ao

Watelet, R. P., 76 bc

Waters, E. D., 78 m, 79 ay, 79 bk

Watson, G. K., 77 at

Webster, D. J., 75 an

Weg, H., 75 bo

Weimer, George A., 76 o

Weinhold, J., 63 l

Weissler, P., 65 p

Welsh, H. W., 62 i, 72 ap

Welz, A. W., 78 dz

West, C. D., 71 ap, 74 g, 74 j, 74 k,
74 ad, 74 bh, 74 cb, 76 k, 80 l

Westbury, E. T., 70 af

Wheatley, J. C., 79 bx, 79 by

White, M. A., 68 c, 70 v, 71 ao, 72 b,
72 au, 73 q, 73 al, 74 n, 74 o,
75 r, 76 ay, 77 x, 78 bz, 78 cb,
79 an

White, Ronald, 76 l

Wiedenhof, N., 74 d

Wilding, Tony, 71 aa

Wile, D. D., 60 s

Wiley, R. L., 78 bb

Wilkins, Gordon, 71 ar

William, C. G., 73 f

Wilson, David Gordon, 75 am, 78 br

Wilson, S. S., 75 aq

Winberge, E. B., 43 a

Wingate, C. A., 77 ax

Wintringham, J. S., 60 n, 61 b

Witzke, W. R., 77 at

Wolgemuth, C. H., 58 g, 63 n, 68 ah,
69 b, 69 ag

Wu, Yi-Chien, 77 ac

Wulff, H. W. L., 72 ae

Wuolijoki, J. R., 48 f

CRIMINAL CASES IS
OF POOR QUALITY

Wurm, Jaroslav, 75 e
Wyatt-Mair, G. F., 79 ah, 79 bt, 79 cx
Yagi, S., 61 m
Yakahi, S., 43 a
Yang, W. J., 75 bq
Yang, Y., 80 W
Yano, R. A., 72 ap
Yates, D., 78 aj, 78 dd
Yeats, F. W., 75 l, 75 y
Yellott, Y. I., 57 l
Yendall, E. F., 52 e, 58 f
Yzer, Jacobus, A. L., 52 g, 56 b
Zacharias, F. A., 71 m, 71 w, 71 au,
73 a, 73 y, 74 be, 77 bt
Zanzig, J., 65 q
Zapf, Horst, 70 i, 70 l, 70 ad
Zarinchang, J., 70 ag, 75 d, 72 az
Zeuner, G., 1887 a
Zimmerman, F. J., 71 be
Zimmerman, J. E., 77 ct
Zimmerman, M. D., 71 c
Zindler, G. F., 69 aj
Ziph, B., 79 av, 80 x
Zykov, V. M., 74 am, 74 bs

8. CORPORATE AUTHOR INDEX

A corporate author is the organization the personal author works for and the organizations that sponsored the work. A reference may have several corporate authors. The references (Section 7) and the reports themselves were searched for corporate authors.

Advanced Technology Lab

69 aa

AERE-Harwell

61 g, 66 f, 67 i, 70 e, 70 z,
70 aa, 70 ab, 71 ap, 74 f, 74 g,
74 h, 74 i, 74 j, 74 k, 74 ac,
74 ad, 74 bh, 75 l, 75 y, 76 k,
77 t, 78 dm, 78 dv

Aerojet Energy Conversion Co.

78 ca

Aerojet Liquid Rocket Co.

68 e, 68 h, 68 j, 69 i, 69 ak,
70 r, 71 az, 72 d, 72 k, 73 r,
73 at, 74 x, 74 au, 75 p,
75 au, 76 al, 76 aq, 77 cd

Aerospace Corp.

71 as, 71 bb, 74 at, 74 bp,
74 bq, 75 ae

AFFDL

67 e, 68 x, 69 l, 70 ac, 71 bf,
72 t, 72 z, 74 l, 75 a, 75 b,
76 l, 78 do, 78 dz, 78 ea

Air Product & Chemicals, Inc.

71 j, 71 be, 74 as

Air Systems Command

63 j

Aisin Seiki Company, Ltd.

79 t, 79 aw, 79 bh

American Gas Association

62 m, 77 r, 77 ck

American Industrial Systems, Inc.

76 bq

American Machine Co.

08 a

Amtech Incorp.

78 g, 78 bc

Argonne National Laboratories

78 m, 78 ac, 78 cx, 79 ai, 79 aj,
79 ay, 79 bi, 79 bk, 79 cy

Arthur D. Little, Inc.

59 j, 60 d, 61 h, 63 s, 64 f,
78 dz, 79 aj

Atomic Energy Commission

71 ay, 72 e, 72 f, 72 al, 73 ax

Battelle

61 e, 62 m, 65 a, 65 u, 66 c,
67 b, 68 o, 68 y, 69 d, 73 ay

BNW

79 bu

LIST OF COMPANIES
OF YOUR COMPANY

Boeing	Corning Glass Works
77 au, 78 ah, 78 cy	77 o
Booz-Allen Applied Research Inc.	Cummins Engine Co.
70 w, 72 ao	74 aa
Bremen Mfg, Co.	D-Cycle Power Systems, Inc.
13 b	77 q
Brigham Young University	Defense Research Establishment
77 h, 79 h, 79 ad	78 bx
Bucknell University	DeLamater Iron Works
77 ad	1887 b, 1888 b, 1888 c, 1890 b
Burns and McDonnell Engineering Co.	Department of Commerce
78 di	77 ct
Carnegie-Mellon University	Department of Defense
78 cz, 80 w	51 r
Chevron Research Co.	Department of Energy
74 aq	77 bx, 77 by, 77 ck, 78 d, 78 g, 78 i, 78 k, 78 l, 78 r, 78 t, 78 w, 78 x, 78 y, 78 z, 78 aa, 78 ab, 78 ac, 78 ad, 78 ag, 78 ak, 78 bv, 78 bw, 78 cc, 78 cd, 78 ce, 78 cg, 78 ck, 78 cl, 78 cm, 78 cn, 78 co, 78 cp, 78 ct, 78 cv, 78 ei, 79 a, 79 e, 79 f, 79 j, 79 l, 79 n, 79 ai, 79 ay, 79 ba, 79 bd, 79 bi, 79 bk, 79 bl, 79 bm, 79 bn, 79 br, 79 bu, 79 bv, 79 bw, 79 bz, 79 ca, 79 cb, 79 cc, 79 cg, 79 ch, 79 ci, 79 cj, 79 ck, 79 cm, 79 cn, 79 co, 79 cp, 79 cr, 79 ct, 79 cv, 79 cw, 79 cz, 79 da, 80 a, 80 f, 80 k, 80 q, 80 r, 80 s, 80 t, 80 v, 80 w
Coleman Co., Inc.	
57 f	
Combustion Utilities Corp.	
29 b	
Commissariat A L'Energie Atomique	
73 am	
Consolidated National Gas Service Co	
72 y	
Control Data Corp.	Department of Transportation
71 n	72 w, 75 bf

ORIGINAL PAGE IS
OF POOR QUALITY

Durham University

53 b, 58 e, 59 b, 59 e, 60 g,
60 k, 60 l, 60 u, 61 a, 61 k,
61 l, 62 e, 62 f, 62 h, 62 p,
63 g, 63 o, 66 j

Eaton Corp.

74 ar

Ebasco Services Incorp.

75 ce

Ecole Polytechnique de Varsovie

74 cc

English Electric Co.

59 c

Electro-Optical Systems

60 w

ERDA

72 al, 72 ap, 74 bc, 75 ba, 75 bs,
75 bv, 75 bz, 76 j, 76 bf, 76 bn,
77 b, 77 k, 77 p, 77 s, 77 ab,
77 aj, 77 ao, 77 aq, 77 ar, 77 as,
77 at, 77 av, 77 cj, 77 ck, 77 cs,
78 ai

ERG, Inc.

73 p, 77 a, 77 u, 79 bc

Ethyl Corp.

60 n, 67 p

European Nuclear Energy Agency

66 n

Fairchild Hiller Corp.

69 ab

Fairchild Space & Electronics Co.

75 bt, 76 ag, 78 j, 78 aq, 78 eh

FFV Company

80 p

Florida International University

76 ba

Ford Aerospace & Communications Corp.

79 ak

Ford Motor Co.

73 h, 76 ah, 77 k, 77 l, 77 aq,
77 by, 78 w, 78 y, 78 cc, 78 cg,
78 cv, 78 dj, 78 dl, 79 s

Gas Research Co.

32 b

General Electric

65 k, 69 c, 76 j, 77 w, 77 aj,
77 ck, 78 d, 78 af, 78 av, 78 bb,
78 by, 78 cq, 78 dn, 79 f, 79 aq,
79 as, 79 bo, 80 a

George Mason University

79 cs

General Motors Corporation

42 b, 60 a, 62 g, 62 n, 63 i,
64 g, 65 t, 68 i, 68 p, 68 v,
68 aa, 69 f, 69 j, 69 k, 69 v,
69 ad, 69 ae, 69 ao, 69 ap, 74 ah,
75 am, 75 aw, 78 bf, 78 bg, 78 bh,
78 bi, 78 bj, 78 bk, 78 bl, 78 bm,
78 dk

Glenallan Engineering & Development
Company, Ltd.

73 ac

CATALOGUE OF
OF POOR QUALITY

Goddard Space Flight Center

69 aa, 71 am, 79 bc

Hague International

75 am

Hartford National Bank and Trust Co.

49 c, 51 f, 52 c, 52 d, 52 f,
52 g, 52 h, 52 i, 55 d, 56 b,
56 d, 56 e, 56 f, 57 c, 57 h,
57 i, 57 j

HEW

69 d, 69 al, 70 x, 71 ba, 74 r,
74 av, 74 aw, 75 be, 76 as, 78 cb,
79 c

Hittman Associates

66 a, 74 bn

Honeywell Radiation Center

74 l

Hughes Aircraft

68 w, 68 x, 70 ac, 72 t, 72 z,
75 a, 78 do, 78 ea

IBM

71 s

IIT Research Institute

65 i, 65 j, 78 aj, 78 dd

Indian Institute of Science

54 a, 55 a, 59 k

Institute of Gas Technology

67 f, 75 e

Institute of Nuclear Physics-USSR

67 h

Intermediate Technology Development
Group

72 az

International Research and Technology
Corp.

73 af

Isotopes, Inc.

69 aj

Jet Propulsion Laboratory

75 t, 77 ac, 77 ae, 78 a, 78 b,
78 au, 78 bu, 78 bw, 78 cr, 78 cs,
78 ei, 79 n, 79 aa, 79 bn, 79 bp,
79 cb, 79 cv

John Hopkins University

77 ax

Joint Center for Graduate Study

75 q, 75 ag, 76 c, 76 ay, 77 h,
77 x, 77 aa, 77 ao, 77 cc, 77 ch,
77 ci, 78 l, 78 o, 78 p, 78 ad,
78 bt, 78 bz, 78 cb, 78 ck, 78 db,
78 dx, 79 c, 79 h, 79 q, 79 ad,
79 ag, 79 an, 79 bg

Josam Manufacturing Co.

76 p

Kaiser Engineers

60 m

Kings College, London

58 a, 61 a, 61 k, 62 e, 62 f,
63 f, 63 g, 75 i, 76 h, 77 z,
77 an, 77 ba, 78 n, 78 be, 78 bp

ORIGINAL PAGE IS
OF POOR QUALITY

Laboratoriet for Energiteknik

74 ab, 76 w

Lafayette College

71 be

L'Air Liquide Societe Anonyme

19 a

Leybold-Heraeus

67 o

Linde Air Products Co.

52 e

Malaker Labs, Inc.

63 h, 63 p

M.A.N.-MWM

70 i, 70 l, 71 m, 71 w, 71 au,
72 c, 72 aq, 73 a, 73 y, 73 ad,
73 aw, 74 u, 74 be, 77 bt

Marquette University

74 aa

Martini Engineering

78 dp, 79 b, 79 i, 79 bj, 79 bk,
79 bq, 80 f, 80 g, 80 h, 80 i

Martin-Marietta Corp.

64 j

McDonnell Douglas Astronautics

68 c, 68 l, 68 s, 68 u, 69 a, 69 x,
69 ac, 69 al, 70 v, 70 x, 71 i,
71 ao, 71 ba, 72 b, 72 d, 72 m,

72 ak, 72 an, 72 au, 73 q, 73 w,
73 al, 73 an, 74 n, 74 o, 74 p,
74 av, 75 r, 75 be, 76 r, 76 v,
76 as, 76 ay, 77 x

Mechanical Technology Inc.

72 v, 76 az, 77 b, 77 m, 77 s,
77 ar, 78 i, 78 x, 78 ba, 78 bd,
78 cf, 78 cl, 78 cw, 78 dt, 79 e,
79 o, 79 p, 79 r, 79 am, 79 ba,
79 bc, 79 bm, 79 bz, 79 cn, 79 co,
79 ct, 80 f, 80 q

Medtronics, Inc.

73 w

Minot State College

77 ak, 77 bf

M.I.T. Mass. Institute of Tech.

62 b, 62 c, 65 v, 66 h, 66 p,
67 l, 67 n, 68 g, 68 m, 68 r,
69 n, 69 o, 69 am, 70 y, 71 s,
71 an, 72 ar, 73 ay, 75 am, 75 bb,
75 bf, 76 bm, 78 at

Motorola, Inc.

75 o

NASA-Lewis

55 b, 61 i, 64 k, 65 k, 65 n, 65 y,
71 am, 74 bc, 75 ah, 76 ai, 76 ap,
77 p, 77 ab, 77 ae, 77 ao, 77 aq,
77 ar, 77 as, 77 at, 77 au, 77 av,
77 bd, 77 bp, 77 cj, 77 cs, 78 b,
78 l, 78 q, 78 v, 78 w, 78 x, 78 y,
78 z, 78 ab, 78 ad, 78 af, 78 ag,
78 ah, 78 ai, 78 aj, 78 ak, 78 au,
78 bu, 78 cc, 78 cd, 78 ce, 78 cf,
78 cg, 78 ck, 78 cm, 78 cn, 78 co,
78 cp, 78 cq, 78 ct, 78 cv, 78 cw,
78 cy, 78 cz, 78 da, 78 dl, 78 dn,
78 dt, 79 a, 79 l, 79 n, 79 o, 79 p,
79 bl, 79 bm, 79 br, 79 bv, 79 bw,
79 bz, 79 ca, 79 cb, 79 cc, 79 co,
79 cp, 79 cr, 79 ct, 79 cw, 80 f,
80 q, 80 r, 80 s, 80 t, 80 v, 80 w

ORIGINAL PAGE IS
OF POOR QUALITY

National Academy of Science	Northwestern University
75 bh	79 l
National Bureau of Standards	Odessa Technology Institute of Food & Refrigerating Industry-USSR
64 k, 66 a, 77 ad, 77 cf	58 b
National Heart and Lung Institute	Office of Naval Research
69 al, 70 x, 71 b, 71 i, 71 j, 71 ba, 72 d, 72 h, 72 ak, 72 an, 73 an, 74 av, 75 be, 76 as, 78 bt, 78 cb, 78 dx, 79 c, 79 q	50 a, 68 ag, 74 q, 77 ct
National Institute of Health	Ohio University
76 t, 76 u	63 h, 68 ah, 69 h, 71 g, 72 y, 73 b, 73 t
National Research Council	Ormat Turbines, Ltd.
61 j	78 ar, 79 ac
National Science Foundation	Pahlavi University - Iran
75 ac, 77 cs	75 d
National Space Development Agency of Japan	Penn State College
79 ax	58 g, 69 b, 69 ag
Naval Engineering Experiment Station	Philips, Eindhoven
51 r	43 b, 46 a, 46 c, 46 d, 47 b, 47 c, 48 j, 48 k, 49 d, 49 e, 49 f, 49 g, 49 h, 49 i, 49 j, 50 b, 50 c, 50 d, 51 g, 51 h, 51 i, 51 j, 51 k, 51 l, 51 m, 51 n, 51 o, 51 p, 52 j, 52 k, 52 l, 52 m, 52 n, 52 o, 52 p, 52 q, 52 r, 52 s, 53 d, 53 f, 53 g, 53 h, 53 i, 53 j, 54 d, 54 e, 54 f, 59 f, 59 g, 60 c, 60 e, 62 j, 62 k, 63 e, 64 i, 65 b, 65 g, 65 h, 65 x, 66 k, 67 j, 68 d, 68 q, 68 ac, 69 e, 69 m, 69 r, 70 d, 70 j, 70 u, 71 e, 71 f, 71 m, 71 ag, 72 a, 72 c, 72 ah, 73 d, 73 h, 73 aj, 74 c, 74 d, 74 u, 74 bv, 75 f, 75 h, 75 m, 75 ay, 76 f, 76 at, 76 bt, 77 ax, 77 bb, 77 bw, 77 bz, 78 t, 78 u, 78 an, 78 ao, 78 aw, 78 ax, 78 az, 79 al, 79 at, 79 au, 79 av, 00 a, 00 d
New Process Industries, Inc.	
75 bx, 77 ca	
Northern Alberta Institute of Tech.	
78 bs, 79 ao	
Northern Research & Engineering Corp.	
65 e	
Northrop Space Labs	
55 b, 65 y	

Philips, North American

57 g, 57 k, 58 c, 58 h, 58 i,
59 d, 59 h, 59 l, 59 m, 60 o,
60 p, 60 q, 60 r, 60 t, 63 r,
65 v, 66 l, 67 e, 70 h, 70 p,
70 ah, 71 l, 71 p, 71 v, 73 x,
73 ap, 74 b, 74 w, 74 bj, 75 b,
75 m, 75 ab, 76 e, 76 am, 77 f,
77 v, 77 y, 77 ax, 77 bx, 78 bb,
79 aq, 79 av, 79 az, 79 bc

Purdue University

68 m, 68 r, 69 n, 70 m, 71 aj,
71 ak, 74 br

RCA

72 af, 74 y, 75 ac

R & D Associates

79 be

Reactor Centrum Nederland

66 d

Reading University - U.K.

75 k, 78 ay

Recold Corp.

60 s

Research Corp.

38 b, 39 a, 71 aq, 72 x

Rider-Ericsson Engine Co.

06 a, 06 c

Rocketdyne

64 c, 65 c, 67 c, 67 d

Roesel Lab

74 s

Royal Naval Engineering College

78 ap, 79 z, 79 ab, 79 ae, 79 cf

Shaker Research Corp.

78 v, 78 da, 79 l

Sigma Research Inc.

78 m, 79 ay, 79 bk

Space Power Systems, Corp.

60 b, 60 f

Stanford University

50 a, 52 a, 53 a, 76 ak

Stirling Technology Inc.

80 x

Stirling Power Systems

78 ci, 78 cj, 79 ap, 80 p

Solar Energy Research Institute

79 cu

Stone & Webster Engineering Corp.

71 ak

Sunpower

75 n, 75 s, 75 cf, 76 bd, 78 e,
78 as, 78 dr, 78 du, 79 ar, 79 bf

Syracuse University

64 d, 65 d, 66 i

TCA Stirling Engine Research and
Development Co.

70 f, 70 g, 72 u, 75 al, 78 al

Technical University of Denmark

77 cd

CLIP
OF POOR QUALITY

Texas Instruments, Inc.

67 l, 72 am

Thermo Electron Corp.

71 b, 72 d, 74 ba, 75 ai, 76 bc,
78 ac, 78 cx, 79 cy

Thermo-Mechanical Systems Co.

72 ap

Tokyo Gas Company, Ltd.

78 ed, 79 t

Union Carbide Corp.

75 an

United States Congress, OTA

78 n

United States Department of Army

66 e, 67 q, 73 q, 73 as, 77 ab

United States Environmental Protection
Agency

73 ak, 74 an

United States Naval Post-Graduate-School

64 a, 64 e

United Stirling of Sweden

70 o, 71 m, 71 ah, 73 a, 73 s,
74 z, 75 j, 75 az, 75 bk, 75 by,
77 i, 77 j, 77 al, 77 am, 77 bj,
77 cl, 78 aa, 78 cu, 79 r, 79 bv,
80 t, 80 v

United Technologies Research Center

79 s

Universite Paris X

74 cc

University of Bath

68 af, 71 ae, 72 aj, 72 ax, 73 bd,
74 bu, 78 f, 78 bs, 79 ao

University of Birmingham

70 k, 71 u

University of Calgary

68 n, 68 ad, 69 p, 69 q, 70 g,
71 k, 71 n, 71 o, 72 j, 73 i, 73 j,
73 m, 73 u, 73 v, 74 ao, 74 bx,
76 ax, 76 bl, 77 cg, 78 f, 78 bs,
78 dc, 79 y, 79 ao, 80 c, 80 d,
80 n, 80 o

University of California at Berkeley

75 am

University of California at
Los Angeles

79 m

University of California at San Diego

79 bx, 79 by

University of Dakar - Senegal

77 cu

University of Florida

69 o, 70 q

University of London

52 b, 53 c, 61 q, 67 f

University of Michigan

61 n, 68 b

University of Texas

74 bt

University of Tokyo

61 m, 69 m, 78 ed, 78 ee, 79 t,
79 u, 79 aw, 79 ax, 79 bh

University of Toledo

78 ai

University of Utah

75 ba, 76 au

University of Wisconsin

60 j, 60 v, 60 x, 61 b, 71 h

University of Witwatersrand

75 w, 76 i, 76 x, 76 y, 77 c,
77 d, 77 e, 77 g, 77 af, 77 bq,
78 s, 78 am, 79 g, 79 af, 79 ah,
79 bb, 79 bg, 79 bt, 79 cx

Utah University

74 az

Washington State University, Medical
College

77 x, 78 bz, 79 an

Wayne State University

71 q, 72 r, 73 ar

Westinghouse

73 ax, 74 w, 74 ax, 74 ay, 75 ab,
75 cb, 76 am, 76 ao, 76 ap, 77 cb

West Pakistan University of Engineering
and Technology

65 i

Winnebago Industries, Inc.

78 ch

Wright Patterson AFB

62 o, 73 au, 73 av, 74 1

Wolfe & Holland, Ltd.

79 ae

Zagreb University

68 k

9. DIRECTORY

This section gives as complete list as possibly of the people and organizations involved in Stirling engines in 1979. Eighty-two organizations responded to the questionnaire that was sent out or are mentioned in the recent literature as being currently active in Stirling engines. These questionnaires are given in Section 9.5 in alphabetical order by company. For the convenience of the reader, the questionnaires were analyzed to obtain as far as possible a ready index to this information. The following indexes are given:

1. Company
2. Contact Person
3. Country and Persons Working
4. Service or Product

9.1 Company List

Even though the questionnaires in Section 9.5 are given in alphabetical order by organization, it is sometimes difficult to be consistent about the organization. Therefore, for the convenience of the reader, the organizations are given with the entry number in Table 9-1.

9.2 Contact Person

The person or persons mentioned in the questionnaires as the contact person are given in alphabetical order in Table 9-2.

9.3 Country and Persons Working

This information is not as informative as was hoped as many of the large efforts in Stirling engines like Phillips and United Stirling did not answer this question.* Table 9-3 shows the country, gives the number used in Section 9-5 and in Tables 9-1 and 9-2, and gives the number of workers if it was given. Otherwise a number is estimated. The number is preceded by an approximation sign (). The total number of organizations and workers for each country is given in Table 9-4.

9.4 Service or Product

In order for the information contained in this survey to be of maximum use, Table 9-5 has been prepared which gives the service or product offered or being developed. The numbers in Table 9-5 refer to entry numbers in Section 9-5.

9.5 Transcription of Questionnaires

The Questionnaire set out was somewhat ambiguous so the answers came back in different ways. Also to keep from repeating the questions the following format is followed:

*However, estimates were made from other sources.

Table 9-1
ORGANIZATIONS ACTIVE IN STIRLING ENGINES

1. Advanced Mechanical Technology, Inc.
2. Advanced Energy Systems Division, Westinghouse Electric Corporation
3. Aerojet Energy Conversion Company
4. AGA Navigation Aids Ltd.
5. AiResearch Company
6. Aisin Seiki Company, Ltd.
7. All-Union Correspondence Polytechnical Institute
8. Argonne National Laboratory
9. Boeing Commercial Airplane Company
10. British Oxygen Company
11. Cambridge University, Engineering Department
12. Carnegie - Mellon University
13. CMC Aktiebolag
14. Cryomeck, Inc.
15. CTI-Cryogenics
16. G. Cussons, Ltd.
17. Daihatsu Diesel Compy
18. Eco Motor Industries Ltd.
19. Energy Research & Generation, Inc.
20. Fairchild Industries
21. Far Infra Red Laboratory
22. F. F. V. Industrial Products
23. Foster-Miller Associates
24. General Electric Space Division
25. Hughes Aircraft Company
26. Japan Automobile Research Institute, Inc.
27. Jet Propulsion Laboratory
28. Joint Center for Graduate Study
29. Josam Manufacturing Company
30. Leybold Heraeus
31. M.A.N. - AG
32. Martini Engineering
33. Martin Marietta Inc.
34. Massachusetts Institute of Technology

35. Mechanical Engineering Institute
36. Mechanical Technology Incorporated
37. Meiji University
38. Mitsubishi Heavy Industries
39. N. V. Philips Industries
40. N. V. Philips Research Laboratories
41. National Bureau of Standards
42. National Bureau of Standards Cryogenics Laboratory
43. NASA-Lewis Research Center
44. Nippon Piston Ring Company, Ltd.
45. Nissan Motor Company, Ltd.
46. North American Philips Corporation
47. Wm. Olds and Sons
48. Ormat Turbines
49. Alan G. Phillips
50. Radan Associates Ltd.
51. Ross Enterprises
52. Royal Naval Engineering College
53. Schuman, Mark
54. Shaker Research Corporation
55. Shipbuilding Research Association of Japan
56. Ship Research Institute
57. Solar Engines
58. Starodubtsev Physicotechnical Institute
59. Stirling Engine Consortium
60. Stirling Power Systems Corporation
61. Sunpower Inc.
62. TCA Stirling Engine Research and Development Company
63. Technical University of Denmark
64. Texas Instruments
65. Thermacore, Inc.
66. Tokyo Gas Company
67. Tokyo Institute of Technology
68. United Kingdom Atomic Energy Authority
69. United States Department of Energy
70. United Stirling
71. Urwick, W. David

72. University of Calgary
 73. University of California, San Diego
 74. University of Tokyo
 75. University of Tokyo, Department of Mechanical Engineering
 76. University of Tokyo, Faculty of Engineering
 77. University of Witwatersrand
 78. Weizmann Institute of Science
 79. West, C. D.
 80. Yanmar Diesel Company
 81. Zagreb University
- Late Inersions:
82. Thomas, F. Brian
 83. Clark Power Systems Inc.

Table 9-2

ALPHABETICAL LIST OF CONTACT PERSONS

Allen, Paul C. (73)
 Anderson, Niels Elmo (63)
 Beale, William T. (61)
 Beilin, V. I. (7)
 Benson, G. M. (19)
 Billett, R. A. (50)
 Bledsoe, J. A. (24)
 Blubaugh, Bill (3)
 Carlquist, Stig. G. (13)
 Chellis, Fred F. (15)
 Chiu, W. S. (24)
 Clarke, M. A. (52)
 Cooke-Yarborough, E. H. (68)
 Curulla, J. F. (9)
 Daniels, Alexander (46)
 Derderian, H. (18)
 Didion, David (41)
 Doody, Richard (25)
 Ernst, Donald M. (65)
 Finkelstein, Ted (62)
 Fujita, H. (55)
 Fuller, B. A. (16)
 Gifford, William (14)
 Goto, H. (17)
 Griffin, John (57)
 Hallare, Bengt (70)
 Haramura, Shigenori (6)
 Hayashi, H. (26)
 Hirata, Masaru (75)
 Hoagland, Lawrence C. (1)
 Hoehn, Frank W. (27)
 Holtz, Robert E. (8)
 Hoshino, Yasunari (45)
 Hughes, William F. (12)
 Hurn, R. W. (69)
 Ishizaki, Yoshihiro (76)
 Isshiki, Naotsugu (67)
 Johnston, Richard P. (28)
 Kolin, Ivo (81)
 Krauter, Allan I. (54)
 Kushiyama, T. (38)
 Lampert, William B. (60)
 Leo, Bruno (25)
 Marshall, W. F. (69)
 Martini, W. R. (32)
 Marusak, Tom (36)
 Miyabe, H. (37)
 Moise, John (3)
 Nakajima, Naomasa (74)
 Ogura, M. (66)
 Olds, Peter (47)
 Organ, Allan J. (11)
 Paulson, Douglas N. (73)
 Percival, Worth (70)
 Phillips, Alan G. (49)
 Polster, Lewis (29)
 Pouchot, W. D. (2)
 Pronovost, J. (18)
 Qvale, Bjorn (3)
 Ragsdale, Robert (43)
 Rallis, C. (77)
 Reader, G. T. (52)
 Rice, Graham (59)
 Ross, Andrew (51)
 Schaaf, Hanno (31)
 Schock, A. (20)
 Schuman, Mark (53)
 Shtrikman, S. (78)
 Smith, Joseph L., Jr. (34)
 Spigt, C. L. (40)
 Stultieis, M. A. (39)
 Sugawara, E. (44)
 Sutton-Jones, K. C. (4)
 Syniuta, Walter D. (1)
 Toscano, William M. (23)
 Tsukahara, Shigeji (56)
 Tufts, Nathan, Jr. (30)
 Umarov, G. Ya (58)
 Urielli, Israel (48)
 Urwick, W. David (71)
 Walker, G. (72)
 West, C. D. (79)
 Wheatley, John C. (73)
 White, Maurice A. (28)
 Yamada, T. (80)
 Yamashita, I. (35)
 - - - - -
 Thomas, F. B. (82)
 Clark, D. A. (83)

Table 9-3. COUNTRY AND PERSONS WORKING

United States Org. No.	United States Workers	United States (Cont.) Org. No.	United States (Cont.) Workers	Japan Org. No.	Japan Workers	United Kingdom Org. No.	United Kingdom Workers	Sweden Org. No.	Sweden Workers
1	3	61	16	6	~7	4	~3	13	1
2	0	62	3	17	~2	10	~5	22	~50
3	5	64	~10	26	~1	11	1	70	~125
5	~10	65	1	35	~2	16	~2		
8	6	69	1	37	~1	50	1		
9	1	73	4	38	~2	52	7		
12	1	79	~1	44	4	59	8		
14	~5	83	7	45	2	68	0		
15	~20			55	~2	82	1		
19	10			56	5				
20	~1			66	~1				
21	~1			67	4				
23	4			74	2				
24	~20			75	2				
25	45			76	4				
27	3			80	~3				
28	7								
29	0								
32	2								
33	~10								
34	1								
36	52								
41	0								
42	~2								
43	~12								
46	2								
49	0								
51	1								
53	1								
54	2								
57	~15								
60	19								

(Continued on next page)

ORIGINAL SOURCE OF POOR QUALITY

Table 9-3. COUNTRY AND PERSONS WORKING (continued)

Netherlands		U.S.S.R.		Germany		Canada		Israel	
Org. No.	Workers	Org. No.	Workers	Org. No.	Workers	Org. No.	Workers	Org. No.	Workers
39	~50	7	12	30	6	18	4	48	1
40	~100	58	~5	31	~50	72	2	78	~1
South Africa		Denmark		Australia		Malta		Yugoslavia	
Org. No.	Workers	Org. No.	Workers	Org. No.	Workers	Org. No.	Workers	Org. No.	Workers
77	3	63	1	47	~1	71	0	81	1

ORIGINAL PAGE 11
OF FOUR QUARTERS

Table 9-4
 WORLDWIDE BREAKDOWN IN STIRLING ENGINE INDUSTRY

Nation	Number of Organizations	Number of Known Workers
United States	40	~307
Japan	16	~44
United Kingdom	9	~28
Sweden	3	~176
Netherlands	2	~150
West Germany	2	~56
U.S.S.R.	2	~17
Canada	2	6
Israel	2	~2
South Africa	1	~3
Denmark	1	1
Australia	1	~1
Malta	1	1
Yugoslavia	1	1
TOTAL	83	~793

Table 9-5

STIRLING ENGINE PRODUCTS AND SERVICES

(Numbers refer to entry numbers in Section 9.5)

Artificial Heart Power - 2, 3, 28, 75
Automobile Engines - 6, 26, 29, 36, 43, 70
Ceramic Materials - 19
Coal-fired Engines - 1, 8, 23, 31, 70
Combustors - 38
Cooling Engines - 5, 10, 11, 14, 15, 19, 21, 25, 33, 39, 40, 42, 62, 64, 76
Cryo Engines - 35, 76
Demonstration (Model) Engines - 16, 18, 30, 47, 51, 53, 57, 71, 82
Diesel-Stirling Combined Cycle - 75
Electric Generator Engines - 6, 7, 18, 19, 22, 83
Engine Analysis - 11, 20, 32, 37, 52, 56, 59, 61, 62, 63, 74, 75, 77, 78
Engine Plans - 11
Free Piston Engines - 19, 36, 40, 61
Fuel Emissions - 69
Gas Bearings - 19
Gas Compressors - 19, 34, 36
General Consulting Services - 13, 32, 62, 72
Heat Exchangers - 38, 59, 72, 74, 81
Heat Pipes - 52, 59, 65
Heat Pumps - 19, 24, 40, 41, 62, 63, 66, 76
Hydraulic Output - 19, 83
Isothermalizers - 19, 32
Linear Electric Generators - 19, 36, 61
Liquid Piston Engine - 52, 77, 79
Liquid Working Fluid Engines - 73
Mechanical Design - 11, 13, 17
News Service - 32, 49, 50
Regenerators - 19, 37, 59, 72
Remote, Super-reliable Power - 4, 60, 68
Rotary Stirling Engine - 76
Seal Research - 9, 12, 19, 44, 54, 56
Ship Propulsion - 52, 55
Solar Heated Engines - 27, 36, 57, 58, 61
Test Engines - 18, 24, 27, 30, 45, 51, 59, 67, 77, 80, 81
Wood Fired Engines - 18, 51, 67, 74

ORIGINAL PAGE IS
OF POOR QUALITY

(Entry No.)	Company Name Company Address Attn: Persons to Contact Telephone	(Persons Employed*)
--------------	--	---------------------

*on Stirling work

indicates that the question was not answered and number was estimated by author.

- (1) Advanced Mechanical Technology Inc. (AMTI) (3)
141 California St.
Newton, Mass. 02158
Attn: Dr. Lawrence C. Hoagland or Dr. Walter D. Syniuta
Telephone: (617) 965-3660

Department of Energy (Argonne National Laboratories) sponsored program on large stationary Stirling engines (500-3000 hp) for use in Integrated Community Energy Systems (ICES).

AMTI is prime contractor for DOE program and United Stirling (Malmo, Sweden) is subcontractor on Stirling engine design/development. Ricardo Consulting Engineers Ltd. (England) will serve as consultants to USS. Emphasis is on burning coal and coal-derived fuels and biomass in large engines for ICES. Program is just getting underway. We are under contract for phase I only which is an 8-month conceptual design study.

- (2) Advanced Energy Systems Div., Westinghouse Electric Corp. (0)
P. O. Box 10864
Pittsburgh, Pa. 15236
Attn: W. D. Pouchot

Had worked on System Integration for artificial heart power using a Stirling engine. Program was phased out in 1978. No current activity.

- (3) Aerojet Energy Conversion Co. (5)
P. O. Box 13222
Sacramento, Ca. 95813
Attn: John Moise or Bill Blubaugh
Telephone: (916) 355-2018

Have developed thermocompressor with potential for 10-year high reliability life for driving fully implantable left heart assist system. The unit has demonstrated over 17 percent efficiency with 20 watts input, weighs 0.94 kg and has a volume of 0.43 liters. Over 120,000 hours of endurance testing has been accomplished on thermocompressors for heart assist application.

- (4) AGA Navigation Aids Ltd. (~3)
Brentford, Middlesex, TW 80 AB, England
Attn: K. C. Sutton-Jones
Telephone: 01-560 6465 Telex: 935956

We have reached the stage of preparing production drawings following full evaluation of the prototype thermo-mechanical generator. It is our intention to commence production early in 1980 and expect to have this machine on the market by the middle of next year (viz. June 1980.) It is anticipated

that the selling price for this unit will be approximately £11,000 and the unit we provide will be capable of delivering 60W 24V continuously into a battery for the consumption of approximately 450 KG. of pure propane gas per annum.

We hope to undertake further development to ascertain that the machine will also operate from less refined fuel, but this will take some time yet to perfect.

(5) AiResearch Co. (~10)
Cryo/Cooler Div.
Murray Hill, N. J.
No Response

(6) Aisin Seiki Co., Ltd. (~7)
1, Asahi-machi 2-chome
Kariya City, Aichi Pref., Japan
Attn: Shigenori Haramura
Telephone: 0566 24 8337 Telex: 4545-714 AISIN J

The development of the Stirling engine has been started from October, 1975, by Aisin Seiki Co., Ltd., a member of Toyota Motor Group of Companies. We are at present developing a 50 KW Stirling engine for automobile and generator use. This is in cooperation with Tokyo University and under a grant from M.I.T.I. We are trying to achieve the max shaft power of 50KW/3000 rpm and the thermal efficiency of 30 percent/1500 rpm. We have recently achieved 41 KW/2000 rpm and 27.80 percent/1000 rpm. Furthermore we are also developing a 10 hp engine and are conducting research into heat pump systems in cooperation with Tokyo Gas Co.

(7) All-Union Correspondence Polytechnical Institute (12)
USSR, Moscow, 129278
ul, Pavla Korchagina, 22
Attn: Docent Beilin V. I.
Telephone: 283 43 87

Developing of highly effective device with the 20 KW power engine, using gaslike hydroge as fuel.
(Martini comment: This probably means hydrogen working gas.)

(8) Argonne National Laboratory (6)
Components Technology Division
Building 330
Argonne, Illinois 60439
Attn: Robert E. Holtz
Telephone: (312) 972-4465 Telex: 910-258-3285

The goal of this program is to develop and demonstrate large stationary Stirling engines, in the 500 to 3000 hp range, that can be employed with solid coal, coal-derived fuels, and other alternate fuels. Included in this effort are engine design, integration of the heat source with the engine, component testing, prototype construction and testing, and implementation. Accomplishments: Three industrial teams have initiated a conceptual design study of alternate engine configurations. This effort will be followed by the industrial based final design and construction efforts. Studies concerned

with the integration of the engine with various combustor options are underway. Also, experimental efforts dealing with both seals testing and the measurement of the heat transfer and fluid mechanics during oscillating flow conditions are underway.

- (9) Boeing Commercial Airplane Co. (1)
P. O. Box 3707 M.S. 4203
Seattle, Wa. 98124
Attn: John F. Curulla
Telephone: (206) 655-8219

Evaluation of Reciprocating seals concepts has shown that no seal to date (1) Footseal, (2) NASA Polyimide Chevron Seal, (3) Bell Seal or (4) Quad Seal can meet the stringent requirements of 1500 fpm surface speed with 1750 psig gas pressure and 275°F ambient.

- (10) British Oxygen Co. (~5)
Cryocooler Division
Wembley, London, England.
No Response

- (11) Cambridge University Engineering Department (1)
Trumpington St.
Cambridge CB2 1PZ
U. K.
Attn: Allan J. Organ
Telephone: Cambridge 66466 Telex: 81239

Development of computer simulations of Stirling cycle machines. Design of miniature Stirling cryogenic coolers. Design of Stirling engines 1/4 - 5 KW. Preparation of facsimile manufacturing drawings of Stirling engines no longer commercially available (KYKO, Philips 200 Watt (1947) etc.)

- (12) Carnegie-Mellon University (1)
Pittsburgh, Pa. 15213
Attn: William F. Hughes
Telephone: (412) 578-2507

Study of seals for Stirling engine (reciprocating dry and lubricated.) We have been interested in temperature calculations and development of criteria for operation below deleterious temperatures.

Presently we have been able to estimate temperature rises in these seals and hope to extend work to include elasto-hydrodynamic and pumping effects. This program is sponsored by NASA.

- (13) CMC Aktiebolag (1)
Sanekullavagen 43
S-21774 Malmo
Sweden
Attn: Stig G. Carlqvist
Telephone: 040-918602 Telegrams: Cemotor

Engineering consulting activity based on 30 years of development experience on advanced heat engines; 12 years on turbo-charged Diesel engines and 12 years on Stirling engines. Current program on Stirling engines is in the power range of 10 - 3000 HP, direct as well as indirect heat transfer and is mainly based on a new simplified engine concept and on improved components.

Accomplished in earlier activity the build-up of major Stirling engine company in Sweden (including advanced Stirling engine R & D laboratory.)

- (14) Cryomeck, Inc. (~5)
Syracuse, New York, Attn. Dr. William Gifford

No response

(Martini comment: Dr. Gifford is also Professor Mechanical Engineering at the University of Syracuse. Cryomeck is a cooling engine company.)

- (15) CTI-Cryogenics (~20)
266 Second Ave.
Waltham, MA 02154
Attn: Fred F. Chellis
Telephone: (617) 890-9400

Design, development and manufacture of cryogenic coolers operating on the Stirling cycle, Vuilleumier cycle, and other regenerative cycles. Presently in production manufacture of the Stirling cycle Army Common Module Cooler. We are the American builder and supplier for the Philips designed Model B Stirling cycle machines for production of liquid nitrogen or liquid oxygen at about 25 liters per hour.

- (16) G. Cussons Ltd. (~2)
102 Great Clowes Street
Manchester, M7 9RH
England
Attn: B. A. Fuller
Telephone: Telex: 667279

Supply of Stirling cycle hot air engine to universities, technical colleges and vocational training centres worldwide.

- (17) Daihatsu Diesel Co. - Japan (~2)
Mr. H. Goto

No response

Involved in design and construction of an 800 hp Stirling engine for a sea craft (79a, 79bj).

- (18) Eco Motor Industries Ltd (4)
P. O. Box 934
Guelph N1H 6M6
Ontario, Canada
Attn: J. Pronovost or H. Derderian
Telephone: (519) 823-1470

1/4 HP instrument test bed. Wood fired commercial model under development. 1/2 and 1 KVA. commercial generating set propane fired under development.

- (19) Energy Research & Generation, Inc. (10)
Lowell & 57th Street
Oakland, Ca. 94608
Attn: G. M. Benson
Telephone: (415) 658-9785

ERG has been developing for over ten years resonant free-piston Stirling type machines (Thermoscillators) including hydrostatic drives, linear alternators, heat pumps, cryogenic refrigerators and gas compressors. In addition, development has continued on a cruciform variable displacement crank-type Stirling engine having a Rinja arrangement. ERG is performing R & D on heat exchangers, heat pipes, isothermalizers, regenerators, gas springs, gas bearings, seals, materials (including silicon nitride and silicon carbide), and computer modeling as well as on linear motors and alternators, hydraulic drive components and external heat exchangers and heat sources (including combustors and solar collectors.) ERG has built and tested several test engines and presently has separate electro-mechanical, hydraulic, engine and heat exchanger test cells. ERG sells heat exchangers, regenerators, linear motor/alternators, linear motoring dynamometer test stands, gas springs/bearings, dynamic seals and hydraulic components. ERG plans to sell soon an oil-free isothermal compressor with linear motor drive and small Thermoscillators and laboratory demonstrators. The current status on ERG Stirling engines is given in references 77 a and u.

Current work involves both corporately funded and Government sponsored R and D programs. The Government contracts include: Advanced Stirling Engine Heat Exchangers (LeRC DEN-3-166); 15 KW(e) Free-Piston Stirling Engine Driven Linear Alternator (JPL 955468); Free-Piston Stirling Cryogenic Cooler (GSFC NAS 5-25344); Free-Piston Stirling Powered, Accumulator Buffered, Hydrostatic Drive (LeRC NAS 3-21483), Duocel, Foilfin and Thermizer Heat Exchangers (ONR N00014-78-C-0271), Hydrogen/Hydride Storage (Argonne 7-895451). Pending contracts include Reciproseals, Large Linear Alternators, and Hydrostatic Drive Components.

- (20) Fairchild Industries (~1)
 Germantown, Md.
 Attn: Mr. A. Schock
 No response
 Martini comment: Al Schock has written a fully rigorous Stirling engine computer program under DOE sponsorship.
- (21) Far Infra Red Laboratory (~1)
 U. S. Army Engineer Research and Development Lab.
 Fort Belvoir, Virginia
 No response
- (22) F. F. V. Industrial Products (~50)
 Linkoping, Sweden
 No response
 Martini comment: FFV makes the engine the Stirling Power Systems uses. They also are 50 percent owner of United Stirling. They are a Swedish National Company.
- (23) Foster-Miller Associates (4)
 350 Second Avenue
 Waltham, Mass. 01254
 Attn: Dr. William M. Toscano
 Telephone: (617) 890-3200

ORIGINAL PAGE IS
OF POOR QUALITY

"Design and Development of Stirling Engines for Stationary Power Generation Applications in the 500 to 3000 Horsepower Range". Program funded by DOE/ANL. FMA has been Phase I entitled Conceptual Design. Work has just been initiated; no accomplishments to date.

- (24) General Electric Space Division (~20)
P. O. Box 8661
Philadelphia, Pa. 19101
Attn: Mr. J. A. Bledsoe

No response

Martini comment: G. E. has been building in cooperation with North American Philips a Stirling engine originally designed for radioisotope space power (79 aq). G. E. has also been building a free-piston Stirling engine for powering a three-ton capacity heat pump. (79 as). G. E. has also designed with North American Philips a test engine for LeRC.

- (25) Hughes Aircraft Company (45)
Cryogenics and Thermal Controls Department
Culver City, Ca. 90230
Attn: Dr. Bruno Leo or Mr. Richard Doody
Telephone: (213) 391-0711 Telex: 67222

Hughes Aircraft Company is continuing its research and development work on Stirling and Vuilleumier cryogenic refrigerators. Currently, emphasis is being placed upon various modified designs of these units for special applications where maintenance-free life is the most important parameter.

- (26) Japan Automobile Research Institute Inc. (~1)
Japan
Mr. H. Hayashi
No response

Involved in feasibility study of a Stirling engine for an automobile (79 u).

- (27) Jet Propulsion Laboratory (45)
4800 Oak Grove Drive
Pasadena, Ca. 91103
Attn: Frank W. Hoehn
Telephone: (213) 354-6274 Telex, etc: FTS 792-6274

The Jet Propulsion Laboratory is currently working on a program to develop a Stirling Laboratory Research Engine which can eventually be produced commercially and be made available to researchers in academic, industrial, and government laboratories. A first generation 10 KW engine has been designed, fabricated, and assembled. The preprototype engine is classified as a horizontally-opposed, two-piston, single-acting machine with a dual crankshaft drive mechanism. The test engine, which is designed for maximum modularity, is coupled to a universal dynamometer. Individual component and engine performance data will be obtained in support of a wide range of analytical modeling activities.

- (28) Joint Center for Graduate Study/University of Washington (7)
100 Sprout Road
Richland, Wa. 99352
Attn: Richard P. Johnston or Maurice A. White
Telephone: (509) 375-3176

Fully implantable power source for an artificial heart. Accomplishments:
1. Demonstrated engine lifetime of four years without maintenance before heater lead failure. 2. Current engine performance: Up to 7.7 watts hydraulic power output with 20.1 percent overall efficiency at 5 watts output from 200 cc engine volume. 3. Engine concept produces pumped hydraulic output with no mechanical linkages or dynamic seals. Capable of total hermetic seal welding for long term containment of working fluids.

(29) Josam Manufacturing Co. (0)
Michigan City, Indiana 96360
Attn: Lewis Polster
Telephone: (219) TR2 5531

A working model has been built to demonstrate the self-starting, torque control. It is on display at the Ontario Science Centre in Toronto. Controlled heating, cooling with hydrogen as working fluid was added by Dr. William Martini who made preliminary studies.

An optimized design has been made for a car and a testing prototype for power and efficiency testing. A proposal is being made for funding. Component suppliers and a consultant have been found.

(30) Leybold-Heraeus (6)
101 River Road
Merrimac, Mass. 01860
Attn: Nathan Tufts, Jr.
Telephone: (617) 346-9286

Stirling engine offered by Leybold is a demonstration engine, permitting students and researchers to perform basic efficiency tests, and to observe through the glass cylinder the function. Pressure/vacuum relationships can be dynamically measured and indicated, or the machine may be mechanically driven as a heat/refrigerator pump. In the U.S. & N. America, contact Mr. Tufts--Internationally, production and sales from Bonnerstrasse 504, Postfach 510 760, 5000 Koln (Cologne), W. Germany. Over 400 sold.

(31) M.A.N. - AG (~ 50)
Maschinenfabrik Augsburg-Nurnberg AG
Postfach 10 00 80
D-8900 Augsburg 1
West Germany
Attn: Hanno Schaaf
Telephone: 0821 322 3522 Telex: 05-3751

Comment by Martini: M.A.N. is a licensee to Philips. They have worked for many years in Stirling engine developments, some of it sponsored by the German government and related to military hardware. Publications from this company are very few. The latest is 1977 bt. They seem to be developing four-cylinder Siemens engines like United Stirling but differing in the arrangement of parts. They have agreed to assist Foster-Miller Associates in designing a 500 to 2000 HP Stirling engine for Argonne National Laboratory.

(32) Martini Engineering (2)
2303 Harris
Richland, Wa. 99352
Attn: W. R. Martini
Telephone: (509) 375-0115
•Preparation of First and Second Edition of Stirling Engine Design Manual for NASA-Lewis.
•Publish Quarterly Stirling Engine Newsletter.
•Evaluate isothermalized Stirling engines for Argonne National Lab.
•Offers Stirling engine computation service for all types of Stirling engines.

(33) Martin Marietta Inc. (~10)
Cryogenics Division
Orlando, Florida
No response

(34) Massachusetts Institute of Technology (1)
Room 41-204
Cambridge Mass. 02139
Attn: Joseph L. Smith, Jr.
Telephone: (617) 253-2296
Ph.D. Thesis research on heat transfer inside reciprocating expander and compressor cylinders as in Stirling engines. Special emphasis on the thermodynamic losses resulting from periodic heat transfer between the gas and the walls of the cylinder

(35) Mechanical Engineering Institute
Agency of Industrial Science and Technology
Japan
Mr. I. Yamashita
No response
Martini comment: Involved in cryo-engine development (79 u).

(36) Mechanical Technology Incorporated (52)
Stirling Engine Systems Division
968 Albany-Shaker Road
Latham, New York 12110
Attn: Tom Marusak
Telephone: (518) 456-4142 ex. 255 Telex, etc. Telecopier (518)
785-2420
TWX 710-443-8150

Automotive Stirling Engine Development Program development of United Stirling, Sweden, kinematic engines for automotive applications; Free-piston Development Engine Programs include: (1) 1 Kwe Fossil-Fueled Stationary Electric Generator (Hardware), (2) 1 Kwe Solar Thermal Electric Generator (Hardware) (3) 3 Kwe Fossil-Fueled Heat Pump (Hardware), (4) 5 Kwe Fossil-Fueled Hybrid Electric Vehicle Propulsion System (Design), and (5) 15 Kwe. Advanced Solar Engine Generator (Design). In addition to these engine programs MTI is developing linear machinery loading devices for free-piston engines. Included are linear alternators, hydraulic and pneumatic motor systems, and resonant piston compressors.

ORIGINAL PAGE IS
OF POOR QUALITY

- (37) Meiji University (~1)
I-I, Kanda-Surogadai
Chiyoda-Ku
Tokyo 101
Japan
Mr. H. Miyabe
Involved in experimental analysis and regenerator research for the
800 hp seacraft engine (79 u, 79bj).
- (38) Mitsubishi Heavy Industries (~2)
5-1 Maronouchi 2 Chrome
Chiyoda-Ku
Tokyo, Japan
Mr. T. Kushiya
No response
Involved in heat exchanger and combustor work on an 800 hp Stirling
engine for a seacraft (79 u, 79 bj).
- (39) N.V. Philips Industries (~50)
Cryogenic Department
Building TQ III-3
Eindhoven - The Netherlands
Attn: M. A. Stultiens
Telephone: ++31 40 7.83774 Telex, etc.: 51121 phtc n1/nphetq
-Minicooler MC80/1W at 80K
-Liquid Air Generator PLA107S/7-8 1/hr.
-Liquid Nitrogen plants PLN106S and PLN430S, resp. 7 and 30 1/hr.
-Liquifiers (80 - 200 K) PPG102S and PPG400S/0, 8kW and 3,2kW at 80K.
-Two stage cryogenerator K20 for Cryopumping 10W/20K + 80W/80K.
-Two stage recondensers PPH110 and PPH440/10 l. and 40 l. H2 reconden-
sation.
-Two stage transformachines PGH105S and PGH420 for targetcooling,
cryopumping, etc.
-Helium liquefier 10-12 1/hr.
Physical Lab., where much research is being done with regard to Stirling
engines, heat-pumps and solar energy systems.
- (40) N.V. Philips Company (~100)
Philips Research Laboratories
Eindhoven, The Netherlands
Attn: C. L. Spigt
Telephone: 040-43g58
Free piston Cryogenerator
Free piston Stirling engine
3kW Stirling engine as heat pump driver
Vuilleumier Cycle
Comments by Martini: This organization is the pioneer of all modern
Stirling engine technology. All the leading companies in Stirling engines
have licenses from this company.
- (41) National Bureau of Standards (0)
Room B126, Bldg. 226

Washington, D. C. 20234
Attn. David Didion
Telephone: (301) 921-2994

Active program terminated

Comments by Martini: NBS did obtain a 1-98 engine from Philips and did test it as the prime mover in a heat pump-air conditioning system. The tests were generally successful. (See 1977 ad).

- (42) National Bureau of Standards (~2)
Cryogenics Laboratory
Boulder, Colorado

No response

- (43) NASA - Lewis Research Center (~12)
Stirling Engine Project Office
Lewis Research Center
21000 Brookpark Rd.
Cleveland, Ohio 44135
Attn: Robert Ragsdale
Telephone: (216) 433-4000

No response

Comments by Martini: NASA -Lewis administers most of the DOE program on automotive Stirling engines. The major program is with MTI and United Stirling. Many much smaller programs are sponsored including this design manual. Internally, NASA-Lewis has developed a third order analysis (79a) and has tested the GPU-3 engine (79 b1). Testing is now proceeding on the United Stirling P-40 engine.

- (44) Nippon Piston Ring Co., Ltd. (4)
No. 1-18, 2-Chome
Uchisaiwaicho, Chiyoda-ku
Tokyo, Japan

Attn: Mr. E. Sugawara
Telephone: Tokyo 503-3311

Telex, etc.: (0222) 2555 NPRT TOJ
Cable address: NPRT TOKYO

1. Development of material capable sliding under absence of lube oil.
2. Basic test and analysis of various piston rings and piston rod seals for pressure, sliding speed, selection of suitable gas, determination of number of seals required, and leakage of gas.
3. Analysis of frictional behaviour during sealing.
4. Development of gas recirculation system.
5. Development of liquid seal and of sealing-liquid recirculation system.

6. Design and manufacturing of piston ring and piston rod seal system for Stirling Engine of 800 PS (HP).

- (45) New Power Source Research Dept. Central Engineering Laboratories (2)
1 Natsushima-cho
Yokosuka 237 Japan
Attn: Yasunari Hoshino
Telephone: (0468) 65-1123

Telex: TOK 252-3011

Purpose: To evaluate the characters of Stirling Engine

Actual State: An experimental two-piston single acting engine was trial made and the fundamental study is being carried out using helium as working gas. Recently gas leakage analysis across piston rings and regenerator tests are mainly conducted. Also a comparison between our test results and the calculated data by means of yours Manual (The first edition of the Stirling Engine Design Manual) is being tried.

- (46) North American Philips Corp. (2)
Philips Laboratories
345 Scarborough Rd.
Briarcliff Manor, N. Y. 10510
Attn: Alexander Daniels
Telephone: (914) 762-0300

.SIPS (Stirling Isotope Power System) - 1 KW electric output engine was designed, fabricated and assembled; currently awaiting performance tests. In-house studies of Stirling cycle.

- (47) Wm. Olds and Sons (~1)
Ferry Street
Maryborough, Queensland
Australia
Attn: Peter Olds

Production Model - Horizontal type.
Detachable piston, reversable lever. Production model is approximately 15 inches long and 6 inches high.

- (48) Ormat Turbines (1)
P. O. Box 68
Yaune, Israel
Attn: Dr. Israel Urielli

Comments by Martini: Dr. Urielli continues his interest in Stirling engines started in his important Ph.D. thesis (77 af) which fully discloses and explains an entirely rigorous third order analysis method.

- (49) Alan G. Phillips (0)
P. O. Box 20511
Orlando, Florida 32814
Attn: Alan G. Phillips

Research and History of Pre 1930 Hot Air Engines. Reprinting of Catalogs on Hot Air Water Pumping Engines from 1871 to 1929. List of Available Publications on Request.

- (50) Radan Associates Ltd. (1)
19 Belmont, Lansdown Road
Bath, United Kingdom BA 1 5DZ
Attn: Mr. R. A. Billett
No response

Comments by Martini: Mr. Billett teaches at the School of Engineering, University of Bath and is involved in Demonstration Stirling engines and teaching aids. He conducts a Stirling engine course each year.

ORIGINAL PAGE IS
OF POOR QUALITY

ORIGINAL PAGE IS
OF POOR QUALITY

(51) Ross Enterprises
37 W. Broad St. #630
Columbus, Ohio 43215
Attn: Andrew Ross
Telephone: (614) 224-9403

(1)

Current work includes development of two fractional horsepower Stirling engines; one of medium pressure, and one of low pressure. The low pressure engine is part of a small DOE appropriate technology grant.

The aim on the medium pressure engine is to provide, in time, a source of small (100 to 200 watts) Stirling engines for the independent researcher, graduate student, hobbyist, etc.

(52) Royal Naval Engineering College
RNEC Manadon, Stirling Engine Research Facility
Crownhill, Plymouth
Devon, England PL53AQ
Attn: Lt. Cdr. G. T. Reader or Lt. Cdr. M. A. Clarke
Telephone: Plymouth 553740 Ext. RNEL 365

(7)

The Royal Naval Engineering College are part of an industrial-university consortium investigating the design and manufacture of Stirling engines. An assessment of Stirling cycle machines in a naval environment is also in hand. Although some experimental work has been done the main effort at present is the development of a general design and simulation algorithm. It is envisaged that a 15-20 KW twin-cylinder engine employing a sodium heat pipe will be on test by December 1979.

Work on the Fluidyne and a tidal flow regenerator test rig is also in progress.

(53) Schuman, Mark
101 G Street S.W. #516
Washington, D. C. 20024
Attn: Mark Schuman
Telephone: (202) 554-8466

(1)

Free piston, modified Stirling cycle heat engine invention available for licensing and development. U. S. and foreign patent protection. Two thermally driven partial models demonstrate key novel features.

(54) Shaker Research Corporation
Northway 10 Executive Park
Bellston Lake, N. Y. 12019
Attn: Allan I. Krauter
Telephone: (518) 877-8581

(2)

This work, which started in February 1978, is directed at applying hydrodynamic and elastohydrodynamic theory to a sliding elastomeric rod seal for the Stirling engine. The work is also concerned with the experimental determination of film thickness, fluid leakage, and power loss. Finally, the work entails correlating the experimental and theoretical results.

The analytical effort consists of two analyses: an approximate analysis of rod seal behavior at the four extreme piston position / piston velocity points and a detailed temporal analysis of the seal behavior during a complete piston cycle.

The experimental effort involves designing, constructing, and running an apparatus. The apparatus contains a moving transparent cylinder and the stationary elastomeric seal. A pressure gradient of 100 psi can be applied across the seal. Frequencies from 10 Hz to 50 Hz with a one inch total stroke can be employed. Film thickness will be measured with interferometry, fluid leakage by level and pressure changes, and power loss by force cells.

At present, the approximate and detailed analyses are complete, and the experimental apparatus is starting to produce quantitative results.

- (55) The Shipbuilding Research Association of Japan (JSBA) (~2)
Senpaku Shinko Bldg., 1-15-16
Toranomon, Minato-ku
Tokyo, Japan
Attn: Mr. H. Fujita

We are researching and developing the marine Stirling engine (double acting 4 cylinders 800 ps) on six years project from 1976.

Items of basic research are cycle simulation, heat exchangers, burner, sealing apparatus, and control system. Performance test of a 2 cylinders experimental engine will be also carried out.

These researches and tests are performed cooperatively by Research Panel No. 173 (SR173) which is consisted of universities, institutes, and companies.

- (56) Ship Research Institute (5)
6-38-1, Shinkawa, Mitaka
Tokyo 181, Japan
Attn: Mr. Shigeji Tsukahara
Telephone: 0422-45-5171

(1) The effect of engine elements such as materials in the regenerator and the dimensions of piston rings on the Stirling engine performance was studied using the Inverted-T type Stirling engine.

It was obtained that the effect of these elements was apparently great. Especially, the effect of the dimension of the piston ring on the net output was very remarkable. For example, the net output was improved in 2.5 times when 15 thin (1 mm) piston rings for a piston were employed instead of 4 thicker (6 mm) piston rings.

In future, amount of leakage of working fluids through piston rings and friction force by piston rings will be measured using the testing machine for Stirling engine elements.

(2) A dynamic mathematical model simulating a Stirling engine is now under development.

- (57) Solar Engines (~15)
2937 W. Indian School Rd.
Phoenix, Arizona 85017
Attn: Mr. John Griffin
Telephone: (602) 274-3541

No response

Comments by Martini: Solar Engines has built 20,000 of their Model 1 engine and 7000 of their Model 2 (See Figure 2-7). Solar Engines plans to build six models of their demonstration scale engines.

- (58) Starodubtsev Physicotechnical Institute (~5)
UL. Observatorskaya 85
Tashkent
Uzbek SSR, U.S.S.R.
Attn: G. G. Ya Umarov

No response

Comments by Martini: Mr. Umarov and his group are very regular contributors to the Soviet Solar Energy Magazine. Quite often the subject is Stirling engines. Mr. Umarov either does not receive or does not answer his mail.

- (59) Stirling Engine Consortium (8)
Department of Engineering
University of Reading
Whiteknights, Reading, Berkshire, RG6 2AY, United Kingdom
Attn: Dr. Graham Rice
Telephone: Reading 85123 Ext. 7325

1. Design of 20 kW helium charged research (Consortium) Engine
2. Re-building of 200 watt Air Charged engine with integral heat pipe cylinder heater head
3. Gas flow test rigs for steady-state and dynamic testing of consortium engine components, namely: heater, regenerator and cooler
4. Cycle analysis

- (60) Stirling Power Systems Corporation (19)
7101 Jackson Road
Ann Arbor, Michigan 48103
Attn: William B. Lampert
Telephone: (313) 665-6767
Telex: 810-223-6010

SPS is responsible for market development on the Stirling engine being produced by FFV in Sweden. The Recreational Vehicle market is the first market being addressed, as the attributes of the Stirling cycle engine are important, i.e., quiet, low vibration, low emissions, etc. The Stirling engine generator set and system installed in a Winnebago Motor Home was introduced to the RV Industry at the National RVIA Show in November, 1978. The innovative system was very well received. Winnebago Industries is planning on limited production beginning in Spring, 1980. The product consists of a 6.5 KW Stirling engine generator set with an integrated total system to provide electricity, hydronic heating and air conditioning that is automatic in operation; thus, providing home-like comfort for the customer.

- (61) Sunpower Inc. (16)
6 Byard St.
Athens, Ohio 45701
Attn: William T. Beale
Telephone: (614) 594-2221

Small electric output free piston engines --100-1000 watt--solar and solid fuel heat-water pumps in same power range using free cylinder mode of the free piston engine, hermetically sealed.

Sunpower sells both the alternator and the water pump with full guarantee for one year.

Sunpower does analysis, computer simulation design, construction and test on all types and sizes of Stirling engines, but specializes in free piston engines.

Late Information: The Sunpower SD 100 engine produced 62 w(e) at an overall fuel-to-electric energy efficiency of 7.5 percent. Hot end temperature was 425C, cold 40C. At 475C hot end temperature power was 80 w(e) and heat-to-electric efficiency was 13 percent.

(62) TCA Stirling Engine Research & Development Company (3)
POB 643
Beverly Hills, Ca. 90213
Attn: Ted Finkelstein
Telephone: (213) 279-1186, 474-8711

1. Development of a gas-fired heat pump and air conditioner.
2. Development of an oilwell gas liquefier.
3. Maintenance and support of TCA Stirling Analyzer Program.

(63) Laboratory for Energetics (1)
Technical University of Denmark
Building 403 DK-2800
Lyngby, Denmark
Attn: Niels Elmo Andersen or Bjorn Qvale

Development of a total energy system composed of a Stirling engine and a Stirling heat pump. The prototype is designed to produce 2 kW of electricity and 8 kW of heat. The total energy utilization is expected to vary from 100 percent at maximum power output to 190 percent at maximum heat output.

Development of a third-order analysis program for Stirling machines. The model is composed of separate models for each of the components of the machine. The cylinder spaces are assumed adiabatic. The heat exchangers and the regenerator models take into account both heat transfer and flow friction.

(64) Texas Instruments (~10)
Cryogenics Division
Dallas, Texas
No response

(65) Thermacore, Inc. (1)
780 Eden Road
Lancaster, Pa. 17601
Attn: Donald M. Ernst
Telephone: 569-6551

At the present time, Thermacore is negotiating a contract for a supporting role in the Argonne National Laboratory Program for the Design and Development of Stirling Engines for Stationary Power Generation Applications in the 500-3000 horsepower range. This effort is directed at the use of liquid metal heat pipes for integrating the heat source with the engine heater-head.

Thermacore's personnel are credited with the current state-of-the-art in terms of life for liquid metal heat pipes: 41,000 hours @ 600°C for nickel-potassium; 35,000 hours @ 800°C for Hastelloy X - sodium.

ORIGINAL FILED IN
OF POOR QUALITY

(66) Tokyo Gas Co., Ltd
Tokyo, Japan 105
Attn: Mr. M. Ogura

(~1)

No response

Involved in a feasibility study of a Stirling engine heat pump (79 u).

(67) Tokyo Institute of Technology
Naotsugu ISSHIKI (Laboratory)
2-12-1 Ookayama Meguroku
Tokyo 152 Japan
Attn: Naotsugu Isshiki
Telephone: 03 420 7677

(4)

1. Experimental study of Stirling engines using several test engines of small size, such as (1) 20 mm diameter & 14 mm stroke swash plate type two cylinder engine of 1/3 kW; (2) the same type of 40 mm diameter and 26 mm stroke engine intended power of 2 kW. The results will be reported in the future.

2. Experimental and theoretical study to know the smallest temperature difference by which the Stirling engine can operate, for future power recovery from waste heat from industry and conventional engines.

(68) United Kingdom Atomic Energy Authority
AERE Harwell
Oxfordshire OX11 0RA
England
Attn: E. H. Cook-Yarborough
Telephone: (0235) 24141

(0)

Telex: 83135

Three development and four field-trial thermo-mechanical generators (TMG) constructed. Radio-isotope heated development TMG has run continuously since Nov. 1974. UK National Data Buoy has been powered by propane-heated 25 w TMG (while at sea) since first installation in 1975. Major lighthouse off Irish coast powered by 60 w TMG since Aug. 1978. Fluidyne liquid-piston Stirling engine originally invented at Harwell.

(69) United States Department of Energy
P. O. Box 1398
Bartlesville, OK. 74003
Attn: R. W. Hurn or W. F. Marshall
Telephone: (918) 336-2400

(1)

Fuels tolerance, emissions, and power delivery characteristics of 10 hp Philips Stirling.

(70) United Stirling (Sweden) AB & Co.
Box 856
S-201 80 Malmo
Sweden

(~125)

Attn: Mr. Bengt Hallare (also Mr. Worth Percival, Washington D. C. office)
Telephone: (202) 466-7286 in Washington, D. C.

No response

Comments by Martini: United Stirling is a licensee of N. V. Philips and is the world leader in producing automotive scale Stirling engines. They have a 40 kw, 75 kw and 150 kw machine. They have installed one in a truck and several in automobiles. They plan serial production of the P-75 (75 kw) engine. They are sub-contractor to MTI on the DOE sponsored automobile program through NASA-Lewis. They are sub-contractor to Advanced Mechanical Technology on the 500-3000 hp design study contract let by Argonne National Laboratories.

(71) Urwick, W. David (0)
85/2 St. Anthony St.
Attard, Malta
Attn: W. David Urwick
Telephone: 40986

Retired engineer living in Malta since 1970. Since that date I have built in my small workshop a series of model Stirling engines, as a piece of amateur research, and I take an intense interest in Stirling engine developments throughout the world. I have had two articles published in "Model Engineer" describing what I have done. Last year at the M.E.E. exhibition in London I was awarded a trophy for a 12-cylinder wobble plate Rider engine of unusual design. A further article is now awaiting publication, which will describe this machine.

(72) University of Calgary (2)
Department of Mechanical Engineering
Alberta, Canada
Attn: G. Walker
Telephone: (403) 284-5772

Energy Flow in Regenerative Systems
Stirling Cycle Cryocoolers
Heat Exchangers for Stirling Cycle Systems

(73) University of California, San Diego (4)
Physics B-019
U.C.S.D.
La Jolla, California 92093
Attn: John Wheatley or Paul C. Allen or Douglas N. Paulson
Telephone: (714) 452-2490

Scientific, non-hardware oriented, studies of Malone type heat engines and appropriate working fluids.

(74) University of Tokyo (2)
Dept. of Mechanical Engineering
HONGO 7-3-1, BUNKYO-KU
Tokyo, 113 Japan
Attn: Naomasa Nakajima
Telephone: (03) 812-2111 ext. 6138

1. Measurements of unsteady flow heat transfer rate at heat exchangers Stirling engines.
2. Development of computer simulation programs for Stirling engine design.
3. Design of Stirling engine driven with wood fuel.

- (75) University of Tokyo, Dept. of Mechanical Engineering (2)
 7-3-1 Hongo, Bunkyo-ku
 Tokyo, Japan
 Attn: Masaru Hirata
 Telephone: Tokyo 03-812-2111 ext. 7133
 1. Diesel-Stirling combined cycle analysis
 2. Artificial heart
 3. Computer simulation of Stirling cycle
- (76) The University of Tokyo, Faculty of Engineering, (4)
 Dept. Nuclear Eng.
 7-3-1, Hongo, Bunkyo-ku
 Tokyo, Japan 113
 Attn: Yoshihiro Ishizaki
 Telephone: (03) 812-2111, ext. 3163, 7565
 .Rotary Stirling engine and rotary Stirling refrigerator.
 .Multi-phase Stirling refrigerator.
 .Cryo-Stirling engine for the LNG power station.
 .Conceptual design for the application of the Stirling cycle machines.
- (77) University of Witwatersrand (~3)
 Dept. of Mechanical Eng.
 1 Jan Smuts Ave.
 Johannesburg 2001, South Africa
 Attn: Prof. C. Rallis
 Telephone: 39-4011 Telex: 8-7330 SA
 No response
 Comments by Martini: Programs: Have built and tested a Stirling engine experiment (78 s). Have developed a rigorous third order computer code (77 af). Have evaluated liquid piston engines (79 af).
- (78) Weizmann Institute of Science (~1)
 Dept. of Electronics
 Rehovot, Israel
 Attn: Professor S. Shtrikman
 Telephone: (054) 82614 Telex: 31900
 Studies of second order design methods.
- (79) West, C. D. (~1)
 114 Garnet Lane
 Oak Ridge, Tennessee 37830
 Attn: C. D. West
 Telephone: (615) 483-0637
 Theoretical and experimental investigations of liquid piston engines. Past accomplishments include invention and development of "Fluidyne" liquid piston energy.
- (80) YAN MAR Diesel Co. - Japan
 Mr. T. Yamada
 No response
 Involved in a Stirling test engine (79 u). (~3)

ORIGINAL PAGE IS
OF POOR QUALITY

(81) Zabreg University
Faculty of Technology
Mose Pijade 19
41000 Zagreb, Yugoslavia
Europe
Attn: Dr. Ivo Kolin
Telephone: 33-242

(1)

The current program on the Stirling engine is developed under the general title which may be called: The new performance of the Stirling cycle. It includes two main lines of improvement on kinematic and thermodynamic field. The work continues beginning with the first experimental engine from 1972 having new working mechanism which produces a more appropriate movements of both pistons. That leads to the new indicator diagram closer to Stirling than to the Schmidt cycle. The further program is conceived in such a way as to connect the advantages of improved working mechanism with the new methods of heat transfer. That is now the main line for the future experimental and theoretical research in this field.

Late Insertions:

(82) F. Brian Thomas
Putson Manor
Hereford HR2 6BN
United Kingdom
Attn: F. Brian Thomas
Telephone: Hereford 65220

(1)

My opposed twin rhombic drive motor won first prize at Model Engineer Hot Air Engine Competition Jan. 1979. Butane gas fired. 15cc pistons swept volume. Pressurized to 40 psia. Developed 8 watts (mechanical) at 3,000 rpm. Drives its own water cooling circulation pump and a bicycle dynamo!

Currently engaged in building the second of a series of "Swing Beam Engines."

(83) Clark Power Systems, Inc.
916 West 25th Street
Norfolk, VA. 23517
U.S.A.
Attn: David A. Clark
Telephone: (804) 625-5917

(7)

Doing design work on a new form of Stirling cycle engine which will be used to generate hydraulic or electric power.

Appendix A

PROPERTY VALUES

Property values for the gases and the solids and liquids used in designing Stirling engines are given in this appendix, both in the form of tables and charts as well as equations which are used as subroutines in computer programs. Also included are heat transfer and fluid flow correlations commonly used in Stirling engine design.

Table of Contents

Table A-1. Common Conversion Factors	313
Thermal Conductivity	
Equations	
Table A-2. For gases	314
Table A-3. For liquids	314
Table A-4. For solids	315
Graphs	
Figure A-1. For gases and liquids	316
Figure A-2. For solids	317
Figure A-3. Various	318
Specific Heats	
Table A-5. Heat Capacities of Working Gases	319
Viscosity	
Table A-6. Viscosity of Working Gases	320
Prandtl Number	
Table A-7. Prandtl Numbers for Working Gases	321
Heat Transfer and Fluid Flow	
Figure A-4. Flow Friction Coefficient for Screens with Recommended Relationship	322
Figure A-5. Friction Factor and Heat Transfer Correlation for Flow Inside Circular Tubes with Recommended Relationships	323
Figure A-6. Heat Transfer Coefficient for Screens with Recommended Relationship	324

Table A-1

Common Conversion Factors
(Standard Units for this Manual are Underlined)

To Convert	To	Multiply By
inches	<u>centimeters</u>	2.540
pounds/sq. in.	<u>megapascals (MPa)</u>	0.006894
atmospheres	<u>megapascals (MPa)</u>	0.1013
<u>megapascals (MPa)</u>	atmospheres	9.872
<u>megapascals (MPa)</u>	psia	145.05
<u>centimeters</u>	inches	0.3937
BTU/hr	<u>watts</u>	0.2931
calories	<u>joules</u>	4.1868
BTU	<u>joules</u>	1055
<u>watts</u>	BTU/hr	3.412
<u>joules</u>	calories	0.2388
<u>joules</u>	BTU	9.479 E-4
<u>Viscosity</u>		
<u>g/cm·sec</u>	poise	1
centipoise	<u>g/cm·sec</u>	0.01
<u>Thermal Conductivity</u>		
<u>watts</u> <u>cm °K</u>	BTU/hr ft°F	57.79
BTU/hr ft °F	<u>w/cm °K</u>	0.01731
BTU/hr ft ² (°F/in)	<u>w/cm °K</u>	1.443 E-3
<u>Heat Transfer Coefficient</u>		
<u>w/cm² K</u>	BTU/hr ft ² F	1761
BTU/hr ft ² F	<u>w/cm² K</u>	5.678 E-4

Table A-2
Thermal Conductivity of Gases

$KG = \exp(A + B \ln(T))$
 $KG =$ Thermal Conductivity of gas, w/cmK
 $T =$ Temperature, K

Gas	A	B
Helium, 1 atm	-10.1309	+0.6335
Hydrogen, 1 atm	-11.0004	+0.8130
Water vapor, 1 atm	-15.3304	+1.1818
Carbon dioxide, 1 atm	-16.5718	+1.3792
Air, 1 atm	-12.6824	+0.7820

Table A-3
Thermal Conductivity of Liquids

Equation
 $KL = \exp(A + B \ln(T))$
 $KL =$ Thermal Conductivity of Liquid, w/cm K
 $T =$ Temperature, K

Liquid	A	B
Sodium	2.3348	-0.4113
Engine Oil	-5.2136	-0.2333
Freon, CCl_2F_2	-7.3082	0

Table A-4
Thermal Conductivity of Solids

Equations

KM = Thermal Conductivity w/cmK

T = Temperature, K

$KM = \exp(A + B \ln T)$

Material	A	B
300 series Stainless Steel	- 4.565	+0.4684
Lucalox Alumina	+12.45	-2.440
Commercial Silicon Carbide	+ 2.661	-0.6557
Pyrex Glass	- 7.207	+0.4713
Low Carbon Steel	+ 1.836	-0.4581
70 w/o Mo, 30 w/o W	+ 4.990	-0.7425
Rene 41	- 5.472	+0.5662

ORIGINAL SOURCE
OF INFORMATION

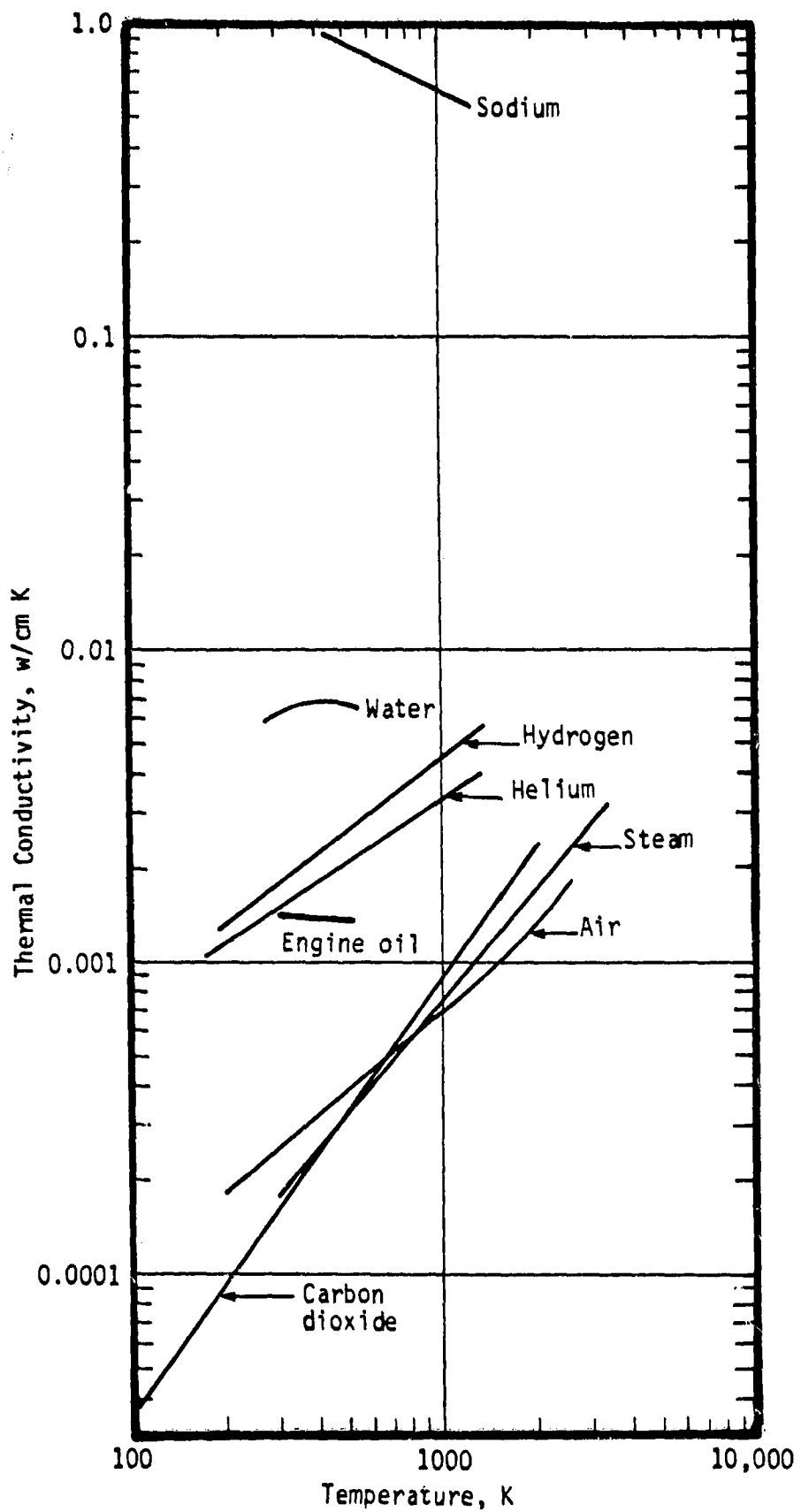

Figure A-1 Thermal Conductivity of Liquids and Gases usable in Stirling Engines

ORIGINAL PAGE IS
OF POOR QUALITY

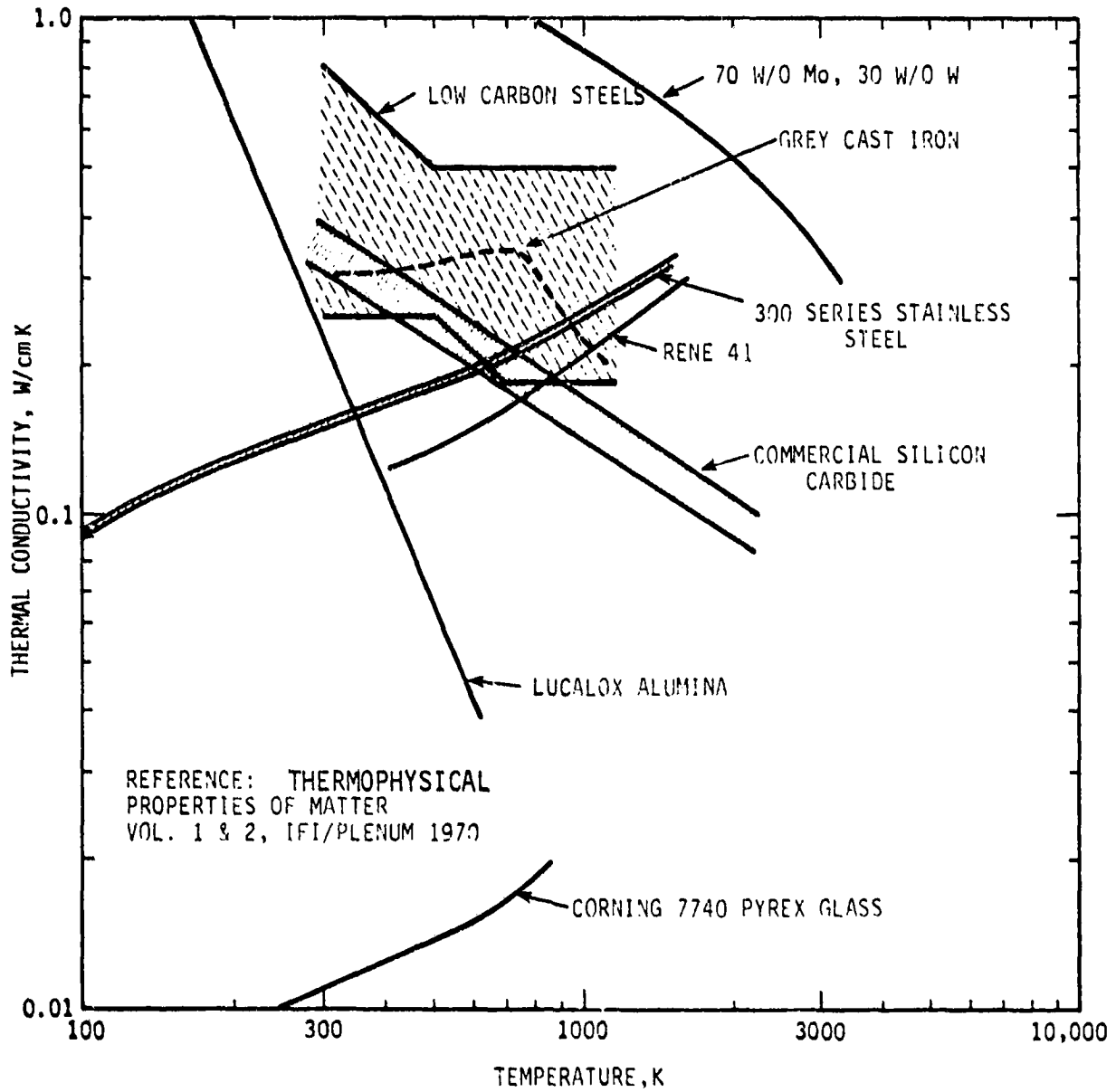

Figure A-2. Thermal Conductivities of Probable Construction Materials for Stirling Engines.

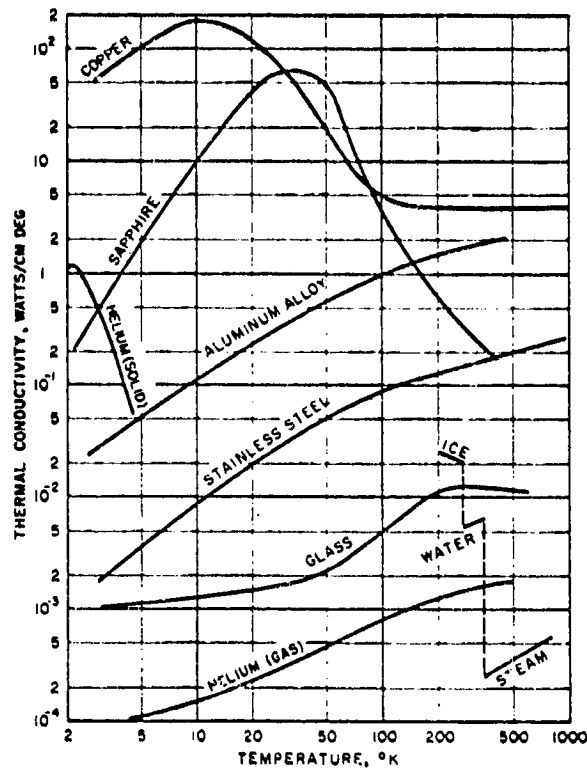

Figure A-3. Typical Curves Showing Temperature Dependence of Thermal Conductivity
(From American Institute of Physics Handbook, 2nd Ed., pp. 4-79).

ORIGINAL PAGE IS
OF POOR QUALITY

Table A-5

Temperature K	Heat Capacities for Working Gases, J/g K					
	Hydrogen ¹		Helium ¹		Air ²	
	CP	CV	CP	CV	CP	CV
298.15	14.31	10.18	5.20	3.12	1.0057	0.7188
400	14.50	10.37	5.20	3.12	1.0140	0.7271
500	14.52	10.39	5.20	3.12	1.0295	0.7426
600	14.56	10.43	5.20	3.12	1.0551	0.7682
700	14.62	10.49	5.20	3.12	1.0752	0.7883
800	14.70	10.57	5.20	3.12	1.0978	0.8109
1000	14.99	10.86	5.20	3.12	1.1417	0.8548
1200	15.43	11.30	5.20	3.12	1.179	0.892
1500	16.03	11.90	5.20	3.12	1.230	0.943
2000	17.03	12.90	5.20	3.12	1.338	1.051
2500	17.86	13.73	5.20	3.12	1.688	1.401
3000	18.40	14.27	5.20	3.12	---	---

¹From American Institute of Physics Handbook, Sec. Ed., pp. 4-49.

²From Holman, J. P., "Heat Transfer," Fourth Ed., p. 503, McGraw Hill, 1976.

Table A-6

Viscosity of Working Gases
g mass/cm sec at
PAVG = 10 MPa

TR K	Hydrogen MU	Helium MU	Air MU
300	9.131×10^{-5}	1.984×10^{-4}	1.979×10^{-4}
400	1.113×10^{-4}	2.498×10^{-4}	2.515×10^{-4}
500	1.313×10^{-4}	2.913×10^{-4}	3.051×10^{-4}
600	1.513×10^{-4}	3.377×10^{-4}	3.587×10^{-4}
700	1.713×10^{-4}	3.840×10^{-4}	4.123×10^{-4}
800	1.913×10^{-4}	4.304×10^{-4}	4.659×10^{-4}
1000	2.313×10^{-4}	5.232×10^{-4}	5.731×10^{-4}
1200	2.713×10^{-4}	6.160×10^{-4}	6.803×10^{-4}
1500	3.313×10^{-4}	7.552×10^{-4}	8.411×10^{-4}
2000	4.313×10^{-4}	9.872×10^{-4}	1.109×10^{-3}
2500	5.313×10^{-4}	1.219×10^{-3}	1.377×10^{-3}
3000	6.313×10^{-4}	1.451×10^{-3}	1.645×10^{-3}

Ref: American Institute of Physics Handbook, 2nd Edition, pp. 2-227.

The above data are based upon the following equations:

For hydrogen:

$$\text{MU} = 88.73 \times 10^{-6} + 0.200 \times 10^{-6}(\text{TR} - 293) \\ + 0.118 \times 10^{-6}(\text{PAVG})$$

For helium:

$$\text{MU} = 196.14 \times 10^{-6} + 0.464 \times 10^{-6}(\text{TR} - 293) \\ - 0.093 \times 10^{-6}(\text{PAVG})$$

For air:

$$\text{MU} = 181.94 \times 10^{-6} + 0.536 \times 10^{-6}(\text{TR} - 293) \\ + 1.22 \times 10^{-6}(\text{PAVG})$$

Table A-7

Prandtl Numbers for Working Gases
Prandtl Number, PR, dimensionless
(101 atm pressure)

Temperature K	Hydrogen PR	Helium PR	Air PR
300	0.720	0.688	0.761
400	0.730	0.709	0.772
500	0.744	0.717	0.795
600	0.757	0.711	0.830
700	0.771	0.718	0.864
800	0.781	0.729	0.899
1000	0.810	0.749	0.974
1200	0.846	0.770	1.057
1500	0.890	0.795	1.189
2000	0.923	0.828	
2500		0.858	
3000		0.837	

ORIGINAL
OF POOR QUALITY

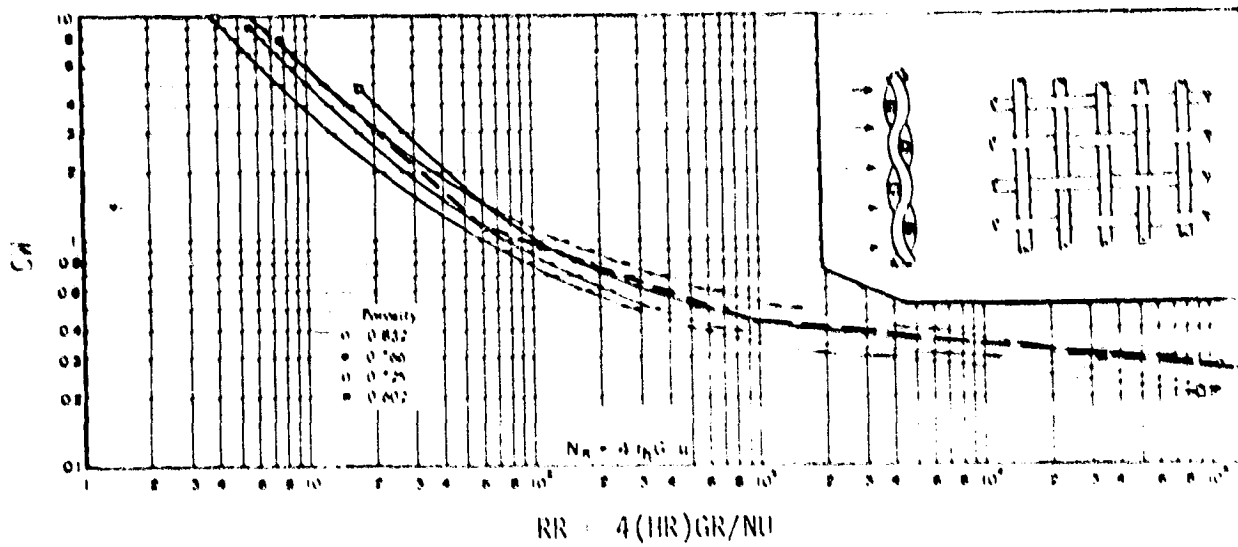

Figure A-4. Flow Through an Infinite Randomly Stacked Woven-Screen Matrix. Flow Friction Characteristics: a Correlation of Experimental Data from Wire Screens and Crossed Rods Simulating Wire Screens. Perfect Stacking, i.e., Screens Touching, is Assumed. (64 1, p. 130)

The dotted line is the recommended relationship.
Its equation is:

For $RR < 60$ let:

$$\log CW = 1.73 - 0.93 \log(RR)$$

For $60 < RR < 1000$:

$$\log CW = 0.714 - 0.365 \log(RR)$$

For $RR > 1000$:

$$\log CW = 0.015 - 0.125 \log(RR)$$

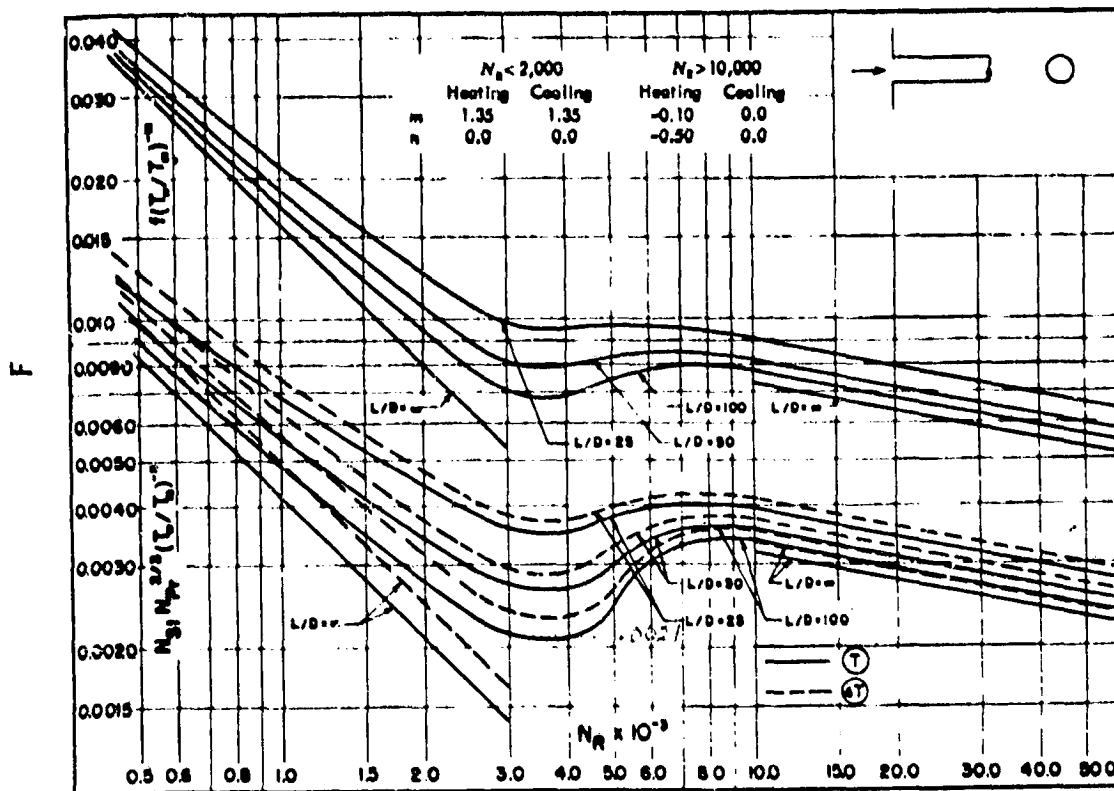

Figure A-5. Gas Flow Inside Circular Tubes with Abrupt Contraction Entrances; a Summary of Experimental and Analytical Data. (64 1, p. 123)

For Friction factor the recommended correlation is:

For $RE \leq 2000$:

$$CW = 16/RE$$

For $RE > 2000$:

$$\log(CW) = -1.34 - 0.20 \log(RE)$$

For heat transfer coefficient the recommended correlation is:

$$\text{if } RE < 3000 \text{ then } ST = \exp(.337 - .812 \ln(RE))$$

$$\text{if } 3000 < RE < 4000 \text{ then } ST = 0.0021$$

$$\text{if } 4000 < RE < 7000 \text{ then } ST = \exp(-13.31 + .861 \ln(RE))$$

$$\text{if } 7000 < RE < 10000 \text{ then } ST = 0.0034$$

$$\text{if } 10000 < RE \text{ then } ST = \exp(-3.37 - .229 \ln(RE))$$

$$\text{where } ST = N_{ST} (N_{Pr})^{2/3}$$

CHARACTERISTICS
OF FOUR QUALITY

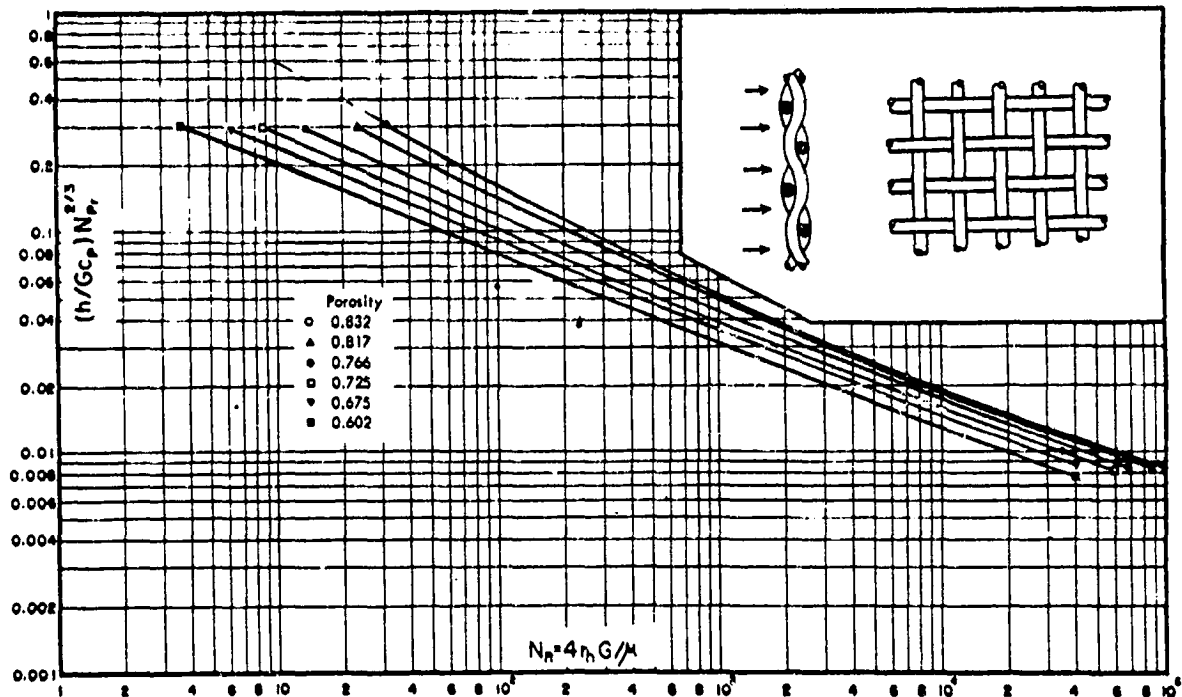

Figure A-6. Gas Flow Through an Infinite Randomly Stacked Woven-Screen Matrix, Heat Transfer Characteristics; a Correlation of Experimental Data from Wire Screens and Crossed Rods Simulating Wire Screens. Perfect Stacking, i.e., Screens Touching, is Assumed (64 1, p. 129).

The recommended equation to use for this correlation is:

$$\log \left(\frac{H}{G(CP)} (PR)^{\frac{2}{3}} \right) = -0.13 - 0.412 \log (RR)$$

$$\frac{\ln}{2.303} \left(\frac{H}{G(CP)} (PR)^{\frac{2}{3}} \right) = -0.13 - \frac{.412}{2.303} \ln (RE)$$

$$ST = \left(\frac{H(PR)^{\frac{2}{3}}}{G(CP)} \right) = \exp(-0.299 - 0.412 \ln(RE))$$

APPENDIX B

NOMENCLATURE FOR BODY OF REPORT

In this design manual it was decided to use a nomenclature that would be compatible with all computers right from the start so that there would be no need for translating the nomenclature later on. This means that Greek letters and subscripts which have traditionally been part of engineering notation will not be used because no computer can handle them. All computers employ variable names with no distinction between capital letters and small letters. Restrictions for the three main engineering languages are:

FORTRAN - First character must be a letter. Other characters may be letters or numbers. Limit is usually six.

PASCAL - Same as FORTRAN but usually there is no limit to the length of the variable name as long as letters and numbers are used with no punctuation or spaces.

BASIC - First character must be a letter. Second character may be a letter or number. Additional characters may be carried along but are ignored in differentiating variables.

In order to be compatible with all these computer languages and in order to use a reasonably compact nomenclature, the restrictions imposed by the BASIC language will be adopted. This limits the number of variables to 936, which is adequate. Those who program in PASCAL or FORTRAN might want to add to the two letter variable name given here to make it more descriptive.

In PASCAL the type of each variable must be declared in advance. The categories are:

- integer
- real
- character (string)
- boolean

Arrays are also declared in advance.

In FORTRAN there are only real or integer variables. Without specific type declaration variables beginning with I, J, K, L, M and N are integers and the rest are real. This convention is not supported in this nomenclature table. In programming in FORTRAN one should declare all the variables real or integer at the start. If a variable name is used to identify an array (i.e. A(X,Y,Z)) it cannot also be used to identify a variable (i.e. A). Words are handled with format statements.

In BASIC variables beginning with any letter can be declared integers. Otherwise, all variables are assumed to be real numbers. For instance, if I is declared an integer all variables such as IN, IX, IA etc. are made integers also. If a statement evaluates IA as 3.7, the computer will use it as 3, the

integer part. This nomenclature does not group the integers. Therefore, all numbers in the nomenclature are assumed real.

BASIC uses suffixes to identify what type of variable or degree of precision is desired. The suffixes are:

- % integer
- ! single precision
- # double precision
- \$ string (letters, number, punctuation, spaces)

Although integers compute faster than single precision numbers, all variables in this nomenclature are presented as single precision real numbers. BASIC assumes this if no suffix is given.

BASIC handles arrays as an additional suffix. For instance, AX can be used as a variable. In addition, AX(A, B, C) can be used as a three-dimensional array without being confused with AX. Since FORTRAN cannot do this, a variable name in this nomenclature will be either an array name or single real number, but not both.

String variables are useful in BASIC or PASCAL programs but will not be defined in this nomenclature.

The explanation of each variable starts out with a noun. For instance, "heat transfer area" becomes "area of heat transfer". This is done so that when the meanings are alphabetized, similar meanings will be together. Table B 1 gives the nomenclature alphabetized by symbol. Table B 2 gives the nomenclature alphabetized by meaning.

Table B-1
 NOMENCLATURE FOR BODY OF DESIGN MANUAL
 (Alphabetized by Symbol)

A	Counter for finding right average pressure.
AA	Factor of correlation, power with pressure.
AB	$\sqrt{(CR)^2 - (EE-RC)^2}$
AC	Area of heat transfer for cooler, cm^2 .
AF	Area of flow, cm^2 .
AH	Area of heat transfer for heater, cm^2 (or in general).
AK ()	Array of thermal conductivities, $w/cm K$.
AL	Angle of phase, degrees.
AM	Area of face of matrix, cm^2 .
AS	Ratio of heat transfer area to volume for matrix, cm^{-1} .
AT ()	Array of area of metal for heat conduction.
AU	Ratio to TC to TH = TC/TH, commonly call tau.
B	Constant for Table Spacing
B1	$\sqrt{(CR)^2 - (EE + RC)^2}$
BA	Exponent of correlation of power with pressure.
BF	Factor of correlation of power with standard.
BH	Heat, basic input, watts.
BP	Power, basic, watts.
C ()	Array of cold volumes, cm^3 .
C3	Constant in internal temperature swing loss equation.
C4	Length of connecting rod to cold space, cm .
CA	Option on cooler type 1 = tubes, 2 = annulus, 3 = fins.
CC	$\sqrt{(CR-RC)^2 - EE^2}$
CD	Volume, cold, dead, cm^3 .
CF	Loss, flow, cooler, watts.
CL ()	Array of cold space live positions.
CM	Factor, conversion = 2.54 $cm/inch$
CN	Minimum of array- FC().
CP	Capacity of heat of gas at constant pressure, j/gK .
CQ	Loss of heat by conduction, watts, individually and collectively.

- CR Length of connecting rod, cm (if two cranks to hot space).
- CV Capacity of heat of gas at constant volume, j/gK.
- CW Factor of friction for matrix or tubes.
- CX Volume, cold, dead outside, cooler tubes.
- CY Maximum of Array FC().
-
- D1 Diameter, effective or real, of power duct, cm.
- D2 Diameter of power piston in gamma engine, cm.
- D3 Diameter of power piston drive rod if in working space, cm.
- D4 Diffusivity, thermal in displacer, cm²/sec.
- D5 Diffusivity, thermal in cylinder wall, cm²/sec.
- DB Diameter at seal in cold space or diameter of displacer, cm.
- DC Diameter inside of engine cylinder, cm.
- DD Diameter of displacer or piston rod (if in working space), cm.
- DH Density of gas in heater g/cm³.
- DI Diameter, inside of annular regenerator, cm.
- DK Density of gas in cooler, g/cm³.
- DL Factor in Schmidt equation = $\sqrt{(AU)^2 + 2(AU)(K) \cos(AL) + K^2} / (AU + K + 2S)$
- DM Diameter of hot space manifold tubes, cm.
- DN Diameter of heater manifold tubes, cm.
- DP Pressure, difference of, MPa.
- DR Diameter of each regenerator or OD of annular regenerator, cm.
- DT Temperature, increase of in cooling water, K.
- DU Temperature, increase of in cold space, K.
- DV Temperature, increase of in hot space, K.
- DW Diameter of wire or sphere in matrix, or thickness of foils, cm.
-
- E Effectiveness of regenerator, fraction.
- E2 Clearance, end in gamma type power piston, cm.
- E4 Density of displacer wall g/cm³.
- E5 Density of cylinder wall, g/cm³.
- E6 Density of matrix solid material, g/cm³.
- EC Clearance, piston end, cm.
- EE Eccentricity in a rhombic drive, cm.
- EF Efficiency of cycle, fraction.
- EH Emissivity of hot surface.
- EK Emissivity of cold surface.

ORIGINAL PAGE IS
OF POOR QUALITY

- ES Emissivity of radiation shields.
ET Angle used in Schmidt equation (see equation 6-36).
- F Angle of crank, degrees.
F1 Fraction of cycle time gas is assumed to leave hot space at constant rate.
F2 Fraction of cycle time gas is assumed to enter hot space at constant rate.
F3 Fraction of cycle time that flow out of the cold space is assumed to occur at constant rate.
F4 Fraction of cycle time gas is assumed to enter cold space at constant rate.
- FA Factor for area effect in radiation heat transfer.
FC () Array of gas mass fractions in cold space.
FE Efficiency of furnace, %.
FF Fraction of matrix volume filled with solid.
FH () Array of gas mass fractions in hot space.
FM Factor for emissivity effect in radiation.
FN Factor for number of radiation shields in radiation.
FQ Factor, conversion = 60 Hz/RPM.
FR Fraction of cycle time flow is into hot space.
FS Loss, mechanical due to seal friction, watts.
FW Flow of cooling water, g/sec.
FX Flow of cooling water per cylinder, GPM or liters/minute.
FZ Credit for flow friction, watts.
- G Clearance around hot cap, cm.
G1 Constant of conversion = 10^7 g/(MPa · sec² · cm).
GC Velocity, mass, in cooler, g/sec cm².
GD Velocity, mass, in connecting duct, g/sec cm².
GH Velocity, mass in heater, g/sec cm².
GR Velocity, mass, in regenerator, g/sec cm².
- H () Array of hot volumes, cm³.
H1 Option for heater, 1 = tubes, 2 = fins, 3 = single annulus heated one side.
HC Coefficient of heat transfer at cooler, w/cm²K.
HD Volume, hot dead, cm³.
HH Coefficient of heat transfer in heater, w/cm²K.
HL () Array of hot space live positions, cm.

HN Minimum of array FH ().
 HP Factor, conversion = $1.341E-3$ HP/watt.
 HR Radius, hydraulic, of matrix = $P0/AS$.
 HW Loss, flow in heater, watts.
 HX Maximum of array FH ()
 HY Coefficient of heat transfer, $\text{watts/cm}^2\text{K}$.

 I Counter for iterations.
 IC Diameter inside of cooler tubes of space between fins or annular clearance, cm.
 ID Diameter, inside of cold duct, cm.
 IH Diameter, inside, of heater tubes or space between fins or gap in annulus, cm.
 II Power, indicated, watts.

 K Swept volume ratio = VK/VL
 K3 Constant in reheat loss equation.
 KA Coefficient in gas thermal conductivity formula.
 KB Coefficient in gas thermal conductivity formula.
 KG Conductivity, thermal, gas, w/cmK .
 KK CP/CV
 KM Conductivity, thermal, metal, w/cmK .
 KS Option for enclosed gas inside of hot cap, 1 = H2, 2 = He, 3 = air.
 KX Conductivity, thermal, composite of matrix.
 L () Array of gas inventories times gas constant at each increment during cycle.
 L1 Length of Power Duct, cm.
 L4 Length of temperature wave in displacer.
 L5 Length of temperature wave in cylinder wall.
 LB Length of hot cap, cm.
 LC Length of cooler tubes, cm. (total).
 LD Length, cooled, of cooler tubes, cm.
 LE Length of cold duct (pressure drop), cm.
 LF Length of cold duct (dead volume), cm.
 LH Length of heater tube or heater fin, cm.
 LI Length, heated, of heater tubes, cm.
 LK Coefficient of leakage of gas, frac/MPa sec .
 LL Length of regenerator, cm.

LM Length of hot space manifold tubes (for dead volume), cm.
 LN Length of heater manifold tubes (for dead volume), cm.
 LO Length of hot space manifold tubes (for press drop), cm.
 LP Length of heater manifold tubes (for pressure drop), cm.
 LR Length of regenerator, cm.
 LX Coefficient of gas charge leaking per time increment per pressure difference, frac/MPa.
 LY Summation of M*R.

 M Moles of working fluid, g mol.
 M1 Coefficient to calculate gas viscosity.
 M2 Coefficient to calculate gas viscosity.
 M3 Coefficient to calculate gas viscosity.
 M4 Capacity of heat of displacer wall, j/gK.
 M5 Capacity of heat of cylinder wall, j/gK.
 M6 Capacity of heat of regenerator metal, j/gK.
 MD(X,Y,Z) Array for efficiency data, %.
 ME Efficiency, mechanical, %.
 MF Loss due to mechanical friction in seals, watts.
 ML () Array of compression space live positions for gamma engine, cm.
 MP(X,Y,Z) Array for power data, HP.
 MR Product of gas inventory and gas constant, j/K.
 MS Mesh of screen or foils, number/length.
 MT () Array of metal temperatures, K.
 MU Viscosity of gas, g/cm sec.
 MW Weight, molecular, of gas, g/g mol.
 MX Mass of regenerator matrix, g.

 N Number of cylinders per engine.
 N1 Number of power ducts per cylinder.
 N3 Option for engine cylinder material - 1 = glass or alumina, 2 = stainless steel, 3 = iron, 4 = brass, 5 = aluminum, 6 = copper.
 N4 Option on regenerator matrix material (see N3).
 N5 Option on regenerator wall material (see N3).
 NC Number of cooler tubes per cylinder or spaces between fins.
 ND Angle of increment, degrees.
 NE Number of cold space manifold tubes per cylinder.

NH Number of heater tubes or fin spaces per cylinder.
 NM Number of hot space manifold tubes per cylinder.
 NN Number of tubes per cylinder in heater tube manifold.
 NO Number of cold ducts per cylinder.
 NP Power, net, watts.
 NR Number of regenerators per cylinder.
 NS Number of internal radiation shields in displacer or hot cap.
 NT Number of transfer units in regenerator.
 NU Frequency of engine, Hz.

OC Diameter, outside of cooler tubes or fin height, cm.
 OD Diameter, outside, of cold space manifold, cm.
 OG Option of operating gas - 1 = hydrogen, 2 = helium, 3 = air.
 OH Diameter, outside of heater tube or height of fins, cm.
 OM Speed of engine, radians/sec.

P () Array of pressure during cycle first with MR = 1, then at average pressure.
 P4 $\pi/4 = 0.785398$
 PG Pressure, average gas, MPa.
 PI $3.14159 = \pi$
 PM Pressure, mean, for all P's, MPa or dimensionless.
 PN Minimum of P().
 PU Porosity of matrix.
 PP Factor, conversion = 0.006894 MPa/psia.
 PR Prandtl Number of the 2/3 power = $(Pr)^{2/3}$.
 PX Maximum of P().

QB Heat supplied by heater, watts.
 QC Heat absorbed by cooler, watts.
 QI Loss due to internal temperature swing, watts.
 QN Heat, net required, watts.
 QP Loss, pumping for all N cylinder, watts.
 QR () Array of heat transferred in regenerator, joules.
 QS Loss, shuttle, for all N cylinders, watts.

R Constant, gas, universal = 8.314 j/(g mol (K)).
 R1 Option on regenerator type - 1 = screen, 2 = foam metal, 3 = spheres,
 4 = slots.

R2 Radius of crank to cold space, cm.
 RA Factor, conversion = 0.0174533 radians/degree.
 RC Radius of crank (if two cranks to hot space), cm.
 RD Volume, regenerator, dead, cm³.
 RE Reynolds number, heater or cooler.
 RH Loss, reheat, watts.
 RM Density of gas at regenerator, g/cm³.
 RO () Array of gas density, g/cm³.
 RR Reynolds number for regenerator.
 RT Reynolds number, heater.
 RV Ratio of dead volume to expansion space volume = VD/VL.
 RW Loss, flow in all regenerators of engine, watts.
 RZ Reynolds number, cooler.

S Ratio of dead volume mass to maximum expansion space mass.
 SC Thickness of hot cap wall, cm.
 SD Stroke of displacer or hot cap = 2RC, cm.
 SG Factor in shuttle heat loss.
 SI Constant, Stefan - Boltzman = $5.67 \times 10^{-12} \text{ w/cm}^2 \text{ K}^4$
 SL Loss due to matrix temperature swing, watts.
 SP Speed of engine, RPM.
 SR Thickness of wall of regenerator housing, cm.
 SS Thickness of inside regenerator wall if annular regenerator, cm.
 ST Stanton number times $(Pr)^{2/3}$

TA TH/TC
 TC Temperature, effective, of cold space, K.
 TF Temperature of inside heater tube wall, F.
 TH Temperature, effective, of hot space, K.
 TL Temperature of gas leaving regenerator, K.
 TM Temperature of inside heater tube wall, K.
 TR Temperature of regenerator, K.
 TS Temperature, swing of, in matrix, K.
 TU Number of transfer units.
 TW Temperature of inlet cooling water, K.
 TX Temperature of cooler tube metal, average, K.
 TY Temperature of inlet cooling water, F.
 ,Z Temperature along regenerator, K.

- V () Array of total gas volume at each increment during cycle.
- V1 Number of velocity heads due to entrance, exits and bends in hot space manifold.
- V2 Number of velocity heads due to entrance, exits and bends in heater tubes or fins.
- V3 Number of velocity heads due to entrance, exits and bends in heater manifold.
- V4 Number of velocity heads due to entrance, exits and bends in cooler.
- V5 Number of velocity heads due to entrance, exits and bends in cold duct.
- V6 Number of velocity heads due to entrance, exit and bends in power duct.
- VA Volume, total of annulus.
- VC Velocity through gas cooler or connecting duct, cm/sec.
- VD Volume, total dead, cm³.
- VH Velocity of gas through gas heater, cm/sec.
- VK Volume, cold, live (associated with displacer), cm³.
- VL Volume, hot live, cm.
- VM Volume, cold dead, actually measured in beta engine, cm³.
- VN Minimum of V().
- VP Volume, live, associated with the power piston, cm³.
- VR Ratio of volumes, maximum/minimum.
- VT Volume, total, sum of compression and expansion space live volumes, cm³.
- VX Maximum of V().
- W () Array of works, joules.
- W1 Work for 1 cycle and one cylinder, joules.
- WC Flow, mass, into or out of cold space, g/sec.
- WH Flow, mass, into or out of hot space, g/sec.
- WR Flow, mass, through regenerator, g/sec.
- X Temporary variable.
- XB Factor to calculate shuttle heat loss.
- XX Factor, correction, for large angle increments.
- Y Temporary variable.
- YK Factor in shuttle heat loss equation relating to wall properties and frequency.
- YY Temporary variable.

Z Temporary variable.
Z1 Factor of compressibility of gas.
ZA Flag for iteration method, 0 for rapid iteration, 1 for slower method that is sure.
ZB Counter for number of iterations.
ZH Loss, static, heat conductor, specified, watts.
ZK Factor in shuttle heat loss equation relating to wave-form of motion.
ZZ Flag for heat conduction method, 0 for specified, 1 for calculated.

TABLE B-2
 NOMENCLATURE FOR BODY OF DESIGN MANUAL
 (Alphabetized by Meaning)

ORIGINAL PAGE IS
 OF POOR QUALITY

Angle of crank	degrees	F
Angle of increment per time step	degrees	ND
Angle of phase	degrees	AL
Angle used in Schmidt equation (6-36)	degrees	ET
Area of flow	cm ²	AF
Area, frontal, of matrix	cm ²	AM
Area of heat transfer for cooler	cm ²	AC
Area of heat transfer for heater or in general	cm ²	AH
Array of areas of metal for heat cond.	cm ²	AT()
Array of cold space live positions	cm	CL()
Array of cold volumes	cm ³	C()
Array of compression space live positions for gamma engine	cm	MC()
Array for efficiency data	%	MC(X,Y,Z)
Array of fraction of gas mass to the total in the cold space	--	FC()
Array of gas densities	g/cm ³	RO()
Array of gas inventories x gas constant at each increment during cycle	j/K	L()
Array of gas mass fractions in hot space	--	FH()
Array of heats transferred between gas and solid in regenerator	joules	QR()
Array of hot space live positions	cm	HL()
Array of hot volumes	cm ³	H()
Array of metal temperatures	K	MT()
Array for power data	HP	MP(X,Y,Z)
Array of pressures during cycle, first at M * R = 1, then at average pressure	MPa	P()
Array of thermal conductivities	w/cmK	AK()
Array of total gas volumes during cycle	cm ³	V()
Array of works	joules	W()
Capacity of heat of cylinder wall	j/gK	M5
Capacity of heat of displacer wall	j/gK	M4

ORIGINAL PAGE IS
OF POOR QUALITY

Capacity of heat of gas at constant pressure	J/gK	CP
Capacity of heat of gas at constant volume	J/gK	CV
Capacity of heat of regenerator metal	J/gK	M6
Clearance around displacer in annular gap heater	cm	IH
Clearance around displacer in annular gap cooler	cm	IC
Clearance around hot cap	cm	G
Clearance, end, in gamma type power piston	cm	E2
Clearance piston end	cm	EC
Coefficient to calculate gas viscosity	--	M1
Coefficient to calculate gas viscosity	--	M2
Coefficient to calculate gas viscosity	--	M3
Coefficient of gas leakage	frac/MPa sec	LK
Coefficient of gas leakage	frac/ (increment)(MPa)	LX
Coefficient in gas thermal conductivity formula	--	KA
Coefficient in gas thermal conductivity formula	--	KB
Coefficient of heat transfer	watt/cm ² K	HY
Coefficient of heat transfer at cooler	w/cm ² K	HC
Coefficient of heat transfer in heater	w/cm ² K	HH
Conductivity, thermal, composite of matrix	w/cmK	KX
Conductivity, thermal, gas	w/cmK	KG
Conductivity, thermal, metal	w/cmK	KM
Constant of conversion = 10 ⁷	g/(MPa·sec ² cm)	G1
Constant in internal temperature swing loss equation	--	C3
Constant in reheat loss equation	--	K3
Constant Stefan-Boltzman = 5.67 x 10 ⁻¹²	w/cm ² K ⁴	SI
Constant for table spacing	--	B
Counter for finding right average pressure	--	A
Counter for iterations	--	I
Counter for number of iterations	--	ZB
Credit of heat for flow friction	watts	FZ
Density of cylinder wall	g/cm ³	E5
Density of displacer wall	g/cm ³	E4
Density of gas in cooler	g/cm ³	DK
Density of gas in heater	g/cm ³	DH
Density of gas regenerator	g/cm ³	RM

	ORIGINAL LISTING OF POOR QUALITY		
Density of matrix material		g/cm ³	E6
Diameter of displacer		cm	DB
Diameter of displacer drive rod		cm	DD
Diameter, effective or real of power duct		cm	D1
Diameter of hot space manifold tubes		cm	DM
Diameter, inside of annular regenerator		cm	DI
Diameter of inside of cold duct		cm	ID
Diameter, inside of cooler tubes		cm	IC
Diameter, inside of engine cylinder		cm	DC
Diameter, inside of heater manifold tubes		cm	DN
Diameter, inside of heater tubes		cm	IH
Diameter, outside of annular regenerator		cm	DR
Diameter, outside of cold space manifold		cm	OD
Diameter, outside of cooler tubes		cm	OC
Diameter, outside of heater tube		cm	OH
Diameter of power piston drive rod if in working space (gamma engine)		cm	D3
Diameter of power piston in gamma engine		cm	D2
Diameter of each regenerator		cm	DR
Diameter of wire or sphere in matrix		cm	DW
Diffusivity, thermal in displacer		cm ² /sec	D4
Diffusivity, thermal in cylinder wall		cm ² /sec	D5
Eccentricity in a rhombic drive		cm	EE
Effectiveness of regenerator		--	E
Efficiency of cycle		--	EF
Efficiency of furnace		%	FE
Efficiency, mechanical		%	ME
Emissivity of cold surface		--	EK
Emissivity of hot surface		--	EH
Emissivity of radiation shields		--	ES
Exponent of correlation of power with pressure		--	BA
Factor to calculate shuttle heat loss		--	XB
Factor to calculate shuttle heat loss		--	SG
Factor of compressibility of gas		--	Z1

ORIGINAL PAGE IS
OF POOR QUALITY

Factor, conversion = 2.54	cm/inch	CM
Factor, conversion = 60	Hz/RPM	FQ
Factor, conversion = 1.341E-3	HP/watt	HP
Factor, conversion = 0.006894	MPa/psia	PP
Factor, conversion = 0.174533	rad/degree	RA
Factor, correction to work diagram for large angle increments	--	XX
Factor of correlation, power with pressure	--	AA
Factor of correlation of power with standard	--	BF
Factor for effect of areas in radiation	--	FA
Factor for emissivity effect in radiation		FM
Factor of friction for matrix or tubes	--	CW
Factor for number of radiation shields in radiation		FH
Factor in Schmidt Equation (see Eq. 6-36)	--	DL
Factor in shuttle heat loss equation	--	YK
Factor in shuttle heat loss equation		ZK
Flag for heat conduction method	--	ZZ
Flag for iteration method	--	ZA
Flow of cooling water per cylinder	GPM or liter/ min.	FX
Flow of cooling water	g/sec	FW
Flow, mass into or out of cold space	g/sec	WC
Flow, mass into or out of hot space	g/sec	WH
Flow, mass through regenerator	g/sec	WR
Fraction of cycle time gas is assumed to leave hot space at constant rate	--	F1
Fraction of cycle time gas is assumed to enter hot space at constant rate	--	F2
Fraction of cycle time gas is assumed to leave cold space at constant rate	--	F3
Fraction of cycle time gas is assumed to enter cold space at constant rate	--	F4
Fraction of matrix volume filled with solid	--	FF
Fraction of time flow is into hot space	--	FR
Frequency of engine	Hz	NU
Heat absorbed by cooler	watts	QC
Heat, basic input	watts	BH
Heat, net required	watts	QN

Heat supplied by heater	joules	QB
Height of fins in cooler	cm	OC
Height of fins in heater	cm	OH
Length of regenerator	cm	LR
Length of cold duct (dead volume)	cm	LF
Length of cold duct (pressure drop)	cm	LE
Length of connecting rod	cm	CR
Length of connecting rod to cold space	cm	CA
Length, cooled, of cooler tubes	cm	LD
Length, of cooler tubes, total	cm	LC
Length, heated, of heater tubes	cm	LI
Length of heater manifold tubes (for dead volume)	cm	LN
Length of heater manifold tubes (for pressure drop)	cm	LP
Length of heater tube or heater fin	cm	LH
Length of hot cap or displacer	cm	LB
Length of hot space manifold tubes (dead volume)	cm	IM
Length of hot space manifold tubes (pressure drop)	cm	LO
Length of power duct	cm	L1
Length of temperature wave in cylinder wall	cm	L5
Length of temperature wave in displacer	cm	L4
Loss, flow, cooler	watts	CF
Loss, flow in heater	watts	HW
Loss, flow in all regenerators of engine	watts	RW
Loss of heat due to conduction, calculated	watts	CQ
Loss due to internal temperature swing	watts	QI
Loss due to matrix temperature swing	watts	SL
Loss due to mechanical friction except seals	watts	MF
Loss, mechanical, due to seal friction	watts	FS
Loss, pumping, for all N cylinders	watts	QP
Loss, reheat	watts	RH
Loss, shuttle, for all N cylinders	watts	QS
Loss, static heat conduction, specified	Watts	ZH
Mass of regenerator matrix	g	MX
Maximum of array FC()	--	CY

ORIGINAL DOCUMENT
OF POOR QUALITY

Maximum of array FH()	--	HX
Maximum of P()	MPa	PX
Maximum of V()	cm ³	VX
Mesh of screen or foils	number/cm	MS
Minimum of array FC()	--	CN
Minimum of array FH()	--	HN
Minimum of P()	MPa	PN
Minimum of V()	cm ³	VN
Moles of working fluid	g mol	M
Number of cold ducts per cylinder	--	NO
Number of cold space manifold tubes per cylinder	--	NE
Number of cooler tubes per cylinder or spaces between fins	--	NC
Number of cylinders per engine	--	N
Number of heater tubes or fin spaces per cylinder	--	NH
Number of hot space manifold tubes per cylinder	--	NM
Number of internal radiation shields in displacer or hot cap	--	NS
Number of power ducts per cylinder		N1
Number of regenerators per cylinder	--	NR
Number of transfer units	--	TU
Number of transfer units in regenerator	--	NT
Number of tubes per cylinder in heater tube manifold	--	NN
Number of velocity heads due to entrance, exit and bends in cold duct	--	V5
Number of velocity heads due to entrance, exit and bends in cooler	--	V4
Number of velocity heads due to entrance, exit and bends in heater manifold	--	V3
Number of velocity heads due to entrance, exits and bends in heater tubes	--	V2
Number of velocity heads due to entrance, exit and bends in hot space manifold	--	V1
Number of velocity heads due to entrance, exit and bends in power duct		V6

Option on cooler type:	1 = tubes 2 = annulus, cooled one side 3 = fins		CA
Option for enclosed gas inside of hot cap:	1 = H ₂ 2 = He 3 = air	--	KS
Option for engine cylinder material:	1 = glass or alumina 2 = stainless steel, super alloy or SiC 3 = cast iron or carbon steel 4 = brass 5 = aluminum 6 = copper		N3
Option for heater:	1 = tubes 2 = fins 3 = single annulus heated one side	--	H1
Option of operating gas:	1 = hydrogen 2 = helium 3 = air	--	OG
Option on regenerator matrix material (Same as N3)		--	N4
Option for regenerator type:	1 = screens 2 = foam metal 3 = spheres 4 = slots	--	R1
Option on regenerator wall material (Same as N3)		--	N5
Porosity of matrix		--	PO
Power, basic		watts	BP
Power, indicated		watts	IP
Power, net		watts	NP
Prandtl, number to 2/3 power		--	PR
Pressure, average		psia	PS
Pressure, average gas		MPa	PG
Pressure, difference of		MPa	DP
Pressure, mean		--	PM
Product of gas inventory and gas constant		j/K	MR
Radius of crank to cold space		cm	R2
Radius of crank (if 2 cranks then to hot space)		cm	RC
Radius, hydraulic, of regenerator matrix		cm	HR
Ratio of dead volume to expansion space volume		--	RV
Ratio of dead volume mass to expansion space mass		--	S

Ratio of heat transfer area to volume of matrix	cm ⁻¹	AS
Ratio of TH to TC	--	TA
Ratio of TC to TH	--	AU
Ratio of volumes, maximum/minimum	--	VR
Reynolds number, cooler	--	RZ
Reynolds number, heater	--	RT
Reynolds number, heater or cooler	--	RE
Reynolds number, regenerator	--	RR
Space between fins in cooler	cm	IC
Space between fins in heater	cm	IH
Speed of engine	Radians/sec	OM
Speed of engine	RPM	SP
Stanton, number $\times (Pr)^{2/3}$	--	ST
Stroke of displacer or hot cap	cm	SD
Summation of $M * R$	j/K	LY
Temperature of cooler tube metal, average	K	TX
Temperature, effective, of cold space	K	TC
Temperature of gas leaving regenerator	K	TL
Temperature, effective, of hot space	K	TH
Temperature of inlet cooling water	K	TW
Temperature of inlet cooling water	F or C	TY
Temperature of inside heater tube wall	F or C	TF
Temperature of inside heater tube wall	K	TM
Temperature, increase of, in cold space	K	DU
Temperature, increase of, in cooling water	K	DT
Temperature, increase of, in hot space	K	DV
Temperature along regenerator	K	TZ
Temperature of regenerator, effective	K	TR
Temperature, swing of, in matrix	K	TS
Thickness of expansion cylinder wall	cm	SE
Thickness of foils in slot type regenerator	cm	DW
Thickness of hot cap wall	cm	SC
Thickness of inside regenerator wall if annular regenerator	cm	SS
Thickness of wall of regenerator housing	cm	SR

Velocity of gas through gas cooler or connecting duct	cm/sec	VC
Velocity of gas through gas heater	cm/sec	VH
Velocity, mass, in connecting duct	g/sec cm ²	GD
Velocity, mass, through cooler	g/sec cm ²	GC
Velocity, mass, in heater	g/sec cm ²	GH
Velocity, mass, in regenerator	g/sec cm ²	GR
Viscosity of gas	g.cm sec	MU
Volume, cold, dead	cm ³	CD
Volume, cold, dead actually measured in beta engine	cm ³	VM
Volume, cold, dead outside cooler tubes	cm ³	CX
Volume, cold, live (with displacer)	cm ³	VK
Volume, hot, dead	cm ³	HD
Volume, hot, live	cm ³	VL
Volume, live (with power piston)	cm ³	VP
Volume, regenerator, dead	cm ³	RD
Volume, total, of annulus	cm ³	VA
Volume, total, dead = HD + RD + CD	cm ³	VD
Volume, total, live = VL + VK	cm ³	VT
Weight, molecular of gas	g/g mol	MW
Work for one cycle and one cylinder	joules	W1

APPENDIX C

Isothermal Second Order Design Program

In this appendix the Isothermal Second Order Design Program is explained. A nomenclature is given which pertains only to Appendix C. Two BASIC programs were prepared--one for design purposes and one to compare the General Motors data with predictions. From the design program written in BASIC, a program written in FORTRAN was prepared and validated. A listing of the FORTRAN program is given in this appendix. This program takes a file of data for input, and prints the input quantities and the results. Finally, a sample of the design program output and the final results of the comparison program are presented.

C.1 Description

The program described in this appendix is an outgrowth of the calculation procedure presented at the 1978 IECEC (78 o) and also in the authors 1979 IECEC paper (79 ad). The following major changes have been made over the previous publications.

1. Corrections have been made to the program particularly the effect of multiple cylinders had not been taken into account consistently.
2. Property values for hydrogen, helium, or air can be used. In addition, the effect of temperature on thermoconductivity has been taken into account when previously only the effect of temperature on viscosity was written into the program.
3. For the cases that are non-convergent, the program adopts a more cautious method so that the process would be convergent no matter what design had been chosen. The process shown in reference 78 o for selecting the effective hot gas and cold gas temperature was found to be non-convergent in some cases.
4. All flow resistance including losses due to bends and entrances and exits are included.
5. Temperature difference between the effective gas temperature and the adjacent heat exchanger can be set at any specified fraction of the log mean temperature difference.
6. Static heat leak can be calculated from dimensions or specified in advance.

The basic assumption in the isothermal second order design program described herein is that there exists an effective hot space and cold space constant temperature that can be used to compute the power output per cycle for a Stirling engine. This effective gas temperature is assumed not to change during the cycle, although, in fact, it really does to an important degree. It is assumed that the effective temperature can be calculated by determining the

amount of heat that must be transferred through the heat exchanger during a particular cycle and this should determine the offset between metal temperature and the effective gas temperature. For instance, the hot space temperature is less than the heat source temperature by a fraction of the log mean temperature difference in the gas heater that is needed to transfer the heat to the hot space from the heat source. In the same way, the effective cold space temperature is hotter than the heat sink water temperature by a fraction of the log mean temperature difference for that heat exchanger.

The method of zeroing in on the effective hot and cold gas temperatures is most critical in determining how long the calculation takes per case. The original computational procedure determines the temperature difference required from the present heat requirement and the heat transfer capabilities of the heat exchanger. For well designed engines, with large heat exchangers, this iteration method for the effective temperatures is rapidly convergent. However, when only a small amount of heat exchange surface is specified in the engine the original method leads to completely uncontrolled oscillations or very slow damping of the solution. For these cases the program switches to a more cautious iteration procedure. In the first iteration, the effective hot space temperature is assumed to be the same as the hot metal temperature and the effective cold space temperature is assumed to be the same as the inlet cold water temperature. Then the error between the amount of heat that must be transferred in the gas heater compared with the amount of heat that is transferred due to the temperature difference is computed. Another error is computed for the amount of heat that must be transferred in the gas cooler compared to the amount of heat that can be transferred due to the temperature difference. Next, these two temperature differences are changed by an amount input into the program, in this case, 64° K, that is the hot space temperature is decreased by 64 degrees and the cold space temperature is increased by 64 degrees. The calculation is repeated and the heat transfer errors for both the hot and the cold space are again computed. This error is usually less because the heat required is somewhat less but the heat that can be transferred is a lot more and they are beginning to get into balance. At this point, we have two temperatures and two errors for the hot space and two temperatures and two errors for the cold space. It would seem reasonable then to apply a secant method to extrapolate what the temperature would be for zero error in both the hot and cold space. This was tried and found to be computationally unstable because the two iteration processes strongly interact. Therefore, it was found necessary to be more cautious about approaching the roots of these two equations. The procedure used here makes successive corrections of 64 degrees until the heat transfer error changed sign. Then it makes successive corrections of 16 degrees until another sign change is noted, and then 4 degrees, and then 1 degree and so on. This iteration procedure has been found to be unconditionally stable for all cases that have been tried, but it is time consuming. For very small heat transfer areas and a specified constant heat leak the calculated effective gas temperatures can be wrong. The program stops and the error is indicated. If static heat losses are calculated from the dimensions then this problem does not occur.

The first convergence method requires 45 sec/case. The second method requires between six and seven minutes to compute using the Radio Shack TRS-80 and the Microsoft BASIC computer program. Using the Prime Interim 750 CPU computer with FORTRAN, the first convergence method requires two seconds per case to compute.

Note in editing: This program is valid for four cylinder engines only.

C.2 Nomenclature

A	N/RM
A1	Counter for finding right average pressure
AA	.435 correlation of power with pressure
AC	Heat transfer area for cooler, cm^2
AF	Area of flow, cm^2
AH	Heat transfer area of heater, cm^2
AL	Phase angle alpha = 90 degrees
AS	Area to volume ratio for regenerator matrix = $179 \text{ cm}^2/\text{cm}^3$ for Met Net 0.05-0.20
B	Table spacing constant
BA	.1532 = exponent of correlation of power with pressure
BF	Bugger factor to convert power outputs to nearly what GM says they should be
BH	Basic heat input, watts (BHI)
BP	Basic power, watts
C()	Cold volumes at 360/ND Points/cycle
CD	Cold dead volume, cm^3
CF	Cooler windage, watts
CM	2.54 cm/inch
CN	Minimum FC()
CP	Heat capacity of hydrogen at constant P = $14.62 \text{ j/g K @ } 700 \text{ K}$ (assumed not to vary importantly with temperature)
CR	Length of connecting rod, cm
CRT	Logical Unit no. for input file
CV	Heat capacity of hydrogen at constant volume = $10.49 \text{ j/g K @ } 700 \text{ K}$
CW	Friction factor for Met Net and others
CX	Cold dead volume outside cooler tubes, cm^3
CY	Maximum FC()
DC	Diameter engine cylinder, cm
DD	Diameter of piston drive rod, cm
DN	360/ND
DP	Pressure drop, MPa
DR	Diameter of regenerator, cm
DT	Temperature rise in cooling water, K

DU Temperature change for cold space, K
 DV Temperature change for hot space, K
 DW Diameter of "wire" in regenerator, cm = .0017(2.54) = 0.00432 cm
 EC Piston end clearance, cm
 F Crank angle, degrees
 FC1 $(F3 + F4)/2$
 FC() Fraction of gas mass in cold spaces at 360/ND Points/cycle
 FE Furnace efficiency, %
 FF Filler factor, fraction of regenerator volume filled with solid
 FH1 $(F1 + F2)/2$
 FH() Fraction of gas mass in hot spaces at 360/ND Points/cycle
 FQ 60 Hz/rpm
 FR $(FH + FC)/2$
 FW Flow of cooling water, g/sec
 FX Cooling water flow GPM @ 2000 rpm per cylinder
 F1 Fraction of cycle time gas is assumed to leave hot space at constant rate
 F2 Fraction of cycle time gas is assumed to enter hot space at constant rate
 F3 Fraction of cycle time that flow out of cold space is assumed to occur at constant rate
 F4 Fraction of cycle time that flow into cold space is assumed to occur at constant rate
 G Gap in hot cap, cm = 0.56 cm
 GC Mass velocity through cooler, g/sec cm²
 GD Mass velocity in connecting duct, g/sec cm²
 GH Mass velocity in heater, g/sec cm²
 GR Mass velocity in regenerator, g/sec cm²
 H() Hot volumes at 360/ND Points/cycle
 HC Heat transfer coefficient at cooler, w/cm² K
 HD Hot dead volume, cm³
 HH Heat transfer coefficient in heater, w/cm² K
 HN Minimum FH()
 HP 1.341E-3 HP/watt
 HX Maximum FH()
 I Iteration counter
 IC ID of cooler tube, cm

ID Inside diameter of connecting duct, cm
 IH ID of heater tubes, cm
 IP Indicated power, watts
 J Iteration counter
 KA Coefficient for gas thermal conductivity calculation
 KB Coefficient for gas thermal conductivity calculation
 KG Gas thermal conductivity, watts/cm K
 KM Metal thermal conductivity, w/cm K
 K3 Constant in reheat loss equation
 L1 Fraction of total gas charge leaking per MPa P per second
 L() Gas inventory x gas constant, j/K (changes due to leak)
 LB Length of hot cap, cm
 LC Length of cooler tube, cm
 LD Heat transfer length of cooler tube, cm
 LE Length of connecting duct, cm
 LH Heater tube length, cm
 LI Heater tube heat transfer length, cm
 LP Logical unit No. for output file
 LR Length of regenerator, cm
 LX Fraction of gas charge leaking per time increment per ΔP
 LY Accumulation of MR's
 M Number of moles of gas in working fluid, g mol
 ME Mechanical efficiency, %
 MF mechanical friction loss
 MR Gas inventory times gas constant, j/K
 MU Gas viscosity, g/cm sec
 MW Molecular weight, g/g mol
 MX Mass of regenerator matrix
 M1 }
 M2 } Coefficients in viscosity equation
 M3 }
 N Number of cylinders per engine
 NC Number of cooler tubes per cylinder
 ND Degree increment in time step (normally 30 degrees)
 NE Number of connecting ducts per cylinder
 NH Number of heater tubes per cylinder

NP Net power, watts
 NR Number of regenerators per cylinder
 NT Number of transfer units in regenerator, NTUP
 NU Engine frequency, Hz
 N\$ "Name"
 OC OD of cooler tubes, cm
 OD Outside diameter of connecting duct, cm
 OG Operating gas, 1 = hydrogen, 2 = helium, 3 = air
 OH Heater tube OD, cm
 P() Pressures first with MR = 1, later at average pressure
 PG Average gas pressure, MPa
 PI 3.14159
 PM Mean Pressure, of all P's
 PN Minimum pressure, MPa
 PP 0.006894 MPa/psia
 PR Prandtl number to the 2/3 power = $(Pr)^{2/3}$
 PS Average pressure, psia
 PX Maximum pressure, MPa
 P4 $\pi/4 = .785398$
 QC Heat absorbed by cooler, watts
 QN Net heat required, watts
 QP Pumping loss for all N cylinders
 QS Shuttle loss, watts
 R Gas constant, 8.314 j/g mol K
 RA 0.0174533 radians/degree
 RC Crank radius, cm
 RD Regenerator dead volume, cm³
 RE Reynolds number, heater or cooler
 RH Reheat loss, watts
 RM Gas density for regenerator, g/cm²
 RP Sum and average of power ratios
 RQ Sum and average of efficiency ratios
 RR Regenerator Reynolds number
 RT Reynolds number, heater
 RW Regenerator windage, watts, for all cylinders in engine
 RZ Reynolds number, cooler

SC Wall thickness of hot cap, cm
 SE Wall thickness of expansion cylinder wall, cm
 SL Temp swing loss, watts = QTS
 SP Engine speed, RPM
 SR Wall thickness of regenerator housing, cm
 ST Stanton number $\times (\text{Pr})^{2/3}$
 TC Effective cold space temperature, K
 TF Inside heater tube wall temperature, F
 TH Effective Hot space temperature, K
 TM Inside heater tube wall temperature, K
 TR Regenerator temperature, K
 TS Matrix temp swing, K = DELTMX
 TW Inlet cooling water, K
 TX Cooler tube metal temperature average, K
 TY Inlet cooling water temperature, F
 V() Total gas volume at 360/ND Points/cycle
 VC Velocity through gas cooler or connecting duct, cm/sec
 VH Velocity through gas heater, cm/sec
 VN Minimum total volume, cm^3
 VX Maximum total volume, cm^3
 V\$ "Value"
 WC Flow rate into or out of cold space, g/sec
 WH Flow rate into or out of hot space, g/sec
 WR $(\text{WH} + \text{WC})/2 = \text{g/sec}$ through regenerator = WRS
 W1 Work for one cycle and one cylinder, joules
 X Temporary variable
 XX Correction factor to work diagram for large angle increments
 Y Temporary variable
 YY Temporary variable
 Z Temporary variable
 ZA 0 for rapid iteration method, = 1 for slower iteration method when rapid method does not work
 ZB Iteration counter
 ZH Specified static heat conduction loss, watts
 ZZ 0 for specified static conduction, 1 for calculated static conduction

```

.NULL.
C          ISOTHERMAL SECOND ORDER CALCULATION
C          PROGRAM ISO -10 OCT 1979-
C          WRITTEN BY WILLIAM R. MARTINI
C          PROGRAM WRITTEN WITH THE PRIMOS OPERATING SYSTEM
C PROGRAM MUST HAVE ACCESS TO BOTH THE INPUT FILE AND AN OUTPUT FILE
C   SEE ATTACHED REFERENCE FOR LIST AND DESCRIPTION OF NOMENCLATURE
C*****
C SETS UP ARRAYS (DIMENSIONS)
C          DIMENSION H(13),C(13),P(13),FH(13),FC(13),V(14)
C SETS UP INTEGERS
C          INTEGER A1,OG,ZA,ZB,ZZ,CRT,TRM
C SETS UP REAL NUMBERS
C          REAL IC,ID,IH,IP,KA,KB,KG,KM,K3,L1,LB,LD,LE,LI,LR,LX,LY,M,ME,MF,
C          1MR,MU,MW,MX,M1,M2,M3,NP,NU,LC,LH,L(14),NT,ND
C SETS UP LOGICAL UNIT NUMBERS. 'CRT' IS THE LOGICAL UNIT NUMBER FOR
C THE INPUT FILE, AND 'LP' IS THE LOGICAL UNIT NUMBER FOR THE OUTPUT
C FILE.
C          DATA CRT/5/,LP/6/
C PROGRAM READS IN ENGINE DIMENSIONS, OPERATING CONDITIONS, AND
C CONVERSION CONSTANTS FROM THE INPUT FILE. ALSO THIS IS THE RETURN
C POINT AFTER A CASE HAS BEEN COMPLETED. IF THERE ARE NO MORE CASES TO
C RUN (I.E. AN END OF FILE OCCURS), THE PROGRAM CALLS EXIT.
C          300 READ(CRT,*,END=45) DC,LC,LD,IC,OC,NC,PI
C          READ(CRT,*) P4,DW,FX,ME,FE,OG,ZZ
C          READ(CRT,*) ZH,LH,LI,IH,OH,NH,DD
C          READ(CRT,*) RA,G,LB,PS,KM,SC,SE
C          READ(CRT,*) SR,LR,DR,NR,FF,CR,RC
C          READ(CRT,*) N,AL,TF,TY,SP,AA,BA
C          READ(CRT,*) ID,LE,NE,BF,PP,CM,FQ
C          READ(CRT,*) R,HP,EC,L1,AS
C THE DEGREE INCREMENT IS SET AT 30 DEGREES.
C          ND=30
C A CORRECTION FACTOR IS CALCULATED WHICH INCREASES THE ACCURACY IN
C CALCULATING THE WORK INTEGRALS WITH 30 DEGREE INCREMENTS.
C          XX=1.+5.321E-5*ND**1.9797
C TEMPERATURE CHANGE FOR COLD SPACE (DU) AND TEMPERATURE CHANGE FOR HOT
C SPACE (DV) ARE SET.
C          DU=64.

```

C.3 FORTRAN Listing of Program with Comments

ORIGINAL PAGE IS
OF POOR QUALITY

```

      DV=64.
C THE FIRST THING THE PROGRAM DOES IS TO COMPUTE A LIST OF ENGINE
C VOLUMES.
C
C CONVERSION TO KELVIN DEGREES FROM INPUT FAHRENHEIT DEGREES.
      TM=(TF+460.)/1.8
      TW=(TY+460.)/1.8
C CONVERSION TO HERTZ AND TO MPA.
      NU=SP/60.
      PG=.006894*PS
C DETERMINES GAS PROPERTY VALUES FROM 'OG' (IF 'OG' = 1, THE PROPERTY
C VALUES FOR HYDROGEN ARE USED. IF 'OG' = 2, THE PROPERTY VALUES FOR
C OXYGEN ARE USED. IF 'OG' = 3, THE PROPERTY VALUES FOR AIR ARE USED.)
C PROPERTY VALUES FOR ADDITIONAL GASES MAY BE ADDED IF DESIRED.
      IF(OG.EQ.1) GOTO 20
      IF(OG.EQ.2) GOTO 21
      KA=-12.6824
      KB=.7820
      CP=1.0752
      CV=.7883
      M1=1.8194E-4
      M2=5.36E-7
      M3=1.22E-6
      MW=29.
      PR=.9071
      GOTO 22
20    KA=-11.0004
      KB=.8130
      CP=14.62
      CV=10.49
      M1=8.873E-5
      M2=2.E-7
      M3=1.18E-7
      MW=2.02
      PR=.8408
      GOTO 22
21    KA=-10.1309
      KB=.6335
      CP=5.2

```

ORIGINAL PAGE IS
OF POOR QUALITY

CV=3.12
M1=1.6614E-4
M2=4.63E-7
M3=-9.3E8
MW=4.
PR=.8018

C CONVERSION OF COOLING WATER FLOW TO GRAMS/SECOND. INITIALLY COOLER
C TUBE METAL TEMPERATURE IS MADE THE SAME AS THE INLET COOLING WATER
C TEMPERATURE. THE TOTAL HEAT TRANSFER AREAS FOR ALL THE ENGINES
C COOLERS AND ALL THE ENGINES HEATERS ARE CALCULATED.

22 FW=63.12*FX
TX=TW

AC=PI*IC*LD*NC*N
AH=PI*IH*LI*NH*N

C CALCULATES ENGINE DEAD VOLUMES AND INITIALIZES PRESSURES AND VOLUMES.
C INITIALIZES FOR DETERMINATION OF AVERAGE PRESSURE AND MAXIMUM AND
C MINIMUM VOLUMES.

HD=P4*IH*IH*LH*NH+EC*DC**2.*P4
CX=P4*ID*LE*NE
RD=(1.-FF)*P4*DR**2.*LR*NR+PI*DC*G*LB
CD=CX+P4*IC**2.*LC*NC+EC*P4*(DC**2.-DD**2.)
PM=0.
VX=0.
VN=1.E30

C INITIALLY SETS THE EFFECTIVE HOT SPACE TEMPERATURE TO THE HOT METAL
C TEMPERATURE AND THE EFFECTIVE COLD SPACE TEMPERATURE TO THE COOLING
C WATER TEMPERATURE FOR THE FIRST TIME AROUND. CALCULATES THE LOG MEAN
C TEMPERATURE FOR THE REGENERATOR. CALCULATES THE LEAKAGE COEFFICIENT
C FOR 30 DEGREE INCREMENTS.

TH=TM
TC=TW
TR=(TM-TW)/ALOG(TM/TW)
LX=L1*ND/(360.*NU)

C SINCE THE THERMOCONDUCTIVITY ENTERS THE CALCULATION ONLY AT THE
C REGENERATOR TEMPERATURE IT CAN BE CALCULATED BEFORE THE MAIN
C ITERATION LOOP.

KG=EXP(KA+KB*ALOG(TR))

C START OF DO LOOP 23 TO CALCULATE ENGINE VOLUMES.

ORIGINAL PAGE IS
OF POOR QUALITY

```

DO 23 I=1,13
C CALCULATES THE HOT VOLUME AND COLD VOLUME FOR EACH ANGLE INCREMENT FOR
C CRANK OPERATED PISTONS. SINCE A DOUBLE ACTING MACHINE HAS A PISTON
C DRIVE ROD (DD) AND A SINGLE ACTING MACHINE DOES NOT, "DD" IS USED AS
C AN INDICATOR OF WHETHER THE COLD VOLUME OF THE ENGINE IS ABOVE THE
C PISTON OR BELOW IT.
  X=30.*(I-1)*RA
  J=I
  IF(DD.EQ.0) GOTO 24
  Y=(30.*(I-1)+AL)*RA
  GOTO 25
24 Y=(30.*(I-1)-AL)*RA
25 H(J)=P4*DC**2*(RC-SQRT(CR**2-(RC*SIN(X))**2)+RC*COS(X)+CR)+HD
  IF(DD.EQ.0) GOTO 26
  C(J)=P4*(DC**2-DD**2)*(SQRT(CR**2-(RC*SIN(Y))**2)-RC*COS(Y)-CR+RC)
  1+CD
  GOTO 27
26 C(J)=P4*DC**2*(RC-SQRT(CR**2-(RC*SIN(Y))**2)+RC*COS(Y)+CR)+CD
C CALCULATES THE TOTAL GAS VOLUME AND FINDS THE MAXIMUM VOLUME.
27 V(J)=H(J)+RD+C(J)
  IF(V(J).GT.VX) VX=V(J)
C FINDS THE MINIMUM VOLUME.
  IF(V(J).LT.VN) VN=V(J)
C CALCULATES THE INITIAL GAS INVENTORY.
  IF(J.EQ.3) L(1)=PG*(H(J)/TH+RD/TR+C(J)/TC)
C END OF LOOP TO CALCULATE ENGINE VOLUMES
23 CONTINUE
C 'ZA' IS SET AT ZERO SO THAT THE FASTEST WAY OF ARRIVING AT THE PROPER
C EFFECTIVE HOT SPACE AND COLD SPACE TEMPERATURE WILL BE TRIED FIRST.
C ALSO A COUNTER, 'ZB', IS SET AT ZERO.
  ZA=0
  ZB=0
C INITIALIZATION
200 A=0
29 PM=0
  LY=0
C START OF DO LOOP 28 (TO CALCULATE PRESSURES).
DO 28 I=1,13

```

ORIGINAL PAGE IS
 OF POOR QUALITY

```

C CALCULATE PRESSURE
  P(I)=L(I)/(H(I)/TH+RD/TR+C(I)/TC)
C CALCULATE GAS INVENTORY FOR NEXT INCREMENT DUE TO LEAKAGE
  L(I+1)=L(I)*(1.-LX*(P(I)-PG))
C ACCUMULATE VALUES, MEAN PRESSURE AND MEAN GAS INVENTORY.
  IF(I.EQ.1) GOTO 28
  PM=PM+P(I)
  LY=LY+L(I)
C END OF DO LOOP 28 (TO CALCULATE PRESSURES FOR ONE ENGINE CYCLE)
28  CONTINUE
C INDEXES CYCLE COUNTER, CALCULATES MEAN PRESSURE, READJUSTS GAS
C INVENTORY TAKING INTO ACCOUNT GAS LEAKAGE.
  A=A+1
  PM=PM/12.
  IF(A.LT.3) GOTO 30
  L(1)=L(13)
  GOTO 31
30  L(1)=L(13)*PG/PM
C CONVERGENCE CRITERIA: PRESSURE FROM BEGINNING TO THE END OF CYCLE
C MUST NOT CHANGE BY MORE THAN ONE HUNDRETH OF A PERCENT AND THE MEAN
C PRESSURE MUST BE WITHIN ONE PERCENT OF THE DESIRED GAS PRESSURE.
C USUALLY ONE OR TWO CYCLES ARE REQUIRED TO MEET THIS CRITERIA.
31  X=ABS(P(1)-P(13))
  Z=ABS(PM-PG)
  IF(X.GT..0001.OR.Z.GT..01) GOTO 29
C INITIALIZING
  W1=0
  PX=0
  PN=10000.
  MR=LY*ND/360
C START OF DO LOOP 32 (FINDS THE MAXIMUM AND MINIMUM PRESSURE).
  DO 32 I=1,13
  IF(P(I).GT.PX) PX=P(I)
  IF(P(I).LT.PN) PN=P(I)
32  CONTINUE
C START OF DO LOOP 33 (FINDS THE WORK PER CYCLE BY INTEGRATING THE

```

ORIGINAL PAGE IS
OF POOR QUALITY

```

C PRESSURE VOLUME LOOP).
  DO 33 I=1,12
    W1=W1+(P(I)+P(I+1))*(V(I+1)-V(I))/2.
  33 CONTINUE
C BASIC POWER FOR THE WHOLE ENGINE IS CALCULATED FROM THE INTEGRATED
C POWER USING THE CORRECTION FACTOR XX WHICH COMPENSATES FOR THE
C TRUNCATION ERROR OF USING ONLY A SMALL NUMBER OF POINTS TO INTEGRATE.
  BP=NU*XX*W1*N
C INITIALIZING
  HX=0
  CY=0
  HN=1
  CN=1
C CALCULATES AN ARRAY GIVING THE FRACTION OF THE TOTAL GAS INVENTORY IN
C THE HOT SPACE AND IN THE COLD SPACE FOR EACH POINT DURING THE CYCLE.
  DO 34 I=1,13
    FH(I)=P(I)*H(I)/(MR*TH)
    IF(FH(I).GT.HX) HX=FH(I)
    IF(FH(I).LT.HN) HN=FH(I)
    FC(I)=P(I)*C(I)/(MR*TC)
    IF(FC(I).GT.CY) CY=FC(I)
    IF(FC(I).LT.CN) CN=FC(I)
  34 CONTINUE
C IF FH(I) AND FC(I) ARE GRAPHED AS A FUNCTION OF THE ANGLE, IT IS SEEN
C THAT A GOOD APPROXIMATION OF THE GRAPH IS TO HAVE TWO PERIODS PER
C CYCLE OF CONSTANT MASS FLOW INTERSPERSED WITH PERIODS OF NO FLOW AT
C ALL. F1 TO F4 ARE THE FRACTIONS OF THE TOTAL CYCLE TIME WHEN
C DIFFERENT FLOWS ARE ASSUMED TO OCCUR (SEE NOMENCLATURE).
C WHEN 'FH1' AND 'FC1' ARE CALCULATED, THE AVERAGE CYCLE TIME, WHEN FLOW
C IS ASSUMED TO OCCUR EITHER INTO OR OUT OF THE HOT SPACE AND EITHER
C INTO OR OUT OF THE COLD SPACE, IS CALCULATED.
  F1=(HX-HN)/(6*(FH(1)-FH(3)))
  F2=(HX-HN)/(6*(FH(10)-FH(8)))
  F3=(CY-CN)/(6*(FC(8)-FC(10)))
  F4=(CY-CN)/(6*(FC(3)-FC(1)))
  FH1=(F1+F2)/2
  FC1=(F3+F4)/2

```

ORIGINAL PAGE IS
OF POOR QUALITY

```

C EFFECTIVE MASS FLOW INTO OR OUT OF THE HOT SPACE IS CALCULATED.
  M=MR/R
  WH=(HX-HN)*M*MW*NU/FH1
C EFFECTIVE MASS FLOW INTO OR OUT OF THE COLD SPACE IS CALCULATED.
  WC=(CY-CN)*M*MW*NU/FC1
C FRACTION OF THE TIME THE FLOW IS ASSUMED TO PASS THROUGH THE
C REGENERATOR AND THE FLOW RATE OF THE REGENERATOR IS CALCULATED AS THE
C AVERAGE BETWEEN THE HOT AND COLD FLOWS.
  FR=(FH1+FC1)/2
  WR=(WH+WC)/2
C REGENERATOR GAS DENSITY.
  RM=.1202*MW*PG/TR
C CALCULATES REGENERATOR WINDAGE LOSS.
  MU=M1+M2*(TR-293.)+M3*PG
  GR=WR/(P4*DR**2*NR)
  RR=DW*GR/MU
  CW=2.7312*(1+10.397/RR)
  DP=CW*GR**2*LR/(2E+7*DW*RM)
  A=N/RM
  RW=DP*WR*2.*FR*A
C CALCULATES HEATER WINDAGE LOSS. IN THIS CALCULATION THE VISCOSITY FOR
C THE INPUT TEMPERATURE AND SUBROUTINE 'REST' RETURNS THE FRICTION
C FACTOR FOR THE INPUT REYNOLDS NUMBER. THE CALCULATION TAKES INTO
C ACCOUNT FRICTIONAL LOSSES, AS WELL AS 4.4 VELOCITY HEADS FOR AN
C ENTRANCE AND AN EXIT LOSS, ONE 180 DEGREE BEND, AND TWO 90 DEGREE
C BENDS.
  MU=M1+M2*(TM-293.)+M3*PG
  RM=.1202*MW*PG/TM
  A=N/RM
  GH=WH/(P4*IH**2*NH)
  RE=IH*GH/MU
  RT=RE
  IF(RE.LT.2000.) GOTO 35
  X=ALOG(RE)
  X=-3.09-.2*X
  CW=EXP(X)
  GOTO 36
35  CW=16./RE
36  AF=P4*IH**2*NH

```

ORIGINAL PAGE IS
OF POOR QUALITY

```

VH=WH/(RM*AF)
DP=2*CW*GH**2*LH/(1E7*IH*RM)+VH**2*4.4*RM/2E7
HW=DP*WH**2*FH1*A
C THIS CALCULATES THE WINDAGE LOSS THROUGH THE GAS COOLER AND THE
C CONNECTING TUBE. THE SAME COMMENTS FOR THE GAS HEATING WINDAGE LOSS
C APPLY HERE AS WELL. THE VELOCITY HEADS CHARGE TO THE GAS COOLER IS
C 1.5 FOR A SIMPLE ENTRANCE AND EXIT LOSS. IN THE CONNECTING HEAD LINE,
C THREE VELOCITY HEADS ARE CHANGED TO ACCOUNT FOR ENTRANCE AND EXIT LOSS
C PLUS TWO 90 DEGREE BENDS.
MU=M1+M2*(TX-293.)+M3*PG
RM=.1202*MW*PG/TX
A=N/RM
GC=WC/(P4*IC**2*NC)
RE=IC*GC/MU
RZ=RE
IF(RE.LT.2000.) GOTO 37
X=ALOG(RE)
X=-3.09-.2*X
CW=EXP(X)
GOTO 38
37 CW=16./RE
38 AF=P4*IC**2*NC
VC=WC/(RM*AF)
DP=2*CW*GC**2*LC/(1E7*IC*RM)+VC**2*1.5*RM/2E7
GD=WC/(P4*ID**2*NE)
RE=ID*GD/MU
IF(RE.LT.2000.) GOTO 39
X=ALOG(RE)
X=-3.09-.2*X
CW=EXP(X)
GOTO 40
39 CW=16./RE
40 AF=P4*ID**2*NE
VC=WC/(RM*AF)
DP=DP+2*CW*GD**2*LE/(1E7*ID*RM)+VC**2*3.0*RM/2E7
CF=DP*WC**2*FC1*A
C CALCULATES INDICATED POWER.
IP=BP-HW-RW-CF

```

ORIGINAL PAGE IS
OF POOR QUALITY

C CALCULATES MECHANICAL FRICTION LOSS.
 $MF = (1. - ME/100.) * IP$
 C CALCULATES NET POWER.
 $NP = IP - MF$
 C CALCULATES BASIC HEAT INPUT.
 $BH = BP / (1. - TC/TH)$
 C CALCULATES REHEAT LOSS FOR MET NET .05-.20 WHICH IS USED IN THE 4L23
 C MACHINE. THIS SECTION IS SPECIFIC FOR THIS TYPE OF REGENERATOR
 C MATERIAL.
 $IF(RR.LT.42.) GOTO 41$
 $IF(RR.LT.140.) GOTO 42$
 $X = EXP(1.78 - .5044 * ALOG(RR))$
 $GOTO 43$
 41 $X = EXP(-.1826 - .0583 * ALOG(RR))$
 $GOTO 43$
 42 $X = EXP(.5078 - .243 * ALOG(RR))$
 43 $NT = X * LR / DW$
 $X = WR * CP * (TH - TW)$
 $Y = RD * CV * (PX - PN) * NU * MW / (R * FR)$
 $K3 = FR * (X - Y)$
 $RH = K3 / (NT + 2) * N * 2$
 C CALCULATES TEMPERATURE SWING LOSS.
 $MX = NR * P4 * DR ** 2 * LR * FF * 7.5$
 $TS = K3 / (NU * MX * 1.05)$
 $SL = K3 * TS * N / (2 * (TH - TX))$
 C CALCULATES PUMPING OR APPENDIX LOSS.
 $X = (PI * DC / KG) ** .6$
 $Y = ((PX - PN) * MW * NU * CP * 2 / ((TH + TX) * R)) ** 1.6$
 $Z = G ** 2.6$
 $QP = N * X * 2 * LB * (TH - TX) * Y * Z / 1.5$
 C CALCULATES SHUTTLE HEAT LOSS.
 $QS = 2 * P4 * RC * RC * KG * (TH - TC) * DC / (G * LB) * N$
 C CALCULATES STATIC HEAT LOSS. THIS CAN BE EITHER SPECIFIED OR
 C CALCULATED FROM THE BASIC DIMENSIONS.
 $IF(ZZ.EQ.1) ZH = (TH - TC) * (KM * ((DR ** 2 * P4 * FF + PI * DR * SR) / LR +$
 $1 * PI * DC * (SC + SE) / LB) + KG * (DR ** 2 * P4 * (1 - FF) / LR + DC ** 2 * P4 / LB))$
 C SUMS ALL LOSSES TO CALCULATE NET HEAT DEMAND.
 $QN = BH + ZH + SL + RH - HW - RW / 2 + QS + QP$

ORIGINAL PAGE IS
 OF POOR QUALITY

```

C CALCULATES COOLER HEAT LOAD.
  QC=QN-NP
C TEMPERATURE RISE IN COOLING WATER.
  DT=QC/(FW*4.185)
C EFFECTIVE COLD METAL TEMPERATURE.
  TX=TW+DT/2
C CALCULATES HEAT TRANSFER COEFFICIENT IN THE COLD HEAT EXCHANGER.
C
  RE=RZ
  J=1
C GOTO SUBROUTINE REST
  GOTO 100
44 HC=ST*CP*GC/PR
C
C TWO DIFFERENT METHODS OF ARRIVING AT THE PROPER EFFECTIVE HOT SPACE
C AND COLD SPACE TEMPERATURE ARE INTERSPERSED. THE FASTEST WAY,
C WHICH IS USUALLY TRIED FIRST, INVOLVES CALCULATING WHAT THE
C TEMPERATURE DIFFERENCE HAS TO BE BETWEEN THE METAL TEMPERATURE AND
C THE EFFECTIVE GAS TEMPERATURE CONSIDERING THE HEAT TRANSFER
C CAPABILITY OF THE HEAT EXCHANGER AND THE CORRECTION FACTOR.
C HOWEVER, IF THE HEAT EXCHANGER IS TOO SMALL, THE FIRST ITERATION
C METHOD GOES UNSTABLE AND A SECOND, MORE CAUTIOUS, METHOD MUST BE
C EMPLOYED. THE 'ZA' IS THE FLAG WHICH SHOWS THAT THE SECOND
C METHOD IS CALLED IN.
  IF(ZA.EQ.1) GOTO 46
C
C 'X' IS USED AS A TEMPORARY VARIABLE FOR THE PREVIOUS COLD
C TEMPERATURE. THE COLD TEMPERATURE IS CALCULATED, ASSUMING THERE IS
C NO ERROR BETWEEN THE HEAT THAT CAN BE TRANSFERRED AND THE HEAT THAT
C SHOULD BE TRANSFERRED. CONTER 'ZB' IS INDEXED. A TEST IS NOW MADE
C OF THE 'TC' VALUE JUST CALCULATED. IF THE EFFECTIVE COLD GAS
C TEMPERATURE IS GREATER THAN THE EFFECTIVE HOT GAS TEMPERATURE OR
C LESS THAN THE COOLING WATER TEMPERATURE THIS ITERATION METHOD HAS
C GONE UNSTABLE AND THE SECOND, MORE CAUTIOUS, METHOD IS BROUGHT IN.
C ALSO IF THE FIRST ITERATION METHOD HAS NOT COME TO AN ANSWER WITHIN
C 10 ITERATIONS, ('ZB' GREATER THAN 10), THE SECOND ITERATION METHOD
C IS BROUGHT IN. THE INITIAL CHANGE IN THE HOT GAS TEMPERATURE, 'DV',
C AND IN THE COLD GAS TEMPERATURE, 'DU', ARE BOTH SET AT 64 DEGREES.
C THE FLAG 'ZA' IS SET AT 1 AND 'TC' AND 'TH' ARE SET AT THE INITIAL

```

ORIGINAL PAGE IS
 OF POOR QUALITY

C VALUES. CONTROL PASS TO 46 WHERE THE SECOND APPROACH BEGINS. IF
 C THE VALUE OF 'TC' DOES NOT INDICATE THE SECOND APPROACH IS NEEDED
 C CONTROL PASSES TO 48 TO START CALCULATION OF THE EFFECTIVE
 C TEMPERATURE IN THE HOT SPACE.

X=TC

YY=HC*FC1*AC*N*BF

TC=QC/YY+TX

E2=QC-YY*(TC-TX)

ZB=ZB+1

IF(TC.GT.TH.OR.TC.LT.TX.OR.ZB.GT.10.) GOTO 47

GOTO 48

C ON THE FIRST TIME THROUGH 'TC' = 'TW' AND THE ERROR IN THE COLD SPACE,
 C E2, IS MADE EQUAL TO THE REQUIRED HEAT TRANSFER THROUGH THE GAS
 C COOLERS, 'QC'. THEN THE NEXT ESTIMATE FOR 'TC' IS MADE BY ADDING
 C 'DU', 64 DEGREES, TO 'TX', THE AVERAGE TEMPERATURE OF THE GAS
 C COOLER METAL. THE PROGRAM THEN GOES TO 48, SKIPPING OVER THE REST OF
 C THE ADJUSTMENT PROGRAM FOR THE COLD SPACE.

46 IF(TC.EQ.TW) GOTO 49

C IF 'TC' IS NOT EQUAL TO 'TW', AS IT WILL BE FOR ANYTHING EXCEPT
 C FOR THE FIRST TIME THROUGH, THE PREVIOUS ERROR IS SAVED AS 'E1'.
 C THEN 'E2' IS CALCULATED AS THE DIFFERENCE BETWEEN THE HEAT THAT
 C SHOULD BE TRANSFERRED AND THE HEAT THAT CAN BE TRANSFERRED BY THE
 C CAPABILITIES OF THE HEAT EXCHANGER.

E1=E2

E2=QC-HC*FC1*AC*N*(TC-TX)*BF

C IF THIS ERROR IS POSITIVE, THEN THE CORRECTION NUMBER, 'DU', IS
 C ADDED TO THE COLD TEMPERATURE, 'TC', AND THE PROGRAM GOES ON TO THE
 C HOT SPACE ANALYSIS.

IF(E2.GT.0) GOTO 50

C IF THIS ERROR IS NEGATIVE AND THE PREVIOUS ERROR WAS POSITIVE,
 C THEN THE DEGREE INCREMENT, 'DU', IS JUST DIVIDED BY 4, FOR FUTURE
 C CORRECTIONS.

IF(E2.LT.0.AND.E1.GT.0) DU=DU/4

C THE DEGREE INCREMENT IS SUBTRACTED FROM 'TC'. IF 'TC' BECOMES
 C GREATER THAN 'TM', THE HOT METAL TEMPERATURE, OBVIOUSLY THERE IS
 C INSUFFICIENT COOLER HEAT TRANSFER AREA AND THE PROGRAM STOPS FOR
 C THIS CASE. THIS CAN OCCUR FOR SMALL COOLER AREAS AND SPECIFIED HEAT

ORIGINAL FILE IS
 OF POOR QUALITY

```

C LEAKS.
  TC=TC-DU
  IF(TC.GT.TM) GOTO 51
C CALCULATES HEAT TRANSFER COEFFICIENT FOR GAS HEATER. FLAG 'ZA'
C INDICATES WHETHER THE FAST METHOD OF CONVERGENCE AT 59 OR THE SLOW
C METHOD AT 52 SHOULD BE USED.
48  RE=RT
    J=2
C GOTO SUBROUTINE REST
  GOTO 100
59  HH=ST*CP*GH/PR
    IF(ZA.EQ.1) GOTO 52
C THIS IS ANALOGOUS TO THE COMMENT MADE AFTER 44 ON THE COLD SPACE,
C EXCEPT THIS IS FOR THE HOT SPACE.
  Y=TH
  YY=HH*FH1*AH*N*BF
  TH=TM-QN/YY
  E4=QN-YY*(TM-TH)
  IF(TH.GT.TM.OR.TH.LT.TC) GOTO 47
  GOTO 53
C THIS IS ANALOGOUS TO 46 TO 48, EXCEPT THIS IS FOR THE HOT SPACE.
52  IF(TH.EQ.TM) GOTO 54
    E3=E4
    E4=QN-HH*FH1*AH*N*(TM-TH)*BF
    IF(E4.GT.0) GOTO 55
    IF(E4.LT.0.AND.E3.GT.0) DV=DV/4
    TH=TH+DV
    IF(TH.LT.TW) GOTO 56
    GOTO 55
C CONVERGENCE CRITERIA FOR THE FIRST ITERATION METHOD. THE ITERATION
C IS COMPLETE WHEN CHANGE IN THE EFFECTIVE HOT SPACE AND COLD SPACE
C TEMPERATURE IS LESS THAN ONE DEGREE KELVIN PER ITERATION.
53  X1=ABS(TH-Y)
    X2=ABS(TC-X)
    IF(X1.GT.1.OR.X2.GT.1) GOTO 200
    GOTO 57
C CONVERGENCE CRITERIA FOR THE SLOWER, SECOND METHOD OF ITERATION.
C CONVERGENCE IS COMPLETE WHEN THE AIR IN THE HOT SPACE AND THE AIR IN
C THE COLD SPACE ARE BOTH LESS THAN 1% OF THE HEAT TRANSFERRED THROUGH

```

ORIGINAL PAGE IS
 OF POOR QUALITY

C THE HEAT EXCHANGERS.

```
58  X1=ABS(E4)
    X2=ABS(E2)
    X3=QN/100
    X4=QC/100
    IF(X1.GT.X3.OR.X2.GT.X4) GOTO 200
```

C COMPLETES PREPARATION FOR OUTPUT

```
57  A=-HW-RW/2
    B=100.*IP/QN
    C1=QN*(100./FE-1.)
    D=FE*NP/QN
    E=100.*QN/FE
```

C REINITIALIZING

```
I=I+1
ZA=0
ZB=0
GOTO 60
```

C LOCATION OF CONTROL FOR THE SECOND ITERATION METHOD.

```
47  DV=64
    DU=64
    ZA=1
    TC=TW
    TH=TH
    GOTO 46
```

C LOCATION OF CONTROL IF 'TC' EQUALS 'TW'.

```
49  E2=QC
    TC=TX+DU
    GOTO 48
```

C LOCATION OF CONTROL IF 'E2' IS GREATER THAN 0.

```
50  TC=TC+DU
    GOTO 48
```

C BECAUSE OF INSUFFICIENT COOLER AREA THE PROGRAM IS TERMINATED FOR
C THIS CASE.

```
51  WRITE(LP,1)
    GOTO 300
```

C LOCATION OF CONTROL IF 'TH' EQUALS 'TM'.

```
54  E4=QN
    TH=TM-DV
    GOTO 58
```

ORIGINAL PAGE IS
OF POOR QUALITY

```

C LOCATION OF CONTROL IF 'TH' IS NOT LESS THAN 'TW'.
55 TH=TH-DV
   GOTO 58
C BECAUSE OF INSUFFICIENT HEATER AREA THE PROGRAM IS TERMINATED FOR
C THIS CASE.
56 WRITE(LP,2)
   GOTO 300
C THIS IS WHERE THE PRINTING OF THE OUTPUT STARTS. TO COMPRESS OUTPUT
C THE OPERATING CONDITIONS AND ENGINE DIMENSIONS ARE IDENTIFIED ONLY BY
C THEIR FORTRAN SYMBOL.
C
C PRINTS PROGRAM HEADING
60 WRITE(LP,10)
C PRINTS CORRENT OPERATING CONDITIONS
   WRITE(LP,3) SP,PS,ND,TF,L1,TY,FX,OG
C PRINTS CURRENT DIMENSIONS
   WRITE(LP,4) DC,DR,IC,OC,DW,DD,IH,OH,G,LB,LR,CR,RC,LC,LD,LH
   WRITE(LP,5) LI,NC,NR,N,NH,FF,AL,CX,ME,FE,EC,SC,SE,SR,ZZ,ZH,KM,ID,
1LE,NE,BF
C PRINTS POWER OUTPUTS AND HEAT INPUTS
   WRITE(LP,6) BP,BH,HWRH,RW,QS,CF,QP,IP,SL,MF,ZH,NP,A
   WRITE(LP,7) QN,B,C1,D,E
   WRITE(LP,8) TM,TW,TH,TC
C PRINTS WORK DIAGRAM FROM DATA
   WRITE(LP,9)
   DO 61 I=1,13
   F=ND*I-30.
   G=L(I)/R
   WRITE(LP,11) F,H(I),C(I),V(I),P(I),G
61 CONTINUE
   GOTO 300
C END OF MAIN PROGRAM
45 CALL EXIT
C
C SUBROUTIN REST
C CALCULATES STANTON NUMBER FROM REYNOLDS NUMBER
100 IF(RE.GE.10000.) ST=EXP(-3.57024-.229496*ALOG(RE))
   IF(RE.LT.10000.) ST=.0034
   IF(RE.LT.7000.) ST=EXP(-13.3071+.861016*ALOG(RE))

```

ORIGINAL PAGE IS
OF POOR QUALITY

IF(RE.LT.4000.) ST=.0021
IF(RE.LT.3000.) ST=EXP(.337046-.812212*ALOG(RE))
IF(J.EQ.1) GOTO 44
GOTO 59

C

C OUTPUT FORMAT:

```
1  FORMAT(10('*'),'INSUFFICIENT COOLER AREA',10('*'))
2  FORMAT(10('*'),'INSUFFICIENT HEATER AREA',10('*'))
3  FORMAT('CURRENT OPERATING CONDITIONS ARE: '//SP=',F10.2,T17,'PS=',
1F10.2,T33,'ND=',F10.2,T49,'TF=',F10.2/, 'L1=',F10.4,T17,'TY=',
2F10.4,T33,'FX='F10.4,T49,'OG=',I2//)
4  FORMAT('CURRENT DIMENSIONS ARE: '//DC=',F10.4,T17,'DR=',F10.4,T33,
1'IC=',F10.4,T49,'OC=',F10.4/, 'DW=',F10.5,T17,'DD=',F10.4,T33,
2'IH=',F10.4,T49,'OH=',F10.4/, 'G=',F11.5,T17,'LB=',F10.4,T33,'LR=',
3F10.4,T49,'CR=',F10.4/, 'RC=',F10.4,T17,'LC=',F10.4,T33,'LD=',F10.4,
4T49,'LH=',F10.4)
5  FORMAT('LI=',F10.4,T17,'NC=',I5,T33,'NR=',I3,T49,'N=',I3/, 'NH=',I4,
1T17,'FF=',F10.4,T33,'AL=',F10.2,T49,'CX=',F10.4/, 'ME=',F10.4,T17,
2'FE=',F10.4,T33,'EC=',F10.5,T49,'SC=',F10.5/, 'SE=',F10.5,T17,'SR=',
3F10.5,T33,'ZZ=',I3,T49,'ZH=',F10.2/, 'KM=',F10.4,T17,'ID=',F10.4,
4T33,'LE=',F10.4,T49,'NE=',I3/, 'BF=',F10.4//)
6  FORMAT('POWER, WATTS',T34,'HEAT REQUIREMENT, WATTS'/,2X,'BASIC',
1T20,F13.4,T36,'BASIC',T55,F13.4/,2X,'HEATER F.L.',T20,F13.4,T36,
2'REHEAT',T55,F13.4/,2X,'REGEN.F.L.',T20,F13.4,T36,'SHUTTLE',T55,
3F13.4/,2X,'COLER F.L.',T20,F13.4,T36,'PUMPING',T55,F13.4/,2X,'NET',
4T20,F13.4,T36,'TEMP.SWING',T55,F13.4/,2X,'MECH.FRIC.',T20,F13.4,
5T36,'CONDUCTION',T55,F13.4/,2X,'BRAKE',T20,F13.4,T36,'FLOW FRIC.',
6'CR','EDIT',T55,F13.4)
7  FORMAT(34('-'),T36,'HEAT TO ENGINE',T55,F13.4/, 'INDICATED EFF.%=',
1F10.4,T36,'FURNACE LOSS',T55,F13.4/, 'OVERALL EFF.%=',F10.4,T36,
2'FUEL INPUT',T55,F13.4)
8  FORMAT(54('-')/, 'HOT METAL TEMP. K=',F10.4,T34,'COOLING WATER ',
1'INLET TEMP., K=',F10.4/, 'EFFEC.HOT SP.TEMP.K=',F10.4,T34,'EFFEC.',
2'COLD SP.TEMP.K.=',F10.4/54('-')//)
9  FORMAT('FINAL WORK DIAGRAM: '//ANGLE',T11,'HOT VOL.',T23,'COLD VOL.
1',T36,'TOT. VOL.',T50,'PRESSURE',T63,'GAS INV.')
```

10 FORMAT('/////ISOTHERMAL SECOND ORDER CALCULATION--'/' PROG. ISO'
1/' 10 OCT 1979'/'WRITTEN BY WILLIAM R. MARTINI'//)

11 FORMAT(1X,I4,T8,F11.4,T21,F11.4,T34,F11.4,T47,F11.4,T60,F11.4)
END

ORIGINAL PAGE IS
OF POOR QUALITY

ORIGINAL PAGE IS
OF POOR QUALITY

C.4 Sample of Input File for FORTRAN Program

```
.NULL.  
10.16,12.9,12.02,.115,.167,312,3.14159  
.785398,.00432,25.0,90.,80.0,1,0  
9680.,41.8,25.58,.472,.640,36,4.06  
.0174533,.0406,6.40,1400.,.2,.0635,.1016  
.0510,2.500,3.500,6,.2,13.65,2.325  
4,90.,1200.,135.,2000.,.435,.1532  
0.76,71.,6,.4,.006894,2.54,60.  
8.314,1.341E-3,.0406,0.,179.  
BOTTOM
```

C.5 Sample of Output File Produced by FORTRAN Program

WETHEMAL SECOND ORDER CALCULATION---
PROG. PSD
10 DEC 1979
WRITTEN BY WILLIAM R. MARTINI

CURRENT OPERATING CONDITIONS ARE:

TC=	2000.00	PS=	1400.00	ND=	30.00	TF=	1200.00
LL=	0.0000	TY=	135.0000	FX=	25.0000	OG=	1

CURRENT DIMENSIONS ARE:

MP=	10.1600	DP=	3.5000	TC=	0.1150	OC=	0.1670
OH=	0.00432	DD=	4.0600	IH=	0.4720	OH=	0.6400
D=	0.04060	LB=	6.4000	LR=	2.5000	CR=	13.6500
RC=	2.3250	LC=	12.9000	LD=	12.0200	LH=	41.8000
LI=	25.5800	ND=	312	NR=	6	N=	4
NH=	36	FE=	0.2000	AL=	90.00	CX=	254.2804
NE=	90.0000	EE=	80.0000	EC=	0.04060	SC=	0.06350
SE=	0.10160	SR=	0.05100	ZZ=	0	ZH=	9680.00
KM=	0.2000	LD=	0.2600	LF=	71.0000	NE=	6
BE=	0.4000						

C.5 (Continued)

POWER, WATTS		HEAT REQUIREMENT, WATTS	
BASIC	90420.2656	BASIC	164159.8750
HEATER F.L.	2656.5659	REHEAT	3952.1211
REGEN.F.L.	4115.2744	SHUTTLE	1767.5664
COLER F.L.	2682.3604	PUMPING	1003.5267
NET	80966.0625	TEMP.SWING	19857.3164
MECH.FRIC.	8096.6055	CONDUCTION	9680.0000
BRAKE	72869.4531	FLOW FRIC.CREDIT	-4714.2031
-----		HEAT TO ENGINE	194706.1875
INDICATED EFF.%=	41.5837	FURNACE LOSS	48676.5469
OVERALL EFF.%=	29.9403	FUEL INPUT	243382.7188
-----		-----	
HOT METAL TEMP. K=	922.2222	COOLING WATER INLET TEMP., K=	330.5555
EFFEC.HOT SP.TEMP.K=	824.2458	EFFEC.'COLD SP.TEMP.K.=	370.1363
-----		-----	

FINAL WORK DIAGRAM:

ANGLE	HOT VOL.	COLD VOL.	TOT. VOL.	PRESSURE	GAS INV.
0	643.5826	443.6575	1210.9871	8.5046	2.2454
30	622.3497	526.2712	1272.3679	7.8026	2.2445
60	561.4412	591.0422	1276.2305	7.4862	2.2445
90	471.2589	615.6417	1210.6477	7.6176	2.2445
120	372.9461	591.0422	1087.7354	8.2426	2.2445
150	295.8666	526.2711	945.8848	9.3518	2.2445
180	266.5925	443.6575	833.9971	10.7450	2.2445
210	295.8666	367.8761	787.4897	11.9049	2.2445
240	372.9462	316.6937	813.3870	12.2546	2.2445
270	471.2589	298.8514	893.8574	11.7079	2.2445
300	561.4412	316.6937	1001.8820	10.6541	2.2445
330	622.3497	367.8759	1113.9727	9.5029	2.2445
360	643.5826	443.6575	1210.9871	8.5046	2.2445
BOTTOM					
T,P300					
.NULL.					

ORIGINAL PAGE IS
OF POOR QUALITY

C.6 Comparison Program Results

Table C-1 gives the final comparison between the isothermal second order analysis with a corrections factor of 0.4 and the General Motors validated predictions of the performance of their 4L23 engine. Figures 3-1 to 3-3 show the graphs from R. Diepenhorst "Calculated 4L23 Stirling Engine Performance", 19 Jan. 1970, Section 2.115 of GMR-2690 (reference 78 bh). These graphs were read as accurately as possible with dividing calipers to obtain the power outputs and efficiencies quoted in column 5 and 8 of Table C-1.

ORIGINAL PAGE IS
OF POOR QUALITY

Table C-1 Comparison of Isothermal Second Order Analysis of the
4L23 Engine with the experimentally validated analysis by General Motors

CORRECTION FACTOR IS .4

TEMP. INSIDE TUBES DEG. F	ENGINE SPEED RPM	AVERAGE GAS PRESSURE PSIA	CALC. NET POWER BHP	GM'S NET POWER BHP	CALC. --- GM'S	CALC. EFF. %	GM'S EFF. %	CALC. --- GM'S
1000	500	200	2.62076	3.5	.748788	9.66371	13	.743362
1000	500	600	8.18884	10	.818884	17.6122	20.5	.859129
1000	500	1000	17.829	15.5	1.89865	24.1888	21.5	1.12586
1000	500	1400	24.2204	20	1.21182	25.8797	21.2	1.22874
1000	500	1800	30.9003	24	1.28751	26.2991	20.7	1.27849
1000	500	2200	37.3246	28	1.33302	26.2454	20.4	1.28654
1000	500	2600	43.5383	31	1.48446	25.9448	20.3	1.27887
1000	500	3000	49.5371	35	1.41535	25.5816	19.2	1.32821
1000	1000	200	4.49795	6.5	.691993	12.643	18.6	.679733
1000	1000	600	20.1874	21	.961387	25.5284	24.5	1.04197
1000	1000	1000	33.8811	31.6	1.06966	27.5784	24.68	1.11744
1000	1000	1400	46.4931	42.2	1.18173	27.7492	24.62	1.1271
1000	1000	1800	58.6614	53	1.18682	27.378	24.4	1.12205
1000	1000	2200	70.2416	61.6	1.14829	26.7468	23.7	1.12856
1000	1000	2600	81.2223	69.1	1.17543	25.9818	23.5	1.18561
1000	1000	3000	91.6151	80	1.14519	25.1629	22.85	1.18122
1000	1500	200	7.11356	10.2	.697488	15.7813	21.2	.7444
1000	1500	600	29.8816	30.8	.944208	26.7582	25.85	1.06787
1000	1500	1000	47.7864	48	.99555	27.6727	24.82	1.11494
1000	1500	1400	65.3724	65.2	1.08264	27.3434	24.7	1.18782
1000	1500	1800	81.8567	80	1.02321	26.5773	24.3	1.09372
1000	1500	2200	97.2645	93.4	1.04138	25.6539	23.68	1.08336
1000	1500	2600	111.848	104.6	1.06929	24.7868	23.3	1.06838
1000	1500	3000	125.162	117.8	1.0625	23.784	22.92	1.0342
1000	2000	200	10.2341	12.8	.799538	18.5711	21.38	.868621
1000	2000	600	36.8744	40	.901861	26.3485	24.68	1.0676
1000	2000	1000	58.8906	61.2	.962265	26.6618	24.25	1.09946
1000	2000	1400	80.1847	82.2	.975483	26.0043	23.92	1.08713
1000	2000	1800	99.6717	100	.996717	25.8874	23.5	1.06414
1000	2000	2200	117.447	117	1.00382	23.912	22.9	1.04419
1000	2000	2600	133.615	138.4	1.02465	22.7779	22.26	1.02326
1000	2000	3000	148.119	146.6	1.01836	21.6488	21.78	.993689
1000	2500	200	12.517	15	.834464	19.4292	20.68	.939517
1000	2500	600	41.8193	45	.91154	24.9972	23.5	1.06371
1000	2500	1000	66.5678	70.5	.944224	24.9168	23	1.08334
1000	2500	1400	89.7166	96	.934548	23.9849	22.52	1.06585
1000	2500	1800	110.485	115.8	.954106	22.8299	21.9	1.04246
1000	2500	2200	128.968	135	.955317	21.5916	21.28	1.01464
1000	2500	2600	145.12	150.5	.964251	20.3362	20.55	.989595
1000	2500	3000	158.847	164	.968581	19.0674	20	.953372

ORIGINAL PAGE IS
OF POOR QUALITY

Table C-1 page 2

CORRECTION FACTOR IS .4

TEMP. INSIDE TUBES DEG. F	ENGINE SPEED RPM	AVERAGE GAS PRESSURE PSIA	CALC. NET POWER BHP	GM'S NET POWER BHP	CALC. --- GM'S	CALC. EFF. %	GM'S EFF. %	CALC. --- GM'S
1200	500	200	3.32173	5	.664345	11.6456	16.2	.718863
1200	500	600	9.64861	12	.804051	19.912	21	.948189
1200	500	1000	19.3385	18	1.07436	26.3574	22	1.19806
1200	500	1400	28.0843	23.8	1.18001	28.5274	23.5	1.21393
1200	500	1800	36.1386	29.8	1.2127	29.1077	25.2	1.15507
1200	500	2200	43.6916	35.7	1.22385	29.0153	25.2	1.1514
1200	500	2600	51.044	41.5	1.22998	28.6662	24.8	1.15589
1200	500	3000	58.1783	46.2	1.2591	28.1641	24.2	1.16381
1200	1000	200	5.99465	9.6	.624443	15.9358	20.5	.777357
1200	1000	600	23.5559	25.2	.934757	28.4136	26.4	1.07627
1200	1000	1000	39.7536	39	1.01932	30.7539	27.1	1.13483
1200	1000	1400	54.8003	53.2	1.03008	30.9618	28.15	1.09989
1200	1000	1800	69.3318	67.2	1.03172	30.5546	28.12	1.08658
1200	1000	2200	83.2575	79	1.05389	29.8603	27.9	1.07855
1200	1000	2600	96.5653	89.6	1.07774	29.0436	27.62	1.05154
1200	1000	3000	109.245	100	1.09245	28.1503	27.2	1.03494
1200	1500	200	8.60958	13.2	.652241	18.3454	23.15	.792458
1200	1500	600	34.541	38	.908973	30.2007	28.42	1.06266
1200	1500	1000	56.9282	59	.964885	31.2388	28.5	1.0961
1200	1500	1400	78.1827	80	.977284	30.9805	28.61	1.08006
1200	1500	1800	98.4938	100	.984938	30.1219	28.4	1.06063
1200	1500	2200	117.561	118	.996278	29.1301	28.09	1.03783
1200	1500	2600	135.512	134.6	1.00678	28.0727	27.72	1.01272
1200	1500	3000	152.27	147	1.03585	27.0001	27.26	.990467
1200	2000	200	12.0855	16.5	.732457	21.0913	23.92	.881743
1200	2000	600	43.5594	48.3	.90185	30.2114	28.27	1.06867
1200	2000	1000	71.624	76.8	.932604	30.6477	28.27	1.08411
1200	2000	1400	97.8483	103	.949983	29.9458	28.15	1.06379
1200	2000	1800	122.349	127	.96338	28.8887	27.7	1.04291
1200	2000	2200	145.139	151	.961184	27.7176	27.22	1.01828
1200	2000	2600	166.119	171.8	.966931	26.5185	26.8	.989498
1200	2000	3000	185.433	189.9	.976476	25.314	26.3	.962509
1200	2500	200	15.034	20	.751699	22.4181	23.85	.939962
1200	2500	600	50.7294	57	.88999	29.3204	27.5	1.0662
1200	2500	1000	82.951	90.8	.913557	29.3326	27.25	1.07643
1200	2500	1400	112.663	122	.923463	28.366	27.05	1.04865
1200	2500	1800	139.982	150	.933213	27.1412	26.5	1.0242
1200	2500	2200	164.017	176.8	.932223	25.8461	25.85	.999851
1200	2500	2600	187.301	201	.931844	24.5266	25.32	.968666
1200	2500	3000	207.336	222.5	.931847	23.217	24.76	.937682

ORIGINAL PAGE IS
OF POOR QUALITY

Table C-1 page 3

CORRECTION FACTOR IS .4

TEMP. INSIDE TUBES DEG. F	ENGINE SPEED RPM	AVERAGE GAS PRESSURE PSIA	CALC. NET POWER BHP	GM'S NET POWER BHP	CALC. --- GM'S	CALC. EFF. %	GM'S EFF. %	CALC. --- GM'S	
1400	500	200	3.8984	5	.779679	13.8406	20.6	.633039	
1400	500	600	11.0842	13	.85263	21.9642	22	.998372	
1400	500	1000	21.2487	19	1.11793	27.9864	23.5	1.19091	
1400	500	1400	31.3435	26.8	1.16953	30.5553	24.65	1.23957	
1400	500	1800	40.5026	34.6	1.1706	31.2583	25.5	1.2255	
1400	500	2200	49.1747	40	1.22937	31.2182	25.5	1.22424	
1400	500	2600	57.499	45.2	1.2721	30.8423	25.5	1.2095	
1400	500	3000	65.6139	53.5	1.22643	30.3114	25.25	1.20045	
1400	1000	200	7.26227	10	.726227	18.3442	26.68	.687565	
1400	1000	600	26.8723	28.2	.924549	30.3501	28.62	1.06045	
1400	1000	1000	44.6622	44.8	.996925	33.1791	29.5	1.12472	
1400	1000	1400	61.9119	62.5	.99859	33.4803	30	1.11601	
1400	1000	1800	78.4856	77.2	1.01665	33.0664	30.2	1.09491	
1400	1000	2200	94.4544	92.5	1.02113	32.3539	30	1.07846	
1400	1000	2600	109.804	104	1.05581	31.5087	29.75	1.05885	
1400	1000	3000	124.516	120	1.03763	30.5724	29.5	1.03635	
1400	1500	200	10.0865	15	.672431	20.6355	29.1	.709122	
1400	1500	600	39.1084	44.8	.872956	32.7985	30.6	1.07185	
1400	1500	1000	64.7508	68.1	.95082	34.0154	31.39	1.08364	
1400	1500	1400	89.1473	92.8	.968639	33.6879	31.72	1.06204	
1400	1500	1800	112.622	117.5	.958488	32.9807	31.8	1.03461	
1400	1500	2200	134.845	140	.963179	31.8748	31.5	1.0119	
1400	1500	2600	155.933	160	.97458	30.775	31.21	.988061	
1400	1500	3000	175.875	180	.977082	29.6553	30.92	.959097	
1400	2000	200	13.6023	18.5	.735261	22.9853	29.75	.772617	
1400	2000	600	49.9158	57.8	.863596	33.1715	31.05	1.06032	
1400	2000	1000	82.3647	89.8	.917201	33.7093	31.45	1.07184	
1400	2000	1400	112.967	121.2	.932072	33.831	31.58	1.04595	
1400	2000	1800	141.831	151.2	.938033	31.9458	31.4	1.01738	
1400	2000	2200	168.967	180	.938707	30.7367	31.05	.989909	
1400	2000	2600	194.259	205.5	.945298	29.4964	30.65	.962362	
1400	2000	3000	217.865	230.2	.946415	28.252	30.32	.931794	
1400	2500	200	17.162	22	.780092	24.6463	29.5	.835469	
1400	2500	600	58.9921	67.9	.858889	32.6346	30.6	1.06649	
1400	2500	1000	96.9011	106.8	.907314	32.7329	30.73	1.06518	
1400	2500	1400	132.294	145.2	.911113	31.7754	30.65	1.03672	
1400	2500	1800	165.278	180	.918211	30.5214	30.2	1.01064	
1400	2500	2200	195.737	213.3	.917661	29.1889	29.8	.973493	
1400	2500	2600	223.831	244.1	.916964	27.8327	29.27	.950893	
1400	2500	3000	249.438	273.5	.912023	26.4886	28.72	.922303	

AVERAGE RATIO					.9798%				1.03673

APPENDIX D

ADIABATIC SECOND ORDER DESIGN PROGRAM (RIOS)

D.1 Description

D.1.1 Introduction

As was stated in the first edition of the design manual the Rios method for Stirling engine design is highly regarded by engineers at the Philips Company as being almost equivalent to their proprietary codes. Dr. Glendon Benson has stated that it is the basis for his proprietary code.

In his 1969 thesis, (69 am) P.A. Rios published a computer code for a Stirling refrigerator. This code was somewhat verified through experimental data obtained from his two piston-two cylinder Stirling refrigerator.

Prof. J.L. Smith, Jr., of M.I.T. stated that this program was found to be reliable and useful by North American Philips engineers for designing cooling engines. At the time the Philips engineers used this program they had no program of their own but could get performance predictions for specific designs from N.V. Philips, Eindhoven, Netherlands. Other comments made at a panel discussion on Stirling engines at the 1977 Intersociety Energy Conversion Engineering Conference in Washington D.C. indicated that the Rios program is as good as the proprietary Philips program.

In order to verify these claims we obtained a card deck from Prof. Smith containing a listing of the Rios program as found in his thesis. Then we added to the Rios program equations to calculate the dimensionless numbers required by the Rios program from engine dimensions. We also added equations to the end of the program to calculate the losses for a real engine. These equations are given in the Rios thesis but are not part of the Rios program. The program was installed on the Amdahl 470/6 - II computer at Washington State University. It is accessed from the Joint Center for Graduate Study using a computer terminal connected to the WYLBUR system. The program executes in 0.91 seconds. Compiling and linking requires 2.76 seconds.

Although the original Rios program is for a refrigerator, the program given in Section D.3 has been modified to apply to an engine. The author decided to apply it to the General Motors 4L23 engine, a four cylinder, double acting crank operated engine with tubular heat exchangers since this engine is most similar to present day automobile engines.

This appendix contains a complete nomenclature list which Rios did not have. Next is a listing of the FORTRAN program with many comments that make the program understandable. The full numerical results of 18 test cases summarized in Table D-1 are on file at Martini Engineering. The comparison on Table D-1 shows that the pumping or appendix loss predicted by the Rios program is an order

Table D-1
 COMPARISON OF RIOS AND GENERAL MOTORS
 CALCULATION FOR THE 4L23 ENGINE

Case	Temp. Inside Tubes of	Engine Speed rpm	Ave. Gas Press. psia	Rios Brake Power HP	GM Brake Power HP	Rios GM	Rios Overall Eff. %	GM Overall Eff. %	Rios GM
1	1000	1000	200	8.31	6.5	1.28	19.23	18.6	1.03
2	1000	1000	1400	57.62	42.2	1.37	31	24.62	1.26
3	1000	1000	2600	104.16	69.1	1.51	35.22	23.5	1.50
4	1000	2000	200	14.34	12.8	1.12	21.76	21.38	1.02
5	1000	2000	1400	103.63	82.2	1.26	30	23.92	1.25
6	1000	2000	2600	186.51	130.4	1.43	29.99	22.26	1.35
7	1200	1000	200	9.65	9.6	1.01	21.11	20.5	1.03
8	1200	1000	1400	67.79	53.2	1.27	33.98	28.15	1.21
9	1200	1000	2600	123.09	89.6	1.37	35.05	27.62	1.27
10	1200	2000	200	16.82	16.5	1.02	24.03	23.92	1.00
11	1200	2000	1400	123.83	103.0	1.20	33.27	28.15	1.18
12	1200	2000	2600	224.14	171.8	1.30	33.47	26.8	1.25
13	1400	1000	200	10.80	10.	1.08	22.50	26.68	0.84
14	1400	1000	1400	76.70	62.5	1.23	36.24	30.0	1.21
15	1400	1000	2600	139.68	104.	1.34	37.45	29.75	1.26
16	1400	2000	200	18.99	18.5	1.03	25.77	29.75	0.87
17	1400	2000	1400	142.03	121.2	1.17	35.91	31.58	1.14
18	1400	2000	2600	257.72	205.5	1.25	36.19	30.65	1.18

ORIGINAL PAGE IS
 OF POOR QUALITY

**ORIGINAL PAGE IS
OF POOR QUALITY**

of magnitude larger than the same loss predicted by the isothermal second order program. The equations used are entirely different for the two cases. The equation used in the isothermal second order analysis was checked with the original source and was found to be correct. Rios derives his appendix loss equation in his thesis. Then in other parts of the thesis the equation is quoted differently. Although the author does not understand the reasons for many assumptions Rios makes, it is clear that the equation must be substantially modified for a heat engine. Rios ignores the temperature swing loss which for the 4L23 engine is quite large. The program presented in Appendix D should be modified to use the correct appendix loss equation and include the temperature swing loss equation. However since these two errors compensate and since they are relatively small corrections it was not considered worthwhile repeating the 18 production cases.

D.1.2 The Rios Calculation Method Rios starts by calculating a perfect engine and then makes corrections. His perfect engine obeys the following assumptions. (69 am, pp. 24-26)

1. At each instant in time the pressure throughout the engine is uniform.
2. Hot and cold gas spaces are adiabatic - no heat transfer to or from either the expansion or the compression space.
3. Heat transfer in the heater, cooler, and regenerator is perfect - zero temperature difference between gas and neighboring wall.
4. The temperature at any point in a heat-exchange component is constant with time.
5. Uniform temperature exists at any cross section perpendicular to the direction of flow.
6. The gas in the cylinders is perfectly mixed.
7. The Ideal Gas Laws apply.

In broad outline the Rios calculation method proceeds as follows:

1. Calculate dimensionless quantities from the engine dimensions and operating conditions.
2. Calculate engine volumes for the angle increment selected.
3. Calculate engine pressure to go with the volumes and given operating conditions. Start with an arbitrary initial pressure and traverse the cycle twice. The second cycle will be correct.
4. Calculate power losses:
 - a. heater windage
 - b. regenerator windage
 - c. cooler windage

5. Calculate heat losses:
 - a. reheat
 - b. shuttle
 - c. pumping
 - d. heater ineffectiveness
 - e. cooler ineffectiveness
6. If 5d or 5e are appreciable, modify the heat source and heat sink temperature then re-do parts 1, 3, 4, and 5. Three iterations has been found adequate for convergence.

D.2 Nomenclature for Appendix D

Rios did not give a nomenclature so the one given below has been tabulated to the best of the authors knowledge and understanding.

- AFC = Cooler free flow area, cm^2
AFH = Heater free flow area, cm^2
AFR = Regenerator free flow area, cm^2
ALF = 4.7123889 (270 degrees)
ARG = Sin (PV angle)
BDR = Regenerator diameter, cm
BEC = Piston end clearance, cm
BPD = Piston diameter, cm
BPL = Hot cap length, cm
BRC = Piston gap, cm
BRL = Regenerator length, cm
BRO = Regenerator density factor
BST = Piston stroke, cm
BTC = Effective cold temperature, K
BTC1 = Cold metal temperature, K
BTR = Regenerator temperature, K
BTW = Hot effective gas temperature, K
BTW1 = Hot metal temperature, K
BWD = Effective regenerator wire diameter, cm
C() = Cold space as fraction of the stroke amplitude at mid-increment
C() varies from 0 to 2 and back.
CALF() = Sin change per radian increment
CALFP = CALF()
CFI = Cos of phase angle

CI() = Same as C() for beginning of increment
 CMMAX = Largest cold dimensionless mass
 CMU = Cold hydrogen viscosity
 CNTU = Number of heat transfer units in cold space
 COFI() = Cos values for cold space
 CON = Conduction loss, watts
 CPI = Hydrogen heat capacity
 CRC = $\sqrt{ZZC^2 - CALF()^2}$
 CRW = CRC in hot space
 CTD = Cooler tube inside diameter, cm
 CTLL = Total cooler tube length, cm
 CTLS = Cooled cool tube length, cm
 CVI = Hydrogen heat capacity
 DALF = $2\pi/NDIV$
 DC() = Angle derivative of C()
 DCI() = Angle derivative of CI()
 DDD = Cooler duct diameter, cm
 DLL = Cooler duct length, cm
 DM = Sum of changes in mass (DMRE)
 DMC = Cold dimensionless mass change XDMC()
 DMRE = Sum of changes in mass (DM)
 DMW = Hot dimensionless mass change XDMW()
 DMX = Dimensionless change in mass relating to X, the fraction from
 the cold end
 DP = Change in pressure
 DPR = DP array
 DTC = Cooler metal temperature - effective temperature
 DTH = Delta T_H
 DV = Dead volume, cm^3
 DVC = DC()
 DVCI = DCI()
 DVW = DW()
 DVWI = DWI()
 DW() = Angle derivative of W()
 DWI() = Angle derivative of WI()

ORIGINAL PAGE IS
 OF POOR QUALITY

DX = 1/XNDS
EX1 = 1 - XNHT
EX2 = 2 - XNHT
FC = Cold friction factor
FFF = Friction flow credit, watts
FH = Hot friction factor
FR() = Regenerator friction factors (3 pts.)
FI = Phase angle, rad.
FI1 = Phase angle in deg.
FIPV = PV angle (output) arcsin (ARG)
FR() = Regenerator friction factor
G1 = Y value subplot
G2 = Y value subplot
GDMS() = Calculated mass flow values
GGV = Dead volume at side of hot cap, cm³
GINT() = Flow loss variable
GI2() = Pressure drop value
GI3() = Pressure drop value
GLH = Heater pressure drop integral
GLR = Regenerator pressure drop integral
GLS = Cooler pressure drop integral
H(1) = Fraction of total reduced dead volume from cold end to midway in cooler
H(2) = Fraction of total reduced dead volume from the cold end through the cooler
H(3) = Fraction of total reduced dead volume from the cold end through half the regenerator
H(4) = Fraction of total reduced dead volume through the regenerator
H(5) = Fraction of total reduced dead volume through the middle of the gas heater (1-H(5) includes the rest of the heater and clearance on the end and sides of the hot cap)
HAC = Cold active volume amplitude, cm³
HAV = Hot active volume amplitude, cm³
HCV = Reduced cooler and cold ducting dead volume, dimensionless
HEC = Reduced cold end clearance dead volume, dimensionless
HGV = Reduced hot cap gap dead volume, dimensionless
HHC = Reduced hot clearance dead volume, dimensionless
HHV = Reduced heater dead volume, dimensionless

ORIGINAL PAGE IS
OF POOR QUALITY

HMU = Hot hydrogen viscosity
HRV = Reduced regenerator dead volume, dimensionless
HT = Basic heat input, watts
HTD = Heater tube inside diameter, cm
HTE = Heat to engine, watts
HTLL = Total heater tube length, cm
HTLS = Heated heater tube length, cm
HTW = Hot end heat transfer integral, dimensionless
IND() = Array that shows if mass change is positive, or negative in
warm and cold sides
J = Temporary angle variable, radians
K = 1 if warm mass change is positive, 2 if negative
L = 1 if cold mass change is positive, 2 if negative
LUP = Iterational counter
M = X value for plot calculation
MBR = Number of regenerators
MCT = Number of cooler tubes per cylinder
MHT = Number of heater tubes for cylinder
MW = Dimensionless mass in hot space = (mass, grams)(R)(BTW)/(PMX1(HAV))
N = NDIV or x value for plot subroutine
NN = 1 up to phase angle, 2 after
NDIV = Number of divisions per crank rotation (must be a multiple of 4
so that the phase angle at 90 degrees can be an even number of divisions)
(Program must be revised if NDIV is not 360)
NDIV1 = NDIV + 1
NDS = Number of divisions in dead space
NE = NDIV/4 + 1
NET = Regenerator filler option +5 = metnet
-5 = screen
NF = NDIV/4
NFF = NF + 1
NFI = (phase angle)(NDIV)/360
NFIN = Main loop final counter, for first part = phase angle, for second
part = end of cycle
NIN = NDS + 1
NITE = Cycle counter (counts to 15)
NL = (NDIV/2) + 1

NLOP = Option counter limits changes in options to 7 (removed in final version)
 NO = IND(K,L) - 1, 2, 3, or 4 starts as 1
 NOC = Number of cylinders
 NS = (NDIV/4) + 2
 NST = Main loop initial counter, for the first part = 1, for second part =
 phase angle
 NT = (NDIV/4) + 2
 NWR = Governs printout, zero for overall results only, different from zero
 added PV data
 P = Pressure, dimensionless
 PALF = Thermal diffusivity of piston
 PDR = Piston rod diameter, cm
 PI4 = $\pi/4 = .78539816$
 PAVG = Dimensionless average pressure
 PMAX = Maximum pressure, dimensionless
 PMIN = Minimum pressure, dimensionless
 PMX = Maximum pressure (MPa)
 PMX1 = Avg. pressure MPa
 PR() = Pressure, dimensionless, fraction of maximum pressure
 PO = Basic power, watts
 POT = Net power, watts
 PS = Dimensionless pressure from end of previous cycle
 PW = Pressure at halfway point for increment
 QB = Beta for shuttle heat loss calculation
 QCP = Cooler windage, watts
 QDK = Reheat factor
 QFS = Pumping loss factor
 QHC = Shuttle loss, watts
 QHG = Pumping loss, watts
 QHP = Heater windage, watts
 QHR = Reheat loss, watts
 QLM = Reheat factor, λ_1
 QL1 = Shuttle factor, λ_1
 QNPH = Reheat pressurization effect
 QNTU = Regenerator transfer units, dimensionless
 QP = Windage factor

ORIGINAL PAGE IS
 OF POOR QUALITY

ORIGINAL PAGE IS
OF POOR QUALITY

QR() = Regenerator windage loss values, watts
QRP = Average regenerator windage, watts
R = Gas constant, joules/(gm)(K)
R2 = Constant = $R(g_c)^2$
RE() = Regenerator Reynolds number in cold, middle, and hot part
REC = Cold Reynolds number
REH = Hot Reynolds number
RER = Regenerator Reynolds factor
RMU = Regenerator hydrogen viscosity, g/cm sec.
RNTU = Regenerator heat transfer units
RP = Maximum pressure/minimum pressure
RVT = Displaced mass ratio
S = Pressure at halfway point, dimensionless
SALF() = Sin values for cold space
SALFP = Average sin values for cold space
SFI = Sin of phase angle
SHR = Specific heat ratio for working gas
SIFI() = SALF()
SIFIP = SALF(1)
SMC = Cold mass + $\frac{1}{2}$ change in mass
SMW = Hot mass + $\frac{1}{2}$ change in mass
SPD = Engine speed, rad/sec
TEC() = Dimensionless cold gas temperature
TEST = Ensures that difference in dimensionless mass < .001
TEST1 = Ensures that difference in dimensionless pressure < .005
TEW() = Dimensionless hot gas temperature
TMPC = Average TEC()
TMPW = Average TEW()
TCDM = Dimensionless average cold temperature for entire cycle
TWDM = Dimensionless average warm temperature for entire cycle
UDM() = Critical mass flow values from subplot
UIN() = Critical pressure drop integral values from subplot
UI23, 24, 33, 34 = Critical pressure drop values
UPA = Power piston area, cm^2
UTR = Temperature ratio = $\frac{\text{hot metal temp, K}}{\text{cold metal temp, K}}$

ORIGINAL PAGE IS
OF POOR QUALITY

VC = C()
VCC = Cold volume cm^3
VCD = Cold dead volume, cm^3
VCI = CI()
VD = Reduced dead volume, dimensionless
VH = Hot volume, cm^3
VHD = Hot dead volume, cm^3
VRC = Regenerator dead volume, cm^3
VT = Total volume, cm^3
VW = W()
VWI = WI()
W() = Hot space as fraction of the stroke amplitude, calculated at mid increment
WC = Dimensionless cold work
WI() = Same as W() for beginning of increment
WMMAX = Largest hot dimensionless mass
WW = Hot work, dimensionless
X = Short term variable
XDMC() = Change in cold mass, grams
XDMW() = Change in hot mass, grams
XI1 = Pressure drop integral - accounts for the relationship between the shapes of mass and pressure fluctuations
XI2 = Influence of mass flow time variation on the heat transfer
XI3 = XI1/XI2
XINT = Basic pressure drop integral - for windage
xMC = Cold gas mass, relative to total inventory
XMCX() = Cold gas mass, grams
XMT() = Total mass, grams
XMW = Hot gas mass, relative to total inventory
XMWS = Hot dimensionless gas mass from previous cycle
XMWX() = Hot gas mass, grams
XND = NDIV
XNDS = NDS
XNHT = Value for exponent in heat transfer relation of regenerator matrix
XX = Short term variable
Y = |DMX|

ZEF = Indicated efficiency, %

ZZC = Connecting rod length/½ stroke for cold piston

ZZW = Connecting rod length/½ stroke for hot piston

D.3 FORTTRAN Listing with Full Comments

```

1. //R1054L23 JOB (),KOSOROK,NOTIFY=WRMJC,REGION=120K
2. // EXEC FORTGCLG
3. //FORT.SYSIN DD *
4.
5. C IF MEMORY IS A PROBLEM ALL DIMENSIONS TO 720 CAN BE CHANGED TO 361
6. O DIMENSION XDMC(720),XDNW(720),IND(2,2),PR(720),XMCX(720),XMX(720)
7. 1 ,TEC(720),TEW(720),XNT(720)
8. O DIMENSION W(720),C(720),WI(720),CI(720),DW(720),DC(720),DWI(720),
9. 1 DCI(720),DPR(720)
10. DIMENSION SIFI(720),COFI(720),SALF(720),CALF(720),H(5),UIN(5),
11. 1 UDM(5),GDMS(20),GINT(20),GI2(20),GI3(20),RE(3),FR(3),QR(3)
12. C SPECIFIED ENGINE DIMENSIONS AND OPERATING CONDITIONS ARE READ
13. C IN FROM DATA CARDS
14. 2 READ(5,5) ZZC,ZZW,XNHT,PMX1,SPD,NET,NOC
15. C STOPS IF NEXT DATA SET IS BLANK
16. IF(ZZC) 4000,511,4000
17. 4000 READ(5,1) SHR,NFI,NDIV,NWR,NDS,DDD,DLL
18. READ(5,1710) BTC,BTW,BFD,BST,BPL,BRC,BEC
19. READ(5,1720) PIR,BRO,BDR,BWD,BRI,MBR,MCT
20. READ(5,1730) CTU,CTLL,CTLS,HTD,HTLL,HTLS,MHT
21. C CONSTANTS ARE NOW SETUP
22. PI=3.1415926
23. PI4=.78539816
24. C HOT AND COLD METAL TEMPERATURES ARE SET AT GIVEN HOT AND COLD
25. C GAS TEMPERATURES
26. BTW1 = BTW
27. BTC1 = BTC
28. C POWER PISTON AREA
29. UPA= BPD*BFD*PI
30. C TEMPERATURE RATIO, INVERSE OF NORMAL
31. UTR = BTW/BTC
32. C HOT CYLINDER VOLUME AMPLITUDE IS REFERENCE VOLUME FOR ALL
33. C DIMENSIONLESS VOLUMES.
34. HAV = UPA*BST/2
35. GGU = PIF*BFD*BPL*BRC
36. C INITIALIZE LUP COUNTER-SET FOR 3 ITERATIONS
37. LUP = 1
38. C
39. C ***RETURN POINT AFTER 1 CYCLE***
40. C

```



```

40. THE FOLLOWING ARE REDUCED, DIMENSIONLESS, DEAD VOLUMES IDENTIFIED BY
41. AN INDEX AND MINIMUM EFFECTIVE GAS TEMP. AND HAV
42. 337 HBT = GBV*(BTW/(HTW*(BTC+BTC)))
43. HEC = (UPA-PDR*PDR*PI4)*BEC*UTR/HAU
44. AFD = PI*CTD*ACT*ANCT
45. HEV = (AFD*CTLL+DDD*DDD*PI4*XLL*XMR)*UTR/HAU
46. AFR = PI*BDR*BDR*MBF*BRD
47. HRV = AFR*BRL*2*BTW/(HAU*(BTW+BTC))
48. XHT = PI*HTD*HTD*XNHT
49. HHV = AFH*HTLL/HAU
50. HHC = UPA*BEC/HAU
51. VD = HCV+HEC+HCV+HRV+HHV+HHC
52. THE FOLLOWING ARE HOT, REGENERATOR AND COLD DEAD VOLUMES IN CU.CM,
53. VHD=AFH*HTLL+UPA*BEC
54. VRD=GBV+AFR*BRL
55. VCD=(UPA-PDR*PDR*PI4)*BEC+HCV*HAU/UTR
56. ON THE FIRST ITERATION ONLY THE INPUT VALUES ARE WRITTEN OUT
57. IF(LUP-1) 343,343,346
58. 343 HAC = HAV-PI4*PDR*PDR*BST/2
59. WRITE(6,1805)
60. WRITE(6,1810) BTC,BTW,BPD,BST
61. WRITE(6,1820) BPL,BRC,BEC,PDR
62. WRITE(6,1830) BRD,BDR,BWD,BRL
63. WRITE(6,1840) MBR,MCT,CTD,CTLL
64. WRITE(6,1850) CTLS,HTD,HTLL,HTLS,MHT,XNHT
65. WRITE(6,1860) PMX1,SPD,NET,NDC
66. WRITE(6,2010) ZZC,ZZW
67. THE REDUCED DEAD VOLUME IS DIVIDED INTO FRACTIONS, RE-EVALUATED
68. EACH ITERATION BECAUSE OF CHANGE IN TEMPERATURES
69. 346 H(1) = (HEC+HCV/2.)/VD
70. H(2) = H(1)+HCV/(2.*VD)
71. H(3) = H(2)+HRV/(2.*VD)
72. H(4) = H(2)+HRV/VD
73. H(5) = H(4)+HHV/(2.*VD)
74. CALCULATIONS FROM 349 TO 295 ARE ON FIRST ITERATION ONLY. ENGINE
75. VOLUMES AND VOLUME DERIVATIVES ARE CALCULATED AND DECISION MATRIX
76. IS DEFINED
77. IF(LUP-1) 349,349,295
78. 349 XND = NDIV
79. NDIV1 = NDIV + 1
80.

```

```

81. C DALF=0.0174 RADIANS/INCRIMENT
82.   DALF = 6.2831853/XND
83.   NT = NDIV/4+2
84.   NE = NT - 1
85. C CALCULATION STARTS AT 270 DEG=4.71 RADIANS IN RADIANS IF THE
86. C FRONT SIDE OF THE COLD PISTON IS USED AND AT 90 DEG=1.57 RADIANS
87. C IN RADIANS IF THE BACK SIDE IS USED AND ROOM MUST BE ALLOWED FOR
88. C A PISTON DRIVE ROD. THIS GIVES THE PROPER CURVE SHAPE.
89. C CALCULATION ALWAYS STARTS WITH ZERO COLD LIVE VOLUME.
90.   IF(PDR) 4060,4060,4070
91. 4070 ALF=1.5707963
92.   GO TO 4080
93. 4060 ALF = 4.7123889
94. 4080 NF = NDIV/4
95. C CALL SUBROUTINE TO CALCULATE DUPLACABLE SPACE ABOVE OR UNDER COLD
96. C PISTON AT THE MIDPOINT AND AT THE BEGINNING OF EACH ANGLE
97. C INCRIMENT AS A FRACTION OF THE PISTON STROKE AMPLITUDE.
98. C SUBROUTINE ALSO CALCULATES DERIVATIVES TO BE USED LATER.
99.   CALL VOLC(DALF,NF,C,CI,DC,DCI,ZZC,NDIV,SIFI,COFI,SALF,CALF,
100.   IPDR,ALF)
101. C THE PHASE ANGLE MUST BE 90 DEG FOR A HEAT ENGINE AND 270 DEG FOR
102. C A HEAT PUMP
103. 100 FI = DALF*NF
104.   FI1 = FI*180./PIE
105.   WRITE(6,11) CHR,NDIV,FI1,NDS,DDD,DLL
106.   SFI = SIN(FI)
107.   CFI = COS(FI)
108. C NOW THE HOT SPACE FRACTIONS AND DERIVATIVES ARE CALCULATED FOR
109. C EACH INCRIMENT.
110.   OCALL VOLW(U,WI,OW,OWI,CFI,SFI,ZZW,NDIV,SIFI,COFI,SALF,CALF,
111.   J DALF)
112. C CHOICE MATRIX IS DEFINED-SEE NOTE #2
113.   IND(1,1) = 1
114.   IND(1,2) = 5
115.   IND(2,1) = 4
116.   IND(2,2) = 2
117. C FIRST GUESS AT INITIAL QUANTITIES.
118. C COUNTER NN IS 1 AT START OF CYCLE WHEN LIVE COLD VOLUME IS ZERO.
119. C IT BECOMES 2 AFTER LIVE HOT VOLUME BECOMES ZERO. PHASE ANGLE IS
120. C 270 DEG FOR A HEAT PUMP AND 90 DEG FOR A HEAT ENGINE

```

ORIGINAL PAGE IS
OF POOR QUALITY

```

121.      295 NN = 1
122.      C  NONE OF THE GAS MASS IS ASSUMED TO BE IN THE COLD SPACE TO START,
123.      C  VOLUME IS ZERO,
124.          XMC = 0.
125.      C  RELATIVE PRESSURE IS ASSUMED TO BE MAXIMUM, APPROXIMATION.
126.          P = 1.
127.      C  AT START ALL GAS MASS IS ASSUMED TO BE IN THE HOT SPACE, IGNORES
128.      C  DEAD VOLUME,
129.          XMW = 1.-CFI
130.      C  MASS FROM PREVIOUS CYCLE IS ASSUMED AT START TO BE ZERO. TO ASSURE
131.      C  AT LEAST 2 CYCLES TO CONVERGENCE.
132.          XMWS = 0.
133.      C  PREVIOUS CYCLE PRESSURE
134.          PS = 1.
135.      C  INITIAL ASSUMPTION FOR VALUE OF IND(K,L) IS CORRECT FOR HEAT
136.      C  ENGINE WRONG FOR HEAT PUMP.
137.          NO = 1
138.      C  INITIALIZE DIMENSIONLESS WORKS
139.          WW = 0.
140.          WC = 0.
141.          NITE = 1
142.          NST = 1
143.          NFIN = NFI
144.      C  DISPLACED MASS RATIO
145.          RVT = HAC*UTR/HAV
146.          CI(NDIV1)=CI(1)
147.          WI(NDIV1)=WI(1)
148.      C  *****
149.      C  START OF MAIN DO LOOP; RETURN POINT AFTER EACH INCRIMENT
150.      404 DO 102 I=NST,NFIN
151.      C  TRANSFERS VOLUMES AND DERIVATIVES FROM STORAGE
152.          VW = W(I)
153.          VC = C(I)
154.          VWI = WI(I)
155.          VCI = CI(I)
156.          DVW = DW(I)
157.          DVC = DC(I)
158.          DVWI = DWI(I)
159.          DVCI = DCI(I)
160.      C  SPLITS TO 4 OPTIONS

```

ORIGINAL PAGE IS
OF POOR QUALITY

```

151.      GO TO (201,202,203,204),NO
152.  C   INTEGRATION PROGRAM FOR MASS INCREASING IN BOTH HOT AND COLD SPACES,
153.  C   NO-1 --(SEE NOTE #3)
154.  C   COMPUTES PRESSURE CHANGE BASED UPON INITIAL CONDITIONS
155.  201 DP = -SHR*P*(RVT*DUCI+DVWI)/(RVT*UCI+VWI+SHR*VD)*DALF
156.  C   FINDS PRESSURE AT MID INCRIMENT
157.      S = P+DP/2.
158.  C   CALCULATES FINAL PRESSURE CHANGE BASIC UPON MID POINT VALUES
159.      DP = -SHR*S*(RVT*DVC+DVW)/(RVT*VC+VW+SHR*VD)*DALF
160.  C   CALCULATES MASS CHANGES
161.      DMW = S*DVW*DALF+VW*DP/SHR
162.      DMC = -(DMW+VD*DP)/RVT
163.  C   DETERMS CHOICE MATRIX
164.      IF(DMW)302,301,301
165.      301 K = 1
166.      GO TO 303
167.      302 K = 2
168.      303 IF(DMC) 304,305,305
169.      304 L = 1
170.      GO TO 306
171.      305 L = 2
172.      306 NC = IND(K,L)
173.  C   IF CHOICE IS CHANGED NEXT ITERATION WILL BE THROUGH A DIFFERENT
174.  C   OPTION
175.      GO TO 400
176.  C   INTEGRATION PROGRAM FOR MASS DECREASING IN BOTH HOT AND COLD SPACES,
177.  C   NO-2 (SEE OPTION 1 FOR DETAILED EXPLANATION)
178.  202 IF(XMC) 803,801,801
179.  803 XMC = 0.0
180.  801 IF(XMW) 805,802,802
181.  805 XMW = 0.0
182.  802DP = -SHR*(XMC*RVT*DUCI/UCI+XMW*DVWI/UWI)/
183.  1   (XMC*RVT/P+XMW/P+SHR*VD)*DALF
184.      DMC = XMC*(DUCI*DALF/UCI+DP/SHR/P)
185.      DMW = -RVT*DMC-VD*DP
186.      S = P+DP/2.
187.      SMC = XMC+DMC/2.
188.      SMW = XMW+DMW/2.
189.  ODP = -SHR*(SMC*RVT*DVC/VC+SMW*DVW/VW)/
190.  1   (SMC*RVT/S+SMW/S+SHR*VD)*DALF
191.
192.
193.
194.
195.
196.
197.
198.
199.
200.

```

ORIGINAL PAGE IS
OF POOR QUALITY

```

201.      DMC = SMC*(DVC*DALF/VC+DP/SHR/S)
202.      DMW = -RVT*DMC-VD*DP
203.      IF(DMW) 312,312,307
204.      312 K = 2
205.      GO TO 308
206.      307 K = 1
207.      308 IF(DMC) 309,309,310
208.      309 L = 2
209.      GO TO 311
210.      310 L = 1
211.      311 NO = IND(K,L)
212.      GO TO 400
213.  C   INTEGRATION PROGRAM FOR MASS DECREASING IN COLD SPACE AND INCREASING
214.  C   IN HOT SPACE, NO=3 (SEE OPTION 1 FOR DETAILED EXPLANATION)
215.      203 IF(XMC) 704,703,703
216.      704 XMC = 0.
217.      703ODP = -SHR*(P*DVWI+XMC*RVT*DVCI/UCI)/(VWI+XMC*RV)
218.      1      /P+SHR*VD)*DALF
219.      DMC = XMC*(DVCI*DALF/UCI+DP/SHR/P)
220.      DMW = -RVT*DMC-VD*DP
221.      S = P+DP/2.
222.      SMC = XMC*DMC/2.
223.      SMW = XMW+DMW/2.
224.      ODP = -SHR*(S*DVW+S*SMC*RVT*DVC/VC)/(VW+S*SMC*RVT
225.      1      /S+SHR*VD)*DALF
226.      DMC = SMC*(DVC*DALF/VC+DP/SHR/S)
227.      DMW = -RVT*DMC-VD*DP
228.      IF(DMW) 313,314,314
229.      314 K = 1
230.      GO TO 315
231.      313 K = 2
232.      315 IF (DMC) 316,316,317
233.      316 L = 2
234.      GO TO 319
235.      317 L = 1
236.      318 NO = IND(K,L)
237.      GO TO 400
238.  C   INTEGRATION PROGRAM FOR MASS DECREASING IN COLD SPACE AND DECREASING
239.  C   IN HOT SPACE, NO=4 (SEE OPTION 1 FOR DETAILED EXPLANATION)
240.      204 IF(XMW) 705,702,702

```

ORIGINAL PAGE IS
OF POOR QUALITY

```

241.      705 XMW = 0.
242.      7020DF = -SHR*(P*RVT*DVC1+XMW*DVWI/VWI)/(RVT*VCT
243.      1      +XMW/P+SHR*VD)*DALF
244.      DMW = XMW*(DVWI*DALF/VWI+DF/SHR/P)
245.      DMC = -(DMW+VD*DF)/RVT
246.      S = P+DF/2.
247.      SMC = XMC+DMC/2.
248.      SMW = XMW+DMW/2.
249.      ODP = -SHR*(S*RVT*DVC+SMW*DVW/VW)/(RVT*VC
250.      1      +SMW/S+SHR*VD)*DALF
251.      DMW = SMW*(DVW*DALF/VW+DF/SHR/S)
252.      DMC = -(DMW+VD*DF)/RVT
253.      IF(DMW) 319,319,320
254.      319 K = 2
255.      GO TO 321
256.      320 K = 1
257.      321 IF(DMC) 322,323,323
258.      323 L = 1
259.      GO TO 324
260.      322 L = 2
261.      324 NO = IND(K,L)
262.      C INCRIMENTS PRESSURE AND MASS
263.      400 P = P+DF
264.      XMC = XMC+DMC
265.      XMW = XMW+DMW
266.      C CALCULATES WORKS
267.      PW = P-DF/2.
268.      WC = WC+PW*DVC*DALF
269.      WW = WW+PW*DVW*DALF
270.      C RECORDS RESULTS INTO ARRAYS
271.      PR(I) = P
272.      DFR(I) = DF
273.      XMCX(I) = XMC
274.      XMWX(I) = XMW
275.      XDNC(I) = DMC
276.      XDHW(I) = DMW
277.      C *****END OF MAIN DO LOOP*****
278.      102 CONTINUE
279.      GO TO (401,402),NN
280.      C RESET MAIN DO LOOP FOR LAST PART OF CYCLE

```

ORIGINAL PAGE IS
OF POOR QUALITY

```

281.      401 NST = NFI+1
282.          NFIN = NDIV
283.          NN = 2
284.          GO TO 404
285.      C   TESTS FOR CONVERGENCE AT END OF CYCLE.  THE CHANGE IN THE FRACTION
286.      C   OF MASS IN THE HOT SPACE FROM ONE CYCLE TO THE NEXT MUST BE LESS
287.      C   THAN 0.1%, AND THE CHANGE IN PRESSURE FROM ONE CYCLE TO THE NEXT
288.      C   MUST BE LESS THAN 0.5%.  HOWEVER, NO MORE THAN 15 CYCLES ARE
289.      C   ALLOWED.
290.      402 TEST = SQRT((XMWS-XMW)**2)
291.          TEST1 = SQRT((PS-P)**2)
292.          IF(NITE-15) 471,471,406
293.      471 IF(TEST-.001)473,473,405
294.      473 IF(TEST1-.005) 406,406,405
295.      C   REINITIALIZE FOR NEXT CYCLE
296.      405 NN = 1
297.          XMC = 0.
298.          PS = P
299.          XMWS = XMW
300.          WW = 0.
301.          WC = 0.
302.          NST = 1
303.          NFIN = NFI
304.          NITE = NITE+1
305.          ND = 4
306.          GO TO 404
307.      C   THE DIMENSIONLESS PRESSURES AND WORKS HAVE BEEN CALCULATED FOR ONE
308.      C   CYCLE.  NOW THE ADDITIONAL HEAT AND POWER LOSSES WILL BE CALCULATED.
309.      C   CALCULATE AVERAGE DIMENSIONLESS PRESSURE.
310.      406 PAVG=0
311.          DO 3000 I=1, NDIV
312.      3000 PAVG=PAVG+PR(I)
313.          PAVG=PAVG/NDIV
314.      C   DETERMINE MAXIMUM AND MINIMUM DIMENSIONLESS PRESSURE
315.          PMAX = XLARGE(PR,NDIV)
316.          PMIN = SMALL(PR,NDIV)
317.      C   ADJUST DIMENSIONLESS WORKS TO RELATE TO NEWLY DETERMINED MAXIMUM
318.      C   PRESSURE
319.          WC = WC/PMAX
320.          WW = WW/PMAX

```

ORIGINAL PAGE IS
OF POOR QUALITY

```

321. C PRESSURE RATIO
322.     RP = PMAX/PMIN.
323. C FIND MAXIMUM MASSES AND ADJUST THEM TO MAXIMUM PRESSURE.
324.     CMMAX = XLARGE(XMCX,NDIV)
325.     WMMAX = XLARGE(XMWX,NDIV)
326.     CMMAX = CMMAX/PMAX
327.     WMMAX = WMMAX/PMAX
328. C CALC. MAX. PRESSURE, MPA
329.     PMX=PMAX*PMX1/PAVG
330. C CALCULATES ANGLE BETWEEN PRESSURE WAVE AND VOLUME WAVE FOR A HEAT
331. C ENGINE.
332.     ARG = 2.*RP/(RP-1.)*WW/3.1416
333.     IF(1.-ARG**2) 1607,1608,1609
334.     1608 FIPV = ARSIN(ARG)
335.     XNDS = NDS
336. C CALCULATES VALUES USED IN FLOW LOSS CALCULATIONS AND FLOW INTEGRALS
337.     X = 0.
338.     DX = 1./XNDS
339.     NIN = NDS + 1
340.     CDR = PMAX**(XNHT-2.)*DALF**(XNHT-1.)
341.     DO 854 I=1,NIN
342.     CALL PDINT(X,XDMW,XDMC,RVT,DC,NDIV,DMRE,PR,XINT,DFR,XI1,XI2,XNHT)
343.     XINT = XINT/DALF/PMAX
344.     DMRE = DMRE/PMAX/6.2832
345.     XI1 = XI1*CDR/(1.5708*DMRE)**(1.-XNHT)
346.     XI2 = XI2*CDR/(1.5708*DMRE)**(2.-XNHT)
347.     XI3 = XI1/XI2
348.     GDMS(I) = DMRE
349.     GINT(I) = XINT
350.     GI2(I) = XI2
351.     GI3(I) = XI3
352.     X = X+DX
353.     854 CONTINUE
354. C INTERPOLATES FLOW INTIGRALS
355.     DO 910 I=1,5
356.     UIN(I) = PLOT(GINT,H(I))
357.     UDM(I) = PLOT(GDMC,H(I))
358.     910 CONTINUE
359.     UI23 = PLOT(GI2,H(2))
360.     UI24 = PLOT(GI2,H(4))

```



```

361.          UI33 = PLOT(GI3,H(2))
362.          UI34 = PLOT(GI3,H(4))
363.      C    *****CALCULATION OF CONSTANTS*****
364.      C    SPECIFIC FOR HYDROGEN GAS
365.          HMU = .8873E-04+.2E-06*(BTW-293.)
366.          CMU = .8873E-04+.2E-06*(BTC-293.)
367.          BTR = (BTW-BTC)/ALOG(BTW/BTC)
368.          RMU = .8873E-04+.2E-06*(BTR-293.)
369.          CP1 = 14.6
370.          CV1 = 10.46
371.          R2 = 82.3168E6
372.          R = 4.116
373.      C    *****COLD EXCHANGER PRESSURE DROP*****
374.          REC = UDM(1)*PMX*SPD*HAC*CTD/(BTC*AFH*CMU*R)
375.          IF(REC-2000.) 1985,1985,1986
376.          1985 FC = 16./REC
377.          GO TO 1987
378.          1986 FC= EXP(-1.34-.2*ALOG(REC))
379.          1987 GLS = CTLL*SPD*SPD*HAC*HAC*FC*UIN(1)/(CTD*AFH*AFH*BTC*R2)
380.          QP = NOC*SPD*PMX*HAC/(2.*PIE)
381.          QCP = QP*GLS
382.      C    *****HOT EXCHANGER PRESSURE DROP*****
383.          REH = UDM(5)*PMX*SPD*HAC*HTD/(BTW*AFH*HMU*R)
384.          IF(REH-2000.) 1988,1988,1989
385.          1988 FH = 16./REH
386.          GO TO 1993
387.          1989 FH = EXP(-1.34-.2*ALOG(REH))
388.          1993 GLH = HTLL*SPD*SPD*HAC*HAC*BTW*FH*UIN(5)/(HTD*AFH*AFH*BTC*BTC*R2)
389.          QHP = QP*GLH
390.      C    *****SCREEN--METNET OPTION*****
391.          RER = PMX*HAC*SPD*BWD/(AFR*R)
392.          RE(1) = RER*UDM(2)/(BTC*CMU)
393.          RE(2) = RER*UDM(3)/(BTR*RMU)
394.          RE(3) = RER*UDM(4)/(BTW*HMU)
395.          DO 2030 I=1,3
396.          IF(NET) 2015,2015,2022
397.          2015 IF(RE(I)-60.) 2017,2017,2018
398.          2017 FR(I) = EXP(1.73-.93*ALOG(RE(I)))
399.          GO TO 2030
400.          2018 IF(RE(I)-1000.) 2019,2019,2021

```

ORIGINAL IN QUANTITY

```

401. 2019 FR(I) = EXP(.714-.365*ALOG(RE(I)))
402. GO TO 2030
403. 2021 FR(I) = EXP(.015-.125*ALOG(RE(I)))
404. GO TO 2030
405. 2022 FR(I) = 2.73*(1.+10.397/RE(I))
406. 2030 CONTINUE
407. C *****REGENERATOR PRESSURE DROP*****
408. GLR = BRL*SPD*SPD*HAC*HAC/(BWD*AFR*AFR*R2*BTC)
409. QR1 = QP*GLR*UIN(2)*FR(1)
410. QR2 = QP*GLR*UIN(3)*FR(2)*BTR/BTC
411. QR3 = QP*GLR*UIN(4)*FR(3)*UTR
412. QRP = (QR1+QR3+4.*QR2)/6.
413. C CALCULATES EFFECTIVE HOT AND COLD GAS TEMPERATURES BASED UPON THE
414. C NUMBER OF TRANSFER UNITS IN THE HEAT EXCHANGERS, SPECIFIC FOR
415. C HYDROGEN
416. CNTU = .112*CTLS/(CTD*REC**,2)
417. DTC = WC*(SHR-1.)/(2.*UDM(1)*SHR*(EXP(2.*CNTU)-1.))
418. BTC = BTC1*(1.-DTC)
419. HNTU = .1044*HTLS/(HTD*REH**,2)
420. DTH = WW*(SHR-1)/(2*UDM(5)*SHR*(EXP(2.*HNTU)-1.))
421. BTW1 = BTW*(1.-DTH)
422. C NOTE, TEMPERATURE TIO IS REDEFINED FOR NEXT ITERATION
423. UTR = BTW/BTC
424. C *****REHEAT LOSS*****
425. RNTU = BRL*4.37/(BWD*SQRT(PI4*2.*RE(1)))
426. QNTU = BRL*4.031/(BWD*SQRT(PI4*2.*RE(3)))
427. QNFH = AFR*BRL*.1950/(PI4*HAC*UDM(2)*(UTR-1.))
428. QDK = QNFH*(UI33+UI34*UDM(2)/UDM(4))/2.
429. QLM = (1.+QDK)/(RNTU/UI23+QNTU*UDM(2)/(UDM(4)*UI24))
430. QHR = UDM(2)*CF1*(BTW-BTC)*SPD*PMX*HAC*QLM*NOC/(R*BTC*2.)
431. C *****SHUTTLE LOSS*****
432. QL1 = 231.2*SQRT(SPD*BRC*BRC)
433. QB = (2.*QL1*QL1-QL1)/(2.*QL1*QL1-1.)
434. QHC = .00146*BST*(ETW-BTC)*PI4*BPD*BST*QB*NOC/(BRC*BPL)
435. C *****PUMPING LOSS*****
436. QFS = (RP/(BTW/(BTW-2.*BTC)-BST/BPL))+(1./((BTW/((BTW-2.*BTC)+BST/
437. 1BPL)))
438. QHG = ABS(SPD*PMX*GGV*BST*SHR*QFS*ARG*NOC/((SHR-1)*BPL*RP*S.))
439. C *****BASIC POWER*****
440. PD = (WW*HAU+WC*HAC)*(+.50)*PMX*SPD*NOC/PIE

```

ORIGINAL PAGE IS
OF POOR QUALITY

```

441. C *****NET POWER*****
442.     POF = PO-QCF-QHP-QRF
443. C GET READY TO REPORT ON ONE ITERATION AND PREPARE FOR THE NEXT.
444. C RESET HOT END DIMENSIONLESS HEAT TRANSFER INTEGRAL
445.     HTW = 0.
446. C THE PROGRAM TRIES TO KEEP PMAX=1. THIS ADJUSTMENT OF THE PRESSURE
447. C AND MASSES DOES THIS
448.     DO 509 I=1,NDIV
449.     PR(I) = PR(I)/PMAX
450.     XMCX(I) = XMCX(I)/PMAX
451. 509 XMWX(I) = XMWX(I)/PMAX
452. C DIMENSIONLESS HOT AND COLD GAS TEMPERATURES FOR EACH INCRIMENT.
453. C IF THEY ARE LESS THAN ZERO CORRECT TO ZERO
454.     WI(NDIV1) = WI(1)
455.     CI(NDIV1) = CI(1)
456.     DO 1001 I=1,NDIV
457.     IF(XMCX(I)) 1003,1003,1002
458. 1002 TEC(I) = PR(I)*CI(I+1)/XMCX(I)
459.     GO TO 1006
460. 1003 TEC(I) = 0.
461. 1006 IF(XMWX(I)) 1004,1004,1005
462. 1005 TEW(I) = PR(I)*WI(I+1)/XMWX(I)
463.     GO TO 1001
464. 1004 TEW(I) = 0.
465. 1001 CONTINUE
466. C DIMENSIONLESS AVERAGE HOT AND COLD GAS TEMPERATURES FOR FULL CYCLE.
467.     TEW(NDIV1) = TEW(1)
468.     TEC(NDIV1) = TEC(1)
469.     PR(NDIV1) = PR(1)
470.     XMCX(NDIV1) = XMCX(1)
471.     XMWX(NDIV1) = XMWX(1)
472.     TWDM = 0.
473.     TCDM = 0.
474.     DO 573 I=1,NDIV
475.     DMW = XMWX(I+1)-XMWX(I)
476.     IF(DMW) 574,575,575
477. 574 TMPW = (TEW(I)+TEW(I+1))/2.
478.     TWDM = TWDM+(TMPW-1.)*DMW
479. 575 DMC = XMCX(I+1)-XMCX(I)
480.     IF(DMC) 576,573,573

```

```

481.      576 TMPC = (TEC(I)+TEC(I+1))/2.
482.      TCDM = TCDM+(TMPC-1.)*DMC
483.      573 CONTINUE
484.      TWDM = TWDM*SHR/(SHR-1.)
485.      TCDM = TCDM*SHR/(SHR-1.)
486.      C   HOT END HEAT TRANSFER INTEGRAL FOR FULL CYCLE AND TOTAL GAS MASS AT
487.      C   EACH POINT IN THE CYCLE. TOTAL MASS SHOULD NOT CHANGE.
488.      DO 1021 I=1,NDIV
489.      HTW = HTW+(WI(I+1)-WI(I))*(PR(I)+PR(I+1))/2.
490.      1021 XMT(I) = XMCX(I)*RVT+XMWX(I)+PR(I)*VD
491.      C   BASIC HEAT INPUT, WATTS
492.      HT = HTW*SPD*PMX*HAV*NOC/(2.*PIE)
493.      C   SPECIFIC STATIC CONDUCTION HEAT LOSS FOR THE 4L23 ENGINE
494.      CON = 9680.
495.      C   FLOW FRICTION CREDIT, WATTS
496.      FFF = (QHP+.5*QRP)*(-1)
497.      C   HEAT TO ENGINE, WATTS
498.      HTE = HT+QHR+QHC+QHG+CON+FFF
499.      C   INDICATED EFFICIENCY, %
500.      ZEF = 100.*POF/HTE
501.      C   PRINT OUT RESULTS OF ONE ITERATION
502.      WRITE(6,12) LUP
503.      WRITE(6,3010) PD,HT
504.      WRITE(6,3020) QHP,QHR
505.      WRITE(6,1925) QRP,QHC,QCP,QHG,POF,CON,ZEF,FFF,HTE
506.      WRITE(6,1921) BTW,BTC,RVT,VD
507.      C   AFTER ALL LOSSES ARE TAKEN INTO ACCOUNT LUP IS INDEXED. THE PROGRAM
508.      C   DOES 3 ITERATIONS WITH PRINTOUTS BEFORE GOING INTO A SUMMARY.
509.      LUP = LUP+1
510.      IF(LUP-3) 339,339,1607
511.      C   IF INPUT VALUE NWR IS OTHER THAN ZERO THE FOLLOWING SUMMARY
512.      C   INFORMATION IS PRINTED AT THE END OF THE COMPUTATION
513.      1607 IF(NWR) 1613,606,1613
514.      1613 WRITE(6,51) TWDM,TCDM
515.      C   PRINT OUT EACH 10 DEGREES, ANGLE, HOT VOLUME, HOT GAS TEMPERATURE,
516.      C   COLD VOLUME, COLD GAS TEMPERATURE, TOTAL VOLUME, PRESSURE
517.      1149 WRITE(6,20)
518.      DO 3001 I=10,NDIV,10
519.      X=PR(I)*PMX
520.      VH=VHD+HAV*WI(I)

```

ORIGINAL PAGE IS
OF POOR QUALITY

```

521.          ME=VDD/FCT(1)*HAC
522.          DT=VH/DROD*VE
523.    3001 WRITE(6,21)I,VH,VC,PI,X
524.    E   STARTS OVER WITH NEXT DATA SET.
525.      606 GO TO 2
526.      511 CALL EXIT
527.        1 FORMAT (F10.4,4I10,2F10.4)
528.        5 FORMAT (5F10.4,2I10)
529.       11 FORMAT (21H SPECIFIC HEAT RATIO=F10.4,10X,16H DIV. PER CYCLE=
530.         115/1X,20H PHASE ANGLE(DEG.)=F10.4,9X-'INCR. IN DP INT.=',I5/
531.         23X,'DUCT DIAMETER(CM)='/,F10.4,10X,'DUCT LENGTH(CM)='/,F10.4/' OUTPUT
532.         3T:'/)
533.       12 FORMAT(' ITERATION ',I2)
534.    3010 FORMAT(9X,' BASIC POWER(WATTS)='/,F10.1,9X,' BASIC HEAT(WATTS)='
535.         1F10.1)
536.    3020 FORMAT(5X,' HEATER WINDAGE(WATTS)='/,F10.1,8X,' REHEAT LOSS(WATTS)='
537.         1,F10.1)
538.       510FORMAT(' DIMENSIONLESS AVG. GAS TEMP'/' HOT END ',F10.4,10X,
539.         1'COLD END ',F10.4)
540.    2010 FORMAT (2X,19H COLD CRANK RATIO =
541.         1F10.4,7X,' HOT CRANK RATIO =',F10.4)
542.    1710 FORMAT (7F10.4)
543.    1720 FORMAT (5F10.4,2I10)
544.    1730 FORMAT (6F10.4,I10)
545.    1805 FORMAT(18H INPUT DIMENSIONS:)
546.    1810 FORMAT(21H   COLD MET TEMP(K)=F10.4,8X,18H HOT MET TEMP(CM)=
547.         1F10.4/5X,16H PISTON DIA(CM)=F10.4,7X,19H PISTON STROKE(CM)=
548.         2F10.4)
549.    1820 FORMAT(21H   HOT CAP LENGTH(CM)=F10.4,10X,16H PISTON GAP(CM)= F10.4
550.         1/21H   PIST END CLR(CM)= F10.4,8X,18H PIST ROD DIA(CM)= F10.4)
551.    1830 FORMAT(5X,16H REGEN POROSITY= F10.4,11X,15H REGEN DIA(CM)=
552.         1F10.4/21H   REG. WIRE DIA(CM)= F10.4,8X,18H REGEN LENGTH(CM)=
553.         2F10.4)
554.    1840 FORMAT(7X,14H NUM OF REGEN= I5,19X,12H NUM OF CT = I5,
555.         1/21H   COOL TUBE DIA(CM)= F10.4,10X,
556.         216H TOT CT LEN(CM)= F10.4)
557.    1850 FORMAT(4X,17H COOL CT LEN(CM)= F10.4,5X,21H HEATER TUBE DIA(CM)=
558.         1F10.4/5X,16H TOT HT LEN(CM)= F10.4,9X,17H HEAT HT LEN(CM)= F10.4/
559.         29X,12H NUM OF HT = I5,13X,18H HEAT TRAN. EXP. = F10.4)
560.    1860 FORMAT(1X,20H AVG. PRESSURE(MPA)= F10.4,3X

```

ORIGINAL PAGE IS
OF POOR QUALITY

```

561.      123H ENGINE SPEED(RAD/SEC)= F10.4/5X,16H NETNET OPTION = I5,
562.      215X,16H NUMBER OF CYL.= I5)
563.      1921 FORMAT(8X,20H EFFEC. HOT TEMP(K)= F10.1,6X,
564.      121H EFFEC. COLD TEMP(K)=F10.1/5X,23H DISPLACED MASS RATIO =F10.4,
565.      28X,19H REDUCED DEAD VOL = F10.4/)
566.      1925 FORMAT(28H REGENERATOR WINDAGE(WATTS)= F10.1,6X,
567.      121H SHUTTLE LOSS(WATTS)=F10.1/5X,23H COOLER WINDAGE(WATTS)=F10.1
568.      2,5X,22H APPENDIX LOSS(WATTS)=F10.1/10X,18H NET POWER(WATTS)=F10.1,
569.      38X,19H CONDUCTION(WATTS)= F10.1/9,19H INDICATED EFF.(Z)= F10.1,
570.      45X,22H FLOW FRICTION(WATTS)= F10.1/42X,23H HEAT TO ENGINE(WATTS)=
571.      5F10.1)
572.      20 FORMAT(' PRESSURE,MPA-VOLUME,CM3 DATA FOR ONE CYLINDER'// ANGLE DE
573.      16',5X,'HOT VOL.',6X,'COLD VOL.',5X,'TOTAL VOL.',7X,'PRESSURE')
574.      21 FORMAT(5X,I5,3X,F10.4,5X,F10.4,5X,F10.4,5X,F10.4)
575.      END
576.
577.      C      SUBROUTINE TO FIND LARGEST OF A LIST
578.      FUNCTION XLARGE(X,NDIV)
579.      DIMENSION X(720)
580.      XLARGE = X(1)
581.      DO 505 I=2,NDIV
582.      IF(XLARGE-X(I)) 506,505,505
583.      506 XLARGE = X(I)
584.      505 CONTINUE
585.      RETURN
586.      END
587.
588.      C      SUBROUTINE TO FIND SMALLEST OF A LIST
589.      FUNCTION SMALL(X,NDIV)
590.      DIMENSION X(720)
591.      SMALL = X(1)
592.      DO 507 I=2,NDIV
593.      IF(SMALL-X(I)) 507,507,500
594.      508 SMALL = X(I)
595.      507 CONTINUE
596.      RETURN
597.      END
598.
599.      C      SUBROUTINE TO INTERPOLATE
600.      FUNCTION PLU(X,Z,10)

```

ORIGINAL PAGE IS
OF POOR QUALITY

```

601.      DIMENSION X(20)
602.      N = 10.*H
603.      Z = H-N/10
604.      M = M+1
605.      G1 = X(M)
606.      N = M+1
607.      G2 = X(N)
608.      PLOT = Z*G2+(1.-Z)*G1
609.      RETURN
610.      END
611.
612.      C  SUBROUTINE TO LIST COLD VOLUMES AND DERIVATIVES
613.          SUBROUTINE VOLC(DALF,NF,C,CI,DC,DCI,ZZC,NDIV,SIFI,COFI,SALF,CALF,
614.          1FDR,ALF)
615.          DIMENSION C(720),CI(720),DC(720),DCI(720)
616.          DIMENSION SIFI(720),COFI(720),SALF(720),CALF(720)
617.          NDIV1 = NDIV+1
618.          DO 852 I=1,NDIV1
619.              COFI(I)=COS(ALF)
620.              SALF(I)=SIN(ALF)
621.          852 ALF=ALF+DALF
622.          DO 855 I=1,NDIV
623.          855 CALF(I) = (SALF(I+1)-SALF(I))/DALF
624.              CALF(NDIV1) = CALF(1)
625.          DO 851 I=1,NDIV
626.              SIFI(I) = SALF(I)
627.          851 SALF(I) = (SALF(I)+SALF(I+1))/2.
628.              COFI(NDIV1) = COFI(1)
629.              SIFI(NDIV1) = SIFI(1)
630.              N = NF*4
631.              DO 302 I = 1,N
632.          201 CRC = SQRT(ZZC**2-CALF(I)**2)
633.      C  SEE NOTE #1
634.          IF(FDR) 7010,7010,7020
635.          7020 C(I)=1.-SALF(I)+CRC-ZZC
636.              CI(I)=1.-SIFI(I)+CRC-ZZC
637.              DC(I)=-CALF(I)*(1.-SALF(I)/CRC)
638.              DCI(I)=-CALF(I)*(1.-SIFI(I)/CRC)
639.              GO TO 302
640.          7010 C(I)=1.+SALF(I)-CRC+ZZC

```

ORIGINAL PAGE IS
OF POOR QUALITY

```

641.          CI(I)=1.+SIFI(I)-CRC+ZZC
642.          DC(I)=CALF(I)*(1.-SALF(I)/CRC)
643.          DCI(I)=CALF(I)*(1.-SIFI(I)/CRC)
644.    302 CONTINUE
645.          RETURN
646.          END
647.
648.    C    SUBROUTINE FOR PRESSURE DROP INTEGRAL CALCULATION
649.          SUBROUTINE PDINT (X,DMW,DMC,RVT,DVC,NDIV,DM,PR,XINT,
650.    1      DPR,XI1,XI2,XNHT)
651.          DIMENSION DMW(720),DMC(720),DVC(720),PR(720),DPR(720)
652.          DM = 0.
653.          XINT = 0.
654.          XI1 = 0.
655.          EX1 = 1.-XNHT
656.          XI2 = 0.
657.          EX2 = 2.-XNHT
658.          DO 101 I=1,NDIV
659.            DMX = DMC(I)-X*(DMW(I)/RVT+DMC(I))
660.            Y = ABS(DMX)
661.            DM = DM+Y
662.            A = DPR(I)*Y**EX1
663.            IF(DMX) 201,202,202
664.    201 A = -A
665.    202 XI1 = XI1+A
666.            XI2 = XI2+Y**EX2
667.    101 XINT = XINT+Y*DMX/PR(I)*DVC(I)
668.            XNDIV = NDIV
669.            RETURN
670.            END
671.
672.    C    SUBROUTINE TO LIST HOT VOLUMES AND DERIVATIVES
673.          SUBROUTINE VOLW(W,WI,DW,DWI,CFI,SFI,ZZW,NDIV,SIFI,COFI,SALF,CALF,
674.    1      DALF)
675.          DIMENSION SIFI(720),COFI(720),SALF(720),CALF(720)
676.          DIMENSION W(720),WI(720),DW(720),DWI(720)
677.          SIFIP = SIFI(1)*CFI-COFI(1)*SFI
678.          DO 101 I=1,NDIV
679.    201 SALF1 = SIFI(I+1)*CFI-COFI(I+1)*SFI
680.          SALFP = (SIFIP+SALF1)/2.

```

ORIGINAL PAGE IS
OF POOR QUALITY

```

681.      CALFF = (SALF1-SIFIP)/DALF
682.      CRW = SQRT(ZZW**2-CALFF**2)
683.      W(I)=1.+SALFF-CRW+ZZW
684.      WI(I)=1.+SIFIP-CRW +ZZW
685.      DW(I)=CALFF*(1.-SALFF/CRW)
686.      DWI(I)=CALFF*(1.-SIFIP/CRW)
687.      101 SIFIP = SALF1
688.      RETURN
689.      END
690.      //GO.SYSIN DD *
691.      5.874      5.874      .204      9.6516      209.44      5      4
692.      1.39      90      360      1      10      .76      71.
693.      330.      1033.      10.16      4.65      6.4      .0406      .0406
694.      .060      .8      3.5      .0043      2.5      6      312
695.      .115      12.9      12.02      .472      41.8      25.58      36
696.      0.0
697.      //
698.      CXXXXXXXX      XXXXXXXXXXX      XXXXXXXXXXX      XXXXXXXXXXX
699.      C      XXXXXXXXXXX      XXXXXXXXXXX      XXXXXXXXXXX
700.      C      INTEGER DATA MUST BE RIGHT JUSTIFIED.  THERE ARE 7 DATA FIELDS PER
701.      C      LINE OF 7 COLUMNS EACH.
702.      C      DATA FIELD LAYOUT IS AS FOLLOWS:
703.      C*****ZZC *****ZZW *****XNHT *****PMX1 *****SPD *****NET *****NOC
704.      C*****SHR *****NFI *****NDIV *****NWR *****NDS *****DDD *****DLL
705.      C*****BTC *****BTW *****BFD *****BST *****BFI *****BRC *****BEC
706.      C*****FDR *****BRD *****BDR *****BWD *****ERL *****MER *****NCT
707.      C*****CTD *****CTLL *****CTLS *****HTD *****HTLL *****HTLS *****NHT
708.      C      NEXT DATA SET REPEATS LAST.
709.      C      CHANGE ACCORDING TO DATA PRINTOUT.
710.      C      DATA MUST BE WITHIN CONTROL CARDS(//).
711.
712.
713.
714.
COMMAND?

```

D.4 Evaluation of Appendix Loss as Calculated by Rios

In his 1969 series (69 am), Rios calculated the appendix loss in a Stirling refrigerator. He refers to this loss as the loss due to gas motion in the radial clearance. The appendix loss calculated by Rios is more than an order of magnitude higher than that calculated by the second order method. It was decided to evaluate the derivation of Rios more closely (69 am, pp. 136-138) to determine the cause of such a large discrepancy. Many steps taken by Rios were not understood by this author, but when the adaptation from refrigerator to heat engine was carefully analyzed, some changes were made that resulted in an appendix loss comparable to that given by the second order code.

D.4.1 Rios Appendix Loss Adapted to a Heat Engine

The pumping or appendix loss is the loss due to gas flow into and out of the radial clearance between the piston and displacer. The following assumptions are made:

1. The radial clearance is small, so it can be assumed that the gas entering and leaving the radial clearance volume is at the adjacent cylinder wall temperature.
2. The temperature gradient at the stroked part of the cylinder is smaller than that of the unstroked part and is approximated by Rios to be:

$$\frac{dT}{dx} = \frac{\Delta T}{2 \text{ BPL}} \quad (\text{D-1})$$

Where $d T$ = the temperature gradient
 $d x$ = distance along the stroked part of the cylinder
 ΔT = the temperature difference from one end of the gap to the other
BPL = the hot cap or gap length

**ORIGINAL PAGE IS
OF POOR QUALITY**

3. Variations in piston motion, pressure and gas flow may be approximated by sinusoids.

The highest average pressure and temperature in the gap is reached near top dead center, after the hot cap has compressed the hot gases into the gap. The lowest average pressure and temperature is reached near bottom dead center, after the expansion stroke of the hot cap (where the total engine volume is maximum).

Considering assumption 2, Rios calculates the space - average temperature fluctuation of the stroked and unstroked parts of the gap is:

$$\bar{T} = \frac{BTC1 + BTW}{2} + \frac{(BTW - BTC1) BST}{BPL} \sin (SPD(t)) \quad (D-2)$$

so
$$\bar{T}_{min} = \frac{BTC1 + BTW}{2} - \frac{(BTW - BTC1) BST}{BPL} \quad (D-3)$$

and
$$\bar{T}_{max} = \frac{BTC1 + BTW}{2} + \frac{BTW - BTC1}{BPL} \frac{BST}{2} \quad (D-3)$$

where \bar{T} = the space-average temperature fluctuation
 \bar{T}_{min} = the minimum space average temperature
 \bar{T}_{max} = the maximum space average temperature
 BTC1 = the cold metal temperature
 BTW = the hot gas temperature
 BST = the hot cap stroke
 SPD = engine speed, rad/sec
 t = time, seconds

The pressure is:

$$p = \frac{PMX + PMN}{2} + \frac{PMX - PMN}{2} \sin ((SPD)t - \emptyset) \quad (D-5)$$

where P = the pressure fluctuation
 PMX = the maximum pressure (MPa)
 PMN = the minimum pressure
 \emptyset = the angle between the pressure and volume variations

A small error is introduced if it is assumed that the maximum temperature and pressure occur simultaneously, and that the minimum pressure and temperature occur simultaneously. The mass difference is assumed to be the difference between the mass of each of these points and is calculated by Rios to be:

$$M_G (max) - M_G (min) = \frac{GGV}{R} \left[-\frac{PMX}{T_{max}} + \frac{PMIN}{T_{min}} \right] \quad (D-6)$$

where $M_G (max)$ = the maximum mass in the gap

M_G (min) = the minimum mass in the gap
GGV = the dead volume in the gap
R = the gas constant

The mass fluctuation amplitude is defined to be:

$$M_{AG} = \frac{1}{2} \frac{GGV}{R} \left[\frac{P_{MIN}}{\bar{T}_{min}} - \frac{P_{MAX}}{\bar{T}_{max}} \right] \quad (D-7)$$

And the gap mass fluctuation is approximated by :

$$M_G = M_{MG} + M_{AG} \sin ((SPD)t - \phi') \quad (D-8)$$

where M_{MG} is the average mass in the gap

Rios assumes that:

$$\phi' \approx \phi \quad \text{because both are close to } 180^\circ \quad (D-9)$$

From equation D-1 the temperature of the gas moving in and out of the radial clearance is given by Rios as:

$$T = \bar{T} - \frac{(BTW - DTC)(BST)}{4 BPL} \sin ((SPD)t) \quad (D-10)$$

The enthalpy flow into the cylinder is given by:

$$d H_G = -CP1 T dM \quad (D-11)$$

$$= -CP1 \left(\bar{T} - \frac{(BTW - BTC1) BST}{4 BPL} \sin (SPD \times t) \right) SPD M_{AG} \quad (D-12)$$

$$\cos (SPD \times t - \phi) dt$$

where $CP1$ = the heat capacity of the gas at constant pressure

$d H_G$ = the enthalpy flow into the cylinder

$d M$ = the mass flow into the gap

Net enthalpy flow per cycle is integrated by Rios to be:

$$H_G = \int d H_G = \frac{PIE}{4} CP1 M_{AG} \Delta T \left(\frac{S}{L} \right) \sin \phi \quad (D-13)$$

$$= \left(\frac{PIE}{4} \right) \left(\frac{SHR}{SHR-1} \right) \left(\frac{BST}{BPC} \right) \left(\frac{1}{RP} \right) (PMX)(GGV) \sin \phi (QFS) \quad (D-14)$$

where:

$$QFS = \left[\frac{1}{\frac{BTW + BTC1}{BTW - BTC1} - \frac{BST}{BPL}} - \frac{RP}{\frac{BTW + BTC1}{BTW - BTC1} + \frac{BST}{BPL}} \right]$$

PIE = 3.14159

SHR = the specific heat ratio of the gas

So total enthalpy flow is given by:

$$QHG = H_G \frac{SPD}{2 \times PIE} \tag{D-15}$$

$$= \frac{PMX \times GGV \times BST \times SHR \times \sin \emptyset \times SPD \times NOC \times QFS}{RP \times 8 \times BPL \times (SHR - 1)} \tag{D-16}$$

where QHG = the appendix loss
NOC = the number of cylinders

D.5.2 Results

Some major errors were found. In a refrigerator, maximum pressure and minimum temperature occur almost simultaneously in the gap while in a heat engine the maximum pressure and maximum temperature occur almost simultaneously. The correction is shown in Equation D-6.

The second error had resulted from a confusion of signs in Rios thesis. In his derivation (69 am, 136-138) the mass difference correctly contains a subtraction sign, while on page 57 and in his sample calculation (Appendix I, page 178) the sign is incorrectly changed to a plus sign.

The computer program in Section D.3 gives the pumping loss as:
(See lines 435-438)

```
C *****Pumping loss*****
QFS = (RP/(BTW/(BTW - 2. x BTC) - BST/BPL)) + (1./(BTW/((BTW - 2. x BTC)
+ BST/BPL)))
QHG = ABS(SPD x PMX x GGV x BST x SHR x QFS x ARG x NOC/((SHR - 1) x
BPL x RP x 8.))
```

Based upon the analysis given above it should be:

$$X = (BTW + BTC1)/(BTW - BTC1)$$

$$Y = BST/BPL$$

$$QFS = - RP/(X + Y) + 1./(X - Y)$$

$$QHG = ABS(SPD \times PMX \times GGV \times BST \times SHR \times QFS \times ARG \times NOC/((SHR - 1) \times BPL \times RP \times 8.))$$

The formula for QFS is quite different. The formula for QHG is unchanged.

C-5

OPTIMAL CASE IS
OF POOR QUALITY

$$\text{Let } Z = \text{BTW}/(\text{BTW} - 2 \cdot X \cdot \text{BTC})$$

Then the ratio of the new pumping loss to the old pumping loss, RATIO, is:

$$\text{RATIO} = \frac{\text{RP}/(X + Y) + 1/(X - Y)}{\text{RP}/(Z - Y) + 1/(Z + Y)}$$

For case 17 which is compared in detail in Section 7

$$\text{PMX} = 12.86 \text{ MPa}, \text{ PMIN} = 6.95 \text{ MPa}$$

from the pressure - volume data for every 10". Therefore

$$\text{RP} = 12.86/6.95 = 1.850$$

$$\text{BTW} = 1033 \text{ K}$$

$$\text{BTC} = \text{BTC1} = 330 \text{ K}$$

Therefore:

$$X = \frac{1033 + 330}{1033 - 330} = 1.939$$

$$Y = \frac{4.65}{6.4} = 0.727$$

$$Z = \frac{1033}{1033 - 2(330)} = 2.769$$

$$\text{RATIO} = + 0.211$$

Therefore the true pumping (appendix) loss for case 17 is $14162.7(0.211) = 2988$.
Now it only disagrees by a factor of 3 rather than 14.

APPENDIX E

ADIABATIC CYCLE ANALYSIS BY THE MARTINI METHOD

The method given below is a small extension of the work published earlier (75 ag). It does not require the solution of a differential equation, but instead requires the solution at each time step of an algebraic equation that is implicit in the unknown pressure.

E 1 Nomenclature for Appendix E

- A = initial temperature multiplier for expansion space
 AD = phase angle, degrees
 AR = phase angle, radians
 B = initial temperature multiplier for compression space
 C () = compression space volumes, cm³
 CP = heat capacity of helium at constant pressure
 = 5.20 j/gk
 CR = nondimensional, temperature corrected clearance ratio

$$CR = \frac{2 * E * T}{V} \left(\frac{DE}{T} + \frac{DR}{TR} + \frac{DC}{T * E} \right)$$

 CS = CR * V / (2 * E * T)
 DA = angle increment, radians
 DC = dead volume with compression space, cm³
 DE = dead volume with expansion space, cm³
 DR = Regenerator dead volume, cm³
 DT = time increment, seconds
 E = ratio between absolute temperature of heat rejection and heat reception
 E () = expansion space volumes, cm³
 F = crank angle measured from the minimum volume in the expansion space, radians
 GA = (k-1)/k where k = Cp/Cv
 = .286 for hydrogen
 = 0.400 for helium
 I = integer counter
 I2 = counter to indicate which temperature will be solved for in Finkelstein equations.
 IN = number of time increments per revolution
 IM = IN
 IX = iteration counter

NOMENCLATURE (continued)

- K = swept volume in expansion space/swept volume in compression space
- K1 = $V \cdot CR / (R \cdot 2 \cdot E \cdot T)$
- K2 = $V / (2 \cdot E \cdot W \cdot R \cdot T)$
- MC = mass flow into compression space g/sec.
- ME = mass flow into expansion space, g/sec.
- MH = measured heat input j/cycle
- MR = gas inventory time gas constant, j/k
- MW = measured work j/cycle
- NC = nondimensional heat transfer coefficient for compression space
- NE = nondimensional heat transfer coefficient for expansion space
- OM = angular velocity, radians/sec
- P() = common gas pressure, MPa
- PI = 3.14159
- PM = mean pressure
- PQ = $(P(I+1)/P(I)) \uparrow GA$
- R = gas constant for helium
= 2.0785 j/gk
- SP. = sum of the pressures
- T = temperature of cylinder walls and heat exchange associated with the expansion space, K.
- T() = bulk gas temperature in the expansion space
- TR = effective temperature of gas in regenerator, K
- U = step function for expansion space; if ME > 0 then U = 1 if not U = 0
- U() = bulk gas temperature in the compression space
- V = total swept volume of expansion space, cm³
- VM = maximum VT(I)
- VT(I) = E(I) + C(I)
- W = total hydrogen gas inventory, grams
- WC() = mass of gas in compression space, grams
- WE() = mass of gas in expansion space, grams
- WR = W * R
- X = temporary variable
= step function for compression space
- Y1 = trial expansion space temperature K
- Z = counter to tell which gas
- Z1 = trial compression space temperature K

E 2 Derivation of Equations

In general the total gas inventory at time increment I is:

$$W = \frac{P(I)*E(I)}{R*T(I)} + \frac{P(I)*C(I)}{R*U(I)} + \frac{P(I)*V*CR}{R*2*E*T} \quad (E1)$$

mass in expansion space
mass in compression space
mass in dead spaces

$$W = WE(I) + WC(I) + P(I)*K1 \quad (E2)$$

at time increment I + 1 the gas inventory is

$$W = \frac{P(I+1)*E(I+1)}{R*T(I+1)} + \frac{P(I+1)*C(I+1)}{R*U(I+1)} + \frac{P(I+1)*V*CR}{R*2*E*T} \quad (E3)$$

$$W = WE(I+1) + WC(I+1) + P(I+1)*K1 \quad (E4)$$

In Equations E1 and E3 the knowns are W, E(I), E(I+1), R, C(I), C(I+1), V, CR, E, T. The unknowns are T(I), U(I) AND P(I) in Equation E1 and T(I+1), U(I+1) and P(I+1) in Equation E3. One must start by assuming T(0) = T and U(0) = E*T and then P(0) can be calculated from Equation E1. Equation E3 still has three unknowns. To find a solution we must use the adiabatic compression law.

That is:

$$\frac{T(I+1)}{T(I)} = \left[\frac{P(I+1)}{P(I)} \right]^{\frac{k-1}{k}} = PQ \quad (E5)$$

where k = Cp/Cv = 1.40 for hydrogen. So (k-1)/k = 0.286. Also

$$\frac{U(I+1)}{U(I)} = \left[\frac{P(I+1)}{P(I)} \right]^{.286} = PQ \quad (E6)$$

Equation E5 and E6 do not depend upon the mass of gas being considered. The mass may change. It does not matter. If WE(I+1) < WE(I) then gas is leaving the expansion space. For the gas in the expansion space Equation E5 applies. Thus by combining Equations E3, E4, and E5

$$WE(I+1) = \frac{P(I+1)*E(I+1)}{R*T(I)*PQ} \quad (E7)$$

In the first edition of the Design Manual (78 ad, pp. 65-71) it was assumed that the masses of gas are proportional to volumes. However, this is not strictly true. For instance the volume of the expansion space may be decreasing so gas would be expected to be flowing out. However, if the total volume of gas is decreasing at a higher rate, gas may be flowing into this space instead of out of it. In consideration of this possibility a more exact formulation is given here than was used in the first edition of the Design Manual.

If $WE(I+1) > WE(I)$ gas is entering the expansion space. In this case we have two kinds of gas, the gas that was in there the whole time and the gas that entered.

For this case, the volume of the gas space at the end of the increment $E(I+1)$ is divided into two parts.

$$E(I+1) = \underset{\substack{\text{original} \\ \text{gas}}}{ES(I+1)} + \underset{\substack{\text{new} \\ \text{gas}}}{EE(I+1)} \quad (E8)$$

The original gas volume shrinks to

$$ES(I+1) = \frac{WE(I)*R*TS(I+1)}{P(I+1)} \quad (E9)$$

where $TS(I+1)$ is the new temperature of the original gas.

Substituting in Equation E5

$$ES(I+1) = \frac{WE(I)*R*T(I)*PQ}{P(I+1)} \quad (E10)$$

The new gas volume is calculated by:

$$EE(I+1) = \frac{(WE(I+1) - WE(I)) * R * TE(I+1)}{P(I+1)} \quad (E11)$$

where $TE(I+1)$ is the new temperature of the entering gas. Since this gas starts at temperature T , application of Equation E5 gives

$$EE(I+1) = \frac{(WE(I+1) - WE(I)) * R * T * PQ}{P(I+1)} \quad (E12)$$

Combining Equation E8 with E10 and E12 gives

$$E(I+1) = \frac{WE(I)*R*T(I)*PQ}{P(I+1)} + \frac{(WE(I+1) - WE(I)) * R * T * PQ}{P(I+1)} \quad (E13)$$

which reduces to

$$WE(I+1) = \left(\frac{E(I+1)*P(I+1)}{R*PQ} \right) - WE(I)*(T(I) - T) T \quad (E14)$$

Similarly for the compression space, if gas is flowing out, that is

if $WC(I+1) < WC(I)$ then

$$WC(I+1) = \frac{P(I+1)*C(I+1)}{R*U(I)*PQ} \quad (E15)$$

If gas is flowing in, that is $WC(I+1) > WC(I)$ then

$$C(I+1) = \frac{WC(I)*R*U(I)*PQ}{P(I+1)} + \frac{(WC(I+1) - WC(I)) * R * E * T * PQ}{P(I+1)} \quad (E16)$$

which reduces to

$$WC(I+1) = \frac{\frac{C(I+1)*P(I+1)}{R*PQ} - WC(I) [U(I) - E*T]}{E*T} \quad (E17)$$

To calculate $WE(I+1)$ and $WC(I+1)$ one does not need to calculate the next temperatures, $T(I+1)$ and $U(I+1)$ because they are worked into Equations E7 to E17. However, these temperatures will be used in the next increment and must be calculated. If $WE(I+1) > WE(I)$ then gas is entering the expansion space. The temperature of the gas already in this space becomes:

$$T(I+1) = T(I)*PQ \quad (E18)$$

and the temperature of the gas entering the expansion space is:

$$T(I+1)^1 = T*PQ \quad (E19)$$

The average gas temperature is the mass average of these two gas masses so

$$T(I+1) = \frac{T(I)*PQ*WE(I) + T*PQ*(WE(I+1) - WE(I))}{WE(I+1)} \quad (E20)$$

If $WE(I+1) < WE(I)$ then $T(I+1)$ is calculated by Equation E18.

The temperatures in the compression space are treated in a similar way. If $WC(I+1) > WC(I)$ then

$$U(I+1) = \frac{U(I)*PQ*WC(I) + T*E*PQ*(WC(I+1) - WC(I))}{WC(I+1)} \quad (E21)$$

If $WC(I+1) < WC(I)$ then

$$U(I+1) = U(I)*PQ \quad (E22)$$

The calculation proceeds in the following order:

1. Pick $P(0)$ from the known initial conditions given a measured pressure or a pressure computed assuming gas spaces have surrounding metal temperature.
2. For the next time step choose $P(I+1)$ the same as $P(I)$, $P(0)$ the first time around.
3. If $E(I+1) > E(I)$ calculate $WE(I+1)$ by Equation E14 if not by Equation E7.
4. If $C(I+1) > C(I)$ calculate $WC(I+1)$ by Equation E15 if not by Equation E17.
5. Calculate the mass balance error EE by:
$$EE = WE(I+1) + WC(I+1) + P(I+1)*K1 - W \quad (23)$$
6. Choose another $P(I+1)$ 1% greater than $P(I)$.
7. If the already calculated $WE(I+1) > WE(I)$ then calculate $WE(I+1)$ by Equation E14; if not then by Equation E7 (Using $P(I+1)$ from Step 6).
8. If the already calculated $WC(I+1) > WC(I)$ then use Equation E15; if not, Equation E17 (Using $P(I+1)$ from Step 6.)
9. Calculate another mass balance by Equation E23.
10. By the secant method estimate what $P(I+1)$ should be by extrapolation or interpolation of the two errors and the two pressures to determine what pressure would give zero error.
11. Repeat steps 7, 8, 9, and 10 until convergence is obtained at an error in mass balance of less than one part per million.
12. Accumulate integral of $VT(I)$ vs. $P(I)$ curve to obtain work output per cycle.
13. Accumulate integral of $E(I)$ vs. $P(I)$ curve to obtain heat input per cycle.
14. If $WE(I+1) > WE(I)$ then calculate $T(I+1)$ by Equation E20; if not then by Equation E18.
15. If $WC(I+1) > WC(I)$ then calculate $U(I+1)$ by Equation E21; if not then by Equation E22.

16. Index to the next set of expansion and compression space volumes and start over with step 2.
17. After one full revolution, print out the value of the integrals accumulated and compare the pressure at 360° with the pressure at 0° . If the error is greater than 0.1%, then repeat the cycle.

The above calculation procedure has been programmed using a TRS-80 computer in the Basic language.

Martini Adiabatic Cycle Results

The first thing to show is that this calculation procedure gives exactly the same results as the Finkelstein-Lee method (60 v, 76 bl). Table E1 compares the results. Time steps from 12 per cycle to 240 per cycle (30° increment to 1.5° increment) are shown. The 240 per cycle was as large as the 16K storage TRS-80 computer available at the time could handle with the computer formulation which saves all results in arrays. Figure E1 shows how the numerical results extrapolate to zero angle increment. The extrapolation (Figure E1, Table E1) is in all cases extremely close to what Finkelstein said it would be. The agreement is amazing since Ted Finkelstein performed these calculations without benefit of computer. One important thing to note is that relatively large angle increments can be used still with reasonable accuracy. For instance, for a 15° angle increment the errors are:

	<u>Error %</u>
Pressure Ratio	-1.05
Work Required	+0.88
Heat Input	-2.37
Coefficient of Performance	-3.30

Table E 1
 COMPARISON OF FINKELSTEIN ADIABATIC CYCLE CALCULATIONS AND
 MARTINI ADIABATIC CYCLE CALCULATIONS
 Sinusoidal Motion, $K = 1$, $E = 2$, $CR = 1$, $AD = 90^\circ$

This Report Degree Increment	Steps Cycle	Maximum Press Minimum Press	Energy Output joules cycle	Heat Input joules cycle	Coefficient of Performance	Iterations Required
30	12	5.198	-.87831 WRT	0.453119 WRT	0.515899	3
15	24	5.2140	-.894804 WRT	0.471572 WRT	0.527012	3
4	90	5.1930	-.890696 WRT	0.480606 WRT	0.539584	2
2	180	5.178	-0.888513 WRT	0.481783 WRT	0.542235	2
1.5	240	5.1742	-.887832 WRT	0.482141 WRT	0.543054	2
0	∞	5.162	-.8865 WRT	0.483 WRT	0.545	Extrapolation
Finkelstein (Ref. 60 v)	Not Given	5.16	-0.886 WRT	0.481 WRT	0.543	

ORIGINAL PAGE IS
 OF POOR QUALITY

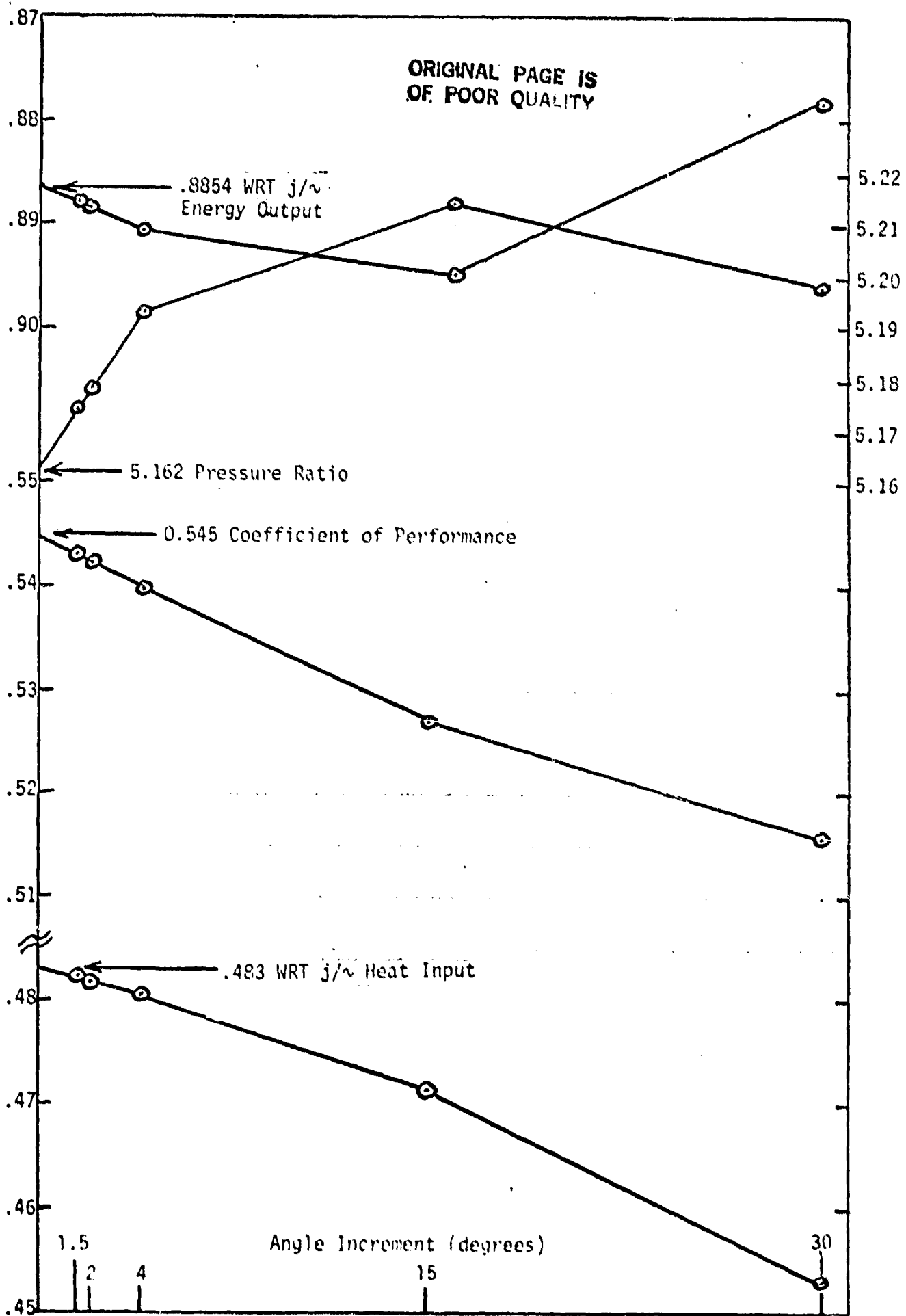

Figure E-1. Extrapolation of Results to Zero Angle Increment.

APPENDIX F

NON-AUTOMOTIVE PRESENT APPLICATIONS AND FUTURE APPLICATIONS OF STIRLING ENGINES

In this appendix "present applications" will be defined as products that are for sale on the open market as well as products that are in limited production and are for sale even if the sale is restricted or at a very high price.

F1 Present Applications

F1.1 Demonstration Engines

Small, inexpensive demonstration engines are excellent educational tools and serve well to inform the general public and the technical community of new technical possibilities. Two Stirling engines made by Solar Engines of Phoenix, Arizona, (Figure F1) have been widely advertised and sold. Model 1 sells with a book on Stirling engines by Andy Ross. Model 2 comes assembled with a parabolic mirror for solar heating.

From the author's own experience, both of these engines work reliably and have a high no-load speed, but can produce very little power. However, tests have shown that they produce about 60 percent of the maximum possible indicated power, considering the temperature applied, the speed and the displacement of one atmosphere air.

Two handsome models are offered by ECO Motor Industries Ltd., Guelph, Ontario, Canada (See Figure F-2). These engines are fired with methyl alcohol. The "Stirling" hot air engine uses a unique linkage devised by Mr. Pronovost, the proprietor. The "Ericsson" engine models the linkage of the improved Ericsson pumping engine of 1890. Both engines come with assembly and operating instructions and working drawings.

A model Stirling engine designed especially as a classroom demonstration of a heat engine and a cooling engine is available from Leybold-Heraus, Koln, Germany (See Figure F-3). It produces measureable power (about 10 watts). The engine has glass walls so the movement of both the piston and the displacer can be observed.

Sunpower has offered for sale a classroom demonstrator for a number of years. So far about 50 of these demonstrators have been sold. In the fall of 1976 I was asked to analyze one that had been modified for laser heat input. In its original condition I calculated this engine could produce about 7 watts indicated power at an indicated efficiency of 15 percent. This engine operated at 2.5 atm average pressure and 20 Hz with helium. The rub was (literally) that the measured combined mechanical efficiency and alternator efficiency was only 12.4 percent. The presently reported characteristics are: 41 cm high, 23 cm square base, 4 kg, 2-10 watts output. Prices were (Aug. 1978):

ORIGINAL PAGE IS
OF POOR QUALITY

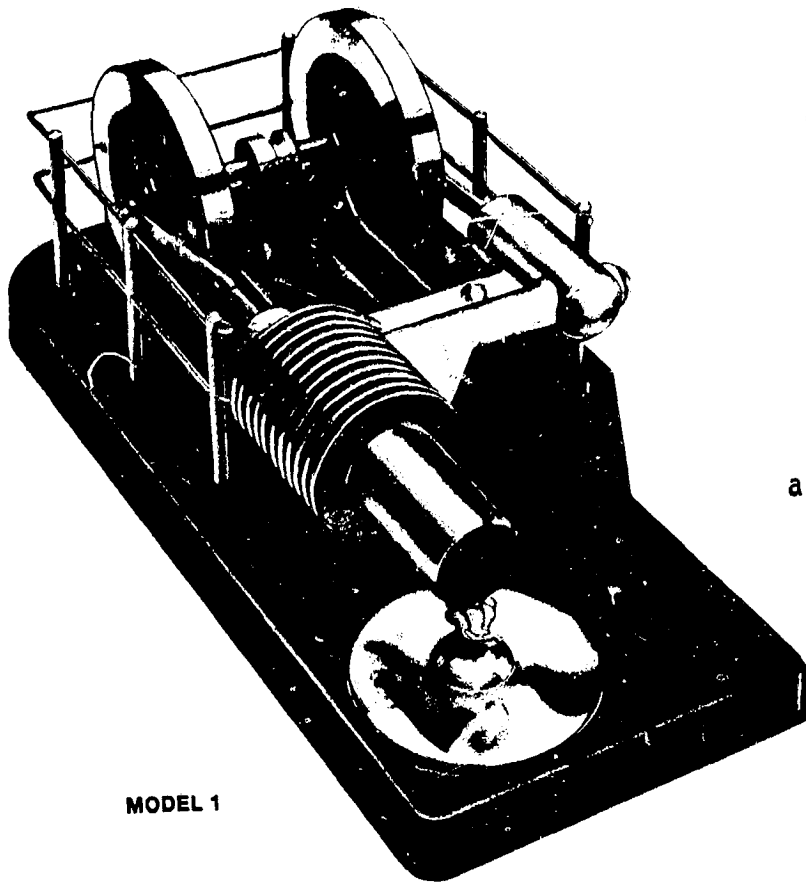

MODEL 1

a. Model 1 - Flame heated engine.
(77 br)

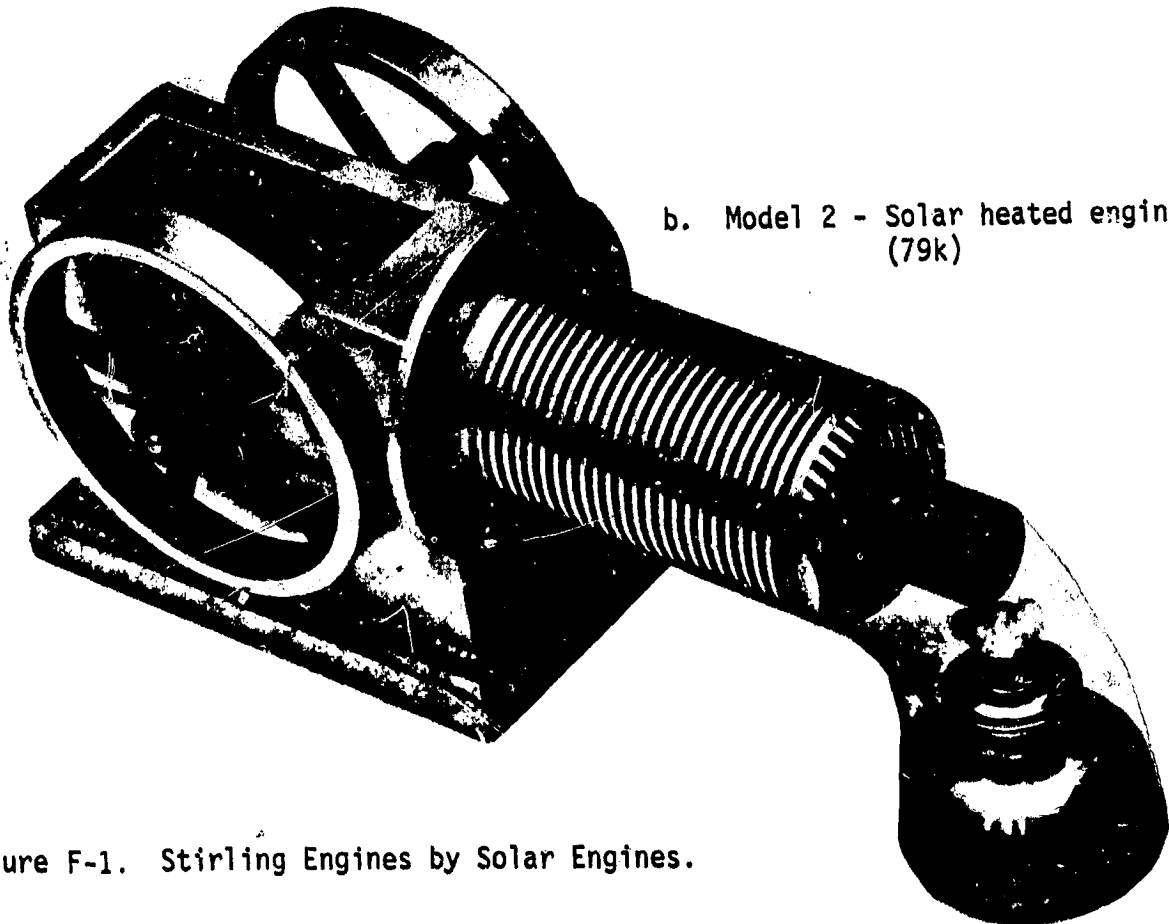

b. Model 2 - Solar heated engine.
(79k)

Figure F-1. Stirling Engines by Solar Engines.

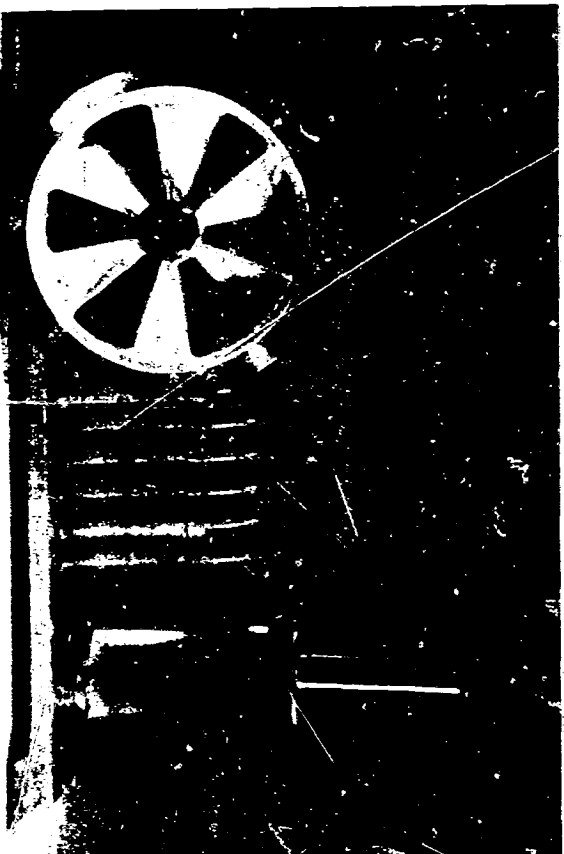

a. "Stirling" Hot Air Engine.



b. "Ericsson" Hot Air Engine.

Figure F-2. ECO Motor Industries engines.

ORIGINAL PAGE IS
OF POOR QUALITY

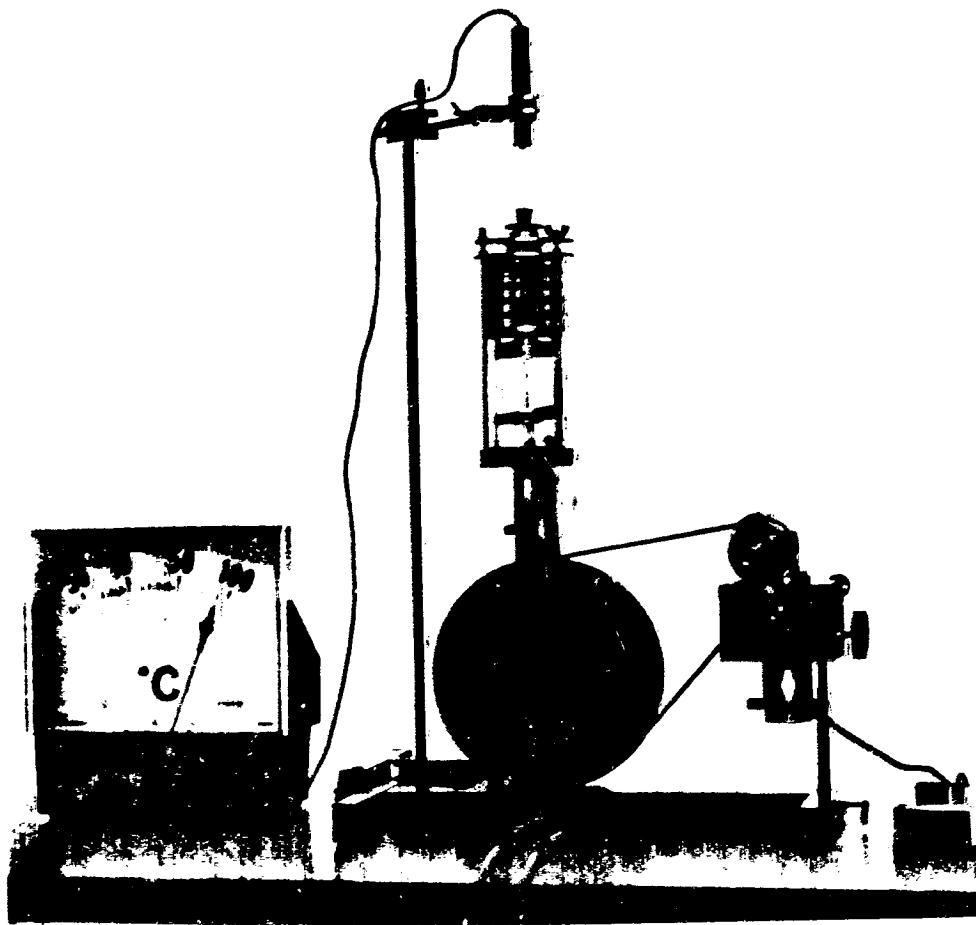

Figure F-3. The Leybold-Heraus Model Hot Air Engine.



MODEL SD-100

Figure F-4. The Model SD-100 Sunpower 70 w Electric Power Source.

ORIGINAL PAGE IS
OF POOR QUALITY

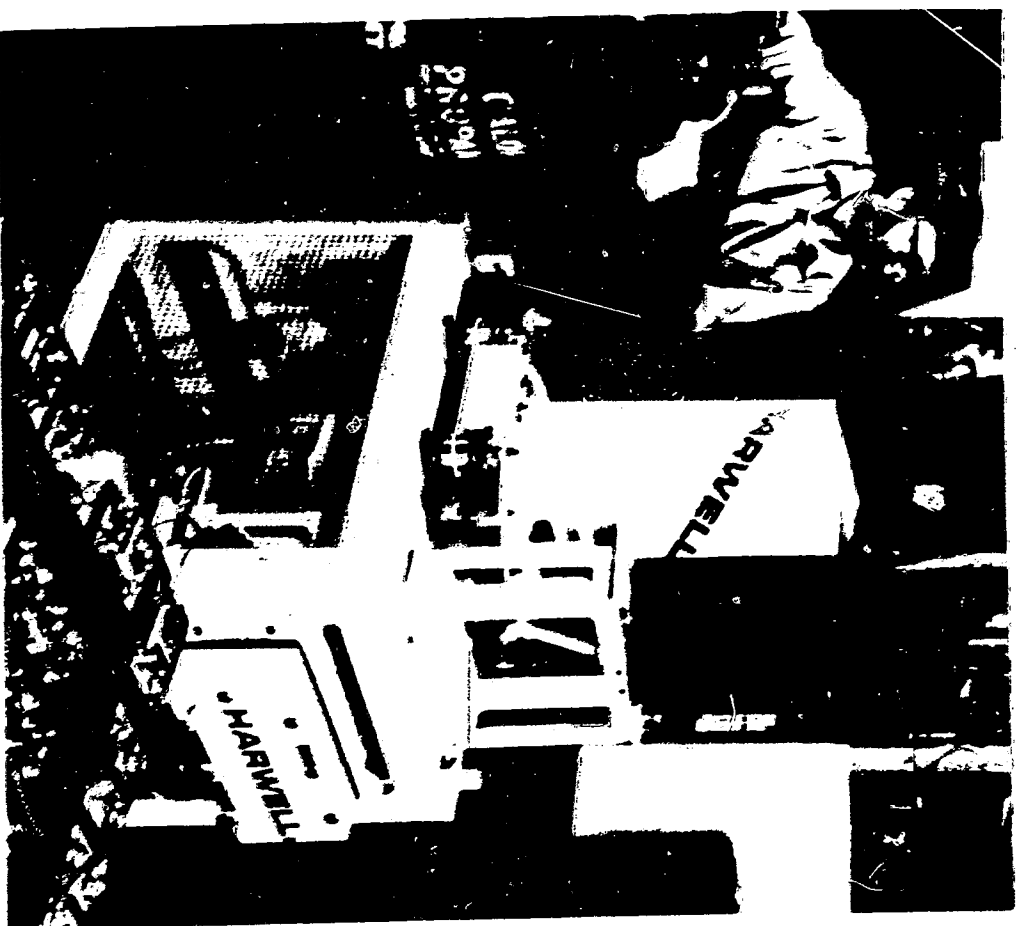

Figure F-5. The Harwell Thermo-Mechanical Generator.

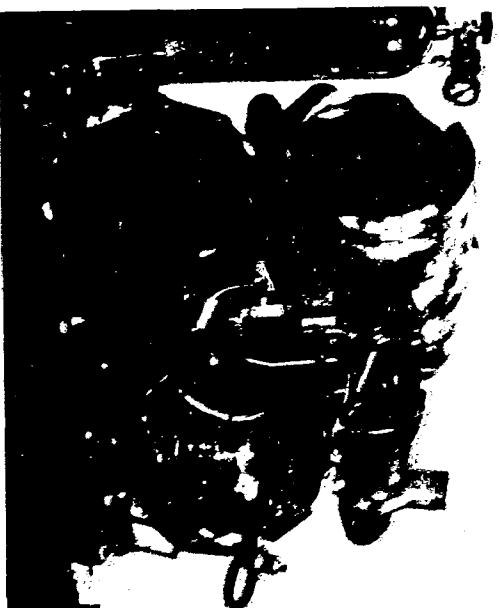

Figure F-6. Stirling Power Systems 8 kw Stirling Engine Combined with a 6.5 kw, 60 Hz, 170/240 VAC Generator.

ORIGINAL PAGE IS
OF POOR QUALITY

Model 10B with factory installed water pump	\$500
Alternator to fit 10B engine	\$400
Fresnel lens with mount and clock drive	\$640
Propane heater to replace 100 w electric heater	\$100
Cooler	\$ 50
Refrigerant pump with inertia compressor	\$200

This engine is still a reasonable starting point to learn first-hand about Stirling engines of intermediate efficiency. With intelligent improvements one can show up to 20 percent overall efficiency from this engine.

F1.2 Electric Power Generators

Stirling electric power generators are beginning to be applied because they have been shown to be very reliable and quiet.

Sunpower's Model SD-100 generator produces 70 w (e) of 12 VDC electric power (See Figure F-4 .) It operates at 35 hz with helium at 16 bar. Propane heats the engine to 650 C. It operates silently. It has operated an electric trolling motor at full power. Current developmental price is \$5,000 each!

AGA Navigation Aids Ltd. is selling the thermo-mechanical generator (TMG) developed at Harwell, England (77 t.) Their 25 watt machine when operating on propane uses only 27 percent of the fuel required by a 25 w (e) thermo-electric generator. In addition, the TMG shows no power degradation after over four years of operation. Two models are available: a 25 watt, 10 percent efficient machine; and a 60 watt, 9 percent efficient machine. Generators up to 250 watts are planned. Two are in actual use. Figure F-5 shows a developmental TMG before it was installed in the National Data Buoy off Land's End, England.

Stirling Power Systems of Ann Arbor, Michigan, has eight 8 kw Stirling engines from FFV of Sweden built into automatic total power systems for Winnebago motor homes (79 ap). Figure F-6 shows the power system ready for installation into the side of the vehicle. The power system is entirely automatic. It starts from cold in 15 seconds. Electricity is supplied to the electric refrigerator, stove and air conditioner and lights. Waste heat from the engine is supplied to convectors in the motor home if heat is needed or to the radiator on the roof if it is not.

This development incorporates improvements in the full system; much of which is not related to the Stirling engine. However, in this system two prime features of the Stirling engine are demonstrated--quietness and reliability. Table F-1 compares the measured sound level at various points of a Stirling engine equipped motor home with the same home equipped with a gasoline engine. Note that the conventional powered system is 250 percent more noisy than the Stirling-powered machine. To calibrate the dBA sound rating, 62 dBA is a kitchen exhaust fan and 59 dBA is a bathroom exhaust fan as used on a motor home. Reliability is as yet not proven because none of them are in the hands of the average customer. The life of a Stirling engine is estimated at 5,000 to 10,000 hours compared with 2,000 hours for an Otto cycle engine. Projected maintenance requirements (Table F-2) are speculative, but indicate that the motor home owner who will probably not care for the gasoline engine as well as he should would be much better off with the Stirling engine.

Present models operate on unleaded gasoline to use the same fuel as the motor home engine. Later models will be equipped to operate on various types of fuels including diesel oil, fuel oil, and kerosene.

ORIGINAL PAGE IS
OF POOR QUALITY

Table F-1. Sound Level Measurements (78 c1)

	STIRLING ENGINE	OTTO-CYCLE ENGINE	% Higher Noise
A weighted scale, one meter from source, outside	55 dBA	80 dBA	250%
Kitchen, inside	51 dBA	56 dBA	50%
Rear Seats, inside	48 dBA	58 dBA	100%

Table F-2. Projected Maintenance Requirements

	STIRLING ENGINE	OTTO-CYCLE ENGINE
Check Oil	N/A	20 hours
Change Oil	N/A	150 hours
Change Oil Filer	N/A	300 Hours
Change Spark Plugs	N/A	500 hours
Tune-Up	N/A	500 hours
Add Helium Bottle	2,000 hours	N/A
Change Igniter	2,000 hours	N/A

Fuel economy, a major advantage in other Stirling engines, is not true here. It is reported that the Stirling system uses slightly less fuel than its conventional counterpart. Designers of the engine purposely traded off efficiency for lower manufacturing costs.

F1.3 Pumping Engines

The old hot air engines were used almost entirely for pumping water. Today only one is known to be almost ready for sale. Metal Box India has been developing a fluid piston engine. According to Dr. Colin West, they have one that will pump water ten feet high at an efficiency of 7 percent using propane gas as fuel. They plan to market a coal-fired machine in India.

F2 Future Applications

For this manual, "future applications" are defined as one-of-a-kind engines on out through just an idea. Treatment in this section will be brief with the reference being given if possible.

F2.1 Solar Heated Engines

Solar heated Stirling engines are not new. John Ericsson built one in 1872 (77 br). Now they are seriously being considered. Pons showed that system cost of solar Stirling power in mass production is projected at 5¢/kwh (79 dk.) Presently utilities are purchasing new capacity at 5¢/kwh. This study plans an 18.6 m (61 ft) diameter front braced mirror with a P-75 engine at the focus.

Sunpower, Inc. has designed and built a 1 kw free piston Stirling engine directly connected to an alternator. (78 ac). Performance (78 as) of 42 percent engine efficiency at 1.25 kw output at 60 Hz from a 10 cm diameter power piston operating with an amplitude of 1 cm and a charge pressure of 25 bar has been predicted for the SPIKE (See Figure F-7.) A different test engine which could be solar heated attained a measured 32 percent efficiency at 1.15 kw output (79 ar). Solar heated engines of 100 kw size operating at 60 Hz are envisioned.

Mechanical Technology Incorporated has been doing the linear generator for the above development. The generator efficiency has hit 90 percent, but because of gas spring losses, engine efficiency of 33 percent is degraded to 19 percent system efficiency. MTI plans a 15 kw, 60 Hz engine-generator for a dispersed mirror solar electric system.

F2.2 Reliable Electric Power

Besides those developments already in the present application category DOE is sponsoring two different developments for isotope-powered electric power generation in remote locations. One uses the Philips Stirling engine (79 aq). The other uses a free-piston engine and linear electric generator (79 e, 79 am). These developments had been linked to radioisotope heat, but this part was cancelled. These engines use electric heat. Plans are to substitute a combustion system.

F2.3 Heat Pumping Power

Stirling engines in reverse, heat pumps, have enjoyed a good market in the cryogenic industry to produce liquified gases and to cool infrared sensors and the like (77 ax).

Stirling engines have also been tested to take the place of the electric motor in a common Rankine cycle heat pump for air conditioning (77 ad, 78ax, 79 at). One free-piston engine pump is being developed for this purpose (77 w). Engine driven heat pumps have the advantage of heating the building with both the waste heat from the engine and the product of the heat pump (77 j). Also being considered and undergoing preliminary testing are Stirling heat engine heat pumps. These could be two conventional Stirling engines connected together (73 x) or free-piston machines which eliminate much of the machinery and the seals (69 h). Using machines of this type it appears possible that the primary fuel needed to heat our buildings can be greatly reduced to less than 25 percent of that now being used (77 h, 78 p). With this type of incentive Stirling engines for house heating and cooling may be very big in the future.

ORIGINAL PAGE IS
OF POOR QUALITY

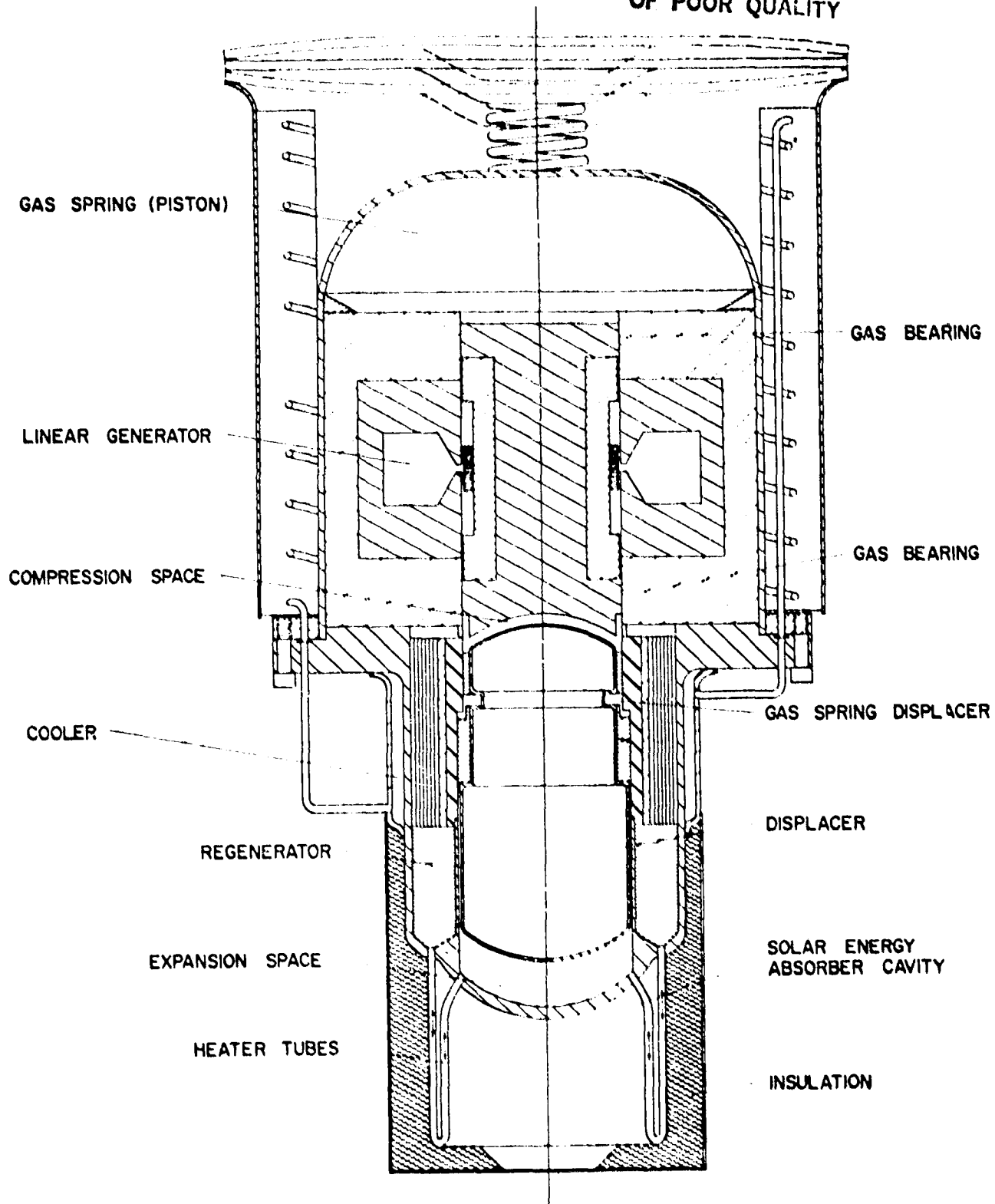

SUNPOWER 1 KILOWATT ENGINE
SPIKE

Figure F-7.

F2.4 Biomedical Power

Miniature Stirling engines are now being developed to power an artificial heart (72 ak). Indeed this engine appears uniquely suited for this application since it is very reliable and can be made efficient in small sizes. One engine of this size ran continuously for 4.07 years before both electric heaters failed. Most engine parts had operated 6.2 years with no failures. Once the blood pump compatibility with the body is improved to the order of years from the present six months then this application area will open up.

Between the tens to hundreds of horsepower required for automobiles and the few watts required for artificial hearts may be many other applications. For instance, powered wheelchairs now use a cumbersome lead-acid battery and control box between the wheels and an electric motor belt driving each large wheel. With a Stirling engine and thermal energy storage the same performance might be obtained, using a TES-Stirling engine, belt driving each wheel with the speed controlled electrically. The large battery box and controls could be dispensed with and the chair could become truly portable by being collapsible like an unpowered wheelchair. There may be many specialized applications like this.

F2.5 Central Station Power

Many people have asked if Stirling engines are useful in the field of central station electric power. Very little has been published attempting to answer this question (68 k). R. J. Meijer (77 bc) calculates that Stirling engines can be made up to a capacity of 3,000 HP/cylinder and 500 HP/cylinder Stirling engines have been checked experimentally using part engine experiments (77 bc). Many simple but efficient machines could be used to convert heat to say hydraulic power. Then one large hydraulic motor and electric generator could produce the power. In the field of advanced electric power generation it should be emphasized that the Stirling engine can operate most efficiently over the entire temperature range available and could supplant many more complicated schemes for increasing the efficiency of electric power generation.

Argonne National Laboratory has the charter from DOE to foster 500 to 2,000 HP coal-heated neighborhood electric power total energy systems (78 g, 79 ai, 79 aj). Initial studies show that straightforward scale-up of known Stirling engines and the applications of known materials could lead to considerable improvement in our use of coal.

F2.6 Third World Power

Stirling engines in some forms are very simple and easy to maintain. They can use available solid fuels more efficiently and attractively than the present alternative. Metal Box India's development of a coal-fired water pump has already been mentioned. Also it has just been demonstrated that 1 atm minimum pressure air engines (79 bj, 79 ar) designed with modern technology can generate 880 watts while an antique engine of the same general size only generated 50 watts. There is probably a very good market for an engine that would fit into a wood stove or something similar and operate a 12 volt generator or a water pump. The waste heat from the engine would still be usable to heat water or warm the room and electricity would be produced as well.

F2.7 Power For Other Uses?

Who is to say whether the above list of uses is complete. As these machines come into use and many people become involved in perfecting them for their own purposes, many presently unforeseen uses may develop. A silent airplane engine may even be possible for small airplanes. The Stirling engine is still a heat engine and is limited to the Carnot efficiency as other heat engines are, but it appears to be able to approach it more closely than the others. Also the machine is inherently silent and uses fewer moving parts than most other engines. What more will inventive humans do with such a machine? Only the future can tell.