



Hal Roth, author of
How to Sail Around the World

Handling Storms at Sea

THE **5** SECRETS OF HEAVY WEATHER SAILING

"No one speaks to the contemporary sailor with more authority than Hal Roth." -Naval Institute

HANDLING STORMS AT SEA







Overleaf: What is blue-water sailing really like when it's stormy and big seas are running? Here's my Santa Cruz 50 hurrying eastward near Marion Island in the Southern Ocean. The ever-faithful windvane is steering nicely while I play with the mainsail reefs and adjust the sails as the boat races through the water and makes great whooshing sounds as she surfs forward on a wave. You know that the yacht will rise up as the next crest comes, but sometimes you wonder if she is buoyant enough. You take a deep breath and say a silent prayer.

ALSO BY HAL ROTH

- Pathway in the Sky (1965)
Two on a Big Ocean (1972)
After 50,000 Miles (1977)
Two Against Cape Horn (1978)
The Longest Race (1983)
Always a Distant Anchorage (1988)
Chasing the Long Rainbow (1990)
Chasing the Wind (1994)
We Followed Odysseus (1999)
How to Sail Around the World (2004)
The Hal Roth Seafaring Trilogy (2006)



HANDLING STORMS AT SEA

The 5 Secrets of Heavy Weather Sailing

Hal Roth



INTERNATIONAL MARINE / McGRAW-HILL

CAMDEN, MAINE • NEW YORK • CHICAGO • SAN FRANCISCO • LISBON •
LONDON • MADRID • MEXICO CITY • MILAN • NEW DELHI •
SAN JUAN • SEOUL • SINGAPORE • SYDNEY • TORONTO

Copyright © 2009 by Hal Roth. All rights reserved. Except as permitted under the United States Copyright Act of 1976, no part of this publication may be reproduced or distributed in any form or by any means, or stored in a database or retrieval system, without the prior written permission of the publisher.

ISBN: 978-0-07-164345-0

MHID: 0-07-164345-1

The material in this eBook also appears in the print version of this title: ISBN: 978-0-07-149648-3, MHID: 0-07-149648-3.

All trademarks are trademarks of their respective owners. Rather than put a trademark symbol after every occurrence of a trademarked name, we use names in an editorial fashion only, and to the benefit of the trademark owner, with no intention of infringement of the trademark. Where such designations appear in this book, they have been printed with initial caps.

McGraw-Hill eBooks are available at special quantity discounts to use as premiums and sales promotions, or for use in corporate training programs. To contact a representative please visit the Contact Us page at www.mhprofessional.com.

Photograph and illustration credits may be found on page 260.

Title page photo: Heading north and banging away to windward in the Kuroshio Current south of Japan. The white cylindrical object at the bottom of the photograph is a plastic float at the end of a bamboo overboard pole.

TERMS OF USE

This is a copyrighted work and The McGraw-Hill Companies, Inc. (“McGraw-Hill”) and its licensors reserve all rights in and to the work. Use of this work is subject to these terms. Except as permitted under the Copyright Act of 1976 and the right to store and retrieve one copy of the work, you may not decompile, disassemble, reverse engineer, reproduce, modify, create derivative works based upon, transmit, distribute, disseminate, sell, publish or sublicense the work or any part of it without McGraw-Hill’s prior consent. You may use the work for your own noncommercial and personal use; any other use of the work is strictly prohibited. Your right to use the work may be terminated if you fail to comply with these terms.

THE WORK IS PROVIDED “AS IS.” McGRAW-HILL AND ITS LICENSORS MAKE NO GUARANTEES OR WARRANTIES AS TO THE ACCURACY, ADEQUACY OR COMPLETENESS OF OR RESULTS TO BE OBTAINED FROM USING THE WORK, INCLUDING ANY INFORMATION THAT CAN BE ACCESSED THROUGH THE WORK VIA HYPERLINK OR OTHERWISE, AND EXPRESSLY DISCLAIM ANY WARRANTY, EXPRESS OR IMPLIED, INCLUDING BUT NOT LIMITED TO IMPLIED WARRANTIES OF MERCHANTABILITY OR FITNESS FOR A PARTICULAR PURPOSE. McGraw-Hill and its licensors do not warrant or guarantee that the functions contained in the work will meet your requirements or that its operation will be uninterrupted or error free. Neither McGraw-Hill nor its licensors shall be liable to you or anyone else for any inaccuracy, error or omission, regardless of cause, in the work or for any damages resulting therefrom. McGraw-Hill has no responsibility for the content of any information accessed through the work. Under no circumstances shall McGraw-Hill and/or its licensors be liable for any indirect, incidental, special, punitive, consequential or similar damages that result from the use of or inability to use the work, even if any of them has been advised of the possibility of such damages. This limitation of liability shall apply to any claim or cause whatsoever whether such claim or cause arises in contract, tort or otherwise.

Contents

Preface	xi
PART ONE. A LOOK AT THE OCEAN	1
Chapter 1. An Overview	5
Chapter 2. What Is an Ocean Wave?	9
Chapter 3. More on Big Waves	21
PART TWO. RESPONDING WITH ONBOARD CONTROLS	33
Chapter 4. A Few Notes on Reefing the Sails	37
Chapter 5. The Wind's Up: Let's Heave-To	47
Chapter 6. Let's Lie A-Hull	55
Chapter 7. Running Off	65
PART THREE. RESPONDING WITH OFF-BOAT CONTROLS	71
Chapter 8. What Is a Sea Anchor?	74
Chapter 9. Parachutes in the Sea	84
Chapter 10. Parachutes in Action	99
Chapter 11. What Is a Drogue?	110
Chapter 12. A New Idea	116
Chapter 13. Do Drogues Really Work?	130
Chapter 14. Bow or Stern: Which Scheme Is Better?	142
PART FOUR. PLANNING, CHARTWORK, HURRICANES, AND FEAR . . .	151
Chapter 15. Passage Planning: The Best Time to Go	155
Chapter 16. The Chart Game, or Where Am I?	167

Chapter 17. Is a Storm Coming?	173
Chapter 18. A Hurricane: The Evil Eye	179
Chapter 19. Fear and Uncertainty	195
Glossary: A Sailor's Words	203
References and Notes.	225
Appendix 1. Addresses for Equipment and Organizations	229
Appendix 2. A Sailor's Log for a Stormy Day in the South Atlantic	231
Appendix 3. FitzRoy's Meteorological Pamphlet	234
Acknowledgments and Photo Credits	260
Index	261



Preface

I've never seen a book that suggested a step-by-step approach to storm management. I suppose it's because until recently there were so few sailing boats making long sea passages. Yet today the yacht manufacturers turn out thousands of vessels every year. Most of these boats never go anywhere and sit idle in marinas while their owners buy gadgets and perfect the varnish. A few vessels, however, head out, and each year there are more. On our first trip to Tahiti in 1967, Margaret and I counted ten yachts tied up along the Papeete waterfront. Today there are hundreds, so many in fact that most are sent elsewhere on the island.

With world-cruising vessels numbering in the thousands—perhaps as many as 10,000 or more—a few get into trouble each year during heavy weather. In an attempt to help these boats, I have written this little guide about storm tactics.

It seems to me that these procedures fall into five categories. If your boat is semi out of control and you're confused about what to do, I suggest step 1. If the yacht continues to have problems with the weather you go to step 2, and so on. Most storms are modest and short-lived, but occasionally there's a whopper. Then you consider categories 4 and 5.

I certainly don't claim to know it all. After 40 years of knocking around the oceans of the world, however, I think I can pass along a few tips about dealing with strong winds and big waves.

This book is a slim volume because the business of storm tactics is not big and complicated; it's small and focused on essentials. You do one thing. If it works, OK. If it fails to work, or when it stops working, you move on to something else.

There's a good deal of gossip and rumor floating around about what to do in storms. I've attempted to sort out what is helpful from what is merely conflicting or confusing. I can think of only one or two technical papers on storm management prepared by engineers, but there have been hundreds of magazine articles written by sailors with varying levels of experience. Another source is information put out by commercial companies that sell parachutes and drogues. I'm sure all this is well-intentioned, but when does a brochure become sales hype?

I hope these pages will give you some ideas about how to proceed on those scary days when the wind howls, the boat heels, and a bit of unease flickers through your mind. I'm sure that a few readers will disagree with some of the things I say in this book, but it's a beginning and I've done my best. As knowledge grows about storm management for small sailboats, I hope others will write their books and we can all learn.

* * *

While I've worked on these recipes for hanging on, I've often thought of Joseph Conrad's story about when he took his oral examination for his captain's papers. (I think it was in *Mirror of the Sea*, but I am unable to find the reference.) In any case, my recollection of the yarn is as follows:

A very nervous First Officer Conrad appeared before a panel of hard-boiled veteran captains, who sat scowling from behind a long oaken table. The master mariners fired question after question at the trembling candidate.

A key question dealt with a frightful gale. The ship was being blown inexorably toward a lee shore. One by one the panel of captains took away the candidate's defenses.

"I'd try to claw off by sailing close-hauled . . ."

"No, the sails are blown out."

"I'd drop the main anchor at the limit of the chain so the anchor would catch the bottom as the water shoaled . . ."

"No, the anchor's gone."

"The kedje anchor . . ."

"That's gone too."

"I'd signal for a towboat to give me a pluck to safety."

"No towboats."

"Maybe there's a river along the shore that I could aim for."

"The coast is rockbound and there are no rivers."

"I'd hope for a wind shift . . ."

"The onshore wind is stronger than ever."

"I don't know what else I could do," said Conrad, twisting his hands together and desperately trying to think of an answer.

One grizzled old sea dog behind the table leaped to his feet and shouted: "You'd get down on your hands and knees and pray to God for deliverance from the storm. That's what you'd do! You would ask His help for divine guidance. You never, never, never give up!"



Part One

**A LOOK AT
THE OCEAN**

We own small sailing yachts because they're a pleasant and endlessly fascinating way to use the wind to move us from place to place. The more adventurous of us have slightly larger vessels that are decked, reasonably watertight, and have two or more sails that can be easily adjusted for different wind strengths. Our boats have sleeping berths, a galley for the cook, and a navigation center to help us find our way. We have toilets and washing facilities, clothes, charts, books, tools, and a hundred small things to make our lives comfortable and secure while we're sailing.

Some of us make our way across great distances on the oceans. We navigate along the edges of continents, sail to distant islands, steer the boat across lakes, head across estuaries, and go up and down rivers. When the weather's good and the breeze is fair, there's no scheme of traveling that's more satisfying; there's no better way to explore our world, whether it's 10 miles to the first headland or 1,000 miles over the horizon.

The mere fact that strangers invariably come down to your boat to meet you and talk about your trip shows the wide appeal of unhurried sailing.

Their questions are always the same: Where are you from? Where are you going? Why are you doing this? What kind of a boat is this? What does it cost? Do you ever get scared? What do you do in storms? What do you eat? How do you decide where to go? How do you find your way?

We tell them that on a good day it's glorious to feel the wind on our faces, to see the waves running easily alongside, and to breathe the fresh air. Our little sailboat is a magic carpet to distant dreams. . . .

To help plan our sailing trips we often use a series of seasonal weather guides called *pilot charts*. We read about our sailing areas and destinations in special books called *Pilots*. In addition there are weather forecasts and many kinds of cruising guides. The best guides carry no advertisements and are worth buying even if you pick up only a single point.

We try to go during the summer to avoid the storms of winter. Sometimes we sail in the spring and fall. On long voyages it may be impossible to juggle all the dates so that we're at sea during the most favorable times.

The reversal of seasons between the Northern and Southern Hemispheres is something else to consider. If our sailing plans work out favorably we can sail in summery conditions in both Canada and New Zealand. But if we plan an unrealistic schedule or are delayed, as so often happens, it could mean sailing during *two* winters. As a practical matter, what's often done is to stay in a sheltered harbor for a few months until the winter storms and low temperatures are over and we see daffodils around the shores.

Of course we try to leave port when the local weather is good to give us a favorable start. But sometimes, in spite of all the rosy predictions and planning, the weather turns bad and the sea grows angry. Then the sailing is harder. Sometimes much harder.

Suitably handled, a sailboat can deal with almost any strength of wind—from using the lightest and biggest running sails all the way down to bare pole(s). The problem in difficult going is not the wind, but the seas that are built up by the wind. As heavy-weather-safety researcher Donald Jordan says, “Wind doesn't cause capsizes. Breaking seas do.”

In this book I'm going to talk about techniques that sailors employ to deal with storms. I will thoroughly discuss reefing, heaving-to, lying a-hull, running off, and using devices at the bow or stern to control a yacht in heavy weather. I will try to explain some of the physics involved between a small sailing yacht and an upset, nasty ocean.

I will define tsunamis, hurricanes, and discuss the occurrence of giant waves. I will touch on planning aids and, finally, some thoughts about calming fear and uncertainty among the crew when the winds and sea are cruel and unpleasant.

At the beginning, let me say that I am certainly not Mr. Know-It-All, and I have more questions than answers; yet with patience and the help of others, I hope to clarify some of these matters. My purpose in this book is simply to explain ways for sailors to deal with nasty weather in the easiest possible manner. It's a tricky subject because of the variety of boat designs, some disagreement about storm management techniques, the influence of commercial interests, and the uneven experience of boatowners and sailors.

This book is about monohull sailing yachts between 25 feet (7.6 meters) and 55 feet (16.8 meters). Most offshore sailing yachts are in this grouping. In my judgment, boats less than 25 feet are too small to carry all the gear and supplies necessary for long-distance voyaging. In addition, yachts smaller than 25 feet have a greatly increased chance of capsizing. I have little specialized knowledge of yachts over 55 feet. My experience is with ballasted, monohull vessels, although some of the material in this book is applicable to multihulls, fishing boats, and recreational power vessels.

BEAUFORT WIND SCALE

Beaufort Force	Description	Sea Conditions	Wind speed knots	Wave height meters	Wave height feet
0	Calm	The sea is like a mirror.	<1	0	0
1	Light air	Ripples without foam crests.	1-3	0.1	0.3
2	Light breeze	Small wavelets. Crests glassy but do not break	4-6	0.2-0.3	0.6-1
3	Gentle breeze	Large wavelets. Crests begin to break. A few whitecaps.	7-10	0.6-1	2-3
4	Moderate breeze	Small waves becoming longer. Frequent whitecaps	11-16	1.0-1.5	3-5
5	Fresh breeze	Moderate waves with long form. Many whitecaps. Little spray.	17-21	2.0-2.5	7-8
6	Strong breeze	Large waves begin to form. Extensive whitecaps. Some spray.	22-27	3.0-4.0	10-13
7	Near gale	Sea heaps up and white foam blows in streaks in the direction of the wind.	28-33	4-5.5	13-18
8	Gale	Moderately high waves of greater length; edges of the crests begin to break into spindrift. Streaks of foam.	34-40	5.5-7.5	18-25
9	Strong gale	Higher waves. Crests begin to tumble. Dense streaks of foam. Spray may affect visibility.	41-47	7.0-10	23-33
10	Storm	Very high waves with long toppling crests. The sea all white as foam is blown off in dense bands. Spray affects visibility.	48-55	9-12.5	30-41
11	Violent storm	Giant waves limit visibility. The edges of the wave crests are blown into froth. The sea is covered with blowing spray.	56-63	11.5-16	38-53
12	Hurricane	Seas tumultuous. Air filled with foam. The ocean is totally white with driving spray. Visibility seriously reduced.	64+	14+	Over 46

Note 1. Wave heights refer to probable heights of well-developed wind waves in the open sea.

Note 2. The lag effect between the wind getting up and the sea increasing should be considered.

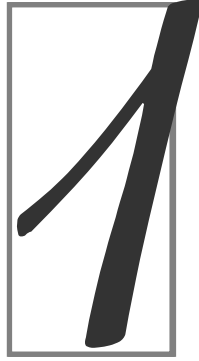

AN OVERVIEW

Before we begin, let's put this storm business in perspective. I know my own experiences best, so let me talk about them. During the past 40 years I've sailed some 200,000 miles on the world's oceans either alone or with my wife. These voyages include eleven trips across the Atlantic, five voyages across the Pacific, and three trips around the world—including two via the Southern Ocean when I sailed to 58° south. I've gone around Cape Horn three times, anchored in the outer Aleutian Islands, circled the big island of Newfoundland twice, and had a hard look at the long coast of Labrador.

Impressive, huh? A wonderful or a foolish way to spend one's life? Yet in all those seagoing passages—some up to 52 days in length—I've never seen prolonged winds of hurricane strength and only one violent storm of Force 11.

If I close my eyes and think hard (and refer to my old logbooks), I remember a strong gale (Force 9) in the Gulf of Alaska during the summer of 1968. There was a Force 10 problem in 1970 off the Oregon coast west of the mouth of the Columbia River. In August 1974, while passing through the Strait of Le Maire between Tierra del Fuego and Isla de los Estados near Cape Horn, Margaret and I ran off under bare pole before a severe Force 10 storm from the southwest. On that same run north to Mar del Plata, Argentina, we sailed mostly in gale conditions (Force 8) and flew a storm trysail for seven out of eleven days.

The strongest storm I've been in was a sustained Force 10 to 11 wind of 55 knots and extraordinary seas about 1,200 miles south-southwest of Perth, Australia, in the Southern Ocean in January 1991, during one of my solo trips. A month later I ran off



to the north in front of a turbulent Force 9 strong gale a little northeast of the southern tip of New Zealand's South Island.

In March 1992, a strong gale (46 knots from the northwest) stopped me while sailing northward between the Argentine mainland and West Falkland Island. My choice was the scary lee shore of Jason West Cay to the east or being pushed off to the southwest (see Appendix 2 for the log of this account).

More recently, Margaret and I sailed from the east coast of the U.S. to Turkey in the eastern Mediterranean and back. Except for short-lived blasts from local winds at the entrance to the Strait of Gibraltar and in one place in the Aegean for a few hours, we had no winds over 35 knots during the 18,132 miles of the voyage.

My point in this wind recital (six strong storms in 40 years) is that violent weather is infrequent, and that with care in planning, bad days can be avoided or certainly minimized. When a storm does appear, I've worked out a system of five steps to follow. We do one thing, and if that doesn't handle the situation we do the next.

I suggest the following:

Step 1. Deep reefs in the mainsail; a smaller headsail.

Step 2. Heave-to.

Step 3. Lie a-hull.

Step 4. Run off.

Step 5. Employ a parachute sea anchor from the bow or a drogue or drag device from the stern.

The first four actions are what I propose to call *onboard control methods*, steps that you can take on the boat to keep the sailing under control. Number 5 involves *off-boat control methods*, which require special equipment and techniques. In the chapters that follow I will do my best to detail these steps, sort the good from the bad, and explain my thinking and reasoning.

Let me speak plainly. Over the years I've come to know that many small-boat sailors grossly exaggerate wind speeds. They throw around words like "gales" and "hurricanes" and "50-knot winds" when what they really mean are strong breezes, near gales, passing squalls, and 30-knot winds. The emphasis is always on peak gusts, not the minimums when the wind drops.

Some readers may accuse me of being a mean old man, but I'm tired of reading articles in sailing magazines by writers who endlessly circulate hokum about winds and storms and who seem to be more conversant with a thesaurus than a reefing handle. Some of these writers actually talk of hurricane winds and having sails up in the same paragraph.

I've learned that true, sustained wind speed is usually far less than what I imagine, especially if there's spray flying around, the wind is cold, it's blowing in my face, and I'm tired. Consider the Weather Channel on television and how often the traveling announcers go to a hurricane site along a beach somewhere and talk about a huge storm when behind them you see an almost flat sea. ("We're early," or "The storm's already gone," they say.)

In magazine stories ("It was really blowing . . .") you can generally halve the reported strength of winds and be closer to the truth. I own a carefully calibrated Swedish wind-measuring device and when I use it, I'm always crestfallen about the true strength of my deck-level readings, even when I correct them for the standard height of 33 feet, or 10 meters, above the water. I've learned to judge the speed of the wind by carefully evaluating whitecaps, sea conditions, the heel of the yacht, and how much sail the yacht can stand.

I remember my friend, the veteran sailor Peter Tangvald, laughing about storm stories. He mentioned one account in which the cook passed up a bowl of soup to the helmsman while he was sitting in the cockpit steering in a Force 10 storm.

"In the first place," said Peter, "with all the rolling, the soup would probably have spilled. Secondly, if the man had managed to hang on to the bowl, the wind would have sucked the soup right out of the bowl. Finally, I think with all the water flying around, the helmsman's appetite would have been pretty slim. People who write such stuff have never been out in real storms."

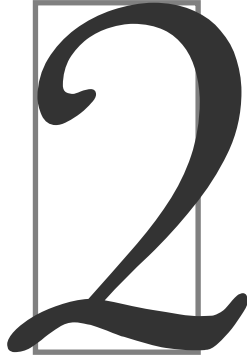

WHAT IS AN OCEAN WAVE?

It sounds almost biblical to say that in the beginning the sea is calm until the wind arrives. First there are a few ripples and trifling wavelets. Once these have formed, the wind has something to blow against. The tiny waves grow in size, and energy is transferred from the moving air to the water. Then with more wind, the waves grow longer and steeper until the crests commence to break and we watch a choppy sea unfold in front of us.

These surface waves have been formed by mechanical means. If the wind dies, the wave energy will spread out and become longer and smaller in amplitude, all due to dispersion and in part to gravity. Ultimately the waves die as a result of friction in the water and other dissipative effects.

If the wind grows stronger, most of its force is transferred to longer, higher waves, which can absorb more energy, and we see that larger waves are constantly replacing smaller ones. Depending on the wind strength and the span of water over which the wind can blow, this process goes on and on; the small waves disappear into larger ones until the size of the waves suits the force of the wind and we have a condition called a *fully developed sea*.

This often means that in front of us is an ocean with orderly whitecaps and an endless procession of waves rumbling in lockstep from the horizon. But what is the

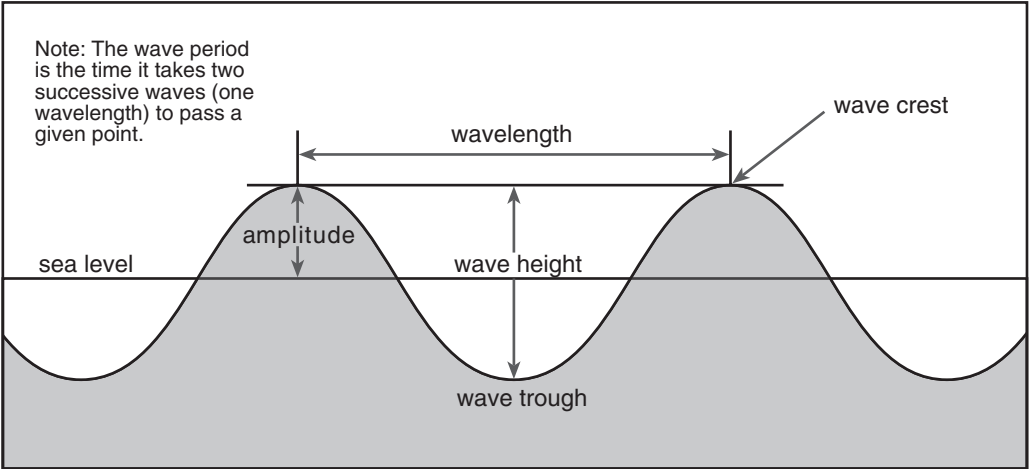

Parts of a wave.

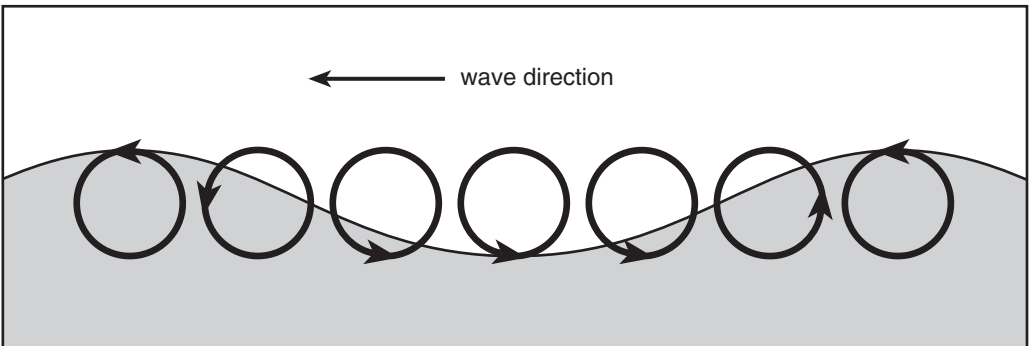

The diameter of the circle is the height of the wave. The period is the time required for the circle to make one revolution. Or said more simply, the particles in the top of the wave move forward; in the bottom of the wave, or the trough, the water particles move backward.

nature of waves? Are they a real menace for small boats? Or is all this talk overblown and exaggerated? Let's see what the scientists can tell us.

In 1802, a pioneering investigator in fluid mechanics named Franz Gerstner worked out the first wave theory and found that water particles in a wave move in circles. Although much of Gerstner's early work has been superseded by modern hydrodynamics, this pioneering researcher described how the particles at the crest of a wave travel *with* the wave, while the particles in the trough move in the opposite direction.

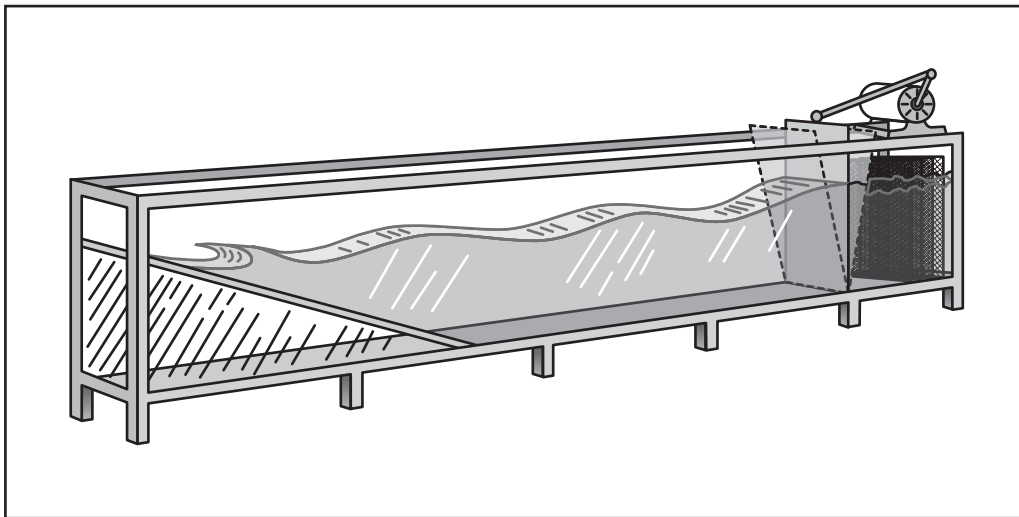

A glass-sided wave channel. A variable-speed motor with an adjustable yoke drives a paddle, hinged at the bottom, to generate waves with periods of 0.7 to 1.4 seconds and heights up to 1 foot. The waves on the backside of the generator are absorbed by special screens.

From his studies, Gerstner learned that although the appearance of waves sweeping ahead on the ocean might suggest that the wind is pushing lots of water, in truth the forward movement of the water is trifling.

If you watch a resting bird or a stick of wood on the surface in a 20-knot wind, for example, you will see that the bird or piece of wood going with the drift hardly moves forward at all. “Waves are only moving forms,” writes the authority Willard Bascom in his book *Waves and Beaches*.¹

In deep water, most waves run in a smooth, regular fashion according to laws and formulas that scientists have learned from their studies. These mathematical connections help us understand that waves are packets of energy moving through the water—energy that’s being transferred from one water particle to another.

In later years scientists improved on Gerstner’s early work and built long boxes with glass sides that served as flow channels. The investigators generated waves with an adjustable-speed paddle at one end that at first was operated by hand and later with a variable-speed electric motor. As the researchers examined the relationships between wave period, height, length, and velocity, they learned that all these things were tied together by physical laws that could be expressed by mathematical formulas. Wavelength, for example, varies directly with wave period—the time elapsed

between the passage of successive crests past a given point—whereas wave height does not.

Wave velocity varies with wavelength according to the formula:

$$V = \sqrt{\frac{gL}{2\pi}}$$

where V is velocity in feet per second (fps) in deep water,
 g is the acceleration due to gravity, 32.2 ft/sec/sec (often written as ft/sec²),
 L is the wavelength in feet, and
 π is the constant 3.1416.

A formula for wavelength is:

$$L = 5.12T^2$$

where T is the wave period in seconds.

Turned around, the formula reads:

$$T = \sqrt{\frac{L}{5.12}}$$

Thus out in the ocean, a wave with a length of 300 feet between crests will have a velocity of 39 fps (23.1 knots or 26.6 mph) and a period between wave crests of 7.7 seconds. You can easily examine these relationships between the speed, length, and period of waves in deep water in the accompanying graph.

Wave velocity (V) is therefore directly related to wave period (T). Since we know that $L = 5.12T^2$ and that $V = \sqrt{\frac{gL}{2\pi}}$, by substitution we can work through to

$$V = \sqrt{\frac{164.8 \times T^2}{6.28}} \quad \text{or} \quad V = 5.12T.$$

If you're in the cockpit during a storm and wondering how fast the waves are moving, multiply the period between crests—say, 10 seconds—which you can get by counting or using a stopwatch, by 5.12 (5 is close enough). The answer for a 10-second period is about 50 fps or 34 mph or 29½ knots. A close-enough approximation is that the wave velocity in knots is about three times its period in seconds. (Full disclosure: There should be a small subtraction from the period for the speed of the yacht; see page 16.)

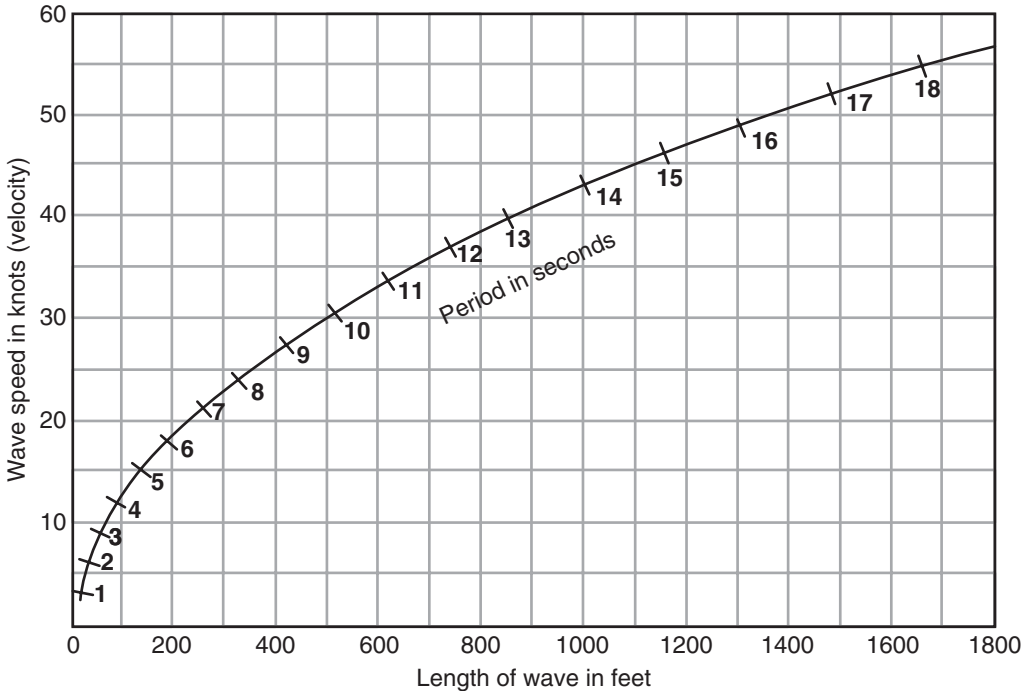

Relationships between speed, length, and period of waves in deep water, based on the theoretical connection between period and length.

Looking at the relationships still another way, the wavelength in deep water is roughly equal to the square of the period in seconds multiplied by 5. For example, a period of 10 seconds squared is 100. Five times 100 gives 500 feet, a good approximation of the wavelength.

BREAKING WAVES

When scientists increased the height of the waves in the flow channel by moving the paddle faster in their big glass tank, they saw that the waves became very steep, collapsed, and formed *breaking waves*. The researchers found that the waves would break when the wave height exceeded one-seventh of the wavelength. In these circumstances the unstable wave breaks at the top, and masses of broken water cascade down its face.

Deepwater sailors have long described the front of a breaking wave as a waterfall. At sea this process is augmented by strong wind pressure from behind—the force that caused the wave in the first place. A yacht caught in a large breaking wave is liable to be pitched forward, out of control. Then the boat is not only subject to tons

Table of Sea Conditions 1

Fetch in n. miles	Force 4 (11-16 knots)			Force 5 (17-21)			Force 6 (22-27)			Force 7 (28-33)		
	time in hours	height in feet	period in seconds	time	height	period	time	height	period	time	height	period
10	3.7	2.6	2.4	2.2	3.5	2.8	2.7	5.0	3.1	2.5	6.0	3.4
20	6.2	3.2	2.9	5.4	4.9	3.3	4.7	7.0	3.8	4.2	8.6	4.3
30	8.3	3.8	3.3	7.2	5.8	3.7	6.2	8.0	4.2	5.8	10.0	4.6
40	10.3	3.9	3.6	8.9	6.2	4.1	7.8	9.0	4.6	7.1	11.2	4.9
50	12.4	4.0	3.8	11.0	6.5	4.4	9.1	9.8	4.8	8.4	12.2	5.2
60	14.0	4.0	4.0	12.0	6.8	4.6	10.2	10.3	5.1	9.6	13.2	5.5
70	15.8	4.0	4.1	13.5	7.0	4.8	11.9	10.8	5.4	10.5	13.9	5.7
80	17.0	4.0	4.2	15.0	7.2	4.9	13.0	11.0	5.6	12.0	14.5	6.0
90	18.8	4.0	4.3	16.5	7.3	5.1	14.1	11.2	5.8	13.0	15.0	6.3
100	20.0	4.0	4.4	17.5	7.3	5.3	15.1	11.4	6.0	14.0	15.5	6.5
120	22.4	4.1	4.7	20.0	7.8	5.4	17.0	11.7	6.2	15.9	16.0	6.7
140	25.8	4.2	4.9	22.5	7.9	5.8	19.1	11.9	6.4	17.6	16.2	7.0
160	28.4	4.2	5.2	24.3	7.9	6.0	21.1	12.0	6.6	19.5	16.5	7.3
180	30.9	4.3	5.4	27.0	8.0	6.2	23.1	12.1	6.8	21.3	17.0	7.5
200	33.5	4.3	5.6	29.0	8.0	6.4	25.4	12.2	7.1	23.1	17.5	7.7
220	36.5	4.4	5.8	31.1	8.0	6.6	27.2	12.3	7.2	25.0	17.9	8.0
240	39.2	4.4	5.9	33.1	8.0	6.8	29.0	12.4	7.3	26.8	17.9	8.2
260	41.9	4.4	6.0	34.9	8.0	6.9	30.5	12.6	7.5	28.0	18.0	8.4
280	44.5	4.4	6.2	36.8	8.0	7.0	32.4	12.9	7.8	29.5	18.0	8.5
300	47.0	4.4	6.3	38.5	8.0	7.1	34.1	13.1	8.0	31.5	18.0	8.7
320				40.5	8.0	7.2	36.0	13.3	8.2	33.0	18.0	8.9
340				42.4	8.0	7.3	37.6	13.4	8.3	34.2	18.0	9.0
360				44.2	8.0	7.4	38.8	13.4	8.4	35.7	18.1	9.1
380				46.1	8.0	7.5	40.2	13.5	8.5	37.1	18.2	9.3
400				48.0	8.0	7.7	42.2	13.5	8.6	38.8	18.4	9.5
420				50.0	8.0	7.8	43.5	13.6	8.7	40.0	18.7	9.6
440				52.0	8.0	7.9	44.7	13.7	8.8	41.3	18.8	9.7
460				54.0	8.0	8.0	46.2	13.7	8.9	42.8	19.0	9.8
480				56.0	8.0	8.1	47.8	13.7	9.0	44.0	19.0	9.9
500				58.0	8.0	8.2	49.2	13.8	9.1	45.5	19.1	10.1
550							53.0	13.8	9.3	48.5	19.5	10.3
600							56.3	13.8	9.5	51.8	19.7	10.5
650										55.0	19.8	10.7
700										58.5	19.8	11.0
750												
800												
850												
900												
950												
1000												

These tables are partially derived from H.O. Publications 603 and 604. The wave heights are significant wave heights, which are defined as the average wave height (trough to crest) of the highest one-third of the waves.

Table of Sea Conditions 2

Fetch in n. miles	Force 8 (34-40 knots)			Force 9 (41-47)			Force 10 (48-55)			Force 11 (56-63)		
	time in hours	height in feet	period in seconds	time	height	period	time	height	period	time	height	period
10	2.3	7.3	3.9	2.0	8.0	4.1	1.9	10.0	4.2	1.8	10.0	5.0
20	3.9	10.0	4.4	3.5	12.0	5.0	3.2	14.0	5.2	3.0	15.0	5.9
30	5.2	12.1	5.0	4.7	15.8	5.5	4.4	18.0	6.0	4.1	19.8	6.3
40	6.5	14.0	5.4	5.8	17.7	5.9	5.4	21.0	6.3	5.1	22.5	6.7
50	7.7	15.7	5.6	6.9	19.8	6.3	6.4	23.0	6.7	6.1	25.0	7.1
60	8.7	17.0	6.0	8.0	21.0	6.5	7.4	25.0	7.0	7.0	27.5	7.5
70	9.9	18.0	6.4	9.0	22.5	6.8	8.3	26.5	7.3	7.8	29.5	7.7
80	11.0	18.9	6.6	10.0	24.0	7.1	9.3	28.0	7.7	8.6	31.5	7.9
90	12.0	20.0	6.7	11.0	25.0	7.2	10.2	30.0	7.9	9.5	34.0	8.2
100	12.8	20.5	6.9	11.9	26.5	7.6	11.0	32.0	8.1	10.3	35.0	8.5
120	14.5	21.5	7.3	13.1	27.5	7.9	12.3	33.5	8.4	11.5	37.5	8.8
140	16.0	22.0	7.6	14.8	29.0	8.3	13.9	35.5	8.8	13.0	40.0	9.2
160	18.0	23.0	8.0	16.4	30.5	8.7	15.1	37.0	9.1	14.5	42.5	9.6
180	19.9	23.3	8.3	18.0	31.5	9.0	16.5	38.5	9.5	16.0	45.5	10.0
200	21.5	23.5	8.5	19.3	32.5	9.2	18.1	40.0	9.8	17.1	46.0	10.3
220	22.9	24.0	8.8	20.9	34.0	9.6	19.1	41.5	10.1	18.2	47.5	10.6
240	24.4	24.5	9.0	22.0	34.5	9.8	20.5	43.0	10.3	19.5	49.0	10.8
260	26.0	25.0	9.2	23.5	34.5	10.0	21.8	44.0	10.6	20.9	50.5	11.1
280	27.7	25.0	9.4	25.0	35.0	10.2	23.0	45.0	10.9	22.0	51.5	11.3
300	29.0	25.0	9.5	26.3	35.0	10.4	24.3	45.0	11.1	23.2	53.0	11.6
320	30.2	25.0	9.6	27.6	35.5	10.6	25.5	45.5	11.2	24.5	54.0	11.8
340	31.6	25.0	9.8	29.0	36.0	10.8	26.7	46.0	11.4	25.5	55.0	12.0
360	33.0	25.0	9.9	30.0	36.5	10.9	27.7	46.5	11.6	26.6	55.0	12.2
380	34.2	25.5	10.0	31.3	37.0	11.1	29.1	47.0	11.8	27.7	55.5	12.4
400	35.6	26.0	10.2	32.5	37.0	11.2	30.2	47.5	12.0	28.9	56.0	12.6
420	36.9	26.5	10.3	33.7	37.5	11.4	31.5	47.5	12.2	29.6	56.5	12.7
440	38.1	27.0	10.4	34.8	37.5	11.5	32.5	48.0	12.3	30.9	57.0	12.9
460	39.5	27.5	10.6	36.0	37.5	11.7	33.5	48.5	12.5	31.8	57.5	13.1
480	41.0	27.5	10.8	37.0	37.5	11.8	34.5	49.0	12.6	32.7	57.5	13.2
500	42.1	27.5	10.9	38.3	38.0	11.9	35.5	49.0	12.7	33.9	58.0	13.4
550	44.9	27.5	11.1	41.0	38.5	12.2	38.2	50.0	13.0	36.5	58.0	13.7
600	47.7	27.5	11.3	43.6	39.0	12.5	40.3	50.0	13.3	38.7	60.0	14.0
650	50.3	27.5	11.6	46.4	39.5	12.8	43.0	50.0	13.7	41.0	60	14.2
700	50.3	27.5	11.8	49.0	40.0	13.1	45.4	50.5	14.4	43.5	60.5	14.5
750	56.2	27.5	12.1	51.0	40.0	13.3	48.0	51.0	14.2	45.8	61.0	14.8
800	59.2	27.5	12.3	53.8	40.0	13.5	50.6	51.5	14.5	47.8	61.5	15.0
850				56.2	40.0	13.8	52.5	52.0	14.6	50.0	62.0	15.2
900				58.2	40.0	14.0	54.6	52.0	14.9	52.0	62.5	15.5
950							57.2	52.0	15.1	54.0	63.0	15.7
1000							59.3	52.0	15.3	56.3	63.0	16.0

of falling water from above, but gravity adds to the force acting on the hull as the boat is dropped or catapulted into the wave trough below. The total forces of such impacts can be enormous.

But I must be careful not to exaggerate. In truth this breaking wave business happens only rarely at sea, because in deep water the crest-to-crest wavelengths tend to be hundreds of feet long and roll along smoothly day after day. Though the waves may be high, their height seldom approaches one-seventh of their length.

Another way of saying this is that a wave becomes unstable when its crest angle begins to fall below 120 degrees. You can readily understand this, because any nonbreaking wave has a rather gentle crest angle and does not threaten to explode and break. If you study the aerial photograph of Bass Strait in truly horrifying wind and sea conditions on page 20, you will see that the first enormous breaking wave to the right of the yacht has a crest angle of perhaps 80 degrees. In other words, the boat is threatened by a waterfall.

In the Force 10 to 11 storm that I mentioned in Chapter 1, I remember counting the time of the passing wave crests over and over while I was steering. The apparent wave period was 10 to 11 seconds, which meant that the apparent wavelengths were on the order of 565 feet. Because of the relative motion between the wave period and the yacht, however, I needed to subtract the distance covered by the boat while I counted. My matchstick on the waves was traveling at about 7.5 knots or 12.7 fps. (To convert knots to feet per second, multiply by 1.689.)

In 10.5 seconds, therefore, the boat would have covered 133 feet. From 565, subtract 133, which gives 432 feet, the *actual* wavelength. The graph on page 13 tells us that a 432-foot wavelength has a period of 9.5 seconds. In Table 2 on page 15 we see that a Force 10 storm blowing long enough over a wide enough expanse of ocean to create a 9.5-second wave period will have produced a maximum wave height of about 38 feet, which—as the helmsman during that storm—I thought was about right. But that height would have been a little less than *one-eleventh* of the wavelength—not one-seventh—so the waves weren't breaking.

My point is that if the wind is steady and is blowing across deep water, breaking waves do not appear to come from the one-seventh rule, but from other causes. To wit: troublesome cross-seas, leftover seas from old storms, an ocean current, a tidal stream, shoals, a salinity imbalance, a large passing ship*—anything that upsets the

*During the 1950 Atlantic race, the yacht *Cohoe*, while running in enormous seas in mid-ocean, was passed closely by the Italian liner *Saturnia* traveling at speed. Two waves with immense breaking tops crashed over the sailing boat, which broached. "It was the heaviest blow that *Cohoe* had ever taken, and no doubt [was] caused by freak seas resulting from the liner's wash crossing the great following waves," wrote Adlard Coles, the yacht's captain.²

roughly straight-line flow of the waves. Eventually my boat capsized violently because old waves from a different direction mixed with new waves. Finally one of these menacing combinations broke under the yacht and flipped the boat upside down.

If a crest breaks loose from a large wave, the separated water can move faster than the wave itself and in a slightly different direction. The two masses of water may then collide with disastrous results to a nearby vessel.³

Three things govern the magnitude of waves caused by wind: the speed of the wind; the length of time that it blows; and the *fetch*, or distance, over which it blows. When the wind velocity increases, the waves become higher and the periods longer. The amount of energy in larger waves is much greater, because the energy is proportional to the square of the wave height.

Moderate-size waves that exhibit a white breaking *crest* are not breaking waves, and there's some misuse of these terms. With wind of any significance, the tops of most regular waves show white breaking *crests*. We're all familiar with the whitecaps (or white horses) of a Force 5 *fresh breeze* of 17 to 21 knots.

Depending on the fetch, the height of Force 5 waves runs from 3.5 to 8 feet (Table 1, page 14). We know that the tops of waves running before a steady 21-knot wind simply crest and tumble at the top. There's no danger for a seagoing yacht in our size range.

As the wind increases, however, the waves begin to look a bit more alarming. The wavelength—the distance between two adjacent crests—increases as well, and the toppling crests grow in size. By the time we climb the scale to Force 8 (34 to 40 knots) and examine a fetch of, say, 100 miles, with the wind blowing for 13 hours, the significant wave height has grown to almost 21 feet. One of these bundles of energy whooshes past the boat every 6.9 seconds. The most frequent wave height, however, would be about half the significant height, or 10.5 feet; 10% of the waves would be about 25% higher than the significant wave height, or 26 feet.

A Force 9 storm blowing over the same 100 miles of fetch for 12 hours would produce a significant wave height of about 26 feet. These waves sweep past the boat every 7.6 seconds. Most of the waves would be half of this, or 13 feet; 10% would be 25% higher, or about 33 feet. This is beginning to be heavy stuff, and we need to know how to deal with it. If these winds are steady and we have plenty of sea room under our lee, we can run with the storm for a long time, hopefully in the right direction. Often we can get the boat to steer herself while the up-and-down ocean rolls past.⁴

SHOAL WATER AND THE LEE SHORE PROBLEM

The foregoing discussion applies to deep water in the open ocean. However, there's another kind of breaking wave that's familiar to everyone, which is when a wave nears the shore and finally breaks in shoal water.

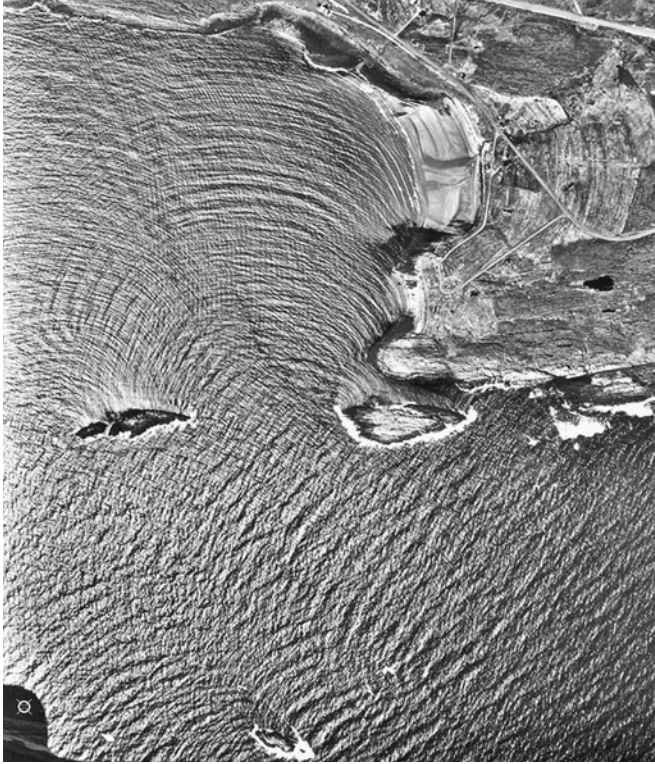

A stunning example of wave interplay (refraction and diffraction) near Kiberg on the extreme northeast coast of Norway. Note the wave patterns along the upper part of the island to the left.

Sailors near the shore know that the motion of the boat definitely changes when the boat moves into shoal water. In clear weather you can see the shore and change course. In fog, snow, heavy rain, or a moonless night, the change in motion may alert you that you're near land or a shoal patch. You should immediately slow down and try to determine the depth of the water. If you hear breakers ahead, take a compass bearing of the sound and make a severe course change (180 degrees if possible).

If you believe you're near land and have a lee shore problem and no other option is available, by all means try to anchor, preferably with a long nylon line as the water depths decrease. Even if the boat is not in soundings but things are out of control and she's merrily blowing downwind toward rocks and cliffs, put out one or more anchors on long lines with the hope that the anchors will catch as you're

blown into shallower depths. *This is not the time for prayer or hesitation but the time to act quickly and with resolution.* Put out all your anchors on different lines, and hope that you can hang on for a few hours until the wind shifts.

What good does it do to reserve any anchors on board? They're certainly no good if you're ashore and wrecked.⁵

This reminds me of a story that Andy Thomson, a fabled South Sea schooner captain, told me 40 years ago. Andy had his ship, the *Tiare Taporo*, in Avatiu harbor on the north side of Rarotonga in the Cook Islands when an unannounced hurricane swooped in from the north. Avatiu harbor is only a tiny crack in the coral reef. Sixty-knot squalls and big seas began to roll in, and the 168-ton schooner was trapped on a dead lee shore.

Andy had his crew put out all his anchors on line and chain. When that was done he told his boys to unreeve all the halyards and every piece of running rigging and to get out all the spare line. They then took each line out to a coral head, dove down and tied it in place, and ran the line back to the ship.

"By the time the hurricane hit the little harbor, we had out maybe thirty lines, four anchors, and all the chain on board," said Andy. "We fired up the engine, ran her at full throttle, and stood regular watches, hoping to go nowhere. By now the wind was shrieking and things looked dark. We chafed through some of the lines and a few broke, but we made it through the storm. Afterward it took us three days to undo all the strings and get back in order."

The point is that when you're threatened, use every tool you have. Then try a prayer or two.



Here's the whole story in one photograph: the helplessness of a sailing yacht lying almost parallel to a huge breaking wave. The best defense appears to be to keep the bow or stern into the tempest by an off-boat device that produces enough drag in the water to hold the bow or the stern into the storm as the wave passes. This view was taken near Bass Strait between southeast Australia and Tasmania on December 27, 1998, during the Sydney–Hobart race. The yacht is named Stand Aside, she's 41 feet long, and has already been dismasted. A life raft is hanging off her port quarter and a wisp of smoke, perhaps from a flare or smoke grenade, is blowing off to leeward of the boat. The waves are moving from the lower right toward the upper left, following the streaks on the water. Note the almost vertical faces of the waves in the center of the picture and the white water streaking down their fronts. Using the length of the yacht as a scale, the waves are about 45 feet high. The wave in the upper right-hand corner, however, appears steeper and higher. I judge this breaking wave train to have heights of 50 feet or more, truly a daunting prospect for a small boat at sea. The wave height here is due to the interaction of the south-flowing current along the east coast of Australia and hurricane-force west winds blowing through Bass Strait.

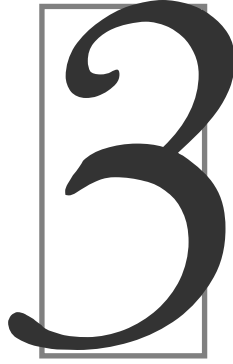

MORE ON BIG WAVES

A breaking wave (also known as a rogue, a giant, a freak, an extreme wave, or a superwave) is an enormous wall of water that collapses and falls with great force because the wave is too high for its forward speed. The wave accelerates and *spills*—with lots of air and foam—into a wide band of white water. Or the wave *plunges*, with solid water projected forward in an arc.

If the wave is small, the detached crest doesn't amount to much. If the wave is large—on the order of 30 to 35 feet or higher—the avalanching crest may contain tons of water that can violently engage a 1,000-foot ship or a 50-foot yacht. The associated troughs, or “holes in the sea,” can be lethal to a vessel.

The appearance of these waves is almost the same as those colossal waves that break on Hawaiian beaches and attract big-time surfers and marine photographers. As I mentioned earlier, the difference is that the waves near the beach tumble into white water because the waves' energy is concentrated in a shallower water column. This increases the energy density, and meanwhile, by the dispersion relation, the waves' velocity decreases as the water shoals. This causes the waves to compress, peak up, and collapse.

If a breaking wave at sea gets mixed up with a strong opposing ocean current, the wave's behavior is exaggerated even more. Or said another way, current against wind means that higher waves appear more frequently. These effects are well known in the northeast-flowing Japanese Kuroshio Current, the North Atlantic Gulf Stream, and the Agulhas Current that runs south along the east coast of South Africa, plus a hundred other places. Even at the mouth of your local river,

the waves can heap up more frequently (and reach higher than you'd expect from the shoaling bar) when there's a strong onshore wind meeting the river current and an ebb tide.

There are ways to work around these problems, and the point of this book is to discuss them in detail. In the upcoming chapters we'll see how the yacht *Banjo*—trying to lie a-hull in dangerous surface conditions—mixed it up with a breaking wave and a deep trough and came out second best. There's the *Winston Churchill*, a handsome 55-foot wooden cutter that entered the 1998 Sydney–Hobart race, hopefully to win. She was knocked apart when she fell off a huge breaking wave and into a cavernous trough off the southeast corner of Australia. The boat sank at once, and only six of her nine-man crew were rescued.⁶

I've seen a videotape taken from a U.S. Coast Guard helicopter hovering above a large yacht that's lying sideways to a breaking wave. As the film clip proceeds, it shows the boat falling into a trough and making a sickening crunch that was loud enough (even above the noise of the helicopter) for the entire aircrew to groan in disbelief and sympathy.⁷

It has long been known that if a line comes from a strong point (a sea anchor or a drogue) somewhere away from the boat, the line can be used to turn the vessel so that she shows her bow or stern to the storm. The real-world question is how to do this safely and maintain control of the boat.

Sailors have long talked about immense waves that are 50, 60, 70, or even 80 feet high. Just as regularly, scientists have dismissed these claims as delusional fantasy, like three-eyed fish or blue mermaids. Nevertheless, some of these sightings are hard to dismiss.

In 1933 in the Pacific, the U.S. Navy oiler *Ramapo*, on her way from Manila to San Diego, sailed into a huge storm that lasted seven days. The officers on the bridge did some clever triangulation using the ship's mast and measured a wave that was 112 feet from peak to trough—the same height as a ten-story building. The period of this wave was 14.2 seconds, and its length was 1,128 feet. The *Ramapo* survived the storm because her length—478 feet—fitted into these big waves and allowed the ship to head downwind without harm.⁸

In recent years at least five large cruise ships (the Italian *Michelangelo* in 1966, the British *Queen Elizabeth II* in 1995, the German ships *Bremen* and *Caledonian Star* in 2001, and the Norwegian *Dawn* in 2005) have suffered severe damage 75 feet or more above the water from waves estimated to have been 90 to 100 feet in height. Other well-found old and new ships are suffering losses at the alarming—and hard to believe—rate of one ship (over 2,500 gross tons) lost or destroyed every 5½ days. And this rate is increasing.⁹

In February 2000, a British oceanographic research ship in a gale west of Scotland measured waves up to 95 feet. Seven research scientists on board wrote in the journal *Geophysical Research Letters* about “the largest waves ever recorded by scientific instruments.”¹⁰

Still, many oceanographers were skeptical and stuck to the numbers that came out of their beloved Linear Model, a bell-shaped graph that gives the probability of wave heights.

“It’s like . . . children in a class,” says Dr. Jim Gunson of the British Meteorological Office. “There is an average height of the children and most . . . are around that height. Some are quite a bit taller or shorter, but the chance that a child is three or four times the height of the average child is very, very small.”¹¹

As we saw in the last chapter, significant wave height—the average height of the highest one-third of the waves—is a better measure of sea state than average wave height when a mariner wants to evaluate the challenges he or she will face. The significant wave height will be half again the average wave height, and seas of that size, while not prevalent, will not be rare either. Out of every 30 waves, an average of five attain significant height.

If we isolate the highest 10% of all waves, their average height will be 25% higher than the significant wave height and twice the average wave height. Out of every 30 waves, one or two on average will be this high. There is nothing mysterious at work here—we are simply working our way toward the tail of a normal bell-curve distribution.

According to the Linear Model, therefore, if there’s a big storm in which the significant wave height is 39 feet, one or two of every 30 waves could have a height of around 50 feet. The chance of a 100-foot wave, however, is virtually nil, and this was the accepted wisdom among scientists until recently. Twelve years ago, however, something happened that made scientists, ship designers, and marine insurers begin to lose faith in the famous Linear Model.

The big Draupner oil rig platform in the North Sea is 100 miles from land and has to take the weather as it comes. To check the wave heights, a scientist rigged a laser device, which in a heavy storm regularly recorded waves 40 feet high. On New Year’s Day in 1995, however, the recording device suddenly picked up a steep wave that was 85 feet (26 meters) high from trough to crest. The amplitude (sea level to crest) of 18.5 meters was more than *three* times the average height of the wave train. This was proof positive that giant waves were real; maybe the sailors who had claimed to see the monsters out there somewhere were not so dumb.¹²

In 1991 and 1995 the European Space Agency put satellites with synthetic-aperture radar into orbit. In 2000, a team of scientists directed by Dr. Wolfgang Rosenthal set

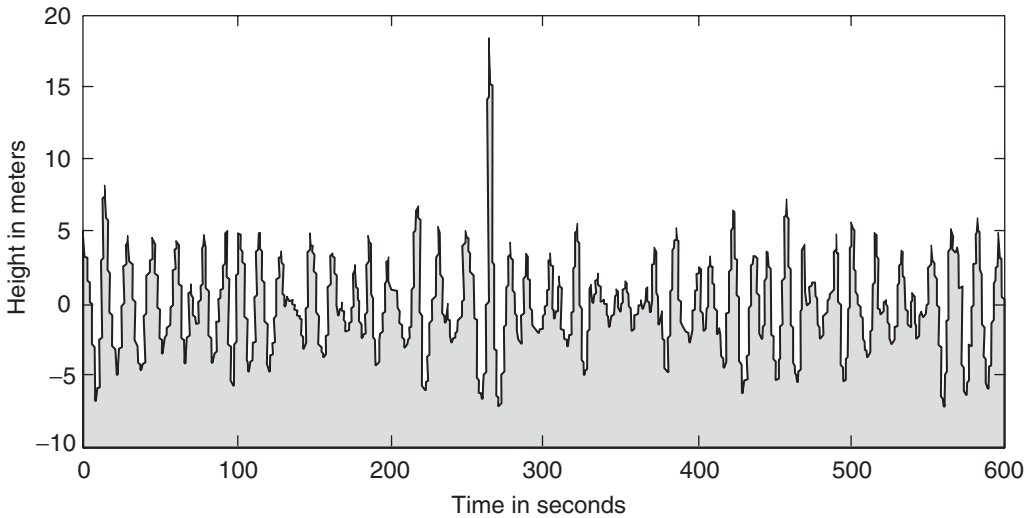

A trace of the Draupner oil rig platform “New Year’s Day wave” in the North Sea in 1995, which changed oceanographers’ perception of superwaves.

up a trial program called MaxWave to learn about these giant waves—how they form, how long they last, and whether they can be predicted. Every year dozens of big ships disappear at sea, with the cause generally blamed on fire or poor maintenance. Could giant waves be the culprit or a main part of the cause? Do we need to improve the designs of ships and offshore oil platforms?

While the European radar satellites were over the oceans they were programmed to collect 5×10 km “imagettes” of the sea surface every 200 km. Suitable mathematical interpretation of the imagettes gave wave energy and directions—called ocean-wave spectra—for wide areas. This information was passed along to various weather centers to help with their sea state forecasts. Dr. Rosenthal suspected that there might be more information on the imagettes, so he and his coworkers examined 30,000 of them for the tell-tale fingerprints of giant waves. The scientists were amazed to discover ten waves above 25 meters (82 feet, trough to crest) dotted randomly all over the world at any one time.¹³

Evidence of extraordinary waves comes from still another source. In September 2004, the whirling winds of Hurricane Ivan raced across the Gulf of Mexico and knocked out three giant oil rig platforms and three enormous floating oil rigs. Earlier, scientists from the U.S. Naval Research Laboratory had moored six wave-tide instruments 50 miles east of the Mississippi Delta at depths ranging from 195 to 295 feet. After the Category 4 hurricane had passed, the recording devices revealed that waves higher than 90 feet (trough to crest) had passed over the instruments.¹⁴



In 1974, the 132,000-ton Norwegian tanker Wilstar, fully laden with crude oil, lost her bow (1-inch steel plate plus steel beams) when she plunged into a deep trough (“a hole in the sea”) near Durban, South Africa. The big ship was motoring at reduced speed in gale conditions. A low-pressure area had moved across a few hours before and caused a sudden wind shift. The ship was 10 miles east of the 100-fathom line, where the sea bottom is rough and cut up with underwater canyons and slopes—ideal conditions for giant waves. It’s speculated that the long hulls of these ships are subjected to tremendous shearing forces when they fall into a trough. According to Lloyd’s Register, 143 ships of this size were lost from 1981 to 2001, or about seven per year.¹⁵

In Sebastian Junger’s best-selling book *The Perfect Storm*, the author reports that Canadian buoy 44137, just south of Sable Island, recorded significant wave heights of 50 feet and maximum wave heights (trough to crest) of 100 feet during the 1991 Halloween storm. These are among the highest waves ever recorded.

In the commercial and military world these wave problems cry out to be solved, because when big ships go down, the losses are enormous, even before the related costs of manpower, scheduling, insurance, oil spills, and searches are factored in. Besides the vessels at sea, there are hundreds of offshore oil platforms that have to withstand the battering of the sea.

The steel hulls of present-day large commercial ships are built to withstand about 15 tonnes (a tonne being a metric ton or 1.1 standard tons) per square meter. Engineers calculate, however, that a rogue wave can strike a square meter of hull with a pressure of up to 100 tonnes, which can destroy a vessel. These are

challenging numbers to overcome, and the more scientists and engineers can learn about superwaves and how to avoid or deal with them, the better.

There are at least five causes of giant waves. None is absolute, and the descriptions and importance attached to the various factors vary from one oceanographer to the next.

1. **Focusing by current.** When storm-force waves are driven into a strong opposing current or eddy, the wavelengths shorten and wave heights increase. The oncoming wave trains may compress into a superwave. This is the most probable theory, but it doesn't fit all cases. The best-known area for this phenomenon is in the Cape Agulhas region off the southern tip of Africa. It's in this region where many oil-laden supertankers have disappeared or been severely damaged, sometimes by plunging into deep troughs where their long hulls have been subjected to overwhelming shear stress (see photo on page 25).
2. **Diffraction focusing.** The diffractive focusing of a wave caused by the seabed or coastal shape may direct several small waves to meet in phase. Their crest heights combine to create a freak wave. This shallow-water effect is primarily a coastal phenomenon, but it has also been reported in the South Atlantic and the Indian Ocean, where sea mounts (undersea mountains) rise close enough to the surface to affect long-period waves.
3. **In-phase interaction.** In this theory, two or more wave trains—perhaps from other storms or from different stages of development of the same storm—meet in phase, and their crest heights combine to create a freak wave. A variation of this is that higher waves generated by a storm may overtake and consume smaller waves, thus growing increasingly in size. Whether this phenomenon can continue up to superwave size is unknown.
4. **Nonlinear effects.** It's possible to have a freak wave occur by natural, variable processes from a random background of smaller waves. In such a case it is thought that an unusual, unstable wave may form that “sucks” energy from adjacent waves and grows to a near-vertical monster before becoming unstable and collapsing. Such a superwave (and the plunging troughs commonly seen before and after it) may last only a few seconds or minutes before either breaking with force or collapsing to normal size.

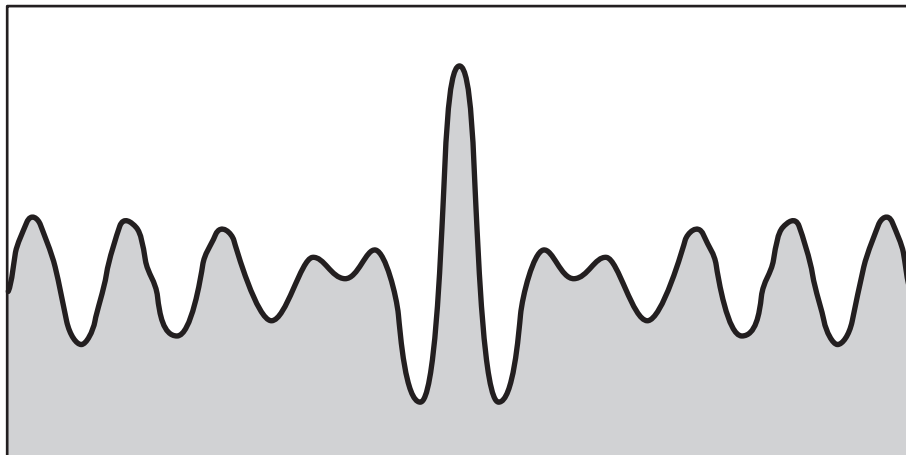

A graph line of a superwave formed from a background of smaller, random waves. The enlarged wave may take energy from the adjacent waves on either side. The greatly enlarged wave may have a life of only a minute or two.

5. **The tail of the bell curve.** Some scientists believe that rogue waves simply inhabit the “long tail” of the normal wave-spectrum bell curve. That is, a rogue wave is a statistical improbability, but not an impossibility, and no freakish interaction is required to explain its existence.

Any of these effects might combine with other mechanisms (unknown or listed above) to produce superwaves.

There’s no lack of mention of big waves in the literature of small-boat sailing. Here is one from Joshua Slocum’s famous book *Sailing Alone Around the World* (available in many editions more than a century after its first publication):¹⁶

“My ship [the year was 1895] passed in safety Bahia Blanca, also the Gulf of St. Matias and the mighty Gulf of St. George [along the Argentine coast in the South Atlantic]. Hoping that she might go clear of the destructive tide-races, the dread of big craft or little along this coast, I gave all the capes a berth of about fifty miles, for these dangers extend many miles from the land. But where the sloop avoided one danger she encountered another. For, one day, well off the Patagonian coast, while the sloop was reaching under short sail, a tremendous wave, the culmination, it

seemed, of many waves, rolled down upon her in a storm, roaring as it came. I had only a moment to get all sail down and myself up on the peak halliards, out of danger, when I saw the mighty crest towering masthead high above me. The mountain of water submerged my vessel. She shook in every timber and reeled under the weight of the sea, but rose quickly out of it, and rode grandly over the rollers that followed. It may have been a minute that from my hold in the rigging I could see no part of the *Spray's* hull. Perhaps it was even less time than that, but it seemed a long while, for under great excitement one lives fast, and in a few seconds one may think a great deal of one's past life. No only did the past, with electric speed, flash before me, but I had time while in my hazardous position for resolutions for the future that would take a long time to fulfill. The first one was, I remember, that if the *Spray* came through this danger I would dedicate my best energies to building a larger ship on her lines, which I hope yet to do. Other promises, less easily kept, I should have made under protest. However, the incident, which filled me with fear, was only one more test of the *Spray's* seaworthiness. It reassured me against rude Cape Horn."

Here's another account, this one from Alain Gerbault's *Flight of the Firecrest*, first published in English in 1926:¹⁷

"It was a dirty looking morning on the 20th [of August, 1925] and the climax of all the gales that had gone before. It was the day, too, when the *Firecrest* came near to making the port of missing ships. As far as the eye could see there was nothing but an angry welter of water, overhung with a low-lying canopy of leaden, scurrying clouds, driving before the gale.

"By ten o'clock the wind had increased to hurricane force. The seas ran short and viciously. Their curling crests racing before the thrust of the wind seemed to be torn into little whirlpools before they broke into a lather of soapy foam. These great seas bore down on the little cutter as though they were finally bent on her destruction. But she rose to them and fought her way through them in a way that made me want to sing a poem in her praise.

"Then, in a moment, I seemed engulfed in disaster. The incident occurred just after noon. The *Firecrest* was sailing full and by, under a bit of her mainsail and jib. Suddenly I saw, towering on my limited horizon, a huge wave, rearing its curling, snowy crest so high that it dwarfed all others I had ever seen. I could hardly believe my eyes. It was a thing of beauty as well as of awe as it came roaring down upon us.

"Knowing that if I stayed on deck I would meet death by being washed overboard, I had just time to climb into the rigging, and was about half-way to the masthead when it burst upon the *Firecrest* in fury, burying her from my sight under tons of solid water and a lather of foam. The gallant little boat staggered and reeled under the blow,

until I began to wonder anxiously whether she was going to founder or fight her way back to the surface.

“Slowly she came out of the smother of it, and the great wave roared away to leeward. I slid down from my perch in the rigging to discover that it had broken off the outboard part of the bowsprit. Held by the jibstay it laid in a maze of rigging and sail under the lee rail, where every sea used it as battering ram against the planking, threatening at every blow to stave a hole in the hull.

“The mast was also swaying dangerously as the *Firecrest* rolled. Somehow the shrouds had become loose at the masthead. There was now a fair prospect that the cutter would roll the mast out of her, even if the broken bowsprit failed to stave the hole it seemed trying for. The wind cut my face with stinging force, and the deck was, most of the time, awash with breaking seas.

“But I was obliged to jump to work to save both boat and life . . .”

And finally, here’s an account from Jean Gau, which appeared in *To Challenge a Distant Sea*.¹⁸

“Sometime during the night of February 27 [1965] the catastrophe occurred.

“About three in the morning I heard a strange noise approaching my boat [a 30-foot Tahiti Ketch designed by John Hanna]. I could not believe my ears. What is happening? Probably nothing—or something. I thought: It *must* be a furious wave that is coming, head first, and about to tumble on deck? Instinctively I grabbed the side of the bunk. Suddenly in a terrifying din, like an explosion, an enormous wave hit the port side and tons of water fell on deck. I was thrown violently against the ribs of the boat, to be immediately covered by all sorts of items, sail bags, charts, books.

“*Atom* had capsized!

“Her keel now lay over my head!

“All openings were tightly closed at the time except for a small porthole on the after wall of the cabin. Through that opening a powerful jet of water now spewed into the cabin. My heart sank for I expected this to be the last blow. I remained breathless for seconds. ‘I am finished,’ was all that I could think of. I had suspected that one day I would meet at sea one of those ultimate waves that would bury my boat and me completely. I now believed it was all over. Alone in the moving darkness, entangled and nearly buried under debris, frightened, unable to get up and help myself, succumbing to an acceptance of death, I was suddenly aware that *Atom* had righted herself! Her heavy iron shoe had saved us.

“In an effort to overcome my sense of distress and hopelessness, I decided that I had to get out of that cabin! Freeing myself, hurting and bruised, I hurried topside. A dreadful turmoil was raging about the boat. . . . *Atom* had been dismasted!

“What a horrible sight—bowsprit, stumps of masts, spars, splintered booms, sails, and lines torn and tugging to leeward, all held by tangled shrouds and halyards. Gone, too, was the dinghy. All [this] had happened in a few seconds!”

All three of these sailors—Joshua Slocum, Alain Gerbault, and Jean Gau—successfully overcame being swamped and damaged and, like good sailors, continued their voyages.

TSUNAMIS

Tsunamis are fast surface waves capable of traveling great distances. They are caused by seismic events and take some hours to cross an ocean so that warnings are possible if an alarm system has been set up. A tsunami, a Japanese word from *tsu* (port) + *nami* (wave), maintains significant energy levels until it finally breaks with catastrophic force in shoal waters. In Chile, on May 22, 1960, a severe undersea earthquake created tsunamis (pronounced *ts nã mē*) that traveled to New Zealand, 6,000 nautical miles away, where they raised water levels almost 8 feet in some east coast ports.

In December 2004, an immense tsunami struck the coastal areas along the eastern Indian Ocean. More than 225,000 people were killed and huge breaking waves (up to 100 feet high) caused catastrophic damage along the coastal areas.

Generally tsunamis involve a series of waves that break on shore. In between the separate waves, the water is sucked out of coastal harbors and rivers. Out and in! Out and in! My friend Ross Norgrove was aboard his yacht *White Squall* in a small harbor on New Zealand’s east coast when the May 1960 tsunami hit.

“I remember it all perfectly,” Ross told me. “First we had a surge in the water level in the harbor. Then all the water ran out and the different boats were in the mud, some on their sides. The dumbbells were on the harbor floor, picking up fish. The smart people were running for the hills. I checked my anchor and then took off to high ground. Sure enough, in a little while the water came back and poured into the harbor higher than ever.”

By chance I visited Hilo, Hawaii, a few weeks after the same Chilean tsunami had struck the islands. Hilo had been the worst hit and had suffered waves up to 35 feet, which destroyed the waterfront. I remember being impressed by a long row of parking meters that were all twisted and bent and knocked flat.

But I am talking about shore damage. At sea the height of tsunami waves is only a foot or two and almost unnoticeable. Tsunamis out on the ocean can be ignored.

SWELL

When the weather changes and the wind moves away from a section of the ocean over which it has been blowing for some hours, the shape and character of the waves

become different. Without the nexus of a constant wind, the crests diminish in height and become more rounded and even-sided. This form of the sea is called *swell*, and can travel for thousands of miles.

Swell moves across the ocean from the area in which it originates toward a distant shore in *trains*, or groups of waves that can be thought of as bundles of energy. The velocity of a wave train is only about half normal speed, because at the front of the train some of the energy of the swell is used to put water particles into orbit. This causes the forwardmost waves to lose their energy and disappear. New waves appear at the back of the train, however, so the total number of waves is unchanged. Knowledge of this speed reduction is important, because forecasters use it to predict the arrival of waves from far-off storms.

“A wave group whose period averages twelve seconds will take two days to cross one thousand miles of open ocean,” writes Willard Bascom. An individual 12-second wave will take only half as long.¹⁹

The onset of pronounced swell is well known to hurricane watchers and small-boat sailors because it means that trouble is coming. The larger the swell, the bigger the approaching problem.

But enough inquiry into the quirky behavior of waves. As mariners we’re full of curiosity about the sea, but as small-boat sailors confronting foul weather our concerns are more immediate and practical. We want to know *what to do* about the conditions at hand or just ahead. That’s what we’ll explore next.

This page intentionally left blank



Part Two

**RESPONDING
WITH
ONBOARD
CONTROLS**

This page intentionally left blank

It seems presumptuous of me to sit in front of a laptop computer in the warm, dry cabin of my yacht *Whisper* while I'm tied up at a friend's dock in Maryland trying to write about heavy-weather sailing. Certainly being exposed to a storm out on the ocean puts the skipper and his crew in another world. The sailing conditions may be nasty, there may be problems with the boat, sea room may be doubtful, and the crew may be nervous and not feeling too well.

In the part of the book that we're about to look at, I will discuss four long-standing, traditional schemes to deal with bad weather sailing that I call *onboard control methods*:

1. Close-reefing the sails up to Force 6 (22 to 27 knots).
2. Heaving-to up to Force 7 (28 to 33 knots).
3. Lying a-hull up to Force 8 (34 to 40 knots), depending on sea conditions.
4. Running off up to Force 9 (41 to 47 knots), with concern about sea room.

These four sailing maneuvers can all be accomplished on board a sailboat, some—depending on how the running rigging is set up—without leaving the cockpit. You need no extra gear, but planning and practice will make these maneuvers quicker and easier, with less wear on the sails and the crew.





A FEW NOTES ON REEFING THE SAILS

Every novice sailor learns about reefing—that is, making big sails small by reducing the area exposed to the wind. Since 90% of recreational sailing yachts have a Bermudian sloop rig with a single mast, let's consider how to reef the mainsail when the wind increases.

The mainsail generally goes up and down on slides that run in a track on the after side of the mast. To reef the mainsail you head the vessel into the wind. This takes all the pressure off the sail, which then flaps like a flag in the wind. (For strong winds and heavy seas, see Chapter 7 for an alternate procedure.)

You then ease the main halyard (generally with a turn on a winch) until the desired luff reefing cringle comes down and is even with the gooseneck (the pivoting connection between the main boom and the mast). Next you secure the luff reefing cringle with a lashing, hook, or snapshackle. Then you tighten the main halyard so that the front of the sail is tensioned and straight. There should be no scallops in the vertical luff rope or tape.

Next you pull down the after edge, or leech, of the sail by hauling on a line called a pendant that runs from a pad eye near the end of the boom, up to the reefing cringle,

A mainsail with a roller-reefing arrangement in which the main boom is revolved by a mechanism at the forward end. I count nine rolls in this deep reef.

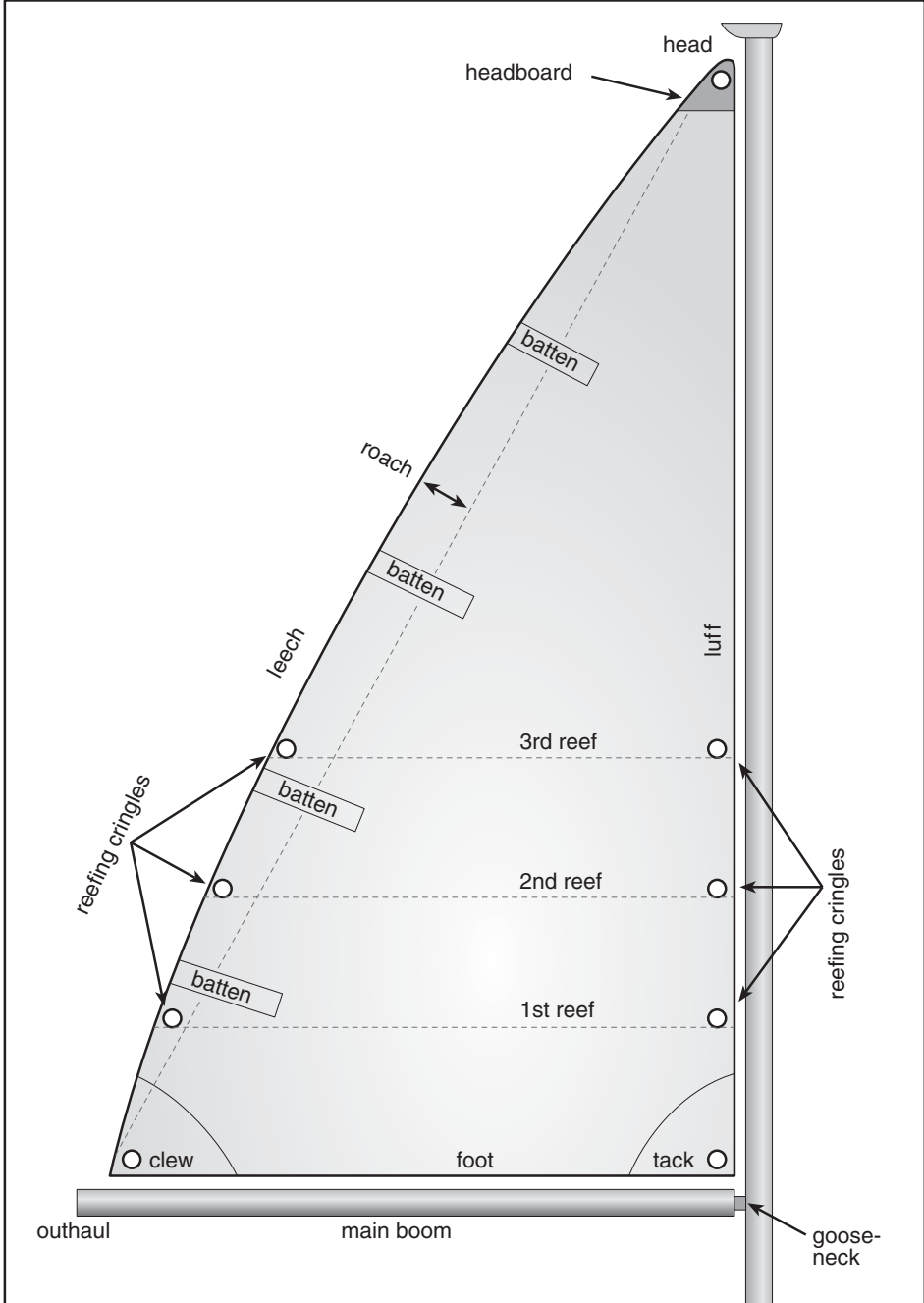

Parts of a Bermudian mainsail set up for slab reefing.

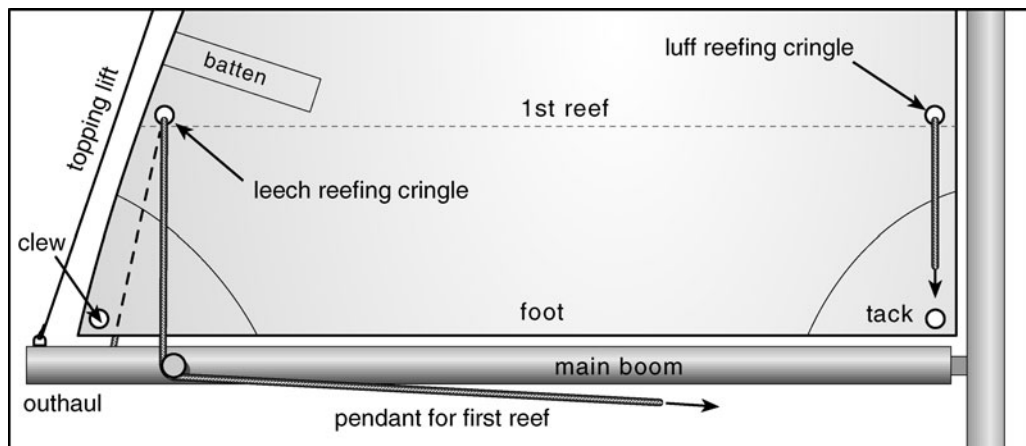

How slab reefs work.

down to a block in or near the boom end, and finally forward to the gooseneck area (see illustration). You put the mast end of the reefing pendant on a mast winch and crank away until the leech reefing cringle is pulled down to the boom and the foot of the sail is straight and tight. Presto, the sail is reefed. Details of slab reefing schemes vary slightly, but I've described the main thrust.

Often there's an almost horizontal line of reefing ties sewn into the sail between the luff and leech cringles. With these ties you can bundle up the bunt, or loose part, of the sail (i.e., the part taken out of service by the reef) to keep the sail neat and tidy and out of trouble. If you use these ties, it's important to fasten them *under the foot of the sail* and not around the boom. If you forget to loosen the ties when you shake out a reef, there's a good chance that the hoisting tension of the halyard will tear the foot of the mainsail. As a practical matter I don't use these ties, which I find unnecessary and a waste of time. It looks a little sloppy to have folds of cloth hanging over one side of the main boom, but in practice it works very well.

There's also a clever single-line reefing scheme for smaller boats (invented by Garry Hoyt) that combines the two main steps.

If the wind increases more, we tie in a second or third reef exactly like the first reef. When you go off on a trip, it's good practice to have a leech reefing pendant in place for each reef in the mainsail. These are always put in place at the dock, not at sea. If I use any knots (say a bowline to the pad eye on the boom) I always add a racking seizing to prevent the knot from untying itself, since there's often a great deal of line shaking and noise when reefing.

When you need a reef you want to be able to tuck it in quickly. Trying to feed the end of a line through the leech cringle when the boat is rolling around and you have to reach up is a good way to fall over the side. Reefing is sometimes a difficult business; try to make every aspect of it as easy as possible.

Most modern yachts that head offshore have three reefing positions (and three separate reefing pendants) for the mainsail. Some have only two; a few have four. I estimate that 90% of sailing yachts have mainsails with tied or slab reefs because the procedure is the least expensive, and is quick and easy to carry out. The shape of the reefed sail is usually excellent because you can control the tension on two sides of the sail.

If you reef the mainsail with a roller-reefing main boom, you generally ease the main halyard with one hand and crank the boom around and around with a handle on a geared mechanism located where the boom is connected to the mast. Or the mast may have a fore-and-aft hole for a direct connection from a crank in front of the mast to the front of the boom.

A few long-distance sailing yachts have mainsails with vertical furling and reefing arrangements that depend on a rotating vertical shaft inside the mast. Unfortunately the full-height shaft is heavy, the hidden rotating mechanisms are critical to success, and the all-up cost is high. When everything's working, they're wonderful. Note that a mainsail that furls vertically cannot have horizontal battens and thus can carry no roach, which results in a loss of sail area.

STORM TRYSAIL

An alternative to a third reef in the mainsail is to fly a storm trysail. It can be made of the same fabric as the mainsail—say 8- or 9-ounce Dacron, depending on the size of the boat; soft fabric is easier to store. Trysails are sometimes edged with 1-inch nylon tape, which makes them very strong for their size. A trysail eases the rolling of the boat, and together with a small jib can drive a vessel close to windward in moderate sea conditions, although reaching is usually the sail's best course. Different sailmakers use various types of trysail constructions. Since the sail is relatively flat, I don't think the direction and cut of the cloths are too important. Meanwhile the mainsail, which is made of lighter cloth, can be furled on the boom, and given a rest until the heavy weather is over.

In my judgment, the trick of using a trysail is to have it all ready so you don't have to fiddle with tracks, the tack pendant, and the sheet. For starters, entirely too many yachts require you to remove the mainsail slides from the mast track and then insert the trysail luff slides. This may be easy at the dock, but in stormy conditions at night,

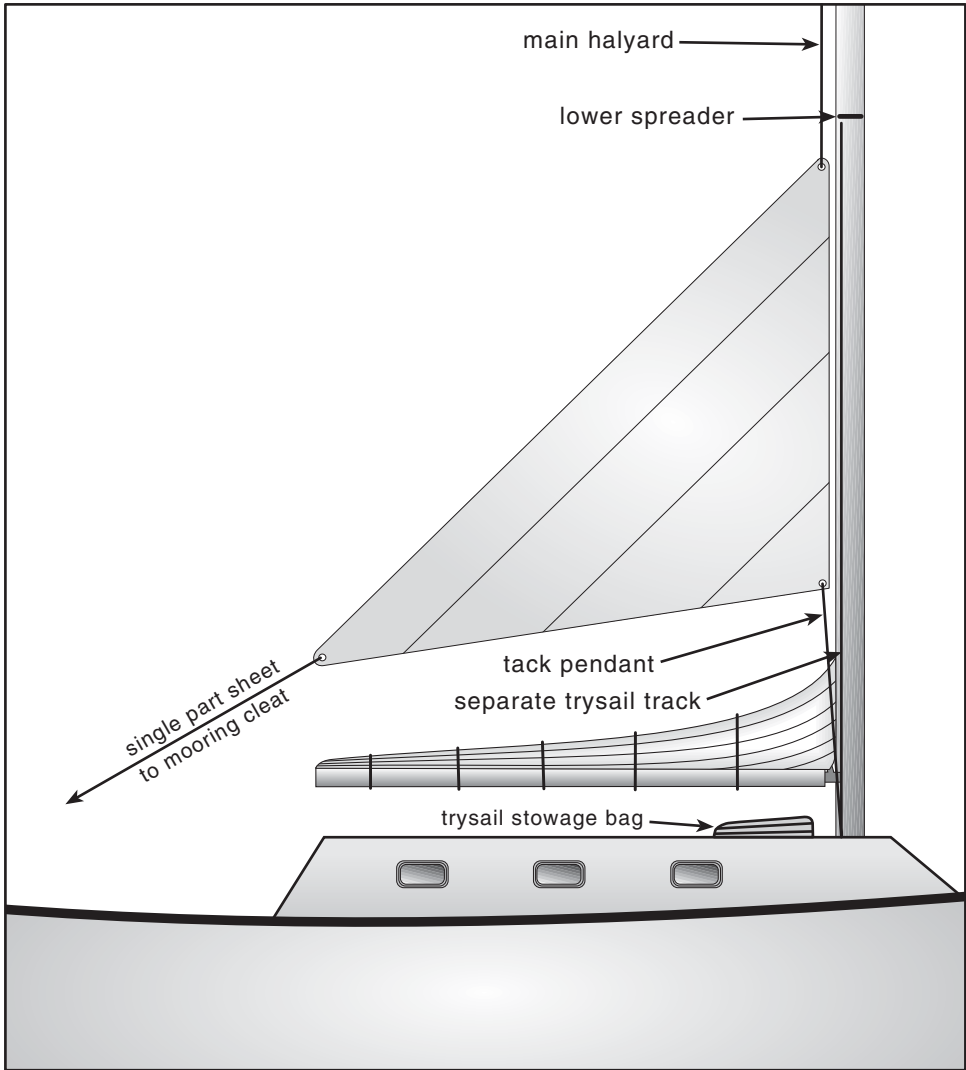

Details of a storm trysail.

fiddling with slides and screwdrivers is madness. There are arrangements where the trysail slides are fed into a short alternate track and then a transfer slide moves the slides into position. However, the trysail is hoisted infrequently, and these alternate tracks can become corroded and hard to use.

My trysail has its own track, which runs from the deck to the lower spreader with a hex-headed bolt at the top to stop the top slide. This special track can be mounted either to port or starboard of the mainsail luff track. Being offset to one side makes no difference.

The luff slides stay in place in the track so the sail is always ready to hoist. Because the sail is seldom used, I stuff it in a vinyl bag (with the sliders still on the track) that lives on deck behind the mast. This bag has half a dozen grommets spaced along the bottom so any water that's flying around can run out. The bag also holds the sheet and the tack pendant.

Some sailors lead the trysail sheet to the end of the main boom or to a special block and then to a winch. I've found that as a practical matter the sheet seldom needs to be adjusted. On my 35-footers, I rig a single-part sheet by splicing one end of 1/2-inch-diameter Dacron line to the clew of the trysail. When I hoist the sail, I lead the other end of the sheet to a stern mooring cleat, work out a suitable length, and belay it. I have sewn a heavy black thread marker to the sheet where it goes around the mooring cleat, which allows me to deal with the trysail sheet quickly.

Because the storm trysail is hoisted as high as possible (to the lower spreader) the sail needs a long tack pendant. I make this up ahead of time by splicing a piece of 1/2-inch line to the tack of the sail. I splice a snapshackle to the lower end, which I attach to a pad eye near the bottom of the mast.

To use the trysail, I simply pull the bag off the sail, attach the sheet to an aft mooring cleat, and snap the bottom of the tack pendant to its pad eye. I then tie on the halyard and hoist away. The total time to do all this is 10 or 15 minutes, most of which is spent securing the mainsail to the boom with extra ties or a length of light line. While the trysail is in use, the main boom can hang on its topping lift, although this risks possible chafe on the trysail or its sheet. Alternatively it can rest on a boom gallows should one be fitted. A third option is to lower the boom to the deck or the coachroof, lash it there, and tie the topping lift away from the trysail to back up the forestay.

In stormy weather the upper part of the mast sometimes moves around in a scary fashion. Depending on the details of the rig, you can usually set up both running backstays (if fitted) at the same time to help make a bulletproof setup, since the running backstays normally reach above the trysail.

If your boat's mainsail is, say, 350 square feet and each reef removes about 20% of that area, you're taking out 70 square feet with each reef or 210 square feet with three reefs. This leaves about 140 square feet in the triple-reefed mainsail. A trysail of 120 square feet (say 34% of the mainsail) is a reasonable size.

When the trysail is made, it's useful to have the sailmaker put a row of grommets along the short luff of the sail. Then, in case the trysail mast track is damaged or does not exist, you can run the sail up with a rope lacing around the mast.

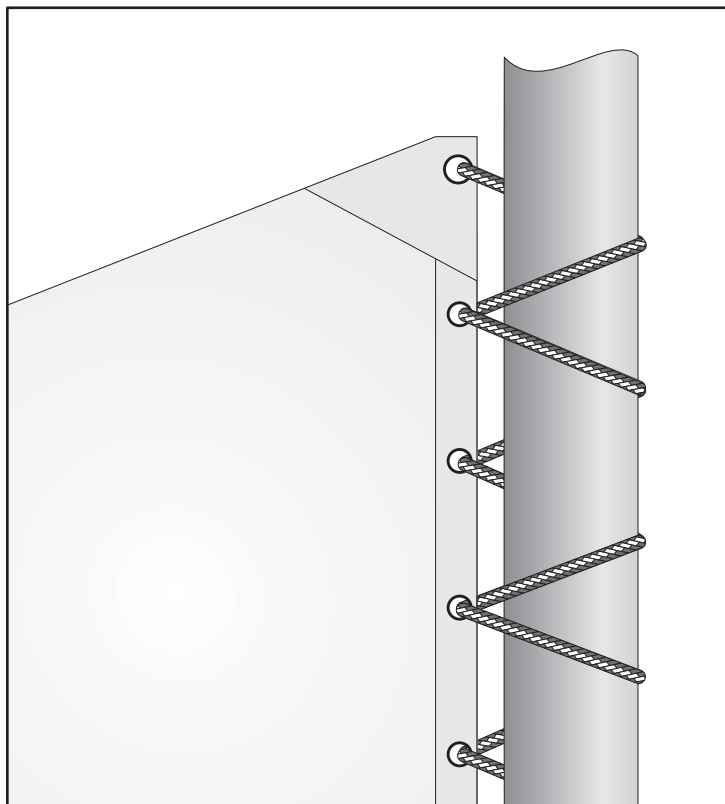

In case the trysail track cannot be used or is not available, the trysail can be hoisted up the mast with this non-jamming lacing. Note how the line is doubled around the mast. This same arrangement is often used with gaff mainsails.

OTHER SMALL SAILS

It's quite common for cruising yachts to add a forestay to a sloop rig to enable the yacht to carry a staysail. A forestay is a substantial wire that goes from roughly three-quarters of the mast height down to the foredeck—perhaps aft of the windlass—and is more or less parallel with the headstay. A staysail with roughly 50% of the area of a 110% jib is easy to hoist and handle during tacks. Together with a deeply reefed mainsail or trysail, the staysail makes a snug rig that is well suited to strong winds.

Forestay tension must be opposed by running backstays or a jumper strut to keep the mast in column when the staysail is set in heavy weather. Fitting two extra running backstays or a jumper strut gives the mast greatly increased support. Adding a forestay, however, interferes with the normal tacking of any sail ahead of it. In practice the jib

or genoa set on the headstay usually has to be pulled (horsed) around the forestay, which means that a crewman has to go forward.

If you choose this route, you have two options. You can either (1) live with a permanent forestay (my choice), or (2) arrange for a quick disconnect at the foot of the forestay. This way the wire can be moved back and out of the way when you're not using the staysail and are doing a lot of tacking. Some of these quick-disconnect setups, however, are unbelievably complicated because when you take the forestay back to the mast or side deck you have to deal with extra wire length.

Because the sheeting angle for the staysail is generally inboard and forward, you need suitably located blocks. Sometimes a block can be hung on a shroud fitting or at the forward end of the genoa track if it is angled inboard from aft to forward. I leave these staysail blocks in place all the time.

When not in use, the staysail (hanked or shackled to the forestay) and its sheets can be stored in a small vinyl or cloth bag and left on the foredeck. Like the trysail bag, the staysail bag needs half a dozen grommets pressed into its bottom so water can drain out.

The staysail is often a good choice for stormy weather. It's also extremely handy in light going when navigating around islands and close to shore. The small sail is easy to pull across when you're tacking, yet it keeps the boat going and is easy to back if you want to pivot the yacht quickly.

There are definite advantages to a ketch, yawl, or schooner rig in heavy weather because it's possible to set more small sails that can be added or subtracted. The captain of a ketch can elect to drop his mainsail entirely and proceed with a headsail and the mizzen. A schooner can be stripped of all her sails except for a reefed foresail. A yawl can go along with her small mizzen and a staysail up forward.

Today practically all sailing yachts have roller-furling sails on one or more stays. When the systems are working, they're heaven because they're so easy to use. When they misbehave, however, they can be a major problem that can threaten to bring down the rig. If you anticipate breezy weather, you can make a good argument for taking down the 150% light genoa and hoisting the 100% jib or something smaller. Try to do this before the wind gets up. Or maybe hoist nothing at all and go with a hanked staysail on the forestay.

Twice in my sailing career I've had a roller-furling headsail turn into a monster. Both times the trouble started in gale conditions with a furled headsail. The problems began with slight fluttering of a little of the leech high up on the rolled sail. The fluttering soon increased to hard flapping as more of the sail was pulled out from the roll. (This sounds impossible, but it happens.) Because this took place in 40-knot winds,

I began to hear and feel serious banging and the beginning of terrible flogging that made the mast tremble and jerk.

On one of these occasions, Margaret and I were sailing into Red Bay in Labrador. We were strangers to the area and our attention was taken up with the intricacies of the bay entrance.

At first I tried to pull the furling line tighter, but it had no effect. I then loosened the jib halyard and tried to lower the entire sail. Of course this was impossible since most of the sail was furled. Because of restrictions in the bay entrance we couldn't run off. And since we were reaching with a reefed mainsail and having problems with the jib, it was impractical to turn around and beat out of the entrance. I decided not to use the engine while we had our hands full with the strong wind and sail problems.

What to do? The wind seemed gustier than ever. Margaret steered into the bay proper where there was more room. By now the flogging of the sail was terrible. We quickly dropped the mainsail and anchored. As we swung into the wind the headsail continued to bang and flog. The clew would have beheaded anyone on the foredeck.

Finally I came to my senses. I let the furling line go, put one of the sheets on a winch, and cranked in a little tension. This opened out the sail all the way. Now the sail flogged worse than ever and the mast shook violently. I put the furling line on another winch and madly cranked away. As the sail began to roll up, Margaret eased the sheet but kept some tension on it. In a couple of minutes the troublesome sail was furled and the excitement was over.

Apparently when I had furled the headsail as we turned for the entrance to Red Bay, I failed to keep enough tension on the clew of the sail to ensure a tight furl throughout the entire sail. If we had been out in the open we could have run off downwind, let the sail unwind, and refurled it more tightly.

But wait! While I was sitting in the cockpit recovering my breath, I began to think about this sail-furling problem. Why in two instances did the loose leech appear in the same place high on the sail? Maybe the problem is the geometry of the furling arrangement. In a perfect furl, when the line of the sheet angle (deck block to clew) is extended, it should be perpendicular to the headstay. This allows the sail to roll up and down like a window shade. But a window shade is rectangular; a sail is an oddball triangle. If the sheet block is moved forward, there will be increased tension on the leech of the sail and less tension on the foot. If the sheet block is moved aft, the sheet will ease the leech of the sail and tighten the foot.

Later I talked to my engineer-sailor friend Ed Boden, who suggested trying out the furling gear on a calm day at the dock. "Move the deck block back and forth along the fairlead track until you have the best possible furl for the entire sail," said Ed. "Mark

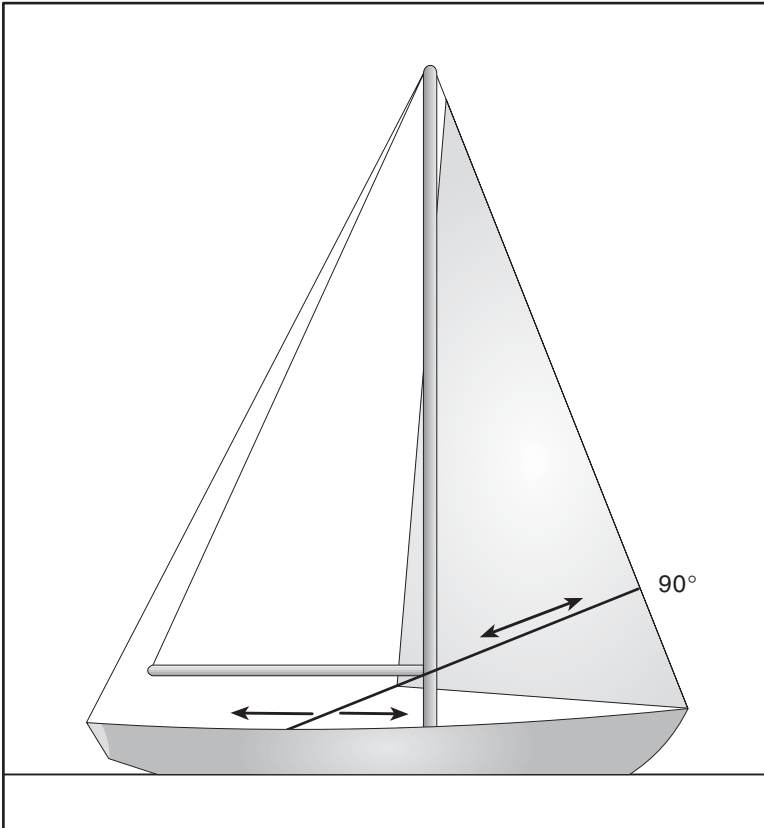

Ideal sheeting angles for furling headsails.

this position with a dab of paint or whatever. Then before furling out on the water, move the fairlead slide to the marked position.”

More considerations: (1) Since the leech length of the sail is roughly twice its foot measurement, the cloth along the leech will stretch more. (2) The foot will roll more tightly than the head because of the concentration of area, weight, and sheet tension forward of the clew. High up on the sail there is less area, the pull is directed more down than aft, and the furled sail forms a smaller bundle. All of this translates to a looser furl up high and the chance for a strong wind to unwind and pull out a little of the sail. This may happen only once in a thousand times, but believe me, it can happen.

Shall I go on? . . .



THE WIND'S UP: LET'S HEAVE-TO

OK, enough talk about waves and sails. Let's get on to the real stuff. The wind has begun to blow harder and the sea is a little nasty. Spray is flying around and our next port is to windward or nearly so. The boat is laboring despite being deeply reefed, and the motion is unpleasant.

It's been a long day and everyone on board is tired. We're 80 miles from the nearest land. It would be nice to stop the yacht and rest a bit and maybe even eat something. Also we have a couple of small repairs to make, but it's impossible to do them with the boat jumping around.

SEA ROOM

Here I must speak of *sea room* and what it means. The definition is simplicity itself, but the concept is fundamental to long-distance sailing. *Sea room* means enough room on an ocean, a lake, or an estuary so the yacht won't blow ashore. During a storm a captain may try a number of management techniques, but no matter what he elects, he can't afford to get mixed up with the shore.

As discussed throughout this book, there are a number of schemes for keeping small sailing vessels under control in heavy weather. However, they all depend on being at sea and in deep water *away from land*—usually far from land.

If a yacht is near land or shoals and a strong onshore wind is pushing the boat steadily toward the beach or the cliffs, the only hope for the vessel is to head offshore. This means sailing 20, 50, or 100 miles away from the land to an area where the boat will be safe. Such sailing may be difficult or even impossible because the yacht will not have enough power to force her way offshore—“to claw off” the lee shore, as seamen say.

If the wind is blowing at an angle to the shore or the storm is moving rapidly, there's a much better chance of gaining an offing and staying safe. But these are desperate maneuvers that are much better avoided by keeping a sufficient offing in the first place. When the weather is bad, you want plenty of sea room. *This is a fundamental rule of offshore sailing.*

Am I saying that you should always stay away from land when you're sailing? Of course not. But when the barometer is dropping, the weather forecast is poor, the sea has an unusual swell, or the top of the blue sky is streaked with long, parallel banners of filmy cirrus (mare's tails), it's time to consider whether the gentle winds will blow up into an onshore storm. It's time to think of sailing space and sea room.

Insurance company underwriters believe that if you go to sea and sail out of sight of land, you're in terrible danger. They immediately want to either cancel the policy or double your premiums. The underwriters are dead wrong; it's the opposite that is true. Yachts are seldom lost at sea but are often driven to destruction when they play hide-and-seek with shoals and rocky shores.

Many novices like to sail close to shore “just in case.” This often puts them in significant danger because coastal navigation is much more demanding. There is often more commercial traffic (coastal ships, tugs hauling barges, fishing boats), and the added hazards of fishing traps, nets, and buoyed lines. Near land the wind may be less steady, and if it quits and the auxiliary engine fails for any reason, the yacht can quickly be in trouble.

What is a suitable offing? Five or 10 miles is hardly enough, but the distance you need depends on the strength of the expected storm and its duration. Fifty or 100 miles is better, but the distance needs to be keyed to the area where you're sailing, the configuration of the land, offshore islands, and the likelihood of strong winds (which we can estimate from the relevant pilot chart and weather forecasts that I'll discuss later).

A half-century ago, my friends Eric and Susan Hiscock aboard the 30-foot *Wanderer III* were involved in a frightful Pacific storm between Tonga and Fiji. Their yacht was blown across 120 miles of ocean during the four days of the storm.

If you're going from A to B and have the choice of following an ironbound coast or cutting across on a deepwater route, I would definitely pick the deepwater route.

This is even easier today, since we have the advantage of GPS positions to help us locate our targets with certainty.

As a practical matter, you generally leave port with a reasonable forecast and good weather and are unlikely to run into heavy winds before two or three days. By that time you will generally be well underway and have ample sea room.

The odds are that a storm will not blow directly on shore; most storms are reasonably fast moving and usually change direction in 24 or 36 hours and slide away from a slow-moving sailboat.

Another point about sea room is that a vessel is safer in deep water, because in shoaling depths near the shore, wave action is sometimes quite severe. In deep water, when the wind blows from one direction for some hours, the waves may be high, but they tend to be even and regular. In shoal water, the wave action may be unpredictable and violent. As the depths decrease or you pass over a shoal, the waves may break unexpectedly. Sailors say that the waves are “feeling the bottom.” Try to avoid shallows and shoal water when the wind is up.

If I were short of sea room and was aware that a strong onshore wind was coming, I would not hesitate to use the engine to drive the boat farther offshore. Five hours at 5 knots would mean an additional 25 miles of offing. Some sailors would use the engine to run toward shore “to get in somewhere.” If you have the chart, plenty of daylight, and you know the area, this is certainly possible. But for a stranger or even someone with local knowledge, it's a hazardous move.

HEAVING-TO AND FOREREACHING

By the time we think about slowing or stopping the boat by heaving-to, the wind is 25 knots or more and we have small sails up. The vessel is hard pressed, or perhaps we want to stop the boat to wait for daylight to enter a port. We have tied a slab reef or two in the mainsail, taken a few turns if the mainsail has a roller-furling boom, or cranked the luff rod if the yacht has in-mast furling. We may roll a few turns in a roller-furling jib, put up a smaller jib, or perhaps set a staysail instead of a jib.

Heaving-to is always done on the wind, not when running. This means that it will be easy to deal with the mainsail for reefing.

We tack the yacht and come about. Only instead of releasing what becomes the windward jibsheet when we pass through the eye of the wind, we don't touch it. The boat heads into the wind, but with the rudder offset and without the drive of a properly set headsail, the sailboat slows appreciably and almost—but not quite—stops.

The sails and rudder may need a little adjustment so the yacht rides steadily without heading up or falling off. This may require pushing the tiller a little to

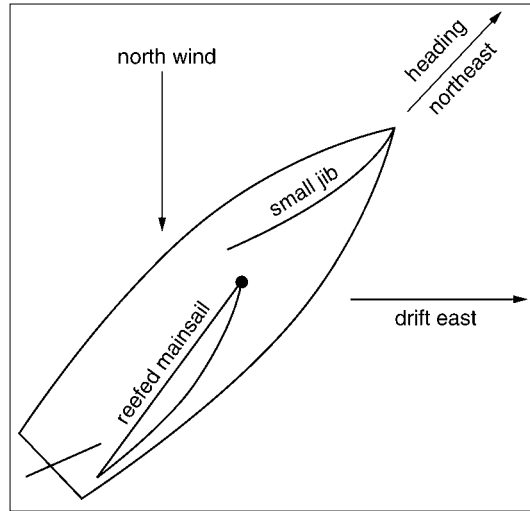

The forces involved when a sailing vessel is hove-to.

leeward (or turning the wheel to windward) so the sideways push of the backed headsail to leeward is balanced by the rudder tending to turn the boat up into the wind.

The rudder gives a turning force one way; the backed headsail pushes in the opposite direction. *Note that for the rudder to be effective the yacht must have a little forward motion. If the boat were stopped dead, the rudder would be useless.* The boat slows and shows only a small wake at the stern. My friend Carol Hasse calls this “parking” a boat.

When hove-to, a boat will usually make a square drift. This means that if the wind is from the north and the vessel is hove-to on the port tack and heads roughly northeast, she will drift east, as the drawing shows.

In the various yachts that I’ve sailed, heaving-to is quick, simple, and positive. One person can do it in a minute or less. Suddenly the boat seems relaxed and quiet; the crashing and bashing and sea noise are cut in half.

If the wind is not too strong (say 25 knots or less from dead ahead) you can heave-to nicely with a large overlapping headsail. Occasionally this is a handy option if you want to stop for an hour to fix something, take photographs, have a meal, or wait for daylight. If you see that you’re drifting toward land, simply come about and reverse everything to heave-to on the offshore tack.

If the yacht is unhappy with her sails and rudder balance, you’ll know it quickly because the sailboat will involuntarily tack, and her calm behavior will be upset by

a violent lurch when the main boom slams over and the mainsail fills with a noisy crack on the other board. You'll need to play with the rudder and maybe the mainsail area. Once you find the balance point, however, the boat will stay calm and quiet. When a yacht is hove-to, she will range ahead slowly at speeds of from 0 to 3½ knots, depending on her size, the hull design, strength of the wind, and sea conditions.

A heavy-displacement, long-keeled design will almost stop, make a course at right angles to the wind, and leave a smooth patch of water (a "slick") to weather. A modern fin-keeled, spade-rudder design may push along at 2½ to 3½ knots no matter what you do. But the angle of heel will decrease, the motion will be easier, and less water will fly around than when she was crashing along at 6 or 7 knots or more.

Traditionalists will laugh at the thought of a boat hove-to making 2 or 3 knots. However, in the real world of today's light-displacement, fin-keeled, spade-rudder designs with big rigs, you do anything you can to keep these featherweights from self-destructing. A deeply reefed mainsail and a small backed jib together with the drag of a partially turned rudder will reduce speed significantly. During the more than 60,000 miles I sailed my Santa Cruz 50 on long passages by myself, I had plenty of time to try out this technique. It wasn't perfect, but the scheme is quick, easy, and effective.

A less-practical variation of heaving-to is sometimes called *forereaching*. In this you take down or roll up the headsail(s) entirely and proceed under the mainsail (usually reefed) by itself. Because yachts are designed with a little weather helm, the yacht under her mainsail will jog along at a knot or two and gradually head into the wind. The boat will slow as the sail luffs, then fall off to leeward a bit before starting the game all over. Exactly how a vessel forereaches depends on her hull design, the strength of the wind, the sea conditions, and the way her rudder is adjusted.

Forereaching seems to work best with steady winds and seas—say a Force 6 strong breeze with winds of 26 knots and waves up to 10 or 12 feet. One trouble with forereaching is that if the waves are a little mixed up or the wind is squally, the vessel may change tacks as she heads up into the wind. The main boom will then slam across as the yacht lurches to the other tack. All this puts a heavy load on the sail and the mainsheet hardware, and the noise and violent motion will enrage the cook and any sleepers below.

When a boat is hove-to with a reefed mainsail and a small backed headsail, there is wind pressure on *two* sails. One is near the bow; the second is aft of the mast. Together the two sails make the force situation more dynamically balanced. The single sail

behind the mast of a forereaching boat makes balance and tracking harder to achieve. This is especially true on a high-aspect, fin-keeled design because of the lack of forward lateral area beneath the water.

Nevertheless, I have forereached many times in a long-keeled boat with just a storm trysail. The yacht jogged along slowly, hour after hour, while the wind whistled overhead.

CHAFE

It's unusual, but during large, slow-moving storms, sailing yachts are sometimes hove-to for as long as three or four days. Depending on how the rig is set up, you should frequently check all over the vessel for chafe, particularly at the clew of the reefed mainsail. If you have tied in mainsail reefs, the reefing pendants often have a hard life where they make a U-turn through the big stainless steel cringles stamped through the leech of the sail.

A good *horizontal* fix is to pass two or three turns of a 10-foot length of $\frac{3}{8}$ -inch-diameter line through the cringle and take it to a fitting at the end of the main boom. Then run a couple of turns of a second short line *vertically* around the boom and through the cringle. With the reefing cringle held firmly by multiple turns of the two short lines, you can ease (but not release) the main reefing line to live for another day.

With a backed jib, there will be a heavy strain on the weather jibsheet, which will probably be jammed against the shrouds. Depending on sheet tension, as the yacht slides up and down on passing seas, this line and the clew area of the sail may move up and down imperceptibly and in a few hours merrily saw themselves to destruction. Tie a bundle of doubled-up rags or slide a piece of heavy split hose around the jibsheet, or put a doubled-up towel or sail bag between the sail fabric and the shrouds. Anything to save the sail and line.

Another idea is to slip a snatch block onto the sheet and run a line from the block to the toerail or anywhere handy. Putting tension in the line will pull the sheet slightly off the rigging. Sometimes you can re-lead the sheet *inside* the shrouds, but that makes one more thing to remember and undo when you start sailing again. If you're hove-to with a staysail or a storm jib, the life of the clew and the sheet may be easier.

In addition, crane your head aloft and look at the sails and running rigging high up. Investigate any thumping, banging, or pinging noises you can hear or feel. It's incredible the damage that a line beating back and forth even a little can do—both to itself and to anything it touches.

Chafe is a sailor's worst enemy and one that's constantly trying to destroy your beautiful sails and cut up your expensive running rigging into shorter and shorter pieces of useless line. For reasons known only to God, chafe always seems to occur in the middle of a piece of new line rather than at the ends. . . .

Heaving-to is a good technique in Force 6 and Force 7 winds and their resultant seas. When it stops working well—either because the wind and seas continue to increase or because your boat and rig aren't well adapted to the tactic—it's time to try something else.

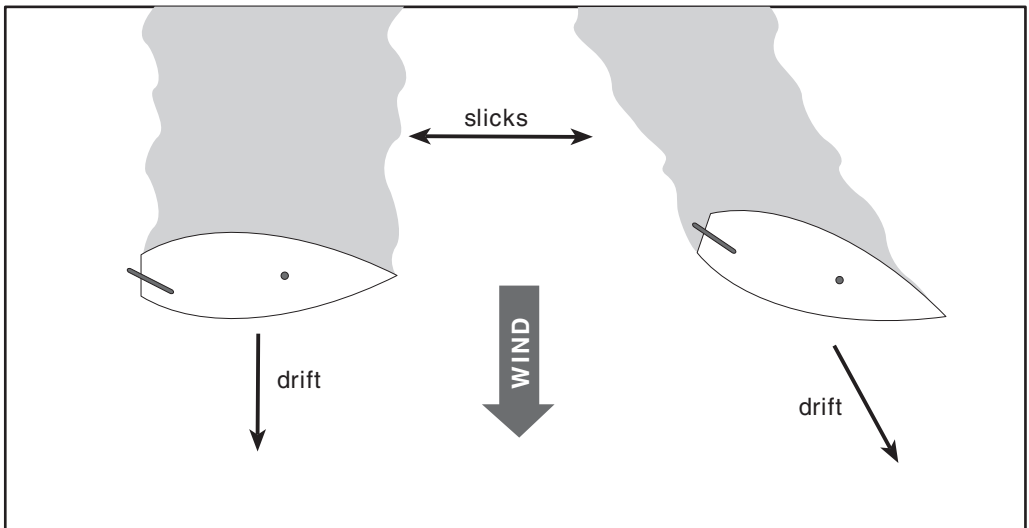

Yachts lying a-hull. The boat on the left is drifting directly downwind and creating a slick to windward. The sailboat on the right is positioned at an angle to the wind. Part of her smooth is wasted, and her port bow area is more exposed.



LET'S LIE A-HULL

When a boat is hove-to under shortened canvas and the wind and seas increase, the balance of the yacht can be upset. The sails may start to shake and the yacht's motion may become nervous and unsteady. Each yacht acts differently depending on:

1. Her hull form.
2. The number of masts.
3. The amount of sail that's up and how the area is adjusted.
4. The windage of the hull, deck structures, exposed dinghies, dodgers, cockpit weather cloths, biminis, furled sails, and so on.

With more wind, the hove-to boat may put half her side deck underwater. She may start to sail faster than you think is safe. Or the yacht may head up and then fall off uncontrollably. Heavy water may begin to thump on board.

Another scheme that can work in Force 7 and 8 and perhaps higher winds, depending on sea conditions, is simply to take down all the sails and let the vessel drift slowly before the storm. This is called lying a-hull. Most boats with their deep underbodies will lie at right angles to the seas and skid downwind sideways at a slow and steady rate.

This sounds terribly dangerous, but if the wind has been blowing from one direction for a number of hours and there is plenty of water depth, the seas are often remarkably regular, and the boat will ride well with the waves broad on the beam. At first the

noise and motion are alarming, but as long as there are no upset or irregular seas, you can get along tolerably well.

In the past, many deepwater small-boat sailors regularly took down all sails in gale or near-gale conditions. The well-known English sailor Humphrey Barton, who made dozens of Atlantic crossings, preferred to remain hove-to under suitable canvas until the wind was strong enough to keep his boat comfortably heeled without any sails up at all.

While sailing from Bermuda to Newport on one trip, the great sailor K. Adlard Coles wrote: "By 2000 . . . [the wind] had attained Force 8 by hand anemometer at deck level, and at least Force 9 on the Beaufort notation which is taken at 33 feet above the surface of the sea. Following my usual practice in gales, all sail was lowered and *Cohoe* lay a-hull all night under bare pole. On deck it was difficult to distinguish between air and water on account of the spindrift and torrential rain. Next morning, Friday May 26th, we were able to get under way again at 0730, running under storm jib."²⁰

Another captain wrote of his arrival on the Atlantic side of the Panama Canal Zone in strong weather:

"We lay a-hull for a few hours to avoid arriving at Cristobal during the night. I was much impressed by the way . . . [the yacht] behaved; I suppose the seas were running about ten feet high and the wind was Force 7, for we had sailed with a strong trade for three days . . . [The boat,] with her helm lashed down and sailing at about half-a-knot from the pressure of the wind on her masts and rigging, tried to head up into the wind, but then fell away, so that she pursued a slow and wavering course on each side of a line at right angles to the wind. Meanwhile she drifted to leeward at about the same speed, leaving a short slick to windward, caused by the water boiling up under her keel."²¹

Speaking for myself, in lying a-hull in a ballasted long-keeled monohull with no sail up to steady the boat, one of my yachts rolled terribly. Many sailors, however, report that the force of the wind keeps their boats heeled to leeward with little or no rolling. I suspect that the motion depends on the beam of the boat, its ballast arrangement, the keel depth, the amount of top-hamper, and the strength of the wind.

The yacht's alignment to the wind can be adjusted to some extent with her rudder. You can lash the tiller a little to leeward (or turn the wheel to windward) to keep the head of the yacht from falling off. Depending on the boat's design, she may even respond well enough to her rudder to lie with the wind 45 or 50 degrees off the bow.

As the boat drifts sideways before the wind, the hull leaves an area of settled water to windward. Sailors call this a *smooth* or *slick*, and it tends to isolate the boat somewhat



from waves that slide past outside the area of the slick. The trouble with the slick, however, is that the yacht has to be carefully oriented to the wind and seas. If the boat gets turned for any reason or the waves increase in size, the protection of the slick is lost.

“I think you’re talking about a separated wake, which is what occurs behind a bluff body as it moves through a fluid,” says Nick Newman, a professor of hydrodynamics at the Massachusetts Institute of Technology and a keen small-boat sailor. “Picture the wake behind your hand as you move it palm-first through the water. It includes a lot of vorticity. If it is organized into large alternating vortices on each side, it is known as a Karman vortex street, but my perception of a yacht lying a-hull is that it will leave to windward a somewhat random and disorganized wake with a lot of small-scale vorticity. You can probably picture what this would be like in smooth water, but in waves it is more difficult to see.

“I can’t give you a simple explanation of why the interaction between the waves and vorticity is beneficial,” says Professor Newman. “However I suppose one could say that the relatively random motions of the wake destroy some of the more organized structure of the wave, especially near a steep crest that is already somewhat unstable and close to breaking.”²²

Professor Newman feels that the word “slick” should be used differently—to denote pouring oil on water. Doing this creates a thin layer of a different kind of fluid right on the surface. This type of interaction with a wave is completely different from the separated wake mentioned above.

It’s well understood that the tactic of lying a-hull works best when the wind is steady and the seas are regular. If you’re 5 miles off a weather shore, for example, and the wind is whistling from the land, the seas will have had no time to build up to dangerous sizes.

Long-time sailor and scientist Dr. John Letcher recently suggested to me that in heaving-to or lying a-hull, sailors should consider the difference between the port and starboard tacks. As a storm progresses, the wind generally changes direction slightly (usually veering—i.e., shifting clockwise—in the Northern Hemisphere) while the seas continue to roll in from the old direction. Unless the drift of the yacht is straight downwind, one tack or the other will send the slick off in the direction the waves are coming from and give the boat a better ride.

“When either lying a-hull or heaving-to,” writes Dr. Letcher, “one tack will put the waves more on the bow while the other tack will put them more on your quarter.” The latter is a lot more comfortable in terms of motion and wetness.

Remember that our little game in a strong wind is to play for time and a change in the weather. With luck, after 4 or 5 hours of lying a-hull, the storm may decrease or move off.

The danger in lying a-hull with the seas broad on the beam is considerable, and you need to make this move with caution and a constant eye on the sea conditions. If the swells begin to get confused, the wind shifts, or the storm increases, the seas may get *out of phase* with one another and become upset and irregular. Then it’s possible that a whopper may break near or on top of your vessel and overwhelm her with tons of water. An argument can also be made for seas that get *in phase* with one another and augment already existing seas. Whatever the cause, we must avoid big seas that thunder on board and strike the side of the vessel.

“Every cubic meter of seawater contains slightly more than one ton of mass,” writes Captain William Kielhorn in *SAIL* magazine. “A breaking sea wave may easily contain 500 tons or more, curling and racing downslope at speeds up to 20 or 30 knots.”²³

Even a small breaking wave is extremely dangerous. Think of a waterfall suddenly landing on top of the vessel and shoving her bodily to leeward. The impact is the same as being dropped on concrete. Damage almost always occurs on the leeward side of the boat and can mean a stove-in coachroof, collapsed portlights, or heavy damage to the

hull. The force of the water can easily carry away pulpits, sails tied to lifelines, dinghies, deck gear, and even the rig itself.

If you're lying broad-on to the seas, and the waves increase in size and the white water around you begins to look and sound nasty, you must promptly stop lying a-hull. If you have the length of the boat parallel to the waves, you present the entire side of the hull to the storm. A much more sensible defensive posture is to run off downwind or take other steps that we will consider later in the book.

If the seas increase in the middle of the night, you must bestir yourself and take immediate action. You must not hope that things will get better or decide to wait until daylight. You need to act at once.

Think of the yacht as a 40-foot log in the ocean. If the log is parallel to the waves and they become dangerous, the log will be rolled over and over. In a large breaking wave, the log may be dropped from the top of a crest all the way to the bottom, perhaps 35 feet. But if the log is kept at right angles to the wave crests by various means, the log has a chance of making it through the storm without being rolled or flipped.

I'll say it again. You must avoid lying a-hull in big seas that have begun to break. When conditions allow you to lie a-hull, it's still unnerving to be in your bunk listening to the seas hissing past hour after hour and wondering whether the weather is getting better or worse. Again and again the seas slide up and then race away with great bubbling sounds. You doze off. When you awaken and look out, you realize the rolling is less and the storm is moving off. The clouds are clearing. There's sunshine here and there! The storm is over. It's time to put up some sails and start moving again.

But if the storm intensifies and you hear a crash in the distance as a big wave topples into a mass of white foam, it's time to bestir yourself. The roar of a breaking wave is a signal to change your tactics before solid water lands on board and begins to push the boat against the solid water to leeward. These signals have been documented many times in all oceans. And probably even more by vessels that haven't come back.

To take one example, consider the voyage of the Contest 31 sloop *Banjo* en route from Bermuda to Greenport, New York, in July 1975. This trim fiberglass sloop with three aboard left St. George's with an excellent weather forecast and made good time toward the northwest for three days. Then on Saturday, July 28, at 35° north, crewman Alfred Boylen heard on the radio that a tropical disturbance named Blanche was headed northeast from Bermuda. Boylen hoped they were far enough to the west to miss the storm.

Unfortunately by 1600 on July 28, Blanche struck poor *Banjo*, and according to Boylen, "We were in it with the wind increasing to hurricane force." The crew went

through the usual sail drill. First one reef in the mainsail and a change from the #1 jib to the smaller #2. Soon the three men took off the main entirely and changed to the storm jib. Finally the crew handed all the sails and lay a-hull.

If we assume that a 60-knot wind was blowing across a 100-mile sweep of ocean, the significant wave height would have been about 35 feet. The distance between crests would have been roughly 390 feet, and one of these big waves would have rolled past *Banjo* every 8½ seconds at a speed of perhaps 26 knots (see the tables in Chapter 2). The average wave height would have been 22 feet; 10% of the waves might have measured 44 feet. Since *Banjo* was lying a-hull and parallel to the waves, her sideways speed would have been very low.

“By 1800 the seas had built to 50 feet or more with many big surfs,” said Boylen. At 1845, he noted, “There was plenty of motion but it was not too uncomfortable.”

Less than 2 hours later, a calamity took place. “About 2000 we felt a big lift, an almost weightless drop, and a sudden stop with a crash that reverberated as though we were inside a kettledrum,” said Boylen. “A second later another shudder ran through the ship along with a slashing roar as the crest of the wave from which we had dropped fell on top of us while we lay in the trough. We estimated that we had dropped 50 feet on our side from a crest into a trough.”

My interpretation of this mishap is as follows: The yacht was picked up and fell off the top of wave A, which continued to surge ahead at 26 knots and was gone. The boat then plunged into the trough between waves A and B. “A second later” (8.5 seconds?), crest B fell on *Banjo*. Or could these enormous waves have been out of sync and closer together?

Recall that earlier we calculated the time and distance between the crests passing *Banjo* at roughly 8.5 seconds and 390 feet respectively, so in 2 seconds, crest A would have moved 92 feet beyond the yacht. In 4 seconds it would have moved 184 feet. Then “a second later” (46 feet), a waterfall from wave B fell on *Banjo*. This plus the first drop caused fatal damage.

The truth is that we don’t have enough facts to know what really happened. Boylen said “a second later.” Was that literally 1 second, or was it 8 seconds? We’re told that “we felt a big lift, an almost weightless drop, and a sudden stop.” Certainly there must have been time intervals between those events. But how long were they?

The men in *Banjo* were being speeded up, slowed down, and rotated all the time and probably had no idea of the vessel’s orientation at any given moment or which waves were doing what.

“Unfortunately,” says sailing authority Ed Boden, who reviewed this incident, “both the estimation of distances and the exact description of events during a critical moment

in a storm are highly suspect. Certainly at that moment no one was looking out of the main hatch with a stopwatch and a video camera.”*

Poor *Banjo* was severely damaged. Her rudder was jammed, and water came in from a 6-foot-long fore-and-aft split in her fiberglass hull next to the rudder skeg, the vertical appendage to which the front of the rudder was attached. In spite of three pumps, the crew couldn't keep up with the inflow of water. The men set off an emergency position-indicating radio beacon (EPIRB), which brought a U.S. Coast Guard plane that dropped a powerful gasoline-driven pump. By 1000 on July 29, the pumps were dealing with the water, the storm had moved away, and the weather had turned fair.

Unfortunately the split in the hull was worsening. It was impossible to steer *Banjo*, and she was still 300 miles from the nearest port. The Coast Guard asked a big ship to stand by, and 16 hours after the mishap, the three men abandoned the yacht.²⁴

In a long postmortem discussion, the owner of *Banjo* believed that the Dutch yacht was well constructed, but he faulted the builder on the way the hull and rudder skeg were laid up separately and then glassed together with a secondary bond. When *Banjo* fell off the breaking wave, the skeg apparently took a massive blow. Additionally, the skeg may have acted as a lever where it was attached to the hull.

It is the contention of this book that the forces involved between breaking waves and yachts are far greater than owners of small vessels realize. My feeling is that no vessel—large or small—can be expected to survive 50-foot drops and avalanches of water without significant damage, even if the hull is built of welded steel. In my judgment, the crew should have run *Banjo* off before the storm or taken more aggressive action. To deal with breaking waves we need to refine our storm management techniques. If *Banjo* had been lying bow- or stern-to the wave that smashed the yacht, she might well have survived without damage.

It was just 50 years ago that Miles and Beryl Smeeton sailed from Coronel, Chile, in their 46-foot ketch *Tzu Hang*, which they had laboriously rebuilt after a terrible smash before a huge wave in the Southern Ocean. The Smeetons were keen to make it around Cape Horn on their second attempt, but at 48° 30' south, about 300 miles west of Golfo de Peñas, the barometer dropped to 950 millibars and a fierce Force

*This incident has an uncanny resemblance to the foundering of the 55-foot *Winston Churchill* in the 1998 Sydney–Hobart race. Another source is a 2-minute video, given to me by Don Jordan, in which a Coast Guard helicopter from Miami is over a large yacht that is sideways to a breaking wave and gets smashed. Both incidents reinforce the wisdom of not riding parallel to breaking waves.

10 storm from the northwest began to rage. Following advice given to them by the Chileans in Coronel before they left, Miles handed all sail and lay a-hull. Initially it was satisfactory, but as the seas built up and the two sailors heard the monsters roaring past, their situation grew more dicey.

At 1600 on December 26, a breaking wave roared down on the white-hulled ketch lying with her side exposed to the storm. Like *Banjo* in the preceding account,

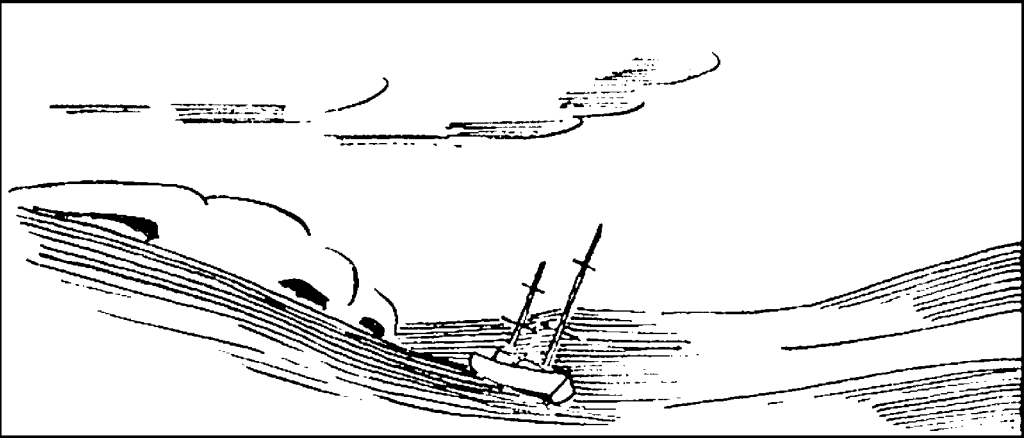

1. Caught by . . .

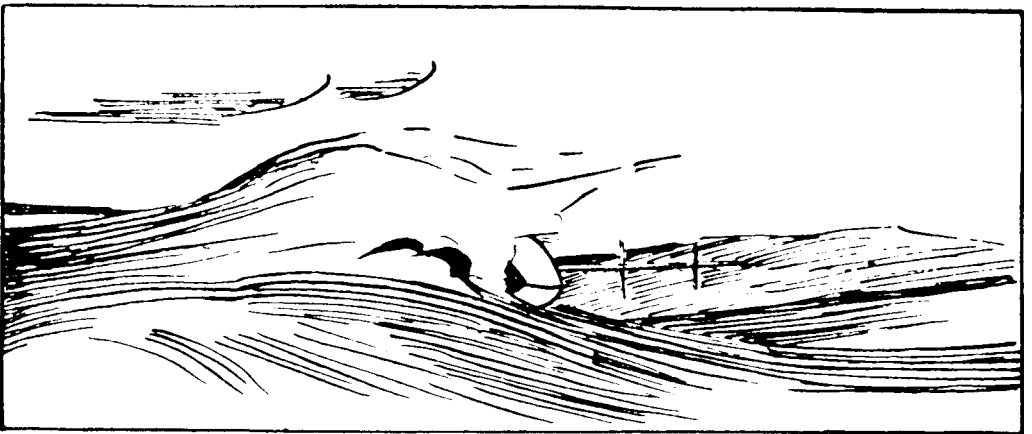

2. A breaking wave . . .



3. *Clean over . . .*

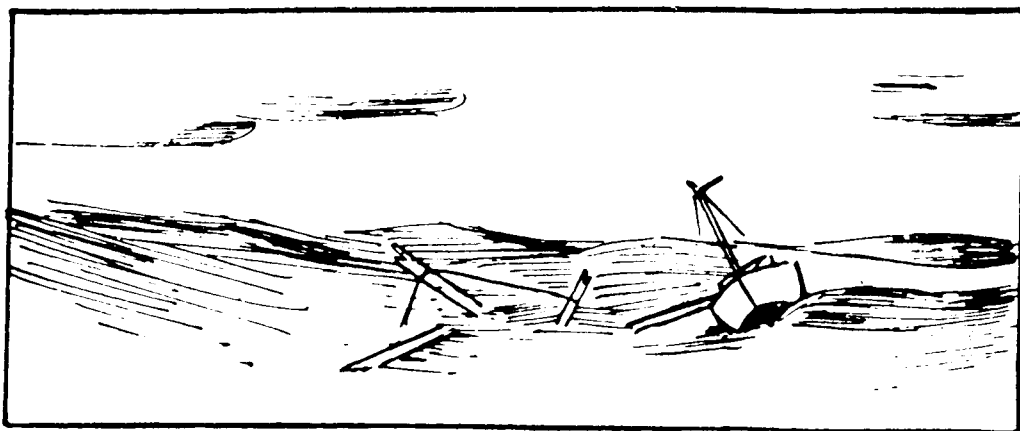

4. *Upright again, with wreckage to windward.*

the collapsing wave capsized the yacht and caused great damage; the smash broke each mast into three pieces.

The Smeetons managed to set up a small jury rig, and with a fair wind from the south sailed north for 1,200 miles to Valparaiso. Later Miles made these four drawings, which have a nice feel of realism about them since he was on board. Never again did he lie a-hull when there was a danger of breaking waves about.



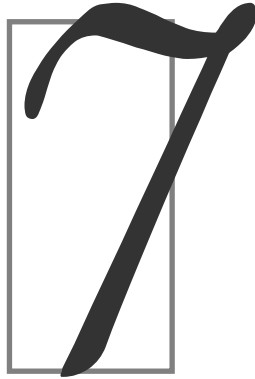

RUNNING OFF

When there's too much wind for heaving-to or lying a-hull, the next step is to run off. It's no mystery when this is necessary. By now the sea has become lively and you hear big waves crashing and breaking in the distance. Heavy water has begun to thump on board and the situation is scary. The world around the boat has increased in violence and you need to do something.

The only good thing about this alarming scenario, at least in my experience, is that storms violent enough to make you run off are usually fast moving and spin away in a day or two. Then it's back to normal sailing.

In large, chaotic seas, sailors usually decide to turn tail and flee before the tempest simply because it's the easiest thing to do. You don't need any special equipment or techniques; just steer downwind and keep the stern dead before the overtaking waves. Or maybe a little to one side or the other—whatever works and keeps heavy water from thudding on deck. The advantage of running downwind is that you point a narrow and less vulnerable part of the boat toward the storm, and you're going *away* from the waves.

Often when you run off, the wind may be blowing toward your target, perhaps hundreds of miles ahead, and the storm may boost you on your way, which of course is

Running hard to the east in the Gulf of Alaska, August 1968. The mainsail is down and the boat is going along with a small cotton storm jib. We're in the trough of a wave just after the crest has passed.

good for your progress and self-esteem. Conversely, if you are running off and traveling away from your destination, you will want to sail as slowly as possible.

It's imperative to have plenty of sea room when you're running off. If there are rocks or an island ahead, you may be able to fudge your downwind course a little to miss the problem. The last thing you want is to run into something.

Running off in a sailing vessel is certainly nothing new. The Bible tells us (Acts 27) that when St. Paul and other early Christians were arrested in Jerusalem in A.D. 58, they were eventually put on a grain ship from Egypt that was headed for Rome. The big ship—with 276 people on board—sailed late in the season from the south coast of what is now Turkey.

Because of poor weather the captain tried to winter on the south coast of the island of Crete, but the port he selected was unsatisfactory. The captain then attempted to move his ship to a more suitable harbor farther west along the south coast. Once he got underway, however, the wind changed and his only option was to keep going and try for Rome. The grain ship headed west and ran off before fresh east-northeast winds. Two thousand years ago, position-keeping was primitive, and after sailing 500 miles the ship on which St. Paul was a passenger piled up on the east coast of Malta on an inky black night. The year was A.D. 60.²⁵

SHORTENING SAIL

Today most yachts are Bermuda-rigged, with triangular sails for both the mainsail and jib. The jib, genoa, or staysail is attached to the headstay or forestay with ordinary clip-on metal hanks or with a luff tape that's part of a roller-furling gear. The latter includes a small rotating drum with a wrap-up line that controls the rotation of the furling gear. To reef a roller-furling headsail, you roll up the sail a number of turns by putting the furling line on a winch and cranking away. The shape of the sail may not be perfect, but if there's plenty of wind and you're running off, it doesn't make much difference. It may be helpful to move the sheet block forward as you wind up the sail.

If you're heading directly downwind, a headsail will be largely blanketed by the mainsail; the jib or genoa flaps about uselessly behind the mainsail and makes terrible banging noises as the sail fills with wind and then loses it.

You then have two choices, depending on how much sail you want to carry. You can douse the headsail completely or hold it out on the side opposite the mainsail with a spinnaker pole. Or, depending on the size of the sail, you can use a smaller whisker pole, which is easier to handle than a spinnaker pole and needs no guys. A poled-out sail will balance the rig nicely, but if the wind increases you may have to take down the pole and sail. Handling spinnaker poles in heavy weather is certainly part of the game.

It's necessary and you can get quite good at it, but there's some effort and a little risk involved.

Using the mainsail alone as an alternative technique may work just as well. The eased main boom should be held down with a vang or a strong tackle (which I prefer). A line from the end of the boom to the stemhead or windlass will keep the mainsail from gybing. Sometimes you can speed along downwind for days with just a deeply reefed mainsail.

Most people reading this are familiar with the fundamentals of reefing a mainsail, and the subject is well covered in Chapter 4. What's not so well known is how to deal with the mainsail when you're running off downwind, the wind is increasing, the sail is plastered against the lee shrouds, and you desperately need another reef.

If the boat is running hard in big seas, there's no possibility of rounding up into the wind to drop the mainsail for reefing. What to do? My answer is to pull the sail down while it's full of wind. Since I'm not strong enough to do this by hand, I use a winch. On my 50-footer I worked out the scheme of reaching up with a 15-foot length of $\frac{5}{16}$ -inch-diameter line, slipping it through one of the luff reefing cringles, and securing it with a bowline. Then, with the line hanging down vertically, I put a few turns on a halyard winch and crank it a turn or two.

The slides and sail (which perhaps already has one or two reefs) groan and protest and then suddenly come down. The extra power of the winch is enough to do it. Sometimes I have to climb up a few feet to reach a suitable luff cringle, so I stand on a mast winch or the lowest mast step so I can reach high enough. Afterward I generally untie this extra line because there are already a mass of lines on the mast and boom.

I've done this hundreds of times and it always works (unless I forget to release the halyard). If there's a squall and the sail is really jammed against the lee shrouds, I have learned to help my cause by pulling in the mainsheet a little or turning the boat slightly (with a windvane, an autopilot, or a crewman in the cockpit) to reduce the pressure on the sail. But in general, and without risking damage to the mainsail, a small amount of winch power applied to the luff in this fashion will bring down the sail for reefing. Or even all the way down if you want to drop the entire mainsail.

To lower a large jib secured to the headstay with hanks, simply ease the halyard little by little while keeping a turn around a winch or cleat so the sail doesn't take charge. If there's a lot of wind and the sail begins to flog, it's a good idea to drop the sail partway and secure the halyard. Then wrap a couple of 4-foot ties around the parts of the sail that you can reach to squeeze the sail together. Once you have the sail on deck, unclip the hanks, stow the sail below, and hoist something smaller. I suggest that you put the

sail below so it's out of the way. Try not to have two unsecured sails on deck at the same time; while you're concentrating on one, a squall can sneak up on you and whisk the other sail over the side. And never tie a sail to the lifelines, because a boarding sea can easily fill part of the sail and knock the lifeline stanchions flat.

If the headsail is held to the headstay with a luff tape, you need to be even more careful when lowering it in a storm. Try to keep a turn of the halyard around something so the sail doesn't come swishing down out of control and zip over the side. (Yes, it has happened to me.) I've found that if I partially drop a sail with a luff tape and belay the halyard, I can get a tie or two around part of the sail to help control the beast.

If you're rolling up a roller-furling sail in stormy conditions, keep a little tension on the sheets when furling. This will make a tighter furl. When done, let the sheets go around the furled sail a couple of times. The wind can get into a loosely furled sail and cause thorny problems as we've seen.

In strong winds, a tiny hanked jib or staysail up forward will help the yacht stay on course. If the boat is still overpowered, try dropping most of the sail and show just the head.

The next step is to drop everything and go to bare pole(s). A Force 9 strong gale (41 to 47 knots) should push a vessel downwind at 5 knots or so with no sails up. If the boat goes slower, the wind may not be as strong as you think.

When you're running off downwind in a modern yacht in stormy weather and there's a problem to leeward, you may be able to angle your course slightly to steer clear of an island or landmass. If you have daylight, a good chart, and are steering carefully, you may even think that you can work yourself into a sheltered bay or river. *Don't try it*, because big waves may be breaking at the entrance. The thing to do is to stay at sea until the storm moves away. Then wait a little until the sea goes down. Carefully check your route ahead with binoculars, and *then* make your entrance. If you have any information about the tidal stream, *high slack water* may be the best time to enter the bay. You may be able to determine high and low water by using binoculars on marks on the land and beaches. If a local pilot is available, by all means hire him.

Remember that if you use reasonable management techniques, you will seldom get into trouble at sea. It's around land where you can lose everything.

Even if the weather is stormy, running off with strong following winds will often allow days of wonderful and exhilarating sailing. It's exciting to hurry along at a boat's maximum speed for watch after watch. The yacht will lift up and rush forward in a torrent of white foam as the crest of each wave whooshes past. Then the boat will pitch down a little as she slides into the trough beyond. These two steps (up, down; up, down) will be repeated hundreds of times as the sailboat hurries to her

next destination. Such sailing is glorious and fills you with admiration for the sea and love for the sport.

If the wind continues to freshen, however, there finally comes a time when the boat speed increases and the yacht begins to hesitate on the top of each sea and surfs forward with the wave. Water begins to slop on board. The steering becomes more demanding, and as the vessel rises on a wave, she may try to round up beam-on to the seas. This tendency is called *broaching*. If this happens and the yacht is caught by a breaking crest, the boat could roll over sideways with disastrous results.

“It is one thing to run full bore down the rapids of the Colorado River, where the entire field of water is moving. It is another thing to run full bore in a gale at sea, where the field is more or less stationary . . .” writes Victor Shane. “In every gale there is the *perception* that the whole field of water is actually moving. Because of this . . . there is often a false sense of security associated with running downwind.

“One gets the feeling that one is ‘going with it.’ . . . Not only is this perception false, but the false sense of security it evokes can be quite dangerous. . . . Falling off a crest in the rapids of the Colorado may be harmless enough—rafters do it all the time, grandma and the kids squealing with delight. Unfortunately, falling off a wave at sea is an entirely different proposition. It is very dangerous . . . because the yacht does not land in a cushion of water that is moving at the same speed as itself. Rather it usually does a belly flop into a concrete wall of stationary green water. Remember doing that first painful belly flop off the diving board at summer camp? . . . Then you will understand why so many sailboats have received near death blows after falling off waves at sea.”²⁶

When a yacht sailing at speed begins to turn sideways, her broaching tendency is increased by the broad surface of the lee bow pushing against the water. In addition, the particles in the trough are moving against the hull. (Recall that water particles at the crest revolve forward; in the trough the particles go backward. See page 10.) Broaching can be countered to some extent by putting up a little sail forward to help pull the yacht downwind. This sail will also help to keep the boat on track.

When you’re running off and (1) the waves sliding up astern begin to look particularly steep and threatening, (2) green water is beginning to fall on board, and (3) the steering is becoming dicey, it’s time to shorten sail again. I’ve found that when I do this, the nasty-looking waves sliding up behind the boat look less menacing.

Nevertheless, reducing sail is a delicate business that I feel is best done little by little. Beginners, sometimes overestimating wind strength, tend to reduce sail too much at one time, which can result in an undercanvased boat that tends to wallow and allow poor control. You want to maintain the zip and drive that keeps the yacht going nicely, but short of broaching tendencies. This suggests that yachts heading for potential

stormy areas might consider breaking up the area of a genoa into a jib and a staysail, which will allow more sail choices and easier sail handling. A ketch, yawl, or schooner has many advantages in this regard.

Let's consider the wind when you run off. Once you begin moving with the wind behind the yacht, the storm seems a little less violent because the wind strength (say 45 knots) is diminished by your speed (say 7 knots). Thirty-eight knots may seem only a trifle under 45 knots, but in truth the wind force is *25% less* because wind forces vary with the square of their velocities ($39^2 \div 45^2 = 0.75$). In addition, now you're going *with the waves* and not into them or across them as you are when you have the vessel hove-to or lying a-hull.

When running off downwind I've had reasonable luck with steering by using a windvane steering device or a small autopilot. Sometimes with a little sail forward, the boat will steer herself. "Hand steering in heavy going," writes Ed Boden, "aside from being wet and usually cold, is fatiguing and leads to bad judgment. I don't recommend it for shorthanded sailing and especially for singlehanders."

When you're running off, you want drive from a sail as far forward as possible. Hence a storm jib or a staysail is better than a storm trysail or a deeply reefed mainsail hoisted farther aft on the rig. But any sail you can carry will help the motion and improve life aboard.

"I often ran off without sail, using windvane steering," writes circumnavigator Ed Arnold. "It's easy to get up to 6 or 7 knots in a Force 8 or better. Fine, if I wanted to go in that direction. . . . I remember three days sailing west around Cape Horn when I went in a circle and wound up back where I started!"

A time may come, however, when you're running off and the boat goes too fast without any sail up at all. You're under bare pole and the steering is difficult and maybe getting worse. How do you slow down? You begin dropping drag devices over the stern to slow the boat, or you turn the bow of the yacht into the wind and fall back on a parachute dropped into the sea. Both of these actions are complicated subjects that I will examine in subsequent chapters.



Part Three

**RESPONDING
WITH
OFF-BOAT
CONTROLS**

We're about to consider a second group of storm management tools that will keep the bow or the stern into the wind and seas in storms of Force 10 and higher. This means 48 knots and more, although many sailors will have deployed a parachute or drogue when the wind was much less.

This is a good place to stop and summarize what we've been through up to this point. To be realistic, few sailing yachts meet storms stronger than a sustained Force 9 strong gale (41 to 47 knots) unless they choose to go sailing during bad seasons in windy places or have incredibly bad luck.

To recap a little, in Chapters 4 through 7, I discussed four *onboard control methods*, and suggest the following:

1. Carefully reef the mainsail and reduce headsail area up to Force 6 (22 to 27 knots).
2. Heave-to with small sails up to Force 7 (28 to 33 knots).
3. Lie a-hull with all sails down and with a sharp eye on the steadiness of the seas up to Force 8 (34 to 40 knots).
4. Run off up to Force 9 (41 to 47 knots) with concern about adequate sea room. You might set a scrap of storm jib to help you on your way.
5. Now we'll add a fifth category that I call *off-boat control methods*. These schemes stop or slow the boat in winds of Force 10 (48 to 55 knots) or more. This involves either a parachute sea anchor, whose main line (or bridle) comes in over the bow, or we'll consider a drogue, whose main line (or bridle) comes in over the stern. These devices are powerful, but their use requires a little study because they function in opposite ways.

The following six chapters deal with this specialized equipment for category 5: three for parachutes (Chapters 8, 9, and 10) and three for drogues (Chapters 11, 12, and 13). Each section describes the basic concept, details of the equipment, and how it has (or has not) worked for a number of sailors in frightful storms at sea. Even if

you've already decided on what steps you will take in storms, I suggest that you read these chapters because you might pick up an idea or two.

A following chapter (14) sums up what I've learned and what I think is the easiest and best. Some readers and makers of off-the-boat equipment may not agree with my recommendations, and I'm quite aware that there may be several ways to reach the same endgame, which is to keep the boat and her crew safe. Nevertheless, I feel bound to make a few suggestions about off-boat control devices.

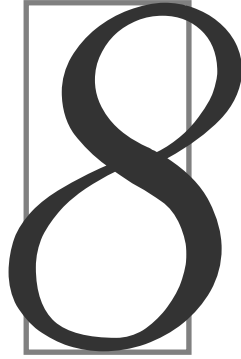

WHAT IS A SEA ANCHOR?

The concept of a sea anchor for small vessels in storms is as old as seafaring itself. The idea seems to have come from the notion that if all else fails, the crew can tie a bundle of oars, masts, poles, awning battens, and anything that's handy on deck to the end of a long line. Then if the people on board toss this collection of odds and ends over the side and lead the line to the bow, the boat, being larger and with more wind resistance, will blow downwind faster than the sea anchor. The floating sea anchor will tend to hold the narrow bow of the vessel up into the wind. The idea is that the whole procession will then slowly drift downwind directly in-line with the axis of the storm.

In theory, if the smooth and streamlined bow is headed into the wind and is held in this position by the sea anchor, the boat will be set up in the best possible manner to ride out the storm. The efficiency of this scheme depends on the drag of the sea anchor, which is just awash or a little below the surface.

As far as I can find out, the use of sea anchors on yachts and fishing boats in modern times is largely due to a book written by Captain J. C. Voss in 1913. Voss was a professional Canadian sailor who in 1901, when he was 47, took one crewman and spent a little over 3 years sailing a small boat from Victoria, British Columbia, west-about to England, three-quarters of the way around the world.²⁷

Voss's vessel was a long, slim, decked-over log canoe (with slightly built-up topsides and a cabin) named *Tilikum* that was driven by a small three-masted gaff rig with a total sail area of just 230 square feet. (The four sails ranged in size from only 39 to 79 square feet.) The boat was 38 feet long (including the figurehead); her beam was an

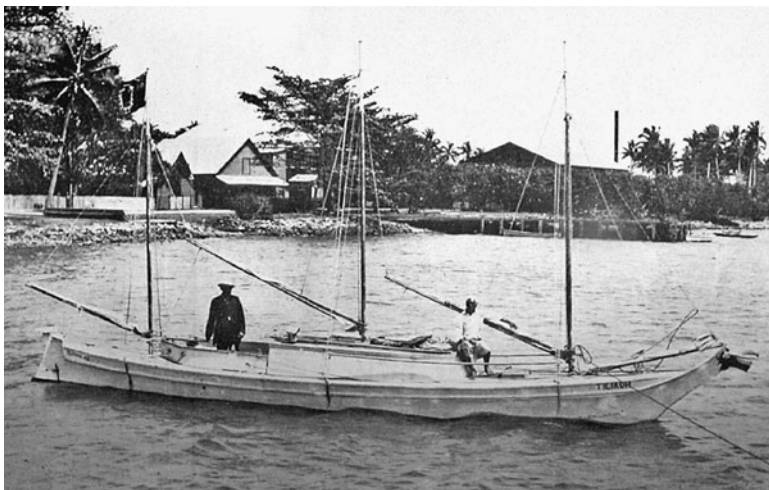

The jaunty Tilikum in Apia, Western Samoa, in 1901, with Captain Voss at the tiller. It had four very small sails.

ultra-skinny 5 feet 6 inches, and she drew just 2 feet. *Tilikum* was hacked out of a red cedar log, stiffened with oak frames, floors, and a keelson. She was ballasted with 1,700 pounds of sandbags and lead.

During his trip, Voss dealt with gales by tossing out a cone-shaped canvas sea anchor (22 inches in diameter with a bag 4 feet long) from the bow of *Tilikum* and striking all sail except for a small riding sail hoisted astern. According to Voss's book, *Tilikum* lay nicely with her head to the wind and stayed within a range of $2\frac{1}{2}$ points (28 degrees) of the wind's direction. Meanwhile the Canadian captain and his crewman went below to rest and smoke their pipes.

Tilikum lay successfully to her sea anchor dozens of times during the voyage. Much has been made of Voss's technique, and his name is always brought up when sea anchors are mentioned to prove how good they are. Unfortunately this argument is quite specious today because the designs of modern sailing yachts—whether long-keeled or with a fin keel—are completely different from the shallow-draft, narrow-beamed, low-rigged *Tilikum* of a century ago.

Voss's boat had the hull form of a canoe or a lifeboat, which have the same windage and draft forward as aft, whereas the hulls of practically all modern high-performance yachts are significantly different. Today's boats have (1) more underwater area aft than forward, and (2) their tall rigs have greater windage forward than aft. The combination of (1) and (2) tends to turn a boat at right angles to the wind and exposes her vulnerable

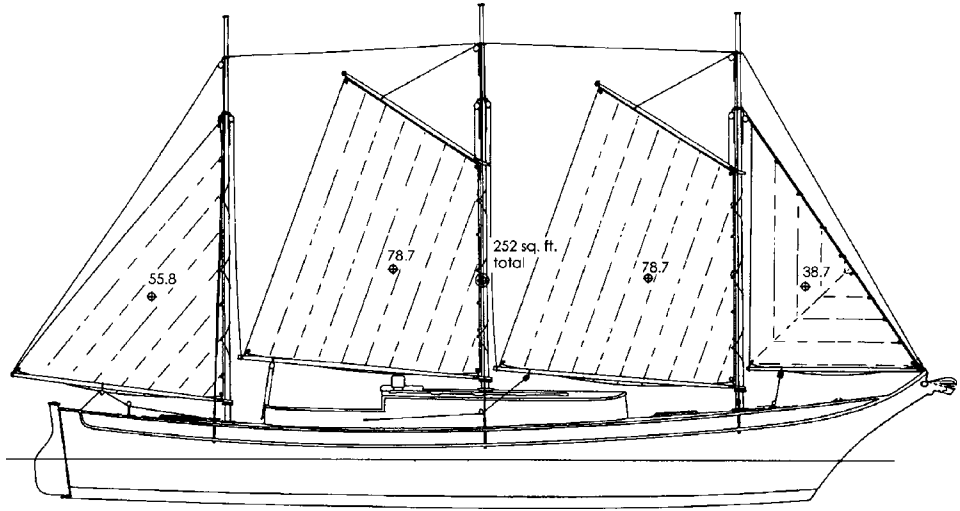

Tilikum had a long straight shallow hull form topped by a small sail plan. Her windward performance was poor, but according to researcher Nicol Warn (who made this fine drawing) she could reel off 100 to 150 miles per day in a moderate sailing breeze off the wind.

side to the fury of a storm. This is about the same orientation as when lying a-hull, as discussed in Chapter 6, only we're now considering storm management in stronger winds.

Captain Voss's concept and rules were useful for the yachts and long-hulled sealing schooners of his era, but in the 21st century the designs of our sailing yachts are quite different.

W. A. Robinson, another sailor of vast experience, points out that Voss unwittingly gives innumerable arguments against sea anchors, which a careful analysis of the latter part of his book will reveal: "Not the least of these is the fact that after all his experience with *Tilikum*—which never met the ultimate storm—he was unable to provide a sea-anchor that would stand up when he finally did meet it years later in *Sea Queen*, a yacht of only 19 feet water-line."²⁸

The authority Eric Hiscock agrees that Voss's *Tilikum*, with her balanced hull form and windage and a small riding sail at the stern, will ride well to a sea anchor.

"A normal [modern] yacht," writes Hiscock, "drawing more water aft than she does forward, and having greater windage forward than she has aft, will not lie like that. No matter how large the sea-anchor, she is bound to make sternway; her bow, having less grip than her stern on the still, deep water, is more affected by the wind, breaking crests

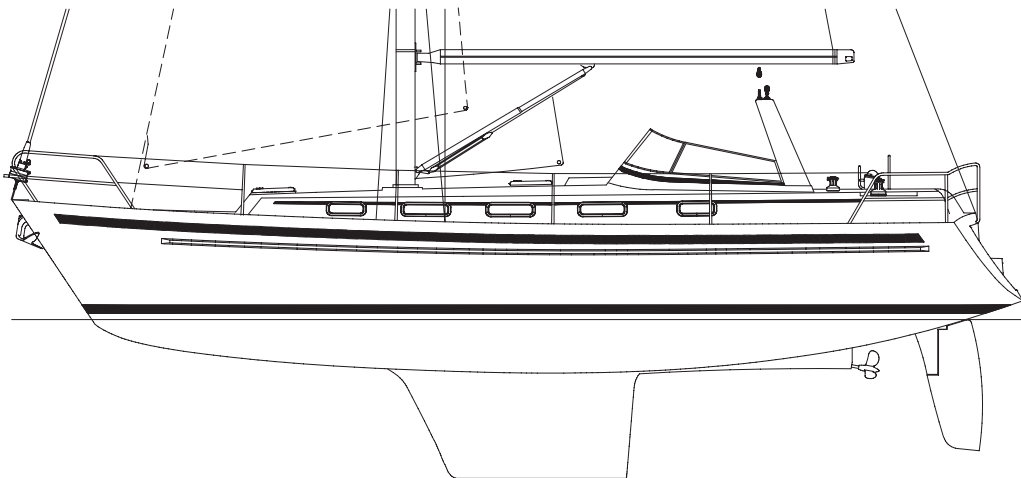

The 2006 Swedish Malö designed by Hans Leander. A typical modern design with three times the draft of Tilikum. With no sails up, this yacht will turn away from the wind, pivoting on her underbody because of the resistance of the mast and forward rigging.

and surface drift, so that it falls off to leeward; the hull pivots on its heel, and eventually [the boat] takes up a position more or less beam on to wind and sea, just as it will when lying a-hull. If a riding sail is set aft and sheeted flat, the position may be improved, but even then the yacht will not lie head to wind, though she may come up occasionally and fall off on the other tack, the sail flogging dreadfully at times, and the strain on the rudder caused by sternway being great.”²⁹

Sailors can help their cause by setting a small riding sail on a mizzenmast, or they can hoist a tiny storm jib immediately forward of the mainmast backstay to help turn the ship’s head toward the wind. But if the ship’s heading changes with passing seas, such a sail may flog itself to death while the noise threatens the crew’s sanity.

Earl Hinz suggests a better idea: a wedge-shaped riding sail that will always exert some sideways force no matter how the yacht moves in relation to the wind. The head of this small sail can be held in place with a shackle around the backstay and hoisted with the main halyard. The tack can be secured to the main boom or fittings in the cockpit or on the coachroof. The port and starboard clews of the V-shaped sail can be held apart with a boathook or a scrap of wood. Two short lines from the clews downward to aft mooring cleats or elsewhere complete the job.³⁰

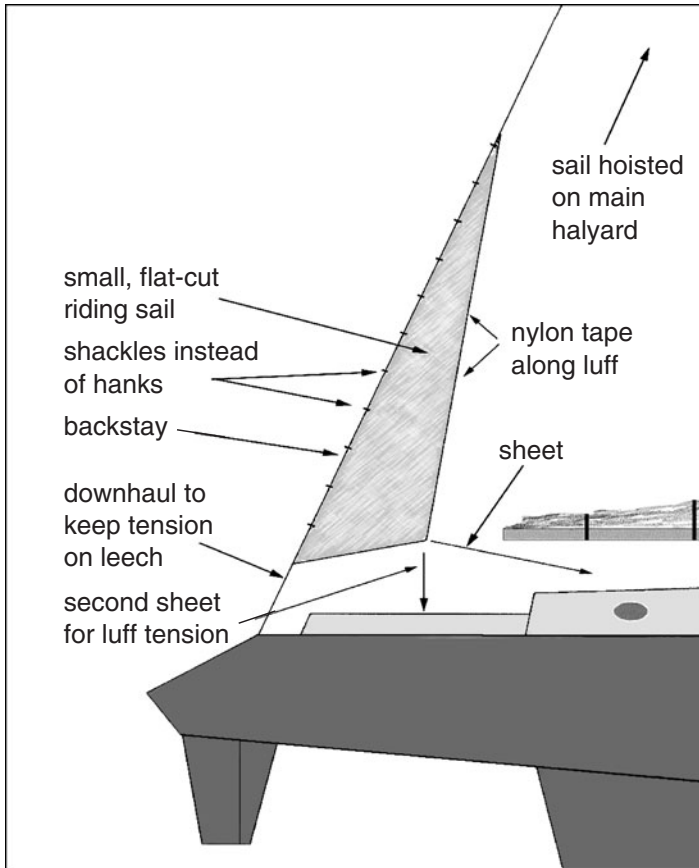

This scheme for a storm-riding sail employs a single small sail. In strong winds the problem is to keep the sail from flogging and destroying itself. It may be useful to reinforce the luff with nylon tape and to use two sheets. Area? Take three-quarters of the length of the yacht and use this number as the square footage. This means 38 square feet for a single sail for a 50-footer, etc. For a V-shaped sail, double the figures.

In New Zealand, the firm of W. A. Coppins in Motueka has sold large numbers of these wedge-shaped riding sails to commercial squid fishing boats. “The sails are set at 30 to 40 degrees to the centerline of the boat,” says Bill Coppins. “The two sails create a wedge shape that kicks the boat back into the wind as soon as the vessel wants to point off.”

John Armitage wrote me about a wedge-shaped riding sail that he made in Norway for his 38-foot sloop in 1979. “I first tried using an ordinary storm jib,” says John, “but

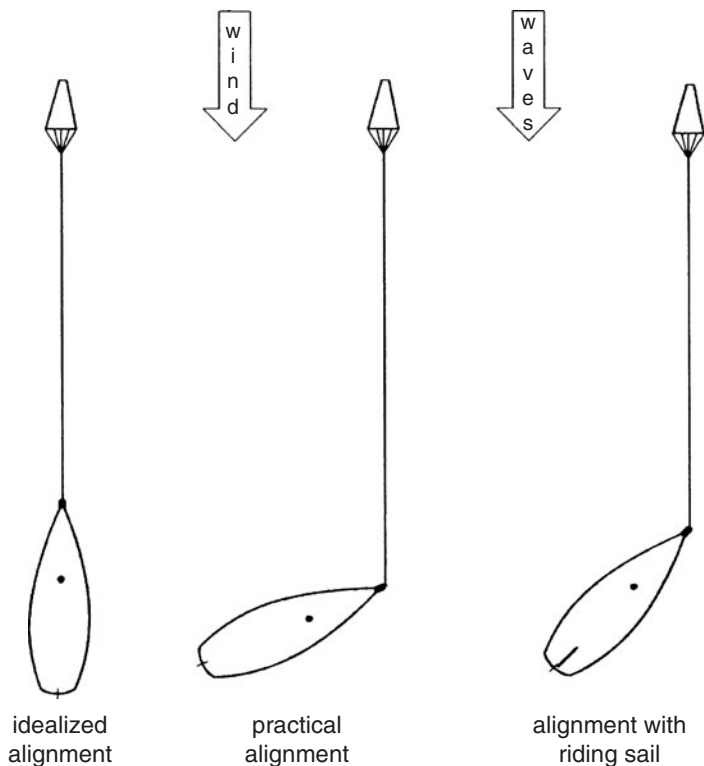

Modern yachts lying to a cone-shaped fabric sea anchor. Left: The optimum position, head to wind, is seldom achieved. Middle: Normally a sailing yacht will take up a position at 70 degrees or so to the wind. This puts the vessel in a poor position relative to waves. Right: The addition of a riding sail improves the angle, but the yacht is still vulnerable. The small sail at the stern has a hard life in strong winds as the boat dances around on passing seas.

found that it slammed badly when the wind went from one side to the other. The sail shook the whole boat. Really bad. Overall, it seemed worse than no riding sail at all.

“Then I noticed that the Norwegian fishing boat riding sails were built like a V-shaped wedge, with the sharp edge of the V into the wind. I sewed a V-wedge sail of heavy sailcloth with strong edge taping. I hoisted this little sail with its V-luff—stiffened to be about 2 inches broad—low on the backstay, with the two clews leading outboard to the port and starboard quarters. I used a generous roach on the leeches and feet. When I tightened everything, the little sail sat there in all winds without a twitch. The slamming was gone and my new riding sail made a miraculous reduction in sheering back

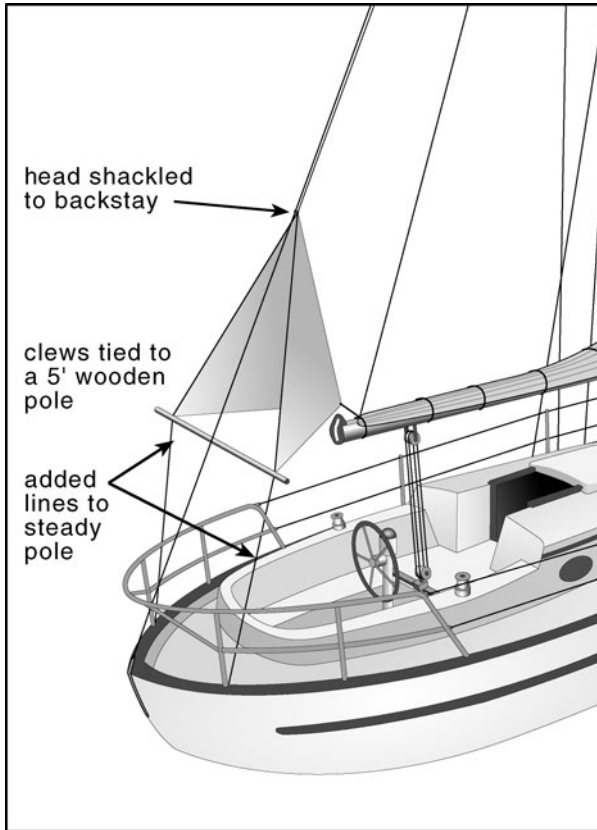

An alternative to the Hinz sail (above) might be to construct a riding sail entirely of thin plywood with the blades held in position with a wooden crosspiece. The plywood sail could be hoisted and kept in position the same way as the Dacron sail in the illustration. The wooden sail would be cheaper than a cloth sail, more durable, and when not in use could be knocked down and stored flat in a locker. In an emergency, extra plywood could be a godsend.

and forth at anchor in gusty winds. The sail not only reduced the load on the anchoring system, but it made the entire ride much calmer and less worrisome.”

Fishing boats, motor vessels, and multihull sailing yachts that have long straight keels present more balanced hulls to the sea and have a greater chance of heading into the wind and waves, particularly if they use a bridle with a parachute sea anchor. Earlier I mentioned that more than half of a modern sailboat’s lateral area below the water is aft of amidships, particularly when you consider the rudder.

Additionally, a sailing yacht has lots of windage up forward because of her single forward-located mast (sloop or cutter) and bulky roller-furled jib at the bow, something that 90% of sailboats carry today. The combination of the aft keel area and forward windage combine to turn the sailing yacht away from the wind. This exposes the vulnerable sides of the yacht to a breaking wave.

“Then,” writes the veteran Maurice Griffiths, the long-time editor of *Yachting Monthly*, “the merry, sparkling sea—which tops the scales at 64 pounds for each cubic foot, or 35 cubic feet to the ton—can be about as friendly as a ton of wet concrete when it chooses to break over a small vessel.”³¹

“This is exactly what happened to me during a violent Pacific storm,” said New Zealand sailor Ross Norgrove when I saw him in Tortola in 1985 and talked with him about his experiences with the sea anchor that he deployed from his 11-ton sailboat



John Armitage's Hale Kai in Norway showing the V-shaped riding sail he devised after talking with local fishermen. Although John speaks of hoisting the riding sail on the ship's backstay, this photograph shows the head raised by the main halyard and the tack of the sail held in position by a line to the mast.

White Squall. "As soon as we streamed the sea anchor at the bow, the yawl turned sideways and I knew it was a disaster."

Since today's typical long-distance cruising yacht is 42 or 43 feet long, a suitable conical sea anchor would have a mouth about 30 inches in diameter and a bag 5 feet long. It would be made of heavy Dacron, and the mouth would be supported by a stainless steel ring hinged for folding so the sea anchor could be collapsed for stowage. Six or eight small lines would be spliced around the circumference of the metal ring and led to a heavy thimble to take the line from the boat.

Today's experts who have read over the last page say that Ross Norgrove's problem was certainly caused by using a V-shaped conical bag that was much too small. The companies that deal in these devices make their sea anchors of large parachute designs. For a sailing yacht 42 to 43 feet long, they recommend diameters from 12 to 18 feet—far greater than the Voss model.

This sea anchor would probably have a small float on a short line attached to the metal ring at the front of the parachute (where the shroud lines collect) to keep the

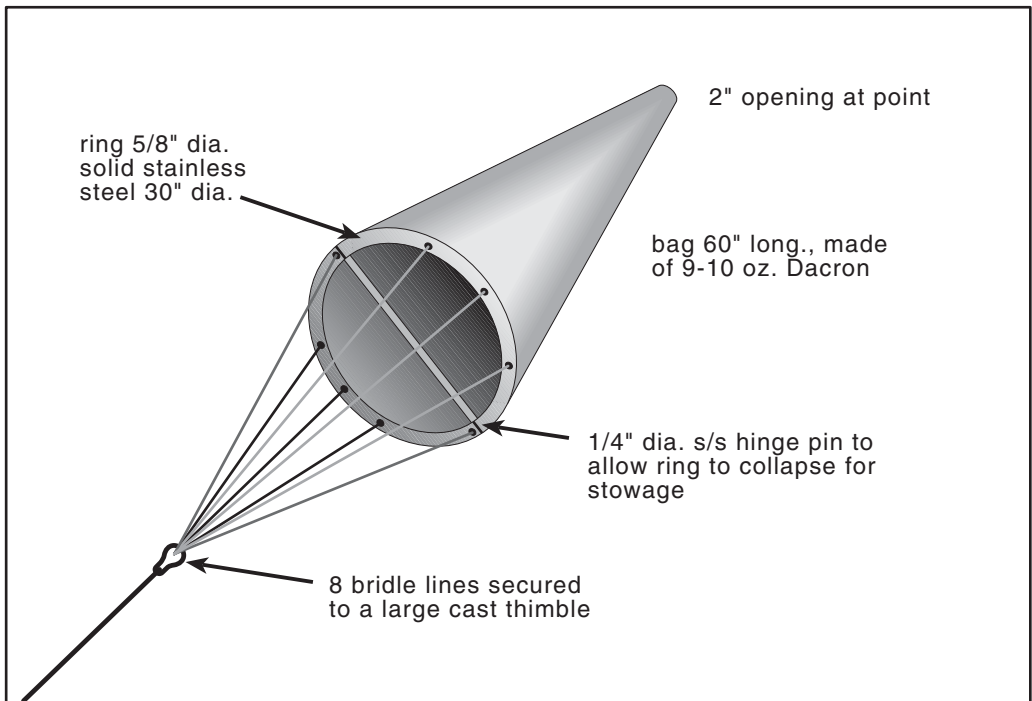

Voss-type fabric sea anchor with hinged metal ring that collapses for storage.

device from sinking. In addition there might be a light floating trip line and small buoy tied to the far end of the parachute canopy to help with recovery after the storm.

Although the latest marine catalogs are filled with seemingly unlimited offerings, you won't find a sea anchor of the Voss type shown above. These days there are better control techniques—parachutes and drogues—for yachts and fishing boats caught out in horrendous storms.

Which scheme is better? Or are they both good? Read on.



PARACHUTES IN THE SEA

The basic notion is simplicity itself. If you get overtaken by a great storm, you drop a substantial nylon parachute in the water and connect it to the bow of the sailboat with a very long nylon line.

As the strong gale or storm-force wind blows the yacht downwind, the horizontal line tugs at the parachute, which opens and fills with water and becomes an almost stationary point in the sea. When large waves sweep past the boat, the nylon line tightens and stretches, and tends to align the yacht parallel to the long line.

Because nylon line is elastic as well as strong, it's almost as if the boat were attached to a giant rubber band as she rises on crests and dips in troughs. In case a large breaking wave sweeps down on the yacht, the parachute and its tether hold the vessel's bow into the passing wall of water.

The size of the parachute generally runs from 6 to 24 feet in diameter for the 25- to 55-foot monohull yachts that we're discussing in this book. In terms of displacement or all-up cruising weight, the numbers go from 10,000 pounds for a 30-footer to as much as 45,000 pounds for a 55-foot sailing vessel. We know that with all the gear and provisions on board, cruising boats gain 15% to 20% in weight over their designed displacement.

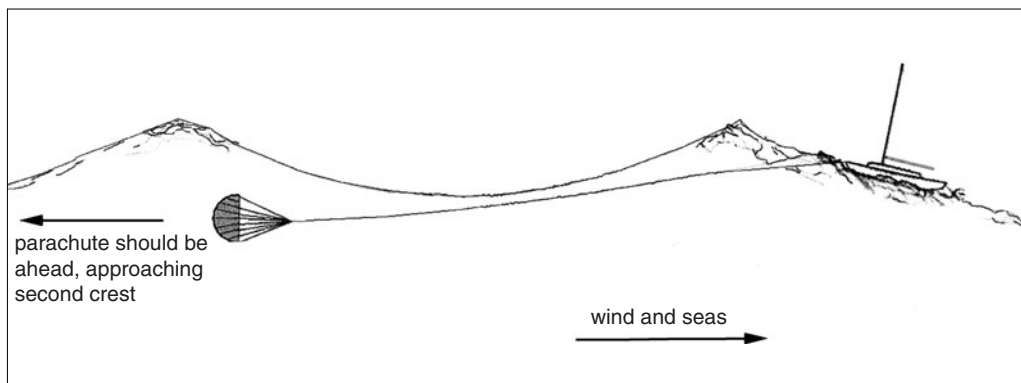

An idealized sketch of a 45-foot sailing yacht hanging on a small parachute. In an offshore Force 9 strong gale that's been blowing steadily for 10 hours, the significant wave height would be about 24 feet, and the crests would be roughly 260 feet apart. Ideally the parachute should be on the second crest ahead of the boat, which would suggest some 500 feet of $\frac{3}{4}$ -inch-diameter nylon. The parachute experts' figure for the 45-foot vessel would be 450 feet of line or ten times the length of the vessel.

Alby McCracken of Sale, Australia, manufactures the Para-Anchor, and supplies many multihull and monohull yachts as well as large numbers of fishing boats. "The parachute must be of sufficient size so it has more resistance than a sailing yacht," cautions Alby. "If the parachute is too small, the boat may pull the parachute."

It's well known that when you drag an ordinary metal anchor along the bottom, the tip-off that it's not embedded is that a modern monohull sailboat will lie beam-on to the wind as the anchor bumps along the sea floor. And we know that not heading into the wind when lying to a parachute puts the vessel in a bad position because of the danger that a breaking wave could capsize the yacht.

New Zealander Bill Coppins, of W. A. Coppins, also manufactures para-anchors and agrees with Alby: "A para-anchor too small for the boat will tend to let the boat point off and end up beam-on to the wind. In addition we've worked on the shape of our para-anchor to maximize drag. We've found that a good shape in the para-anchor creates more drag, which allows us to cut down on the size a little. This reduces bulk and cost and eases handling and stowage problems. This has cost us a lot of time in trial and error and testing. I've been designing and manufacturing sea anchors for the last 38 years, and this has paid off on the safety side of things."

The people who sell parachutes tell us that during severe storms a parachute sea anchor should be deployed on a line 300 to 600 feet in length. The recommendation

is twice the distance between wave crests or ten times the overall length of the boat; say 400 feet for a 40-footer, 500 feet for a 50-footer, etc.

Alby McCracken points out that nylon has a stretch factor of about 30% when wet, which means that a 400-foot rode under load is actually about 520 feet long. Because of the stretchiness, about 25% of the initial loading is captured by the rode itself. When the stretchiness is used up, then the full load is applied. The longer the rode, the less the strain on the boat and the parachute.

“Both rode diameter and length are important to achieve maximum comfort and safety from the Para-Anchor system,” says Alby. “Too large a diameter and the stretch of the line is reduced. But a line that has too small a diameter likewise reduces the elasticity, because the rode is stretched to its maximum too much of the time. If the diameter is too small, the risk of a rode line breaking becomes very real.”

Supposedly when you utilize a parachute, the boat faces directly into the wind, which exposes the strongest and most streamlined part of the vessel to the storm. You’ve anchored the boat to the sea, and the waves thunder past harmlessly. Assuming that you have plenty of sea room and that shipping traffic is not a problem, you can retire to the cabin and wait in safety until the storm eases or passes. Then you recover the parachute, pack away the line, and continue on your way.

This is all a grand idea, but it’s not quite that simple in practice for four reasons:

1. The boat must head (or almost head) into the oncoming seas.
2. The vessel cannot be steered and needs ample sea room. Once the storm rages and a parachute is deployed, it’s impossible to haul it in until the wind drops. If there’s shipping traffic or problems with islands, a coastline, a troublesome tidal stream, current, or a lee shore, you need to consider other options.
3. At times the connection between the yacht and the long line coming from the parachute can have a load of thousands of pounds and must be kept free from chafe. This takes forethought and careful preparation because it may not be possible to inspect the bridle or connection on the foredeck during a storm.
4. If the boat slides backward for any reason, the loads on the rudder become significant.

Let’s look at #1. A real problem with a parachute sea anchor is whether the yacht will face into the wind and waves or turn sideways to oncoming seas. We saw in the

last chapter how the vessel of John Voss (from 1901) and a representative modern monohull sailboat (the Swedish Malö from 2006) have completely different rigs and underbodies.

A modern boat swept by seas coming at the bow tends to pivot on its center of lateral resistance, sometimes known as the center of lateral plane (CLP) or the center of lateral area (CLA). This underwater center tends to be aft of amidships, and the pivoting motion is augmented by the windage of the forward-placed rig and especially the bulk of a roller-furling headsail. A rolled-up headsail with a luff measurement of 45 feet and an average diameter of 5 inches has an area of almost 20 square feet. These two forces impart a turning motion to push the bow sideways to the wind. Remember, the force on a given area increases with the square of the wind velocity as the wind speed picks up.

Experts have shown that the wind force on an anchored boat increases substantially with side-to-side yawing. On an anchor line the forces “can treble or quadruple average rode tension,” writes oceanographer Dr. William Van Dorn.³² Presumably the same thing happens with a sea anchor. In addition to this, the water in a breaking wave crest adds to the forces against a boat. These two effects greatly increase the loads on both the boat and every part of the sea anchor gear as the vessel presents more side area to the wind and water.

We know that exposing the side of the boat to breaking waves is what we must avoid! Each vessel acts differently, of course, but any forces that fail to keep the bow close to the wind are problems for yachts hanging on parachutes. Nevertheless a stationary parachute of adequate size and a long, stretchy connecting line tend to minimize yawing and keep the bow of a yacht facing the wind much of the time.

To keep the bow of a monohull sailing yacht into the wind, Fiorentino, a Newport Beach, California, company that specializes in selling parachute sea anchors in the United States and elsewhere, reprints an article on its website (as of September 2008) that discusses a sequence of responses called “Trilibrium Factors.” The sequence suggests (1) that you reduce sail forward. If the boat persists in lying sideways to the wind, the article’s next recommendation (2) is to use the rudder to steer more into the wind. If this is unsuccessful, the next suggested response is (3) shortening the long line between the sailboat and the parachute to reduce any slack in the line to the parachute.

These suggestions do not seem feasible because in the 40-knot winds and higher that we’re discussing, the yacht may already be down to bare pole(s). In Force 9 and above, many sailors are extremely reluctant to go to the foredeck to shorten the line to the parachute. In any case, such a step may be impossible because of waves crashing on board, the heavy loads on the line, plus having to deal with chain and perhaps complicated chafing gear.

Additionally, I find it hard to understand the rationale of adjusting the rudder of a yacht hanging on in 40 knots plus. A parachute sea anchor of sufficient size used off the bow almost anchors a boat to the sea.

Under these circumstances the rudder is largely useless. Indeed, one of the basic problems of using a parachute is that a particularly severe wind gust or a giant wave may shove the yacht backward and put severe loads on the rudder. These can be minimized by building stops on the hull to limit the rudder movement and lashing the tiller or wheel mechanism with heavy shock cord. In the next chapter, I tell the account of *Prisana II*, a 45-foot heavy-displacement ketch, that survived a horrendous storm by using a parachute only to find that her 2-inch-diameter grade 316 stainless steel rudder shaft had twisted 15 degrees.

Australian Alby McCracken, who supplied the parachute and gear for *Prisana II*, has another view. "It's an impossible task to adjust the rode length in stormy conditions. Who wants to be on the foredeck playing games with the line at 0200 hours with minimal crew as backup in 50 knots? An impossible task."

New Zealander Bill Coppins, who has been making parachute sea anchors for yachts and fishing boats for decades, agrees with Alby. "It's too risky to go up to the bow to shorten the rode to reduce slack. We place weights along the rode from the midpoint of the line toward the yacht. We do this with heat-shrink tubing filled with lead shot. These weights are only to take up the slack when the rode goes limp. They help ease the rode as the tension comes on and reduce the jolt at full tension."

Often a length of chain with or without a weight is added to the nylon to weigh down the system. This means that when the yacht pulls on the line, the boat will have to lift and straighten out the chain before any tension is directed to the nylon and the parachute. Whatever the length of chain, three-quarters or more of the rode should be nylon so there's plenty of stretch in the system. Long lengths of chain may not be as helpful as formerly thought.

"I agree that chain anywhere but at the boat end adds a complication," says Don Whilldin of the Para-Tech Engineering Company of Silt, Colorado. "I'm familiar with the case of a 40-foot boat in Force 9 conditions with 200 feet of rode, 100 feet of chain with a 45-pound anchor at mid-chain, and then 200 feet of rode to the boat. The report: the rode was straight, the chain was straight, and the anchor was thrashing around the chain.

"Recently I talked to a second person who had a similar experience," says Whilldin. "After going over the loads, it's clear that the weight of 100 pounds (in this second case) would have to be significantly more to generate any real force to help the situation. In my judgment, the only practical location for chain is at the boat end to deal with chafe."

Two hundred pounds of $\frac{3}{8}$ -inch-diameter BBB chain is 122 feet long. It seems a bit much to ask of a person at the bow to deal with difficult-to-handle chain and to make the hookups with the nylon line at each end while the boat is dancing around.

Depending on the strength of the storm, the duration of the wind, and the distance over which the wind blows, the seas tend to grow longer and higher. To keep the parachute far ahead of the yacht on a 10x line means that ideally the captain should anticipate sea conditions hours ahead. Yet he presumably has only one parachute and a given length of long line. Once it's in, that's it, although it might be possible to bend on another length of line.

Setting the parachute by slipping the line into the water without tangles when the boat is rolling heavily is by no means a simple job. To help with these problems, the alert makers of parachute sea anchors have designed special stowage bags that hold both the parachute and the line. These bags or satchels are easy to use from the cockpit area and in most cases go overboard with the long rode. This assumes that the line from the bow has been rigged in advance and led around outside the lifelines (to which it's held with breakaway ties). The bag or bags allow the parachute and line to run out quickly. A useful tip if a deployment bag is not used is to douse the parachute with seawater to keep it from ballooning out and inflating like an unwanted spinnaker.

All the parachute companies urge their customers to practice setting the parachute and to work out the lines and handling details in light weather, and if possible to deploy the chute in daylight.

As you might imagine, it's hard to recover a parachute after a storm, particularly a large chute. To deal with this, there are various retrieval schemes that incorporate light floating lines and small floats attached to the head of the parachute. Once a retrieval line is secured on board, the main nylon line can be slackened or dropped over the side. This collapses the parachute, which can then be easily recovered.

Yet retrieval lines can cause terrible tangles and snarls, and some captains refuse to use them. Floats and trip lines are notorious for fouling propellers, steering-vane water paddles, rudders, and the sea anchor itself. You can make a strong case for not employing them at all and dealing with the recovery by a capstan or winch at the bow. Or—with the greatest care—using the engine at its slowest speed during daylight hours.

The parachutes themselves are usually made of 4- to 8-ounce nylon with reinforced seams. Various U.S., Australian, and New Zealand companies sell chutes from 3 to 40 feet in diameter, which are used to stabilize boats that range from small outboard-powered inflatables up to commercial fishing and research vessels 150 feet long.

Most of the business of these companies is with fishing boats. Commercial boats put out parachutes on fishing grounds (engines off) or when the crew is resting. Recreational

powerboats sometimes employ chutes, and catamarans and trimarans use them to advantage in storms.

For monohull sailing yachts of 25 to 55 feet, the parachutes range in size from 6 to 24 feet in diameter (recommendations vary) and cost from \$200 to \$2,000 (in 2008) plus shipping. It's worth checking what comes with the parachute because a complete setup requires the main nylon line, a heavy-duty swivel, floats, recovery lines, and launching bags.

Smaller yachts from 25 to 35 feet in length often use inexpensive 9-foot-diameter surplus military parachutes from the U.S. Bureau of Ordnance (BuORD), although these may be no longer available except in consignment shops. These small chutes are constructed of coarse-weave nylon that tends to give a little under load and allows some water to pass through the material. This keeps the whole system a bit springy and flexible.

Reports of torn or pierced panels during storms suggest that adequate performance is quite possible from less than perfect chutes. Indeed, professional delivery skipper Charles Kanter, who was caught out in a 37-foot sloop in a Force 10 storm in the Caribbean, tied a line to the three corners of a genoa, fed it over the side, and lay to it as to a sea anchor. Kanter was amazed to see large waves roll up to the sail in the water and collapse into harmless spray and foam.³³

"In the 38 years that we have been making para-anchors we have had only one rip because of storm conditions," says Bill Coppins. "Fortunately, the anchor held. Today, however, we use high-density ripstop nylon, which is four times stronger. We also cut the nylon on the bias, which prevents the para-anchor from ripping the complete length of the panel, because the weft and warp are at 45 degrees."

To stop parachutes from revolving, twisting the line, and possibly collapsing the chute, the panels on one side may need a few lead weights while the opposite side may require a small float or two. Most users fit a heavy swivel between the parachute and the main nylon line. One maker (Don Whilldin's Para-Tech Engineering Co. in the U.S.) says that it constructs its parachute panels so that spinning or rotation is impossible.

Bill Coppins believes that on a well-shaped and well-balanced parachute sea anchor, weights and floats are unnecessary. "Of the thousands of para-anchors from 1.5 to as much as 52 meters in diameter we have made, I have never had a problem with an anchor twisting to the point of fouling. The main difficulty is the deployment and the setting of the anchor, which is where problems can occur. That's because some brands do not have a good deployment system. This is really important, because in a big storm you get only one chance. If the para-anchor fouls in those conditions, you will not be able to recover it."

THE CHAFE PROBLEM

Chafe of the line at the bow and attachment point is a big concern. A user needs to take extreme care to protect this line at this point because in a storm the boat will be skipping about in every direction and continually yawing, pitching, and rolling. This subjects the line to strains in all directions, and these moves can drastically change the lead. A wave from an odd direction may turn the yacht so that the line to the parachute is pulled over metal parts or the hull itself in directions that seem impossible. If there are any rough or sharp metal edges within sight, the line will find them.

Remember that the loads are significant and much higher than recreational sailors are used to dealing with. When you're working with long lines and the boat is jumping all over the place on big waves, you must be alert and careful to keep your arms and legs away from a coil of line that's spinning away as it goes over the side. Keep a sharp knife handy. A bread knife with a serrated blade (from the galley) or a large sailing knife with a special serrated blade cuts through line particularly well.

Many times, sailors have hauled in a suspiciously slack piece of nylon at the bow to find that the line has parted and the yacht is actually lying a-hull. Even with stout lines, the loads induced by drogues and sea anchors often come close to the breaking point of the line, the fittings, and attachment points. In one documented case, two sailors pulled in a 426-foot line to a parachute sea anchor after a big storm and found that their $\frac{3}{4}$ -inch-diameter nylon had stretched 65 feet.³⁴

I believe the best scheme to protect the line from destruction at the bow is *to move the line entirely off the yacht* and away from anything that could possibly cut or abrade it. One way is to unshackle the main anchor and move it elsewhere. Then shackle the end of the chain to the nylon line leading to the parachute, wire the pin, and let out a little chain.

On board, the chain should go to a robust chain stopper, a fitting ideally made from steel plate (galvanized after construction) that is held by substantial through-bolts with a metal backing plate. The chain stopper is designed to take heavy tension loads; the gypsy on the windlass or capstan is not. In addition, run secondary lines from the chain to the mooring cleats and the mast. See the drawing on page 92 for another scheme.

If you can't move the anchor, you can use a separate piece of chain of suitable breaking strength. Try to arrange the lead to avoid metal scraping on metal. A bundle of rags or an old towel may help. Then shackle the outer end of the chain (say 15 or 20 feet ahead of the yacht) to a carefully made eye splice formed around a heavy-duty cast-metal thimble in the nylon line leading to the parachute.

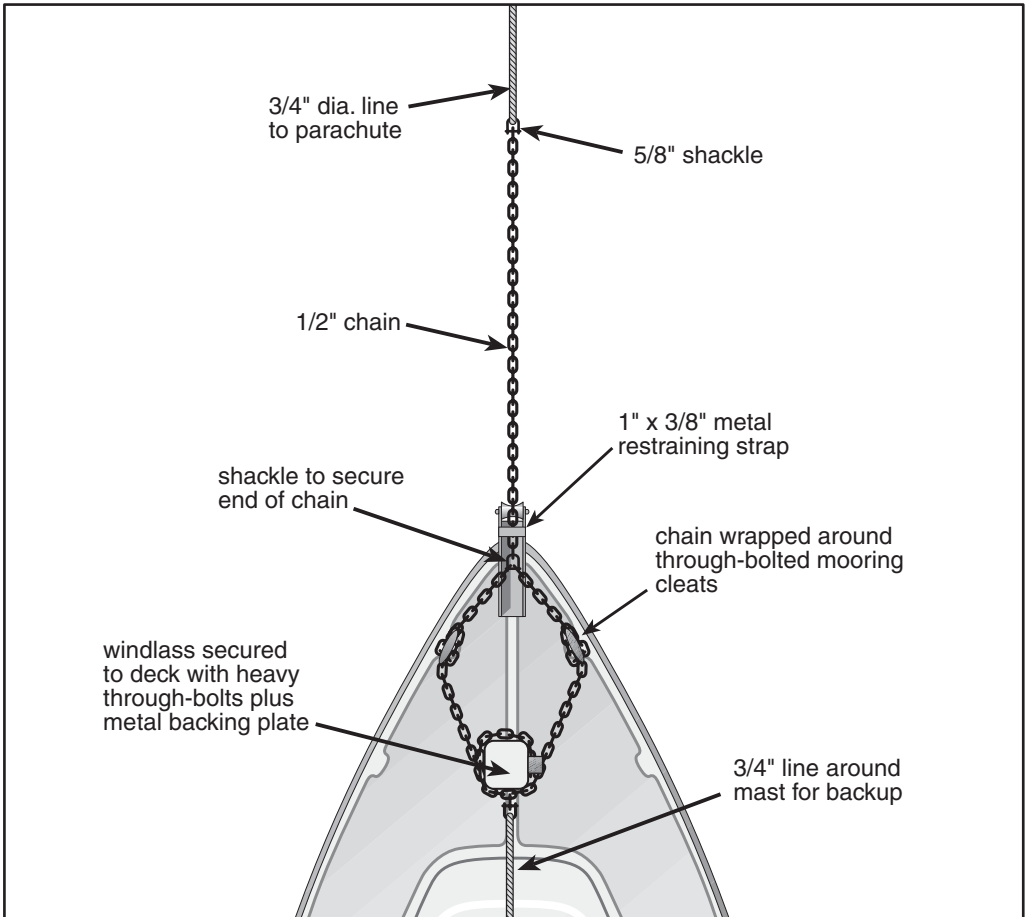

One possible hookup of a parachute sea anchor is to wrap heavy chain around and around strong points at the bow. This will minimize chafe and require little attention. Rags wrapped around the chain where it passes through the metal stem fittings will minimize noise and wear.

Bill Coppins has some worthy remarks about chafe. “We have two solutions that work well,” he writes. “The first is a chafing sock that fits over the rode and is placed at the point of chafe. The chafing sock has an outer case of leather, which has remarkable chafe resistance as we know from the leathers that we use on oars where they rub on rollicks [rowlocks, also called oarlocks]. Nothing else lasts like leather.

“Inside the leather we use 2,000-denier nylon, which is rolled up to give several thicknesses. This is how it works. The leather on the outside is tied to the boat or bow roller. The innermost part of the nylon is tied to the rode at each end. If there’s movement, the outer leather does not move because it’s tied to the boat. The inner nylon moves on itself, however, and several layers all share a bit of the chafing load.

“Nylon is extremely slippery and creates almost no friction,” says Bill. “Compared with other fabrics, nylon lasts about five times longer. A racing motorcyclist wears leather on the outside and layers of nylon on the inside. If a rider should fall off his bike and slide across the hard track, the nylon and leather prevent the track from wearing through to his body. In another application, forestry chainsaw operators wear several layers of nylon. If a chainsaw drops onto a leg, the strong layers of nylon stall the chainsaw, preventing terrible injuries.

“The other chafing system we use for sailors who want chain but don’t like its horrible clunking sound is a steel wire cable that’s shackled into the rode at the bow,” says Bill. “This is a 14 mm diameter wire cable with a 32 mm heavy rubberized covering, which is molded over the cable. This system is quieter than chain and is not as hard on the boat.”

The Line from the Boat to the Parachute

Let’s look at some real numbers. American-made Samson $\frac{3}{4}$ -inch-diameter, double-braided nylon has a breaking strength of 19,400 pounds. Samson’s three-strand $\frac{3}{4}$ -inch-diameter nylon has a breaking strength of 13,500 pounds. Some experts opt for *single*-braided nylon, which eliminates any possible chafe between the core braid and the outer braid covering.

To match the Samson $\frac{3}{4}$ -inch double-braided nylon takes $\frac{1}{2}$ -inch chain (safe working load 4,500 pounds; breaking strength 18,000 pounds). Half-inch chain (or $\frac{5}{8}$ - or $\frac{3}{4}$ -inch for larger vessels) may seem enormous, but you only need 20 or 30 feet for a safe hookup at the bow. To connect $\frac{1}{2}$ -inch chain to the line takes a $\frac{5}{8}$ -inch shackle whose working load is rated at 6,500 pounds. The $\frac{5}{8}$ -inch shackle has a $\frac{3}{4}$ -inch-diameter pin that should just fit through a link of the $\frac{1}{2}$ -inch chain. A $\frac{5}{8}$ -inch shackle seems enormous and weighs almost a pound and a half, but in the world of storms we’re dealing with, the loads are calculated in big numbers.

After the shackle pin is tightened, it should be secured with two or three wraps of soft iron wire. If you’re into this, try to buy the chain, shackles, swivel, and the cast thimble at the same time so you can check that everything is of equivalent strength and that all the parts will fit together. Sometimes in the chain game it’s necessary to use two D-shackles if the threaded part of a shackle won’t fit through the next fitting. Try to avoid this.

To the Sunday sailor this sort of hardware may seem gigantic, even ridiculous, until you consider the forces involved and the fact that if you elect to go with a parachute you want to stay connected during the ultimate storm. The hookup can tolerate no weak links.

What about the hull end of the separate piece of chain mentioned above? How do you fasten it? One scheme, as shown in the drawing on page 92, is to wrap the chain around the mooring cleats and the foredeck windlass and shackle the end of the chain back to the incoming chain in a sort of loop. Then run a secondary line to the mast as a backup.

Don't even think of dropping an eye splice at the end of the nylon rode over a cleat at the bow. This will almost certainly lead to failure. Slipping a length of thick-walled hose (such as engine cooling-water hose) over the nylon line and belaying it to a forward mooring cleat is a marginal procedure for many reasons. The loads may tear off the mooring cleats, which are notoriously undersized and poorly fastened on many boats. As I said earlier, if the highly tensioned line is drawn across the edge of various stem fittings, abrasion can quickly lead to ruinous chafe and loss of the parachute.

Since there's often a big load on the line, there's little chance of pulling in a few feet and sliding a piece of hose down the line to change the nip. If you elect this method, it's worth fitting 3 or 4 feet of thick-walled hose over the line in advance and reserving, say, 20 or 30 feet of line on deck. Then from time to time the cable can be eased a little and the hose readjusted to present new surfaces to the attachment points. The hose should be long enough to go from the cleat area forward to the bow roller and beyond so that when the boat swings from side to side (more than you might think), the line is protected and won't touch any stem fittings. Note: I vote against this method.

A bridle connected to two strong points on the foredeck has the advantage of pulling against two places instead of one, reducing the load on each, and may help keep the bow pointed toward the wind and waves. Each leg of a bridle should be able to take the full load of the main rode when the boat yaws, or swings, and one leg of the bridle goes slack. If the bridle is offset, or if you use a hawsehole on one side or the other of the bow, it may help reduce yawing. If a splice in any of the lines is necessary (never use knots), the rope's breaking strength will be reduced by 10% to 20% at the splice, depending on which rope company figures you trust.

This is the place to mention the advice of my friends Lin and Larry Pardey, who are well-known contemporary sailors. They currently campaign a heavy-displacement traditional English cutter named *Taleisin*, a long-keeled, engineless 29½-footer that displaces 19,000 pounds, a splendid small yacht that Larry built himself. This is on the small end of world cruising yachts, but the Pardeys are intrepid voyagers who have

sailed far and wide—including a trip around Cape Horn in 2002—and have written extensively about their voyages and long-distance sailing.

The Pardeys are advocates of a parachute sea anchor, and in their current yacht they use a storm trysail in conjunction with a 12-foot-diameter nylon chute on a 300-foot warp. They pull their boat sideways to the warp (see the drawing) by bending on a short pendant line a little ahead of the bow. Then they take a strain on the pendant until it pulls the yacht sideways (about 45 degrees) to the line going to the parachute. The Pardeys do not use a trip line.³⁵

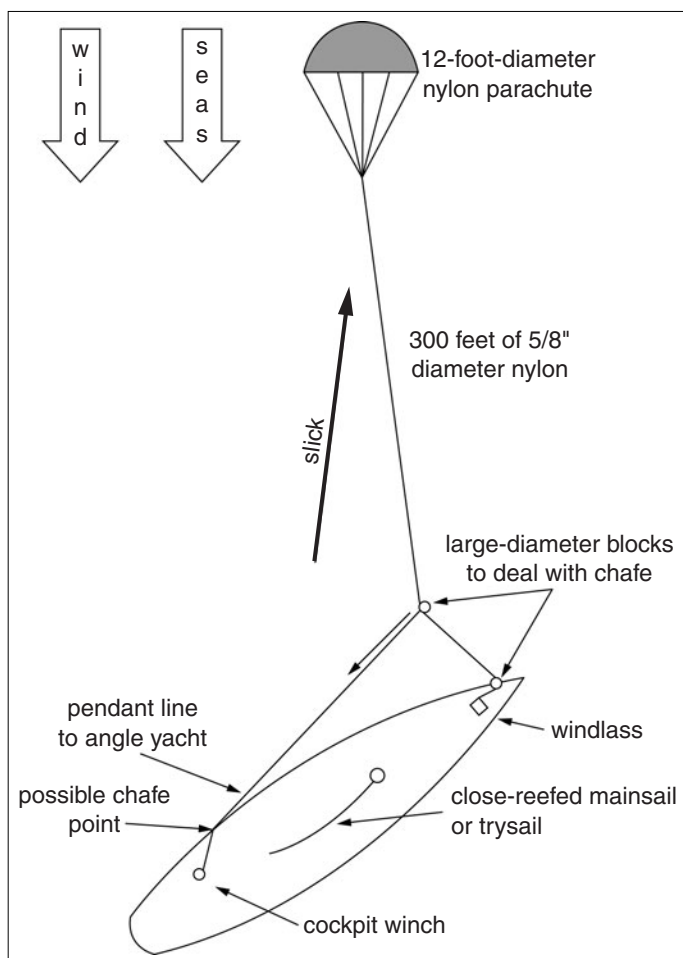

The Pardey bridle system of rigging a pendant to the parachute line turns their boat Taleisin partially sideways. This appears to work well for smaller yachts.

This sideways pull keeps the wind on one side of the closely reefed mainsail or storm trysail, stops the boat from tacking back and forth, and improves the motion below. The Pardeys call their scheme “heaving-to,” but since they use a parachute in addition to one or more storm sails, their maneuver is clearly something else, at least in the traditional sense of the term. The Pardeys say that their plan eliminates backing down on the rudder; nevertheless they recommend rudder stops and lash their tiller with shock cord.

The idea is to drift slowly downwind (at roughly $\frac{3}{8}$ of a knot) behind the slick made by the hull, which tends to break up large waves heading for the yacht. Certainly if there is a lee shore problem, this sea anchor plan is ideal. The Pardeys write that they have had excellent results with this storm management system for many years. They worked it out on their previous boat, a similar design that was only 24 feet 7 inches overall. With the smaller boat the Pardeys used an 8-foot-diameter BuORD parachute.

To understand the forces involved in the Pardey system, an engineer friend made the following calculations:

Construct a line extending the main rode toward the boat. The angles from this line to the bridle are drawn about 60 degrees and 30 degrees. Using these angles, and assuming that the tension on the parachute rode is 10,000 pounds, the aft bridle leg would experience a tension of about 5,000 pounds and the forward bridle leg would have 8,660 pounds.

The Pardeys’ success may be linked to the design of their boat: heavy displacement, a long keel, and a full underbody. Several other yachts of similar size and design have had good results with this scheme. As far as I know, however, the use of a side pendant to pull the yacht around has not translated to larger yachts, because the tension loads on the short pendant line cause it to break. This may be because the pendant line lacks the stretch of the longer line to the parachute. Or it may be as simple as under-sized line.

With a pendant line there are more angles and connections, which can mean more chafe. Don Whilldin of Para-Tech has worked around some of these problems by shackling (1) the forward end of the chain coming off the bow, and (2) the forward end of the pendant line (or bridle leg) to the beginning of the long line to the parachute. By using suitable thimbles and shackles, his scheme eliminates any chafe between the pendant and the line going to the parachute. The other end of the pendant line is taken to the side of the yacht, where it goes through a piece of hose or a large snatch block and then to a winch or other strong point.

The angle that the boat makes in relation to the wind is determined by adjusting the length of the pendant. Together with a triple-reefed mainsail or trysail set behind

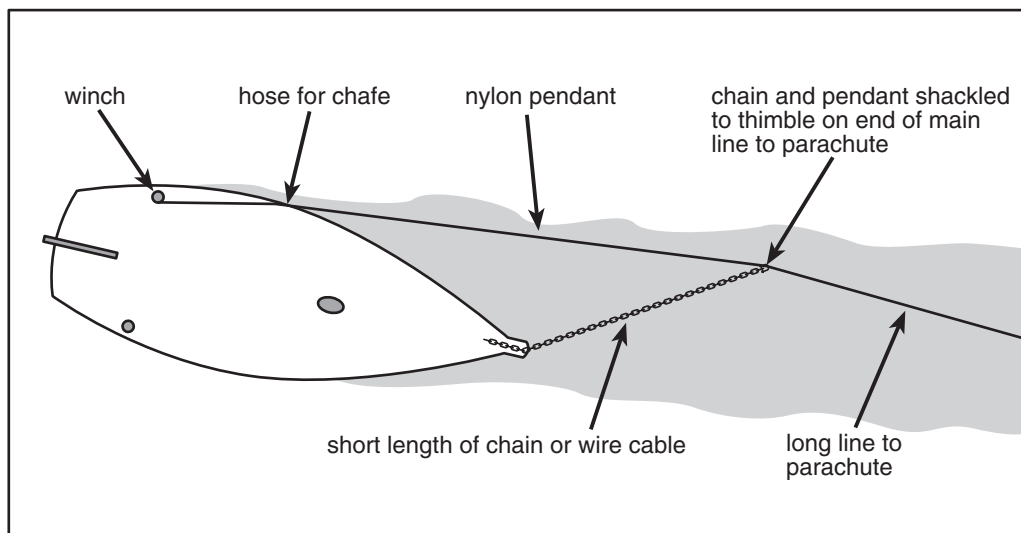

Don Whilldin of Para-Tech as worked out this scheme of turning a yacht slightly by using a pendant line (or bridle leg) on one side of the vessel. To reduce chafe, both the pendant and the chain leading from the bow are shackled to the main line leading to the parachute.

the mast (depending on the wind strength) this offset may help stabilize the motion. The bridle with two attachment points distributes the load.

The offset bridle arrangement pulls the yacht sideways a little. An angle of 15 to 30 degrees improves the ride but increases the strain on the short pendant. A shallower angle (5 to 10 degrees) puts less strain on the pendant line and its attachments, but the ride is less comfortable. Each yacht is different, however, and it takes trial and error to discover the best angle for particular sea conditions. Don Whilldin has found that he can adjust the pendant line easily by taking up on it when the yacht swings a little toward the pendant side and puts some slack in the line.

Most sailing vessels built today have a canoe underbody, a fin keel, a spade rudder, and a displacement relative to overall length of only about 60% of the Pardey vessel. In other words, the typical cruising yacht of today, a 42-footer, has lighter displacement and much more windage for her size than the Pardeys' boat.

The Santa Cruz 50 that I sailed twice around the world had a displacement of about 21,000 pounds with stores, tools, and extra sails. This is only about 10% more than the Pardeys' 19,000-pound 29 $\frac{1}{2}$ -footer, yet the Santa Cruz was 50 feet long and

46½ feet on the waterline. Additionally, a full-keeled monohull sets up a wider slick than a yacht with a fin keel. In truth, a small, heavy-displacement traditional design and the shiny vessels you see at today's boat shows are very different creatures.

The Pardey bridle fails to address the difficult problem of a breaking sea coming from a different direction and striking the more vulnerable side of the yacht. With the line from the parachute already angled to 45 degrees, the vessel is only 45 degrees from being broadside-on to a possible breaking sea. Larry Pardey attaches great importance to the slick generated between the yacht and the parachute, and I'm sure he's right. We all know, however, that during turbulent weather in the Southern Ocean, the winter temperate zones, or a northeast gale in the Gulf Stream, an occasional breaking wave may roll in 40 or 50 degrees from the prevailing direction of the other waves.

I feel it's wise to try to keep the bow or the stern of the yacht heading into all big waves—breaking or not. Upset waves from abeam can be particularly nasty and cause terrible damage, as we saw in Chapter 6. It's wonderful to be able to use a slick to help a sailing yacht in a violent storm, but unfortunately there are many unknowns about the effectiveness of slicks for modern vessels.

10

PARACHUTES IN ACTION

I have in front of me a giant paperback book called *Drag Device Data Base*, expertly written by Victor Shane of Summerland, California. This 1998 book is a compilation of the experiences of 120 users of sea anchors and drogues. The long and short accounts are broken down according to whether the drag devices were employed on sailing monohulls, sailing multihulls, or recreational and fishing powerboats. In this fourth edition, Victor makes a valiant attempt to include all the information, whether the parachutes worked or not and whether the drogues were a disaster or a magic cure. It's a specialized sailing book for hard-core offshore sailors (like me) or commercial fishermen.

The first section deals with monohulls that have used parachute sea anchors off the bow. I plowed through all 41 cases and decided that 26 owners found sea anchors helpful. Three said no. On three others, the line to the device broke. I judged nine accounts to be irrelevant or negated by poor seamanship.

According to the reports, if a parachute sea anchor is out ahead of a yacht on a long nylon line that is shackled to a length of chain or steel cable leading from the bow or otherwise protected from chafe, there's an excellent chance of good results.

As I mentioned in the last chapter, the Pardey bridle, which pulls the boat to one side or the other and is generally used with a heavily reefed mainsail or trysail, can ease the motion during a storm. This appears to function well for smaller vessels in the 25- to 32-foot range, but as noted earlier, the highly tensioned pendant line tends to break in larger vessels, probably because the line is too short to allow much stretch.

Though there aren't enough cases to have any statistical merit, I note unofficially that for monohull boats in the range of our study, a $\frac{5}{8}$ -inch-diameter three-strand nylon line (for boat lengths of 25 to 35 feet) or a $\frac{3}{4}$ -inch-diameter three-strand line (for boat lengths to 55 feet) has worked very well. Both three-strand and double-braided line are frightfully expensive in long lengths. According to one U.S. catalog, 400 feet of $\frac{3}{4}$ -inch-diameter line costs \$556 (\$1.39 per foot). The same length of double-braided nylon is \$956 (\$2.39 per foot). Sailors often choose the three-strand because it's 42% cheaper.

Unfortunately three-strand line is subject to *hockling*, an unusual occurrence that twists the strands against the lay and results in back turns and a tangle of knots that cannot be undone. Hockling sometimes occurs when a load on the line is suddenly released, which certainly happens in the parachute application. Hockling immediately reduces line strength by 50% or more. Fortunately, I have not heard this problem mentioned in connection with parachutes or drogues.

The manufacturers of parachute sea anchors are unanimous in recommending braided nylon line. Bill Coppins is an enthusiastic booster for New Zealand-made line. He suggests a pliable nylon braid that has a breaking strength of 18,000 pounds for $\frac{5}{8}$ -inch or 16 mm diameter. The cost is U.S. 92 cents per meter, which works out to only U.S. 28 cents per foot. (Similar line in the U.S. costs \$1.24 to \$2.69 a foot. Obviously we should all buy line in New Zealand!)

The episodes in Victor Shane's book suggest that use of lengthy 1-inch-diameter nylon lines is likely to miscarry, perhaps because heavier lines have limited stretch. A stiffer, stronger line without resilience may be inclined to break or tear out the deck fittings on the boat.

All agree that at times there can be a terrific strain on the line to the parachute, and sometimes the line breaks. Certainly the line stretches significantly. And finally, recovering the device can sometimes be slow and difficult. Nevertheless, when the sea conditions and anchor work together, parachutes can be extremely helpful and have saved hundreds of boats from disaster. We know that this is the ultimate accolade, but then only the successful come back.

The following accounts are based on reports in the *Drag Device Data Base* and other books, plus my reporting.

In July 1996, six Australians set off on a six-month cruise along the southwest coast of their vast country. Unfortunately it was the winter season, and the Bureau of Meteorology warned the sailors that they were headed for "one of the worst seas in the world for storms."

The yacht was a 45-foot Tayana Surprise fiberglass ketch named *Prisana II*. She was a modern design with a fin keel and spade rudder. The vessel displaced 13 tons and carried 5 tons of ballast. She had two masts of equal height with in-mast furling. There were five adults on board. Steve, Deborah, Trevor, and Sam were experienced sailors. Patrick was a beginner. Ben, the son of Steve and Deborah, was 7 years old.

The general plan was to travel west from Adelaide across the Great Australian Bight to Cape Leeuwin on the southwest corner of Australia—a distance of 1,200 miles. Then to turn the corner and sail north to the town of Dampier, on the northwest coast.

Because of the warning from the weather people, the captain decided to prepare his 18-foot-diameter Para-Tech device for immediate use. To deal with the hookup between the bow of the boat and the line to the parachute, the crew elected to use the ship's anchor and the windlass, which was set on a $\frac{3}{8}$ -inch-thick metal plate and through-bolted to the deck with six $\frac{3}{8}$ -inch stainless steel studs.



Prisana II's Australian journey during the winter of 1996.

The crew shackled a short length of $7/16$ -inch chain to a $1/2$ -inch chain link that was welded to the crown of the anchor, which was stowed in a specially built hawsepipe. A second slightly slack piece of $7/16$ -inch chain was put in place as a backup and shackled to a $5/8$ -inch-diameter stainless steel bolt set across the cheeks of the crown of the anchor.

The anchor itself was held three ways: (1) by the ship's chain, which was secured; (2) by a turnbuckle attached to the baseplate under the windlass; and (3) with a slack length of $7/16$ -inch chain between the anchor and the windlass plate.

Finally the parachute itself was connected to 410 feet of $3/4$ -inch-diameter three-strand nylon line with a $3/4$ -inch stainless steel swivel. This long line was tucked away in a special deployment bag. The various parts were connected with $1/2$ -inch Ronstan stainless steel shackles, which had a safe working load of 9,900 pounds. All told, the preparations to hook up the parachute were massive and included backup arrangements wherever possible.

Prisana II crossed the Great Australian Bight with fair winds, and on the eighth day from Adelaide the crew rounded Cape Leeuwin, one of the four great capes of the Southern Ocean. The yacht had made good time, but now the prospects changed. The boat encountered lots of big ship traffic, the barometer was falling, and the seas became large and unruly. Soon a north wind of 30 knots blew up. The captain headed out to sea (west) on the starboard tack. During the night the wind switched to the west

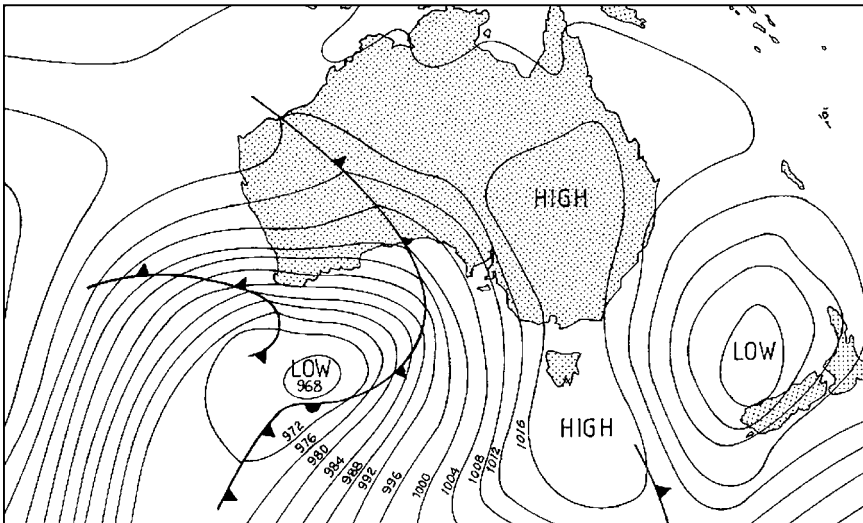

Australian weather chart for July 17, 1996.

and gusts reached 40 to 45 knots. The yacht was 80 miles west of Cape Leeuwin when the crew put her on the port tack and sailed north.

Late on July 14, the boat was west of Cape Naturaliste. The captain would have headed for an anchorage, but the wind had risen to 40 knots from the north-northeast. It was almost dark and no one on board was familiar with the ironclad coast. The weatherfax showed that a complex low-pressure area was rapidly approaching the yacht. The crew thought of using the parachute, but because of the heavy shipping traffic along the west coast, they shortened sail and plugged onward. They reasoned that if they could hang on for a few hours, the approaching weather system would give them southwest winds and an easy run to Fremantle.

Instead the wind increased to 50 knots from the north-northeast, and the seas grew accordingly. The only option was to head farther out to sea. On the morning of July 15, Perth Radio warned of a new gale. At that time, *Prisand's* barometer read 996 millibars. By the end of the day the wind had switched to the west and the barometer had dropped to 990. The only good news was that the seas had eased off somewhat.

"As the night progressed, squalls reached 60 knots and lightning could be seen behind us as we sailed in a northerly direction," wrote Deborah. "Eventually the anemometer was off the scale at over 65 knots and the seas were rising dramatically. At . . . 0300 a huge wall of white water knocked us over to starboard. The helmsman . . . was chest-height in water, and our masts were horizontal . . . Ben and I were asleep below and we were both flung out of our bunks."³⁶

Three of the men deployed the 18-foot parachute anchor in the dark. This was easy because they'd prepared everything beforehand. Earlier on, one end of the nylon line had been connected to the chain at the bow and led aft outside the port side lifelines (held by plastic cable ties) to the cockpit. The bag with the main nylon line was alongside the cockpit, so the crew quickly unlaced the top and shackled the other end of the line to the parachute. The men then eased the trip line, float buoys, and parachute over the side. Everything ran out in about 30 seconds, and the boat was pulled head to wind. The crew furled the sails.

The men had rigged a $\frac{3}{4}$ -inch-diameter Pardey bridle line to the rode to pull the yacht a little sideways to the parachute, but the line (breaking strength 13,500 pounds or more) broke almost at once. The 410-foot line to the parachute thus led directly ahead from the bow and was connected to the chain as described earlier.

"During the morning of Tuesday 16 July I ventured into the cockpit and was immediately awestruck," wrote Deborah. "The seas were incredibly huge . . . I later found out that seas were reported to be 36 ft (11 m) on top of a 30 ft (9 m) swell—a total of around 64 ft (20 m). When the parachute rode emerged as it spanned a trough, it sliced through the water like a knife, and one could see massive tension

come on it as *Prisana* surged forward and back. A lot of white water was being swept from the tops of the swell, with large rolling crests of white water underneath. *Prisana* took many loads of white water across the deck, and even some green water.”³⁷

Prisana was only 30 miles west of Rottneest Island, and though the west wind was screaming “at over 70 knots” the yacht seemed anchored to the sea and held in one place by the parachute. The crew was unconcerned about sea room.* The boat was in the south-flowing Leeuwin current and drifting south at 0.9 knot, but she had unlimited sea room in that direction. The crew lashed the steering quadrant on the rudder shaft to keep the rudder centered, but 1/4-inch cord and then 5/8-inch braid broke. Three-quarter-inch braid finally held the quadrant in place. Later the crew discovered that the 2-inch-diameter stainless steel rudder shaft had twisted, which gives an idea of the forces that were involved.

The noise of the storm was horrendous, and heavy water bombarded the deck. The ketch was rolling gunwale to gunwale and yawing about 45 degrees one way and 35 degrees the other. From time to time the rode became slack when the boat turned partially sideways. When she straightened out, there was a tremendous jerk as the line tightened.

The shipping traffic was a constant worry. At first light on July 17, Steve saw on radar that an enormous container ship was less than a mile away. After great effort Steve managed to raise the ship on the VHF radio. In the huge seas that were running, the big ship’s watch officer was quite unable to see the yacht and only reluctantly altered course a little, passing the Australian yacht by less than a half-mile.

The wind continued to blow at 70 knots all day, and the radio reported that a cyclone had struck nearby Perth. By July 18 the wind had eased to 50 knots. The barometer began to rise, but the seas were still monstrous and becoming steeper as the yacht moved into shallower water near the coast. Eddies of the Leeuwin current were pushing the boat east. The crew—now worried about sea room—decided to pull in the parachute, which had been set for 59 hours, but even with the engine running this was a daunting job.

The yacht headed for Rottneest Island, just east of Perth, in only 30 to 40 knots of wind, “which felt like a gentle breeze,” according to Deborah.

By the middle of the morning of July 19, the crew motored into the Fremantle Sailing Club, “grateful that we had decided to buy a parachute anchor.” The local harbors were closed, the ferries had stopped running, a nearby big ship had lost thirty containers, and the officials and ship captains all said that they had never seen such huge seas. The weather bureau described the tempest as a “rare winter tornado,” and reported that the winds in South Perth had peaked at 108 knots.³⁸

*According to engineer and circumnavigator Ed Arnold, surface current is 1/40 of the wind speed. A 70-knot wind would mean a surface drift of 1 3/4 knots.

The storm was over, but poor *Prisana II* had been battered and suffered thousands of dollars worth of damage. Her 2-inch-diameter grade 316 stainless steel rudder shaft had twisted 15 degrees. A forward bulkhead needed rebuilding, four lifeline stanchions were torn out of the deck, there were holes in two panels of the parachute, and so on. The repairs took a month.

The hookup between the bow of the boat and the line to the parachute held, but only because of the secondary backups. The threads on the turnbuckle that tied the anchor to the windlass base plate were stripped. The 1/2-inch chain link that had been welded to the anchor was ripped off. All the 1/2-inch stainless steel shackles were stretched and twisted. Finally, when the crew measured the 410-foot line to the parachute, they discovered that *it had stretched 66 feet*.

Certainly the Para-Tech chute performed well. It had saved the boat and her plucky crew of six, but *Prisana* had had a little luck as well. Thankfully, few of us will ever be out in such sea conditions.

Ardevora was a 55-foot aluminum centerboard ketch owned by Tim Trafford of Plymouth, England. On September 6, 1997, after a run from Easter Island, the yacht was at 40° south and just 30 miles west of the Chilean coast, near the entrance to Rio Calle-Calle, which leads to the city of Valdivia. The wind was from the north and gusting up to 47 knots.

The boat was in the north-setting Humboldt Current, and with the wind against the current the seas were steep and nasty. The yacht had been hove-to under various storm sails, but the captain decided that the boat was closing the coast too rapidly. Trafford could have gone on the other tack, but he was concerned about getting downwind of Valdivia, his destination.

The crew put out an 18-foot-diameter Para-Tech sea anchor on 600 feet of 1-inch plaited nylon, an exhausting job that took 2 hours. The line was led through a closed fairlead near the stemhead on the starboard side, then to a snatch block on the starboard toerail, and finally to two cockpit winches.

The sea anchor dragged the bow of the big yacht head to wind. "The motion was appalling," said the captain. *Ardevora* was pitching up to 45 degrees above and below the horizon, rolling her gunwales under, and yawing up to 30 to 40 degrees on either side of the wind. When the boat swung to starboard, the nylon line rubbed on the hull between the fairlead and the stemhead, which was 2 1/2 feet ahead. Backing the mizzen boom (sail down) to starboard to try to keep the boat on the starboard tack had little effect. The three on board tried to rig a starboard bridle on the sea-anchor line, but under the conditions it was impossible.

The load on the two big Lewmar 65 cockpit winches was so great that the captain feared they would be torn off. "No anchor winch or deck cleat could have survived the

load,” said Trafford. A few hours later it was blowing a steady 45 knots, gusting to 60, and during large breaking crests the yacht surged astern. The captain was so worried about his rudder that he considered cutting the warp. Four hours after deployment, the rode parted.

“Lying to our sea anchor was an unpleasant experience,” said Trafford. “The sea anchor is a tool of very last resort.”³⁹

Experts who have read this account have said that *Ardevora’s* 18-foot parachute was too small. It should have been 24 feet in diameter. In addition, the load on the line from the parachute should have been taken on bow fittings or on a bridle secured at the front of the boat. Finally, the 1-inch-diameter plaited nylon line may have lacked the shock-absorbing stretch of $\frac{3}{4}$ -inch nylon braid.

In 1981 Roger Olson was singlehanded a 26-foot Bristol Channel Cutter named *Xiphias* south along the east coast of Australia when he was overtaken by Hurricane Tia from the north. Olson, a boatbuilder from Costa Mesa, California, knew that he shouldn’t have been sailing in Queensland waters during the season of bad weather. To compensate, however, he was ready with a 12-foot BuORD parachute and 300 feet of $\frac{5}{8}$ -inch-diameter nylon, plus 20 feet of chain and a heavy swivel.

Roger secured one end of the nylon rode at the bow and ran the line through a fairlead at the end of *Xiphias’s* long bowsprit. For protection against chafe he sewed a length of leather around the line where it passed through the fairlead. He then led the long line outside the lifelines and back to the cockpit, tying the line to the lifelines with strong thread in a few places.

Now he had almost all of his 300-foot nylon anchor line in the cockpit, where he coiled it carefully and kept it in order with a few ties. Roger stored the BuORD parachute, the swivel, and the chain in a bag in the lazarette. When the tropical storm he was in became a cyclone and Roger could no longer stay hove-to, he decided to deploy the parachute.

He attached the end of the 300-foot warp to the chain coming from the parachute in the bag and eased the parachute, the chain, and the long line over the side. As the parachute began to take up, the warp broke the light ties along the lifelines and gradually the little 26-footer began to ride to the parachute. Roger furled the sails and hurried below.

He stayed there for three days while the wind climbed to 60 knots and the seas rose to 30 to 40 feet. When *Xiphias* descended into a deep wave trough, the boat often slowed and yawed up to 50 degrees to one side.

“As she neared the crest more tension would be put on the rode, pulling the vessel straight,” said Roger. “I never checked for chafe [at the bow] because I was too frightened to go forward.”⁴⁰

* * *

In November 1998, the 45-foot American yacht *Freya*, a long-keeled cruising sloop, left Tonga and headed for the Bay of Islands in New Zealand. Aboard were Bruce Burman and his wife and son. The distance was 1,100 miles, and the course was south-southwest. The vessel had sailed to within 140 miles of her target when a 45-knot strong gale from the east overtook her.

The captain put out an 18-foot-diameter Para-Tech parachute anchor from the bow and waited for the weather to improve. Though the boat sheered from side to side, the boat lay behind the parachute on 450 feet of new $\frac{3}{4}$ -inch-diameter three-strand nylon. Every 2 hours Bruce went forward to the bow to check the line for chafe and to change the nip.

Before dawn, a huge breaking wave from the south turned the yacht upside down. She recovered at once, but the inside of the vessel was a shambles from food, broken glass, and drawers and lockers that had been dumped. The front hatch (whose hinges had been mounted with wood screws) broke open and let in some 200 gallons of seawater. While Burman was repairing the hatch, he saw that the sea anchor was gone. When he checked the line, he discovered that it had snapped off 10 feet from the bow and had stranded for 18 inches.

Burman said the line failed at the moment of impact with the wave from the south. The rollover broke the life raft bracket; the raft inflated but was soon lost when its painter chafed through. Both the single-sideband and VHF radios didn't work. The Burmans turned on an emergency position-indicating radio beacon (EPIRB). In worsening weather and lying a-hull in huge breaking seas, which was certainly asking for trouble, the yacht was knocked down again and the front hatch torn off. Later the yacht was capsized and dismasted. The three Burmans were finally winched aboard a New Zealand helicopter.

The point of this account is that a breaking wave from a different direction capsized the yacht and overtaxed the line, which parted. It's a pity that Captain Burman didn't run off after the first capsize, when the line to the parachute broke. And how unfortunate it was that the troublesome front hatch was not properly secured with through-bolts, which might have saved the vessel and made the rescue unnecessary when the boat was only 140 miles from her destination.⁴¹

In late June 1998, the fiberglass yacht *Celtic* sailed from Dutch Harbor on Unalaska Island, at the eastern end of the Aleutians. She was a big 50-foot center cockpit ketch designed by John Alden and built by the Fuji Shipyard in 1975. *Celtic* was 33 feet on the waterline with a beam of 12 feet 6 inches and displaced 15 tons. She had a full keel with a cutaway forefoot and was crewed by Steven McAbee, his wife Pamela, and their son Zach. They were headed for Majuro in the Marshall Islands, just north of the equator and a little to the west, a distance of 3,012 nautical miles.

The McAbees started off in light weather (sunshine and glassy seas), but their weatherfax charts soon began to show a deepening low-pressure area south of Adak Island to the west. Each new chart showed the low moving closer. Captain McAbee had expected gales, and up on the bow, ready for use, was a Para-Tech sea anchor complete with trip line buoys, 400 feet of $\frac{3}{4}$ -inch three-strand nylon line, and 150 feet of chain. In addition, in the lazarette he had a drogue with its own bridle, line, and chain.

The wind settled into the south and increased to 30 knots (near gale) with 8-foot seas. McAbee had packed the sea anchor, trip line, and rode into a large canvas bag and lashed it to the bow rail with the bitter end hanging out a hole cut in the bottom. He untied the bag, shackled the bitter end to the anchor chain (the anchor had been disconnected and stored below), attached the buoys to the trip line, and let her go. Everything went smoothly, and soon *Celtic* was securely moored to the parachute. The crew hoisted a reefed mizzen and went below. That night the wind rose to 40 knots (gale), gusting to more than 50, while the seas increased.

"I was really pleased with the performance of the sea anchor and the way *Celtic* rode," said McAbee. "During the five days of gale winds at 40 to 50 knots and seas of 18 to 25 feet, I never felt we were in danger. As the storm worsened and seas began to break over *Celtic*, I began to wish I had some way to attach all that chain and rode to the bobstay eye on *Celtic's* stem so her bow would ride higher, but there was no changing anything once it was set. [From time to time] huge waves would break on us, darkening the cabin as green water rolled over the ports."

By the time the storm was over, the McAbees had had their fill of granola bars, crackers, and soda. They'd also seen enough gales. It had been hard to sleep, except for Zach, who was unflappable and able to sleep while weightless and "bouncing off the ceiling."

The weatherfax showed another low headed for *Celtic*, so the crew decided to make a run for it. The wind had switched around to the west but had dropped to near calm. They fired up the engine and ran south for 48 hours, which moved them about 300 miles farther and hopefully out of "gale alley."⁴²

On July 8, 13 days after leaving Unalaska, McAbee shut down the engine. He had only 10 gallons of fuel left, and the three on board had eaten most of the perishable food supplies. Counting the four days anchored on Unalaska Island waiting for good weather before they'd started and the five days hove-to during the gale, they had spent a total of nine days going nowhere. They still had a long way to sail, so they headed for Hawaii (22°N) to rest and resupply before going on to the Marshall Islands (7°N).

"The weather gradually improved and the temperature slowly rose," wrote Captain McAbee. "The perpetual cloud cover grudgingly gave way, and soon I was startled by a huge fiery ball that rose into the sky and threatened to blind us. Pamela explained

that it was called the sun and that it was a common sight in most parts of the world. I guess I'd been living in Dutch Harbor [Alaska] so long I'd forgotten."⁴³

Twenty-seven days after leaving Unalaska Island, *Celtic* sailed into Nawiliwili Bay on the southeast corner of the island of Kauai in the Hawaiian Islands.

So for some sailors, parachute sea anchors are a panacea. All admit that they're a handful to deal with, although practice and planning and the use of satchels and bags help. Others consider them hell. I've reviewed five incidents: one particularly severe, two that ended because of broken lines to the parachute, one of a large yacht with an average experience, and the tale of a gutsy sailor in a small vessel that came through a sustained storm of 60 knots. Of the five, one boat was lost and another was substantially damaged. The other three were ready to go to sea again.

At the beginning of this chapter I wrote about Victor Shane's account of many experiences with parachute sea anchors. Of 41 cases of monohull sailing yachts lying to sea anchors, 26 owners found sea anchors helpful. Three said no. On three others the line to the device broke. I judged nine accounts to be irrelevant or negated by poor judgment.

If I subtract the irrelevant cases from the total, the numbers suggest that of 32 incidents, 26, or 81%, were successful. The negative accounts, six in number, or about 18%, say otherwise.

Actually 81% in violent storm situations seems fairly good, and we know that hundreds—thousands?—of sailors have used parachute sea anchors in less violent situations with safety and satisfaction. Of course these numbers are based on such a small number of incidents that they have no statistical validity, and as I mentioned at the beginning of this chapter, I'm well aware that only the survivors write in.

Nevertheless these numbers point toward success and suggest that parachute sea anchors certainly have a place in storm management techniques. The biggest problems for monohull sailing yachts are threefold: keeping the yacht pointing into the wind and seas, the hookup at the bow, and dealing with chafe on the main line to the parachute.

"My opinion," writes Bill Coppins, "is that if one wants to go offshore and have a chance of survival in extreme conditions, the only way is to have a sea anchor that is properly set up to suit the boat. That means (1) a parachute of the correct size; (2) a good rode; (3) proper chafing gear; and (4) no short cuts." Bill feels strongly that if these criteria are met, 99% of yachts will survive storms.

I have a fifth rule: If you want to stay healthy and out of the newspapers, don't push your luck by sailing during the winter or the stormy seasons. Head out during the summer.



WHAT IS A DROGUE?

So far we've had a careful look at a number of storm management tools:

1. Reefing the sails.
2. Heaving-to.
3. Lying a-hull.
4. Running off.
5. Using a parachute sea anchor.

Now we'll examine the other half of the fifth option of storm controls: the use of a drogue or drag device towed behind a vessel to slow her if she picks up too much speed from strong wind and waves coming from astern. A drogue helps maintain reasonable steering control, and if the vessel is overtaken by a breaking wave, the drogue tends to hold the stern of the boat into the overtaking wave. This helps keep the yacht from turning broadside to the sea and possibly broaching and being rolled over sideways. Or even worse, from being pitchpoled—flipped end over end like a tumbleweed in Arizona. These are certainly dreadful prospects.

While mentioning these horrific things, however, I believe we need to keep them in perspective. Again and again in this book I've spoken of the unlikelihood of meeting severe storms and breaking waves. For what it's worth, I can say that only once in my sailing career have I shook hands with a really violent breaking wave situation, and that lasted 6 or 8 hours. We need to tuck away in the back of our minds a system or

systems to deal with extreme winds and breaking waves and to put the equipment on board to carry out our defense, but we shouldn't flog ourselves with excessive angst about what might or might not happen.

Yachting magazines and entirely too many sailing books tend to make you believe that there's a Force 10 problem circling beneath every distant cloudbank. In order to make exciting reading, some of these accounts are repeated over and over again by writers with minimal sailing experience—some who have barely crossed an ocean or two. Meanwhile the safe and easy passages are ignored. Yet editors will buy a white-knuckled storm story every time because they hope it will sell books and magazines.

I've written many times that in my experience 50% of the time the winds I've met have been 15 knots or less; it seems to me that what you need is a sail plan with lots of area for light winds, but a rig that can be shortened down quickly and easily.

To continue: We've seen that a parachute sea anchor functions at the bow of a boat and is set at the end of a nylon warp hundreds of feet long. The yacht hangs on this line from the parachute and is essentially anchored to the sea.

The function of a drogue is just the opposite. The vessel may be racing along before a strong wind with a wild and unpleasant motion and be hard to steer. A wind-vane steering device or an autopilot may not be able to keep up. An expert helmsman can cope for only a few hours before he's exhausted. If you put a measured drag behind the boat, however, she will slow dramatically and her motion will be greatly improved. The waves rolling up astern no longer look so threatening, and the steering changes from semi out of control to something more regular and docile.

When a big wave charges up from astern and tends to turn the yacht broadside, the drogue firmly holds the back of the boat into the wave. Depending on the drag of a particular size and design of drogue, it can hold the yacht relatively immobile or it can yield significantly. This almost sounds as if the drogue needs a variable shutter of some kind that can be opened and closed to control the amount of resistance. Several such devices have been marketed briefly, but in practice a variable shutter doesn't appear to be necessary, and a drogue size is generally selected on the basis of a boat's displacement.

An advantage of using a drogue in heavy weather is that the yacht can be steered a little, which means that she can be maneuvered away from big ships and islands and reefs. With a parachute sea anchor, once it's set there are no steering options, and while the storm rages on, recovery is impossible. Additionally, as we have seen, backing down on a parachute sea anchor can put threatening loads on a ship's rudder, which needs to be tied off and supported with stops and heavy shock cord.

We saw in the last chapter how *Prisana's* 2-inch-diameter stainless steel rudder shaft twisted 15 degrees during the great storm she experienced while hanging on a

parachute at the southwest corner of Australia. With a drogue, the boat is moving forward all the time, which means the rudder is operating in normal fashion.

During the 1970–71 Antarctic circumnavigation of the 53-foot cutter *Awahnee*, Bob Griffith and his crew lay to a stern drogue time after time. However, *Awahnee* had a strong crew of six and used a sea anchor that not many yachts would be able to produce or manage. “We hove-to with the stern into the wind and swell held by a sea anchor consisting of about 300 feet of line with half a dozen car tires and a small anchor on the end,” wrote crew member Pat Treston in the New Zealand magazine *Sea Spray*.⁴⁴

In several gigantic Antarctic storms, the crew of *Awahnee* set as many as three drogues—one of 80 feet of $\frac{7}{16}$ -inch chain, a second of two or three car tires on 200 feet of line, and a third of 600 feet of line with an anchor and a tire on the end. “However we had to steer all the time to try to keep the quarter to the wind and waves,” wrote Treston. Broken water flew everywhere, and there was some damage, but the yacht and crew came through unharmed.

I marvel at the success of the voyage and the cheerful, heroic crew, but I shudder at the work involved. Certainly a modern drogue would have been more effective and easier to handle.

A drogue can be made of almost anything as long as it's down in the water so the waves won't pick it up and carry it forward on the surface. In October 1985, the yacht *Hudie*, a 37-foot Tayana cutter, en route to Key West from Galveston, Texas, ran into Hurricane Juan. During the crew's spirited fight with the sea, they managed to slow from 6 knots to 3 by putting out four warps, each 250 feet long, to which they tied buckets, tarps, sail bags, an 8-foot dinghy full of water, and an *Igloo ice chest loaded with ice and sodas*.⁴⁵

Thirty-five years ago I used two automobile tires for a drogue in a Force 9 storm off the Oregon coast. I ran a short length of chain through the tires and then shackled the chain to a $\frac{5}{8}$ -inch-diameter line that I streamed from the transom. The tires slowed the vessel, but sometimes a wave washed them up alongside the cockpit. I tried to deal with this by adding lead weights to the tires to sink them a little. But the tire arrangements took a lot of work just when you felt like not working at all. Today's commercially produced drogues are vastly superior in all ways.

In 1984, while preparing his 55-foot ketch for a fall trip from New York to the Caribbean, longtime sportsman Frank Snyder asked sailmaker Skip Raymond to make a stern drogue “from some kind of open net.”

“Skip went to work,” wrote Snyder, “beginning with a small model before building the full-sized drogue, which is 3 feet in diameter at the forward end, 4 feet long, and tapers to 1 foot in diameter at the after end. It is made of 2-inch nylon webbing,

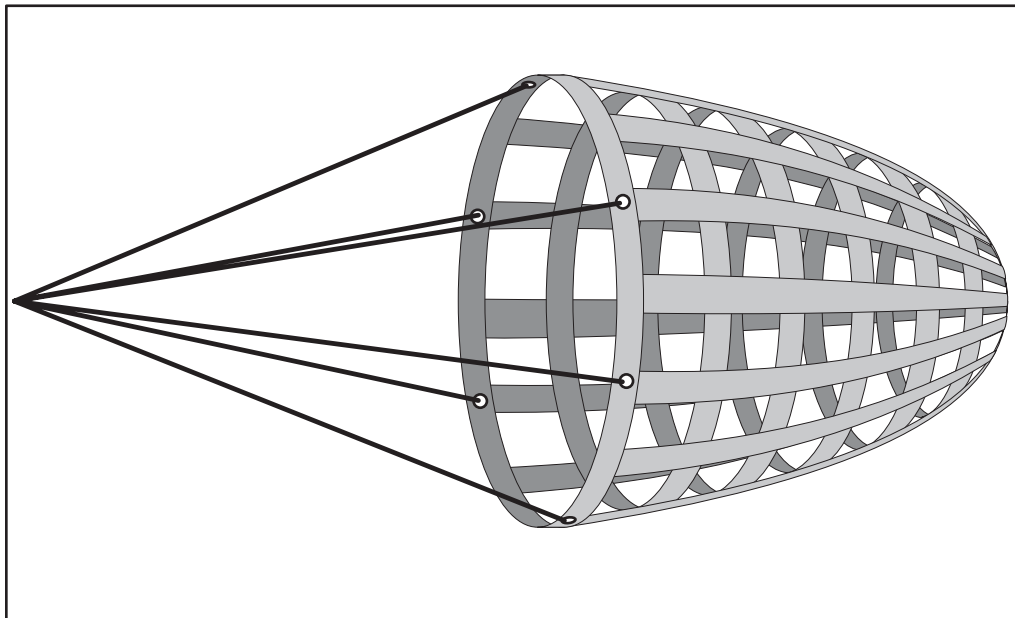

The basket drogue designed by Skip Raymond.

stitched in 6-inch squares. Spliced into the $\frac{3}{8}$ -inch 1×19 wire hoop at the forward end are seven $\frac{5}{16}$ -inch nylon lines 6 feet long, which converge and are spliced into a single, heavy swivel.”

For stowage, it's possible to turn the heavy 1×19 wire into a figure eight and fold one half back on itself, making a compact loop that goes into a small, flat bag 2 feet long, 1 foot wide, and 4 inches deep.

Snyder put Skip Raymond's drogue on board his yacht *Southerly*, never thinking that on his trip to Bermuda the drogue would have its first big test. For the first 30 hours the powerful yacht had fair winds and averaged 8 knots. Then the barometer began to drop and the sky clouded over. At dusk on the second day *Southerly* was in the Gulf Stream. The wind was southwest, Force 10. The twisty Gulf Stream current and the seas from the southwest were soon scrapping with one another; in truth the surface of the ocean was a mess.

The crew reefed, then took down the jib entirely, and finally set the storm trysail. Though the vessel was big and powerful, she had trouble dealing with the conditions, and Captain Snyder found that his boat couldn't handle the trysail on a reach. The crew wrestled the trysail down and began to run under bare poles.

The new seas from the southwest were soon larger than the old seas that were running, so the course was changed to east-northeast. But the yacht had become almost unmanageable. She slowed to 3 knots on the back of a wave, and then increased her speed to 10 knots when the yacht skidded down the front of a wave. Sometimes a larger wave speeded her up to 12 knots or more; cross-seas threatened to capsize the vessel.

Snyder decided to try the Galerider drogue. The crew led the bitter end of 200 feet of 1¹/₄-inch-diameter nylon line around the transom and through the starboard chock to the coffee grinder on the after deck. Then the men used a giant shackle to secure the big eye splice in the line to the swivel on the drogue. Finally the crew dropped the drogue into the water.

The effect was miraculous. Within minutes the yacht's speed dropped and she was soon running at 3 knots. "The effect of slowing the boat in that big seaway was magical: a moment earlier the boat had been charging like a mad bull, with the helmsman struggling at the wheel; the next she was docile and under full control," wrote Snyder.⁴⁶

Southerly continued to roll, but she responded to her wheel and was safe. The seas continued to increase for the next 3 hours, and several big waves crashed on board. By 0200 the wind went to the north; at 0400 the storm was down to Force 7, and then the storm was over. The next morning the crew easily pulled in the drogue and found no signs of chafe on the gear. The initial trial had been a whopping success.

Skip Raymond, who patented his product (The Galerider Storm Survival System), suggested that the big basket might be good for scooping up a man who fell over the side. The *Southerly* crew tried this in the tropics and found that the basket was large enough for both a victim and a rescuer, who could snap his safety harness to the swivel at the top of the basket. The device can be dropped from a block at the end of the main or mizzen boom, which can then be used as a hauling yard. This arrangement is also handy for lifting heavy supplies from a dinghy.

Since the *Southerly* episode in 1984, the firm of Hathaway, Reiser, and Raymond of Stamford, Connecticut, has sold thousands of these drogues of different sizes for yachts and fishing vessels of various displacements.

Other sailors have found that recovering one of these modern drogues is by no means as simple as Frank Snyder wrote about in his 1986 article. Sailor and author Beth Leonard, whose ocean-crossing credentials are substantial and well-known, writes as follows: "Hauling back the drogue takes a huge amount of sustained physical effort. Using our primary winch and working in shifts of 20 to 30 minutes each, [Evans and I have] taken over 2 hours to winch in the 300-foot rode." Sometimes, in desperation, Beth and Evans have led the line forward to the electric anchor windlass on their 47-foot Van de Stadt sloop.⁴⁷

Two generations ago, Tom Steele, who circumnavigated twice in *Adios*, a heavy-displacement, slightly lengthened 32-foot Tahiti ketch, wrote about his adventure with two hurricanes off the coast of Baja California. With adequate sea room and under bare poles, he dragged 300 feet of 1-inch-diameter nylon line with an anchor at the end. This drag produced an even, powerful strain at all times, and his boat remained stern-to, moving at 1½ to 2 knots. Steele found this method superior to using a warp alone, which he said “may skip ahead when the boat surges forward, just when more strain is needed.”⁴⁸

All yachts and fishing boats have anchors. Lacking anything better, I would have no hesitation about following Tom Steele’s idea and dropping an anchor astern when running before a violent storm.

In the years since the capsize and upside-down roll of my Santa Cruz 50 in the Southern Ocean, I’ve had plenty of time to reflect on the mishap. I believe that protection from monstrous seas translates directly into keeping the bow or the stern headed into the waves. Getting broadside-on (or even close to broadside-on) is dangerous because the vessel may be rolled over or picked up and dropped on the unyielding sea. But how do you do this? Using a parachute sea anchor from the bow is one answer. Dragging a drogue from the stern is another approach. But even with these devices, I worry that under some conditions our modern yachts may lie close to being broadside on to the waves. This is a situation that we must avoid when the sea is all white and our ears are filled with the screaming wind.

Let’s look further into drogues.



A NEW IDEA

We now come to the work of Donald Jordan, his research on the capsizing of sailing yachts, and his invention of a new type of drogue.

During World War II, Jordan was a bright young engineer who worked on the design of military fighter planes. Later he joined the Pratt and Whitney Aircraft Company in Connecticut and eventually became chief engineer. When he retired in 1976 he spent 10 years at the Massachusetts Institute of Technology as a senior lecturer. An ever-curious engineer, he has invented many clever devices.

One of the world's great sailing yacht competitions is the 605-mile Fastnet Race that goes from Cowes, on the Isle of Wight in the English Channel, westward to the southern tip of Ireland. The boats then turn around the 177-foot Fastnet Rock lighthouse and head back to Plymouth in southwest England. The race is a great sailing and social event in the usually gentle English summer. In 1979, 303 yachts crewed by 2,700 sailors entered the competition.⁴⁹

Unfortunately, after the race began, a vicious Force 10 storm—poorly reported by the weather forecasters—slammed into the fleet, most of which was woefully unprepared for such weather. Boats were capsized, dismasted, and half-filled with water. Some sailors took to their life rafts; others stuck to their boats. Distress signals brought helicopters and big ships, and in a few hours a huge rescue attempt was underway. Even so, there were 15 deaths.

The authorities and the sailing world were aghast that a supposedly robust yachting fleet had been so decimated. Boats were rolled over, destroyed, and sunk in waves

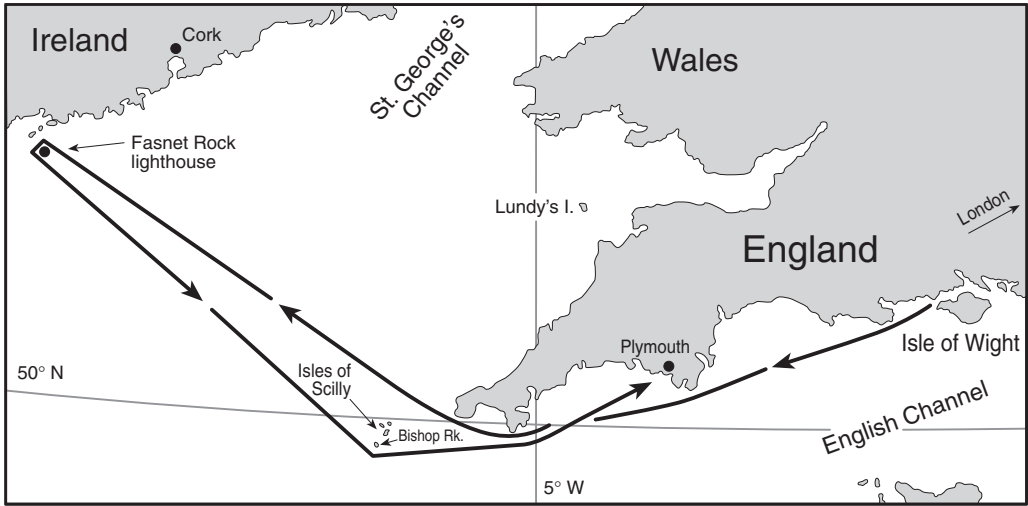

The route of the 605-mile Fastnet Race.

that were said to be as high as 50 feet. Only 85 of the 303 yachts that began the Fastnet managed to complete the race.

It was clear that the weather warnings were vague and poorly distributed to the captains, and there were questions about the skills of many of the yachtsmen. In addition, a number of the boats appeared to be poorly designed and flimsily built, particularly with regard to rudders and cabin entrance arrangements.

Although Jordan was not an ocean sailor and has never been in an offshore storm, he had been a Sunday sailor for years. When he read the newspaper accounts about the Fastnet Race, the loss of life, and the many yachts that were abandoned, he was horrified.

When I visited him at his Connecticut home in January 2003, he reflected on his long career, which ranged from designing Vought fighters for the Navy to working on the first jet engine for the Boeing 747. In those days he had been exposed to hundreds of difficult technical problems that seemed impossible at first, but which eventually yielded to patient inquiry. He wondered if some of the same engineering principles could be applied to small vessels to keep them out of trouble.

"After the Fastnet storm, I followed the investigations in England and the U.S.," Jordan told me. "I read all the technical reports and discussed the problem of storm survival with sailors and marine engineers. The thrust of the conclusions of the committees and research agencies looking into the tragedy was directed toward 'killer boats.' Of the 303 yachts, five sank. At least 75 were flipped upside down with their

masts vertically downward. Another 100 dipped their masts in the water. It was widely believed that the carnage was the result of modern yacht design: a beamy, light-displacement hull with a fin keel, a spade rudder, and high freeboard.”

Yet when tests were conducted in England to investigate these suspect design trends, none was found to have a major effect. Jordan repeated the tests in the United States with the same results.

“It was clear to me that the design of the boat and the sailing skills of the skipper and his crew had little to do with the tragedy,” said Jordan. “The large fleet was simply exposed to conditions not known before during a summer regatta. In other words, at Force 7 to 8, the boats and their crews were operating at the high edge of their design and skills. When exposed to a Force 9 to 10 storm, the fleet was overwhelmed. What could we do to reduce the risk?”

In all these investigations, little attention was focused on the role of an external device—that is, a sea anchor or drogue. The University of Southampton in England conducted a brief series of tests that showed encouraging results with a drogue, but the work was put aside.

The British Royal National Lifeboat Institution (RNLI) had used drogues for a number of years. Their drogue, a cone type, was deployed from their motor lifeboats when returning through an inlet with breaking waves. During bad conditions it was sometimes reported that the drogue would be pulled out of the steep face of a following wave and catapulted toward the boat. In at least one case it ended up ahead of the vessel. Drogues are no longer used by the RNLI because its modern rescue boats are larger, with more powerful engines, and can outrun the waves in inlets and bay entrances.

“I decided to undertake the subject of breaking wave capsize and attempt to find a practical engineering solution,” Jordan told me during my interview with him. “I thought that with the modern tools available from aircraft technology, such a goal should be possible. Certainly any competent aerospace company has handled problems much more challenging. Yet to my knowledge, no one else was concerned with this aspect of sailing safety.

“Throughout the ages the surface of the sea in a hurricane has been the ultimate example of a hostile and dangerous environment,” said Jordan. “Yet when compared to space, undersea, or even the thin atmosphere through which millions of people now travel through the air in comfort and safety, the sea in a storm is relatively benign in a modern engineering sense.

“The temperature and pressure at the surface of the sea are reasonable, and water is a safe and familiar fluid. Water speeds are low, less than 40 mph, and airspeeds are

low also, less than 100 mph. Even accelerations are modest, 2 to 3 g. Why must boats be damaged and sailors drowned?”⁵⁰

Jordan gave me a list of questions he had made when he started his work. The list was typical engineer-speak:

1. Should the external force be applied at the bow (with a sea anchor) or at the stern (with a drogue)?
2. How much force must be applied to prevent capsize?
3. Can the force be applied soon enough to catch the boat before it capsizes?
4. Is the maximum loading on the vessel consistent with the boat's structure and attachments?
5. Could the required equipment satisfy constraints of size, weight, cost, complexity, and ease of operation to the extent that it would gain acceptance by deep-sea skippers?

To learn about capsize problems, Jordan needed to expose full-size instrumented boats to a survival storm and record the speeds, loads, accelerations, etc. This was obviously impossible, so he decided to use model boats. Jordan made small wooden models from 1 to 3 feet in length, weighted so they were dynamically similar to full-scale boats.

“Could watching a small wooden model in a tank or in open water outdoors tell an observer what a 40-foot yacht would do in a Fastnet storm?” I asked.

“The answer is a qualified yes,” said Jordan. “The engineering community is thoroughly familiar with the technical rationale for scaling from small size to large size. Certain events lend themselves to scaling, and such testing can provide accurate predictions. If we drop an object from 6 feet and measure the time it takes to reach the floor, we can accurately scale this time to any height and any weight. However, if we measure the drag of a scale model of an America's Cup contender in a towing tank, it is difficult to scale this result up to the big boat with enough accuracy to be really helpful. The problem with a breaking wave capsize is much like dropping the weight. Relatively simple model tests can be extremely useful.”

Jordan bought a child's shallow swimming pool and set it up in the basement of his house. He worked out a way to discharge a controlled jet of water at a model to simulate being struck by a breaking wave. He arranged to vary the mass and velocity of the jet until a model could be violently capsized. He recorded the motion of the yacht by taking stroboscopic photographs to measure the velocities and accelerations.

He learned that the acceleration of the model is the same as that of the full-scale boat, but the time for the event and the velocity the model achieves vary with the square root of the scale. A 2-foot model of a 32-foot boat would capsize in 1 second, while the full-size boat would take 4 seconds to capsize. The model would reach a speed of 8 ft/sec, while the boat would reach 32 ft/sec, and so forth.⁵¹

In order to test a variety of models, Jordan built a small replica of the 1927 Fastnet winner (a very deep and narrow English cutter with a full keel and gaff rig). He constructed a model of a 1938 yacht and one from the 1980s (a beamy, fin-keeled, spade-rudder design). He shaped and ballasted the models so they were dynamically similar to full-size boats. This meant scaling the dimensions to a reasonable accuracy and loading each model so that it floated on the same waterline.

By 1982, he'd arranged with the U.S. Coast Guard to use its test facilities, towing tanks, and powerboats to make a study of capsizes caused by wave action in heavy weather. Jordan and the Coast Guard hoped to increase safety at sea by preventing storm damage to small vessels out in the ocean.

Most boatowners who venture offshore have read the works of Hiscock, Knox-Johnston, Moitessier, Slocum, and the Smeeton—people who've been out there—and are familiar with their hesitant advice about handling big storms. "What is needed," said Jordan, "is basic and realistic information about how yachts actually fare in hard going in big seas, so that sailors will have *positive and assured information about what to do.*"

Offshore sailors yearn for true, unbiased, noncommercial information from scientists, engineers, naval architects, and voyagers with hands-on experience in all aspects of staying safe at sea. However, the number of offshore sailors is too small to support a membership organization capable of undertaking technical studies. We don't have a *Consumer Reports* magazine or a National Highway Traffic Safety Administration, so we welcome the work of the U.S. Coast Guard and qualified individuals who contribute to offshore sailing safety.

Jordan tested his models in the Coast Guard's indoor wave tank in Groton, Connecticut. He went outdoors and watched what his models did in upset waves formed by the wake of a 42-foot Coast Guard patrol boat, which he loaded with cement moorings until a suitable breaking stern wave was formed. Jordan was able to change the height and severity of the stern waves by varying the speed of the boat.

He soon learned that when one of his models was struck by a small wave, the model would roll down and recover. When the size of the wave was increased, the boat would roll to 90 degrees, just far enough to put the mast in the water. A further increase in the size and energy of the wave made little difference until a point was

reached when the boat was picked up by the wave and thrown down in the trough. In this process the boat was essentially airborne because the wave collapsed beneath it.

If the boat were struck abeam, it would land in the trough on its leeward side, striking the water with a large impact load. The trajectory of such an event can be readily modeled on a computer, and Jordan studied the pertinent velocities, accelerations, and loads as they changed with boat displacement, moments of inertia, and other variables.

Jordan found that in breaking waves, 25-foot sailboats have a high risk of capsize and 60-footers have a low risk.

The next step was to evaluate sea anchors and drogues. Jordan went outdoors and released models in natural waves with winds equivalent in model scale from gale force up to hurricane force. He found that a relatively small drag device tethered from the stern would hold the stern into the wind with little yaw.

When a drag device was tethered from the bow, however, the boat yawed significantly, which put unacceptable loads on the line to the parachute. "The reason for this," said Jordan, "is that all boats must be designed to be directionally stable when moving forward. Otherwise it would not be possible to steer the vessel. Therefore, if moving backward, the boat would be unstable and would yaw and tend to turn broadside to the sea. A large parachute—which is essentially immovable in the water—was required to prevent the bow from falling off. Even so, the boat yawed violently at times and put a high load on the line to the parachute. Also, some of the yawing forces may come from the forward-placed rig and the aft-placed center of lateral area, which imparts a turning motion [see Chapter 9].

"In my first studies, I saw right away that a sea anchor from the bow was not the solution," said Jordan. "All of my effort henceforth was devoted to tethering the boat from the stern with a drogue. I tried various drogue sizes and configurations, which included cones, parachutes, vented shapes, and proprietary designs. Initially nothing stopped the boat from being driven up to wave speed.

"I then tried to find out how large a force would be required to catch and decelerate a boat before it pitchpoled. Any type of drogue takes a finite time to build up load because of slack in the line, elasticity of the nylon, and time for the drag device to fill. When struck by a breaking wave, the acceleration of the boat is so high, approximately 2 g, that the boat would move only 10 to 12 feet before reaching wave speed. Thus the function of the drogue is not only to prevent the boat from being driven forward by the wave but to catch the boat before it is rolled or pitchpoled."

Initially Jordan used a simple disc-shaped piece of wood for a drogue. This was easy to scale up to full size, whereas cones or parachutes were more complicated. He adjusted the wave generator in the towing tank so that without a drogue, the model

capsized violently. Then he added the drogue and gradually increased its size until the model rode through the overtaking wave.

“In a storm with 40-foot waves,” says Jordan, “the surface water is moving toward the boat in the crest and away from the boat in the trough. Thus a single drogue riding near the surface will move toward and away from the boat by 40 feet with the passage of every wave. Also the boat will move toward and away from the wave. This means that the towline will become slack and taut, slack and taut. If the slack in the towline is large at the time of a breaking wave strike, the boat may capsize before the drogue can act.”

Jordan ran tests in a glass-walled flow channel tank to study the underwater motion of a drogue in large storm waves. According to the designer, a single drogue device was unacceptable. It tumbled if struck by a breaking wave, and on occasion was pulled out of the face of a steep storm wave. If weighted, the drogue collapsed and sank when the towline went slack.

Jordan finally developed the idea of a series of 6-inch fabric cones woven into a long line with a small weight at the end. This eliminated the problems of a single drogue and kept the slack out of the line.

He spaced the fabric cones along the line every 20 inches and based the number of fabric cones (100 to 200) on the displacement of the vessel in question. “The cones

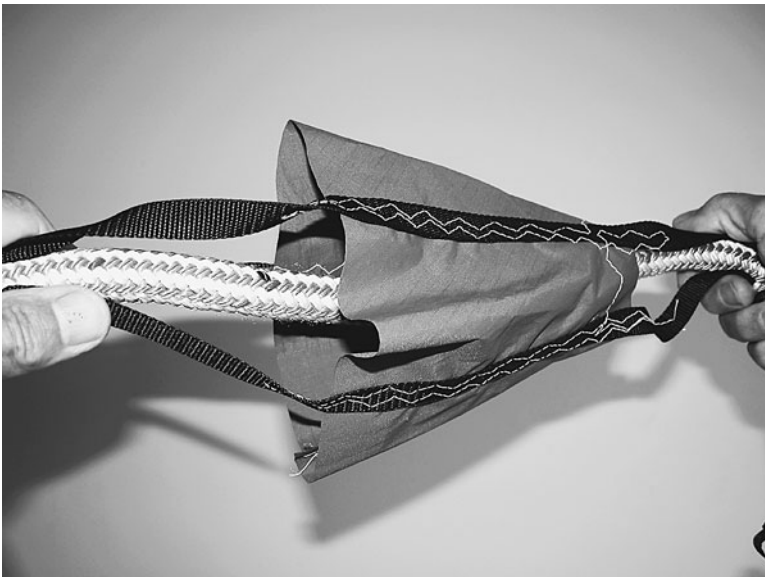

A 6-inch single cone is securely woven into a double-braided nylon line with three $\frac{3}{4}$ -inch nylon tapes.

function as check valves,” says Jordan. “They provide high drag going forward and low drag going backward with essentially no hesitation when reversing. The cones cannot turn inside out, and they never foul by wrapping around the line. The maximum design load on each cone is low—less than 200 pounds—which allows them to be made of lightweight material. As far as I know, no properly made cone has ever failed or fouled in service.”⁵²

In the case of a rare breaking wave strike, the drogue must catch the boat quickly—within 1 or 2 seconds—to prevent a capsize. With a long elastic rode and a single-element drogue or a parachute, the load may not build up fast enough to catch the boat in time.

With the series drogue, the cones begin close to the boat where they’re fixed to the heavy line. The cones are small, and open quickly; thus the series drogue will build up a load at once. According to Jordan, in a typical wave strike, the load will start to increase in 1 second and will peak in 3 seconds.

The peak load during the strike is largely determined by the displacement of the boat. The drogue must catch the semi-airborne boat and decelerate it. The inertia force associated with this deceleration is the major portion of the total load. It is therefore necessary to adjust the number of cones, the diameter of the rode, and the strength of the attachments for each drogue to match the displacement of the boat.

According to Jordan, with too little drag the yacht won’t be slowed enough to resist a possible capsize from a breaking wave. With too many cones, on the other hand, the vessel will be held too rigidly and something will break. *The design load*, says Jordan, *should be one-half the displacement of the yacht* (see the accompanying table). This represents a once-in-a-lifetime ultimate load. In an ordinary storm, the peak load is only 10% to 15% of the design load.

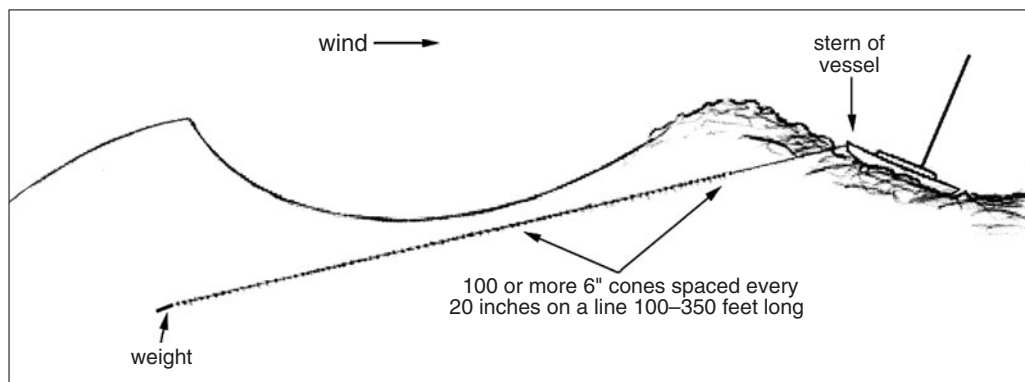

Jordan Series drogue stretched out behind a yacht in heavy going.

JORDAN SERIES DROGUE APPLICATION TABLE

Displacement in thousands of pounds	10	15	20	25	30	35	40	45	50
Number of cones	100	107	116	124	132	139	147	156	164
Length of line in feet	242	254	269	282	295	307	320	335	349
Diameter of braid in inches	5/8	5/8	3/4*	3/4*	3/4*	3/4*	7/8*	7/8*	7/8*
Sinker weight in pounds	15	15	15	15	25	25	25	30	30

**Line may be tapered.*

“In general,” said Jordan, “I designed the drogue to provide a peak force of 50% to 60% of the displacement of the vessel when the boat is struck by a worst-case breaking wave. As a comparison, a large parachute sea anchor that’s deployed from the bow will develop a drag more than thirty times as much as the series drogue at the same speed. In truth, a large parachute is the practical equivalent of being anchored to the bottom.

“In that once-in-a-lifetime ultimate storm that I hope you will never see,” he said, “there’s a good chance that the line to the parachute will break or the hull attachments will be torn from the boat long before such a load is reached.”

In May 1987, the U.S. Coast Guard published Jordan’s engineering report (CG-D-20-87) titled “Investigation of the Use of Drogues to Improve the Safety of Sailing Yachts.”

Here’s my summary of Jordan’s essential points as they apply to offshore sailors in monohull sailboats. Some of the conclusions are surprising:

1. The number of small boats that go to sea has increased dramatically. When caught in a storm, most sailors choose to lie a-hull or run off. Few sailors carry drogues.
2. A capsizing caused by a breaking wave is rare. A sailor can go through a lifetime of ocean sailing without being involved in such a mishap.

3. Wind doesn't cause capsizes. Breaking seas do.
4. In tests with breaking waves, all models without a drogue capsized. When struck abeam, the models capsized violently and rolled 360 degrees. When struck on the quarter, the models sometimes pitchpoled. If the mast is gone, the vessel is much more vulnerable to capsize.
5. In a major storm, all single-element drogues will ride on the surface and may be thrown toward the boat by a breaking wave.
6. If a drogue is used, it should be deployed from the stern rather than from the bow. With a drogue from the stern, a sailboat will lie stern-to the wind and sea. With the same drogue (or sea anchor) set forward, the bow of a modern monohull sailboat will turn away from the wind, sometimes up to 70 degrees. This may put the vessel in grave peril.
7. The tests clearly show that a drogue deployed from the stern can hold a boat into a breaking wave crest and prevent capsizing. Use of a drogue improves the motion of a sailboat in a storm and reduces leeward drift.
8. In a great storm, the crew may be exhausted and confused. If the drogue and lines aren't ready, the chance to ride through a breaking wave may be lost. The drogue should be on hand and ready so that one person can deploy it quickly and safely—at night or in a storm.
9. Boat design changes don't affect capsizing. Models of typical sailboats from the 1920s, 1930s, and 1980s showed no difference in capsize tests.
10. A boat lying a-hull or sideways in nonbreaking seas moves more or less with the surface water and won't capsize. However, if a breaking wave strikes the boat, it will likely capsize violently.
11. Two or more storm waves may combine to form a larger wave that may become a dangerous breaking wave.
12. The drogue should be attached to the boat with a V-bridle whose lines are shackled to stout chainplates or other special attachment points at the corners of the transom. All drogue lines should be spliced around high-load cast-metal thimbles (see Appendix 1 for source) and not tied, for example, with bowlines. Running a bridle line through a chock and belaying it to a mooring cleat may not be adequate and can lead to fitting overload, chafe, and failure.

13. During a breaking wave strike, a drogue puts significant loads on the hull. According to Jordan, the attachments at each corner of the transom should be built to take 70% of the design load. For a total drogue design load of 15,000 pounds, for example, each bridle leg and attachment should be capable of carrying 10,500 pounds, a number that may be reached only once or twice during the life of the equipment.
14. When the boat is aligned to a wave, the load on each leg of the bridle is 50% of the total. But in a wave strike, the vessel is usually a bit to one side or the other, and much of the load is on one bridle leg. The load isn't applied instantly but builds at a finite rate, and as it increases, the boat yaws to reduce the angle. Computer analysis shows that the load on a single bridle leg can reach 70% of the maximum load before the other leg kicks in and begins to share it.

When using a series drogue, it should be connected to the boat with a V-bridle. Jordan has calculated that the length of the bridle should be two and a half times the distance between the two attachments at the upper corners of the transom. This ensures that with a straight pull, the load in each bridle arm will not exceed 52% of the total load. For instance, on my current 35-footer the transom width is 7 feet, so the V-bridle should be 17.5 feet long. The bridle streaming behind the vessel is important and provides a turning moment to keep the boat's stern to the waves.

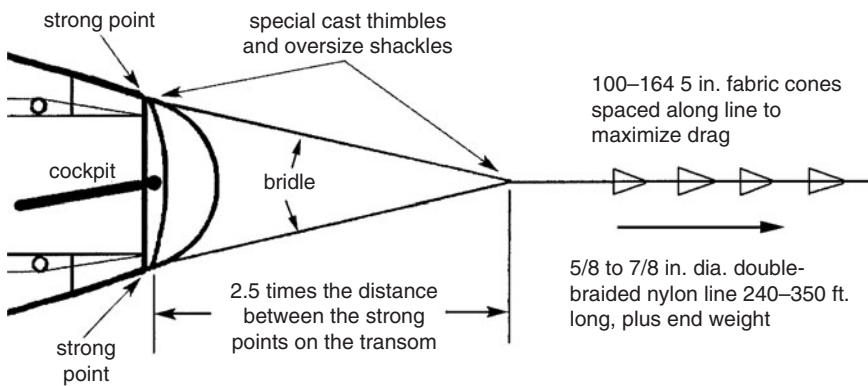

Details of the transom bridle and hookup of a series drogue to allow the boat to run downwind without steering.

What this means in the real world is that once the Jordan drogue is in place, no steering of any kind is necessary. “The yacht is moving forward all the time, so you don’t need to lash the tiller in place,” says Ed Arnold. “But to keep it from banging around during a cross-sea, I tie the tiller amidships with light line. If I had a wheel I would be hesitant to lock it in place because a cross-sea might break something or misalign the wheel with the rudder. I would tie shock cord on the wheel.”

Since no steering is necessary, the people on board can deploy the drogue and go below where they’ll be protected from the wind, waves, and cold.

“The boat rides easily with less than 10 degrees of yaw and with a drift rate of 1.5 knots,” says Jordan. “The drogue loads are low, about 15% of the [total] design load, . . . [which] is only approached in the rare event of a ‘worst case’ breaking wave strike capable of catapulting the boat ahead of the wave. . . . [If this happens], the drogue is designed to align the semi-airborne boat with the wave, decelerate the vessel, and pull it through the breaking crest without exceeding the allowable load on the drogue or boat.”⁵³

The yacht needs a strong cockpit (preferably small and with large-diameter, unobstructed drains) and a stout companionway and sliding hatch that can withstand

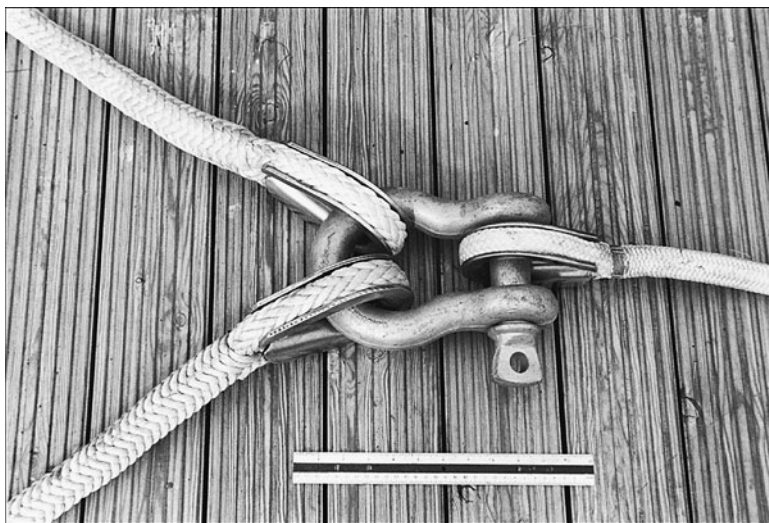

The gear for the series drogue is big and heavy because the potential loads are high and there can be no failures. This photograph shows the transom bridle (left) and main line hookup (right) for a 32,000-pound 43-footer. These lines are 1 $\frac{1}{8}$ inches and $\frac{7}{8}$ inches. The metal thimbles are cast, not stamped. The shackle to connect these three fittings is 10 inches long. (Note: The shackle pin is not wired in this photo.)



Cones and line spread out on a dock. For stowage, the drogue apparatus fits into one or two nylon duffel bags.

occasional boarding seas. The washboards and hatch must be securely fastened and have suitable inside locking arrangements to hold them firmly in place.

During boarding seas the boat is usually accelerated up to wave speed, which means that the velocity of the breaking crest is not high relative to the boat. Jordan says that he knows of no instances of damage to the rudder, cockpit, or companionway of a yacht with his drogue arrangement. During the development of the series drogue, the Coast Guard had good results with the device on motor lifeboats in breaking seas at the mouth of the Columbia River in Oregon, one of the most hazardous river mouths in the world. Another test subjected a batch of the sailcloth cones to 15,000 openings and closings. The fabric cones came through it in good condition.

When I talked with Jordan, he recalled that in his early days, he worked on the design of the first jet fighter to be flown from an aircraft carrier. He mentioned that the dynamics of carrier landing problems are remarkably similar to a boat equipped with a drogue that is struck by a breaking wave. The wave represents the catapult that launches the aircraft. When the plane lands, the drogue represents the arresting gear on the deck of the carrier that catches the aircraft and decelerates it without exceeding the design loads on the aircraft or the arresting gear. The latter, like the series drogue, can

be adjusted for the weight of each aircraft in the landing process so that the inertia load during deceleration does not exceed the design load.

Unlike all the other parachute and drogue manufacturers, there are no patents or proprietary fees connected with the series drogue. Jordan has no financial interest in it. Any sailmaker can fabricate one, or you can make the whole thing yourself, a tedious job. For more information, look at Coast Guard report CG-D-20-87, available from the National Technical Information Service, 5285 Port Royal Road, Springfield, Virginia 22161, USA. On the Internet, you can download the 61-page paper from www.acesails.com.

In 2007, the prices from Ace Sailmakers for complete, ready-to-use units ranged from \$1,161 (for a yacht with 10,000 pounds displacement) to \$1,472 (for a 25,000-pound displacement) and up to \$2,040 (for a 50,000-pound displacement). Bundled up, a unit is surprisingly small, and can be fitted into one or two nylon bags for storage on the after deck or in a locker. I repeat: You will need strong connections to the hull.

Ace also sells kits for making a series drogue. For a 20,000-pound displacement, you would need 116 cones on a 194-foot line with a 75-foot leader, or a total of 269 feet. The cones only are \$464, the kit costs \$915, and the completed series drogue is \$1,339.

Jordan suggests that for a fiberglass sailing monohull of 14,000 pounds displacement, you bolt on two stainless steel straps, each $\frac{1}{4} \times 2\frac{1}{4} \times 18$ inches, and fasten them to the after deck or hull with six $\frac{3}{8}$ -inch-diameter bolts. If you have a metal hull, suitable heavy tabs or chainplates can be welded in position on the corners of the transom. These straps or tangs make good, nonchafe attachment points for docking lines during storms or winter storage.

Several users report problems with the bridle lines getting fouled with a steering vane mounted on the transom. These sailors suggest floating lines (or small floats) for the bridle and a small float where the heavy shackle connects the bridle lines to the main line of the drogue. Since there may be a big load from the series drogue, it's important to tie the shackle pin with many wraps of wire.

In 2007, Jordan estimated there were 1,100 to 1,400 series drogues aboard ocean-cruising sailboats. Many captains have carried these devices aboard for years without using them. Except for difficulties in recovering series drogues after a storm, all the performance reports that I've seen have been favorable.

This specialized drogue designed for the ultimate storm is not cheap, the hull connections are complicated, and you may never use it. But who can tell when another Fastnet disaster will occur?

13

DO DROGUES REALLY WORK?

Consider the following letter from circumnavigator Ed Arnold, who wrote me while heading for South Africa after rounding Cape Horn on a singlehanded voyage in his 35-foot aluminum-hulled boat *Nomad*.

February 3, 2002

Hal,

I have used the Jordan Series drogue many times both for safety in breaking seas and to hold position. Don Jordan estimated the forces on a boat in a breaking crest and designed the drogue to quickly establish the necessary restraining force to drag the boat through the crest. This resulted in a relatively short and stiff main line compared to many recommendations for parachute sea anchors. More or larger cones might be better if one were trying to hold position. My 20,000-pound boat required 117 cones.

I attach the bridle with shackles to tangs welded to the corners of my transom. Forces are large, and a chafe-free attachment is necessary. The drogue works well from the stern; I tried it from the

bow and found it would not hold the bow closer than 70 degrees to the wind.

I have deployed it 3–4 times due to breaking seas. The first time in the N. Atlantic south of Iceland I had about F10 winds and seas of 25 feet or more. The boat was held within ± 30 degrees from the wind. Most of the sluing was in the troughs where the wave backflow reduced tension on the drogue and where the wind was momentarily less. Mary and I stayed below with periodic checks on the VHF for shipping. The cockpit would have been very wet and at times almost dangerous. Boarding seas filled the cockpit several times, but none broke directly on us. Drift was about 2.5 knots. Surface current is $\frac{1}{40}$ th of the wind speed, so a knot of the drift was surface current.

I had similar results in the Gulf of Alaska and near Cape Horn during the present voyage: F9 or F10 winds with very high seas near Cape Horn. At all times I felt safe, although a full breaking sea on board might do real damage. The other 4–5 uses have been to hold position when I could no longer go upwind and I did not want to run downwind. A larger drogue would have helped. I have not had any tangles during deployment or use. I did have the bridle get under the windvane rudder, and now use a floating line for the bridle.

Retrieving is hard work, and I would appreciate knowing an easier way. I have a retrieval line to the head of the bridle, which I winch in. Then, with some danger to fingers, I can get the main line around a winch during a surge of the boat. This is winched to the first cone. I take one turn on the winch and manually snub during stress and take in during a back surge. The cones survive the snubbing around the winch. With patience and effort it all comes in.

The stern and companionway of my long-keeled aluminum boat were designed to take a breaking sea. Some boats would not be strong enough.

Ed

The problem that Ed Arnold had recovering his Jordan Series drogue is not unique. Nevertheless, after the storm the drogue must be retrieved. The problem is quite understandable and attests to the astonishing and immediate drag of the multiple fabric cones. We saw in Chapter 11 the problem that Beth Leonard had recovering a Galerider drogue. Donald Jordan tends to scoff at these difficulties, but he has never had to

recover one of his drogues at sea. When I asked Ed Arnold, who wrote the letter above and who has used a series drogue a dozen times or more, he replied as follows:

. . . I could often get one turn of the bridle leg over a sheet winch during a stern-down pitch, taking considerable risks with my fingers. Then I managed to crank in the bridle leg and get past the shackles onto the main line. More often, I used a rolling hitch to my secondary winches until the shackles got aboard. Then I continued with rolling hitches until I got to the cones. At this point I managed to get a turn around the main winch and used pulls during down-pitching and snubbing to hold the line uptake. A few times I lost most of my headway when the tension was too great to snub.

It helps to have the self-steering operating so that the boat maintains a direct downwind direction. Even with no sails downwind, my vane held a good course. I had boat speeds less than 5 knots, usually 2–3 knots, during retrieval.

It always took a few hours to retrieve and stow, sometimes half the day. Be sure to have some treat handy, either liquid or otherwise, to celebrate (hooray!) getting the drogue aboard with all your fingers intact.

I learned to tie a retrieval line to the shackle at the throat of the bridle. I winched this in to get the shackle aboard and then used rolling hitches as needed to get a turn on the primary winch with the main line. This retrieval line helped save the fingers. I used a rope I had aboard, maybe about 1/2-inch diameter. I never had it break as conditions during retrieval were usually not too severe. It was one more line to sort out once everything was back on the boat.⁵⁴

Lin Pardey reports that when the crew of the 50-foot steel Arctic island exploration vessel *Tiama* tested their series drogue in winds of 20 knots, the device slowed the vessel to 2 knots and held her almost directly before the wind. But retrieval was extremely difficult. “Six strong crew took almost 3 hours to retrieve it and . . . were totally exhausted even though there was only 20 knots of wind.”⁵⁵

Dutch sailors Willem and Corri Stein, aboard their 39-foot Joshua ketch *Terra Nova*, thought the 5,100-mile passage from South Africa to Australia in early 2004 would be straightforward. On February 11, however, the northwest wind increased to storm force and the seas began to build up. *Terra Nova* ran on with only a single sail, the ship’s smallest yankee. That night the wind increased and the bright red ketch was

knocked down. There was some minor damage, and Willem and Corri found the experience scary. The vane gear couldn't handle the steering, so the two-person crew took turns at the wheel. They averaged 5 knots under bare poles.

At the end of the day, the Steins, tired from steering and the violent motion, deployed their Jordan Series drogue, which had 150 small cones sewn along a 1-inch polyester line 400 feet long with a 22-pound block of lead at the end. As soon as the drogue was out, *Terra Nova's* speed dropped to 2 knots, and she kept her stern nicely into the seas. Life became tolerable and allowed the crew to sleep.

"The next day the wind abated a bit, but the strain on the drogue was still too much to even think about getting it back on board," said Willem.

There was a new problem. Due to the heavy pitching of the boat in the seaway, the bridle lines tangled around the water blade of the Aries windvane gear. The Steins hoisted a storm jib, which put more force on the drogue lines and kept them free of the water blade.

When the wind eased, the Steins tried to haul the drogue on board, but the task seemed impossible. "Even getting it around one of the sheet winches was such a dangerous exercise that I gave up after I nearly got one of my hands amputated," said Willem.

The Steins might have been able to use their engine to back down a little on the drogue while they pulled it in, but the engine was out of order because water had run into the fuel tank during the knockdown a few days earlier. Willem and Corri waited two more days for the sea to calm down.

Finally, in desperation, they cut the lines to the drogue. I've sailed with Willem and Corri in Newfoundland and know they are tough, dedicated, experienced small-boat sailors. It must have been a hard decision to cut away the drogue, which they had made with so much effort.⁵⁶

After thinking about this problem, I wonder if the following might be a solution: Run a 1/2-inch-diameter recovery line from the anchor windlass at the bow outside the lifelines and back to the stern. Loosen one of the bridle lines (hitch on a short line and take it to a winch to pull some slack in the bridle line so you can disconnect the shackle from the chainplate) and attach the recovery line. Then let go the other bridle line. Now, with the stern no longer fastened to the drogue, the boat should swing around 180 degrees and drift downwind from the drogue, bridle, and recovery line. You will have to pay attention to the lead of these lines at the bow, but it should be possible to pull them straight in with the powerful windlass, whether it's operated by hand, an electric motor, or hydraulic power. I've never attempted this with a series drogue, but I think it or some variation is worth a trial.

Anything to save fingers! Note that this scheme moves the recovery effort away from complications of a line around a spade rudder or the water components of a windvane steering device. Additionally, the recovery effort at the bow eliminates

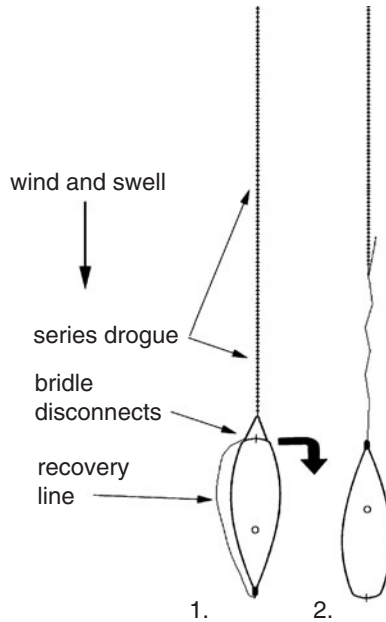

A possible drogue recovery scheme in light weather.

problems of winching in the line in the cockpit with complications from the stern pulpit and other cockpit or transom gear.

In spite of these reports, other users of drogues write of simply pulling in the line by hand with no apparent difficulties. Obviously the recovery of drogues needs more investigation.

In 1991, Gary Danielson of St. Clair Shores, Michigan, sailed a lightweight Ericson 25-footer named *Moon Boots* from the United States to Europe and back. He had good crossings, and used both a Galerider drogue and a Jordan Series drogue during Force 8 weather.

To slow the boat, Gary put out the Galerider, but when he wanted to hold his position, he employed the Jordan Series drogue, which worked well. If the boat crested a wave, however, the large and heavy sliding companionway hatch would slide open because the inside locking hardware was broken. Each time the hatch slammed open, water poured into the cabin.

According to Donald Jordan, Gary's hatch wasn't washed open by the waves but slid forward because the drogue decelerated the boat as it passed over a crest. With a functioning latch, he'd have had no problem.

"For small, light boats, the peak load occurs when the boat is airborne from a wave strike and the drogue must catch and decelerate it," said Jordan. "For large, heavy

boats, the peak load occurs when the boat is surfing down the face of a breaker and the drogue prevents the yacht from crashing into the trough.”⁵⁷

After three months of delightful cruising in Tonga, Jack and Norma Thomson sailed from Nuku’alofa in their Discovery 42 yacht named *Egress II*. The date was November 9, 1998, and the trim sloop was headed for New Zealand, some 1,040 miles to the south-southwest.

The weatherfaxes from New Zealand suggested benign winds, and true enough, for the first four days the winds were fair and light, which allowed the Thomsons to fly their cruising spinnaker part of the time. Late on the fourth day, however, a new weather chart showed a low-pressure area developing between Fiji and New Caledonia. The storm was rapidly approaching *Egress II*.

The Thomsons reacted by putting three reefs in the mainsail and drastically reducing their headsail area. Less than 5 hours later the weather front was upon them, with 35 knots of wind from the east, a falling barometer, and heavy rain. By 0400 of the fifth day from Nuku’alofa, the wind was gusting to 40 knots. During the day the clouds parted to show the sun, the wind eased slightly, and by sundown the clouds were back and a warm front passed over the yacht.

The low apparently collided with a big high over New Zealand. This compressed the isobars of the low, and caused increased wind strength. Then the low changed direction to the north and passed over the yacht once again. By the morning of the sixth day, the boat was sailing at 7 to 8 knots under a triple-reefed mainsail and a small staysail. Because of the changes in the direction of the low, the seas were 15 to 20 feet high, confused, and breaking. Soon the wind was 40 to 50 knots with gusts to 55 and higher.

The Thomsons dropped the mainsail and prepared to deploy a Jordan Series drogue they carried on board. Their boat displaced 30,000 pounds, so their drogue had 145 cones on a tapered line 325 feet long. The drogue had four parts: a short bridle, 75 feet of 1-inch braid, 100 feet of $\frac{3}{4}$ -inch-diameter braid, and 150 feet of $\frac{1}{2}$ -inch braid. The Thomsons shackled all the parts together, faked down the line, and tied a dinghy anchor to the end. Then standing clear, Jack dropped the anchor into the water. The line ran out quickly, and the boat’s speed dropped to 1 knot or so. The Thomsons doused the small jib, locked the rudder, and hurried below.

It was now 0900, Saturday, November 14, the sixth day from Tonga. The sea conditions were violent. *Egress* was occasionally swept by waves, and sometimes water squirted around the edges of the companionway washboards. To keep the sliding hatch under control, Jack jammed it shut with a big fastening. With all the water flying around, the Thomsons soon discovered that the hatch over the galley leaked. Large and small waves came from three directions, and Jack and Norma had to hang on carefully when they moved around the cabin.

For three days the yacht was swept by wind and waves, but she continued on a course of west-northwest at 1 knot or so. Fortunately the vessel had plenty of sea room. During the storm the Thomsons occasionally climbed into the cockpit to check for chafe problems. When they looked aft, they were unable to see any of the cones on the drogue.

Finally, on the morning of November 17, the ninth day from distant Nuku'alofa, the storm was over. The seas were down and the wind had collapsed to 10 knots. Jack hauled in the drogue hand over hand. The Thomsons put up the sails and again headed for New Zealand, now 400 miles away. By checking GPS positions, Jack reckoned that *Egress* had logged about 100 miles while hanging on the drogue.

In this same storm, other boats fared poorly. The boat *Never Monday* had problems while riding to a parachute sea anchor. A mooring cleat at the bow tore loose and the rudder was damaged. Another boat bashed into the sand of Northeast Beach on New Zealand's North Island. The captain made it ashore, but a woman on board drowned. A third boat lost her mast.

The Jordan Series drogue served *Egress* well and held her narrow stern into the waves, and kept her from turning sideways to the storm. Later, when the Thomsons checked over the drogue, they found that a few of the knots holding the cones to the main line had come undone, but the tension on the line had kept the cone fastenings in place. Wonderful!⁵⁸

Richard Herring and Jacinta MacKinnon, who live on Cape Breton Island at the east end of Nova Scotia, Canada, decided to sail their Contessa 32 *Moonstruck* to Bermuda and then to the Caribbean. The two sailors cleared Halifax for Bermuda, 880 miles south, on October 12, 1995.

This is normally an easy summer voyage, but anyone who sails a small boat in these latitudes of the Atlantic late in the year needs to keep a rabbit's foot in his pocket. Richard and Jacinta had planned to sail during the summer, "but we were delayed by one problem after another," said Richard. "Now we hoped to slip south between gales."

A look at the North Atlantic pilot chart for October indicates a 2% to 5% chance of a Force 8 or more gale. The winds are fairly evenly spaced around the compass and usually have strengths of Force 4 and 5.

The two Cape Breton Islanders left with a good forecast and had two days of splendid sailing in sunny weather. "On our third day out, the radio started yammering about a southwest gale," said Richard. "The prediction was true, and a few hours later we were down to three reefs and the storm jib trying to continue south.

"The wind and seas kept rising, and soon it was impossible to go on. We took down the small sails, which wasn't very hard, since they were only tiny scraps of Dacron. We turned and ran downwind, to the northeast, under bare pole. At that time

we were 210 miles south of Halifax. The first land ahead of us was Sable Island, a dangerous 26-mile-long sliver of land—generally fogbound—on the edge of the continental shelf about 180 miles under our lee.”

“Running under bare pole was a mess,” said Jacinta. “The boat seemed to be going at hull speed, and the cockpit was continually filling up from waves that slammed on board.”

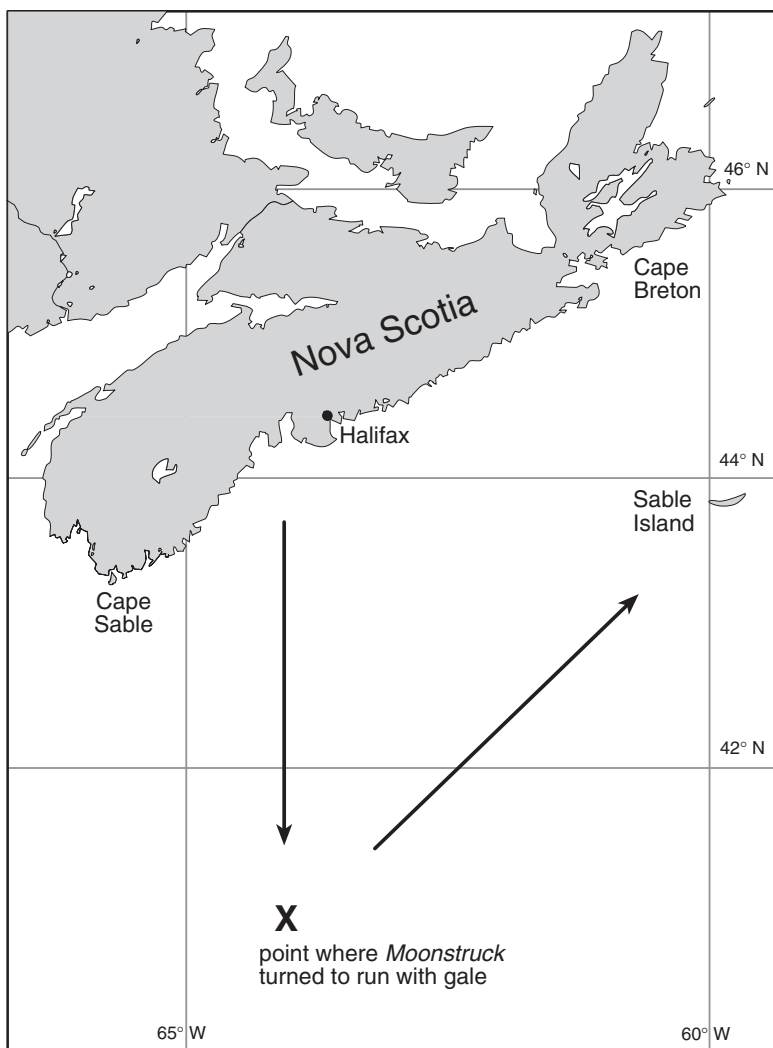

Moonstruck's track during the violent storm south of Nova Scotia. Sable Island is a tiny, curved sliver of land usually wreathed in heavy fog.

Before the two sailors had left on the trip, a friend had given them a Galerider drogue. It was a large model designed for a vessel that displaced 30,000 pounds. *Moonstruck* displaced only 10,000 pounds, but the big drogue was all they had. Richard and Jacinta rigged a 20-foot bridle, which they attached to the jibsheet winches—fortunately oversized with strong mountings. They wrapped pieces of rawhide around the bridle lines where they went through the fairleads to the winches.

“We had run about 28 miles to the northeast when Jacinta and I dropped the Galerider into the sea and let out 300 feet of line,” said Richard. “It was guesswork on our part, but 300 feet turned out to be the correct length to keep the drogue one wavelength back. Unfortunately, the rope we used was 1/2-inch-diameter three-strand nylon. The line was very stretchy, and the boat acted like a giant yo-yo. All this movement allowed the stern to come around and almost put us broadside to the waves as we yawed from side to side.

“This was an extremely dangerous position, so we began to steer by hand to keep the stern of the boat into the storm,” said Richard. “By now the wind was a steady 55 knots (Force 10), and the waves were 25 feet high. In a few gusts the wind increased to 70 knots and the waves rose to 30 feet. We didn’t have a windvane steering device or an autopilot that was capable of steering *Moonstruck* in these conditions, so Jacinta and I took turns steering by hand.”

“As soon as we deployed the Galerider, the boat’s motion calmed down and we were in complete control,” recalled Jacinta. “Our speed dropped from hull speed to 1 or 2 knots as we ran off. If the gale had been short-lived we might have been able to hang on without the drogue, but it would have been impossible after 24 hours because of fatigue, stress, and fear.”

“If the wind continued from the southwest we had reasonable sea room, depending how long the gale lasted,” said Richard. “I figured that Sable Island was about 150 miles ahead of us. At 40 miles a day, the island was a little less than four days away. Certainly there would be a weather change before then.

“We saw two big ships at different times and spoke to them on the VHF radio. Both masters offered to take Jacinta and me off, but we told them that we were in control of things and in no danger. Our boat never gave us a single electrical or mechanical problem and handled the weather as if it were a summer breeze. Our biggest fear was losing the Galerider because of the skinny line.

“With the constant steering, fatigue was our main problem,” said Richard. “You just wear out with only two people on board. I considered trying to set the storm jib to lessen the yawing, but there was so much water flying around that I didn’t want to get out of the cockpit and go forward. We might have been able to adjust the bridle length

to control the yawing. However, there was a big load on the bridle lines and I didn't want to risk losing the drogue.

"What it comes down to in these big storms is that whatever scheme you decide on at the beginning is the scheme you will follow all the way through," [italics added] said Richard. "A drogue, a parachute, special sails, or whatever you use should be ready at a moment's notice—just like a life raft. It's simply too risky to try something new when it's midnight, you're tired, waves are dropping on board, and the change may not work."

On the third day the winds around *Moonstruck* began to ease, and soon the waters around the 32-foot *Contessa* started to look more friendly. Either the gale was moving on or Richard and Jacinta had run away from it. Sailors know that when a gale is over, it's over, and soon you're whistling for wind.

"The Galerider is a great design in that there's no trip line required to recover it," said Richard. "We used the winches to retrieve the bridle. Then we slowly winched and hauled in the main line. The seas were down to 4 feet or so and the wind had dropped to less than 20 knots. We didn't use the engine for fear of running over the line. The drogue came in fairly easy. We just waited for the line to slacken with the wave motion and then pulled slowly and steadily.

"If we run into another big storm," Richard told me, "I plan to use a $\frac{5}{8}$ - or $\frac{3}{4}$ -inch-diameter line, probably of three-strand Dacron. Besides that, maybe a smaller Galerider drogue would be more suitable for my favorite boat."

Earlier, in the discussion of parachute sea anchors, I mentioned the *Drag Device Data Base* book. Let's see what Victor Shane, the patient author of that impressive collection, says about monohull sailing yachts using drogues behind the boats.

In all, there are 19 accounts. Sixteen captains had excellent results slowing their vessels with a variety of drag devices. The Galerider and Jordan Series drogue were the most popular. Two boats employed the Seabrake drogue from Australia.

As a group, however, the skippers used anything they had on board to slow their boats. This included long lines with nothing at the ends, a sail with its three corners tied together at the limit of a 200-foot length of $\frac{5}{8}$ -inch-diameter three-strand nylon line, sail bags, tarpaulins, an 8-foot submerged dinghy, various large plastic cones, a frail-looking 24-inch hand-sewed parachute, and a metal bucket with holes cut in the bottom. We saw in Chapter 11 how Tom Steele took his Tahiti ketch through two hurricanes by dragging a 300-foot line with an anchor at the end. And let's not forget the example set by solo sailor Robin Knox-Johnston in 1968 in *Subhaili* when he was overtaken by a huge storm in the Southern Ocean. He had good results from 720 feet of floating line that he put out in a giant loop.⁵⁹

The goals of the sailors in all these cases were twofold: (1) to keep the narrow stern of the yacht facing any oncoming breaking waves (maybe yawing 15 degrees to one side or the other), and (2) to exert maximum restraining force on the stern of the yacht if the boat is overtaken by a breaking wave. The series drogue appears to reach its maximum drag quickest, because its individual 5-inch-diameter, 6-inch-long fabric drogues are woven into the nylon line starting just aft of the stern bridle.

A single-element drogue device at the end of, say, a 350-foot line provides a slower braking action because of the time required to straighten out the line, for the line to stretch, and for the drogue at the end to take up its position. We're only talking about a few seconds, but big waves come unannounced, and with a breaking wave, the quicker the drogue response, the better.

Some captains adjust the length of their drogue lines a good deal. One man reported that he kept his Galerider device on the same side of a wave as the boat except that the drogue was two waves back.

Although drogue buyers are solemnly warned by the makers to bolt or weld substantial chainplates to the corners of the transom, it's clear that many users simply run the bridle through fairleads and belay the lines to aft mooring cleats. ("Adding chainplates is another job I never completed.") This is definitely not recommended, because if a major wave strike occurs, the mooring cleats may be torn off. Also, chafe is a bigger problem if the line goes through fairleads.

Yet if the bridle lines are put on cockpit winches, it's possible to steer the yacht a little by taking up on one and easing the other. This could be of great help if the boat is being set toward an island or other danger.

In June 1994, Michael Ferguson, the captain aboard *St. Leger*, a 41-foot cutter, found himself running in huge seas in the awesome Queen's Birthday Storm between New Zealand and Tonga. Ferguson discovered that the 250-foot floating line to his Galerider drogue was slackening 12 to 15 feet in the wave troughs and threatened to wrap around the windvane steering gear. Michael gradually cranked in the slack on a winch until the drogue was on the same wave as the boat, but located on the far side of the crest, 80 to 90 feet back. In winds above 60 knots, the Galerider safely held the yacht while the Saye's Rig vane gear steered perfectly for two and a half days until the cyclone moved off.⁶⁰

Two of the 19 yachts in the section on Monohulls Using Drogues in Victor Shane's book were abandoned after catastrophic damage and their crews rescued. One was *Hudie*, a Tayana 37 that we met in Chapter 11. She got involved in a meandering hurricane in the Gulf of Mexico in October 1985. Her heroic crew tried everything, including a 9-foot BuORD parachute, a collection of drag devices, and finally an

attempt to motor into the storm. In the end a giant wave engulfed the vessel and cap-sized her with great damage. A big fishing boat took off the crew.

In the second case, during the Queen's Birthday Storm mentioned above, a Norseman 447 sloop named *Destiny* left New Zealand in June 1994 headed for Tonga. The boat ran into an unpredicted cyclone augmented by microburst-generated extreme storm waves. The captain and his wife—Dana and Paula Dinius—went through the usual sail drill down to bare pole and finally deployed a plastic Sea Squid drogue (no longer made) on 200 feet of 1/2-inch braided line, plus a short length of chain for weight. The drogue slowed *Destiny* to 3 to 4 knots in the troughs and 7 to 8 knots on the crests.

It was necessary to steer by hand because the wind was so strong (80 knots, said the captain) that the wind pressure on the transom pushed the yacht to port or starboard. Sometimes it took full opposite rudder to correct the yawing of the stern. Twice the drogue pulled out of the wave behind the sloop; the boat speed immediately zoomed from 7 to 14 knots.

Finally the wind dropped to 50 knots and began to clock to the south as the eye of the storm passed overhead. The wind shift started a new wave train, which mixed with the old and created what the captain called "a stacking effect." Two or three breaking waves combined to make a superwave and a supertrough.

Destiny finally plunged from the heights into the depths where she was rolled, pitchpoled, and ended up with her mast wrapped around the hull. The captain's leg was broken at his hip. It was a bad scene, and the yacht was abandoned.⁶¹

Who knows how many other yachts haven't come back at all? Surviving in extreme weather is a dicey business—hence this inquiry into management schemes that have been successful. In this small sample of 19 boats, the success rate was 89%, but think what the number might have been if drogue devices hadn't been used.

14

BOW OR STERN: WHICH SCHEME IS BETTER?

So far we've gone through five different storm management schemes for fore-and-aft-rigged monohull sailing boats 25 to 55 feet in length. I've attempted to cover all the arguments for and against each technique.

To sum up, I propose the following actions:

1. Deep reefs in the mainsail; a smaller headsail.
2. Heave-to by adjusting the sails.
3. Lie a-hull. No sails up in regular seas.
4. Run off, perhaps with a tiny storm jib at the bow.
5. Employ a parachute sea anchor from the bow or a drogue device from the stern.

My suggestion is to use these storm moves in order—from 1 through 5. The first four are traditional plans for coping with wind and seas, and mariners have used these techniques for hundreds, perhaps thousands, of years. None of these four cost anything, and they'll get you through most bad weather. They require no special equipment and are quite adequate for ordinary storms. At least they've served me and my sailing friends well.

Number 5—parachutes and drogues—is made up of more modern ideas designed to deal with breaking waves and horrific storm conditions. These off-the-boat devices use the concept of a line coming from a strong point *away from the yacht* to keep the bow or the stern pointing into the wind and waves. Hopefully these inventions can help us stay away from those terrible words: *Lost at sea*.

Plan 5 requires special equipment and perhaps minor modifications to the boat. In addition, the handling and recovery of these devices may be difficult—sometimes extremely difficult. You will need some hauling strength, which means tackles, winches, or a windlass. Since most recreational sailors will never see storms of Force 9 or above, except from the safety of a marina or protected harbor, each captain will have to decide whether to burden his or her yacht with still another piece of equipment.

If you choose your seasons carefully and do your best to stay away from bad weather, there's a good chance that you will never experience a strong gale, a storm-force problem, or see a 30-foot breaking wave. But who can tell?

Reports from many sources agree that easing something over the transom and letting out a line is much simpler than dealing with a parachute, float, shroud lines, and a cumbersome nylon warp that can be as much as 500 feet long. It's easier to check a stern line or a stern bridle for chafe from a rear cockpit than from the foredeck, where even the brave may fear to tread in a violent storm. The rudder is safer with a drogue, although a weak cockpit structure can be a danger.

One user of both parachute sea anchors from the bow and the Jordan Series drogue from the stern is the veteran English sailor Noel Dilly, who campaigns a 28-foot Holman & Pye Twister design named *Bits*. Professor Dilly says that the series drogue has no give at all, "whereas with the para-anchor, it is like attaching the boat to a bungee cord that is being loaded and unloaded all the time."

He adds: "The series drogue acts faster than any other device, and it will align the stern to the wave direction soonest after a wave strike."⁶²

In recent years the Wolfson Unit of the School of Engineering Sciences at the University of Southampton in England, supported by funds from the Royal Ocean Racing Club, has studied storm tactics. Among many projects, the scientists have investigated the influence of drogues or sea anchors on a yacht's behavior in breaking waves.

"This research . . . complemented similar studies in the USA by Donald Jordan," writes Peter Bruce, the editor of the 30th anniversary edition of *Adlard Coles' Heavy Weather Sailing*. "These studies showed that use of a suitable drogue, deployed from the stern of the yacht, will cause it to lie steadily downwind and downwave. This

means that any breaking wave will see only the transom of the yacht and will not be able to exert any capsizing force.”⁶³

If you're going offshore in less than perfect weather or have doubts about what you might find, I recommend that you carry either a parachute sea anchor or a drogue or, in an ideal world, both. Parachute sea anchors certainly have their place in storm management situations, and over the years have saved hundreds of yachts. A drogue is far simpler to use, however, and has the advantage of keeping a steady track (less yawing).

I opt for one of the following:

1. The **Jordan Series drogue** is the best of the lot in my judgment and has been carefully engineered for the ultimate storm. The trouble with a long elastic rode and a single-element drogue or parachute at the far end of the line is that the load may not build up fast enough to catch the boat in time to hold her bow or stern into a breaking wave. With its multiple cones, however, the Jordan device jumps to its maximum drag strength in a few seconds and will hold the boat's stern into a breaking sea. Other schemes may not act quickly enough.

Series drogues can be bought completed or in kit form from several sources. One is Ace Sailmakers, of East Lyme, Connecticut (see Appendix 1 for address).

2. The **Galerider drogue** was designed by Skip Raymond and is sold by Hathaway, Reiser, and Raymond sailmakers of Stamford, Connecticut (see Appendix 1 for address). I've already discussed this drogue, which has been bought by thousands of sailors since its introduction in 1984.

The Galerider is simple to use, uncomplicated, and can certainly help a yacht in difficult circumstances. Nevertheless, it is essentially a surface instrument. I have seen photographs of a Galerider drogue just at the surface (or a few inches below) kicking up a tremendous fuss and significantly slowing the boat. However, there is no design mechanism to sink the drogue in case of an accelerated breaking wave. (Would a chunk of lead or a short length of chain help to sink the drogue slightly?) In a large breaking wave during the ultimate storm—which may never be met—I fear that the Galerider might skip down the front of a big

overtaking wave and fail to hold the stern of the yacht into the wave. Nevertheless, this device is an excellent product because of its modest cost, simplicity, ease of use, and compact stowage. Certainly the Galerider is easy to understand and is a hundred times better than towing automobile tires.

3. The **Seabrake drogue**, invented and patented by John Abernathy of Merimbula, Australia, has been sold in various models since 1983 (see Appendix 1 for address).

Normally the front of the Seabrake should be weighted with 2 meters of $\frac{3}{8}$ -inch chain, shackled between the drogue and a 50-meter braided polyester line (not nylon), say the instructions. The Seabrake is designed to travel just below the surface of the water at from 3 to 7 knots.



This large drogue is made of two cones of stout blue fabric that are positioned so that the larger diameters of the two cones face each other (separated by a short space). Rings of heavy stainless steel wire support the cones, which are held together with wide nylon strapping. At low speeds the flow through the two facing cones is moderate, but at higher speeds the flow increases sharply and tends to inflate the aftermost cone. This partially closes the rear exit for the water. Now instead of leaving through the aft part of the rear cone, most of the water pours out of the space between the two cones and greatly increases the drag of the device.

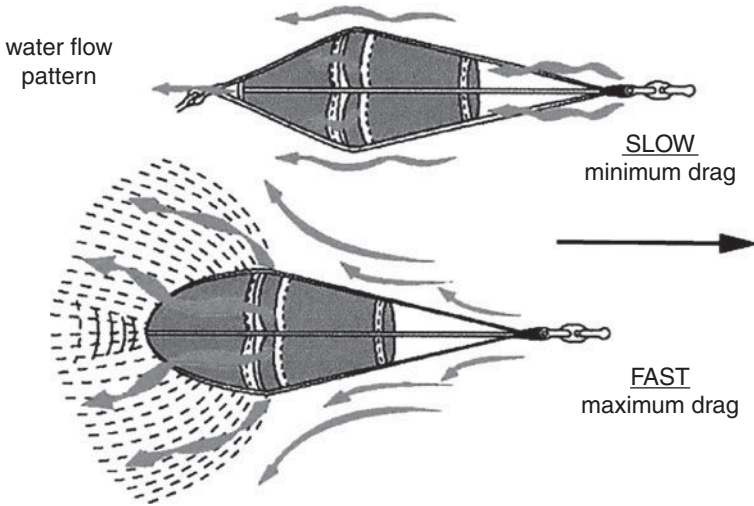

The water flow pattern of the Seabrake as drawn by the inventor.

This Australian device is quite large and comes in various sizes, depending on the length and weight of the boat. If this drogue is towed from a bridle and the lines are taken to port and starboard cockpit winches, a vessel can be steered by taking up or letting out the bridle lines. It can also be used as a bosun's chair, as a vertical flopper stopper to minimize rolling at anchor, and as a control device when entering rivers or inlets or crossing a bar when coming in from the sea. The units do not rotate and don't need a swivel at the front of the drogue. The Seabrake has been used successfully by many sailors, particularly in Australia.

4. The **Seaclaw drogue** is made and sold by W. A. (Bill) Coppins of Motueka, New Zealand (see Appendix 1 for address). This device is constructed of strong ripstop PVC and is designed as a large squarish bag with stainless steel spreaders. In use the bag is pulled along by two straps sewn along the top. The harder the pull, the more the Seaclaw tends to dive, so that in a breaking wave situation, the drogue is pulled deeper instead of being snatched out of the water. Normally the Seaclaw works at a 6:1 dive ratio, which means that with the recommended 60 meters (about 200 feet) of line out, the drogue runs along at a depth of 10 meters.

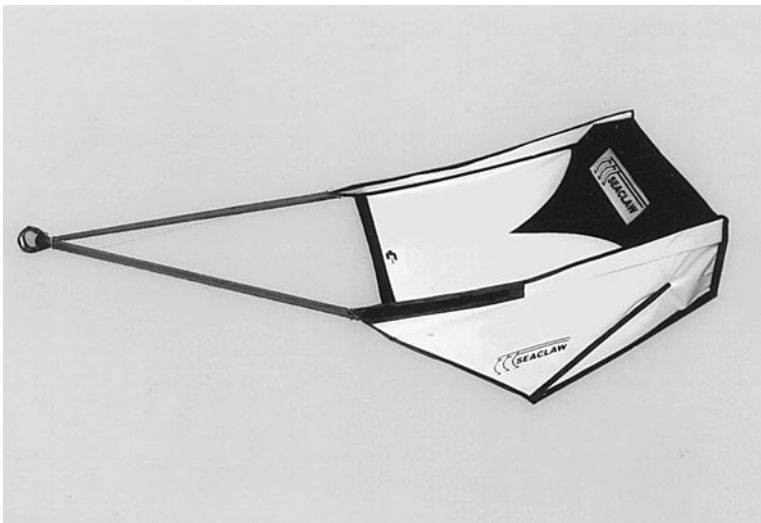

The carefully engineered Seaclaw drogue is essentially a squarish bag that is dragged behind the vessel to slow her. The greater the pull, the more the drogue tends to dive.

According to its maker, no weight (chain) is needed to sink the device because its shape keeps it below the surface of the water. With increased forward pull on the drogue, the Seaclaw has a reverse thrust arrangement that creates additional drag. The Seaclaw also has a small built-in float that lifts the drogue to the surface when the pull on the device is stopped after a storm.

5. The **Delta drogue** was invented and patented by Don Whilldin of Silt, Colorado, in 1994 (see Appendix 1 for address).

The Delta drogue is made of vinyl-coated nylon fabric and is available in five sizes, depending on the length of the vessel. “Sizes are baseline only,” says Whilldin. “If you prefer more drag to go slower, go to a size larger. If you prefer to go faster (less drag) go to a size smaller.”

The line connecting the Delta drogue to the vessel should be a minimum of 200 feet long, says the maker, and is designed to be shackled to a bridle with legs at least 50 feet long to allow for adjustment. A short length of chain at the drogue end will help keep the device below the surface. When the drogue is in the water behind the yacht, “try to position the device so that it’s in the meaty part of the

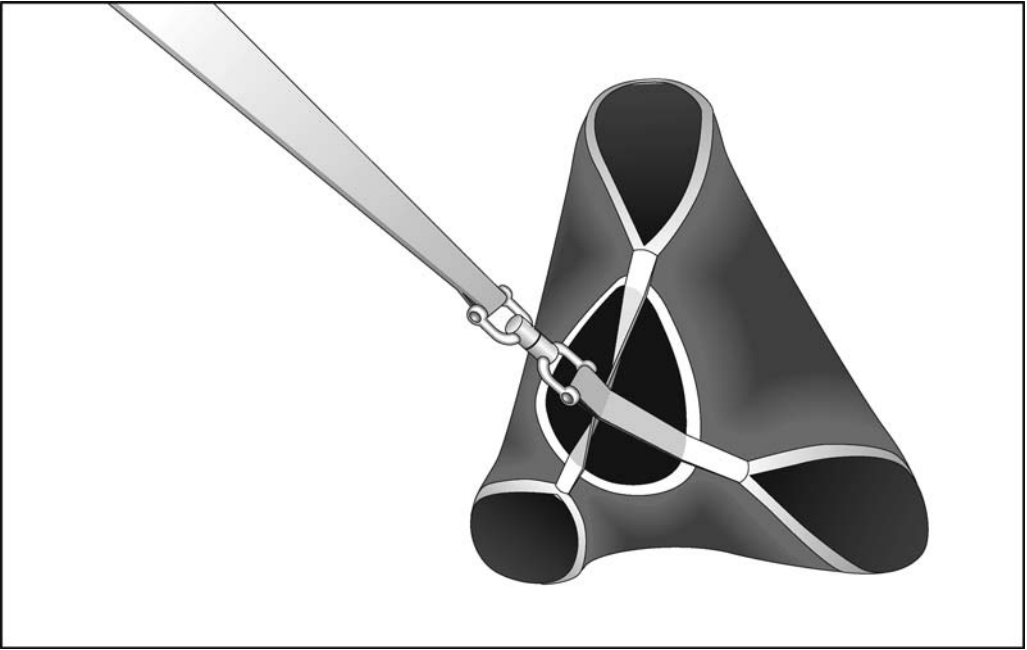

The speed-limiting Delta drogue is made of heavy-duty material. It should be weighted and towed behind the vessel on a line at least 200 feet long.

wave and not in thin air,” says Whilldin. “This is important because drogues have been known to pull out of wave faces. When this happens, the towline goes slack, the boat takes off on a sprint, and may yaw, broach, or capsize. When the drogue finally takes hold again, it may wrench something out of the deck or cause [other damage].”

Whilldin lists four uses for drogues:

1. Speed-limiting drogues can be of immense value in strong following seas and have been used to stabilize the attitude of small craft since antiquity. No doubt there are many yachts sailing today that would have gone down had it not been for the grace of God and some sort of drag device that slowed them down.
2. Towed off the stern with a bridle, a speed-limiting drogue can be used as an emergency steering device in the event of steering failure by adjusting the lengths of the bridle legs to generate yaw.

3. Towed off the windward quarter, a speed-limiting drogue can be used to help maintain directional stability while negotiating dangerous harbor entrances.
4. Towed off the stern of a vessel in tow, a drogue can all but eliminate the dangerous “whiplash” effect when the towing boat slows or stops.

According to Whilldin, a speed-limiting drogue will significantly increase the efficiency of an autopilot. If the drogue is used with a bridle, most boats will steer themselves. If a drogue is used without a bridle (and with the towline secured well forward of the rudder) the boat can be steered through an arc of 90 degrees to avoid ships, reefs, headlands—any and all problems that are ahead.

The last of the drogues (#6) is the **Para-Drogue** (see drawing next page) invented by Alby McCracken of Sale, Australia (see Appendix 1 for address), and consists of two small towed parachutes, one behind the other. The forward (and larger) parachute is attached to the end of an 80-meter (about 260 feet) line connected to a bridle on the boat. The shroud lines of a much smaller parachute are fastened to the dome area of the larger chute. Each of the parachutes is cut differently, and they interact with each other, “creating a very high drag and consequent pressure wave,” says McCracken.

The Para-Drogue will not break free of the water and maintains an even and positive drag on the stern of a vessel, according to the maker. In tests, the device showed a drag of 265 kg at 5 knots, a drag of 480 kg at 7 knots, and 890 kg at 9 knots. Unlike other drogues, the bridle ends are shown fastened to the midships area and well forward of the ship’s rudder. This means the boat can be steered to a limited extent.

On a recent test aboard a yacht sailing to Antarctica and overtaken by gale-force winds, this steering arrangement worked well and allowed the crew to steer by winching in the bridle line on the side they wanted to turn. Under some circumstances a spinnaker pole can be strapped athwartships across the transom and the bridle lines run through blocks at each end of the pole and back to the cockpit sheet winches. This allows easy emergency steering by adjusting the bridle lines on the winches.

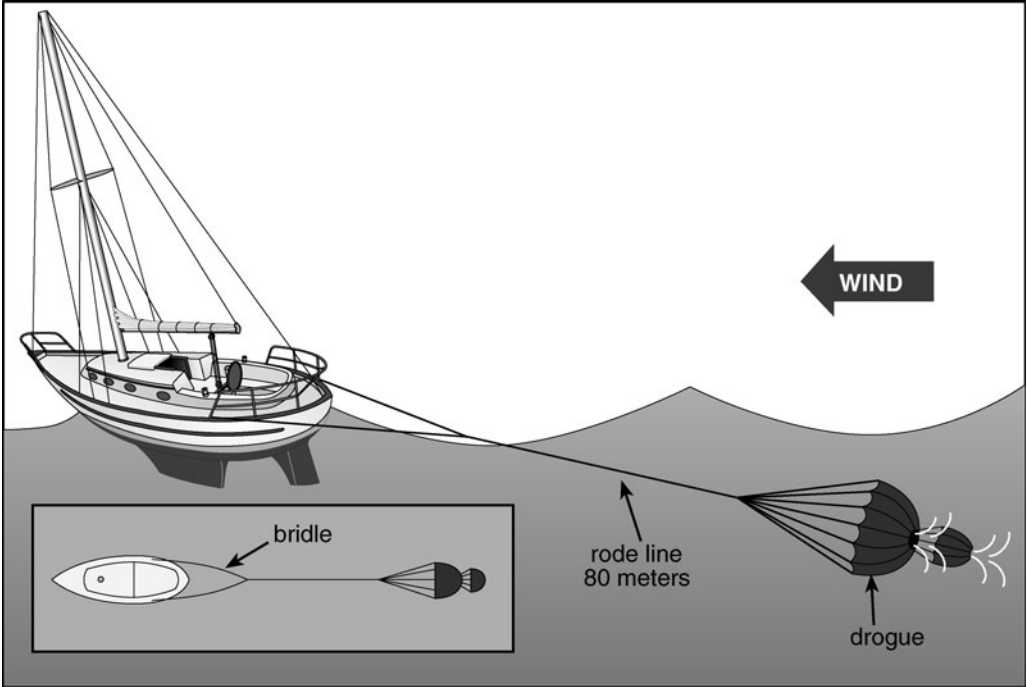

As might be expected, when Alby McCracken invented his Para-Drogue device he employed a small parachute astern plus a still smaller chute aft of the principal one. Alby recommends that his bridle lines go to a midship position.



Part Four

**PLANNING,
CHARTWORK,
HURRICANES,
AND FEAR**

This page intentionally left blank

In the previous fourteen chapters I've written all I know and have been able to find out about controlling a sailing yacht in upset seas and windy weather. Here now are some thoughts on a few related aspects of the offshore sailing game:

Chapter 15. Passage Planning: The Best Time to Go

Chapter 16. The Chart Game, or Where Am I?

Chapter 17. Is a Storm Coming?

Chapter 18. A Hurricane: The Evil Eye

Chapter 19. Fear and Uncertainty

There is also a glossary with hundreds of sailing terms. Some of these words are vital; others are important. A few may be obscure. But all are necessary so that sailors can talk to one another in precise terms quickly and without confusion.

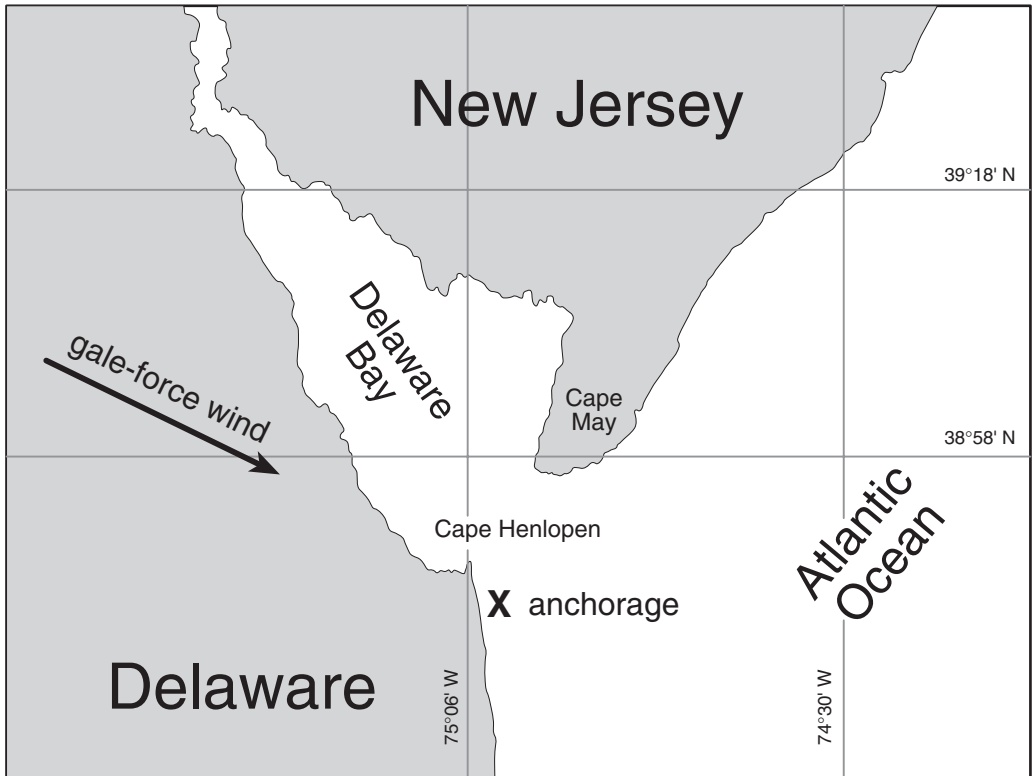

Try to take advantage of an ill wind. While sailing from Maine to Annapolis on November 2, 1988, Margaret and I ran into gale-force winds blowing out of 40-mile-long Delaware Bay. There was no way we could have made our way into the bay with the west-northwest wind whistling in our faces, particularly with a foul tide. What to do? Let the boat drift out to sea hove-to or lying a-hull? Wait a minute! We knew there were sandy beaches along the Atlantic shore a few miles south. Why not go in close to land and anchor off the weather shore until the gale blew out? Are you kidding? Anchor in the Atlantic Ocean with a gale blowing? Why not? We headed south and just past Cape Henlopen came to smooth water because of the protection of the shore. From our chart we knew that the bottom was sandy and shelving, so we crept to the west until we were in 20 feet. The wind gusts ripped at my clothes while I tossed over a Danforth anchor, which dug in at once. The nylon line was a big rubber band, and the yacht scarcely moved in the calm water. Margaret cooked a nice meal, we hung up a light, and went to sleep. The only signs of mankind were a few people on the beach, who looked at us unbelieving. The next morning the gale was gone, and as soon as the tide turned, we began a favorable run up Delaware Bay in easy winds.

15

PASSAGE PLANNING: THE BEST TIME TO GO

Most people think about long sailing trips for months or years in advance. Where will you be heading? How much time will it take? Who will crew the boat? Are there good anchorages? What about money? Do you have a list of special places to see?

Will you be making crew changes along the way? If so, is there a convenient airport with reasonable service and a suitable place for your crew to stay if you're delayed a few days? (Oh yes, work out in advance who is going to pay which bills.) Finally, will you be able to shop for food in those distant places or will you have to carry it with you?

Are there suitable facilities for hauling out the boat? Will you be doing all the maintenance? Do you have enough spare parts, fastenings, tools, and bottom paint on board? Plus extra sails?

What about the winds? Are there seasonal wind patterns? If they're strong, will you be bucking into 20- to 30-knot winds? Is there a longer but easier way to your goal? Perhaps an island to stop at? Worse yet, are there hurricane, typhoon, or monsoon seasons? Don't forget to consider the winds for the return trip.

Will fog be a problem? Do you need to add a radar set? Are there secondary harbors along the way? What about the politics of the place where you're heading? Are yachtsmen considered tourists and welcomed, or are they harassed with special fees and radio reporting requirements? If you're going foreign, drop a one-sentence letter to

the embassy or nearest consulate for the latest word on private yachts. Keep the dated reply on board. Check the renewal date of your passport. Do you need a visa(s) before you go? Are there security problems or areas to avoid?

Most sailors take an intelligent interest in the places where they're going and read an up-to-date book or two to give themselves a few ideas about their destination. Magazine articles are good too; it's surprising how many articles you can clip in the course of a year. It's easy to ask for tourist brochures, but they're usually too full of simplistic optimism to be of much value.

Browse in your local library. Check recent cruising guides written by knowledgeable authors. If you have a computer, try a search engine such as Google. If possible, talk to sailors who have been there and can give you the lowdown. Sailing organizations like the Seven Seas Cruising Association and the Ocean Cruising Club regularly publish articles on all sorts of popular and obscure sailing areas (see Appendix 1 for addresses).

Many years ago, when Margaret and I sailed from Japan to the Aleutian Islands, we saw that there was a U.S. naval base (restricted) on Adak Island, where we were headed. I went to the U.S. naval attaché in Tokyo and asked him to write to the commander at Adak and request his permission for us to stop for a few days, an arrangement that worked out perfectly.

But no more questions and recollections! Let's get on with real planning for a new sailing trip.

The most important thing is the wind. If possible we want to avoid calms (at the bottom end) and storms (at the high end). We like to have moderate winds and seas, hopefully with the wind abeam or from behind the boat. But how do you plan your voyage to maximize fair weather? Or said another way: how do you stay away from storms and headwinds, or at least minimize your exposure to them?

If you're in the Northern Hemisphere, you don't go sailing in the North Atlantic in December or January. If you're in Sydney and want to cross to New Zealand, try not to pick the winter months of the Southern Hemisphere. Otherwise storms are likely to make your passage across the Tasman Sea a bad experience. Of course, if you sail long enough you will encounter storms, but careful planning will help you stay away from most of them. You play the percentage game and pay attention to the experiences of those who have gone before you.

In my sailing career I've sailed more than most small-boat owners, yet I've seen very few severe storms. Maybe I've been lucky, but I think it was because of careful planning.

It's hard to realize that prior to 1847, there was no organized system of reporting wind directions, their strength, and particulars about ocean currents. No one really

had a grasp of seasonal wind changes and the severity and occurrence of storms. Commercial sailing ships headed out without much of an idea of what they'd find. Veteran captains who made the same runs year after year accumulated anecdotal knowledge, but if the ships were sent to a new port, the ships' officers had little idea of the conditions ahead. Captains who worked for the same company whispered to one another about winds, but there was no scientific analysis of conditions at sea.

In 1842, a brassy and outspoken 36-year-old lieutenant named Matthew Fontaine Maury was appointed head of the U.S. Navy's Depot of Charts and Instruments, presumably a dead-end job. As Maury settled into his new position he discovered a roomful of old ships' logs that navy captains had been required to send to headquarters after every voyage. Each day the various captains or navigators posted the logs with the ship's position, the weather, currents, the strength and direction of the wind, and so on. Maury—reading some of these logs—was appalled at the miserable times that navy sailing ships made from port to port in the 1840s.

As the lieutenant examined the old logbooks he wondered if he could collect parts or all of the entries—sometimes done in gorgeous copperplate writing—and combine these snippets into a greater whole. Could he take from many and distill these postings in a form so that all mariners could profit from what their predecessors had found in the oceans and along the shores of the world?

Maury's first efforts were crude, but he had a keen scientific mind and soon improved his collection of weather and sea data. Although the old navy logbooks were helpful, Maury realized he needed more information, so he devised a better and more inclusive form that he sent to ship captains all over the world.

To learn about ocean currents, he had small sealed bottles tossed overboard from ships; months later they would be washed ashore on distant beaches. When the enclosed letter reached Washington, D.C., a midshipman would record a new dot of information. In return for filling out forms, Maury sent his thanks and his charts and books to merchant ship officers wherever they might be. One of his ideas was to make charts that showed his information in pictorial form with clever symbols and arrows so that ship officers could quickly follow suggested winds or dodge adverse currents. Besides these pilot charts he assembled nautical data and general information into books that he called *Sailing Directions*.

Maury's special charts are truly roadmaps of the sea, and with their neat wind roses and curved lines of different colors are fascinating documents. The lieutenant and his staff sorted out the trade winds, the westerlies, the variables, and the doldrums on a month-to-month basis. It was Maury's genius to turn a hodgepodge of largely useless information into a scientific methodology of routes and winds for all the world's sailors to use.

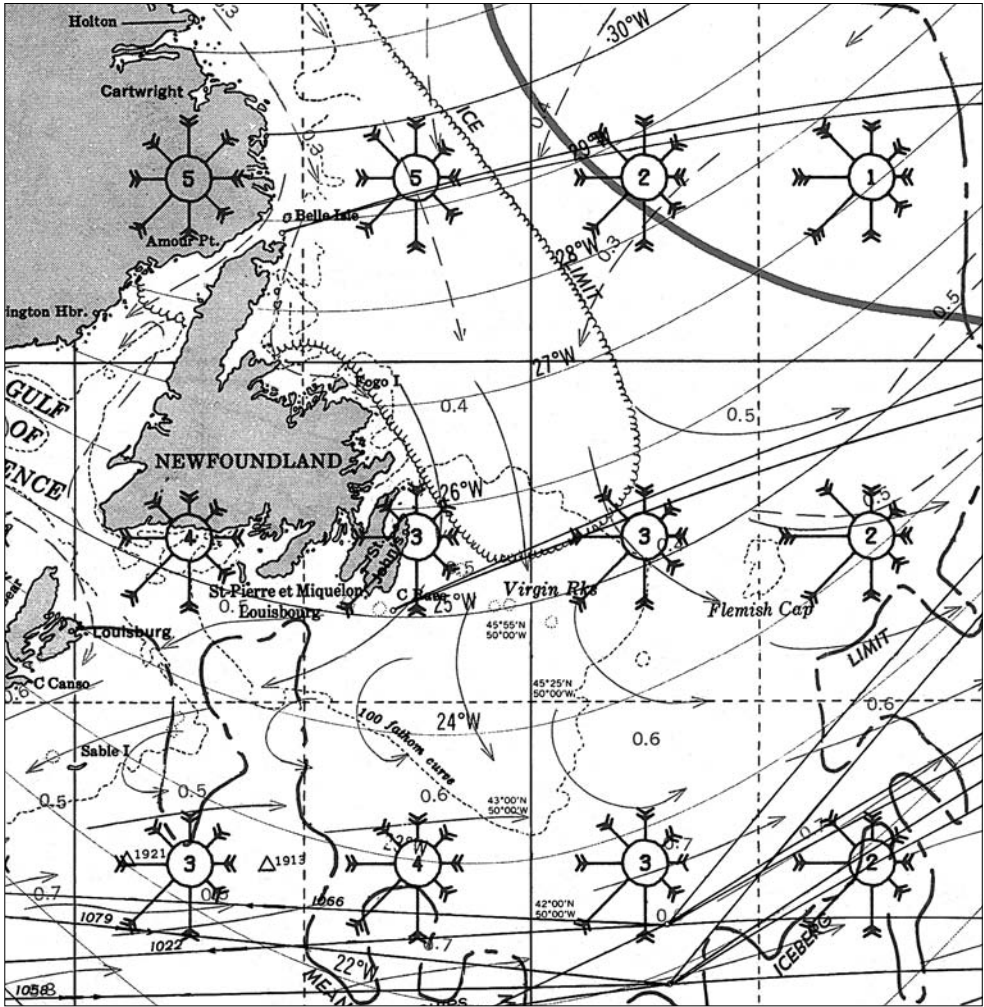

Detail of the June 1976 pilot chart of the North Atlantic that shows the weather south and east of Newfoundland. For each 5° square there is a blue wind rose that details the winds over a long period. The arrows fly with the wind and show the wind's direction. The length of the arrow—measured from the outside of the circle on a handy scale—gives the percent of the total number of observations in which the wind has blown from that direction. The number of feathers on each arrow shows the average force of the wind on the Beaufort scale. The number in the center of the circle gives the percentage of calms. In addition, pilot charts have small inset chartlets that tell about tropical cyclones (in green), gale frequency (in red), surface pressure (in blue), visibility (in purple), and so forth. Currents are indicated on the main chart with long green arrows. A thick red line suggests wave heights. Ice dangers are depicted with a red scrolled line. In addition, the pilot charts have general written comments about weather for each month.

It was the great age of long-distance sailing ships, and as soon as ship masters understood Maury's ideas, they enthusiastically subscribed to his books and charts. With even limited knowledge of ocean currents and prevailing winds, the captains bettered their port-to-port times. This meant that company profits were higher, there was less wear and tear on the ships, and the passages were easier on the officers and crews.

In a celebrated case in 1848, a Captain Jackson in the bark *W.H.D.C. Wright* took a load of flour from Baltimore to Rio de Janeiro in 38 days. He unloaded the flour and filled his ship with sacks of coffee for the return trip, which he made in 37 days. Normally such a voyage would have taken 55 days each way. When Jackson pulled into Baltimore *he was 35 days ahead of schedule*. This record run was entirely due to Maury's new *Sailing Directions* and his wind and current charts. Before Maury, ships on that route had sailed all the way to the eastern Atlantic, where they crossed the doldrums near the Cape Verde Islands. Maury said this was all wrong, and told the captains to sail a direct course and stand in close to Cabo de São Roque on the northeast tip of Brazil, where there was a favorable southerly current near the shore. This routing saved thousands of miles and dramatically shortened the port-to-port times.⁶⁴

For over 150 years the U.S. Navy has carefully continued and improved Maury's pilot charts. Today they are published in small atlases of twelve charts (one for each month) for the South Atlantic (\$16), the North Atlantic (\$40 for a double set), the South Pacific (\$18), the North Pacific (\$21), and the Indian Ocean (\$21). Since these charts are based on thousands of observations taken over a century or more, they don't go out-of-date quickly or need corrections.

So pick your month, your start and finish (San Diego to Hawaii? Christmas Island to the Keeling-Cocos? Casablanca to Tenerife? Norfolk, Virginia, to Portland, Maine?), and write out the conditions you are likely (but not positive) to find. Read the weather summary, examine the wind roses, pay attention to the chartlets, the ocean currents, and all the rest. You will begin to see and understand the sort of weather and coastal and sea conditions you will likely find. Then examine the pilot charts for the months before and after your first selection to see how the conditions change.

The pilot charts aren't infallible, and it's possible to encounter other conditions than the stated figures, *which are averages, not certainties*. Yet by and large these charts are a marvelous planning aid and will help you play the percentages. Unfortunately, no one knows how global warming will affect winds and storms.

You will find more detailed information about weather and winds and regional storms (along with masses of material about local ports and conditions) in *Sailing Directions*. These volumes—often called *Pilots*—tell about sailing conditions in every part of the world. Although many countries publish regional information, the main *Pilots* are

from the United States and Great Britain. There are 72 volumes of U.S. *Pilots* and 74 volumes of Admiralty *Pilots*. Of course you only need books for the part of the world (or your own country) you plan to visit—generally one or two volumes. These are of inestimable value to mariners, and you should purchase new volumes—together with the latest supplements—to cover your itinerary. Although there is almost universal interchangeability, U.S. *Pilots* are written with U.S. charts in mind. Admiralty *Pilots* have many U.K. chart references. So if there is any choice, you should purchase *Pilots* and charts from the same country. Modern *Pilots* often have aerial photographs of harbors and intricate approaches, as well as drawings of tricky places and are of the greatest help.

Each U.S. *Pilot* has some 250 loose-leaf pages (about $8\frac{1}{2} \times 11$ inches) that fit into a heavy and bulky binder (whose metal parts soon rust). Replacement pages are issued every few years to update the text. Though the *Pilots* are prepared for all mariners, the emphasis tends to be on large commercial vessels; in recent years the tendency has been to bypass smaller places and to deal more with major ports.

Admiralty *Pilots* are permanently bound volumes that measure $8\frac{1}{2} \times 12$ inches and are easier to store than the bulky U.S. *Pilots*. Supplements are issued from time to time, and every 8 or 10 years each volume is revised and reprinted. Like their U.S. counterparts, the Admiralty books are packed with information about a particular area and include a chapter on regional weather. The writing is clear and pithy but decidedly pessimistic and negative, as such books must be that describe every hazardous area and every treacherous rock.

Mal Tennant, who is in charge of *Sailing Directions* at the U.K. Hydrographic Office in Taunton, wrote me that sales of the Admiralty *Pilots* now exceed 250,000 copies a year. His office also deals with the *Mariner's Handbook*, *Admiralty Distance Tables*, and *Ocean Passages for the World*. To keep up with new information and writing, there are 29 editors, each of whom is either a Master Mariner or a Royal Navy officer with command experience. In addition there is a meteorologist to keep track of the weather sections.

“The terse, clipped, informative style of these volumes is familiar to yachtsmen,” notes one observer. “Verbiage and time-wasting and woolly conceptions are rigidly excluded.” The writing in these books no longer follows along a coast, describing every feature, but is now done in a waterway and port format.⁶⁵

Many are the sailors who have constructed a crude harbor chart based on the sentences in a *Pilot* when a large-scale chart was suddenly found to be missing.

Writing in November 2007, it seems amazing that there's a new wrinkle with U.S. *Sailing Directions*. It's possible to download parts or all of each of the 72 volumes (some with colored photographs and useful sketch maps) *free* except for the paper and

ink for your printer. In addition you can download parts or all of other useful items, including books such as the *American Practical Navigator* (Bowditch), *Distances Between Ports*, *NGA Light Lists*, *USCG Light Lists*, *Sailing Direction Planning Guides*, and *Radio Navigational Aids*. You can download atlases of pilot charts (mentioned earlier), *Chart No. 1* (which explains all the symbols used on charts), *The Radar Navigation and Maneuvering Board Manual*, and so forth, all at no charge.

How to Obtain Free *Sailing Directions*

1. Using Google, type in "Maritime Safety Information." Click, and when the site comes up, click again. From the menu at the left, click "Publications." From the menu at the top, choose "Sailing Directions Enroute." Click again.
2. At the bottom of the same page, click on "SW Coast of Africa" to bring up the list of all 72 volumes.
3. Select your book choice (for example, pick #154 *British Columbia*) and click on it. This will put the title in the box near the bottom of the page. Click "View" to open the table of contents.
4. Click on the book title (Pub. 154) at the TOP of the page.
5. This will bring up your selection in a compressed (ZIPPED) folder.
6. Choose "Open with compressed folder." Click on grayed-out OK. Wait for the file to be opened.
7. This will bring up a square figure labeled #154. Click on it.
8. This will open to an NGA wizard. Follow along for six steps. At #5, check a box that says "Install PDU Support Files."
9. When the wizard is completed, you're back at the 154 setup window. On the menu at the left, check "Extract all files."
10. This will lead you through a three-step wizard that helps you copy files from inside a ZIP archive. Click "Next," "Next," and "Finish" on pages 1, 2, and 3. (Ignore boxes on page 2.)
11. Go to START at the bottom of the Desktop and click. Choose "All Programs" and follow through all the files to NGA_Data. Go to Sailing Directions and then to #154 with red mark. Click to open book file.

I suggest that you print out a few pages and read them to see if the material will be helpful. Some of these *Pilots* have 200 pages, which is tedious and expensive to print out. Yet it's better to err on the side of too many pages than too few; if you select a small number of pages you may find yourself short of information if you want to duck

into an alternate anchorage. It's a good idea to three-hole-punch the pages and put them into a binder to keep everything neat and in order. Since you're doing this yourself, it's easy to change the size of the printed-out pages so the finished binder will fit on your boat's bookshelves.

If you want the entire *Sailing Directions*, you might put it on a CD and take it to a commercial printing house like Staples. In some cases it's cheaper to purchase a large bound book (*Bowditch*, for instance) from the U.S. Government Printing Office. With some of these sailing publications, you need to pay attention to the date of the last corrections.

A special kind of *Pilot* that is sometimes available is a yachtsmen's guide prepared by a sailing group, a knowledgeable author, or local authorities. For example, the Clyde Cruising Club publishes an excellent, up-to-date *Pilot* for Scotland. A *Cruising Guide to the New England Coast*, by Roger Duncan and John Ware, is splendid, particularly for Maine. There are several useful yachtsmen's *Pilots* for the West Indies. In the Galápagos a local charter-boat captain has written a handy little guide. These books need to be used with caution, depending on the publication date and the authority, but generally they are well worth having even if you pick up only a single helpful point.

Note that I am speaking of guides prepared by experienced seamen, not publicity handouts put out by tourist bureaus. Generally speaking, if a guide has advertising, it is useless for sailing information because it's more beholden to advertisers rather than to sailors.

So far we've discussed pilot charts and *Pilot* books (or *Sailing Directions*). In addition to these planning aids, there are several books you should be aware of. One is *Ocean Passages for the World*, a hefty British Admiralty publication that makes hundreds of recommendations for sea voyages. The book is written in a telegraphic style, and a spartan text tells about routes, courses, special problems, and likely winds. My 1973 edition has 27 pages on wind and weather, 190 pages on steamship routes, 18 pages on sailing ship routes, and 30 pages of general notes and cautions. The book comes with eight foldout charts (in a pocket at the back) that detail climate, currents, and sailing ship routes.

No sailing enthusiast will fail to be enthralled by Chart 7 (Admiralty Chart 5308), "The World Sailing Ship Routes," a sketch map of the globe, on which pink, gray, yellow, and brown bands flow artery-like across the oceans of the world to suggest routes in various directions for different times of the year. Even if you don't buy *Ocean Passages*, it's worth purchasing chart 5308 separately and tacking it above your desk. The colorful tracks are based on the experiences of thousands of large commercial sailing vessels (gone but not forgotten) over a century or more.

The second book is *World Cruising Routes* by Jimmy Cornell (International Marine, 2008, \$59.95). This is a nuts-and-bolts book, now in its sixth edition, that describes hundreds of routes in the Atlantic, Pacific, Indian Ocean, Red Sea, and Mediterranean in terms of small-boat transits.

Don't slavishly follow the mob, however—do your own thing. Just be aware of routes and seasons that have been successful for others.

To explain the use of these books and charts, let me tell you about a Pacific trip that Margaret and I made. Our goal was an extended voyage around the major part of the Pacific. When we studied the planning guides, we soon discovered that we faced three main problems: the South Pacific hurricane season, typhoons off the coast of Japan, and gales and fog around the Aleutian Islands. The problem was to juggle dates to minimize our exposure to these hazards. In addition, we hoped to stay in the belts of running or reaching winds, to sail with favorable currents, and to maintain a reasonable schedule.

Margaret and I pulled a figure of 18 months out of the air and started sticking pins with date flags into a general Pacific chart. Reading in various Pacific *Pilots* and studying the pilot charts along with books that other voyagers had written told us that we should sail north from Samoa by November to miss the South Pacific hurricane season. Similar study about the east coast of Japan suggested that we should sail north and east before July to minimize our exposure to typhoons.

The Aleutian Islands aren't affected by revolving storms, but have a winter gale frequency of up to 20% (a Force 8 or more problem every six days on average). We changed dates and moved the schedule backward and forward and decided to leave Japan in mid-summer so that we would be in the North Pacific when the gale frequency was least. As expected, we encountered some fog, but the frequency of August gales in the Aleutians and Bering Sea varied from 1% to 7%, suggesting that summer was the best time for a visit.

In other words, we tried to play the averages to have as storm-free a trip as possible. This could have meant staying in a protected harbor during a bad season or hurrying to cross a dangerous area to minimize exposure to severe hazards.

We also talked with merchant ship officers—who always seem to be in a hurry—about routes and places. We have found that big-ship people are often keenly interested in yachts and will go out of their way to help you. The captain and mates will sometimes give you extra charts and pass on all sorts of advice and people to see.

We've learned that the long way around is often shorter if the detour takes you away from strong headwinds and adverse currents. For example, we know a yacht owner who repeatedly tried to go northeastward into the Caribbean toward Venezuela from Cartagena, Columbia. The month was April and the trades blew strongly. According

to the pilot chart, the prevailing wind was Force 6 from the northeast plus 28 miles of adverse current per day. Though the captain was determined and the ketch was powerful, she could make no easting until the owner abandoned his head-on approach. He finally made his easting via long reaching legs to the northward into an area where the wind and current were more favorable. *Longer but easier.*

Ocean Passages does not recommend the direct route between Hawaii and San Francisco, because a small vessel would be thrashing to windward for hundreds of miles and beating back and forth trying to make mileage to the northeast—directly into the trade wind and contrary current. The suggested route is roughly northward, close-hauled or almost close-hauled on the starboard tack, until you pass above the northeast trades into the westerlies, whose latitude varies with the month, depending on the location of the North Pacific high-pressure area.

In time you learn a few wrinkles. For example, if you're going to sail through an island group, it's helpful to arrive at the windward end so you will have a free wind from island to island. . . . In the Tuamotus there are often extensive underwater reefs running far out from the south and southeast sides of the atolls—the coral grows toward its nutrients, which flow from the southeast trade wind, I am told—and a mariner is advised to sail around the north rather than the south side of an island. . . . You may wish to delay a passage through a hazardous area until you have a full moon to help you see at night. . . . In going northward from Rio de Janeiro against the Brazil Current, it may be wise to wait until the northeast monsoon (so-called locally) has eased. A week in port may be a week gained. . . . The weather systems around Vancouver Island come from the northwest or southeast. Depending on your direction of sailing, it will pay you to wait for a fair wind. . . . And so on.

When you go foreign, it's hard to decide where to stop. Some ports are famous and you want to see them. Tahiti and Moorea are easy choices, but shall we go to Kapingamarangi or Pingelap? To Suvorov or Rakahanga? To Abemama or Tabiteuea? You make some stops because of your reading or from recommendations, because of protected anchorages, because you are tired and want to rest, or simply because you are intrigued with the name. Margaret and I prefer to make fewer stops but to stay at new ports for longer times.

Another planning consideration—at least in the areas of the world with low and dangerous islands—is a clear and uncluttered route. It's best to go out of your way to avoid unlighted islands at night. Not only will your passage be simpler in deep water where the currents may not be so variable, but you can relax and enjoy the passage instead of dying a thousand navigational deaths.

Commercial shipping lanes mean constant vigilance and worry; if you can arrange to cross shipping lanes at right angles during daylight and then leave them far behind, all the better.

Boat and ship navigation today is almost 100% by GPS, which has uncovered the embarrassing fact that many of our carefully drawn charts are several miles out of position. These charts are gradually being redrawn, but the goal of precise coordinates on all charts is still years away, and we may be using old charts and at the same time GPS coordinates that don't match up. This means that we have to take extra precautions around hazardous places and tricky entrances even when using satellite devices. When things look dicey or you're unsure of yourself, always try to confirm your position in *two different ways*—by land bearings crossed with depth soundings, by the bearings of two light signals, and so forth. If things don't add up, head offshore for a few hours to sort things out.

My friend Pete Passano had to pay for expensive repairs to his steel-hulled *Sea Bear* when he tried to use GPS to navigate through a coral passage leading to Anegada Island in the Caribbean. The 39-foot cutter piled up on the coral by failing to have a crewman aloft who was wearing polarized sunglasses, had good sunlight from behind, and who could call steering instructions down to the helmsman. It's absolute folly to sail in unfamiliar waters close to shore and rely on electronic charting alone. As Ed Boden says, "Crash is the computer game's middle name."

A few years ago when we were sailing north along the coast of Labrador, I was astonished to discover that one of our charts was surveyed only down a narrow north-south track in deep water for big ships. The rest of the chart was blank white paper. Between the plotted track and the rocky shore, we were on our own.

Ocean cruising isn't the only kind of sailing that should have careful planning. Coastal passages and lake trips are much easier, quicker, more satisfying, and safer if you prepare for them by checking into prevailing winds, storm patterns, times of calms, land breezes, and so forth. While genuine local knowledge is helpful, waterfront gossip sometimes has little value; the loudest talkers may never have left the harbor. You may be astonished at what a little study of books and charts will reveal. Do it yourself. Don't rely on others.

Oh yes. Beware of last-minute send-off parties. Say goodbye to everyone, cast off, and go to a nearby secluded anchorage where you can rest, deal with last-minute sorting, and leave with a clear head.

A voyaging sailor's schedule shouldn't be too detailed and structured. In the first place, you are almost never on time. You are behind schedule because of maintenance on the yacht (the parts didn't come; the weather was rotten; the sailmaker needed another few days) or because you have found a new place and new friends. When you make extended trips, and sail to new islands and coastlines and strange towns and villages, you have to throw away the calendar.

All of these remarks have been long and complicated and may seem overwhelming. Just take your planning one step at a time and work out your trip bit by bit. You can do it, and the result will be a safer and more satisfying voyage.



16

THE CHART GAME, OR WHERE AM I?

A sound investment for safety and peace of mind is a great stack of up-to-date charts before you begin a long trip. If you are in doubt about whether you need a certain chart, *buy it*. You need small-scale charts for planning and navigational use, medium-scale for the approaches to islands and coastlines, and large-scale detailed drawings to guide you into harbors, through intricate passages, and up rivers. Plus the pilot charts for your area.

Not only must a prudent mariner have adequate information about intended ports, he ought to have limited coverage of contingency stops. If you have a problem along the way and decide to head for a convenient port to leeward, it's good to have the charts. If you haven't room for all the charts when you set out, or are unsure whether you will continue after the first long jump, arrange to order a batch of charts at your first major stop. (Keep a few paper chart catalogs on board.)

These days many charts have been digitized and fit nicely on CDs or chips. You read them on a computer, which is quick, handy, and eliminates bulky paper chart stowage. Even with the cost of a computer or special viewer, the whole scheme is much cheaper and marvelous as long as everything works. Sometimes tide and current information can be visually integrated with the image on the screen, and the ship's GPS position can be interfaced to show a creeping symbol. All these things translate to less

plotting and measuring by hand which means increased precision and fewer errors in your sailing. The advantages of digital charts are tempting.

But what if the ship's electricity fails and the chart plotter quits? Or the computer is dropped, or stops working because of a few drips from your oilskins or a splash of salt water on the chart table? Or a wave slops on board and some of it falls on your computer below?

"Laptops are notoriously water-sensitive, and can be ruined in one regrettable wet moment," warns the West Marine catalog in the section on digital charts.

Of course, if the screening device quits you can send the device to the manufacturer for repairs at the next stop. I can tell you with certainty, however, that in many foreign places, the problems with delivery services and customs agents are not only disheartening but often insurmountable.

You may be able to deal with this problem by (1) having a backup or "hardened" computer, (2) employing a special viewing device for the cockpit, or (3) having a few small-scale paper charts that will get you to your destination. Otherwise you may be reduced to sailing the Pacific with a page torn from the *National Geographic Atlas*.

I vote for #3—paper charts—above. Even the makers of digital charts recommend that you carry "adequate" paper charts, just in case. My friend Greg Zinga recently bought a chart plotter, which came with all the U.S. charts for \$800. This seemed a wonderful bargain until he read—you guessed it—"not to be used for navigation." This is not reassuring.

Typical of the statements issued by sellers of digital charts for recreational purposes is this warning: "C-MAP electronic charts are NOT currently considered legal replacements of official HO charts and so should be used only as supplements to these, together with prudent navigation habits."

Yet if commercial and military ships employ electronic charts exclusively, why can't recreational sailors use the same charts? The answer is that the standards of accuracy, updating, and reading devices for electronic charts for commercial and military vessels *far exceed* those in place for recreational vessels. Essentially the leisure market for electronic charts is unregulated and highly price competitive, whereas the big-ship market is subject to many expensive-to-meet regulations.

The problems continue:

"Some mariners have the misconception that because charts can be viewed on a computer, the information displayed has somehow become more accurate than what appears on paper," writes Captain Nick Perugini of NOAA. "It is ironic that electronic charts now give the mariner the ability to zoom in to charted depths that are based on surveys conducted 100 years ago. Some mariners believe that vector data is always

more accurate than paper or raster data. Clearly, if an electronic chart database is built by vectorizing a paper chart, it can be no more accurate than the paper chart.”⁶⁶

“People assume that electronic charts are more accurate because they are new and off the shelf,” veteran sailor Priscilla Travis wrote me in an e-mail dated October 25, 2007.

“This summer when I was sailing in Norway, I heard three tales from experienced sailors using ‘up-to-date’ electronic charts,” she said. “All three sailors discovered significant, verifiable errors. Other stories of mistakes on electronic charts continue to appear in the yachting press.”

Another factor with digitized charts—at least for me—is that I’m in the habit of spreading out a paper chart and examining it to get a feel for an area. I’m used to drawing lines on charts, showing charts to people, and thinking about the good and bad points of this route or that while I decide on my next move. Usually when I sail into a port, I have a large-scale, folded chart in one hand and the tiller in the other. I like the size, clarity, and mass of detail on a paper chart. With a digital image, I tend to lose perspective, orientation, and a sense of exactly where I am. I suppose in time I could learn to work around these subjective considerations, but just now they’re important to me.

To deal with this problem I would have to take my laptop or a viewing device into the cockpit. How long, I wonder, would these devices work with salt spray flying around? My friend Art Paine, a professional yacht captain, recently told me about a big yacht he was hired to sail that had a laptop in the cockpit along with a mouse to control the computer. Of course when the yacht heeled, the mouse fell into water on the cockpit floor . . . *“and Alice ran after the rabbit to see it pop down a large hole under the hedge.”*

I don’t mean to be a spoilsport because I too would like to use digital charts. As of 2008, however, I think their use for recreational vessels needs more development and less hype.

One problem with U.S. paper charts is that the national authority that issues them is forever changing (NGA, formerly NIMA, etc.). NOAA’s latest venture is to pair with a private company called OceanGrafix to print out charts on demand. These are printed in bright colors with the latest chart corrections. West Marine sells them for \$19.75 a sheet. Standard U.S. charts on paper cost the same, but are corrected less frequently.

Some of my friends recommend Bellingham Chart Printers (<http://tidesend.com>), which copies U.S. charts and sells them at a lower price. Most charts are full size; others are reduced to two-thirds of the original size (24 × 36 inches) to facilitate stowage. These are all U.S. charts, which are not copyrighted. Most countries copyright their charts.

Don’t downplay the importance of chart corrections. Margaret and I almost lost our lives at Bramble Cay, near Torres Strait in northern Australia, because a new survey somehow showed a critical reef on the wrong side of an island. I complained

vigorously and received an official letter of apology from the Australian Hydrographer, but this hardly paid for repairs to our yacht and the wear and tear on the crew.⁶⁷

Unfortunately, the cost of charts has risen astronomically. The tab for 25 full-size charts is now close to \$500. World-cruising sailors often trade charts, and I am sure this practice will continue. Sometimes when a cruise is completed, called off, or postponed, it's possible to purchase a big roll of charts cheaply. Ask around. In the Eastern Caroline Islands, I salvaged an enormous roll of Southeast Asian and Japanese charts from a wrecked tuna boat. Another time Margaret and I met the Norwegian yacht *Preciosa*, whose crew was given a set of charts for almost the entire world by a friendly shipping company.

I have also heard of small-boat sailors buying charts from shipping companies (sometimes through big agencies), which periodically replace their charts. While I'm not a fan of outdated charts, which can be dangerous to use, an old chart is certainly better than no chart. If your charts are still in print, they can usually be brought up to date by consulting suitable *Notices to Mariners*, which are available by mail or online. Unfortunately, correcting charts takes a lot of time.

Light lists have up-to-date positions of lights and buoys, and it's worth checking the positions of these aids to mariners for critical areas.

It's enlightening to use GPS positions to check a few key points on charts and see how they match. The World Geodetic System 1984 (WGS 1984) is the datum that GPS is based upon. However, older charts not tied to WGS 1984 can be slightly off, and somewhere along the line there could have been small surveying errors. You may be surprised to find discrepancies of 2 or 3 miles in some cases, a discovery sure to keep the navigator on his toes. In 2000, Margaret and I were sailing along the south coast of Newfoundland in dense fog, trying to find the entrance to Grey River, a tiny outport community. We discovered that the entrance to the river was 2 miles east of its position on the Canadian chart. Fortunately our radar set was working.

It has long been carved in stone that the key to successful navigation is not only to be bright and alert, but if possible not to rely on any *single aid* to navigation for critical landfalls. It's much smarter to check your position in different ways (bearings of lighthouses, water depths, electronic devices, radar, celestial, sounds of surf, visual descriptions, etc.). Oh yes, keep someone on deck looking around.

To show what a sailor is up against, and how important it is to check your position by *two separate means* and *to keep up with chart corrections*, consider the following story by Blue Bradfield.

Dr. Bill Smythe was en route from Samarai, Papua New Guinea, to Australia, and worked out his course to take advantage of one of the few reefs in the Coral Sea that was marked by a light beacon. It would be dark before he reached the light, so Bill

drew a course that would take him within a mile of the beacon. When he had run his distance and didn't see the light, Bill assumed that his boat speed had been less than he thought. After 2 more hours, however, Smythe began to get worried. A few minutes later the yacht crunched into a reef and was a total loss. When dawn finally came, Bill looked up and saw the light beacon only 200 yards away. It had been discontinued just a few days before he left Samarai, and he had not seen the *Notice to Mariners*. . . .⁶⁸

At the moment we have about 150 charts on *Whisper*, plus six volumes of *Pilots* and assorted pilot charts. Several dozen charts are in the chart table. We fold each chart in half (with the printed part outside so we can see what it is) and stow it flat. The rest of the charts are rolled up in three or four big black plastic garbage bags, each with a general label on the outside. Margaret keeps a record book that lists all the charts on board by name, number, latitude and longitude, and the owner (in the case of borrowed charts).

Half of our charts are from the United States, but we often buy Admiralty charts directly from a British agent. I have telephoned a credit card order to Kelvin Hughes (see www.kelvinhughes.com for phone numbers) in Ilford, England, and had the mailing tube with the charts in my hand 48 hours later in Maryland. (There are no customs duties on charts.) In particular I find the Admiralty chart catalog (NP131) handy for ordering, for route planning, and as a general onboard atlas when reading books. (Where exactly is Mauritius? Is the Caledonian canal in Scotland? Where is Cyprus in relation to Turkey? And so on.)

Small-scale Admiralty charts are especially good for planning purposes, and in general, I prefer the English charts because of more information and better draftsmanship and color. Nevertheless we try to use the charts of the country through which we travel (Canadian charts for Canada, New Zealand for the Cook Islands, Japan for its islands, and so forth). If your sights are on French Polynesia, by all means purchase French charts—there are 15 in all—from the national hydrographic authority in France (see Appendix 1 for address). Don't forget suitable tidal tables, tidal height tables, and light lists.

The invention and widespread use of the global positioning system (GPS) have revolutionized marine navigation. GPS has made the Nautical Almanac, traverse tables, and radio direction finding (RDF) things of the past. It seems to me that thousands of potential cruising sailors never made the leap to sea because they didn't have the mind-set to deal with the challenges of celestial navigation (sextant, timepiece, and sight reduction tables) and were secretly unsure of themselves. GPS dispelled their fears overnight and is largely responsible for those little clusters of sailing yachts huddled in a corner of the harbor in a thousand faraway places.





IS A STORM COMING?

The truth is that once you push off from, say, Southwest Harbor, Maine, and head for the Azores, far across the Atlantic, you're on your own. Absolutely on your own. Certainly you try to leave a harbor when the weather's good and you have a favorable forecast before you on the chart table. You and your crew are presumably rested, and the boat is in reasonable condition with adequate stores.

Ideally you should sail in the months when the weather is settled and you have reaching or running winds. After a few days, however, the weather may change to calms (when you need your big, light-weather sails), to headwinds, or to a storm. Then it's up to you.

All this adds a bit of spice and challenge to traveling at sea. If the weather were always steady and perfect, sailing would be easy, but then we'd condemn it as a boring sport. Certainly changing, trimming, reefing, and repairing sails are key parts of life at sea on a sailboat. And of course most sailors try to make good time, because the first question you always hear when you arrive at your destination is: "How many days?"

One of your main forecasting tools while on passage is the ship's barometer. Meteorologists have long measured atmospheric pressure in millibars (mb), in millimeters (mm), or inches of mercury, which is certainly an obsolescent unit. More recently, meteorologists worldwide have adopted hectopascals (hPa) as the basic measuring unit (1 hectopascal equals 1 millibar). In Canada, the weather experts use

kilopascals (kPa), one of which equals 10 mb or 10 hPa. The unit to remember is the hectopascal, certainly an ear-bender the first time you hear it on the radio.

If the ship's barometer stays high for 48 hours or so, there's a reasonable chance that fair weather will continue. When the pressure drops (from, say, 1010 hPa to 998) you may see a significant weather change. (To see how widely the barometer and other weather indicators were used in the past, see Appendix 3.)

You can also follow the weather with printouts from a weatherfax machine. A single-sideband radio connected to a laptop computer with suitable software will enable you to access dozens of weather charts. Reading these charts, however, is not a simple business, especially for beginners.

There are many shore stations transmitting ordinary weather and storm forecasts. In fact there's so much stuff sent out that you can easily be intoxicated by technical weather information and spend all your time fretting and worrying over highs and lows and storm warnings.

Because weather and navigation are closely tied to one another, here's a short list—from the simplest to the most complex—of sailing schemes for sailing out of sight of land:

1. **Dead reckoning** means keeping track of the time, compass readings, and boat speeds. The time run on a given course, when multiplied by boat speed, gives the distance run on that course. You then plot this information on the chart. Offshore currents and tidal considerations are complications. You take the weather as it comes. Few people trust dead reckoning for long distances.
2. **Celestial navigation.** This requires a sextant, accurate timekeeping, sight reduction tables, and weather clear enough to be able to see the sun, stars, moon, or planets. A wonderful shortcut for modern sextant users is a pocket-size computer to deal with the calculations. These devices have built-in nautical almanacs for up to the year 2100, plus built-in sight reduction tables. One good calculator is the Star Pilot, which fits easily in your hand and can help you find your position quickly. The Star Pilot can also do complex lunars (to calculate accurate time from the sky), and identify stars and planets. A particularly handy feature (among many) is to calculate the distance between two distant points by punching in the latitude and longitudes of each place. The readout can be either rhumb-line or great-circle routing.

With regard to timekeeping, U.S. government radio stations at Kauai, Hawaii, and Ft. Collins, Colorado, transmit precise time signals 24 hours a day on 2.5, 5, 10, 15, and 20 MHz on a worldwide basis.

The two stations also transmit brief weather information at 8, 9, and 10 minutes past the hour. A typical 45-second weather announcement might be as follows:

North Atlantic weather west of 35 West at 1700 UTC; Hurricane Donna, intensifying, 24 North, 60 West, moving northwest, 20 knots, winds 75 knots; storm, 65 North, 35 West, moving east, 10 knots; winds 50 knots, seas 15 feet.

These transmissions can be picked up by an inexpensive SSB receiver.

3. **The global positioning system (GPS)**, a scheme in which a small onboard electronic device picks up signals from a system of 24 satellites that continuously orbit the earth. By automatic triangulation from three or more of the satellites, the GPS unit on the boat gives the ship's precise latitude and longitude in a few minutes, rain or shine, night or day. During the last 20 years, big and little ships have become almost totally dependent on GPS; boats that go offshore generally carry an inexpensive just-in-case spare. Even the military leans heavily on GPS. Believe it or not, celestial navigation is no longer taught at the U.S. Naval Academy in Annapolis.
4. **A mass of computer programs** that can deal with the weather, e-mail, automatic positioning on electronic charts, and communications of all types. To some sailors, satellite telephones are vital, and can be coupled with programs for weather information, Internet access, and personal or business calls.
5. **Routing by a weather professional on shore**, an expert who radios or e-mails directions to the boat and advises the best course with regard to wind, sea, and other conditions.

Of these five weather and navigational systems, the use of the almost foolproof GPS system (#3 in the list above) has become standard for offshore sailing. The lure of gadgets and maybe slightly easier sailing (#4), however, is compelling, but where do you start and stop?

If you've decided to have a single-sideband transceiver on board and have taken care to have good aerial and ground arrangements, the next step is to buy suitable software to receive weather maps. Many sailors choose to work from 500 mb weather charts. These show the high- and low-pressure areas and help you check how the winds at the ship fit into weather systems on the weather chart and whether you should change

course for a better slant. If you're on the north side of an east-going low in the Northern Hemisphere, for instance, the wind will be from the east (and be easterly on the south side of a Southern Hemisphere low). If your vessel is on the west side of a south-moving high in the Southern Hemisphere, the wind should be from the north (and be from the south on the west side of a Northern Hemisphere high). And so on. Some weather charts have little arrows with feathers that give the direction of the wind and its force. The interpretation of weather charts, however, is a big subject that needs a lot of specialized study and is beyond the scope of this book.

Every year the software choices include more options, which mean more complications and more dollars. GPS is a wonderful invention that we all value because it gives us a quick and precise position any time of the day or night. But whether it's necessary to display its readings automatically on electronic charts or even to have electronic charts at all is up to you. To go further, it's possible to hire a land-based professional router (#5 above) to advise you on your most favorable course and the winds and weather you can expect.

The whole game is one of complexity and cost.

For example, if you decide to use gridded binary files (usually called GRIBs) for detailed weather analysis, you will need a computer and specialized software. If you want to take your computer into the cockpit, you may find that you can't read the screen in bright light or sunshine. This means that you will have to buy a special viewing device. A satellite telephone can solve many weather, navigation, and communication problems, but for starters it's expensive, complicated, demands power, takes up a fair amount of space, and requires you to pay airtime charges.

As of early 2008 there are six big companies in the marine software business. All claim special features, but you may decide that you want products from several manufacturers. Sometimes there are problems with compatibility between the different systems, and each side points to the other. Before you spend lots of money, ask yourself some hard questions. Try to talk with others who have bought these systems. Do you really need buoy data for Alaska and chart corrections for Mozambique? What about currents and tidal streams? Few yachts will opt for collision avoidance schemes, but it's possible to purchase the software. If you have a radar set, is it necessary for it to be tied in to your navigation system? One program comes with 13 DVDs.

And horror of horrors, what if you're leaning on this software and all its nifty programs and the ship's electricity goes off or the SSB radio packs up? Then what? You're back to square one and seat-of-the pants sailing.

But wait! It's not the end of the world. Don't stick a dagger in your heart. Columbus and Magellan sailed a lot of miles without radio connections back to mainland

Spain or satellite help from the heavens above. And both captains had some great adventures.

Do your own weather forecasting. Books on weather are universally ponderous, dull, and wonderful sleep inducers, but a handy little guide to weather is Alan Watts's 64-page booklet titled *Instant Weather Forecasting* (Sheridan House, 2001). It has 24 color pages and 24 pages of interpretation plus 11 pages of text at the beginning. Some readers might think it too simplistic, but if you use it on deck and read every word, the book is surprisingly helpful.

For example, If you look high up into the top of a clear blue sky and see long parallel banners of jet stream cirrus (sometimes with ribbed crossbars) at heights of 5 miles or more, you're watching a sky that means the weather is going to worsen. In the Northern Hemisphere these cloud banners run from west to east or from northwest to southeast. This suggests that the surface winds will back to southern quadrants and increase.

The Force 2 to 4 west to northwest winds at the boat will become Force 5 to 8 southwest to southeast winds in 6 to 12 hours. This will be accompanied by a falling barometer over the next 12 to 24 hours. A more rapid fall in 6 to 12 hours suggests winds of Force 6 to 8; a major drop in 3 to 6 hours (unlikely) may give winds of Force 9 to 10.

Fascinating stuff. Read on.

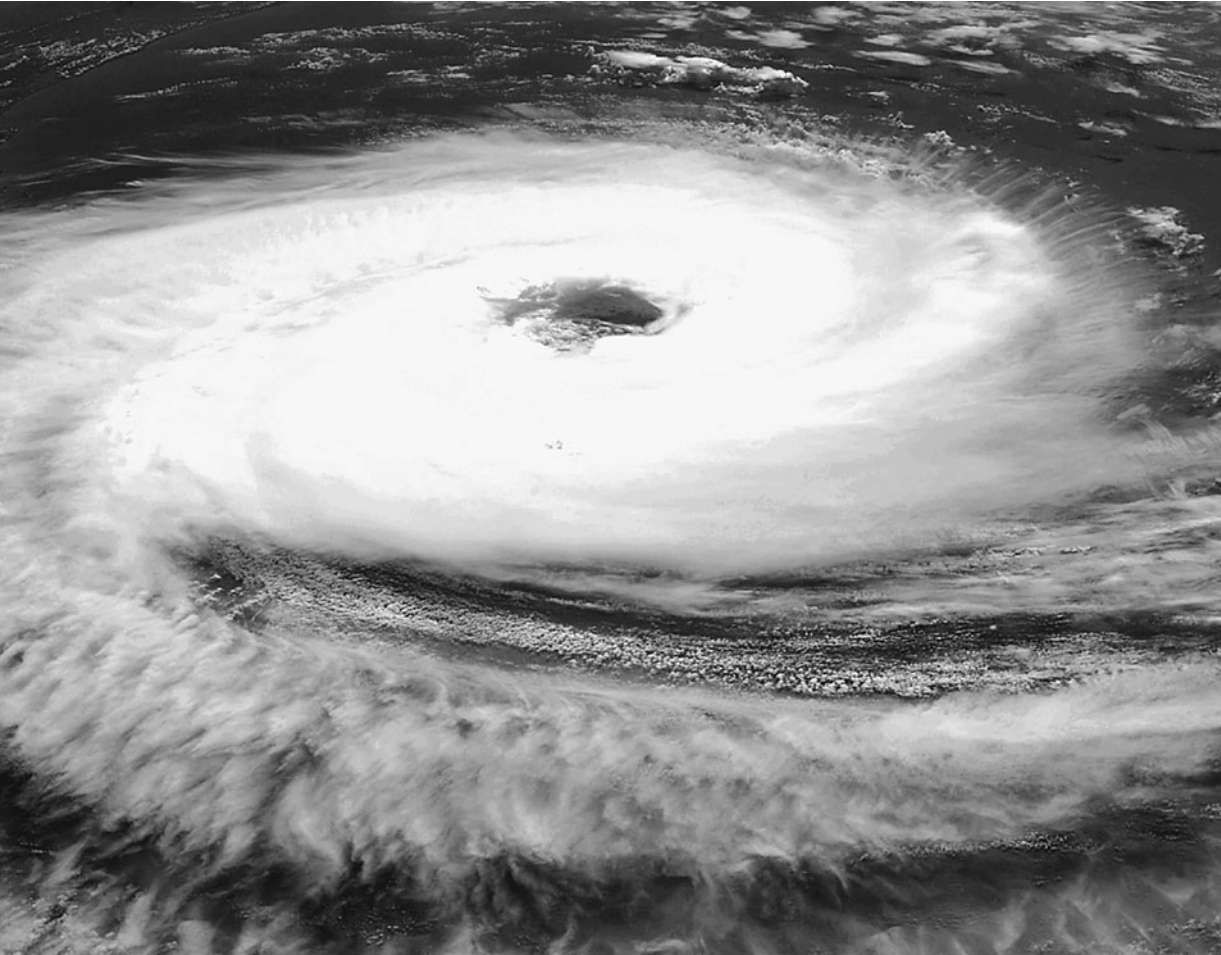

Cyclone Catarina, a rare South Atlantic tropical cyclone near Brazil, viewed from the International Space Station on March 26, 2004. Note that the circulation is clockwise in the Southern Hemisphere. This means that if this low-pressure area is moving from west to east and a yacht is sailing east, the vessel should be on the north side of the low at a distance far enough to the north—say 350 miles from the center—so that the ship's winds are moderate and fair.

18

A HURRICANE: THE EVIL EYE

The word comes from *Huracan*, the Carib Indian God of Evil. These frightful storms sweep across vast oceans and are a collection of devastating winds, violent spiraling thunderstorms, and colossal seas. From a distance a hurricane looks white and solid except for a dark hole at the center called the eye, the axle of a great spinning wheel.

Unlike gales and storm-force winds, which develop and move in straight or curving lines, hurricanes (also called typhoons or cyclones) are rapidly spinning outbursts of extreme winds that occur in seasonal patterns on tropical seas, generally in specific areas. These storms have no weather fronts associated with them; they're true revolving storms.

Each is a kind of specialized cloud engine that needs warm, moist air as fuel. The necessary heat is taken from ocean water that is heated to at least 80° Fahrenheit (27° Celsius) to a depth of hundreds of feet. The warm air rises high into the atmosphere, where its entrained moisture condenses into water droplets, which give up the heat that evaporated the water in the first place. It is this heat energy that powers a hurricane. However, not all tropical depressions become tropical storms; fewer still become hurricanes.

In the North Atlantic, these giant storms are often spawned in the eastern part of the ocean near Africa and the Cape Verde Islands (16° N) and move westward across

the ocean as gradually intensifying tropical depressions or storms. Once in the Caribbean (see #1 on the accompanying map), Atlantic hurricanes usually move west or northwest before curving to the north or northeast. They threaten the waters off the lower East Coast of the United States before losing force as they encounter cooler land and sea temperatures. In addition, Caribbean hurricanes menace the waters off the east coast of Central America and Mexico. There are about six Atlantic hurricanes each year.⁶⁹

Hurricanes occur in the Pacific on the west coast of Central America and Mexico (#2 on the map) and sweep to the northwest. This area experiences an average of seven or eight tropical storms each year from May to November. In the Far East, hurricanes (called typhoons) develop in the Philippines and China Sea (#3) and travel northward toward China, Taiwan, and Japan. In this region there are about 18 typhoons each year, which can occur in any month. February has the least; June to December have the most.

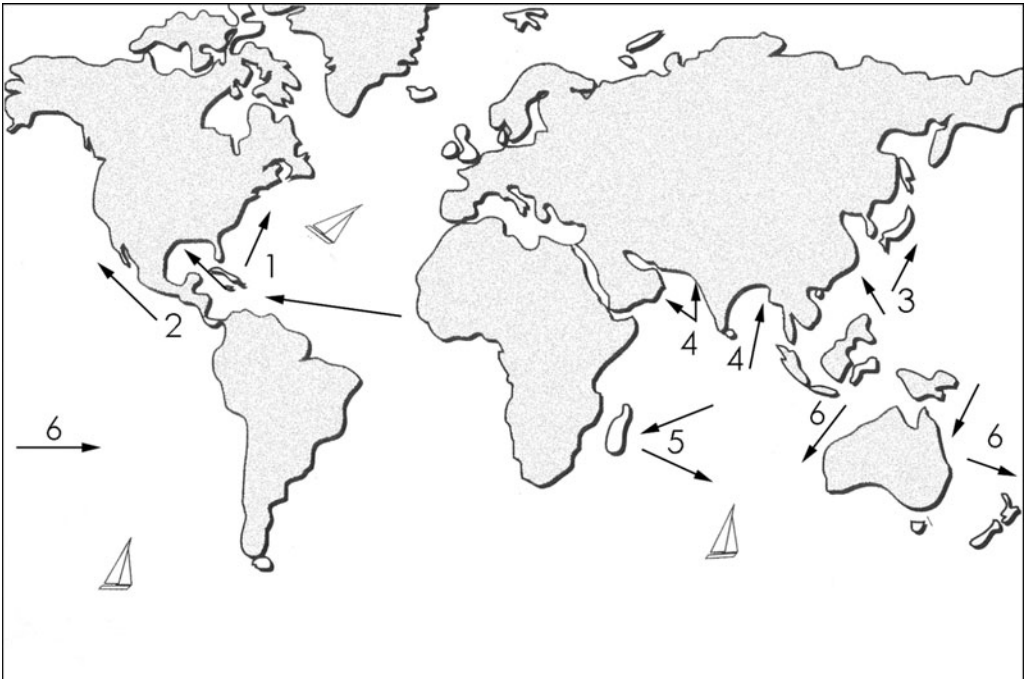

Worldwide hurricane distribution.

In region 4, hurricanes—called cyclones—blow up on each side of India (E and W) in the Arabian Sea and the Bay of Bengal, sometimes going ashore with terrific force in Bangladesh. In region 5, giant rotating storms occur seasonally in the South Indian Ocean east of Madagascar, where they're also called cyclones. These storms typically make a U-shaped track from north to south, with the base of the U toward the west.

Region 6 has three areas: A revolving storm called a willy-willy sweeps southwest from the Timor Sea to NW Australia. The second area is along the east coast of Australia to longitude 160° E. Like the storms in the south Indian Ocean, the Australian hurricanes form U-shaped tracks from north to south, with the base of the U toward the west.

Finally, between January and April in region 6—in the western portion of the South Pacific—ferocious hurricanes can ravage Vanuatu, Fiji, and nearby islands. These ferocious storms sometimes extend as far east as Tahiti and the western Tuamotus in French Polynesia.

How big are hurricanes? They range in size from a radius of 120 miles (small) to 480 miles (giant). The average has a radius of about 300 miles, which means a whirling dervish 600 miles across measured between the outermost closed lines of isobars.

From this short summary we see that tropical revolving storms, whether they're called hurricanes, typhoons, or cyclones, are nasty customers that we must avoid. As Bowditch puts it in Chapter 39: "Rarely does the mariner who has experienced a fully-developed tropical cyclone . . . wish to encounter a second one. . . . The rapidity with which the weather can deteriorate . . . and the violence of the fully developed tropical cyclone, are difficult to visualize if they have not been experienced."

In the real world of small-boat sailors, it's easy to say that we should avoid revolving storms entirely. But sometimes we make bum decisions or the weather flips upside down. The photograph at the beginning of this chapter shows a giant revolving storm in the South Atlantic, a location where hurricanes are never seen. Yet there it is, and suddenly we're near one of nature's monsters, a dragon in a breathing fit. What to do? The answer is to somehow ease away from the hurricane. To go to one side or the other. Or to stand still and let the storm head away while you spin the boat's prayer wheel.

Here are a few ideas for dealing with a North Atlantic hurricane. If you're in the Southern Hemisphere, remember to reverse directions: counterclockwise becomes clockwise.

A useful predictive feature of hurricanes is a deliberate swell that comes from the storm while it's still many hours away. If you're sailing along nicely and begin to see

and feel a steady and unrelenting swell (usually from another direction, every 9 to 12 seconds), you can add this clue to those coming from the barometer, the radio, and high-level cirrus clouds.⁷⁰

Hurricanes are well known for areas of low barometric pressure; the deeper the drop, the more violent the winds. Once when Margaret and I were sailing in Japan, the aneroid barometer on our boat angled down to the nine o'clock position, the lowest I've ever seen. I thought it was the end of the world. Fortunately we managed to slip into a fishermen's typhoon shelter while the storm spiraled off in another direction.

The *eye*, or center, of a hurricane travels forward from 5 to 50 mph. The winds of these great storms spin counterclockwise in northern latitudes, spiraling inward, and increase in speed as they approach the eye. It's useful to consider a revolving storm (see the drawings on pages 183 and 185) as an image split in the middle by a diameter line that represents the storm's forward direction.

In the Northern Hemisphere the right half of the circle is called the *dangerous semicircle*. The reason is that the spiraling winds of the storm are heading in the same general direction as the system's forward motion. This makes the speed of the hurricane's rotational winds and the storm's movement additive (say 65 knots plus 20), and the resultant wind speeds are therefore maximized. In the left or *navigable semicircle*, the forward movement of the storm and its winds are subtractive (65 minus 20). This means that we should always try to sail in the left or navigable semicircle.

If the eye is moving directly toward your vessel, the wind direction will remain constant and its velocity will increase until the eye arrives. Then the wind will drop, often to a dead calm, but with a terrible sea, and the heavily overcast sky will clear to sunshine and blue sky. Once the eye has moved past the ship, the wind will suddenly become violent again, but from the opposite direction. The heavy cloud cover will return. This 180-degree wind shift plus the extreme seas that accompany the storm are better read about than experienced.

A boat ahead of the storm that tries to go from one side of the hurricane to the other is said to be "crossing the T." This is a bad move and should not be attempted, because if the storm speeds up or the vessel is delayed, she will be in a desperate position. If you know the direction the hurricane is traveling, the best move is to go laterally away from the revolving storm. If the storm is heading north, for example, and you're in the left semicircle, try to sail west. If you're in the right semicircle, head east. Never mind if this is not your sailing course; we're talking about survival. You must get away from the hurricane. Hopefully you have plenty of sea room. If you're in an area with islands, try to work to the lee side of land, sail in close, and either sail back and forth or anchor. If the wind shifts, you will have to move, always keeping the island before you as a shield.

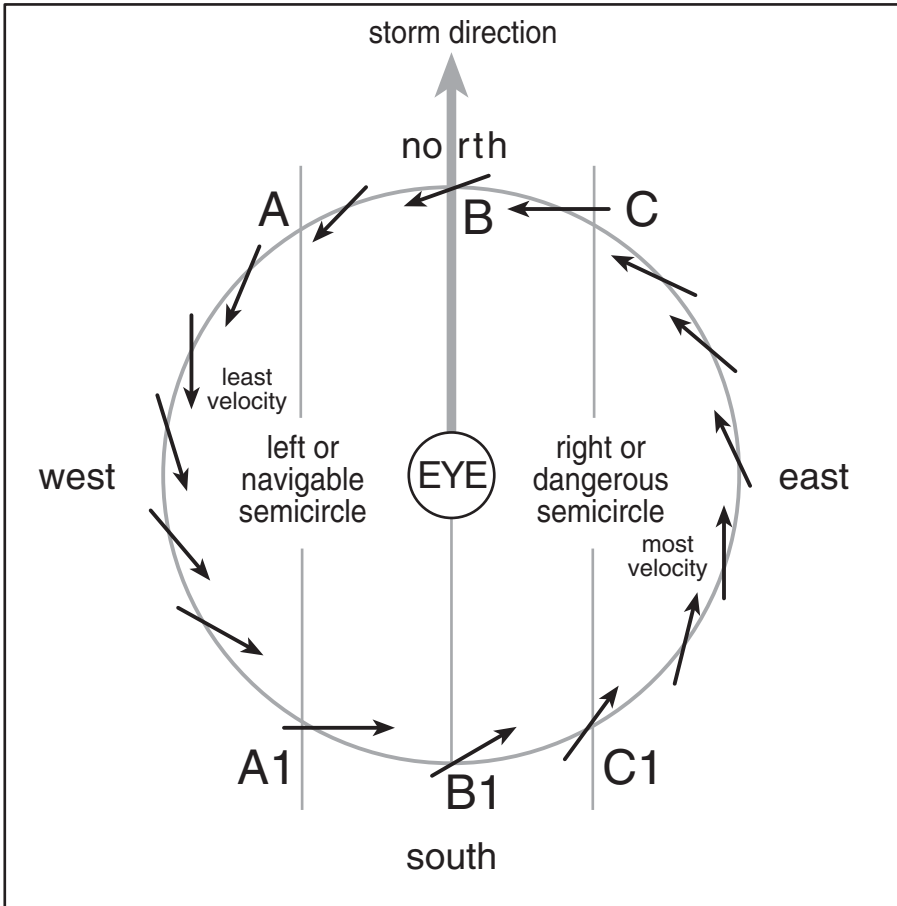

In this drawing the hurricane is headed north, but a revolving storm can travel in any direction.

In the above drawing, vessels are at positions A, B, and C as the storm approaches. When the storm has passed, the vessels will be at A1, B1, and C1, respectively. Each vessel will have experienced an entirely different series of wind directions and velocities.

1. If the storm in the drawing is moving to the north, the vessel at A has wind from the northeast initially, backing (shifting counter-clockwise) to north, northwest, and finally, at A1, west. The wind

strength will be least when it's blowing from the north, because then the storm's speed of travel will be directly subtractive from the velocity of the rotational winds around the eye (say 65 minus 20). With the wind from any northerly direction, you will have a fair wind and should be able to sail west—away from the storm. If you find yourself at the 0900 position you should head southwest (still with a fair wind) and then south. If you find yourself at position A1 you should try to head south with the west wind.

2. The vessel at B has a constant wind from east-northeast and should head west toward the navigable semicircle with the wind on her starboard quarter. If she holds her position at B while the storm moves northward, the boat will continue to have heavy winds from the east-northeast until the eye arrives. After the calm of the eye, the wind will rise violently from the west-southwest and stay in that quarter to position B1. A boat at B1 should head east or southeast to keep a fair wind that should rapidly take her away from the storm.
3. The vessel at C, in the most desperate of all the positions, has the wind from the east. This will tend to blow the boat directly into the hurricane's path, and "crossing the T." To prevent this, boat C should make every effort to sail northeast, but this may be impossible with great seas and the wind on the starboard bow. As the storm moves north, vessel C's wind will gradually improve, veering (shifting clockwise) to southeast, south, and finally, at C1, to southwest. However, the hurricane-force wind and seas in the dangerous semicircle may make any intelligent sailing impossible. In our example, C's winds from the south will be 65 plus 20, or 85 knots. A's winds in the navigable semicircle will be 65 minus 20, or 45 knots, roughly half those of C.

Vessel C will be lucky to survive.

According to Ed Boden, the dynamic wind pressure, or wind force, difference between the navigable semicircle and the dangerous semicircle varies as the square of the wind's velocity. Comparing the two, $45 \times 45 = 2025$; $85 \times 85 = 7225$. The ratio between the two is $7225 \div 2025 = 3.6$. In other words the 85-knot wind would have over three and a half times the power of the 45-knot wind!

Since this concept is so important, let's look at these points with another drawing and slightly different words. The vessel at A should put the wind at 160 degrees off the

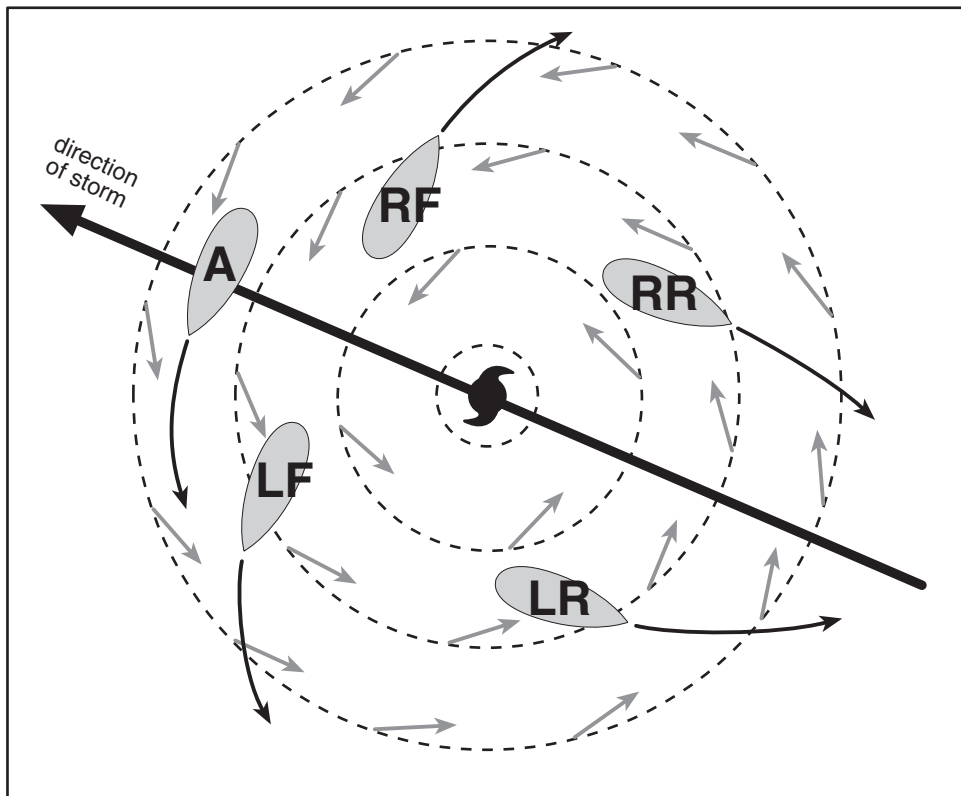

This hurricane is traveling west-northwest. The dangerous quadrant has the vessels RF and RR.

starboard bow. Since she is “crossing the T,” the captain should make every effort to move into the left semicircle of the system.

The vessels at RF and RR should put the wind at 045 degrees off the starboard bow and attempt to make the best possible course and speed to clear the revolving storm. These two boats will experience appalling winds and seas and may not be able to make any progress at all.

The sailors at LF and LR should put the wind on the starboard quarter and make the best possible course and speed to escape the cyclone.

If you find all this talk about arrows and wind directions confusing, this little table may help.

HURRICANE AVOIDANCE OPTIONS

Vessel Location	Action On Board Ship
Ahead of tropical cyclone	Put the wind at 160 degrees off the starboard bow and make the best possible course and speed into the left semicircle.
Right semicircle of a tropical cyclone	Put the wind at 045 degrees off the starboard bow and attempt to make the best possible course and speed to escape to the right. Wind and waves may make this extremely difficult or impossible.
Left semicircle of a tropical cyclone	Put the wind at 135 degrees off the starboard bow and make the best possible course and speed to escape to the left.
Behind the tropical cyclone	Maintain best possible course and speed directly away from the hurricane.

To make any sense of these directions, we need to know the current position of the hurricane and which way it's moving. If every hour you write in the logbook the direction of the wind, its strength, the barometer reading, the ship's course, and the sea conditions, these numbers may help you figure out where you are in relation to the hurricane.

Severe storms are carefully watched by government weather observers all over the world, and official warnings and the latest positions are broadcast regularly to ships at sea. You can listen to many stations (even the brief warnings on WWV and WWVH) on a simple SSB receiver with an external antenna. If an SSB receiver is connected to a computer with weatherfax-receiving software, you can pick up text and graphical weather information.

Here's a typical warning from the New Zealand Met Service:

STORM WARNING 182
 AT 140600UTC
 Low 985hPa near 40S 178W moving east 20kt.

1. In a belt 120 miles wide centred on a line 41S 179E 39S 180 38S 179W

Southwest 50kt easing to 40kt next 6 hours. Storm area moving eastnortheast 20kt.

2. Outside area 1 and within 240 miles of low in northwest semicircle:

Clockwise 35kt. Gale area moving east 20kt.

Or you can go to higher communication levels. These include various satellite hookups, an SSB transceiver, ham radio, a NAVTEX receiver, private weather routers, e-mails, a high-frequency fax, at least four kinds of U.S. Coast Guard transmissions, and so on. The list of radio gear, software, and computers goes on and on. All this means expense, upkeep, and time and power demands for up-to-the-minute weather information. Some of this equipment requires special training and experience to use, but when a real hurricane is in the offing, it's certainly no time to begin trying to figure out the manuals.

I urge you to use the easiest and simplest equipment. Don't forget to collect a list of radio frequencies and times before sailing, and update it occasionally.

A weatherfax image that shows the latest position and movement of the hurricane can be of the greatest value. All you need to do is to plot the ship's position on the weatherfax and consider an appropriate course.

An excellent Internet website for listings of worldwide marine weather broadcasts, information on how to use them, many links, and more is www.franksingleton.clara.net.

THE 34-KNOT RULE

Big ships use two other techniques when they're threatened by hurricanes. The first is the *34-Knot Rule*, which mandates that vessels should make every effort to steer clear of 34-knot winds (the lower end of Force 8) when the winds are associated with a tropical revolving storm. By the time the wind reaches 34 knots, the sea state approaches levels that interfere with ship maneuverability and restrict a vessel's chances to work away from the cyclone.

THE 1-2-3 RULE

The second technique is the *1-2-3 Rule*, which is derived from the latest 10-year average of forecast errors associated with tropical cyclones. Though recent forecasting trends and error predictions have improved, there are still large errors in deciding where a hurricane will be in 48 or 72 hours. The 1-2-3 Rule attempts to deal with

these uncertainties by using information from the latest TCM (Tropical Cyclone Forecast/Advisory) issued by the U.S. National Weather Service for Atlantic and Pacific waters every 6 hours during storm seasons. Other countries put out similar reports for hurricane areas elsewhere in the world.

To understand a TCM and deal with the 1-2-3 Rule takes a little effort. For starters, let's examine a typical TCM. To help follow this document, I've numbered each of the 17 parts, and where necessary I've added a line or two of explanation in italicized type in brackets. All TCMs follow the same form.

WTPA22 PHFO 200853
TCMCP2

1. TROPICAL STORM IOKE FORECAST/ADVISORY
NUMBER 2

NWS CENTRAL PACIFIC HURRICANE CENTER
HONOLULU HI CP012006

0900 UTC SUN AUG 20 2006. [*The header language is precise. Ioke is a tropical storm, which means an organized rotary circulation, and sustained wind speeds of at least 35 knots.*]

2. TROPICAL STORM IOKE HAS FORMED WELL SOUTH OF HAWAII BUT WILL NOT IMPACT THE STATE. [*Watches, warnings, and news.*]

3. TROPICAL STORM CENTER LOCATED NEAR 10.6N
159.0W AT 20/0900Z
POSITION ACCURATE WITHIN 30 NM. [*We will take this uncertainty into account when we plot the storm's current position.*]

4. PRESENT MOVEMENT TOWARD THE WEST-NORTHWEST OR 290 DEGREES AT 11 KT.

5. ESTIMATED MINIMUM CENTRAL PRESSURE 1002 MB.

6. EYE SIZE ESTIMATE. [*Omitted in this report.*]

7. MAX SUSTAINED WINDS 35 KT WITH GUSTS TO 45 KT.
34 KT . . . 30NE 30SE 15SW 15NW. [*With sustained winds of 35 knots, Ioke barely qualifies as a storm. Any less, and a rotating tropical disturbance would be called a depression. The 34-knot winds extend outward from the eye 30 nautical miles to the northeast and southeast and 15 miles to the southwest and northwest. Since this is a west-moving storm in the Northern Hemisphere, the north semicircle is the dangerous one, and we are not surprised to see that storm-force winds extend farther from the eye to the north than the south.*]

12 FT SEAS . . . 30NE 40SE 15SW 15NW.

WINDS AND SEAS VARY GREATLY IN EACH QUADRANT.
RADII IN NAUTICAL MILES ARE THE LARGEST RADII
EXPECTED ANYWHERE IN THAT QUADRANT.

8. REPEAT . . . CENTER LOCATED NEAR 10.6N 159.0W AT
20/0900Z. AT 20/0600Z CENTER WAS LOCATED NEAR
10.4N 158.5W. [*Storm center and time of advisory (0900) are repeated; then the time and position 3 hours earlier (0600) are given.*]

9. FORECAST VALID 20/1800Z 11.0N 160.7W. [*12-hour forecast of eye location.*]

MAX WIND 40 KT . . . GUSTS 50 KT. [*The storm is expected to strengthen.*]

34 KT . . . 40NE 40SE 25SW 20NW.

10. FORECAST VALID 21/0600Z 11.7N 163.3W. [*24-hour forecast of eye location.*]

MAX WIND 50 KT . . . GUSTS 60 KT. [*Further strengthening is expected.*]

50 KT . . . 15NE 0SE 0SW 10NW.

34 KT . . . 65NE 45SE 30SW 50NW.

11. FORECAST VALID 21/1800Z 12.8N 166.1W. [*36-hour forecast of eye location.*]

MAX WIND 60 KT . . . GUSTS 75 KT. [*The storm is expected to approach hurricane strength in 36 hours.*]

50 KT . . . 40NE 20SE 20SW 40NW.

34 KT . . . 100NE 55SE 40SW 85NW.

12. FORECAST VALID 22/0600Z 13.9N 168.1W. *[48-hour forecast.]*
 MAX WIND 65 KT . . . GUSTS 80 KT. *[The storm is expected to be a hurricane in 48 hours.]*
 50 KT . . . 40NE 20SE 20SW 40NW.
 34 KT . . . 120NE 40SE 40SW 120NW.

13. FORECAST VALID 23/0600Z 16.7N 171.3W. *[72-hour forecast.]*
 MAX WIND 70 KT . . . GUSTS 85 KT.
 50 KT . . . 90NE 25SE 25SW 50NW.
 34 KT . . . 150NE 40SE 40SW 100NW.

14. EXTENDED OUTLOOK. NOTE . . . ERRORS FOR TRACK HAVE AVERAGED NEAR 200 NM ON DAY 4 AND 225 NM ON DAY 5 . . . AND FOR INTENSITY NEAR 20 KT EACH DAY. *[The average four-day position forecast error for prior tropical storms is 200 miles. We will use a more conservative long-term average error of 100 miles per day, however.]*

15. OUTLOOK VALID 24/0600Z 19.3N 173.0W. MAX WIND 70 KT . . . GUSTS 85 KT. *[Due to the low level of certainty of a storm forecast four days out, wind radii are not provided with the 96-hour forecast. Use the same threshold wind values as in the 72-hour forecast.]*

16. REQUEST FOR 3 HOURLY SHIP REPORTS WITHIN 300 MILES OF 10.6N 159.0W.

17. NEXT ADVISORY AT 20/1500Z.

FORECASTER NASH

What the 1-2-3 Rule amounts to is that although the present position of a storm can be known with reasonable certainty (within 30 nautical miles in the case of Tropical Storm Ioke), the further into the future you attempt to forecast the storm's position, the less precise your forecast becomes. A mariner would like to know where the storm will be tomorrow and the day after that and so on. This is possible, but only at the cost of increasing uncertainty. So what's done is to plot the uncertainty.

The wise men of the sea have decided that winds over 34 knots and the upset water and waves that accompany such winds in the vicinity of a tropical revolving storm are risky and dangerous. So based on information in the latest TCM, we can plot the radii of 34-knot winds. These can be forecast for the announced position of the tropical storm or hurricane. But what will happen in 12 hours, one day, one and a half days, and two, three, four, and five days?

A professional forecaster decides what these winds will be and where they will be found, and we plot his results. This gives us a small circle at the beginning and a series of circles of increasing size as we move away from the first position. I've plotted four of the eight positions on the August 20 TCM for Hurricane Ioke and have made the accompanying drawing, which looks like a squashed balloon.

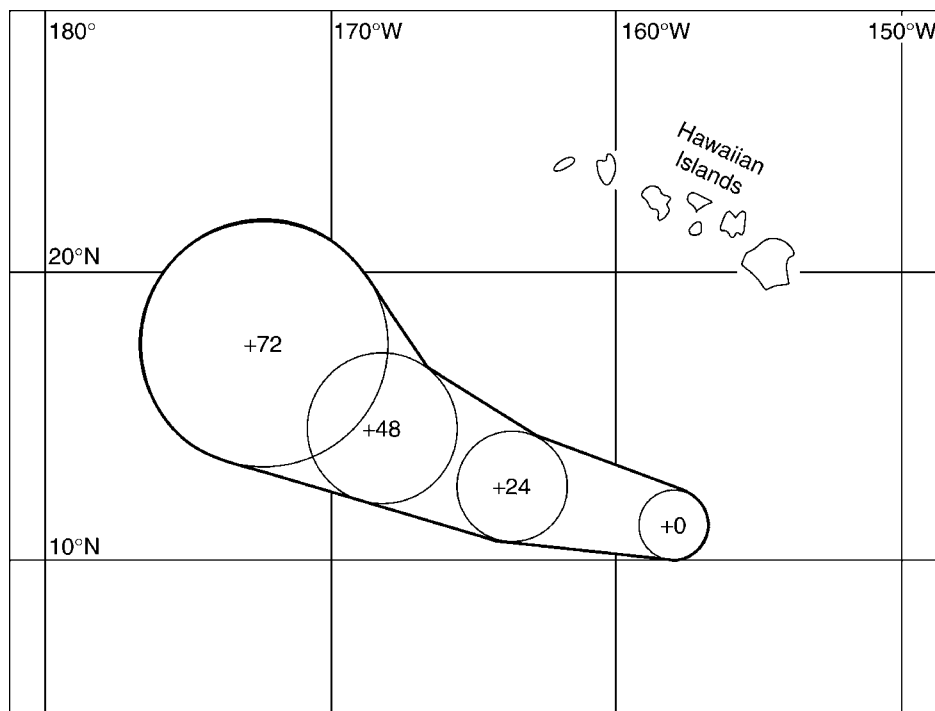

1-2-3 Rule plot of Tropical Storm Ioke south of the Hawaiian Islands on August 20, 2006. At 0900 UTC, the storm position is shown along with the predicted centers at 24, 48, and 72 hours. For 72 hours the wind prediction is 70 knots with gusts to 85. This 1-2-3 Rule plot warns mariners to stay outside the heavy black line where the predicted wind should be no more than 34 knots. This revolving storm is moving west-northwest at 11 knots.

For 0 hours, the time of the forecast, we're told that 34-knot winds extend outward as much as 30 miles from the storm's center, and the uncertainty of the current position of that center is 30 miles. We therefore draw a circle with a radius of 60 miles around the storm's reported present position. (Note that the circle drawn for each forecast uses the highest value of the four wind quadrants. This makes the plotting simpler and provides additional safety.)

In 24 hours the storm is predicted to be centered at 11.7° N 163.3° W. At this location we draw a circle with a radius of 30 miles (present position uncertainty) plus 65 miles (maximum forecast 34-knot wind radius) plus 100 miles (average 24-hour track error), or 195 miles.

In 48 hours the storm is predicted to be at 13.9° N 168.1° W. We draw a second circle with a radius of 30 miles plus 120 miles (maximum extent of 34-knot winds in the 48-hour forecast) plus 200 miles (average two-day track error), or 350 miles. And around the predicted 72-hour location we draw a circle with a radius of 30 miles plus 150 miles plus 300 miles, or 480 miles. That's a circle almost 1,000 miles in diameter that we want to be outside of in three days.

The rule of thumb is that the average track error is 100 miles for the 24-hour forecast, 200 miles for the 48-hour forecast, and 300 miles for the 72-hour forecast.

But what, you ask, happens if I don't have the latest TCM bulletin from the weather people? Suppose the radio has broken down or the propagation is bad. Maybe I don't have the most recent frequencies and times of transmission. Or maybe the ship's batteries are dead. Then what?

Then you're on your own, and it's back to Buys Ballot's Law to find out what the cursed hurricane is doing. The law says that when you stand with your back to the wind in the Northern Hemisphere, the center of low pressure will be to your left. High pressure will be to your right. If you do this faithfully once an hour, and write down the bearings of the highs and lows and the barometer reading, in time you should be able to construct a little drawing of the hurricane's path. In general you will want to sail toward high pressure and away from low pressure.

If the pressure is falling, there's a noticeable swell, the wind stays in the same direction, and the cloud cover is thickening and lowering, you may be in the direct line of the hurricane.

"Bands of dark, heavy clouds alternate with thinner spirals as the wind increases," says weather expert William Crawford. The wind will drop to zero in the eye, and when it resumes, the wind will be from the opposite direction and the barometer will be rising.

If our intrepid sailor is in the right-hand semicircle as Tropical Storm Ioke is passing, the barometer will fall at first, then begin to rise. The wind will slowly veer from

north to east to south. The passing eye will probably be out of sight roughly to the west of the boat.

If our little ship is in the left-hand semicircle as Ioke passes, the wind will back from north-northwest to west, then south-southwest. Remember that if we're in the Northern Hemisphere and the wind veers, our vessel must be in the right-hand semicircle. If the wind backs, we must be in the left-hand semicircle.⁷¹

But even if you have a TCM position report of the hurricane or have worked out your own from Buys Ballot's Law, it will take a steady hand to plot it on the chart while the boat is jumping around and the wind is screeching outside. The crew may be terrified, and some may be wiped out and in their bunks. There can be problems with sails or deck gear. Even if you are able to think clearly and work out a plan, it may be impossible to carry it out.

It seems ironic that once you're locked into really severe stuff, the weather reports themselves are of little use except to indicate a way out that you may be unable to take. This is why it's so important to avoid such tempests and begin immediate actions to increase your distance from a tropical revolving storm, no matter what direction you have to go.

If all else fails and things are looking dicey, I would quickly put out a Jordan Series drogue or any sort of drogue you might have on board. If you don't have any dedicated off-the-boat gear, tie a long stout line to an anchor and secure the inboard end of the line to the strongest point on the stern (or use a bridle). Fit some chafing gear; then toss the anchor astern, and retire below.

I would pad myself with a couple of pillows and scrunch down behind the lee cloth in my bunk with a good book on espionage. I would pretend that I was a spy and about to meet the luscious Natasha Vasilotova, who was desperate for my photos of the secret machinery. . . .



Can you go to windward in a hurricane? Here we see a boat trying hard in winds above 60 knots during the 1998 Sydney–Hobart race. The sea is all white and running at heights of perhaps 20 feet, the crew is down to a storm trysail, and it's quite apparent that the yacht is making abysmal progress. The racing crew is perched along the windward rail, but the boat is heeled over so far that the crew's combined weight (1,500 pounds?) is having little effect. In fact, with the boat heeled so extremely to port, the railbirds' weight is actually increasing the capsizing force. Presumably this is only a momentary knockdown, but with the rudder out of the water, the boat cannot be steered, no matter how skilled the helmsman. With the storm trysail set, the mast looks to be under extreme pressure; once it gets out of column, the chances of failure are great. And when the mast goes, it's the end of the race and a whole new set of hazards and dreadful expenses.

What would I have done? Since progress to windward is hopeless, I would have stopped the yacht or run off downwind. In a race, however, the aim is to stay on course no matter what the price. Nevertheless when sailing becomes a survival situation it's time to take other action. I would have stopped the boat, taken down the sail, and run off downwind under bare pole. This would have taken the pressure off the mast, all the crew except one could have taken refuge in the cabin, and the boat would have slowly gone downwind. If the yacht was moving too fast downwind, I would have dropped an anchor on a long line over the stern. At sea, survival is mostly a waiting game; in 12 (?) hours the wind might be down, it might change direction, and the sailing conditions might be more reasonable. I think it's smarter to finish late than not to finish at all. As for the race, the competitors may be faring even worse. Who knows? Sometimes at sea, everything's a crapshoot.

19

FEAR AND UNCERTAINTY

When I'm way out on the ocean in a small boat and a storm swoops down and the yacht starts hopping around, all sorts of crazy things flash through my mind. Will the hull crack open? Will the bulkheads give way? Will the mast come down? And what about the rudder? Oh dear, there are so many things that could go wrong!

Yet in my heart of hearts, I know that the hull is strong, the bulkheads are firmly in place, and the mast and rigging are in good order. I'm aware that the boat was properly designed and built, and I've tried hard to keep her in good condition. Certainly the boat has come through lots of storms during her career. No doubt there will be more. She won't sink. The crew won't be lost.

Yet sometimes I have funny little feelings . . .

My dictionary says that *fear* is a state of agitation and anxiety caused by the presence of danger. Everybody knows that when you're far out at sea and a fierce storm is raging, it's a nervous time. It's the moment when you hope the yacht will survive and that you've taken the best and most sensible measures against the wind and seas.

We all know that the worst time for a new sailor is when he (or she) faces his first storm. Then the shiny world is suddenly dark and gray. The boat makes new sounds and different motions that are novel and unexpected. Our new sailor soon discovers that he has to hang on when he moves around and that his steps must be small and cautious. Because of this, a degree of uncertainty and a measure of slowness creep into everything.

For the people on board, *experience is everything*. After dealing with a dozen Force 8 to 10 problems at sea, the skipper simply accepts storms as part of the game. He uses

the most suitable storm tactics, knows about ample sea room, keeps a safe distance from shipping lanes, and shows a bright light at night. Some sailors use illegal strobe lights because a high-intensity flashing light is more easily seen. Dinghies and loose gear on deck are doubly tied down to keep them quiet. The captain takes the first 3-hour watch himself or assigns someone else.

If the yacht is in reasonable order below, the first thing is to rest and be quiet. If the boat is essentially stopped or running off before the storm, there's certainly no need for everyone to stay awake. Or to be bleating over the radio about the parlous state of affairs.

A storm may last for three days. On the first you may think you're going to die. On the second you realize that the yacht hasn't capsized and the bilge is dry. The mast is still up and maybe the boat will make it. On the third you're standing at the stove trying to concoct something good to eat. On the fourth day, the easy winds are back, you're on course, sunning yourself in the cockpit, and thinking about the sailing life and how good it is.

A few years back, Margaret and I were at the Kettenburg boatyard on Shelter Island in San Diego preparing for a Pacific trip. While a welder was repairing our stern pulpit, we were putting on stores, checking that we had the right charts, and dealing with a dozen small jobs.

We met a number of boatowners who were headed to Mexico and points south. In fact, two sailboats were leaving the next day. Both were 38-footers with a couple as crew, and both were headed to the Marquesas Islands in French Polynesia, almost 3,000 miles to the southwest. On the afternoon before they left, we all had a little party at the boatyard, and we hoisted our signal flags that spelled out "I wish you a pleasant voyage."

The next morning the two boats set off together in light winds. Someone in the yard kept in radio contact and told us that on the second day the two yachts still had trifling winds. After three days, one boat had logged only 190 miles, the other 235.

The 190-mile couple was feeling the blues, and their radio messages were filled with gloom and doom. "We're so discouraged," they said. "We'll never get there." The next day it was: "Little wind and a big swell." Then the slower boat said: "At this rate we may run out of food." Apparently they were not pushing their boat very hard. Meanwhile the faster boat had picked up the northeast trade wind and was zipping along at 140 miles per day. Soon their radio signals began to get faint and crackly.

After eight days the couple on the slower boat still had not found the trade wind. The two sailors lost their nerve, returned to San Diego, avoided their sailing friends, and quietly put their boat up for sale. The second boat arrived in French Polynesia after a 28-day voyage and sent back a series of glorious postcards.

What was the difference between the two boats? The crew of the slower boat was simply scared. The couple had lost all their self-confidence. It was fear and uncertainty on every side.

“The wind will never come,” they said. “Nobody’s around to help us. What if one of us gets sick?” The intrepid sailors we had met two weeks earlier had become pathetic whiners. The gray world of fear had triumphed.

I like to think myself a hero, but I’ve had my moments. During one of my eastabout solo trips round the world, I stopped at East Falkland Island off the coast of Argentina. I wanted to fill my water tanks, which were empty because of a stupid plumbing mistake I had made. It was just after the Falkland War, when all the lighthouses had been darkened and the navigational buoys removed. I went into a complicated little bay on the north side of Choiseul Sound on the east coast, where the British Army had a dock and a small base.

The military people kindly filled my water tanks and gave me a paper sack with three or four loaves of fresh bread. Already it was late in the day, and I began to worry about sailing before dark. There was a trifling northwest wind, so I put up the mainsail, cast off, and had sailed half a mile or so when a launch with four or five men came alongside. I stopped my boat by heading into the wind and letting the mainsheet run out and asked for instructions to make my way out to sea. The officer in charge talked on and on. Finally we traded salutes and the launch sped away.

I sailed south from the bay into Choiseul Sound and turned east toward the Atlantic. By now it was dark; there was no moon. I knew there were lots of dangerous, kelp-covered rocks in the area. I should have gone back to the army base and anchored until morning, but when I looked behind me I could no longer see the entrance.

Suddenly I felt the yacht slow as we glided into a heavy field of kelp that swished along the sides of the hull. I knew that kelp grows upward from rocks 60 feet deep or as little as 3 feet. My keel needed a little over 8 feet.

Though the weather was cold and I was wearing a heavy, three-layer Musto outfit, I could feel sweat running down my back. I was scared—terrified—that I had turned east too soon and would pile up on rocks I couldn’t see; I eased a little south from the compass course I had laid out. I was absolutely scared to death and afraid that by my bumbling I had jeopardized the entire voyage and maybe my life.

The bottom was too rocky and uneven to anchor, so I kept going slowly with just the mainsail up. Never was I so relieved when an hour later, the depth sounder moved from 4 fathoms to depths off the scale. The land was behind me. I was safe at sea!

Why had I been scared? Why was I a victim of fear? By my stupidity and lack of sensible action, I had allowed myself to become locked into a quicksand of darkness and danger, a situation that I should have predicted and avoided.

Fear can be brought on by a fierce storm or by more quiet and subtle things. Desperation because of no wind. Fear of the unknown. A nasty navigational problem. Sickness or an accident on board. Something wrong with the boat. A crewman who has become irrational. There must be a hundred reasons for fear.

When you feel the pain of fear, what can you do? Each of us is different, of course, and it depends on the problem and your reactions. Maybe the weather is stormy and you've decided to stop the boat. After a careful look in all directions, at the sails and their furling, a check of the water depth, and wind and sea conditions, you go below, leaving a lookout if necessary. As soon as you're in the cabin, you or someone in the crew notes the ship's position on the chart and the time and conditions in the logbook. By now your oilskins are partially or fully off and you may think about a light feeding. Or the thought of food may be revolting. Yet you know you should eat and drink a little something to keep up your strength. My favorite is dry crackers with a little chicken or tuna from a small can (6 ounces) packed in spring water, not oil.

SAFE IN THE CABIN

During severe weather the best place for everyone except the lookout or helmsman is below in the cabin. During the days before leaving the harbor, you or one of the crew or yard workers presumably screwed down all the floorboards. There are restraints (fiddles or strings) on all the shelves, and the pots and pans and loose things in the galley are tucked away after each meal. Each drawer should have a generous toggle or strong hardware to keep it closed, and underneath lockers should have their toggles in place. Even the chart table lid should have a positive closing latch of some kind. In a storm the motion can be severe, and it's not the time to upset the crew with flying books, a potful of hot soup, or missiles from the tool drawer.

A quiet, untroubled cabin can mean peace of mind—just what the captain and crew need when they're upset and a bit nervous from the antics of a violent storm.

Except for perhaps a lookout on deck, I've learned that during a severe storm the best place for everyone is in his bunk—safe and dry—behind a strong lee cloth. Speaking for myself, I try to relax in a narrow world that seems secure and less noisy, a private place where I can rest and collect my thoughts. I find that if my hair is on fire with worry, it's a good time to sort things out. When I'm relaxed and at ease, fear and tension tend to disappear. If I can doze or sleep a little, all the better. If I'm slept out, I read a thriller (*The Day of the Jackal*) or try an easy crossword puzzle.

I have strong feelings about berths, because sailors spend a lot of time in them. I believe that each person should have his own bunk, and that it should be comfortable and snug but not overly restrictive. Ideally it should have a little shelf with a fiddle or a drawer for a few personal items, a reading light, and—depending on the weather—a suitable sheet and maybe a blanket or two.

The best berth in my current 35-footer doubles as a cabin settee and is adjustable in width with bolt-type locks at each end. For use as a comfortable sitting place, it is 12 inches wide; for use as a berth it slides open to 18 inches. Sometimes it helps to have a couple of extra pillows to fit around my body.



We've had comfort and good luck staying in berths with simple lee cloths like these. Margaret, in 2003, is at the right. On the left, I'm sacked out in 1966, 37 years earlier! Note that we've added a third line to help support the lee cloth and to take some of the load. Note also that the lee cloths run from the shoulder to the thigh. If a lee cloth is longer, it's impossible to climb in and out of the berth quickly. With a half or three-quarter length, I can sit up, swing my legs, and put my feet on the cabin sole. The cloth at the left is canvas; the one at the right is a porous, open-weave plastic material that's cooler in hot weather. I urge sailors to use these lee cloths every time they turn in—even in dead calms—because you never know when the boat will roll and throw you out. Also you can relax and sleep better when you're aware that you're secure in your berth, not half hanging on. Depending on the height of a lee cloth, it can help protect you from books, galley pots, and the contents of a drawer that has somehow opened and become airborne shrapnel.

Each berth should have a lee cloth that will keep the occupant in place no matter what the boat does. My lee cloths measure 40×26 inches, with the long dimension reaching from my shoulder to my thigh. I fasten the bottom 4 inches of the long dimension of the lee cloth to the wooden frame underneath the berth cushion with six long screws set through fender washers. This means that the cloth extends roughly 20 inches above the cushion, depending on its thickness. The dimensions of a lee cloth and the way it's secured in place are not important, just so it keeps the occupant firmly in place when the yacht rolls to leeward. Choose a higher cloth rather than a lower one.

The lee cloth has a $5/16$ -inch-diameter rope sewn around the edges, and three grommets spaced along the top (at each corner and in the middle). Short $3/16$ -inch-diameter lines extend upward from the grommets to a strong grabrail along the sides of the cabin. I pull the lee cloth sharply upward and clove-hitch the lines in place. When I don't want the lee cloths, I tuck them under the cushions; when they're wanted, they can be pulled out and tied up quickly. A canvas expert can make two or three of these cloths in a few hours.

On other yachts I've slept against leeboards made of $5/16$ - or $3/8$ -inch plywood, but they were unsatisfactory because the wood was too hard, too low, too splintery, and too hot in the tropics. The boards were hinged and fitted under the cushions, but made the seats lumpy.

I despair writing about lee cloths, and I apologize for beating this subject to death, but I've read dozens of accounts—some by extremely experienced small-boat sailors—who have been thrown out of their berths in rough weather and suffered terrible injuries—a broken nose, a smashed arm, a fractured leg. Such injuries are doubly serious at sea because medical care is usually not available and is certainly not convenient.

I don't understand why all sailors don't make something similar to what I've described and use lee cloths for all sleeping areas as a matter of course.

Let's talk about the mental aspects of fear. Naval experts have long known that a sailor's state of mind in a survival situation is vital. During the early days of World War II, German submarines sank hundreds of British ships in the North Atlantic. The crews had to take to the lifeboats, often in appalling conditions. It was amazing how some sailors died almost at once, while others resolutely clung to life for weeks and were rescued. Survival wasn't tied to body size or age, because many big, husky young men died the first or second day. Survival seemed more related to pluck, spirit, stout-heartedness, determination, and the will not to give up.

In other words, fight fear with resolve and determination. As Don Whilldin writes: "Enforce a positive attitude, avoid despair like the plague, and don't allow doubt and resignation to set into your crew. Not even for one second."⁷²

Fear is not cowardice. Fear has more to do with uncertainty and irresoluteness, which are based on unknowns and the lack of knowledge of a situation. Part of fear is anxiety and being afraid. The remedy for the sickness caused by these close-knit words is to find out what you're afraid of and try to remedy it.

Is the boat going to sink? No, I trust her. Are you going to be run down by a giant merchant ship? Stick your head out of the main hatch and look around. If you see no ships, you can cross that one off for the moment. Is the vessel going to be swamped by big seas? No, not if you've selected the best storm plan. Are you going to run into rocks? No, because your position shows that you're 112 miles from land. And so on.

I believe that if you knew the storm was going to last for 14 more hours, that you would have to go out on deck twice during that time to deal with a loose sail, and that tomorrow the wind and seas would be down, you could go to sleep without worry. I'm convinced that if you know all sides of a situation, you can handle it.

So when you're at sea and nervous about the weather and other problems, pull yourself together. Try not to think about how awful things are. Think positively. Give yourself projects and busy work. Sharpen your knife. Polish the brass barometer. Mend the rip in your shirt. Read about your next port in the *Pilot* book. Measure the length of each piece of spare running rigging and label the coils. . . .

If you have a crewman who is terrified of standing watch at night, don't mock him or tell him how cowardly he is. This will only further embarrass and isolate him from you and the others in the crew. Put him on watch during the day or ask him to peel the potatoes for dinner.

Remember that if you weren't worried before, you shouldn't be worried now. According to statistics from the U.K. Department of Transport, it's ten times safer to travel by sea than to cross the road.

I remember when I was a boy of 10 or 11 in our house in Cleveland, my grandfather would sometimes send me down to the basement on cold winter nights. I was told to turn down the gas flame under the hot-water tank and put a few shovelfuls of small lumps of coal ("slack") on the fire and reduce the draft to bank the furnace for the night.

I did as I was told, but I was terrified by the darkness of the dimly lit basement—particularly the coal bin, which I was certain was full of hidden horrors. I was so scared that I thought my bones were rattling.

I told my grandfather about this, so he took my hand and together we went down the steps to the basement. There he turned a powerful flashlight into all the dark corners, including the coal bin. Under the clear bright light, all I saw were concrete walls, the laundry tubs, and the workbench.

“Have you seen anything bad or spooky?” asked my grandfather.

“No, nothing at all.”

“Do you feel safe now?”

“Yes, Grandfather.”

“Will you be able to handle these jobs at night on your own?”

“Yes, Grandfather.”

Together we turned down the flame under the water heater and banked the furnace. My grandfather had taught me that *the cure for dread and fear is to shine a clear, bright light across the cobwebs in your head*. I was never scared to do my little jobs in the basement again.

Glossary

A SAILOR'S WORDS

I apologize for using specialized sailing terms throughout this book, but seagoing boats are complicated, and sometimes actions have to be taken quickly. To facilitate this, sailors use precise words to describe gear or actions so that everyone will know what the speaker is talking about in unmistakable terms.

ABAFT. Nearer the stern than another object. “Abaft the mast.”

ABEAM. At right angles to the fore-and-aft centerline of the boat.

ABOUT. A vessel is said to go, come, or put about when she moves from one tack to the other.

ACCIDENTAL GYBE. When running before the wind, to change course and cause the wind blowing from behind the vessel to swing one or more sails and booms from one side to the other. If the wind is strong, this violent movement of a boom can threaten to bring down the rig. A heavy boom can usually be controlled by the main-sheet or boom tackles.

AFT. Toward the stern. “Take this line aft.”

AFTERMOST. Farthest toward the stern. “Take this line to the aftermost cleat.”

AGROUND. When the keel touches the seabed and motion stops.

AHEAD. In front of or toward the direction of the bows.

A-HULL. Lying at sea without any sail set in a gale.

ALEE. Away from the direction of the wind. To leeward.

ALOFT. Up above; in the mast or the rigging.

AMIDSHIPS. The middle area of a vessel; the word sometimes refers to the fore-and-aft centerline—that is, neither to port nor starboard. “Put the helm amidships.”

AMPLITUDE. One-half the distance from the crest of a wave to the trough.

ANEMOMETER. An instrument for measuring the strength of the wind.

APPARENT WIND. The direction and strength of wind that is felt on a moving object. Compare with TRUE WIND.

ASTERN. Behind or in the direction of the stern.

ATHWART or **ATHWARTSHIPS.** Across; the opposite of FORE-AND-AFT.

AWASH. Just washed over by water. “The rocks we hit were awash.”

AWEATHER. To windward; toward the weather side.

AWEIGH. Describes an anchor that is away from the bottom and being hoisted.

BACK (verb). To sheet or hold the clew of a sail to windward. If a jib is backed, it moves the bow of the boat to leeward. "He backed the staysail to swing the bow."

BACKING. A term used to describe the movement of wind, which is said to back (say from south to southeast) when it moves counterclockwise in the Northern Hemisphere. In the Southern Hemisphere, this term is reversed and refers to a clockwise movement (say from west to northwest). Backing has also been defined as moving in a direction contrary to the track of the sun. Compare with VEER.

BACKSTAY. A principal support, often of 1 × 19 wire cable, leading from a high point on a mast to a strong point on the transom or after deck to keep the mast from bending forward.

BALLAST. Weight—often lead, iron, or stones—that is carried low in the bilge or on the keel to give stability to a vessel.

BARE POLE or **BARE POLES.** Sailing or blowing along with no sails hoisted in extremely strong winds.

BATTEN. A strip of flexible wood, metal, or plastic that is inserted in a pocket on the leech of a sail to stabilize the roach and prevent curling and fluttering.

BEAM. (1) The extreme width of a vessel. (2) A transverse timber that supports the deck. (3) A vessel is said to be on her beam ends when her masts are horizontal.

BEAR AWAY or **BEAR OFF.** To steer to make the vessel turn away from the wind.

BEARING. The direction of an object in terms of compass points or degrees.

BEAT (verb). To tack; that is, to make progress to windward by a zigzag course with the wind first on one side of the boat and then on the other.

BEAUFORT SCALE. A wind scale invented by Admiral Sir Francis Beaufort in 1805 to help judge wind and sea strength. (See the beginning of Chapter 1 on page 4.)

BECALMED. When there is no wind and the sails hang limp.

BELAY (verb). To secure a rope on a cleat, pin, or other object. "He belayed the line on the cleat."

BELLY. The fullness or draft of a sail, controlled by adjusting tension on the edges. Also called camber. See DRAFT.

BEND (verb). To fasten one rope to another, or to fix a sail in position on its spars. "Bend on the sails."

BERMUDIAN or **MARCONI RIG.** A modern sail plan with a three-sided mainsail and jib set on a tall mast that was developed to a high state of efficiency by sailors in Bermuda. Because of the height of the mast and its complex support wires, it looked to sailors of the 1920s like the lofty antennas at a Marconi wireless station.

BERTH. A sleeping place in the cabin of a boat. It's also an area alongside a dock or in an anchorage that's occupied by a vessel.

BIGHT. A bend or loop in a line. Also a wide, curving bay along a coastline.

BILGE. The curve of a vessel's bottom where it merges into the sides. Also the low area inside a vessel beneath the cabin sole where water collects. "Pump the bilge."

BINNACLE. The stand on which the compass is mounted, usually placed just forward of the helmsman. In many boats, it is part of the steering wheel complex.

BITTER END. The innermost part of an anchor cable, which always must be secured to the ship.

BLADE. The flat outer part of an oar.

BLOCK. A device for changing the lead or direction of a line with minimum friction. In layman's terms, a pulley (but never mentioned on board).

BOARD. A single leg or tack when sailing close-hauled.

BOATHOOK. A pole with a hook in the end, used to grab a line.

BOBSTAY. A chain, wire, or rod underneath a bowsprit or boomkin that supports the spar against upward pull.

BOLTROPE. A rope sewn along or into the edge of a sail to strengthen it and take the strain off the cloth. If the cloth is gathered in slightly as it is sewn, it will increase the draft or curvature of the sail.

BOOM. A spar to which one edge of a sail is attached.

BOOMKIN. A short strut extending aft from the transom to support the mizzensheet blocks or the mizzen backstay of a ketch or yawl.

BOOTTOP. A painted band, often in a contrasting color to the topsides, that runs the full length of the hull just above and parallel with the waterline.

BOSUN'S CHAIR. A canvas, Dacron, or wooden seat in which a crewman is hoisted aloft to inspect or work on a mast or rigging.

BOW (rhymes with "how"). The forwardmost part of the hull.

BOWSPRIT. A horizontal or almost horizontal spar that projects forward from the bow and from which a headstay and jib are often set. The bowsprit may hold anchor fittings.

BREAKING WAVE. When a wave moves into shallow water, its length decreases rapidly while its height peaks up. The suddenly steepened wave becomes unstable, and the crest topples forward as the wave collapses. Also used to describe large waves that break and topple in deep water.

BREAST LINE. A mooring line that leads abeam from a boat to a pier or float. Compare with SPRING LINE.

BROACH (verb). To accidentally slew around in spite of the helmsman so that the wind is brought abeam when running before a heavy sea.

BULKHEAD. A transverse partition belowdeck that separates parts of a vessel and adds strength to the hull.

BULWARKS. Solid protection built up vertically around the edges of a deck to prevent people or gear from being washed overboard.

BUNK. A built-in bed or berth aboard a ship.

BUNKBOARD. A vertically mounted device (say 3½ feet long × 2 feet high) made of wood and secured to the edge of a berth to keep a sleeping crew member from falling out or being thrown out of a windward berth when the boat heels. See LEE CLOTH.

BURDENED VESSEL. A boat obliged by racing or right-of-way rules to avoid other boats that have the right of way. A boat on the port tack, for example, is burdened by a vessel on the starboard tack.

BY THE LEE. Running with the wind on the same side as the boom. It generally means that the boat is close to an accidental gybe.

CABLE. (1) One-tenth of a nautical mile or 200 yards. (2) A heavy line or chain.

CAN. A plastic or metal cylinder that serves as a navigation mark along a channel.

CANOE STERN. A type of hull design with a stern that has a pointed end that projects beyond the rudderstock.

CAPSTAN. A mechanical or hand-driven device with a vertical barrel that gives increased power when hauling on a line or chain.

CARVEL-PLANKED. Wooden hull construction in which the planking runs fore and aft and the planks are fitted against one another and usually caulked for watertightness.

CATAMARAN. A vessel with two separated hulls parallel to one another.

CATENARY. The curve or sag in the chain rode between the vessel and her anchor on the sea floor.

CAT RIG. A fore-and-aft rig with one mast right forward and a single sail.

CEILING. The inside planking of a vessel. Light wooden covering attached to the inside of the frames.

CENTERBOARD. A retractable flat plate of metal, wood, or fiberglass that pivots on an athwartships pin in a cavity in the boat's bottom or keel. When retracted, a centerboard reduces a yacht's draft. When lowered, the centerboard increases a boat's lateral resistance and improves her windward performance. See DAGGERBOARD.

CHAFE. To damage or destroy by rubbing.

CHAINPLATES. Sturdy metal straps (usually vertical) bolted along the sides, bow, and stern of a hull to which standing and running rigging are attached to support the mast or other gear.

CHARLEY NOBLE. The deck parts of a chimney coming from a galley stove or a cabin heater.

CHUTE. Slang for spinnaker. Derived from “parachute.”

CLAW OFF. To sail toward the wind and away from a lee shore.

CLEAT (noun). A device, usually with two horizontal horns, that is bolted to the deck or cockpit area to which a line under strain is secured. Note: Cleat is a noun, not a verb. “He belayed the line to the cleat” is correct. “She cleated the line around the new fitting” is wrong.

CLEW. The lower after corner of a fore-and-aft sail.

CLINKER or **CLINKER-BUILT.** A method of hull construction in which the edges of the horizontal planks overlap slightly and are fastened to one another with glue, screws, or bolts.

CLOSE-HAULED. Sailing as close to the wind as possible.

CLUB-FOOTED JIB. A jib with a boom.

COACHROOF. A part of the deck raised to give increased headroom below.

COAMING. A small bulwark around a cockpit or other deck structure to stop water.

COFFEE GRINDER. A large, powerful winch driven by two vertical handles that project from a pedestal. The winch drum is often some distance away and is driven by mechanical links underneath the deck.

COMPANIONWAY. Steps leading below from the deck.

COMPASS. A glass or plastic dome enclosing a card that indicates magnetic directions. The card floats in a liquid that dampens the card’s motion.

COMPASS ROSE. A compass card printed on a nautical chart that helps a sailor orient the chart to true north and magnetic north.

COURSE. The direction to sail.

CREST. The highest point of a wave.

CRINGLE. A rope eye formed on the outside of the boltrope of a sail and fitted with a metal thimble. Often used for reefing purposes.

CUTTER. A fore-and-aft-rigged vessel with one mast, a mainsail, and two headsails (staysail and jib).

DAGGERBOARD. A flat piece of metal, wood, or fiberglass that works like a centerboard. Rather than pivoting, however, it retracts vertically in a fore-and-aft slot. When pulled up, a daggerboard reduces a yacht’s draft. Lowered, it increases the boat’s lateral resistance and improves windward performance. Compare with **CENTERBOARD.**

DAVITS. A small framework with two arms reaching out over the side of a vessel used to hoist and hold a dinghy or small boat. Often mounted at the transom.

DEADLIGHT. A strong metal cover that can be clamped over the glass on the inside of a portlight to increase its strength.

DEAD RECKONING or **DR.** The calculation of a boat's present position by advancing the previous position for the course made good and distance run over the ground. A position is advanced by using speed, elapsed time, and course.

DEEPWATER WAVE. An offshore wave that appears to be moving water in a horizontal direction, but in fact most of the water molecules are moving round and round in a circular pattern with a diameter equal to the wave height. An object on the surface (block of wood, resting bird) returns to almost the same position after the passage of each wave.

DEPTH SOUNDER. An electronic device that tells the depth of the water.

DEVIATION. A shipboard compass error caused by the proximity of onboard iron (tools, engine, magnets, etc.). The amount of error depends on the direction the vessel is heading.

DISMASTED. To lose the mast or rig. "The headstay broke and the sloop was dismasted."

DISPLACEMENT. The weight of vessel. Sometimes called tonnage.

DOGHOUSE. A shelter forward of a cockpit. Often increased in height for headroom.

DOUBLE-ENDER. A Scandinavian-type boat with a pointed stern, usually with an outboard rudder.

DOUSE (verb). To lower a sail quickly.

DOWNHAUL. A line used for pulling down a sail.

DOWNWIND. Away from the direction the wind is blowing.

DRAFT. (1) The distance between the waterline and the lowest part of the keel or centerboard. Often spoken of as the amount of water that a boat draws. (2) The amount and position of fullness or curve in a sail.

DRIFT (verb). To be carried by wind and/or current.

DRIFTER. A large, featherweight jib used in light airs.

DROGUE. A device dragged from the stern to slow progress through the water and to keep a vessel from broaching.

EASE. To slacken.

EBB. The outgoing tide; opposite of FLOOD.

EDDY. A circular current or a stream running in the opposite direction to the main tidal stream.

END FOR END. To reverse a line or halyard to equalize wear.

EPIRB. An emergency position-indicating radio beacon that transmits a signal via satellite to a ground station. Used for distress signaling.

FAIRLEAD. A fitting through which a line is passed to alter the direction of its lead or to keep it clear of other gear.

FAIRWAY. The middle of a channel, usually between landmasses and often marked with buoys.

FAKE DOWN or **FLAKE DOWN.** To prepare a line for running without kinks or twists by having a crewmember hand for hand the line along its length to remove twists and snarls. The inboard end is called the bitter end, which is generally fastened to a strong point. The line is then half-coiled or arranged on deck with each loop (fake or flake) just overlapping the one under it so the line can run out quickly.

FALL. The hauling part of a line.

FATHOM. Six feet.

FETCH. (1) (verb) To reach a desired point of land or buoy. (2) (noun) A contributing factor of wave height; specifically, the straight-line distance the wind has blown over the surface, generally from a windward shore to the vessel. "A fetch of 10 miles."

FLOOD. The incoming, rising, upstream tide. Opposite of **EBB**.

FLOORS (hull construction). Athwartship strengthening pieces that connect the frames or ribs on the starboard side of the vessel to the frames or ribs on the port side. In yachts, the cabin sole usually rests on the floors.

FLUKE. The pointed part of an anchor that digs into the ground.

FLYING (verb). A triangular sail is set flying when its luff is not fastened to a stay but is held by the tack (at the forward lower corner), the head (at the top), and the clew (the back bottom corner).

FOOT. The lower edge of a sail.

FORE-AND-AFT. In-line with the keel.

FOREFOOT. The most forward part of the underbody of a hull.

FOREREACH. To make headway when hove-to. Often done with the mainsail alone.

FORESAIL. The fore-and-aft sail set on the aft side of a schooner's foremast.

FREE. Not close-hauled. "The yacht was running free."

FREEBOARD. Height of the topsides of a hull.

FREQUENCY. The number of complete cycles of a periodic process occurring in a certain unit of time.

FULL AND BY. Sailing close-hauled with all sails full.

FULLY DEVELOPED SEA. A sea or lake condition in which wind of a certain strength blowing across an unobstructed stretch of water (the **FETCH**) reaches a state of equilibrium in which the waves become more rounded and harmonious and neither increase nor decrease in size.

FURL. To fold a sail side to side along a spar and to secure it with ties. A harbor furl is particularly neat, with the folds even and wrinkle-free, and is considered a good sign of seamanship.

GAFF. The upper spar to which a quadrilateral mainsail, foresail, or mizzen is bent.

GAFF JAWS. The fitting at the inboard end of a gaff to secure the spar to the mast. Gaff jaws are often covered with leather to facilitate movement and reduce wear on the mast.

GALE. A Force 8 storm on the Beaufort scale, which means winds of 34 to 40 knots and moderately high waves that exhibit streaks of foam and whose edges are beginning to break into spindrift.

GALE WARNING. A formal warning that a gale-force wind is about to enter a specified region.

GALLEY. A seagoing kitchen.

GALLOWS. A permanent framework that supports the main or foresail boom when the sail is lowered.

GALVANIZE. To coat iron or steel with zinc to protect it from corrosion. Usually done by hot dipping after the metal has been cleaned. Electro-galvanizing is not as good.

GARBOARD or **GARBOARDS.** The fore-and-aft plank next to the keel in a carvel-built wooden boat.

GENOA. A large jib that overlaps the mainsail.

GIMBALS. Mounting arrangements that use gravity to permit a weighted table, stove, berth, or compass to pivot so their tops remain horizontal when the boat heels.

GIPIY or **GYPSY.** The horizontal drum of a winch around which line or chain is turned to heave in the anchor. Sometimes called a wildcat.

GOOSENECK. The universal joint that holds the forward part of the mainsail boom to a mast.

GRAPNEL. A small anchor with four or more arms designed to hook strong points on the sea floor.

GREAT-CIRCLE ROUTE. A sailing route calculated to follow the curvature of the earth. It saves distance on long passages, but requires the course to be changed from time to time. A piece of string pulled tight between two points on a globe makes a great-circle route. Generally used on passages over 200 miles. Compare with **RHUMB LINE**.

GREEN WATER. Solid water shipped aboard.

GROMMET. A metal ring punched or sewn into a sail or canvas work, often at the corners.

GUNWALE. Pronounced "GUN'l." The rail of a boat where the deck meets the topsides.

GUY. (1) A steadying line attached to one end of a spar to hold it in a desired position. (2) A controlling line attached to the weather clew of a spinnaker.

GYBE (noun or verb). Gybing and tacking are the two basic maneuvers of sailing. If a vessel is running before the wind, and the helmsman turns the boat so that the wind blowing against a sail is changed from one side of the sail to the other, he is said to have gybed or completed a gybe. It usually means changing the wind from one quarter (across the stern) to the other. If the sail is on a boom, this heavy spar sometimes swings across violently. (Sometimes written as “jibe.”) See ACCIDENTAL GYBE.

HALYARD. A line used for hoisting a sail or flag. Generally it’s vertical and reeved through a block mounted on the mast.

HAND. (1) (verb) To lower a sail or spar. (2) (noun) A crew member.

HANDY BILLY. A tackle used to give extra pulling power on a line.

HANK. (1) (noun) A clip, usually of bronze, used to hold the luff of a sail to a stay. (2) (verb) To install a sail with a hanked luff on a stay. “He hanked the staysail to the forestay.”

HARD or **ON THE HARD** (noun). The paved area of a boatyard where small vessels are hauled ashore and blocked up for storage. “The blue yawl was on the hard for the winter.”

HARDEN or **HARDEN UP** (verb). To trim a sail almost flat for windward work.

HARD UP or **HARD DOWN** (verb). Putting the tiller as far as possible to windward or to leeward, respectively.

HEAD. (1) (noun) Toilet room on a vessel. (2) (noun) The upper corner of a triangular sail. (3) (verb) To aim a boat in a direction. “Head into the wind.”

HEADBOARD. A special piece of wood or aluminum at the head of a mainsail or mizzen to assist with hauling the sail aloft. It often has extra mast slides for strength.

HEADROOM. The height measurement inside a cabin.

HEADSAIL. A triangular sail that is set in front of the mainmast or the forwardmost mast.

HEADWAY. A boat’s forward motion.

HEAVE-TO. To trim shortened sails and the helm so that the vessel almost stops when facing strong winds.

HEEL. To lay over or list.

HELM. The steering position. “Susan, take the helm.”

HOIST. (1) (verb) To raise a sail. (2) (noun) The length of a sail’s luff.

HULL. The body of a vessel exclusive of her masts and gear.

HURRICANE. A Force 12 storm on the Beaufort scale. Tumultuous seas and winds of 64 knots or more. The air is filled with foam and the sea is totally white with driving

spray. Although hurricanes are widely believed to affect thousands of square miles, many of these storms have relatively small diameters. In the western Pacific and Indian Ocean such storms are called typhoons.

HURRICANE WARNING. An announcement—generally given on radio or television—that a Force 12 storm is about to appear. The visual warning is two red flags, each of which has a large black square in the middle.

IN IRONS. Headed directly into the wind with no headway and the sails fluttering so the boat cannot bear off on either tack. If the vessel begins to drift backward, she is said to be making a STERNBOARD.

JIB. The foremost headsail.

JIBE. My preferred spelling is GYBE, which is easier to pronounce, less confusing—particularly to beginners—and doesn't get confused with JIB.

JUMPER STRUT. A way to reinforce the upper part of a Bermudian mast by adding a metal or wooden strut placed at 90 degrees to the mast on the forward side and adding bracing wires above and below the strut.

JURY RIG. A makeshift or substitute rig.

KEDGE. A light general-purpose anchor that can be carried out in a dinghy and used to haul a vessel off when she has gone aground.

KELLET. A weight, usually of lead, lowered along an anchor line to increase the holding power of an anchor. A kellet can also be used to lower the height of a cable in a shallow anchorage when propellers are a hazard.

KETCH. A two-masted fore-and-aft-rigged boat whose smaller mizzenmast is stepped forward of the rudderpost.

LANYARD. A small line used to secure an object.

LEAD (rhymes with "said") **LINE.** A light line, weighted at one end and marked in feet, fathoms, or meters, that is used to determine the depth of water.

LEECH. The aftermost part of a triangular sail.

LEECH LINE. A light adjustable line sewn into the tabling along a sail's leech to control flutter and shaking.

LEE CLOTH. A rectangle of canvas (say 3½ feet long × 2 feet high) hung vertically along the inside edge of a windward fore-and-aft berth to keep the occupant from falling or being thrown out when the boat heels to leeward.

LEE HELM. The tendency of a vessel to turn her bow away from the wind. Considered to be dangerous. Compare with WEATHER HELM.

LEE SHORE. A sailor's worst peril is land toward which the wind is blowing.

LEEWARD. Pronounced "LEW-ard." Away from the wind. Compare with **WINDWARD**, which means toward the wind.

LEEWAY. The amount that a boat is pushed to leeward while she is sailing because of the force of the wind.

LIFELINES. Strong wires that are strung from the bow pulpit through stanchions mounted along the deck to the stern pulpit. The wires make a safety fence for the crew working on deck.

LIMBER HOLES (hull). Fore-and-aft holes drilled through the floors connecting the frames (beneath the cabin sole) to permit water to drain to the deepest part of the bilge where it can be pumped out.

LOA. Length overall. The on-deck length of a boat from the stem to the transom.

LOOM. The part of an oar that is in the boat when rowing. Said by some to be the part from the blade to the handle or grip.

LP. A measurement on a sail. The LP refers to a line at right angles to the luff that runs through the clew and is used in headsail measurements.

LUFF. (1) (noun) The forward part of a fore-and-aft sail. (2) (verb) To alter course toward the wind (or to head up). This slows or stops the drive of the sails and makes them flap.

MAINSAIL. The principal sail on the mainmast.

MAKE FAST. To secure or belay a line.

MARCONI or **BERMUDIAN RIG.** A modern sail plan with a three-sided mainsail and jib set on a tall mast that was developed to a high state of efficiency by sailors in Bermuda. Because of the height of the mast and its complex support wires, it looked to sailors of the 1920s like the lofty antennas at a wireless, or Marconi, station.

MAST. A vertical spar to support rigging, yards, and sails.

MAST STEP. A frame or slot to secure the lower end of the mast, often on the keel.

MEATHOOK (slang). A broken (and often unseen) strand of rigging wire that sticks out and can rip a sail or a finger.

MERCATOR CHART. A system of chart drawing based on the earth's globe. The meridians and parallels of latitude appear as lines crossing at right angles. The converging meridians of the sphere have been spread to parallel lines on the chart; the parallels of latitude are still parallel, but instead of being equidistant, the distance between them increases poleward while keeping proportional with the spreading of the meridians. Thus islands near the equator are shown normal size, but toward the poles, landmasses are increasingly enlarged. This is of no practical importance until you reach latitudes of 60° or higher. With a few exceptions, all charts in use are Mercator projections. A straight-line course on such a chart is called a **RHUMB LINE**. It's important to

remember that all distances measured on a Mercator chart must *always be taken on the latitude scale* (along the sides). If you measure distances on the top or bottom along the longitude scales, your navigation will have serious errors.

MIZZENMAST OR MIZZENSAIL. The aftermost mast or sail on a ketch or yawl.

MONKEY'S FIST. A large knot, usually with an enclosed weight, at the end of a heaving line.

MONOHULL. A boat with one hull.

MOOR. (1) To tie up or make a vessel fast alongside a pier or between two posts or buoys. (2) To anchor with one anchor ahead and one behind so that the boat lies between the anchors.

MULTIHULL. A boat with two (catamaran) or three (trimaran) hulls.

NAVEL PIPE (with an "e"). The fitting on the foredeck through which the anchor chain or cable passes.

NEAP TIDES. Tides that occur at the quarter moon. They have less range at this time of the month, the high water being lower and the low water higher than average. Compare with **SPRING TIDES**.

NEAR GALE. A Force 7 storm on the Beaufort wind scale. Winds of 28 to 33 knots.

NIP. A sharp bend in a rope where it passes over a sheave or through a fairlead. "It's a good plan to change the nip frequently to avoid chafe."

NUN. A plastic or metal cone-shaped buoy.

NYLON. A synthetic fiber used in making strong, stretchy line and tough, lightweight cloth. Sailors favor nylon lines for many anchoring situations, and use nylon cloth for spinnakers and lightweight sails.

OARLOCK. A crutch or holder into which an oar is shipped when rowing. Also called rowlocks or rollicks.

OCEAN CURRENT. Consistent movement of water in the open sea not produced or affected by tidal influence.

OFFING. Position at a distance from the shore. "The ship had an offing of 25 miles."

OFF SOUNDINGS. Beyond the 100-fathom depth mark.

OFF THE WIND. Downwind, on a broad reach or run.

ON SOUNDINGS. Inshore of the 100-fathom depth mark.

ON THE WIND. Sailing close-hauled.

OUTHHAUL. A line that adjusts the position of the clew and foot tension on a boomed sail.

OVERHANG (hull). The amount a vessel extends beyond the waterline at the bow and stern.

PAD EYE. A small metal oval or diamond-shaped plate bolted to the deck or elsewhere that has a vertical eye to take a block or fitting.

PAINTER. A short towing or docking line secured to a dinghy's bow.

PARTNERS. The opening in the deck through which the mast passes.

PAY OUT. To ease chain or line.

PELICAN HOOK. A hinged hook with a retaining link often used on lifelines.

PENDANT. Any short control line, such as a reefing pendant that hangs from the reef cringle on the leech of a mainsail. Also used to describe a short length of wire attached to the head of a small jib to adjust the halyard length. The word is frequently confused with PENNANT, which is a flag, not a control line.

PENNANT. A decorative, signal, or identifying flag, frequently triangular in shape. Do not confuse this word with PENDANT.

PERIOD. The time in seconds it takes for a wave crest to travel one wavelength.

PINCH (verb). To sail too close to the wind so that the sails luff and the speed of the boat drops.

PITCHPOLE. A storm accident that causes a boat to pitch into a violent forward somersault when her stern is lifted by an enormous following wave.

POINT. To sail close-hauled. Good pointing ability means a boat that sails well to windward.

POOPED. Describes a vessel over whose stern a large wave has broken and has filled the cockpit.

PORT. The left-hand side of a vessel when looking forward,

PORTLIGHT or **PORTHOLE.** A small pane of glass or plastic, sometimes arranged to open, that is set in a strong frame and mounted along the sides of the cabin or topsides to allow light below. The preferred term is "portlight."

PREVENTER (noun). A control line fastened to the end of a movable boom that pivots in a horizontal direction. Often used to describe the line rigged between the end of the mainsail (or foresail or mizzen) boom and the stem. This line "prevents" an accidental gybe when running downwind, and the after end of the mainsail boom is eased and well outside the hull.

PULPIT. A high metal guardrail made of heavy tubing or pipe and mounted at the bow or stern. Lifelines run between the bow and stern pulpits via stanchions that are spaced along the edges of the deck.

PURCHASE or **TACKLE** (both nouns). An arrangement of a line and two or more blocks to increase pulling power. "He clapped a four-part purchase (or tackle) between the halyard and the deck to tension the line." Note: In marine usage, tackle is pronounced "TAY-cul."

QUARTER. The areas on either side of a vessel between amidships and the transom. Usually described as the port quarter or starboard quarter.

RACE. A rapid and upset movement of water because of tide rips from conflicting tidal streams. A constricted tidal flow.

RACKING SEIZING. A seizing made with figure-of-eight turns to prevent lines or knots from slipping.

RAKE. The angle a mast, transom, or bow makes with the perpendicular.

RANGE (nouns). (1) A beacon or other marker that, when lined up with a second marker, indicates a channel. (2) The difference in level between the high and low water of a tide.

RASTER CHART. A direct copy or scan of an existing paper chart that looks identical to the original. When you zoom in and out of a raster chart, everything grows larger or smaller, but the amount of detail remains the same. See VECTOR CHART.

REACH (noun). A course sailed across the wind. If the wind is at 90 degrees to the long dimension of the hull, the boat is sailing a beam reach. If the wind is forward of 90 degrees, the boat is on a close reach. If sailing with the wind aft of 90 degrees, it's a broad reach.

REACHING (verb). Sailing with the wind coming from the side.

READY ABOUT. An order to prepare for a tack. It is followed by the command "helm's alee" or "hard alee."

REEF. To reduce sail area.

REEFING HANDLE. A removable hand crank fitted to a geared mechanism at the forward end of the main boom. When you turn the crank, it rolls up the mainsail for reefing, something like a window shade.

REEVE. To pass a line through a hole, ring, sheave, or block. "He climbed the mast to reeve a new main halyard."

RHUMB LINE. A straight-line compass course between two points on commonly used Mercator charts. Rhumb-line courses are generally used for trips of 200 miles or less. Compare with GREAT-CIRCLE ROUTE.

RIG. A vessel's mast(s), rigging, and sails.

ROACH. A convex curve along the edges of a sail, sometimes supported with battens.

RODE. Anchor line. The word "cable" is sometimes used, but it generally suggests chain.

ROGUE WAVE. A catch-all, nonscientific term for a very large, unexpected wave that occurs on a seemingly random basis out on the ocean.

ROLLER FURLING. A vertically angled scheme that rolls the luff of a sail around a wire or rod to diminish the size of the sail. If the rolling is continued, the sail is completed rolled up or furled.

ROLLER REEFING. Reefing the mainsail whose foot is fastened to the main boom, which has a special mechanism to revolve the boom.

ROUND UP. To bring a vessel's head to wind.

ROWLOCK or **OARLOCK.** A small crutch or holder into which an oar is shipped when rowing.

RUN or **RUNNING.** To sail before the wind.

RUNNING BACKSTAY. A movable wire or line that supports a mast from aft against the force of the sails. Often used to support the forward pull of a staysail.

RUNNING BY THE LEE. Running with the wind on the same quarter as the boom. Not a good practice. See **ACCIDENTAL GYBE.**

RUNNING RIGGING. Halyards, sheets, lifts, and other adjustable lines and wires that are used to hoist and control sails and spars. Compare with **STANDING RIGGING.**

SCANTLINGS. The dimensions of the frames, planks, plating, fiberglass layup, etc., that are used in the construction of a vessel.

SCHOONER. A fore-and-aft-rigged vessel, usually with two masts, in which the mainmast (positioned aft) is taller than the foremast (stepped forward).

SCOPE. The length of chain or line of a vessel at anchor.

SCULL. To propel a dinghy or small boat by working a single oar from side to side over the stern while the angle of the blade is changed with each stroke.

SCUPPERS. Overboard drains on deck or in the cockpit.

SEA ANCHOR. Anything (lumber, oars, a mast, a parachute) tied to a long line at the bow and tossed overboard to hold the bow of a vessel into the wind.

SEACOCK. A valve, usually hand operated, that opens and closes a pipe or through-hull that drains the galley sink, the cockpit, etc. When a seacock is closed, unwanted water cannot enter the boat.

SEA STATE. A numerical rating (1 to 9 on the Pierson-Moskowitz scale) that refers to the height, period, and character of waves on the surface of a large body of water.

SEIZING. The secure binding together of two lines or two parts of the same line.

SELF-BAILING. A boat cockpit with drains or scuppers that empties itself of unwanted water because it's above the waterline.

SERVE (verb). A process that protects line from chafe or the elements by spirally binding it across the short dimension with marline or light cord.

SET. (1) (verb) To raise a sail. (2) (verb) To cause an anchor to dig into the holding ground. (3) (noun) The carrying of a boat by current or a tidal stream.

SHACKLE. A U- or D-shaped metal fitting with an eye in each arm through which a pin is screwed or driven.

SHAKE OUT. To let out a reef.

SHALLOW-WATER WAVE. When waves enter shallow water, they are said “to feel the bottom” and become taller and slow down, eventually breaking on shore.

SHEAVE. Pronounced “shiv.” The grooved roller over which a line passes when it goes through a block.

SHEER. The curve of the gunwale when viewed from abeam in profile. A straight sheer has no curve between stern and bow; a normal sheer is concave; a reverse sheer is convex. A broken sheer reflects poor design or marginal construction. A hogged sheer suggests that the hull is collapsing from age. Sailors and boat aficionados generally favor a normal, or concave, sheer and spend much time discussing this aspect of boat design.

SHEET. A line attached to the clew of a sail to control its trim or setting.

SHROUD. A wire or rod giving athwartship support to a mast, bowsprit, or bumpkin.

SIGNIFICANT WAVE HEIGHT. The average height of the highest one-third of the waves (trough to crest). This figure is used by scientists, but doesn't identify larger waves that can cause great damage. The maximum wave height can be up to two times (or more) of the significant wave height.

SKEG. A special appendage built into the hull below the water to which the front of a ship's rudder is attached. A skeg protects the rudder and increases its security with added hinge points.

SLAB REEF. A tied reef in a mainsail to reduce the area by a given amount. A “slab” of the foot is taken out by lines at the luff and leech.

SLACK WATER. Period between flood and ebb tide when the tidal stream stops.

SLICK (nouns). (1) A settled patch of water to windward caused by the hull of a vessel drifting sideways before strong winds. Sometimes called a SMOOTH. (2) An extremely large chisel used in boatbuilding.

SLOOP. A fore-and-aft-rigged sailing boat with a mainsail and one headsail.

SMALL-CRAFT ADVISORY. A forecasting term given over the radio or television warning that approaching weather will be dangerous for small vessels near shore.

SMOOTH (noun). A settled patch of water to windward of the hull of a vessel drifting sideways or near sideways before strong winds. Also called a SLICK.

SNAPSHACKLE. An easily operated shackle with a hinged closure bar held with a spring-loaded pin instead of a threaded bolt-type closure.

SNATCH BLOCK. A block with an opening in one side of the shell so that a long line can be inserted without having to thread it through the block.

SNUB. To put sudden tension on a line or anchor cable.

SNUGGED DOWN. Well reefed; under a small or comfortable area of sail for the existing wind and point of sail.

SOLE or **CABIN SOLE.** The floor of a cabin or cockpit.

SOUND (verb). To measure the depth of water with a marked stick or weighted line.

SOUNDINGS or **IN SOUNDINGS** or **ON SOUNDINGS** (nouns). A measurement of water depth as marked on charts. Generally 100 fathoms or less.

SPINNAKER. A large lightweight nylon sail set forward of the mast on downwind legs and reaches.

SPINNAKER SOCK. A long collapsible tube of light cloth used to control a spinnaker when setting or furling the sail.

SPLICE. A method of joining ropes by interlacing the strands from each side.

SPREADER or **SPREADERS** (mast rigging). Wood or metal struts that hold wire shrouds at a carefully designed distance from the mast so that adequate angles (generally 9 to 12 degrees) can be maintained at the masthead for athwartship mast staying.

SPRING LINE. A docking line that runs at an acute angle from the pier to the boat to help stop fore-and-aft surging. Generally boats need forward springs and after springs together with the usual bow and stern docklines. Four lines in all.

SPRING TIDES. Water movements at the time of the full and the new moon. The tides have greater ranges; the high water is higher and the low water is lower than the average.

SPRITSAIL. A quadrilateral sail whose peak is held aloft by a long slim pole or sprit that goes from tack to peak. This one-sail rig is often used on dinghies and small boats.

STANCHIONS. Vertically mounted stainless steel or aluminum rods or pipes mounted along the deck to support lifelines. Together with lifelines and pulpits, they make a fence to help keep the crew from falling overboard.

STANDING PART. The part of a line that is made fast and not hauled upon.

STANDING RIGGING. Shrouds and stays that support the mast and spars and are not handled during the sailing of the vessel. Compare with **RUNNING RIGGING**.

STARBOARD. The right-hand side of a vessel when looking forward.

STARBOARD TACK. A vessel is on the starboard tack when close-hauled with the wind blowing over her starboard bow.

STAY. A length of wire or rod giving fore-and-aft support to a mast. Hence: headstay, forestay, backstay.

STAYSAIL. A fore-and-aft working sail set forward of a mast and hanked to a forestay.

STEEPNESS. The measure of a wave's height to its length ($H \div L$). A wave whose crest angle is less than 120 degrees or one-seventh will break.

STEERAGEWAY. Enough speed to make the steering function.

STEM. The forward part of the bow.

STERN. The aftermost end of a hull.

STERNBOARD. Going backward. "The boat is caught in irons and is making a sternboard." Note: A vessel can be steered backward by pointing the back edge of the rudder in the direction you want to go.

STIFF. A vessel is stiff when she does not heel easily. The opposite of TENDER.

STOPPER KNOT. A knot at the end of a line to stop it going through a block. With braided line a stopper knot is often a figure-eight knot.

STORM. Force 10 on the Beaufort scale. Winds of 48 to 55 knots.

STRONG GALE. Force 9 on the Beaufort scale. Winds of 41 to 47 knots.

STUD-LINK CHAIN. Chain in which each link has a crossbar to prevent the sides pulling together and collapsing under great strain.

STUFFING BOX. A special fitting around the propeller shaft on the inside of the hull to prevent the entrance of water.

SWELL. Long, usually low waves caused by a distant storm.

TABLING. Cloth reinforcement along the edge of a sail.

TACK. (1) (noun or verb) Tacking and gybing are the two basic maneuvers of sailing. When a sailing vessel with forward motion tacks, she turns into the wind and a little beyond. This causes the wind to go from pressing on one side of the sails to the other. After a successful tack, the boat moves ahead on a new course that is 90 to 115 degrees from the old course. The result is a zigzag course to windward. (2) (noun) The lower forward corner of a fore-and-aft sail.

TACKLE or **PURCHASE** (both nouns). An arrangement of a line and two or more blocks to increase pulling power. Pronounced "TAY-cul." "He clapped the tackle between the halyard and the deck to tighten the line."

TAFFRAIL. The rail along the deck that runs across or around the stern.

TAIL (verb). To haul on a line around a winch or capstan that is turned by another crew member.

TANG. A metal strap fastened to a strong point to which standing or running rigging is attached.

TELLTALE. A short length of yarn or ribbon tied to a stay to indicate wind direction.

TENDER. (1) A vessel that heels easily. (2) A yacht's dinghy or small boat.

THIMBLE (rigging). A round or heart-shaped metal eye with a concave outer surface into which metal cable or fiber line fits smoothly to reduce chafe and point loading.

THOLEPINS. Short hardwood wooden dowels (say $5/8$ -inch or 15 mm diameter) fitted vertically along a small boat's midship gunwale area. Oars are then tied to the tholepins when rowing.

THROUGH-HULLS. Plumbing pipes that pierce the hull below the waterline for various drains and inlets. Each through-hull should have a seacock just inside the hull in case of a plumbing failure inside the boat. Through-hull functions are often combined to minimize their number and upkeep.

TIDAL STREAM (noun). The horizontal movement of water caused by changing tides. The times of tides and tidal streams are usually different and are found by consulting tide tables, tidal atlases, and special marks on charts. Since a current is a flow of water that continues for a long period, it is incorrect to speak of tidal currents. The proper term is tidal stream, which refers to a short-term horizontal water movement of, say, 6 hours.

TIDE or **TIDES.** The periodic vertical rise and fall in the surface level of oceans and lakes caused by the gravitational forces of the sun and moon.

TILLER. A wooden or metal bar used by the helmsman to move the rudder.

TOE RAIL. A low wooden or aluminum rail built along the edge of a deck to provide footing when the boat is heeled. Often this rail has a series of holes into which blocks can be shackled for use with running rigging.

TOPPING LIFT. An adjustable line that holds up the end of a boom or pole.

TOPSIDE or **TOPSIDES.** (1) (noun) The side of the hull above the waterline. (2) (verb) A word used to describe the movement of a person from below-deck accommodations to the outside deck. "The two women went topsides."

TRANSDUCER. A device that converts a physical property into an electrical property. Three examples are a sound transducer for depth, a wheel for speed, and a vane for wind direction.

TRANSOM. The athwartship surface at the farthest aft point of a vessel.

TRANSVERSE. Across, athwartships, at right angles to fore-and-aft.

TRAVELER. A track or bar with a sliding adjustment that permits athwartship control of running rigging.

TRIM (verb). To take in. "He trimmed the sheet on the winch." The commands to the winch grinder are usually "trim" (to take in) and "ease" (to let out).

TRIMARAN. A vessel with three parallel hulls held at fixed distances from one another by strong crosspieces.

TROUGH. The lowest point of a wave.

TRUE WIND. The direction and strength of wind felt on a vessel that is not moving. APPARENT WIND is the wind felt on a moving object.

TRYSAIL. A small storm sail set in place of the mainsail in heavy weather.

TURNBUCKLE. A tension-adjusting device made of threaded rods that screw into a threaded barrel. Used to tension running rigging.

UNDERWAY. Moving under power or sail.

UPWIND. The direction from which the wind is blowing.

VANG (nouns). (1) A line led to the deck from the end of a gaff boom or sprit to control the spar. (2) One or more tackles used to keep a boom from lifting on downwind or reaching legs. Sometimes called a kicking strap.

VARIATION. The difference between true and magnetic north in a given area. Every nautical chart shows the variation for the region covered by the chart. Compass courses need to be corrected for both variation and deviation.

VECTOR CHART. Also known as an electronic nautical chart (ENC), a vector chart looks computer generated and is made up of a series of points and lines. Details can be switched on and off electronically, and objects can be clicked on to learn more details. When zooming in or out on a vector chart, only the geographic features grow larger or smaller. Any text remains the same. Vector charts lack most topographic features. Compare with RASTER CHART.

VEER or **VEERING.** A term used to describe the movement of wind, which is said to veer (say from west to northwest) when it moves clockwise in the Northern Hemisphere. In the Southern Hemisphere, this term is reversed and refers to a counterclockwise movement (say from west to southwest). Veering has also been defined as moving in a direction that follows the track of the sun. Compare with BACKING.

VELOCITY. Rapidity or speed of motion. A vector quantity whose magnitude is the body's speed and whose direction is the body's direction of motion.

VIOLENT STORM. Force 11 on the Beaufort scale. Winds of 56 to 63 knots.

WAKE. The water turbulence that follows a moving vessel.

WARP. An anchor or mooring line.

WASHBOARDS. Two or three strong boards placed horizontally in fitted vertical slots on either side of the companionway to close the entrance to the cabin of a sailing yacht.

WAVE HEIGHT. The vertical distance between the crest and the trough.

WAVELENGTH. The horizontal distance between two adjacent wave crests. Crest to crest.

WAVE PERIOD. The time in seconds between the arrival of consecutive crests passing a stationary point.

WAY. The movement of a vessel through the water.

WEAR (verb). The act of turning a boat to the other tack by maneuvering her away from the wind and gybing instead of tacking. In this maneuver, the stern of the vessel is taken through the eye of the wind. Wearing is sometimes done when it is impossible to tack a boat because of head seas and poor forward speed.

WEATHER HELM. The basic design of a sailing vessel that causes her to head into the wind when the tiller or wheel is released. Considered a safety measure.

WEATHER SHORE. A shore to windward of a vessel that offers shelter.

WEIGH (verb). To raise an anchor. "The two sailors weighed the 100-pound anchor." One does not "way" an anchor.

WHIP. (1) (noun) A single block with a line rove through it that gives a 2:1 purchase. (2) (verb) To secure the loose strands or yarns at the end of a line by tightly wrapping turns of heavy thread or light cord at right angles to the line. Often called a whipping (noun). "I want you to whip both ends of this line."

WHISKER POLE. A small-diameter spar attached between the mast and the clew of a jib to hold the sail out against a following wind when running wing and wing. A smaller version of a spinnaker pole.

WINCH. A mechanical device for tensioning lines. Two or three turns of the line to be tightened are taken around a drum that is turned by gears driven by a handle or an electric or hydraulic motor.

WINDLASS. A powerful winch, usually placed at the bow for hauling chain, line, and anchors on board. A windlass has a horizontal drum; a CAPSTAN has a vertical drum.

WINDWARD. Toward the wind.

WING AND WING. Sailing on a run with the eased mainsail on one side of the boat and the jib on the other, the clew of the jib stretched before the wind with a spinnaker or whisker pole. The mainsail boom is held down and in place with a boom vang or tackle.

WISHBONE or **WISHBONE RIG.** A fore-and-aft boom structure used behind a mast. It has two opposing curved arms shaped like a wishbone (or banana) between

which a sail is hoisted. The clew of the sail is tensioned by an adjustable line (the out-haul) taken to the after end of the wishbone.

WORKING SAILS. Sails that are easy to set and use in ordinary weather.

YAWING. A vessel whose bow swings from side to side, usually when running, is said to yaw.

YAWL. A two-masted fore-and-aft-rigged sailing vessel whose aftermost (mizzen) mast is located behind or abaft the rudderpost. The mizzen is usually a small sail. In light weather the aft mast can be used to set a mizzen staysail.

References and Notes

Chapter 2

1. Willard Bascom, *Waves and Beaches* (Garden City, New York: Doubleday, 1964), p. 26.
2. K. Adlard Coles, *Sailing Years* (Clinton Corners, New York: John de Graff, 1981), p. 157.
3. Bascom, *Waves and Beaches*, p. 55.
4. An excellent short paper on wave behavior is “Expecting the Unexpected Wave: How the National Weather Service Marine Forecasts Compare to Observed Seas” in *Mariners Weather Log* 49, no. 2 (NOAA, August 2005), by Robbie Berg and Jamie Rhome. See www.vos.noaa.gov/MWL/aug_05/nws.shtml.
5. William G. Van Dorn, *Oceanography and Seamanship* (New York: Dodd, Mead, 1974), Section VII.

Chapter 3

6. For *Banjo*, see Chapter 6, pages 59–61 of this book. For a full account of the *Winston Churchill*, see Rob Mundle, *Fatal Storm* (Camden, Maine: International Marine, 1999) and G. Bruce Knecht, *The Proving Ground* (Boston: Little, Brown, 2001). Knecht’s book is excellent.
7. This 2-minute video clip is available from Ace Sailmakers (www.acesails.com).
8. The *Ramapo* account has been widely reprinted. Enter “Ramapo giant wave” on Google or another search engine.
9. For these astonishing numbers, see Paul C. Lin, “A chronology of freaque wave encounters” *Geofizika* 24, no. 1 (2007) and recent issues of Lloyd’s List that deal with accidents, sinkings, and disappearances.
10. William J. Broad, “Rogue Giants at Sea,” *New York Times*, July 11, 2006.
11. “Freak Wave” transcript on BBC Two, November 14, 2002.
12. The graph of the New Year’s Day Wave has been reprinted in a dozen articles. Dr. Kristian B. Dysthe, University of Bergen, Norway, has written many original papers on waves and their behavior. Typical is “Freak waves, rogue waves, extreme waves and ocean wave climate.” See www.math.uio.no/~karstent/waves/index_en.html.
13. Wolfgang Rosenthal, “Rogue Waves” (undated), GKSS Forschungszentrum GmbH, Geesthacht, Germany. See www.soest.hawaii.edu/PubServices/2005pdfs/Rosenthal.pdf.
14. Broad, *NYT*, July 11, 2006.
15. Peter Britton, “Nightmare Waves Are Too Real to Deepwater Sailors,” *Smithsonian* (February 1978), pp. 65–66. See also note 9.
16. Joshua Slocum, *Sailing Alone Around the World* (New York: Westvaco Corp., 1969), pp. 88–89.

17. Alain Gerbault, *Flight of the Firecrest* (London: Hodder and Stoughton, 1926), pp. 148–50.
18. James Tazelaar and Jean Bussiere, *To Challenge a Distant Sea* (Chicago: Henry Regnery, 1977), pp. 189–90.
19. Bascom, *Waves and Beaches*, p. 65.

Chapter 6

20. K. Adlard Coles, *Sailing Years*, p. 146.
21. Miles Smeeton, *The Sea Was Our Village* (Lymington, Hampshire, England: Nautical Publishing, 1973), pp. 93–94.
22. E-mail from Professor Nick Newman dated July 26, 2006.
23. William V. Kielhorn, “Sea Anchors,” *SAIL* (May 1976). Also see “Letters to the Editor” in the September 1975 issue of *SAIL*.
24. *Telltale Compass* (June 1976). A nautical newsletter (no longer in print) published by Victor Jorgenson of Lake Oswego, Oregon.

Chapter 7

25. Ernle Bradford, *Paul The Traveller* (New York: Macmillan, 1974). A remarkable study of St. Paul by an historian with a long seafaring background.
26. Victor Shane, *Drag Device Data Base* (Summerland, California: Para-Anchors International, 1998), pp. 2.2–2.3.

Chapter 8

27. John Claus Voss, *The Venturesome Voyages of Captain Voss* (London: Rupert Hart-Davis, 1955). Also see “Tilikum” by Nicol Warn in *WoodenBoat* 121 (Nov./Dec. 1994). This splendid article and illustrations should satisfy the most ardent Voss fan.
28. W. A. Robinson, *To The Great Southern Sea* (London: Peter Davies, 1957), p. 177.
29. Eric Hiscock, *Voyaging Under Sail* (London; New York: Oxford University Press, 1970), p. 177.
30. Earl R. Hinz, *Heavy Weather Tactics Using Sea Anchors & Drogues* (Arcata, California: Paradise Cay, 2000), pp. 67–69.
31. Maurice Griffiths, *Yachting Monthly* (May 1967), p. 233.

Chapter 9

32. William G. Van Dorn, *Oceanography and Seamanship* (New York: Dodd, Mead, 1974), p. 74.
33. Charles Kanter, *Cruising World* (February 1985).
34. Shane, *Drag Device Data Base*, p. 5.1.42. This stretch of nylon is not exaggerated and can be verified in engineering handbooks.
35. Lin and Larry Pardey, *Storm Tactics Handbook* (Vista, California: Pardey Books, 1995), pp. 36–39.

Chapter 10

36. Peter Bruce, *Adlard Coles' Heavy Weather Sailing*, 30th anniversary edition (Camden, Maine: International Marine, 1999), p. 272.
37. *Ibid*, p. 273.
38. *Ibid*, p. 108.

39. Peter Cumberlidge, ed., *Roving Commissions* (London: Bookcraft Midsomer Norton, 1998), pp. 78–81. Bruce, *Adlard Coles' Heavy Weather Sailing*, pp. 285–90.
40. Shane, *Drag Device Data Base*, pp. 5.1–20.
41. Steve Dashew and Linda Dashew, *Surviving the Storm* (Tucson, Arizona: Beowulf, 1999), pp. 65–77.
42. Shane, *Drag Device Data Base*, p. 5.1.46.
43. Steven McAbee, "Crossing Gale Alley," *Ocean Navigator*, (Nov./Dec. 1997).

Chapter 11

44. Pat Treston, "Mission Antarctica," a splendid ten-part series in the New Zealand magazine *Sea Spray* that began in June 1971. It's a pity this material was never made into a book.
45. Shane, *Drag Device Data Base*, p. 5.5.7.
46. Frank V. Snyder, "Galerider Handles a Gale," *Yachting* (September 1986).
47. Beth A. Leonard, "Time to Put on the Brakes," *Cruising World* (December 2005).
48. Thomas S. Steele, "Twice Around in *Adios*," *Yachting* (December 1964), p. 35.

Chapter 12

49. John Rousmaniere, *Fastnet, Force 10* (New York: W. W. Norton, 1980). The magisterial account of the race.
50. Much of the quoted material in this chapter is from a paper by Donald Jordan dated February 25, 2001, and my interview with him on January 6–7, 2003.
51. Donald J. Jordan, "What Causes a Boat to Capsize?" *SAIL* (February 1982), pp. 47–57.
52. Letter to the author dated November 9, 2006.
53. Jordan paper titled "Designer's Notes 3" (undated).

Chapter 13

54. E-mail from Ed Arnold dated September 15, 2006.
55. See www.sailnet.com/forums/showthread.php?postid=2150.
56. Willem and Corri Stein, "Knocked Down in the Southern Ocean," *Ocean Navigator* 149 (October 2005). Also an e-mail to the author dated April 19, 2002.
57. This account of *Moon Boots* is based on Shane, *Drag Device Data Base*, pp. 5.5.8–5.5.9.
58. *Commodore's Bulletin*, Seven Seas Cruising Association, July 1999.
59. Robin Knox-Johnston, *A World of My Own* (London: Corgi Books, 1971), p. 108.
60. Shane, *Drag Device Data Base*, p. 5.5.26.
61. *Ibid*, p. 5.5.17.

Chapter 14

62. Dashew and Dashew, *Surviving the Storm*, p. 465.
63. Bruce, *Adlard Coles' Heavy Weather Sailing*, p. 23.

Chapter 15

64. There have been many biographies of Maury, certainly a hero to all sailors. A recent good one is Chester G. Hearn, *Tracks in the Sea* (Camden, Maine: International Marine, 2002), pp. 95–121. See www.eraoftheclipperships.com/page14web.html for a brief account and some meaningful quotes from Maury.

65. E-mail to the author from Mal Tennant dated February 1, 2008. Also see John Brown, "Searchlight on a Silent Service," *Yachting Monthly* (September 1978).

Chapter 16

66. Captain Nick Perugini, "Behind the Accuracy of Electronic Charts—What Every Mariner Should Know About Electronic and Paper Charts," *Sea Technology* (March 2001).
67. Hal Roth, *Always a Distant Anchorage* (New York: W. W. Norton, 1988), Chapter 11.
68. S. E. Bradfield, *Road to the Sea* (London: Temple Press, 1964), p. 69.

Chapter 18

69. There are hundreds of books and articles on hurricanes. A good beginning is at: www.physicalgeography.net/fundamentals/7u.html.
70. Eric J. Holweg, *Mariner's Guide For Hurricane Awareness in the North Atlantic Basin* (Washington, D.C.: NOAA, 2000), p. 12. This 57-page guide is well worth downloading from www.nhc.noaa.gov/marinersguide.pdf.
71. William P. Crawford, *Mariner's Weather* (New York: W. W. Norton, 1978), pp. 158–61.

Chapter 19

72. Don Whilldin, "Instructions for Using Your Para-Tech Sea-Anchor," p. 3. See www.seaanchor.com/pdf/sea_anchor_instructions.pdf.

Appendix 1

ADDRESSES FOR EQUIPMENT AND ORGANIZATIONS

Bill Coppins
W. A. Coppins Ltd.
255 High Street
Motueka, Tasman 7120, New Zealand
www.paraseaanchor.com

Alby McCracken
Para-Anchors Australia
P.O. Box 1377
Sale, Victoria 3850, Australia
www.paraanchors.com.au

Don Whilldin
Para-Tech Engineering Co.
2117 Horseshoe Trail
Silt, CO 81652, USA
www.seaanchor.com

Cast thimbles are available from:
Bosun Supplies Inc.
P.O. Box 86
Arnold, MD 21012, USA
www.bosunsupplies.com

Jordan Series drogue:
Dave Pelissier
Ace Sailmakers
3-D Colton Road
East Lyme, CT 06333, USA
www.acesails.com

Galerider drogue:

Hathaway, Reiser, and Raymond
184 Selleck Street
Stamford, CT 06902, USA
www.hathaways.com

Para Drouge: see page 150 (McCracken above)

Seabrake drogue:

Seabrake International
P.O. Box 501
Merimbula, NSW 2548, Australia
www.seabrake.com

Seaclaw drogue: W. A. Coppins (see above)

Sailing organizations:

Seven Seas Cruising Association
2501 East Commercial Boulevard, Suite 201
Fort Lauderdale, FL 33308, USA
www.ssca.org

Ocean Cruising Club

38 Acacia Road
Hampton, Middlesex TW12 3DS, U.K.
www.oceancruisingclub.org

French charts can be purchased from the national hydrographic authority (each chart costs €9.60):

Établissement Principal du SHOM
CS 92803
29228 Brest, Cedex 2, France
www.shom.fr

Appendix 2

A SAILOR'S LOG FOR A STORMY DAY IN THE SOUTH ATLANTIC

Excerpt from Hal Roth's log for March 22, 1991, during the 50-foot *Sebago's* run from Sydney, Australia, to Punta del Este, Uruguay, a distance of 7,603 miles (51 days). I left Sydney on February 6. By March 22, I had rounded Cape Horn and was sailing north in the South Atlantic. On March 22, the east coast of Argentina (Cabo Virgenes—the eastern entrance to the Strait of Magellan) was off to port. The big island of West Falkland was to starboard, with a fringe of small unlighted islands (the Jasons) off its western shore. The distance from Cabo Virgenes to Jason West Cay is 266 miles. At 1100, aboard *Sebago*, the wind was north at 38 knots. At 1300, the wind was north at 46 knots.

0027. The westernmost Jason islet bears 051°M and is 45 miles away. Every bit of northing we get increases our safety angle. However I changed course to 030° a while ago. How wonderful to have the GPS instead of doing this with night star sights.

0042. I got the idea of getting out the West Falkland chart and plotting the outer (westernmost) Jason West Cay, which is at 50°58'S, 61°28'W. I put this in the GPS as a waypoint and get 052°M at 42 miles.

0100. The lights to the west are definitely fishing boats strung out from north to south. There are 20 or 30 vessels and their lights illuminate the clouds. I climbed up on the main boom, but I cannot see the lights themselves, only their loom. I find that I am extremely nervous tonight. I have just made a cup of tea and have had something to eat to try to calm down.

0121. The other factor in this little game to get past Jason West Cay on a black night is that with the wind backing I have to keep easing off toward Jason in order to keep the vessel going. We're strapped right in. Close-hauled with some water ballast to keep her upright.

0409. An amusing night. I had full sail in 19 knots on the wind—true wind—to clear Jason, and my course was getting poorer because the wind continued to back. All day yesterday. From S-SSW-W-NW—and now N, the direction I want to go. I tacked, rolled up the jib, bore off from the fishing fleet, and put in two reefs. I then let out some jib and sailed a little on the starboard tack. The course was poor and would

have put me in the fishing fleet. I tacked again to port. Now with two reefs and a small jib I can sail better. I topped up the water ballast tank to port. Pulling down one reef and then a second was a puff and a drag! No wonder I need to eat.

0435. No sleep tonight. Good thing I had a nap earlier. Wind now 25 knots from the north, which means that once I weather Jason West Cay and go east, the whole north side of the Falklands will be a lee shore. Will I ever get to Uruguay?

0614. What a pity to stop. However we were only 20 miles from West Jason Cay, which was becoming a lee shore. My course of 050° was no good, and there's no telling how strong this storm will become. I have tacked toward the Argentine mainland. The jib is rolled up. We are jogging along under the double-reefed mainsail at 2 knots or a little more, with the water ballast to windward. Wind 28 to 30 knots from the north. What else can I do?

1130. Frightful squalls from the north and a terrible sea. I have headed west to ease the motion and to keep from breaking things. What a pity to run into this weather system when I was going so well yesterday. The wind is roaring and screeching. If only the cursed gale was from the south instead of the north. With a course of 300°, however, I am making a little northing. We're only 49 miles from 50°S. I'm a little worried about the fishing boats, but we'll have to take such problems as they come. Jason West Cay, for interest, now bears 098° and is 30 miles away.

1206. Punta del Este is 1,006 miles on 011°M. I reckon the low is west of us. If it is moving east, the winds will veer from N to NW to W. But who knows how the low is traveling, except for a generally westerly movement. Believe it or not, we're making a little movement north in all this maelstrom.

1509. A busy two hours. I've put a third reef in the mainsail, but the wind was too strong for me to get the reef cranked down properly in spite of a number 52 winch. The reef didn't seem to make the slightest difference. While dealing with it, the vessel was rolling heavily, and I got the halyard around the mast steps. Also I had the wrong running backstay set. After a struggle I got the halyard free although I had to drop the sail and climb up about ten feet to untangle the halyard at the head of the sail. Abysmal conditions. Some difference from yesterday when we had sun, light seas, and a fair wind. I got soaked while working at the mast. At the moment the wind is only 32 knots, which seems almost calm after the sleet and heavy squalls. I just had a bowl of hot noodles and put on three dry Musto underwear tops. Lovely! I'm a bit awed by the barometer reading of 981. I have seen two fishing boats. (We have just passed the second, which is anchored on a bank.)

2009. I'm very tired. A snow and sleet squall went through and the wind shifted to the northwest. We were doing only a little better than west. In fact most of our non-progress was up and down. I tried to tack with the shifted water ballast but we weren't

going fast enough. I wore her around and we began to sail much better. I let out more jib. The sky began to clear to the northwest. Higher clouds. *Alto cumulus*, *altostratus*, and a few bits of blue and streaks of sun. I was worried about the barometer, which is down to 976, but it hasn't moved with the wind shift. It has been extremely rough and I wonder whether something in the barometer broke in one of the bangs as we fell off a wave. Anyway we're doing 7 to 8 knots with part of the jib and the reefs in the main. The mainsail isn't set just right, but I am too tired to go forward. I must have made 50 trips to the foredeck in the last 24 hours. I have made some herb tea, which I am looking forward to. 996 miles to Punta del Este on 012°M.

2221. Now the clouds are at middle heights and of all shapes and sizes. Patches of *altostratus* mixed with *altocumulus*. Some are long thin sausages. Others are puffs of cotton. The sun is setting to the west and has filtered underneath the clouds. A few minutes ago all the delicate furrows and rolls of the clouds were bathed in a yellow light. Then a gauzelike pink that gradually reddened, and finally became a fiery crimson. This was mixed with the bluish-gray of the clouds in the places hidden from the sun. A nice scene. A big sky that's so much nicer than the dull stratus of the storm.

Appendix 3

FITZROY'S METEOROLOGICAL PAMPHLET

I've long had a barometer on my yachts, but in truth I've paid only cursory attention to the little arrow that moves to the right or left as the atmospheric pressure goes up and down. But 150 years ago British Vice-Admiral Robert FitzRoy—who once was the captain of HMS *Beagle* and sailed with Charles Darwin—taught sailors that the barometer is helpful and reliable if you know how to read it and incorporate other information. FitzRoy, who coined the term “weather forecast,” wrote the little pamphlet that follows, which is filled with advice and hints for those who go to sea and have concern for the wind and waves. This booklet is a rare item, and is reproduced courtesy of the U.K. Meteorological Office and its dedicated librarians.

**BAROMETER AND WEATHER
GUIDE.**

BOARD OF TRADE.

1858.

COMPILED BY R. ADM. FITZROY, F.R.S.

SECOND EDITION.

LONDON:
PRINTED BY GEORGE E. EYRE AND WILLIAM SPOTTISWOODE,
PRINTERS TO THE QUEEN'S MOST EXCELLENT MAJESTY.
FOR HER MAJESTY'S STATIONERY OFFICE.

AND SOLD BY
J. D. POTTER, *Agent for the Admiralty Charts*, 31, POULTRY,
AND 11, KING STREET, TOWER HILL.
1859.

Price Sixpence.

A contraction of rules for foretelling weather—in accordance with the following pages—is submitted, for scales of common barometers.

<p>RISE</p> <p>FOR</p> <p>N. ELY. NW.—N.—E.</p> <p>DRY</p> <p>OR</p> <p>LESS WIND.</p> <hr/> <p>EXCEPT</p> <p>WET FROM N. ED.</p>	<p>FALL</p> <p>FOR</p> <p>S. WLY. SE.—S.—W.</p> <p>WET</p> <p>OR</p> <p>MORE WIND.</p> <hr/> <p>EXCEPT</p> <p>WET FROM N. ED.</p>
--	--

Add one tenth for each hundred¹/₂ feet above the Sea.

LONG FORETOLD—LONG LAST,

SHORT NOTICE—SOON PAST.

FIRST RISE AFTER LOW,

FORETELLS STRONGER BLOW.

P R E F A C E.

~~~~~

MANY persons have advocated placing barometers at exposed fishing villages; and the Board of Trade has sanctioned the principle of some assistance by Government to a limited extent, depending on the necessity of each case, and other contingencies, such as the care, publicity, and setting of the barometers.

It was thought advisable to substitute a few words on the scales of these instruments in place of those usually engraved (which are not the most suitable), and to compile brief and plain information respecting the use of weather glasses.

The following pages were prepared; but only the first few were intended particularly for this purpose.

After writing these, it was suggested that some remarks might be added for the benefit of many persons, especially young officers at sea, and the suggestion was complied with; yet not so as to diminish the portability of this compilation, or increase its price.

These remarks, derived from the combined observation, study, and personal experience of various individuals, are in accordance, generally, with the results obtained by eminent philosophers.

The works of Humboldt, Herschel, Dové, Sabine, Reid, Redfield, Espy, and others, are appealed to in confirmation of this statement.

To obviate any charge of undue haste, or an insufficiently considered plan—which may be fairly brought against many novelties—the following testimony to the first published suggestion of such a measure is submitted.

In the First Report of the Committee on Shipwrecks (1843), at pages 1, 2, 3, the following evidence was printed by order of the House of Commons:—

“ I think that the neglect of the use of the barometer has led to the loss of many ships. From a want of attention to the barometer, they

have either closed the land (if at sea), or have put to sea (being in harbour in safety) at improper times ; and in consequence of such want of precaution the ships have been lost, owing to bad weather coming on suddenly, which might have been avoided had proper attention been paid to that very simple instrument. While alluding to the use of barometers, I may remark, that if such weather-glasses were put in charge of the Coast-guard, at the principal stations round the coast, so placed as to allow any one passing by to look at them, they might be the means, not only of preventing ships from going to sea just before bad weather was coming on, but of preventing the great losses of life which take place every year on our coasts (particularly in the Orkney Islands and on the coasts of Scotland and Ireland), owing to fishing vessels and boats going to sea when bad weather is impending. No bad weather ever comes on our coasts without timely warning being given by the barometer. The oldest seamen are often deceived by the look of the weather, but there is no instance on record of very bad weather, such as would have involved loss of life to the extent we have heard of in several years, having come on without the barometer having given timely warning. By the very small expense of an establishment of barometers, so placed as to be accessible to any fishermen, boatmen, or others on the coasts, much loss of life, as well as loss of boats, and even shipping, might be prevented.

“ What state of the barometer indicates danger?—It varies in different climates according to the range. The range is small between the tropics, but very large in the higher latitudes. In our climate the range is usually about two inches. The barometer falling considerably below its average height is at once an indication that some considerable change is going to take place, and when it falls low, as for instance (in our climate) to near 29 inches, or below 29 inches, a gale is certain to follow.

“ Are the Committee to understand that you are of opinion that every ship ought to have a barometer on board?—I think that every ship ought to have either a barometer or sympiesometer, which is an efficient substitute for a barometer.

“ Does the barometer show a sudden change of wind as well as the coming on of bad weather? Supposing a gale of wind is blowing, and you are sailing with a fair wind, does the barometer show any change of wind?—Decidedly.

“ Supposing the wind was at West-north-west and it shifted suddenly to West-south-west, would the barometer indicate that?—It requires some practice to be able to say *exactly what is likely to take place* after a change in the barometer ; but the principal point for a seaman is, that no violent wind will blow without the barometer giving warning. He may not know exactly from what quarter the wind will come, but no strong wind will come on without warning being given.

“ You recommend that at the Coast-guard stations there should be a barometer, by means of which people would know when a violent

## 5

wind was coming on ; but as it would not indicate the quarter from which it was coming, would you have the merchant ship always remain in port till the barometer showed fine weather ?—Being accustomed to the barometer on our coast, one could tell from what quarter the wind would probably come by the height of the barometer, taken in connexion with its previous height, and the state of the weather, and the strength of winds that had prevailed before. Taking the state of the barometer in connexion with the appearance of the weather one could make a satisfactory conclusion as to the quarter from which any violent wind would come. And the barometer, after very little practice, can be used by any man. There is no difficulty in using it sufficiently to know that danger is coming on ; and if danger is coming on, a man refrains, of course, from exposing himself to it ; the quarter from which the wind comes being of minor consequence.

“ With a North-easterly wind, in this part of the world, the barometer stands, on an average, about half an inch higher than with the same strength of wind from the South-westward. All over the world there is a similar difference proportionate to the range of the mercury for which allowance should always be made in considering the height of the barometer.”\*

In the first Number of Meteorological Papers, published by the Board of Trade, 1857, is the following passage respecting the use of weather-glasses :—

“ The variety of interesting and useful, if not always important, subjects included within the range of meteorology, is not perhaps sufficiently realized in the minds of active participators in the world's stirring work. Irrespective of any scientific object, how much utility is there to all classes in what is commonly called ‘ weather wisdom ’ ? In our variable climate, with a maritime population, numbers of small vessels, and especially fishing boats, how much life and property is risked unnecessarily by every unforeseen storm ? Even animals, birds, and insects have a presaging instinct, perhaps a bodily feeling, that warns them ; but man often neglects his perceptive and reasoning powers ; neither himself observes, nor attends to the observations of others, unless special inclination or circumstances stimulate attention to the subject. Agriculturists, it is true, use weather-glasses : the sportsman knows their value for indicating a good or bad scenting day ; but the coasting vessel puts to sea, the Shetland fisherman casts his nets, without the benefit of such a monitor, and perhaps without the weather wisdom which only a few possess, and cannot transfer to others.

“ Difficult as it is to foretell weather accurately, much useful foresight may be acquired by combining the indications of instruments

---

\* In South latitude the South wind corresponds to our North wind in its nature and effects. The Easterly and Westerly winds retain their respective peculiarities in both hemispheres.

(such as the barometer, thermometer, and hygrometer) with atmospheric appearances. What is more varying than the aspect of the sky? Colour, tint of clouds, their soft or hard look, their outline, size, height, direction, all vary rapidly, yet each is significant. There is a peculiar aspect of the clouds before and during westerly winds which differs from that which they have previous to and during easterly winds, which is one only of the many curious facts connected with the differing natures of easterly and westerly currents of air throughout the world, which remain unchanged, whether they blow from sea to land, or the reverse.\*

“Perhaps some of those who make much use of instruments rather undervalue popular knowledge, and are reluctant to admit that a ‘wise saw’ may be valuable as well as a ‘modern instance;’ while less informed persons who use weather-glasses unskilfully too often draw from them erroneous conclusions, and then blame the barometer.

“Not only are reliable weather-glasses required at the smaller outlying ports and fishing places, but plain, easily intelligible directions for using them should be accessible to the seafaring population, so that the masters of small vessels, and fishermen, might be forewarned of coming changes in time to prepare for them, and thus become instrumental in saving much property and many lives.”

*June 1858.*

R. F.

---

\* Exclusive of local land and sea breezes of hot climates.

---

## HOW TO FORETELL WEATHER.

FAMILIAR as the practical use of weather-glasses is, at sea as well as on land, only those who have long watched their indications, and compared them carefully, are really able to conclude more than that the rising glass\* USUALLY foretells less wind or rain, a falling barometer more rain or wind, or both; a high one fine weather, and a low, the contrary. But useful as these general conclusions are, *in most cases*, they are *sometimes* erroneous, and then remarks may be rather hastily made, tending to discourage the inexperienced.

By attention to the following observations (the results of many years' practice and many persons' experience) any one not accustomed to use a barometer may do so without difficulty.

The barometer shows whether the air is getting lighter or heavier, or is remaining in the same state. The quicksilver falls as the air becomes lighter, rises as it becomes heavier, and remains at rest in the glass tube while the air is unchanged in weight. Air† presses on everything within about forty miles of the world's surface, like a *much* lighter ocean, at the bottom of which we live—not feeling its weight, because our bodies are full of air, but feeling its currents, the winds. Towards any place from which the air has been drawn by suction,‡ air presses with a force or weight of nearly fifteen pounds on a square inch of surface. Such a pressure holds the limpet to the rock when, by contracting itself, the fish has made a place without air§ under its shell. Another familiar instance is that of the fly which walks on the ceiling with feet that stick. The barometer tube, emptied of air, and filled with pure mercury, is turned

---

\* Glass, barometer, column, mercury, quicksilver, or hand.

† Or atmosphere, or the atmospheric fluid which we breathe.

‡ Or exhaustion.

§ A vacuum.

down into a cup or cistern containing the same fluid, which, feeling the weight of air, is so pressed by it as to balance a column of about thirty inches (more or less) in the tube, where no air presses on the top of the column.

If a long pipe, closed at one end only, were emptied of air, filled with water, the open end kept in water and the pipe held upright, the water would rise in it more than thirty feet. In this way water barometers have been made. A proof of this effect is shown by any well with a sucking pump—up which, as is commonly known, the water will rise nearly thirty feet, by what is called suction, which is, in fact, the pressure of air towards an empty place.

The words on scales of barometers should not be so much regarded for weather indications, as the rising or falling of the mercury; for, if it stand at *Changeable*, and then rise towards *Fair*, it presages a change of wind or weather, though not so great, as if the mercury had risen higher; and, on the contrary, if the mercury stand above *fair* and then fall, it presages a change, though not to so great a degree as if it had stood lower: besides which, the direction, and force of wind, are not in any way noticed. It is not from the point at which the mercury may stand that we are alone to form a judgment of the state of the weather, but from its *rising* or *falling*; and from the movements of immediately preceding days as well as hours, keeping in mind effects of change of *direction*, and dryness, or moisture, as well as alteration of force or strength of wind.

In this part of the world, towards the higher latitudes, the quicksilver ranges, or rises and falls, nearly three inches—namely, between about thirty inches and eight-tenths (30·8), and less than twenty-eight inches (28·0) on extraordinary occasions; but the usual range is from about thirty inches and a half (30·5), to about twenty-nine inches. Near the Line, or in equatorial places, the range is but a few tenths, except in storms, when it sometimes falls to twenty-seven inches.

The sliding-scale (vernier) divides the tenths into ten parts each, or hundredths of an inch. The number of divisions on the vernier exceeds that in an equal space of the fixed scale by one.\*

By a thermometer the *weight* of air is *not* shown. No air is within the tube. None can get in. But the bulb of the tube is

---

\* See pages 23 and 24.

full of mercury, which contracts by cold, and swells by heat—according to which effect the thread of metal in the small tube is drawn down or pushed up so many degrees : and thus shows the temperature.\*

If a thermometer have a piece of linen tied round the bulb, wetted enough to keep it damp by a thread or wick dipping into a cup of water, it will show less heat than a dry one, in proportion to the dryness of the air, and quickness of drying.† In very damp weather, with or *before* rain, fog, or dew, two such thermometers will be nearly alike.

For ascertaining the dryness or moisture of air, the readiest, and surest method is the comparison of two thermometers ; one dry, the other *just* moistened, and *kept so*. Cooled by evaporation as much as the state of the air admits—the moist (or wet) bulb thermometer shows a temperature nearly equal to that of the other one, when the atmosphere is extremely damp, or moist ; but lower at other times,—in proportion to the dryness of air, and consequent evaporation,—as far as twelve or fifteen degrees in this climate ; twenty or even more elsewhere. From four to eight degrees of difference is usual in England ; and about seven is considered healthy for living rooms.

The thermometer fixed to a barometer intended to be used only as a weather-glass shows the temperature of air about it nearly—but does not show the temperature of mercury within exactly. It does so however near enough for ordinary practical purposes—provided that no sun, nor fire, nor lamp heat is allowed to act on the instrument partially.

The mercury in the cistern and tube being affected by cold or heat, makes it advisable to consider this when endeavouring to foretell coming weather by the length of the column.

---

Briefly, the barometer shows weight or pressure of the air ; the thermometer—heat and cold, or temperature ; and the wet thermometer, compared with a dry one, the degree of moisture or dampness.‡

It should be remembered that the state of the air *foretells*, rather than shows present weather (an invaluable fact too often

---

\* Thirty-two degrees is the point at which water begins to freeze, or ice to thaw.

† Evaporation.

‡ The two thus combined making a hygrometer : for which some kinds of hair, grass, or seaweed may be a make-shift.



overlooked); that the longer the time between the signs and the change foretold by them, the longer such altered weather will last; and, on the contrary, the less the time between a warning and a change, the shorter will be the continuance of such foretold weather.

---

If the barometer has been about its ordinary height, say near thirty inches, at the sea level,\* and is steady, or rising—while the thermometer falls, and dampness becomes less—North-westerly, Northerly, or North-easterly wind—or less wind—may be expected.

On the contrary—if a fall takes place, with a rising thermometer and increased dampness, wind and rain (or snow) may be expected from the South-eastward, Southward, or South-westward.

Exceptions to these rules occur when a North-easterly wind, with wet (rain or snow) is impending, before which the barometer often rises (on account of the *direction* of the coming wind alone), and deceives persons who, from that sign only, expect fair weather.

When the barometer is rather below its ordinary height, say, near twenty-nine inches and a half (at the sea level *only*), a rise foretells less wind, or a change in its direction towards the Northward,—or less wet; but when the mercury† has been low, say near 29 inches—the first rising usually precedes, and foretells, strong wind—(at times heavy squalls)—from the North-westward—Northward—or North-eastward—*after* which violence a rising glass foretells improving weather—if the thermometer falls. But, if the warmth continue, probably the wind will back (shift against the sun's course), and more Southerly, or South-westerly wind will follow.

The most dangerous shifts of wind, and the heaviest Northerly‡ gales happen after the mercury first rises from a very low point.

Indications of approaching changes of weather, and the direction and force of winds, are shown less by the height of mercury in the tube, than by its falling or rising. Nevertheless, a height

---

\* It stands lower, about a tenth of an inch for each hundred feet of height directly upwards, or vertically, above the sea; where its average height, in England, is 29.94 inches (at 32°).

† In an Aneroid, a metallic, or a wheel barometer, the hand's motion should correspond to that of mercury in an independent instrument.

‡ Southerly in South latitude.

of about 30 inches (at the level of the sea) is indicative of fine weather and moderate winds.

The barometer is said to be *falling*, when the mercury in the tube is sinking, at which time its upper surface is *sometimes* concave or hollow: The barometer is *rising*, when the mercurial column is lengthening; its upper surface being then, as usual, convex or rounded.\*

A rapid rise of the barometer indicates unsettled weather. A slow rise, or steadiness, with dryness, shows fair weather.

A considerable and rapid fall is a sign of stormy weather and rain. Alternate rising and sinking show very unsettled weather.

The greatest depressions of the barometer are with gales from the S.E., Southward, or S.W.; the greatest elevations, with winds from the N.W., Northward, or N.E.

Although the barometer generally falls with a Southerly, and rises with a Northerly wind, the contrary *sometimes* occurs; in which cases the Southerly wind is dry and the weather fine; or the Northerly wind is wet and violent.

When the barometer sinks considerably, high wind, rain, or snow will follow: the wind will be from the Northward, if the thermometer is low (for the season)—from the Southward, if the thermometer is high.

Sudden falls of the barometer, with a Westerly wind, are sometimes followed by violent storms from N.W. or North.

If a gale sets in from the Eastward or S.E., and the wind veers by the South, the barometer will continue falling until the wind becomes S.W., when a comparative lull may occur; after which the gale will be renewed; and the shifting of the wind towards the N.W. will be indicated by a fall of the thermometer as well as a rise of the barometer.

Three things appear to affect the mercury in a barometer:—

1. The direction of the wind—the North-east wind tending to raise it most—the South-west to lower it the most, and wind from points of the compass between them proportionally as they are nearer one or the other extreme point.

N.E. and S.W. may therefore be called the wind's extreme bearings.

The range, or difference of height, of the mercury, due to change of direction *only*, from one of these bearings to the other (supposing strength or force, and moisture, to remain the same)

---

\* In the best columns, those of standards for example, no concavity is seen, at any time.

amounts in these latitudes to about half an inch (shown by the barometer as read off).

2. The amount, taken by itself, of vapour, moisture, wet, rain, or snow, in the wind or current of air (direction and strength remaining the same) seems to cause a change amounting in an extreme case to about half an inch.

3. The strength or force alone of wind from any quarter (moisture and direction being unchanged) is preceded, or foretold, by a fall or rise, according as the strength will be greater or less, ranging in an extreme case to more than two inches.

Hence, supposing the three causes to act together—in extreme cases—the mercury might range from about 31 (30·8) inches to near 27 (27·1) inches, which has happened occasionally.

Generally, however, as the three act much less strongly, and are less in accord—ordinary varieties of weather (the wind varying between S.W. and N.W.—with more or less cloudiness, or rain) occur much more frequently than extreme changes.

Another general rule requires attention; which is, that the wind usually veers, shifts, or goes round, *with the sun*, (right-handed in northern places, left-handed in the southern parts of the world,) and that, when it does not do so, or backs, more wind or bad weather may be expected instead of improvement.

In a barometer the mercury begins to rise occasionally before the conclusion of a gale, sometimes even at its commencement, as the equilibrium of the atmosphere begins to be restored. Although the mercury falls lowest before high winds, it frequently sinks considerably before heavy rain. The barometer falls, but *not always*, on the approach of thunder and lightning, or when the atmosphere is highly charged with electricity.\* Before and during the earlier part of serene and settled weather, the mercury commonly stands high, and is stationary.

Instances of fine weather, with a low glass, occur exceptionally, but they are always preludes to a duration of wind or rain, *if not both*.

After very warm and calm weather, rain or a storm is likely to occur; or at any time when the atmosphere has been *heated* much above the usual temperature of the season.

Allowance should invariably be made for the previous state of

---

\* Thunder clouds sometimes rise and spread against the wind (lower current). It is probable that there is a meeting, if not a conflict of air currents, electrically different, whenever lightning is seen. Their concurrence, when the new one advances from polar regions, does not depress the barometer, except in oscillation, which is very remarkable at the time.

the column during some days, as well as hours, because its indications may be affected by remote causes, or by changes close at hand. Some of these changes may occur at a greater or less distance, influencing neighbouring regions, but not visible to each observer whose barometer feels their effect

There may be heavy rains or violent winds beyond the horizon, and the view of an observer, by which his instruments may be affected considerably, though no particular change of weather occurs in his immediate locality.

It may be repeated, that the longer a change of wind or weather is foretold by the barometer before it takes place, the longer the presaged weather will last; and, conversely, the shorter the warning, the less time, whatever causes the warning, whether wind, or a fall of rain, or snow will continue.

Sometimes severe weather from an equatorial direction, not lasting long, may cause no great fall of the barometer, because followed by a *duration* of wind from polar regions:—and at times it may fall considerably with polar winds and fine weather, apparently against these rules, because a *continuance* of equatorial wind is about to follow. By such changes as these one may be misled, and calamity may be the consequence if not thus forewarned.

The veering of the winds is a direct consequence of the earth's rotation, and currents of air from the polar regions alternating or contending with others from the equator.

The polar currents are cold, dry, and heavy. Those from the equatorial parts of the world are warm, moist, and comparatively light. Their alternate or combined action (foretold by the glasses and other signs)—solar heat and electricity, cause all the varieties of weather that we experience.

It is not intended to discourage attention to what is usually called "weather wisdom." On the contrary, every prudent person will combine observation of the elements with such indications as he may obtain from instruments.

The more accurately the two sources of foreknowledge are compared and combined, the more satisfactory will the results prove.

---

A few of the more marked signs of weather—useful alike to farmer and seaman, are the following:

Whether clear or cloudy, a rosy sky at sunset presages fine weather; a red sky in the morning bad weather, or much wind

(if not rain):—a grey sky in the morning fine weather; a high dawn, wind; a low dawn, fair weather.

Soft-looking or delicate clouds foretell fine weather, with moderate or light breezes;—hard edged oily-looking clouds, wind. A dark, gloomy, blue sky is windy;—but a light, bright blue sky indicates fine weather. Generally, the *softer* clouds look, the less wind (but perhaps more rain) may be expected;—and the harder, more “greasy,” rolled, tufted, or ragged, the stronger the coming wind will prove. Also, a bright yellow sky at sunset presages wind; a pale yellow, wet:—and thus by the prevalence of red, yellow, or grey tints, the coming weather may be foretold very nearly: indeed, if aided by instruments, almost exactly.\*

Small inky-looking clouds foretell rain; a light scud, driving across heavy clouds, wind and rain; but if alone, wind only.

High upper clouds crossing the sun, moon, or stars in a direction different from that of the lower clouds, or wind then blowing, foretell a change of wind (beyond tropical latitudes).†

After fine clear weather the first signs (in the sky) of change are usually small, curled, streaked, or spotty clouds, followed by an overcasting of vapour, that grows into cloudiness. This murky appearance, more or less oily or watery, as wind or rain will prevail, is a sure sign. The higher and more distant the clouds seem to be, the more gradual, but extensive, the coming change of weather will prove.

Generally speaking, natural, quiet, delicate tints or colours, with soft undefined forms of clouds, foretell fine weather: but gaudy, or unusual hues, with hard, definite outlines presage rain and wind.

Misty clouds forming, or hanging on heights, show wind and rain coming—if they remain, or descend. If they rise, or disperse, the weather will improve, or become fine.

When sea birds fly out early, and far to seaward, moderate

---

\* Indications of weather, afforded by colours, seem to deserve more critical study than has been often given to the subject. Why a rosy hue at sunset, or a grey neutral tint at that time, should presage the reverse of their indications at sunrise;—why bright yellow should foretell wind at either time, and pale yellow, wet;—why clouds seem soft, like water colour; or hard edged, like oil paint, or Indian ink on an oily plate;—and why such appearances are infallible signs—are yet to be shown satisfactorily to practical men.

† In the trade winds of the tropics there is usually a counter current of air, with light clouds,—which does not indicate any approaching change. In middle latitudes such upper currents are not so evident, except before a change of weather.

wind and fair weather may be expected. When they hang about the land, or over it, sometimes flying inland, expect a strong wind, with stormy weather. As many creatures, besides birds, are affected by the approach of rain or wind, such indications should not be slighted by the observer of weather.

There are other signs of a coming change in the weather known less generally than may be desirable; and, therefore, worth notice here.

When birds of long flight, such as swallows and others, hang about home and fly low—rain or wind may be expected. Also when animals seek sheltered places, instead of spreading over their usual range: when pigs carry straw to their sties; and when smoke from chimneys does not ascend readily, (straight upwards during a calm,) an unfavourable change may be looked for.

Dew is an indication of fine weather. So is fog. Neither of these two formations occurs under an overcast sky, or when there is much wind. One sees the fog occasionally rolled away, as it were, by wind—but not formed while it is blowing.

Remarkable clearness of atmosphere, near the horizon; distant objects, such as hills, unusually visible; or raised (by refraction); and what is called “a good *hearing* day” may be mentioned among signs of wet, if not wind, to be expected.

More than usual twinkling of the stars; indistinctness or apparent multiplication of the moon's horns; haloes; “wind-dogs;” and the rainbow; are more or less significant of increasing wind, if not approaching rain.

Near land, in sheltered harbours, in valleys, or over low ground, there is usually a marked diminution of wind during part of the night—and a dispersion of clouds. At such times an eye on an overlooking height may see an extended body of vapour below which the cooling of night has rendered visible.

Although the preceding remarks are probably sufficient for their principal purpose—these pages may fall into the hands of persons familiar with the subject, to whom the following observations may be addressed, as *reasons* for what has been so briefly, if not too positively outlined.

As the mercurial column rises with increase of pressure by the atmosphere, and descends when the pressure diminishes, it indicates a greater or less accumulation of air, which, like other fluid, such as water (when heaped above its average level or reduced below it, from whatever cause),—will have a tendency to fall or rise till the general equilibrium is restored. An observer may

be under the centre of such accumulation or depression, he may be more or less distant from it, though within the influence of whatever horizontal movement of air may be caused by such temporary increase or diminution of pressure. Hence the barometer shows, and generally foretells, changes of wind; but as complications always occur, and as changes are of greater or less extent, affecting or extending through a wider or more limited area, accompanied by hygrometric and electrical alterations, it is extremely difficult at times to say beforehand what particular change of weather is to be expected, and at what interval of time; although after the event the correspondence of barometric changes with those of the weather can be readily traced. However notwithstanding occasional perplexity, the general character of weather during the next few days may be predicted by an observer who understands the nature and use of this instrument and the thermometer, and has watched them in the few immediately preceding days.

In endeavouring to foretell weather, the general peculiarity should always be remembered, that the barometric column usually stands higher with easterly than it does with westerly winds; and with winds from the polar regions higher than with those from the direction of the equator. Hence the highest columns are observed with north-east winds in northern latitudes, and with south-east in the southern hemisphere.

In middle latitudes there is an average difference (unreduced or observed height as read off) of about half an inch, other things being similar, between the heights of the mercury with North-easterly, or with South-westerly winds.

The steadier the column, or the more gradually it moves, the more settled in character will the weather be, and conversely. In the tropics, when the barometric column moves contrary to its usual daily motion, inferior weather may be expected (temporarily).

This regular movement, whether tidal, or otherwise connected with the sun's influence—sensible in tropical latitudes, but more or less masked elsewhere—amounts to nearly two tenths of an inch near the equator, the highest being about nine, and the lowest near three o'clock.

---

Some movements of the atmosphere may be illustrated by reference to the motion of water drawn off from a reservoir by a small opening below; or by similar *upward* draught through a syphon; or by a gradual pouring in at the upper surface.

From a slight motion at the commencement, affecting only that portion of the fluid adjoining either of those places of diminution or repletion, gradually all the water becomes influenced and acquires more or less rapid movement. But suppose a long reservoir or canal of fluid which has two such points of exhaustion or two of such repletion (as imagined above), and that one of either is near each end of the vessel. If each aperture be opened at the same moment, equal effects will be caused in each half of the fluid towards either end of the vessel, but in the middle there must be a neutral point at which the water falls, yet has no horizontal motion. The converse takes place in raising the level. And in the case of fluid drawn off or diminished in weight at one end while increased by repletion at the other, the *whole* body of water will move similarly to that in the former vessel, but unequally. Hence it is evident, that before horizontal motion occurs, an augmentation or a diminution of pressure must take place somewhere more or less remote; and so it is with the lighter fluid atmosphere,—which has centres, lines, or areas of depression towards which currents flow.

Such considerations show in some degree why the barometric changes usually precede, but sometimes only accompany, changes of weather: and, though very rarely, occur without any sensible alteration in the wind current of the atmosphere. An observer may be near a central point towards which the surrounding fluid tends,—or from which it diverges. He may be at the very farthest limit of the portion of fluid that is so influenced. He may be at an intermediate point—or he may be between bodies of atmosphere tending towards opposite directions.

It has been said, that “a whirlwind which sets an extended portion of the atmosphere into a state of rapid revolution diminishes the pressure of the atmosphere over that portion of the earth’s surface, and most of all at the centre of the whirl. The depth of the compressing column of air will, at the centre, be least, and its weight will be diminished in proportion to the violence of the wind.” But this has been controverted with respect to the *general* effect of air in horizontal motion, and the depth of the column in question.

Moreover, there are two kinds of whirlwinds—one caused by rarefaction, tending to lighten vertical pressure under the vortex, certainly, though not, perhaps under all the current drawn towards it: and the other, a consequence of opposing winds, which occasion huge eddies or whirlwinds of compression.



Some whirlwinds are accompanied by rushes from the upper atmosphere, from the colder regions, which, mingling with warmer and moister air near the sea, cause dense clouds. About their centre it sometimes happens that the barometer falls as much as two or three inches, showing a diminution of atmospheric pressure by nearly a tenth part; when it should be expected, from physical considerations alone, that very dense clouds would be formed.\*

---

The column of mercury falls about one tenth of an inch for each hundred feet of elevation above the sea level, but varying when it becomes much more elevated.† Due allowance, therefore, should be made in observing on high land.

The tides are affected by atmospheric pressure, so much that a rise of one inch in the barometer will have a corresponding fall in the tides of nine to sixteen inches, or say one foot for each inch.‡

---

Vessels sometimes enter docks, or even harbours, where they have scarcely a foot of water more than their draught; and as docking, as well as launching large ships, requires a close calculation of height of water, the state of the barometer becomes of additional importance on such occasions.

---

To render these pages rather more useful at sea, in *any* part of the world, a few words about squalls and hurricanes are here offered to the young seaman.

Generally, squalls are preceded, or accompanied, or followed by clouds; but the very dangerous "white squall" (of the West Indies and other regions), is indicated only by a rushing sound, and by white wave crests.

"Descending squalls" come slanting downwards, off high land,§ or from upper regions of atmosphere. They are dangerous, being sometimes violently strong.

A squall cloud that can be seen through, or under, is not likely to bring, or be accompanied by, so much wind as a dark continued cloud extending beyond the horizon. How the comparative hardness or softness of clouds foretells more or less wind or rain, was stated in pages 13 and 14.

---

\* Even in ordinary changes of weather it is interesting, as well as useful, to mark the formation or disappearance of clouds, caused by colder and warmer currents of air mixing.

† Depending on pressure and temperature.

‡ Sir James Ross—M. Daussy.

§ Williwaw (Whirl-awa?) of the old sealers and whalers.

The expressions "hardening up," "softening," or looking "greasy," are familiar to seamen: and such very sure indications are the appearances so designated, that they can hardly be mistaken.

The rapid or slow rise of a squall cloud—its more or less disturbed look—that is, whether its body is much agitated, and changing form continually, with broken clouds, or scud, flying about—or whether the mass of cloud is shapeless and nearly quiet, though floating onwards across the sky—foretells more or less wind accordingly.

An officer of a watch, with a good eye for clouds and signs of changing weather, may save his men a great deal of unnecessary exposure, as well as work, besides economising sails, spars, and rigging.

In some of the "saws" about wind and weather, there is so much truth that, though trite and simple, their insertion here can do no harm.

Adverting to the barometer :—

When rise begins, after low,  
Squalls expect and clear blow.

Or :—*First* rise, after very low,  
Indicates a stronger blow.

Also :—Long foretold, long last :  
Short notice, soon past.

To which may be added :—In squalls—  
When rain comes before wind,  
Halyards, sheets, and braces mind.

---

And :—When wind comes before rain,  
Soon you may make sail again.

---

Also, generally speaking :—  
When the glass falls low,  
Prepare for a blow ;  
When it rises high,  
Let all your kites fly.\*

---

To these short expressions—well known, in practice, to the experienced ; a very concise but sure rule may be added, for avoid-

---

\* Sailors call the light sails, used only in very fine weather, "flying kites."  
B 2

ing the centre or strongest part of a hurricane, cyclone, typhon, tornado, or circling storm.

With your face towards the wind, in North latitude, the centre of the circling, or rotatory storm, will be square to your right. In South latitude, square to your left.

The apparent veering of the wind, and the approach or retreat of the dangerous centre, depend on your position in the circular whirl or sweep.

Draw a circle ;—mark the direction of the rotation or circulation, by an arrow with the head towards the left hand (against the movement of a watch's hands) in North latitude ; but towards the right (or with the hands of a watch) if in South latitude. The direction of the wind, and the bearing of the centre, show your position in the meteor, for such it is, though perhaps hundreds of miles in diameter ; and the veering of the wind, or the contrary, and its change in strength, will show how the meteor is moving bodily—over a region of the world, revolving horizontally—or inclined at a certain angle with the horizontal plane.

If the observer be stationary, in North latitude, and the centre pass on his polar side, he will experience a change of wind from Southward by the West towards North ; but if it pass between him and the Equator, the change will be from Southward by the East towards North ; but otherwise in South latitude, as his place in circles sketched will show more clearly than words. The roughest sketch or diagram, indicating the various directions of wind, and the course of the meteor's centre, will show more plainly than descriptions—which must necessarily vary with each case, and are tedious.

Cyclonology, or really meteorology, is simple enough in these great characteristic effects ; but their causes must be the philosopher's study, rather than that of the young practical seaman.

Where it not for this reflection, one might endeavour to show how all the great trade winds—the no less important anti-trades,\* or nearly constant Westerly winds,—and their complicated eddying offsets, are all (on greater or smaller scales) alternating or circulating breadths, or zones of atmosphere, between which, at distant intervals, occur those strong eddies, or storms, called hurricanes—typhoons—tornadoes— or cyclones.

The great easterly and westerly movements—so clearly shown by philosophers to be the consequence of cold polar currents of

---

\* Herschel.

air—warm equatorial currents—and diurnal rotation of the earth;\* are the grand ruling phenomena of meteorology—to which storms, and all local changes, occurring but occasionally, are subordinate and exceptional.

---

In the previous observations, a general reference has been made to mercurial barometers of the ordinary kind; but, excepting the construction of the instruments themselves, those observations apply to all barometers, wheel—aneroid—or metallic—and likewise, of course, to the sympiesometer, which is a modified barometer. But as these four last-mentioned instruments are scarcely so familiar as the simplest form of barometer, it may be useful to add a few words about each of them.

---

The WHEEL barometer has a syphon tube, partly filled with mercury, on which, at the short or open end of the tube, a float moves, to which a line is attached that moves a wheel, carrying an index.†

---

ANEROID barometers, if often compared with good mercurial columns, are similar in their indications, and valuable; but it must be remembered that they are not independent instruments; that they are set originally by a barometer,‡ require adjustment occasionally, and may deteriorate in time, though slowly.

The aneroid is quick in showing the variation of atmospheric pressure, and to the navigator who knows the difficulty, at times, of using barometers, this instrument is a great boon, for it can be placed anywhere, quite out of harm's way, and is not affected by the ship's motion, although faithfully giving indication of increased or diminished pressure of air.§ In ascending or descending elevations, the hand of the aneroid may be seen to move (like the hand of a watch), showing the height above the level of the sea, or the difference of level between places of comparison.||

---

\* Dové.

† For a barometer of this kind, Admiral Milne has invented self-registering mechanism, that answers well.

‡ A small turnscrew being applied gently to the screw head at the back. This is often necessary, on receiving or first using an aneroid that has long been lying by, or that has been shaken by travelling.

§ It is a good weather glass—to be suspended on or near the upper deck, for easy reference;—and is unlikely to be injured by mere concussion of air, or vibration of wood, when guns are fired.

|| Allowing 0,0011 of an inch for each foot.

The principle on which it is constructed may be explained in a few words, without going into a scientific or minute detail of its various parts. The weight of a column of air, which in a common barometer acts on the mercury, in the aneroid presses on a small circular metal box, from which nearly all air is extracted; and to this box is connected, by nice mechanical arrangement, the hand visible over the face of the instrument. When the atmospheric pressure is lessened on the vacuum box, a spring acting on levers, turns the hand to the left, and when the pressure increases, the spring is affected differently, the hand being turned to the right. It acts in any position, but as it *often varies several hundredths with such a change*, it should therefore be held uniformly.

The known expansion and contraction of metals under varying temperatures, caused doubts as to the accuracy of the aneroid under such changes; but they were partly removed by introducing into the vacuum box a small portion of gas, as a compensation for the effects of heat or cold; the gas in the box, changing its bulk on a change of temperature, being intended to compensate for the effect on the metals of which the aneroid is made. Besides which, a further and more reliable compensation has lately been effected by a combination of brass and steel bars.\*

METALLIC barometers (in *outer* shape and size like aneroids) have not yet been tested adequately in very moist, hot, or cold air for a sufficient time. They, as well as sympiesometers, are likewise dependent or secondary instruments, and liable to deterioration. For limited employment, when sufficiently compared, they may be useful.

The SYMPIESOMETER is considered to be more sensitive than the marine barometer, falling sooner, and rising earlier: but this is only a consequence of the marine barometer tube being contracted, to prevent oscillation or "pumping." In the sympiesometer a gas is used, which presses on the confined surface of the liquid with an uniform pressure at an equal state of temperature. The liquid is raised or depressed by an increase or diminution in the density of the atmosphere, and the change of temperature is allowed for, by the sliding scale of the instrument being always set to agree with the height of the mercury in the attached thermometer, bringing the *pointer* on the sliding scale of the sympiesometer to the same degree on the inverted scale (over

---

\* The manufacture of these useful auxiliary instruments (all French originally) has been improved much latterly.

## 23

which it slides) as is indicated by the thermometer; the height of the fluid, as then shown by the sliding scale, indicating the pressure of the atmosphere.

As the instrument is delicate, great care should be taken, in carrying or handling, always to keep the top upwards, and to preserve it from casual rays of the sun, fire, or lamp.

Oil sympiesometers seem to be affected more than mercurial, or others, or the barometer, by lightning or electricity. That they, and the hermetically sealed "STORM GLASSES," are influenced by causes besides pressure and temperature, appears to be probable.

---

The daily movement of the barometer may be noted (in a form or table of double entry) at the hour of each observation, by a dot at the place corresponding to its altitude, and the time of observing; which dot should be connected with the previous one by a line. The resulting free curve will show at a glance what have been the movements during the days immediately previous, by which, and not merely by the last observation, a judgment may be formed of the weather to be expected.

Such a diagram may be filled up by the entries in the register *uncorrected*, its object being to serve as a weather guide for immediate use, rather than for future investigation. If closely kept up, it will prove to be of utility, and will in some degree reward the trouble of keeping an accurate and regular record.

---

HESITATION is sometimes felt at first using the vernier of a barometer, for want of explanation.

The general principle of this moveable dividing scale is, that the total number of the smallest spaces or subdivisions of the vernier are made equal, taken altogether, to one less than that number of the smallest spaces in an equal length of the fixed scale.

For example:—ten spaces on the vernier being made equal to nine on the scale, each vernier space is one tenth less than a scale space; and if the first line or division of the vernier agree exactly with any line of the scale, the next line of the vernier must be one tenth of a tenth (or one hundredth) of an inch from agreement with the next *scale* division: the following vernier line must be two hundredths out; and so on: therefore, the number

of such differences (from the next tenth on the scale) at which a vernier line agrees with a scale line, when set, is the number of hundredths to be added to the said tenth; (in a common barometer, reading only to hundredths of an inch).

The vernier of a barometer reading to thousandths of an inch, is on a similar principle, though differently divided. In this application of it, generally, twenty-five vernier spaces equal twenty-four of the scale spaces, which are each half a tenth, or five hundredths of an inch; therefore, the difference between one of the vernier and one of the scale is two tenths of a hundredth, or two thousandths of an inch [25)050(002].

This is the usual graduation of scientific barometers; but for ordinary purposes, as weather-glasses, a division, or reading, to the hundredth of an inch is sufficient.

When set properly, the vernier straight edge, the top of the mercury, and the observer's eye, should be on the same level; the edge (or pointer) just *touching*\* the middle and uppermost point of the column.

Great care should be taken to look thus square, or at right angles to the scale.

Light, or something white, at the *back* of the tube, assists in accurately setting the vernier.

---

The aneroid has been recommended, in these pages, as a weather-glass; but it may increase its usefulness to append a table for measuring heights (approximately) by this, or any barometer, which can be compared with another, or itself, at a higher or lower station.†

---

The difference between the number of feet opposite the height of a barometer, at one station, and that at another station, is their difference of height, nearly.

---

\* Like the sun's edge, or limb, touching the sea horizon, as seen inverted when using a sextant.

† If a measure of a height rather greater than the aneroid will commonly show, be required—*re-set* it, thus—When at the upper station (*within its range*), and having noted the reading carefully, touch the screw behind so as to bring back the hand a few inches (if the instrument will admit), then read off and start again. *Reverse the operation when descending*. This may add some inches of measure *approximately*.

25

TABLE.

| Barometer<br>Inches. | Height in<br>feet. | Barometer<br>Inches. | Height in<br>feet. | Barometer<br>Inches. | Height in<br>feet. |
|----------------------|--------------------|----------------------|--------------------|----------------------|--------------------|
| 31·0                 | 0                  | 26·8                 | 3829               | 22·7                 | 8201               |
| 30·9                 | 85                 | 26·7                 | 3927               | 22·6                 | 8317               |
| 30·8                 | 170                | 26·6                 | 4025               | 22·5                 | 8434               |
| 30·7                 | 255                | 26·5                 | 4124               | 22·4                 | 8551               |
| 30·6                 | 341                | 26·4                 | 4223               | 22·3                 | 8669               |
| 30·5                 | 427                | 26·3                 | 4323               | 22·2                 | 8787               |
| 30·4                 | 513                | 26·2                 | 4423               | 22·1                 | 8906               |
| 30·3                 | 600                | 26·1                 | 4524               | 22·0                 | 9025               |
| 30·2                 | 687                | 26·0                 | 4625               | 21·9                 | 9145               |
| 30·1                 | 774                | 25·9                 | 4726               | 21·8                 | 9266               |
| 30·0                 | 862                | 25·8                 | 4828               | 21·7                 | 9388               |
| 29·9                 | 950                | 25·7                 | 4930               | 21·6                 | 9510               |
| 29·8                 | 1038               | 25·6                 | 5033               | 21·5                 | 9632               |
| 29·7                 | 1126               | 25·5                 | 5136               | 21·4                 | 9755               |
| 29·6                 | 1215               | 25·4                 | 5240               | 21·3                 | 9878               |
| 29·5                 | 1304               | 25·3                 | 5344               | 21·2                 | 10002              |
| 29·4                 | 1393               | 25·2                 | 5448               | 21·1                 | 10127              |
| 29·3                 | 1482               | 25·1                 | 5553               | 21·0                 | 10253              |
| 29·2                 | 1572               | 25·0                 | 5658               | 20·9                 | 10379              |
| 29·1                 | 1662               | 24·9                 | 5763               | 20·8                 | 10506              |
| 29·0                 | 1753               | 24·8                 | 5869               | 20·7                 | 10633              |
| 28·9                 | 1844               | 24·7                 | 5976               | 20·6                 | 10760              |
| 28·8                 | 1935               | 24·6                 | 6083               | 20·5                 | 10889              |
| 28·7                 | 2027               | 24·5                 | 6190               | 20·4                 | 11018              |
| 28·6                 | 2119               | 24·4                 | 6297               | 20·3                 | 11148              |
| 28·5                 | 2211               | 24·3                 | 6405               | 20·2                 | 11278              |
| 28·4                 | 2303               | 24·2                 | 6514               | 20·1                 | 11409              |
| 28·3                 | 2396               | 24·1                 | 6623               | 20·0                 | 11541              |
| 28·2                 | 2489               | 24·0                 | 6733               | 19·9                 | 11673              |
| 28·1                 | 2582               | 23·9                 | 6843               | 19·8                 | 11805              |
| 28·0                 | 2675               | 23·8                 | 6953               | 19·7                 | 11939              |
| 27·9                 | 2769               | 23·7                 | 7064               | 19·6                 | 12074              |
| 27·8                 | 2864               | 23·6                 | 7175               | 19·5                 | 12210              |
| 27·7                 | 2959               | 23·5                 | 7287               | 19·4                 | 12346              |
| 27·6                 | 3054               | 23·4                 | 7399               | 19·3                 | 12483              |
| 27·5                 | 3149               | 23·3                 | 7512               | 19·2                 | 12620              |
| 27·4                 | 3245               | 23·2                 | 7625               | 19·1                 | 12757              |
| 27·3                 | 3341               | 23·1                 | 7729               | 19·0                 | 12894              |
| 27·2                 | 3438               | 23·0                 | 7854               | 18·9                 | 12942              |
| 27·1                 | 3535               | 22·9                 | 7969               | 18·8                 | 13080              |
| 27·0                 | 3633               | 22·8                 | 8085               | 18·7                 | 13219              |
| 26·9                 | 3731               |                      |                    |                      |                    |



## Acknowledgments and Photo Credits

My sincere thanks to all the people who generously gave their time and specialized knowledge to help this project:

Ed Arnold  
Ed Boden  
John Letcher  
Nick Newman  
Victor Shane  
Eric Sponberg  
Priscilla Travis

Page 11 illustration adapted from *Waves and Beaches* by Willard Bascom.

Page 13 illustration adapted from *Bowditch*.

Page 18 photograph courtesy Fjellanger Widere.

Pages 20 and 194 photos courtesy Richard Bennett.

Pages 24–27 courtesy of Kristian B. Dysthe, University of Bergen, Norway.

Page 25 photograph from *Smithsonian* magazine (February 1978) pp. 65–66.

Pages 62–63 illustrations courtesy of Miles Smeeton.

Pages 75, 76 photo and illustration courtesy Nicol Warn/ *WoodenBoat*.

Page 77 illustration courtesy Malö.

Page 81 photograph courtesy John Armitage.

Pages 127, 128 courtesy Priscilla Travis.

Page 145 photograph courtesy John Abernathy.

Page 147 photograph courtesy Seaclaw.

Page 178 photograph courtesy NOAA.

Illustrations on pages 10, 11, 13, 24, 27, 38, 39, 41, 43, 46, 54, 78, 80, 82, 92, 97, 101, 113, 137, 148, 150, 154, 183, and 185 by Ted Tollefson.

Photos and drawings not credited courtesy Hal Roth.

# Index

Numbers in **bold** indicate pages with illustrations

## A

Abernathy, John, 145  
Ace Sailmakers, 129, 144, 229  
Adak Island, 156  
*Adios*, 115  
*Adlard Coles' Heavy Weather Sailing* (Bruce), 143–44  
Admiralty publications. *See* British Admiralty publications  
Agulhas Current, 21, 26  
aids to navigation, 170–71  
aircraft carrier landings, 128–29  
Aleutian Islands, 163  
*American Practical Navigator* (Bowditch), 161  
anchors  
    as drogues, 112, 115, 139  
    lee shores and, 18–19  
*Ardevora*, 105–6  
Armitage, John, 78–80  
Arnold, Ed, 70, 127, 130–32  
*Atom*, 29–30  
*Awahnee*, 112

## B

backstays, 43–44  
*Banjo*, 22, 59–61  
bare poles, 68  
*Barometer and Weather Guide* (FitzRoy), 234–59  
barometers  
    forecasting with, 174, 234–59  
    hurricanes, readings during, 182  
    units of measurement, 173–74  
Barton, Humphrey, 56  
Bascom, Willard, 11, 31

Bass Strait, 16, **20**  
Beaufort wind scale, 4  
bell curve, 23, 27  
Bellingham Chart Printers, 169  
Bermuda sloop rigs, 37, **38**, 66  
berths, 198–200, **199**  
*Bits*, 143  
Blanche, tropical disturbance, 59–61  
Boden, Ed, 45–46, 60–61, 70, 165, 184  
Boylen, Alfred, 59–60  
breaking waves. *See also* giant waves  
    capsize from, 3, 16–17, 107, 115, 124–26  
    current, wind, and, 21–22, 26  
    damage from, 58–59  
    deep water, 13, 16–17, **20**  
    defined, 13, 21  
    height, 22–23  
    height, significant, 23  
    lying a-hull and, 58–**63**  
    plunge, 21  
    shoal water, 17–19, 21  
    spill, 21  
    troughs, 21, 22, 25  
    weight of, 58  
*Bremen*, 22  
bridle systems  
    drogues, 125–**26**, **127**, 129, 133–**34**, 140  
    parachute sea anchors, 94–98, **95**, **97**, 99  
British Admiralty publications  
    *Admiralty Distance Tables*, 160  
    charts, 171  
    *Mariner's Handbook*, 160  
    *Ocean Passages for the World*, 160, 162  
    *Pilots*, 160  
British Royal National Lifeboat Institution (RNLI), 118  
broaching, 69

Bruce, Peter, 143–44  
 BuORD (U.S. Bureau of Ordnance)  
   parachutes, 90, 96, 106, 140–41  
 Burman, Bruce, 107  
 Buys Ballot's Law, 192

**C**

cabin accommodations, 198–200, **199**  
*Caledonian Star*, 22  
 Cape Henlopen anchorage, **154**  
 capsize  
   breaking waves and, 3, 16–17, 107, 115,  
   124–26  
   Fastnet Race, 116–18, **117**  
   hull and rig design and, 117–18  
   Jordan's studies of, 119–26  
   size of boat and, 3, 121  
 Catarina, Cyclone, **178**  
 celestial navigation, 174–75  
*Celtic*, 107–9  
 chafe, 52–53, 91–93, **92**, 96  
 chainplates, 125, 129, 140  
 Chart 7 (“World Sailing Ship Routes”), 162  
*Chart No. 1*, 161  
 charts  
   accuracy of, 165, 168–70  
   availability of, 169, 170, 171  
   buying before a trip, 167  
   corrections to, 170–71  
   cost of, 169, 170  
   of current, 156–59, **158**  
   datum for, 170  
   electronic vs. paper, 167–69  
   *Pilots*, relationship to, 160  
   resources for, 230  
   stowage, 171  
   using, 169, 171  
   of wind, 156–59, **158**  
 clawing off, 48  
 clouds, 177  
 Clyde Cruising Club, 162  
 cockpit design, 127–28  
*Cohoe*, 16, 56  
 Coles, K. Adlard, 16, 56  
 commercial ships, 163  
 computers, 168, 169, 174

computer software, 175–76  
 Coppins, Bill, 78, 85, 88, 90, 92–93, 100, 109,  
   146, 229  
 coral reefs, 164, 165  
 Cornell, Jimmy, 163  
 Crawford, William, 192  
 crew changes, 155  
 cruising guides, 2  
*Cruising Guide to New England* (Duncan and  
   Ware), 162  
 current  
   charts of, 156–59, **158**  
   wind, wave development, and, 21–22, 26  
   wind speed and, 104  
 cyclones, **178**, 181. *See also* hurricanes

**D**

Danielson, Gary, 134  
 dead reckoning, 174  
 deep water  
   breaking waves, 13, 16–17, **20**  
   safety of vessel and, 48–49  
   velocity of waves, 12–**13**  
   wavelength in, 13, 16  
   waves in, 11–**13**  
 Delta drogue, 147–49, **148**  
*Destiny*, 141  
 diffraction, **18**, 26  
 Dilly, Noel, 143  
 Dinius, Dana, 141  
 Dinius, Paula, 141  
*Distances Between Ports*, 161  
*Drag Device Data Base* (Shane), 99, 100, 109,  
   139, 140  
 Draupner oil rig platform, 23, **24**  
 drogues. *See also* Delta drogue; Galerider drogue;  
   Jordan Series drogue; Para-Drogue; Seabrake  
   drogue; Seaclaw drogue  
   advantages of, 111, 143–44  
   bridle systems, 125–**26**, **127**, 129, 133–**34**,  
   140  
   capsize prevention with, 124–26  
   chainplates for, 125, 129, 140  
   conditions for, 72  
   experiences of sailors, 112–15, 140–41  
   hurricanes and, 193

- Jordan's studies of, 121–26  
 limitations of, 121–22  
 materials for, 112, 139  
 parachute sea anchors compared to, 143–44  
 performance of, 129, 140, 143–44  
 recovering, 114, 129, 131–**34**, 136, 139  
 resources for, 229–30  
 rudder and, 111–12, 143  
 steering while using, 111–12, 127, 140, 148, 149, 150  
 theory of, 110, 111, 134–35, 140  
 turning vessel with, 22  
 uses for, 148–49
- Duncan, Roger, 162
- E**
- Egress II*, 135–36  
 electronic charts, 167–69  
 European Space Agency, 23–24  
 extreme wave. *See* breaking waves;  
 giant waves
- F**
- Fastnet Race, 116–18, **117**  
 fear, 195, 196–98, 200–202  
 Ferguson, Michael, 140  
 fetch, 17  
*Firecrest*, 28–29  
 FitzRoy, Robert, 234–59  
*Flight of the Firecrest* (Gerbault), 28–29  
 flow channel, **11**  
 food, 196, 198  
 Force 4 winds, 6, 14  
 Force 5 winds, 6, 14, 17  
 Force 6 winds  
   onboard control methods, 34, 53, 72  
   sea conditions, 6, 14  
 Force 7 winds  
   hull and rig design, sailing skills, and, 118  
   onboard control methods, 34, 53, 55, 72  
   sea conditions, 6, 14  
 Force 8 winds  
   hull and rig design, sailing skills, and, 118  
   onboard control methods, 34, 55, 72  
   sea conditions, 6, 15, 17  
 Force 9 winds  
   bare poles, 68  
   chance of sailing in, 72  
   hull and rig design, sailing skills, and, 118  
   onboard control methods, 34, 72  
   sea conditions, 6, 15, 17
- Force 10 winds  
   Fastnet Race, 116–18, **117**  
   hull and rig design, sailing skills, and, 118  
   off-boat control methods, 72–73  
   sea conditions, 6, 15  
   *Tzu Hang* experience, 61–**63**
- Force 11 winds, 6, 15  
 foreign ports, 155–56, 164  
 forereaching, 51–52  
 forestay, 43–44  
 freak wave. *See* breaking waves; giant waves  
 French charts, 171, 230  
 fresh breeze, 17  
*Freya*, 107
- G**
- Galerider drogue  
   alternative uses for, 114  
   design and dimensions of, 112–**13**  
   experiences of sailors, 112–14, 134, 136–40  
   performance of, 139, 140, 144–45  
   recommendation, 144–45  
   recovering, 114, 131, 139  
   resources for, 230
- Gau, Jean, 29–30  
 Gerbault, Alain, 28–29  
 Gerstner, Franz, 10–11  
 giant waves. *See also* breaking waves  
   causes of, 26–**27**  
   damage from, 22–23, **25**–26, 60–61  
   evidence of, 23–**25**  
   height, 22–23, **24**  
   Linear Model, 23  
   literary mentions of, 27–30  
   research on, 23–24  
   troughs, 22, 25, 26–**27**
- glossary, 154, 203–24  
 GPS (global positioning system), 165, 170, 171, 175  
 Great Britain, U.K. Hydrographic Office, 160.  
   *See also* British Admiralty publications

GRIBs (gridded binary files), 176  
 Griffith, Bob, 112  
 Griffiths, Maurice, 81  
 Gulf Stream, 21, 113

## H

*Hale Kai*, **81**  
 Hasse, Carol, 50  
 Hathaway, Reiser, and Raymond, 114, 144  
 headsails  
   lowering in a storm, 67–68  
   reefing, 44–**46**, 66, 68  
   running off, 66–68, 70  
 heaving-to  
   balance of yacht and, 55  
   chafe and, 52–53  
   conditions for, 34, 72  
   Pardey's technique, 96  
   tack choice and, 58  
   techniques, 49–51, **50**  
 height of waves, **10**, 12, 16, 17, 22–23, **24**  
 height of waves, significant, 14–15, 17, 23  
 Henlopen anchorage, Cape, **154**  
 Herring, Richard, 136–39, **137**  
 Hinz, Earl, 77–78  
 Hinz sail, 77  
 Hiscock, Eric, 48, 76, 78  
 Hiscock, Susan, 48  
 hockling, 100  
 holes in the sea, 21, 25  
 Hoyt, Garry, 39  
*Hudie*, 112, 140–41  
 hull and rig design  
   capsize and, 117–18  
   cockpit design, 127–28  
   parachutes and, 96, 97–98  
   sea anchors and, 74–77, **75**, **76**, **77**, 81–82  
   size of boat and capsize risk, 3, 121  
 Humboldt Current, 105  
 Hurricane Ivan, 24  
 Hurricane Juan, 112  
 hurricanes  
   avoiding, 181, 186  
   characteristics of, 179  
   conditions in, 6, 118–19  
   dangerous semicircle, 182–86, **183**

development and movement of, 179–81, **180**  
 eye, movement of, 182  
 forecasting movement of, 187–93, **191**  
 lee shore and, 19  
 navigable semicircle, 182–86, **183**  
 off-boat control methods, 193  
 1-2-3 Rule, 187–92, **191**  
 origin of word, 179  
 predictive features, 181–82  
 sailing in, **194**  
 size of, 181  
 stories of sailing in, 7  
 34-Knot Rule, 187  
 warning information, 186–87  
 winds and movement of, 182–86, **183**, **185**

## I

in-phase interaction, 26  
*Instant Weather Forecasting* (Watts), 177  
 “Investigation of the Use of Drogues to  
   Improve the Safety of Sailing Yachts”  
   (U.S. Coast Guard and Jordan), 124–26,  
   129  
 Ioke, Tropical Storm, 188–92, **191**  
 islands, 164  
 Ivan, Hurricane, 24

## J

Jordan, Donald  
   aircraft carrier landings, 128–29  
   capsize studies by, 3, 117–29  
   career of, 116  
   drogue recovery, 131–32  
   drogue studies and development, 121–29,  
     134–35  
   “Investigation of the Use of Drogues to  
     Improve the Safety of Sailing Yachts,”  
     124–26, 129  
   parachute sea anchor studies, 121  
 Jordan Series drogue  
   application table, 124  
   availability of, 129, 144  
   bridle systems, 125–**26**, **127**, 129, 133–**34**  
   cost of, 129  
   development and design of, **122–24**, **128**  
   experiences of sailors, 130–36, 139–40

hurricanes and, 193  
 performance of, 129, 136, 139, 140, 143–44  
 recommendation, 144  
 recovering, 129, 131–**34**, 136  
 resources for, 229  
 stowage, **128**, 129  
 Juan, Hurricane, 112  
 Junger, Sebastian, 25

## K

Kanter, Charles, 90  
 Karman vortex street, 57  
 Kelvin Hughes, 171  
 ketch rigs, 44  
 Kiberg, Norway, **18**  
 knots-to-feet-per-second conversion, 16  
 Knox-Johnston, Robin, 139  
 Kuroshio Current, **iv**, 21

## L

laptop computers, 168, 169  
 Leander, Hans, 77  
 leeboards, 200  
 lee cloths, **199**, 200  
 lee shores, 18–19, 48  
 Leeuwin, Cape, **101**, 102–3  
 Leonard, Beth, 114, 131  
 Letcher, John, 58  
 light lists, 161, 170  
 line. *See* nylon line  
 Linear Model, 23  
 lying a-hull, 55–63  
   breaking waves and, 58–**63**  
   conditions for, 34, 72  
   danger of, 58–59  
   experiences of sailors, 56, 59–**63**  
   slick and, **54**, 56–58  
   tack choice and, 58

## M

MacKinnon, Jacinta, 136–39, **137**  
 mainsail  
   reefing, 37–40, **38**, **39**, 67  
   running off, 66, 67  
 maintenance, 155  
 Malö, 77

Maury, Matthew Fontaine, 157, 159  
 McAbee, Pamela, 107–9  
 McAbee, Steven, 107–9  
 McAbee, Zach, 107–9  
 McCracken, Alby, 84–85, 86, 88, 149–50, 229  
 merchant ships, 163  
 meteorological pamphlet, 234–59  
*Michelangelo*, 22  
*Moon Boots*, 134  
*Moonstruck*, 136–39, **137**

## N

navigation  
   GPS, 165, 170, 171, 175  
   successful, 170–71  
   weather and navigational systems, 174–75  
*Never Monday*, 136  
 Newman, Nick, 57–58  
*NGA Light Lists*, 161  
 night sailing, 197–98  
*Nomad*, 130  
 nonlinear effect, 26–27  
 Norgrove, Ross, 30, 81, 82  
 Northern Hemisphere, 3, 156, 176, 177  
*Norwegian Dawn*, 22  
*Notice to Mariners*, 170, 171  
 nylon line, 86, 93, 100

## O

Ocean Cruising Club, 156, 230  
 OceanGrafix, 169  
*Ocean Passages for the World* (U.K. Hydrographic Office), 160, 162  
 off-boat control methods, 7, 72–73, 143  
 Olson, Roger, 106  
 onboard control methods, 7, 34, 72  
 1-2-3 Rule, 187–92, **191**

## P

Paine, Art, 169  
 Para-Anchor, 84–85, 86, 229  
 parachute sea anchors. *See also* Para-Anchor; U.S. Bureau of Ordnance (BuORD) parachutes  
   bridle systems, 94–98, **95**, **97**, 99  
   conditions for, 72  
   cost of, 90

parachute sea anchors. (*Cont.*):

- damage to, 90
  - design and dimensions of, **82–83**, **84–85**, 89–90
  - drogues compared to, 143–44
  - effectiveness of, 99
  - experiences of sailors, 94–96, 100–109, 136
  - hull and rig design and, 74–78, **75**, **76**, **77**, 81–82, 96, 97–98
  - Jordan's studies of, 121
  - limitations of, 86–89
  - market for, 89–90
  - performance of, 90, 105, 108, 109, 143, 144
  - recovering, 89
  - resources for, 229
  - riding sails, 76, **78–81**
  - rode, adjusting length of, 87, 88, 89
  - rode, chafe problems, 91–93, **92**, 96
  - rode, chain, 88–89, 91–**92**
  - rode, cost of, 100
  - rode connections, **92**, 93–94
  - rode recommendations, 85–86, 93–98, 99–100
  - rudder and, 87, 88, 111
  - setting, 89
  - sizing of, 84–**85**, 106
  - slick and, 98
  - steering while using, 111
  - theory of, 74, 84
  - Trilibrium Factors, 87
  - turning vessel with, 22
  - Voss's technique, 74–**76**
  - Voss-type, **82**, 83
- Para-Drogue, 149–**50**
- Para-Tech Engineering Company
- bridle systems, 96–**97**
  - contact information, 229
  - experiences of sailors with parachute from, 88, 101–6, 107–9
  - rode, sea anchor, 88
- Pardey, Larry, 94–96, 97–98, 99
- Pardey, Lin, 94–96, 97–98, 99, 132
- parking a boat, 50
- passage planning. *See also* pilot charts
- avoiding storms, 2–3, 109, 143, 156, 163, 173

- coastal cruising, 165
- commercial ships, assistance from, 163
- coral reefs, 164, 165
- crew changes, 155
- foreign ports, 155–56, 164
- guides for, 2, 156–63, **158**, 230
- islands, 164
- longer routes, 163–64
- maintenance along the way, 155
- schedules, 165–66
- shipping lanes, 165
- tips and recommendations, 163–66
- weather considerations, 2–3, 155, 156, 163–64

Passano, Pete, 165

*Perfect Storm, The* (Junger), 25

period, **10**, 11–**13**, 14–15, 17

Perugini, Nick, 168–69

## pilot charts

- accuracy of, 159
- availability of, 159
- cost of, 159
- information on, **158**
- passage planning with, 2
- Sailing Directions*, 156–62, **158**

*Pilots*

- availability of, 159–61
  - passage planning with, 2
  - printing, 161–62
  - sales of, 160
  - special guides, 162
  - updates to, 160
- pitchpole, 110
- pleasures of sailing, 2
- Preciosa*, 170
- Prisana II*, 88, 100–105, **101**, **102**

**Q**

*Queen Elizabeth II*, 22

Queen's Birthday Storm, 140, 141

**R**

*Radar Navigation and Maneuvering Board Manual*, 161

*Radio Navigational Aids*, 161

*Ramapo*, 22

- Raymond, Skip, 112–13, 114, 144
- reefing sails, 37–46
  - conditions for, 34, 72
  - mainsail, **36**, 37–40, **38**, **39**, 67
  - roller-furling headsail, 44–46, 66, 68
  - roller-reefing mainsail boom, **36**, 40
  - single-line reefing, 39
  - slab reefing, 37–40, **38**, **39**
  - vertical mainsail furling, 40
- riding sails, 76, **78–81**
- rivers, 21–22
- Robinson, W. A., 76
- rode, sea anchor
  - adjusting length of, 87, 88, 89
  - chafe problems, 91–93, **92**, **96**
  - chain, 88–89, 91–**92**
  - connections, **92**, 93–94
  - cost of, 100
  - recommendations, 85–86, 93–98, 99–100
- rogue wave. *See* breaking waves; giant waves
- roller-furling headsail, 44–46, 66, 68
- roller-reefing mainsail boom, **36**, 40
- Rosenthal, Wolfgang, 23–24
- Royal Ocean Racing Club, 143
- rudder
  - drogues and, 111–12, 143
  - heaving-to and, 49–50, 51
  - lying a-hull and, 56
  - parachute sea anchors and, 87, 88, 111
  - shaft, twisted, 88, 104, 105
- running backstays, 43–44
- running off, **64–70**
  - advantages of, 65
  - biblical reference to, 66
  - broaching, 69
  - conditions for, 34, 72
  - entering bays or rivers, 68
  - exhilarating sailing of, 68–69
  - headsails, 66–68, 70
  - mainsail, 66, 67
  - sea room and, 66
  - shortening sail, 66–68, 69–70
  - steering, 70
  - wind strength, 70
- S**
- sailboats. *See* hull and rig design
- Sailing Alone Around the World* (Slocum), 27–28
- sailing and storm experience, 5, 7, 110–11, **152**, 231–33
- Sailing Directions*, 156–62, **158**
- Sailing Directions Planning Guides*, 161
- Sailing organizations, 230
- sails. *See also* reefing sails
  - chafe, 52–53
  - forereaching and, 51–52
  - headsails, 44–46, 66–68, 70
  - heaving-to and, 49–**50**, 51
  - mainsail, **36**, 37–40, **38**, **39**, 66, 67
  - riding sails, 76, **78–81**
  - rig styles and, 44
  - sheeting angles, 45–46
  - staysail, 43–44, 68
  - storm trysail, 40–**43**
- Santa Cruz 50, 51, 97–98, 115
- satellite telephones, 176
- schedules, 165–66
- schooner rigs, 44
- Scotland *Pilot*, 162
- sea anchors. *See* parachute sea anchors
- Sea Bear*, 165
- Seabrake drogue, 139, **145–46**, 230
- Seaclaw drogue, 146–47, 230
- Sea Queen*, 76
- sea room, 47–49, 66
- seas. *See also* breaking waves; giant waves
  - fully developed sea, 9
  - swell, 30–31
  - table of sea conditions, 14–15
  - wind-built seas and sailboat handling, 3
- Sea Squid drogue, 141
- seawater, weight of, 58
- Sebago* log, 231–33
- self-confidence, 196–97
- send-off parties, 165
- series drogues. *See* Jordan Series drogue
- Seven Seas Cruising Association, 156, 230
- Shane, Victor, 69, 99, 100, 109, 139, 140
- sheet blocks, 45–46
- sheets and chafe, 52–53
- shipping lanes, 165



- shoal water  
 breaking waves, 17–19, 21  
 diffraction, **18**, 26
- slab reefing, 37–40, **38**, **39**
- slick  
 defined, 51  
 heaving-to and, 51  
 lying a-hull and, 56–58, **57**  
 parachutes and, 98
- Slocum, Joshua, 27–28
- sloop rigs, 37, **38**, **46**
- Smeeton, Beryl, 61–63
- Smeeton, Miles, 61–63
- smooth, 56. *See also* slick
- Smythe, Bill, 170–71
- Snyder, Frank, 112–14
- software, 175–76
- Southerly*, 113–14
- Southern Hemisphere, 3, 156, 176
- spinnaker poles, 66–67
- Spray*, 27–28
- square drift, **50**
- Stand Aside*, **20**
- Star Pilot, 174
- staysail, 43–44, 68
- staysail blocks, 44
- Steele, Tom, 115, 139
- steering. *See also* rudder  
 with drogues, 111–12, 127, 140, 148, 149, 150  
 with parachute sea anchors, 111  
 running off, 70
- Stein, Corrie, 132–33
- Stein, Willem, 132–33
- steps to handling storms, 7, 142
- St. Leger*, 140
- storms. *See also* hurricanes  
 avoiding, 2–3, 109, 143, 156, 163, 173  
 eating during, 196, 198  
 entering bays or rivers, 68  
 experience and acceptance of, 195–96, 198  
 exposure to, 34  
 preparation for, 110–11  
 sailing and storm experience, 5, 7, 110–11, **154**, 231–33  
 scheme for managing, sticking with a, 139  
 sea room and, 47–49  
 steps to handling, 7, 142  
 stories about, 7–8, 111  
 winter sailing, 2–3, 109, 156
- storm trysail, 40–**43**
- Subaili*, 139
- summer sailing, 2–3
- superwave. *See* breaking waves; giant waves
- survival, 200
- swell, 30–31
- Sydney-Hobart race, **20**, 22, 61, **194**
- T**
- table of sea conditions, 14–15
- Taleisin*, 94–**95**
- Tangvald, Peter, 8
- Tennant, Mal, 160
- Terra Nova*, 132–33
- 34-Knot Rule, 187
- Thomson, Andy, 19
- Thomson, Jack, 135–36
- Thomson, Norma, 135–36
- Tiama*, 132
- Tiare Taporo*, 19
- tides, 68
- Tilikum*, 74–**76**
- timekeeping, 174–75
- tires as drogues, 112
- To Challenge a Distant Sea* (Gau), 29–30
- Trafford, Tim, 105–6
- trains, wave, 31, 141
- Travis, Priscilla, 169
- Treston, Pat, 112
- Trilibrium Factors, 87
- Tropical Storm Ioke, 188–93, **191**
- trysail, 40–**43**
- tsunamis, 30
- typhoons, 180. *See also* hurricanes
- Tzu Hang*, 61–**63**
- U**
- U.K. Hydrographic Office, 160
- University of Southampton, School of Engineering Sciences, 143
- U.S. Bureau of Ordnance (BuORD)  
 parachutes, 90, 96, 106, 140–41

- U.S. Coast Guard  
 capsizes studies with Jordan, 120  
 “Investigation of the Use of Drogues to Improve the Safety of Sailing Yachts,” 124–26, 129  
*USCG Light Lists*, 161  
 U.S. Government Printing Office, 162  
 U.S. Navy, Depot of Charts and Instruments, 157, 159
- V**  
 velocity, 12–13  
 Voss, J. C., 74–76, 75  
 Voss-type sea anchor, 82, 83
- W**  
 W. A. Coppins, 78, 85, 146, 229  
*Wanderer II*, 48  
 Ware, John, 162  
 Watts, Alan, 177  
 wave channel, 11  
 waves. *See also* breaking waves; giant waves  
 amplitude, 10  
 Beaufort wind scale, 6  
 crest, 10, 12, 17  
 crest angle, 16  
 diffraction, 18, 26  
 fully developed sea, 9  
 height, 10, 12, 16, 17  
 height, significant, 14–15, 17, 23  
 period, 10, 11–13, 14–15, 17  
 refraction, 18  
 slick and, 56–58, 57, 98  
 stacking effect, 141  
 table of sea conditions, 14–15  
 theory of, 10–13  
 trains, 31, 141  
 trough, 10  
 velocity, 12–13  
 wavelength, 10, 11–13, 16, 17  
 wind and development of, 9, 17  
*Waves and Beaches* (Bascom), 11  
 weather  
 computer software, 175–76  
 forecasting, 174, 175–77, 234–59  
 information sources, 174, 175, 177, 186–87  
 passage planning and, 155, 156, 163–64  
 weather and navigational systems, 174–75  
 weatherfax, 174, 187  
 weight of breaking waves, 58  
*W.H.D.C. Wright*, 159  
 Whilldin, Don, 88, 96–97, 147–49, 229  
 whisker poles, 66–67  
*Whisper*, 34, 171  
 white caps, 17  
 white horses, 17  
*White Squall*, 30, 82  
*Wilstar*, 25  
 wind  
 Beaufort wind scale, 4  
 charts of, 156–59, 158  
 current and wave development, 21–22, 26  
 current and wind speed, 104  
 forecasting weather from, 175–76  
 rose, 158  
 running off and wind strength, 70  
 speed of, exaggeration of, 7–8  
 strength of and sailboat handling, 3  
 wave development and, 9, 17  
 wind-measuring devices, 8  
*Winston Churchill*, 22, 61  
 winter sailing, 2–3, 109, 156  
*World Cruising Routes* (Cornell), 163  
 World Geodetic System 1984 (WGS 1984), 170  
 “World Sailing Ship Routes” (Chart 7), 162
- X**  
*Xiphias*, 106
- Y**  
 yawl rigs, 44
- Z**  
 Zinga, Greg, 168