

SECOND EDITION

Emergency Navigation

Find Your Position
and Shape Your Course at Sea
Even If Your Instruments Fail

David Burch

Founder and President,
Starpeth School of Navigation

"Anyone venturing offshore should read this book thoroughly." –Yachting

Emergency Navigation

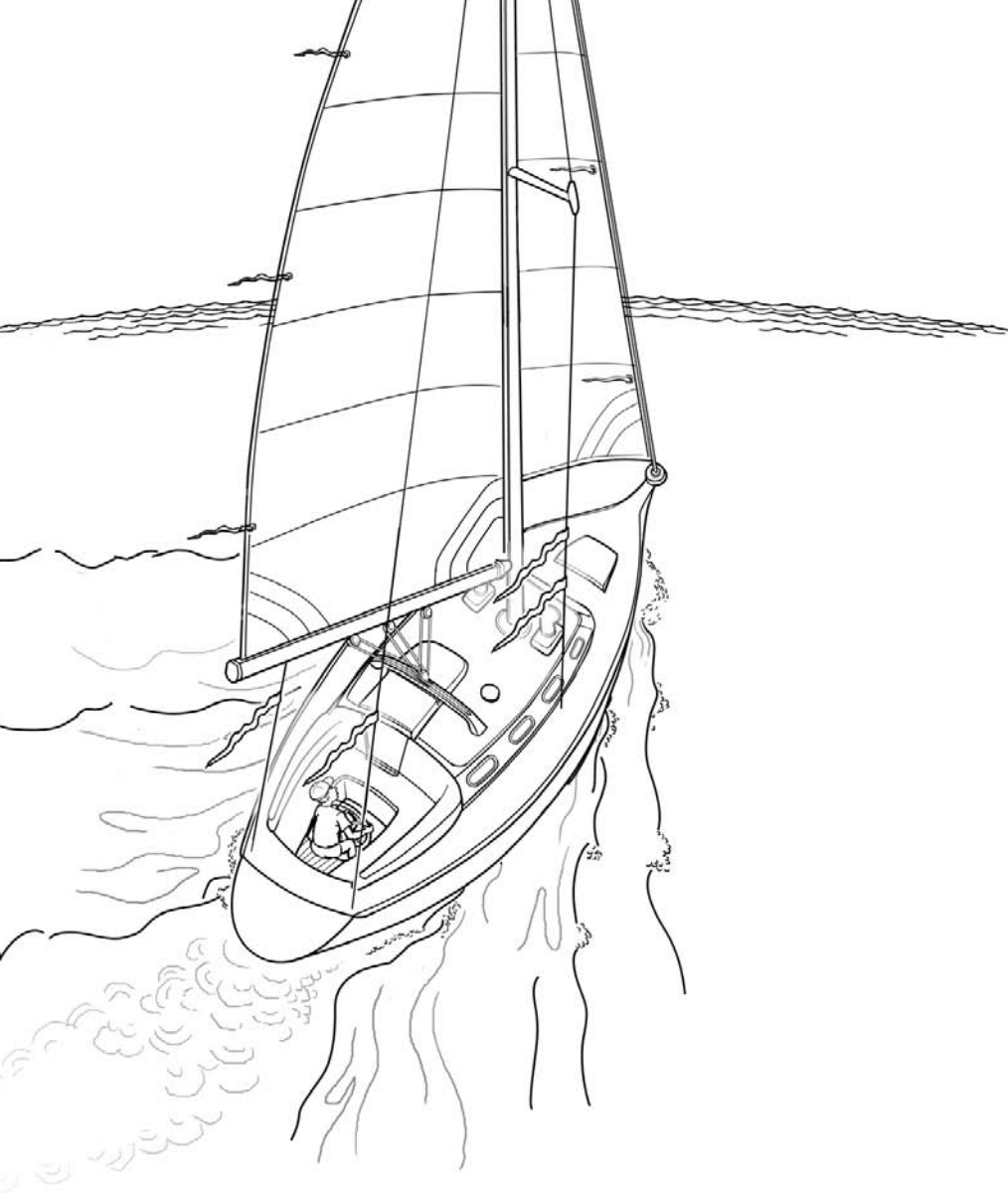

SECOND EDITION

Emergency Navigation

Find Your Position
and Shape Your Course at Sea
Even If Your Instruments Fail

David Burch



International Marine / McGraw-Hill

Camden, Maine • New York • Chicago • San Francisco • Lisbon • London • Madrid • Mexico City • Milan
New Delhi • San Juan • Seoul • Singapore • Sydney • Toronto

Copyright © 1986 by International Marine and © 2008 by David F. Burch. All rights reserved. Manufactured in the United States of America. Except as permitted under the United States Copyright Act of 1976, no part of this publication may be reproduced or distributed in any form or by any means, or stored in a database or retrieval system, without the prior written permission of the publisher.

0-07-164338-9

The material in this eBook also appears in the print version of this title: 0-07-148184-2.

All trademarks are trademarks of their respective owners. Rather than put a trademark symbol after every occurrence of a trademarked name, we use names in an editorial fashion only, and to the benefit of the trademark owner, with no intention of infringement of the trademark. Where such designations appear in this book, they have been printed with initial caps.

McGraw-Hill eBooks are available at special quantity discounts to use as premiums and sales promotions, or for use in corporate training programs. For more information, please contact George Hoare, Special Sales, at george_hoare@mcgraw-hill.com or (212) 904-4069.

TERMS OF USE

This is a copyrighted work and The McGraw-Hill Companies, Inc. ("McGraw-Hill") and its licensors reserve all rights in and to the work. Use of this work is subject to these terms. Except as permitted under the Copyright Act of 1976 and the right to store and retrieve one copy of the work, you may not decompile, disassemble, reverse engineer, reproduce, modify, create derivative works based upon, transmit, distribute, disseminate, sell, publish or sublicense the work or any part of it without McGraw-Hill's prior consent. You may use the work for your own noncommercial and personal use; any other use of the work is strictly prohibited. Your right to use the work may be terminated if you fail to comply with these terms.

THE WORK IS PROVIDED "AS IS." MCGRAW-HILL AND ITS LICENSORS MAKE NO GUARANTEES OR WARRANTIES AS TO THE ACCURACY, ADEQUACY OR COMPLETENESS OF OR RESULTS TO BE OBTAINED FROM USING THE WORK, INCLUDING ANY INFORMATION THAT CAN BE ACCESSED THROUGH THE WORK VIA HYPERLINK OR OTHERWISE, AND EXPRESSLY DISCLAIM ANY WARRANTY, EXPRESS OR IMPLIED, INCLUDING BUT NOT LIMITED TO IMPLIED WARRANTIES OF MERCHANTABILITY OR FITNESS FOR A PARTICULAR PURPOSE. McGraw-Hill and its licensors do not warrant or guarantee that the functions contained in the work will meet your requirements or that its operation will be uninterrupted or error free. Neither McGraw-Hill nor its licensors shall be liable to you or anyone else for any inaccuracy, error or omission, regardless of cause, in the work or for any damages resulting therefrom. McGraw-Hill has no responsibility for the content of any information accessed through the work. Under no circumstances shall McGraw-Hill and/or its licensors be liable for any indirect, incidental, special, punitive, consequential or similar damages that result from the use of or inability to use the work, even if any of them has been advised of the possibility of such damages. This limitation of liability shall apply to any claim or cause whatsoever whether such claim or cause arises in contract, tort or otherwise.

DOI: 10.1036/0071481842



Professional



Want to learn more?

We hope you enjoy this McGraw-Hill eBook! If you'd like more information about this book, its author, or related books and websites, please [click here](#).

Contents

List of Figures and Tables		viii
Foreword to the First Edition		xii
Preface to the Second Edition		xiii
Acknowledgments		xv
Chapter 1.	Introduction	1
	<i>What Is Emergency Navigation?</i>	1
	<i>The Scope of This Book</i>	2
	<i>Preparation for Navigational Emergencies</i>	3
Chapter 2.	Time and Place at Sea	9
	<i>Latitude Regions and Seasons Defined</i>	10
	<i>Time in Navigation</i>	12
	<i>Finding Position versus Keeping Track of Position</i>	13
Chapter 3.	Directions at Sea	15
	<i>Choosing a Route</i>	16
	<i>Compass Checks</i>	17
	<i>Steering without a Compass</i>	21
Chapter 4.	Steering by Wind and Swells	27
	<i>Reading the Wind</i>	29
	<i>Swells, Waves, and Ripples</i>	34
	<i>Wind Shifts</i>	37
Chapter 5.	Steering by the Stars	42
	<i>Know the Whole Sky</i>	42
	<i>How the Stars Move</i>	43
	<i>Steering by the North Star</i>	47
	<i>The Summer Triangle</i>	53
	<i>The Great Square of Pegasus</i>	54
	<i>Finding North without the North Star</i>	54
	<i>Steering by Orion</i>	56
	<i>Steering by Gemini and Procyon</i>	57
	<i>Steering by Scorpio</i>	58
	<i>Steering by the Southern Cross and the South Pole</i>	59
	<i>Steering by Overhead Stars</i>	62
	<i>Steering by Zenith Stars</i>	64
	<i>Star Paths</i>	70
	<i>Timing Low Stars</i>	72

Chapter 6.	Steering by the Sun	75
	<i>Sunrise and Sunset</i>	75
	<i>Morning Sun and Afternoon Sun</i>	78
	<i>Local Apparent Noon</i>	82
	<i>Solar Time Method</i>	86
	<i>The Shadow-Tip Method</i>	89
	<i>The Tropics Rule for the Sun</i>	93
	<i>Sun Crossing Due East or West</i>	93
	<i>Sun Compasses</i>	94
	<i>When the Sun Is Obscured</i>	98
Chapter 7.	Steering by Other Things in the Sky	99
	<i>The Moon</i>	99
	<i>The Planets</i>	106
	<i>Clouds, Birds, and Planes</i>	108
	<i>Satellites</i>	114
Chapter 8.	Steering in Fog or Under Cloudy Skies	115
	<i>How to Make a Magnetic Compass</i>	116
	<i>Direction Finding with a Portable Radio</i>	117
	<i>Streaming a Line along the Centerline</i>	119
	<i>Finding the Sun as a Viking Would</i>	121
Chapter 9.	Currents	124
	<i>Ocean Currents</i>	125
	<i>Tidal Currents</i>	128
	<i>Wind-Driven Currents</i>	129
	<i>Coastal Currents</i>	130
Chapter 10.	Dead Reckoning	132
	<i>Emergency DR</i>	132
	<i>Finding Boat Speed</i>	134
	<i>DR Errors from Speed and Direction</i>	136
	<i>DR Errors from Current and Leeway</i>	142
	<i>Progress to Weather</i>	146
Chapter 11.	Latitude at Sea	148
	<i>Makeshift Altitude Measurements and Calibrations</i>	148
	<i>Makeshift Altitude Corrections</i>	155
	<i>Latitude from Polaris</i>	156
	<i>Latitude from Zenith Stars</i>	159
	<i>Latitude from Horizon-Grazing Stars</i>	162
	<i>Latitude from Double Transits of Circumpolar Stars</i>	169
	<i>Latitude from the Sun at LAN</i>	170
	<i>Latitude from the Length of Day</i>	178
	<i>Keeping Track of Latitude</i>	183

Chapter 12.	Longitude at Sea	186
	<i>Longitude from Sunrise or Sunset</i>	187
	<i>Longitude from LAN (the Equation of Time)</i>	189
	<i>Finding UTC from a Known Position</i>	197
	<i>Keeping Track of Longitude</i>	197
Chapter 13.	Coastal Piloting without Instruments	201
	<i>Signs of Land at Sea</i>	202
	<i>Visible Range of Lights and Land</i>	207
	<i>Distance Off</i>	211
	<i>Running Fix from Radio Bearings</i>	216
	<i>Course Made Good in Current</i>	217
Chapter 14.	What to Do with What You've Got	219
	<i>Routine Navigation with Everything</i>	219
	<i>Position by Radio Contact</i>	226
	<i>Everything but UTC</i>	228
	<i>Everything but a Sextant</i>	234
	<i>Everything but Sight Reduction Tables</i>	240
	<i>Everything but a Compass</i>	245
	<i>Everything but an Almanac</i>	246
	<i>Nothing but UTC</i>	249
	Annotated Bibliography	250
	<i>Basic Marine Navigation</i>	250
	<i>Almanac Data</i>	251
	<i>Stars and Star Identification</i>	252
	<i>Finding Longitude without Time</i>	252
	<i>No-Instrument Navigation</i>	253
	<i>Emergency Seamanship</i>	256
	<i>Periodicals of Interest to Emergency Navigation</i>	256
	<i>Meteorology and Oceanography</i>	257
	<i>Published Aids to Navigation</i>	258
Index		260

List of Figures and Tables

Figure 1-1.	Section of a <i>U.S. Pilot Chart</i> near New Zealand.	6
Figure 1-2.	Backup navigational gear.	7
Figure 1-3.	A modern electronic navigation backup kit.	8
Figure 2-1.	Latitude regions in emergency navigation.	10
Figure 3-1.	A boat headed north, making good a course to the north-northwest.	16
Figure 3-2.	Windward sailing as a variation on parallel sailing.	17
Figure 3-3.	Backup method for checking a compass at sea.	19
Figure 3-4.	Portable compass card.	22
Figure 3-5.	A portable compass card in use.	22
Figure 3-6.	Estimating angles with hands and fingers at arm's length.	23
Figure 3-7.	Estimating distance off course from steering errors.	25
Figure 4-1.	Keeping track of a heading relative to clouds.	28
Figure 4-2.	Using telltales to read apparent wind direction.	30
Figure 4-3.	True wind direction versus apparent wind direction.	31
Figure 4-4.	Section of a <i>U.S. Pilot Chart</i> near Cuba.	33
Figure 4-5.	Swells, waves, and ripples.	35
Figure 4-6.	Wind shift at a (cold) front.	38
Figure 4-7.	Wind patterns around raining squalls.	39
Figure 4-8.	Guidelines for minimum course loss in a squall.	40
Figure 5-1.	How to locate the pole of the sky from known star groups.	43
Figure 5-2.	Nightly progression of the stars.	44
Figure 5-3.	"Pillars of light."	45
Figure 5-4.	Motion of eastern stars at various latitudes.	46
Figure 5-5.	Finding <i>Polaris</i> with the Pointers (<i>Dubhe</i> and <i>Merak</i>) of the Big Dipper.	48
Figure 5-6.	Finding <i>Polaris</i> from Cassiopeia.	49
Figure 5-7.	Polar stars viewed to the north and south from several latitudes.	50
Figure 5-8.	All stars fade as they descend toward the horizon.	51
Figure 5-9.	Ways to find <i>Polaris</i> .	53
Figure 5-10.	Using pointers to find north when <i>Polaris</i> is obscured.	55
Figure 5-11.	Orion on the horizon.	56
Figure 5-12.	Pointing <i>Mintaka</i> (leading star of Orion's belt) backward to the horizon to find east.	57
Figure 5-13.	The Gemini- <i>Procyon</i> line.	58
Figure 5-14.	Finding south from Scorpio.	59
Figure 5-15.	The Southern Cross.	60

Figure 5-16.	Ways to find the south pole of the sky.	61
Figure 5-17.	Finding south from <i>Achernar</i> and <i>Canopus</i> .	62
Figure 5-18.	Finding west from overhead stars.	63
Figure 5-19.	Application of the Half-Latitude Rule.	65
Figure 5-20.	Accuracy of the Half-Latitude Rule.	66
Figure 5-21.	Finding the declination of an unknown star from its peak height on the meridian.	68
Figure 5-22.	Graphical solution for amplitude.	69
Figure 5-23.	Polynesian star paths.	70
Figure 5-24.	Circumpolar star paths.	72
Figure 5-25.	Keeping track of star bearings by timing low stars.	73
Figure 6-1.	Path of the sun observed from northern latitudes showing peak heights and sunrise-sunset bearings throughout the year.	76
Figure 6-2.	Maximum amplitude of the sun at different latitudes.	77
Figure 6-3.	How the sun's amplitude varies with the date.	77
Figure 6-4.	Finding the sunrise location from the rising angle.	78
Figure 6-5.	Rising and setting angles at different amplitudes.	79
Table 6-1.	Rising Angles	80
Figure 6-6.	Timed arc for finding sunrise location.	81
Figure 6-7.	Using a kamal.	84
Figure 6-8.	Finding the time of LAN.	85
Figure 6-9.	Principle of the solar time method.	87
Figure 6-10.	Using the solar time method.	88
Figure 6-11.	Shadow tips move eastward throughout the day.	89
Figure 6-12.	Handheld shadow board for finding east.	90
Table 6-2.	Shadow-Tip Errors	91
Figure 6-13.	A shadow-pin sun compass.	95
Figure 6-14.	A kamal sun compass.	96
Figure 7-1.	The moon's eastward motion through the stars.	100
Figure 7-2.	Near full-moon view at local midnight.	102
Figure 7-3.	The lighted side of the moon points in the direction of the sun.	103
Figure 7-4.	Local morning view of a waning half-moon.	104
Figure 7-5.	Local evening view of a waxing half-moon.	104
Table 7-1.	Summary of Moon Behavior	105
Figure 7-6.	Using the moon's horns as an indicator of south and north.	106
Figure 7-7.	Planet identification.	106
Figure 7-8.	The apparent eastward motions of Venus and Jupiter through the stars.	107
Figure 7-9.	Winds aloft.	109
Figure 7-10.	Cirrus clouds as signs of winds aloft.	110
Figure 7-11.	Waves in cirrocumulus and altocumulus clouds.	111
Figure 7-12.	Air routes over the North Atlantic.	113
Figure 7-13.	Air routes over the North Pacific.	113

Figure 8-1.	A makeshift compass.	116
Figure 8-2.	Using a portable AM radio for radio direction finding.	118
Figure 8-3.	Streaming a line aft to hold course in the fog.	120
Figure 8-4.	Finding the bearing to the sun when it is below the horizon or obscured by clouds using a polarized lens and a sheet of cellophane.	122
Figure 9-1.	Major ocean currents of the world.	125
Figure 9-2.	A current log figured from a pilot chart.	127
Figure 9-3.	Analyzing rotary currents.	129
Figure 10-1.	Makeshift DR plots.	133
Figure 10-2.	Measuring boat speed with a chip log.	134
Figure 10-3.	Combining independent errors.	138
Figure 10-4.	Graphical way to find the position uncertainty caused by errors in steering and distance run.	140
Figure 10-5.	Position errors as percentages and how position uncertainty increases with distance run.	141
Figure 10-6.	Measuring leeway by streaming a line over the stern.	144
Figure 10-7.	Progress to weather.	146
Figure 11-1.	Using a kamal to measure small angles.	149
Figure 11-2.	Selected star-pair calibration angles.	150
Figure 11-3.	Graphical determination of the star spacings of the Southern Cross.	151
Figure 11-4.	Calibrating a kamal.	152
Figure 11-5.	Using a plumb-bob sextant.	153
Figure 11-6.	Winking your finger at arm's length to measure relative angles.	154
Figure 11-7.	Low-angle refraction corrections to sextant sights.	156
Figure 11-8.	Correction needed to find latitude from the height of <i>Polaris</i> .	158
Figure 11-9.	Finding latitude from zenith stars.	160
Figure 11-10.	Using a plumb line to spot zenith stars.	161
Figure 11-11.	Taurus and Orion passing over islands of the mid-Pacific, with details of the Marquesas.	163
Figure 11-12.	Latitude from the Southern Cross.	165
Table 11-1.	Opportunities for Latitude from Horizon-Grazing Stars	166
Figure 11-13.	Opportunities for finding latitude from horizon-grazing stars.	168
Figure 11-14.	Declination of the sun.	172
Figure 11-15.	Figuring the sun's declination from the date.	173
Figure 11-16.	A mariner's ring and ways to calibrate it.	176
Figure 11-17.	A makeshift pinhole quadrant assembled with clear 2-inch packing tape.	178
Figure 11-18.	A mariner's astrolabe.	179
Figure 11-19.	How sunrise and sunset times change with location on July 5.	182
Figure 11-20.	A makeshift plotting sheet.	183
Figure 11-21.	Progress to the south noted by descending stars.	184

Figure 12-1.	Motion of the sun's geographical position on a globe.	187
Figure 12-2.	Section of a sunrise-sunset table from a <i>U.S. Tide Table</i> .	188
Figure 12-3.	Interpolating sunrise-sunset tables for date and latitude.	190
Figure 12-4.	Measuring the time of LAN from observed watch times of sunrise and sunset.	191
Figure 12-5.	Comparison of three ways to find the UTC of LAN at Greenwich.	192
Figure 12-6.	The Equation of Time and the UTC of LAN at Greenwich, which is 12:00:00 corrected for the Equation of Time.	193
Figure 12-7.	Makeshift prescription for finding the Equation of Time (EqT).	194
Figure 12-8.	Errors in the makeshift prescription for the Equation of Time.	195
Figure 12-9.	An analemma.	196
Figure 12-10.	A makeshift plotting sheet.	198
Figure 12-11.	A makeshift chart showing a diagonal run of 89 miles with one course change.	199
Figure 13-1.	Cloud caps over an island and coastal mountain range.	202
Figure 13-2.	Mountain wave clouds as a sign of land.	203
Figure 13-3.	Possible air traffic approaches to a holding pattern off Bermuda.	204
Figure 13-4.	Reflected swell pattern.	205
Figure 13-5.	Refracted swell pattern near an isolated island or atoll.	206
Figure 13-6.	Visible range of land.	207
Figure 13-7.	Comparing geographic range and nominal range.	209
Figure 13-8.	Comparing nominal range and luminous range.	210
Figure 13-9.	Finding distance off by horizontal angle.	212
Figure 13-10.	Finding distance off by vertical angle.	213
Figure 13-11.	Doubling the angle on the bow.	215
Figure 13-12.	Running fix from radio bearings without a chart.	216
Figure 13-13.	Figuring current set.	218
Figure 14-1.	DR errors marked on a plotting sheet.	221
Figure 14-2.	Section of a logbook showing DR errors and error currents.	222
Figure 14-3.	Vector plot of DR errors.	224
Figure 14-4.	Another vector plot of DR errors.	225
Figure 14-5.	Section of a Marine Service Chart.	227
Figure 14-6.	Second plot of a star-moon fix for finding UTC.	232
Figure 14-7.	Final plot of the star-moon fix to find UTC.	233
Figure 14-8.	Sight reductions of horizon sights of the sun and moon.	238
Figure 14-9.	Plot of a sun-moon fix from horizon sights.	239
Figure 14-10.	Photo sextant sights.	239
Figure 14-11.	Plot of a high-altitude fix from overhead stars done without sight reduction.	242
Figure 14-12.	A single-star, high-altitude fix done without sight reduction.	243
Figure 14-13.	Section of a 2102-D Star Finder.	246

Foreword to the First Edition

David Burch's book is a comprehensive review of emergency navigation at sea that is a pleasure to read. Throughout the book he keeps returning to first principles of navigation, which he expounds with admirable clarity. His emergency procedures are explained in terms of natural (often astronomical) laws, so that their rationale is fully comprehensible and their practical applications and limitations clearly defined. The book is a far cry from some emergency handbooks, with their mixed bag of semi-anecdotal advice, and is not intended to serve as such. Yet in an emergency situation, with the sextant overboard and the watch broken, it would be of far more use to the unfortunate mariner.

But this work, despite its title, is far more than an essay on the principles and practice of emergency procedures. It is a particularly well-written account of the principles of navigation in general, and as such, cannot fail to bring fresh insights to all of us. Certainly it clarified for me certain areas of nautical astronomy that I thought I had grasped, but had not.

It is rare to read a book that is equally successful in expounding matters of principle and the practical realities of their application on the real ocean, but David Burch has succeeded in this also.

It is well to be overly conservative in matters of marine navigation—the reefs of the Pacific are littered with the wrecks of the overconfident. I merely want to stress that emergency navigation, as explained by David Burch, is not so very hard. Given this book to study, its practice is within the reach of any of us.

Non-instrumental navigation is often thought of in the context of the tropical Pacific where the feats of the Polynesians and Micronesians have focused our attention.

David Burch makes clear that its application is worldwide. After all, the Norse discoverers of America had no more instruments (if we discount the dubious sunstone) than the settlers of New Zealand. When we traversed the south magnetic pole in the southern summer of 1981–82, the compass was useless for 600 miles. There was admittedly a SatNav aboard, but for direction between fixes, a sun diagram was constructed much as is explained in this book. Together with swell, wave, and wind patterns, it enabled us to steer accurately, except on two occasions when we had to lie-to in calms when falling snow obscured the sun.

Polar and tropical seas are admittedly environmental extremes, particularly the former. Less exotic, but fully as serious, navigational emergencies may arise off Maine or California, and readers of this book will be well-armed with the knowledge to deal with them. Dip into its pages, then, for pleasure and profit; the stern specter of disaster apart, the book is stimulating, easy to read, and has something to teach everyone.

One last point, but not the least significant: every section and paragraph is permeated with sound practical seamanship. Apart from the work's other virtues, this alone would make it worthwhile.

—David Lewis, author of *We, the Navigators: The Ancient Art of Landfinding in the Pacific* and *Ice Bird: The Classic Story of the First Single-Handed Voyage to Antarctica*

Preface to the Second Edition

This book was first published in 1986 after about six years of research on the subject. From then until now we (myself and my colleagues at the Starpath School of Navigation) have worked continuously in the field of marine navigation and can proudly state that we have not found concept or technique errors in the book, nor have we found significant things that should have been included that were not. New technology has brought some new options, but we have lost a few as well—we can take sextant sights with cell-phone cameras now, but we cannot analyze the sights with the routing functions of a GPS (global positioning system) unit as we used to do with those of a Loran unit.

In 1986 electronic navigation for yachts was primarily Loran and the Transit Satellite Navigation system. This is all replaced now by GPS, which is more accurate and more dependable than either of those, and also more ubiquitous. Besides very small handheld units, GPS is on plug-in cards for laptops, in cell phones, and even wristwatch units. Bluetooth models that communicate wirelessly with computers and PDAs (personal digital assistants) throughout the boat are not much bigger than a marshmallow. It is almost negligent these days to go to sea—or even down a river—without a handheld GPS and a few extra batteries.

A few new emergency techniques have been added to this edition and some expanded upon, especially the role of a makeshift quadrant and related devices for taking sun sights—motivated in large part by the fact that several people have actually done this underway over the years with some success. Our work on Viking sunstones has also found its way into this book, with the adaptation of polarized sunglasses to the task of finding the sun when obscured by clouds. With the passage of time, there were changes on nearly every page, sometimes revised descriptions, but mostly due to changes in technology or government resources. Essentially every government agency related to navigation or marine weather has changed names or been restructured in some manner, and of course, there are now invaluable Internet references for all aspects of this book as there are for most aspects of modern life.

But the real shocker in the preparation of this second edition came creeping out of the details—the stars have moved! What we in the classroom call the fixed stars . . . the immutable stars . . . the one thing we can depend on to always be the same . . . they have moved. So now twenty-five years later *Polaris* is not 48' off the pole, it is 42'—a 6-mile shift in our reckoning when finding latitude by *Polaris*. Sad but true. Time goes by. Columbus saw the star some 3° off the pole 500 years ago, so I guess it all makes sense. It is of course the precession of the polar axis that causes this shift, not that of the stars, but from a navigator's perspective, it doesn't matter what causes it—the star is no longer where a 1986 almanac says it is. Thus we also needed to update the declinations of the stars mentioned in the text.

In theory, the need for the knowledge of this book should be decreasing. There are GPS units in most cell phones these days, and a satellite phone with worldwide coverage is within the budget of every oceangoing mariner, and solar chargers for both of these are improving steadily. But the reality is just the opposite. In fact, the more convenient the electronic options become,

the less time is spent learning fundamental navigation, and most of emergency navigation is just creative application of the basics. But when the basics are not there, the mariner has nothing to fall back upon. And anyone who regularly uses computers and electronic gadgets knows well they are not dependable. The more you work with them, the more you know how vulnerable they are. It could be as simple as one day you push in a button, and it does not come back out. Nothing works, and there is absolutely nothing you can do about it.

The need for basic navigation training has never been higher, and the value of practice with emergency techniques has not diminished with time—it is like taking some hours of aerobatics training when first learning to fly, so you know what to expect if you ever are forced to do anything like that.

Please see starpath.com/emergencynavbook for news and updates on this book, plus links to an online course on emergency navigation that provides practice exercises and discussion for each chapter, as well as a way to contact the author for questions and comments on the text.

Finally, I am sad to note here the loss of David Lewis, who had kindly provided the foreword to the first edition. He was unique amongst the great sailors and adventurers of our time. He had an unlimited supply of valuable experience, which he shared readily. David Lewis died in 2002 at the age of 85, still active in sailing and writing. He had just completed an update to his autobiography, *Shapes on the Wind* (HarperCollins, 2002). It was always a pleasure and learning experience to visit with him.

Acknowledgments

You cannot write on emergency navigation without reaffirming the indebtedness that all mariners owe to Harold Gatty, author of *The Raft Book: Lore of Sea and Sky* and other studies of emergency navigation on land and sea. I have learned much from his work and have been motivated by it. I am especially grateful to the late Dr. David Lewis for his review of the original manuscript of this book and his foreword to the text. His definitive study of Polynesian navigation, *We, the Navigators*, was my introduction to the topic of no-instrument navigation, which in turn led me to investigate the application of Polynesian methods at other latitudes, and from there to this book.

The initiation of the first edition of this work in 1979 was made possible by a grant from the Washington Sea Grant Program under NOAA Grant No. NA79AA-D-00054. Their assistance remains much appreciated.

I was assisted in the production of this second edition by Tobias Burch, whose fine work is, as always, much appreciated. Others who have kindly contributed their time and insights are acknowledged in the relevant sections.

This page intentionally left blank

Chapter 1

INTRODUCTION

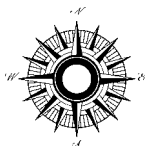

Have you ever wondered what you would do if circumstances left you in charge of a boat in the middle of the ocean, without any navigation equipment? Let's say you were wearing a watch, but had no electronic navigation tools such as GPS, no navigation books or tables, no knotmeter or log, no sextant, and no compass. And suppose, on top of that, you had no idea where you were in the first place. Could you figure out your location from your watch and the stars, and from there steer a course halfway across the ocean without a compass? One goal of this book is to tell you how to achieve these things—and other, less dramatic feats of contingency navigation.

At sea we must accept that everything can get wet, turned upside down, and dropped. Any piece of equipment, no matter how well guarded, can fail or be lost—somehow we could end up without it. There is no way around this; it is part of the challenge we accept when we go to sea. We must be self-reliant. If equipment fails, we must either go on or go back, 1 mile or 1,000 miles, without it. Navigational equipment is no exception. In the worst case, we should be prepared to navigate with none of our customary aids. And we can't discount skills in no-instrument navigation simply because the chances we'll ever need them are small. The chances *are* very small. But we only have to need them once to give new meaning to statistics.

WHAT IS EMERGENCY NAVIGATION?

This book uses the term *emergency navigation* in a special way. Here it simply means navigation with limited or makeshift instruments, regardless of the circumstances. An emergency in the usual sense is not required. Indeed, one purpose of this book is to show just the opposite: if the only problem at hand is the loss of our customary navigation tools, there need not be an

emergency in the usual sense—if we are prepared. Another goal of this book is to show that any oceangoing navigator can learn the necessary skills to be prepared.

You don't have to be a master mariner, born and reared on the sea, or a descendant of an elite line of Polynesian navigators to discover your position at sea and find your way across an ocean without conventional instruments. But you do have to do your homework. The oceans are big, and they flow in different directions. And the directions of the winds and seas as well as the sun and stars change hourly and daily. The waters around you may span some million square miles, while the island you need to find may be visible only from 30 miles off.

Emergency navigation includes the obvious things you might think of: steering without a compass, finding boat speed without a knotmeter, and keeping track of position without a sextant. But the meaning of emergency navigation also depends in part on what you are used to. It can mean plain, basic celestial or coastwise navigation that you haven't used for years. Perhaps you found that radar and GPS met all your navigational needs—that is, until they got wet, a storm broke off their antennas, or your boat ran out of power.

Set adrift in a life raft without instruments, 1,000 miles from land, you obviously must navigate by emergency methods. But this is the extreme case. The navigator of a comfortable, well-equipped yacht that has somehow lost its customary electronic navigation tools must also resort to emergency navigation. And a sports fisherman a mile offshore may not have a compass when the fog sets in. On a hazardous coast, emergency navigation is just as vital to that mariner as to the mariner whose electronics have failed.

Emergency methods are approximations and tricks. But some of the tricks are good tricks and the approximations not far from the truth. In many cases, routine navigation can benefit from these makeshift methods. After all, the way we ultimately calibrate any instrument is to measure the same object or condition with a more basic instrument. In the end, all instruments must reduce to a measuring stick and a clock—though I wouldn't want to prove this in the case of the compass.

No-instrument skills are a vital asset to anyone's navigation. But keep in mind that the best navigator is not the person who can do the most with the least, but the one who can do the most with what he or she has. The goal of navigation is knowing exactly where you are and how to choose the shortest safe course to where you want to go, under all conditions, using all available navigation equipment—whether this includes GPS, two radars, sonar, gyrocompass, weather facsimile, electronic charting system, and a computer, or just a stick with a string tied to it.

THE SCOPE OF THIS BOOK

This book is not a survival manual in any sense. The subject matter is restricted to navigation and things related to navigation. I can't offer advice on such basic decisions as whether to make for land or stay put after an accident at sea—the conditions of mishaps at sea are never the same. What I do offer, instead, is the background in emergency techniques that should help you make this and other navigational decisions in the particular circumstances at hand.

The purpose of this book is to show the capabilities and limitations of makeshift navigation. The subject is limited, but it is covered thoroughly and practically. The methods described are

not gimmicks but tested procedures. Errors and uncertainties are also analyzed. You can use most of the methods in this book on any vessel, anywhere in the world, and at any time of the year. Exceptions are clearly indicated. Some of the methods are original, while we've reformulated others to show their utility and limitations. Most are basic celestial and coastal navigation procedures that you can carry out with makeshift instruments.

This book is intended for anyone familiar with the rudiments of marine navigation. Many of the methods rely on the basic principles of celestial navigation, but you need not be an expert celestial navigator to use this book since all topics begin with the fundamentals. Experienced navigators will find things here that are already second nature, while the more specialized, less well-known, no-instrument procedures should be of interest to even seasoned navigators. Any navigator, after all, gains confidence and versatility as he or she becomes less dependent upon perishable aids.

The only conventional navigation aids used in the emergency methods are watches and sunrise-sunset tables (tables that list the times of sunrise and sunset at various latitudes throughout the year). Watches are included both because you are likely to have one and because they are such a tremendous help to navigation. Methods without watches are, of course, also covered. Methods using sunrise-sunset tables are described because these tables are included with most tide tables. Of all the special publications for navigation, tide tables are the most likely to be found on a boat, so there is a reasonable chance these tables will be available. As you will see, you can learn more from sunrise-sunset tables than just the times the sun goes up and down.

Naturally, if you have a sextant, chronometer, compass, or *Nautical Almanac* on board, it will be a bonus, and application of these aids to the emergency techniques will be obvious. For example, in some cases you can use the height of a star to judge its bearing and use this bearing to steer without a compass. With a sextant, you can measure a star's height accurately and not have to estimate it.

This book is not intended to be stowed for use in an emergency. It is far better to stow an extra compass than to stow a book on how to steer without a compass—it takes up less space. There are no special tables or fold-out diagrams that make the book itself an aid to navigation. While the tables that are included can be used in an emergency, their primary purpose is for practice. It is much better to practice and learn the techniques before you need them.

You can practice, and even master, many of the techniques in this book on land or on short cruises on inland or coastal waters. It is a good idea to practice as much as you can before departing on an ocean voyage—those vast amounts of spare time you anticipate on a long, slow ocean passage don't always materialize.

In a sense, this book offers you a hobby—a pastime that will exercise your ingenuity, measurement skills, and memory, as well as make you more familiar with the sea and the sky. It is also a hobby that could save your boat (so to speak) someday.

PREPARATION FOR NAVIGATIONAL EMERGENCIES

Again, in discussing emergency preparations, we limit ourselves to navigational matters. A full checklist for emergency preparation includes such things as life rafts, food and water supplies,

first-aid kits, seasickness aids, fishing gear, signaling gear, and other supplies. Books on seamanship and sea survival discuss these preparations. For navigational preparedness on an ocean voyage, the items below are the basics:

- 1** The cardinal rule is: Know where you are at all times to the best of your ability. In midocean, small-boat skippers are tempted to be lax about navigation, which is a bad habit to develop. It could well be that when you do need an accurate position, the sun and stars will be obscured, leaving you to carry on for another day or so by dead reckoning. Close to your destination, this could be hazardous or at least inefficient. Also, if you should need to send a radio distress signal, the more accurately you can relay your position, the better your chances are for rescue. Remember that if a ship is diverted to look for you, the range of visibility from the bridge of that ship may be only 10 miles or so in good conditions, and very much less in poor conditions, especially in big seas.
- 2** Wear a watch and keep track of the rate at which it gains or loses time. As we'll see later, you can accurately navigate around the world with a watch alone. It is the most important piece of emergency navigation gear you can have.
- 3** Carry a registered 406 MHz EPIRB (emergency position-indicating radio beacon). In an emergency, you activate the unit (or it activates automatically when submerged), and it will send out a signal that can be detected by passing satellites and aircraft. Within minutes, your vessel name, location, and emergency status will be known worldwide. The safety system monitoring these signals is the Global Maritime Distress and Safety System (GMDSS), which will direct support and rescue to you. Commercial vessels are required to carry this type of EPIRB, and it is only prudent that recreational mariners do the same. These 406 MHz units are more expensive than their predecessor models (which are no longer allowed), but they are much more effective.

A similar portable emergency transmitter is called a search-and-rescue transponder (SART). Once activated by you or the water, a SART becomes a sensitive, specialized radar detector. When struck by the radar of a passing vessel, or one searching for you, it sends a unique radar signal to the radar screen of the passing vessel, allowing the vessel to home in on you for rescue.

SARTs complement EBIRBs. An EBIRB reports your position to within a mile or so (some have integral GPS for even more accurate location), but if it quits transmitting, or you drift away from the reported position by the time the rescue arrives, a SART will guide the vessel right to you. The searching vessel only has to get within 8 miles or so of you to interact with the SART and lock in on you. Even at much shorter distances, visual location alone would be impossible in bad conditions or at night without lighting. As of this writing (2008), SARTs and EPIRBs cost some \$800 to \$1,200 each.
- 4** Tell someone your destination and arrival time, and of course, let them know when you do arrive or if your itinerary changes. The Coast Guard calls this a float plan, and it is fundamental to safe boating on any waters.

- 5 Consider taking part in some type of satellite tracking system. These days you can, for example, have every email sent from your vessel tagged with your latitude, longitude, course, and speed. With modern software (see, for example, gmn-usa.com, sailblogs.com, skywave.com), this is inexpensive and easy to implement, without any extra hardware expenses.
- 6 If you have radios on board, learn their full potential and the specific uses of various frequencies, especially the standard distress frequencies and other channels monitored by the Coast Guard. Teach others on board how to use the radios. In an emergency, someone else may have to work the radio while the skipper stays at the wheel. This advice on teaching radio usage remains equally valid today as it was twenty years ago (though we are now just as likely to have a satellite phone that could be easier to use, but it will still take detailed instructions).
- 7 Monitor weather broadcasts at least once a day. The best sources of scheduled times and frequencies of weather broadcasts have changed over the years. See the Meteorology and Oceanography section of the bibliography for more information.
- 8 Study the seasonal weather patterns, prevailing winds, and ocean currents along your intended route. For U.S. coastal and connecting waters, this information is given in the *U.S. Coast Pilots*, published by the National Oceanic and Atmospheric Administration (NOAA). There are equivalent publications for Canadian waters called *Sailing Directions*. These books contain a wealth of navigational information beyond that shown on nautical charts; they also include wind, weather, and current data. (See bibliography.)

For international waters, similar information is available in the *U.S. Sailing Directions* and *Planning Guides*, published by the National Geospatial-Intelligence Agency (NGA; formerly the National Imagery and Mapping Agency, NIMA). Worldwide *Sailing Directions*, also called *Pilots*, are published by the British Admiralty. Special charts called *U.S. Pilot Charts* are a convenient and reliable source of seasonal wind and current data. They are published by the NGA according to month and ocean (see Figure 1-1). Magnetic variation, great-circle routes, and other useful data are also given on pilot charts. See the Published Aids to Navigation section of the bibliography.
- 9 With your other emergency gear, stow a hiker's compass, a Davis Mark III plastic sextant (successor of the original lifeboat sextant), a waterproof quartz watch (with known rate), a pilot chart, pencils and notebook (preferably with waterproof paper), and a copy of a long-term sun and star almanac and concise sight reduction tables (explained in Chapter 14). All of this fits in a Tupperware cake box and costs less than \$100 (see Figure 1-2). With this kit you can find your way to any port in the world, on any date, during any year, without any assistance from the outside world.

Needless to say, you might also have another emergency kit containing a handheld GPS, a satellite phone, and a solar charger as shown in Figure 1-3. (The former kit, however, is more enduring and less vulnerable to the environment.) In fact, with a satellite phone in the throw bag, you can literally dial 911 from any location on earth and report your

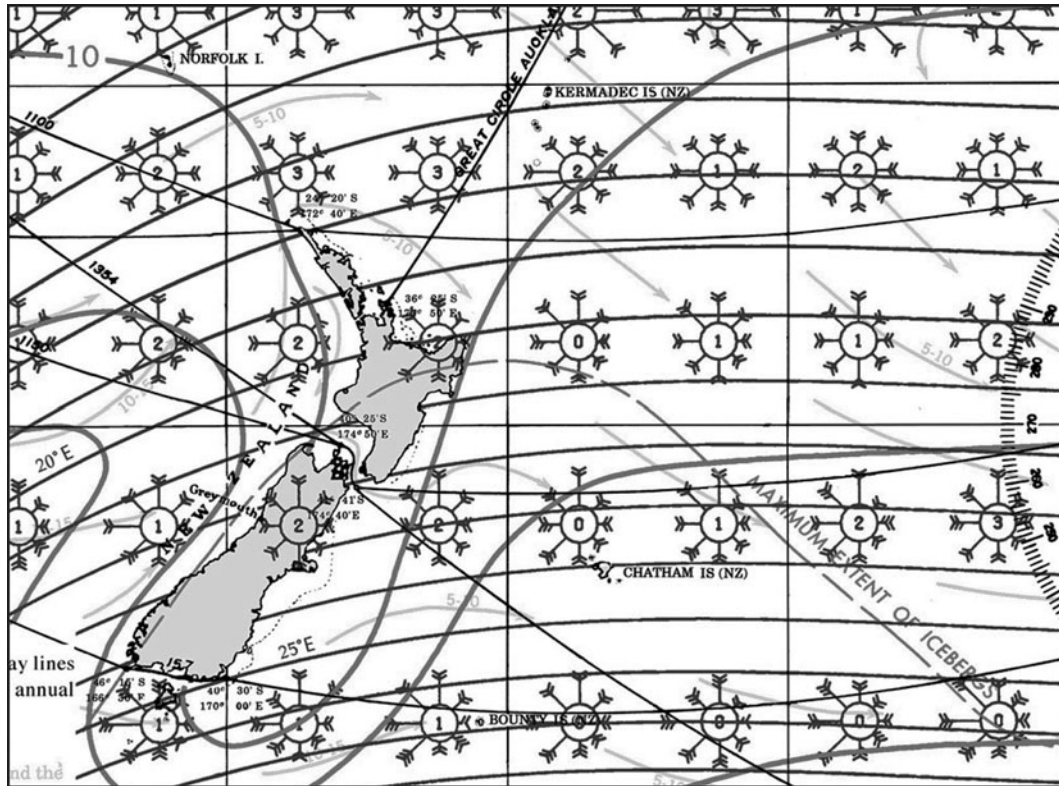

Figure 1-1. Section of a U.S. Pilot Chart near New Zealand. This section from the November chart is shown in the new design now available as a free Internet download in PDF format. It shows wind roses (the arrows fly with the winds, and the number of feathers equals the average Beaufort Force number), magnetic variation (which shifts from about 28° E to 15° E in this region), prevailing currents (the arrows are labeled with daily drift in nautical miles), great-circle routes between major ports, percentage of time with waves or swells greater than 12 feet (the solid lines—one is marked for 10%; 20% and 30% lines are below it), and ice limits of interest in these low latitudes. Other charts in the set for this month show sea and air temperatures, barometric pressures, gale and cyclone frequencies, and visibility. The great-circle route from Auckland to Pago-Pago runs northeast from the North Island; Sydney to Cook Strait shows partially (it is 1,354 nautical miles long), as well as Cook Strait to Valparaiso. We see NE currents of some 10 to 15 miles a day to the west of New Zealand and SE 5 to 10 miles per day on the east side of the islands. Note that the wind in the NE corner of this section is equally likely to be from any direction at that point in November (with a slight bias to the west) at a speed of Beaufort Force 4 (11 to 16 knots). (For another Pilot Chart section, see Figure 4-4.)

situation. The associated satellite phone services can triangulate on your broadcast to locate your position, even if you don't have a GPS. Some companies advertise this service, others do not, but they all can do it—it is how they know where you are calling from to bill you appropriately. At the time of the first edition to this book you could not do this (no GPS nor satellite phones in those days), so some things have changed. What has not changed is what you do if all those electronics fail, and that is what we cover in this book.

10 Keep track of where you are relative to the shipping lanes (great-circle routes between major ports) shown on pilot charts. If you run across commercial traffic at sea, it will



Figure 1-2. Backup navigational gear. Store this equipment in a waterproof bag, inside or near your regular emergency throw bag. Backup navigational procedures are discussed in Chapter 14. The Long Term Almanac by Geoffrey Kolbe shown here includes data for sun and stars until 2050 as well as a complete set of sight reduction tables, so this kit can take you safely to any port in the world, though it will be easiest if you are wearing a watch with known rate as suggested throughout the text. Also shown are a waterproof notebook, Pilot Chart, plotting sheets, pencils, sharpener, and compass.

probably be near one of these lanes. If you are looking for help, shipping lanes are the place to be. Even if you aren't looking for help, when you sail across or along a shipping lane, keep on special alert for traffic. A freighter can come over the horizon and be on top of you in 15 minutes or so. It is fundamental to safe navigation, as well as to the International Rules of the Road, to have a proper watch on duty at all times.

11 In some circumstances, it might be valuable to think in terms of helicopter rescue range when it comes to planning an emergency or contingency route, which is about 250 miles for land-based helicopters. It is hard to think of how this would enter into routine sailing plans, but it is certainly a number to be aware of as you choose routes in potentially troublesome circumstances.

12 And finally, study the principles and practice the methods of emergency navigation. All the safety precautions imaginable cannot guarantee that you will not end up with nothing to go by but your own knowledge and skills. As we shall see, accurate dead reckoning is the key to good emergency navigation just as it is in routine circumstances. The Starpath *Onboard Navigation Exercise Book* (see the Basic Marine Navigation section of the bibliography) provides a practice guide and means to record your progress.



Figure 1-3. A modern electronic navigation backup kit. A satellite phone offers worldwide, all-weather connections as good as typical telephone calls. Dial 911 for assistance just as at home. Also shown is a handheld GPS unit and some extra batteries for it, but a satellite phone call can be triangulated for position even if the GPS fails. A spare battery for the satellite phone, solar charger, and rugged carrying case are also shown. On some systems you can place an emergency call as long as a SIM (subscriber identity module) card is in the device, even though a service plan is not active. Or you can move a SIM card from one unit to another. Check with your provider. (Courtesy globalmarinenet.net)

On an oceangoing vessel, the main responsibility for emergency preparation and navigational safety lies with the vessel's captain and officers. But even in this case, for true self-reliance, the first and last points above are basic for everyone on board, whether crew or passenger: Keep track of your position (as well as your duties allow), and master the rudiments of emergency navigation. A handheld GPS and a personal logbook, for example, can turn your stateroom or your bunk into a navigation laboratory. Remember, in an emergency (without a designated chain of command) the role of leader goes to the one who is best prepared.

Navigating a long ocean voyage without modern instruments is a full-time job, taking continuous concentration. But if you are prepared, you can keep track of your position across any ocean. Columbus did it five centuries ago with no instruments other than a log and a compass and he didn't even know how that worked. We are far better prepared today for a similar voyage with similar "instruments."

Chapter 2

TIME AND PLACE AT SEA

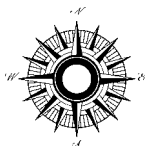

In sight of land, the best way to keep track of your position on the water is relative to charted landmarks. When calling for help in near-coastal waters, it is usually better to report your position as, say, “two miles north of Point Wilson” than it is to read off your latitude and longitude from a chart or electronic device. The latter method is more prone to error; it also assumes your rescuer has some form of electronic navigation or a chart of the area. I stress this point because some skippers are relying on electronic charting that is so convenient they may have forgotten the basics of entering waypoints by latitude and longitude, which is effectively what would have to be done if that is all they knew about your position. If you have an accurate Lat and Lon and know how to convey it, then that is good, but it is also good to know where you are!

Though GPS is an obvious boon to navigation in any circumstance, it is nevertheless dangerous to rely on any one aid alone. The more you rely on electronics, the less practice you get at basic piloting and dead reckoning. In short, you become lazy. Many accidents have resulted from an overconfidence in GPS alone, and sometimes can be traced to simple errors of reading or plotting the digital output—using, say, the position of the cursor when you wanted the position of the boat, and so on. A cross-check with the radar would likely catch such an error.

On the other hand, when out of sight of land, on a featureless sea, you have little choice but to rely on latitude and longitude for position. For record keeping on ocean passages, you could use a small-scale nautical chart of the entire ocean or a plotting sheet that shows only the latitude and longitude grid. In an emergency, you can even use just a blank sheet of paper on which you sketch parallels of latitude. With this you might use a hybrid notation for position, giving your latitude and estimated distance run east or west from a specific longitude, which is called your *departure*.

What you use will depend on what you’ve got. In an extreme case, you can estimate your latitude from the sky using only your fingers, hands, and arms, with very little special knowledge required. But unless that arm has a watch around it, you will never be able to figure your longitude

from what you see in the sky. You will only be able to keep track of how far you sail east or west. Hence the potential usefulness of the hybrid notation.

LATITUDE REGIONS AND SEASONS DEFINED

In emergency navigation and meteorology, it is convenient to divide the globe into latitude bands according to the relationship of the sun to the earth. The three regions are the tropics, the temperate latitudes, and the polar regions.

The tropics are defined as the central belt of the earth extending between latitudes of about $23^{\circ} 26' S$ to $23^{\circ} 26' N$. The special latitude of $23^{\circ} 26'$ is derived from the orientation of the earth's rotation axis, which is tilted $23^{\circ} 26'$ relative to the plane of its orbit around the sun. Because of this tilt, the sun can be viewed precisely overhead only from somewhere within the tropics (see Figure 2-1 and, looking ahead, Figure 11-14). During the fall and winter (from the autumnal equinox on September 23 to the vernal equinox on March 21), the sun is directly overhead at some latitude in the southern tropics. During the spring and summer, the sun is directly overhead at

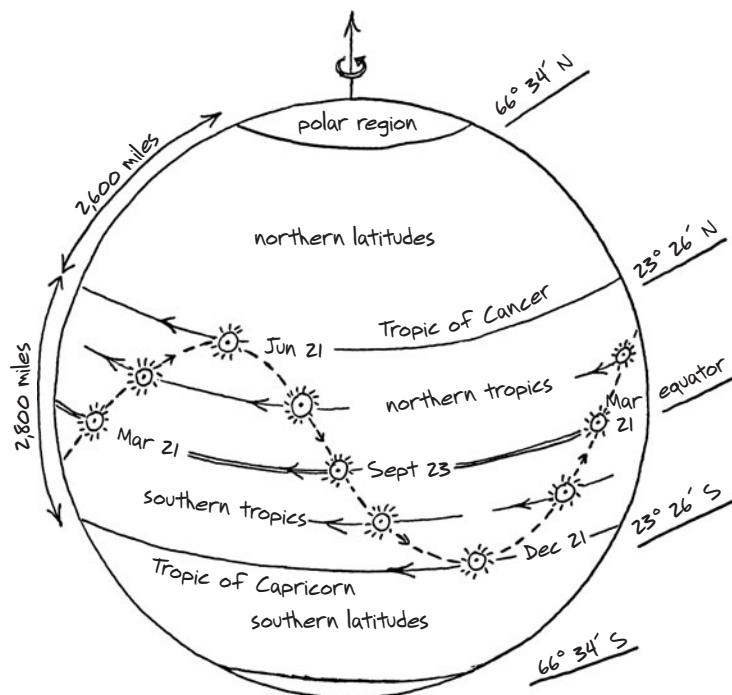

Figure 2-1. Latitude regions in emergency navigation. The sun passes overhead in some latitude of the tropics, defined by the northern and southern limits of the sun's latitude. Some rules and procedures of emergency navigation work only in the tropics (40% of the earth's surface), and many of the methods we cover do not work in the polar regions (8% of the earth's surface). The temperate latitudes between these two regions comprise 52% of the earth's surface. Figure 11-14 explains why the sun moves over the earth as shown here. In Chapter 11, we use the location of the sun to find latitude.

some latitude of the northern tropics. We will come back to this point when we discuss navigation by the sun in Chapter 6.

Throughout this book, we refer to summer and winter as they are defined in the Northern Hemisphere. In the Southern Hemisphere, these seasons are reversed. Thus, July and August are summer months in the United States and winter months in Australia.

The latitudes of the tropics have special significance to emergency navigation for somewhat subtle reasons. Apparent motions of the sun and stars are governed by trigonometric equations involving the sine and cosine functions of the observer's latitude. Throughout the tropics, the latitude angle is small (0° to $23^\circ 26'$), and consequently the sine and cosine functions are approximately equal to their limiting values of 0.0 and 1.0. This greatly simplifies the trigonometric equations, and from these simpler equations, we can learn simple rules that apply in the tropics; we will use the rules, but we won't get involved in the trigonometry itself. For example, within the tropics it is easy to predict the bearing of any star on the horizon and use it to steer without a compass. This is not so easy from other parts of the globe.

The two polar regions are defined as latitudes greater than $66^\circ 34'$ north or south. These regions are unique, as they are the only places on earth where the sun remains above or below the horizon for more than one day. In a sense, the polar regions are the opposite of the tropics, especially in emergency navigation. The latitude $66^\circ 34'$ comes from $90^\circ - 23^\circ 26'$. Navigation in general must be specialized for the polar regions, and many of the emergency celestial methods we cover do not apply in the polar regions. These restrictions are clearly pointed out when they arise.

The regions between the tropics and the polar regions—that is, between latitudes $23^\circ 26'$ and $66^\circ 34'$ —are called the temperate latitudes, or just the latitudes. In this book, “northern latitudes” refers to the general region in the Northern Hemisphere that is north of the tropics and south of the polar region.

These latitude regions defined by the sun are important for navigation because they allow us to navigate by the position of the sun. They are important for meteorology because the average position of the sun determines the weather. There are no similar divisions of the earth according to longitude. Because of the daily rotation of the earth, the earth is essentially symmetrical in the east-west direction.

Measuring Latitude

It is easy to think of latitude differences in terms of nautical miles, since the nautical mile was invented for just this purpose. For practical use, the definition of a *nautical mile* is the distance equal to a latitude change of $1'$, or in terms of degrees:

$$1^\circ \text{ of latitude} = 60 \text{ nautical miles}$$

This relationship is the key to the language of navigation. If your latitude is 20° S, you are 1,200 nautical miles south of the equator. If you want to sail from Cape Hatteras at latitude 35° N due south to Nassau at latitude 25° N, then you must sail south for 10° , or a distance of 600 nautical miles. For several purposes in navigation, it is convenient to remember that 1 nautical mile is just about 6,000 feet (some 15% longer than a statute mile). In this book, I use the words *mile* and *nautical mile* interchangeably; any reference to miles means nautical miles (nmi).

At the equator, 1° of longitude also equals 60 nmi, and, for the trigonometric reasons mentioned above, this is very nearly true throughout the tropics. But as you go farther from the equator, this approximation loses its validity. The conversion of longitude increments to miles is not as simple as it is for latitude increments, since longitude meridians converge at the poles. At latitude 48° , for example, there are only 40 nmi to 1° of longitude. We will return to this problem in Chapter 12 when we discuss longitude.

TIME IN NAVIGATION

There are many kinds of time in navigation books: watch time, standard time, zone time, chronometer time, Greenwich mean time, and universal time. There is also local mean time, apparent time, solar time, sidereal time, and probably others. We must start by simplifying this or get bogged down forever.

To navigate we need to know only one time, currently called universal coordinated time (abbreviated UTC; historically this time was called Greenwich mean time, GMT, which is likely still to be the more familiar term). Since all clocks gain or lose time, we can't have watches that always read UTC precisely.

The time we actually read from our watches is called watch time. Our watches are set to some standard time, which is UTC, plus or minus some whole number of hours. U.S. eastern standard time, for instance, is 5 hours behind UTC (or UTC minus 5 hours). If you are wearing a watch set to eastern standard time that you know gains 10 seconds a month, you can always figure UTC, providing you remember the date you set your watch. For example, if you set it on July 4, and two months later the watch reads 13:20:45, then you know that the correct eastern standard time is 13:20:25 and that UTC is 18:20:25—subtract 20 seconds to correct for the current watch error and add 5 hours to correct for the standard time zone of the watch. And please note, especially, that it does not matter where you happen to be when you read your watch; you will always know UTC. For telling time, *it is the time zone of the watch that matters*, not the time zone the boat is in.

This is standard procedure in celestial navigation. The key points are to know the watch rate—how fast it gains or loses time—and to know that the “watch” is indeed a “chronometer,” which is simply a watch that gains or loses time at a constant rate. It does not matter much what the rate is as long as it is constant. A typical quartz watch these days has a constant rate within 15 seconds or less per month. You can learn the rate of your watch and verify that it is constant by checking it daily for a few months using the National Institute of Standards and Technology website (nist.gov) or its time signals broadcast on WWV or similar shortwave or single-sideband broadcasts around the world. UTC is also available from any GPS unit when in contact with a satellite or from several Internet sources.

Another key point is this: Do not change your watch time at sea. You might be tempted to change it as you sail into new time zones, or perhaps reset it to remove the watch error once in a while, but this is a dangerous procedure since it is easy to lose track of the correct time if you push the reset buttons in the wrong sequence (also the buttons themselves are a candidate for failure that does not need testing underway). It is far better to wait until you make your landfall and then reset it to the local time. The convenience at sea is not worth the risk, and you have more to remember if you keep changing it.

As for all the other types of time, we don't need to deal with them. The only other time of interest in emergency navigation is solar time, which we cover in the Solar Time Method section in Chapter 6 when we discuss keeping track of the sun's direction throughout the day.

FINDING POSITION VERSUS KEEPING TRACK OF POSITION

In emergency navigation, you must distinguish between finding your position from an unknown spot versus keeping track of your position as you move away from a known spot. Keeping track of position using boat speed and course sailed is called *dead reckoning* (DR). In emergency situations, you must rely heavily on DR, since it is not easy to find your position accurately from the sun and stars without proper instruments.

The concern with the distinction between finding your position and keeping track of it rests entirely with the question of accuracy. With modern electronic aids like GPS, a navigator can simply read latitude and longitude from a dial to an accuracy of 100 feet or so.

But no matter how well protected, electronic instruments remain ultimately vulnerable to the rigors of the sea and the idiosyncrasies of all electronics. I have witnessed four GPS failures so far. Two were console-mounted units that failed underway. On one, a button went in and never came out, and the other simply failed to come on. The other two were handheld units on land. On one, the battery would no longer accept a charge, and the other stopped acquiring signals. And this does not count cases where a vessel loses all sources of power. I am sure my experiences are not unique among those who frequently use GPS. Failures remain rare compared to total time in use, but our subject at hand is what to do in rare circumstances.

Celestial Navigation

The more reliable and independent alternative—or at least backup—for ocean navigation is traditional celestial navigation using a sextant, a chronometer, an almanac, and sight reduction tables. With these, a small-boat navigator can pinpoint his or her unknown position to within 5 or 10 miles, or even to as little as 1 or 2 miles with practice and good procedures. (Celestial accuracy can be pushed to about 0.5 mile, but this is not typical and requires special procedures and skills, especially if the boat is moving.)

As soon as any one of your celestial tools (sextant, chronometer, or tables) is lost or broken, you must rely on some form of emergency navigation. And the form you choose depends on the accuracy it offers.

To illustrate this point, consider an incident that leaves you in a life raft somewhere in midocean. You are wearing an accurate watch—meaning you can figure UTC from it to within a few seconds—but have no other navigational equipment. Using the methods of emergency navigation, you can, by doing little more than looking at the sky, determine your location to within about 300 miles. You can obtain this level of accuracy no matter where you are, on any day of the year, using only the most elementary principles and very little special knowledge. If you have practiced these methods and learned a few of the more specialized techniques presented here, you could improve on this accuracy significantly. Under favorable conditions, you might find

your position from scratch to within about 100 miles, or maybe even 50 miles. In this example, we assumed accurate time but no sextant, not even a jury-rigged device.

Without some form of sextant, it is unlikely you could obtain accuracy greater than 50 miles regardless of preparation or conditions. Furthermore, without accurate time, you could not find your longitude at all, although with a watch on erroneous time, you could keep track of changes in longitude by means other than DR.

Though this by no means represents pinpoint accuracy, finding your position from scratch to within 100 miles using only your wits, a watch, and makeshift gear is an admirable achievement, considering the size of the earth's surface—some 200,000,000 square miles. And knowing your position to within 100 miles out of sight of land will likely be sufficient to tell you which way to go to reach safety.

This book does cover the best possible ways to find your position from scratch, but, realistically, this is not a challenge you are likely to face. Furthermore, this level of from-scratch accuracy wouldn't do you much good if you were lost on one of the Great Lakes, for example, though it could possibly be helpful in coastal waters. In approaching the coast of Central America, or numerous other coasts around the world, it might be important to your safety to know what country lies ahead.

The more likely situation you should prepare for is the loss of some *part* of your standard navigational equipment, such as the compass, sextant, or accurate time. You would then, presumably, be starting your emergency navigation from a known position. The point is this: you can sail a long way from a known position using emergency methods of DR before your position becomes uncertain by 100 miles.

There is still another aspect to the distinction between finding and keeping track of position. Later chapters explain several ways to keep track of changes in latitude and longitude by noting changes in the sun and stars. These are basically the same as the methods used to find position, but the difference is you only have to measure relative angles and know relative times to determine changes in position. To actually find latitude and longitude from scratch, you must measure absolute angles and know absolute times. It is much more difficult to measure absolute values than it is to measure relative ones.

To show this more specifically, if the sun sets 5 minutes later today than it did yesterday, you can use this observation to figure out the change in your longitude. But you would need to know the exact UTC of sunset to find your actual longitude. Likewise, one way to find latitude is to measure the angular height of the North Star (*Polaris*) above the horizon. In higher latitudes, this is difficult to do accurately without a sextant. It is easier to determine how much this height has changed since the previous measurement—in short, to find a change in latitude. Again, it is a relative measurement versus an absolute measurement. Relative measurements of the sun and stars provide more accurate information for navigation than trying to find actual position from the sun and stars. On a long voyage, this can be a significant improvement over pure DR.

But you can't take advantage of relative measurements if you don't know where you started from. The cardinal rule for navigational safety and emergency preparation is to know where you are at all times to the best of your ability. An equally important rule is to wear an accurate watch. The value of a watch emerges in nearly every aspect of emergency navigation. You can accurately sail around the world with nothing but a watch. Take it away, and you have to do a lot of work just to go straight for 100 miles.

Chapter 3

DIRECTIONS AT SEA

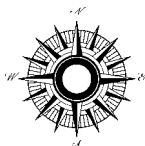

Keeping track of directions is more challenging at sea than it is on land. Lost on land without a compass, you can use the sun or stars once to find directions, and then use these directions to note the bearing of a distant landmark. From then on, you can use the landmark to keep your bearings. At sea there are no permanent reference marks. The wind and swells serve this purpose for short periods of time, but ultimately you must orient yourself using the changing positions of the sun and stars.

On a clear night in the Northern Hemisphere, you have *Polaris* (the North Star) for orientation—it is the one star that essentially does not move, always bearing due north. But *Polaris* is no help on cloudy nights, during the daytime, and in any part of the Southern Hemisphere. In short, you will be unprepared for emergency orientation if all you know is that *Polaris* bears due north. Luckily, you do not need to rely on the North Star alone; you can find directions from many different stars, in northern or southern latitudes, and from the sun during the day.

A basic point to remember with regard to directions at sea is that finding your bearings and holding the proper heading does not guarantee you will arrive at your desired destination. The problems are current and leeway. Current moves you off course in the direction the current is flowing, and leeway moves you off course in the direction the wind is blowing (downwind). In the ocean, most currents flow in the general direction of the prevailing wind, so these problems tend to be additive. For example, a sailboat beating north in 15 knots of true wind from the northeast might slip to leeward some 10°, depending on its draft. If the boat is making 6 knots through the water and the current is flowing west at just over 1 knot, the current would set the vessel downwind another 10° or so. In these circumstances, you could sail with *Polaris* fixed on the bow, thinking you were headed due north, when in fact you were making good a course of some 20° to the west of north (see Figure 3-1).

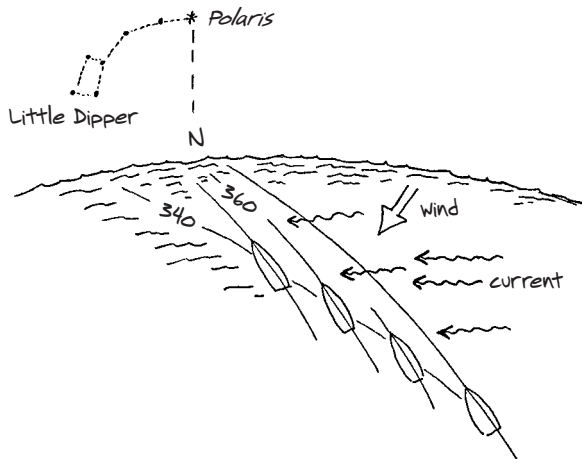

Figure 3-1. A boat headed north, making good a course to the north-northwest. Ocean currents tend to align with prevailing wind, so current and leeway errors are often in the same general direction. The effective leeway in a course made good in strong wind or very light wind is usually much larger than you might suspect before measuring it.

come back to these topics in Chapter 10, where we cover some helpful tricks for estimating the effects of current and leeway. For example, how did I know instantly, without plotting or elaborate calculations, that a current of 1 knot on the beam would set me 10° off course when I was making 6 knots?

CHOOSING A ROUTE

If you are going to make a long voyage, there are several routes you might consider. The route between two points that is most commonly used in small-boat navigation is the *rhumb-line route*, which is simply the straight line drawn between the two points as they appear on a nautical chart. All along a rhumb line, the true heading of the boat remains constant, although the magnetic heading will change if the magnetic variation changes. Strictly speaking, the rhumb line is not the shortest distance between two points on the globe. The shortest distance is the *great-circle route*. But the difference in course distance between these two routes is insignificant except for voyages of over 2,000 miles, and even then only when the departure point and destination are both at high latitudes.

In an emergency situation, it may not be possible to determine an accurate rhumb-line course. And even if it were possible, prevailing winds or currents might not permit the route. An alternative is a variation of what is called *parallel*, or *latitude sailing*. In this case, you estimate the rhumb-line heading and then sail well to windward of your destination. Once you reach the latitude of your destination, you turn and sail at constant latitude until you get there. This is the best route for a long voyage with limited instruments since you can find and keep track of your latitude from the stars without instruments, whereas you need an accurate watch and other information to keep track of your longitude.

You can apply this same philosophy when approaching a coastline. Do not head straight for your destination but well to windward of it (see Figure 3-2); then when you reach the coast, you will know which way to turn. If you head straight for a harbor or landmark, and it is not in sight when you reach the coast, you may not know which way to turn. Under power in light winds, choosing the windward or leeward side of a destination is not so critical, as long as you are

Figure 3-2. Windward sailing as a variation on parallel sailing. Generally the safest route is well to windward of your destination. With practice in emergency navigation, however, you don't need to sail such a conservative, strictly "parallel" route. You must also take into account the prevailing currents and expected wind shifts along the route or near the shore. On reaching an unidentified coast (bottom), remember that the general bearing of the coastline may help you determine where you have landed—but this can be tricky on irregular coastlines or in reduced visibility.

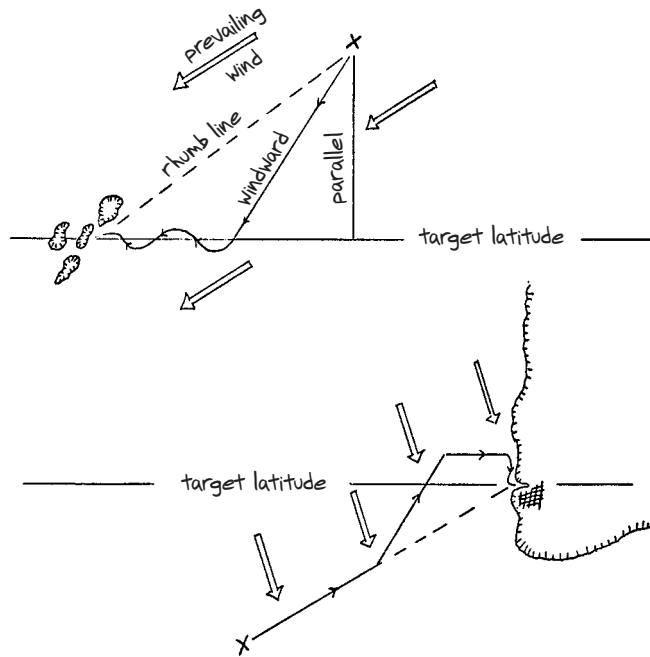

definitely to one side of it. In strong winds, however, it is better, even under power, to do your pounding to weather well offshore—if you can. In big seas you may have no safe choice but to go downwind.

COMPASS CHECKS

A large part of this book covers steering without a compass; however, you may encounter situations where you will have a compass but you won't be sure it is working properly. You will then need to know how to do a compass check. For example, an accident at sea may not necessarily destroy your compass, just damage it. The compass may even appear to be functional, meaning when the boat turns, the compass turns. But is it working accurately? Another situation might be that your primary compass is destroyed, but you have a spare, which you will need to rig and then check its adjustment. Or a lightning strike at sea damages your compass and wipes out all your electronics as well. You will need to check your compass even if it appears to be working properly. (In fact, you should check your compass whenever your boat is struck by lightning.)

Check the Compass Card

If you suspect that your compass may be faulty for any reason, the first thing to do is check that the compass card rotates freely. You can test this by magnetically disturbing the compass, such as with a magnetized screwdriver or magnet from a radio speaker, then carefully watching to see if it returns smoothly to the exact reading it had before you disturbed it. If it doesn't, or if its motion is jerky, the pivot point may be damaged or worn. In the middle of the ocean, you can't do much about this except to remember it and hope that the motion of the boat is enough to keep the card on the proper average orientation. If the pivot sticks at all, you must be especially careful when performing the deviation checks given below: be sure the card is not stuck when you read the compass to check for error. Without a magnetized object to kick the needle around, you can try swinging the ship (turning in a large circle) slowly and watching the needle for jerky motion.

Check the Lubber's Line

Next check the lubber's line alignment. The *lubber's line* is the line defined by the pivot point of the compass card and the index pin that you read your heading from. It should be parallel to the boat's centerline. If there is a misalignment of more than a few degrees, you can usually notice it by simply looking at the lubber's line relative to structures on the boat. If the lubber's line is off, readjust it if possible. If this is not possible, establish a new index mark that makes the lubber's line parallel to the centerline, and read the compass card against this new index mark. Or alternatively, simply note that the compass reads too high by, say, 5° on all headings—the effect is just to offset the reading a constant amount for all headings. Normally, a careful compass check (deviation measurement) will reveal even an offset as small as 1° in the lubber's line. But the method you must use at sea without special aids is not so precise, so do the best you can to establish this line, assume it is right, and go on.

Check for Deviation Error

Next you must check for deviation error, remembering that a compass with deviation error on any one heading has different errors on other headings. Obviously you'll care most about the error in the general direction you want to go, so check that one first, and remember to check the compass again if you change course.

Using Celestial Navigation

The standard way to check a compass at sea is to use celestial navigation. To do this, hold a steady compass heading, note the bearing of the sun according to the steering compass, and then do a standard sight reduction to determine the true bearing (azimuth) of the sun at that time, from that location. Correct this true bearing for local magnetic variation (read from a chart or a GPS), and compare the resulting magnetic bearing to the compass bearing of the sun. If they agree, the compass is right on the heading you steered as you did the comparison. If not, the difference is your compass deviation on that heading. Now repeat the process for other headings of interest.

With a binnacle-mounted compass that has a shadow pin in the center, you can do this check very accurately when the sun is low. Use the reciprocal of the sun's shadow to get its bearing.

Alternatively, at night you might steer toward any identifiable celestial body that lies near dead ahead on your desired course, and then compute the true bearing of that body.

This standard procedure requires correct UTC, sight reduction tables, an almanac, and a known starting location. If you have these aids and information, this is the obvious way to check the compass. If any one of these is missing, you cannot use this procedure. The Everything but an Almanac section in Chapter 14 covers a trick for replacing the almanac, but it is a trick that requires somewhat more than average memory work.

Using "Toward" and "Away" Headings

Without any of these aids, and without sun or stars visible, you can still check your compass out of sight of land from an entirely unknown location. This procedure is fundamental to emergency

preparation on all waters. To do the check, throw a life vest, jerry can, or some other floating object overboard and sail directly away from it, roughly opposite the direction you want to go. Note the compass heading as you sail well away from the object, keeping it dead astern. This takes some practice, but not much. Try aligning it with a boom tied to the centerline or back-sighting along the edge of the cabin top, a hand rail, or other structure parallel to the centerline. Two people can do this more easily than one.

Once you have determined your “away” compass heading in this manner, turn as sharply as possible, sail back toward the object, and note your “toward” compass heading. If the toward heading is exactly 180° from the away heading, your compass has no deviation on either heading, and you have verified that the compass works right on these two particular headings.

If the toward compass heading is not the exact reciprocal of the away heading (exactly 180° different), and you have verified this difference with several trials (turning back in alternate directions), then the compass has error on each of these headings. Figure the actual error this way: The correct magnetic course toward the object is *halfway between what you got and what you expected*. For example, sailing away from an object, the compass heading is 040, and sailing back toward the object (the approximate way you want to go), the compass heading is 240. Since the reciprocal of 040 is 220, then halfway between what you got and what you expected is halfway between 240 and 220, which is 230. So the correct magnetic course toward the object is 230. The compass reads 240 on this heading, so the compass reads 10° too high in the direction you want to go (see Figure 3-3).

Figure 3-3. Backup method for checking a compass at sea. Throw an object overboard and sail away from your desired course, keeping the object astern. The correct magnetic bearing toward the object is halfway between what you get (toward compass reading) and what you expected (reciprocal of away compass reading). The procedure assumes that your turning radius is very small compared to the distance back to the object. This method can also prove useful on inland or coastal waters in reduced visibility. If available, it is best to use a celestial body or distant landmark for your reference point in place of an object thrown overboard.

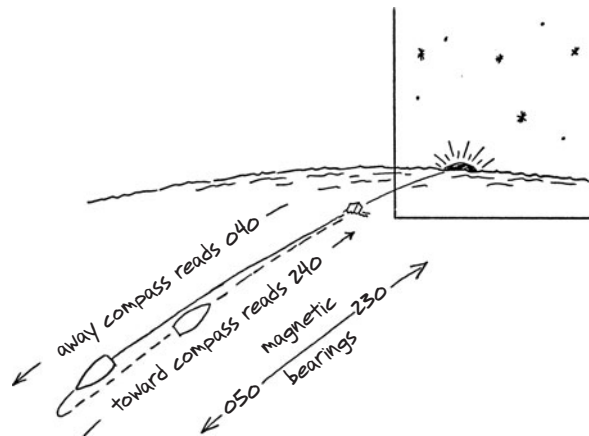

With several tries, you can discover your compass error to within an accuracy of about 5° . Note that this procedure requires good sea conditions, and assumes that the leeway of the object and the boat are the same.

However, if the wind blows the boat sideways through the water more than it blows the object, your conclusions about the compass will be wrong. In strong crosswinds, this method is unreliable. But in calm weather or straight into and out of the wind, it works. Currents have no effect, because they would move both the boat and the object at the same speed. On inland or coastal waters, you can do this much more easily using a distant landmark for the object. At sea,

if the sun happens to lie near dead ahead or astern during the day, use it for the object. You can also use a star at night, but the back bearing is less accurate if the star is at all high, even with someone assisting with the steering. If you use the sun or stars, though, you must do the toward and away bearings fairly rapidly since these bodies are moving across the sky. Toward and away bearings measured within some 10 minutes of each other will do the job with no problem.

The toward and away courses, as we have used them, are reciprocal magnetic headings. In using this method, we have assumed that compass deviation is equal and opposite on reciprocal *magnetic* headings. Strictly speaking, this is only an approximation of the more correct statement that deviations are equal and opposite on reciprocal *compass* headings.

To do this deviation check in the strictly proper way is a more difficult measurement. In principle, you should sail away from the object to get the away course, and then turn and sail on the reciprocal course according to the compass. Then sighting over the compass card, you should note the bearing to the object while holding the reciprocal course. The deviation error would then be equal to half the angle of the object off the bow. The functional difference between these two methods, however, is usually insignificant. The only time it might make a difference is when the maximum deviation on any heading using the first method is large, say 20° or so. In this case, it would be worthwhile to try this method as a double check.

If you intend to compensate for the compass by adjusting the internal magnets to remove the deviation you find, then you can stick with the first method, even if you start out with large deviations. Your first adjustment probably won't be exactly right, but it will be close enough that the resulting deviation will be small. With only a small deviation left for the final adjustment, the first method will be accurate enough.

Using True Direction

An alternative compass check is to use the true direction of the sun or a star that you figure from one of the methods described in Chapters 5 and 6. In this approach, you do not need to know the local magnetic variation. The most accurate of these methods uses *Polaris* at any time of night in the Northern Hemisphere, or the sun at noon from any latitude if you have a watch. Several of the other star methods are also reliably accurate to within 5° in special cases. Using any of these true directions and a makeshift portable compass card (described below in the Steering without a Compass section), head the boat in the direction you want to go and then read the compass. The difference between the compass heading and the true heading is the *compass error*, meaning the sum of deviation on that heading and the variation at that location.

Using a Handheld Bearing Compass

If you have a non-steel vessel, there is another—often much easier—way to check the steering compass that you should not overlook: simply using a handheld bearing compass as a reference. This is standard equipment for inland and coastal navigation, so it is quite possible that one will be on board. The advantage of these compasses is that they have no internal adjustment magnets to throw them off. Also, when you are standing up and holding one at eye level, you are usually sufficiently far from any disturbing magnetic materials so that it will read the earth's magnetic

field correctly. To check the steering compass this way, read the magnetic heading of the boat from the bearing compass and compare it to the steering compass heading. Any difference you find is most likely due to an error in the steering compass.

This method—and bearing compasses in general—may not work on steel vessels because of the magnetic disturbance they cause. But on any vessel, it is best to first check the handheld compass itself with *Polaris* or the noon sun to verify that it works as expected from your particular position on deck. Or better still, sight some celestial body (or distant landmark in coastal waters) and watch its bearing with the handheld compass as you *swing the ship* (slowly turn a full circle). If the object's bearing remains constant for all boat headings, you will know that your handheld compass is not being influenced by the boat. Additionally, beware of steel eyeglass frames, don't lean against iron rigging or hold a flashlight too close to the compass, and heed other standard precautions and procedures for bearing sights.

STEERING WITHOUT A COMPASS

Without a compass, you must get directions from the sun and stars, which are always true directions. (The local magnetic variation and any magnetic disturbances on a boat are completely irrelevant when you don't use a magnetic compass.)

Portable Compass Cards

A portable compass card is an extremely valuable device when you lack a working compass. Making one is as easy as drawing a circle on a flat surface and marking it off in degrees. Draw a cross to represent the cardinal directions, then draw in the diagonals for the intercardinal points. Estimate smaller divisions from there. To set up reference angles, fold a piece of paper into a square, then fold it on the diagonals, and then fold on the diagonals again.

It will more than likely prove handy to draw a compass card right on the boat, in clear view of the helmsman. With this, the helmsman can orient the boat relative to the sun or a star more accurately than would be possible by just guessing the angle.

With a little practice, you should be able to divide a circle into accurate 5° intervals. There are many ways to improvise. You can always draw a circle with a shoestring and a nail. One trick is to draw a circle with a radius of 57 units. The circumference of this circle will then be 360 units, which makes each unit 1° . The units can be millimeters, tenths of an inch, or any convenient distance between two marks made on a piece of paper and used as one unit (see Figure 3-4). The compass rose from any chart is a ready-made compass card. You can cut it out, tape it to a board, and extend the radials for better precision.

There are numerous uses for a portable compass card, for which you might even use a dinner plate. Using the solar time method (see Chapter 6), for example, you might find that the sun lies 30° to the east of due south, bearing 150° . You can then orient the plate with 150° pointing at the sun and read the boat's heading from the plate—or read the bearing along the troughs of swells from the plate. Figure 3-5 shows another example of how to measure wind direction with a portable compass card.

Another thing that helps with emergency direction finding and with many aspects of emergency navigation is the ability to estimate angles using your hands at arm's length (see Figure 3-6). Basically,

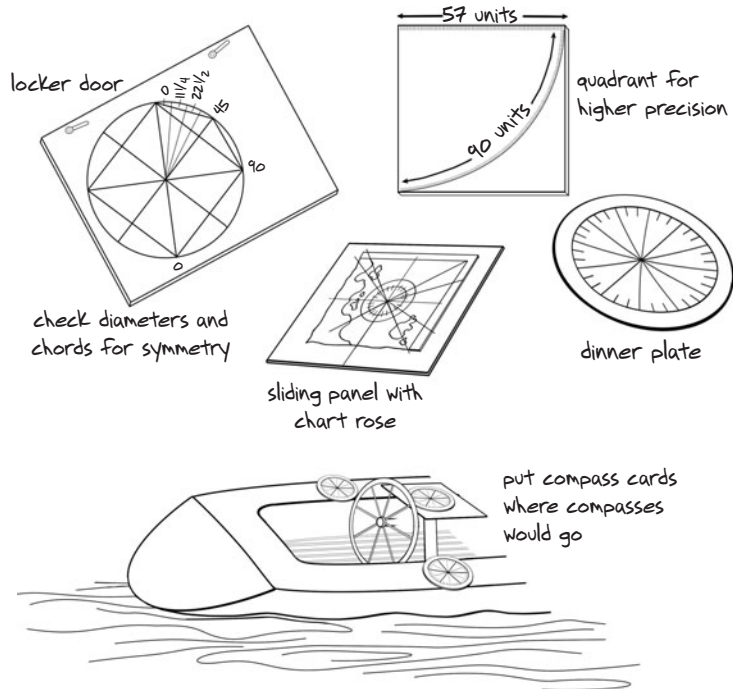

Figure 3-4. Portable compass card. There are numerous uses for a portable compass card in emergency navigation. Find a direction from a celestial body, orient the card, and then use it as a compass (of sorts). A quadrant of a compass card (essentially a protractor) is useful for measuring relative angles in various applications.

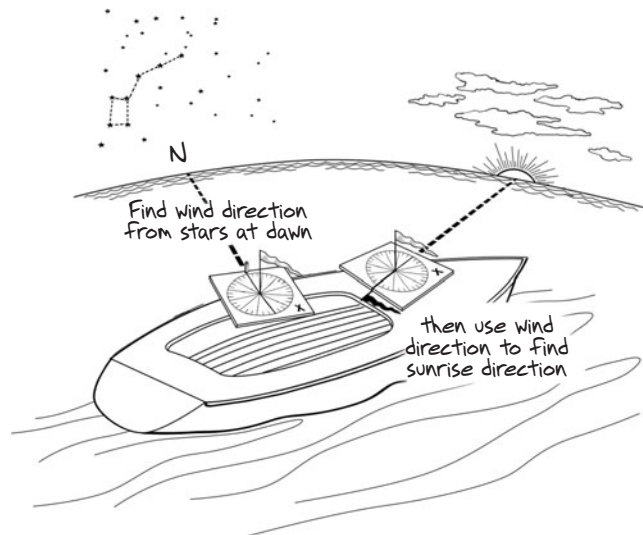

Figure 3-5. A portable compass card in use. Here the morning wind (X) is used as a reference to find the sunrise direction. The planet Venus (not shown) is often a valuable common reference to both star directions and sunrise or sunset directions, since it can often be seen with the naked eye both at night and well into the brighter part of twilight. See also Figure 7-7.

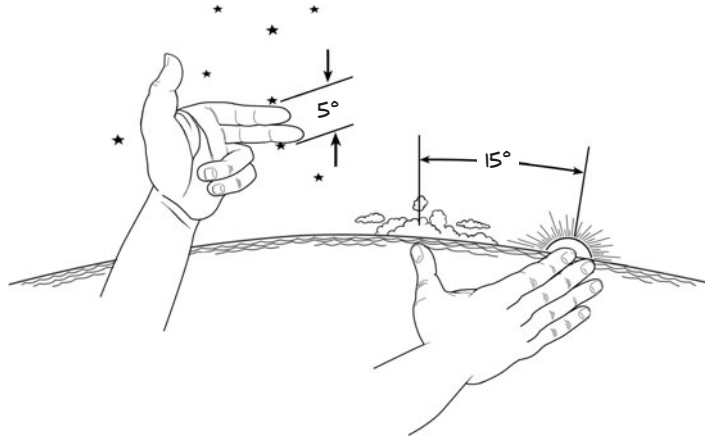

Figure 3-6. Estimating angles with hands and fingers at arm's length. The angle sizes shown are only rough averages. With a sextant available, “calibrate” your own hand using angular distances between distant landmarks that you measured with the sextant. Skill at angle measurements with your hands is a big asset in both emergency and routine navigation. You can make similar calibrations at sea using the distances between low stars, but check that the eye-to-hand length is the same when looking up and looking toward the horizon. If this length changes, the angle calibration changes. See Chapter 11 for more precise makeshift angle measurements.

this is no different from sighting over a compass card, but in some cases it can be even more accurate. Your arm's length corresponds to the compass-card radius, and the larger the reference circle, the more accurate the angular measurements will be.

Finding Direction without a Compass

In most situations, stars are the best source of direction. But with the exception of *Polaris*—the use of which we do not consider here as “steering by the stars”—star directions will not be accurate to the degree. There will, though, usually be several ways to find directions from the stars at any one time. The best approach is to use as many ways as possible and average the results. As an example, suppose you have a bright star near the horizon. One star method might tell you that this star bears 40° south of west. Another, completely independent method might imply that its bearing is 20° south of west. If this is all you have to go by, and you have no reason to favor one method over the other, then at least for the time being, you must consider the bearing of the object to be 30° south of west, with an uncertainty of $\pm 10^\circ$.

You can steer toward a star or cloud formation on the horizon for short periods of time, but these directions soon change. You can often use surface winds and ocean swells for reference directions over longer periods of time—especially the swells, which can, in some cases, persist from a well-defined direction for several days. In the temperate latitudes, another possible reference is the direction of winds aloft, which you can occasionally read from wave patterns in high clouds. These winds, which are in the region of the jet stream, are more stable than the surface winds, although you can determine their direction only when favorable cloud patterns are present.

The general procedure is to steer by the surface wind and ocean swells, using the sun and stars to continuously monitor their directions. The more often you check these directions and the more varied your methods, the more accurate your course becomes.

In fact, the very motion of the sun and stars that makes direction finding difficult also tends to make the average directions you find more accurate. Generally speaking, a star method that errs in one direction when the stars are to the east of you will err in the opposite direction when they are to your west. Consider the sun as an example. From northern latitudes, the sun bears due south at noon. If your goal is to sail due south, you could simply follow the sun throughout the middle part of the day. You would err to the east all morning, but you would err to the west all afternoon by the same amount. The net effect is a fairly good course to the south, although not a very efficient one. You can do much better than this.

Tracking Steering Errors

To get a feel for just how well you can do, you must distinguish between the heading error at any given moment and the net error averaged over an extended run. What you want to know is how much you will be off course due to steering errors alone after traveling a certain distance. Currents and leeway also take you off course, but that is another matter.

If you were to use all the methods of Chapters 5 and 6 to find directions, and used each method many times over a long period of time, each time comparing the result with the correct direction measured with a compass, the average value of all the errors would be about 12° , or maybe even a little more. The largest individual errors would be about 30° or so, if you exclude those methods that give only general directions—east or west, north or south.

Now if you had a way to steer a perfectly straight course and that course was 6° in error, you would go 1 mile off your intended track for each 10 miles you traveled—a 10% position error. You can continue this reasoning, with increasing accuracy, up to a factor of 5 (see Figure 3-7). For example, a constant 12° steering error causes a 20% position error ($2 \times 10\%$), and a constant 18° steering error causes a 30% position error. With a constant 12° error in steering, you would be 200 miles off course after a 1,000-mile voyage. In other words, a constant error of some 12° causes a larger course error over a long voyage. On closer inspection, though, the situation is not so bleak since the error is not going to be constant.

Errors in star steering come from two independent sources. First, some methods are not exact in principle, or they are accurate only under certain conditions. For example, in northern latitudes, an imaginary line through *Procyon* that passes between *Castor* and *Pollux* intersects the horizon near due south, providing *Procyon* is at least halfway up the sky. When these stars are high in the sky (yet not overhead), this method is accurate. When the stars are rising, this rule errs to the east; when they are setting, it errs to the west. The condition of “halfway up the sky” is included to restrict the size of this error in principle.

The second source of error comes from the navigator’s application of the principle. In the Gemini-*Procyon* example, the navigator (you) must somehow project the imaginary line down to the horizon. You can do this by sight or by using a stick as a guide. But however you do it, you can’t expect to do it accurately to the degree. The amount of error that enters at this stage depends on you and how much you have practiced these techniques—and, of course, it depends on the

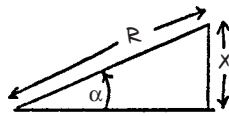

Angle α		$(x \div R) \times 100\%$		
		Exact	Rule	Rule error
$1 \times 6^\circ$	6°	10.5	1×10	5%
$2 \times 6^\circ$	12°	20.8	2×10	4%
$3 \times 6^\circ$	18°	30.9	3×10	3%
$4 \times 6^\circ$	24°	40.7	4×10	2%
$5 \times 6^\circ$	30°	50.0	5×10	0%

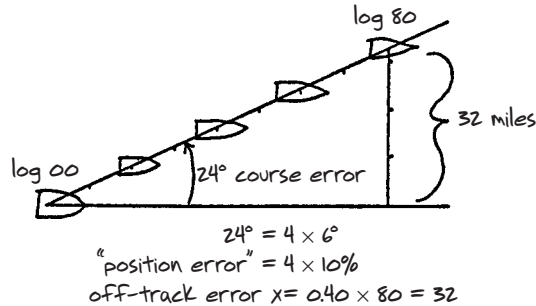

Figure 3-7. Estimating distance off course from steering errors. These data can also prove useful in constructing makeshift instruments for angle measurements. Chapter 10 discusses a variation of this procedure that is of great value in estimating the effects of current and leeway.

sea conditions you must work with. Even with practice, an error of 5° to one side or the other is hard to avoid.

For the most part, however, the errors in principle and the errors in practice are unrelated. They are just as likely to cancel each other out as they are to combine into a larger error. As mentioned before, the combined effect of these errors is about 12° on the average. To find your own average error, practice on land and check yourself with a compass or by the orientation of streets.

Again, the quoted error of 12° is only the typical error you might expect on any single measurement. The saving feature is that the error of a second measurement, from a different set of stars, can be in the opposite direction. When you average the two, you have a roughly 50% chance that the average is more accurate than either one alone. Your chances that individual errors cancel each other out when you average them increases with the number of measurements and the number of different types of measurements.

On a clear night, many star methods are available at any given time, so you can find an accurate average on the spot. If conditions restrict you to one method, such as the sun during the day or a few stars on a hazy night, then it is possible that your course will be off by 20° or more at the time of that measurement. However, your average course throughout the day or night will be more accurate. Generally speaking, the longer you sail on a particular course, continually checking and cross-checking its direction with the stars, the more accurate the course becomes.

The steering accuracy required depends, of course, on the situation. If you are 100 miles off the coast of New York, you only need to know which way is west. But if the nearest accessible land is an isolated island, visible only from 30 miles off, with 1,000 miles of ocean on either side, then steering becomes more critical. However, you must still keep the importance of steering in

perspective. Suppose you are 200 miles from that isolated island and traveling at 3 knots. On a direct route, the island is about three days off. If you have a net steering error of 6° , after 200 miles you will be about 20 miles off course but still in sight of the island. However, if there are ocean currents in the area, a typical current might make the boat drift about 12 miles a day, and near a tropical island, the ocean current might easily be twice this large. If this current is perpendicular to the course and you don't know about it (and thus you can't compensate for it), it will take you 36 miles or more off course in three days, enough that you might miss the island. In this example, knowing the currents would be just as important as being able to steer by the sun and stars.

An important practical point that deserves mentioning more than once is the effect of rain and low clouds on the visible range of islands. Our example island may have a theoretical visible range (see the Visible Range of Lights and Land section in Chapter 13) of 30 miles in clear weather and calm seas, but in a heavy, low-cloud cover, it may be visible only from 10 miles or less. The longer you must wait for the weather to clear, the more important it is to know what the currents might be doing.

Fortunately, prevailing currents in most parts of the world follow the direction of prevailing winds. Since you are likely to be approaching a landfall downwind, it is more likely you will be sailing with the current rather than across it. If you aren't actually crossing a current, it won't change your DR course if you don't know precisely how strong it is; it will just change your time of arrival. Nevertheless, you must always keep currents in mind if you have reason to believe they may be significant.

When sailing to windward, you must also remember to take into account the *leeway* of the boat—how much it slips to leeward on a windward course. For a typical keelboat, this will be (in practice, not theory) somewhere between 5° and 15° , depending on the boat and the wind strength—we'll come back to this point in the DR Errors from Current and Leeway section in Chapter 10. But the effect of leeway on steering differs in an important way from that of current. You can measure or make realistic estimates of your leeway and take it into account in all conditions, whereas you can only make educated guesses about the current.

Chapter 4

STEERING BY WIND AND SWELLS

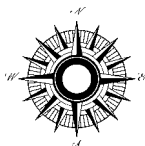

Steering by wind and swells means holding a steady course using wind and swell directions as references. Without a compass, the actual bearing of the course you hold must be found from the sun or stars. Once on course, you look for a temporary reference mark on the horizon near dead ahead. Then holding course by it, you note the relative bearing of the wind and swells. From here on, the general procedure for steering without a compass is not much different from normal sailboat steering.

The first, most immediate goal is to keep the bow pointed toward your temporary reference mark dead ahead. At night this temporary reference is likely to be a star. During the day, it can be a cloud formation on the horizon or even a slight change in the shading of the sky color.

Each time the bow swings off your mark, you bring it back. Then each time you bring the bow back (or every other time or so), check that the wind direction is right when the bow is on the mark. Eventually, the wind angle won't be right when the bow is aligned. If the wind is off, check the waves and swells. If they still agree with the wind, it is time to adjust your heading and find a new temporary mark. Generally, you check the wind first when sailing to windward, and you check the seas first when sailing downwind. In normal sailing, it might only be at this point that you first look at the compass.

In adjusting your heading relative to the temporary mark, you might go, for example, from keeping it right on the bow to keeping it halfway back the length of the bow pulpit, and so on. Or you might pick a new mark altogether. Do whatever it takes to get the wind angle right again, then pick a new mark. In this adjustment, you are assuming that the temporary mark moved, not the wind and swells. But since you won't have a compass to confirm that assumption, you won't be able to make many adjustments like this one before you must go back to the sun or stars to see if the wind or swells have changed.

You can also steer without a temporary mark, using only the wind or swell directions themselves, but in practice it is easier to use a mark when available. Except for the darkest cloudy nights, there is usually something ahead that you can point to. And it is a rare day that does not have a low rim of clouds on the horizon.

A temporary mark, such as a distant cloud formation, can remain at a constant bearing for quite a long time. Sometimes it might change forms but will still remain at the same bearing. On the other hand, clouds in front of you can move across the horizon very rapidly and not be of much use at all. It all depends on how far away they are and how they are moving. The motion of stars or the sun, on the other hand, is much easier to predict (we cover this in detail in Chapter 5). The fastest any of these can move across the horizon when low in the sky is 15° per hour. In short, any chance reference mark near dead ahead is not going to remain fixed in direction for much more than an hour, at best. There are exceptions, of course, which we cover in Chapter 5. But these are not just chance stars that happen to be in front of you. The exception would be when, by happy chance, you were headed toward a star whose bearing changed very little for long periods of time.

Away from moving weather systems and from landmasses, the wind direction is generally stable over much longer periods of time. It can remain constant all day if you are lucky, or even longer. It depends on where you are and when.

In some circumstances when sailing under a spinnaker, driving the boat to keep the bow under the same point on the foot of the sail can be an excellent way to maintain a steady course relative to the apparent wind as you get moved around in the waves.

If you have someone to help with the course monitoring—valuable in emergency steering—he or she does not necessarily have to watch dead ahead. A slick and easy method is to have someone sit in the cockpit to view the horizon athwartships relative to winches or other marks or rigging on the boat (see Figure 4-1). If he keeps his head in more or less the same position, he can easily monitor the heading of the boat relative to clouds or stars on the beam, and do so from a very comfortable position.

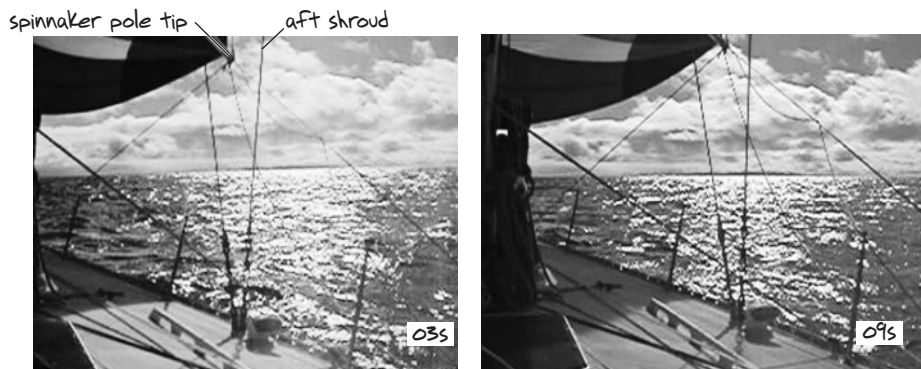

Figure 4-1. Keeping track of a heading relative to clouds. Note the location of the aft shroud relative to the cumulus dome just off the spinnaker pole tip. At 3 seconds, it is just to the left of the dome, and at 9 seconds it is just to the right. Clouds are not permanent references, but this type of alignment is superior to trying to chase a compass card (if you had one) or even a telltale for short-term adjustments.

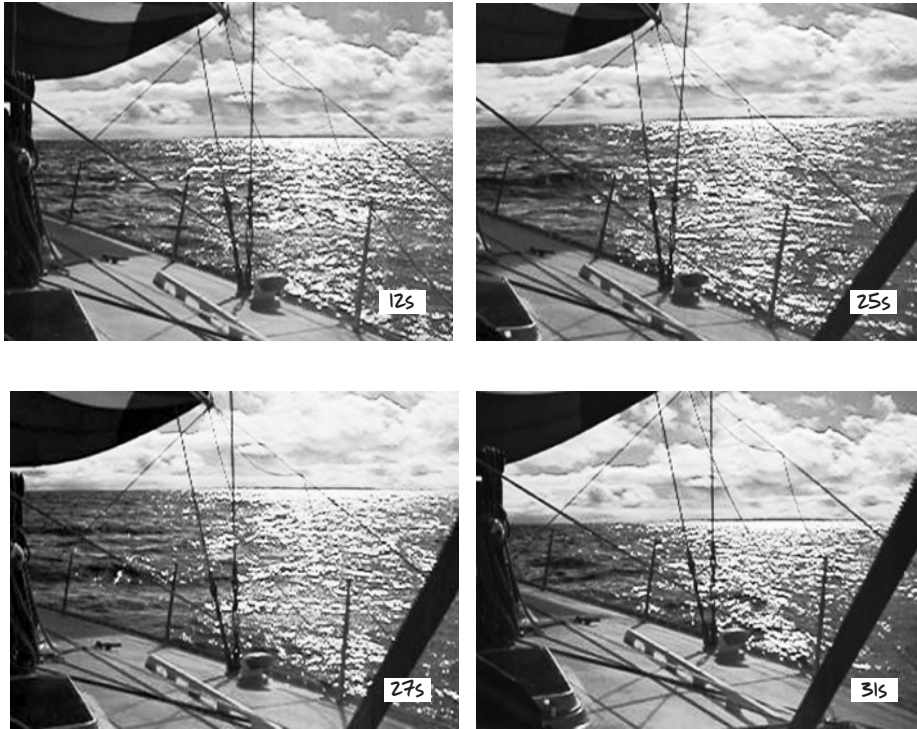

Figure 4-1. (continued)

Regardless of where you are, though, you can never count on the wind and swells alone for directions. Steering by wind and swells is merely the procedure to use between the times you check the direction of sun or stars. With no sun or stars to go by for long periods of time, you may simply have to stop and wait for them to appear.

Just how long you might steer by wind and swells alone depends on the area you are in and your knowledge of its weather and oceanography. It is not within the scope of this book to cover these topics in detail—they are more appropriate to the subject of routine preparation than to emergency preparation—but we'll mention a few of the important points as we come to them.

READING THE WIND

Steering by the wind is a natural thing on a sailboat. Some sailboats on some points of sail will even do it by themselves. Wind vanes and other rigging can also be set to help with this. But a boat sailing strictly by the wind on a featureless ocean could sail in circles if the wind clocked around. And even the steadiest winds shift. For example, the famous trade winds can shift by 90° without upsetting the weatherman. You simply cannot sail long distances by wind alone. You must check its direction as often as possible, using the sun and stars.

Telltails

To watch the wind direction, it is extremely helpful to rig *telltails*, pieces of string or strips of light cloth tied high in the rigging, out of the way of other structures on the boat (see Figure 4-2). Strips of plastic bag or cassette tape also make good telltails, especially in the rain. Telltails show the wind direction instantaneously. It is always better to use a telltale than to guess the wind direction by feeling it. Telltails are common on sailboats, less so on powerboats. But on any boat, if you get stuck without a compass and must watch the wind direction carefully, the first thing you should do is rig a telltale. It is an instrument you can rely on. A prominent telltale on the bow of a powerboat can prove extremely valuable in some cases, even with all your navigation gear working properly, and can be even more valuable on a kayak.

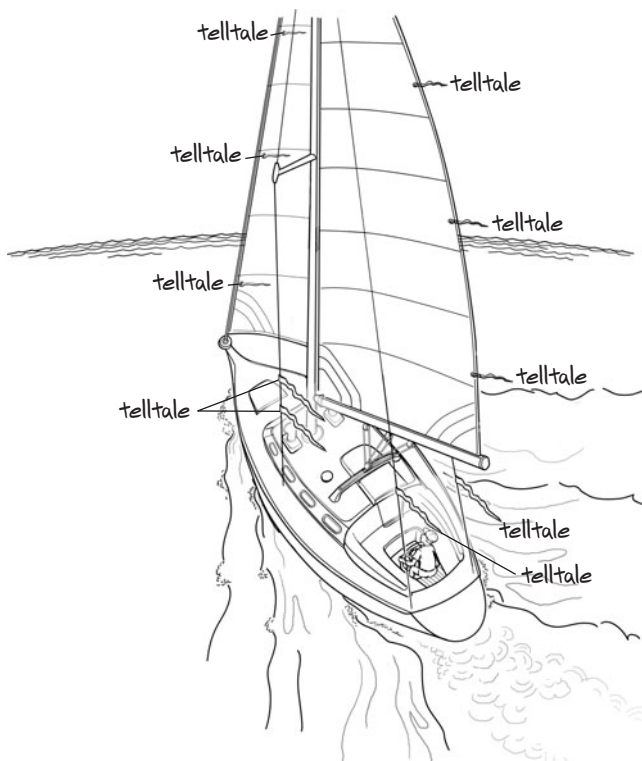

Figure 4-2. Using telltails to read apparent wind direction. Here telltails are flying from the luff of the headsail, leech of the main, windward shrouds, backstay, and running backstay. Long telltails streaming overhead from the backstays are often useful when sailing downwind.

Apparent Wind versus True Wind

When reading a telltale, you need to keep in mind that it shows the direction of the apparent wind as distinguished from the true wind—a distinction that is fundamental to small-craft navigation. The *apparent wind* is the combination of the *true wind* over the water and the effective wind generated by the motion of the boat. The difference between the directions of the true wind and the apparent wind depends on how fast you are moving relative to the

true wind speed. For boat speeds less than 10% or 20% of the true wind speed, the difference is negligible, and you can read the true wind direction directly from the telltale.

When you are moving, the direction of the true wind is always aft of the apparent wind. If the apparent wind is on the beam, you must face this apparent wind and turn aft to look in the direction the true wind comes from. This is true regardless of your point of sail. If the apparent wind is 45° on the bow, the true wind is closer to the beam. If the apparent wind is on the quarter, the true wind is closer to the stern (see Figure 4-3).

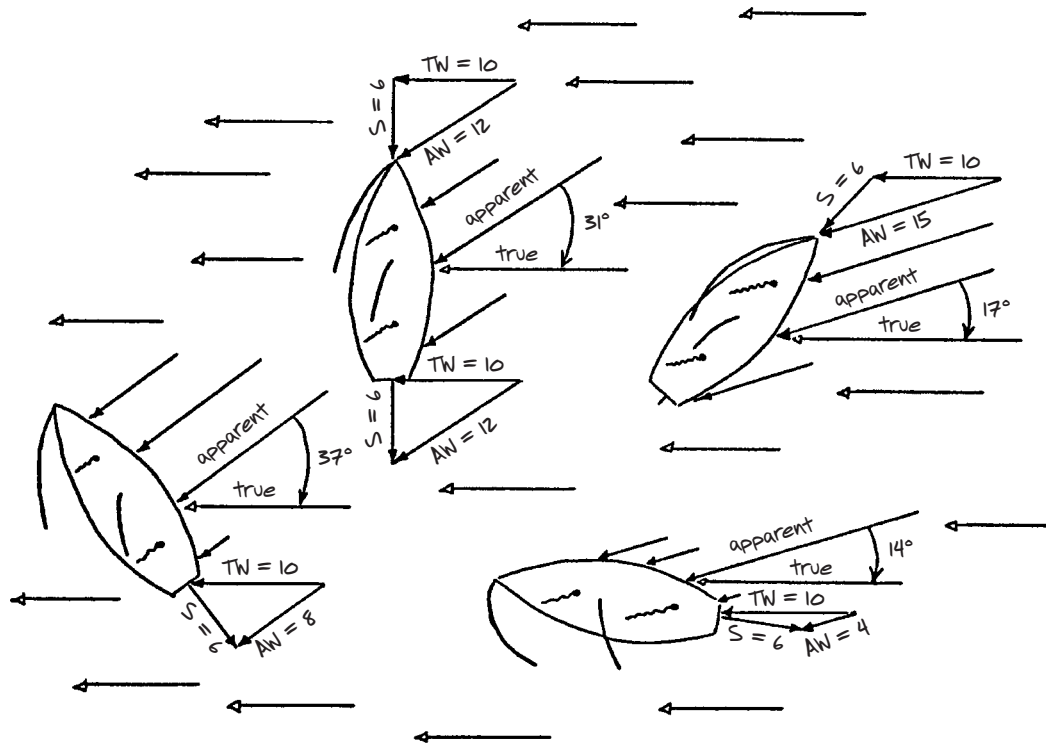

Figure 4-3. True wind direction versus apparent wind direction. The true wind is always aft of the apparent wind. The difference between wind directions is largest when the wind is on the beam (far left). Each boat is moving 6 knots (S = boat speed) in a true wind of 10 knots. The resulting apparent wind speed (AW) is shown for each boat as well.

The exact number of degrees the true wind is aft of the apparent wind depends on your speed relative to the wind and on your point of sail. At any relative speed, the difference between the two is largest when you are sailing with the apparent wind on the beam. The difference is typically somewhere between 10° and 40° . Generally speaking, the higher the performance of the sailboat, the bigger the shift can be.

When relying on the wind for directions, it is ultimately the true wind direction you care about. Apparent and true wind directions won't always be different enough to matter, but in order to steer by the direction of the wind, you should keep their potential differences in mind. The cases to remember are:

- 1 On a beam reach, the true wind can be well aft of the apparent wind. For example, in 5 to 10 knots of true wind, a typical sailboat travels at some 0.6 to $0.7 \times$ the true wind speed. At speeds of $0.65 \times$ the true wind, when the apparent wind is on the beam, the true wind is 41° aft of the apparent wind.
- 2 If the true wind speed changes and your boat speed does not, the apparent wind will shift even though the true wind has not. Say, for example, the boat is traveling at a hull speed

of 7 knots in 10 knots of true wind with the apparent wind on the beam. If the true wind increases to 15 knots without changing direction but the boat speed does not increase much over 7 knots, the apparent wind will shift aft some 20°.

3 Sailing downwind with the true wind well aft, a small change in true wind can result in a large shift in apparent wind direction. Take, for example, a boat traveling at a speed of 6 knots in 12 knots of true wind at 170°. If the true wind shifts forward 20° and drops to 10 knots, the boat speed would likely remain about the same, but the apparent wind would shift forward some 40°. With only the apparent wind shift to go by, you could easily misinterpret this wind shift.

An obvious way to read the true wind direction is to stop the boat. Typically, though, you don't have to go to this extreme; you can usually read the true wind direction from the wave direction or from ripples on the water. These *cat's paws*, as they are sometimes called, are the scalloped ripples that look like fish scales on the surface of the waves. The bigger waves do move in the direction of the wind if it is stable, but when the wind shifts, the wave direction does not follow immediately. Surface ripples, on the other hand, respond instantly to the wind, as if the wind were stroking the surface with a paintbrush. Sometimes you have to stare at the water for a while to see them, but in any wind over a few knots, they are there, and you can spot the wind direction from them.

Steering by the Wind

To steer by the telltales, keep the boat headed so that the telltales maintain a constant direction relative to some reference point on the boat. The trick is to rig telltales in a convenient place, usually on the windward side of the boat—which means one on each side—well off the deck. Sailing downwind on some boats, you might find that a long telltale on the backstay can be seen overhead, looking up from the helm. When this works, it works nicely. If you happen to be beating or on a close reach, you can steer by telltales rigged in the usual way—attached on or through the luff of the headsail, one in the center of each panel (away from seams and hanks), about 18 inches back from the luff. Then with the sails trimmed properly, steer the course that keeps them streaming back along the sail.

Steering without a compass during the daytime requires more concentration than it does on a clear, starry night. To stay accurately oriented during the day, you must watch not only the telltales and distant clouds but also waves and swells, shadows on the boat, and even moving clouds. In one sense, the main job of steering during the day is to hold as steady a course as possible until nighttime. This is especially true if the sun is obscured during the day, or if the sun is out but you don't have a watch. At night you can get accurate bearings from the stars almost continuously.

Prevailing Winds

To make full use of the winds in navigation, it pays to study the prevailing winds of your route before you depart and to understand a few basics of expected wind shifts associated with various

weather patterns. This is standard procedure for a sailing cruise but probably less so on a vessel that does not depend on the wind for power. Pilot charts are the most convenient reference source for climatic ocean winds. They give directions and strengths of winds throughout the oceans for each month. The information is presented as wind roses that show the probabilities of various winds at each location (see Figure 4-4). Similar wind predictions for coastal waters are in the weather appendices to the *U.S. Coast Pilots* or their international counterparts. Local winds are also discussed in the regional weather sections of the *Coast Pilots*.

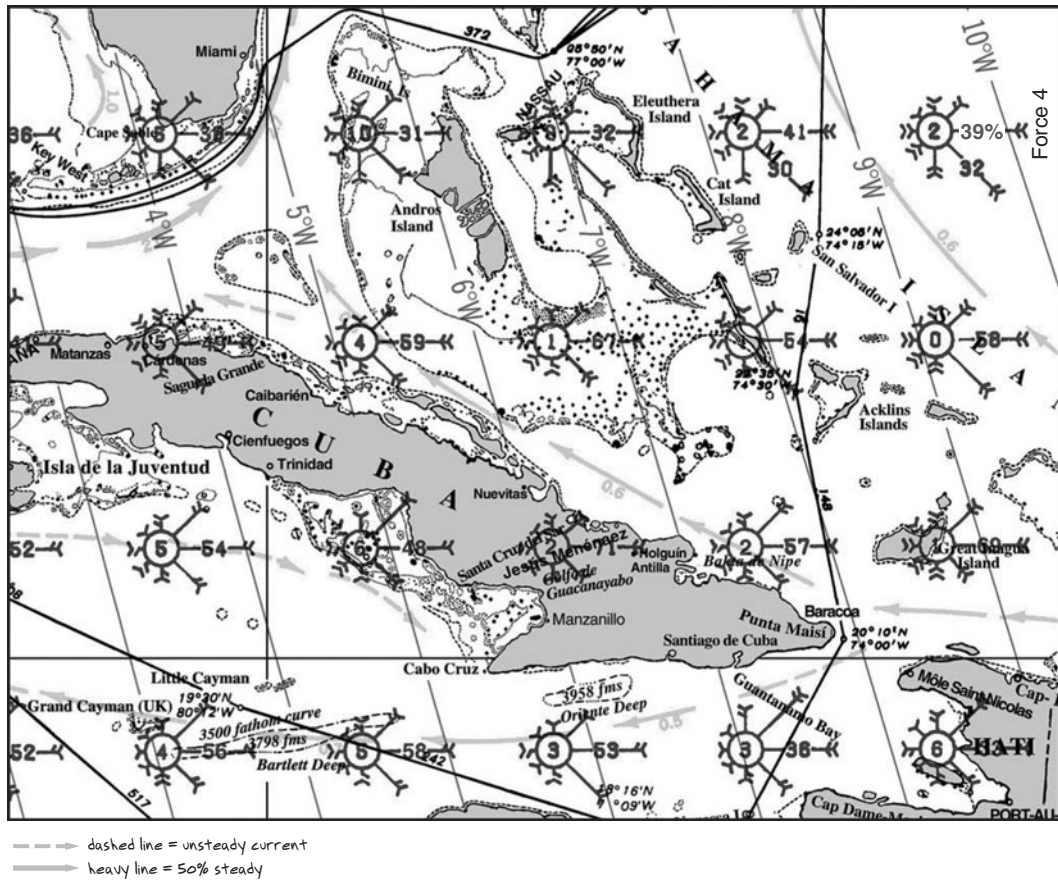

Figure 4-4. Section of a U.S. Pilot Chart near Cuba. August winds near Cuba are given for each 2° of Lat-Lon. In the top right corner, the wind has a 39% probability of being from the east and 32% from the southeast. When the probability is less than 29%, it is represented by the length of the line, which is relative to a printed scale not shown here. The predicted wind speeds are in Beaufort Force numbers, with each side of a feather being one number. In the top right the E and SE winds are Force 4 (11 to 16 knots); the much less likely NE wind would be Force 3 (7 to 10 knots). The circled numbers are the percentage calms at each location. The current arrows in this chart are marked with speed in knots with steadiness indicated by the line style: a heavy line means 50% steady, thinner lines mean 25% to 50% steady, and a dashed current arrow means steadiness is less than 25%. Note the steady Gulf Stream near Florida, and the weak unsteady backstream south of Cuba. Other pilot charts do not have the steadiness data, and some give the speeds in nautical miles of drift per day instead of knots. Magnetic variation and a few segments of great-circle routes with waypoints and leg distances are also visible. (See Figure 1-1 for another sample of a pilot chart.)

The extent to which a given wind prevails determines how much you can rely on the wind direction itself for an approximate true bearing. The trade winds of the tropics are the most notable in this regard. They have a high probability (80% or so) of blowing from the northeast or east in the northern tropics and from the southeast or east in the southern tropics (strengths are usually 10 to 15 knots, but winds of 5 or 20 knots are not uncommon). Trade wind directions can remain stable for several days or longer.

Another example of prevailing winds on a global scale is the clockwise circulation around the Atlantic and Pacific highs and (to a lesser extent) their counterparts in southern oceans with counterclockwise winds. The centers of these vast high-pressure areas, on the other hand, have little or no wind at all for many days. For the sake of emergency preparation, it helps to know what winds you might expect to plan your best course of action—know that the doldrums separate the trades, for example, and so on. See the Meteorology and Oceanography section of the bibliography.

With experience, and in special circumstances, you might guess the wind direction from the weather in general. In several areas of the high temperate latitudes during the summer, for example, you might well guess that moderate, steady winds with fair skies must be from somewhere in the northwest quadrant, and strong winds with foul weather must be from somewhere in the southern quadrant (SW to SE). But this is nothing more than familiarity with prevailing winds and weather patterns, and is not accurate enough to help much with orientation over a long distance.

To steer by the wind, you don't always have to rely on surface winds alone. Sometimes you can read the direction of winds high in the atmosphere from the movement, shapes, and patterns of high clouds. The wind direction aloft is not the same as on the surface, however, and usually remains constant for longer periods of time. Since this reference direction can be determined only from clouds, we'll discuss it further in the Clouds, Birds, and Planes section in Chapter 7.

SWELLS, WAVES, AND RIPPLES

It is usually possible to distinguish three types of wave motions on the surface of the sea: ripples, waves, and swells (see Figure 4-5). We talked about ripples in the previous section; these cat's paws, or wavelets, on the surface of waves show us the instantaneous wind direction. Ripples are just tiny waves with very little inertia. Without inertia to keep them going, they disappear the instant the wind stops, or they change direction the instant the wind changes direction. The direction of ripples can change by the second in response to gusts or small wisps of wind. (They respond fast because they are *capillary waves*, whose restoring force is surface tension, as opposed to larger waves restored by gravity.) Ripples usually ride on waves, and the waves often ride on a gentle, rolling motion of the sea called *swells*.

Waves are caused by local winds. They grow or subside with the wind, and they advance in the direction of the existing wind. The direction and size of swells, on the other hand, are not related to local winds. Swells are the remnants of waves that are no longer driven by the wind that created them; either they outran a storm, or the winds died or changed direction. They usually originate a long distance from the local conditions and may move with or against the local wind, or at any angle relative to it. Swells persist purely from their own inertia, which is immense. When

Figure 4-5. Swells, waves, and ripples. Swells may provide reference directions for many hours or even days. Though only one is shown here, there can be several swells running in different directions at the same time. The directions of swell propagation are unrelated to the local wind. Wind waves, on the other hand, flow in the direction of the existing (steady) wind. If the wind shifts permanently, the wind waves will develop in the new direction soon after. Ripples (cat's paws) on the surfaces of waves and swells respond to the instantaneous wind. Persistent ripples on waves that are not aligned with them may be the first sign of a wind shift.

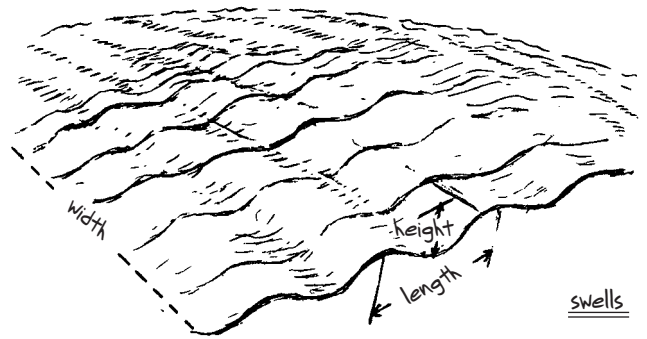

unopposed by counteracting winds, swells may run for 1,000 miles or more and persist for several days or longer. In some areas and seasons, prevailing swells reflect the prevailing storm patterns of some distant region.

The distinction between swells and waves is sometimes difficult to make, especially when the waves are bigger than the swells. But when the swells are at least as big as the waves, they are quite prominent. There can also be swells without waves.

It is not uncommon to see a calm, waveless sea undulating like a giant corrugated-tin roof or washboard. In the more general case, though, the seas are a confused combination of waves and swells. For orientation from the seas, we must distinguish swells from waves because prominent swells can provide persistent reference directions despite changes in the wind and waves.

To do this, recall how waves are defined. *Wave height* is the vertical distance from trough to crest. *Wavelength* is the horizontal distance between successive crests, measured in the direction of the wave's motion. And finally, *wave width* is the transverse extent of the wave in the direction perpendicular to the wave's motion.

The height of waves depends on the strength of the wind, the size of the wind pattern (*fetch*), and the duration of the wind. Wave-height tables in oceanography books show how wave height is determined by wind strength, fetch, and duration. A 20-knot wind might make waves of some 6 to 8 feet (the *significant wave height*, meaning the average height of the highest one-third of all the waves), if the wind blows for a day or so, over a distance of about 100 miles.

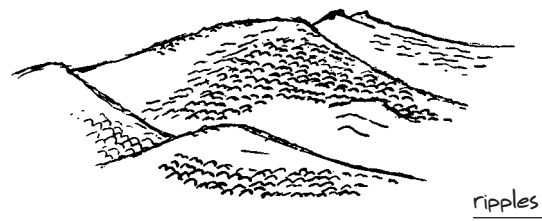
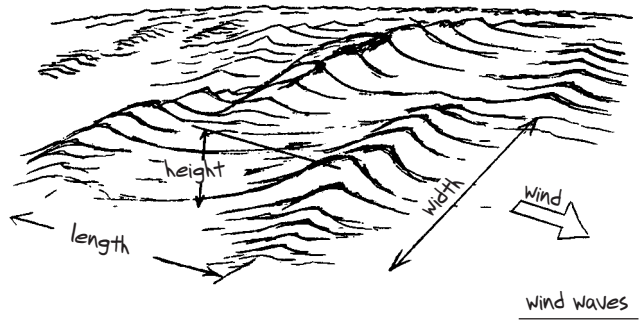

The height of swells depends on the height of the waves they evolved from and the distance they traveled from their source. As swells move away from their wind source, their height slowly decreases and their length increases—they become less steep. In general, the biggest swells are not as steep as even the smallest waves.

Though swells are not as steep as waves, their primary distinction is their shape. Swells have smooth, rounded crests, whereas wave crests are sharp and cusp-like. Waves break; swells do not. And swells are much wider than waves. The width of swells can appear to be unlimited. The troughs of well-developed swells on calm water can look like highways extending out to the horizon—and they can be just as good a reference direction. The widths of waves, on the other hand, are typically only a few times their length, and they appear even narrower because their height is peaked near the center of the wave. Also, successive swells are remarkably uniform in height, like the ridges of a washboard, whereas wind-driven wave patterns are very irregular. If there are waves at all, they have many heights.

Finding Direction Using Swells

Wave directions can sometimes be valuable for spotting the wind direction or, occasionally, even shifts in wind directions. But for a primary reference direction, it is the swells we care about, not the waves. Swell direction can persist for many hours, even days in some cases, regardless of wind and wave changes. On a starless night or during the day, prominent swells provide the best reference direction for steering.

The first task is to identify the swells. Sometimes this is easy, while other times it takes concentration since there can be two or three swells running in different directions at the same time. When this happens, you must choose the most prominent one to use. Usually, the bigger the swell, the better it is, primarily because bigger swells are easier to see and last longer. But sometimes a weaker swell that approaches from ahead or astern, or directly on the beam, is easier to steer by than a stronger swell on a diagonal approach.

One trick that often helps identify the swells is to close your eyes and feel the rhythm of the seas. This is best done lying down in the cockpit or belowdecks, where you can relax without distraction. Once you have identified the rhythm of the seas (such as “LITTLE ONE, one, two, LITTLE ONE, one, two, three, BIG ONE, one, two . . .”), study the water in relation to this rhythm to identify the swells that are causing it. It also helps to concentrate on the relative amounts of pitch and roll associated with the pattern. The swell pattern on the water can best be seen from a high vantage point, such as standing on the boom.

To detect changes and repeated patterns in the swells, record the swell directions, their approximate heights, and the period of time between successive crests—usually somewhere from a few seconds up to 15 seconds or so. Remember, the period you detect can depend on your speed and course heading relative to the swell direction. If you change course, you may have to take this into account to identify the pattern. You may find that the swells come predominantly from one direction. If so, and you get stuck without swells, sun, or stars, you will have some guideline for guessing the swell direction when they reappear.

The National Data Buoy Center’s website (ndbc.noaa.gov) has a special reporting section for each coastal buoy report—the Detailed Wave Summary—that provides the periods and heights

of the waves and swells at each buoy. Combining these observations with the associated online weather maps is an excellent way to learn about these wave patterns. Some surfers' websites are also good resources as surfers care a lot about swell patterns.

When you do reach land, you may have to enter a harbor through a channel or over a river bar, or you may approach a beach in a life raft or dinghy. Remember that even a violent surf can appear meek and smooth when viewed from seaward, so be especially careful. Bar crossings are notoriously hazardous when an onshore swell meets an ebbing flow from the river entrance.

WIND SHIFTS

The biggest problem in steering without a compass is foul weather: no sun or stars, rapidly changing cloud patterns near the horizon, and many wind shifts. One option is to stop and wait it out, and you may have to do just that in some circumstances. But stopping, however much you might want to (by heaving-to, lying ahull with or without a sea anchor, or whatever), is not always the safest thing to do. In big seas, it can be dangerous. If you must run with a storm and still try to keep track of your position when your only reference is the wind and waves, it pays to have some experience in judging wind shifts. You can then make educated guesses about what is taking place and later put the pieces you remember back together to figure out how far off course you might be.

In light air and fair weather, sudden wind shifts are easy to spot relative to temporary reference marks on the horizon, especially if a prominent swell is present to verify it. In stronger winds, the waves might obscure the swell and make this observation more difficult. But with stronger winds, you have bigger waves, and you can usually tell if you have had a significant wind shift from the change in the ride.

Though wind waves do move in the direction of the existing wind, it takes some time for them to respond to a shift in wind direction. During the transition, wind and waves are going in slightly different directions. If you follow the shifted wind around, you meet the waves (or they meet you) at a different angle than you were used to. And this is often quite easy to notice.

But you must be careful about calling such an observation a wind shift. Occasionally, you will get almost the same effect when a new swell pattern first meets your boat. A new diagonal swell can pass under big waves and change their apparent direction without the swell itself becoming prominent for some time. When this happens, one thing to check is the wind on the waves themselves. Check the cat's paws for wind direction relative to wave direction. Also, when the wind does change, you can often see the spray blowing off the tops of the waves at an angle. Or there might be a noticeable bias to the curl of the breakers, which may signal a wind shift.

We have stressed the value of prominent swells for long-term reference directions, but this is not always the case. You can have prominent swell patterns pass you in a short time, almost as if someone had dropped a giant stone in the water somewhere. Generally, these more temporary swells tend to be steeper, implying a more local source—the more persistent swells tend to be long and low, from far away. It is these steeper, temporary swells that often appear as wind shifts on the waves, and they are easily seen in routine sailing. For example, you are holding a steady point of sail, and suddenly the waves are coming from a different direction, but your compass course hasn't changed. Then, after 20 minutes or so, the waves are back to normal.

Another sign of a long-term wind shift is a decrease in wave height while the wind speed remains unchanged. When the wind shifts, the waves cannot respond immediately due to their inertia, so the new wind is partly contrary to the wave direction. This tends to beat down the waves, especially during the period just following a large wind shift. In these cases, wave heights diminish before they rebuild in the new direction.

Weather Patterns

To anticipate wind shifts, it helps to be familiar with the weather patterns of the region. In the temperate latitudes of the Northern Hemisphere, for example, if you spot a frontal system approaching from the clouds—or a sequence of cloud changes—you can count on the wind veering when it crosses, regardless of what kind of front it is (see Figure 4-6). In other words, if you face the wind you've got now, the new wind will shift to the right. If you can tell from the clouds what type of front is approaching, you might be more ambitious with your predictions. Cold fronts bring stronger winds, which typically veer more than those from warm fronts. Each frontal type has distinctive cloud formations and weather. (A wind shift to the left is called a backing shift.)

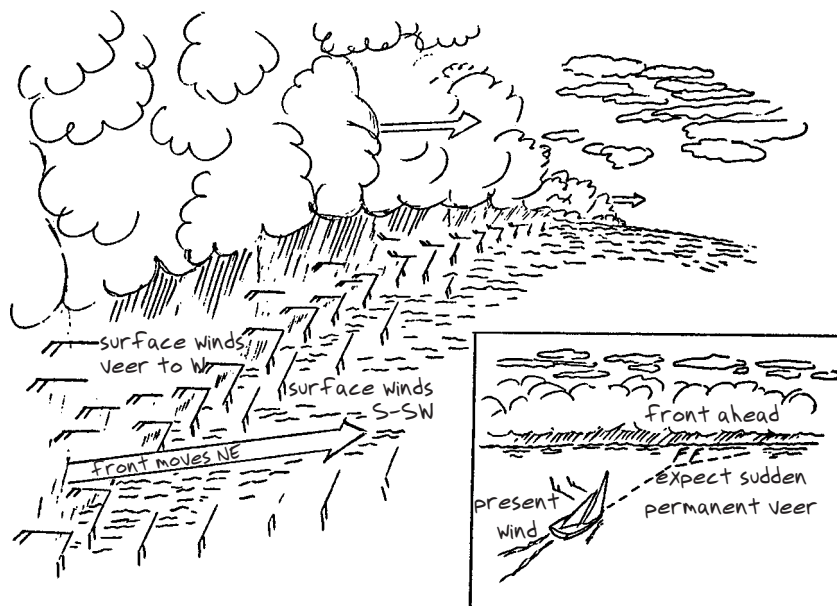

Figure 4-6. Wind shift at a (cold) front. In the Northern Hemisphere, surface winds nearly always veer at any kind of front. Face the wind you have, and the new wind at the front will be from the right (the opposite is true in the Southern Hemisphere). Warm fronts are typically preceded by lowering clouds and long, steady rain, with the wind gradually backing around to the south. Cold fronts often follow close behind warm fronts, in a warm sector of fairly steady winds and broken cloud cover. They often appear as a notable line of tall cumulus clouds, with heavy rain at the front. Occluded fronts are not as easily characterized from their appearance, since they are a combination of warm and cold fronts, though they should also bring a veer to the surface wind. (Standard wind arrows are shown. Each long feather represents 10 knots; each short feather represents 5 knots.)

Squalls

Squalls are complex convective cells with complex wind shifts (see Figure 4-7). They pull up warm, moist air—which gradually alters the surface winds as the squalls approach—then blast it suddenly back down in a strong cold dome of gusty winds at their leading edge. Squalls are common in all waters, but they are easier to distinguish in warmer waters, where they often form during the evening. You can spot them as localized areas of tall cumulus clouds with low ceilings over heavy rains. For emergency steering, it is best to avoid them if possible. But since you often can't, it pays to have some idea of what might happen; otherwise, it is easy to become disoriented if you encounter a series of squalls on an overcast night. For minimum course loss in a squall, use the following guidelines:

- When sailing upwind, tack away from the squall's path.
- When sailing downwind, jibe toward the squall's path.

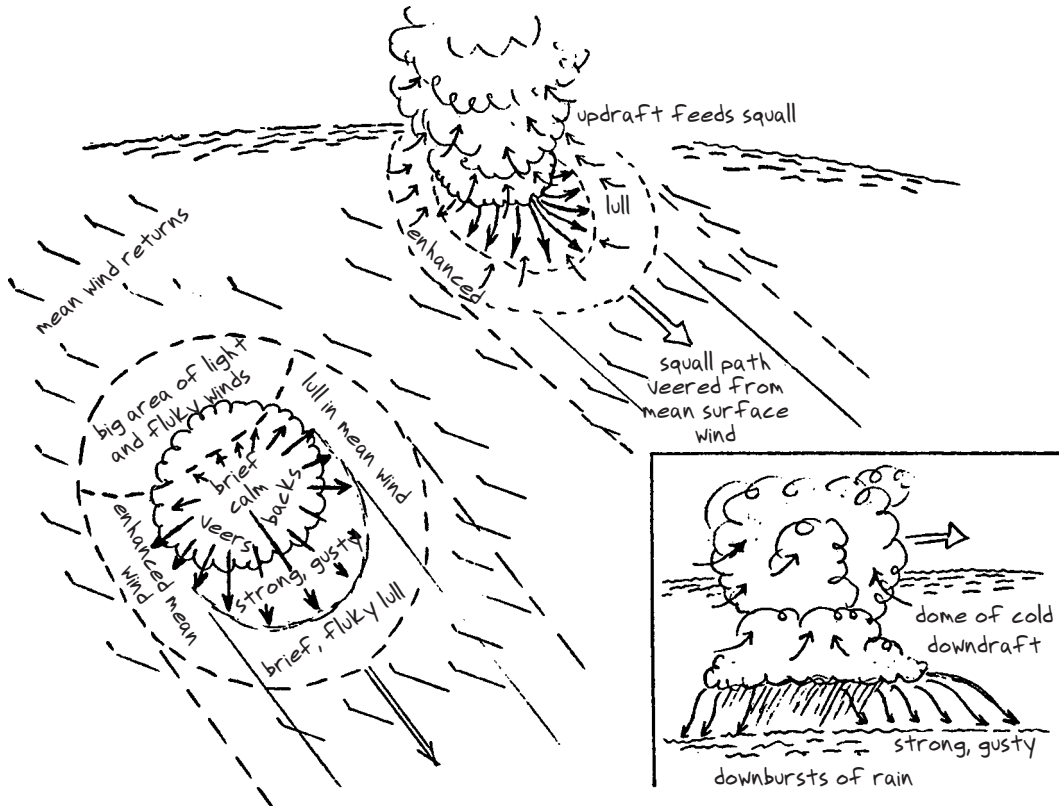

Figure 4-7. Wind patterns around raining squalls. Just outside the squall's strong wind regions, the updraft tends to enhance surface winds toward the squall and diminish surface winds away from the squall. The strong, gusty downburst of cold air comes with the heavy rains. If the squall has a dark ceiling, and it is not yet raining, the worst is yet to come. If the squall approaches with light rain, the worst is past. Generally, there is a long period of light and fluky winds behind a windy squall. The general rule is that before the rain starts, wind is pulled into the cloud; during and just after the rain, the wind is fanning out from the cloud.

These rules are illustrated in Figure 4-8. They are, of course, based on an idealized wind pattern around a squall that won't always be the case. Nor can you always judge the squall's course properly, which can be critical to the choice. Watch the center of the cloud or rain pattern as you would a ship to judge your relative courses—radar is a tremendous help with this evaluation and subsequent maneuvering (see my book *Radar for Mariners* for a discussion of this). Despite the uncertainties, it can help to have the above guidelines to negotiate these situations if you do not have a radar at hand.

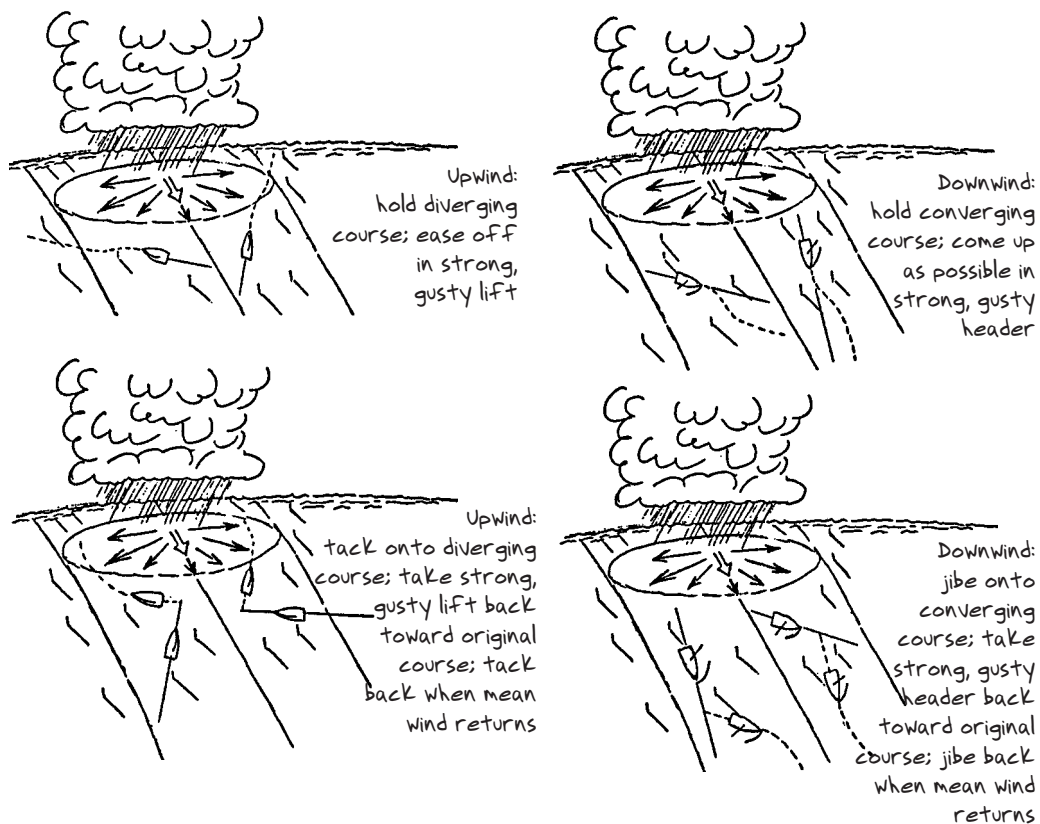

Figure 4-8. Guidelines for minimum course loss in a squall. Expect a brief lull in the mean surface winds shown at the pictured boats, and then a sudden onset of the strong, steadily shifting winds, which are shown under the approaching squalls. It is essential to determine the path of the squall, and where you are relative to it, as carefully as possible. A first guess (in the Northern Hemisphere) is that the squall comes from the right of the mean true wind away from the squall. But severe squalls are tall clouds, which are often being carried along with much higher winds, and which may be flowing in a direction quite different from the surface winds. Watch the squall's motion (if you can see it) as carefully as you would a ship on a potential collision course. On a dark night, you won't see them coming (unless you have radar, on which they show up very nicely), but these pictures might help you plan the rest of the night once one goes by. Though usually individually isolated, the existence of one squall usually means conditions are right for many, and they will all be moving in the same direction. Radar is an invaluable aid for monitoring and then predicting squall motions.

A way to test the guidelines in routine sailing is to hold, tack, or jibe onto the recommended course as soon as it is apparent that the leading edge of the squall can't be avoided—but don't wait too long. The leading cold dome of bad news extends out several miles ahead of the clouds and rain. Later, try to remember what happened and make notes. If the rules work, you shouldn't have to jibe, tack, or head off to China when the squall hits. In contrast, if you fail to do this, the squall might tack or jibe the boat for you, and without a compass and in poor visibility, you could flop around for some time in the trailing lull wondering which way to go.

Needless to say, it is low priority to practice squall maneuvers in real squalls, even when you have all your navigation gear intact, because any sudden increase in wind speed takes all your attention. But it is only prudent to note what took place after the fact and record it. There is no substitute for “going to school” on the first squalls you see and learning from the experience. Although meeting them from different angles on different sides will have different results, it is way more likely than not that a second encounter with the same configuration will have the same results as the first.

Squalls typically come and go in 20 to 30 minutes or so, but if you are sailing fast downwind, you occasionally might get in phase with the squall's motion and ride its leading edge for an hour or longer. In cases like this, you could be actually riding along the edge of a zone at which squalls are forming, dying, and forming again in sequence, as opposed to riding along with the same squall.

Generally, though, wind shifts from squalls are temporary, and eventually the mean wind you had prior to the squall fills back in. This is in contrast to the veering wind shift at a frontal passage mentioned above, which is more permanent because the weather pattern is larger.

To practice reading the wind, think of these guidelines regarding wind shifts for fronts and squalls during your routine sailing. If you prove to yourself that they work more often than they fail, you will be that much more prepared for them and for steering by the wind without a compass. Again, if you do have radar, your practice is even more informative since you can monitor the relative motion of the squall before and after your maneuvers more quantitatively.

Chapter 5

STEERING BY THE STARS

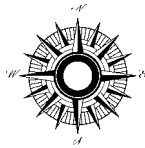

Stars are a part of our environment we can rely on, no matter where we are. In the Arctic or the desert, or at sea a thousand miles from land, when you spot familiar stars, it is like meeting dependable friends. It is comforting in any circumstance to recognize part of our environment, to at least have our bearings. With this attitude in mind, it helps to get to know our friends' names and occasionally look for them, even when we don't need them.

KNOW THE WHOLE SKY

The methods of star navigation presented here work in all parts of the world, since they make use of stars in all parts of the sky. The key to dependable star steering is knowing as much of the whole sky as possible. This is true for two reasons. First, not all methods of star steering have the same accuracy. Some, like the *Polaris* methods, are always accurate to within 1° , while others may work well only when a particular constellation is high in the sky or low near the horizon—and this depends on the time of night and season of the year. Even if a method works well in principle, errors in judgment and measurement can't be avoided. But when you combine several independent ways to find directions, the errors in individual methods tend to cancel each other out, and you end up with an accurate orientation.

On a clear night, you steer by the “shape” of the whole sky, rather than by any one rule. It is a lot like looking at a map in the sky. Most people can glance at a map of North America—in any orientation, even spinning—and tell which way is north. We do this by learning the shape and orientation of the continent as shown in Figure 5-1. The same thing applies to star steering.

The second, perhaps more important, reason for knowing the whole sky is that you may have only a limited part of the sky to go by in cloudy weather. The goal to strive for is the ability to find directions from an isolated patch of stars, anywhere in the sky—in the extreme case, from a

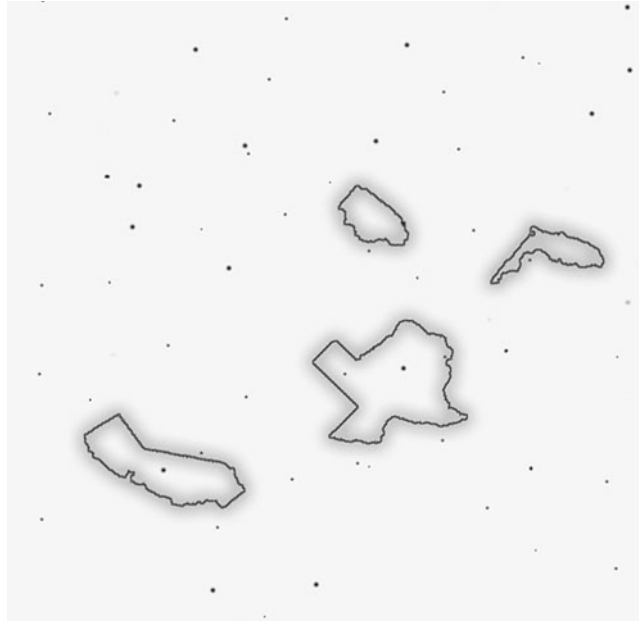

Figure 5-1. How to locate the pole of the sky from known star groups. The trick is to memorize the orientation of star groups just as we do the shapes of the states. No matter what the orientation of this map is or how brief your glimpse, you can identify the direction that is due north—the top left corner of the picture. With a few key groups in mind, you can find the approximate pole of the sky (and hence due north below it) with just as quick a glimpse. It is a component of steering by the shape of the whole sky.

single, unidentified star. This goal accounts for the many different ways we cover to find *Polaris*. With clear skies, you need only one way to find the North Star, but when it is not clear, any one of six widely spaced constellations is almost as good as the North Star for finding true north.

HOW THE STARS MOVE

Steering by the stars for short periods of time is common in routine navigation. Every sailor knows it is easier to steer toward a star than to follow a compass course. But you can't follow any one star indefinitely. Star directions change as the stars move across the sky. To steer by the stars over longer periods of time, it is important to know how stars move.

All stars rise to the east and set to the west. Halfway between rising and setting, a star reaches its peak height in the sky. At its peak height, a star always bears either due north or due south. Unfortunately, you can't often use this fact to find due north or south, since it is difficult at night without a horizon to tell when a star has reached its peak height.

A more useful direction is the bearing of a bright star when rising or setting. For any specific latitude, the place on the horizon where each star rises remains the same for that star throughout the year, and from year to year. In most parts of the world, if you change latitudes, the bearing to a rising star will change with your latitude. There are exceptions, though, and we will take advantage of these for steering.

As the earth orbits the sun each year, the seasons progress, new stars become visible, and the time of sunset changes. But regardless of the time of sunset, all stars rise 4 minutes earlier each night because of the earth's motion around its orbit. This means that if you look at the eastern sky at the same time each night, you will find the stars slightly higher each successive night. Likewise, stars in the western sky are slightly lower each successive night at the same time. Stars near the western horizon at evening twilight will soon be gone for the season (see Figure 5-2).

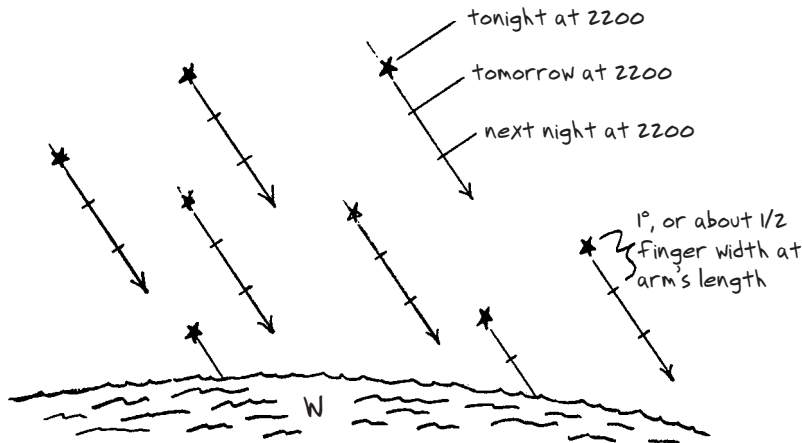

Figure 5-2. Nightly progression of the stars. Because of the earth's annual motion around the sun, all stars appear 1° farther along their paths on each successive night when viewed at the same time. Stars to the east are higher; stars to the west are lower.

The season of a star depends on where you are and where the star is. You can see some stars all night long, every night of the year; others may be visible for only a few hours a night, a few months of the year. But whatever the season of a particular star, that season remains the same for that star from year to year. Each star in the sky—whether you can see it or not from your latitude—crosses over your meridian (your longitude) at midnight local time on a specific day of the year, and that day does not depend on where you are. In this sense, each star in the sky has a “birthday,” its own unique day when it will be at its peak height in the sky at midnight (here midnight means literally the middle of the night—not 2400, but halfway between sunset and sunrise).

In this sense, the stars make an excellent calendar—if only midnight were not such an inconvenient time to read the calendar (early evening would be better). Unfortunately, the time of early evening depends on the time of sunset, and the time of sunset depends on latitude, which in turn throws off the evening schedule of the stars as we sail north or south. From any latitude, though, you can always rely on the seasons of the stars determined by the midnight calendar. Orion, for example, will be on your meridian during the middle of the night in mid-December. Scorpio will be there in early June, regardless of whether you are in Australia or Canada, New York or Hong Kong.

As mentioned earlier, learning the stars is much like learning geography. To see this, it might help to imagine the stars as painted dots on a glass globe that encloses the earth. Stars are grouped into constellations whose positions on the star globe are permanent, just as cities are grouped

within countries whose positions on earth are permanent (we are not discussing politics here!). In this model of the stars, the earth remains stationary, and the star globe rotates once a day about the earth's axis. This model shows how each star circles the earth directly above a specific latitude and how that latitude remains constant for that star (at least on the time scale of decades). The unique latitude of each star is called the star's *declination*.

The bright star *Arcturus*, for example, has a declination of $N 19^{\circ} 08'$. It circles the earth over latitude $19^{\circ} 08' N$, the latitude just south of Wake Island in the western Pacific, or the southern tip of Hawaii (the "Big Island") in the mid-Pacific, or just south of Grand Cayman in the Caribbean. On Wake Island, Hawaii, Grand Cayman, or any other point on earth at this latitude, *Arcturus* passes directly overhead once a day, every day of the year. During late winter and spring, this happens at night, when you can see the star. But it is there once a day, even in other seasons when you can't see it because the sun is up (see Figure 5-3).

The prominent constellation Orion straddles the equator with his upper body over northern latitudes and his lower body over southern latitudes. The westernmost star of his belt has a declination very near 0° , which puts it right over the equator. Observers in northern latitudes watch Orion arc across their southern sky from left to right while observers in southern latitudes watch Orion arc to the north, moving right to left. In each case, the stars are moving east to west. Only

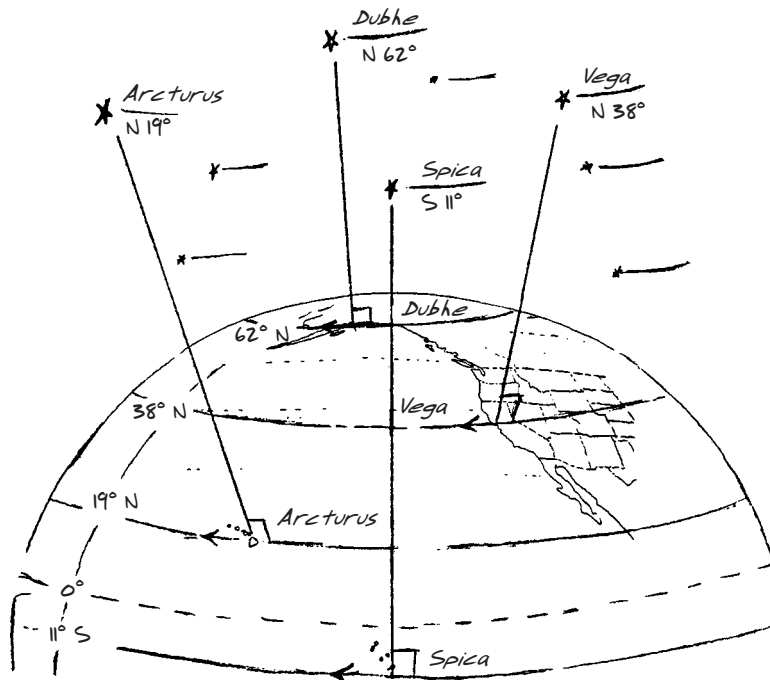

Figure 5-3. "Pillars of light." Each star circles the earth daily over a specific latitude equal to the star's declination. Think of a laser beam emanating from the star, which passes through the center of the earth. Here we show Dubhe passing over Anchorage, Vega passing over San Francisco, Arcturus passing over Hawaii, and Spica passing over the Marquesas. The figure is especially schematic because the fixed celestial longitudes of these stars would not place them over these locations at the same time.

at the equator, the “latitude of Orion’s belt,” will observers see Orion rise due east, pass overhead, and set due west.

As you sail toward the equator from the north or south, you can watch Orion climb higher in the sky each night. When you finally reach the equator, Orion’s belt will pass overhead. As we’ll see in Chapter 11, you can always determine your latitude from the stars that pass overhead; that is, your latitude must be the same as the declination of the stars overhead.

Stars with southern declinations, circling the earth over southern latitudes, are called *southern stars*; stars with northern declinations are called *northern stars*. This brings up an important point that we’ll return to time and again: Southern stars always rise south of due east and set south of due west, and northern stars always rise north of due east and set north of due west (see Figure 5-4). This is true regardless of where you are on earth while watching the stars.

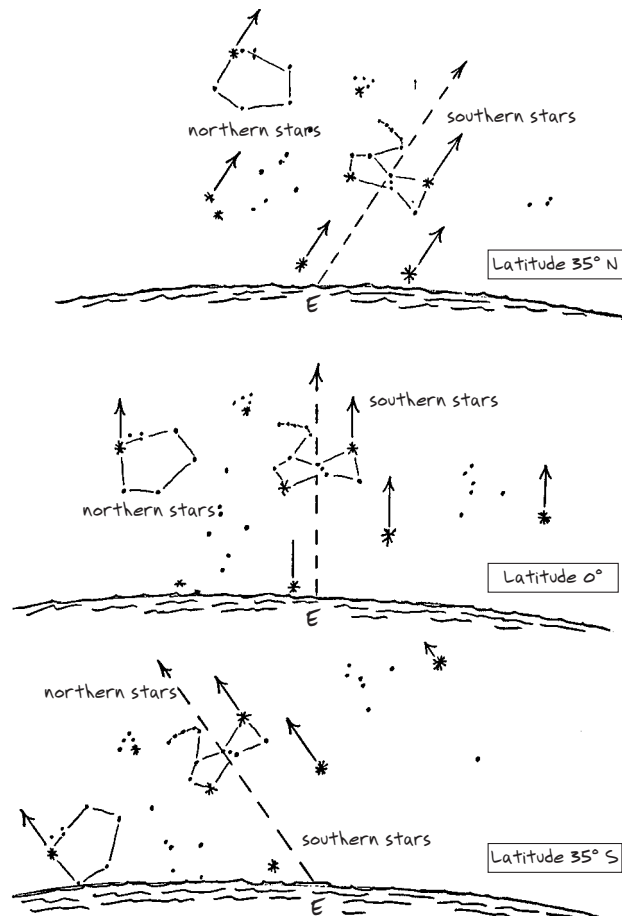

Figure 5-4. Motion of eastern stars at various latitudes. Note how southern stars always rise south of due east, and northern stars always rise north of due east, regardless of the latitude you observe them from. Southern stars are headed south after they rise; northern stars are headed north. Eastern stars rise straight up from the eastern horizon only when observed from the equator.

STEERING BY THE NORTH STAR

The northernmost star is the North Star, *Polaris*. *Polaris* is located above the north pole, which coincides with the earth's axis. This puts *Polaris* at the hub of the sky. All stars rotate counterclockwise around *Polaris*.

To be strictly precise, however, we should point out that *Polaris* is not exactly at the pole, only very close to it. To be precisely over the north pole, the declination of *Polaris* would have to be N 90° exactly, but its declination is only N 89° 18', which is 42' off the pole. Consequently, *Polaris* also circles the pole as all other stars do, but its circle (of radius 42') is so small that the star appears to remain stationary. In special cases, you can find your latitude from the height of *Polaris*, and when you do this, you will take this slight motion of *Polaris* into account, but for emergency steering it is of no significance.

Polaris always bears due north, so with *Polaris* dead ahead, you are sailing due north. Sail any direction you choose by holding *Polaris* at a fixed point on the bow, beam, or stern. To sail west, hold *Polaris* on the starboard beam. When *Polaris* is visible, it will likely be your primary reference, but *Polaris* is visible only in the Northern Hemisphere. The star lies due north at a height above the horizon equal to your latitude. In high northern latitudes, *Polaris* is high in the sky. As you sail south, *Polaris* descends as your latitude decreases. Northern Oregon on the Pacific coast and central Maine on the Atlantic coast are at latitude 45° N, where *Polaris* is found about halfway up the sky. In the northern tropics, *Polaris* is low in the sky, and as you cross the equator, *Polaris* drops below the horizon. However, because of low clouds and haze on the horizon, in practice *Polaris* is rarely visible in latitudes much below about 5° N.

Steering by *Polaris* with the aid of a portable compass card is nearly as easy as steering with a compass. Although *Polaris* is not a bright star (it is about as bright as the stars of the Big Dipper), finding it among the other stars is fundamental to emergency navigation.

Finding the North Star from the Big Dipper

The two stars (*Dubhe* and *Merak*) on the cup end of the Big Dipper point to *Polaris*. These two stars are called the Pointers. The distance to *Polaris* is five times the distance between the pointing stars. If the distance from *Merak* (inside the cup) to *Dubhe* (on the lip of the cup) is two finger widths with your arm outstretched, then the distance from *Dubhe* to *Polaris* is about ten finger widths, measured along the line extending from *Merak* through *Dubhe* (see Figure 5-5).

Leading Stars and Trailing Stars

The Pointers of the Big Dipper are also called the *leading stars* of the Big Dipper, since these stars are at the front of the constellation as it rotates around *Polaris*. All stars rotate counterclockwise around *Polaris* once every 24 hours. Leading stars are at the “bow” of a constellation as it sails around the Pole Star. Stars at the “stern” of a constellation are called *trailing stars*. In the Big Dipper, the cup leads and the handle trails.

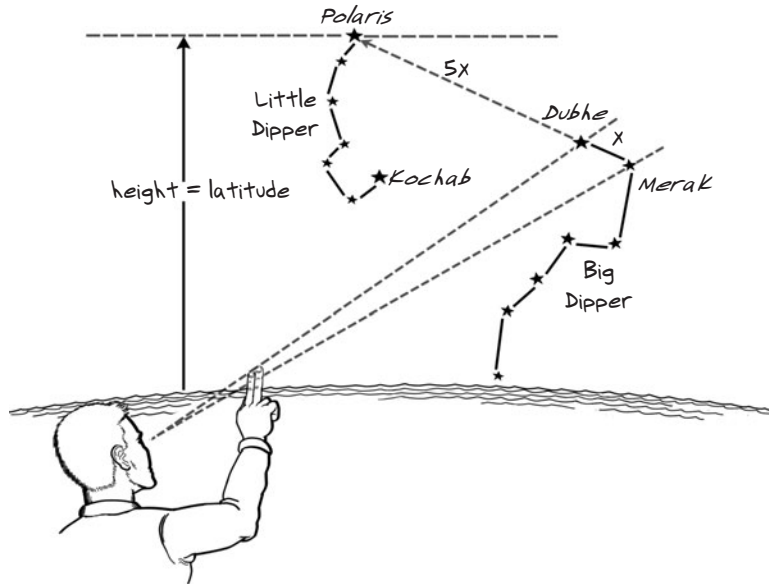

Figure 5-5. Finding Polaris with the Pointers (Dubhe and Merak) of the Big Dipper. The distance to Polaris is five times the distance between the Pointers.

It is very helpful for orientation to learn which stars of a constellation are its leading stars—it may even be the most important thing to know, because when you recognize the leading stars of a constellation, you can tell at a glance which way the constellation is moving. At night without a horizon, you can't easily judge this by simply watching them move. It takes too long, and there is too much to remember. Once you know a constellation's leading stars, though, each constellation becomes an arrow in the sky. Steering by the stars is easy with a sky full of arrows pointing counterclockwise around the north celestial pole or clockwise around the south celestial pole.

Remember, stars rise in the east and move toward the west. If you know where east is, you can say which way the stars are moving. The trick is to know which way the stars are moving in order to tell where east is.

Finding the North Star from Cassiopeia

If the Big Dipper is not visible, the constellation of Cassiopeia shows the way to *Polaris* just as easily. Cassiopeia, the Queen of Ethiopia, is across from the Big Dipper, on the opposite side of *Polaris*. Cassiopeia looks like a big letter M or W, depending on its position in the sky (see Figure 5-6). The constellation is almost symmetrical, although its leading stars are slightly brighter than its trailing stars, and the trailing side of the letter is lazy, or flattened out. But there is an easier way to tell which way this constellation moves. Viewed from *Polaris*, in the middle of its circular path, Cassiopeia always looks like an M. *Polaris* is on the M-side of Cassiopeia—M for middle.

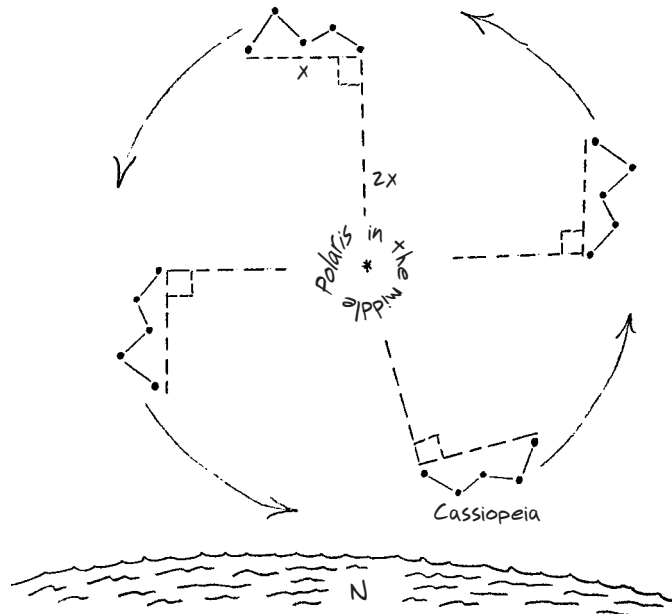

Figure 5-6. Finding Polaris from Cassiopeia. Any view of Cassiopeia alone will tell where north is. Find the nearby region in the sky from which the constellation would look like an M. Imagine a line along the base of the M. Twice that distance from the base at the trailing star of the M is the location of Polaris, even if the star happens to be obscured by clouds. The squares in the corners are reminders that this distance should be projected at right angles to the base. Directly below that point on the horizon is due north.

The distance from Cassiopeia to *Polaris* is twice the base length of the M. To find *Polaris*, measure off the distance at right angles to the base of the M at the trailing star. Cassiopeia is circumpolar (see next section) north of latitude 35° N (Cape Hatteras, North Carolina, or Point Conception, California).

Circumpolar Stars

Stars that never dip below the horizon as they circle *Polaris* are called *circumpolar stars*. If a star is circumpolar, it is visible all night long, every night of the year. In high northern latitudes, many stars are circumpolar because *Polaris* is high in the sky. Traveling south, stars that just skimmed the northern horizon farther north begin to dip below it. A specific latitude called the *colatitude* (equal to 90° minus the declination of the star) marks the circumpolar limit for each star. All Big Dipper stars are circumpolar above latitude 41° N. Therefore, north of Cape Mendocino on the Pacific coast or New York City on the Atlantic coast, the entire Big Dipper is visible all night long, every night of the year.

Circumpolar stars in the Northern Hemisphere travel counterclockwise around the north pole of the sky. In the Southern Hemisphere, stars move clockwise around the south pole of the sky (see Figure 5-7). This means that stars above either pole are headed westward and stars below

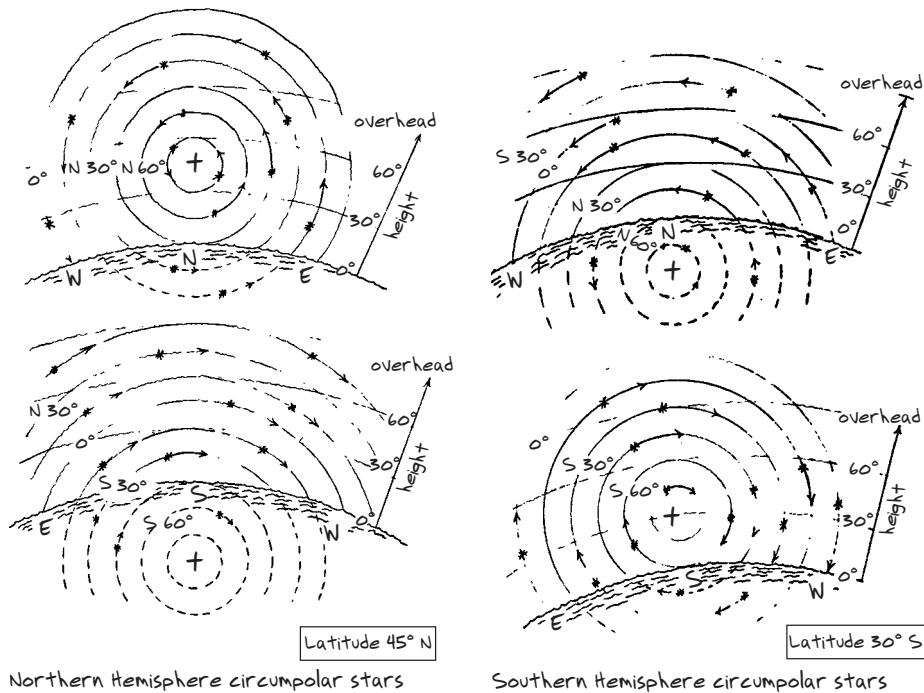

Northern Hemisphere circumpolar stars

Southern Hemisphere circumpolar stars

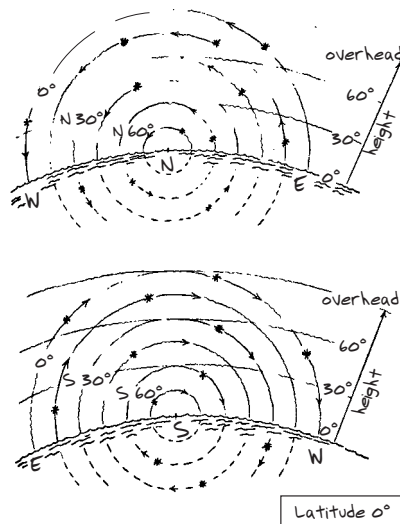

Latitude 0°

Figure 5-7. Polar stars viewed to the north and south from several latitudes. Circumpolar stars are those within the full circles over the horizon. Since they never set, circumpolar stars are visible all night long, every night of the year. We can best express the span of stars we see with special terminology. Same-name stars are those with latitude and declination either both north or both south. Otherwise, they are contrary-name stars. An angle of 90° minus your latitude is called your colatitude. Thus, the range of stars you see along the meridian spans declinations of north colatitude to south colatitude. Same-name stars with declinations greater than your colatitude are circumpolar, while contrary-name stars with declinations greater than your colatitude are never visible. At the equator you see every star in the sky sometime during the year.

either pole are headed eastward. Circumpolar stars are at their highest point in the sky when directly over their pole and at their lowest point in the sky when directly below their pole. As we have just covered, the Northern Hemisphere has a star at the pole, but the Southern Hemisphere does not.

The Brightness and Color of Stars

In practice, circumpolar stars are not always visible at the lowest part of their circular path. It takes an unusually clear night to see stars near the horizon because of the thickness of atmospheric haze. When looking toward the horizon, you are looking through the thickest part of the earth's atmosphere; looking straight up, you are looking through the thinnest part. As a result, bright stars fade as they descend toward the horizon and fainter stars disappear (see Figure 5-8). If you see a single star low on the horizon, you can bet it is a bright one even if it appears faint. Since bright stars are well-known stars, this observation alone often identifies it.

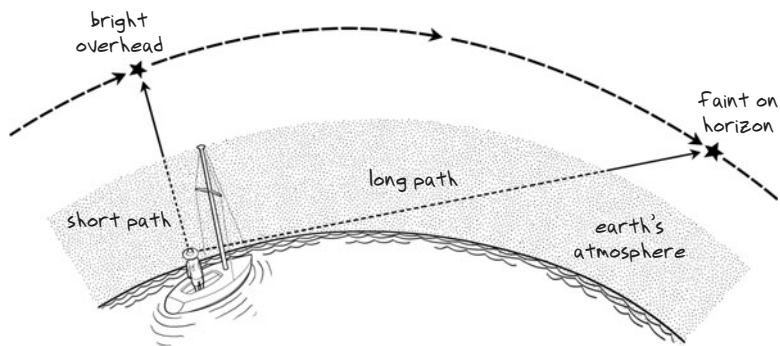

Figure 5-8. All stars fade as they descend toward the horizon. Starlight is scattered and lost as it passes through the earth's atmosphere. Consequently, the longer the path through the atmosphere, the dimmer the star. It takes exceptionally clear nights to see stars low on the horizon, which is unfortunate, since low stars are very valuable to emergency navigation.

There are about twenty very bright stars, called magnitude-one stars. Approximately half of these are northern stars, including *Vega*, *Capella*, and *Arcturus*. The two brightest stars of all are the southern stars *Sirius* and *Canopus*.

The seventy or so next-brightest stars are called magnitude-two. On average, these stars are two or three times fainter than magnitude-one stars. Big Dipper stars are typical magnitude-two stars. Most magnitude-two stars have proper names, in addition to the scientific labels that all stars have.

Magnitude-three stars are another two or three times fainter than the brightest stars. Stars of the Little Dipper are typical magnitude-three stars, except for *Kochab* (pronounced "Ko-kob"), the tip of the cup, and *Polaris*, the tip of the handle, which are magnitude-two. There are some

two hundred magnitude-three stars, but only a few have proper names. On a clear night, many more stars than these are visible to the naked eye, but they are too faint to be relied on for navigation. Generally speaking, the hundred or so brightest stars, about half of which are visible during any one night, are more than sufficient for navigation. Although you need to know a few of the brighter stars, you luckily don't need to know the names of all these potentially useful stars. If you find a convenient star for your course but don't know its name, just make one up. The important thing is to know where the star lies relative to stars you do know.

Most stars have a color, or near-color, other than white, but it takes a highly trained eye to recognize it in most stars. The exceptions to this are few, but they are prominent and beautiful. These are the red giants, which are red (or orange or yellow) even to the untrained eye. Once you can recognize them, they are a big help in identifying these stars and the ones around them. The most prominent red giants are *Antares* in Scorpio, *Arcturus* in Bootes, *Aldebaran* in Taurus, and *Betelgeuse* in Orion. *Castor* and *Pollux* in Gemini provide a good test for spotting color in stars. They are close and bright, but only *Pollux* to the south, toward *Procyon*, is slightly reddish.

The North Star and the Little Dipper

Polaris is the last star on the handle of the Little Dipper. Stars of the Little Dipper are faint, except for *Polaris* and *Kochab*. *Kochab* is on the opposite end of the Little Dipper from *Polaris*, at the tip of the cup. Often when the sky is hazy, *Polaris* and *Kochab* are the only two stars you can see in the entire region between Cassiopeia and the Big Dipper. The guidelines for finding *Polaris* from either Cassiopeia or the Big Dipper (see above) always tell which of the two is *Polaris*. On clear, dark nights, many stars may be visible near the pole. It is handy, then, to remember that *Polaris* is the one on the end of the handle of the Little Dipper.

The handles of the Big and Little Dippers bend in opposite directions. Both dippers have seven stars. Water pouring from one dipper always falls into the cup of the other dipper. The Little Dipper is circumpolar north of latitude 18° N, or, more practically, north of the tropics.

Finding the North Star from Auriga

Auriga is Latin for charioteer. The constellation is usually pictured as a charioteer (without a chariot) holding a mother goat, *Capella*, on one shoulder, with her kids at hand. It is a large, prominent pentagon of five stars. The pentagon is led across the sky by *Capella*, one of the brightest stars in northern skies. The leading edge of the pentagon is marked by the Kids, a triangle of three faint stars next to *Capella*. The two stars (*Menkalinan* and *Theta Aurigae*) on the trailing edge of the pentagon are North Star pointers. The distance to *Polaris* from *Menkalinan* is about five times the distance between the pointing stars. The Auriga pointers, and several other ways to find *Polaris*, are shown in Figure 5-9.

Capella is bright enough to be seen near the horizon—setting northwest in early summer evenings or rising northeast in late-summer evenings. *Capella* is circumpolar north of about latitude 45° N.

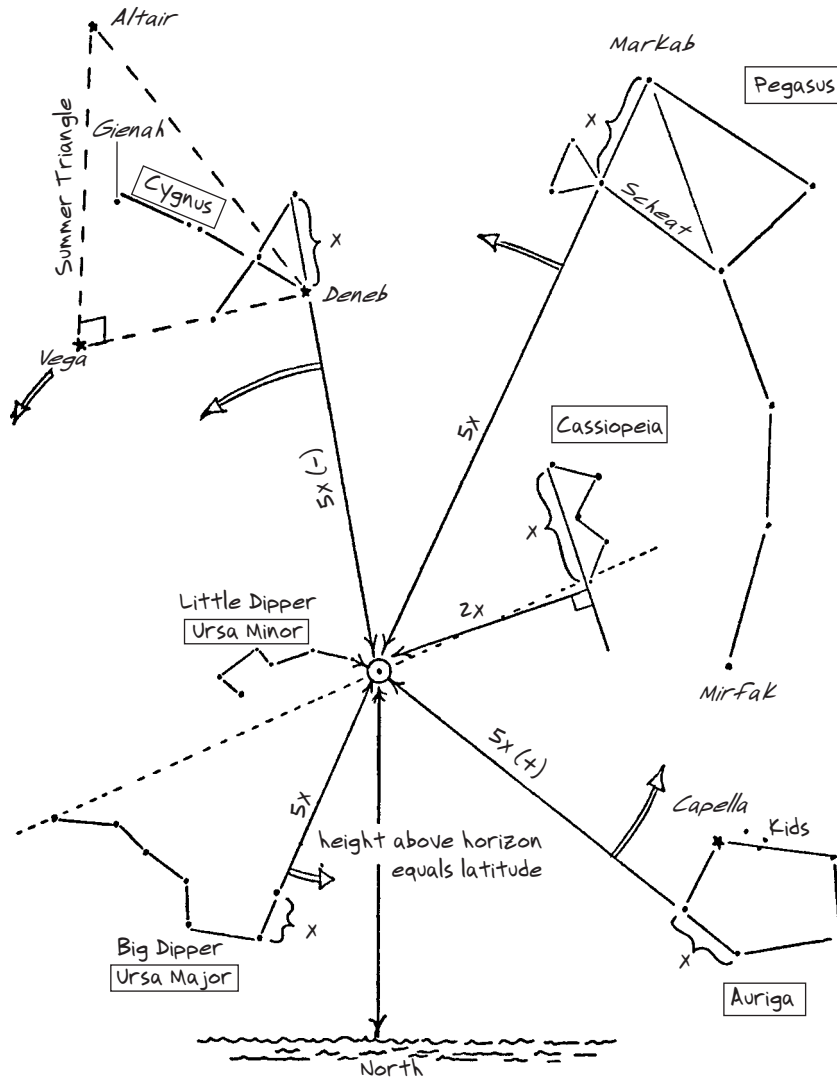

Figure 5-9. Ways to find Polaris. Any one of these widely spaced constellations will locate north. The + or - signs indicate that the polar distances are either somewhat more than or less than exactly five times the pointer spacings. However, it is simpler and adequate to just remember the factor of five—you point with your finger, each hand has five fingers. Stars at the bows of the constellations are the leading stars; those at the sterns are the trailing stars.

THE SUMMER TRIANGLE

Throughout the summer and fall, three of the first stars seen at twilight form a perfect right triangle, called the Summer Triangle or sometimes the Navigator's Triangle (see the upper left portion of Figure 5-9). The Summer Triangle is not a constellation; it is made up of the brightest stars of three different constellations. The brilliant *Vega* is at the right angle, leading the triangle across

the sky. *Deneb* trails from the east, and *Altair* to the south completes the triangle. The Summer Triangle is large; overhead in the Northern Hemisphere, it covers the whole top of the sky.

Whenever the triangle is high in the sky (the lowest star is at least halfway up the sky), the *Deneb-Vega* line points in the east-west direction, with the much brighter *Vega* to the west since it leads. This is a valuable directional aid since overcast skies often obscure all but these three stars. If the triangle is low in the sky, the east-west direction can't be found this way, but north is always on the side of the *Deneb-Vega* line that is opposite to the side that *Altair* is on.

Finding the North Star from the Northern Cross (Cygnus)

The Summer Triangle is the easiest way to find the constellation Cygnus, the Swan—equally well known as the Northern Cross. *Deneb*, the northernmost star of the Summer Triangle, is at the head of the cross. *Deneb* and the trailing star of the cross (*Gienah*) are North Star pointers (see Figure 5-9). Again, the distance to *Polaris* is five times the distance between the pointing stars. The cross is symmetrical, but it is easy to spot the trailing star since the cross is part of the Summer Triangle and *Vega* leads the triangle. *Vega* is the brightest star in the northern sky.

Except for *Deneb*, the stars of the Northern Cross are faint, but the symmetry of the cross makes it stand out among background stars.

THE GREAT SQUARE OF PEGASUS

The Great Square of Pegasus, like the Summer Triangle, is huge. Nearly everyone in the United States could claim this giant square is overhead at the same time. The Great Square could also be called the cup of a giant dipper whose handle stretches across two constellations toward *Capella*. As with the Big Dipper, the cup of this giant dipper leads, and the two leading stars of the cup (*Scheat* and *Markab*) are North Star pointers, with the (now famous!) distance to *Polaris* equal to five times the distance between the pointers (see Figure 5-9). If the handle of the dipper cannot be seen, a small equilateral triangle on the tip of the cup marks the leading edge. You can think of the little triangle pulling the Great Square across the sky.

The top and bottom edges of the cup (perpendicular to the pointers) make good east-west lines whenever the square is high in the sky. Stars of the Great Square are not bright, but the symmetry of the square makes it prominent when high in the sky.

The five equally spaced stars stretching from the tip of the cup to the tip of the handle, where *Markab* is located, form an arc across the sky that is often prominent, even when the Great Square is not.

FINDING NORTH WITHOUT THE NORTH STAR

You don't have to see *Polaris* to find north. If you can point to the place where *Polaris* would be if it weren't for the clouds, that's good enough. And that's just what pointing stars do for you. Every prominent northern constellation has pointing stars, as we have shown: the Big Dipper, Cassiopeia, Auriga, the Northern Cross, and the Great Square. Learn the pointers, and any of these constellations is almost as good as *Polaris* for finding north. In Auriga, for example, *Capella* leads and

the trailing edge of the pentagon points to *Polaris*. Point your finger straight in from these two stars, a distance of five times their separation, and (clouds or no clouds) you are pointing to the pole of the sky. Due north on the horizon is directly below your finger.

You only need to remember which stars are the pointers. The distance is always the same—five times the distance between the pointers. “You point with your finger, each hand has five fingers, five pointers—the distance is five times the pointers.” That’s not much of a mnemonic, but if its silliness helps you remember the factor, it has served its purpose. Technically, the factor is not exactly five in every case, but it is close enough to justify this simple rule and spare the extra memory work. Since there are pointers in every part of the northern sky, chances are if just one patch of sky is clear, pointing stars will be in it. (There are different tricks for the southern sky—see the *Steering by the Southern Cross* and the *South Pole* section below.)

Test yourself with a compass when the North Star is obscured (see Figure 5-10). It helps to use a stick at arm’s length. Align the stick with the pointers and mark off the pointers’ distance on the end of the stick. Take the stick down and put a mark at five times this distance from the end of the stick. Align the stick again with the pointers, holding the mark on the innermost pointer. The tip of the stick will then be at the position of *Polaris*. If *Polaris* is high, you might tie a weighted string to the end of the stick. With the stick in place, the string intersects the horizon at due north. The simplicity and versatility of this method of finding north are reward enough for the time it takes to learn the pointers.

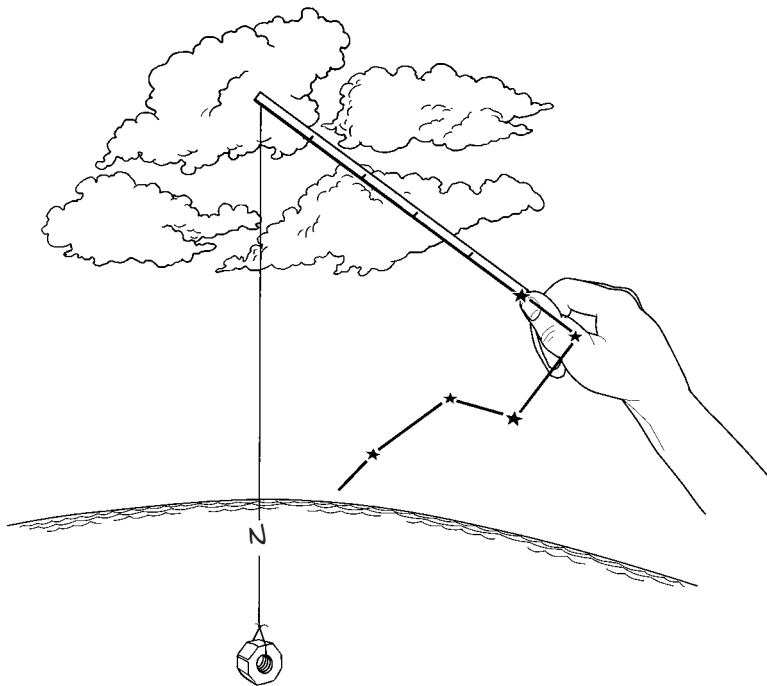

Figure 5-10. Using pointers to find north when *Polaris* is obscured. Hold a stick in-line with the pointers, mark the distance between them, and then mark five times this distance from the end of the stick. Hold the stick as shown, and you have found north. The weighted string is seldom required, but it can offer more precision.

STEERING BY ORION

Orion the Hunter circles the earth above the equator. He is led by Taurus the Bull, whose eye is the brilliant red giant *Aldebaran*. Trailing Orion is the Dog Star *Sirius*, brightest star in all the sky. During winter, everyone on earth shares this majestic constellation of bright stars. Because of its unique location precisely over the equator, the leading star of Orion's belt, *Mintaka*, rises due east and sets due west. You should know this star well when it comes to steering by the stars. Orion's belt rising is as good as a big letter E for east, or W for west when setting (see Figure 5-11). This is true anytime you see the belt on the horizon, regardless of your location on earth, the time of night, or the time of year. The belt is easy to spot, being three close stars in a line at the center of the figure.

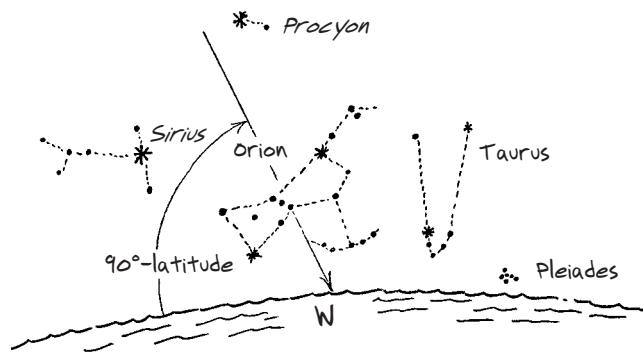

Figure 5-11. Orion on the horizon. From any point on earth, at any time of night, Orion's belt always rises due east and sets due west. The Seven Sisters, the Pleiades, lead the chase of nearby stars. Taurus the Bull follows, fighting off Orion, whose faithful hunting dogs, Sirius and Procyon, trail close behind. Betelgeuse, at the base of Orion's raised arm, and Aldebaran, at the eye of the Bull, are brilliant red giant stars.

The bright stars of Orion form a roughly symmetrical pattern, so it is hard to label leading and trailing stars. But the mythology of neighboring stars tells nicely who's going where. Orion is fighting Taurus the Bull, who was placed in the sky by Atlas to protect his daughters, the Seven Sisters—known as the Pleiades—from Orion, as it turns out. The Sisters lead in flight, the Bull follows, pursued by Orion with his faithful hunting dogs, *Sirius* and *Procyon*, close behind. This story paints an arrow across the sky from the Pleiades to *Sirius*, showing at a glance the direction of many stars.

From northern latitudes, Orion rises on his side and stands up to the south-southwest. In the Southern Hemisphere, Orion crosses the sky standing on his head. But north or south, the Pleiades-Taurus-Orion-*Sirius* chase is on.

Even after Orion's belt rises above the horizon, you can still use it to find east. For a couple of hours after the belt rises, you can use your knowledge of star motions to retrace *Mintaka's* invisible path back to the horizon. This path emerges from the horizon at due east.

The path of any star that bears east or west makes an angle with the horizon equal to 90° minus your latitude (your colatitude). At latitude 50° , eastern stars climb at an angle of 40° ; at

latitude 20° , eastern stars climb more steeply, at an angle of 70° . At the equator, eastern stars rise straight up from the horizon. Western stars descend at the same angle at which they rise, which is the reason twilights are long in high latitudes and short near the equator. At the equator, the sun sets straight down over the western horizon. At high latitudes, the sun sets at a gentle angle, which keeps the sun just below the horizon for a much longer time.

To retrace the path of *Mintaka*, hold a stick up to the star and orient it with the horizon at an angle equal to your colatitude. The stick then intersects the horizon at due east (see Figure 5-12). You can do the same thing when *Mintaka* is setting. Align the stick with *Mintaka* and point it down toward the horizon at the proper angle to locate the place where the star will set, due west.

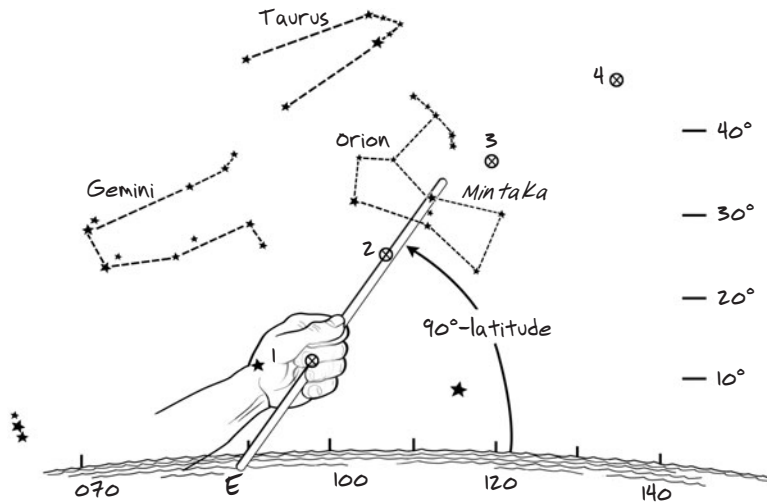

Figure 5-12. Pointing *Mintaka* (leading star of Orion's belt) backward to the horizon to find east. The rising angle to use is your colatitude (90° minus your latitude). The figure shows this being done from latitude 35° N (rising angle 55°) at 2.5 hours after *Mintaka* rose. The method works from most latitudes for 2 to 3 hours past the rising time. The figure is roughly to scale, showing that the same method applied 3.5 hours after rising would give an error of about 10° . Hourly positions of *Mintaka*, after rising, are marked with circled Xs.

Don't be too concerned about judging the rising and setting angles just right. Even if they are off some, you still get a good indication of due east or west this way. Practice this, checking yourself with a compass, and it should stick with you. You can use the same trick for keeping track of sunrise bearings after the sun leaves the horizon. Rising and setting angles at bearings other than due east or west are discussed in the Morning Sun and Afternoon Sun section in Chapter 6.

STEERING BY GEMINI AND PROCYON

Castor and *Pollux* are the two bright stars of the constellation Gemini, the Twins. They lie north of *Procyon*, the lesser of the two Dog Stars trailing Orion. A line from *Procyon* that passes between *Castor* and *Pollux* is a valuable north-south line viewed from many locations. Within latitudes of about 30° N to 50° N, this line often rises conveniently to give a north-south direction as Orion's

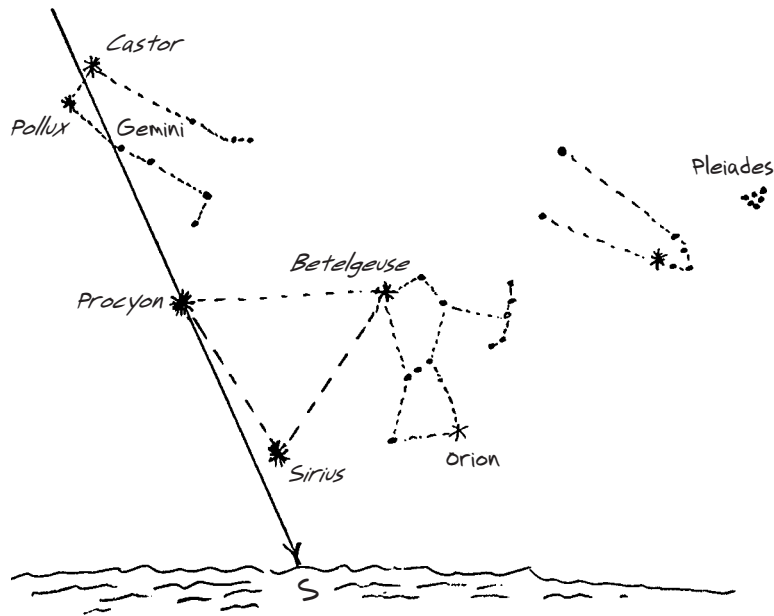

Figure 5-13. The Gemini-Procyon line. Within latitudes of roughly 30° N to 50° N and from 5° N to about 15° S, the indicated line from Gemini through Procyon will intersect the horizon near the meridian when the lowest star is about halfway up the sky. Look for similar lines among the stars once you have established your bearings from other stars. Numerous star pairs lead to the meridian this way, although they often don't work well when the line between them passes overhead—even though both are high in the sky at the time.

belt moves away from the east (see Figure 5-13). Whenever visible, this line gives a general indication of your meridian, but it is only accurate for finding south when the stars are high in the sky—that is, when the lower star is at least halfway up the sky. South of about 50° N, it is easier to locate north than south using this line. The line is useful down to about 15° S. The Dog Stars, *Procyon* and *Sirius*, form an equilateral triangle with *Betelgeuse*, the bright reddish star on Orion's trailing shoulder.

The Gemini-*Procyon* line is just one example of lines in the sky that might prove useful for orientation. Once you have established directions from known stars, look around the sky for pairs of prominent stars that indicate north or south from your latitude. Then check them occasionally throughout the night; such lines can be quite valuable, although their value may be limited to certain times of night. Within 15° of the equator, for example, any two stars that rise together give a fairly good bearing to the elevated pole until the highest is about halfway up the sky.

STEERING BY SCORPIO

Scorpio is on the opposite side of the sun from Orion. As the earth orbits the sun each year, you see Orion in the winter and Scorpio in the summer. Scorpio looks like a scorpion and moves like a scorpion—the head leads and the tail trails. At the neck of the constellation is the bright red star *Antares*. Scorpio passes overhead in Australia, but most of the constellation can be seen

low in the southern sky as far north as the U.S.-Canadian border. From high northern latitudes, the view of Scorpio low in the sky is short and often obscured. But sailing south, Scorpio rises to become an impressive part of the summer sky (see Figure 5-14).

Anytime you see the full scorpion from higher northern latitudes, it must be to the south. You can find due south if you can discern the horizon: note whether the head or tail stands straight up from the horizon (i.e., is perpendicular to the horizon). The head is south when the tail stands up, and the tail is south when the head stands up. From farther south, Scorpio is higher in the sky, and it is harder to tell when head or tail stands up). But even then, this trick often tells whether Scorpio is to the east, to the west, or near due south.

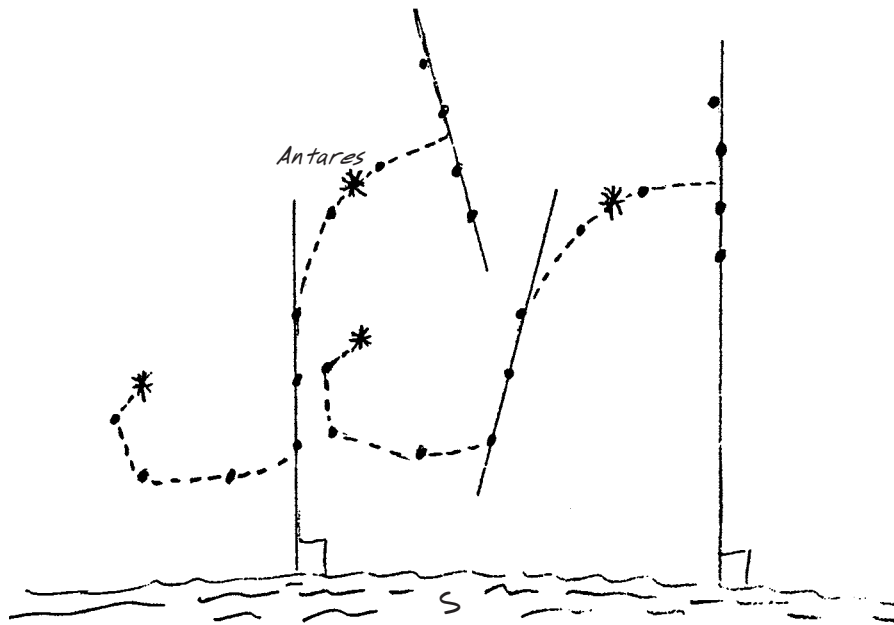

Figure 5-14. Finding south from Scorpio. From higher northern latitudes, you can only see this figure near due south. From lower latitudes, check the relative orientation of head and tail. Try “head south when tail stands up, and tail south when head stands up,” as shown, or come up with another such trick to locate south on the figure when bearings are known from other stars. This can take some practice to apply since the head is not quite a straight line of stars.

STEERING BY THE SOUTHERN CROSS AND THE SOUTH POLE

The Southern Cross is a small cross of four bright stars, easily spotted because of the two very bright stars that trail right behind it. As the name implies, these are southern stars; the full cross cannot be seen north of the tropics. Viewed from the tropics, the cross rises on its side to the south-southeast and stands up as it passes over due south. It lies down on its side again as it sets to the south-southwest. Anytime you see the cross standing up, it bears due south (see Figure 5-15). The two bright stars pushing the cross through the sky indicate at a glance the direction in which the Southern Cross is moving.

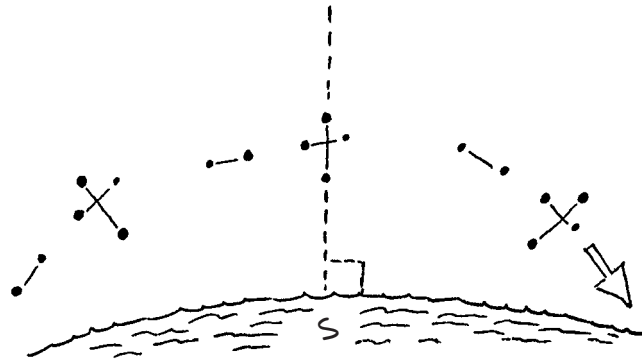

Figure 5-15. The Southern Cross. When the cross stands up, it bears due south. This rule is most convenient when the cross is not too high in the sky. This rule is easier than similar ones for Scorpio, since the vertical stars of the cross are pointers but the star lines on Scorpio's head and tail are not.

You can also use the Southern Cross when it is not standing up, because the upright member of the cross points to the south celestial pole. South of the equator, the south pole of the sky is above the horizon, but there is no “South Star” at this pole—there are no bright stars anywhere near the south pole. Nevertheless, the south pole can be used to find directions just as the north pole is used when *Polaris* is obscured.

The South Pole

The south pole is the mirror image of the north pole. When you cross the equator headed south, the north pole of the sky (where *Polaris* is) drops below the horizon and the south pole rises above it, but no star marks the spot. As you sail farther south, the south pole continues to rise, 1° for each degree of latitude you make to the south. Consequently, throughout the Southern Hemisphere, the height of the south pole above the horizon is always equal to your southern latitude, just as the height of the north pole equals your northern latitude in the Northern Hemisphere.

The only difference between the two poles is the apparent motion of the stars around them. Facing north, you see stars moving counterclockwise around the north pole; but facing south, the same east-to-west rotation of the sky results in the clockwise circulation of stars around the south pole of the sky. Viewed from right at the equator, the north pole is on the northern horizon and the south pole is on the southern horizon. But at any other latitude, only one pole can be above the horizon. Nevertheless, the motion of stars counterclockwise around the north pole and clockwise around the south pole remains the same viewed from any latitude in either hemisphere, even though one of the poles must be below the horizon.

The south-pole pointers are the two stars that form the upright member, or long axis, of the Southern Cross. The distance to the pole is (again) five times the distance between the pointers. Knowing the pointers and how they work, it is easy to see why the cross stands up when it bears due south. This and other ways to find the south pole of the sky are shown in Figure 5-16.

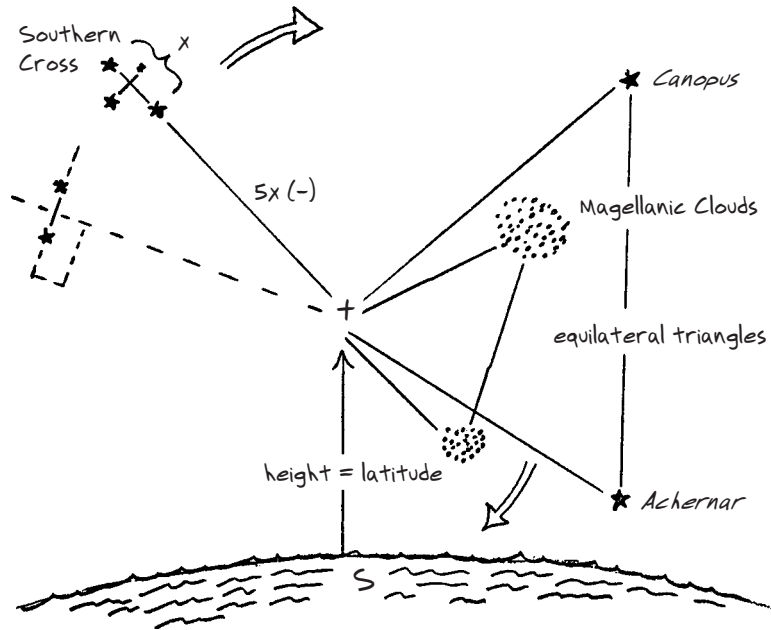

Figure 5-16. Ways to find the south pole of the sky. You can also use the perpendicular bisector line at the two bright stars trailing the cross (Rigel Kentaurus and Hadar) to find south when the pole is below the horizon (i.e., in the Northern Hemisphere). Use of the Southern Cross and the star triangles are also illustrated in Figures 5-15 and 5-17.

Finding the South Pole from Achernar and Canopus

When the Southern Cross is below the horizon, two other very bright stars cross the sky on about the same path as the Southern Cross. They are *Achernar*, leading to the west, followed by the brilliant *Canopus*. These stars are not close together, but they are so bright that they stand out clearly among neighboring stars. The south pole makes up the third corner of an equilateral triangle with *Achernar* and *Canopus*. Due south is directly below the invisible corner of this triangle. If you remember that the height of the pole is equal to your latitude, you should have no trouble picturing where the third corner of the triangle should be. North of the equator, the south pole is below the horizon, but even then you can still use this method to estimate the direction of due south (see Figure 5-17).

Canopus, the second brightest star in the sky, lies halfway between the south pole and *Sirius*, the brightest star in the sky. When *Sirius* is high in the sky, the *Sirius-Canopus* line intersects the horizon near due south. *Sirius* passes overhead in Tahiti (latitude 17° S) and *Canopus* passes overhead in the Falkland Islands (latitude 53° S).

Finding the South Pole from the Magellanic Clouds

The equilateral triangle method of finding the south pole from *Achernar* and *Canopus* can also be applied to the Magellanic Clouds (see Figures 5-16 and 5-17). These are two fuzzy objects in the southern sky that look like small chunks of the Milky Way, though they are actually independent

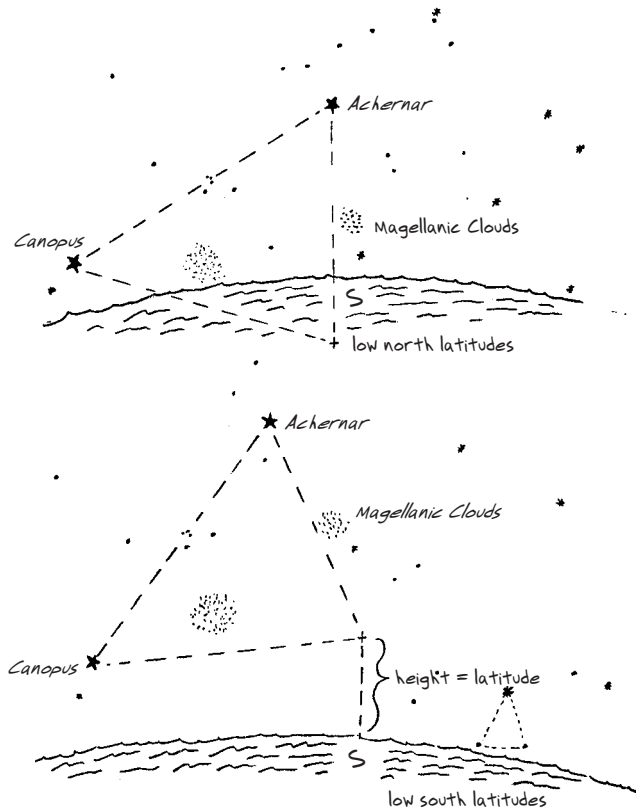

Figure 5-17. Finding south from Achernar and Canopus. Note that these stars make an equilateral triangle with the south pole that you can use to find south from low northern latitudes, even though the pole corner of the triangle is below the horizon.

galaxies a long way from our own. These two galaxies also form an equilateral triangle with the position of the south pole.

The Magellanic Clouds lie about halfway between the *Achernar-Canopus* line and the south pole. Since they are closer to the pole, it is easier to picture the triangle with them. Unfortunately, these two objects are faint, whereas the two stars are very bright. Since they lie in the same general region of the sky, they won't necessarily be an improvement over the two stars, unless one is obscured by clouds. On clear nights, though, they offer one more means of orientation, and every piece of reliable information is helpful.

STEERING BY OVERHEAD STARS

When the sky is hazy, the only stars visible may be one or two unidentified stars overhead. You can find directions from these stars since any star overhead moves due west, no matter where you are. You know due west as soon as you know which way overhead stars are moving.

Tied up at a dock, it is easy to spot the direction of overhead stars by looking up at the stars along the edge of a mast. Stars that line up with the masthead of a 50-foot mast move away from the masthead at an apparent rate of 1 foot per 5 minutes. Still and comfortable, you can find west this way in 5 or 10 minutes.

At sea, this is not quite so easy and it takes longer. First you must hold a steady course while watching the stars move—a problem you don't have at dock or on land. You can do this steering by the apparent wind or sea swells. The main difficulty, however, is the motion of the masthead as the boat rocks with the seas. Even in calm water, the masthead moves, tracing out a regular pattern in the sky. The task is to note the star's position relative to the average position of the masthead as it sways back and forth, tracing out a roughly elliptical path. Since the reference point is less accurate when it is moving, the star must move farther to show the west direction. If the sea is rough, you might do just as well by simply looking up at the stars, but it could take an hour or more to spot the star's direction this way (see Figure 5-18).

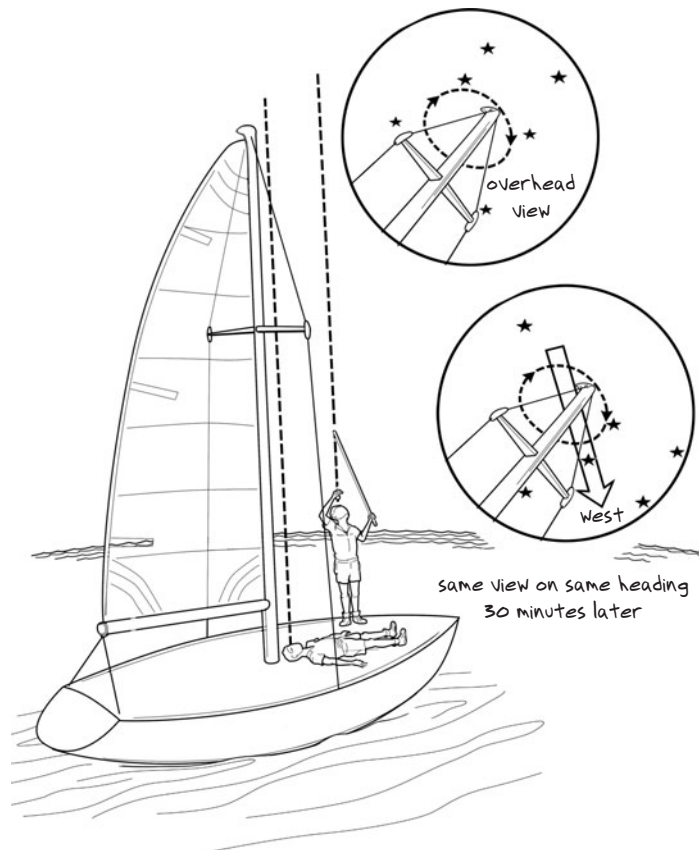

Figure 5-18. Finding west from overhead stars. All stars move west as they pass overhead. Remember, however, it is the direction of motion that is west, not the bearing to the star.

Another method is to use a weighted string tied to the end of a stick. Hold the stick overhead and sight up the string, using the tip of the stick as the reference point. The weight will still swing with the boat, but you can stop it and look again. Unless it is very calm, it generally takes about an hour or more for a star to move far enough away from the zenith to be able to tell its direction, regardless of how you measure it.

If a star is not directly overhead but only very high in the sky, either of these methods still works fairly well. Remember, though, it is always the direction of motion that is west, not the direction of the star. Unless the star passed exactly overhead, its actual bearing could be well to the south or north of west, even though its motion is due west.

STEERING BY ZENITH STARS

You would only use the overhead star method of the previous section when these were the only stars visible, since it takes some time to find directions this way. But even on clear nights, stars that pass directly overhead are extremely valuable for steering by another method.

The point in the sky directly overhead is called the *zenith*, and stars that cross over your zenith are called *zenith stars*. Any star overhead moves due west. If the overhead star passes right across your zenith, or very near to it, then the star itself must bear due west for some period of time after crossing your zenith. When you are near the equator, any celestial body that passes through your zenith bears due west all night long until it sets. Once you recognize it the following night, you will know it bears due east all night until it passes overhead.

Recall the principles: Northern stars (or any celestial bodies with northern declination) always set north of due west, and southern stars always set south of due west. Consequently, any celestial body with declination 0° must set not north or south, but exactly due west. Examples are the star *Mintaka*, the sun on the equinoxes, and the moon or planets as they happen to cross the equator. Viewed from the equator, anything that passes overhead must have a declination near 0° . It bears due west as it leaves your zenith, it is headed toward due west to set, so therefore it must bear due west all night long.

The Half-Latitude Rule

At latitudes away from the equator, however, life is not so simple. Away from the equator, star bearings change as they move away from your zenith. North of the equator, zenith stars set north of due west, so as they descend to the horizon, they must move toward the north. In southern latitudes, overhead stars move from the west to the south as they descend.

Luckily, a simple rule tells how long you can follow any overhead star. When any zenith star descends to a height above the horizon equal to your latitude, its bearing has moved away from due west by an amount equal to half your latitude. This is called the Half-Latitude Rule for zenith stars.

For example, suppose you are at latitude 40° N, and you watch a star pass overhead. As soon as it moves away from the zenith, you can assume it bears due west. As it descends in the sky, its bearing moves slowly to the north, and when its height is about 40° above the horizon, it bears 20° north of west (see Figure 5-19). The job of the navigator is to use this information

Figure 5-19. Application of the Half-Latitude Rule. When a zenith star descends to a height equal to your latitude, it has moved away from west by an amount equal to half your latitude. The rule works at any latitude outside of the polar regions, north or south.

to estimate the star's bearing as it descends. When the star is about halfway down to 40° (at a height of about 65°), an estimate of its bearing would be 10° north of west. The procedure works the same way from any latitude, north or south, but from southern latitudes, the star would move the same amount south of west.

In practice, it is not difficult to estimate a height approximately equal to your latitude—especially in the Northern Hemisphere, since this is the height of *Polaris*. You will probably be watching the height of *Polaris* to keep track of your latitude, and whatever method you use for that can also be used for this job. Obviously, if *Polaris* is visible, it will be your primary source of directions. One trick is to note the height of *Polaris* in hand widths or by marks on a stick when the star is visible; then when *Polaris* is obscured, you have a convenient measurement for this application. In the Southern Hemisphere, use either of the two triangle methods or the Southern Cross pointers to locate the position of the south pole; its height equals your southern latitude.

On clear nights, you need not rely on just one zenith star until it drops too low for this application—though lower stars are usually easier to use when available. Other stars are continuously passing overhead, so you can pick the ones that are most convenient. Watch the stars as they pass overhead. One after the other, they keep an east-west line drawn across the sky. The lower your latitude, the longer you can watch any one star.

The main value of this method is that you don't have to know the stars you follow—you can even use a vacant point between two or three stars. Just make up a name for each star or point to remember it by. It may help to make up your own constellations from overhead stars. If you don't change latitude much, you can use the same stars each night. After the first night, you can also use zenith stars as they approach from the east. These begin to be useful when they reach a height equal to your latitude, then bearing half your latitude to the north (or south) of east, and from there they move toward due east as they climb to the zenith.

As you change latitudes, the stars overhead will also change, since each star is restricted to a specific latitude. But this is no problem. When you note a star has moved away from the zenith, pick new zenith stars to follow. You may begin to see from this how you can keep track of your latitude from zenith stars if you recognize them and know their declinations.

Sailing east or west, you can literally follow unknown zenith stars using the Half-Latitude Rule. If the sun, moon, or a planet happens to pass overhead, you can follow it just as you would

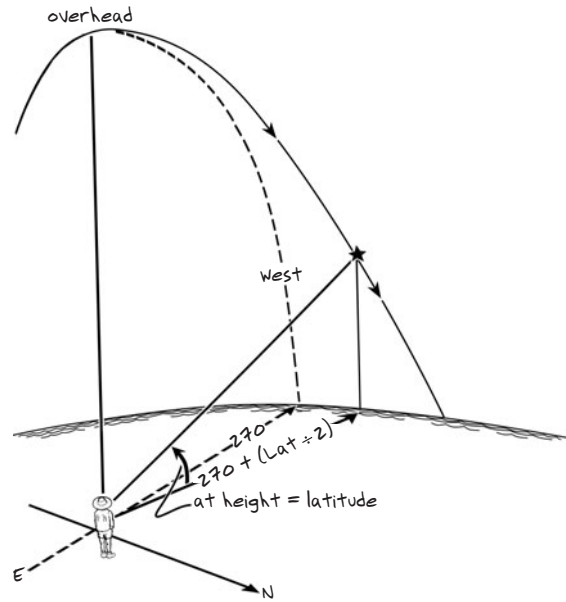

a zenith star. To use the sun or planets this way, you would have to be in the tropics. The moon might pass overhead at latitudes as high as 29° , but it could be used only once—from zenith to setting—because its position in the sky changes rapidly each day. The Half-Latitude Rule is accurate to within 5° from any latitude outside of the polar regions, as shown in Figure 5-20.

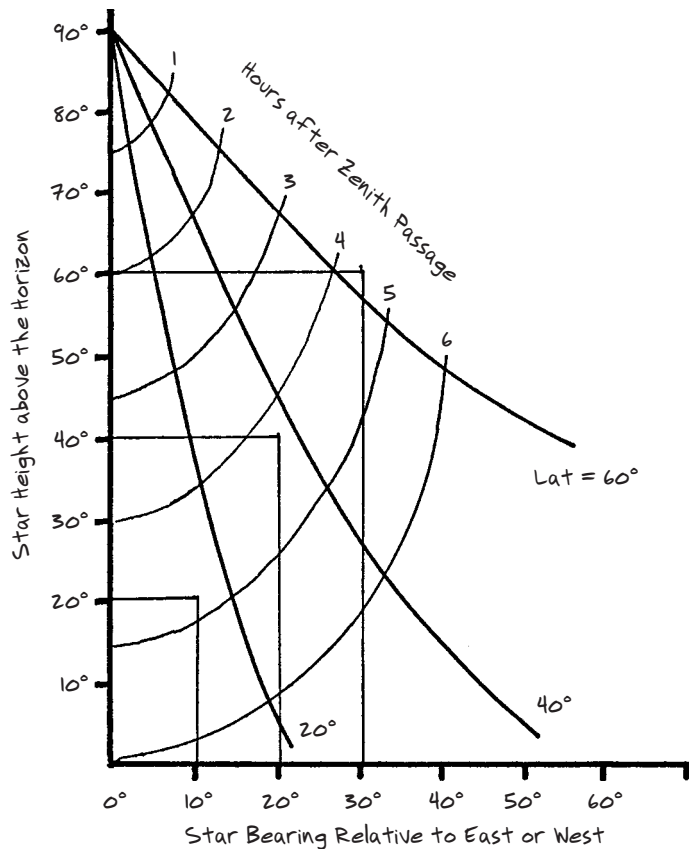

Figure 5-20. Accuracy of the Half-Latitude Rule. The heavier curved lines are actual zenith star bearings as the stars descend. Corners of the rectangles mark predictions of the Half-Latitude Rule. At latitude 40° (N or S), for example, a zenith star descends to a height of 40° in just under 4.5 hours. At that time, its bearing is 23° off of due west—to the north in north latitudes, or to the south in south latitudes. The rule error at this latitude is only 3° . Remember, however, that even though the rule is fairly accurate in principle, you can't apply it to this precision in practice. If you achieve a consistent accuracy of some 10° to 20° this way, you are doing well.

The Tropics Rule

The Half-Latitude Rule works anywhere in the world, at any time of year. But sailing in the tropics, you can use an expanded version of the rule that lets you keep track of zenith star bearings all the way to the horizon. It works only in the tropics, but when you are there, it is very convenient.

Anywhere in the tropics (latitudes $23^{\circ} 26' N$ to $23^{\circ} 26' S$), your zenith stars will set at a bearing that is different from due west by the number of degrees equal to your latitude. At latitude $20^{\circ} N$, zenith stars set 20° north of west and rise 20° north of east. At latitude $10^{\circ} S$, zenith stars rise 10° south of east and set 10° south of west.

The rule is simple and accurate. And again, you don't need to know the names of the zenith stars to use the rule. In the tropics, with the aid of this rule, you can follow any star that passes overhead for as long as it is visible, providing you know your approximate latitude. When the star descends to a height equal to your latitude, its bearing is half your latitude off of west; when it reaches the horizon, its bearing is your whole latitude off of west.

This expanded version of the Half-Latitude Rule is a special case of a much more powerful rule that also works throughout the tropics. In the tropics, you can use a rule to tell where any star (not just zenith stars) rises and sets, providing you know the declination of the star. In other words, viewed from anywhere within the tropics, the place where each star rises and sets depends only on that star's declination, not on your latitude.

We call this the Tropics Rule. In the tropics, a star rises and sets off of due east and west by an amount equal to the star's declination. The declination of *Sirius*, for example, is about $S 17^{\circ}$; it passes overhead in Tahiti in French Polynesia and at Lake Titicaca in southern Peru. Whenever you see *Sirius* setting in the tropics, its bearing is 17° south of west. The bright northern star *Capella* has a declination of $N 46^{\circ}$. It passes over the mouth of the Columbia River on the Washington-Oregon border and over Cape Breton Island in the northern part of Nova Scotia. In the tropics, north or south, when you see *Capella* rising, its bearing is 46° north of east, which is due northeast. Likewise, in the tropics, *Capella* always sets due northwest.

This rule is restricted to the tropics because generally the direction of a rising star depends on the latitude of the observer as well as the declination of the star—a point discussed further below. But within 20° or so of the equator, the change due to the observer's latitude is so slight it can be neglected. At latitudes greater than 24° , however, star bearings on the horizon begin to change more rapidly with latitude. Consequently, this rule is not reliable for latitudes greater than about 24° . The rule, as we applied it to unknown zenith stars above, works even if you don't know the names of stars, because you know their declination must be the same as your latitude since they pass overhead.

The Tropics Rule shows the value of knowing the geography of the stars. If you are going to use horizon bearings of stars for directions, you need to know the declinations of a few stars.

Latitude, Declination, and Amplitude

Most stars in the sky, of course, do not pass overhead. The Tropics Rule for these other stars becomes more valuable as you learn more stars. There is a way around this limitation, however, if you don't mind tuning up your measuring skills. If you have a convenient star but it is not a zenith star and you don't know its declination, you can figure out the star's declination relative to your latitude.

But this is not something you can do from scratch. You must first know your directions before you can find the declination of a star. It is a circular process, an example of reading and steering by the whole sky. You use some stars to find directions; then, knowing directions, you can find the declination of an unknown star. Then you can use the unknown star for directions.

To find the declination of a star, you must note how far the star is off your zenith when it bears due north or south at its highest point in the sky. If a star passes north of you, 10° below your zenith, the declination of that star is 10° north of your latitude. Or suppose you see a star due south at twilight at a height of about 30° above the horizon. Since the full range of heights in the sky is 90° , a star 30° up from the horizon must be 60° down from your zenith. The declination of this star must be 60° south of your latitude (see Figure 5-21). If you are at latitude 15° N, the declination of the star must be S 45° . This star rises 45° south of east and sets 45° south of west throughout the tropics. You can use this trick to find the declination of a star no matter where you are, but the Tropics Rule gives its direction on the horizon only when you are in the tropics.

This procedure for determining declination from known latitude and (at least temporary) bearings can prove very valuable for finding the declinations of the bright planets, Venus and Jupiter. Because of their brightness they are convenient steering guides, but their declinations

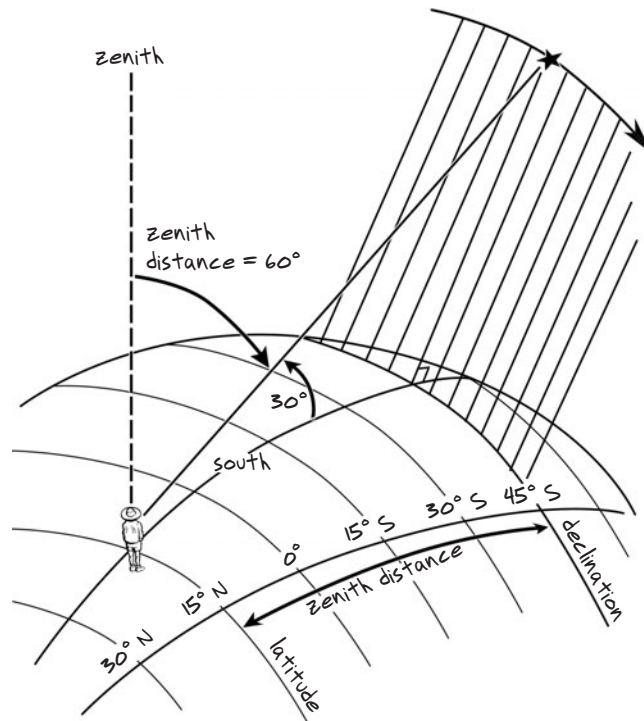
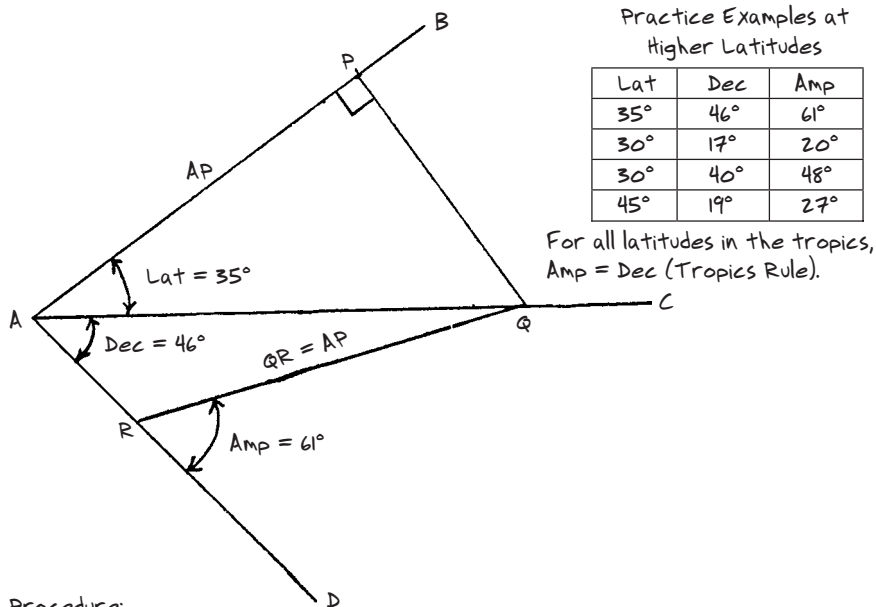

Figure 5-21. Finding the declination of an unknown star from its peak height on the meridian. A star that crosses your meridian at a height of 30° must be 60° down from your zenith. This means its declination is 60° south of your latitude, since the distance between you and the point directly under a star is always equal to the zenith distance of the star. This is true even when the star is not on the meridian, but you can use this fact to find declination only as it crosses the meridian. When using makeshift instruments, you can determine the peak height of a star most accurately when it is either very low (less than 10° or so) or very high (within 10° or so of the zenith). Measurement methods for finding latitude are covered in Chapter 11. To figure star bearings, however, you do not need to determine declinations very precisely.

cannot be memorized because they change throughout the year in irregular ways. Makeshift methods of measuring heights above the horizon and off the zenith are covered in Chapter 11.

Once you know the declination of a star or planet, you can determine where it will rise and set when viewed from any latitude by using a plotting trick. To explain this best, we need a new term. The bearing of a rising star relative to east, or a setting star relative to west, is called the star's *amplitude*. A star with north declination rises north of east and sets north of west, so it is said to have a north amplitude. Amplitudes are thus labeled north or south depending on the declination of the body; in the Sunrise and Sunset section in Chapter 6 we will use the sun's amplitude to keep track of its bearings. With this new term, we can restate the Tropics Rule in a neater form: From any latitude within the tropics, a star's amplitude equals its declination.

Outside of the tropics, a star's amplitude is bigger than its declination, and you can figure out how much bigger using the plotting procedure illustrated in Figure 5-22. With this technique, the sky begins to open up even more for star steering. From any known latitude you can figure the declinations of prominent stars, and from these you can determine where the stars will rise and set.



Procedure:

1. Draw angle BAC = latitude and, below it, angle CAD = declination.
2. At any point P on line AB, draw line PQ perpendicular to line AB.
3. Find point R on line AD that is a distance AP from Q.
4. Then the angle QRD = amplitude of the star.

Figure 5-22. Graphical solution for amplitude. With this procedure you can figure the amplitude of any star whose declination you know or can determine. Note that as latitude decreases, point P approaches point Q and point R approaches point A, so amplitude approaches declination—the Tropics Rule. With a calculator, solve for amplitude from: $\text{Sin}(\text{Amp}) = \text{Sin}(\text{Dec}) \div \text{Cos}(\text{Lat})$.

STAR PATHS

Polynesian Star Paths

The concept of a star path comes from island navigators of the tropical Pacific. The “path” is a sequence of stars with nearly the same declination, which means they rise at nearly the same place on the horizon throughout the tropics (the Tropics Rule). By learning the sequence for the bearing from one island to another, Polynesian navigators have, in essence, established sets of celestial sailing directions. They follow one star as it rises above the horizon until the next in the sequence appears, at which time they shift to the new star for orientation. In this way, they keep track of a particular bearing on the horizon throughout the night. The same technique can be used with setting stars. It is easy to see how indigenous star paths could evolve into finely tuned routes that account for both prevailing currents and the leeway of traditional craft. Poor choices would be removed from the lore by natural selection.

This approach to star steering, unfortunately, is not as versatile outside the tropics. At higher latitudes, stars do not rise as steeply from the horizon as they do in the tropics (rising angle equals your colatitude), so their bearings change much faster as they rise. As a result, you can't follow any one star very long. Another problem at higher latitudes is that the horizon bearing of a star changes with latitude, which further restricts this method to east-west voyages.

When steering by the stars in the tropics, however, you can borrow the method of Polynesian star paths directly (see Figure 5-23). Unlike your Polynesian counterparts,

Figure 5-23. Polynesian star paths. Any sequence of stars with the same declination rises at the same point on the horizon. In the tropics, rising angles to the east or west are steep so you can keep track of this bearing from one star until the next in the sequence appears. The example shown is for latitude 15° N, using stars with declination of about N 30°. The Tropics Rule tells you that this path rises 30° north of east. The radial lines on the path mark 1-hour segments. This path could easily get you through the night as Polaris fades in and out of the clouds.

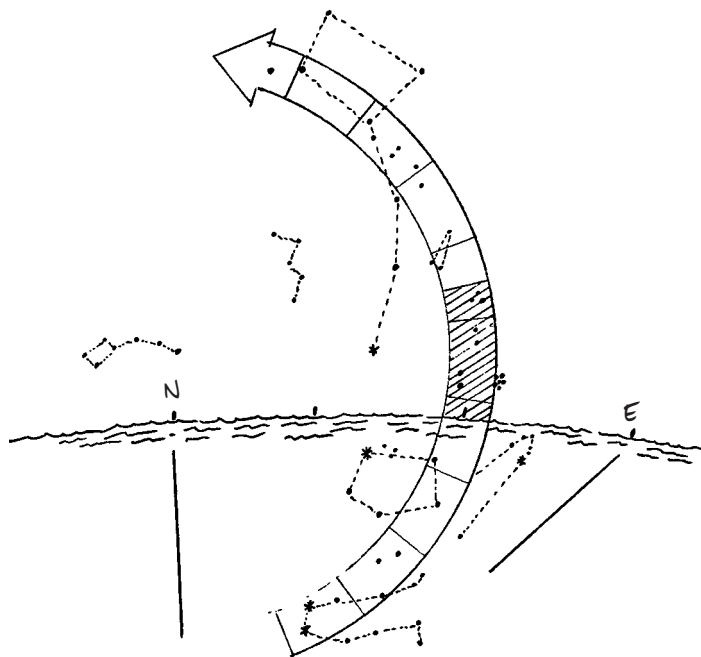

you won't know ahead of time which stars make up the path you need—unless you happen to have a table of star declinations. But you can discover a convenient path using the various other methods of star steering to keep yourself oriented as you note the sequence of stars on the horizon dead ahead. If you are steering without a compass, this process happens almost automatically, since you continuously look to the stars ahead for short-term references. All that remains is to picture patterns or figures in the constellations and make up names for the stars you intend to follow each night.

In its broadest sense, a star path is nothing more than using the same steering stars on successive nights. In this sense, the concept of a star path can be useful at any latitude, especially if your voyage is primarily to the east or west. One example already mentioned is the use of the Half-Latitude Rule for overhead stars as they approach the zenith from the east or descend toward the west. Once you have identified the zenith stars for your latitude, you can use their trail across the sky as a star path to the east or west, even though you may not be headed that way. With a southern component to your course, for example, you can watch the stars just south of your zenith each night to anticipate which new stars will become zenith stars as you proceed.

Circumpolar Star Paths

At high latitudes, you can borrow the Polynesian concept of star paths by looking in a different place for stars that hold their bearings for long periods. In the tropics, look to the east or west near the horizon to find stars that move nearly vertically with little change in bearing. At high latitudes, you can find similar stars by looking to the middle of the sky toward the intercardinal directions. Here you see circumpolar stars moving nearly vertically along the east or west sides of their circular paths around the poles.

At higher latitudes, you can take advantage of the larger numbers of circumpolar stars. Circumpolar stars with the same declination (which puts them on the same circle around the pole) also form a star path of sorts as they pass to the left or right of their pole. At this position, they are traveling nearly vertically and therefore remain at the same bearing for long periods. You can pick out a path of these stars by noting which stars are equidistant from the pole position—a relative measurement that is fairly easy to make. These stars would then be “on their path” when they are at roughly the same height as the pole, just below or above a height equal to your latitude (see Figure 5-24).

From latitude 45° N, for example, the star *Dubhe*, at the tip of the cup of the Big Dipper, will remain within 5° of bearing 320° for over 5 hours as its height drops from about 65° to 30°, coming down around the west side of the pole. Rising through the same arc on the eastern side, it stays at 040° for the same period. *Dubhe* is far enough from *Polaris* that it could easily be visible with *Polaris* obscured, but this technique is potentially much more valuable in high southern latitudes.

In the southern sky, there is an almost continuous ring of prominent stars with declinations near S 60°. These are circumpolar for all latitudes south of 30° S. Figure 5-24 shows how these stars form a convenient star path viewed from latitude 45° S. Remember, though, that the bearing to this type of star path changes as your latitude changes. But the change is gradual and can be

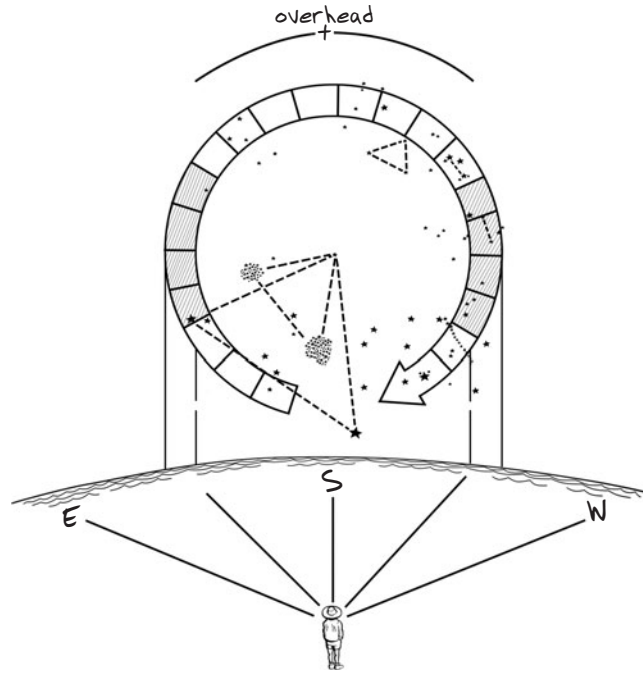

Figure 5-24. Circumpolar star paths. At higher latitudes, circumpolar stars form an elevated star path—keeping constant bearings for several hours—as they pass to the right and left of the pole. This example is for latitude 45° S, using stars with declinations of about S 60° . The radial lines on the path mark 1-hour segments. When no timepiece is available, you could use the heights of prominent stars along such a path for watch changes.

monitored. The primary virtue of this approach is that it gives you a bearing at a glance, without having to draw imaginary lines across the sky.

TIMING LOW STARS

If you have a watch, any star, known or unknown, in about one quarter of the sky can be used for directions conveniently at any time of night. The method is the same as the one we'll discuss in the Solar Time Method section in Chapter 6 for steering by the sun, but it applies even more readily to stars. The principles are explained in Chapter 6, so here we'll only review the method.

First, find directions accurately using any (preferably many) of the previous methods. Then use a portable compass card to note the directions of a few prominent stars low in the sky, bearing roughly opposite to the elevated pole. That is, use stars to the north in the Southern Hemisphere and stars to the south in the Northern Hemisphere. Note the time according to your watch. The time could be wrong, but that's all right; you don't need accurate time here, only relative time. These low stars will then move west along the horizon at a rate of 15° per hour. If you know their direction at one time, you can quickly figure out what it must be at some later time.

Here is an example. At latitude 35° N and at watch time 2230, you see *Antares* to the south-east at a bearing of 140° , which you determined by other methods. At watch time 0230, the next morning, 4 hours later, the bearing to *Antares* will be $140^\circ + (4 \times 15^\circ) = 200^\circ$.

The trick here is to use several different methods to determine accurate bearings to several of these low stars and then simply use these stars from then on. As they approach the western horizon, use their positions to find bearings to subsequent stars to the east that follow along their general path. This is the easiest way of all to keep track of bearings by the stars. In essence, you only have to use the various other methods once or twice a night to check your calibration of these low stars (see Figure 5-25). But you do need a watch.

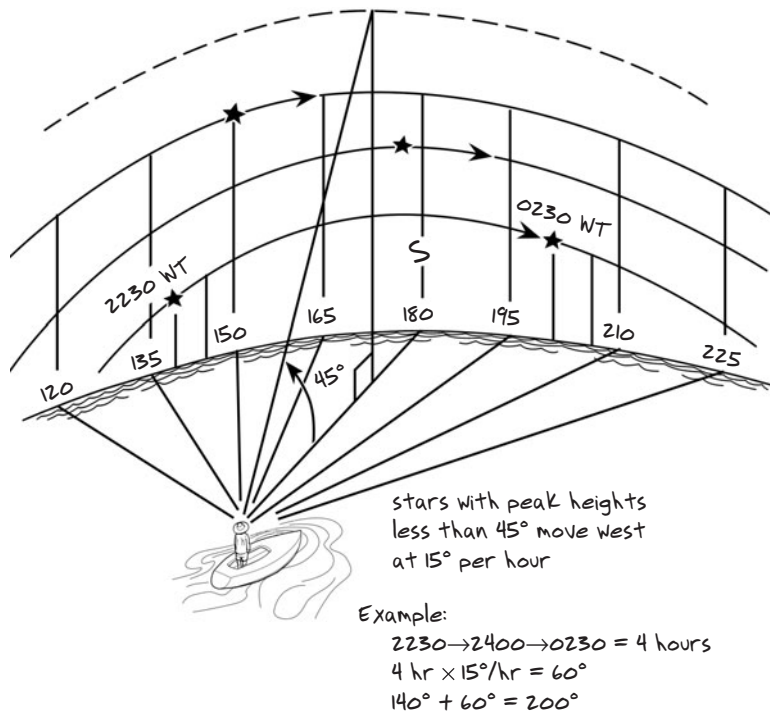

Figure 5-25. Keeping track of star bearings by timing low stars. Any star with a peak height less than halfway up the sky moves west at about 15° per hour. If you have a watch—and once you find bearings from other means—you can use this method the rest of the night. This is the stellar equivalent of the solar time method covered in Chapter 6, and shown in Figures 6-9 and 6-10.

And the stars don't even need to be so very low. As explained in the Solar Time Method section, as long as the stars you choose remain less than 45° above the horizon at their highest point, your error from this method will rarely be more than about 5° , and the errors are equal and opposite on either side of your meridian. If you follow a star this way from one side of the meridian to the other, the errors will cancel each other out. The lower the star, the more accurate the method, but the lower stars are above the horizon for shorter periods. Generally,

you won't know how high some random star to the east is destined to rise, so it is best to start with stars near your meridian. Just look toward the meridian, and any bright star less than halfway up the sky is a candidate. The next night when you see them coming, you'll know they are the good guys.

That's all there is to it. The method takes a little explanation, but don't let that detract from its extreme utility and versatility. With a watch, this is a powerful aid to orientation. The rotation rate of 15° per hour is easy to remember—the earth rotates 360° in 24 hours, which is 15° per hour.

Chapter 6

STEERING BY THE SUN

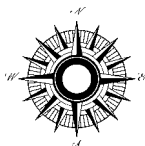

Steering without a compass during the day is quite different from steering by the stars at night. On a clear night, you can glance at the stars and pretty much point to any direction you choose. You can't do this very often with the sun, and you essentially can't do it at all without a watch. To tell the direction of the sun, you have to do some figuring or watch a shadow move. You can always get directions from the sun; it is just not as convenient as using the stars.

The big advantage of daytime steering is that you can see waves, swells, and various other signs of the wind on the water and boat—not to mention a good horizon throughout the day for sun height measurements. During the day, you'll typically steer by the wind and swells and only occasionally figure out the sun's direction to check your course. But when the swells are weak and the winds vary, you have no choice but to steer by the sun throughout the day.

SUNRISE AND SUNSET

To get bearings from the sun in the morning, you need to know the direction of sunrise. The sun always rises to the east, but rarely due east. For most of the year, for most of the world, sunrise lies within 30° of due east, so sunrise always provides a rough determination of east. But you can't steer a boat very far with this much uncertainty.

The precise direction of sunrise depends on your latitude and the time of year. During fall and winter (between the two equinoxes, from September 23 to March 21), the declination of the sun is south, so the sun rises south of east. During spring and summer, when its declination is north, it rises north of east (see Figure 6-1). The sunrise is farthest from due east for about one month on either side of the two solstices, December 21 and June 21. You can safely assume that the sunrise lies within 5° of due east only for about one week on either side of each equinox.

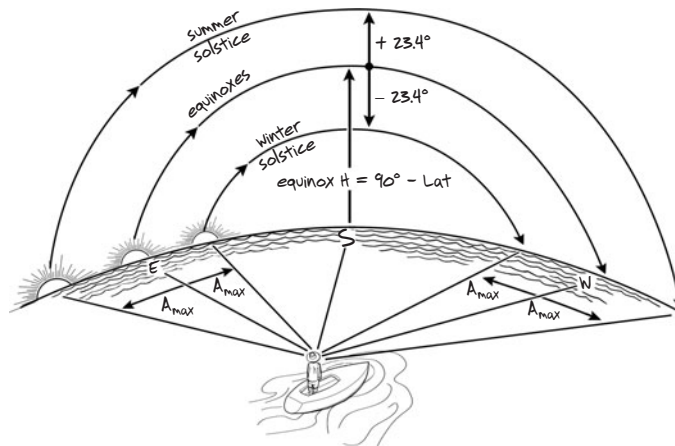

Figure 6-1. Path of the sun observed from northern latitudes showing peak heights and sunrise-sunset bearings throughout the year. The sun's path is symmetrical about the meridian—when the sun rises 20° south of east, it sets 20° south of west. Maximum amplitudes (A_{max}) are tabulated for various latitudes in Figure 6-2.

A procedure for figuring the direction of sunrise from your latitude and the date is given at the end of this section, but apart from this approach (which requires some memory work), the easiest way to find the direction of sunrise is to use the stars. Just before morning twilight, observe the stars to carefully note your heading and the direction of the wind and swells. Then hold a steady course until sunrise and note the sunrise direction relative to your heading. In the Northern Hemisphere with *Polaris* visible, it is best, if possible, to alter course to due north for this—or alternatively, from any location, to head parallel or perpendicular to the swells.

In practice, it is best to assign numerical bearings to your heading and the swells (rather than approximate labels like “northwest”), even though these values won't be very accurate unless you have *Polaris* to go by. For example, preparing for this measurement, you might turn to head straight up the trough of the swells, which you figure from the stars is toward direction 050° , and this puts the wind on your port beam. You then trim to this point of sail and hold course until sunrise. If the sun comes up 30° to the right of the bow according to your makeshift compass card, then the sunrise bearing is 080° . Once you learn the direction of sunrise, it is most convenient to remember it relative to due east—in this example, it would be 10° north of east (see also Figure 3-5 for another method).

The bearing difference between sunrise and due east (or sunset and due west) is the amplitude of the sun. In the example, the sun's amplitude would be 10° N. The amplitude label (north or south) is always the same as that of the sun's declination, since the sun rises and sets north when its declination is north. The amplitude is the thing to remember since it varies systematically throughout the year and applies to sunrise and sunset alike; it is more confusing to remember bearing changes. On the equinoxes, the sun's amplitude is 0° , and from there, it gradually increases day to day to its maximum value at the solstices. How the amplitude changes with date and the maximum value it reaches depend on your latitude, as illustrated in Figures 6-2 and 6-3.

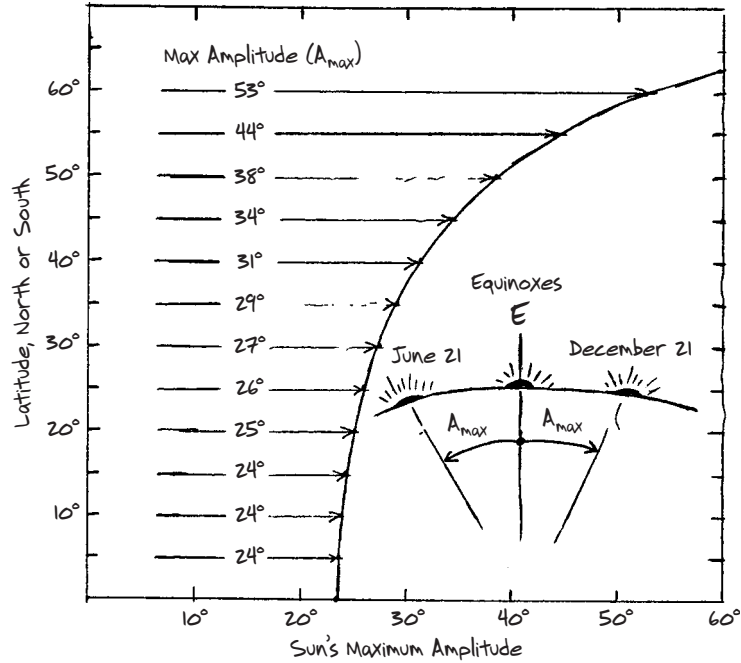

Figure 6-2. Maximum amplitude of the sun at different latitudes. These maximum values occur on the solstices, but throughout the year, the amplitude is south when the sun's declination is south (fall and winter) and north when the sun's declination is north (spring and summer).

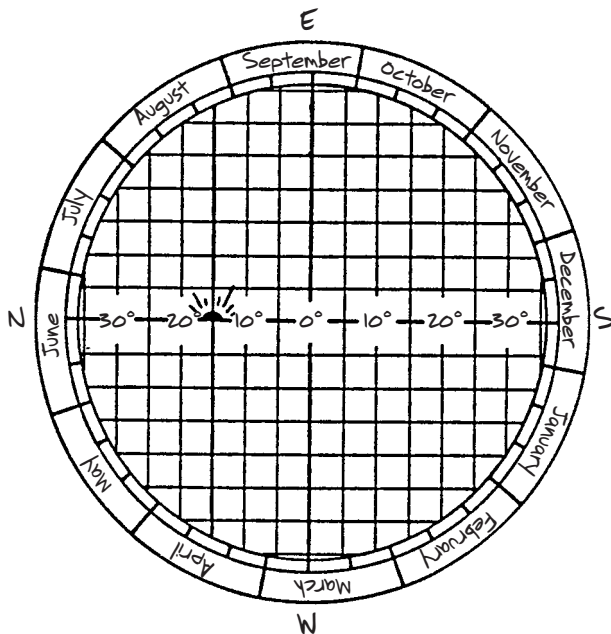

Figure 6-3. How the sun's amplitude varies with the date. Draw a circle and label the circumference with 1° per day with the solstices on the baseline as shown. Then scale the baseline with the maximum amplitude that applies to your latitude. The example shown is for latitude 48° N, where the maximum amplitude is 37° N. At this latitude, the amplitude on April 15 or August 25 is 15° N. This figure shows how the amplitude stays much longer near the maximum values at the solstices than it does near 0° at the equinoxes.

The sun's amplitude won't change much over a week or so unless your latitude changes by more than several hundred miles. Nevertheless, it is good practice to check it daily. After several checks, you'll know the value accurately. You can also find the sun's amplitude from the direction of sunset using early evening stars. Establish the sunset bearing relative to your heading, or alter course straight toward the sunset. Hold course until stars appear, then figure your heading from the stars, and you have the bearing of sunset. From this, figure the amplitude, and you can use it the next morning for orientation. Remember, the sun's path is symmetrical. Knowing the sunset direction is the same as knowing the sunrise direction. If the sun's amplitude is 20° N, it will set 20° north of west and will rise the next morning 20° north of east.

The Tropics Rule section in Chapter 5 and Figure 5-21 showed how to figure a star's amplitude from its declination and your latitude. You can also apply this method to the sun; see the Latitude from the Sun at LAN section in Chapter 11 for a procedure to figure the sun's declination using the date.

MORNING SUN AND AFTERNOON SUN

Once you know the direction of sunrise, you can keep track of the sun's bearing for 2 or 3 hours after sunrise by tracing the sun's path back to the horizon. Do this by locating the point on the horizon where the sun came up (a bearing you know), and then estimate how far off this bearing the sun lies at the present time. There are two ways to do this; one requires a watch, the other doesn't.

Without a Watch

If you don't have a watch, you can use the simple rising angle method, which involves pointing the sun back to its rising position as we did to point Orion's belt (*Mintaka*—see Figure 5-12) back to the horizon (see Figure 6-4). Imagine a line passing through the sun that makes an

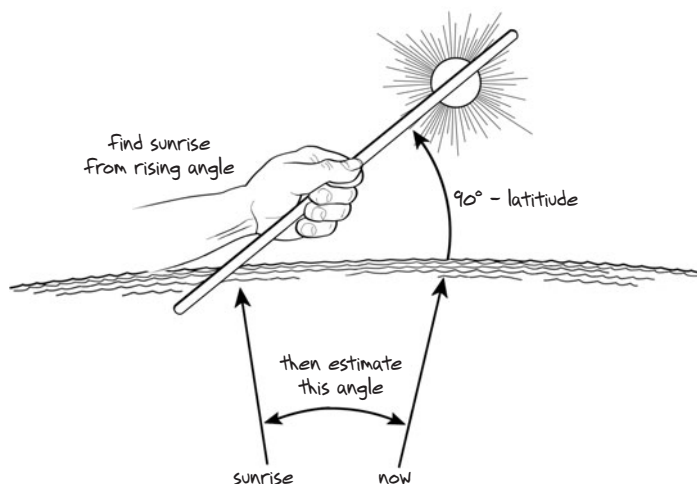

Figure 6-4. Finding the sunrise location from the rising angle. Then you can use the sunrise location to find the present bearing of the sun from the known sunrise direction. The same angle pointed down toward the horizon can be used before sunset. Rising and setting angles are illustrated further in Figure 6-5 and Table 6-1.

angle with the horizon equal to your colatitude. This line intersects the horizon at the location of the sunrise. At latitude 30° N or S, for example, the eastern sun climbs at an angle of 60° . The angle is the same from north or south latitudes; the only difference is the direction in which the sun's path tilts. In northern latitudes, the sun's path rises up and toward the south; in southern latitudes, the path is tilted toward the north, as shown in Figure 6-5. At latitude 10° , the angle of the rising (or setting) sun is about 80° . A stick and makeshift protractor (portable compass card) help in judging the angle, but to find the direction of sunrise, you don't have to judge the angle exactly. Just remember that the lower your latitude, the steeper the angle.

Likewise, for an hour or two before sunset, you can use the same procedure to project the sun forward and down toward the horizon to locate the place where the sun will set.

Strictly speaking, this method is approximate, since the rising angle you use here is exact only if the sun bears due east or west at the time you point the sun toward the horizon. The worst case would be, for example, in high northern latitudes near the winter solstice, when the sun comes up well south of east and moves even farther from east as it rises. But for most of the year,

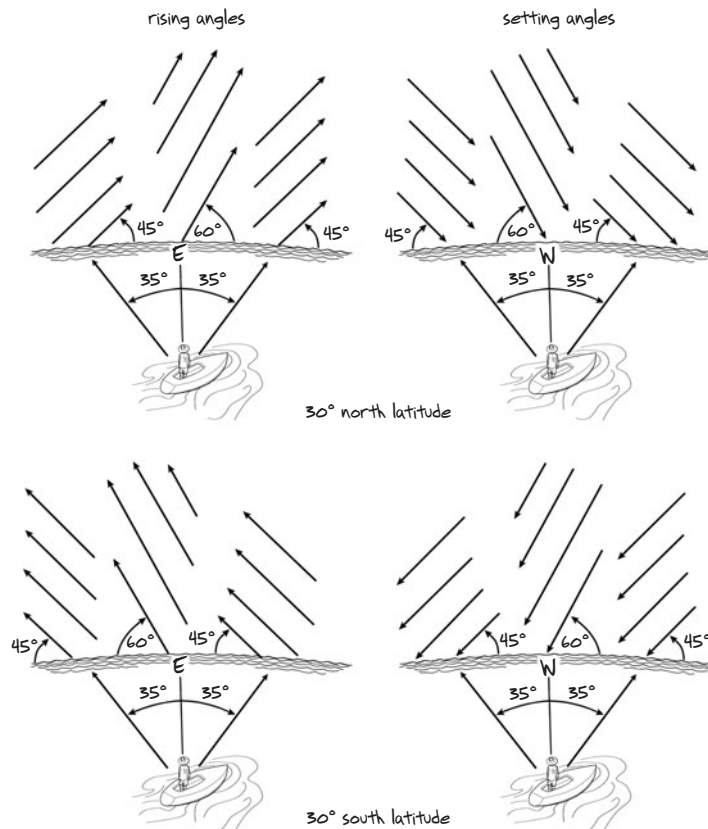

Figure 6-5. Rising and setting angles at different amplitudes. Everything in the sky at a particular bearing climbs or sets at the same angle, which is always the steepest at due east or west where it equals 90° minus latitude (your colatitude). Numerical values are given in Table 6-1.

TABLE 6-1. RISING ANGLES*

	AMPLITUDE (° NORTH OR SOUTH)												
	0	5	10	15	20	25	30	35	40	45	50	55	60
0	90	85	80	75	70	65	60	55	50	45	40	35	30
5	85	83	79	74	69	65	60	55	50	45	40	35	30
10	80	79	76	72	68	63	59	54	49	44	39	34	29
15	75	74	72	69	65	61	57	52	48	43	38	34	29
20	70	69	68	65	62	58	54	50	46	42	37	33	28
25	65	65	63	61	58	55	52	48	44	40	36	31	27
30	60	60	59	57	54	52	49	45	42	38	34	30	26
35	55	55	54	52	50	48	45	42	39	35	32	28	24
40	50	50	49	48	46	44	42	39	36	33	29	26	23
45	45	45	44	43	42	40	38	35	33	30	27	24	21
50	40	40	39	38	37	36	34	32	29	27	24	22	19
55	35	35	34	34	33	31	30	28	26	24	22	19	17
60	30	30	29	29	28	27	26	24	23	21	19	17	14

*Rising angles and amplitudes are illustrated in Figure 6-5.

in most parts of the world, the approximation is a good one—in part because the summer sun in northern latitudes and the winter sun in southern latitudes will likely lie near east or west at the time you do this estimate, even when the amplitude is large. Table 6-1 shows how rising angles vary with amplitude.

With a Watch

When you have a watch, the morning sun can be pointed back to the horizon in another way, which can be more accurate than the simple rising angle method. To use this method, you must know the length of time that has passed since sunrise. You then convert this time to a length along a makeshift measuring stick, using a conversion factor for time passed to length along the stick.

The conversion factor you need is “1 inch per 10 minutes at arm’s length.” To see where this comes from, imagine that you could somehow see the sun’s path drawn across the sky. If you held a stick at arm’s length and lined it up with this path, you would find that the sun moves along the stick at a rate of about 1 inch per 10 minutes. The exact conversion factor depends on the length of your arm. This one assumes that the distance from your eye to the stick is about 2 feet, which is close to the average arm length. This conversion factor is the same one used in

the Steering by Overhead Stars section in Chapter 5 to predict the apparent motion of overhead stars—everything in the sky moves at this rate, since 1 inch per 10 minutes at 2 feet is equivalent to 15° per hour.

Naturally, you can't see the sun's path in the sky—that, after all, is what you want to find. But if you know the time of sunrise and the time of day, you do know how far the sun has traveled since rising. The trick is to put a mark on the stick at a distance from its end equal to the number of inches the sun has traveled since sunrise—a distance you figure from the time passed since sunrise and the conversion factor. Then hold the stick with your thumb at the mark, put your thumb on the sun, and rotate the stick around the sun until the end of the stick touches the horizon. This point is where the sun came up. What you have found is the only place on the horizon where the sun could have started its climb to get to where it is after traveling the distance it did (see Figure 6-6).

In the afternoon, you can use the same method to point the sun ahead to find the sunset direction. If you don't have a stick, you can use your hand at arm's length as a distance marker. According to the conversion factor, an outstretched hand width is some 80 to 100 minutes, depending on the size of your hand.

But whatever method you use to point the sun to the horizon, don't forget the basics. In northern latitudes, whenever you face the sun, it is moving to your right—in the morning you point it back, to the left, and in the afternoon you point it forward, to the right. When you face the sun in southern latitudes, the westward motion of the sun is to your left.

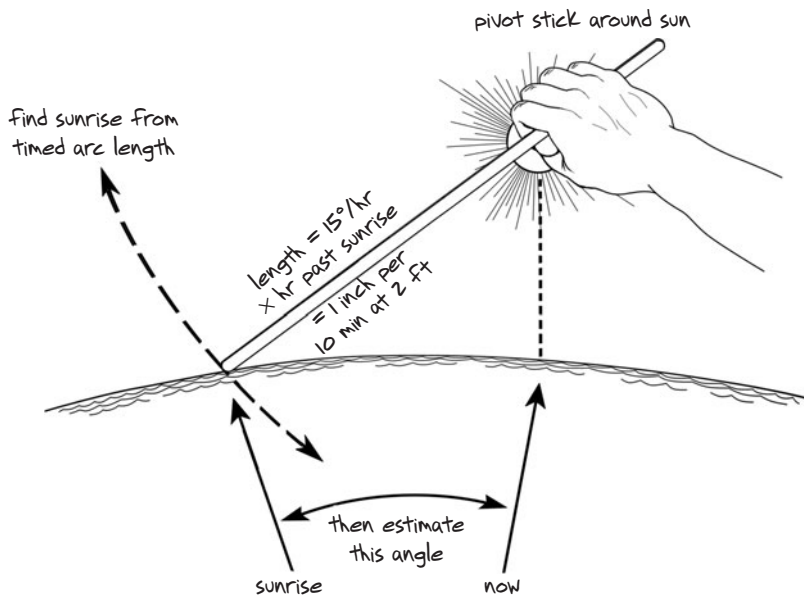

Figure 6-6. Timed arc for finding sunrise location. You can use the same procedure in the afternoon for finding the sunset location if you know the time of sunset. You figure the present bearing of the sun from the known bearing of sunrise or sunset.

You can use this method of pointing the sun back or ahead to its horizon position at any time of the year, from any latitude. Unlike the simple rising angle approximation, this method is accurate for an hour or two after sunrise and before sunset, regardless of the sun's bearing. This trick is just one example of the value of being able to estimate angles with your hands and fingers.

LOCAL APPARENT NOON

The keys to steering by the sun in the middle of the day are having a watch and knowing solar time. Solar time is figured relative to midday, or *local apparent noon* (LAN) as it is known to navigators. LAN is the time of meridian passage of the sun. At LAN the sun has reached its highest point in the sky, bearing due south from northern latitudes or due north from southern latitudes. Knowing solar time assures you of a precise direction of the sun each day at noon, and it helps throughout the day in many cases. Besides its value for sun directions, though, you also need solar time for keeping track of longitude, so we interrupt our direction finding briefly to clarify this concept.

Do not confuse local apparent noon with 1200 according to your watch. It is highly unlikely that your watch will read exactly 1200 at LAN. Your watch could be set on any time zone, but even if it is set on the proper local time zone, the time the sun crosses your meridian depends on where you are within that time zone.

If you have a watch but you know it reads the wrong time (perhaps it stopped, but you don't know how long ago) and you don't know where you are, then the best thing to do is figure out the time of LAN and set your watch to 1200 at that time. Your watch is then at least running on a known time system, even though that system depends on longitude and date.

It is easy to set a watch on solar time, but if your watch is accurately set on another time zone, no matter what it is, definitely do not change it. Accurate time is essential to finding longitude, and for long-distance navigation, this is much more important than solar orientation. You don't want to do anything to your watch that may cause you to lose track of the correct time, regardless of the time zone of the watch. If your watch is accurate, don't change it. When you need the time of LAN you can find it, and it won't matter at all if it happens to be a number way off 1200.

Finding LAN Using Sunrise and Sunset

From a stationary position, LAN always occurs exactly halfway between sunrise and sunset. And for emergency purposes, you are essentially stationary unless you change position during the day by more than 200 miles or so. To find the time of LAN, note the time of sunrise and sunset, add the two times, and divide by 2. That's all there is to it.

It doesn't matter how you define sunrise and sunset as long as you are consistent in the morning and evening. The usual definition of sunrise is the moment the top edge of the sun's disk (upper limb) first appears on the horizon—the full sun will be visible another 2 or 3 minutes later, depending on your latitude and the date. The corresponding definition of sunset is when

the top edge of the sun's disk finally disappears below the horizon. In both cases, you must time the sun crossing the true sea horizon, not just a low layer of clouds near the horizon. When the horizon is obscured by only a small amount—say, less than half the sun's diameter—you can still estimate the time difference between the apparent and true setting times.

As an example, suppose the time of sunrise is 0915 by your watch and the time of sunset is 1933. Then the time of LAN is:

$$(19\text{hr } 33\text{m} + 9\text{hr } 15\text{m}) \div 2 = (28\text{hr } 48\text{m}) \div 2 = 14\text{hr } 24\text{m}$$

So LAN by your watch occurred at 1424. If you want to set your watch on solar time, you would set it back (from whatever it reads at the present time) by 2 hours and 24 minutes (1424–1200 = 2 hr 24). Or you can leave it alone, knowing that according to your watch the sun will lie due south at 1424 tomorrow. This will be true even if your watch is not set correctly on any particular time zone.

It is not necessary to catch the sunrise and sunset on the same day. You could use the sunset one night and the sunrise the next morning. The sights can even be several days apart if you have not moved very far—say, 200 miles, as a rule of thumb. Within these limits, the time of LAN won't change by more than 5 or 10 minutes over a period of several days, and you don't need a more accurate LAN time if all you want is directions from the sun. You do, though, need a more accurate time for finding longitude.

Finding LAN Using a Kamal

Finding LAN from sunrise and sunset is convenient, but unfortunately it is rarely possible to see the sun right on the sea horizon. Even on clear days, the rim of the horizon at sea is often obscured by distant clouds or haze. One way around this problem is to improvise a crude sextant, meaning here just some device for measuring angles. You can then measure the time it takes the sun to go from one fixed height in the morning to this same height in the afternoon. Since the path of the sun is symmetrical, LAN still lies halfway between these two times.

The best type of makeshift sextant for measuring small angles is called a *kamal*, an ancient instrument used by Arabs for dhow navigation along the Persian Gulf and east coast of Africa. A kamal is nothing more than a flat stick or plate (even a credit card!) with a knotted string attached. To use the kamal, hold the knot in your teeth, and hold the plate forward with one hand so that the string is kept tight; this keeps your other hand free for steadying yourself on the boat. The string keeps the plate at a fixed distance from your eye, and if you attach the string to the plate with a bridle, the tilt of the plate also remains constant. A kamal is a very reliable way to make reproducible measurements of small angles.

To make a sight, align the bottom edge of the plate with the horizon, and note the time (in the early morning) when the upper edge of the sun first appears over the top of the plate. In the afternoon, do the reverse: note the time the sun's upper edge just drops below the top of the plate, again with the bottom edge aligned with the horizon (see Figure 6-7). The actual sun height you measure this way doesn't matter as long as morning and afternoon heights are the same. Once you have the two times, use the formula above—add the times and divide by 2—to find LAN.

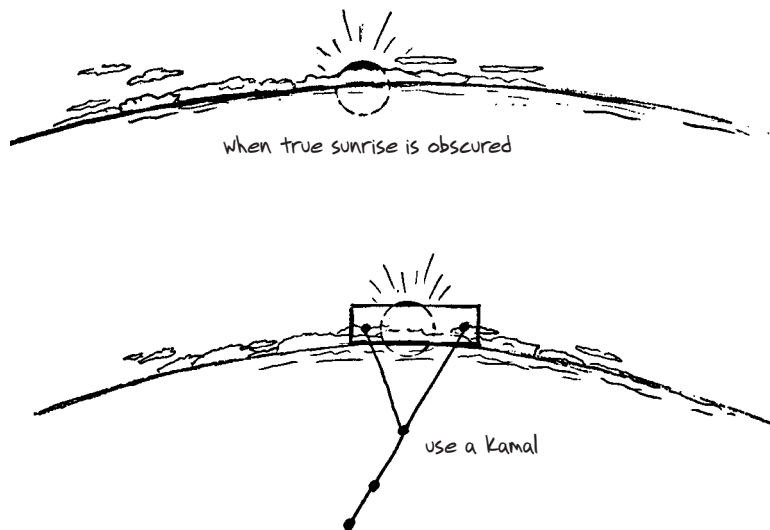

Figure 6-7. Using a kamal. Hold a card or plate at arm's length. Attach a knotted string to the card and hold the string between your teeth to keep the card at a fixed distance from your eyes. You can use a kamal to mark the times when the sun reaches a fixed height above the horizon and when it drops below that height. Add the times and divide by 2 to find the time of LAN.

By placing several knots in the string, you can time several heights. Each knot gives a set of times, and the midpoint of each set gives a LAN time. Due to judgment errors, the LAN times you get from different knots won't all be exactly the same, but the average of several sets will be more accurate than any one set (see Figure 6-8). Again, high accuracy is not required for direction finding alone, but this measurement is fairly accurate, and you can use it for keeping track of longitude, as explained later.

If you don't have the materials to make a kamal, you can use your fingers held at a comfortable arm's length from the eye. With practice, your fingers may be just as good as a kamal. At the other extreme, if you have a proper sextant, you should, of course, use it.

A word of caution: Without a sextant, the main problem with sun height measurements is the sun's brightness. Remember, the sun can damage your eyes very quickly if you look directly at it. You are usually restricted to measuring very low heights while the sun is not yet too bright to look at. Fortunately, the sun often has to rise only a finger width or so to clear the horizon clouds. And in any event, small angles (less than 10° or so) are much preferable to large angles because you can measure small angles more accurately. If you must attempt to measure higher angles when the sun is bright, be sure to use some form of sunshade. This may not be an easy problem to solve, though good sunglasses sometimes work for lower angles. Exposed camera film is one candidate for a sunshade; colored cellophane wrapping paper is another. Or smoke a clear sheet of glass or plastic by burning oil-soaked paper or cloth.

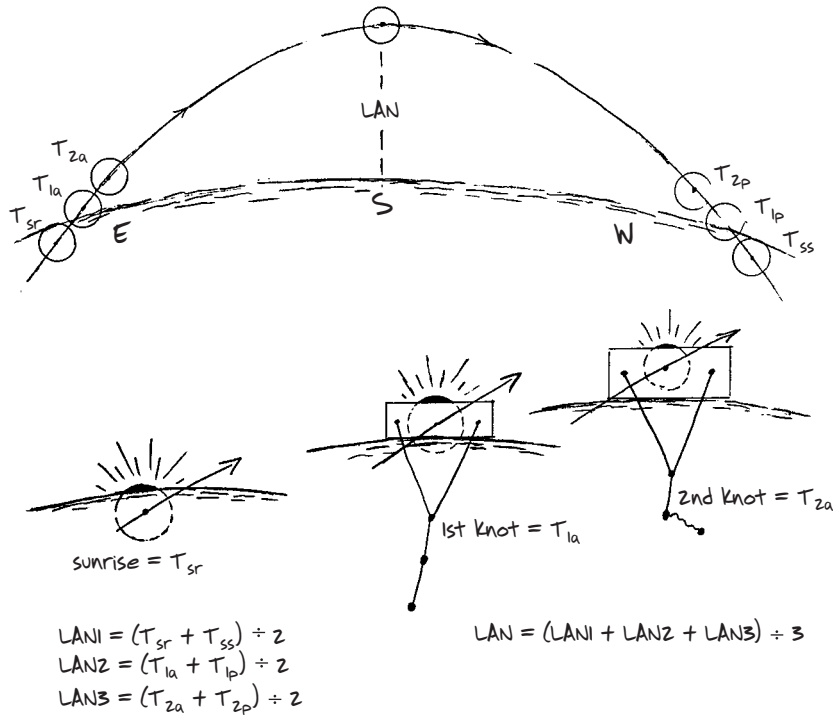

Figure 6-8. Finding the time of LAN. The average of several sights is more accurate than one alone.

Finding LAN Using Sunrise-Sunset Tables

So far we have discussed how to measure the time of LAN with a watch. To do this, you don't have to know where you are, you don't have to know if the watch is running correctly on any particular time zone, and you don't need any special aids. If, however, you have a set of sunrise-sunset tables, you know where you are, and you know the correct time (in any time zone, not necessarily the one corresponding to your present position), then you can figure out the time of LAN without doing any measurements. If all these conditions are met, you can usually figure out the time of LAN more accurately than you can measure it.

Sunrise-sunset tables are included at the back of *U.S. Tide Tables*, so there is a chance you might have a set of these on board. Look up the times of sunrise and sunset for your date and latitude, and then find the time halfway between these two, as in the earlier example. This mid-day time will be the UTC of LAN on the Greenwich meridian. Next convert your longitude (assumed known) to time using these conversion factors: $15^\circ = 1$ hour and $15' = 1$ minute (which is the same factor expressed in smaller units). A table that helps with this conversion is also included in the *U.S. Tide Tables*. Then, if your longitude is west, add these two times to get the UTC of LAN at your longitude. In east longitudes, subtract your longitude to find the time of LAN. This procedure is explained further in the Longitude from LAN section in Chapter 12.

Note that you can get the sunrise and sunset times from tables for any year; these times (to the accuracy you care about) depend only on latitude and day, not on the year. In fact, the midday (LAN) time that you want for this application does not even depend on latitude, even though the sunrise and sunset times themselves do. You will find that you get the same midday time for any latitude as long as you use the correct day. You might also get these times from a commercial radio station or from a recent newspaper that happens to be on board. Newspaper times usually include the longitude correction for the city the newspaper comes from.

With a list of sunrise and sunset times and a known latitude you can also figure the time of LAN relative to sunrise, so a hack watch could be used to mark the time of LAN. For example, if sunrise is at 0559 and sunset is at 1729, then:

$$LAN = (1729 + 0559) \div 2 = 1144$$

so LAN occurs at:

$$1144 - 0559 = 5\text{hr } 45\text{min after sunrise, regardless of your longitude}$$

The time of LAN (meridian passage) is listed directly in the *Nautical Almanac*; you only have to make the longitude correction to get the time you want. The tide-table method is included in case you find yourself offshore in need of sun directions when you didn't plan to be offshore, and therefore you don't have a *Nautical Almanac* on board. In this situation, you are likely to have a watch, know the time, and also know where you are, at least to the level of accuracy needed for this measurement, which is not very high.

SOLAR TIME METHOD

Finding directions from a watch and the sun is especially easy whenever the height of the midday sun is less than 45° above the horizon—that is, less than halfway up the sky. In this case, you only need to know the time of LAN and the time of day to get accurate directions from the sun throughout the day, sunrise to sunset. Your watch time does not have to be right on any time zone, you just need to know the time of LAN on your watch. So the first step is to find the watch time of LAN as explained in the previous section.

To test the height of the sun at noon, check the shadow length of any stick near midday. Whenever the noon sun is anywhere near low enough to be considered for this test, its height does not change significantly for an hour or so either side of LAN, so the precise time you make the test is not critical. If the shadow length is longer than the stick casting the shadow, the height of the sun is less than 45°, and you can use solar time to find directions all day long.

This is an easy test, and it definitely should be made if the maximum height of the sun is in question, as the solar time method can produce serious errors if the sun is too high. When you do the test, the stick should be perpendicular to the horizon, and the surface that the shadow falls on should be parallel to the horizon. A nail in a board held aligned with the horizon is one way to do this, but it is easy to improvise.

The height of the noon sun is important because it, in effect, determines how fast the direction of the sun changes during the day. The sun always moves along its invisible arc across the sky at a rate of 15° per hour, but only when the noon sun is less than 45° high does the sun's bearing move *along the horizon* at a near-constant rate of 15° per hour. In these conditions, it does so to a good approximation throughout the day, sunrise to sunset, as illustrated in Figure 6-9. And since the sun is on your meridian at LAN, if you know the time of LAN and the time of day, you can easily figure out the direction of the sun. From northern latitudes, at LAN the bearing of the sun is due south at 180° . One hour after LAN the sun lies 15° to the west of due south, bearing 195° .

As a further example, suppose the time by your watch is 1120, and you know that LAN will be at 1340 according to your watch. Since it is 2 hours and 20 minutes (or 2.33 hours) before LAN, you know that the sun has to travel $2.33 \times 15^\circ$, or 35° , before reaching due south. In other words, at 1120 the bearing of the sun is $180^\circ - 35^\circ$, or 145° , as shown in Figure 6-10.

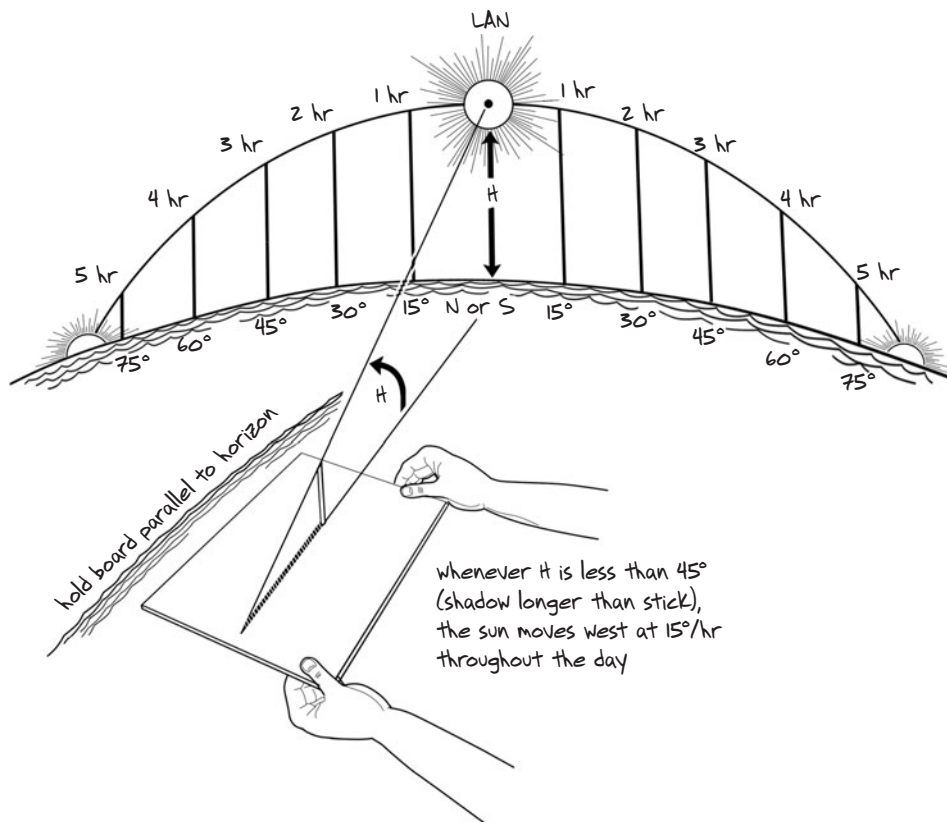

Figure 6-9. Principle of the solar time method. This shows an easy way to check the midday height of the sun. Although this method is an approximation, it is still useful whenever the peak height of the sun is less than halfway up the sky.

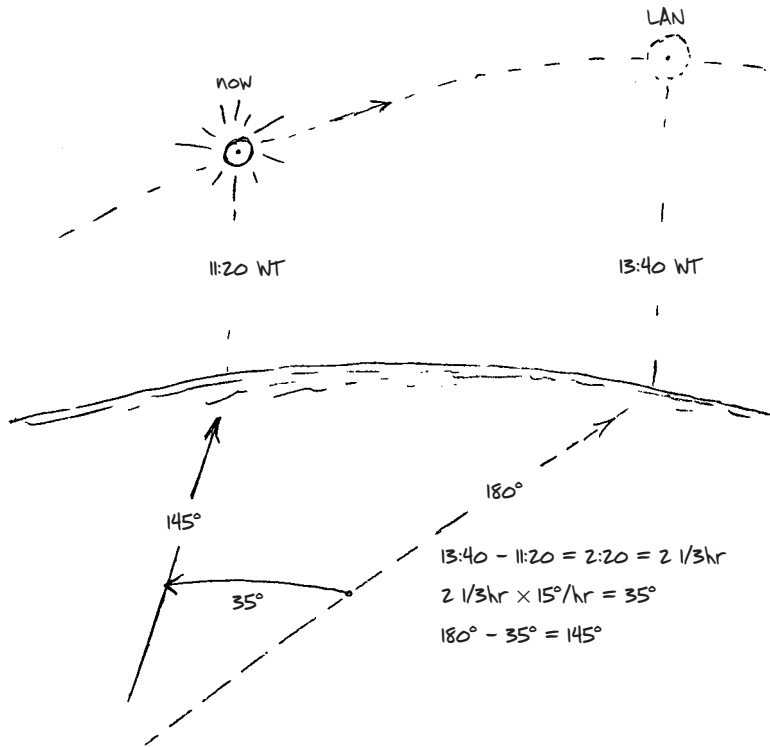

Figure 6-10. Using the solar time method. Once you measure or figure the time of LAN, you can figure sun bearings throughout the day from the time alone. Again, the noon sun must be less than 45° high for this method to work.

Strictly speaking, the solar time method yields only an approximation of the sun's direction. But whenever the noon sun is less than 45° high, this approximation is a good one. As explained above, it is easy to find the time of LAN to within 10 minutes or so, even when moving. Once you've found the time of LAN by your watch, the solar time method always gives the direction of the sun to within about 10° , and it is often even more accurate than that. Remember that 15° per hour is the same as 1° per 4 minutes, so if your time is wrong by 4 minutes, your bearing will only be wrong by 1° .

In northern latitudes, the midday sun is lower in the winter than it is in the summer. So unless you are fairly far north, this method may work only during the winter half of the year. But regardless of your location or the date, if a midday shadow is longer than the stick casting it, you can use the solar time method all day. If not, don't use this method, but instead use some form of a sun compass, as discussed in the Sun Compasses section below. Note that the solar time method can never be used in the tropics.

Note that the method we call the solar time method is a refinement of what is sometimes called the "Boy Scout watch method," in which you point the hour hand of a watch to the sun and then locate the meridian at 1200 on the watch face. How this is intended to work and its severe limitations should be clear from the previous discussions. This form of the method is not reliable.

THE SHADOW-TIP METHOD

As the sun moves westward, shadows move eastward, as illustrated in Figure 6-11. You can find an east-west line from shadow motion just as you can from overhead star motion. Since you have shadows to watch, however, the sun doesn't have to be overhead for you to be able to do it. Near midday all shadow tips move due east, regardless of your location or the time of year. When the sun is high in the sky and you don't have a watch, the shadow-tip method is the best way to get directions from the sun.

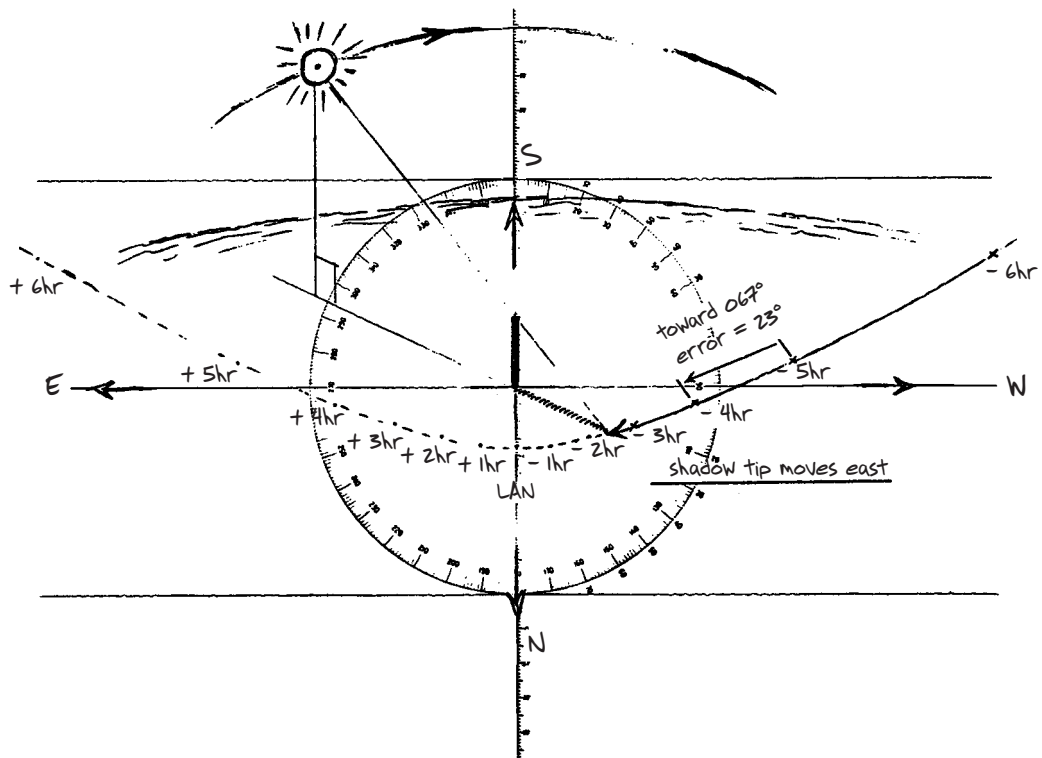

Figure 6-11. Shadow tips move eastward throughout the day. The difference between due east and the direction the shadow tips move depends on latitude, date, and time of year; any error is always to the sunrise side of east in the morning and to the other side of east in the afternoon. Error values are given in Table 6-2. The example shows a summer sun (July 14) viewed in the morning from latitude 45° N.

Keeping track of shadow-tip motion at sea is not as easy as it is on land, but it is far from impossible. In any event, you must improvise. The necessary conditions are that the heading of the boat remain constant as you watch the shadow move, and that the surface on which the shadow falls be level and parallel to the horizon. The stick or rigging catching the shadow does not have to be perpendicular to the horizon, although that may be the most convenient arrangement. However, its orientation relative to the horizon must be the same each time you look at the shadow.

The shadow tip from an inclined stick moves in the same direction as the shadow tip of a vertical stick. Some manuals on direction finding on land suggest orienting the stick toward the sun so you start out with no shadow at all. The shadow tip then moves eastward as it emerges from the base of the stick. We have found that there is no advantage to this method. The only effect it has is to shorten the effective length of the stick, so the measurements take longer. This is not a good way to do it even on land. At sea, this approach is entirely impractical.

Strictly speaking, the heading of the boat can change during your measurement, but each time you are actually marking the location of the shadow tip to get its direction, the heading must be the same. You may want to alter course to align the boat with or against the seas when marking the shadow-tip positions. Or, it could be that you have a large plate or board available. If so, you could mark shadow-tip positions on it by orienting it each time, without worrying about your boat heading. Figure 6-12 shows one way to do this, using a telltale and the apparent wind.

Without such a convenient shadow surface, orient the boat on a course you can hold or repeat, then mark the position of a shadow tip when the boat is not heeled over. After the shadow tip moves enough for a new position to be clearly seen, mark a second point, then

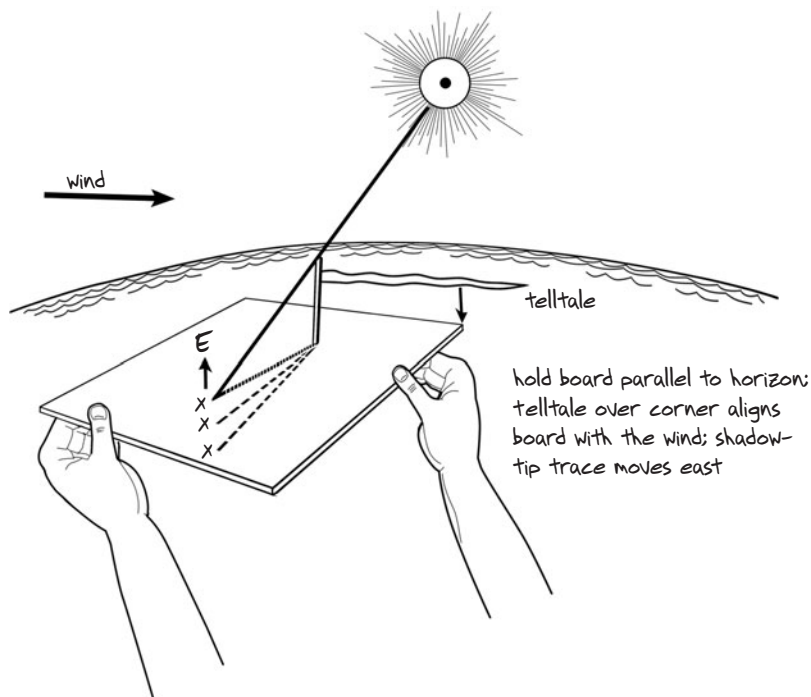

Figure 6-12. Handheld shadow board for finding east. Use the wind or swell direction to orient the board before marking the shadow-tip location. It is best to get several marks before drawing the line to average out alignment errors.

repeat this once or twice more. These marks should form a line, and this line points from west to east.

If you use the deck or cabin top, you can rig a stick perpendicular to the deck and check that the boat is upright by watching the stick relative to the horizon. In a life raft, you have little choice but to hold the stick upright and judge the shadow-tip motion as best you can.

The amount of time it takes to accurately determine the shadow-tip direction depends on the sea conditions and the length of the stick. The longer the stick, the faster the shadow tip moves. Using a 3-foot stick on land, you can easily find east this way in 10 minutes. Bouncing around at sea, it takes longer, sometimes as much as an hour or more. And sometimes the sea is just too rough to use this method at all.

You can rely on the shadow-tip method to be accurate to within 10° or so (at least in principle, if your heading remains constant) for about 2 to 3 hours either side of LAN. This is true regardless of your location or the date. The shadow-tip method works best for about one week on either side of each equinox. At these times, it works exactly all day long, everywhere in the world. But away from the equinoxes—which is most of the time—this method is not reliable in the early morning and late afternoon. In some conditions, it still works fairly well away from midday, but at other times the errors could be as large as 30° or so.

Table 6-2 lists shadow-tip errors for various latitudes, declinations, and times; you can use these values to practice the method.

TABLE 6-2. SHADOW-TIP ERRORS*

HOURS FROM LAN	SAME-NAME DECLINATION					CONTRARY-NAME DECLINATION					
	23.4	18	12	6	0	6	12	18	23.4		
0–1	3	2	2	1	0	1	2	2	3	<i>Latitude</i> 0°	
0–2	10	7	5	2	0	2	5	7	10		
2–3	15	11	7	4	0	4	7	11	15		
3–4	19	15	10	5	0	5	10	15	19		
4–5	22	17	11	6	0	6	11	17	22		
5–6	23	18	12	6	0	6	12	18	23		
0–1	3	2	2	1	0	1	2	3	4	<i>Latitude</i> 20°	
0–2	9	7	5	2	0	3	5	9	12		
2–3	14	11	7	4	0	4	8	13	18		
3–4	19	15	10	5	0	5	11	17	22		
4–5	22	17	12	6	0	6	12	19	25		
5–6	24	19	13	6	0	6	13	—	—		

(continued)

TABLE 6-2. SHADOW-TIP ERRORS* (continued)

HOURS FROM LAN	SAME-NAME DECLINATION					CONTRARY-NAME DECLINATION				
	23.4	18	12	6	0	6	12	18	23.4	
0-1	3	2	2	1	0	1	2	4	5	Latitude 30°
0-2	9	7	5	3	0	3	6	10	14	
2-3	14	11	8	4	0	4	10	15	21	
3-4	19	15	10	5	0	6	12	19	25	
4-5	23	18	12	6	0	7	14	21	27	
5-6	26	20	14	7	0	—	—	—	—	
6-7	27	21	—	—	—	—	—	—	—	
0-1	3	3	2	1	0	1	3	4	7	Latitude 40°
0-2	9	7	5	3	0	3	7	12	18	
2-3	15	12	9	5	0	5	11	18	26	
3-4	20	16	11	6	0	7	14	22	30	
4-5	25	20	14	7	0	8	16	24	—	
5-6	28	22	15	8	0	8	—	—	—	
6-7	31	24	16	—	—	—	—	—	—	
0-1	3	3	2	1	0	1	3	6	11	Latitude 50°
0-2	10	8	6	3	0	4	10	7	27	
2-3	16	13	10	5	0	6	14	24	35	
3-4	22	18	13	7	0	8	17	28	38	
4-5	28	22	16	8	0	9	19	29	—	
5-6	32	26	18	9	0	—	—	—	—	
6-7	36	28	19	—	0	—	—	—	—	
0-1	4	3	2	1	0	2	5	11	25	Latitude 60°
0-2	11	9	7	4	0	6	14	28	48	
2-3	18	15	11	6	0	9	20	36	53	
3-4	25	21	16	9	0	11	24	38	—	
4-5	32	26	19	10	0	12	25	—	—	
5-6	38	31	22	12	0	—	—	—	—	
6-7	44	35	24	12	—	—	—	—	—	
		81	40	32	59	32	40	81		
		days	days	days	days	days	days	days		

*Shadow tips move these number of degrees away from due east. The error depends on latitude, declination, and time relative to LAN, but the error is always toward the sunrise side of east in the morning and toward the other side of east in the afternoon. Recall that when the declination is north, the sunrise is north of east. At latitude 30° N, for example, with the sun's declination at N 18°, shadow tips move 11° north of east in the morning from 2 to 3 hours before LAN and 7° south of east from 1 to 2 hours after LAN. The number of days that the sun's declination lies with the tabulated ranges are shown at the bottom of the table—i.e., the declination is between 12° and 18° for forty days.

THE TROPICS RULE FOR THE SUN

Steering by the sun within the tropics has distinct advantages and disadvantages. One disadvantage is that you can't use the solar time method. An advantage is that you can use the Tropics Rule to find the direction of sunrise and sunset if you know the sun's declination. Also, within the tropics the sun rises and sets at a steep angle, so horizon bearings are useful for a large part of the day.

The Tropics Rule section in Chapter 5 describes finding the bearings of stars when they are rising or setting in the tropics, latitudes $23^{\circ} 26' N$ to $23^{\circ} 26' S$. Within the tropics, you can also apply this rule to the sun. The rule may even be more useful for the sun because you can see the sun low on the horizon more often than you can see stars there.

To use the rule, you need to know the sun's declination, which changes slowly from $N 23^{\circ} 26'$ on June 21 to $S 23^{\circ} 26'$ on December 21. The sun's declination changes at most about 0.5° per day, but the typical daily change is less than half that much. Therefore, if all you knew was the sun's declination a week ago, you wouldn't be far off using that. The Latitude from the Sun at LAN section in Chapter 11 explains how to figure out the sun's declination from the date. (If you remember the limits as 23.4° , it is easier to remember and very close to right. Also it is an easy way to remember where the tropics are.)

The Tropics Rule for the sun is simple: From anywhere within the tropics, the sun's amplitude equals the sun's declination. On July 23, for example, the declination of the sun is $N 20^{\circ}$. Viewed from anywhere in the tropics, on July 23 the sun rises 20° north of east and sets 20° north of west.

When the sun passes overhead, your latitude equals the declination of the sun. In this case, you can apply the rule without figuring out the declination. You have, in effect, measured the declination by sailing under the sun.

SUN CROSSING DUE EAST OR WEST

For half the year, the sun is never due east or west. Viewed from northern latitudes in the winter, the sun rises south of east and stays south throughout the day, setting to the south of west. But during the summer half of the year, the sun rises north of east and crosses over due east on its way to the southern sky, where it spends the middle part of the day. In the afternoons, it crosses back over due west on its way toward setting north of due west.

There is a trick for finding the time of day when the summer sun bears due east or west from northern latitudes; it also applies equally well in the winter when viewing the sun from southern latitudes. You need a watch and sunrise-sunset tables, and you need to know your latitude to within 1° or 2° .

The trick in northern latitudes is to look up the time of sunrise for your latitude and date, and then look up the sunrise time for your date but for a latitude that is 90° south of you. The difference in these two times is the length of time it takes the sun to reach due east after rising. In southern latitudes, use the time for a latitude 90° north of you.

For example, at latitude $40^{\circ} N$ on June 10, the sunrise time according to the tables is 0431. At latitude $50^{\circ} S$ (which is 90° south of $40^{\circ} N$), the sunrise time is 0754. The difference is 3 hours

and 23 minutes. In this case, the sun will bear due east 3 hours and 23 minutes after it rises. Likewise, the sun will bear due west 3 hours and 23 minutes before it sets. Note that you do not need to know your latitude accurately to use this procedure, and you do not need to know the correct time, since the times are relative.

This method is rather specialized, but it may come in handy someday. The *U.S. Tide Tables* list sunrise times for latitudes of 60° S to 76° N. This means that this trick works in the north only when you are above latitude 30° N, or in the south only below latitude 14° S. But since sunrise times are symmetrical in date and latitude, you can extend this in northern latitudes down to 14° N. Just assume you are at a southern latitude, and use the date that is six months later than your present date.

SUN COMPASSES

With a Watch

If the noon sun is less than halfway up the sky and you have a watch, the solar time method described above is nearly as good as a compass. Using this method, you know the sun's direction all day, and from the sun's direction you can find any direction you choose. To steer a boat this way, it helps to make a portable compass card, as explained in the *Steering without a Compass* section in Chapter 3. With the makeshift compass card oriented toward the sun, you can read your heading directly from the card. To simplify things even more, you can mark the compass card with the times the sun is due at different bearings. This saves doing the arithmetic at each course check, since once you've labeled due south with the watch time you found for LAN, all other directions follow at 15° per hour.

If you have a watch but the noon sun is too high to use the solar time method, you can still label your compass card with the sun's direction at various times of the day. One label would be due south at LAN, and a second would be the direction of sunrise at the time of sunrise. At 1 to 2 hours after sunrise, you could find and label the sun's direction by pointing the sun back to the horizon (see the *Morning Sun and Afternoon Sun* section above). Next you could use the shadow-tip method to get a sun direction at about 2 hours before LAN. This covers the day; you can estimate the intermediate times. Now you have a sun compass even though you can't use the solar time method itself.

Without a Watch

You can also make a sun compass without a watch. With this compass, you keep track of the sun's direction from its height. To do this, you need some improvised way to measure the relative height of the sun above the horizon. You don't have to know the actual height of the sun in degrees, you just need to know when the sun has reached the height you've marked, regardless of what it is. You can use a kamal or a shadow-pin compass (see Figure 6-13); if nothing else is available, you can even use your outstretched hands at arm's length. For more accurate ways of making makeshift sun height measurements, see the end of the *Latitude of the Sun from LAN* section in Chapter 11.

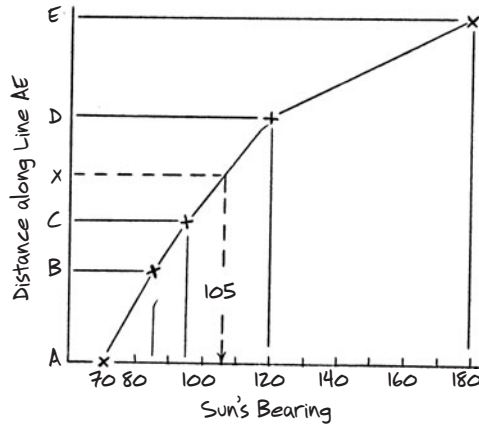
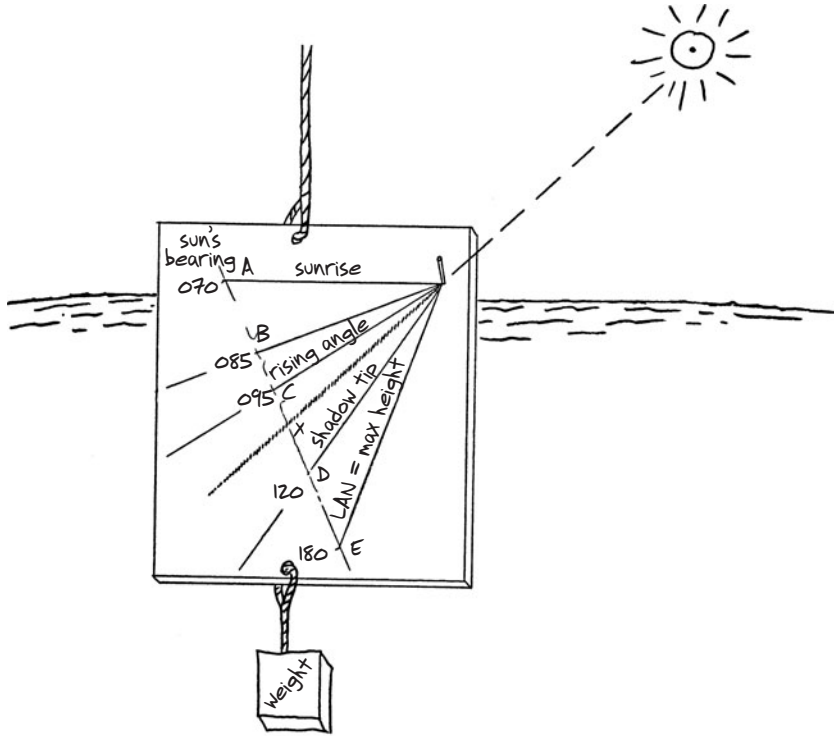

Figure 6-13. A shadow-pin sun compass. The weight holds the board in a vertical position while you orient it by hand until you can mark the pin's shadow on the board. Once you have determined the sun's bearing, mark and label the height, then use these marks in the afternoon, or the next day to find bearings. You can find bearings at intermediate heights from a graph of the known points, using distance along any line AE as shown in the top illustration. This example is for latitude 35° with a sun declination of 15°. This device works for bearings, but it is not accurate enough to use for finding latitude from the sun's height (see Chapter 11).

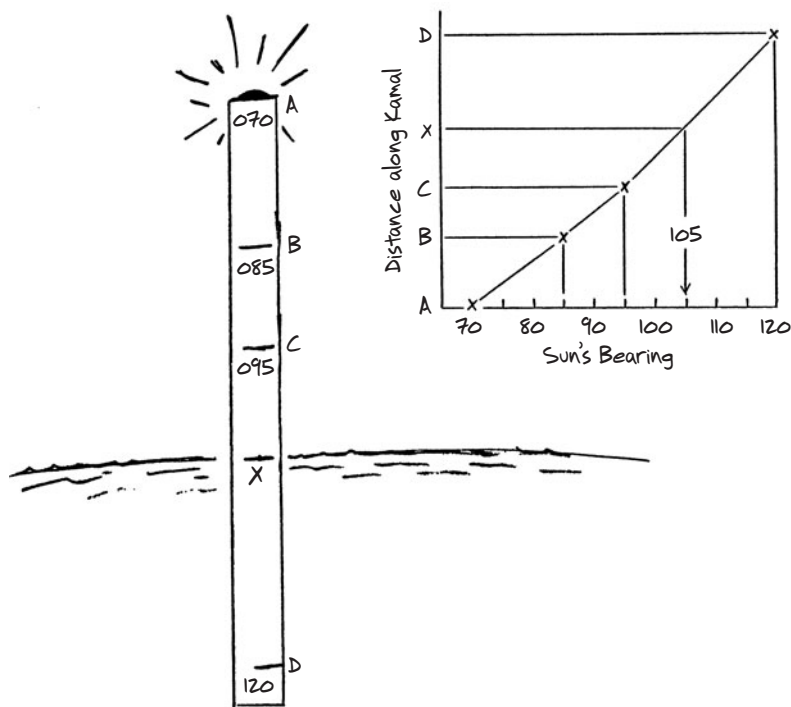

Figure 6-14. A kamal sun compass. You can use a stick, or kamal sun compass, to find the bearing of the sun when it is at a height X above the horizon. Choose a stick (a sail batten) that is just over 3 feet long, and hold it 2 feet from your eye. Use the same numerical example and procedures as in Figure 6-13.

One convenient tool for keeping track of the sun's height in this application is a rod or flat stick about 3 feet long; two sail battens tied together will work well. To mark the sun's height, hold the stick at arm's length. Adjust the stick perpendicular to the horizon, with the sun just covered by the top of the stick when your thumb is aligned with the horizon. Then put a mark where your thumb is (see Figure 6-14). You now have the height of the sun in terms of a length on the stick. If you make the stick (or board, or book) into a large kamal (see page 83) by attaching a bridle and string to hold in your teeth, the results will be more reproducible. If you don't have string and are having trouble reproducing the measurements, try pressing your head against your shoulder as you make the sight. This may keep the eye-to-stick distance more constant.

The trick is to mark the sun's height and its direction just after finding its direction from the rising angle method. Do this two or three times each hour or so after sunrise. Then start a shadow-tip measurement, which might take another hour or so. When you find east, and from this the sun's direction, mark the sun's height and bearing on your stick again. Now you have a stick that shows how the sun's direction changes with its height—and you didn't need a watch. And now you know that when the sun falls to these heights in the afternoon, its bearing to the west will be the same as it was to the east in the morning. With several marks on the stick labeled with sun directions, you can estimate the intermediate directions.

Remember, you will be marking heights when the sun is bright, so you must be careful. If possible, attach a makeshift sunshade to the side or top of the stick. Or using a wide stick or

plate, cover the sun completely, and gradually let it slip in your grip until the sun's glare just appears over the top. Regardless of how you do it, though, you must be careful about looking directly at the sun.

In favorable conditions, you may have a nighttime swell pattern or steady wind that lasts all morning. You can get the direction of the swells or wind from the stars and sunrise, and then can use this reference to calibrate a sun compass from sunrise until noon. If the swells or wind change, you still have your sun compass to steer by.

When the sun is high, you won't be able to use a stick compass (as in the tropics near midday), but you will still find it helpful in the mornings and afternoons. When the sun is high, you will need a form of pinhole quadrant or something similar (see the Latitude of Sun at LAN section in Chapter 11).

It is important to remember that even the crudest measurement of the sun's height is more accurate than a guess. The height of the sun is deceiving near the horizon. When low in the sky, the sun always looks much bigger and higher than it is. The apparent size of the setting sun compared with the midday sun is only one example of the optical illusion—technically called the moon illusion—that leads to overestimating angular heights near the horizon. With a sextant, you can measure the width of the sun to show that it is indeed the same throughout the day. The apparent change in size is only an illusion. The same illusion applies to the moon's size and height near the horizon, which gives rise to the name of the effect.

If you must make a long voyage—in time or distance—you must occasionally remake your sun compass. As a rough rule of thumb, check it every 200 miles or so, or at least once a week even when moving very little. Besides, it probably won't be accurate the first time you make it and will take some practice and repeated measurements before you can be confident that it is doing the job for you. Accurate navigation without instruments is a full-time job—there is no way around it.

Using a Star Finder

If you have a 2102-D Star Finder available (see pages 245–246), don't forget its great value for sun steering—you don't need an almanac to set it up. Just figure the sun's bearing at sunrise, and then plot the sun's position anywhere on the Star Finder that will reproduce this bearing at 0° height using the appropriate latitude template. It won't matter that the sun's celestial longitude that you marked is wrong; its latitude (declination) will be right if the sunrise is right, and that is all you need. With the sun plotted to match the sunrise, you have a sun compass that will work all day.

If you have a watch, note the time of sunrise and label the rim scale with the time—each 15° rotation of the blue template corresponds to a 1-hour interval. Then just rotate the blue template throughout the day and read off the sun's bearings. This timed sun compass will work regardless of the noon height of the sun.

Without a watch, you can still read the sun's bearing as a function of its height. Then label a shadow-pin sun compass directly or derive the calibration curve from a stick compass.

See *The Star Finder Book: A Complete Guide to the Many Uses of the 2102-D Star Finder* (see the Stars and Star Identification section of the bibliography) for an extended treatment of this powerful aid to predicting and understanding celestial body motions.

Leaving Land without a Compass

So far we have discussed making a solar compass of some sort while underway. If you happen to be isolated some place on land, without a compass but with a voyage to safety in front of you, then you can make a solar compass to take with you rather easily. Use any of the methods described earlier to find the true north-south meridian line. Then throughout the day, mark the height of the sun on some kamal-type device or shadow board as a function of its height above the horizon. There is no reason to believe this was not done by early Viking navigators and their tropical Pacific counterparts on their long ocean passages—in fact it would be difficult to imagine that an intelligent navigator would not do this as a matter of course. In both cultures, there are elaborate shrines and monuments built on coastal sites that could have been used for such observations.

The same can be done for bright stars. Such instruments (for sun or stars) will work for relatively long periods of time if the voyage will not entail a large latitude change. Approximate corrections for duration and latitude change could also be made with some reasoning, based on what the declination of the sun was doing during the extent of the voyage.

WHEN THE SUN IS OBSCURED

When the sun is obscured by clouds or fogbanks, or when the sun is just below the horizon, there is still a chance of finding an accurate direction to the sun in special circumstances. Several techniques are outlined at the beginning of Chapter 8. The last section of Chapter 8, Finding the Sun as a Viking Would, discusses finding the sun using polarized sunglasses as a modern substitute for a sunstone—since we assume you probably will not have a piece of Iceland spar (calcite crystal) on board.

Chapter 7

STEERING BY OTHER THINGS IN THE SKY

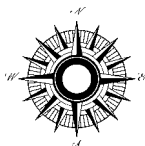

The heights and bearings of all celestial bodies are predictable from laws of nature. The only uncertainty comes from our ability to learn, interpret, and apply the laws. The moon and planets form a separate group in emergency navigation because their own orbital circulations complicate their apparent motions through the sky. Their value to emergency steering lies more in their prominence than in their predictability. They are bright and therefore serve as valuable references—once you have established how they move as seen from where you happen to be. On overcast nights, they may be the only source of directions.

If you happen to sail under the moon or planets, any of the overhead star methods described in Chapter 5 can be applied. And if a planet happens to fit into a star path for your route, so much the better for the length of time you can use it. Other things in the sky like clouds, birds, and planes might also aid your navigation in special circumstances, but their value to orientation on the high seas must be carefully qualified. Once you do get close to your destination, clouds might get you closer, and birds could save the day. They have done so many times before for wayworn mariners.

THE MOON

The moon is the most evasive of all celestial bodies. It moves westward with the stars each day because of the earth's rotation, but it also slips eastward relative to stars because of its own orbital motion around the earth. Since the moon circles the earth once a month, it progresses through the stars at a rate of 360° per (roughly) thirty days, or about 12° per day. If the moon is next to the star *Aldebaran* on one night, on the next night it will be about 12° to the east of *Aldebaran* (which is about half an outstretched hand's width at arm's length; see Figure 7-1).

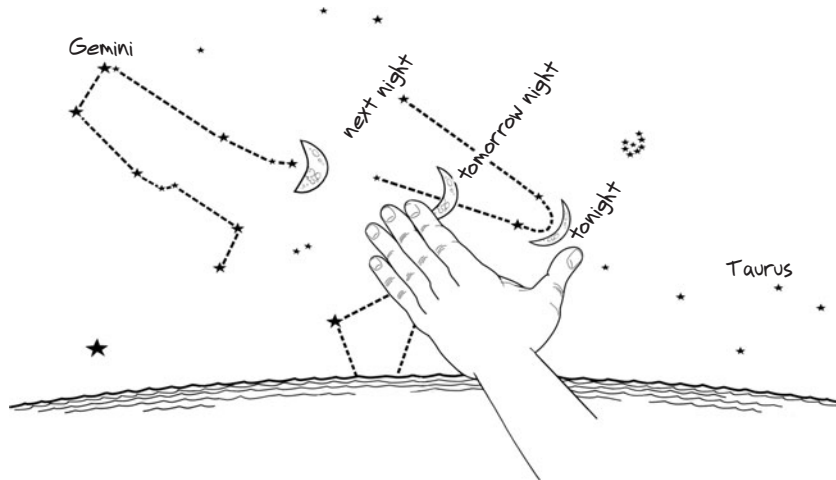

Figure 7-1. The moon's eastward motion through the stars. The moon moves about 12° eastward through the zodiac each successive night. Here the moon is moving from Taurus into Gemini.

The sun also slips eastward through the stars each day due to the earth's orbital motion around the sun, but this motion of 360° per 365 days represents only about 1° per day. For our present purposes, we can overlook this detail and assume that the moon also moves relative to the sun at 12° per day. Nevertheless, the moon's motion through the sky is complicated. We can't simply predict its bearing from day to day as we can with the sun and stars. But we don't need to give up on the moon as a guide to steering. And we shouldn't—in overcast skies it may be all we've got.

Solar Time and the Full Moon

If you have a watch and know solar time, the moon can be helpful on special occasions. When the moon is full, it behaves just like the sun, with solar noon (LAN) changed to solar midnight, meaning LAN plus 12 hours. A full moon crosses your meridian at solar midnight. For example, if you know the sun lies due south at 1330 according to your watch, then a full moon that night will lie due south at 0130.

Furthermore, when the moon is full, you can figure its direction at other times of night using the solar time method described in Chapter 6. But the same restriction applies: the height of the moon at midnight must be less than halfway up the sky. When the midnight moon is low enough, you can use the solar time method for the moon all night long. In the previous example, at 0430, 3 hours past solar midnight, the bearings of the moon would be:

$$180 + (3 \times 15^\circ) = 225^\circ$$

When the midnight moon is just somewhat higher than 45° , you should not use this method more than an hour or so either side of midnight. When the midnight moon is notably higher than halfway up the sky, you can't use the solar time method at all. If the full moon is bright

enough to cast shadows, you can test its height by the length of a shadow, as you do with the sun. Otherwise, just estimate its height using any square; you don't even need a clear horizon. Hold the square roughly parallel to the water and sight along the diagonal to see where the moon is relative to the 45° angle made by the diagonal.

The solar time method applied to the moon is less accurate than it is for the sun, since you must know the precise phase of the moon to use it. The moon is exactly full on only one night of the month, and it takes practice to spot this day by just looking at the moon. On a clear night, you can usually guess it right to within one day—unfortunately, though, you need the moon the most when the sky is not clear. A one-day uncertainty in phase creates a bearing uncertainty of 12° , since the moon moves 12° per day relative to the sun. But that's not the end of the problem. The precise time of full moon technically occurs for only a moment, and that time of day is not the same each month. In short, this method includes a basic uncertainty of $\pm 12^\circ$ at best, even if you did judge the correct day of the full moon.

Considering both these uncertainties (which are not independent), generally speaking you must assume that moon directions, no matter how or when you figure them, are uncertain by about 20° . The uncertainty is large, but it is much better than nothing at all. With a calendar or tables that tell you the precise phase, the uncertainty drops back to about 12° .

When the midnight moon height is below 45° , you can also use the solar time method two or three days before and after the full moon without much loss in accuracy. When the moon is exactly full, the moon and sun are on opposite sides of the earth, which is why they pass us exactly 12 hours apart and why, to a good approximation, the full moon rises when the sun sets and the full moon sets when the sun rises. Each day following full moon, the moon moves 12° to the east of the sun. Since both the sun and moon move to the west, if the moon is now farther east of the sun, the time between the sun's passage and the moon's passage will be longer. The meridian passage of the moon is later than midnight on days following the full moon; at midnight, the moon has not yet reached the meridian. If you conclude from looking at the moon (or from other sources) that it is one day after full moon, then at midnight the moon would be 12° to the east of your meridian. Two days after full moon, the moon would be 24° east at midnight.

The same reasoning shows that on days before the full moon, the time difference between sun and moon is less than 12 hours, so meridian passage of the moon occurs before midnight. If you conclude that it is two days before full moon, you can expect the bearing of the moon at midnight to be 24° to the west of your meridian—it passed you earlier than midnight.

With the inherent uncertainties involved, you do not lose much accuracy by considering the 12° daily motion of the moon to be about the same as the 15° hourly rotation of the earth. And with this approximation, the last example can be expanded to conclude that since the moon is $2 \times 12^\circ$ farther along its orbit, it is about $2 \times 15^\circ$, or 2 hours, ahead of schedule on the meridian. So you can expect the moon two days before full moon to be on the meridian 2 hours before midnight, at 2200 solar time.

With this explanation behind us, we can restate the moon's behavior in a way that makes it easier to remember: The full moon is on the meridian at solar midnight. Therefore, one day before full moon, the moon is on the meridian 1 hour before midnight; one day after full moon, it is there 1 hour after midnight. Two days before, 2 hours before; two days after, 2 hours after (see Figure 7-2).

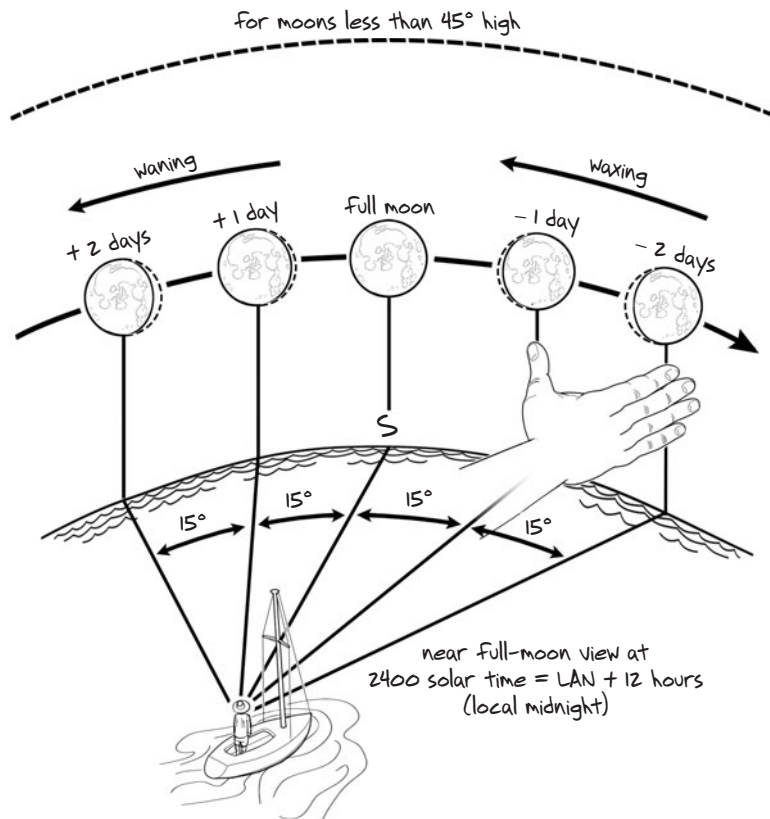

Figure 7-2. Near full-moon view at local midnight. The full moon crosses the meridian at 2400 solar time. One day before full moon, the moon crosses the meridian 1 hour before 2400 (at 2300) and one day after full moon, the moon crosses 1 hour after 2400 (at 0100). Likewise, two days before means 2 hours before; two days after means 2 hours after. For moons less than 45° high, you can use this reference time on the meridian for moon directions several hours either side of meridian passage.

When you conclude from looking at the moon that it is one or two days away from full moon, you must then decide whether it is before or after full moon. In other words, is the moon waxing or waning? The lighted side of the moon always faces the sun (see Figure 7-3), and the moon's daily motion relative to the sun is to the east. In the Northern Hemisphere, if the right side of the moon is lit, the moon is waxing—getting fuller each night. If the left side is lit, it is waning. In the Southern Hemisphere, the opposite is true. The key is to remember that the moon moves to the east. If it is moving closer to the sun (leading it across the sky), it is getting smaller; if moving away from the sun (following it across the sky), it is getting bigger. Practice making this call several times with a daylight moon when it is easier to reason through because both sun and moon are visible. Then it should be easy to do for a nighttime moon.

Another trick in the Northern Hemisphere is to draw a vertical line segment across the tips of the horns so as to form either a letter b or a letter d. A *b* means *bigger* and the moon is waxing; a *d* means *declining* and the moon is waning. In the Southern Hemisphere, it is reversed, so you might think of the French saying *La lune est une menteuse* (the moon is a liar), which

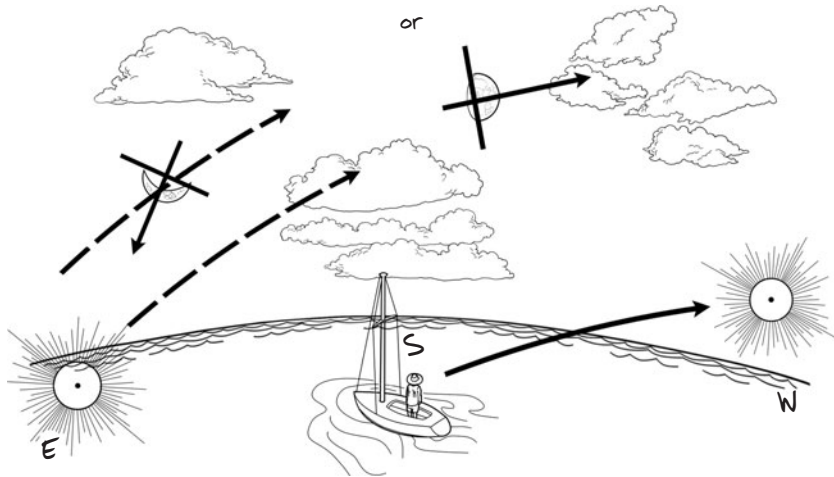

Figure 7-3. The lighted side of the moon points in the direction of the sun. At night, the arrows shown at the moons point in the direction of the zodiac band of constellations (the path of the moon through the stars). In the Northern Hemisphere—or more specifically, when your latitude is north of the moon’s declination—the moon is waxing when its right side is lit, and waning when its left side is lit. Reverse the rule when you are south of the moon.

French mariners use in the Northern Hemisphere with the words *Croître* (increasing—waxing) and *Décroître* (decreasing—waning) depending on the orientation of the crescent. The moon is “lying” because it looks like a C when it is waning and a D when it is waxing.

Other Phases of the Moon

You can also use a half-moon to find directions, as shown in Figures 7-4 and 7-5. A waning half-moon crosses the meridian at 0600 solar time (6 hours before LAN), and a waxing half-moon crosses the meridian at 1800 solar time (6 hours after LAN).

Again, it must be the exact day of the half-moon. And as with the full moon, this is not always easy to determine exactly by just looking at the moon, but neither is it more difficult. Some individuals, like myself, may even find it easier to judge the phase of a near half-moon than a near full moon. With practice, you can judge it to within a day. And as with the full moon, the same procedures and basic uncertainties apply. If you decide it is two days before half-moon, expect the moon on the meridian 2 hours before six o’clock solar time. The rule is the same: Before half-moon, before six o’clock; after half-moon, after six o’clock. Whether the moon is on the meridian in the morning or evening depends on whether it is waxing or waning—on which side is lit. At least for practice, the half-moon is more convenient for directions than the full moon since the times you can use it are more convenient.

Most tide tables include the phase of the moon, and some calendars do also. On calendars, the waxing half-moon is at first quarter; a waning half-moon is at third quarter. If you happen to have a calendar or tide tables, you can remove the uncertainty of judging the phase.

If you happen to have current *U.S. Tide Tables*, accurate time, and approximate longitude, you can expand and simplify your use of the moon for steering considerably, since these tables

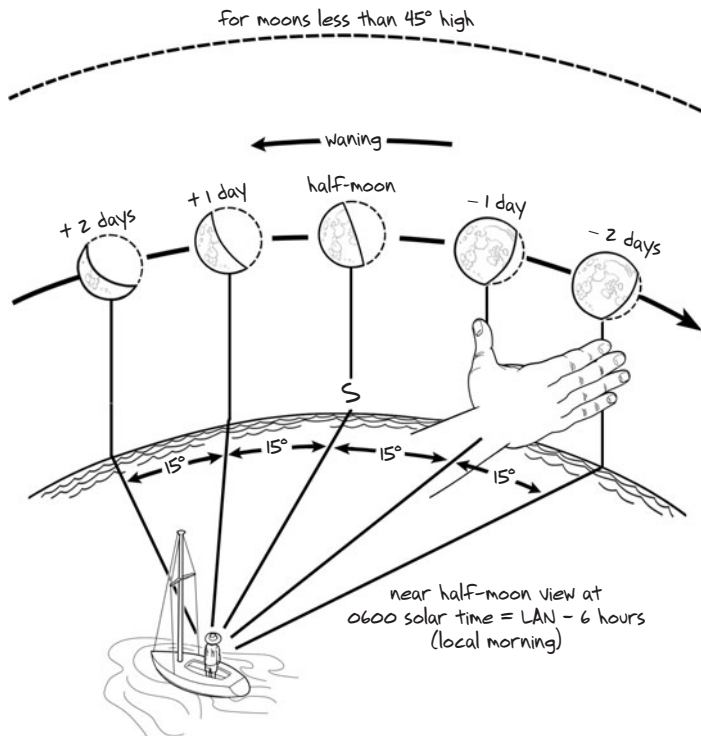

Figure 7-4. Local morning view of a waning half-moon. The waning half-moon crosses the meridian at 0600 solar time. One day before half-moon, the moon crosses the meridian 1 hour before 0600 (at 0500) and one day after half-moon, the moon crosses 1 hour after 0600 (at 0700). Likewise, two days before means 2 hours before; two days after means 2 hours after. For moons less than 45° high, you can use this reference time on the meridian for moon directions several hours either side of meridian passage.

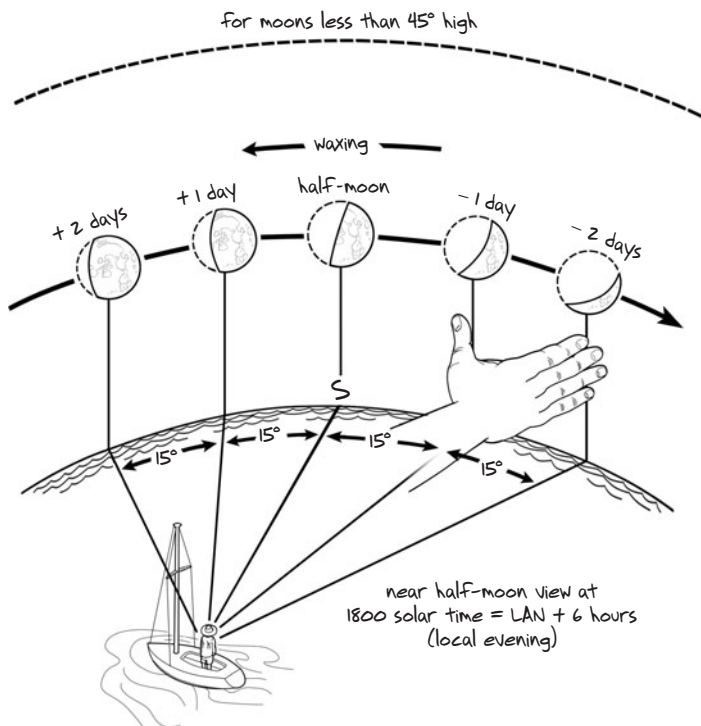

Figure 7-5. Local evening view of a waxing half-moon. The waxing half-moon crosses the meridian at 1800 solar time. One day before half-moon, the moon crosses the meridian 1 hour before 1800 (at 1700) and one day after half-moon, the moon crosses 1 hour after 1800 (at 1900). Likewise, two days before means 2 hours before; two days after means 2 hours after. For moons less than 45° high, you can use this reference time on the meridian for moon directions several hours either side of meridian passage.

include moonrise-moonset tables. Assume the moon crosses the meridian halfway between the tabulated times of moonrise and moonset; this will be accurate to within about 1 hour. More important, you can figure this time for any day of the month (though of course the moon is of no value when it is in front of the sun or close to it). Note that the tables must be for the correct year as well as day to get moonrise and moonset times; expired tables work only for the sun. You must also make the longitude correction, as explained in the Local Apparent Noon section in Chapter 6 (and in the tables themselves), but you don't need accurate latitude. You can use an approximate latitude.

If you don't have correct time or don't know your position, you can still take advantage of these tables for moon steering by figuring the meridian passage time of the moon relative to LAN. Using the proper date and an approximate latitude, figure the time halfway between moonrise and moonset and halfway between sunrise and sunset. You then have the predicted times of meridian passage of the sun and the moon. If halfway between sunrise and sunset is 1210 and halfway between moonrise and moonset is 2030, you can expect the moon 8 hours and 20 minutes after the sun, regardless of its phase and without knowing it. Then when you measure the time of LAN, as explained in the Local Apparent Noon section, you get both sun and moon directions from it. The sun will be on the meridian at LAN; the moon will be there 8 hours and 20 minutes later—and you have figured this without knowing your latitude or longitude. Then, if applicable, use solar time for sun and moon directions at other times of day.

In some circumstances, you may be able to figure the time of moon meridian passage relative to the time of sunrise using these tables, as explained at the end of the Solar Time Method section in Chapter 6. This will depend on the phase of the moon and your knowledge of your latitude.

The behavior of the moon is summarized in Table 7-1.

If you are satisfied with just a rough indication of due south, you can turn to the moon again and look to the orientation of the line drawn across the tips of its horns or terminator as shown in Figure 7-6. This line will point roughly toward the south when you are north of the moon, or north when south of the moon, for quite a few hours of several days either side of the half-moon. It is definitely only an approximation and certain times of the month and year work better than others. We do not have the conditions of accuracy worked out for this method yet, but we will post results as we learn them at starpath.com/emergencynavbook. It is an interesting idea, and worth thinking about as you watch the moon cross the sky.

TABLE 7-1. SUMMARY OF MOON BEHAVIOR

PHASE	AGE (DAYS)	RISES	MERIDIAN PASSAGE	SETS
<i>waxing new moon</i>	0–3	<i>just after sunrise</i>	<i>midday</i>	<i>just after sunset</i>
<i>waxing half-moon</i>	7–8	<i>midday</i>	<i>about sunset</i>	<i>midnight</i>
<i>full moon</i>	14–15	<i>about sunset</i>	<i>midnight</i>	<i>about sunrise</i>
<i>waning half-moon</i>	22–23	<i>midnight</i>	<i>about sunrise</i>	<i>midday</i>
<i>waning new moon</i>	26–29	<i>just before sunrise</i>	<i>midday</i>	<i>just before sunset</i>

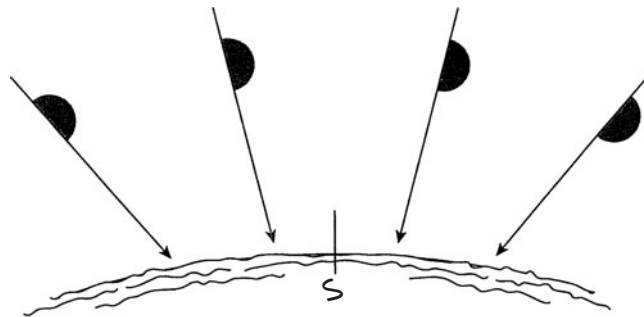

Figure 7-6. Using the moon's horns as an indicator of south and north. You can use the moon's horns, or terminators, to find south when north of the moon, or north when south of the moon. It is a rough indicator of the direction to the southern horizon for much of the time the moon is visible.

THE PLANETS

There are five planets visible to the naked eye: Mercury, Mars, Saturn, Jupiter, and Venus. The first three are not particularly useful for emergency steering, or celestial navigation in general. When visible, they appear similar to bright stars. Mars is the only one with color, being distinctly reddish. Mercury is the closest planet to the sun and is only rarely visible, either just before sunrise or just after sunset. Because of its nearness to the sun, it changes from a morning star to an evening star about every two months. The main effect these three planets have on celestial navigation is the confusion they cause in star identification (see Figure 7-7). They, like all the planets and the moon, wander through the band of zodiac constellations in a way that is difficult to predict.

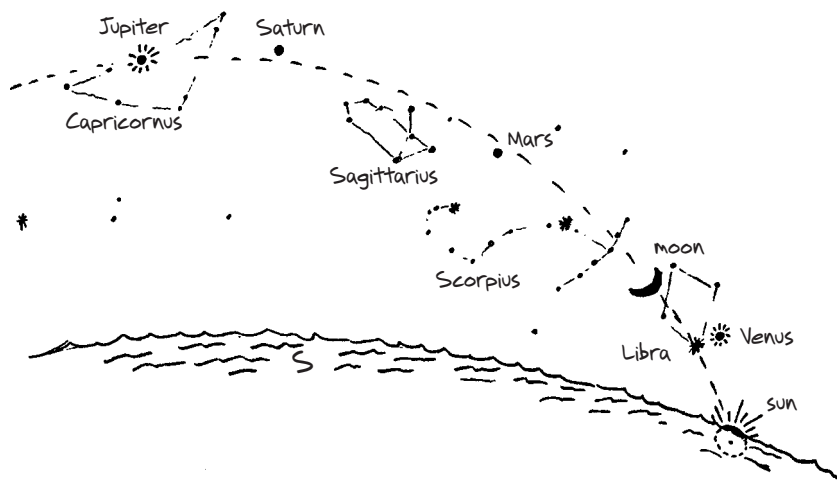

Figure 7-7. Planet identification. Planets (1) do not twinkle as stars do, (2) appear as tiny disks through steadied 10-power binoculars, (3) change positions (and brightness) among the stars, (4) are always found in-line (a giant arc) with the sun and moon, and (5) are always within some zodiac constellation. Venus and Jupiter are always much brighter than the stars. A bright object seen for brief periods at sunrise or sunset very near the sun is likely to be the planet Mercury.

Steering by Jupiter and Venus

Jupiter and Venus, on the other hand, can be extremely valuable steering references because of their exceptional brightness. Though they also look the same as stars to the naked eye, Venus and Jupiter are always much brighter than any stars around them. When they are in the sky at sunset, they will be the first “stars” you see. On hazy nights, they may be all that you see. Venus is especially brilliant, sometimes shining like a spotlight in the sky. As Venus rises through the low layers of the atmosphere, its brightness increases very rapidly, which can give the impression of a vessel with one (illegal!) light sailing rapidly toward you.

Although Venus and Jupiter always remain brighter than any star, the brightness of each planet varies as it moves through the stars. And the planets move through the stars at different rates, and in different directions, though they all follow roughly the same eastward path through the twelve zodiac constellations, which mark the sun’s monthly position among the stars.

The orbit of Venus (like Mercury’s) is inside our own, closer to the sun, so its apparent motion throughout the year is back and forth like Mercury’s, from one side of the sun to the other (see Figure 7-8). Venus spends about seven months as a morning star, then takes about four months to sneak behind the sun and reappear as an evening star. It remains an evening star for another seven months, and then rushes back behind the sun in about one month to start the cycle again as a morning star. The cycle is regular, but without an almanac it is difficult to predict where the planet will be on some future date.

Jupiter, on the other hand, is a distant planet that creeps eastward through the zodiac constellations at a rate of about one constellation per year. At the time of this writing (2008), Jupiter

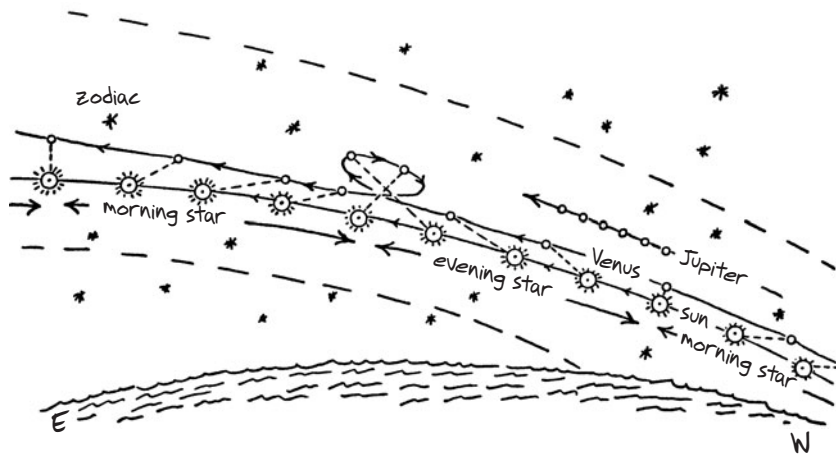

Figure 7-8. The apparent eastward motions of Venus and Jupiter through the stars. To picture the times you see Venus, imagine each sun-Venus pair shown to be its position on successive weeks, and then imagine this sky rotating westward each day, bringing sun, stars, and Venus up over the eastern horizon and down over the western horizon. When Venus is west of the sun, it rises before the sun as a morning star that you see until the sky is too bright to see stars. When east of the sun, it follows the sun over the western horizon, and you see it as an evening star, setting not long after the sun. Jupiter moves through the stars more slowly, progressing eastward through the zodiac at about one constellation per year.

is just leaving Scorpius on its way to Sagittarius. The season of Jupiter is the season of its neighboring stars.

Venus moves through the stars much faster than Jupiter, but the size of its orbit never lets it get farther than about 45° from the sun. When the sun goes down, Venus can't be more than about halfway up the western sky, although for most observations, Venus is closer to the sun than that. For the half-year or so that Venus is an evening star, it follows the sun over the western horizon, never setting later than 3 or 4 hours after the sun. When Venus is a morning star, it rises at most 3 or 4 hours before the sun.

When they are near the horizon, Venus and Jupiter always give a rough estimate of east or west, in the same sense that the sun does. Because the sun and planets follow the same path through the stars, the planets always rise and set someplace where the sun does (on some date) at that latitude. For example, in mid-June 2007, Jupiter happened to be at declination S $21^\circ 47'$ (just northeast of the bright red star *Antares*), where the sun is in early December. So in June 2007, Jupiter rose and set where the sun did in early December—or in early January, since the sun is at any specific declination twice a year. It is not practical to reason through this in some arbitrary circumstance, but you might remember that the amplitude of any planet is always less than the maximum amplitude of the sun at your latitude.

For more specific directions from Venus or Jupiter, you need to identify their bearings relative to the stars. Because of their brightness, they are excellent guides, and it is well worth the trouble. Venus or Jupiter is especially valuable if its declination happens to be near 0° at the time of your voyage. It then behaves like the star *Mintaka* of Orion's belt, rising due east and setting due west—the Tropics Rule section in Chapter 5 and the Latitude from *Polaris* section in Chapter 11 explain ways to estimate the declination of a planet viewed from a known latitude. Unfortunately, Jupiter is near the equator for only a month or two every six years, but Venus is near there for much longer periods each year.

In any event, it pays to note where these planets are and how they move when you have other stars for references. Then, if only these bright objects show through the haze, you have something to go by. You could, for example, use the North Star and a portable compass card to note the bearing of Jupiter at each hour throughout the night. Then if you happen to be sailing east or west at near-constant latitude, once you have checked often enough to get a good set of bearings, they will remain valid for a month or longer—since Jupiter moves so slowly, it behaves much like a fixed star. Venus, however, moves fast through the stars, so you should check its bearings every few days. If you change latitudes, you have to recheck any of the planets, just as you do the sun.

Venus and Jupiter or any bright planet—Mars can be very bright at times as well—are especially valuable if you have a 2102-D Star Finder, as mentioned in Everything but a Compass section in Chapter 14. With this common navigational aid and a watch, you can use the planets all night long for accurate bearings.

CLOUDS, BIRDS, AND PLANES

In this section, we distinguish between steering aids and signs of land. Clouds and birds (and, to some extent, planes) are often strong evidence of nearby land. And if we turn to follow them, they are certainly steering aids in a sense, but that application is best discussed in the Signs of

Land at Sea section in Chapter 13. Here we consider their value and limitations for orientation well away from land. When the task at hand is to maintain bearings, or to decide whether land is near, we should use all possible means, but it is equally important not to confuse the values of nature's various signs.

Clouds

Moving clouds often help with orientation. In the trade wind belts, for example, the small puffs of cumulus clouds that fly by with the nighttime trades provide a quick visual check of the true wind direction. These are low clouds moving with the surface winds, so they won't give you directions you don't already know from the wind. Nevertheless, they are convenient references. Generally speaking, low clouds of any type move in the direction of the surface winds.

We can refine this slightly. In northern latitudes, if you face the true surface wind direction (as opposed to the apparent wind direction, discussed in the Reading the Wind section in Chapter 4), you should notice that low clouds come slightly from the right. In other words, winds just above the surface are veered. The amount varies from some 10° to 30° , depending on several factors but mostly the sea state—the rougher the seas, the larger the veer. In southern latitudes, winds just above the surface are backed, so look for clouds coming slightly from the left.

High and middle-high clouds, however, are potentially more valuable than low clouds for orientation, since we can sometimes use them to gauge the direction of the winds aloft. We have now referred to three different winds: surface winds; veered and backed winds just above the surface that carry low clouds; and winds aloft, meaning winds up around 18,000 feet, in the upper half of the earth's atmosphere. These distinctions are important when it comes to orientation by the winds and clouds.

In the midlatitudes of either hemisphere (30° to 60°), the winds of the upper atmosphere move toward the east from the west, although not necessarily from due west. The band of winds aloft meanders around the globe in a serpentine path (see Figure 7-9), so the direction is just as

Figure 7-9. Winds aloft. Throughout the midlatitudes of both hemispheres, the prevailing winds above some 18,000 feet are from the west. These winds are the storm tracks or steering winds that pull surface weather systems around the globe. The large waves in these high winds slowly undulate and slide eastward, causing the steering winds at any one place to slowly change directions between northwest and southwest, though not in a manner that is predictable over more than a week or so. In contrast, within the tropics, elongated weather disturbances called easterly waves move westward on a fairly regular basis, temporarily altering the trade wind flow as they pass.

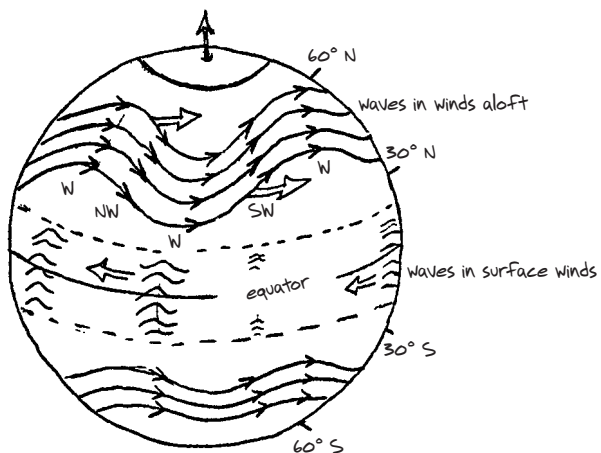

likely to be from the northwest or southwest. Only very rarely does this band distort enough to bring these winds from east of the meridian.

Do not confuse the winds aloft with the surface winds or winds just above the surface. Winds aloft are westerlies regardless of the direction of the surface winds or even changes in the surface winds. The low-pressure systems and fronts that generate the surface winds are themselves pushed eastward around the midlatitudes of the globe by the prevailing westerlies aloft.

The value of winds aloft is their consistency. The direction of winds aloft, whether west, northwest, or southwest, is likely to remain constant for several days or longer, despite hourly and daily changes in the surface winds. If you can spot the direction of the upper winds from high clouds, you have a longer-lasting reference. In many ways, upper winds are to surface winds what swells are to waves.

The highest clouds are cirrus clouds. These are thin, wispy clouds within the winds aloft that often appear out of a clear sky with *mares' tails*, ice crystals falling into slower, warmer winds and streaking back as they evaporate. The orientation of these *fallstreaks* often shows the direction of the upper winds (see Figure 7-10).

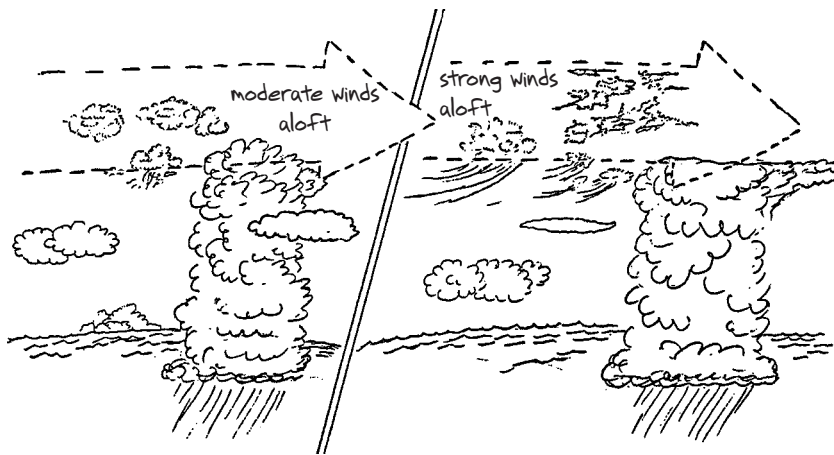

Figure 7-10. Cirrus clouds as signs of winds aloft. Fallstreaks of cirrus clouds usually stream back, in the opposite direction of the winds aloft. This sign, however, can be difficult to read, unless the streaks stream in the same direction in all parts of the sky, and there is also some indication of cirrus bands in-line with the tails. Strong winds aloft are indicated by ragged, torn cirrus and prominent, swept-back tails, and perhaps even noticeable motion to the clouds. Weaker winds aloft have puffier, smoother, apparently stationary cirrus without tails. Strong winds aloft generally mean the weather patterns they carry have strong surface winds. Anvil tops to towering cumulus clouds are also a sign of strong winds aloft.

When cirrus clouds thicken, they sometimes aggregate into cirrocumulus clouds that form a rippled pattern called a *mackerel sky*. A similar, though bolder, wave pattern is often seen on lower, puffier altocumulus clouds. These waves in the clouds are formed by the winds aloft, just as waves on the sea are formed by surface winds. So to picture the direction of the winds aloft, think of them blowing over the clouds, making the wave patterns you see. Sometimes wave patterns in clouds divide into broad bands, or “streets.” And sometimes some of these broad bands form a wave pattern of sorts themselves. But don’t let this broader pattern mislead you. The winds aloft

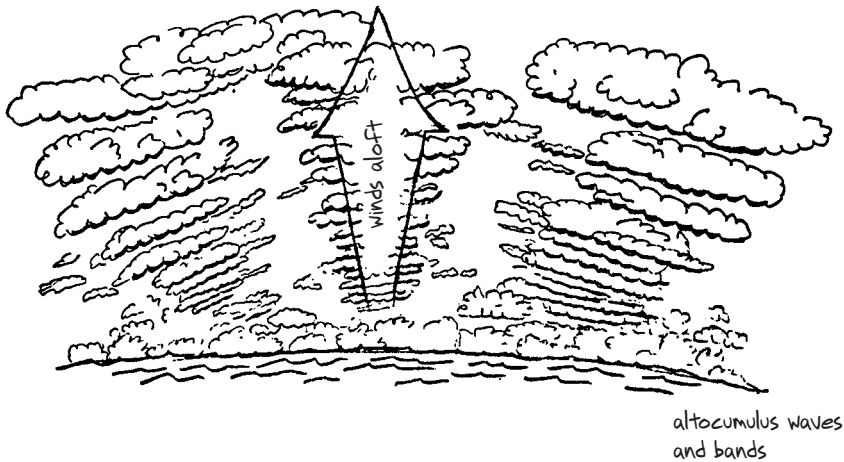
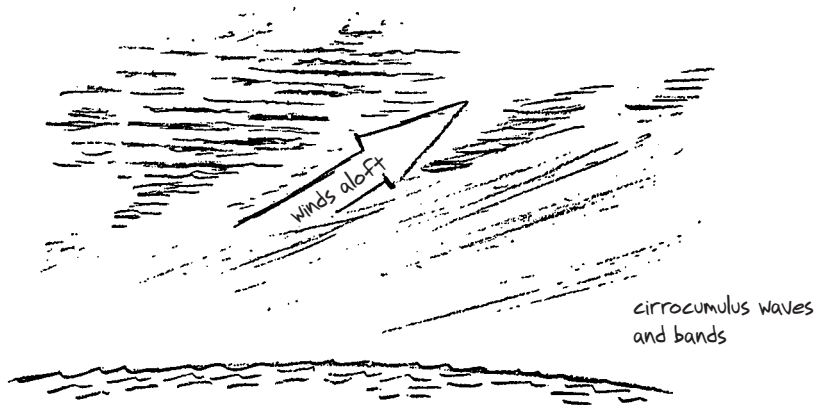

Figure 7-11. Waves in cirrocumulus and altocumulus clouds. Winds aloft make waves in clouds below them just as surface winds make waves in water. The direction of winds aloft is perpendicular to the waves (bottom) and parallel to the bands, or streets, of waves (top). Cirrocumulus waves are more delicate, like ripples in sand, than the more common altocumulus waves, which appear as rows of sheep's backs. Both patterns are transitory—forming, dissipating, and reforming again, perhaps in another part of the sky.

are parallel to the streets and perpendicular to the shorter waves within the streets. Cirrocumulus waves look like ripples in sand dunes, compared with altocumulus waves that look more like sheep stacked up in rows (see Figure 7-11).

The anvil tops of towering cumulus also show the direction of winds aloft. The thunderheads build up until they reach the strong wind aloft, which blows their tops off in the direction of its flow. Sometimes you can even spot this direction from a bias in the orientation of the tops of taller, ordinary cumulus clouds.

Cloud patterns are all temporary. A good wave pattern showing the wind direction may last only a quarter of an hour, though it could last longer. But when it reappears in another part of the sky, you should get the same reference direction from it. The direction is most valuable when

the sun is obscured—say, behind a wave-filled layer of altocumulus, or behind stratus clouds in another part of the sky. But this can't happen too often. Generally, the sun, or at least the bearing to the sun, is discernible when you can read wind directions from the clouds. The direction of the winds aloft is just one more reference to keep an eye on. You should use all you've got. Furthermore, even if this direction is not an aid to your steering at the time, by keeping track of it you know where to look for bad weather. Storms and fronts will approach from the direction of the winds aloft.

Birds

Birds and the directions in which they fly have a place in emergency navigation, but it is not in the middle of the ocean. You will certainly see birds, no matter where you are, and it is indeed interesting to identify them, admire their flight, wish they would come aboard for a visit, and generally wonder what they are doing out there. But that's about it. Birds in the South Pacific could be headed for the Arctic Circle, or they could be just as lost as you are and maybe in more trouble. In short, isolated bird sightings when you know you are more than 80 or 90 miles offshore provide no useful information for steering or navigation. Save your hopes for help from birds until you get closer to land, when you see a lot of them. If so inclined, you might study books on seabirds to help identify those that are known to wander the oceans, and in this way reduce the risk of raising false hopes. Birds as a sign of land are discussed in Chapter 13.

Planes

Airplanes are birds of another feather. Again, in some cases, they might be helpful to orientation and navigation. If you are 100 miles or so from Bermuda or Hawaii, for example, and spot several planes during the day all headed toward or away from the same direction, then chances are you've spotted the direction to an island airport. But even in these cases, keep in mind that standard flight approaches or holding patterns around some airports may completely confuse airplane directions near the airport. Planes must be treated just like birds. Consider the information they suggest based on your approximate location and the number of them you see, and weigh the uncertainties carefully.

The number of plane or contrail sightings you might expect depends on your location relative to great-circle routes between major airports, though this is less certain for planes than it is for ships. Air traffic follows specific tracks in some regions and weather-routed flex tracks in other regions, which take advantage of, or avoid, the winds aloft. Samples are shown in Figures 7-12 and 7-13. Beneath some of the fixed tracks in clear skies you might see planes several times an hour, whereas in other parts of the world you would not see any at all.

To illustrate with a North Pacific example, I made a seventeen-day voyage from Kauai to Puget Sound by a route that did not coincide with any great-circle route to the Pacific Northwest. I did not see a single plane during the crossing. The weather was clear or partly clear about 75% of the time. But on a thirteen-day crossing from San Francisco to Maui, which did follow the great-circle route fairly closely, I sighted a plane nearly every day. On some days, I saw as many as three. In each case, including two night sightings, I could determine the direction to Hawaii

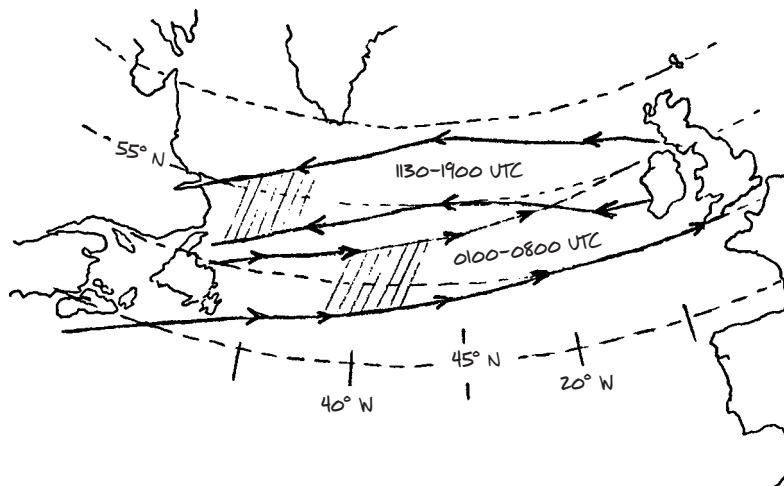

Figure 7-12. Air routes over the North Atlantic. Most traffic will be in these tracks—eastbound at night, westbound during the day. If you have traveled to Europe recently, recall your flight schedule to see if it concurs. Outside of the time intervals indicated, east- or westbound traffic may take whatever route they choose.

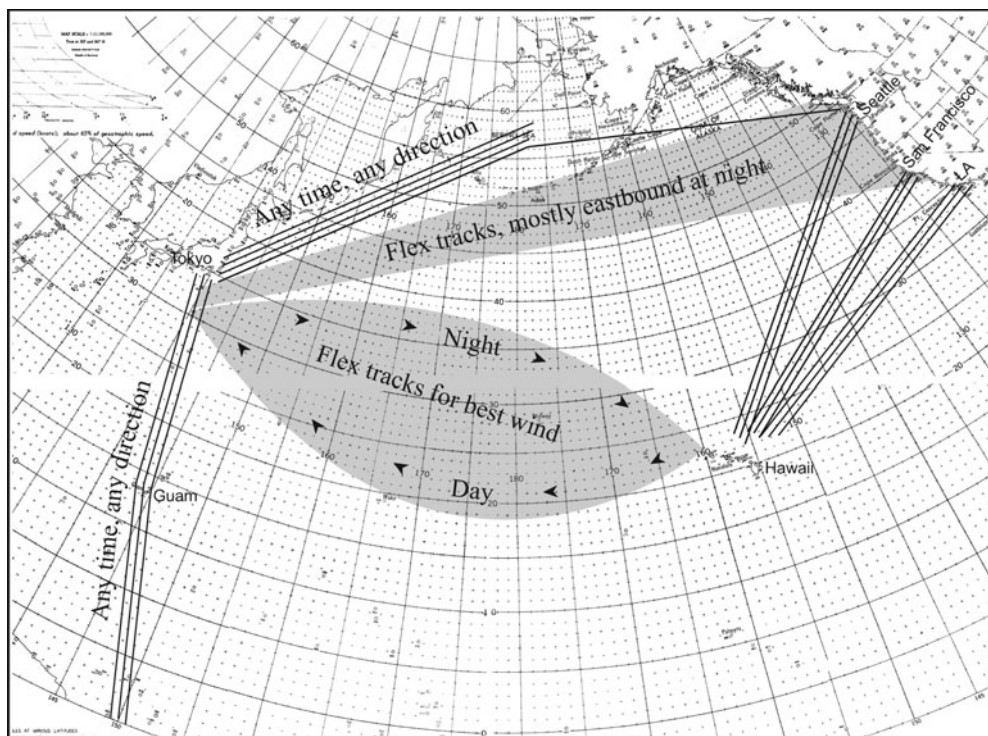

Figure 7-13. Air routes over the North Pacific. The straight lines are specific tracks used in both direction at any time of day. The shaded zones mark flex tracks that are routed depending on the wind, which in turn depends on the season. There is also traffic from Hawaii south to the Society Islands. (Thanks to Captain Jay Towne for discussion of these routes.)

or San Francisco from the flight path. During this voyage, the weather was clear some 95% of the time.

Since some planes and most ships are likely to be close to great-circle routes, several sightings might give you more information than just directions. If you see a lot of traffic, you might assume you are close to a great-circle route. With a pilot chart that shows these routes, you can find an approximate line of position.

SATELLITES

Man-made satellites are a modern addition to the twilight and nighttime sky. They appear as steady lights, moving rapidly across the sky, sometimes faint but sometimes fairly bright. However, there is no way to use their paths as reliable sources of directions as there are many satellites in the sky going in many different directions. The exception is to study the paths of specific satellites before leaving and then they might be useful. There are numerous visible satellite tracking programs online that you can use online or download to your computer for off-line use. They require just periodic updates to keep the data current. Then you can predict precise times and paths of specific satellites from any location on earth.

Chapter 8

STEERING IN FOG OR UNDER CLOUDY SKIES

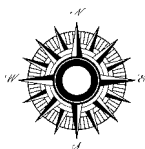

When the sky is cloudy or overcast, you usually lose the help of the sun or stars for steering, although wind and swells may still be present for temporary guides. Sometimes the sun's disk is obscured, but you can still find faint shadows if you look for them carefully. If you can find shadows, you can still use the sun for steering.

A knife blade held perpendicular to your thumbnail or any flat, white surface is a good way to look for faint shadows. As you rotate the blade, the shadow fans in and out just enough to give the direction of the shadow—even on days when you would swear no shadows were to be seen. But use such shadows with caution. What you are finding is the direction of the light source, which may not be the direction of the sun, depending on the uniformity of the cloud cover. A hole in the clouds off to the side of the sun may be your main source of light. There is not much you can do about this but look at the sky and make a guess. You can always find approximate directions this way, however, as the light source can't be too far from the sun.

For more general orientation, you can often tell which side of an overcast sky the sun is on by simply noting the brighter part of the sky. The distinction is more noticeable at sea than we are accustomed to on land. With the full panorama of the sky for contrast, subtle differences in shading are more discernible. During several hours on either side of either twilight, this is especially easy.

There is also a chance of finding an accurate direction to an obscured sun low in the sky as long as there is a patch of clear sky overhead, using a pair of polarized sunglasses (see the last section of this chapter, Finding the Sun as a Viking Would).

Thick weather can come with or without wind. Without steady wind or visibility to see the sea and sky, you are running out of nature's guides. But you may not have to stop just yet; you have a few man-made options to check first. Two of these, a makeshift magnetic compass and an AM radio for radio direction finding, might well keep you going through the fog. In fact, in some

circumstances, either of these options may work well enough to be a primary source of directions, even in clear weather. But if these also fail, leaving you with no way at all to hold a steady course in a known direction, then you must simply stop and wait for the weather to clear.

HOW TO MAKE A MAGNETIC COMPASS

It is a common science exercise in school. You thread a needle through a piece of straw and float it on water. The needle swings around some but finally settles down and orients in the magnetic north-south direction. That's all there is to it. It doesn't even have to be a sewing needle or straight pin; any needlelike piece of iron or steel will do the job—a straightened-out paper clip, a piece of bailing wire, or the pocket clip of a ballpoint pen. It only needs to be light, long, and thin, and somehow rigged to float (see Figure 8-1), and it must be attracted to a magnet. Some (not all) stainless steel is not magnetic and will not work. Just find a magnet and test to see if the object is attracted to it; if so, it will work. Any way you can make it float will do, but try to minimize the drag in the water. Try threading the needle through small pieces of paper, bits of wood, or packing material.

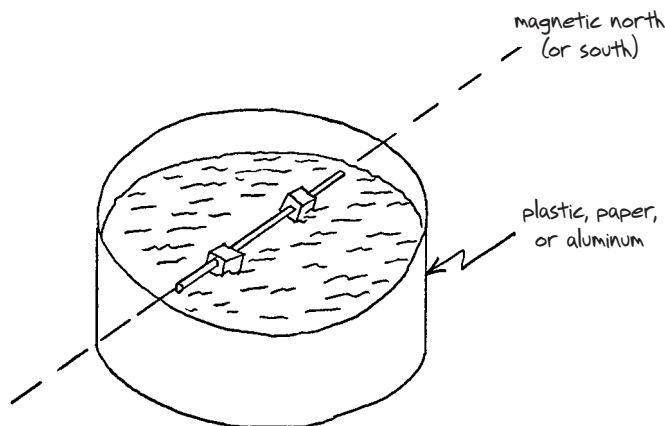

Figure 8-1. A makeshift compass. The floating needle can be any long, thin piece of iron, such as a wire, a strip from a tin-can lid, a straightened-out paper clip, or a clip of a pen or pencil. The needle included in thin-lead mechanical pencils for cleaning the points is ideal. The water or oil container, however, should not contain iron. If a magnet is available, rub the needle on the magnet first, and the compass will work much better—or let it sit on the magnet overnight.

Many needlelike pieces of iron will orient without extra magnetization but you can make them work even better by rubbing them against a permanent magnet. It is not uncommon to have a magnet on board—all radio speakers contain magnets, and some screwdrivers are magnetized. A needle that has been rubbed on a magnet will orient so well that it appears to be tied to magnetic north with a spring.

The container holding the water, however, should have no iron in its composition. Use a paper, plastic, or aluminum container. Tin cans are not good since they contain iron, which disturbs the earth's magnetic field.

A tin-can lid, on the other hand, often orients very nicely. But since it is not long and thin, it doesn't show the magnetic north-south direction. One trick you can use, providing you use it before you need it, is to draw or scratch an arrow on the oriented lid in the direction of the North Star. You then have a compass that points to true north from your location. You can tell if the lid orients by marking it and noting if it returns to the same direction after you disturb it.

A makeshift compass shows the magnetic north-south direction, but you have to decide which is north. The faintest shadow of the sun or shading of the sky will answer the question. And, of course, if you are to travel far by compass, you will need to know the magnetic variation for the area.

A homemade compass is not going to work as well as a ship's compass. It is un-damped, so it will swing around with the motion of the boat. You may have to hold the container in your hands to help compensate for the boat's motion. But it will work, and it is a rare boat that doesn't have the necessary materials on board to make a compass. Ways to improvise are unlimited. Take the time to play with this, and you'll be surprised at how easy it is.

DIRECTION FINDING WITH A PORTABLE RADIO

Radio direction finding (RDF) was at one time a standard technique of coastal navigation in foggy conditions or just out of sight of land. Charted radio beacons located along the coast worldwide transmitted Morse code identification letters, which could be received by special portable RDF radios. The antenna of the RDF receiver rotated to locate the direction of the transmitting beacon, which could then be used for orientation just as you would use a visual bearing. Most of these units also received and oriented on commercial AM stations, which increased the units' usefulness in an emergency since AM stations have a much longer range. The maximum range of most dedicated RDF stations was somewhere between 10 and 150 miles.

If you happen to have a working RDF unit (very unlikely these days, though they still show up in boater's swap shops at times) and proper nautical charts, then you can always find your way once you get into RDF range of a beacon. As of 2008, RDF stations operated by the coast guards of several countries are still broadcasting signals, and their locations, ranges, and frequencies are listed in books published by the United States, Canada, and the UK. They are listed in the Published Aids to Navigation section of the bibliography. However, very few vessels are actually using RDF these days for routine or even emergency navigation—another casualty of GPS. Nevertheless, you may still be able to take advantage of this method if you have a portable AM radio on board.

You may have noticed that an AM radio, especially a small, inexpensive one, gets better reception when oriented in one direction than in another. When this happens, you can rotate the radio to find the strongest reception. The sensitivity of the internal antenna depends on the orientation of the antenna relative to the radio waves emitted from the broadcast station. The effect is exactly the same as the one used in navigational RDF units discussed above.

There are two ways to orient the AM radio. You can rotate it to find either the strongest or the weakest reception. The direction of minimum reception, called the *null*, is the better one to use for

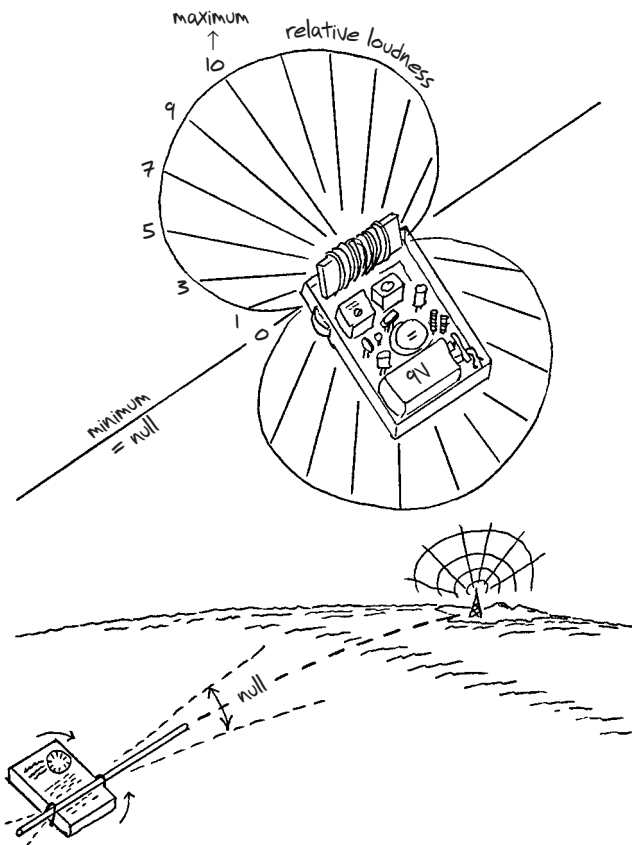

Figure 8-2. Using a portable AM radio for radio direction finding. When reception is weakest, the radio's internal antenna (a ferrite stick wrapped with wire) is aligned toward the broadcast station. The schematic plot of the antenna sensitivity shows why it is more precise to locate the station using the orientation that gives the weakest reception, rather than the strongest. Watching the end of a stick attached parallel to the internal antenna will enhance your audio determination of the null location. Using this method, you can locate bearings to stations several hundred miles out of sight.

direction finding (see Figure 8-2). The direction of the maximum reception is much less precise—at maximum reception, you can rotate the radio through 30° or more before noticing a change in loudness. The null (if one is present), which is at right angles to the maximum, can usually be found to within a few degrees. Sometimes the null is so sharp that the station will completely shut off when you rotate the radio a few degrees; but at other times, or for other stations, there may be no null at all. If you can't find a null, you simply can't use that station at that time. If you can't find a null for any station from the deck of a metal boat, try a different location on deck. It may be that the boat itself is interfering with the reception, though this is rarely a problem on nonmetal boats, regardless of the rigging.

To find the direction of the radio station once you've found a null, you need to know which way the internal antenna is oriented. The antenna is a coil of wire wrapped around a ferrite rod inside the radio. You have to open the radio once to check this. At the null, the ferrite rod aligns with the direction of the broadcast antenna of the radio station.

You won't be able to tell, however, if the rod points toward or away from the station; the rod is symmetrical and the null occurs in both directions. Usually, you will know the rough direction of the station—north or south, for example—and that's all you need to remove this uncertainty. If you don't know your position relative to that station, look for other stations that may help. You can also eliminate this uncertainty for close stations by carrying out a standard running fix using the radio bearings as explained in the Running Fix from Radio Bearings section in Chapter 13.

Remember that the broadcast antenna is not always located near the broadcast station. Nautical charts show the locations of many AM towers and also give the frequency and call letters of the station. But even if you are unsure of the location of the broadcast antenna, a good null still gives you a relative direction to steer by during the fog. If this is your goal, hunt around on the dial to find the station with the best null. Headed toward land, you may just find a station in the direction you want to go.

You may even be able to get more out of your makeshift RDF than just a relative direction to steer by. You might, for example, try for a true direction to a city, or even a rough position fix from the intersection of two or more true bearings. In doing this, however, there are several precautions to keep in mind. First and foremost, your pocket AM radio won't be as reliable as a standard RDF unit. The receiver and broadcast-antenna placement are not designed for this job. If it works at all, you should be grateful. Secondly, the normal precautions used with regular RDF still apply, though they are not often taught in classes these days. Bearings will be most uncertain at dawn and dusk, and signals that reach you after crossing or passing by mountainous terrain are not as reliable for directions as those from unobstructed stations. These precautions apply even if the station shows a good null.

On the other hand, an island station can provide very useful directions to the island for hundreds of miles out to sea. I have received a Honolulu station at 420 nmi off, which oriented very nicely with a \$6 radio. From then on, that little radio would have taken us to Hawaii blindfolded. But as with all techniques described in this book, you should practice using an AM radio for direction finding before you need it.

For this application, cheap radios are better than higher-priced radios, which have extra circuits and better antennas that remove the null. If you pay good money for a radio, you don't want it to shut off when you rotate it 5°. iPods or similar devices have likely replaced all these old, small AM radios in much of the world, but if you have one around or see one for sale in some remote part of the world, you might hang on to it. They are valuable aids to navigation.

STREAMING A LINE ALONG THE CENTERLINE

In some cases, a fishing line or other long, light line can be a valuable aid to steering through thick weather. It might, for example, be especially valuable to a small boat caught offshore without a compass when the fog sets in. It is something to keep in mind in any emergency situation where visibility is reduced.

Simply stream the line aft from the bow or amidships, back and over the stern. Let out a long length of line and then steer to keep the line centered on the transom (see Figure 8-3). You can steer a long distance this way, depending on sea conditions. But you could also go in a large circle if you err in the same direction continuously. Keep an eye on the wind—if there is any—and on

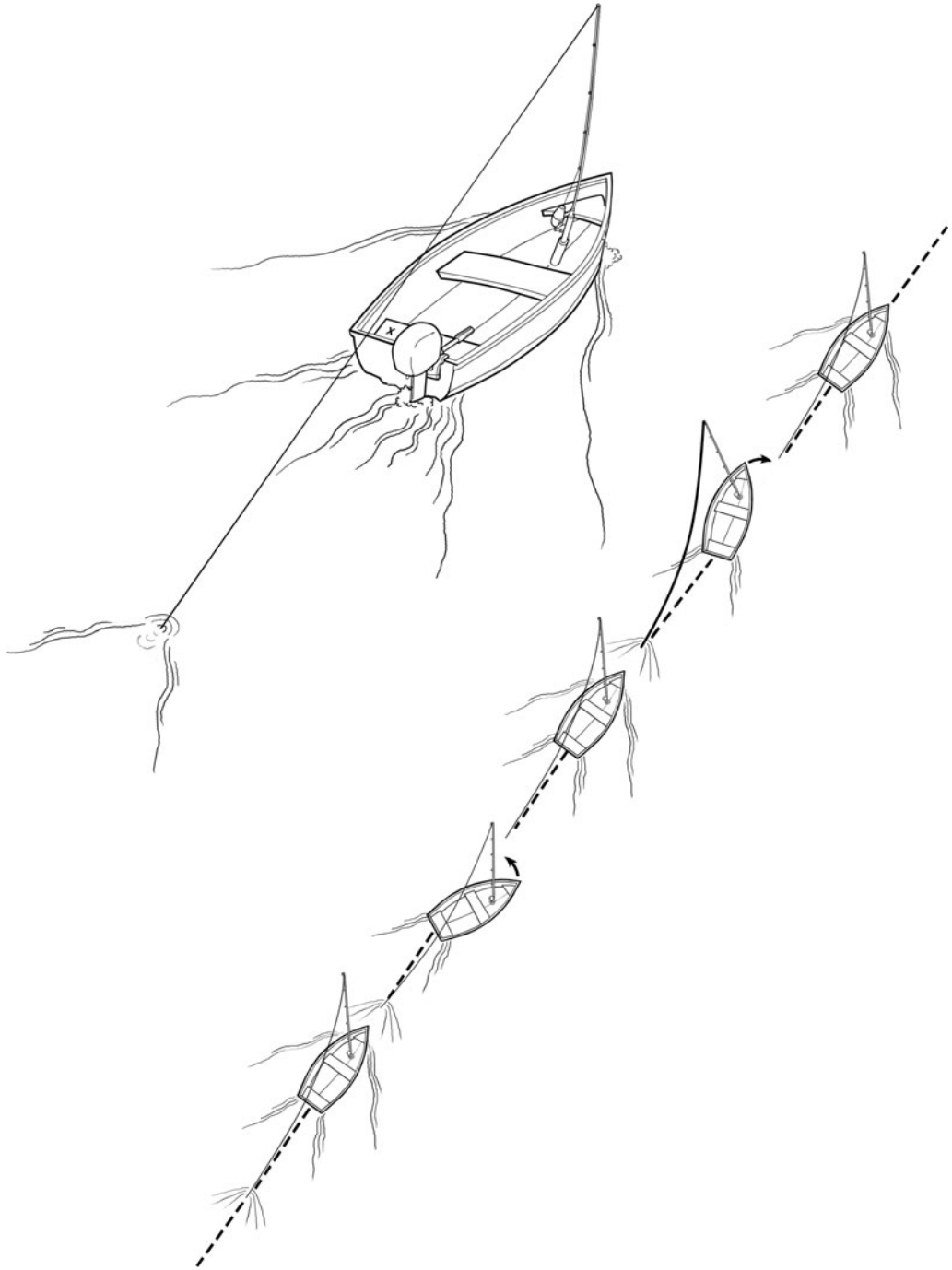

Figure 8-3. Streaming a line aft to hold course in the fog. When a wave throws the bow off course, steer so as to bring the line back to its original position. This method can only be used for limited runs, but it might prove useful if you get caught in thick fog without a compass or GPS.

the swells or waves for help as references. In choppy water, this trick gives you a quick way to get back to your original heading after a wave throws you off.

It is very loosely like steering the boat to keep the bow under the center of the spinnaker when sailing downwind as a way to stay oriented with the wind direction (see Chapter 4).

FINDING THE SUN AS A VIKING WOULD

Leif Karlsen, in his book *Secrets of the Viking Navigators* (see the No-Instrument Navigation section of the bibliography), gives a good argument that the Vikings used crystals of Iceland spar to find the direction of the sun when just below the horizon or when obscured by layers of fogbanks on the horizon, common at latitude 60° N where they did much of their ocean sailing. The technique he proposes works very well. We have done it many times using these Viking sunstones, which are readily available from gem shops online (you need a clear crystal, 1 to 2 inches on a side). This technique can pinpoint the direction to the sun to within a few degrees, and it was in fact used for many years in a more sophisticated arrangement as the basis of the Kollsman Sky Compass in the early days of polar exploration by air.

You can simulate this method with about the same precision using any polarized film, such as the lenses of polarized sunglasses or some polarized camera filters. Some older sextant models also have polarized filters on the sunshades. In addition to that, you need a small piece of cellophane. Many clear packaging tapes, the transparent windows of a CD sleeve, or the protective packaging of many products are often cellophane. (Some clear plastic products that look like cellophane are actually another type of plastic and will not work for this application.)

This technique works because scattered sunlight is polarized. If you imagine a line straight up to your zenith and another line straight toward the sun, then these two lines define a plane. The electromagnetic oscillations within sunlight that has been scattered by air molecules are perpendicular to that plane, whereas in direct sunlight these oscillations are randomly distributed in all directions. Sunlight that has been reflected from a surface (glare from the water, for example) is also polarized, which is the motivation for polarized sunglasses. This light is horizontally polarized parallel to the reflecting surface, which means that sunglasses designed to block this glare are vertically polarized. An easy way to test that a pair of glasses is polarized is simply to look at such a reflective glare and rotate the glasses (looking straight through the lenses to the glare, roll the lenses, without pitch or yaw), and you should see the intensity of the glare change quite noticeably. On land you can do the same with bright glare from a window or car hood or bumper. When the glasses are working properly, you can see through the glare-producing windshield into the car; without them, or with your head turned 90°, you see only glare.

The sun-finding technique, however, uses the scattering polarization, not the reflective, and the scattered light polarization is maximum in the direction that is exactly 90° from the sun's direction in the plane described above. As you won't know this direction to begin with, since this is what you are looking for, start with your best guess. For example, if the sun is just below the horizon (morning or evening), then look straight up. If it is, say, midmorning, and the sun is some 30° high in the sky and behind clouds to the southeast, then look to the northwest, about 30° down from your zenith. This guess does not have to be right—you will find the sun very nicely with your gadget—but you do need to have a patch of clear blue sky where you are looking.

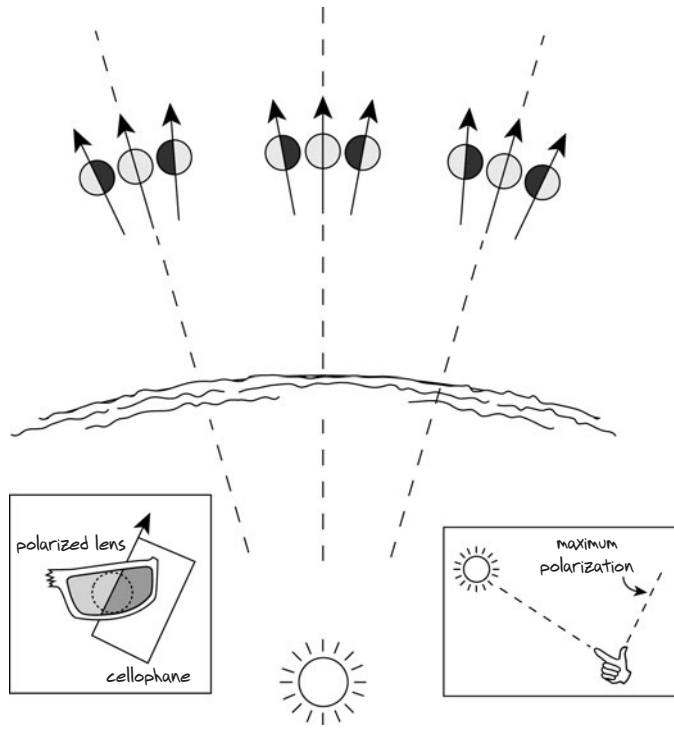

Figure 8-4. Finding the bearing to the sun when it is below the horizon or obscured by clouds using a polarized lens and a sheet of cellophane. The procedure is to find the bearing of maximum polarization, because this direction is opposite to the true bearing of the sun. Start by looking in a direction that is opposite to your best guess of the sun's bearing. You will not know exactly where to look, as that is what you are trying to discover. Once facing that best-guess direction away from the sun, angle your view up from the horizon by an amount that you estimate would put you about 90° from the line straight to the sun. Referring to the right inset, if you point to where you think the sun is, your thumb will point in the best direction to start looking for maximum polarization. If the sun is just on or below the horizon, you would look straight up. If the sun is about 30° above the horizon, you would look in the opposite direction at about 60° above the horizon.

To prepare the lens, attach a piece of cellophane diagonally across the lens as shown in the left inset. Look through the lens with the cellophane on the far side (sky side) of the lens. The lines with the arrowheads in the figure represent the edge of the cellophane, crossing the middle of the lens.

The three center drawings show what you will see when you are facing the proper direction of maximum polarization, directly opposite the true bearing to the sun. When the cellophane edge is perpendicular to the horizon, the lens will be the same shade on both sides (cellophane side and no-cellophane side). When you rotate it slightly to the right and left, the sides will change brightness, as shown in the two figures adjacent to the center one. (Note the two rotated views are shown to the right and left, but they would be in the same position as the center one, just rotated to the right or to the left.) On the other hand, if you are not facing opposite the true direction to the sun, you will see what is shown on the right or left of the center figures. If you are facing to the right, the edge of the cellophane will lean right when the sides have the same brightness, as shown, and when facing to the left of the proper direction, you will see what is shown on the left.

It is a subtle process that takes some practice. But once the procedure is grasped, it can then be repeated much more readily. The sequence is: Look in the approximate right direction and then in the approximate right elevation. Then, starting with the cellophane edge perpendicular to horizon, rotate the lens to find the orientation of that edge line when the two sides are about the same brightness. When you are in about the right direction, the two sides will switch in brightness quite prominently—providing you do indeed have a polarized filter and true cellophane. Note that the sun can be obscured but you must be looking at a patch of clear blue sky for this to work.

In other words, the sun can be below the horizon or behind clouds or fogbanks, but you must have a patch of clear sky somewhere overhead (and perpendicular to the sun direction) to find the sun.

Finding the Sun with a Polarized Lens

The procedure is as follows (see Figure 8-4). First, look in approximately the right direction as explained in the previous paragraph to double-check the orientation of your polarizing filter. If you are using a lens of a pair of sunglasses, chances are the polarization axis is parallel to the bottom of the glasses, which means you will find the brightest or darkest light transmission with the lens parallel or perpendicular to the horizon. If this is not the case, find the best orientation and draw a line across the bottom of the lens when rotated into the darkest or brightest orientation—or mark the horizon with a piece of tape if you don't have the right pen for the job.

Next attach a piece of cellophane to one side of the lens (the side that will be toward the sky). This should have a nice straight edge and the edge should be oriented diagonally across the lens—or diagonal to the line you marked on your lens in the test.

Once you have this polarization compass assembled, look again to the correct direction and rotate the device. You will notice now that the right and left sides alternate in brightness; when the two sides have the same level of brightness, the edge of the cellophane is pointing to the sun. The trick is to hunt around for the best direction; rotate the compass, note the sharpness, turn left a bit, try again, turn right and try again. When the angle is optimum, look up a bit and then down, etc. As shown in Figure 8-4, you are finding a great-circle arc that points to the sun, so when looking to the left of the proper vertical plane, the line will point right, and when looking to the right of it, the line will point left.

Once you find it—if you have access in the clouds—the location of the brightness transition becomes very sharp. The sunlight polarization is at maximum strength when you are exactly 90° from the sun, but it does persist away from that orientation at weaker levels. For samples of such makeshift devices in action, go to starpath.com/emergencynavbook.

Chapter 9

CURRENTS

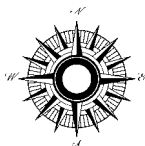

Assuming emergency orientation and helmsmanship are under control, and you are diligent about recording course changes, the main uncertainty in emergency navigation is likely to be caused by currents. You can find boat speed and heading by several means, but these won't give your correct course if the water beneath you is also moving. The problem is much like trying to locate your position in a large bathroom when you know exactly where you are in the bathtub but not where the bathtub is.

Once you are well into a current, you generally have no way to detect its presence, short of doing precise position fixes at timed intervals. Floating objects in a current may drift toward or away from you, but this is due to differences in leeway (windage), not to the effect of the current. Current moves everything in the water at the same rate.

Currents can exist in any body of water. For the most part, currents are driven by the winds and the gravitational pull of the sun and moon. Current strengths and directions are also strongly affected by the earth's rotation and by the shape of the oceans, shoreline, and bottom, as well as the salinity of the water. For keeping track of currents, it is convenient to divide currents into three categories—ocean currents, tidal currents, and wind-driven currents—though, strictly speaking, this is a somewhat artificial classification since the three are not fully independent. The direction in which a current flows is called its *set*; the speed of a current is called its *drift*, which is measured in knots or miles per day.

Needless to say, your knowledge of the prevailing or even temporary current flow could be crucial to your decision making and even to the outcome of your adventure. It would be a pity to make a long ocean passage safely and then confront some unexpected aspect of coastal or island currents that diminishes your success.

OCEAN CURRENTS

Ocean currents are the prevailing circulation of the oceans and generally follow the prevailing circulation of ocean winds. These currents remain fairly constant over large spans of the oceans and over long periods of time, although there are seasonal variations in the set and drift of many ocean currents. There are also unpredictable, short-term variations (that is, lasting several days) in all ocean currents. The general circulation of the oceans is clockwise in the Northern Hemisphere and counterclockwise in the Southern Hemisphere (see Figure 9-1). Ocean currents are strongest along the perimeters of the oceans and are usually weak or nonexistent in midocean (the equator is considered here to be the perimeter that divides the southern and northern oceans).

Throughout most of the oceans of the world, the currents are not strong. A global average might be about $\frac{1}{2}$ knot. But there are notable exceptions. The Gulf Stream in the western North Atlantic and the Kuroshio Current, its counterpart in the western North Pacific, average over 2 knots and can reach speeds in excess of 3 or 4 knots on occasion. Equatorial currents and countercurrents around the world are also strong. These tropical currents average over 1 knot, but they can accelerate significantly in the vicinity of island groups.

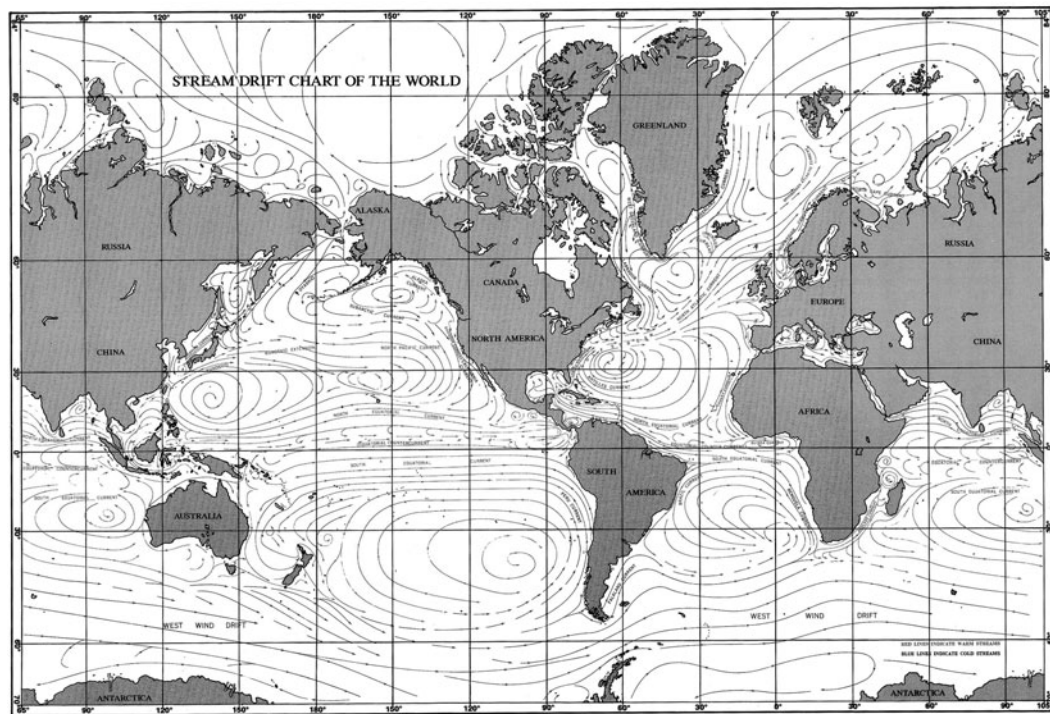

Figure 9-1. Major ocean currents of the world. The patterns shown are for the winter months. The figure is from Bowditch, Pub. 9, which discusses each of the currents in some detail. Pilot charts (sections of which are shown in Figures 1-1 and 4-4) show the currents in more detail for individual oceans. The full Bowditch text and all U.S. Pilot Charts are now available online.

In special cases, you can detect the presence of an ocean or coastal current as you sail into or out of it. The boundaries of the Gulf Stream, for example, are marked by a distinct change in water color—from the gray-green of the Atlantic to the indigo blue of the current. The Gulf Stream is also noticeably warmer than neighboring waters, especially at higher latitudes, which means there are also more squalls and gales over the current. The Gulf Stream often carries with it large amounts of floating seaweed. And in northerly winds (against the current), the seas of the Gulf Stream are noticeably rougher than neighboring waters. Similar properties mark the boundaries of the Kuroshio Current. But these currents are unique in their prominence. Other prevailing currents around the world may show some of these properties, but boundary distinctions are likely to be less prominent.

On any ocean or coastal voyage, it is the responsibility of the navigator to study the currents before and during the cruise. Ocean currents are listed in catalogues and atlases, which predict the currents at various locations and seasons. The *U.S. Pilot Charts* are the best readily available source of ocean currents; they are now online for all oceans and seasons. Among other valuable data, they provide ocean currents pictorially, showing the average set and drift of ocean currents by the month or quarter.

In using any current atlas, however, you must remember that it provides predictions based only on the average of many observations over a period of years. At any given time, the actual current present may be different from the listed value. As a rule of thumb, consider predicted ocean currents to be correct to within $\pm 50\%$. That is, if a current drift is listed as 12 miles a day, to be safe, assume that it could be anywhere from 6 to 18 miles a day: the average plus or minus half the average. Generally, the predicted direction of ocean currents will be fairly close to the actual direction, within some 30° or so, but even this is not guaranteed. In some areas, deep countercurrents sporadically surface, making the predicted direction as wrong as possible.

If the wind is strong for the season and has been that way for a full day or more, then look for the higher end of the average current drift; if the wind is weaker than average for the season for a day or more, then look for the weaker side of the current predictions. The prevailing wind will usually be in the same direction of the prevailing current, but if it should be opposite, then definitely look for weaker surface currents than the average predictions.

Learn the Currents Before You Set Out

For emergency preparation, studying the currents before you depart is invaluable. One convenient way to do this is to lay out your intended course on a pilot chart, and then read off and list the east-west and north-south components of the current for each 5° or so of latitude along your route. This exercise gives you a close look at the currents and how they might enter into your navigation of the voyage—with or without instruments (see Figure 9-2).

Such a study would show, for example, that on a cruise from San Diego to the Marquesas, the predominant set of the current is to the west throughout the voyage, with only a brief interruption by the equatorial countercurrent. At an average speed of 6 knots, this voyage would take about three weeks, and the net drift to the west would be about 280 miles. This is clearly enough to miss the islands if you had to make much of the crossing by DR alone and did not take currents into account.

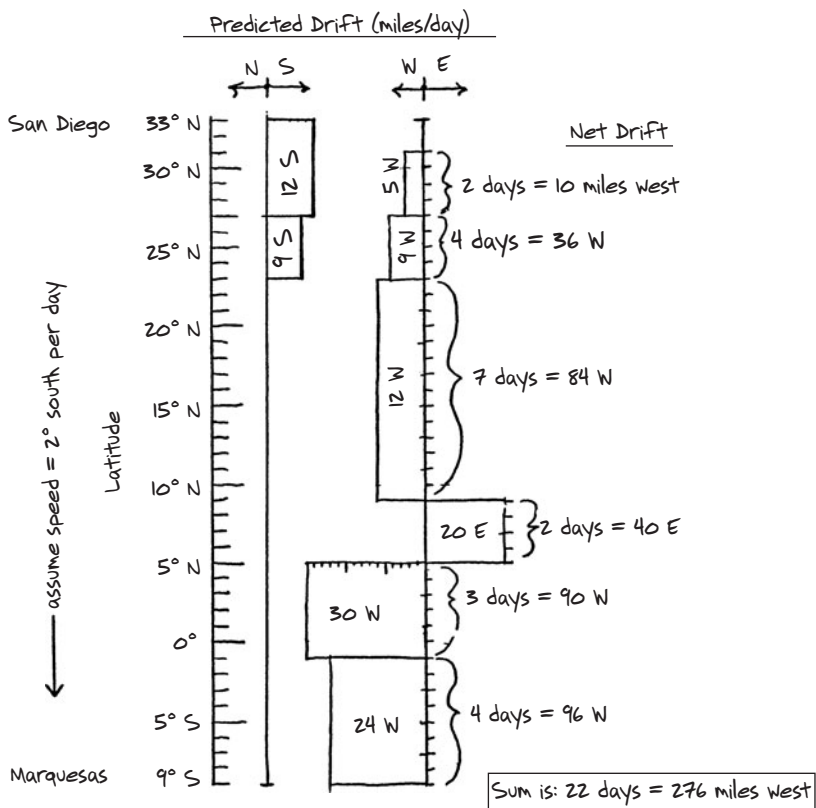
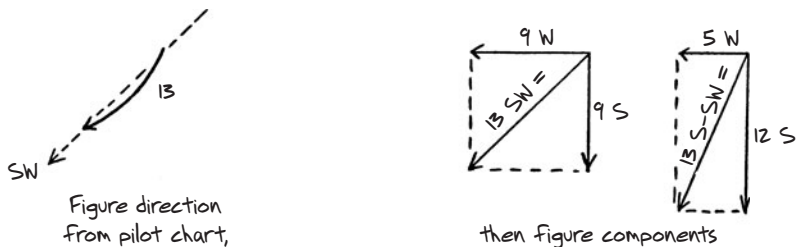

Figure 9-2. A current log figured from a pilot chart. Pilot charts show currents as arrows flying with the set of the current, labeled with the drift in nautical miles per day. First lay out your planned route on the pilot chart, and record the currents and latitudes at which they change (not shown). Then figure the components of the currents as indicated in the illustration, and from these make a plot or table of the results. Then with an estimated speed, you can figure your net set over different legs of the voyage. This example is for a July run from San Diego to the Marquesas at an average speed of 6 knots. The data are from U.S. and British pilot charts. Note that in this example, you would want to make some easting before you got to the southeast trades to compensate for the large westerly set.

It is only remotely possible that you might ever end up adrift without any means of power, but if this occurs, your knowledge of the local currents could well determine the outcome of the adventure. With only emergency navigation to go by, it is essentially impossible to measure the currents present. You simply must have some prior knowledge on which to base a reasonable guess. Remember that currents tend to flow with the prevailing winds, so if all you can make to weather is a knot or so through the water, you must look downwind for a route to safety, even if it is farther to land that way. See, for example, Dougal Robertson's account of his emergency voyage given in his remarkable book, *Survive the Savage Sea*.

TIDAL CURRENTS

Tidal currents are the flow of water associated with the rise and fall of the tides. They have no influence on ocean sailing except near the coast or island channels. Open-channel currents inland tend to increase, subside, and reverse with the tides, in contrast to tidal currents along a coast, which are more likely to rotate with much less change in strength. Although there does tend to be an alongshore bias to many tidal current rotations, meaning that the current direction spends more time along the shore than toward or away from the shore. Tidal currents along a complicated coastline may have speeds of several knots, while a knot or so might be the average along a smooth coast. In either case, since the direction rotates, you are left with little net displacement over a day's time. Generally, tide-height ranges and associated currents are larger at higher latitudes.

If your voyage ends at a river entrance, remember there can be dangerous breaking waves at river bars during the ebb cycle, especially if a strong swell is running. Approaching the back of the breakers from the sea, you may hear them before you see them. Also, at narrow, constricted bay entrances, you may find maximum currents near high and low water on the coast, which can be just the opposite of tidal current behavior near large, open channels. On the ebb, for example, the constriction prevents water from leaving the bay as fast as it leaves the seaward side, so the slope of the water across the constriction builds toward a maximum near low water on the coast, which in turn causes maximum flow through the constriction.

Tidal currents along U.S. coastal waters are given in regional *Tidal Current Tables* (NOAA); they are also discussed more generally in the *Coast Pilots* (NOAA) for American waters and in the *U.S. Sailing Directions* (NGA) for other areas. Many popular reproductions of current tables, however, do not include the rotary behavior of some tidal currents, so primary sources may be called for. The hydrographic offices of many seafaring nations (including the U.S.) have excellent tidal current resources, which are readily available online these days. On British charts, rotary currents are presented on charts in tables keyed to reference points called tidal diamonds. Many practical aspects of navigation in currents and current behavior are presented in *Fundamentals of Kayak Navigation* (see the Basic Marine Navigation section of the bibliography). The limited speed of kayaks along with their ability to go just about any place there is water, requires adventurous kayakers to know as much as possible about currents.

Figure 9-3 shows a valuable way to analyze rotating coastal currents to simplify navigation though them in a manner similar to what we did for ocean currents.

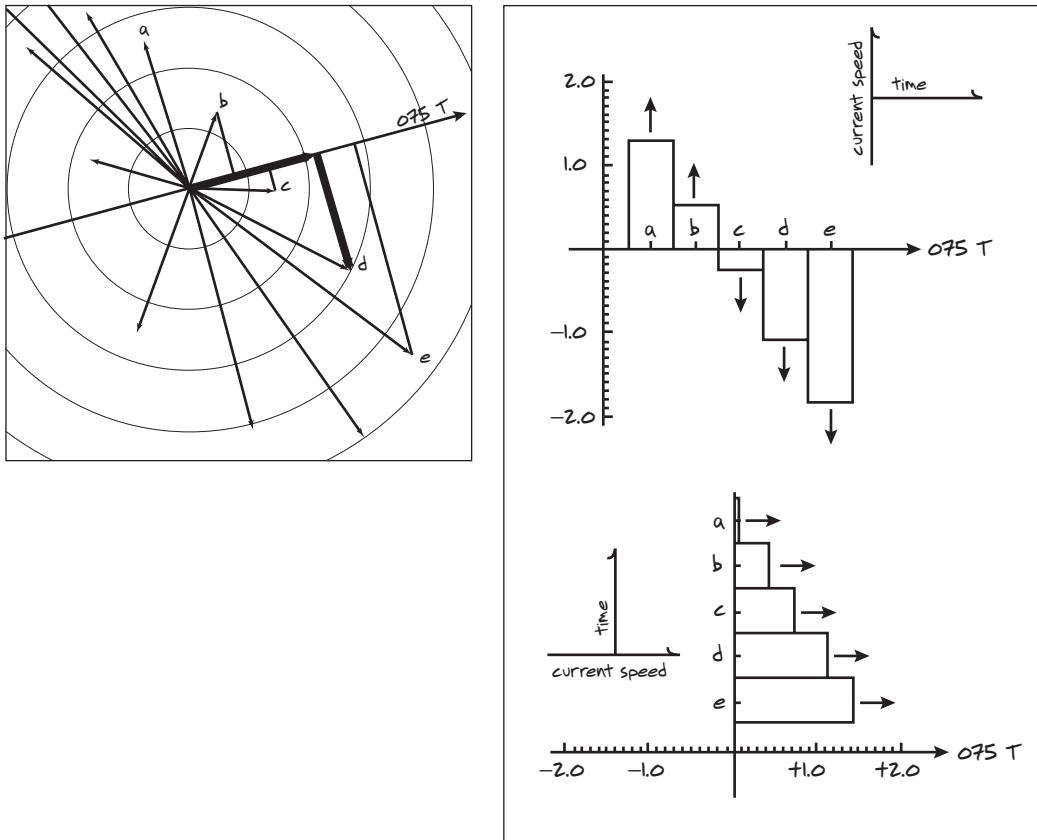

Figure 9-3. Analyzing rotary currents. On the left is a segment of a rotary current diagram, which might be found in this form on a chart or this form could be created from the tidal diamond data on British charts. The rings are 0.5 knot apart. The vector marked d is the current speed and direction at high water (HW). The currents for 1 hour after HW (e) are shown, as well as for 3, 2, and 1 hours before HW (a, b, and c). These data are analyzed for a course of 075 across this current pattern using time d as a sample. The current at d is projected onto the direction 075 to separate the components along the course, just over 1.0 knot in this case, and the component perpendicular to the course, also just over 1.0 knot. On the top right, the current across the course is plotted, showing that the cross-course currents almost cancel during these 5 hours, whereas the current along the course is always with you, building with time to about 1.4 knots. This type of planning helps tremendously with the navigation underway when you do not have GPS to keep you informed of what is going on.

WIND-DRIVEN CURRENTS

On any waters, from oceans to inland lakes, if the wind blows long enough in the same direction, it starts the water moving. Current generated by local, temporary wind is called wind-driven current. The interaction between wind and surface waters is a complicated one with many parameters, so for estimates of these currents you must make do with general rules of thumb rather than precise formulas.

As a rule of thumb, if the wind blows steadily for half a day or more, it generates a surface current with a speed of approximately 3% of the wind strength. In open waters of the Northern Hemisphere, the direction of the current will be roughly 20° to the right of the wind direction, meaning that if the wind is a northerly (toward 180°), the wind-driven current would set toward roughly 200° or so. In the Southern Hemisphere, this current is to the left of the wind, due to the Coriolis force. (The Coriolis force is an apparent force that, due to the earth's rotation, deflects moving objects—such as currents—to the right in the Northern Hemisphere and to the left in the Southern Hemisphere. It increases with distance from the equator.) On the other hand, in confined waterways, you can simply consider the wind-driven component of the surface current to be in the downwind direction.

By this rule, a wind of 20 knots for half a day generates a current of 0.6 knot. You can't count on this rule to give the speed precisely since there are too many variables involved—it works better in strong winds than in light winds (and better after a day's duration compared to just half a day's), but you often care about these effects in strong winds the most anyway. The rule is certainly reliable to within 50%. That is, in the 20-knot example, it is unlikely that the current would be less than 0.3 knot or greater than 0.9 knot. If the wind blows much longer than a day or so, you might expect the current to build slightly. In prolonged, heavy rains, wind-driven currents are likely to be even stronger, since brackish surface water slides more easily over the denser salt water below.

The significance of wind-driven current is not always so much in its strength, but in its effect on other currents and on your progress to weather in strong winds (see the Progress to Weather section in Chapter 10). If you read in the *Sailing Directions*, for example, that currents in some coastal area vary from 1 to 3 knots, you might guess that the upper limit (or slightly above it) applies when strong winds blow with the predicted current direction, and the lower limit (or slightly below it) applies when strong winds blow against the predicted current direction.

COASTAL CURRENTS

Here I'm making a distinction between rotating tidal currents in coastal waters (discussed above) and a broader category of currents that can include other sources that I call coastal currents. Generally, any one point along any coast will have contributions from both; a wind-driven current, for example, could be a coastal current that is not tidal.

We can consider the region of coastal currents to be within some 20 miles of an island or coast or, alternatively, well onto the continental shelf, if it is prominent. Generally, coastal currents are the most difficult to predict. In these coastal regions, currents might be dominated by any one of the three types of currents or even be composed of a combination of all three (ocean, tidal, and wind-driven currents)—or they may be caused by still another effect. A strong onshore wind, for example, can sometimes pile up water against prominent headlands, which in turn creates significant currents when the wind dies and the water flows back to level the surface. In such circumstances, you might find strong currents without wind or tidal changes. Currents of this type are sometimes referred to as being driven by a hydraulic head.

Coastal currents can vary significantly in strength at any one location, and they can vary rapidly and irregularly from point to point along a coast. Coastal or island currents tend to be

stronger closer to shore if the current has an onshore component to its direction, as many do. *Sailing Directions* and *Coast Pilots* are good sources of coastal current information.

In many places around the world, on-shelf coastal currents are primarily wind-driven currents. If the wind blows to the north, currents flow north; with wind to the south, currents flow south. This can be valuable information, since you can use the rule of thumb for strength estimates, but, more important, it helps in interpreting *Sailing Directions*. On the Pacific Coast shelf (Washington to California), for example, *Sailing Directions* often describe the near-coastal currents as southerly in the summer and northerly in the winter. The currents behave in this general way because prevailing winds of the region are from the north in the summer and from the south in the winter. A more informative description might be that these are wind-driven currents. If the winds are unseasonable, it is likely the currents will follow. The primary ocean circulation well off the shelf, however, is persistently to the south in this region throughout the year.

The sea state can often indicate a strong coastal current. A strong current flowing against the wind causes an enhanced chop and steepness to the seas, whereas a current flowing with the wind diminishes the seas just as dramatically. To recognize the effect, however, requires some experience at sea, since you must be able to conclude that the seas are not consistent with the winds. More generally, in a strong coastal current you might notice *confused* seas with not just steeper waves but also more frequent big ones, or frequent waves running perpendicular to the wind. These are dangerous conditions that often signal the presence of a focused *current jet*—a somewhat rare coastal current effect similar to the focused jet stream within the winds aloft.

On inland waters, however, it is easier to spot wind and current flowing in opposite directions since whitecaps will be notably enhanced in regions of contrary flow and diminished in regions where they flow in the same direction.

Chapter 10

DEAD RECKONING

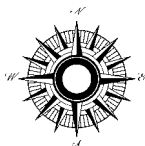

The word “dead” in dead reckoning derives from the abbreviation “ded,” for deduced. Thus, dead reckoning means deduced reckoning. To navigate by dead reckoning, you deduce a new position from an earlier one using onboard measurements of speed and direction. The modern abbreviation for dead reckoning is DR. If you sail northwest for 20 miles, your DR position is 20 miles northwest of where you started. But it is not quite as simple as it sounds.

Chances are you won't be exactly 20 miles, exactly to the northwest of where you started. Currents and leeway; inaccurate helmsmanship; compass, log, time, and/or speedometer errors; and simple blunders in logbook entries can all contribute to errors in a DR position. If it weren't for these factors, you could dead reckon your way across an ocean. These errors individually may be small over a short run, but on a long passage, such small persistent errors accumulate. An error of a few hundred miles after a voyage of a thousand miles is a small percentage error, but it could easily make the difference between finding or missing your destination.

EMERGENCY DR

Accurate DR requires accurate onboard instruments and diligent recording of all course changes. In an emergency, however, you may be left with no instruments at all, and will have to steer by the stars and gauge boat speed by your wake and passing debris. Nevertheless, in most circumstances, even makeshift DR will still be your most reliable means of keeping track of position for distances up to several hundred miles. Chapters 11 and 12 cover methods of finding and keeping track of position using the sun and stars. These celestial methods, though, require some practice and memory work to be useful. Even then, their accuracy without proper instruments will rarely be as good as careful DR for voyages of a few hundred miles. The value of celestial sights becomes apparent when you must make a long voyage—long in time or distance. In this

case, the celestial sights are useful in correcting or confirming your DR. (Celestial sights can also establish an approximate location if you happen to be starting from a completely unknown location—see below.)

Besides steering, the main tasks in emergency DR are finding speed through the water and keeping track of course changes. It is not absolutely necessary to have a watch to do either of these, but it helps tremendously. Some sailors can tell the speed of their boat to within $\frac{1}{2}$ knot from the sail trim, heel, and wake. But if you are drifting in a raft or sailing your own boat under a jury rig, it is easier and more accurate to judge speed if you have a watch.

The main value of a watch for DR, however, is to keep track of how long you have sailed on any one course. It is better to know it was 18 hours than to guess it was about one day. Without a watch, you won't even know how long one day is. Time flies when you're having fun, but it drags on forever when you're in trouble. You can't rely on your own ability to judge time at sea when you are under stress. In a long storm, it is not uncommon to even lose track of the day. The Finding UTC from a Known Position section in Chapter 12 and the Everything but UTC section in Chapter 14 cover methods of checking the time and date from the sun, moon, and stars.

If you have a long voyage ahead of you, keep a written record or make a DR plot of your progress (see Figure 10-1). Without a record of some kind, it is easier to quit caring. After several course changes, you may lose track of your course and with it your position. Knowing where you are is not only a morale booster, and one more way to keep control of the situation, it is also an issue of safety—and perhaps survival.

DR is vital to emergency navigation, but even the best DR is useless if you don't know where you started from. If you don't know your location, then you must start your DR by getting your position from the stars. In general, this will mean you start with an uncertainty of some 100 miles, and possibly even more if you have not practiced the celestial methods. Going to sea without

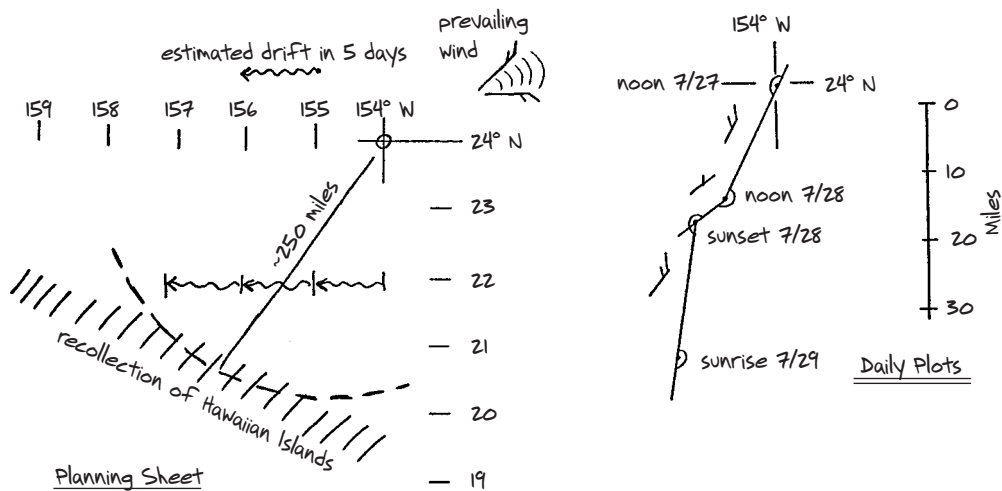

Figure 10-1. Makeshift DR plots. The planning sheet shows a hypothetical emergency occurring some 250 miles north of Hawaii. The location of the islands is drawn in as recalled, as are the current drifts and prevailing winds. In this example, the immediate navigational goal would be to make at least 2° to the south in less than fifteen days to keep from drifting over the top of the islands. Daily plots help you keep track of position and monitor your progress.

wearing a watch is risky, but not knowing where you are when you have the ability to do so is downright dangerous—the operative word would be *negligent*, especially if others are depending on you.

FINDING BOAT SPEED

If you need to find boat speed without instruments, there are several methods you can try. One way is to time the passage of anything floating on the water. If your boat is 30 feet long and it takes 10 seconds to pass a piece of driftwood, then your speed is 30 feet per 10 seconds, or 3 feet per second. The only job left is to convert this feet-per-second speed to knots (nautical miles per hour). One nautical mile is about 6,000 feet, and an hour is 3,600 seconds. So 1 knot is the same as 6,000 feet per 3,600 seconds, or 10 feet per 6 seconds, which means 1 foot per second is $\frac{6}{10}$ knot. In equation form this reads as:

$$\text{Speed (in knots)} = 0.6 \times \text{Speed (in feet per second)}$$

If you are moving at 8 feet per second, your speed is 4.8 knots; 10 feet per second is 6 knots.

You can time anything that floats: debris, seaweed, even a patch of foam. Or throw your own marker off the bow, preferably tied to the stern by a long, light line so you can use it again. Timing the passage is no problem if you have a watch. Without a watch, you must count off the seconds as best you can. If you haven't tried it, test yourself now with a watch to get the pace. The standard method of counting, "One thousand one, one thousand two . . ." works pretty well. Remember to get several speed measurements, as an average result is always more accurate than a single measurement.

Timing a marker as it passes the boat works well, providing the passage times are at least 5 or 6 seconds. For shorter times, results are less accurate. You can get around this by making the reference length longer using a light line. A fishing line or a light sheet is ideal (see Figure 10-2).

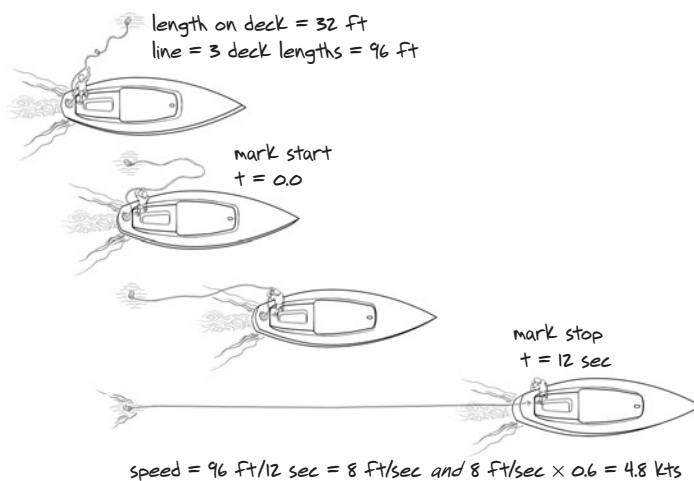

Figure 10-2. Measuring boat speed with a chip log. With a watch and some practice, the measurements are easy and accurate.

Tie an object to the line, then measure off 50 to 100 feet of line—the longer the better, but sea conditions or your available line may determine what length you use. To measure the line, it is convenient to know the length of your outstretched arms, fingertip to fingertip. This length (the original fathom measurement) is about 6 feet on many people. Or use your height or the boat length. To get your speed, tie the line to the stern and cast the marker and line off the bow. Start counting when the marker passes the stern and stop when you begin to tow it. A plastic bottle partially filled with water makes a good marker. Your speed in feet per second is the line length divided by the time it takes to extend the line.

Another way to measure speed is to make an old-fashioned log line and count knots in the line as it streams over the stern—the method that gave us the word “knot” for speed. You can improvise the knot spacing to suit your needs, but here is one way to do it. Tie some object to the line that floats but still has drag in the water (like the partially filled plastic bottle mentioned above). Then tie the first knot 20 feet or so from the object, maybe marked with a piece of cloth. Then tie another knot every 10 feet after that.

Fake the line out carefully so it can run freely, then cast off the float, letting the line stream through your hand. Start counting when the first marker passes your hand, and stop the line at 6 seconds. Haul in the line and count the knots, including the fraction left at your hand. The number of knots that passed your hand in 6 seconds is your speed in knots. If five and a half knots passed by, your speed was 5.5 knots. Or better still, especially at faster speeds, count to 12 and divide the number of knots by 2. With practice, this method is as accurate as a knotmeter. If you have to do it a lot, then a line on a drum or maybe a fishing reel might automate the process some.

For optimum accuracy, it is important to check the boat speed often. If your speed changes by 2 knots and you haven't noted it for 3 hours, you have lost 6 miles in accuracy. This doesn't have to happen very often before you develop serious position errors. It also helps to have frequent speed checks to determine your average speed. With a careful record, you can distinguish short-term fluctuations from the long-term changes that affect your average speed.

Once you have your average speed, distance run is just the average speed multiplied by the number of hours at that speed. If your average speed was 4 knots from 1000 to 1600 and 2 knots from 1600 to 2000, then in those 10 hours you have run:

$$(4 \times 6) + (2 \times 4) = 32 \text{ miles}$$

It is important to do the very best you can with your DR. Use every bit of information you have. Basic DR is your most powerful tool in an emergency. You can go a long way with it—if you keep up with it constantly. There will be errors of course, you can't avoid them all, but if you record all speed and course changes you know about, then chances are the ones you overlook will cancel each other out, as we'll see later in the Routine Navigation with Everything section in Chapter 14.

Prolonged storms are the enemies of accurate DR. In a storm, you have a lot to think about besides navigation, and your course and speed may change significantly. It is easier to say than do, but try to record the times of course changes and occasionally estimate your speed. Then, after things calm down, do your best to put it all back together. Accurate DR is hard work, and

there is certainly some luck involved. But remember the old saying, “The harder you work, the more luck you’ll have.”

Note that if your emergency has left you with a compass in a storm, chances are you will actually know your average course at the end of it fairly well. The reason is that in big waves, it is your compass course that is often foremost in your mind. When a wave throws you off course, your job as helmsman is to get back to the right course relative to the wind as quickly as you can, and the compass course, if not your first guide, will at least be something you check as soon as you are on course. At night you will be looking at it even more.

DR ERRORS FROM SPEED AND DIRECTION

An obvious goal of navigation is to know where you are. A less obvious but equally important goal is to know how well you know where you are—in other words, to know your accuracy. This is especially true in emergency navigation, since so much of it depends on estimates or makeshift measurements. If you figure you are 50 miles offshore, chances are you are reasonably confident your position is closer to 50 than to 100. But how sure are you that it is 50 and not 70, or 30? When a critical decision must be made on the basis of your navigation, you should be prepared to estimate the accuracy of your position.

Position Accuracy

It is helpful to think of position accuracy in terms of percentages. A position uncertainty of 5 miles represents a high level of accuracy if you have traveled 100 miles, but your accuracy is poor if your position is uncertain by 5 miles after traveling only 10 miles. In the first case, the accuracy is 5%; in the second case, it is 50%. A DR accuracy within a few percentage points would be very good, using the best onboard equipment available. With only limited instruments, or maybe none at all, 20% or so is reasonably accurate.

Also, by thinking of your DR accuracy in terms of percentages, it is easier to keep track of how position uncertainty increases over a long voyage. For example, suppose you have a compass, so you know your course accurately, but you have no log or knotmeter. If you decide you are figuring your distance traveled to an accuracy of 20%, it means your position grows uncertain by 20 miles for every 100 miles you travel, which is the same as a 2-mile uncertainty for each 10 miles traveled. With this accuracy, if you start out from a known position and travel what you think is 10 miles, then you can be fairly confident that you have covered at least 8 miles and probably less than 12 miles. After traveling 30 miles, you must assume that your position could be off by ± 6 miles, since 20% of 30 miles is 6 miles. Thus you can see that you should be conservative when estimating your accuracy.

Errors in a DR position can be caused by errors in the distance run or errors in the course direction. Speed and time-on-course errors affect only the distance run, while steering and leeway errors affect only the course direction. Currents, on the other hand, affect both the distance run and the direction.

Errors in Speed

Errors in speed can be caused by errors in the reference length used to measure the speed (boat length or line length) or by errors in timing the passage of this length. Your boat length or your height are known accurately, so line lengths can be measured with a little practice to within 5% accuracy.

Timing with a watch would essentially produce no error if it weren't for the uncertainties in the starting and stopping times. These add up to a possible error of at least 1 second. Put another way, it is hard to time any interval you might be interested in and obtain a result with less than ± 1 second of error. For a time interval of 5 seconds, your timing uncertainty is 1 out of 5, or 20%. This is the reason for trying to keep the time interval as long as possible when measuring boat speed, which is to say, make the log line as long as possible. If you double the time interval, your percentage error in timing is cut in half, since the 1-second starting and stopping uncertainty doesn't change.

In good conditions, you may have about a 5% error in length and about a 10% error in timing. This translates into a total speed error of about 11% in good conditions. You may say my arithmetic is strange, but it isn't. When you have two independent sources of error and one is much larger than the other, the combined error is not the sum of the two but is closer to the larger of the two errors. This is a mathematical result that takes into account the possibility that the errors could be in opposite directions.

From a statistical point of view, two independent errors (uncertainties) combine as the square root of the sum of their squares; in the last example:

$$11 \text{ is approximately } \sqrt{(5 \times 5) + (10 \times 10)}$$

Generally, this is not easy to figure in your head, but this procedure (coincidentally) is the same one used to figure the hypotenuse of a right triangle. Using this analogy, you have a simple way of figuring the combined effect of two errors. As illustrated in Figure 10-3, just sketch a right triangle, using any convenient scale, with the sides proportional to the two errors. The length of the hypotenuse on the same scale is then the combined error. The example in Figure 10-3 shows that a 10% error and a 15% error combine to an 18% error.

Using this procedure, it is easy to see why you can simply neglect the smaller error if it is much less than about half the larger one. In finding speed, if you have a 5% error in length and a 20% error in time, you can forget about the 5% error. Your final uncertainty in speed will be about 20%. On the other hand, if you must combine two errors of about the same size, the final error is about halfway between the sum of the errors and the error itself. Two 10% errors add up to a final error of about 15% (a right triangle would show the exact answer is 14%).

You may also wonder why we bother with this much detail. The reason is that it is unavoidable. You must be able to realistically assess your ability to navigate some particular route and then estimate the accuracy of your position along it. What you know well and what you don't know will vary with the circumstances, and you should be prepared to figure out how the particular uncertainties at hand will affect your navigation. If you must choose between heading for an isolated island 100 miles off versus a continent or string of islands 500 miles off, you had better know beforehand what your chances are of finding the isolated island.

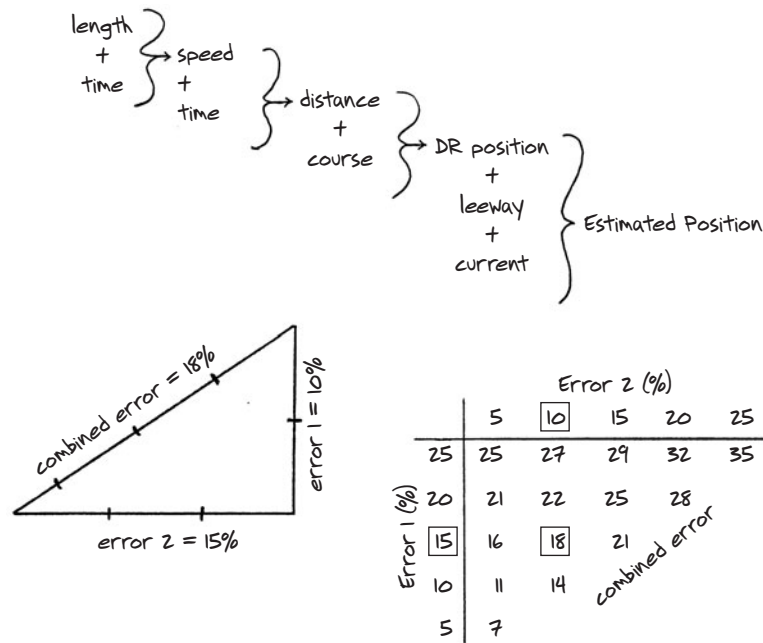

Figure 10-3. Combining independent errors. Independent errors (uncertainties) expressed as percentages add like the sides of a right triangle. The final uncertainty in your estimated position is the combination of the several factors shown. A watch is extremely valuable since it essentially eliminates the timing errors that lead to distance run.

So far, we have used one set of good conditions to illustrate boat speed accuracy—with a watch, a long line, and calm or moderate seas, you can figure your speed to an accuracy of about 10% or so. It is hard to do much better than this, but with some effort and luck you shouldn't have to do much worse under these conditions. A 20% uncertainty in speed, for example, is pretty large—at 5 knots, it would mean you couldn't tell if you were going 4 knots or 6 knots.

So how do you know how well you are doing? For runs of less than a few hundred miles (before the stars “begin to move”), the answer, unfortunately, is that you never really do, until you make your landfall or get some other confirmation. But you can test for consistency by looking at the spread in the values you use to get the average. In measuring speed by log line when you know the 10-foot spacings are accurate, the only uncertainty comes from the timing. At 12 seconds, we estimate this could be about 1 out of 12, or about 8%. If the average of several consecutive measurements is 5 knots, then the individual speeds should vary at most by 8% of 5, or 0.4 knot, between 5.4 and 4.6. If the spread is larger, you may not be timing to 8% accuracy or your speed is not constant to within 8%, and you should increase the uncertainty accordingly. You can't claim a speed accuracy of 8% if you can't reproduce the measurement to within an accuracy of about 8% using this method. Of course, your speed error would be even larger (and undetected) if the knot spacing was not as accurate as you thought.

Bear in mind, however, that regardless of how the average value and the individual values turn out, with these methods, you can't realistically expect to find average boat speed over an extended run with a level of accuracy higher than about 10%. You may find the speed at any one

time more accurately, but it is unlikely that you can check it often enough to claim an average speed with greater than 10% accuracy.

Errors in Distance Run

Errors in distance run are figured the same way as speed errors. You combine the uncertainty in speed with the uncertainty in the time at that speed. If your speed is 5 knots with an uncertainty of 10%, and you run for 10 hours exactly, then the distance run is 50 miles with an uncertainty of 10%, or 5 miles. The time is accurate in this case.

If the speed is 5 knots with a 10% uncertainty, and you run for about 10 hours, but you couldn't say for sure that it wasn't 9 or 11 hours, then you should take into account this extra uncertainty. Plus or minus 1 hour out of 10 is another 10% uncertainty. So in this case, you would still figure you ran 50 miles, but now the uncertainty is about 14% of 50, or 7 miles.

Again, this may appear pretty detailed for emergency navigation—on a 50-mile run, it is unlikely that the difference between a 10% and 14% uncertainty will make much difference to your decision making. But you must learn to appreciate that these details are generally more important in emergency navigation than in routine work. On a long voyage, it could easily be quite important as you approach land to know whether you have been navigating with, say, 20% or 50% accuracy. In the first case, your position uncertainty would be 40 miles after traveling 200 miles; in the second, it would be 100 out of 200. Furthermore, on still longer voyages when you must rely on makeshift celestial observations, your DR position and its accuracy must be continually compared with the celestial position and its own uncertainties. The more accurate your DR is, the better you can interpret the celestial observations.

How Much Accuracy Is Really Needed?

The ultimate accuracy you need, of course, always depends on what you are looking for. In the end, you must always compare your navigation accuracy with the visible range of your target. This topic is covered in the first two sections of Chapter 13.

This discussion of errors should show why it is so important to record the times of all course or speed changes. This is one source of error that can be avoided by keeping a close watch on your DR. The value of a watch is obvious. Even if you don't know the correct time, a running watch greatly improves your DR.

Emergency steering and direction errors were discussed briefly in the Steering without a Compass section in Chapter 3. The accuracy attainable depends on several factors, and typically it will vary from day to day and throughout the day, depending on the sea and sky. In many cases, steering errors tend to average out, which means the longer you strive for a particular course, checking and adjusting its direction regularly, the more accurate it becomes.

Taking into account the rotation of the sky, which helps average out some errors, the suggested rule of thumb for steering accuracy is about 12° , which translates into a lateral off-course position uncertainty of about 20%, as shown in Figure 3-7. In other words, each 100 miles you travel adds 20 miles of uncertainty to the left or right of your position. This estimate assumes you know your *average* heading to within an *average* uncertainty of $\pm 12^\circ$. This is not as difficult to

achieve as it may first appear, but it does take practice. If you are not confident you are doing this well on a particular course, it would be safer to increase your direction uncertainty accordingly. Plus or minus 18° is equivalent to a 30% position uncertainty. Figure 10-4 shows a graphical procedure for estimating lateral position uncertainties from course uncertainties.

On the other hand, if you have *Polaris* or other favorable stars to steer by, you may well do better than 12° . The best way to prepare yourself to gauge this accuracy is to practice the methods of Chapters 5 and 6 before you need them—when you have a compass and can tell precisely how well you are doing. Simply treat it as a game during your routine sailing—it is more than a trivial pursuit.

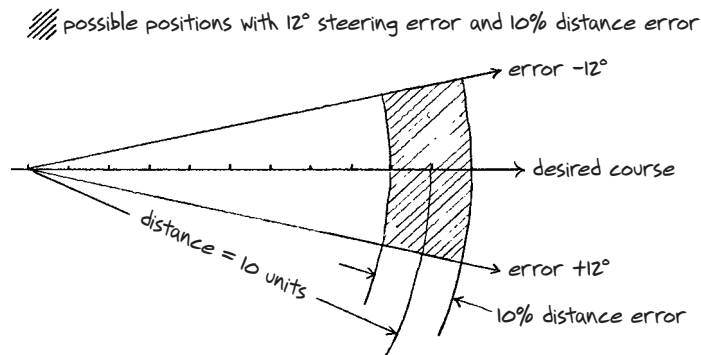

Figure 10-4. Graphical way to find the position uncertainty caused by errors in steering and distance run. Without a log or knotmeter, a 10% distance error is good work, but in many circumstances, and with some practice, you should be able to achieve a better accuracy than 12° on the average course held without a compass. The distance off course you expect to be after sailing with a specific, constant course error can be determined as in Figure 3-7.

Estimating Total Accuracy

You can now make an estimate of total DR accuracy by combining direction accuracy with distance-run accuracy. Do this using the right-triangle rule discussed earlier for combining errors. If you run 100 miles at 15% accuracy, steering at 20% accuracy, your combined position uncertainty would be about 25%, or 25 miles. This means that after 100 miles, you could be anywhere within a circle with a radius of 25 miles, drawn around your DR position (see Figure 10-5). This is a typical level of accuracy you might expect with some work and careful DR records.

If your star steering is weaker, say about 30% accuracy (heading uncertainty of about 18°), but you work harder on boat speed and get it down to 10% accuracy, then you are left with about 32% navigation accuracy, and your circle of uncertainty increases to 32 miles after 100 miles. With good star steering or favorable stars, you might expect 20% accuracy on direction and, with good boat speed measurements and careful course records, 10% accuracy on distance run, leaving an optimum accuracy of some 22%. It is unrealistic to hope for much better than that over a long run, in the best of conditions—which means no significant unknown currents and not going to weather in strong winds.

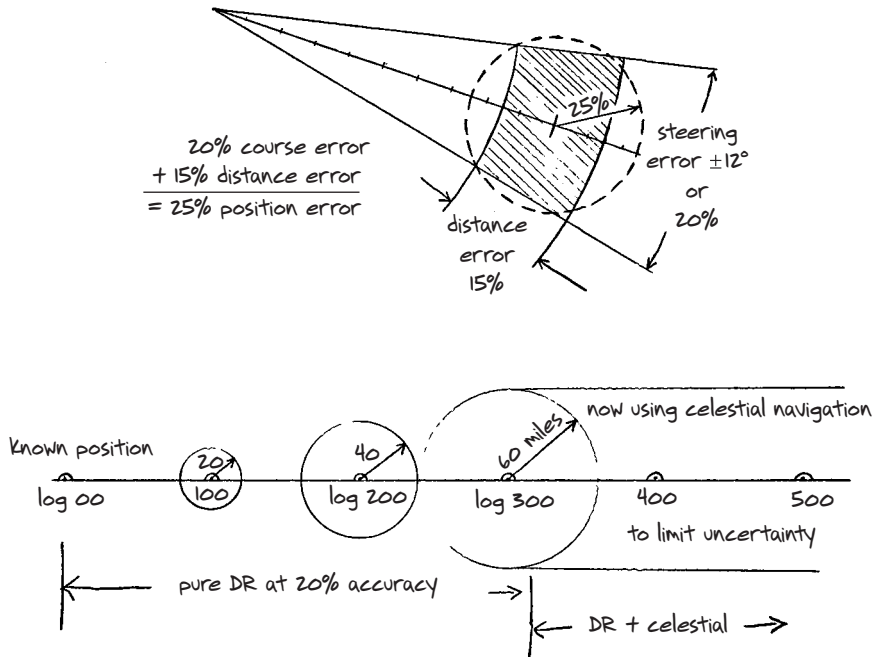

Figure 10-5. Position errors as percentages and how position uncertainty increases with distance run. By expressing steering (course) error as a percentage, you can figure position uncertainty without plotting, using the rules of Figure 10-3. This is, however, clearly an approximation, since the circle of uncertainty you figure this way does not coincide with the shaded area of uncertainty that you figure directly from course and distance. However, the convenience of the percentage method far outweighs its lack of precision. Using percentages, you can more easily tell which navigation factor is most important, and you can judge how far off course you might be after a given distance run—which is critical in determining the best route to safety. After a few hundred miles, it will pay to know the celestial methods that tell you latitude and longitude to within some 60 miles. Without such methods, DR position uncertainty would continue to grow.

Using the recommended 25% navigation accuracy as a typical goal, your position would be uncertain by about 75 miles after traveling 300 miles. But, as we'll see in Chapter 11, you should be able to read your latitude from the stars to within some 60 miles with practice, so you need not let latitude become uncertain by as much as 75 miles at any time or over any run. Your longitude accuracy depends on your watch. If you know UTC, you can do even better than 60 miles, but if you don't know UTC, your longitude uncertainty will generally increase as your DR uncertainty increases. There are ways to minimize this if you start from a known position, which we'll cover in Chapter 12.

We'll stress one final point about accuracy in navigation, which is again a mathematical result of statistics. Always bear in mind that we have been discussing estimates of how much your DR *could* be off as a result of measurement errors, not how much it *will* be off. Not counting unforeseen errors in a persistent direction, it is unlikely that you will be off by as much as these estimates show. Roughly speaking, there is a 50% chance that your actual error will be less than half of the estimated amounts. If you made that 100-mile run at 25% accuracy over and over

again, more than half the time you would be off course at the end by less than 12 miles or so, not 25 miles. But you are only going to do it once (you hope), so you can't count on anything better than what you've figured.

DR ERRORS FROM CURRENT AND LEEWAY

Since emergency navigation usually won't be accurate enough to measure the set and drift of typical ocean currents, the best you can do is simply guess the current using any resource you have, correct your DR accordingly, and estimate the uncertainties involved.

Once the guesses are in hand, corrections are easy to make. If the predicted current is 12 miles a day toward the southwest, at the end of each day's DR, adjust your DR position 12 miles to the southwest, and start the next day's DR from the shifted position. That's all there is to the correction, regardless of your course, or course changes, throughout the day.

Currents

Pilot charts are the most common source of current predictions. As mentioned in the Ocean Currents section in Chapter 9, a rule of thumb for the uncertainty in the listed currents is about 50%. If the current is listed as 14 miles a day, it adds an uncertainty of 7 miles a day to your DR, even after you correct your course for the 14-mile drift. You can combine this with your other uncertainties by converting it to a percentage of your day's run. On a 50-mile day, this current contributes an uncertainty of 7 out of 50, or 14%, to your position. If you are navigating with 25% accuracy (distance and direction combined), the current uncertainty increases this to about 29%, since $\sqrt{25^2 + 14^2} = 29$, according to the right-triangle rule.

You can use this procedure to adjust your DR underway or to estimate your potential progress across currents that lie ahead. Suppose your destination lies due south, but to get there you must sail across southeast trades and a westerly current drift of, say, 14 miles a day. To make good a course to the south against this current, you have to go east (to weather) at least 14 miles a day. To be safe, you should also figure in the current uncertainty, meaning you might have to make as much as 21 miles a day to the east. If you can't point into the wind enough to make this average easting, you may have to consider another route or destination. At the very least, you'll have to keep this current constantly in mind, and whenever the wind backs to the east, follow it around and get east as much as you can.

Leeway

Leeway is another matter, being a more complex effect than current. Any boat sailing to windward slips to leeward to some extent, which causes the actual course to deviate to leeward of the boat's heading. At first glance, this resembles the effect of current, in that both speed and course are affected. But on closer examination, the effects are different.

Leeway is motion *through* the water, not *with* the water as current is, and consequently you can measure it. Also, the effect of leeway on speed is not important, because any method you use to measure speed through the water includes the leeway, or downwind, component. You only

have to measure the leeway angle separately. Leeway angle (usually just called leeway) is the angle between the direction you are traveling through the water and the heading of the boat.

Factors Affecting Leeway

The amount of leeway depends on several factors, a principal one being the draft of the boat. A raft or other flat-bottomed craft has much more leeway than a keelboat; a shoal-draft keelboat has more leeway than a deep-keel boat. For any vessel, though, the amount of leeway is greatest when sailing close-hauled, and on any point of sail, leeway increases with wind strength.

A high-performance sailboat in moderate winds, for example, may slip only 4° or 5° to leeward of its optimum close-hauled course (usually about 45° off the true wind direction). In strong winds (say, 20 knots or so apparent), the leeway of this boat may increase to between 8° and 10°, but in practice probably not much more than this. A less efficient sailboat may slip as much as 15° or so in these winds. There is a practical upper limit to the leeway for all vessels because at a certain wind strength we finally give up the struggle and fall off some. And in a keelboat, leeway decreases rapidly as it falls off a close-hauled course—generally, leeway becomes negligible as the apparent wind approaches the beam.

In very light air, leeway is again a concern. Generally, leeway is much larger than you might suspect when sailing at less than 25% of your potential hull speed. A full-keel 36-footer, for example, sailing to weather at less than 2 knots, might slip to leeward 20° or so. Again, you tend to feel the inefficiency of the boat in these conditions and fall off to get more power, which reduces leeway. Nevertheless, you should keep these navigational consequences in mind if you ever get stuck trying to make way to windward in light air—such as when crossing a vast high-pressure area in the middle of the ocean.

Leeway is the principal concern when it comes to rigging a flat-bottomed boat for sailing. Even with a jury-rigged leeboard, you can't realistically hope to make much progress to weather. Here the concern may not be so much how close you can sail into the wind, but how far you can sail off of dead downwind. It is difficult to even estimate the answer—it depends on everything: hull, leeboard, rudder, rigging, sails, wind, and seas. But you can certainly count on a large leeway when trying to make way to weather in a flat boat. In any jury-rigged craft, you must definitely measure the leeway and figure it into your navigation. And don't forget the leeboard; even a paddle blade makes a big difference.

Measuring Leeway

The definition of leeway and the method of measuring it, however, do not depend on the type of boat or the extent of the leeway. Leeway is always the angle between the boat's track through the water and the direction the bow is pointed. In principle, the wake, or foam trail, of a boat provides the track you need. If a wake were discernible for a sufficient distance, you could measure the leeway by measuring the angle between the centerline and the wake line. But this is more of a theoretical than a practical approach in most circumstances.

A more practical method is to attach a light line somewhere near amidships on the centerline and stream it over the stern. The resistance of the water will pull the line taut in the direction

of your track through the water. Your leeway is then the angle between the dragging line and the centerline—the drag line acts as a visible wake. You can figure this angle by measuring the distance along the centerline from the attachment point to the stern and the distance athwartships along the stern from the centerline to the drag line, as illustrated in Figure 10-6. With these dimensions, you can draw a scaled-down version of the angle to estimate its size. The measurement is not affected by currents.

This measurement is harder to do in strong winds and rough seas, though these are some of the conditions you care about most. Waves throw you off course, which makes it difficult to judge the average shift of the line off the centerline. And strong winds tend to push the exposed line to leeward, which reduces the apparent leeway. As shown in Figure 10-6, your track through the water (the drag line) lies to windward of the stern, so when the line is pushed to leeward, the leeway angle appears smaller than it really is.

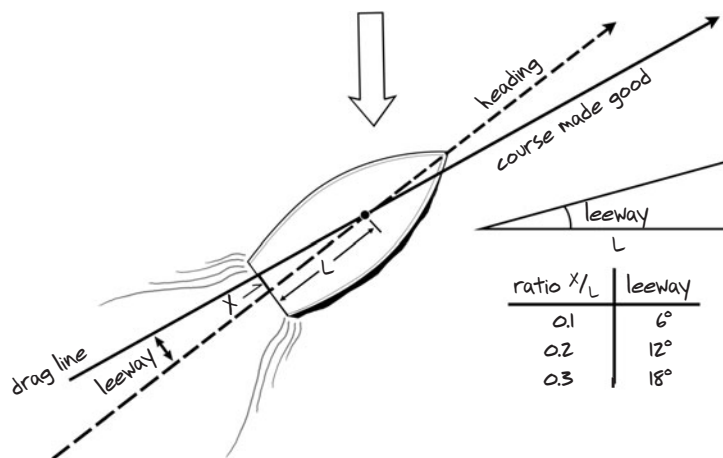

Figure 10-6. Measuring leeway by streaming a line over the stern. As the boat slips to leeward, the line slips to weather of the centerline. The angle between the dragging line and the centerline is your effective leeway. You can determine the angle from the proportions shown—essentially the same rule used in Figure 3-7 to find course errors. In many cases, it is adequate to simply attach the line to the stern and estimate its angle above the centerline.

In principle, you should attach the line to the boat directly below the center of effort of your sail plan, or near it, but it is often difficult to get an unobstructed path from there to the stern. The attachment point is especially important if the line is not light. The drag of the line, when it is attached forward of the center of effort (at the bow, for example), tends to increase your leeway, since the wind pivots the stern to leeward relative to the bow. But a line attached to the stern holds the stern to windward as the bow pivots to leeward, which reduces leeway—basically, a heavy line attached to the stern is a sea anchor. Try different sizes and lengths of line, if available, to find the optimum. You need some drag in the water to keep the line taut against the wind, but any line below the water doesn't help you judge the angle; it just causes drag, slowing you down and altering the true leeway angle if the attachment point is not correct.

Once you've measured the leeway angle, it is a simple matter to include it in your DR. Just offset your recorded course to leeward by the leeway angle, and base your navigation on this corrected course. In a craft with large leeway (and a line available), you could just cast off the line occasionally, align a makeshift compass card with the line, and note the way you are going. In other words, determine your course from the drag line, not the bow of the boat.

The Importance of Knowing Leeway

When sailing your own boat with a normal sail plan, the best approach is to know the leeway ahead of time for various winds, seas, and points of sail. In routine sailing, this information is most easily and accurately obtained by comparing your compass course (assumed accurate) to your GPS value of course over ground when sailing in slack water and steady winds. A well-kept logbook for one active sailing season should do the job, since you can interpolate from the data you get. Remember, you are after actual (effective) leeway, not theoretical values, which will always be much smaller. Published leeways for various yacht designs are like fuel consumption ratings for cars. They can be used to compare models, but they don't tell you what you will actually get in the stop-and-go traffic of honest waves or idling along in the windless middle of an ocean high.

Also, when doing these leeway studies, keep in mind the discussion of the Wind-Driven Currents section in Chapter 9. To have leeway you have to have wind; having wind for an extended time will create downwind currents that will look like leeway! Thus the ideal measurements would take place in a landlocked lake with no current, just after the wind has started but before it has blown for more than half a day or so. If there is doubt about this, go head to wind and just drift to see if your knotmeter speed equals your speed over ground (SOG). No SOG when drifting means no current; SOG with no knotmeter speed means current and no drift (leeway); SOG equal to knotmeter speed means you have some leeway just drifting there. Try different wind angles to test this.

These considerations might seem tedious, but in special circumstances they can be the most crucial element of the navigation. Consider a high-tech, fully equipped, racing rowboat team in the North Atlantic, heading to the UK. They know fairly well where the next favorable meander of the Gulf Stream is located and have to decide the best way to get to it. They could leave the main current at this point, which is turning due south, and sprint to the top of a band of favorable water just a day or two away. Or they could follow along the very much longer route of the current itself, which is looping south for a long run before turning northeast again. The long loop could take more than a week to cover, but if they take the short route and fail to get to the favorable meander in time, it will have moved away from them, and they will be stuck in a part of the ocean with no Gulf Stream at all to help them. They can row at about 2 knots in present seas and winds, and their wind drift is about 1 knot. The local current between meanders is about 0.5 to 1.0 knot (not the 3 to 4 knots of Gulf Stream they are after), and the meander is moving away from them at about 0.75 knot. And all these factors have their own directions! So it is easy to see that even with state-of-the-art GPS, knotmeter, and compass, this is a difficult tactical analysis. Add to all this that they may or may not have a weather report that tells them what the wind will be doing in the next day or so to help decide if wind or current is the key factor at hand.

Needless to say, this is not a typical example, but it is a real one where real analysis had to be done—with a very good outcome, as it turns out; the team won the race by more than a week on the closest competitor. The team ended up leaving the main flow of the Gulf Stream and racing to the top of the next meander, but it was a very hard pull. They had learned that they could spot the warmest water—and fastest current—by white clouds over it. They could see these white clouds ahead, slipping away from them, but they were able to catch them and pick up a tremendous ride for the next few days. It is not difficult to see how elements of this analysis could enter into various emergency situations or even routine yacht racing tactics.

PROGRESS TO WEATHER

Leeway and wind-driven currents act in the same general direction—to leeward. These are two subtle effects in light-air navigation, but their combined effect in strong winds is not subtle. If you overlook these effects, your progress to windward could be significantly less than anticipated. You must be careful about such things in emergency navigation, since you can't count on getting an accurate position later on (in better conditions) to correct for what you've overlooked.

As a specific example, suppose you are close-reaching across a sustained 20-knot northerly at an average speed of 7 knots on a heading of 060° True (an apparent wind of about 25 knots at 45°). And suppose you are unaware of a 6° leeway and the wind-driven current, which in this case is about 0.6 knot in the approximate direction of 210° True (see the Wind-Driven Currents section in Chapter 9).

DR without leeway or wind-driven current would predict a 24-hour run of 168 miles toward 060° True. The 6° of leeway, however, would cause a lateral error of 10% (about 17 miles) to the right of 060° , toward 150° True. And the wind-driven current would set you about 0.6×24 , or some 14 miles toward roughly 210° True during this day's run. The net error would be about 17 miles toward 150° True and 14 miles toward 210° True; when plotted out, as in Figure 10-7, you find the actual position is some 27 miles south (to leeward) of the uncorrected DR position. In the 168-mile run, this is a 16% error that you might have overlooked. And, frankly, even this apparently extreme example underestimates the problem.

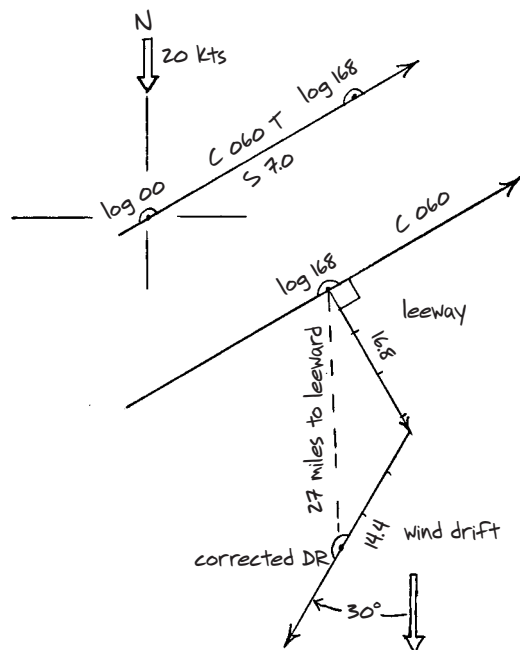

Figure 10-7. Progress to weather. Here a 6° leeway is accounted for as a 10% offset to leeward, and an estimated wind drift at 0.6 knot is assumed to flow 30° to the right of the wind direction. These are both rough estimates, but this corrected position will certainly be closer to the true position than the uncorrected one. These corrections imply a course made good of 069° T, with a net distance run of 157 nmi.

The drift of the current probably wouldn't be much larger than assumed, unless it were pouring rain all day, but the set could be more aligned with the wind than you assumed, especially at lower latitudes where the Coriolis force is weaker. With the current more aligned with the wind, the leeward error would be larger. Also, the leeway could easily be larger than assumed here. That depends on the vessel, sail plan, and heeling angle. But there is yet another problem—helmsmanship—as you confront successive waves. Boats tend to pound going to weather in big seas, and you often alter course briefly at each big wave to minimize this. If this is done by falling off slightly as the bow rises out of the water, you will have a brief but persistent course alteration to leeward, which also inhibits progress to weather over a long run. Estimates of this effect would be even shakier than the others, but it is something to keep in mind when figuring progress to weather in strong winds.

Again, keeping and studying a careful GPS logbook throughout various conditions will teach you about the performance of your boat to weather in strong winds, and thus better prepare you for sailing without GPS. What you are likely to find by studying these logbooks is that your actual miles covered are some 5% to 10% shy of what you figured from your log, with your course made good rotated downwind by some 10° to 20° . In the example of Figure 10-7, the course you sailed of 168 miles at 060° T, then corrected by 16.8 miles to 150° T and 14.4 miles to 210° T, is equivalent to a course made good of 069° T and a net distance of 157.4 miles—the correction was 6% of your distance and 9° of your course.

Chapter 11

LATITUDE AT SEA

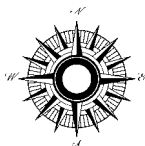

There are several independent ways to find latitude without modern instruments, and the principles behind these methods are easy to understand and remember. With practice, careful work, and some luck, you might achieve an average accuracy of within about 50 miles, although a more conservative range of about 90 miles is more realistic.

To find latitude from the stars, you must measure the angular height of a star above the horizon, or determine how close a star is to directly overhead. The measurements are the same ones used in direction finding, but now the measurements must be precise—latitude error is the same as the star-height error, and since 1° of latitude is 60 nmi, if a star height is wrong by 2° , the latitude figured from it will be wrong by 120 nmi.

As always, repetition is the key to accuracy. Repeat each measurement several times and average the results. You must also learn to calibrate improvised instruments and to choose the best method to use. It is difficult, for example, to measure a star height of 40° with an accuracy of $30'$, but it is easy to measure a height of 4° with this precision. In any event, the measurements take time and concentration and are often tiring to the eyes since most require extended periods of alternating eye focus between stars and hands. You may have to temporarily alter course for a smoother ride, or repeat measurements on several headings to get an accurate average.

MAKESHIFT ALTITUDE MEASUREMENTS AND CALIBRATIONS

Without a proper sextant, the most accurate and convenient angle (altitude) measurements will be of small angles, less than 15° or so. There are several reasons for this, some practical, some mathematical. With a little practice and the simplest of tools, you can measure small angles to within $15'$ or so. Larger angles require a different approach, and the results are less accurate.

Measuring Small Angles with a Kamal

The best makeshift device for measuring small angles is a kamal, mentioned briefly in the Local Apparent Noon section in Chapter 6 for keeping track of relative angles. A kamal is just a flat plate or stick with a knotted string attached to it with a bridle, as shown in Figure 11-1. With the knot in your teeth, hold the plate out in front of you, so that the top edge is aligned with the star, and your thumb is aligned with the horizon. Convert this measured distance along the plate edge to an angular height above the horizon. Holding the knotted string in your teeth keeps the eye-to-plate distance constant, and the bridle keeps the plate perpendicular to the string.

If you happen to have a centimeter ruler, you can make a kamal with built-in calibration. Use the ruler for the plate, and make the knot-to-plate distance equal to 57 centimeters. Then each centimeter along the edge of the plate equals 1° of angle for angles less than 15° or so.

But you don't need a ruler of any kind to make a calibrated kamal, and even if you make one with a ruler, you should still check its calibration with the stars. First, make a kamal with a comfortable string length just long enough so that you can extend it in front of your eye without

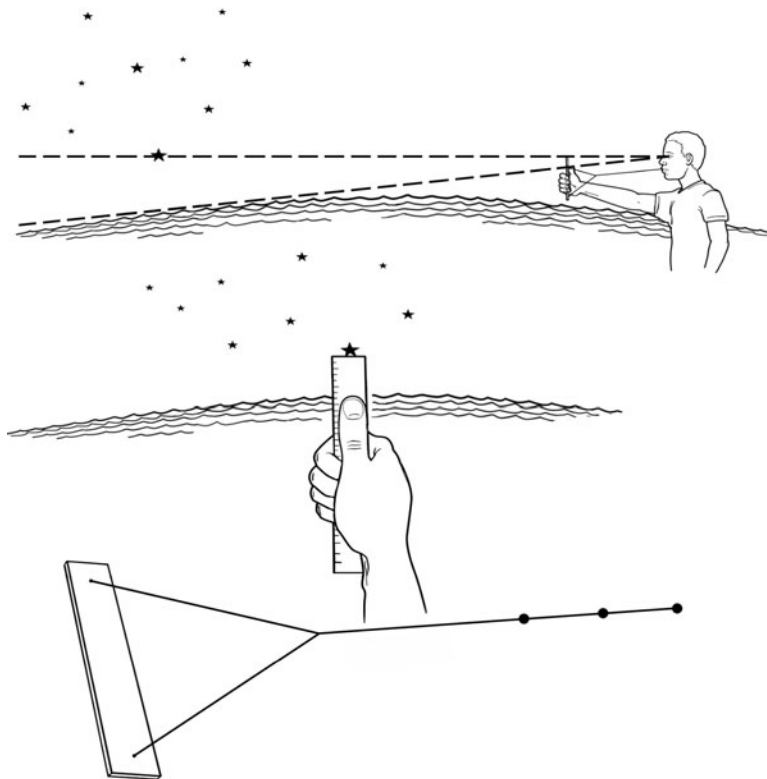

Figure 11-1. Using a kamal to measure small angles. A kamal is an ancient instrument used by Arabs for dhow navigation along the Persian Gulf and east coast of Africa. When the distance from knot to plate is 57 centimeters, each centimeter along the plate is 1° , although kamals of other dimensions can be calibrated just as well using the stars. Small angles can be measured accurately this way, but at larger angles only relative values or changes in angles can be determined.

having to push your shoulder forward. This length will be about 20 inches or so for average arm lengths, but the precise length doesn't matter. Then figure the angle scale along the edge of it from the stars. And now the key point—you need to know a few of these calibration star distances from memory.

Calibrating Star Distances

Figure 11-2 shows a few calibration distances in prominent constellations. The distances between the Pointers in the Big Dipper (5.4°) and the Guards in the Little Dipper (3.2°) make a numerical sequence that is easy to remember. You can also figure these distances for other pairs of stars that might be more convenient for practice. The simplest way is to plot the star positions as waypoints (using declinations for latitudes and sidereal hour angles for longitudes) in an eChart program, and then ask for the distances between them with a route or range-and-bearing tool. Without these electronic wonders, you can plot them on a universal plotting sheet (see Figure 11-3), and measure the distance between them using the latitude scale for degrees. The results will not be as precise, but will be perfectly useful for an emergency application.

You can also compute the distance between two stars using any great-circle navigation computation by inserting one star location as the departure point and the second star location as

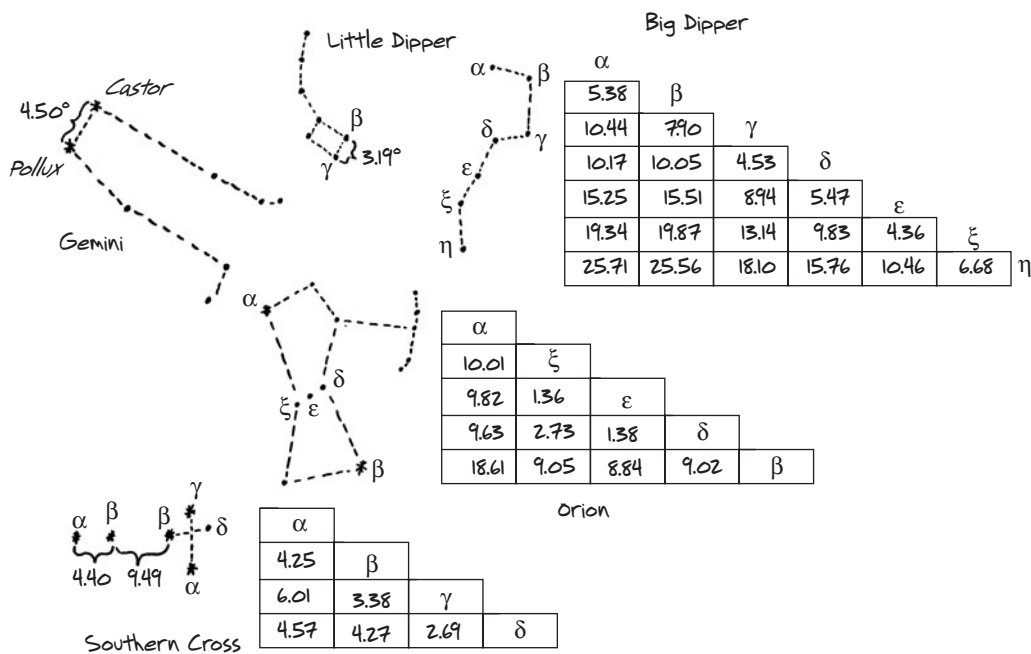

Figure 11-2. Selected star-pair calibration angles. Note the alpha-beta pairs of the Big and Little Dippers (the Pointers and the Guards) form a convenient sequence to remember (5.4° , 3.2°). The stars of Orion's belt are about 1.4° apart. The tables contain the spacings of several pairs in the adjacent constellations. These distances are most easily determined using a programmed calculator or computer and the great-circle sailing function, although they can be found graphically as in Figure 11-3, or entered as waypoints in an eChart program and solved for route distances.

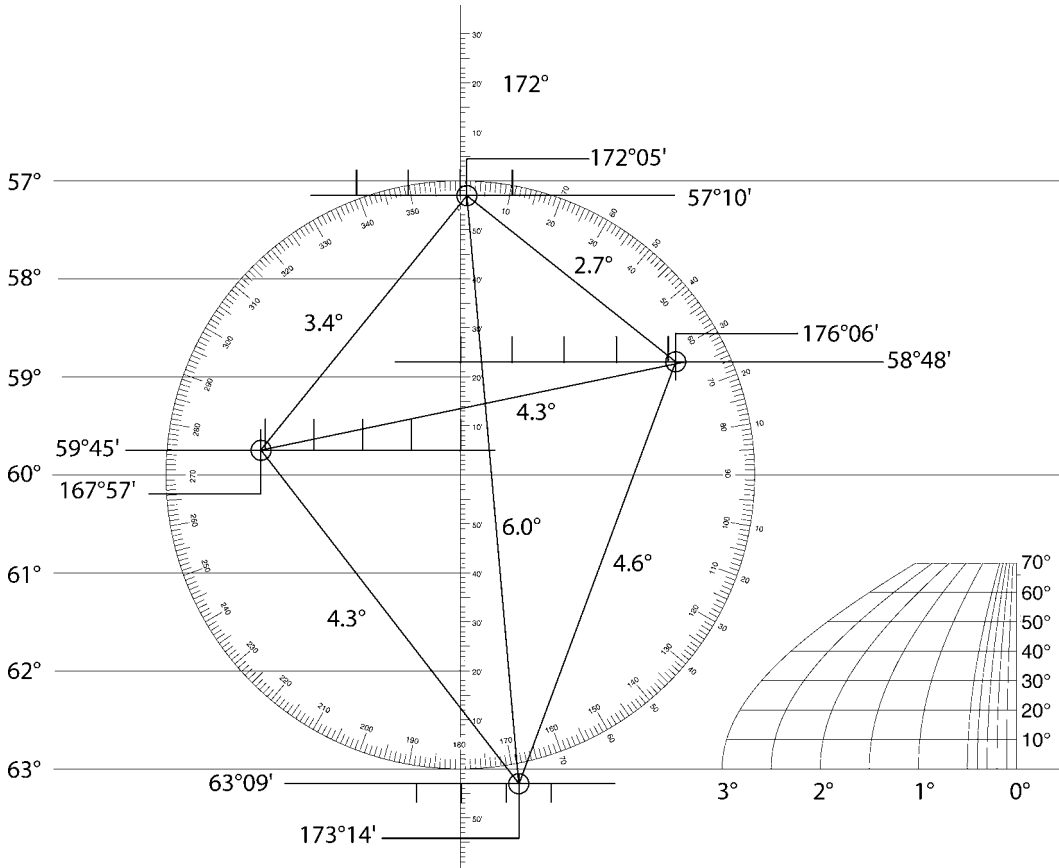

Figure 11-3. Graphical determination of the star spacings of the Southern Cross. The star positions are plotted on a universal plotting sheet using declination in place of latitude and sidereal hour angle (SHA) in place of longitude. Note that such a large “latitude” range (for declination) requires separate “longitude” scales (SHA) for each star, measured relative to SHA = 172°. This method should yield the correct values to within about $\pm 0.2^\circ$. The correct values are shown above, but the actual precision we obtained even with this graphical plotting were as noted. Manual plotting should not be much worse. You can also plot or enter the star locations as waypoints within an eChart program and measure the spacings as the route lengths from one to another. That is actually much easier and more accurate if you have access to such a program.

the destination point. The distance in nautical miles you get is the angular separation between them in arc minutes. (If you are familiar with celestial navigation terminology you can also compute the distances between two stars by doing a sight reduction using one star location as the Assumed Position and the other as the Geographical Position.)

Computing these distances may have to be done before an emergency requires their use, depending on what you are left with, but the angular distances between close stars that you figure this way (or measure directly with a sextant) are valuable aids in learning emergency navigation. You can, for example, use these distances to calibrate your hand and finger widths. For much of the star steering covered in Chapters 5 and 6, you need only approximate angles,

and once you know the angular width of your hand, for example, you can use it for these. A typical finger width at arm's length is about 2° , and an outstretched hand (thumb tip to little-finger tip) is about 20° . Once you have a few star distances marked on the edge of the kamal, you can figure out what the scale must be, since the angular scale is linear for small angles. The process is illustrated in Figure 11-4.

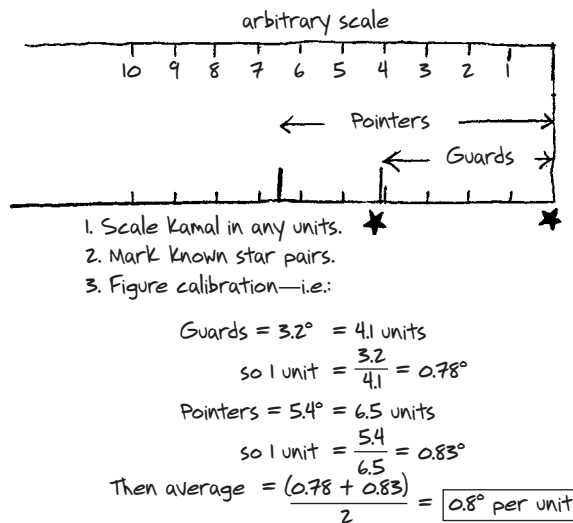

Figure 11-4. Calibrating a kamal. Align the kamal with star pairs of known separation, mark their distance along the plate, and then figure the calibration scale as shown. The example shown uses the Pointers and Guards of the Big and Little Dippers.

Taking Measurements with a Plumb-Bob Sextant

To measure larger angles, you need a more specialized piece of gear called a plumb-bob sextant. Making one requires a large, flat board some 18 inches on a side (like a locker cover or cabinet door); a section of tubing (boat pole section) or hose; two nails or screws, or some way to make holes in the board; a piece of string; and a weight. One design is shown in Figure 11-5. Let the sighting tube define the top edge of a large quadrant with a radius of 57 units, and then verify the other side of the quadrant with the horizon as shown. The string can serve as a draftsman's compass to mark the arc. To make the angle scale along the arc, use the rule that on an arc whose radius is 57 units, 1 unit = 1° . To use the device, align the star in the center of the tube and read the angle where the plumb line crosses the scale—or ask someone to read the scale as you keep it aligned.

The plumb line will swing around as the boat rocks, and you must keep the plate vertical so the string doesn't drag on the plate. But with patience and practice, you can measure star heights this way to within about 1° accuracy, providing the scale is constructed carefully. To make measurements alone, you must pinch the string against the plate while sighting the star and then read it. You need five or six sights for a good average. Two people, however, can do this much better than one. One holds the plate in-line with the star, and the other watches the plumb line on the scale to figure its average position.

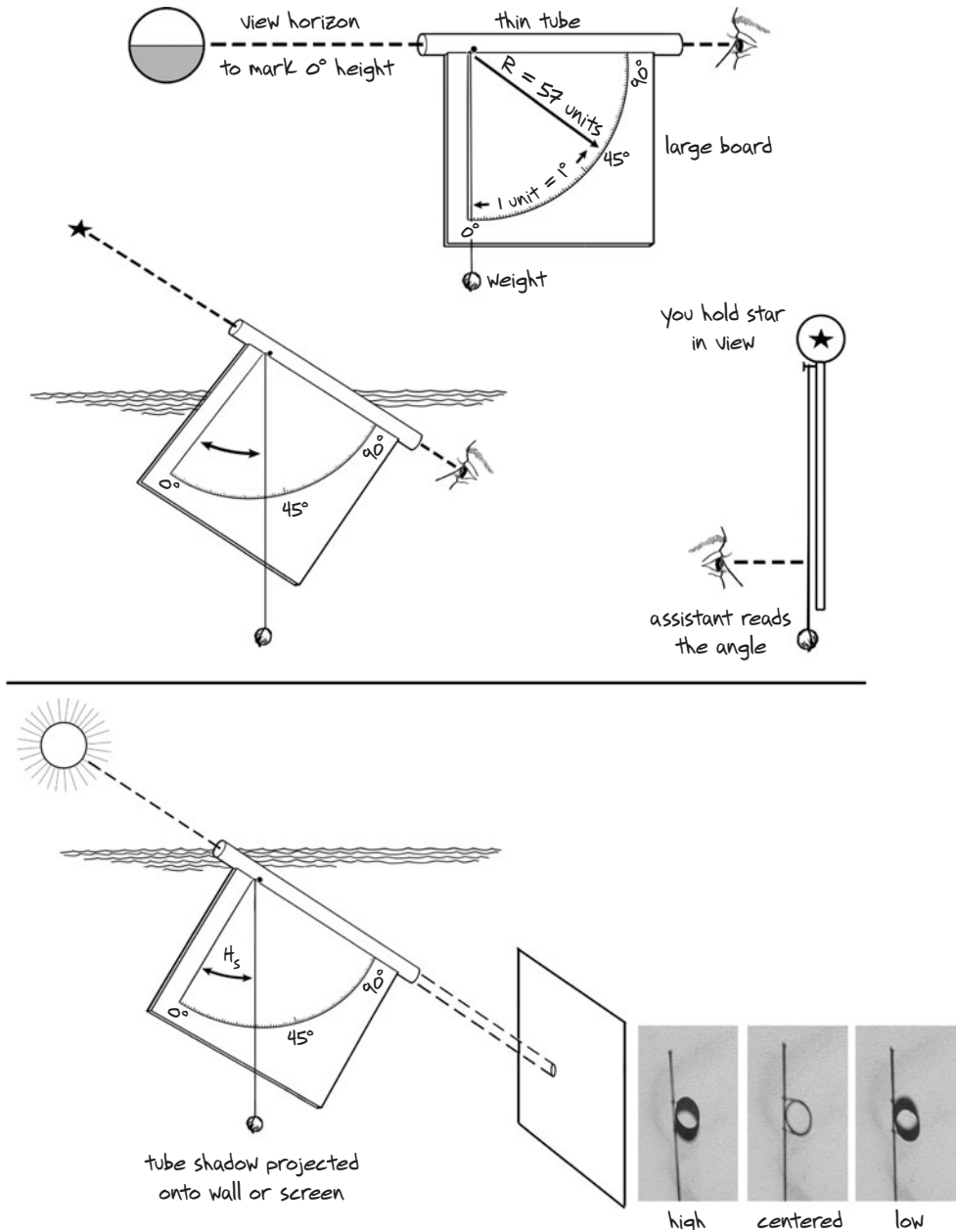

Figure 11-5. Using a plumb-bob sextant. Although it takes care to rig one of these to measure exact angles, it can be used more reliably for relative angles. If the scale is spaced properly, you can, for example, tell that a star height has dropped by 0.5° , but it will be much more difficult to decide if it went from, say, 35.5° to 35.0° or 35.0° to 34.5° . In any use, however, you must take many measurements and then average them for a good result. For use with the sun, shades are required, or use the shadow of the tube wall itself to properly orient the tube as shown in the bottom examples. The "projection screen" can be held by an assistant or rigged to be attached to the main instrument on a boom. For further details on tube quadrants, see the Measuring the Height of the Sun section below.

Star-height measurements made this way are not restricted to twilight since you don't need to see the horizon to do the sights. This makes a good plumb-bob sextant extremely valuable for several applications in latitude reckoning and direction finding. But it takes a lot of practice measuring known altitudes to convince yourself that it is doing the job properly.

To use this device with the sun, you must rig a transparent sun filter of some sort. Taking sun sights is still potentially dangerous to the eyes, so you have to be careful at all times. Alternatively, if you have a tube available (fairly common on a boat with hollow boat poles, mop handles, etc.), or if you can roll up a thin sheet of some material, then you might be able to use the sun's projected image seen after the sunlight passes through the tube, as shown in Figure 11-5. The idea is to watch the projected shadow of the tube circumference and orient the tube with the sun's direction until the pattern is symmetrical, which would mean you have the tube precisely in-line with the sun, and then measure the plumb-line angle. Several makeshift devices for measuring the sun's altitude are presented in the Measuring the Height of the Sun section later in this chapter.

Measuring Relative Angles

You can measure relative angles by several means, and often the eye alone is precise enough to judge relative sizes of small-angle intervals between stars. Viewing a group of three close stars, for example, it is usually easy to judge by just looking at them that, say, stars two and three are

twice as far apart as stars one and three. You can compare finger widths between the stars or distances along a kamal to confirm your observation. Similarly, at twilight you might be able to easily tell that the height of star three above the horizon is the same or just less than the distance between stars two and three.

Another trick is to close one eye and align your finger or a kamal with one of the stars. Then open your eye and close the other, holding your pointer as still as possible (see Figure 11-6). The pointer will shift about 6° , and this angular shift will always be the same—it is determined

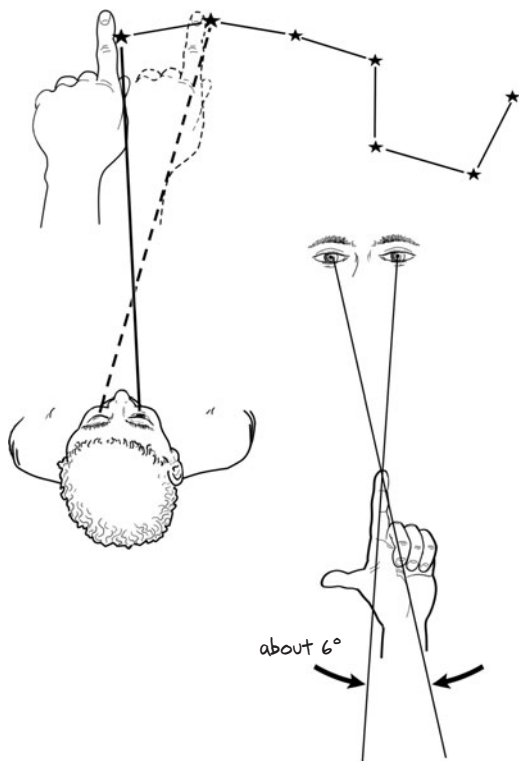

Figure 11-6. Winking your finger at arm's length to measure relative angles. Close one eye and hold your finger in-line with one star of a pair. Open your eye and close the other one. If your finger moves to the other star, the two stars are about 6° apart. If your finger only moves halfway to the other star, the stars are about 12° apart. Calibrate your wink using known star pairs or using a sextant and distant landmarks. A typical wink is about 6° . Winking a kamal edge is easier and more accurate than winking your finger.

by the eye-to-pointer distance (arm or kamal length) and the distance between your eyes. With known star distances or an available sextant, you can calibrate your “wink”—find out if your shift is 6° or 7° , or whatever—and then have this handy trick for quick small-angle measurements that can, with a little practice, be quite accurate. For example, you can find out how much you are slipping to leeward by winking your wake.

MAKESHIFT ALTITUDE CORRECTIONS

Angular height measured relative to the horizon must be corrected for several factors to figure latitude from it with optimum precision. The corrections are listed in the *Nautical Almanac*, and their application is standard procedure in routine celestial navigation. The corrections are each fairly small, but their sum can be significant, especially when you happen to have a sextant and can measure sun and star heights accurately. Even without a sextant and an almanac, you should not overlook these corrections in makeshift latitude sights, since you can estimate them fairly well without an almanac.

The altitude, or angular height, measured directly from a sextant or kamal is called *sextant height* (H_s). The angular height, after all corrections have been applied, is called *observed height* (H_o). You start with H_s and you want H_o . The altitude corrections can be summarized as follows:

$$H_o = H_s \pm IC - Dip - Refraction \pm Semi-diameter$$

The *index correction* (IC) is used only for sights with proper sextants, in which case it is read directly from the sextant after aligning the direct and reflected views of the horizon. It can be positive or negative.

Dip is the correction for the observer’s elevated eye height at the time of the sight. It applies to all sights with conventional sextants and kamals, but not to bubble or plumb-bob sextants. It is always a small negative correction and can be figured accurately from the square root of the observer’s height of eye, expressed in feet above the water:

$$Dip = 1' \times \sqrt{\text{Height of eye (feet)}}$$

For an eye height of 9 feet, the dip is $3'$, so the dip correction is $-3'$.

The *semi-diameter* is half the angular width of the sun, and you should correct for this width in all sun sights. You figure latitude (or any other sun line) from the height of the sun’s center, but you can only measure the height to its upper or lower limb. Within an accuracy of about $0.5'$, the sun’s semi-diameter is constant throughout the year at $16'$. Therefore, the semi-diameter correction is $+16'$ for lower-limb sights and $-16'$ for upper-limb sights. You must apply a similar correction to moon sights, although moon sights without an almanac are not usable and almanacs include the moon’s semi-diameter correction.

Refraction is the bending of light rays as they enter the atmosphere from the vacuum of space. It causes an error in all sights with any instruments. Refraction is largest for low sights, which makes it especially important in emergency navigation. The correction is always negative, but its size depends on the height of the sun or star. For sextant heights (H_s) greater than about 6° :

$$\text{Refraction} = 60' \div H_s$$

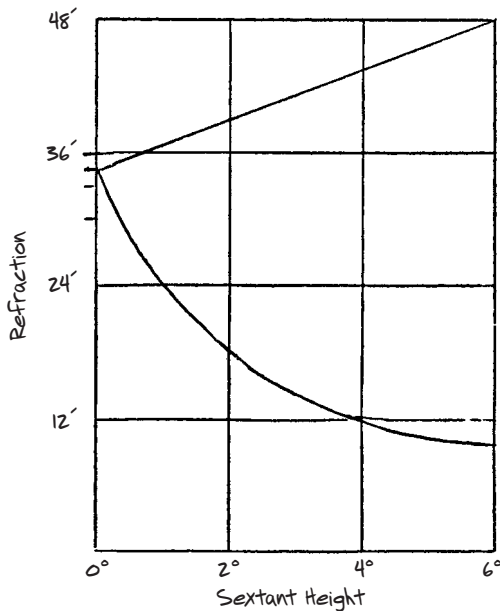

Figure 11-7. Low-angle refraction corrections to sextant sights. To construct the curve of refraction corrections, draw a rectangle as shown (made up of 12 squares), and swing an arc from the upper right corner, through a refraction of 34.5' ($\frac{1}{8}$ unit down from 36') at 0° sextant height. This curve reproduces the exact values to within 1' or so. At a sextant angle of 1°, the refraction correction is 24'; at 4°, it is 12'. This trick was developed by brute force (trial and error). At larger angles, refraction equals 60' divided by the sextant height in degrees. Another reference set that is convenient and easy to remember is at 5° the correction is 10', and at 10° the correction is 5'.

At a star height of 15°, the refraction would be $60' \div 15 = 4'$, so the refraction correction is $-4'$. This approximation is accurate to within about 1' for sextant heights greater than 6°. For lower heights, the correction must be figured with a graph, since it increases rapidly as the height decreases.

To figure low-angle refraction, construct a graph as shown in Figure 11-7. Draw a rectangular graph with 3 units on the horizontal axis to represent 6° of sextant height and 4 units on a vertical axis to represent 48' of refraction. Then, from the upper right corner, swing a circular arc through a refraction of 34.5' at $H_s = 0^\circ$. This arc (which will pass through a refraction of about 9' at $H_s = 6^\circ$) represents the curve of corrections for various small angles. It is accurate to within 1', in principle. With little practice, even a freehand drawing can reproduce the corrections to within a few minutes. The maximum value of 34.5' is an easy number to remember, and also easy to locate on the graph since it is $\frac{1}{8}$ unit down from the third mark, as shown in the figure. Also, one set of values I have found useful over the years, which spans the two approximation regions discussed above, is noting that at an elevation of 5° the correction is 10' and at an elevation of 10° the correction is 5'.

LATITUDE FROM POLARIS

A routine method of finding latitude in the Northern Hemisphere is to measure the angular height of *Polaris* above the horizon. The method works because *Polaris* lies very near the north pole of the sky, and the height of the pole is equal to the observer's latitude. Even without special corrections, the direct sextant height of *Polaris* gives you your latitude to an accuracy of about 1° at worst, and usually better than that. But you can't count on the greater accuracy unless you take into account the difference between the star's position and the pole's position.

To remove this 1° uncertainty, you must make the usual altitude corrections (see the previous section) to the sextant height (H_s) to get the observed height (H_o), and then apply a *Polaris* correction to account for the star's position at the time of the sight. This can be expressed as:

$$\text{Latitude} = H_o + \text{Polaris correction}$$

In routine navigation, you can find the *Polaris* correction in the *Nautical Almanac*, but it is easy to estimate this correction in an emergency without an almanac.

If an emergency leaves you in the Northern Hemisphere with a working sextant and nothing else, the height of *Polaris* is your best way to find and keep track of latitude. Without a sextant, however, the optimum value of this method is pretty much restricted to latitudes between about 5° N and 15° N. At higher latitudes, the star's height is difficult to measure accurately without a sextant, although a large plumb-bob sextant (see the beginning of this chapter) might be accurate to within 1° or so; at lower latitudes, the star is only rarely visible since it is not bright enough to shine through the haze of the low horizon. *Polaris* can't be seen in the Southern Hemisphere, and there is no south star counterpart.

To figure the *Polaris* correction, recall that the declination of *Polaris* is $N 89^{\circ} 18'$, which places the star $42'$ off the north pole of the sky. Consequently, *Polaris*, like all stars, circles the pole once every 24 hours. The only difference with *Polaris* is that its circle (of radius $42'$) is so small that it doesn't appear to move throughout the night. To find accurate latitude, though, you must take this motion into account even though you can't see it. It is the height of the pole (the center of the circle) that is your latitude, not the height of the star. Since you can't see the pole, you have to measure the height of the star, and then figure the difference between the pole height and the star height. This height difference is the *Polaris* correction—in the early days of navigation this was called the “regiment of the pole”—and you can read it from the relative positions of neighboring stars.

The modern “regiment” uses the constellations of Cassiopeia and the Big Dipper, which lie on opposite sides of *Polaris*. The line joining the trailing stars of Cassiopeia and the Big Dipper passes through *Polaris* and the pole, with *Polaris* on the Cassiopeia side of the pole. This line indicates where *Polaris* is relative to the pole. If the line is perpendicular to the horizon with Cassiopeia on top, *Polaris* is directly above the pole, so the correction is $-42'$. If the trailing star of the Big Dipper is on top, *Polaris* is directly below the pole and the correction is $+42'$. If the trailing-star line is parallel to the horizon, *Polaris* and the pole are at the same height, so there is no correction.

But you won't always be lucky enough to find this reference line in one of these convenient orientations during morning or evening twilight when you must do the sight. Generally, this line is tilted relative to the horizon, which puts the correction somewhere between $-42'$ and $+42'$. The first step, then, is to estimate the angle this line makes with the horizon (see Figure 11-8), which you can do using a folded piece of paper or two sticks.

Align one stick with the trailing-star line and hold the other perpendicular to the horizon and in-line with *Polaris*. The angle between the sticks gives the orientation of the line. Then draw a circle with a radius of 6 units to represent the path of *Polaris* around the pole, and draw a line through the center of the circle with the same orientation you observed for the trailing-star line. Now mark the circle with the position of *Polaris*, where the Cassiopeia side of the line crosses the circle. Draw in the vertical axis of the circle and mark it off in 1-unit intervals. Each unit equals $7'$ of angular height difference, which is just the correction you want. To get the correction, move the star to the vertical axis without changing its height and read the correction.

Notice that you don't need to see both Cassiopeia and the Big Dipper to find this correction. The orientation of the line can be found from *Polaris* and the trailing star of either constellation. At lower latitudes, part or all of one of the constellations may be below the horizon.

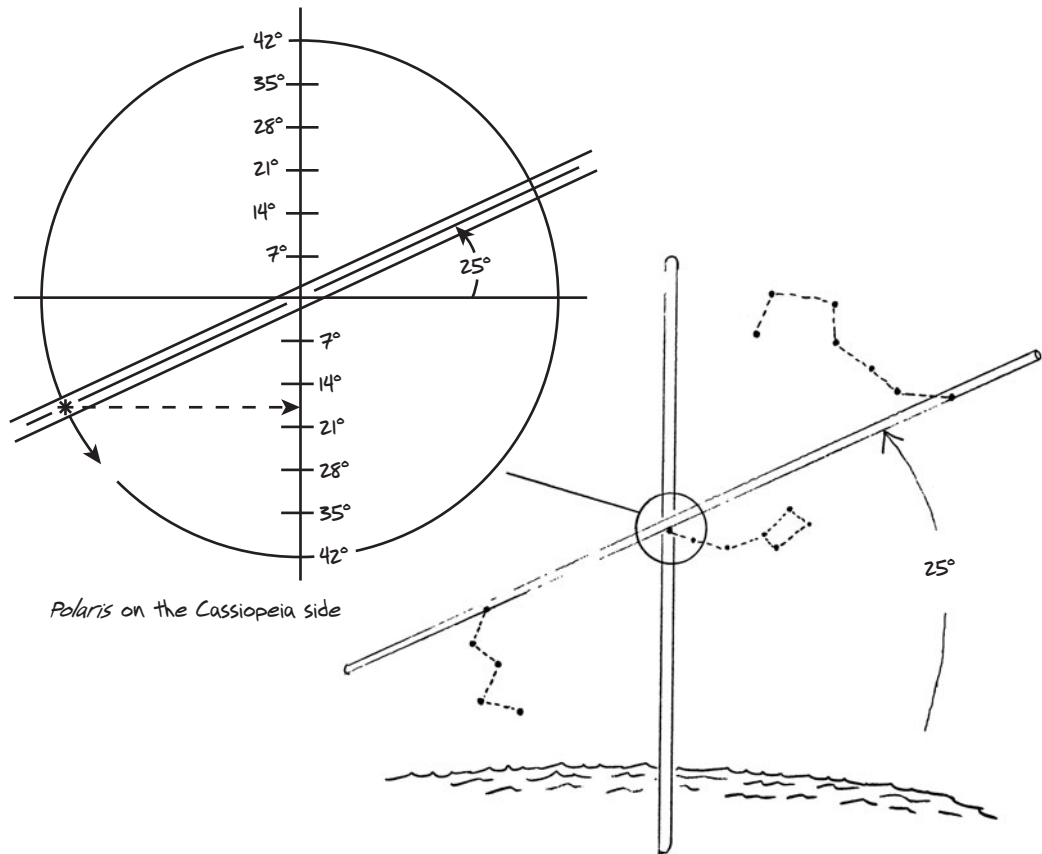

Figure 11-8. Correction needed to find latitude from the height of Polaris. The line between the trailing stars of Cassiopeia and the Big Dipper passes through both the north celestial pole and the star Polaris. The star is on the Cassiopeia side. Hold sticks as shown, or measure the orientation of the trailing-star line by other means, and from this determine the correction as shown. Polaris circles counterclockwise around the pole on a radius of 42'. If the sextant height of Polaris were measured at this moment, you would need to add 18' to that value to get the latitude, because at this moment the star is that much below the true pole of the sky.

Now let's review the full process. Say you measured the height of *Polaris* with a kamal several times and the average value was 10.4°, or 10° 24'. You also noted that the trailing-star line was tilted about 25° up from the horizon at the time of the sights (again the average of several measurements), with the Big Dipper above and to the right of the star. As shown in Figure 11-8, a tilt angle of 25° means the *Polaris* correction is +21'. Referring back to the previous section for the altitude corrections, for an eye height of about 9 feet, the dip correction is -3', and the refraction correction for a star height of 10° is 5', so:

$$\begin{aligned}
 H_o &= H_s - \text{Dip} - \text{Refraction} \\
 &= 10^\circ 24' - 3' - 5' \\
 &= 10^\circ 16'
 \end{aligned}$$

and

$$\begin{aligned} \text{Latitude} &= H_o + \text{Polaris correction} \\ &= 10^\circ 16' + 21' \\ &= 10^\circ 37' N \end{aligned}$$

With a sextant and nothing else but these makeshift corrections, you can usually find latitude to within about 10 to 15 miles at any north latitude. Without a sextant, measuring the height from a kamal (from latitudes south of about 15° N), you can find latitude this way to within about 30' in good conditions and nearly always to better than 50' or so. At higher northern latitudes, you are limited to accuracies of within 1° or 2°, depending on your success with a plumb-bob sextant.

Practice this method of finding emergency latitude when you have a sextant and proper tables to check your results, and you'll know how well you might do without them.

LATITUDE FROM ZENITH STARS

As we learned in Chapter 5, the point in the sky directly overhead is called the *zenith*, and stars that cross over your zenith are called *zenith stars*. Your latitude equals the declination of your zenith stars. The principle is simple and fundamental. The practical problem is deciding whether or not a particular star with a known declination is passing precisely overhead. If the star is not directly overhead at its highest point (meridian passage), you must estimate how many degrees it is to the north or south of your zenith when the star crosses your meridian. If a star passes 2° to the north of your zenith, your latitude is 2° south of the declination of the star—the height of this star as it crosses the meridian would be 88° above the northern horizon. Likewise, stars with declinations south of your latitude will pass to the south of your zenith by the corresponding number of degrees (see Figure 11-9).

Finding latitude from zenith stars is a well-established technique of no-instrument navigation. It has been used routinely by traditional navigators of the Pacific islands, and its practicality has been documented by several contemporary navigators (see the articles by David Lewis and Marvin Creamer listed in the No-Instrument Navigation section of the bibliography). With practice, you can achieve a consistent accuracy of about 1°. Obviously, the sea conditions and the stability of the vessel affect your ability to judge the overhead position of a star. But when the sky is clear enough to see zenith stars, more often than not you can use them to help you find latitude. Plus you can use this method at any time of night that known stars pass overhead, since you don't need to see the horizon to judge the zenith distance.

Another virtue of this method is that you are able to estimate its uncertainty by using the angular distances between stars near your chosen reference star. First establish your zenith point in the sky, and then compare the distance from it to your chosen star with the spacings of other overhead stars in view. After a series of measurements, for example, you might conclude that a star appears to be passing 2° south of your zenith, while related measurements might make you more confident that it is certainly more than 1° south and less than 3° south. You can combine this type of accurate information with the accuracy of your DR latitude, or with any

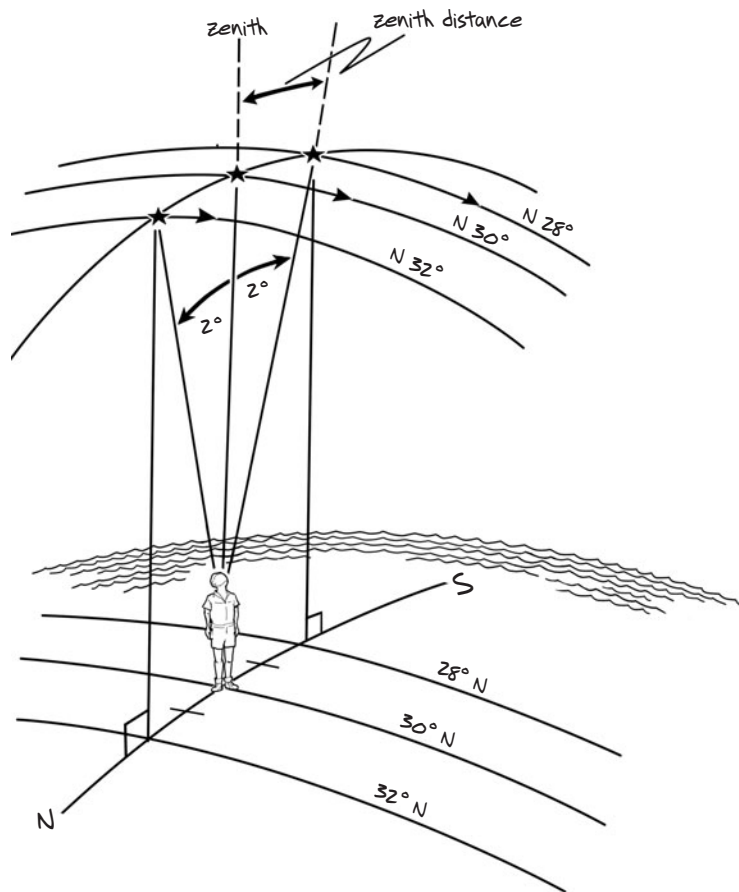

Figure 11-9. Finding latitude from zenith stars. A star that passes directly overhead has a declination equal to your latitude. If a star passes 2° to the south of your zenith as it crosses your meridian, your latitude is 2° north of the star's declination. See also Figure 5-21.

other means you have of checking latitude, to piece together the best possible estimate of your actual latitude. If your course takes you to the south at a DR rate of 60 miles a day, zenith stars should move north at a rate of 1° per day. If they don't, you are doing something wrong with your navigation.

Identifying Zenith Stars and Distances

It is easy to spot zenith stars and zenith distances on land by sighting upward along a pole or plumb line—any string with a weight attached. But at sea, you must contend with the motion of the boat. Several ways of observing overhead stars were suggested in the Overhead Stars section in Chapter 5 and illustrated in Figure 5-18. Sighting along the mast is one way. For this approach, you must take into account the heel of the boat and any rake or bend to the mast.

You will also have to find the optimum course heading for a smooth ride. Using the mast, it is easiest to determine when a star is at the zenith, or at least at its highest point, if you are sailing east or west. But the optimum course in any particular circumstance will depend on the wind and seas.

Another approach is to just look up toward the zenith and then turn in a circle. This may not be the most precise way to judge zenith stars, but it is a convenient way to tell when to start looking in whatever way you do decide is the most accurate. By turning in a circle, you overcome your natural tendency to underestimate the height of a high star (for low stars the common tendency is just the opposite, to overestimate the height). If the star is precisely overhead, it will appear that way regardless of which way you are facing. But if the star is not overhead, it will look lower when you are facing in one direction than when you are facing the opposite direction. If the height looks the same from all directions, you are ready to apply a more precise method.

Though it is sometimes frustrating and tiring to the eyes and neck, I have found that a plumb line can also be quite useful when taking this measurement at sea. The optimum arrangement is a line about 3 feet long attached to a holding stick. From a comfortable reclining position, hold the stick overhead and sight the star along the weighted line. The weight must be steadied continuously, but eventually you'll be able to determine an accurate average position. Or better still, find a place to rig the holding stick so you can lie under it without having to hold it. Attach a pointer to the top of the string for zenith angle calibration (see Figure 11-10).

Figure 11-10. Using a plumb line to spot zenith stars. Here the plumb line is a straight stick attached to a longer stick by a short string. The pointer at the top of the stick represents an angle of 4° , which you can use to judge the relative positions of overhead stars. Or better still, use a kamal to measure distances among close pairs (as made up among Rigel, star A, and star B) and then use these relative distances to judge the location of the zenith. Here, we are located just north of Orion's knees (Rigel and Saiph), about halfway between star A and star B. From the measured spacings of these stars, we can determine our latitude relative to the known declination of Rigel. Locate the zenith point by imagining the center of the pattern made by the motion of the plumb line against the background of stars. The plumb line must frequently be steadied by hand.

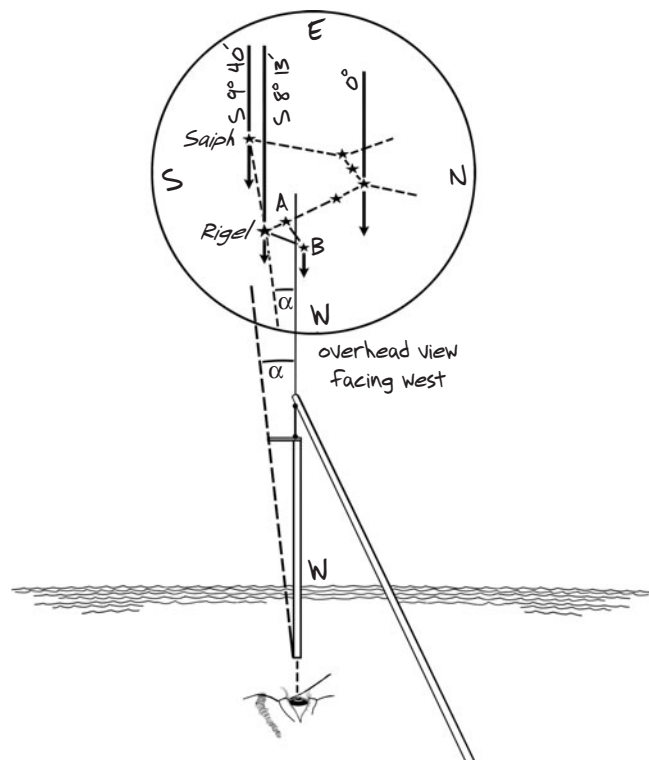

To make the calibrator, use the rule that 1 unit = 1° at a distance of 57 units. For example, at an eye-to-pointer distance of 28.5 inches (57×0.5 inch), each $\frac{1}{2}$ long the pointer is 1° of zenith distance. A 2-inch pointer would be 4° across. You need this information to judge how far off the zenith a known star passes.

Another convenient way to do this is to use a kamal to measure the distances between stars near your chosen reference star. It is easier to note that your reference star is, say, south of the zenith by half the distance between two other stars also in view at the time than to make an unaided guess at its zenith distance. With a calibrated kamal, you can measure the distances between any two close stars fairly accurately.

Try not to get discouraged when you first look up at the stars and find that your reference point (masthead or plumb line) is moving all over the sky, because it will do just that, even in fairly calm waters (see Figure 5-18). But as you watch it, you should be able to detect a repeated pattern. Your reference point is the center or an edge of the pattern, and you can measure the extent of the pattern using a kamal or other angle calibrator. Your job then is to estimate the number of degrees between the star and the reference point as the star passes through its highest point in the sky. With some practice you can gain help with this judgment by “winking” the zenith star (see the beginning of this chapter) as it crosses your reference marker.

Marvin Creamer (see the No-Instrument section of the bibliography) reported the method he found best for locating the zenith of a star was to imagine a great circle running through the zenith star in use and the pole star—or some equivalent location in the Southern Hemisphere. He then imagined this line as dividing the sky into two parts, and he watched this demarcation line in the full panorama of the sky. As the night progressed these two parts eventually became equal, which would put his zenith star in the middle of the sky, overhead. (No further details of the method or its specific results are available, but it is a nice concept, in-line with the Polynesian concept of navigating by the “shape of the whole sky.”)

The best way to remember the declinations of important stars along your route is to associate the stars with the islands or coastal landmarks they cross. Examples are shown in Figure 11-11. At the beginning of any long voyage (before a navigational emergency arises), check the sky throughout the night to see which stars are in season. From an almanac, pick a few prominent stars that cover the latitude range of your voyage and memorize their declinations by checking a chart to see what landmarks they cross. Then, if you should be left to navigate by the stars, you are prepared. Even without an emergency, this provides an interesting record of the sky along your route. You can use the progression of zenith stars to mark the progress of the voyage. Learning the stars becomes almost automatic if you use celestial navigation routinely. After several sight reductions of the same star, you often memorize its declination even if you didn't intend to.

LATITUDE FROM HORIZON-GRAZING STARS

If a bright star of known declination crosses the meridian at altitudes of some 15° or less during twilight, you have a unique and accurate means of finding latitude without a sextant. Star candidates for this method must be bright, since only bright stars can be routinely seen low on the horizon. Furthermore, if you consider the typical sailing domain as 60° N to 60° S, these stars

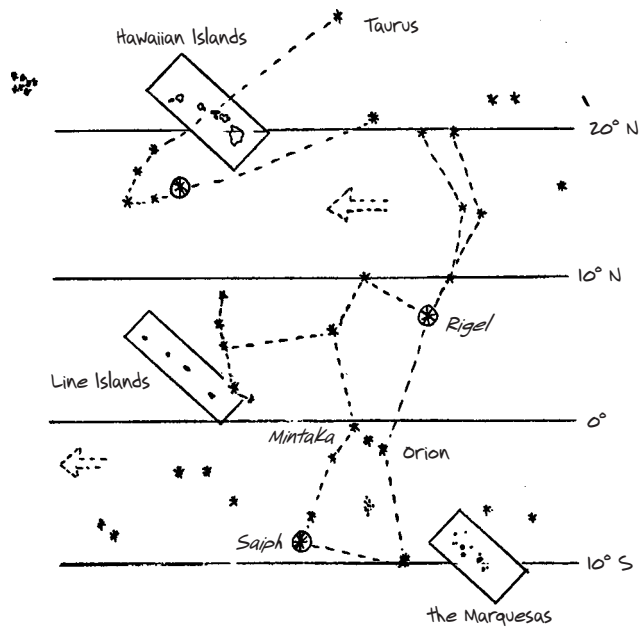
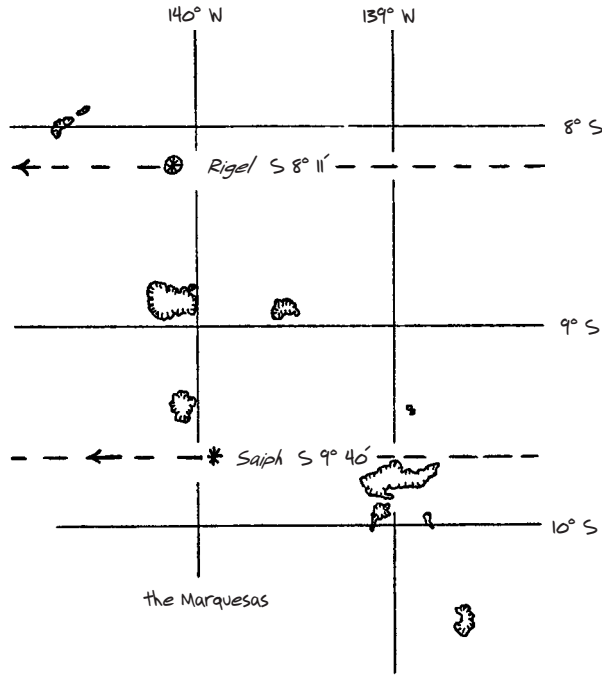

Figure 11-11. Taurus and Orion passing over islands of the mid-Pacific, with details of the Marquesas. Note that the stars near Orion's raised hand are zenith stars for Hawaii, as Orion's bow is for the Line Islands, and Orion's knees are for the Marquesas. Mintaka, the leading star of Orion's belt, circles the earth over the equator. About halfway between Rigel and Saiph would be a good target latitude for a winter voyage to the Marquesas.

must have fairly high declinations if you are to see them cross the meridian at low altitudes. In short, considering brightness and location, there are only six or seven dependable candidates for this method. (The six best are *Capella*, *Vega*, *Canopus*, *Hadar*, *Rigel Kentaurus*, and *Achernar*.) Nevertheless, these few stars alone offer remarkably extensive coverage when you consider their full potential.

Finding Latitude by Meridian Passage

This method is nothing more than conventional latitude by meridian passage applied to low-altitude stars. The principle is the same as the one used for latitude from zenith distance in the previous section. A star crossing the meridian to the south at an observed height of 10° up from the horizon has a zenith distance of 80° down from the zenith. Your northern latitude must be 80° north of the southern declination of the star. If you can measure the height of the star near the meridian, you can figure your latitude. The geometry was illustrated in Figure 5-21.

Any westbound star that crosses the meridian low on the horizon must have a declination name (north or south) contrary to your latitude; thus when you are in north latitudes, it must be a southern star, and vice versa. To figure latitude in this special case of meridian passage, first figure the *polar distance* of the star:

$$\text{Star's polar distance} = 90^\circ - \text{Star's declination}$$

The rule for figuring latitude from meridian passage of contrary-name westbound stars is:

$$\text{Latitude} = \text{Star's polar distance} - \text{Star's maximum } H_o$$

As a specific example, suppose you see *Canopus* (declination S $52^\circ 42'$) low on the southern meridian at twilight, from an eye height of 6 feet. Using a kamal, you measure its sextant height (H_s) to be $5^\circ 30'$. From the Makeshift Altitude Corrections section above, the dip correction is about $-2'$ and the refraction correction is about $-10'$, so:

$$\begin{aligned} H_o &= H_s - \text{Dip} - \text{Refraction} \\ &= 5^\circ 30' - 2' - 10' \\ &= 5^\circ 18' \end{aligned}$$

and:

$$\begin{aligned} \text{Polar distance} &= 89^\circ 60' - 52^\circ 42' \\ &= 37^\circ 20' \end{aligned}$$

You then find:

$$\begin{aligned} \text{Latitude} &= \text{Polar distance} - \text{maximum } H_o \\ &= 37^\circ 20' - 5^\circ 18' \\ &= 32^\circ 02' \text{ N} \end{aligned}$$

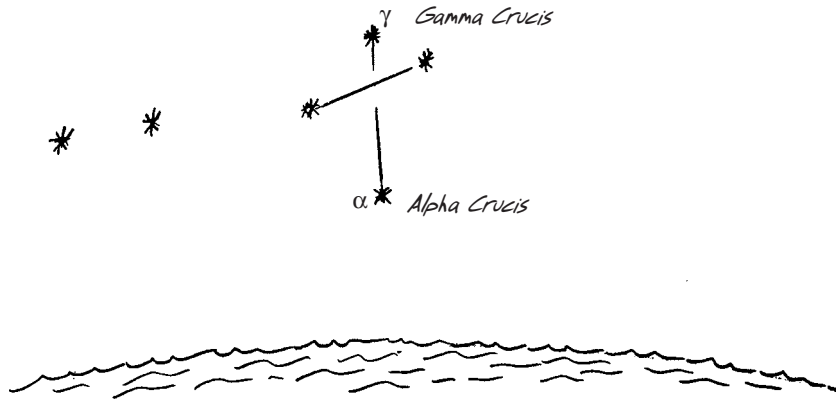

Figure 11-12. Latitude from the Southern Cross. This is a scene from a navigator's dream. The lower star of the Southern Cross, Alpha Crucis or Acrux, has declination S $63^{\circ} 09'$; the upper star, Gamma Crucis or Gacrux, has declination S $57^{\circ} 10'$. These are fairly easy references to remember, and since they are in-line with the south pole, this means they are almost exactly 6° apart. In this view, we know they are on the meridian because they are standing up, and we can tell by eye alone that Acrux is one cross length, or 6° , above the horizon. So its zenith distance is 84° and our latitude is 84° north of $63^{\circ} 09'$ S, or $20^{\circ} 51'$ N. Alternatively, using the latitude rules from the text, its polar distance ($90 - \text{declination}$) is $26^{\circ} 51'$, and its maximum height is 6° , so our latitude is $26^{\circ} 51' - 6^{\circ}$, or $20^{\circ} 51'$ N.

Canopus is the second brightest star in the sky, so it is a prime candidate for this method.

An especially nice example of this method is shown in Figure 11-12. If your known bright star has any star nearby in-line with the pole, you can tell at a glance when the star crosses the meridian—the pair will “stand up.”

You can also apply this method to circumpolar stars moving eastward across the meridian at the bottom of their circular path around the pole. The procedure is the same. Use a kamal to find the height of the star when it crosses or nears the meridian. In the Northern Hemisphere, you want the height of the star when it lies below *Polaris*. In the Southern Hemisphere, you don't have this luxury, but it is still easy to spot stars headed eastward. Viewed from any southern latitude, the stars that move eastward are the ones lying to the south with heights less than your latitude. The same is true looking north from northern latitudes.

For eastbound circumpolar stars, the height on the meridian will be the minimum height of the star as it dips below the pole. The rule for latitude from meridian passage of eastbound circumpolar stars is:

$$\text{Latitude} = \text{Star's polar distance} + \text{Star's minimum } H_0$$

To see a circumpolar star, you must be in the same hemisphere as the star, so latitude always has the same name as declination. Note that the two latitude rules are the same except for the sign of observed height; add minimum observed height for eastbound stars, but subtract maximum observed height for westbound stars. If you do it wrong, you get nonsense (relative to your DR latitude), which is your signal to try it the other way. This symmetry is the reason for the form of the latitude rules.

For example, you see *Capella* (declination N 46° 00') lying below *Polaris* at twilight, and you measure its sextant height (H_s) to be 3° 20' above the horizon from an eye height of 9 feet. So:

$$\begin{aligned} H_o &= H_s - Dip - Refraction \\ &= 3^\circ 20' - 3' - 13' \\ &= 3^\circ 04' \end{aligned}$$

and:

$$\begin{aligned} \text{Polar distance} &= 90^\circ 00' - 46^\circ 00' \\ &= 44^\circ 00' \end{aligned}$$

You then find:

$$\begin{aligned} \text{Latitude} &= \text{Polar distance} + \text{minimum } H_o \\ &= 44^\circ 00' + 3^\circ 04' \\ &= 47^\circ 04' N \end{aligned}$$

Unfortunately, there are not many bright candidates in the Northern Hemisphere for this circumpolar trick other than *Capella* and *Vega*, but on very clear nights, other northern stars may be useful if you happen to know the stars or have a list of star declinations. Sailing just south of the southern tropics, however, there are several bright stars for this application (see Table 11-1).

TABLE 11-1. OPPORTUNITIES FOR LATITUDE FROM HORIZON-GRAZING STARS*

STAR AND TRANSIT	LATITUDE AND DATES FOR A HEIGHT OF ABOUT 2°	LATITUDE AND DATES FOR A HEIGHT OF ABOUT 12°
1 EL	46° N, Jul 11–Sept 4	54° N, Jun 12–Aug 25
1 ML	46° N, Feb 24–Apr 27	54° N, Feb 19–Jun 7
1 EU	42° S, Jan 17–Mar 4	32° S, Jan 29–Mar 7
1 MU	42° S, Aug 31–Oct 22	32° S, Sept 3–Oct 13
2 EL	53° N, Mar 6–Mar 27	63° N, Mar 3–Mar 25
2 ML	53° N, Sept 29–Oct 21	63° N, Sept 29–Oct 22
2 EU	49° S, Sept 8–Sept 30	39° S, Sept 10–Oct 1
2 MU	49° S, Mar 27–Apr 17	39° S, Mar 27–Apr 17
3 EL	39° S, Sept 6–Sept 30	49° S, Sept 5–Sept 29

(continued)

**TABLE 11-1. OPPORTUNITIES FOR LATITUDE FROM HORIZON-GRAZING STARS*
(continued)**

STAR AND TRANSIT	LATITUDE AND DATES FOR A HEIGHT OF ABOUT 2°	LATITUDE AND DATES FOR A HEIGHT OF ABOUT 12°
3 ML	39° S, Mar 23–Apr 16	49° S, Mar 24–Apr 16
3 EU	35° N, Mar 4–Mar 28	25° N, Mar 5–Mar 28
3 MU	35° N, Sept 26–Oct 19	25° N, Sept 26–Oct 20
4 EL	35° S, Jul 5–Jul 31	45° S, Jul 8–Aug 4
4 ML	35° S, Jan 24–Feb 16	45° S, Jan 29–Feb 21
4 EU	31° N, Jan 2–Jan 26	21° N, Dec 30–Jan 23
4 MU	31° N, Jul 25–Aug 18	21° N, Jul 21–Aug 14
5 EL	32° S, Dec 10–Jan 8	42° S, Dec 1–Dec 31
5 ML	32° S, Jul 3–Aug 8	42° S, Jun 3–Aug 6
5 EU	28° N, Jun 12–Jul 12	18° N, Jun 19–Jul 18
5 MU	28° N, Jan 4–Feb 4	18° N, Jan 9–Feb 6
6 EL	31° S, Dec 18–Jan 18	41° S, Dec 9–Jan 10
6 ML	31° S, Jul 13–Aug 18	41° S, Jul 6–Aug 17
6 EU	27° N, Jun 21–Jul 23	17° N, Jun 28–Jul 28
6 MU	27° N, Jan 13–Feb 15	17° N, Jan 17–Feb 16
7 EL	29° S, Nov 22–Dec 18	39° S, Nov 15–Dec 12
7 ML	29° S, Jun 11–Jul 11	39° S, Jun 6–Jul 7
7 EU	25° N, May 23–Jun 20	15° N, May 29–Jun 25
7 MU	25° N, Dec 14–Jan 10	15° N, Dec 18–Jan 13
STAR	RELATIVE BRIGHTNESS	SIGHT ABBREVIATIONS
1. Capella	9	<i>E</i> = evening twilight
2. Vega	10	<i>M</i> = morning twilight
3. Canopus	25	
4. Achernar	6	<i>L</i> = lower transit
5. Hadar	5	<i>U</i> = upper transit
6. Rigil Kentaurus	10	
7. Acrux	4	

*For example, “1 EL” means evening lower transit sight of Capella, which is possible at any latitude between about 46° N and 54° N on any date between about July 11 and August 25.

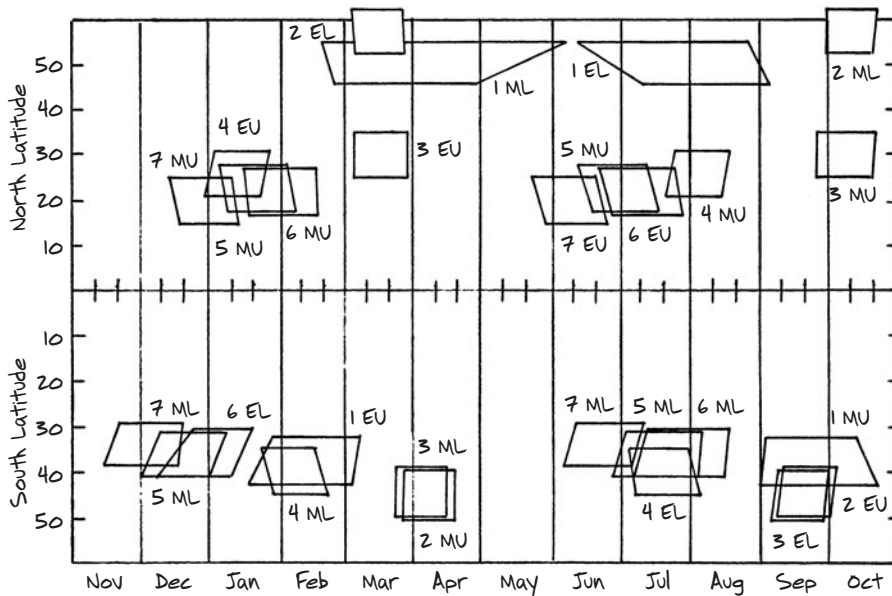

Figure 11-13. Opportunities for finding latitude from horizon-grazing stars. Outlined areas mark where and when a bright star will appear low on the meridian during twilight. See Table 11-1 for specific values and abbreviations. Acrux, shown low on the horizon in Figure 11-12, is star seven. The view shown in that figure must be either during morning (M) twilight of mid-December to mid-January, or evening (E) twilight of late May to late June. These computer calculations show that this method has a good chance of being useful in many parts of the world. It does not work near the equator, though, since there are no bright stars near either pole.

Considering both the westbound (called upper-transit) and eastbound (called lower-transit) applications of this method during both morning and evening twilight, opportunities for this type of sight are fairly numerous, even though there are only seven bright stars to choose from. The latitude ranges and available dates for these stars are shown in Figure 11-13 and in Table 11-1.

One factor that extends their usable dates is the low altitude of the stars at meridian passage. Since the stars are low, their height changes very little near the meridian, so you don't need to actually catch the star crossing the meridian during twilight to get an accurate latitude from its height. For example, a star might be headed toward the meridian at the start of twilight and still be some 5° from reaching it at the end of twilight, when it is too dark or too light to continue measuring its height. But since its arc is so flat, even at 5° off the meridian, its height will be well within 30' or so of its meridian height. This factor has been taken into account in the dates shown in Table 11-1. The information presented is not intended to help in an actual emergency application of this procedure; its goal is just to demonstrate the frequency of the opportunities, showing when and where you might practice it.

Remember that even the brightest stars will not appear bright when low on the horizon. But if the low horizon seems empty except for one faint star, you can bet it is a bright one or you wouldn't see it at all. And since bright stars are well-known stars, seeing one at all is usually enough to identify it. In exceptional cases with crystal-clear skies and about a three-quarter

moon high in the sky—a bright full moon is often too bright—this type of sight is possible during the night using a moonlit horizon, but it is a pretty rare combination of events. If you happen to see it, take advantage of it, but don't wait for it.

If you are confident that you are getting accurate readings from a plumb-bob sextant, you can extend this method to the meridian passage of any star with known declination. The lower-transit latitude rule given above is valid for any star height, but the upper-transit rule, as presented above, is only for contrary-name stars. For same-name stars, or near the equator when you don't know the name, use the latitude rule for the sun (see the Latitude from the Sun at LAN section below).

Although you are essentially limited to twilight sights for accurate latitude, the principle of this method provides a more general way to discover your approximate latitude. Sailing south from high northern latitudes, for example, you would not see *Canopus* at any time during the night; its high southern declination means it would stay below the horizon all night long. But as you continue south, at some latitude *Canopus* will appear on the horizon at some time during the night—providing, of course, it is the right season for it. When you first see *Canopus*, regardless of the time of night, you can figure out how far south you must be.

To do this, use the basic formula for meridian passage of westbound stars:

$$\text{Latitude} = \text{Star's polar distance} - \text{maximum } H_o$$

When the star first appears, its height must be near 0° , so your latitude must be roughly equal to the star's polar distance. The declination of *Canopus* is S $52^\circ 42'$, so the latitude at which *Canopus* first appears is:

$$90^\circ - 52^\circ 42' \text{ or about } 37^\circ 20' \text{ N}$$

If you see *Canopus* at all, at any time during the night, you know for certain that you are at least as far south as $37^\circ 20' \text{ N}$. The same reasoning applies when a star first fails to appear during the night as you sail away from it, but seeing is always better proof than not seeing. Again, because of their brightness and location, the stars listed in Table 11-1 are the prime candidates for such latitude readings, but now with the advantage that their useful dates are greatly extended since it doesn't matter at what time of night you see them.

LATITUDE FROM DOUBLE TRANSITS OF CIRCUMPOLAR STARS

With a working plumb-bob sextant at higher latitudes, you can find latitude from circumpolar stars whenever the night is at least 12 hours long. All you need is the minimum height of a star as it dips under the pole headed east and the maximum height of the same star as it climbs over the top of the pole headed west. The average of these is the height of the pole, which is your latitude:

$$\text{Latitude} = (\text{maximum } H_o + \text{minimum } H_o) \div 2$$

For example, suppose you are in southern latitudes (in the summer) and note that a medium-bright star lies to the south during the early evening. You observe its height with a plumb-bob

sextant (or kamal) and discover that its lowest height is about 13° . Then just before first light in the morning, it has circled halfway around the pole and is now passing through its maximum height of about 67° , which you've read with your plumb-bob sextant. Your latitude must be:

$$(13^\circ + 67^\circ) \div 2 = 40^\circ \text{ S}$$

This method requires chance circumstances, but not particularly rare ones, since you can use any circumpolar star. You don't need to know its declination.

LATITUDE FROM THE SUN AT LAN

In routine celestial navigation, it is standard procedure to find latitude from the meridian passage of the sun. It is not common, however, to use the meridian passage of stars for latitude, as described above. In emergency navigation, the reverse may be true. Though you can use the sun for directions, without a proper sextant it is difficult to measure the height of the noon sun accurately enough to get a useful latitude from it—but it is not impossible.

Since the first edition of this book, two expert sailors—Robin Knox-Johnston, September–October, 1989, and Bobby Schenk, November–December, 1992—have successfully crossed the Atlantic (Canary Islands to the Caribbean) with their only celestial observations being noon sights of the sun using crude or makeshift instruments. Both reported average accuracies of about $\pm 15'$, depending a bit on how this is defined. (See the notes to their entries in the No-Instrument Navigation section of the bibliography.) Their accounts led me to reevaluate my presentation of this method from the first edition, and the results have been encouraging—not to mention the great science fair projects they have inspired!

The problems related to this method are the sun's height and brightness at noon, which rule out the simple, accurate kamal approach. The only exceptions might be an emergency at a high north latitude in December or January or a high south latitude in June or July. In these cases, the noon sun might be low enough to measure with a kamal and a jury-rigged sunshade.

However, if you have a sextant or can make a tube quadrant as described below, the noon sun can be a valuable way to find latitude anywhere, especially in the Southern Hemisphere where you can't find latitude from the height of *Polaris*. The challenge is to construct a device that indicates the angle to the sun without damaging your eyes, and then devise a procedure that lets you determine what this angle actually is. There are several suggestions in the Measuring the Height of the Sun section below.

Determining the Sun's Declination

To get latitude from the height of the sun at meridian passage, you need to know the sun's declination, which changes slowly from day to day. It is listed in almanacs, but you can also figure it fairly accurately from the date. The rule for finding latitude from the sun's height on the meridian depends on where you are relative to the sun. To cover all cases, including a large uncertainty

in DR latitude very near the equator, it is simplest to give signs (+ or -) to latitude, declination, and zenith distances as follows:

- *North latitude and north declination are positive (+)*
- *South latitude and south declination are negative (-)*
- *Looking north to the sun, zenith distance is positive (+)*
- *Looking south to the sun, zenith distance is negative (-)*

With these signs, the equation for latitude is:

$$\text{Latitude} = \text{Declination} - \text{Zenith distance}$$

where

$$\text{Zenith distance} = 90^\circ - \text{maximum } H_o$$

To determine maximum observed height, measure sextant height every few minutes or so as the sun crosses the meridian at midday, and then apply the altitude corrections (see the Make-shift Altitude Corrections section earlier in this chapter) to the maximum sextant-height value.

Here is an example: Looking south to the noon sun, we find its maximum observed height to be 70° when the sun's declination is S 21° .

$$\text{Zenith distance} = -(90^\circ - 70^\circ) = -20^\circ$$

The declination is -21° , so

$$\begin{aligned} \text{Latitude} &= -21^\circ - (-20^\circ) = -0 - 1^\circ + 20^\circ \\ &= -1^\circ \\ &= 1^\circ \text{ S} \end{aligned}$$

A second example is: Looking north to the noon sun, we find its maximum observed height is 60° when its declination is N 15° .

$$\text{Zenith distance} = +(90^\circ - 60^\circ) = +30^\circ$$

The declination is $+15^\circ$, so

$$\begin{aligned} \text{Latitude} &= +15^\circ - (+30^\circ) = -15^\circ \\ &= 15^\circ \text{ S} \end{aligned}$$

Note that for this method of figuring latitude you don't need to know what side of the equator you are or a DR latitude. Generally, however, you know both, in which case the rule is a lot simpler. Latitude is either the sum or the difference between H_o and zenith distance: to get latitude, add them; if that result is nonsense, subtract them; and if it is not clear, use the formula just given.

To figure the declination of the sun (without an almanac), you first need to figure where you are within the present season by counting days. You then convert this position to an angle, since the sun's declination varies throughout the year in a circular pattern. The seasons are marked by the equinoxes and solstices, as shown in Figure 11-14, so figure the angle α as follows:

$$\alpha = [S \div (S + E)] \times 90^\circ$$

where

S = the number of days to the nearest solstice

E = the number of days to the nearest equinox

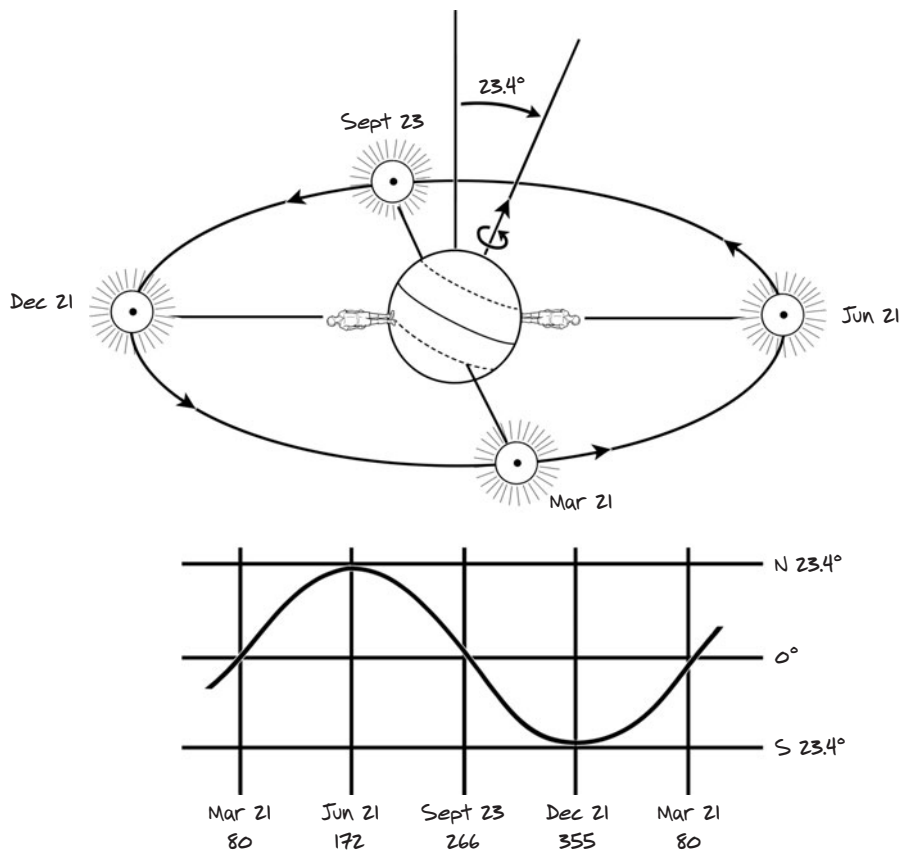

Figure 11-14. Declination of the sun. The sun's declination varies from N 23.4° (or more precisely, 23° 26') to S 23.4°. We use the decimal form here to emphasize the unique number sequence that makes the maximum value easy to remember. The turning points are at the solstices, June 21 and December 21, the longest and shortest days of the year. The sun crosses the equator on the equinoxes, March 21 and September 23, at which times the lengths of day and night are the same. The declination changes most rapidly near the equinoxes (some 24' per day) and most slowly near the solstices. The seasonal oscillation of the declination occurs because the tilt of the earth's axis remains constant as it circles the sun—here shown in reverse, with the sun circling the earth.

If you happen to have a calculator (or cell phone!) that does trig functions, then you can find declination from:

$$\text{Declination} = 23.4^\circ \times \text{Cos}(\alpha)$$

If you don't have a calculator, there is a simple graphical solution: Draw a quadrant of a circle using a makeshift compass card (see the Steering without a Compass section in Chapter 3), and measure the ratio of X/R, as shown in Figure 11-15. You can use any units you like for the length measurements since you only need the ratio. The sun's declination is then found from:

$$\text{Sun's declination} = [X/R] \times 23.4^\circ$$

Figure 11-15. Figuring the sun's declination from the date. Count days to find your angular location within the season, construct the angle and measure the ratio of sides as shown, and use this ratio to scale the maximum value of 23.4° . The radius, R, can be any length. Note how the declination changes slowly as the angle (the date) rises above the solstice, but then changes more rapidly as you approach the equinox. Plotted very carefully, this method is accurate to within $10'$ or so, although an accuracy of $20'$ to $30'$ is a more practical goal. A calculator solution is: $\text{Declination} = 23.4^\circ \times \text{Cos}(\alpha)$. The exact value for July 30 at noon is $N 18^\circ 33', \pm 5'$ depending on your location within the leap-year cycle. The declination on a given date varies some $10'$ within this cycle, but each date has essentially the same declination every four years. Sunrise and sunset times repeat in the same manner.

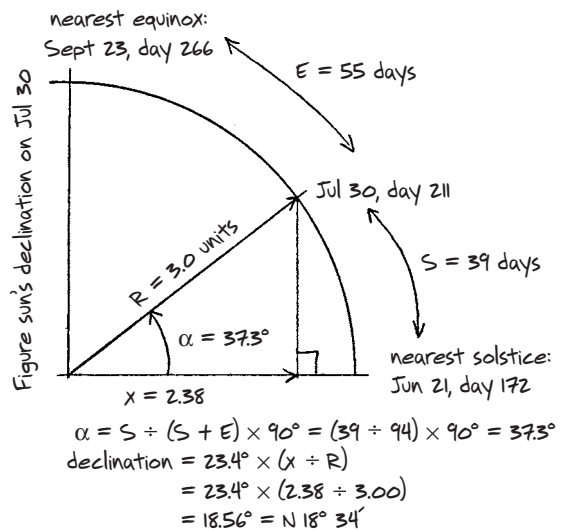

You must, however, still remember when the declination is north (summer half of the year) and when it is south (winter half of the year), as shown in Figure 11-14. In principle, this procedure is accurate to within about $10'$, but some precision is bound to be lost in the drawing. With reasonable care, accuracy to within $30'$ should be possible.

With a sextant and no almanac, your first step should be to generate a declination table, rather than figuring each declination separately when you need it.

Measuring the Height of the Sun

Obviously if you are at home with a workbench and tools at hand, you can construct a device that would measure the height of the sun to just about any precision you desire. Tycho Brahe's famous mural quadrant was accurate to better than $1'$ in 1582—but it took up one wall of a big room. The question is, what can you make in an emergency situation from what you might find

on a typical yacht, and how do you handle the fact that at sea you might have to make measurements from an unstable platform?

The answer to the last question is easy. Without a proper sextant, you probably can't do sights in all conditions, and you may well be restricted to sights in only the best conditions. Reports of actual makeshift sun measurements underway (see the No-Instrument Navigation section in the bibliography) confirm that the measurements were restricted to reasonably good conditions, with notes by all that on some days it was just too rough to take the sights. Even on calm days, if the sun is not shining brightly the sights may not be done well, though this depends on the method being used. Anything using a shadow needs bright sun, but a tube or sighting quadrant with a sunshade might work better with a partially overcast sun.

Below are a few ways to measure the height of the sun at noon. The best reference for such devices is in the history of celestial navigation prior to, say, the development of the backstaff (roughly before the mid-1600s), which is covered in some depth in the first six chapters of Charles Cotter's *A History of the Navigator's Sextant* (see the No-Instruments Navigation section in the bibliography). The key to the construction of some devices is a procedure for labeling the angles based on shadow locations. With a calculator and some knowledge of trigonometry, most of the devices are fairly straightforward to calibrate, but this is not a set of circumstances you can count on. Thus you are limited primarily to designs that use a true circular scale or some simple derivative. This rules out, for example, the popular cross-staff of the early days of navigation, which is relatively easy to build and use but not so easy to calibrate.

Most navigation stations have compass roses readily available, and some even have radar or celestial plotting sheets with large compass roses printed on them, which are ideal for laying out the angles for a makeshift sextant. Without such aids (or maybe even with them), it can be handy to remember that:

$$\text{Circumference} = 2 \pi \times \text{Radius}$$

So if you want a circumference of 360 units for easy angular degrees layout, you need:

$$\text{Radius} = 360 \div 2 \pi = 57.3$$

Thus if you carefully draw a circle with a radius of, say, 57.3×5 mm (11.28 inches), then each 5 mm along the circumference will be exactly 1° . One way to draw the circle very carefully is to measure 57.3×5 mm along a thin flat stick (such as a sail batten or yardstick) and then drill small holes at each endpoint. A divider point in one hole to mark the center and a pencil point in the other hole to draw the line will result in a very accurate circle. The 5 mm unit used here is just an example. You can multiply 57.3 by anything: 0.25 inch, 0.5 inch, or the spacing between two tick marks on an envelope.

In addition to the challenge of constructing a calibrated device, the actual measurements themselves take patience and practice. The inherent conflict is that the larger the makeshift instruments are, the more accurate they are, but the more unwieldy they become, and the more sail area they project. You may have to head downwind to reduce apparent wind and still find a sheltered place on the boat for the sights. It also helps to be seated comfortable and ideally with some rig to hang the device by so you can concentrate on keeping it aligned with the sun without having to hold it up yourself. Also you must hold or fix your watch in the same view as the

shadow or sunbeam you are using to judge the alignment. If you have to turn your view to read the watch, it is easy to lose the alignment.

Shadow Pegboard

The first device we'll cover is a shadow pegboard (see Figures 6-9 and 6-12). Bobby Schenk and his crew (see the No-Instrument Navigation section of the bibliography) used a thin string attached to the top of a peg, a similar method. After leveling the board with the horizon, they pinned the string to the board at the tip of the shadow. Then, while no longer worrying about leveling, they measured the angle the string made with the board using a regular protractor. Their equipment was all relatively small, but by making multiple measurements, they reported they were able to achieve accuracies of less than 15' of latitude ($\frac{1}{4}^\circ$). The tests were made after the voyage, as they did not have a tracking system to compare actual data when underway. (Presumably you could just mark the shadow-tip location when level and then apply the thin string later for the angle measurement.) I have not had as good results with this method as those reported.

Shadow Pinboard

The shadow pinboard is a variation of the pegboard (see Figure 6-13). You can mark the shadows along the base board as shown, or add a square or circular rim to record the shadow locations. In this design, you measure the angle directly with a protractor, although the vertical reference is difficult to establish. The T-shaped instrument is a variation, but also one that is difficult to calibrate. If the shadow is marked on a circular rim, the device is then a form of mariner's ring (described next).

Mariner's Ring

A mariner's ring employs a hole or slit in a weighted ring, which casts a beam onto the inside surface of the ring as shown in Figure 11-16. The rim of a springform cake pan is almost a natural for making a type of mariner's ring. All you have to do is make a single, narrow slit or hole in the rim to cast the line of a sunbeam onto the inside surface of the opposite side of the pan rim. The pan rim, however, is not heavy enough to hang steady without additional weights. This design also calls for an angular scale along the inside circumference that is not linear; therefore, it has to be calibrated. Transferring a true quadrant scale onto the ring is tedious but doable. You must weight the pan so it hangs in the same vertical orientation each time you lift it, and you need a plumb line from the pinhole slit to establish the vertical axis.

You can also make a mariner's ring from plastic, metal, or even steamed wood frames to be quite large with corresponding accuracy. A diameter of 12 to 16 inches, however, is about optimum for operation by a single person.

Note that if you just want to build a device to tell when the sun is at or near its peak height, this type of mariner's ring, or even a smaller one, solves the problem nicely—after the first day's observations to mark the peak height.

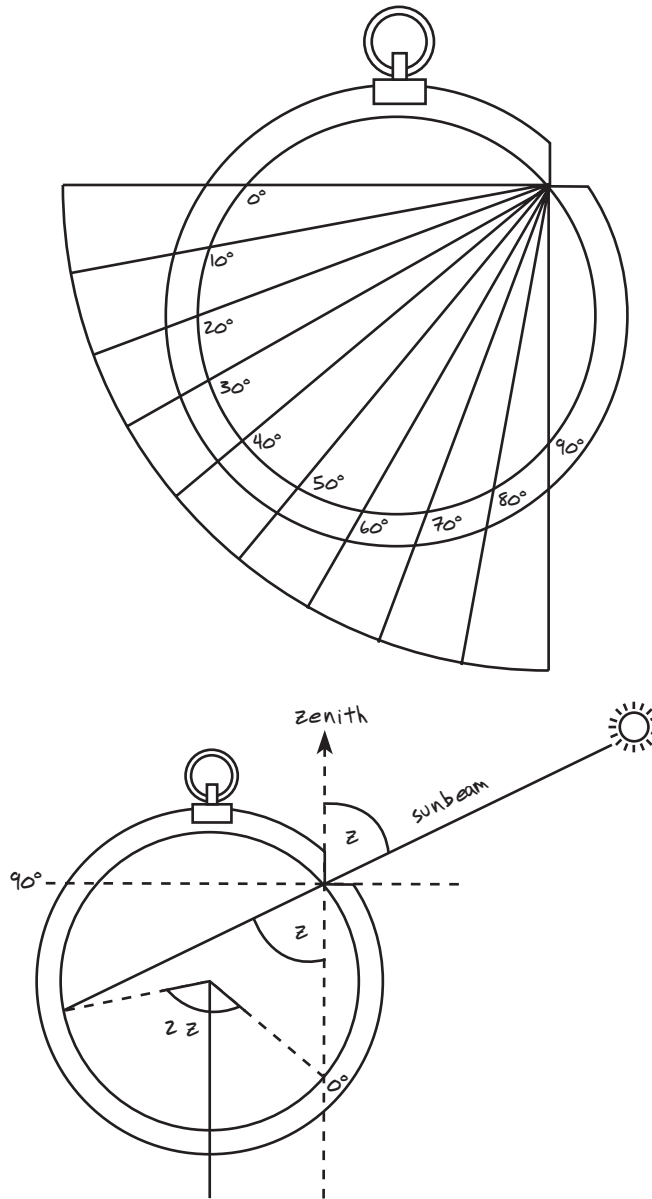

Figure 11-16. A mariner's ring and ways to calibrate it. It appears these were never as popular historically as the mariner's astrolabe (see Figure 11-18), but for emergency purposes they may be more convenient and easier to construct. Makeshift constructions confront the same challenge as historic ones—to calibrate the scale properly for the actual balance of the device. The angles must be relative to a plumb line through the zenith line shown, and that line in practice might not be parallel to the “centerline” of the device due to asymmetries in construction. The top illustration shows one way to lay out the angles relative to a larger quadrant. The bottom illustration takes advantage of a geometry theorem for angles subtended in a circle.

Tube Quadrant

You can use a tube quadrant (see Figure 11-5) in two ways. Either sight the sun through a thin tube with appropriate sunshades, or orient the quadrant so the tube's shadow cast onto a wall or plate below the device is as symmetrical and thin as possible. For sighting you want a smaller-diameter tube to limit the location on the body sighted. For a 1° field of view, use the equation:

$$\text{Tube Length} = 57.3 \times \text{Tube Diameter}$$

Therefore, a $\frac{1}{2}$ -inch tube would have to be about 28 inches long; a sheet of paper rolled up on a pencil is about right. For the shadow application, however, 1 inch or more in diameter may be better, and the length is not as crucial. You can cast the shadow onto a plate or board held in-line with the tube. This tube-shadow application has been used on land with a 22-inch quadrant radius to obtain repeatable measurements within 15' accuracy. The work was presented in a science fair. (David Schreiber, private communication; to my knowledge this arrangement was his discovery, and his communication with me on these results was the motivation to reexamine all these applications.) When sighting the sun or a star through the tube, the process takes two people, one to sight and one to read the plumb-line angle.

Pinhole Quadrant

The pinhole quadrant used in our land-based tests is shown in Figure 11-17—it is one of several we made with similar results. We were able to obtain accuracies below 15' routinely with several models that were readily reproduced. Actual data and more details are presented at starpach.com/emergencynavbook. The device shown was the easiest one to construct and the most accurate for us. The notes on using all these devices given at the beginning of this section (stay out of the wind, etc.) remain crucial.

Mariner's Astrolabe

A mariner's astrolabe (see Figure 11-18) is similar to a pinhole quadrant, but here the pinholes are fixed to a rotating arm with a pointer in-line with the axis of the pinholes. The arm pivots about the center of the compass rose, and if properly balanced—perfectly vertical—when held suspended, the angular height of the sun can be read from the pointer when the pinholes align with the axis of the sun's rays. Robin Knox-Johnston (see the No-Instrument Navigation section of the bibliography) used a device like this with about 15' accuracy, although he took the trouble to replicate an early Mediterranean model instead of designing one of his own that might have worked better.

The astrolabe is easier to use than the quadrant, but you will likely sacrifice some accuracy since the astrolabe design uses only half the dimensions of the device for measuring the angle. Knox-Johnston reported that his took “months to make” even with expert assistance and machinery, and it still had an offset of some 1.5° when suspended and actually put into practice. However, an even larger quadrant can be assembled easily with a fraction of this error since it does not rely on perfectly vertical suspension for its accuracy.

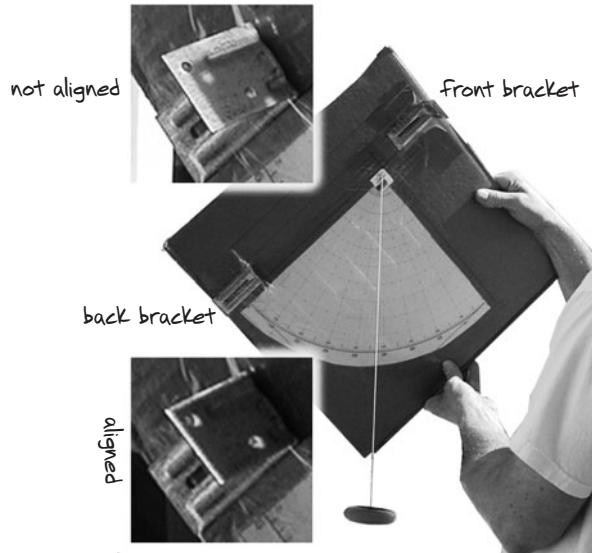

Figure 11-17. A makeshift pinhole quadrant assembled with clear 2-inch packing tape. To construct this device, tape a quadrant of a large radar plotting sheet to a piece of box cardboard. The center-to-90°-line at the top of this plotting sheet will be the main calibration line of the device. Use two identical right-angle steel brackets, taping one at each end, parallel to the calibration line. The dual nail holes in each bracket will provide the “pinholes” (actually about $\frac{1}{8}$ inch in diameter). Next tape a small corner of a credit card at the intersection of the center of the plotting sheet. Carefully draw the calibration line across it, as well as the perpendicular line from center to 0° on the plotting sheet. Next drill a very small hole at that intersection, and run a line of whipping twine through the hole to use for the plumb line. The plastic card will keep this line from deforming the shape of the hole, thus preventing any alteration in the hole’s position on the base cardboard. In bright sun, the images of the front two holes will show very sharply on the back bracket (top inset) and when they coincide with the two holes in that bracket (almost in alignment in the bottom inset), the plumb-line angle can be read. When you are making timed sights, you must hold the watch in the hand near the back bracket so you can see both the clock and the sun rays. When the holes align, note the time, then check for plumb-line stability. It will likely be moving, so tip the board to grab the line to steady it; repeat the process, until you have a steady plumb line, aligned holes, and you have noted the time. With this device, the arc radius is 25.4 cm, which results in a 1° space of 4.4 mm; the angles can be estimated to within $\frac{1}{4}^\circ$ (0, 15, 30, or 45 arc minutes). Actual data from this and similar designs are presented at starpnath.com/emergencynavbook. Average accuracies well under 15’ can be obtained on land, which I think would translate pretty well to calm conditions at sea.

LATITUDE FROM THE LENGTH OF DAY

For most of the year, the length of daylight (sunrise to sunset) depends on your latitude. Sailing south during the summer, the days get shorter; sailing south during the winter, the days get longer. Only around the equinoxes (March 21 and September 23, when the sun crosses the equator) is the length of the day the same for all latitudes (equinox means “equal night”). On the equinoxes, the sun rises at 0600 and sets at 1800 (solar time) everywhere on earth; thus the day and night have the same length on these days. The length of day changes most rapidly with latitude near the solstices, June 21 and December 21, the longest and shortest days of the year.

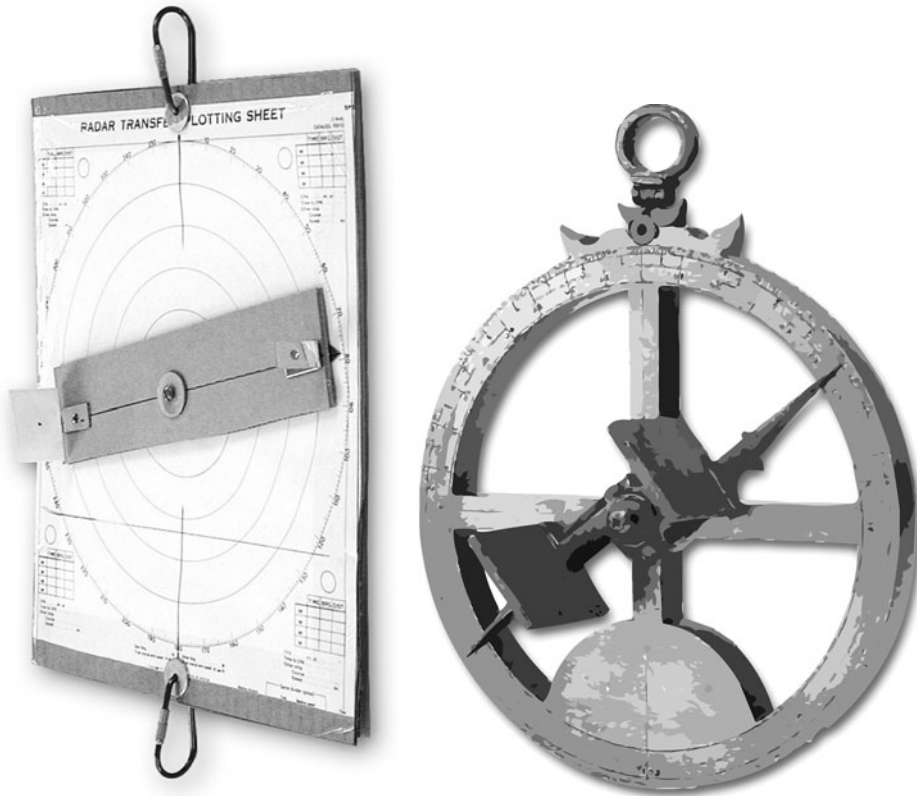

Figure 11-18. A mariner's astrolabe. At left is a makeshift model using a standard (10-inch-diameter) radar plotting sheet. At right is a schematic of an historic model, which was 6 to 15 inches in diameter and had a rotating arm (alidade) with two pinholes centered on a ring and marked off in degrees. The mariner's versions used (mostly on land) during the 1500s and 1600s were simplifications of similar (planespheric) devices used for astronomy several hundred years earlier. The problem is precise balance to ensure the measured angles are valid. The device is symmetrical, so in principle you could make measurements with either end pointed to the sun, and the average might remove some of the asymmetry error. The design of many old models seems to imply this technique, although the technique itself is not discussed in the texts, nor mentioned by Robin Knox-Johnston, who used such a device to monitor his latitude for an Atlantic crossing (see the No-Instrument Navigation section in the bibliography). Note that all old designs of the mariner's model show the plate with large open sections, presumably to minimize the effect of the wind. The earlier planespheric devices were mostly solid plates. Our sample model suffered from windage effects even in a light breeze, but it would still measure angles to within 30' on land with some effort. As with our pinhole device (Figure 11-17), which worked better and was easier to use, this one also employed corner braces for the pinholes.

For several months on either side of each solstice, the length of day changes fast enough with latitude that you can actually determine your latitude from a measurement of the length of the day. To do this, you need a watch and tables that list the times of sunrise and sunset for various latitudes. A set of these tables is included in the back of the *U.S. Tide Tables*. The watch does not have to be set properly on any specific time zone. You only need to measure a time interval, not a specific time.

Measure the Length of Day

To measure the length of the day, note the time (to the second) when the sun's upper edge first appears on the eastern sea horizon and again when it finally disappears below the western sea horizon. The length of daylight is the difference between these two times. If the sun comes up at 09:15:30 and sets at 20:16:50, the length of the day was 11:01:20.

This is a simple measurement when you can see both the sunrise and sunset. But, as mentioned in the Local Apparent Noon section in Chapter 6, it is not often that you can see the precise time of sunset or sunrise on the actual sea horizon, even in the middle of the ocean. The rim of the horizon is frequently obscured by clouds. Luckily, to use this method you do not have to see both the sunrise and sunset. You only need to see one of them, but it is easier and more accurate if you can see both.

The trick to getting around an obscured horizon is to use a kamal to measure the time LAN. LAN always occurs exactly halfway between sunrise and sunset, so if you know the time of LAN, you need to measure the length of only half a day. To see how this works, we need to define five special times:

T_{sr} = the time of sunrise

T_{am} = the time the sun is at some arbitrary low height on the kamal in the morning

T_{pm} = the time the sun is again at this height in the afternoon

T_{ss} = the time of sunset

T_{lan} = the time of LAN

You can figure the time of LAN as follows:

$$T_{lan} = (T_{am} + T_{pm}) \div 2$$

Now you can find the length of day three ways, depending on what you see. If you see both the sunset and sunrise, use:

$$\text{Length of day} = (T_{ss} - T_{sr})$$

If you see the sunrise only, use:

$$\text{Length of day} = (T_{lan} - T_{sr}) \times 2$$

And if you see the sunset only, use:

$$\text{Length of day} = (T_{ss} - T_{lan}) \times 2$$

In the last two cases, you are simply finding the length of half a day and multiplying by 2. Furthermore, these times don't need to be from the same day. You can use times one or two days apart, providing you have not moved significantly. These time measurements are illustrated in Figure 6-8.

Determine Your Latitude

Once you have the length of day, go to the sunrise-sunset tables for the proper date and your approximate latitude. For that date and latitude, subtract the tabulated sunrise time from the sunset time and compare this length of day with your measurement. Then do the same for the next

larger and next smaller latitudes listed in the table. Once you have found a day length that is longer and a day length that is shorter than the one you measured, you can interpolate the results to find your latitude. You may also have to interpolate for the proper day since all dates are not given.

It doesn't matter if your sunrise-sunset tables (tide tables) happen to be outdated. For all practical purposes, the times of sunrise and sunset are the same each year.

This method of finding latitude works best at higher latitudes, above about 30° or so, during the two months before and after each solstice. Nearer the solstices, it works fairly well at all latitudes. It does not work at all for a couple of weeks on either side of each equinox.

The question of how well this method might work under particular circumstances can always be answered ahead of time. Simply look up the number of minutes the length of day changes for 1° of latitude for your date and approximate latitude. If this figure is high, say 5 minutes or more, then you have a precise latitude measurement. If this time is low, 1 or 2 minutes per degree, then this method will not be precise, but it will still give your latitude to within a few degrees, and possibly even better if you have a good view of sunrise and sunset. If the length of day changes by less than 1 minute per degree, this method will not be useful.

Correcting for Distance Run

We have assumed so far that your vessel is not moving. When headed west, you run away from the sun in the morning and chase after it in the afternoon. As a result, you stretch out the length of daylight when traveling west at any latitude. When headed east, you shorten the length of daylight when headed east at any latitude, which of course affects this method since you can change the length of day without changing latitudes. This is an easy problem to correct, however, once you understand the principles and basic chart work.

When headed west during this measurement, shorten your measured day length by 4 minutes for each 1° of longitude (or 1 minute for each 15' of longitude) you made to the west—regardless of your latitude change during the day. When headed east, lengthen the day by the same amount. Then use this corrected time to find your latitude in the sunrise-sunset tables. You don't need to correct for latitude changes, but if your latitude does change, the latitude you figure from the length of day will be halfway between what it was at your sunrise and your sunset. At a steady course and speed, you'll find what your latitude was at midday (see Figure 11-19).

As an example, on July 5 my DR latitude is 39° N to within 2° or so in west longitudes. The observed sunrise is recorded as 05:48:20 watch time, and my course is northwest (315° T) at 6 knots and steady throughout the day. Sunset is recorded as 20:38:12 watch time. The measured day length is 20:38:12 - 05:48:20, or = 14:49:52, which equals = 14.8 hours. At 6 knots, I ran about 89 miles toward 315° T from sunrise to sunset, which corresponds to a westing of 63 miles when the course is plotted. At latitude 39°, there are about 47 miles to each 1° of longitude (explained in Figure 12-9), so my longitude increased by 63 miles × (1°/47 miles), or 1.34°. This calls for a longitude correction of 1.34° × (4 minutes/1°), or 5.36 minutes, which equals 5 minutes, 22 seconds. The corrected day length is then 14:49:52 - 5 minutes, 22 seconds, or 14:44:30. The tables tell me that on July 5 the day length at latitude 38° N is 1443, and at 40° N it is 1455. I can plot these out as shown in Figure 11-19 to discover that my latitude at noon on July 5 is 38° 15' N.

SUNRISE AND SUNSET

DATE	34° N		36° N		38° N		40° N	
	Rise	Set	Rise	Set	Rise	Set	Rise	Set
	h m	h m	h m	h m	h m	h m	h m	h m
JUL 5	04 54	19 15	04 49	19 20	04 43	19 26	04 37	19 32
10	04 57	19 14	04 51	19 19	04 46	19 25	04 40	19 30
15	05 00	19 12	04 54	19 17	04 49	19 22	04 43	19 28
20	05 03	19 10	04 58	19 14	04 53	19 19	04 47	19 25
25	05 06	19 06	05 02	19 11	04 57	19 16	04 52	19 21
30	05 10	19 03	05 05	19 07	05 01	19 11	04 56	19 16

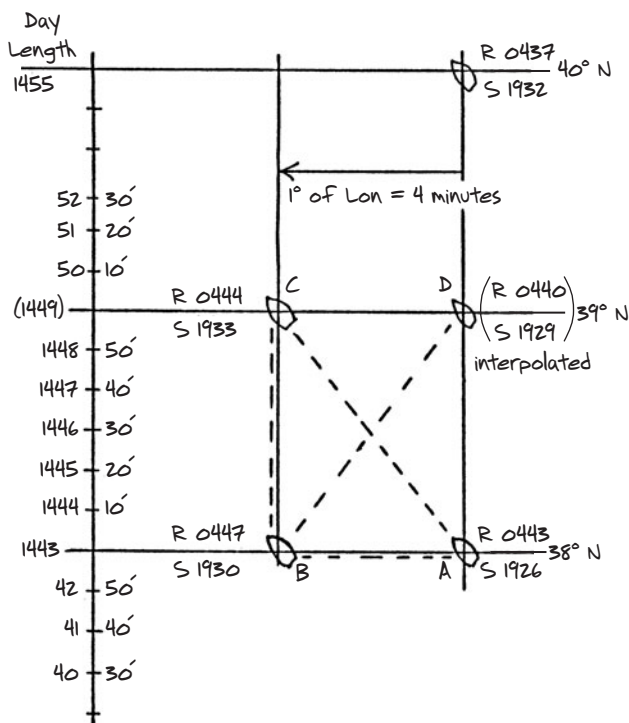

Figure 11-19. How sunrise and sunset times change with location on July 5. Sailing west, sunrise and sunset times increase by 4 minutes for each 1° of longitude covered. Sailing toward the latitude of the sun's declination, the sun rises later and sets earlier, shortening the length of the day, but not in a way that is easy to predict. To find latitude from the length of day, you must correct the measured day length for your change in longitude. Sailing 1° west from A to B, the sun rises (R) at 0443 and sets (S) at 1930, for a measured day length of 1447. The corrected day is 1447 - 4 minutes, or 1443, which the table shows must have been at latitude 38° N. The answer you get will always be halfway between your latitude at sunrise and your latitude at sunset, which in this case are the same. Sailing 1° east from B to D, the sun rises at 0447 and sets at 1929, for a measured day length of 1442. The corrected day is 1442 + 4 minutes, or 1446, which the table shows must have been across a midlatitude of 38° 30' N. Check other routes among the points shown to see more of how this works.

Without making the longitudinal correction, my latitude would have been wrong by about 1° . This is an important correction. This method works best at higher latitudes where longitude changes more rapidly with east-west progress. The conversion between distance run and longitude interval is discussed in the Keeping Track of Longitude section in Chapter 12.

KEEPING TRACK OF LATITUDE

The first way to keep track of latitude is by DR. Sailing due south or north, your latitude changes by 1° for each 60 nmi you cover. Sailing due east or west, your latitude doesn't change. On a diagonal course, you'll need a makeshift chart to figure out your latitude change.

To make a chart, draw a vertical line for the latitude scale and a horizontal line for the longitude scale. The intersection of these two lines marks your initial position. Then choose a convenient miles scale for the voyage you anticipate. One inch or one finger width could be 1 mile or 60 miles, depending on how far you have to go. Since 60 miles = 1° of latitude, you can use your chosen scale and this conversion to mark off the latitude scale in degrees, and then draw in the latitude lines. See the example in Figure 11-20.

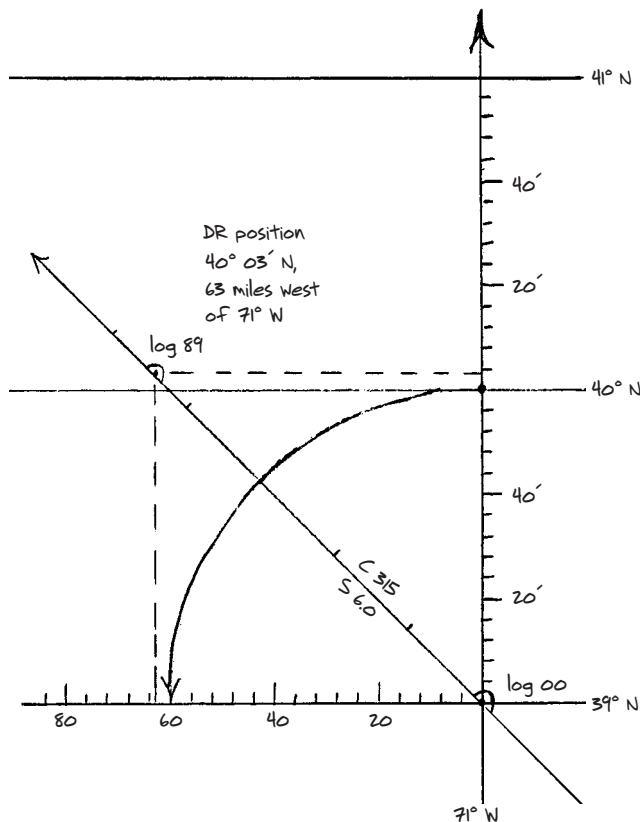

Figure 11-20. A makeshift plotting sheet. A northwest run of 89 miles yields a westward progress of 63 miles. DR latitude can be read directly from this chart, but longitude degrees must be figured separately, as explained in the Keeping Track of Longitude section in Chapter 12 and Figure 12-10.

As you sail from your initial position, keep track of your DR position on the makeshift chart. With this type of chart, you can read your latitude in degrees, but you'll have to keep track of your longitude in terms of miles east or west of your initial longitude (see the Keeping Track of Longitude section in Chapter 12 for how to figure your longitude in degrees with this type of chart).

You should always keep track of your DR latitude as accurately as possible and compare it to your star measurements at every opportunity. These two independent sources of latitude measurements support and strengthen each other. The methods of finding latitude from the sun and stars that we have discussed so far are most valuable when you start navigating from an unknown position. In this case, you must discover your latitude. But if you are starting from

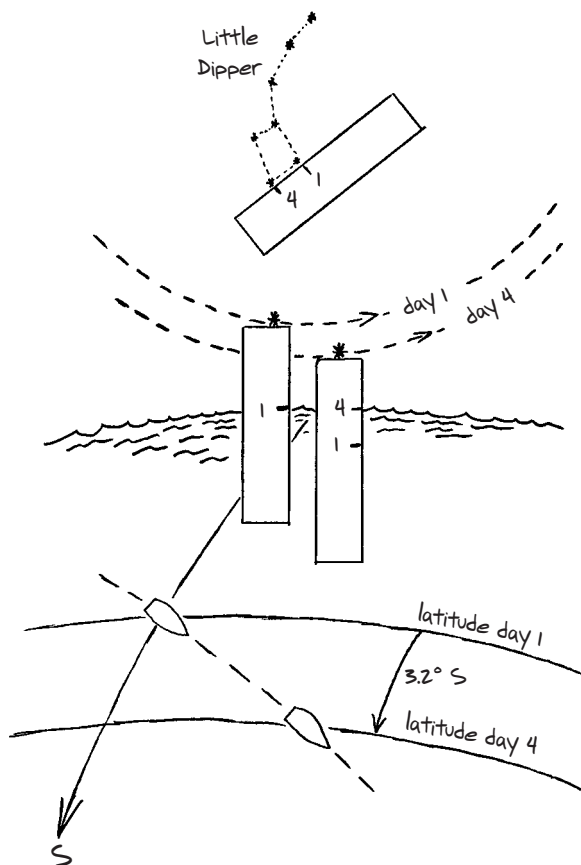

Figure 11-21. Progress to the south tracked by descending stars. The height of a star crossing the northern meridian at twilight on day 1 and again on day 4 was marked with a kamal. During these four days, the star descended the width of the Guards, so you know you made good 3.2° to the south. This measurement tells you nothing about longitude directly, although it might tell you something about your general DR accuracy. If your DR agrees with the 3.2° of southing, you know there is no strong north-south component to your drift, which in some circumstances might give supporting, though not definite, information on longitude reckoning. If the current set is most likely to the southeast in this region, for example, you have learned that its drift must be small, or it would have thrown off the DR latitude.

a known latitude, it is a much easier job. Using the stars, you simply have to keep track of your latitude as you move away from your known position. In this case, you only measure the changes in latitude.

Measuring Changes in Latitude

The principle behind measuring changes in latitude is simple. If you sail south, stars on the southern meridian rise, those on the northern meridian descend, and their height changes by the exact amount that your latitude changes. The reverse occurs as you change latitudes to the north.

For measuring latitude changes, use any star that happens to be on the meridian at twilight. You can use northern or southern stars, and you can use stars of any height—but, again, you will generally get more accurate results from lower stars. The big advantage is that you do not need to know the names or the declinations of the stars you use; you only have to be able to spot the same stars each night. It does help the bookkeeping, though, to make up names for the stars you use.

To begin, rig a kamal to mark the height of a star as it crosses the meridian at twilight. The height of the star can even be fairly high since you don't care about exact angle measurements for this application, only relative ones. As the voyage progresses, watch the position of the star change on the kamal, as illustrated in Figure 11-21. Then compare the change in position (a length along the kamal) with one of the standard references, such as the distance between the Guards, Orion's belt, or others discussed at the beginning of this chapter. If a particular star on the northern meridian descends as the voyage progresses by an amount equal to the distance between the Guards, you know you have traveled about 3.2° , or 192 miles south.

This is a very powerful method of keeping track of latitude. You can use the northern and southern meridian at morning and evening twilight. This method provides one of the best reasons for learning several reference distances between pairs of stars.

Chapter 12

LONGITUDE AT SEA

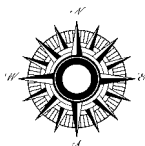

Longitude is time and time is longitude. If you know UTC, you can find your longitude from any place on any date. And equally important, if you know your longitude at the time of an emergency, you can find UTC (if you didn't know it), and then use it to keep track of longitude as you move on. If you are in an unknown position with nothing but UTC, you can find longitude from the sun. If you are in an unknown position with everything but UTC, you can find longitude from the moon (see the Everything but UTC section in Chapter 14).

But you need slightly more than just a timepiece to find longitude from the sun. You need special information, listed in almanacs or easily figured from sunrise-sunset tables. Or, without either of these, you can figure it from the date using a makeshift prescription.

The principles behind the methods are easy to understand. Using the sun's meridian passage at LAN as an example, the sun appears to move westward around the earth once a day, crossing over 360° of longitude every 24 hours, which means the sun moves west at a rate of 15° of longitude per hour. If you see the sun on your meridian now, then someone at a longitude 15° west of you will see the sun on her meridian exactly 1 hour later, regardless of her latitude. If you happen to be at longitude 60° W and the sun crosses the Greenwich meridian (longitude 0°) at 1200 UTC, then the sun will pass you at exactly 1600 UTC, since it takes 4 hours to cover 60° of longitude at 15° per hour (see Figure 12-1). And that is the extent of the theory. If you know when the sun passes Greenwich and you can determine when it passes you, you can figure out your longitude as the number of hours between these two times multiplied by 15. Whenever the sun passes you after passing Greenwich, your longitude is west. If the sun passes you on the way to Greenwich, your longitude is east.

You can apply this principle to the time of LAN, as just described, or to the time of sunrise or sunset. In either case, you compare a measured time with the corresponding time at Greenwich,

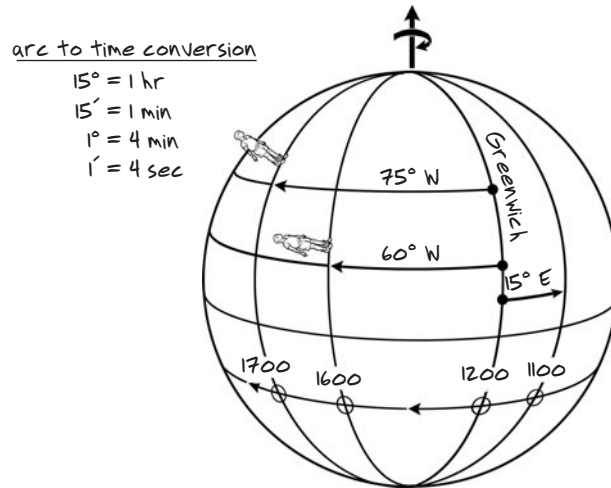

Figure 12-1. Motion of the sun's geographical position on a globe. As the earth turns daily on its axis, the sun moves west at 15° of longitude per hour. On a daily basis, the sun's latitude remains essentially constant, although on a yearly basis, it varies slowly back and forth across the tropics.

and the difference is your longitude. To determine the time at Greenwich, you must look it up in sunrise-sunset tables or figure it out from the date using a rule.

UTC is fundamental to emergency longitude. If you wear a watch and keep track of UTC, with very little practice you will always be able to find your longitude. Even if you don't know UTC or where you are to begin with, a watch is still extremely valuable for keeping track of longitude, as we shall see. Unlike latitude, you must have a watch to check DR longitude against celestial motions.

LONGITUDE FROM SUNRISE OR SUNSET

The easiest way to find emergency longitude is to time the sunrise or sunset. To use this method, you must know UTC, and you also need sunrise-sunset tables from an almanac or tide tables. You can use this method anywhere on any date, providing that you can indeed see the sun rise or set over the true sea horizon. Since the rim of the horizon is often obscured by low clouds, however, this method will not be useful every day, even when the other means are there.

Sunrise time depends on latitude, so when using this method you must find your latitude before you can find your longitude (see Chapter 11 for how to find latitude).

The time of sunrise you want is the moment the top of the sun's disk (upper limb) first appears on the sea horizon. The time of sunset is the moment the sun's disk disappears completely.

To find longitude, note the watch time of sunrise or sunset to the second, and convert this time to UTC by correcting for the time zone of the watch and the current watch error. Then look up the tabulated time of sunrise or sunset for your date and latitude (which might require an interpolation). Subtract the predicted time from the observed time and convert the time difference to degrees. This difference is your longitude.

The conversion rate is 15° per hour, but smaller divisions are also useful and easy to figure:

$$15^\circ = 1 \text{ hour}$$

$$1^\circ = 4 \text{ minutes}$$

$$15' = 1 \text{ minute}$$

$$1' = 4 \text{ seconds}$$

In west longitudes, the observed UTC will be later than the tabulated time. In east longitudes, it will be earlier.

As an example, let's say you are wearing a watch set to Pacific daylight saving time, which is 7 hours behind UTC. The watch gains 0.5 second a day, and it was set to the proper time on July 4. It is now August 4, your latitude is 36° N, and you note that the time of sunset is 21:49:31 by your watch. What is your longitude?

From July 4 to August 4 is thirty-one days, so your watch on August 4 is about 15 seconds fast. The correct UTC of sunset, therefore, is:

$$21:49:31 + 7 \text{ hours} - 15 \text{ seconds} = 28:49:16$$

which is actually 04:49:16 the next day, but this doesn't matter since you only care about time differences, not times. The table in Figure 12-2 shows that on August 4 at latitude 36° N, the time

SUNRISE AND SUNSET

DATE	30° N		32° N		34° N		36° N		38° N		40° N	
	Rise	Set	Rise	Set	Rise	Set	Rise	Set	Rise	Set	Rise	Set
	h m	h m	h m	h m	h m	h m	h m	h m	h m	h m	h m	h m
Aug 4	05 20	18 51	05 17	18 55	05 13	18 58	05 09	19 02	05 05	19 06	05 01	19 11
9	05 24	18 47	05 20	18 50	05 17	18 54	05 13	18 57	05 09	19 01	05 05	09 05
14	05 27	18 42	05 24	18 45	05 21	18 45	05 17	18 52	05 14	18 55	05 10	18 58
19	05 29	18 37	05 27	18 40	05 24	18 43	05 21	18 45	05 18	18 48	05 15	18 52
24	05 32	18 32	05 30	18 34	05 28	18 37	05 25	18 39	05 23	18 42	05 20	18 44
29	05 35	18 26	05 33	18 28	05 31	18 30	05 29	18 32	05 27	18 34	05 24	18 37
Sept 3	05 38	18 21	05 36	18 22	05 35	18 24	05 33	18 25	05 31	18 27	05 29	18 29
8	05 41	18 14	05 39	18 16	05 38	18 17	05 37	18 18	05 35	18 19	05 34	18 21
13	05 43	18 08	05 42	18 09	05 42	18 10	05 41	18 11	05 40	18 12	05 39	18 13
18	05 46	18 02	05 46	18 02	05 45	18 03	05 45	18 03	05 44	18 04	05 43	18 04
23	05 49	17 56	05 49	17 56	05 49	17 56	05 48	17 56	05 48	17 56	05 48	17 56
28	05 51	17 50	05 52	17 49	05 52	17 49	05 52	17 49	05 53	17 48	05 53	17 48

Figure 12-2. Section of a sunrise-sunset table from a U.S. Tide Table. These times are essentially the same from year to year, so outdated tables can be used. Similar tables appear on the daily pages of the Nautical Almanac.

of sunset is 1902. This tabulated time is the UTC of sunset observed from longitude 0°. The time difference is:

$$28:49:16 - 19:02:00 = 09:47:16$$

which can be converted to degrees as follows:

$$9 \text{ hours} = 135^\circ$$

$$47 \text{ minutes} = 11^\circ 45'$$

$$16 \text{ seconds} = 4'$$

So, summing these, your longitude is 146° 49' W.

Remember, it is always the time zone of your watch that matters, not the time zone you happen to be in. With accurate time and sunrise-sunset tables, this method is very reliable. You can count on a longitude accuracy of 20' or so if you interpolate the sunrise tables and you know your latitude well.

Furthermore, with the tables you can always figure how sensitive this method is to your latitude accuracy. Suppose the tables show that for your date and latitude the sunset time changes by 2 minutes for a 1° change in latitude. In this case, if your latitude is uncertain by 1°, the sunset time at Greenwich that you get from the tables will be uncertain by 2 minutes, so the longitude you figure from it will be uncertain by 30'. Longitude error due to a timing error is always the same. If your watch time is wrong by 1 minute, your longitude will be wrong by 15'. Usually you must interpolate the sunrise-sunset tables for both latitude and date, as shown in Figure 12-3.

LONGITUDE FROM LAN (THE EQUATION OF TIME)

You find longitude from the time of LAN just as you do from sunrise or sunset, but for this method you do not need to know your latitude. Also an almanac and/or sunrise-sunset tables are very helpful, but if need be, you can do without them.

First use a kamal (or sextant, if you have one) to measure the UTC of LAN, as discussed in the Local Apparent Noon section in Chapter 6 and the Latitude from the Length of Day section in Chapter 11. Then compare the measured UTC of LAN with the UTC of LAN at Greenwich—which you must look up or figure from the date—and proceed to find longitude as you would with sunrise or sunset times. You can get the UTC of LAN at Greenwich from sunrise-sunset tables by finding the time halfway between the tabulated sunrise and sunset on the proper date, interpolating if necessary. Just use an approximate latitude for this, since the time of LAN does not depend on latitude. To figure the midday time, add the tabulated sunrise time to the sunset time and divide by 2. You can even use outdated tables, since these values do not change much from year to year.

As an example, on August 4 at approximate latitude 30° N, I determine the UTC of LAN to be 22:34:44 from the time halfway between the observed sunrise and sunset times as illustrated

Find sunset time on Aug 7 at 37° 20' N

	36° N	(37° 20' N)	38° N
Aug 4	1902		1906
(Aug 7)	(1859)	(19:01:40)	(1903)
Aug 9	1857		1901

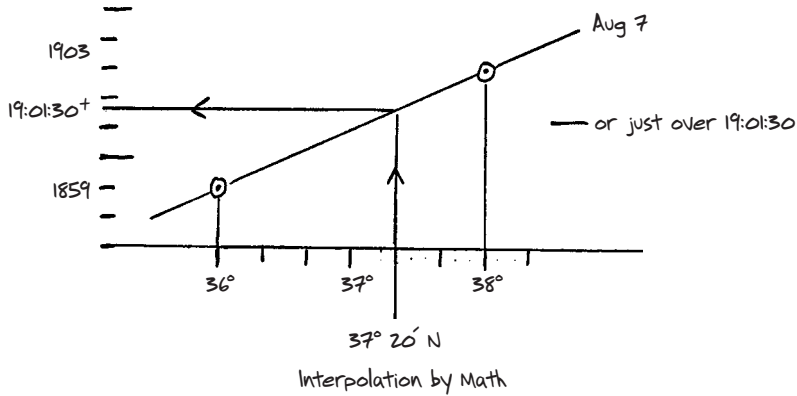
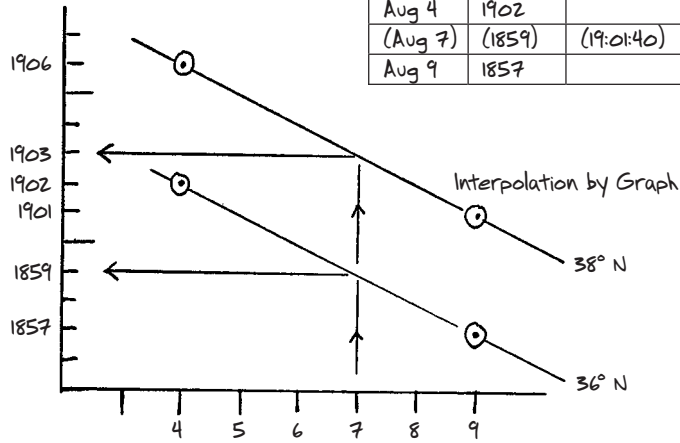

$$\begin{aligned}
 & \left. \begin{array}{l} 1906 \rightarrow 1901 \\ 1902 \rightarrow 1857 \end{array} \right\} = 5 \text{ min} \\
 & \left. \begin{array}{l} 4 \rightarrow 9 = 5 \text{ days} \end{array} \right\} \left. \begin{array}{l} 1 \text{ min/day} \rightarrow \text{Aug 7} = 1902 - 3 = 1859 \\ = 1906 - 3 = 1903 \end{array} \right.
 \end{aligned}$$

$$\left. \begin{array}{l} 1859 \rightarrow 1903 = 4 \text{ min} \\ 36^\circ \rightarrow 38^\circ = 2^\circ \end{array} \right\} 2 \text{ min}/1^\circ = 2 \text{ min}/60'$$

$$\text{or } 37^\circ 20' = 36^\circ + 80' = 1859 + 80' \times (2 \text{ min}/60') = 1859 + 2.7 \text{ min}$$

$$\text{or sunset Aug 7 at } 37^\circ 20' \text{ N} = 19:01:40$$

Figure 12-3. Interpolating sunrise-sunset tables for date and latitude. The tabulated values used are from Figure 12-2.

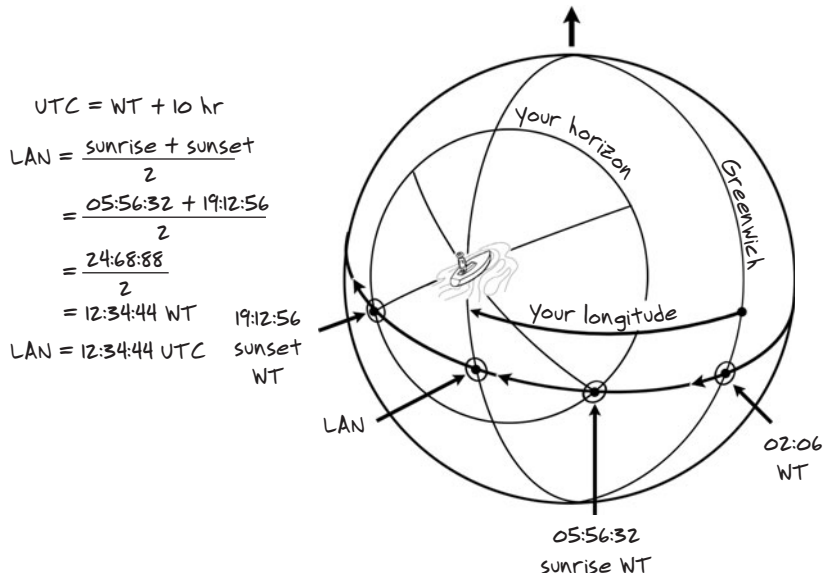

Figure 12-4. Measuring the time of LAN from observed watch times of sunrise and sunset. The watch time (WT) is 10 hours behind UTC.

in Figure 12-4. From sunrise-sunset tables (Figure 12-2), I learn that sunrise on August 4 at latitude 30° N is at 0520 and sunset is at 1851. So LAN at Greenwich is:

$$(05:20:00 + 18:51:00) \div 2 = (24:11:00) \div 2 = 12:05:30$$

The time difference between the observed UTC of LAN and the corresponding time at Greenwich is:

$$22:34:44 - 12:05:30 = 10:29:14$$

And to find longitude, I convert this time difference to degrees:

$$10 \text{ hours} = 10\text{h} \times 15^\circ/1\text{h} = 150^\circ$$

$$29 \text{ minutes} = 29\text{m} \times 15'/1\text{m} = 7^\circ 15'$$

$$14 \text{ seconds} = 14\text{s} \times 1'/4\text{s} = 3.5'$$

Summing the parts, my longitude is 157° 18.5' W. Practical results will certainly not be accurate to this precision, although you can improve on a single Greenwich time obtained from sunrise tables by averaging values from several latitudes at the same date, as shown in part A of Figure 12-5.

Additionally, you can determine the time of LAN from the observed times of sunrise and sunset (LAN is halfway between the two), or you can use a kamal to measure the times of equal heights of the sun, as described in the Local Apparent Noon section in Chapter 6. When the sun is low, you can often get these times quite accurately before the sun is too bright to look at. When using a kamal, take the halfway times between several heights and average the results, as illustrated in Figure 6-8. Your longitude will only be as accurate as your LAN time. With

SUNRISE AND SUNSET

DATE	0°		5° N		10° N		15° N		20° N		25° N	
	Rise	Set	Rise	Set	Rise	Set	Rise	Set	Rise	Set	Rise	Set
	h m	h m	h m	h m	h m	h m	h m	h m	h m	h m	h m	h m
Sept 3	05 56	18 03	05 53	18 05	05 51	18 08	05 48	18 11	05 45	18 14	05 42	18 17
8	05 54	18 01	05 52	18 03	05 50	18 05	05 48	18 07	05 46	18 09	05 43	18 12
13	05 53	17 59	05 51	18 01	05 50	18 02	05 48	18 03	05 47	18 05	05 45	18 07
18	05 51	17 57	05 50	17 58	05 50	17 59	05 49	18 00	05 48	18 00	05 47	18 01
23	05 49	17 56	05 49	17 56	05 49	17 56	05 49	17 56	05 49	17 56	05 49	17 56
28	05 48	+ 17 54	05 48	+ 17 53	05 49	+ 17 53	05 49	+ 17 52	05 50	+ 17 51	05 51	+ 17 50

= 22:102/2 = 22:101/2 = 22:102/2 = 22:101/2 = 22:101/2 = 22:101/2
 = 11:51.0 = 11:50.5 = 11:51.0 = 11:50.5 = 11:50.5 = 11:50.5
 = 1 2 3 4 5 6
 Average of six values is 11:50.67 = 11:50:40

(A)

2005 SEPTEMBER 28, 29, 30 (WED., THURS., FRI.)												191				
UT	SUN		MOON				Lat.	Twilight		Sunrise	Moonrise					
	GHA	Dec	GHA	v	Dec	d		HP	Naut.		Civil	28	29	30	1	
d h	° ' "	° ' "	° ' "	' "	° ' "	' "	°	h m	h m	h m	h m	h m	h m	h m		
28 00	182 18.8	S 1 58.4	238 18.3	12.6	N23 48.4	8.4	54.1	N 72	03 39	05 03	06 10	□	23 40	26 11	02 11	
01	197 19.0	1 59.4	252 49.9	12.5	23 40.0	8.4	54.1	68	04 03	05 10	06 06	□	22 26	24 45	00 45	02 39
02	212 19.2	2 00.4	267 21.4	12.7	23 31.6	8.6	54.1	66	04 12	05 13	06 04	□	23 09	25 05	01 05	02 50
03	227 19.4	01.3	281 53.1	12.7	23 23.0	8.6	54.1	64	04 19	05 16	06 03	□	23 37	25 21	01 21	02 58
04	242 19.6	02.3	296 24.8	12.8	23 14.4	8.8	54.1	62	04 25	05 18	06 02	□	23 59	25 35	01 35	03 06
05	257 19.8	03.3	310 56.6	12.8	23 05.6	8.8	54.1	60	04 30	05 19	06 01	□	24 17	00 17	01 46	03 12
06	272 20.0	S 2 04.2	325 28.4	13.0	N22 56.8	9.0	54.1	N 58	04 35	05 21	06 00	□	24 31	00 31	01 55	03 17
07	287 20.2	05.2	340 00.4	13.0	22 47.8	9.0	54.1	56	04 38	05 22	05 59	□	24 43	00 43	02 04	03 22
08	302 20.4	06.2	354 32.4	13.0	22 38.8	9.2	54.1	54	04 42	05 23	05 58	□	24 54	00 54	02 11	03 27
09	317 20.6	07.2	369 04.4	13.1	22 29.6	9.2	54.1	52	04 44	05 24	05 58	□	25 04	01 04	02 18	03 31
10	332 20.8	08.1	383 36.5	13.2	22 20.4	9.3	54.1	50	04 47	05 25	05 57	□	00 01	01 17	02 24	03 34
11	347 21.1	09.1	398 08.7	13.3	22 11.1	9.5	54.1	45	04 52	05 26	05 55	□	00 24	01 40	02 31	03 37
12	2 21.3	S 2 10.1	52 41.0	13.3	N22 01.6	9.5	54.1	N 40	04 56	05 27	06 00	□	00 47	02 07	02 38	03 40
13	17 21.5	11.1	67 13.3	13.4	21 52.1	9.6	54.1	35	04 59	05 28	06 00	□	01 10	02 26	02 46	03 42
14	32 21.7	12.0	81 45.7	13.4	21 42.5	9.7	54.1	30	05 03	05 29	06 00	□	01 32	02 45	02 54	03 43
15	47 21.9	13.0	96 18.1	13.5	21 32.8	9.8	54.1	20	05 08	05 30	06 00	□	01 54	02 54	03 02	03 44
16	62 22.1	14.0	110 50.5	13.6	21 23.0	9.9	54.1	N 10	05 12	05 31	06 00	□	02 16	03 03	03 10	03 45
17	77 22.3	15.0	125 22.9	13.7	21 13.3	10.0	54.1	00	05 16	05 32	06 00	□	02 38	03 11	03 17	03 46
18	92 22.5	S 2 15.0	140 55.7	13.8	21 03.6	10.1	54.1	00	05 19	05 33	06 00	□	03 00	03 19	03 23	03 47
19	107 22.7	16.0	155 28.5	13.9	20 53.9	10.2	54.1	00	05 22	05 34	06 00	□	03 22	03 39	03 27	03 48
20	122 22.9	17.0	170 01.3	14.0	20 44.2	10.3	54.1	00	05 25	05 35	06 00	□	03 44	03 51	03 34	03 49
21	137 23.1	18.0	184 34.1	14.1	20 34.5	10.4	54.1	00	05 28	05 36	06 00	□	04 06	04 07	03 41	03 50
22	152 23.2	19.0	199 07.1	14.2	20 24.8	10.5	54.1	00	05 31	05 37	06 00	□	04 28	04 14	03 48	03 53
23	167 23.4	20.0	213 40.1	14.3	20 15.1	10.6	54.1	00	05 34	05 38	06 00	□	04 50	04 21	03 54	03 56
SD	16.0	d 1.0	SD	14.7	14.8	14.8										

Exact value from nautical almanac
 = 12:00 - EqT
 = 11:59:60 - 09:25
 = 11:50:35

(B)

Makeshift prescription (From Figure 12-7) gives 11:50:30
 (C)

Figure 12-5. Comparison of three ways to find the UTC of LAN at Greenwich. (A) From sunrise-sunset tables, using the average of several latitudes to get a more precise value for a given date. (B) The exact value from the Nautical Almanac, found by adding or subtracting the tabulated Equation of Time (at 12h UTC) to 12:00:00. Note that the "Mer. Pass." time listed is what we want, but it is only listed to the closest minute. It does, though, tell us if we should add or subtract. (C) The makeshift prescription illustrated in Figure 12-7. Note that the sunrise tables are from 1985 and the almanac is from 2005, which should give essentially the same data for sun and stars since they are a multiple of four years apart.

practice, you should be able to get this time to within a minute or so, corresponding to a longitude accuracy of 15'—as long as you know the UTC of LAN at Greenwich. With a sextant, you can find the time of LAN from morning and afternoon heights quite easily to within 30 seconds when not moving very fast in the north-south direction.

The LAN method of longitude requires more careful measurements than the sunrise method does, but it typically can be used more often since it is not limited by horizon clouds. The greater advantage, however, is that you can use this method without special tables if need be. You can figure the time of LAN at Greenwich from the date, but you can't figure the time of sunrise or sunset without tables.

The UTC of LAN at Greenwich varies from 1144 to 1214 throughout the year due to the tilt of the earth's axis and its (slightly noncircular) orbital motion around the sun. The variation is gradual, but the annual pattern it follows is complex as shown in Figure 12-5. The difference between 1200 and the UTC of LAN at Greenwich is called the *Equation of Time* (see Figure 12-6). It is listed in almanacs (see part B of Figure 12-5) or can be figured from the date using the following prescription.

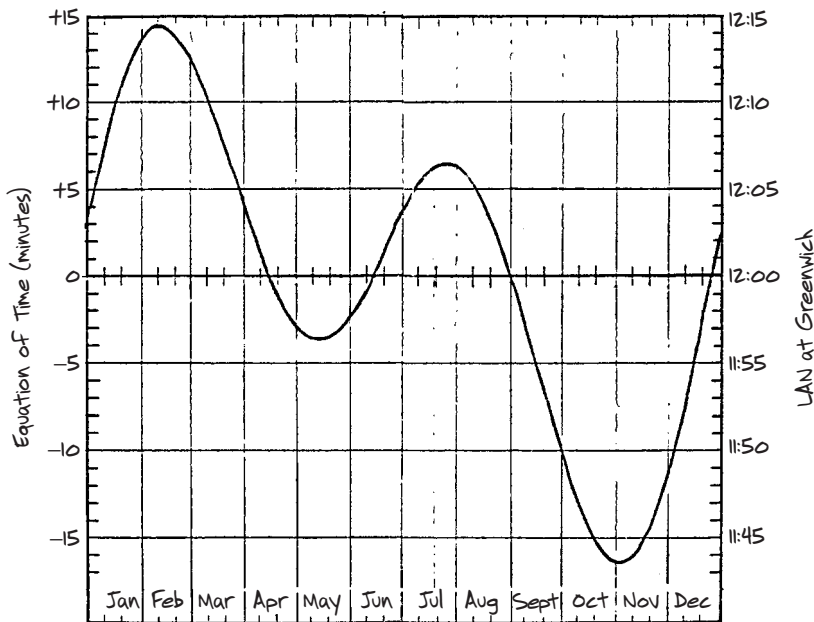
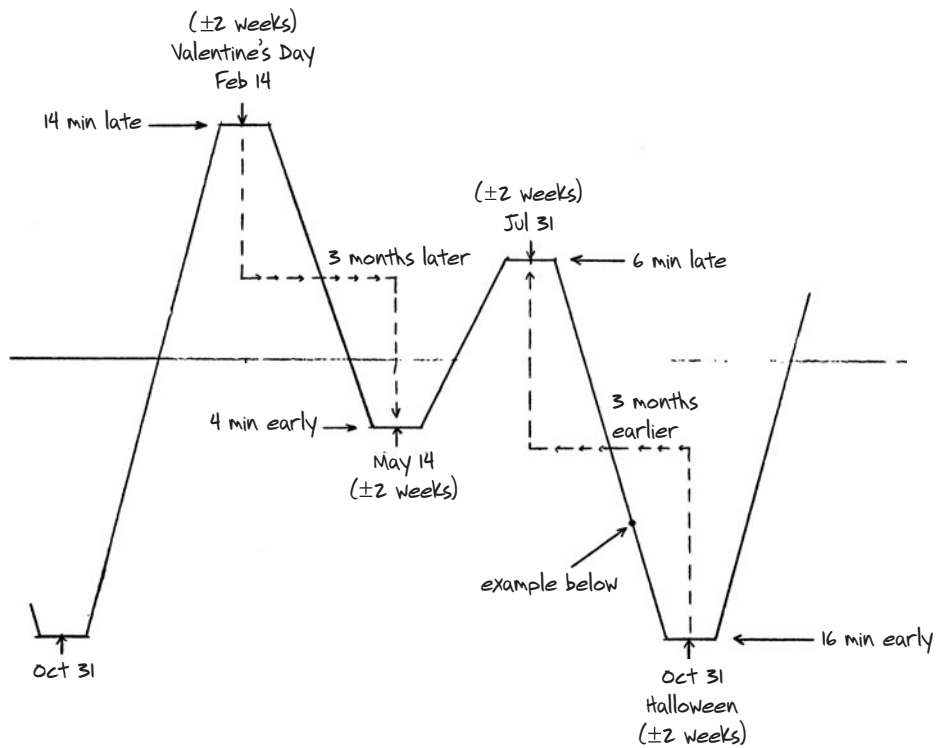

Figure 12-6. The Equation of Time and the UTC of LAN at Greenwich, which is 12:00:00 corrected for the Equation of Time.

Figuring the Equation of Time

On Valentine's Day, February 14, the sun is late on the meridian by 14 minutes (LAN at 1214); three months later, it is early by 4 minutes (LAN at 1156). On Halloween, October 31, the sun is early on the meridian by 16 minutes (LAN at 1144); three months earlier, it is late by 6 minutes (LAN at 1206).

These four dates mark the turning points in the Equation of Time. You can assume that the values at the turning points remain constant for two weeks on either side of the turn, as shown in Figure 12-7. Between these dates, assume the variation is proportional to the date.



Example: Find EqT on Sept 28

Figure slope

$$\begin{array}{l} \text{Jul 31} + 2 \text{ weeks} = \text{Aug 14} \\ \text{Oct 31} - 2 \text{ weeks} = \text{Oct 17} \end{array} \left. \begin{array}{l} \text{Aug 14} \rightarrow \text{Oct 17} = 64\text{d} \\ + 6\text{m} \rightarrow -16\text{m} = 22\text{m} \end{array} \right\} \text{slope} = 22 \text{ min}/64 \text{ days}$$

Interpolate

$$\begin{array}{l} \text{Sept 28} = 19\text{d before Oct 17} \\ \text{correction} = 19\text{d} \times (22\text{m}/64\text{d}) = 6.5\text{m} \\ \text{EqT} = 16\text{m} - 6.5\text{m} = 9.5\text{m} = 9\text{m } 30\text{s early} \end{array}$$

Figure LAN at Greenwich

$$\begin{array}{l} \text{LAN} = 12\text{h} - \text{EqT} = 11:59:60 - 9:30 \\ \text{LAN} = 11:50:30 \text{ UTC} \end{array}$$

Figure 12-7. Makeshift prescription for finding the Equation of Time (EqT). Values at the turning points are assumed constant for two weeks on either side. Intermediate values must be interpolated as shown. The rule begins with “14 minutes late on Valentine’s Day . . .”

There is some symmetry to this prescription, which may help you remember it:

14 late	three months later goes to	4 early
16 early	three months earlier goes to	6 late

but I admit it is no catchy jingle. Knowing the general shape of the curve and the form of the prescription, however, has been enough to help me remember it for some years now. It also helps to have been late sometimes on Valentine's Day! An example of its use when interpolation is required is shown in Figure 12-7.

The accuracy of the prescription is shown in Figure 12-8. It is generally accurate to within a minute or so, which means that longitude figured from it will generally be accurate to within 15' or so.

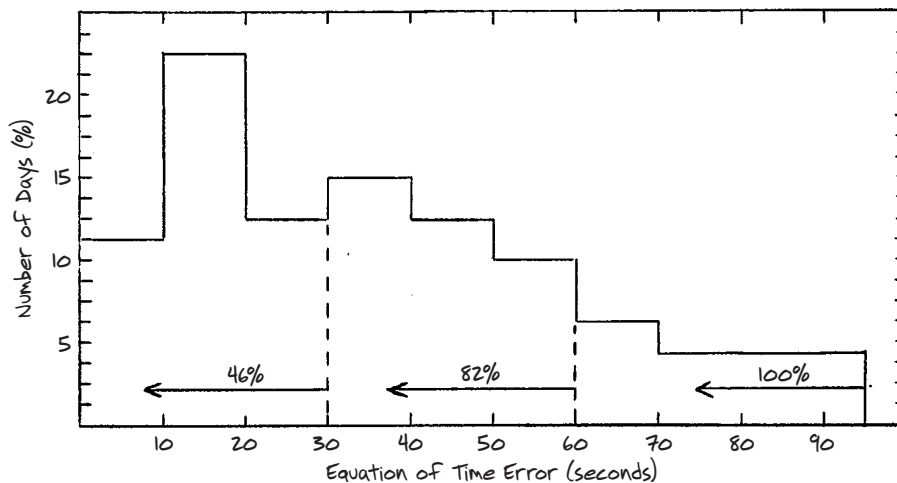

Figure 12-8. Errors in the makeshift prescription for the Equation of Time. For 82% of the year, the values are accurate to within 60 seconds. The maximum error is 95 seconds, which occurs during 4% of the year.

This process for figuring the Equation of Time may appear involved at first, but if you work out a few examples and check yourself with the almanac, it should fall into place. If you are going to memorize something that could be of great value, this is it. When you know this and have an accurate watch, you will always be able to find your longitude; you don't need anything else. With this point in mind, it is worth the trouble to learn it.

Also remember that the LAN method tells you what your longitude was at LAN, even though it may have taken all day to find it. To figure your present longitude, you must dead reckon from LAN to the present. Procedures for converting between distance intervals and longitude intervals are covered in the Keeping Track of Longitude section below.

For completeness, we should add that, strictly speaking, this method assumes your latitude does not change much between the morning and afternoon sights used to find the time of LAN. A latitude change distorts the path of the sun so that the time halfway between equal sun heights is no longer precisely equal to LAN. Consider an extreme example of LAN determined from

sunrise and sunset when these times are changing by 4 minutes per 1° of latitude (above latitude 44° near the solstices). If you sail due south 2° between sunrise and sunset, the sunset time will be wrong by 8 minutes, which makes the halfway time of LAN wrong by 4 minutes. The longitude error would be $60'$, or 1° . But it is only a rare situation like this that would lead to so large an error. It is not easy to correct for this when using low sights to determine the time of LAN. For emergency longitude, you can overlook this problem.

In preparing for emergency navigation before a long voyage, it is clearly useful to know the Equation of Time. Generally, it will change little during a typical ocean passage. Preparing for emergency longitude calculations from the sun involves the same sort of memorization required for emergency latitude calculations. For example, departing on a planned thirty-day passage starting on July 1, you might remember that the sun's declination varies from $N 23^\circ 0'$ to $N 18^\circ 17'$ and the time of LAN at Greenwich varies from 1204 to 1206. Then, knowing the emergency prescriptions for figuring latitude and longitude, you can derive accurate values for any date during this period.

Analemma

The daily location of the sun that you need to navigate can be summarized in a unique figure called an *analemma* (see Figure 12-9). You can think of it as a plot of the Equation of Time versus declination of the sun, but since these are exactly the two parameters that determine where the sun is in the sky at any time of day, the figure has a more physical interpretation. If you were to take a photograph of the sun at exactly the same time of day every day of the year and then superimpose the photos into one figure you would get precisely this figure. Quite a few photographers have done so. Links to these photos and much more discussion of this figure and its ramifications are presented at www.analemma.com and numerous other online references.

For emergency navigation, you might think of the analemma simply as another interesting way to coordinate how these fundamental parameters change throughout the year.

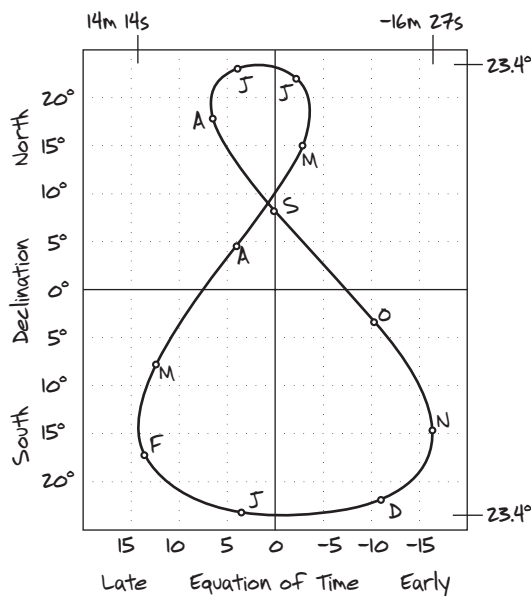

Figure 12-9. An analemma. This unique figure, known to the ancients, is a plot of the sun's declination and Equation of Time—the very two items needed to navigate by the sun without an almanac. If you have this figure memorized you are covered for any contingency! The text presents ways to estimate these values independently. Knowing this layout might help keep things in perspective. The Equation of Time is the difference between the UTC of LAN when observed on the Greenwich meridian relative to 12:00:00 exactly. In mid-February, the sun is late by as much as 14 minutes, so noon at Greenwich would be 12:14 UTC. In early November the sun is early, crossing Greenwich some 16 minutes before 12:00 at 11:44. Dots along the curve mark the first day of each month.

FINDING UTC FROM A KNOWN POSITION

Now that we have found longitude from time, we'll look at finding time from longitude. At the time of an emergency, you might know your longitude but not the time zone or current error of the only watch available. The task then is to use the sun and your known position to set your watch. From then on, you can use the watch to keep track of longitude as you move away from the known position.

Take the following example. Without moving from my known position during the day, I find the time of LAN to be 11:15:30 by the only watch available, and I know I am at longitude $67^{\circ} 25'$ W. From sunrise-sunset tables or from the prescription of the previous section, I figure that the Equation of Time for this day is -13 minutes and 30 seconds, so the UTC of LAN at Greenwich is 12:00:00 - 00:13:30, or 11:46:30. I am west of Greenwich by $67^{\circ} 25'$, which equals 04:29:40 when converted to time at the rate of 15° per hour. Therefore, the UTC of LAN at my longitude should have been 11:46:30 + 04:29:40, or 15:75:70, which equals 16:16:10. Since the watch read 11:15:30, it is slow on UTC by 16:16:10 - 11:15:30, or 05:01:40. In other words, this watch is set on the time zone plus 5 hours, and is 1 minute and 40 seconds slow. From now on, I know UTC is the watch time of this watch plus 5 hours, 1 minute and 40 seconds. With the necessary tables, you could discover the same thing using the observed time of sunrise or sunset.

In a case like this, you almost certainly won't know the watch rate—how much time it gains or loses each day. Without knowing its rate, as time goes by and you move away from the known position, you will gradually lose track of the time. Modern quartz watches, however, are quite accurate. On average, such a watch might gain or lose only 15 seconds or less per month. So it is probable that the uncertainty caused by an unknown watch rate would remain small for a long time. With a modern quartz watch, it would definitely be smaller than the uncertainty in the measured time of LAN or in your makeshift prescription for the Equation of Time.

Obviously, this procedure is of no value if you don't have a good watch or you don't know your position. The key to good emergency navigation is prudent navigation before an emergency occurs. Know where you are to the best of your ability at all times, and wear a good watch. A "good" watch, by the way, can be as simple as a waterproof quartz watch that shows hours, minutes, and seconds plus day and date on the dial, along with a stopwatch function and maybe a countdown timer and an effective light. These days a "very good" watch would be all of that plus a barometer, compass, and GPS, but such watches actually start to get so bulky that you might be reluctant to wear one all the time, which is a disadvantage.

KEEPING TRACK OF LONGITUDE

The accuracy of emergency longitude calculations from the sun and UTC depends on both your knowledge and measurement skills. In special cases, the accuracy may be high and the measurements easy. With accurate time, careful work, and some luck, you should be able to achieve an accuracy to within 50 miles or so from an unknown position. But with uncertainties in watch error, sun height measurements, and the Equation of Time, you must consider that an accuracy to within some 90 miles is a more realistic goal—which is about the same level of accuracy you might expect for latitude without especially favorable conditions.

And to stress another point again, you can generally travel a long distance from a known position by careful DR before your position uncertainty increases to 90 miles. In many situations, your time and effort are better spent on careful DR than on trying to discover your position from the sun or stars. Eventually, though, it is the interplay between DR and direct measurement that will be the key to keeping track of latitude and longitude on a long voyage.

Keeping Track of Longitude

Changes in latitude are easy to figure from distance run, since 1° of latitude always equals 60 nmi. Changes in longitude are not as easy to reckon because the number of miles to a degree of longitude changes with latitude. Throughout the tropics, you can assume that 1° of longitude also equals 60 nmi. However, as your latitude increases from there, the number of miles per degree of longitude begins to decrease—and the farther you get from the tropics, the faster it decreases. Because of this complication, you might end up keeping track of your position with a hybrid notation, such as latitude $35^\circ 10' \text{ N}$, longitude 58 miles west of $68^\circ 30' \text{ W}$.

This hybrid system works fine for recording progress, but to figure your distance off a known longitude, such as a coastline or island, or to keep track of longitude with the sun, you need to convert east-west miles to longitude degrees and minutes. With a pilot chart, or any chart showing your latitude region, you can read longitude miles directly from the chart scales. Or you can figure this without a chart by using the procedure illustrated in Figure 12-10.

Draw a quadrant of a circle with a 6-unit radius to represent 60 nmi. Then from the center of the circle lay off an angle above the base equal to your latitude (north or south). At the point where the latitude angle intersects the circle, draw a line straight down to the base of the quadrant. The distance along the base from this line to the center of the circle is the number of miles per degree of longitude when measured with the same units used for the radius. By varying the latitude angle, you can see how the length of a longitude degree decreases with increasing latitude.

As an example of this procedure, suppose that I am near 35° N in west longitudes. After a two-day run, my longitude has increased by 1°

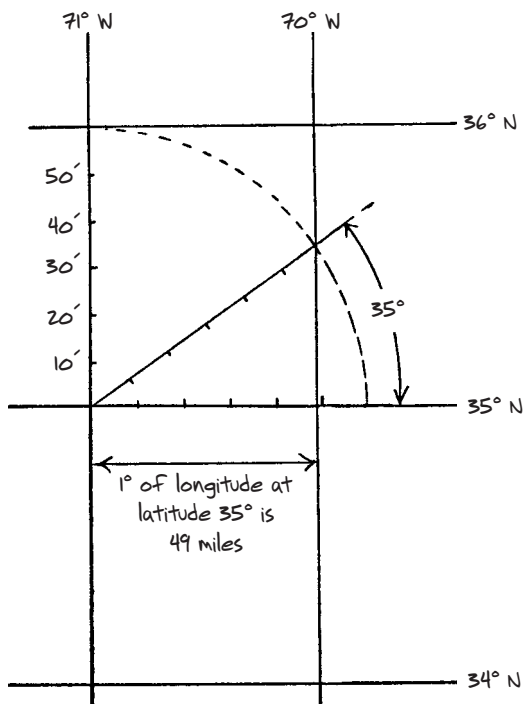

Figure 12-10. A makeshift plotting sheet. Swing a 6-unit arc between the midlatitude and longitude, then draw an angle equal to your midlatitude as shown. The next meridian goes through the intersection of the arc and the angle. The procedure is identical to that used in conventional universal plotting sheets. From this plot, you can deduce that 1° of longitude at 35° of latitude (N or S) is equal to 49 nmi. If you have trig functions on your calculator you can check with: $\text{nmi per } 1^\circ \text{ of Lon} = 60 \text{ nmi} \times \text{Cos}(\text{Lat}) = 60 \times \text{Cos}(35^\circ) = 49.1 \text{ nmi}$.

20' according to UTC of sunrise. Using Figure 12-10, I find that 1° of longitude at latitude 35° equals 49 miles. Using 1° 20' = (80/60)° I figure the length of the longitude interval as:

$$(80/60)^\circ \times 49 \text{ miles}/1^\circ = 65 \text{ miles}$$

In other words, direct measurements from the sun indicate that I have traveled 65 miles to the west during these two days, and this is the value I must compare with my DR. Or, to convert the other way, if I figure I am 58 miles west of 68° 30' W at 35° N, my longitude must be:

$$68^\circ 30' + (58 \text{ miles} \times 60'/49 \text{ miles}) = 68^\circ 101' = 69^\circ 41' W$$

When comparing longitude figures with DR, remember that the comparison is independent of latitude changes. In the last example, I could have traveled due west, or I could have moved 100 miles to the south during the two days. What I am checking with this comparison is only my east-west progress. Consequently, for an arbitrary course direction, you must first plot the number of miles traveled along your actual course and then project that distance onto the east-west axis before you can make the comparison, as shown in Figure 12-11. A similar projection onto the north-south axis must be made for latitude comparisons.

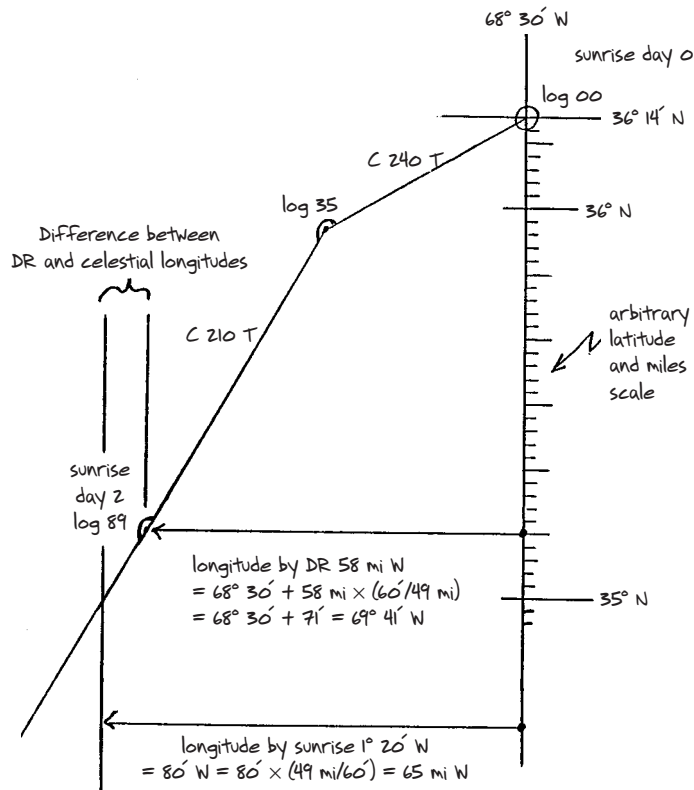

Figure 12-11. A makeshift chart showing a diagonal run of 89 miles with one course change. Westing in miles can be read directly using the latitude scale, but the longitude interval must be figured from the conversion factor of 49 miles per 1° of longitude at 35° latitude, which was found in Figure 12-10.

The Importance of Accurate Time

Without UTC, you can't find longitude, but any good watch that's running can still help you keep track of longitude over a long voyage—even from an unknown or only poorly known position. Suppose that you have a good watch but don't know its time zone or error, and your position is only a rough guess. What can you do?

First, find your latitude; you don't need the time for that, and it might help improve your longitude guess. Then use your longitude guess (no matter how unlikely it might be) to find the time zone and error of the watch, as explained in the previous section—it won't be right, but that doesn't matter. Now, as you move away from that position, just proceed with your DR and longitude measurements from the sun as if you did know UTC from the watch. Knowledge of your actual longitude will never improve over your original guess since your time isn't right, but you can still check for strong east-west currents or leeway over an extended voyage by comparing longitude changes according to DR with those you deduced from the sun.

This is certainly no substitute for knowing the correct time, but it is far better than DR alone if you have a long voyage to make. Suppose, for example, that you are in a strong westbound current of some 2 knots, but don't know it—although you might suspect a current once you find your latitude if you are familiar with the waters. But let's say you aren't. The intended course you hold is due north, and you dead reckon accordingly. Now, how long can you go before the sun tells you that you are being set? The answer is about two days, and in three or four days you should know pretty well by how much. Even with nothing but the prescription for the Equation of Time, you can find longitude to within 50 miles or so, and this current is setting you about that much each day.

Knowing how important accurate time is to navigation, do not overlook chances to set a watch to the correct time. For example, you could have an emergency that leaves you with several handheld GPS units that are working just fine along with several wristwatches on various crew, none of which have known rates or errors. In this case, the first thing to do is use the UTC from the GPS to set the watches correctly. Then, if you run out of batteries or the GPS stops for any reason, you are ready to carry on with the most important data you could have. The UTC shown on a GPS is accurate as soon as the unit has contacted any satellite. If it has not contacted a satellite for a long time or has traveled a long distance, and it still comes on and shows a time, then there is some uncertainty, since it is then effectively acting as a regular quartz watch. This is assuming, it will even tell you the time without having contact with at least one satellite—some do, some do not.

Chapter 13

COASTAL PILOTING WITHOUT INSTRUMENTS

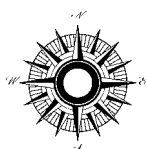

The critical part of ocean navigation rarely takes place in the middle of the ocean. It is the beginning and end of a voyage that typically pose the biggest challenge, usually because they are potentially the most dangerous. We've covered using emergency navigation during a voyage; now we'll review some of the basic points of negotiating a landfall. The visible range of lights and land is fundamental, as it determines what navigational accuracy you need to find your destination. Knowing that you might not see these until you are much closer to land than you anticipated is also fundamental, as are the natural signs of the ocean environment that might help you out.

In some cases, you can read the subtle signs of nearby land from the air, sky, and water before you sight actual land. These signs could help you set a course to safety, and include clouds, birds, insects, flotsam, sea state, and such man-made indicators as aircraft and agricultural or industrial pollution that you can see or smell. Except for clouds, these aids are potentially most valuable when your target landfall is low, since they won't expand the detectable range of land by much more than 10 or 20 miles, if that. In clear weather, you will probably see anything taller than 500 feet or so before these signs are apparent. Clouds are an exception because they effectively raise the elevation of the land.

Once the land is in sight, your primary piloting goal is to keep track of distance off as you make the approach. You can do this in several ways without conventional instruments.

SIGNS OF LAND AT SEA

Clouds

Stationary cumulus clouds often indicate the presence of hills or mountains. They are most prominent in an otherwise cloudless sky, but sometimes cumulus cloud caps are also apparent among moving or thinner clouds. Cloud caps build as the land heats, so look for these to first appear in midmorning and become more prominent as the day progresses. Unfortunately, all cumulus clouds build with the day's heat, so these land indicators may be most valuable during early morning. Stationary cumulus clouds are useful land indicators at all latitudes. Of all the signs of land at sea, cumulus clouds over islands or mountain peaks must be ranked among the most important since they can be seen from the farthest away (see Figure 13-1). Nevertheless, you must always consider your basic DR and other uncertainties before turning to head for the clouds.

In temperate latitudes where the winds aloft can be strong, prominent cumulus clouds (called mountain wave clouds—altocumulus lenticularis) are convincing indications of land. They occasionally form over mountain ridges in strong winds. They look like flying saucers (see Figure 13-2), and although they are usually stationary over the peak, they occasionally

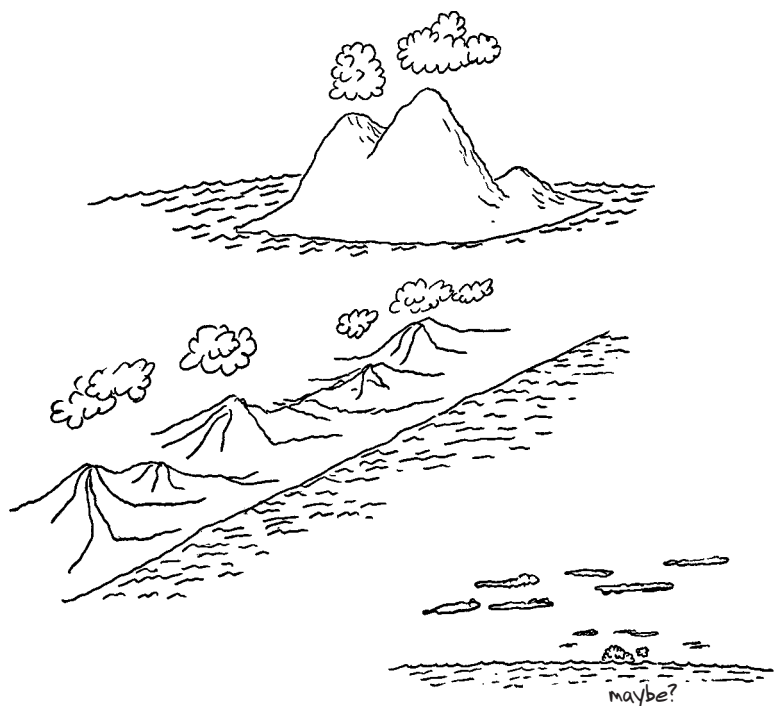

Figure 13-1. Cloud caps over an island and coastal mountain range. Stationary cumulus clouds often build over peaks during midmorning and may be a sign of land not yet in sight. These clouds can, however, also obscure peaks that would otherwise be in view, so the best chance for spotting peaks on the horizon is during early morning.



Figure 13-2. Mountain wave clouds as a sign of land. They are flowing to leeward of a coastal mountain range. These clouds are characterized by their smooth, flying-saucer-like appearance. They can be isolated or in a sequence, as shown here. Mountain wave clouds are formed by strong winds aloft and are fairly rare, but if you see them on the windward horizon they are a convincing sign that land lies ahead.

break loose and keep their remarkable shape as they drift downwind. This is a fairly rare cloud form, but an almost certain sign of land. Since prevailing winds aloft are from the west, you would expect these mostly when headed westward toward a mountainous coast.

Reflected Color in Clouds

Another subtle effect that can also be quite valuable on occasion is the color of land, reefs, or banks reflected onto the clouds above them. This generally requires the right degree of sky cover—enough breaks to let direct sunlight through, but enough cover to form a reflective surface above the water. Shallow waters of tropical or subtropical lagoons or banks, for example, can sometimes show up quite clearly as a turquoise color on the undersides of the clouds above them.

Birds

Birds can provide valuable guides to nearby land in some circumstances, but their use is heavily dependent on local knowledge. You must know the habits of local birds to use the direction of their flight for bearings, and you should still carefully weigh the uncertainties before turning to follow a bird.

Some bird signs may be more encouraging than others. Several birds flying in the same direction at sunset, and several birds flying from the same direction in the morning begin to be pretty good evidence of land—especially if you have identified the birds and you know they sleep on land. Bird flight during the day is generally unreliable, but there may be local exceptions. Thomas Gladwin reported (see the No-Instrument Navigation section of the bibliography), for example, that in the waters of the central Caroline Islands, a white tern flying with a fish sideways in its beak is headed for land no matter at what time of day it is sighted. Presumably it has caught a fish too big to eat at sea and is headed for land to finish it off.

The distance offshore at which a particular bird might be seen depends on the species and location. It also, of course, depends on the randomness of their flight. Be cautious when taking sea stories and bird studies into account when your safety is at stake. It is likely that many land-based birds that roam the seas during the day home in on land at sunset by sight, just as we do.

But since they are higher, they can see farther. From a height of 200 feet, they can see land of the same height from some 25 miles off. Studies of bird navigation in the Pacific islands show the following birds to be the most useful for land bearings, with their approximate ranges offshore given in parentheses: terns and noddies (10 to 20 miles), boobies (30 miles), and frigate birds (50 miles). But there are random exceptions, even among these birds, that might lead you astray. David Lewis, for example, saw twelve boobies 700 miles west of the Line Islands on the first no-instrument voyage of the *Hokule'a* from Hawaii to Tahiti (private communication, 1985).

Airplanes

Using airplane sightings for orientation was discussed at the end of Chapter 7. Near a major airport, these sightings might be extremely valuable for homing in on your target, but you should treat them like clouds and birds—with caution. Consider the information they suggest, but balance it against your basic DR and other information and the corresponding uncertainties. Remember that planes usually land and take off into the wind regardless of their routes (see Figure 13-3). Generally speaking, planes and contrails are overrated in sailors' folklore of how to find an island in a bind, whereas the use of an AM radio to home in on an island station, as discussed in the Direction Finding with a Portable Radio section in Chapter 8, is often overlooked in such discussions.

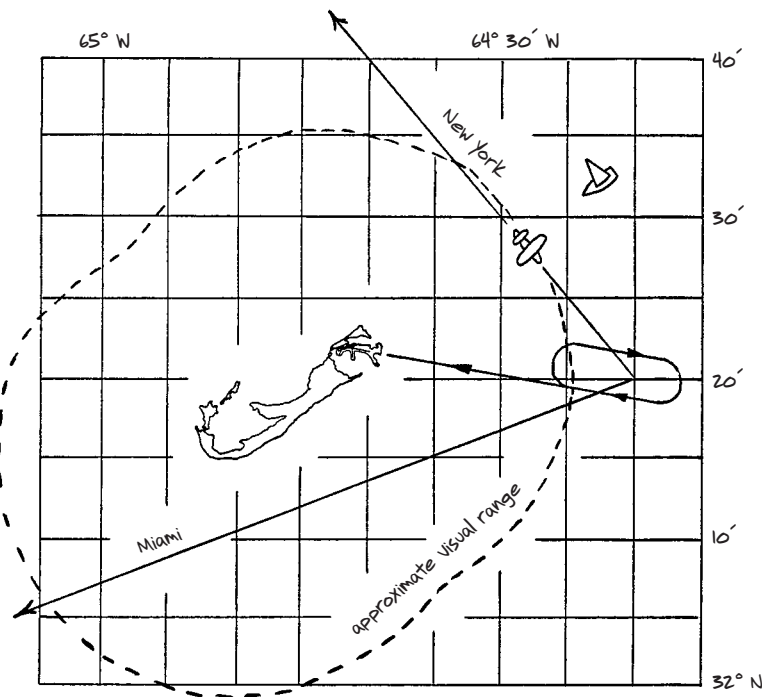

Figure 13-3. Possible air traffic approaches to a holding pattern off Bermuda. The holding pattern shown is from an aircraft chart, but routes to it won't necessarily be as shown here. These are purely schematic to show that plane sightings just out of sight of an island might give misleading bearings to the island. Not likely, just possible.

Insects

The first appearance of insects might also be a sign of nearby land. On one occasion, I noticed a fly on board one day before sighting Hawaii in clear weather. On another crossing, Hawaii was spotted, but the next day we were socked in and I lost sight of the islands. During that day, a flying insect of some kind appeared. These, though, are isolated examples. Most landfalls are likely to be bug free. Nevertheless, it would be good procedure to wait for clear weather if you are socked in close to an island destination when insects first appear on board.

Swell Patterns

Traditional navigators of the Pacific islands are reported to have routinely used swell patterns to locate islands in their waters. This, however, is a subtle art. It generally requires a region of prevailing swells and a highly trained eye to spot recurrent features or deviations in prevailing patterns. Obviously, the typical oceangoing navigator will not derive as much benefit from swell patterns in unfamiliar waters. One exception might be the first appearance of a prominent crossed-swell pattern fairly near an island or shoreline.

If the swells have been steady for some days from one direction, and all swells in the area have always been from that direction, and then you begin to detect weaker swells coming from almost the opposite direction, then quite possibly these new swells have been reflected off a shoreline ahead of you (see Figure 13-4). The crossed-swell interference pattern is often clean and prominent for several miles offshore when the primary swell is reflected off a long, steep shoreline. When you are trying to figure the direction to the shoreline, think of the

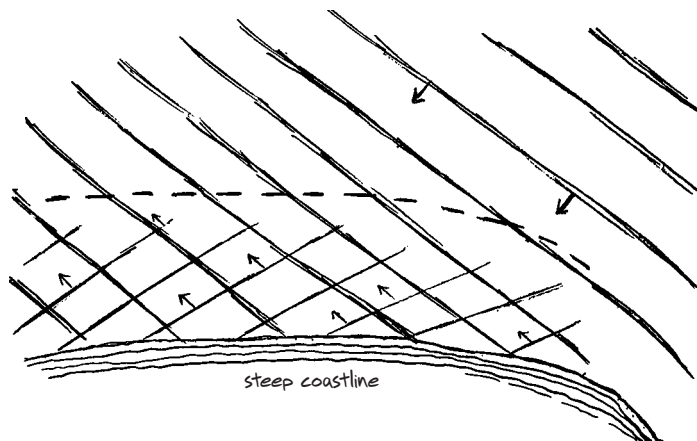

Figure 13-4. Reflected swell pattern. Near a steep coastline, an onshore swell is reflected back out to sea, often causing a prominent crossed-swell pattern, which can be detected several miles or more from the coast. In reduced visibility, or in exceptional cases in clear weather, the appearance of a reflected swell may signal the approach of land—especially if your local knowledge tells you there can be no other source of swells from that direction. Google Earth and similar online aerial photo programs offer a modern way to practice spotting large-scale swell patterns in island groups.

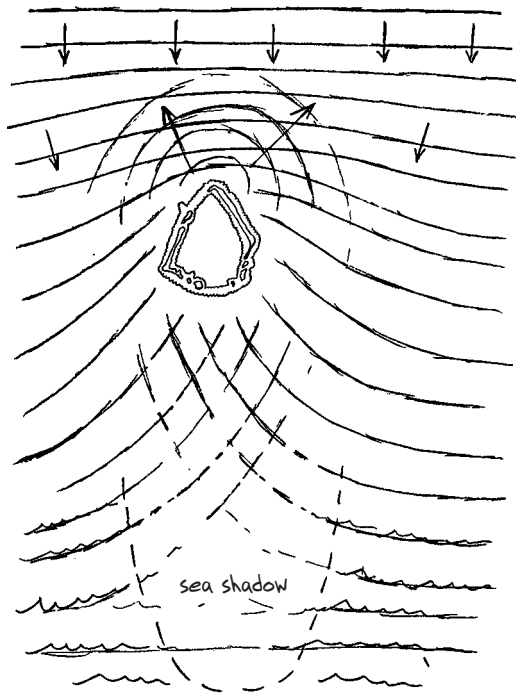

Figure 13-5. Refracted swell pattern near an isolated island or atoll. Swells curve as they approach an obstruction, as if to wrap around it. If you are approaching a very low island from windward, the first sea signs of land might be the appearance of a weak reflected swell. The curvature of the swells might be detectable from the masthead, but these are subtle signs at best in most cases. Approaching from the leeward side, the sea-shadow region of diminished waves and swell might be more convincing evidence of low land not far ahead. Detectable changes in swell patterns might extend some dozen miles or so on each side in exceptional cases, with a single prominent swell running downwind. These subtle signs are something to watch for when looking for such an isolated landfall, but you should not count on them to guide you there.

primary and reflected swells as billiard balls bouncing off a wall. This effect can be seen in any waters with prominent swells, and it may well be detected out of sight of land in reduced visibility.

The same general types of swell patterns develop when a swell is refracted or diffracted around an island or headland (see Figure 13-5), but the direction to the island and the prominence of the interference pattern are harder to read. In foul weather, though, it might still serve as a sign to wait for clear horizons.

Another opportunity to detect land from swells that does not require special training occurs when you sail into the lee of an island that is interrupting the swell pattern. If you know a low island lies somewhere to windward, and the swell (or seas in general) that you have been crossing for some days disappear or become noticeably weaker, although the wind is unchanged, then you may have entered the *sea shadow* of the island (see Figure 13-5). This is almost certainly the case if you continue on and the swell reappears, then you go back and it disappears. As long as the landmass is large enough, swells can be interrupted by even the lowest islands or atolls, so this could well be a sign of land not yet visible. It is interesting to surf around the world's oceans and island groups with an online global aerial photo program, such as Google Earth (earth.google.com) and study the swell patterns. Zoom way in, and you can often see the types of patterns that might be recognizable underway in those areas.

Physical Signs

The first smells or signs of smoke on the horizon are also signs of land to windward, as are freshly broken branches or a general increase of flotsam after a storm. As a rule, however, you should not count on any natural or unnatural signs to guide you to land. Figure the accuracy

of your navigation and the visible range of the land, covered in the next section, and let these determine your choice of target.

VISIBLE RANGE OF LIGHTS AND LAND

Before you can do any piloting, you must be in sight of land or a navigational light, or at least have a usable radio bearing. Understanding the visible range of distant objects is fundamental to navigation, emergency or otherwise. Several factors enter into this, notably the height of the observer, the height of the observed object, and the state of the atmospheric visibility. The curvature of the earth limits your range of sight regardless of the clarity of the atmosphere. If a mountain peak is H feet high and you are standing h feet above the water, then you will first see the tip of the mountain on the horizon (in clear weather and calm seas) when you are D nautical miles from the peak, when you figure D from the following equation:

$$D = \sqrt{H} + \sqrt{h}$$

Figure 13-6 graphically illustrates this equation. This is a handy formula, even though it does require a square root—squaring a few guesses will do the job. A hilltop 3,600 feet high can be seen just on the horizon at some 63 miles off when you are standing 9 feet above water:

$$\sqrt{3,600} + \sqrt{9} = 60 + 3 = 63$$

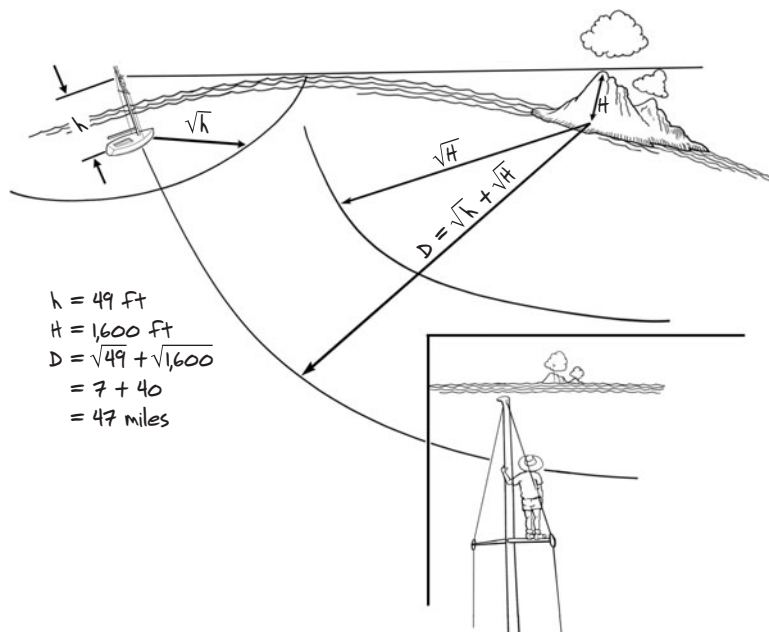

Figure 13-6. Visible range of land. The required accuracy of your navigation depends on the height of your target. Note that you can typically see about 4 or 5 miles farther by climbing to the masthead.

A low island whose tallest feature is a palm tree 64 feet high cannot be seen from a 9-foot elevation until you are 11 miles off ($8 + 3$). Standing on the spreaders at a height of 49 feet, you might spot this island at about 15 miles off ($8 + 7$). Obviously the accuracy required of your navigation depends on what you are looking for.

This visible-range formula gives an approximation of the mathematically correct results tabulated in the *Light List* and other books (the formula results are 15% smaller than the tabulated ones). The simple square-root formula, however, not only does away with the tables, it is more reliable than the tables. The slightest chop on the water or a slight haze around the land will reduce its visible range by much more than 15%. Even the shorter range figured from the formula should be considered optimistic.

Often, even when you are sailing in clear skies, the islands or coastlines you are looking for are veiled in mist or local rain showers. Cloud caps can also obscure the upper heights of peaks even in locally clear weather. Visible-range calculations tell you only when the tops should first come into view; with many clouds about, you might not see the land even when it is above the horizon. For this reason, your best chance of spotting land might be in the early morning, before cloud caps build.

Nautical charts show the average elevation of coastal lands in addition to peak heights and locations. With the visible-range formula and a chart—or even a rough recollection of or guess at the elevations—you can estimate the visible range of land. When using mountain peaks, remember you are figuring the distance to the peak, not to the coastline. If you want to find an island, the formula tells you roughly how accurate your navigation must be. To be conservative, though, I would want to be able to do somewhat better than that if the island were an isolated target.

When looking for navigational lights, the same formula and procedures apply. A light located 144 feet above the water can be seen from an elevation of 16 feet at a distance of $12 + 4$, or 16 miles. The brightness of the light and clarity of the atmosphere, however, also limit the visible range of lights at night.

So far we have discussed *geographic ranges*, which tell us when an object is above the horizon. This places a limit on visible range, regardless of the clarity of the atmosphere or the brightness of the light. But being within the geographic range of a light does not guarantee you'll see it at night. You see bright lights farther than dim ones, and even a bright light can be extinguished by fog or rain.

Nautical charts and the *Light List* specify the brightness of lights by giving their *nominal range*, which is how far you can see the light on a clear night when not limited by geographic range. Consider a light that is 81 feet high with a nominal range of 14 miles. If you were standing 9 feet above the water, the geographic range of the light would be $3 + 9$, or 12 miles. Once you reach 12 miles off, you could see this light on clear nights, since the nominal range is larger than 12 miles. On the other hand, if you were standing on the spreaders at an eye height of 49 feet, the geographic range to this light would be $7 + 9$, or 16 miles. Once you reach 16 miles off, you could (in principle) see this light during the day, but not at night. Viewed from the spreaders, the light is above the horizon, but it only shines out to 14 miles. You would have to be 14 miles off to see it from the spreaders at night. From the deck, the limitation is geographic; from the spreaders it is the brightness of the light (see Figure 13-7).

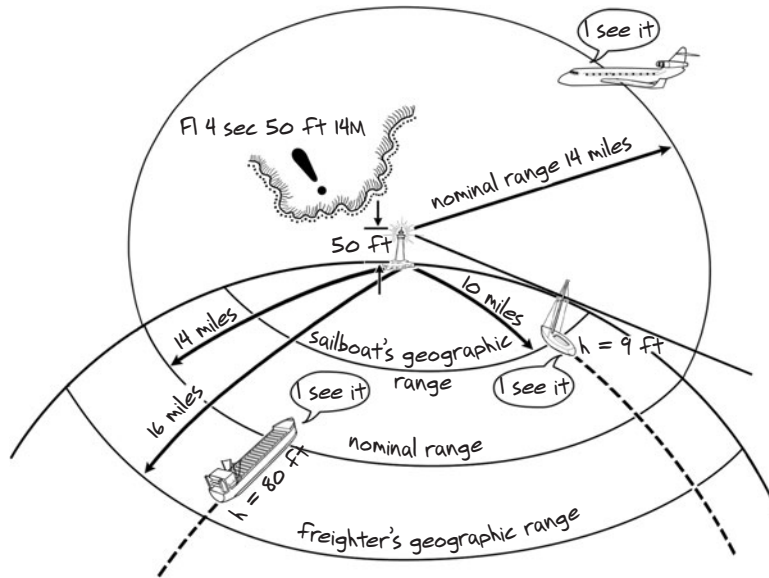

Figure 13-7. Comparing geographic range and nominal range. The nominal range of a light is a measure of its brightness. When seen from a sailboat, it is often the height of the light that limits range of visibility, not the brightness of the light.

Remember that white lights may appear reddish or somewhat orange when first seen on the horizon, and the true flashing characteristic of a light may not be apparent until you are fairly close to it. If a light sequence includes both colored and white flashes, you usually see the white ones at a greater distance than the red or green ones.

You can sometimes see the glow, or loom, of a bright light in the sky long before you see the light itself. What is happening here is that the height of the light is being increased to the height of the clouds or haze above it, so the geographic range is bigger. Cities or towns also light up the sky. Frequently, the loom of a city is sufficiently bright and localized to use it for a bearing to the city from a long way off. The loom of Miami, Florida, for example, can be seen routinely from some 60 or 70 miles offshore (John Dowd, private communication).

In reduced visibility, you must replace the light's charted or tabulated nominal range with its *luminous range*, which you must compute. The procedure is easy; the problem is figuring how much the visibility is reduced. The atmospheric visibility is how far you can see unlighted objects in daylight. Even during daylight, this is not easy to figure at sea, but you need it at night, which makes it still more uncertain. Even a rough guess, such as 10 miles (clear weather), 1 mile, or 0.1 mile, will help you plan the approach. One trick is to simply note, late in the day or at early twilight, whether you can discern a horizon between sea and sky. If you can, the visibility (in nautical miles) must be greater than the square root of your eye height in feet (h). If you can't see a horizon, the visibility must be less than the square root of h .

Once you have estimated the atmospheric visibility, you can find the luminous range of the light from the luminous-range diagram in the *Light List*, or in an emergency, you can figure it without this aid, using the following formula:

$$\text{Luminous range} = [(\text{Visibility} \div 10) \times (\text{Nominal range})] + 1 \text{ mile}$$

You can use this formula for visibilities down to about $\frac{1}{2}$ mile.

For example, consider a light with a charted nominal range of 22 miles. If you estimate the prevailing atmospheric visibility at 4 miles, the luminous range is:

$$[(4 \div 10) \times (22)] + 1 = (0.4 \times 22) + 1 = 9.8 \text{ miles}$$

In other words, a 22-mile light is reduced to about a 10-mile light when the visibility is 4 miles (see Figure 13-8).

As another example, note that a 5-mile light in 5-mile visibility can be seen only from about 3.5 miles, as figured by:

$$[(5 \div 10) \times (5)] + 1 = (0.5 \times 5) + 1 = 3.5$$

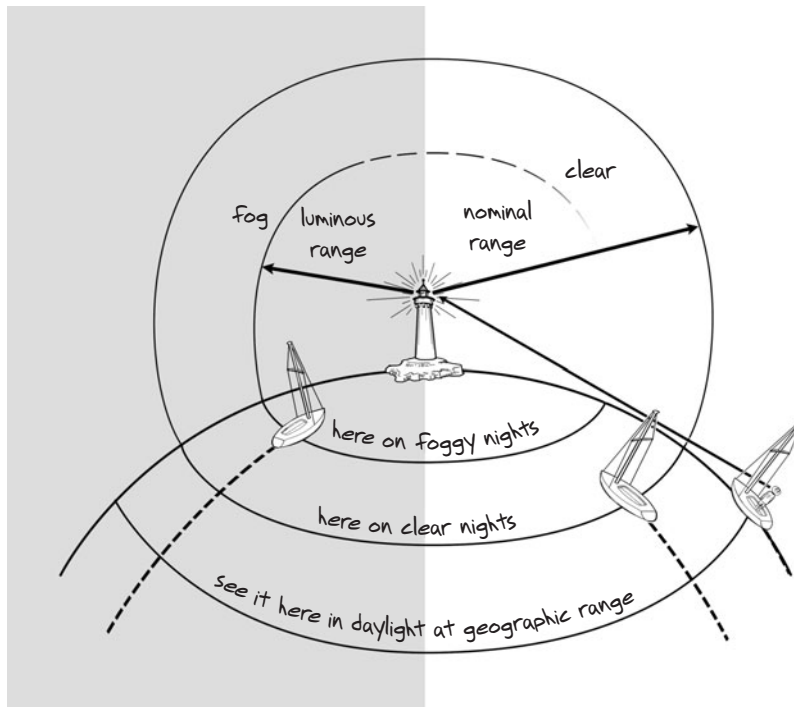

Figure 13-8. Comparing nominal range and luminous range. In reduced visibility, you must compare the geographic range of a light with its luminous range to see which determines the visible range. You can figure luminous range from a table in the *Light List* or by using the formula given in the text.

This luminous-range formula is a simple approximation of a complex table. It is correct to within 20% or so, which is good enough, since you will never know the visibility any better than that. The formula is, in fact, adequate for routine navigation as well. When looking for a light in reduced visibility, figure the geographic range and the luminous range; the visible range is the smaller of the two. Naturally, if you can't reasonably estimate the nominal range of the light in question, you can't do any of this preparation.

DISTANCE OFF

When a known navigational light is visible from a high point on your boat but not from a lower one, then you can assume your distance off the light is fairly near the geographic range of the light viewed from the higher elevation. This method of judging distance off is called *bobbing the light*. It works best in calm water and clear skies, when the geographic range is well within the nominal range—i.e., for low, bright lights. Distance off figured this way won't be precise, because no geographic range formula or table is precise, but you must be fairly close to this geographic distance off for this phenomenon to occur.

Besides being able to see farther, another good reason to watch for lights from a high elevation, such as standing on the boom, is the chance of bobbing a light. Then you can jump down to bob the light when it first appears. If you spot it first from below, you may have missed this chance. In any event, if you can see the light at all, you must be within its geographic range, and this alone gives some data on distance off.

Finding Distance Off with a Kamal

Throughout this book, we have stressed the value of small-angle measurements made with a kamal. You can put this skill to further use in finding distance off in sight of land. The procedure is to measure the angular width or height of some landmark and then figure distance off (quite accurately) from this angle and the size of the landmark. You can do this in an emergency with nothing but a stick and a string, but this method is more than an emergency trick. Given your choice of any equipment to use for finding distance off, you might still choose a stick and a string, once you are accustomed to this easy and accurate method. (Designing and calibrating a kamal are covered at the beginning of Chapter 11.)

To use the kamal, first identify from the chart and your surroundings (or from your local knowledge and the surroundings) one wide landmark with prominent edges, or two nearby objects that are at roughly equal distances from you and less than 15° or so apart when viewed from your vantage point. They could be, for example, two sides of a large rock, two rocks, two towers or stacks, two peaks, two sides of a bay or valley, or two edges of an island. Then hold the kamal sideways to measure the horizontal angle between the two sides (see Figure 13-9). The angle you get from the kamal would be the same as the difference between the magnetic bearings to the two sides, but generally you can directly measure these small angles much more precisely than you can the individual bearings.

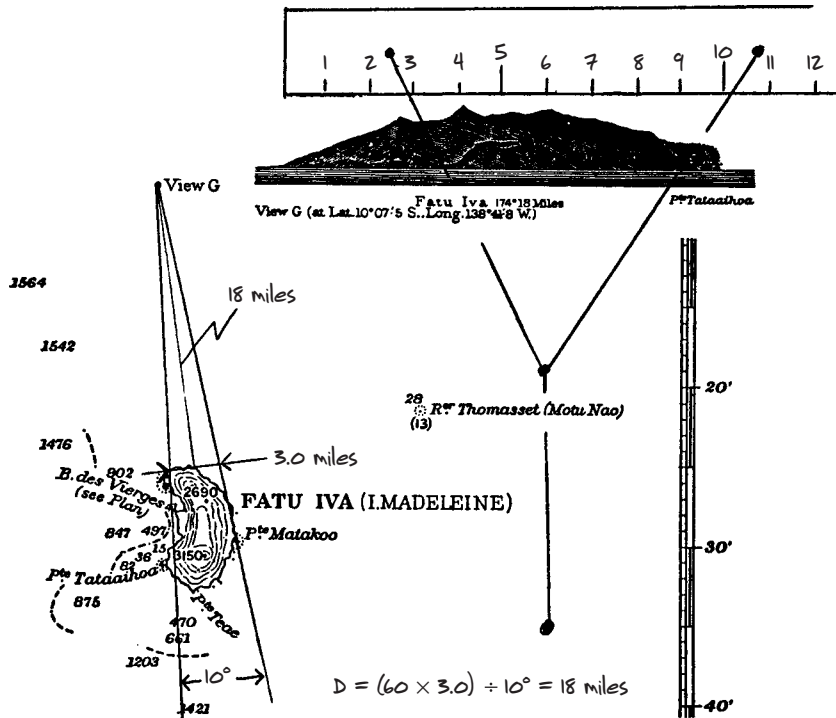

Figure 13-9. Finding distance off by horizontal angle. Use a calibrated kamal (or sextant if you have one) to measure the horizontal angle subtended by the object from your perspective. Then measure the width of the object from that perspective on a chart, and use the range formula given in the text to find distance off. Note that you are finding your distance to the point at which you measured the width. You can find your position from a bearing and a distance off, or from two distances to two separated features (at the intersection of two circles of position).

Next figure your distance off the center of the two objects from the following formulas:

$$\text{Distance off (in miles)} = 60 \times [\text{Target width (in miles)} \div \text{Kamal angle (degrees)}]$$

or

$$\text{Distance off (in miles)} = \text{Target width (in feet)} \div [100 \times \text{Kamal angle (degrees)}]$$

The two forms of the formula are equivalent since 1 nmi is very nearly 6,000 feet.

This method works for any distance off as long as you are sure of the actual width of the feature you measured. For example, I see two prominent peaks on an island to the south that are 6° apart according to the kamal. From the chart, I measure these peaks to be 2.5 miles apart when viewed from the north. My distance off the peaks is:

$$(2.5 \times 60) \div 6 = 25 \text{ miles}$$

With practice, you can often determine horizontal angles with adequate precision by winking your finger (see the beginning of Chapter 11).

As you get closer to land, use the same procedure to find distance off from a vertical kamal angle (see Figure 13-10). With the kamal, measure the angular height of a landmark above the shoreline, then figure distance off from:

$$\text{Distance off (in miles)} = \text{Target height (in feet)} \div [100 \times \text{Kamal angle (degrees)}]$$

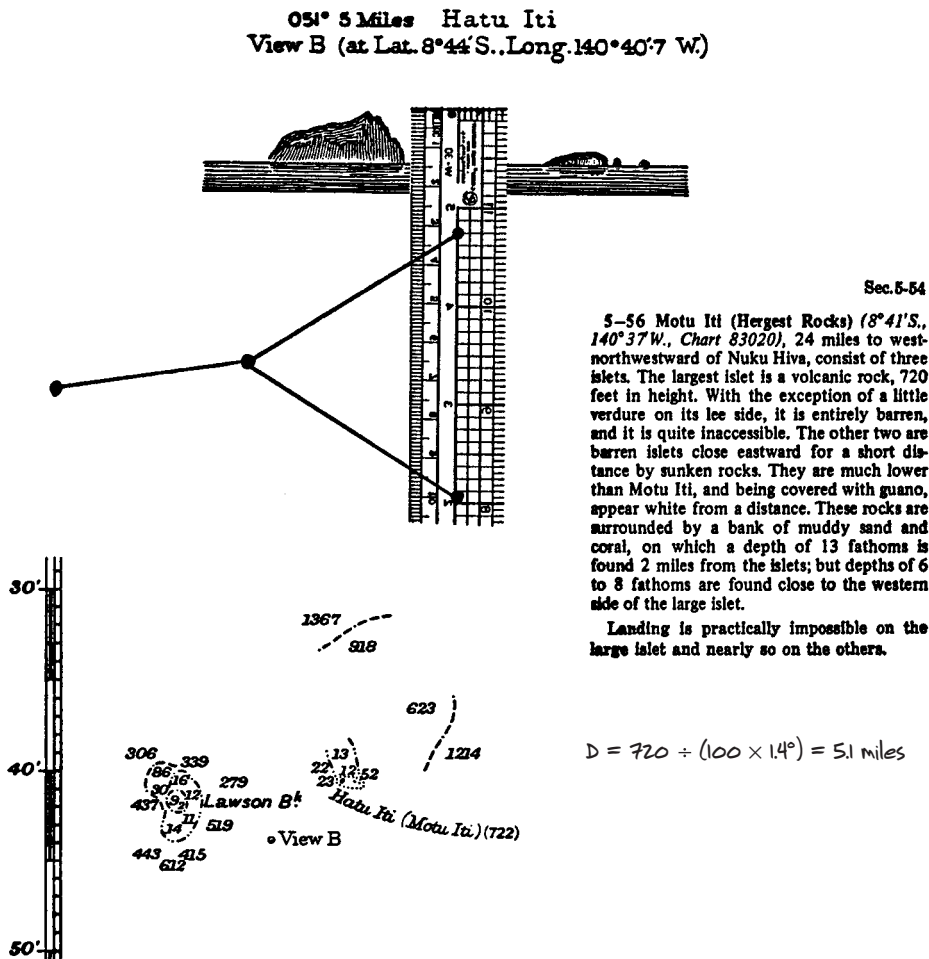

Figure 13-10. Finding distance off by vertical angle. Use a calibrated kamal or sextant to measure the vertical angle from the tip of the object to the shoreline below it. Then look up the height (in feet) of the object from a chart, Light List, or Sailing Directions, and use the range formula given in the text to find distance off. Note that you are finding your distance to the peak of the object, not to the shoreline. The inset text describing this islet is from DMA Pub. 80, Sailing Directions for the Pacific Islands, Volume III, which disagrees with the charted height of this rock by 2 feet. This publication has been replaced with NIMA Pub. 126, which includes much less detail—a reminder to hang on to your old Sailing Directions if you have some.

For this application, however, you must be within view of the true shoreline, which means your answer to distance off shouldn't be much larger than the square root of your eye height. Standing on deck at an eye height of 9 feet, this will work for distances of 3 miles or so. You can stretch it some, maybe up to 50%, out to distances of 5 miles or so, but the result will not be accurate until you get within geographic range of the shoreline. As an example, I see a hilltop 2° above the shoreline according to my kamal. The charted elevation of the hill is 460 feet, so my distance off is:

$$460 \div (100 \times 2) = 2.3 \text{ miles}$$

Note that the formula for vertical angle is the same as that for horizontal angle. In each case, you are simply dividing the target size (in hundreds of feet) by the kamal angle (in degrees) to get distance off (in nautical miles). For close-in navigation, vertical angle is often more convenient than horizontal angle, because your target is well located. Elevations of peaks and lights are charted or given in *Coast Pilots* and *Sailing Directions*.

Finding Distance Off by Doubling the Angle on the Bow

While holding a straight course along or toward a shoreline, you can find your distance off any landmark you see by *doubling the angle on the bow*. For this method, you don't need a chart or any special knowledge of the landmark.

First note the angle of a landmark relative to your heading (the angle on the bow), and then keep track of the distance you must travel along your course line to double this angle. Your distance off the landmark is then equal to the distance you traveled to double the angle.

For example, I note that a prominent rock lies 30° on my port bow as I begin to keep track of my distance run (which would be the case if I were headed toward, say, 270° , and the rock's bearing was 240°). When the rock has moved aft to 60° on the bow (bearing 210°), I figure that I have traveled 2 miles. Therefore I am now 2 miles away from the rock. In routine navigation with a binnacle compass, this is often a convenient measurement to make using the compass pins at 045° and 090° . Sighting over the center pin when sailing along a shoreline, you can get your distance offshore without leaving the helm.

Without a compass, you must improvise the angle measurements. Any type of makeshift compass card will do, or you can use a folded piece of paper, since you don't need to know what the angle is, only that you doubled it. There are many ways to improvise (see Figure 13-11).

An obvious advantage of this method is that you can find distance off any landmark, and you don't need a chart of the area to do it. You must, though, be close enough to land that bearings to the landmark change within a reasonable time relative to anticipated currents in the region. The error in this method is very roughly equal to your DR error over the time of the run. If it took 1 hour in 1 knot of current, you could be off by about 1 mile. If doubling the bow angle will take too long for your needs, you can apply the running fix method—discussed in the next section—to visual bearings, which also does not require a chart.

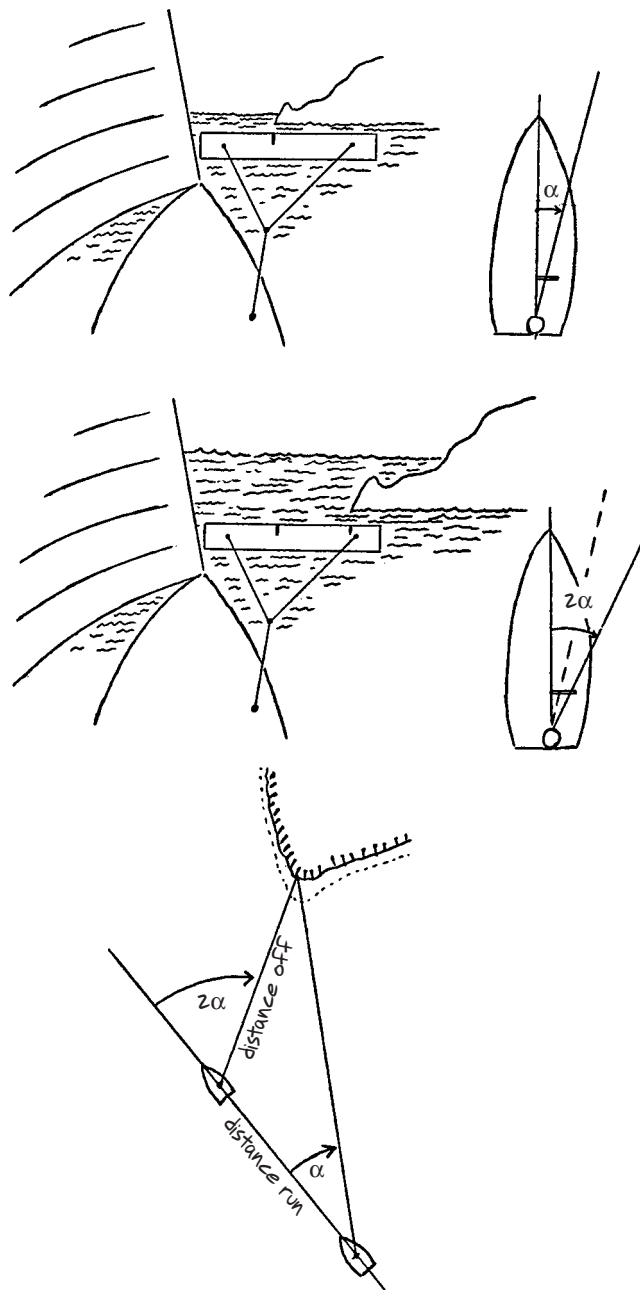

Figure 13-11. Doubling the angle on the bow. Record the angle on the bow (top) and then hold a straight course until the angle has doubled (middle). Your distance off will then be equal to the distance you had to run to double the angle (bottom). Here the bow angle is shown measured with a kamal, but a portable compass card or even a folded piece of paper will do as well. Remember that these are relative angles; a kamal used this way is not accurate for measuring specific numerical values of these larger angles.

RUNNING FIX FROM RADIO BEARINGS

Without instruments in the fog, you don't have much to pilot by, except possibly a makeshift radio bearing from an AM radio. You won't necessarily know where the broadcast antenna is, but you can still keep track of relative position using an unknown antenna location. You must, though, be close enough to the antenna that bearings to it change within some reasonable time in relation to uncertainties in local currents. Also the station must be somewhere other than dead ahead, not one you are homing in on—though you could head off course and use this trick to find distance off the antenna if necessary.

Doing this in the fog without a compass, you also need some way to hold a steady course direction, as discussed in Chapter 8. In sea fog, you might have a steady wind direction to help with this. In radiation fog, it might be calm enough to use a trailed line. The value of this type of running fix, however, is not necessarily limited to fog. You can receive AM broadcasts a long way out of sight of land.

First note the angle on the bow to the AM station using the procedures from the Direction Finding with a Portable Radio section in Chapter 8. You can use actual bearings if you have them, but you don't need them. Then hold a steady course and keep track of distance run until the radio bearing on the bow changes by 15° or more (to be useful, this method requires a good null). Presumably you will be headed toward land, so the bearing should move aft as you proceed—if it doesn't, you may have learned something important. With the two angles on the bow and the distance run between them, you can figure your distance off the AM antenna with the plotting work illustrated in Figure 13-12.

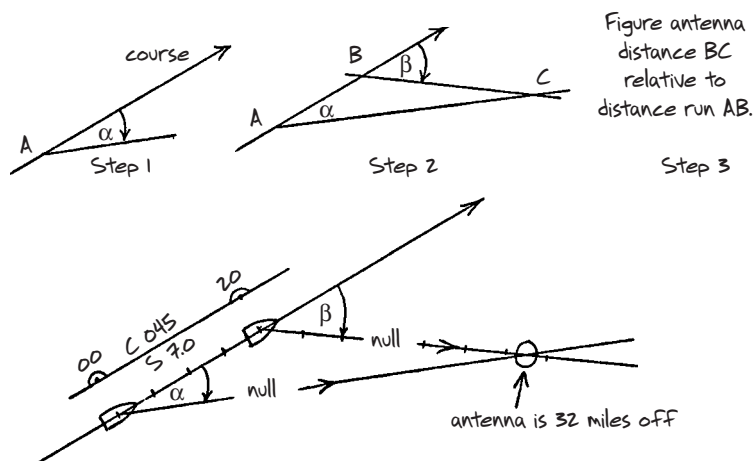

Figure 13-12. Running fix from radio bearings without a chart. Step 1: Draw your course line at some estimated distance off and lay off the first bow angle to the antenna that you find from the null direction. Step 2: At any point B, draw in the second bow angle so that a triangle is formed on the page. Step 3: Figure the antenna distance relative to the distance run, as shown. The intersection angle at the antenna determines the quality of the fix. Radio bearings are often difficult to determine precisely, so you might have to run some distance to make this angle large enough to use. Put another way, if the antenna is very far off, this will only give you a very approximate fix. This procedure is a generalization of the bow-angle method of Figure 13-11, and as such, it does not require you to travel so far as to double the bow angle to find distance off. You could use this method for visual bearings if needed.

Draw a line to represent your course line and lay off the first bow angle. Then, at some arbitrary distance up the course line from there, lay off the second bow angle so that you form a triangle on the page. The two bearing lines will intersect at the unknown antenna location, forming the smallest angle of the triangle, equal to the difference between the two bow angles. Your distance off the antenna is the line you just drew to complete the triangle, which you can read using the distance run along the course line between bow angles to set the scale. With this procedure, you can keep track of your position relative to the antenna. This is potentially a very powerful technique in some coastal regions or near island chains with several AM stations available. For example, it could help locate your position when you are in sight of a coastline but still too far offshore for good visual bearings.

COURSE MADE GOOD IN CURRENT

We discussed current corrections to DR in midocean in the DR Errors from Current and Lee-way section in Chapter 10. Although there are notable exceptions, currents are generally stronger in coastal waters, which makes your navigation of them there more critical. For example, if you overstand an island channel entrance in strong trade winds because you didn't reckon the currents properly, you may have quite a problem on your hands in beating back to it. In the ocean, you might get by with correcting your daily runs, but along a coast you might want more immediate information, such as course made good in current or heading to steer to hold a desired course. Although these are not strictly the same problem—the amount you point into a current to track straight does not always equal the amount you get set if you don't—they are nevertheless fairly close in most cases. Considering the uncertainties involved, you can use the same solution for both.

The amount you get set if you do nothing or the amount you should point into a current to track straight we will call your *set*. To figure the set, you need an estimate of the water speed (*current*) and your own speed through the water (*speed*). The set then depends on whether you go straight across the current with it hitting your beam, or diagonally across the current with it hitting your bow or quarter sections (see Figure 13-13). The results are easy to figure without plotting. For current on the beam:

$$\text{Set} = (\text{Current} \div \text{Speed}) \times 60^\circ$$

For current on the bow or quarter:

$$\text{Set} = (\text{Current} \div \text{Speed}) \times 40^\circ$$

This is a simplified solution to a vector problem, but you rarely know current strength or direction well enough for a more accurate solution. Note that current on the bow or quarter sets you off course by the same amount; the only difference is how fast you go. Current on the bow slows you down; current on the quarter speeds you up.

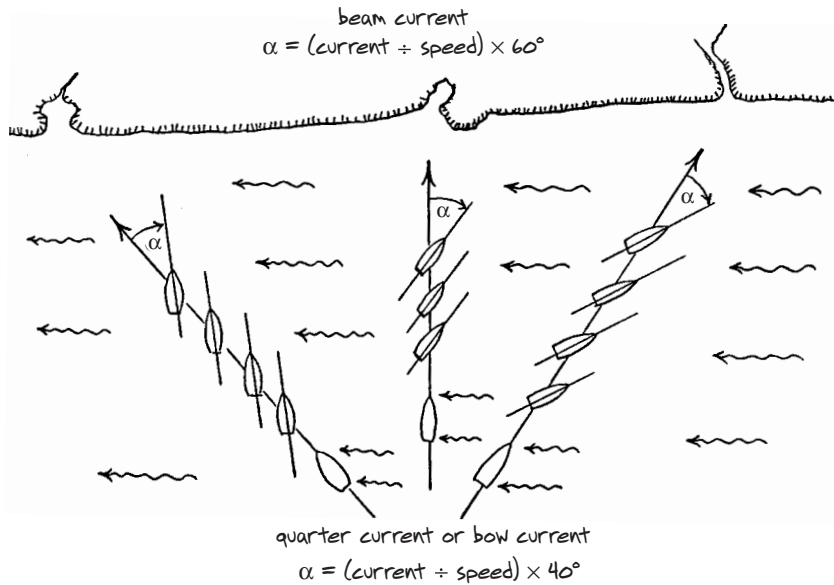

Figure 13-13. Figuring current set. The estimates shown are approximations to the proper vector solutions. These convenient approximations are more than adequate in most cases, because you rarely know the current strength or direction well enough to do any better. With current on the bow, boat speed is slowed by roughly three quarters of the current speed, which is about what you gain with current on the quarter. This estimate of set angle assumes boat speed is at least two or three times greater than the speed of the current.

As an example, let's say I am making about 5 knots through the water in the direction I want to go but anticipate entering a current of about 2 knots on my port bow as I get closer in. My set will be about:

$$(2 \div 5) \times 40^\circ = 16^\circ$$

If I do nothing, I will be set right about 16° . If the winds allow it, I could head upcurrent to the left by 16° and should track straight along my previous course.

Note that this approximation for set angle only works well for current speeds less than three-quarters of the boat speed.

Chapter 14

WHAT TO DO WITH WHAT YOU'VE GOT

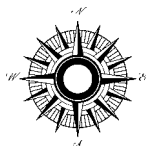

So far we have covered emergency navigation using few, if any, conventional aids. A watch and sunrise-sunset tables are the only specific items we've taken advantage of. In most cases, the supplemental value and application of other aids are obvious, if they are available. A proper marine sextant, for example, would greatly improve position and direction finding even in the absence of other standard aids or tables. Likewise, an almanac opens up much more of the sky for use in steering and position fixing.

Having only one specific aid is one thing; losing only one specific aid is another. With a bit more work, you can do away with any one of the aids often considered vital without losing much accuracy or efficiency in navigation. These contingency procedures are easy once you are familiar with the emergency navigation methods covered so far. Navigators unfamiliar with emergency procedures will find that an almanac is the one aid that is the most difficult to do without—which is worth noting, since an almanac is also the item that is least likely to have a backup. There are now, however, very convenient long-term almanacs available in print and electronic versions (see the Almanac Data section of the bibliography).

ROUTINE NAVIGATION WITH EVERYTHING

When it comes to celestial navigation, having “everything” essentially means having the following:

- *compass*
- *sextant*
- *UTC*
- Nautical Almanac

- *sight reduction tables, such as Pubs. 249 or 229 or the Nautical Almanac Office (NAO) table included in every almanac*
- *plotting sheets*
- *plotting tools (parallel rulers, dividers, protractor, pencils, erasers, notebook)*

A 2102-D Star Finder (or the British equivalent, N.P. 323) is extremely valuable in routine and emergency navigation but it is not strictly essential.

A thorough, nonelectronic backup system might include the items below, which are also shown in Figure 1-2:

- *spare compass*
- *two quartz watches (rated waterproof)*
- *Davis Mark III plastic sextant*
- *long-term almanac and concise sight reduction tables*
- *a few universal plotting sheets*
- *plotting tools (parallel rulers, dividers, protractor, pencils, erasers, notebook)*
- *pilot chart*

This backup system will get you anywhere your primary system will, though it may take more work. For example, the plastic vernier sextant is small and lightweight but neither as accurate nor as easy to use as a high-quality metal one, and the sight reduction procedure required with the NAO concise tables and a long-term almanac is more involved than it is with Pubs. 249 or 229 and the annual *Nautical Almanac*.

For primary or backup navigation, however, it is not the style of equipment that is important, but what you do with it. Even if your primary electronic backup system—GPS, handheld satellite phone, and a couple dozen batteries—is in order, the recommended procedures for routine offshore navigation are the same—and, of course, you still need backup celestial gear. No foreseeable electronic development will change this.

The main goal of routine navigation should be accurate dead reckoning, regardless of what other aids or systems you use. The reason is simple. You may well have to navigate by DR alone, no matter what other aids you have on board. Even the best GPS systems are not 100% dependable in a small boat at sea, and you can't do celestial fixes when the sky or horizon is obscured. To be self-reliant, you should be prepared to make a landfall with DR and radio bearings alone.

To develop accurate DR, you must keep an accurate logbook of course changes and log readings, and then carefully compare your DR position with your celestial or electronic fixes each day. One convenient way to do this is to convert the difference between each fixed position and the corresponding DR position into an effective “current” by dividing the distance between the two positions by the time run since the last fix. Then keep a separate record of these error currents and the prevailing wind conditions (see Figure 14-1). To evaluate your DR and plan ahead, you need this estimate of the rate at which you might go off course in specific wind conditions.

For example, if your DR position was 26 miles southwest of your fix, and the last fix was taken 13 hours ago, then the sum of the errors is equivalent to a “current” of 2 knots to the

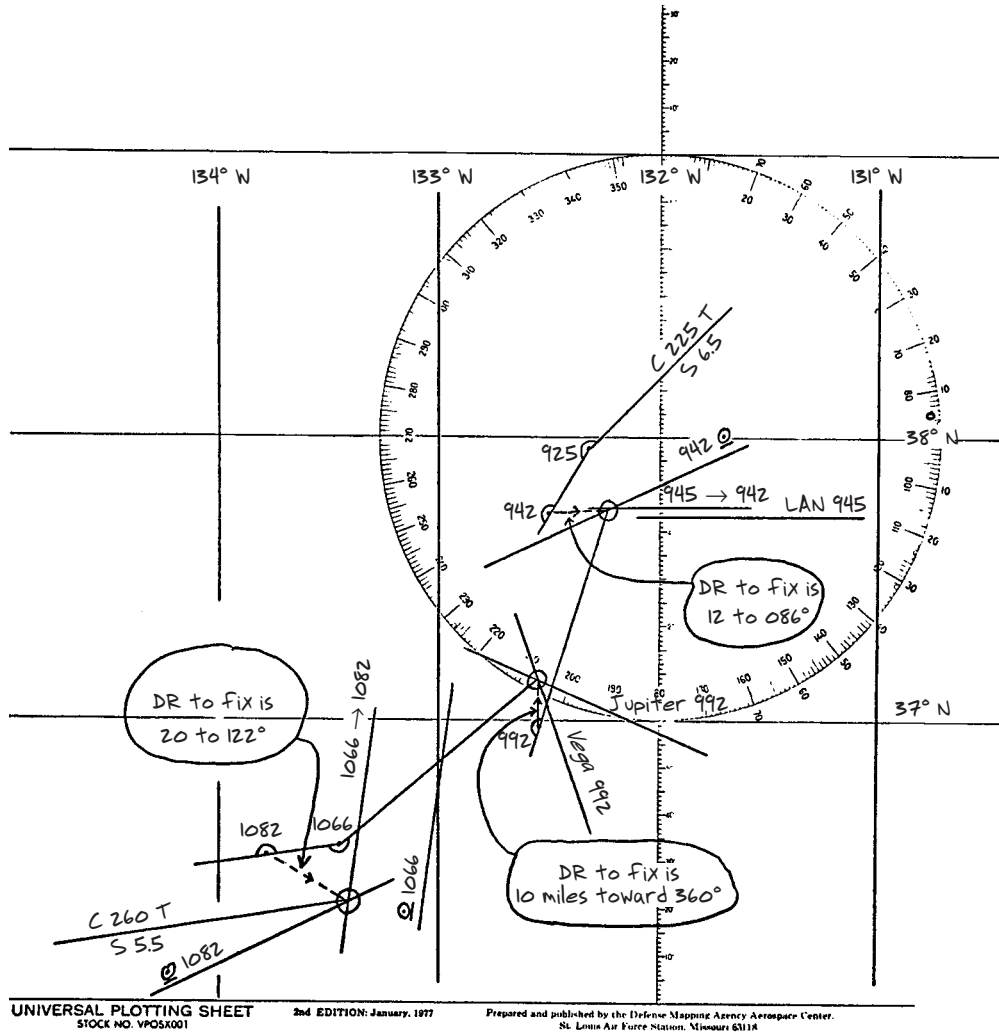

Figure 14-1. DR errors marked on a plotting sheet. The celestial fix taken at log reading 942 was 12 miles to the east of the 942 DR position. It is good practice to keep a record of these DR errors on the plotting sheet. A red arrow from DR to fix is one way to highlight this important information. This DR plot is for a section of the logbook shown in Figure 14-2.

southwest. This could be due to real current, instrument errors, or just a blunder in a logbook entry. Nevertheless, by making this check regularly, you will soon spot any consistent errors that might indicate a faulty log or compass. Logbook blunders will also stand out. When beating to weather, remember the several “invisible” factors that retard progress discussed in the Progress to Weather section in Chapter 10. In any conditions, though, this procedure shows very clearly how well you could navigate by DR alone if you had to. A sample DR log is shown in Figure 14-2.

Log reading	Time/date	Fix position	Type of fix	Distance and bearing DR to fix	Hours to last fix	Error current (knots)	Average speed (knots)	Miles logged	DR error percentage
0075	0400/4	48-23, 124-45	bearing fix						
0272	0900/5	46-00, 128-10	Rfix sun-Venus	11 T 215	29.0	0.4	6.8	197	6
0480	1530/6	44-04, 131-11	Rfix sun	17 T 012	30.5	0.6	6.8	208	8
0634	1400/7	41-38, 132-03	Rfix sun	07 T 300	22.5	0.3	6.8	154	5
0789	1330/8	39-02, 130-55	Rfix sun	30 T 095	23.5	1.3	6.6	155	19
0942	1330/9	37-45, 133-14	Rfix sun	12 T 086	24.0	0.5	6.4	153	8
0992	2130/9	37-09, 132-32	Vega-Jupiter	10 T 360	8.0	1.3	6.3	050	20
1082	1400/10	36-22, 133-24	Rfix sun	20 T 122	16.5	1.2	5.5	090	22
1161	0530/11	35-17, 133-48	Venus-2 star	19 T 084	15.5	1.2	5.1	079	24
1181	1100/11	34-58, 133-55	sun-moon	02 T 280	5.0	0.4	3.6	020	10
1285	1600/12	34-08, 135-12	Rfix sun	07 T 035	29.0	0.2	3.6	104	7
0364	0600/13	33-15, 136-16	moon-Venus	15 T 122	14.0	1.1	5.6	079	19
1412	1700/13	32-28, 136-13	Rfix sun	06 T 110	11.0	0.5	4.4	048	13
1696	0930/15	29-56, 139-54	Rfix sun-moon	28 T 320	40.5	0.7	7.0	284	10
1730	1330/15	29-30, 140-23	Rfix sun	07 T 162	4.0	1.8	8.5	034	21

Figure 14-2. Section of a logbook showing DR errors and error currents. The fix at log 942, for example, was taken 24.0 hours after the last fix. During this time, the DR had gone wrong by 12 miles, which means there was, in effect, an error current of 0.5 knot to the east during that leg of the voyage. This “current” could be from any source, including logbook entry errors or errors in the fixes themselves. Unless the ocean currents are large, it is unlikely that these “currents” reflect actual motion of the water. This 12-mile correction to the DR plot was made after sailing 153 miles, which means it corresponds to a DR error of 8% in the terminology used in the text. Other data recorded in the logbook, but not shown here, include compass course, knotmeter speed, wind speed and direction, barometer, sea conditions, speed made good, and sails set.

Log reading	Time/date	Fix position	Type of fix	Distance and bearing DR to fix	Hours to last fix	Error current (knots)	Average speed (knots)	Miles logged	DR error percentage
1865	0600/16	28-34, 142-40	moon-* Venus	03 T 270	16.5	0.2	8.2	135	2
1923	1430/16	28-12, 143-21	Rfix sun	17 T 032	8.5	2.0	6.8	058	29
1981	2200/16	27-52, 144-12	Jupiter- Vega	08 T 105	7.5	1.1	7.7	058	14
2265	1100/18	25-44, 149-09	Rfix sun	11 T 285	37.0	0.3	7.7	284	4
2343	2200/18	25-15, 150-26	Vega- Alkaid	05 T 360	11.0	0.5	7.1	078	6
2401	0700/19	24-42, 151-11	Venus-3 star	07 T 057	9.0	0.8	6.4	058	12
2486	2200/19	24-12, 152-30	Altair- Jupiter	15 T 360	15.0	1.0	5.7	085	18
2573	1530/20	23-17, 153-32	LAN (lat, lon)	11 T 074	17.5	0.6	5.0	087	13
2614	2200/20	22-49, 154-06	Jupiter-2 star	07 T 310	6.5	1.1	6.3	041	17

If this “current” turns out to be roughly the same each day, you could include it in your future DR, even if you aren’t certain where it comes from. On the other hand, if the error current turns out to be a knot or so in random directions, then you should consider that after two days of pure DR you could be some 48 miles off course, but probably not much more than this—even over longer runs—if the “set” of the errors is truly random (see Figures 14-3 and 14-4).

The ubiquitous use of GPS for offshore sailing comes with a tendency to overlook the basics of navigation. You might be tempted to navigate by simply recording the electronic fix in the logbook every few hours or so, but this is a dangerous practice. Unless the electronics are also monitoring and recording compass headings and logged runs—which requires more sophisticated gear that is not as common—then you are learning nothing about your DR accuracy. If the electronics fail under these conditions, you must start the *real* navigation with no recent data on the boat’s instruments or a crew not trained to make logbook entries, and probably from an unknown position. In short, your position is going to get worse before it gets better.

Another procedural point important to emergency preparation is how you handle timekeeping. It is best to navigate by the watch you wear and use the radio each day to check the watch, recording its watch error in a chronometer log but not resetting it. This way, if you lose radio time signals or GPS, you still have a well-rated watch. Setting your watch every few days by radio, or using a stopwatch and the radio time signals themselves for timing celestial sights, is dangerous

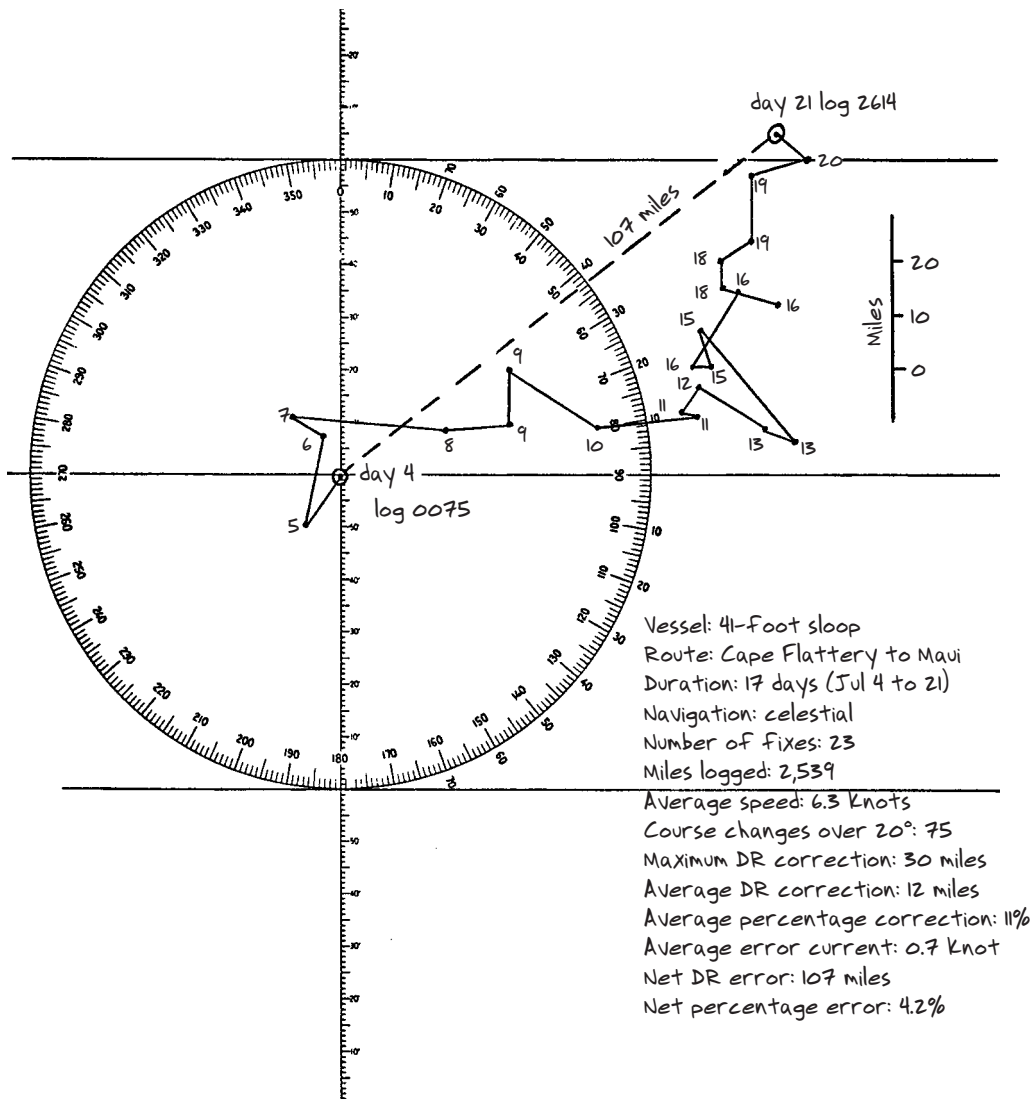

Figure 14-3. Vector plot of DR errors. The individual DR errors logged in Figure 14-2 are plotted sequentially here to show how the vessel would progressively have gone off course if these corrections had not been made. If no fixes had been taken on this voyage, the boat would have been 107 miles off position at log reading 2614. In this particular example, however, it would not have been off its course line, since these errors accidentally left the vessel very near its actual course line at the time. Note that even though the individual errors averaged some 11% (taking into account distance covered on each leg), the net error was only 4%, which shows how random DR errors tend to cancel out over a long run—in part because these DR errors also reflect errors in the celestial fixes. (This is shown even more dramatically in Figure 14-4 for another voyage.) The average DR error current was 0.7 knot (taking into account more time spent on each leg), which is somewhat higher than is typical for a sailboat keeping a careful DR log—the winds were unusually erratic for this trip.

Vessel: 50-foot sloop
 Route: Kawai to Cape Flattery
 Duration: 18 days (Aug 2 to 21)
 Navigation: celestial
 Number of fixes: 19
 Miles logged: 2,736
 Average speed: 6.5 Knots
 Course changes over 20°: 46
 Maximum DR correction: 30 miles
 Average DR correction: 13 miles
 Average percentage correction: 7%
 Average error current: 0.5 Knot
 Net DR error: 10 miles
 Net percentage error: 0.3%

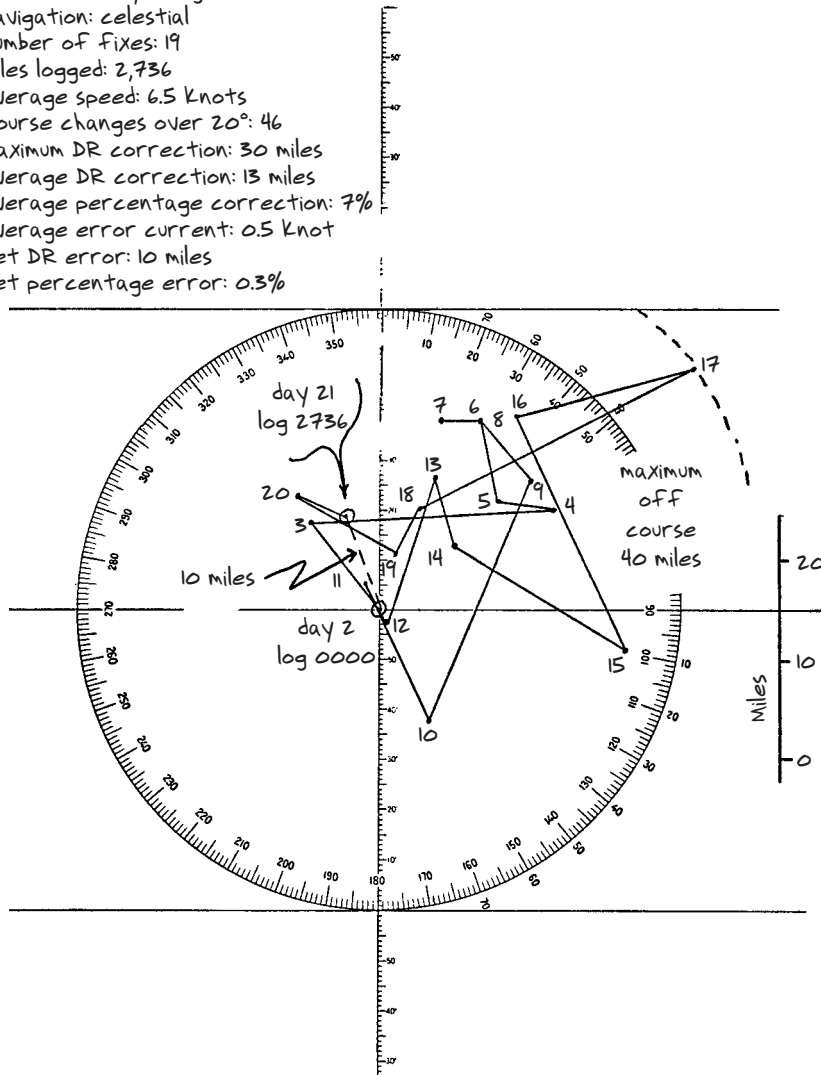

Figure 14-4. Another vector plot of DR errors. Here the DR errors cancel out almost completely. This is in part luck, but not entirely. The predicted ocean currents over this route nearly cancel out, so they were not expected to contribute. But more important, the boat's log and compass were accurate, and a careful logbook was kept. Any confirmed course change over 5° was logged—the 46 changes listed above reflect only the number of times the course changed 20° or more, either at once, or after four 5° entries. Even with this care, corrections as large as 30 miles were made, though some large corrections followed weather legs in daylong storms, with steady winds of 30 to 35 knots.

since you would lose accurate UTC with the loss of the radio. With a rated watch, you can always figure out UTC, no matter where you are or what other aids you might lose. For any long passage, UTC is without a doubt the most valuable aid to have.

When sailing with GPS working well, frequent log entries for GPS values of course and speed over ground (COG and SOG) along with compass heading and knotmeter speed will provide valuable checks on effective leeway, current reckoning, and instrument calibrations.

The main point here is that to learn about DR, it is important to practice it. When you have GPS you can learn precisely how well you are doing at DR. Make it a challenge to do the very best you can over a few hours or over a few days. It could be a most worthwhile preparation for almost any form of navigational emergency.

POSITION BY RADIO CONTACT

With two-way radio or satellite phone contact to land or another vessel, you are essentially never lost. A vessel in sight could tell you your position, but even when completely out of sight, a vessel or land station in radio contact could help pinpoint your position. If out of sight, but still in VHF (very high frequency) radio contact, you know a lot about your position just based on the radio signals. The range of VHF signals is more or less limited to line of sight—the geographic range from antenna to antenna. To estimate your maximum separation, use the geographic range formula from the Visible Range of Lights and Land section in Chapter 13, with H equal to the contact's antenna height (which the contact provides) and h equal to your antenna height. The intensity and clarity of the signal are also some indication of the distance off.

Furthermore, in an emergency, the Coast Guard can locate a transmitting antenna by radio direction finding (RDF). This can be done on any marine frequency, VHF for short-range communications or single-sideband (SSB) for long-distance communications. This service, however, should only be used for a true emergency, since it could require an expensive coordination of land, sea, and air operations. There are other things to try first if you are lost but not in danger.

For one thing, you can always get UTC if you have radio contact. You could even be told the Equation of Time precisely for your date and from this figure your longitude from the time of LAN (see the Longitude from LAN section in Chapter 12). Your contact could also possibly tell you your approximate latitude from the length of day you report, if you didn't have the sunrise-sunset tables to figure it out yourself. Or the contact could tell you your approximate latitude by looking up the declinations of the overhead stars you describe. Even if you didn't have a watch, you could report the live observation of sunrise and sunset, from which they could use their clocks to determine your longitude. For any help of this kind, though, you should know what to ask for—radio operators, or even skippers of other vessels, are not likely to be trained in these special cases of celestial navigation. And if you know these principles, you are prepared to help others, should you receive such an emergency call. The radio call, by the way, would be Pan-Pan, not Mayday.

Once you've established an approximate position, look for any nearby traffic that might further identify your position by radio contact. Some VHF radios include built-in RDF capability. With these, you can home in on another vessel or even get bearings to the antennas used for coastal weather broadcasts (their locations and heights are shown on NOAA Marine Service Charts, an example of which is shown in Figure 14-5).

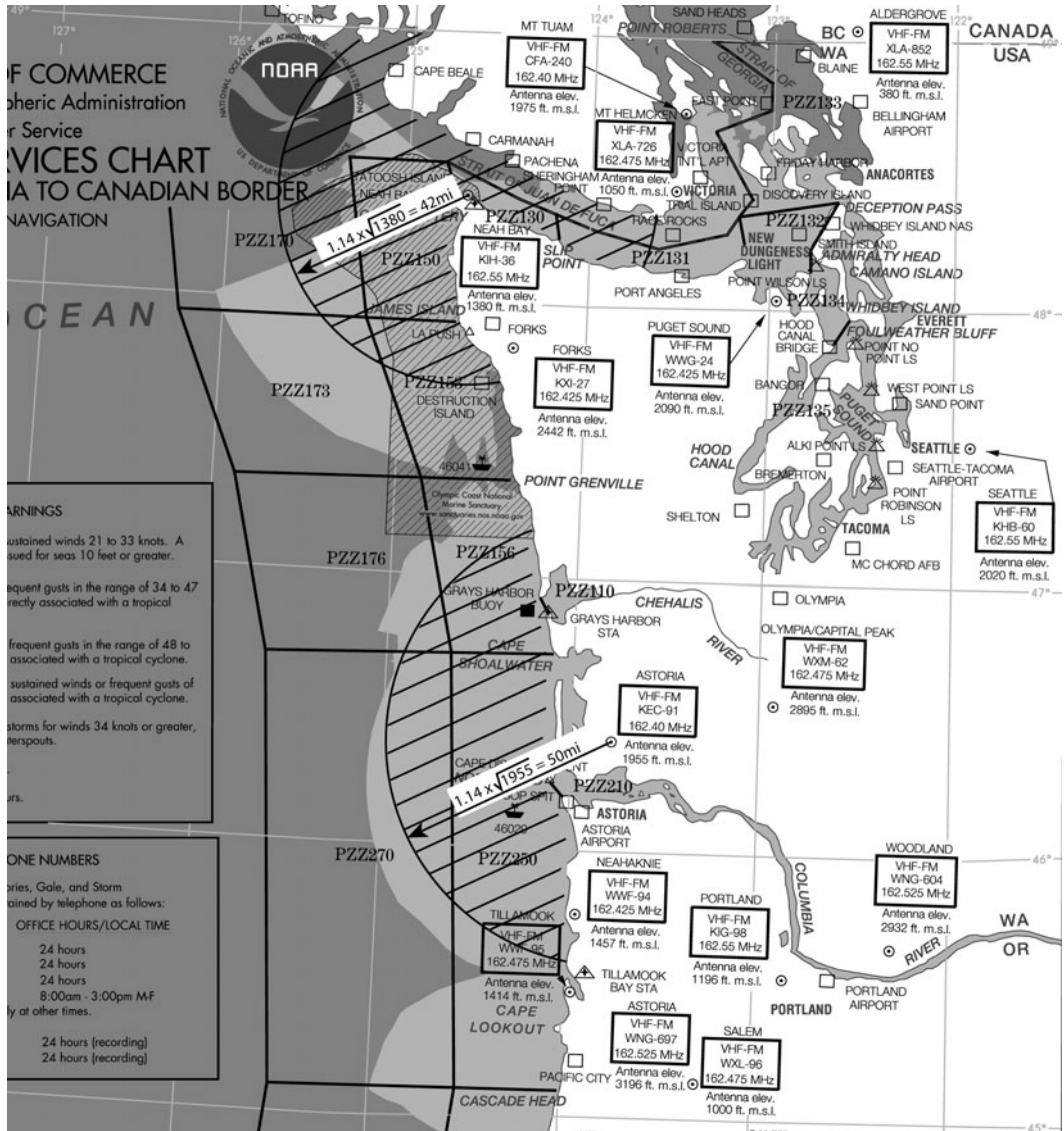

Figure 14-5. Section of a Marine Service Chart. Thirteen charts cover all U.S. waters. They list all weather services in the area, including broadcast antenna locations and elevations. You can figure the approximate radio range of the individual stations in miles by taking $1.14 \times \sqrt{\text{antenna height in feet}}$. For example, if you can hear the KEC-91 weather broadcast, then it is likely you are within the shaded region shown around it. If the signal is strong, you are probably well within it. If broken, you are more likely near the limit of reception. Two examples have been manually drawn on this chart and marked with cross hatching. Note that along the coast between these two stations you would likely hear only the KXI-27 broadcast from Forks, Washington. This particular chart section is from MSC-10, Point St. George, California, to the Canadian border. The corresponding chart for Hawaiian waters (MSC-13) is an especially valuable aid, since it includes a map of surface wind patterns around the islands. Marine Service Charts are now online for ready access. Also extremely valuable are their graphic definitions of the forecast zones (i.e., PZZ173) used in NAVTEX, plain text, and some voice broadcasts.

WHAT TO DO WITH WHAT YOU'VE GOT

EVERYTHING BUT UTC

“Everything but UTC” means having a perfectly good running watch—along with the rest of the “everything” list above—but not knowing the watch error. Below we show how to find the watch error to get back to truly having “everything,” but that process takes some work. It is important to remember that even without accurate time, you can still find accurate latitude. Latitude does not require accurate time. Just knowing the date will get you a sun declination from your almanac to within a few tenths of a minute in the worst case, but you do not have to rely on a noon sight. Just take any round of star sights or a running fix from the sun, and use the relative times from your watch to reduce the sights and plot a fix. The latitude will be correct, and the longitude will be off by exactly your watch error converted to longitude at the rate of 15' of longitude for each 1 minute of time error, or 1' for every 4 seconds of time error.

The longitude error will be to the west if your watch is fast, or to the east if it is slow. You might think of it this way: Say you do a noon sight and find the sun is due south of you at 1400 UTC. Then using the almanac, you find your longitude by looking up the Greenwich hour angle (GHA) of the sun at that time. Let's say it was 100° W. But your watch is fast by 1 hour, so the actual time was 1300, in which case the actual GHA of the sun at the time of your sight was 75° W (since all bodies move west at 15° of longitude per hour), so your fast watch time led you to conclude that you were farther west than you really were.

In general, UTC can rightfully be considered the most vital non-physical aid to celestial navigation. But with practice, more work, and some reduction in longitude accuracy, you can even do without it—if you have everything else. In short, an experienced, well-equipped celestial navigator can indeed find longitude from an unknown position without UTC, which in turn provides the watch error for other applications. Even with UTC, knowing and practicing some form of finding longitude without time will lead you to be a more confident and versatile navigator.

It is not likely that a well-prepared vessel would end up losing track of UTC with everything else in place, but stranger things have been known to happen at sea. (Remember that your GPS provides accurate UTC whenever it is in contact with a satellite, but in between those times, or when just sitting unused for any reason, the unit is effectively just a quartz watch with a corresponding watch rate for gaining or losing time, anywhere from 1 to 15 seconds per month.)

There are several ways to find longitude without time. The primary virtue of the method called *lunar altitudes* is that celestial navigators already know how to do it, even if they don't know they do. It requires only standard equipment and routine celestial navigation procedures.

Historically, the better-known method of finding longitude from the moon (called the *lunar-distance method* or just *lunars*) is not very popular these days, outside of a select circle of devotees who not only keep the method alive but work steadily on perfecting it. The main drawback of the standard lunars method is that it requires special tables or computer computations as well as special sight techniques. However, with this special preparation, and some practiced skill at taking the sights, the lunar-distance method is more versatile and more accurate than the lunar-altitude method. For a short version of the lunar-distance method, see John Letcher's book; other references listed in the Finding Longitude without Time section of the bibliography go into more depth. For emergency preparation, however, the lunar-altitude method is the better choice. It is easier to learn, and it doesn't require special measurements or procedures.

The moon is the only celestial body that moves through the stars fast enough to allow you to use its location among the stars to determine time. The procedure requires only that the moon be in the eastern or western quadrant during twilight, which is fairly common. If it is not, you can wait a few days until it is. The closer the moon is to due east or due west, the better. This alone does not guarantee the optimum conditions for this procedure, but it is usually sufficient. Furthermore, it will be obvious when you do this how well it might work when it is really called for.

Step 1. First make your best guess at UTC and set your watch to that time. You can, for example, set your watch as accurately as you know your longitude, using the watch time of LAN (see the Finding UTC from a Known Position section in Chapter 12). This is easy to do using a sextant: Take sights a few hours before LAN, find the times that the sun descends to these heights after LAN, and then find the average of the times midway between these sets of a.m. and p.m. sights. In an a.m. sight, measure the sun height at some arbitrary time before LAN and note this time. Then in the p.m. sight, set the sextant to that height and watch the sun descend in the instrument until it reaches that height again, and note the time. Do this for three or four sights before and after LAN.

Once you have the watch time of LAN this way, use the almanac and your estimated longitude to figure what the time should have been if your longitude were exact. The difference is your first estimate of the watch error. Set your watch by adjusting for this error; you now have the watch running as well as you know your longitude. The next step is to figure out from the moon how accurate this longitude is.

Step 2. With your watch set to this best-guess time, take a careful round of moon and star sights at twilight, using an easterly or westerly moon and any two stars that would give a good fix if you did know UTC. Take the sights in rotation—first star, moon, second star—then repeat the round until you have at least four good sights of each body. Do this as quickly as you can without sacrificing accuracy.

Step 3. Next you must graphically rule out the bad sights and pick a simultaneous height for each—as if you had taken all three simultaneously. This is still just standard procedure, though all navigators don't necessarily do it this way. On one sheet of graph paper, plot sextant heights versus watch times for each object. Then draw a best-fit line through the sights of each object, disregarding any obviously bad sights. Finally, pick a time, and read off the simultaneous heights of the three objects from the lines drawn through the sights. This graph effectively averages the sights and takes into account any motion of the boat between sights. You get the moon and star heights you need from the lines, even though you didn't take any sights at that particular time. You now have three good heights at one time, although you know the time is not precise. Next you must find out how much this time is off.

Step 4. Do the sight reductions of each sight in the usual manner, using your best guess of a DR position at the sight time, and carefully plot the lines of position (LOPs). The two star lines will intersect near your proper latitude, but the moon line will not go through this intersection if your time is wrong. The trick now is to adjust the watch error until the moon line agrees with the star lines, and from this you get your proper longitude and watch error.

You want the moon bearing east or west so its LOP will be near vertical and thus more sensitive to the sight times.

Step 5. Figure your adjustments for the next iteration. If the moon is fast (moon line west of the star fix), the watch is slow, and vice versa. In either case, your true position is on the

moon side of the star fix. From the plotted LOPs, read the longitude difference between the star fix and the moon line (where it crosses the latitude of the star fix), and figure your first guess of the watch error as 2 minutes for each 1' of this longitude difference. To remember that, note that the moon circles the earth at roughly $360^\circ/30d = 12^\circ/24h = 1'/2m$. So adjust your time by this amount and also adjust the DR longitude by a corresponding amount (as if you did another LAN sight). And then do the sight reduction of these same sights again with the corrected UTC and a new DR position adjusted to match what you have found so far. Your new latitude is the star-fix latitude, and your new longitude is the star-fix longitude adjusted by the first-guess watch error. For each minute of watch error, move your longitude 15' from the star-fix longitude toward and past the moon line.

That is the process; repeat step 5 as often as needed. After these second sight reductions, the moon line will cross closer to the star fix, and you repeat this process until it coincides.

The process is straightforward, but requires careful plotting. Using standard universal plotting sheets with parallels drawn 3 inches apart, it will likely be necessary to first plot on a condensed scale, with 3 inches equal to 6° of latitude, until you get the watch time to within 20 minutes or so, and then progress on up to 3 inches equals 60', then 6', and then possibly even 0.6' of latitude as the watch error diminishes.

The sextant sights must be accurate for this method to yield accurate longitude and UTC. The moon moves relative to the stars only about 12° per day, which is $0.5'$ per minute. Turned over, this gives the 2 minutes of time for each 1' of star-moon longitude difference that you use for the rough watch-error correction. Consequently, a 1' error in sextant height could cause a 2-minute error in time, which is a 30' error in longitude. But even this is optimistic, since the moon is unlikely to be moving in the optimum direction when you take the sights. In other words, if you can find your longitude to within 30' or so from an unknown position without UTC, you are doing well. With care, though, you shouldn't do much worse than that.

This method was described in modern times by John Letcher in his book *Self-Contained Celestial Navigation with H.O. 208*, which includes several numerical examples and variations of the procedure. Its concepts and practice date to the earliest days of celestial navigation; refinements, extensions, and limitations of the method have been added (Kerst 1975, Luce 1977, Bennett 2007), but for emergency use, the simplest form of this procedure is all you need (see the Finding Longitude without Time section of the bibliography). It will be clear as you practice it that careful sights, sight reductions, and plotting are vital for optimum accuracy. In an emergency, though, you don't need the level of accuracy expected in routine sailing.

As an example, consider a vessel that somehow ends up without a radio or UTC after several days of storm sailing with poor navigation records. After things settle down, a LAN sight gives a midday latitude of $35^\circ 30' N$, but accurate longitude is not known. The best guess for midday longitude is about $74^\circ W$. Using this longitude guess and the observed watch time of LAN, the watch is set to UTC. The vessel is ghosting south-southwest at some 2.5 knots, and the estimated DR position at evening twilight is $35^\circ 14' N, 74^\circ 07' W$, after taking a series of star and moon sights. The date is March 24, 1985.

Four or five sights of *Regulus*, *Sirius*, and the lower limb of the moon are taken in rotation and plotted versus the corresponding watch times. A sight time of 23:15:00 UTC (relative to the time set at LAN) is chosen and the following three observed heights are figured from the sextant heights read from the graph:

<i>Regulus</i>	$H_o = 39^\circ 51.6'$
<i>Sirius</i>	$H_o = 38^\circ 07.1'$
LL moon	$H_o = 30^\circ 32.1'$

The first sight reduction from the DR position of $35^\circ 14' N, 74^\circ 07' W$, at 23:15:00 UTC gives these lines of position:

<i>Regulus</i>	$a = 265.2'$	Toward 100.9°
<i>Sirius</i>	$a = 11.6'$	Toward 175.0°
LL moon	$a = 266.8'$	Away from 263.6°

These lines plotted on a scale of 3 inches equal to 6° of latitude give the following results: star fix at roughly $35^\circ 26' N, 68^\circ 37' W$, with the moon line located about $12'$ to the west, indicating that the UTC used was slow by about $12' \times 2 \text{ minutes} = 24 \text{ minutes}$. These values are all fairly rough because a condensed scale had to be used to plot these large altitude intercepts (a-values). This gives a longitude correction of $24m \times (15'/1m) = 360' = 6^\circ$ west of the star fix. Adding 24 minutes to the first UTC, adjusting the star-fix longitude 6° to the west, and assuming the star-fix latitude, here is the second sight reduction.

The second sight reduction (see Figure 14-6) from $35^\circ 26' N, 74^\circ 37' W$, at 23:39:00 UTC gives these lines of position:

<i>Regulus</i>	$a = 4.8'$	Toward 105.0°
<i>Sirius</i>	$a = 15.8'$	Toward 181.7°
LL moon	$a = 6.2'$	Away from 266.8°

These lines plotted on a scale of 3 inches equal to $6'$ of latitude give the following results: star fix at $35^\circ 9.2' N, 74^\circ 36' W$, with the moon line located $7.7'$ to the east, indicating that the UTC used was fast by about $7.7' \times 2 \text{ minutes} = 15.4 \text{ minutes} = 15 \text{ minutes}, 24 \text{ seconds}$. This gives a longitude correction of $15.4m \times (15'/1m) = 231' = 3^\circ 51'$ east of the star fix. Subtracting 15 minutes and 24 seconds from the last UTC, adjusting the star-fix longitude $3^\circ 51'$ to the east, and assuming the latest star-fix latitude, here is the third sight reduction.

The third sight reduction from $35^\circ 9.2' N, 70^\circ 45' W$, at 23:23:36 UTC gives these lines of position:

<i>Regulus</i>	$a = 0.1'$	Toward 104.8°
<i>Sirius</i>	$a = 1.0'$	Away from 181.7°
LL moon	$a = 0.7'$	Toward 263.6°

These lines plotted on a scale of 3 inches equal to $0.6'$ of latitude give the following results: star fix at $35^\circ 10.2' N, 70^\circ 44.6' W$, with the moon line located $1.3'$ to the west, indicating that the UTC used was slow by about $1.3' \times 2 \text{ minutes} = 2.6 \text{ minutes} = 2 \text{ minutes}, 36 \text{ seconds}$. This gives a longitude correction of $2.6m \times (15'/1m) = 39'$ west of the star fix. Adding 2 minutes and 36 seconds to the last UTC, adjusting the star-fix longitude $39'$ to the west, and assuming the latest star fix latitude, here is the last sight reduction.

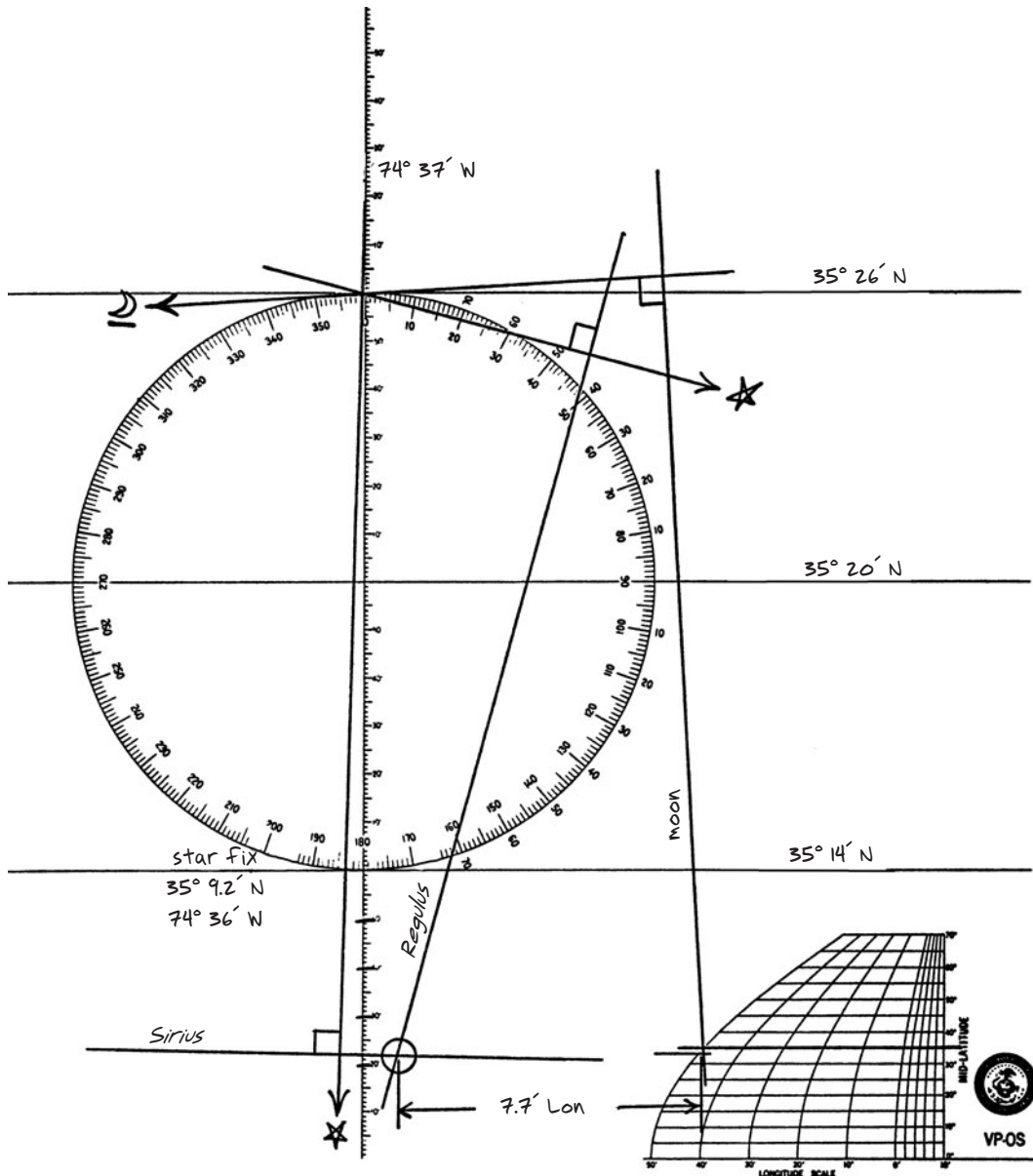

Figure 14-6. Second plot of a star-moon fix for finding UTC. After plotting all three lines using the largest convenient expansion of the latitude scale, measure the longitude difference from the star fix to the moon line, equal to 7.7' in this case. Here the moon is "slow" (behind, or east, of the star fix), so the watch is "fast." You must now reduce the UTC used for these sights by 7.7×2 minutes, or 15 minutes and 24 seconds, and do the sight reductions again. Repeat this process until the moon line crosses the star fix, then you'll know you have found the correct UTC, and with it your longitude. Note that all three LOPs are plotted from the same assumed position, which is only possible if the sight reductions are done with a calculator, as these were. Sight reduction tables will do the job just as well (though this method takes more work using tables, since each LOP will have a separate assumed longitude along the assumed latitude line).

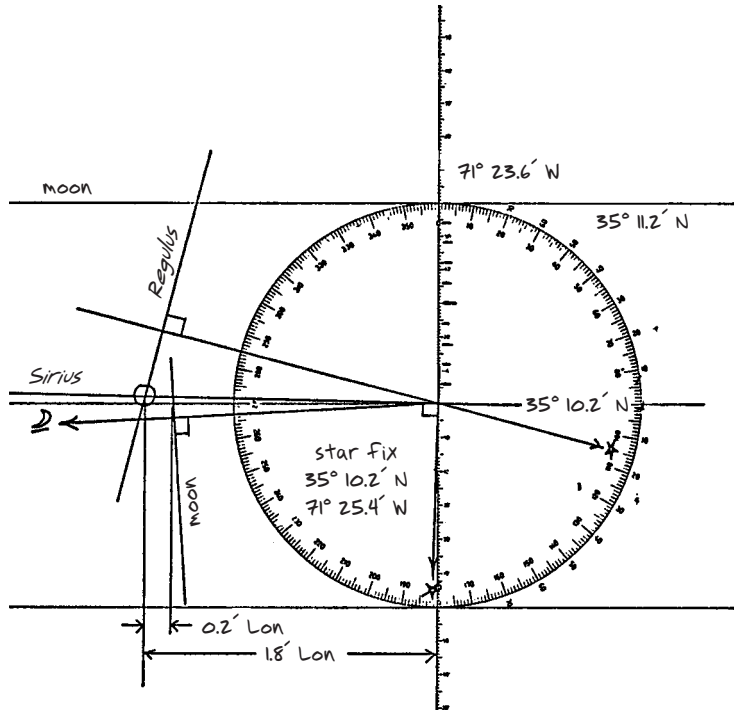

Figure 14-7. Final plot of the star-moon fix to find UTC. This is as far as it is practical to go. The moon line agrees with the star fix to within 0.2' of longitude. Chances are the sextant heights of the stars and moon aren't precise enough to carry this further. See Figure 14-6 for other notes on this type of plot.

The fourth sight reduction (see Figure 14-7) from $35^{\circ} 10.2' N$, $71^{\circ} 23.6' W$, at 23:26:19 UTC gives these lines of position:

Regulus	$a = 1.4'$	Away from 104.8°
Sirius	$a = 0.0'$	Toward 181.8°
LL moon	$a = 1.3'$	Toward 267.0°

These lines plotted on a scale of 3 inches equal to 6' of latitude give the following results: star fix at $35^{\circ} 10.2' N$, $71^{\circ} 25.4' W$, with the moon line located 0.2' to the east, indicating that the UTC used was fast by about $0.2' \times 2 \text{ minutes} = 0.4 \text{ minute} = 24 \text{ seconds}$. This gives a longitude correction of $0.4m \times (15'/1m) = 6'$ east of the star fix. Subtracting 24 seconds from the last UTC and adjusting the star-fix longitude 6' to the east, the final longitude and UTC are $71^{\circ} 19.4' W$, 23:25:55. The watch is 10 minutes and 55 seconds slow; the longitude guess at LAN was quite a bit off.

The UTC accuracy ultimately depends on the accuracy of the measured heights, although you need accurate sight reductions and plotting to get any consistent answer at all. If the plotting is not accurate, it takes more sight reductions to find the UTC that makes all the lines coincide. There are ways to shorten the procedure, but it is probably best to just remember the basic philosophy and nail down the answer through sheer repetition.

If you work through this example as practice, you probably won't get the same a-values or the exact same star fixes, since these depend on the sight reduction methods used and plotting precision. This example was chosen at random, reduced with a calculator, and plotted with no more than routine care, but you should come to about the same conclusions about longitude and time at each step, and definitely end up with the same final answer. To see how this works, try starting with a different first guess as to the time and longitude. Here is a summary that shows how position and UTC improve with successive sight reductions:

	LATITUDE	LONGITUDE	UTC	WATCH ERROR
DR	35° 14' N	74° 7' W	23:15:00	?
1st	35° 26' N	74° 37' W	23:39:00	24m slow
2nd	35° 9.2' N	74° 45' W	23:23:36	8m 36s slow
3rd	35° 10.2' N	71° 23.6' W	23:26:19	11m 36s slow
4th	35° 10.2' N	71° 19.4' W	23:25:55	10m 55s slow

Note that latitude improves quickly, and the first sight reduction done here doesn't really count. You would have had to repeat that one even if you had known UTC, since the DR position was so far off.

It is good training in celestial navigation to practice this procedure. With some experience, you'll see that you can also extend it to sun-moon sights during the day. With a known latitude from LAN, you can do this whenever the sun and moon have nearly the same or opposite bearings. There are other examples online at starpath.com/emergencynavbook.

If you know the time but have lost only the date—not so unlikely as you might guess when away from land—then a single sight reduction of a star-moon or sun-moon fix for each day in question will do the job. The moon moves 12° each day, so only the right day will yield a fix near your DR position. Or just look at the night sky as shown in Figure 7-1—it is easy to spot this 12° shift relative to the stars. To locate the moon's proper position among the stars on each of the days in question, figure its sidereal hour angle (SHA) at the time you plan to look from:

$$\text{SHA moon} = \text{GHA moon} - \text{GHA Aries}$$

Use this with the moon's declination to plot it on the star maps in the *Nautical Almanac*. A 2102-D Star Finder is also very convenient for this application.

EVERYTHING BUT A SEXTANT

If you have an almanac and sight reduction methods and the correct time, then steering is not an issue; you can compute the true direction to the sun during the day and to any other body at night at any time. So you are left to look into how you might best find position without a sextant but with everything else in place. There are a couple of options.

Horizon Sights

If you ever lose the only sextant on board, but still have UTC and all your other standard celestial navigation tools and books available, you still have an opportunity for more or less routine

navigation—you can take horizon sights of the sun and moon. To do sun sights this way, note the time of sunrise or sunset to the second, call the sextant height of the sun's upper limb $0^{\circ} 0'$ at that time, and do a normal sight reduction for a line of position. Then do a conventional running fix between sunrise and sunset.

Using the sun alone, this method is not highly accurate, but it is a useful complement to other emergency procedures. You will have an uncertainty of 5 to 10 miles or so in each of the sun lines since they are so low, and some error in your all-day or all-night run, which will throw off the running fix.

If you can see the moon cross the horizon on the same day or night, bearing some 30° or more away from the sun's horizon bearing, then you might get a sun-moon fix that could be more accurate since it would reduce the uncertainty of the running fix. Avoid narrow crossing angles because the large inherent uncertainty in the sights will cause a large position uncertainty for narrow intersections.

In exceptional cases, you might also use this method with Venus or Jupiter, or perhaps even the two brightest stars, *Sirius* and *Canopus*. These opportunities will come during the night, so for rising sights, you must precompute or spot the bodies one night and anticipate them the next. However, exceptionally clear skies and smooth seas are required to see these bodies cross the horizon rising or setting.

Bobbing a Planet

A trick that might help verify nighttime rising or setting times was suggested by Leonard Gray in his book *Celestial Navigation Planning*. Since you usually can't discern the horizon at night, try bobbing the planet when it first appears, just as you might do with a light as you cross the geographic range (well within the nominal range) trying to get a rough check of distance off (see the Visible Range of Lights and Land section in Chapter 13). Position yourself at a high elevation (such as standing on the boom), and watch for the object to rise. When you first spot it, jump down to bring the horizon forward. If the object was indeed just on the true sea horizon as viewed from above, your new position should obscure it. Then go back up to verify the sight. If you wait from below, the object may be above the horizon when you first detect it. When watching a body set, watch from below, then bounce up when it disappears to see if you can bring it back. But you must move fast in either case; it only takes about 10 seconds or so for a planet to change altitudes by an angle that is too big to bob across. And remember, these nighttime sights, however they are done, could be way off. You must treat them as just more pieces of data and fit them—with their uncertainties—into the sum of the information you have.

Low clouds on the distant horizon are your big enemy, both day and night. You must time horizon sights as the object crosses the true sea horizon, not just a low rim of clouds—and these clouds are there more often than not. During the day, you can see the clouds, and even make estimates of the time it takes for the sun or moon to move from cloud rim to horizon, but at night, you can't see the clouds, which reduces the value of moon sights. Binoculars are a big help to horizon sights, especially at night. But if you can bob the upper limb of the moon or a planet (and be sure the waves aren't bobbing it for you), you can be reasonably confident that it is crossing the sea horizon at the time.

Sight Reductions

Sight reductions of horizon sights typically involve negative values of the observed altitude (H_o), calculated altitude (H_c), or both, so you must carefully reason through the required algebraic corrections and the subtraction of the two when figuring the a-values. The azimuth (Z_n) can also require special procedures depending on the tables you use. Otherwise, the sight reduction and plotting procedures are standard.

Pub. 229 sight reduction tables, however, are awkward to use for this application because of the way they record negative altitude data. Check the instructions in Section C, part 4, for details. The procedure boils down to this: if the proper declination puts you across the C-S line (from the proper LHA end of the page), call the listed H_c negative, reverse the sign of the d-value, and figure Z (azimuth angle) by subtracting the listed one from 180° .

Pub. 249 tables are more convenient since they list negative H_c values with the proper d and Z. The lower precision of the Pub. 249 numbers has little significance for these sights, which are so uncertain to begin with. Preprogrammed calculators should do the job adequately, though they may be off a few miles, depending on how they do the altitude corrections near 0° . The NAO Sight Reduction Tables, included in each copy of the *Nautical Almanac*, have specific notes on how to handle the negative F values that occur in these sights. In the instructions for the standard NAO tables, special procedures are called for in steps 3, 7, and 8. The process is similar to what is done with Pub. 229.

Here is an example to practice with: DR is $26^\circ 20' N, 76^\circ 30' W$, on June 3, 2007. H_s (upper limb of the sun) is $0^\circ 0'$ at UTC 10h 12m 49s from an eye height of 9 feet above the water level. Local atmospheric conditions are temperature $84^\circ F$ and pressure 1020 mb. Note there is no index correction for this type of sight made without a sextant. From the almanac at sight time, GHA sun = $333^\circ 41.2'$, dec sun = $N 22^\circ 17.6'$. Thus we choose assumed latitude = $26^\circ N$, and assumed longitude = $76^\circ 41.2' W$. This gives an LHA of 257° . Thus we enter the sight reduction tables with Lat = $26^\circ N$, LHA = 257° , dec = $N 22^\circ 17.6'$. Pubs. 229 and 249 give the correct answer to within $0.1'$ of $H_c = -1^\circ 11.4'$ and $Z_n = 064.4^\circ$. The NAO tables give $H_c = -1^\circ 12'$ and $Z_n = 063.9^\circ$.

Then we have to figure H_o . We start with the apparent height:

$$H_a = H_s - Dip = 0^\circ 0' - 2.9' = -2.9'$$

Then:

$$\begin{aligned} H_o &= H_a \pm \text{Altitude correction} \\ &= -2.9' - 49.6' + 3.0' \\ &= -0^\circ 49.5' \end{aligned}$$

The $49.6'$ is the tabulated upper-limb altitude correction at $H_a = 0^\circ$. The $+3.0'$ is the “additional altitude correction” for the temperature and pressure (discussed more below).

So we have $H_c = -1^\circ 11.4'$ ($71.4'$) and $H_o = -49.5'$ and the difference is:

$$71.4' - 49.5' = 21.9'$$

So the altitude intercept for our LOP is a = $21.9'$ Toward 064.4 . The label is *Toward* because $-49.5'$ is larger than $-71.4'$.

The big uncertainty in these sights comes from refraction, which is at a maximum for horizon sights. Refraction depends on the density of the air, which in turn depends on temperature and pressure—as well as the sea state and the wind, which mixes up the air in the meter or so right next to the water that these light rays must travel through. You might argue that the correction should be a bit larger for $H_a = -2.9'$ (compared to the value we used, which is for $H_a = 0^\circ 0'$), maybe $-50.2'$ or so based on the rate this correction is changing. But this fine-tuning is probably not justified with the other uncertainties involved. There is a special table in the *Nautical Almanac* for abnormal refraction corrections in various atmospheric conditions. These corrections can be as large as 5 or 6 miles for horizon sights, though in our example it was just $3'$. My feeling, however, is that the uncertainties in these extra corrections must be at least as large as the corrections themselves, so I typically ignore them in routine sights. Mirages are, after all, just abnormal refraction, and if you've ever seen an impressive one, you begin to appreciate how large the effect can be. I assume that all very low sights are uncertain by some $\pm 5'$ or so on the a-values, and do everything else in the standard fashion. Nevertheless, it seems only reasonable to include this special correction when doing horizon sights, even though we ignore them in routine sights at higher altitudes where they are much smaller.

Dutton's Navigation and Piloting reports that Captain P.V.H. Weems made ten horizon sights on six occasions with an average error of 2 miles and a maximum error of 4 miles. Further details are not given. My own data (pieced together from logbook and plotting-sheet notes) for about the same number of sights are similar—about half were as good as I knew my position at the various times (2 to 5 miles), but an equal number appeared to be off by at least 5 miles and maybe more. Mine were all sun lines taken offshore, and only DR positions were available in most cases. More scientific results (even from a coastline) would be interesting, but it would take a lot of them before I would be more optimistic. Localized air masses well away from the vessel could influence the results, as could the prevailing air-sea temperature difference, the wind strength, and probably other factors.

Examples of the sight reductions and a plot of a sun-moon fix from horizon sights are shown in Figures 14-8 and 14-9.

Photo Sextant Sights

Another technique that might work in some circumstances, if you happen to have all your tools but a sextant, is to take a photo sextant sight. You'll also need a digital camera (or even a cell-phone camera) and a computer on board. (This may seem pretty techie, but is not so unlikely these days. Many mariners document their trips with email logs and even send photos back home via satellite or SSB connections during an ocean passage.) This is another example—like building a quadrant at home—that makes for an interesting hobby activity. This one will make you more familiar with the sky, your camera, and your computer graphics programs.

The trick is to take a digital photo of the sun or moon when low to the horizon and ideally at a time when another celestial body—any star or any planet—is also in the camera's view. When you have such a photo you can get a position fix. Two sights will give you two intersecting LOPs; if you get just the sun or the moon alone, all you'll get is one LOP. With

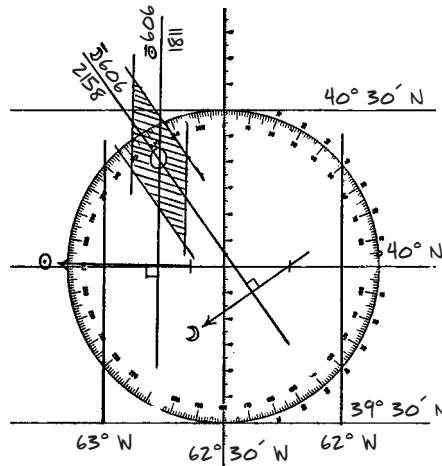

Figure 14-9. Plot of a sun-moon fix from horizon sights. The sight reductions plotted here are from Figure 14-8. Note that the inherent uncertainty of ± 5 miles in each of the lines can cause a large position uncertainty (shaded area) for narrow intersections. These sights were taken about 4 hours apart, so a running fix would have been required if the vessel had been moving. A more common fix of this type would be a running fix between sunrise and sunset. The intersection angle for such a fix would be twice the sun's amplitude, which means that this method would not work near the equinoxes. In general, this method works better at higher latitudes.

some experience or practice with exposures, filters, and general photography, you can get some pretty good photos. Personally I don't know about such things and have just taken the photo and hoped for the best, or asked others to take them, such as the sun shot shown in Figure 14-10.

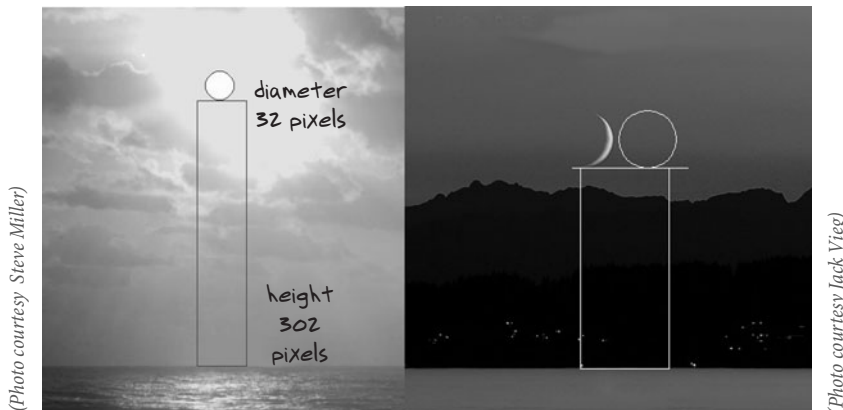

Figure 14-10. Photo sextant sights. **Left:** With a graphics program we fit a circle around the circumference of the sun and noted its diameter, 32 pixels in this case. Then we constructed a rectangle to measure the height of the lower limb above the horizon, 302 pixels. At the time of this sight, the semi-diameter of the sun was $16.2'$ as listed in the Nautical Almanac, so $32 \text{ pixels} = 2 \times 16.2'$, and $302 \text{ pixels} = 5^\circ 6'$, which would be H_s lower limb. **Right:** Similar photo of a setting new moon, taken to the West, across Puget Sound. The diameter of the moon was 65 pixels, the semi-diameter at the time was $15.0'$, and the height was 224 pixels, which leads to $H_s = 1^\circ 43'$. Both sun and moon sights lead to lines of position within a few miles of the true position. This same moon sight was taken with a cellphone camera and (quite accidentally) gave an even more accurate line of position though the picture was much poorer quality. Full details of all sights are online at starpath.com/emergencynavbook.

Once you have the photo, load it into your computer using your favorite graphics program. My favorite for this operation (and many other things such as weather map analysis) is Paint Shop Pro (paintshoppro.com), although most photo processing or graphics programs will do the job. If you don't have one, do an Internet search on "free graphics programs" to find one you like. For this application, the key program feature you need is a way to measure the pixel-count length of a line, or dimensions of a circle or rectangle. It is a common feature that most such programs will have. You'll also find that a layers option is handy, which lets you create your drawing on a separate, transparent layer on top of the main photo without altering the photo itself. Then if you make a mistake, you can just undo your work without having to worry about the photo; this is more of a convenience than a necessity, however.

Using the program's measurement tool, measure the height of the sun above the horizon in pixels, and then measure the diameter of the sun in pixels—these will establish the scale. Next look up the semi-diameter of the sun (about 16') in the almanac. If the sun, for example, is 5.5 diameters above the horizon, then its height is $5.5 \times 32' = 176'$; or H_s (lower limb) at the time of the photo is $2^\circ 56'$. For these low sights, it is likely best to use the horizontal diameter of the sun as the reference rather than the vertical diameter, since the latter will likely be smaller due to refraction. This is the reason they call this dimension of the sun a semi-diameter and not a radius. An example of the analysis is shown in Figure 14-10.

EVERYTHING BUT SIGHT REDUCTION TABLES

This concept is inherently different now than it was at the time of the first edition of this book. There really aren't many circumstances today where you might end up with all your celestial navigation tools except sight reduction tables. Since 1989 the NAO Sight Reduction Tables have been included in each printing of the *Nautical Almanac*. They are based on the original Davies Concise Tables, developed by Admiral Thomas D. Davies and Dr. Paul Janiczek. These tables provide an excellent solution, easily learned with a supporting worksheet. They are not quite as precise as the much larger Pub. 229 tables, but are more than adequate for practical ocean navigation. They are a logical choice for modern oceangoing mariners whose primary choice of sight reduction is likely to be a celestial navigation program on a computer or calculator.

However, it is not impossible to end up without sight reduction tables, as there are mariners still using the *Air Almanac* (strangely recommended in some texts and popular videos for mariners) though it is now distributed on CD, with only a print-on-demand option for the book itself. Or you might find in an old (pre-1989) *Nautical Almanac* in the ship's library, or a copy of the various printed long-term almanacs from the past—most modern versions of these include the NAO tables with them. And there is a chance that you might have a PC version of a Perpetual Almanac and not a celestial navigation program itself. So it is not totally out of the question that you might need to navigate with more or less everything except conventional sight reduction methods. Don't forget, however, that for quite a long time, it was the convention of popular electronic charting programs to include a celestial navigation solution. You may even have one of these and not know it. Often they were just listed under a Utilities or Tools menu, with little other mention in the program documentation.

Latitude by Polaris or from LAN

As covered earlier, finding your latitude from *Polaris* (Chapter 11) or your latitude and longitude from LAN (Chapters 11 and 12) do not require sight reduction, so these methods are available to you without sight reduction tables. You can also find latitude from any star that happens to be on the meridian at twilight, as covered in the Latitude from Horizon-Grazing Stars section in Chapter 11.

High-Altitude Sights

Very high sights in celestial navigation are usually avoided because they are hard to take and require special sight reduction procedures. But these special procedures do not require sight reduction tables, so high sights are more attractive when you don't have any way to do sight reductions. The method is based on the fundamental principle of celestial navigation: You measure and then correct the sextant height (H_s) of a star to find its observed height (H_o). From its observed height you figure its zenith distance ($z = 90^\circ - H_o$), which is your distance from the geographical position (GP) of the star at the time of the sight. The almanac tells you where the GP was at the time of the sight, so now you know you are on a circle whose radius is equal to the zenith distance centered at the GP. With two such sights, you have a fix at the intersection of the two circles. For normal (lower) sights, you can't plot these circles because their radii are so large, but for very high sights you can.

To do the fix, take regular sextant sights of two stars that are above 85° or so. These are difficult sights, so you need several of each to get a good average. Next figure observed height for each in the usual way. Then use the almanac to find the precise location of the GP of each star at the time of the sights, and plot these two points on a universal plotting sheet centered near your DR position. Use a condensed scale on the plotting sheets, such as 3 inches to 2° of latitude. The latitude of the GP is the star's declination and the longitude of the GP is the star's GHA, or $360^\circ - \text{GHA}$ in eastern longitudes. Figure the zenith distance for each star and then draw the circles of position centered at the GPs. Figure 14-11 shows a fix done this way using *Castor* and *Pollux*. There will be two intersections, but your DR position or the observed bearings of the stars should rule out the wrong one if the stars are far enough apart.

Two stars at about the same height some 90° apart provide the best conditions for this, but you can plot the candidates ahead of time to pick the best available pair. For this method (or for latitude from stellar meridian passage), you will likely have to rely on stars from the back of the *Nautical Almanac*, where data are given for 173 stars. With a long twilight, you can sometimes do this fix with one star alone, since bearings change rapidly for very high stars. A single-star fix done this way is illustrated in Figure 14-12.

This plotting procedure and fix are most accurate for high stars at low latitudes. For lower stars at higher latitudes, a circle is no longer a good approximation of the "circle" of equal altitude on a Mercator plot. The proper elliptical shape of the circle of position must be figured from great-circle calculations but these are usually done with sight reduction tables, which you don't have now. If you stick with stars above 85° or so, this won't be a problem.

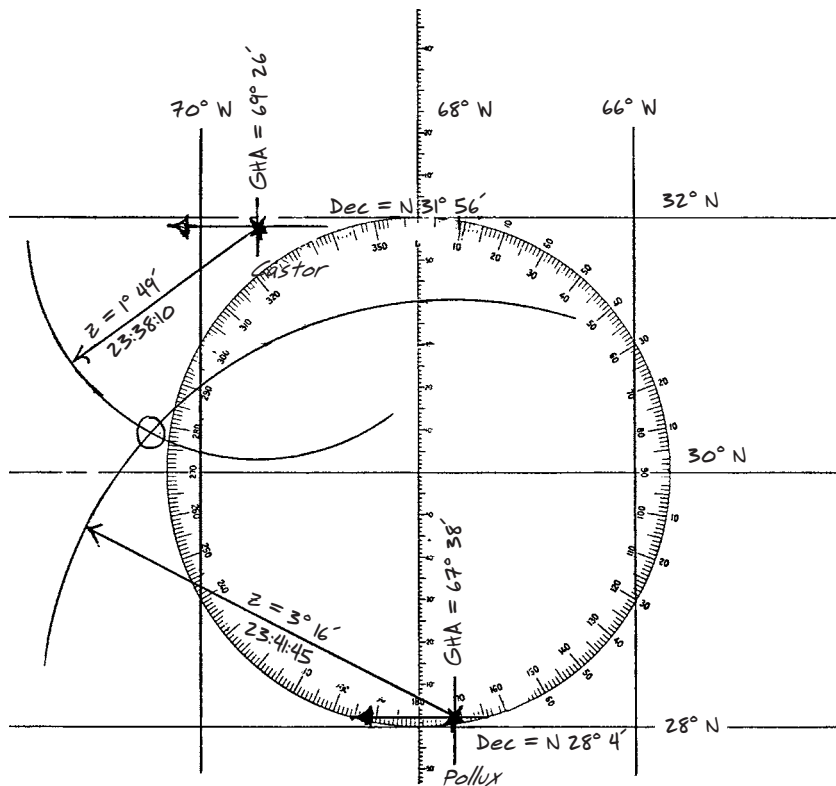

Figure 14-11. Plot of a high-altitude fix from overhead stars done without sight reduction. Measure H_s for two high stars, convert them to H_o in the usual manner, and then figure the zenith distance ($z = 90^\circ - H_o$) of each. Then plot the geographical positions (GP) of each star at the times of the sights on a plotting sheet with condensed scales. Each sight gives you a circle of position centered at the GP, with radius equal to the zenith distance. Here Castor and Pollux of Gemini are used as they pass overhead. The sights are difficult but manageable in smooth seas. The trick is to stay oriented toward the star, and wait for it to reappear when the boat rocks it out of view. If you try to chase it around as the boat rocks, you will get poor sights. It also helps to start as early as possible and follow the star up, to get used to looking in the right direction. The sights don't have to be as high as those shown here to get a fix. Down a few degrees, the sights are much easier; but the plotting is less accurate. Even this fix is off (to the west) by about 5 miles, which represents a typical plotting error in this type of fix.

Sight Reduction by Direct Computation

The sight reduction tables we are accustomed to using do nothing more than solve for two parts of a triangle drawn on the surface of a sphere. If you have a calculator that does sines and cosines and you happen to have these formulas written down somewhere, then you can solve for the calculated height (H_c) and azimuth angle (Z) directly. In fact, you can end up with answers that are even more accurate than the ones you get from tables such as Pub. 249, Pub. 229, or the NAO tables in the *Nautical Almanac*. Though it is unlikely you might memorize these, a course in celestial navigation (see the Basic Marine Navigation section of the bibliography) often presents the

routes, which you can then use for celestial sight reduction. But there is a subtlety involved with modern routing computations. In the old days of SatNav and Loran and essentially all eChart programs, the great-circle distance between two points on earth was computed using a round earth model. But modern global distance computations in all GPS units and some eChart programs (but not all) are based on more accurate shapes of the earth, called *chart datums*. These days, the term *great-circle distance* is more properly *ellipsoidal distance* when referring to the output from a GPS route computation. Thus the distance from Seattle (47° 39' N, 122° 20' W) to Tokyo (35° 40' N, 139° 45' E) is different in a WGS84 (World Geodetic System 1984) world shape (4,163.39 nmi) than it is for a round earth solution (1' = 1 nmi), which you would get from sight reduction tables or a *Bowditch* great-circle distance formula (4,150.43 nmi).

While the former answer identifies how far apart these places are if you were to travel from one to the other, it is wrong in relation to a celestial sight reduction—by about 13 nmi. Routing and sailing navigation are done on a real (ellipsoidal) earth shape when using GPS, whereas celestial navigation is all carried out on an imaginary earth surface that is a perfect sphere with a circumference of 360°, which equals 360 × 60 nmi, or 21,600 nmi. The WGS84 earth (closer to the real shape of the earth), on the other hand, has a polar circumference of 21,602.5 and an equatorial circumference of 21,638.8—a 36-mile difference.

So if you want to do a celestial navigation sight reduction with an electronic device, then you first have to learn what type of computation it is doing. The manuals typically will not tell you. Any old Transit SatNav system or Loran unit will likely be using a round earth and be OK, as well as most eChart programs. If the device lets you choose a chart datum, chances are it is doing ellipsoidal computations, and this will not work for you. You can always use the Seattle–Tokyo data above as a test case.

If you have access to a calculator or software program or an electronic device that does basic round-earth great-circle computations, then here is the procedure for a sight reduction:

- 1 Enter your present position into Waypoint 1 (WP 1).
- 2 Enter declination and GHA as Lat and Lon into Waypoint 2 (WP 2). If GHA > 180°, enter 360°–GHA, and call it East Lon.
- 3 Ask for range and bearing from WP1 to WP2. You must use great-circle instead of rhumb-line computations if given a choice.
- 4 The initial heading answer (H_c) is the azimuth, Zn.
- 5 The great-circle distance (GC range) answer is the zenith distance (z) in arc minutes. Find H_c by dividing this answer by 60 to convert it to degrees, then subtract this from 90°:

$$H_c (\text{degrees}) = 90^\circ - (\text{GC range} \div 60)$$

Then convert it to degrees and minutes.

Examples

WP 1	WP 2	GREAT-CIRCLE OUTPUT	
DR-Lat/DR-Lon	Dec/GHA	GC H_i	GC Range
45° 20' N	03° 40.8' S	182.3°	2942.3' = 49.038° = z
124° 15' W	126° 01.2' W	Z_n	40.962° = 40° 57.7' = H_c
45° 20' N	58° 22.1' N	346.7°	4454.9' = 74.248° = z
124° 15' W	279° 13.8' W use 80° 46.2' E	Z_n	15.752° = 15° 45.1' = H_c
40° 00' N	26° 48.5' S	234.0°	5403.4' = 90.057° = z
124° 15' W	127° 13.2' W	Z_n	-00.057° = -0° 03.4' = H_c

All GPS units let users set the chart datum to use—and it is indeed crucial that you have this set to match your charts or notable discrepancies can occur that might baffle your best anchoring skills. Many of them let you select a user-defined datum as one of the options. With that knowledge, you should be able to simply enter the proper criteria for a round earth and proceed as desired. But life is not that simple . . . or perhaps it is simpler. Most units that do accept a user-defined grid will indeed accept criteria for a round earth and even use them when navigating to provide Lat-Lon positions to match that shape. But when it comes to global distance computations, they all default back to WGS84 regardless of what datum you have selected for local navigation. Thus you are spared this esoteric technique if all you have to work with is a GPS unit.

EVERYTHING BUT A COMPASS

The loss of your compass makes storm steering more difficult, but general navigation in clear skies is not hard when you have all the rest of your routine celestial gear in place. Just do a series of sight reductions from your DR positions throughout the day and night for accurate sun and star bearings. Ways to steer without a compass, covered in Chapters 3 and 4, will be helpful. With sight reductions, they can be fine-tuned with accurate reference bearings.

If the “everything else” you have includes a 2102-D Star Finder—which it should—then finding reference bearings is especially easy. It takes a few minutes to set it up every day or so, but then it gives you true bearings to all celestial bodies you might use throughout the day and night. You just read them from a scale as you rotate the dial to new times (see Figure 14-13).

For the immediate job of hands-on steering, a few telltales are extremely valuable, as well as a judiciously placed shadow pin arrangement. Bobby Schenk reported that he and his crew found it very useful to mount a shadow board and large pin right in front of the helmsman where the compass used to be.

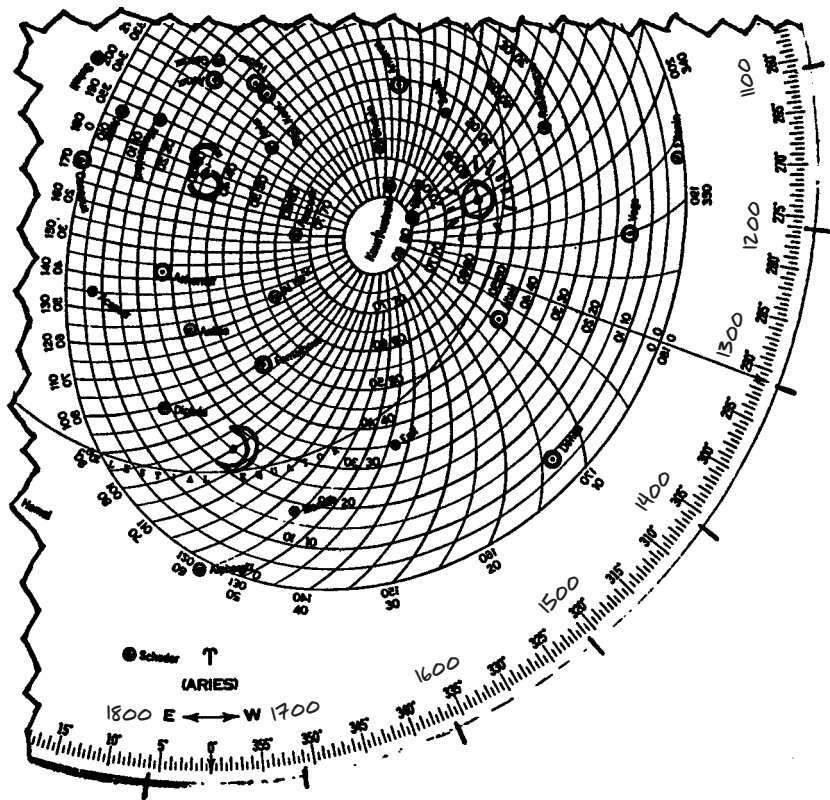

Figure 14-13. Section of a 2102-D Star Finder. This device (and the essentially identical British counterpart called N.P. 323) is a tremendously helpful aid to routine navigation, and a godsend in an emergency. Any long-term almanac is all you need to set it up, and after that you have bearings to all celestial bodies, day and night. This one is set to local time 1300 at latitude 35° S. At this time, the moon bears 080° True at a height of 25° , and the sun bears 330° True at a height of 60° . To find bearings at later times, just rotate the template grid to the new time, and read the new bearings. As you rotate the disk, the sun will set, the moon will rise, and the heights and bearings to all the brighter stars in this particular sky will be apparent. The second edition of *The Star Finder Book* explains the full potential of this device with many practical examples.

EVERYTHING BUT AN ALMANAC

With training in emergency navigation, you can do without an almanac, as discussed throughout this book. With makeshift prescriptions, you can figure the sun's declination to within $30'$ or so for latitude (see the Latitude from the Sun at LAN section in Chapter 11) and the Equation of Time to within 1 minute or so for longitude (see the Longitude from LAN section in Chapter 12). We now add to this a makeshift rule for finding the sun's GHA, which will allow you to take conventional sun lines at any time of day without an almanac. With everything but an almanac, the accuracy of your position is determined by your precision in performing these makeshift prescriptions, including the altitude corrections of Chapter 11.

The sun's GHA can be figured as follows:

$$\text{Sun's GHA} = (\text{UTC} - \text{mer pass time}) \times 15^\circ/\text{hr}$$

where “mer pass time” is the UTC of LAN at Greenwich, which you figure from the Equation of Time prescription given in Chapter 12—or look it up using the time of midday, halfway between sunrise and sunset, read from tide tables or from a smart cell phone or PDA. Whenever the UTC is earlier than the mer pass time, add 24 hours to the UTC to maintain positive values throughout.

For example, let's find the sun's GHA at 17:28:40 UTC on September 28. First figure the Equation of Time on September 28 and from it the UTC of LAN, as illustrated in Figure 12-7. The answer is 11:50:30. So:

$$\begin{aligned} \text{GHA} &= 17:28:40 - 11:50:30 \\ &= 5:38:10 \end{aligned}$$

$$5 \text{ hours and } 38.2 \text{ minutes} = 5.636 \text{ hours}$$

Then convert this to arc units as:

$$\begin{aligned} \text{GHA} &= 5.636\text{hr} \times 15^\circ/\text{hr} \\ &= 84.542^\circ \\ &= 84^\circ 32.5' \end{aligned}$$

The accuracy of this method of finding GHA is determined by the accuracy of the Equation of Time, which should be well within 1 minute in most cases, giving a GHA to within about 15'.

With the sun's GHA and declination, you can take sun lines, and from running fixes between sun lines, you can find your position. With careful reckoning of the declination and GHA, you should be able to achieve daily positions from the sun to within 30 miles or so without an almanac.

In the Northern Hemisphere, you can find latitude from *Polaris* without an almanac to within 60' or so, but you still need tricks or prescriptions if you are to reduce this uncertainty (see the Latitude from *Polaris* section in Chapter 11). Other latitude methods from Chapter 11 can be carried out more precisely with a sextant and no almanac, but they generally require that you know a few star declinations. As for finding longitude, the sun is your only hope. There is simply no way to find longitude from the stars, moon, or planets without an almanac of some kind. Clearly, every vessel should carry a long-term almanac for sun and stars as a backup. And even then, you should think twice before taking the only annual almanac on deck for a few sight reductions in the fresh air and sunshine.

A long-term almanac for stars alone is included in Pub. 249, Volume 1 (this is updated every five years). Geoffrey Kolbe has compiled an easy-to-use, thin, one-volume almanac, which also includes concise sight reduction tables, valid until 2050. An extended almanac and sight reduction tables for all celestial bodies valid for five-year increments is included in George Bennett's *The Complete On-Board Celestial Navigator*. All three of these publications are self-contained

celestial navigation solutions, containing both almanac data and sight reduction methods. The long-term almanac for sun and stars included in earlier editions of *Bowditch* and reproduced in some texts is no longer published, in part because of known errors in the data. Also remember you can do sun and star navigation with an outdated annual *Nautical Almanac*. The prescription is given in the almanac for the following year, and you can repeat this for another two years. Every fourth year, the sun and star data repeat (2011 should be the same as 2007, 2012 same as 2008, and so on) at least to well within the range of accuracy you need in an emergency. Other than preprogrammed calculators and software programs, there is no feasible long-term almanac for the moon and planets—the closest solution being the five-year products of George Bennett. See the bibliography for more information on these sources.

If you happen to recall the sidereal hour angles and declinations of a few stars from previous work (before the almanac was lost), you can do routine star sights of these once you figure the GHA of Aries. The formula is more involved, but it works:

$$\begin{aligned} GHA \text{ Aries} = & [DD + (UTC \div 24)] \times (360^\circ \div 365) + (UTC \times 15^\circ/\text{hr}) \\ & + 15' - (15' \text{ for each year past the last leap year}) \end{aligned}$$

where DD is the number of days from September 21—DD is positive (+) if past September 21 and negative (–) if before September 21. Thus November 15 has DD = +55 and July 28 has DD = –55, but the extra correction of 15' is + in both cases. The formula is accurate to within about 10'.

For example, let's find GHA Aries at 17:28:40 on September 28, 2009. September 28 is seven days past September 21, so DD = 7. The UTC is 17:28:40 = 17 hours and 28.67 minutes = 17.478 hours, and 2009 will be one year past the next leap year (the number of a leap year is divisible by 4, or 400 if it is a centennial number), so the correction is $-1 \times 15'$. So:

$$\begin{aligned} GHA \text{ Aries} = & [7 + (17.478 \div 24)] \times (360^\circ \div 365) \\ & + (17.478 \times 15^\circ) + 15' - (1 \times 15') \\ = & (7.622^\circ + 262.170^\circ) \\ = & 269.792^\circ \\ = & 269^\circ 47.5' \end{aligned}$$

Obviously, it is a good idea to take a backup almanac—it takes time to multiply and divide to three decimal places by hand. Nevertheless, regardless of your backups and their backups, you could still end up with nothing but your memory to go by, which you would soon hope included the sun's declination, the Equation of Time, and the declinations of a few prominent stars.

To figure the Equation of Time from a long-term almanac, first figure the sun's GHA at 1200 UTC. This will be either a small angle of 4° or less (LAN before 1200), or a large angle of 356° or more (LAN after 1200). The Equation of Time is the small angle converted to time at 15° per hour (4 minutes per 1°, 4 seconds per 1') in the first case, or 360° minus the larger angle converted to time in the second case.

NOTHING BUT UTC

With nothing but UTC and the methods we have covered throughout this book, you should be able to find your way to safety from any point on earth. Coordinated Universal Time is ultimately the one thing to know to keep from getting lost. You can find latitude without time, but to find longitude you need UTC. With UTC, and nothing more than the makeshift rule for the Equation of Time, you can always find your position. Clearly then, it is very important to have a good watch and keep track of UTC.

And though some memory work and practice are needed to make full use of UTC, learning this and all the rest of emergency navigation can be quite a rewarding pastime for offshore sailors. It is good practice in navigation, even if you never need it. Sometimes you do better with what you've got if you know what you can do without it.

Annotated Bibliography

BASIC MARINE NAVIGATION

Bowditch, Nathaniel. *The American Practical Navigator: An Epitome of Navigation*. Pub. 9, bicentennial ed. Washington, D.C.: NIMA, 2002. Included as part of the Digital Nautical Publications CD-ROM available for purchase from the U.S. Government Printing Office (bookstore.gpo.gov). The encyclopedia of marine navigation on all waters. It includes a brief section on lifeboat navigation and valuable information on oceanography and weather. For a full copy of the latest edition, go to www.starpath.com/navpu.bs.

Burch, David. *Celestial Navigation: A Home Study Course*. Seattle: Starpath Publications, 2006. A thorough course on small-craft ocean navigation with extensive practical exercises. Includes all necessary materials and table selections plus online access to an instructor for questions and discussion. Available at starpath.com or call 800-955-8328.

———. *Fundamentals of Kayak Navigation*. 4th ed. Guilford, Connecticut: Globe Pequot Press, 2008. Devoted to navigation from a kayak, but since this involves essentially no instruments, and in many cases no hands, it is good training for emergency navigation.

———. *Inland and Coastal Navigation: A Home Study Course*. Seattle: Starpath Publications, 2006. Practical small-craft navigation explained in simple terms with extensive exercises. Topics limited to ones we need and use. Includes a nautical chart and optional electronic chart training and online access to an instructor for questions and discussion. Available at starpath.com or call 800-955-8328.

———. *Onboard Navigation Exercise Book*. Seattle: Starpath Publications, 2007. Explains actual navigational exercises to be carried out underway using real targets and opportunities that present themselves; includes forms to record the results. Completing a few samples of each would demonstrate a practical, working knowledge of navigation, radio use, and marine weather. Available at starpath.com or call 800-955-8328.

Cutler, Thomas J. *Dutton's Nautical Navigation*. 15th ed. Annapolis: Naval Institute Press, 2003. The “other Bowditch,” meaning another classic American navigation reference, which many find a more readable alternative for an authoritative treatment of marine navigation. Subject matter restricted to navigation, with a short treatment of emergency procedures.

Eyges, Leonard. *The Practical Pilot: Coastal Navigation by Eye, Intuition, and Common Sense*. Camden, Maine: International Marine, 1989. A basic navigation text with emphasis on short-cut estimates, especially small-angle navigation using kamal-like measurements.

Out of print, but readily available online.

Lecky, Squire Thornton Stratford. *Wrinkles in Practical Navigation*. London: George Philip & Son, 1881–1942. One of the “modern” classics of navigation, from the other side of the Big Pond. First edition is from 1881; subsequent editions lasted until a 1947 printing of the 17th edition. Compare to *Bowditch* in the United States with its first edition in 1802 and most recent edition in 2002, still in print. Same level of detail on many topics, some covered in more depth than *Bowditch*, others less, but always more interesting to read because of the outspoken style of the author, despite his tendency to ramble. Widely available online and in reproduction format, or occasionally an original at modest price.

Maloney, Elbert S. *Chapman Piloting and Seamanship*. 65th ed. New York: Hearst Books, 2006. The classic introduction to small-craft seamanship and navigation on inland or coastal waters.

Rousmaniere, John. *The Annapolis Book of Seamanship*. 3rd rev. ed. New York: Simon & Schuster, 1999. A popular reference similar to *Chapman’s* with a practical sailboat orientation. Used by many sailing schools.

ALMANAC DATA

Astronomical Applications Department, U.S. Naval Observatory (aa.usno.navy.mil). Remains the primary source for almanac data for mariners. The Celestial Navigation Data under the Data Services link is an absolute dream machine for celestial navigators. Just enter time, date, and location and it lists the entire sky by H_c and Z_n along with the sum of the altitude corrections and the GHA and declination for each body. This display can be used to test any theory or to make an unlimited number of practice sights and fixes for any ocean, any date. It is ideal for planning your celestial navigation sights for your next voyage, or for super-convenient star and planet identification as you look at the sky around you at home.

Bennett, George G. *The Complete On-Board Celestial Navigator*. 2007–2011 ed. Camden, Maine: International Marine, 2007. Extended almanac (for all celestial bodies) and sight reduction tables for all celestial bodies valid for five-year increments. This book can also be used for lunar distance solutions using the author’s new sight reduction tables available at gbennett.customer.netspace.net.au.

Duffett-Smith, Peter. *Practical Astronomy with Your Calculator*. 3rd ed. New York: Cambridge University Press, 1988. Explains, in simpler terms, the equations used to calculate almanac data.

Kolbe, Geoffrey. *Long Term Almanac for Sun and Selected Stars*. Seattle: Starpath Publications, 2008. Almanac data are valid until 2050. A copy of the NAO Sight Reduction Tables is included, which makes this a self-contained navigation system. Available at starpath.com or call 800-955-8328.

Meeus, Jean. *Astronomical Algorithms*. Richmond, Virginia: Willmann-Bell, 1991. The standard reference on celestial calculations.

Seidelmann, P. Kenneth, ed. *Explanatory Supplement to the Astronomical Almanac*. Sausalito: University Science Books, 1992. The official explanation of the mathematics behind almanac calculations.

Starpath Publications. *Starpath Perpetual Almanac*. Seattle: Starpath Publications, 2003. PC software program that provides almanac data for all celestial bodies from 1576 to 2050. Available at starpath.com or call 800-955-8328.

www.time.gov. A joint enterprise of the National Institute of Standards and Technology (NIST; Boulder, Colorado) and the U.S. Naval Observatory (USNO; Washington, D.C.), this is a wonderful online resource on accurate time and all about time.

STARS AND STAR IDENTIFICATION

Allen, Richard H. *Star Names: Their Lore and Meaning*. New York: Dover Publications, 1963. The classic study. Also available as a searchable ebook at elibrabooks.com.

Burch, David. *The Star Finder Book: A Complete Guide to the Many Uses of the 2102-D Star Finder*. 2nd ed. Seattle: Starpath Publications, 2003. A comprehensive explanation of this important aid to celestial navigation with many numerical examples and a section on its use in emergency navigation—turns the star finder into a handheld planetarium. Requires a 2102-D Star Finder, available at starpath.com and elsewhere. Also available as a searchable ebook at elibrabooks.com.

“The Heavens.” You can explore an electronic version of this popular star chart at nationalgeographic.com/stars/chart. You can purchase your own copy of this large, attractive, laminated, and useful star map (it has same format as the round star maps in the *Nautical Almanac*) at shop.nationalgeographic.com; search on “heavens map” to find it.

Kyselka, Will, and Ray E. Lanterman. *North Star to Southern Cross*. Honolulu: University Press of Hawaii, 1976. A brief summary of astronomy and the mythology of the constellations with unique star maps for each month. A helpful incentive to learning the stars.

Stellarium (stellarium.org) and Cartes du Ciel (stargazing.net/astrocpc). These freeware planetarium software programs are excellent for practicing star identification and star motions. See also the Astronomical Applications Department under Almanac Data above.

FINDING LONGITUDE WITHOUT TIME

Bennett, George G. “Longitude from Lunar Altitudes Simplified.” *Navigation: Journal of the Institute of Navigation* 53, no. 2 (2006). Presents a method of obtaining the time or longitude estimate by interpolation without going through the iteration procedure described in the Everything but UTC section in Chapter 14. See also *Navigator’s Newsletter*, no. 97, Fall 2007.

Chichester, F. “Longitude without Time.” *Journal of Navigation* 19 (1966): 105.

Kerst, D. W. “Longitude without Time.” *Navigation: Journal of the Institute of Navigation* 22, no. 4 (1975–76): 283; and 25, no. 1 (Spring 1978): 87.

Letcher, John S. *Self-Contained Celestial Navigation with H.O. 208*. Camden, Maine: International Marine, 1977. Although H.O. 208 was never a popular means of sight reduction, this book remains an excellent treatment of practical celestial navigation. Among the several special topics covered are finding UTC from the moon and correcting LAN longitude sights for latitude changes during the measurement. Long out of print and hard to find used, but well worth the effort.

Luce, J. W. “Longitude without Time.” *Navigation: Journal of the Institute of Navigation* 24, no. 2 (1977): 112.

NavList, an online newsgroup (groups.google.com/group/NavList). This long-standing, very active online discussion group has dozens of experts on celestial navigation who discuss this subject frequently; several have their own web pages devoted to the topic of lunar distances. They also discuss longitude from lunar altitudes. An archive of the discussion back to 1986 is available.

NO-INSTRUMENT NAVIGATION

Burch, David. “Emergency Navigation Card.” Sausalito: Paradise Cay Publications, 1988. Contains a backup sun almanac, the world’s shortest sight reduction tables, ways to figure sun’s bearing, and brief reminders of star steering, finding position, and other methods covered in this book.

———. Starpath online course on emergency navigation. A unique opportunity to work through practical examples and exercises based on this text, along with in-depth discussion and quizzes. See course description at starpath.com/emergencynavbook.

Cotter, Charles H. *A History of the Navigator’s Sextant*. Glasgow: Brown, Son & Ferguson, 1983. Covers many early sextant precursors that could be made in an emergency. See also Cotter’s *A History of Nautical Astronomy* (London: Hollis & Carter, 1968), which covers techniques and almanac developments as well.

Creamer, Marvin. “Incredible Journey” and “A Star to Steer Her By.” *Cruising World*, May and September, 1984. A two-part account of his circumnavigation without instruments that took place between December 21, 1982, and May 17, 1984. See also “What Makes a Good Navigator” in *Ocean Navigator*, August 1985, an article about Marvin Creamer and his voyage. Unfortunately these articles contain no specifics of the voyage or techniques used other than that latitude was determined by zenith stars and an outline of how he judged the zenith (see the Latitude from Zenith Stars section in Chapter 11). In one article he reports that his DR position was off by 1,000 miles when approaching Tasmania (mostly a very large longitude error perhaps from wrong estimates of current corrections—note in the Knox-Johnston

voyage [see opposite] that Knox-Johnston modified the predicted currents to account for actual winds present and did much better with longitude DR). Other articles report that all other of the Creamer landfalls (including two earlier transatlantic no-instrument voyages) were very accurate, but no specifics or actual data have been published for any of the voyages. Regardless of the details, however, he did sail around the world without compass or modern navigation equipment and received numerous awards and acknowledgments of this singular accomplishment. See globestar.org for more information.

Finney, B. R., B. J. Kolonsky, S. Somsen, and E. D. Stroup. "Re-Learning a Vanishing Art." *Journal of the Polynesian Society* (Auckland, New Zealand) 95, no. 1 (March 1986): 41–90. Describes Nainoa Thompson's training in no-instrument navigation and his subsequent navigation of the sailing canoe *Hokule'a* from Hawaii to Tahiti and back. See also *Pacific Navigation and Voyaging* (compiled by Ben Finney; Polynesian Society [University of Auckland, New Zealand]: Memoir 39, 1975), which is different from the more specifically related Polynesian Voyaging Society (see pvs.kcc.hawaii.edu), and *Vaka Moana: Voyages of the Ancestors* (edited by K. R. Howe; Honolulu: University of Hawaii Press, 2007), for latest knowledge of Polynesian navigation and seamanship. The University of Hawaii library also has a wealth of unique resources on this topic; see library.manoa.hawaii.edu.

Fisher, Dennis. *Latitude Hooks and Azimuth Rings: How to Build and Use 18 Traditional Navigational Tools*. Camden, Maine: International Marine, 1995. Though the book implies the use of real tools and materials, not makeshift constructions, it explains many interesting projects that would be good preparation for emergency applications, not to mention the hobby factor.

Gatty, Harold. *Nature Is Your Guide: How to Find Your Way on Land and Sea*. New York: Penguin Books, 1979. A "Raft Book for Land" with a summary of *The Raft Book's* (see next entry) marine methods. A unique source of natural guides in various parts of the world, though some of the reported ways of orientation on land are anecdotal.

———. *The Raft Book: Lore of the Sea and Sky*. New York: George Grady Press, 1943. The pioneering first work devoted specifically to emergency navigation. It contains a wealth of information on emergency pathfinding, with a thorough compilation of the various signs of land at sea. The potential value of celestial methods included may be overestimated in some cases. Several methods rely on special aids provided with the book, intended as a life-raft companion.

Gladwin, Thomas. *East Is a Big Bird: Navigation and Logic on Puluwat Atoll*. Cambridge: Harvard University Press, 1974. An interesting look at the society, psychology, and techniques of traditional navigators in this region.

Karlsen, Leif K. *Secrets of the Viking Navigators: How the Vikings Used Their Amazing Sunstones and Other Techniques to Cross the Open Ocean*. Seattle: One Earth Press, 2003. Presents a very plausible explanation of how sunstones could have been used underway, along with other tools and procedures. Also available as a searchable ebook at elibrabooks.com.

Knox-Johnston, Robin. *The Columbus Venture*. London: BBC Books, 1991. The author sailed from Gomera in the Canary Islands to San Salvador in the Bahamas (3,000 miles in thirty-three days), along the original Columbus route and without a sextant. Instead, he used a replica of a small 15th-century astrolabe for latitude measurements. Although there is no actual documentation that Columbus or any other mariner of the period actually used such devices underway, Columbus did presumably have one on board, and Knox-Johnston's goal was to investigate how Columbus might have navigated. He had previously calibrated his replica with sextant measurements, which included a 90' offset to all readings. Once underway, he achieved remarkably good accuracy when subsequently comparing his log to data from an Argos tracking satellite. He also demonstrated that he could reestablish his compass error (purposely inserted before departure) from *Polaris* observations within a few days, and he could also (presumably) correct his watch error (also purposely introduced at departure) using celestial observations from his initially known longitude (he had an accurate nautical almanac) and radio signals (he monitored USCG weather broadcasts throughout the trip, which are of short duration at four specific times each day). An important contribution of his voyage was his demonstration that with a compass, precision walker log, timepiece, and good logbook procedures, along with pilot chart knowledge of ocean currents, you can indeed do very accurate DR—a point we stress often in this book. His DR was off by only 27 miles upon arrival, after making current corrections of some 200 miles throughout the voyage, which is also witness to his superb seamanship and extensive experience. His current atlas had called for a total set of some 300 miles, but he could judge along the way from wind speeds and directions that the predictions would be overestimates in the conditions he observed. And in this sense Knox-Johnston did accomplish his goal; although some may find little else good to say about Columbus, Columbus was indeed a master at ocean DR, as can be discerned from his *Diaries*.

Lewis, David H. "An Experiment in Polynesian Navigation." *Journal of Navigation* 19 (1966): 154. Gives navigational details of his no-instrument voyages from Tahiti to New Zealand.

———. *We, the Navigators: The Ancient Art of Landfinding in the Pacific*. 2nd ed. Honolulu: University of Hawaii Press, 1994. The classic study of Polynesian navigation; includes a comprehensive bibliography. (Note: David Lewis wrote the Foreword to this book; see also the Preface to this book.)

Owendoff, Robert S. *Better Ways of Pathfinding*. Harrisburg, Pennsylvania: The Stackpole Company, 1964. Covers orientation on land with an enthusiastic emphasis on the shadow-tip method.

Schenk, Bobby. *Transatlantik in die Sonne: Ocean ohne Compass und Co*. Bielefeld: Delius Klasing, 1995. An account (in German) of Schenk's no-instrument voyage of 2,600 miles from the Canary Islands to Barbados in 1989. The creative crew constructed several makeshift instruments to monitor latitude, notable of which was a fixed-angle reflecting sextant preset to mark their destination latitude at the appropriate date. They steered by a shadow pin at the binnacle location along with a coincidental approximate relationship

between height and bearing of the sun. They reported an accurate landfall, but did not have tracking data to evaluate accuracy underway. Bobby Schenk is a notable yachtsman, with many accomplishments, including other books and valuable teaching materials. (Thanks to Dr. Christopher Winter for confirmation of my translation and interpretation of pertinent sections of Schenk's book.)

EMERGENCY SEAMANSHIP

Bruce, Peter. *Adlard Coles' Heavy Weather Sailing*. 6th ed. Camden, Maine: International Marine, 2008. Describes and analyzes many accounts of storms at sea and how the various skippers and vessels handled them.

Dowd, John. *Sea Kayaking: A Manual for Long-Distance Touring*. Rev. 5th ed. Vancouver; Berkeley: Greystone Books, 2004. Includes much sound seamanship. The author has covered thousands of miles offshore in a kayak.

Rousmaniere, John. *Fastnet, Force 10*. Rev. ed. New York: W. W. Norton, 2000. The author sailed in the 1979 Fastnet Race. See also "1979 Fastnet Race Inquiry," prepared by the Royal Yachting Association and the Royal Ocean Racing Club. Available from the United States Racing Union. An informative study of the effects of a violent storm that overtook an ocean racing fleet of 303 yachts. Fifteen lives were lost, twenty-four yachts were abandoned with five lost. Extremely valuable lessons on safety equipment and procedures are documented. Topics include yacht stability, storm procedures, heavy-weather sails and rigging, safety equipment and use. See also a newer, tragically similar account with even more detail on crucial safety equipment and procedures in the coroner's report from the 1998 Sydney-Hobart Race; equipped.org/sydney-hobart_inquiry_index.htm reproduces the complete CD of the coroner's report, including all interviews, and provides related links. See also www.bom.gov.au/inside/services_policy/marine/sydney_hobart/contents.shtml for the preliminary report on meteorological aspects of the race.

PERIODICALS OF INTEREST TO EMERGENCY NAVIGATION

Celestial Navigation from the pages of the Journal of the Institute of Navigation (navigationfoundation.org/IONcelnav.htm). A single CD compilation of 286 articles on celestial navigation and related topics from 1946 to 2002. Work on the selection of the articles and the CD production was carried out by the Foundation for the Promotion of the Art of Navigation (see *The Navigator's Newsletter* entry opposite) and donated to the ION. Go to the website for a list of the articles included and a link to purchase the product. The CD of all articles costs \$25, which is the same as the cost of a single article on more modern topics from the same journal. It is a wonderful resource for anyone interested in celestial navigation.

Institute of Navigation *Newsletter* (ion.org/newsletter). A quarterly nontechnical print (for members) and online publication (open to the public) that contains timely topics in all phases of navigation, though still mostly electronic.

International Association of Institutes of Navigation (iainav.org) provides contact information for all Navigation Institutes (about twenty members), many of which have online newsletters.

Journal of Navigation (rin.org.uk/resources/journal-archive). Published by the Royal Institute of Navigation, this is similar to its U.S. counterpart but with more articles of general interest. A DVD with a complete copy of all articles from 1948 to present is available for \$200 for nonmembers (\$150 for members). The institute also has a public online newsletter, *Navigation News* (rin.org.uk/resources/navigation-news), with topical articles on all aspects of navigation.

The Navigator's Newsletter (navigationfoundation.org/newsletter.htm). The quarterly publication of the Foundation for the Promotion of the Art of Navigation and available to members. A unique resource for information on practical details of celestial navigation and related topics. An electronic archive of all past issues is available.

METEOROLOGY AND OCEANOGRAPHY

Bigelow, Henry B., and W. T. Edmonson. *Wind Waves at Sea, Breakers and Surf*. Pub. 602. Washington, D.C.: U.S. Naval Oceanographic Office, 1977. A nonmathematical yet thorough treatment of waves. Ebook available at elibrabooks.com.

Britton, Graham P. *An Introduction to Sea State Forecasting*. Edited by Kenneth E. Lilly. Washington, D.C.: National Weather Service, 1981. A technical publication from the NWS designed to help marine weather forecasters predict sea state. Ebook available at elibrabooks.com.

Burch, David. *Modern Marine Weather*. Seattle: Starpath Publications, 2008. How to take weather into account for local and global voyage planning and navigation using the latest technologies as well as the time-honored methods of maritime tradition. Go to starpath.com or call 800-955-8328.

———. “Starpath Weather Trainer.” A computer-based training program that is a comprehensive learning tool and resource covering all aspects of marine weather for ocean voyaging or lake sailing, for kayakers or ship captains, with special sections on tactics for racing and cruising sailors. Go to starpath.com or call 800-955-8328.

Kotsch, William J. *Weather for the Mariner*. 3rd ed. Annapolis: Naval Institute Press, 1983. A popular introduction to the facts and principles.

Mariner's Weather Log (for free download, go to vos.noaa.gov/mwl.shtml; for print subscription, go to bookstore.gpo.gov). This National Weather Service publication is issued

three times a year. It includes a detailed summary of marine weather with related articles. It also serves as a newsletter for the Voluntary Observing Ships program that provides the live observations used to develop weather forecasts. It is the best source of recent storm and hurricane statistics.

NOAA weather resources (nws.noaa.gov/om/marine/pub.htm). See also the Published Aids to Navigation section below. For live weather data, see the following websites: Ocean Prediction Center (www.opc.ncep.noaa.gov), National Hurricane Center (www.nhc.noaa.gov), National Data Buoy Center (ndbc.noaa.gov).

Pierson, Willard J., Jr., Gerhard Neumann, and Richard W. James. *Practical Methods for Observing and Forecasting Ocean Waves by Means of Wave Spectra and Statistics*. Pub. 603. Washington, D.C.: U.S. Naval Oceanographic Office, 1955. Contains theory and graphs on sea state forecasting. On the technical side. Ebook available at elibrabooks.com.

Thomson, Richard E. *Oceanography of the British Columbia Coast*. Ottawa: Department of Fisheries and Oceans, 1981. Although examples are all from British Columbia and the Pacific Northwest coast, the book remains an outstanding introduction to coastal oceanography for readers in any part of the world. A wonderful book.

Van Dorn, William G. *Oceanography and Seamanship*. 2nd ed. Centreville, Maryland: Cornell Maritime Press, 1993. A unique resource on the nature of the wind and sea and how they interact with the boats we sail. Provides numerical details without being overly technical. Highly recommended.

Walker, Stuart. *Wind and Strategy*. New York: W. W. Norton, 1973. Covers details of winds and wind shifts from various weather patterns. Racing oriented and not easy reading, but worth the effort.

Watts, Alan. *Weather Forecasting Ashore and Afloat*. London: Adlard Coles, 1968. Written with sailors in mind. An excellent, nontechnical book on weather with emphasis on shipboard forecasting from clouds and winds. *Instant Weather Forecasting* (New York: Dodd, Mead, 1968) and *Instant Wind Forecasting* (New York: Dodd, Mead, 1975) are shorter versions.

PUBLISHED AIDS TO NAVIGATION

Here is a list of the publications every navigator should know about and have copies of for the waters he or she travels—a dogmatic statement, but nevertheless true! There are excellent Canadian and British counterparts for most of these—see charts.gc.ca (Canadian Hydrographic Service) and ukho.gov.uk (UK Hydrographic Office). The U.S. editions are nearly all now available online. We provide an easy-to-use (and remember) link to them at starpath.com/navpubs. (The government web addresses are nws.noaa.gov/om/marine/pub.htm, www.nga.mil/portal/site/maritime, or chartmaker.ncd.noaa.gov.) All U.S. electronic charts are now public domain.

They are crucial for planning and navigation underway. Some of these publications are expensive in printed format, even though they are available at no charge as Internet downloads. There is also a commercially available CD or DVD compilation of these plus many more products (see Bowditch Plus!—A Complete Navigator’s Library, at starpath.com).

All Waters

Chart No. 1. A booklet that describes all chart symbols and definitions.

Coast Pilots (U.S. Coast Guard). Present crucial navigational information not on charts, including weather and current data. For U.S. waters only.

Light Lists (U.S. Coast Guard). Annual data on all aids to navigation, newer than charts and more in depth.

Marine Service Charts. Thirteen maps cover U.S. waters, listing all weather sources available in convenient format. Not as well known, but nonetheless extremely valuable aid.

Nautical charts. Made by NOAA for U.S. waters and by NGA for international waters.

Navigation Rules, International–Inland (U.S. Coast Guard). The most important book in navigation! Covers international rules plus U.S. inland rules.

Sight Reduction Tables for Air Navigation (NGA). Pub. 249. Three volumes of comprehensive tables of altitude and azimuth designed for the rapid reduction of astronomical sights in the air.

Sight Reduction Tables for Marine Navigation (NGA). Pub. 229. Six volumes designed to facilitate the practice of celestial navigation at sea by the intercept method.

International Waters

List of Lights, Radio Aids, and Fog Signals. Published in seven volumes. Each volume contains lights and other aids to navigation that are maintained by or under the authority of foreign governments.

Pilot Charts. Available for each ocean and each month. Show winds, currents, variation, shipping routes, water temperatures, gale frequencies, and much more.

Radio Navigational Aids. Pub. 117. Lists schedules, and frequencies of radio broadcasts of navigation information, UTC, and weather.

Sailing Directions. Similar to *Coast Pilots* for international waters. See also oceanic *Planning Guides*.

Index

Numbers in **bold** indicate pages with illustrations

A

Achernar, **61, 62**, 167–68

Air Almanac, 240

air traffic, 99, 108, 112–14, **113, 204**

Aldebaran, 52, **56, 57, 99**

almanacs. *See also Nautical Almanac*;
sight reduction tables

backup gear kit, 5, 7, 247

emergency value of, 13, 248

long-term, 5, 7, 247–48

navigating without, 219, 246–48

resources for, 251–52

types of, 240

Alpha Crucis (Acrux), **165**, 167–68

Altair, **53, 54**

altitude. *See* angle (altitude)

measurements

altocumulus clouds, 110–11

altocumulus lenticularis clouds, 202–3

American Practical Navigator, The
(Bowditch), **125**, 244, 248, 250

amplitude

defined, **69**

of stars, **69**

of sun, 76–78, 77, **79**–80, 93

AM radios, 115–16, 117–19, **118**, 204,
216–17

analemma, **196**

angle (altitude) measurements

corrections to, 155–56

estimating, 21, **23**

methods and calibrations, 148–55,

149, 150, 151, 152, 153, 154, 185,

211–14, **212, 213, 215**

Antares, 52, 58, **59, 73, 108**

anvil-topped clouds, 111

apparent wind, 30–32, **31**

Arcturus, **45**, 51, 52

Aries, 248

Auriga, 52, **53**, 54–55

away and toward courses, 18–20, **19**

B

backup navigational gear, 5–6, 7,
8, 247

bar crossings, 37, 128

bay entrances, 37, 128

beam reach, 31–32

bearings

compass check with, 18

landmarks at sea, 15, 47

low stars, timing, 72–74, **73**

radio bearings, **216**–17

on sun, 76, 78

Bennett, George, 247, 248, 251, 252

Bermuda, 112, **204**

Betelgeuse, 52, **56, 58**

Big Dipper

as circumpolar stars, 49

distance between stars in, 47, **48, 150**

Little Dipper, relationship to, 52

locating North Star from, 47, **48, 53**,
157–58

magnitude of stars in, 51

Pointers in, 47, **48, 53, 54, 55, 150**

stars in, 47, **48**

birds, steering by, 99, 108, 112, 203–4

bobbing a light or planet, 211, 235

Bootes, 52

bow angle, doubling the, 214–15

Bowditch, Nathaniel, **125**, 244, 248, 250

Boy Scout watch method, 88

Brahe, Tycho, 173

British Admiralty, *Sailing Directions*,
5, 130, 131, **213**, 259

British pilot charts, 5, **127**, 128–29,
259

British star finder (N.P. 323), 220, 246.
See also Star Finder, 2102-D

C

Canopus, 51, **61, 62**, 164–65, 166–68,
169, 235

Cape Breton Island, 67

Capella

brightness of, 52

as circumpolar star, 52

declination of, 67

finding latitude with, 166–68

locating north from, 52, **53**, 54–55

magnitude of, 51

capillary waves, 34

Capricornus, **106**

Cassiopeia, 48–49, **53**, 157–58

Castor

color of, 52

distance between *Pollux* and, **150**

steering by, 24, 57–58, **242, 243**

cat's paws, 32, 34, **35, 37**

celestial navigation

accuracy of, 13–14, 139

compass checks with, 18, 19–20

high-altitude sights, 241–42, **243**

methods based on, 3

tools for, 13

value of, 132–33

Celestial Navigation Planning (Gray),
235

cellophane, 121, **122**, 123

chart datum, 244, 245

charts. *See also* pilot charts

electronic charting programs, 240, 244

elevation data, 208

radio beacon towers, 117, 119

resources for, 258–59

chip log, **134**–35

chronometer, 3, 12

- circles, drawing, 174
- circumpolar stars, 49–51, **50**, 71–72, 165–66, 169–70
- cirrocumulus clouds, 110–11
- cirrus clouds, **110**
- close reach, **31**, 32
- clouds
- reflected color in, 203
 - steering by, 23, **28–29**, 99, 108, **109–12**, **202–3**
 - types of, **110–11**
 - visibility of, 26
- coastal piloting
- currents and, 130–31, 217–18
 - distance off, 201, 211–15
 - land, signs of, 108–9, 112, 201, **202–7**
 - radio bearings, **216–17**
 - visible range of lights and land, **207–11**
- coastlines
- currents along, 128–29, 130–31
 - sailing toward, 16–17, 37
 - swell patterns, **205–6**
- colatitude, 49, **50**, 56, 57
- color of stars, 52
- Columbia River, 67
- commercial traffic, 6–7
- compass
- adjusting, 20
 - backup, 3, 5, 7
 - checking function of, 17–21, **19**
 - deviation error, 18–21, **19**
 - emergency value of, 3
 - makeshift magnetic, 115–17, **116**
 - navigating without, 245–46
- compass card
- checking rotation of, 17
 - portable, 21–23, **22**
 - sun compass, 94–98, **95**, **96**
- compass course, 136
- Complete On-Board Celestial Navigator, The* (Bennett), 247, 248, 251
- confused sea, 131
- contrary-name stars, **50**
- coordinated universal time. *See* time; universal coordinated time (UTC)
- Coriolis force, 130, 147
- Cotter, Charles, 174, 253
- Creamer, Marvin, 159, 162, 253–54
- Cuba, **33**
- cumulus clouds, 111, **202–3**
- current jet, 131
- currents
- boundaries of, 126
 - compass error checks and, 19
 - course made good in, 217–18
 - data sources, 5, **6**, **125**, 126, 131, 142
 - direction of (set), 124, 130
 - effect on course, 15–16, 124, 136, **138**, 142, 145–47, **146**
 - log, **127**
 - predictions about, accuracy of, 126
 - speed of (drift), 124, 126–27, 128, 130
 - steering accuracy and, 26
 - strength of, 124, 125, 130–31
 - studying along route, 126–28, **127**
 - types of, 124, **125–31**
 - understanding, 16, 124
 - wind and, 15–16, 26, 126, 129–30, 145, **146–47**
- Cygnus, **53**, 54
- D**
- Davies, Thomas D., 240
- Davies Concise Tables, 240
- Davis Mark II sextant, 5, 7
- day length, latitude from, 178–83
- dead reckoning (DR)
- accuracy of, 7, 132–33, 135–36, 139–42, **140**, **141**, 145, **146–47**
 - celestial sights compared to, 132–33
 - course plotting, **133**
 - defined, 132
 - distance run, 135, 136, **138**, 139, 140–41, **146–47**
 - emergency DR, 132–34, **133**
 - errors in, 132, 136–39, **138**, **140**, **141**, 142–43, 220–23, **221**, **224**, **225**
 - independent errors, 137, **138**
 - latitude, tracking, **183–85**
- length of voyage and accuracy of, 132–33, 136, 139
- logbook entries, 220–23
- longitude, tracking, **198–200**
- practicing, 226
- relative measurements
- compared to, 14
- reliance on, 13
- vessel speed and, 133, 135–36, 137–39, **138**
- watch, value of, 133, 134, 139
- declination of planets, 68–69, 108
- declination of stars
- amplitude and, **69**
 - calculating, 67–69, **68**
 - defined, **45–46**
 - memorizing, 162, **163**
 - star paths, **70–72**
 - zenith stars, 64, 162, **163**
- declination of sun, 75–76, 93, 108, 170–73
- Deneb*, **53**, 54
- departure, 9
- deviation error, 18–21, **19**
- distance off, 201, 211–15
- distance run
- calculating, 135
 - day length and, 181–83, **182**
 - errors in, 136, **138**, 139, 140–41, **146–47**
- distress signalling devices, 4
- Dog Stars. *See* *Procyon*; *Sirius*
- doubling the angle on the bow, 214–15
- Dowd, John, 209
- downwind sailing, **31**, 32
- drag line, 145
- Dubhe*, **45**, 47, **48**, 71
- Dutton's Navigation and Piloting*, 237
- E**
- eastern stars, 56–57
- east-west, locating. *See also* steering by sun
- Deneb-Vega* line, **53**, 54
 - Mintaka* and, **56**, **57**
 - overhead stars, 62–64, **63**
 - Venus and Jupiter, 108

electronic charting programs, 240, 244
 electronic navigation, 5–6, **8**, 9
See also GPS
 ellipsoidal distance, 244
 e-mail, 5
 emergency navigation
 backup navigational gear, 3, 5–6, 7, **8**, 247
 challenges of, 2
 defined, 1–2
 importance of, 2
 methods, 3
 practicing, 3, 7
 resources about, 256–57
 responsibility for, 8
 emergency position-indicating radio
 beacon (EPIRB), 4
 emergency preparations, 3–7, **8**
 emergency seamanship resources, 256
 Equation of Time, 189, **191–96**, 248, 249
 equinoxes, 75–76, **77**, **172**, **173**, 178
 equipment. *See* navigational aids and equipment
 evening star, **107**, 108
 eyes, distance between, **154–55**
F
 fallstreaks, **110**
 flat-bottomed hulls, 143
 float plans, 4
 fog, steering in, 115–23, **120**, **122**, **216–17**
 French Polynesia, 67
 frontal systems, **38**
Fundamentals of Kayak Navigation, 128, 250
G
Gamma Crucis (Gacrux), **165**
 Gemini
 color of stars in, 52
 distance between stars in, **150**
 steering by, 24, 57–**58**, **242**, **243**
 geographic range, 208–9, **210**, **211**
Gienah, **53**, 54
 Gladwin, Thomas, 203
 Global Maritime Distress and Safety System (GMDSS), 4

Google Earth, 205, 206
 GPS
 backup gear kit, 5, **8**
 errors while using, 9
 failure of, 13
 great-circle sailing calculations, 243–45
 logging entries for, 226
 reliance on, 9, 223
 time from, 200, 228
 Grand Cayman, **45**
 Gray, Leonard, 235
 great-circle routes, **6**, 16, **17**, 112, 114, 243–45
 Great Square of Pegasus, **53**, 54
 Greenwich hour angle (GHA), 228, 246–48
 Greenwich mean time (GMT), 12. *See also* time; universal coordinated time (UTC)
 Guards, **150**, **151**, **184**, 185
 Gulf Stream, 125–26, 145–46
H
Hadar, **61**, 167–**68**
 Half-Latitude Rule, 64–**66**, 71
 handheld bearing compass, 20–21
 harbor entrances, 37, 128
 Hawaii, **45**, 112–14, **113**, 119, **163**, 205, 227
 helicopter rescues, 7
 high-altitude sights, 241–**42**, **243**
History of the Navigator's Sextant, A (Cotter), 174, 253
Hokule'a (Lewis's boat), 203
 horizon-grazing stars, 162, 164–69, **165**, **168**, 241
 horizon sights, 234–37, **238**, **239**
 hull design, leeway and, 143
 hydraulic head, 130
I
 Iceland spar, 98, 121
 inland waters, **19**, 129, 131
 insects, 205
 islands, 26, **206**, 208
J
 Janiczek, Paul, 240
 Jupiter, 68–69, **106**, **107–8**, 235

K
 kamal
 angles, measuring, **149–50**, 185, **215**
 calibrating, 149, **150–52**
 distance off, finding, 211–14, **212**, **213**
 LAN, measuring, 83–**85**, 180
 star distances, measuring, 162
 sun height, measuring, 94, **96**
 Karlsen, Leif, 121, 254
 kayaks, 128
 keelboats, 143
 Kids, 52, **53**
 knot (speed), 135
 Knox-Johnston, Robin, 170, 177, 254, 255
Kochab, **48**, 51, 52
 Kolbe, Geoffrey, 5, 7, 247, 251
 Kollsman Sky Compass, 121
 Kuroshio Currents, 125, 126
L
 land, signs of, 108–9, 112, 201, **202–7**. *See also* coastal piloting
 landmarks at sea, 15, 47
 latitude
 errors in, 148
 estimating, 9
 finding, 14
 finding longitude with moon and, 230–34, **232**, **233**
 finding with stars, 14, 46, 47, 148, 156–70, **158**, **160**, **161**, **163**, **165**, **168**, 241
 finding with sun, 170–78
 finding with zenith stars, 64–**69**
 LAN accuracy and, 86
 measuring, 11–12, 148, 185
 position fixing with, 9–10
 regions, **10–11**
 rising and setting of stars and, 56–57, 67–**69**, **184–85**
 sun location and, **10**, 11
 tracking, 14, **183–85**
 latitude (parallel) sailing, 16–17
 leading stars, 47–48

leeboards, 143
 leeway
 currents, wind, and, 15–16, 145
 defined, 142–43
 effect on course, 26, 136, **138**, 142,
 146–47
 factors that affect, 143
 importance of knowing, 145–46
 measuring, 143–44
 Letcher, John, 228, 230, 253
 Lewis, David, xii, xiv, xv, 159, 203
 Libra, **106**
Light List, 208, 259
 lights, **207–11**
 Line Islands, **163**, 203
 Little Dipper. *See also* North Star
 (*Polaris*)
 Big Dipper, relationship to, 52
 as circumpolar stars, 52
 distance between stars in, **150**, **151**,
 184, 185
 magnitude of stars in, 51
 stars in, **16**, **48**, 52
 local apparent noon (LAN)
 finding latitude with, 170–78
 longitude, finding from, 186, 189,
 191–96
 measuring, 83–85, 180
 steering by moon, 100–105, **102**,
 103, **104**
 steering by sun, 82–88
 logbooks, 8, 145, 147, 220–23
 longitude
 accuracy of, 197–98
 converting to time, 85
 Equation of Time, 189, **191–96**
 estimating, 9–10
 finding, 14
 finding from moon, 186, 228–34,
 232, **233**
 finding from sun, 186–96, 247
 measuring, 12, 198
 position fixing with, 9–10
 resources about, 252
 time and, 186–87, 197
 tracking, 14, 184, 197–99

Long Term Almanac for Sun and Stars
 2000–2005 (Kolbe), 5, 7, 247, 251
 low-angle refraction corrections,
 155–56
 lubber's line, 18
 luck, 136
 luminous-range formula, 209–11, **210**
 lunar-distance method, 228
M
 mackerel sky, 110–11
 Magellanic Clouds, **61–62**
 magnetic compass, making, 115–17,
116
 magnetic disturbances on vessel,
 20–21
 magnetic variation, 5, 16, 18, 20
 magnets, 116
 magnitude of stars, 51–52
 mares' tails, **110**
 mariner's astrolabe, 177, **179**
 mariner's ring, 175–76
 Marine Service Charts (NOAA),
 226–27, 259
Markab, 53
 Marquesas, **45**, 126–27, **163**
 Mars, **106**, 108
Menkalinan, 52, 53
Merak, 47, **48**
 Mercury, **106**, 107
 meridian passage. *See also* local
 apparent noon (LAN)
 defined, 159
 of moon, 101–2, 103–5, **104**
 of stars, 159, 162–69, **165**, **168**
 of sun, 82, 186
 meteorology resources, 256–58
 Miami, 209
 miles. *See* nautical miles
Mintaka, **56–57**, **163**
Mirfak, 53
 moon
 behavior of, 105
 horizon sights of, 234–35, **238**, **239**
 lighted side of, 102, **103**
 longitude, finding from, 186, 228–34,
 232, **233**

movement of, 99–100, 101
 north-south, locating, 105–6
 phases of, data sources, 103
 size appearance of, 97
 solar time method and full moon,
 100–102
 solar time method and moon phases,
 103–6
 steering by, 99–106
 waxing vs. waning, 102–3
 moon illusion, 97
 moonrise-moonset tables, 103, 105
 morning star, **107**, 108
 mountain wave clouds, 202–3
 mural quadrant, 173
N
 National Almanac Office (NAO) Sight
 Reduction Tables, 236, 240
 National Data Buoy Center, 36–37
 National Geospatial-Intelligence
 Agency (NGA)
 Planning Guides, 5
 resources from, 259
 sight reduction tables (Pub. 229 and
 Pub. 249), 236, 238, 240, 259
 U.S. Pilot Charts, 5, **6**, **125**, 126, 259
 U.S. Sailing Directions, 5, 128
 National Imagery and Mapping
 Agency (NIMA), 5. *See also* National
 Geospatial-Intelligence Agency (NGA)
 National Oceanic and Atmospheric
 Administration (NOAA)
 Marine Service Charts, 226–27, 259
 navigational aids, 258–59
 Tidal Currents Tables, 128
 U.S. Coast Pilots, 5, **33**, 128, 131
 weather resources, 258
Nautical Almanac, 3, 86, 155, 188, 220,
 236, 237, 240, 241, 248
 nautical miles, 11–12
 navigation. *See also* electronic
 navigation
 goal of, 2
 knowing position, 4
 resources about, 250–51, 258–59
 routine, 219–26, **221**, **224**, **226**

navigational aids and equipment.

See also stick (as navigation tool)

calibration, 2

for emergency navigation, 3

emergency navigation kits, 5–6, 7, 8, 220

failure of, 1–2

losing one aid, 219

no-instrument navigation resources, 253–56

for routine navigation, 219–20

Navigator's Triangle, 53–54

NGA. *See* National Geospatial-Intelligence Agency (NGA)

NOAA. *See* National Oceanic and Atmospheric Administration (NOAA)

no-instrument navigation resources, 253–56

nominal range, 208–9, 210

north, locating. *See also* North Star (*Polaris*)

Gemini-*Procyon* line, 57–58

knowing star constellations and, 43

moon, 105–6

from pointers, 54–55

Northern Cross, 53, 54

Northern Hemisphere and latitudes

circumpolar stars, 49–51, 50

current patterns, 125, 130

defined, 10, 11

frontal systems and wind shifts, 38

moon waxing vs. waning, 102–3

Orion in, 45–46, 56

seasons, 11

solar time method, 88

squalls in, 40

star movement in, 60, 64, 165

star steering in, 71–72

stars visible in, 15, 20

sun crossing due east or west, 93–94

sun height in, 88

sun path, 79, 81

sunrise direction, figuring, 76

sun rising and setting angles,

79–80

true direction and compass check, 20
veered wind, 109

northern stars, 46, 51, 64

north pole, star movement around, 47, 48, 49–51, 50, 60

North Star (*Polaris*)

bearings from, 15, 47

declination of, 47, 157

finding latitude with, 14, 47, 156–59, 158, 241

location of in Little Dipper, 16, 48, 52

magnitude of, 51

north pole, relationship to, 47, 157

star movement around, 47, 48, 60

steering by, 15, 16, 47, 48–49, 52–54, 53

steering by, accuracy of, 42

true direction and compass check, 20

visibility of, 47

Nova Scotia, 67

null, 117–19, 118

O

ocean currents, 125–28

oceanography resources, 256–58

ocean swells. *See* swells

Onboard Navigation Exercise Book (Starpath Publications), 7, 250

Orion

belt of, orientation of, 56–57

belt stars, declination of, 45

color of stars in, 52

distance between stars in, 150, 185

finding latitude with, 161

leading and trailing stars, 56

nightly progression of, 45–46

season for visibility, 44

steering by, 56–57, 163

overhead stars, 62–64, 63, 241–42, 243

P

Pacific island navigators, 98, 205

Pan-Pan radio call, 226

parallel (latitude) sailing, 16–17

Pegasus, 53, 54

Perpetual Almanac, 240

Peru, 67

photo sextant sights, 237, 239–40

pilot charts

backup gear kit, 5, 7

British, 5, 127, 128–29, 259

currents information and route planning, 125, 126–27, 142

information included on, 5, 6, 33

resources for, 259

Pilots (British Admiralty), 5

pinhole quadrant, 177, 178

planes, steering by, 99, 108, 112–14, 113, 204

planets. *See also* moon; sun

bobbing a, 235

declination of, 68–69

horizon sights of, 235

identification and characteristics, 106

steering by, 99, 106–8, 107

Planning Guides (NGA), 5

Pleiades, 56, 58

plotting sheets, 150, 151, 174, 183

plumb-bob sextant, 152–54, 153, 169–70

Pointers

distance between, 47, 48, 53, 150, 152

locating north from, 54–55

locating North Star from, 47, 48, 52, 53, 54–55

locating south from, 60–61

polar distance, 164

Polaris. *See* North Star (*Polaris*)

polarized lens, 121–23, 122

polar regions, 10, 11

Pollux

color of, 52

distance between *Castor* and, 150

steering by, 24, 57–58, 242, 243

Polynesian navigators, 162

Polynesian star paths, 70–71

position. *See also* dead reckoning (DR)

celestial methods for finding and tracking, 132–33

finding, 13–14

fixing by latitude and longitude,

9–10

knowing where you are, 2, 4
 tracking, 8, 9, 13–14
 prevailing wind, 32–34, **33**
Procyon, 24, **56**, 57–58
 progress to weather, **146–47**

R

radar, 40
 radar signals, 4
 radio beacons, 117–19, **118**
 radio bearings, **216–17**
 radio direction finding (RDF),
 115–16, 117–19, **118**, 204, **216–17**,
 226
 radios, 5, 226
 radios, types of
 AM radios, 115–16, 117–19, **118**, 204,
216–17
 RDF radios, 117
 VHF radios, 226
 reciprocal magnetic headings,
 18–20, **19**
 red giants, 52
 refraction, 155–56, 237
Regulus, 230–33
 rhumb-line route, 16, **17**
Rigel, **161**, **163**
Rigel Kentaurus, **61**,
 167–68
 ripples, 32, 34, **35**, 37
 river entrances, 37, 128
 Robertson, Douglas, 128
 rotary currents, 128–29
 routes
 choosing, 16–17
 compass course, 136
 currents along, studying, 126–28,
127
 emergency preparations and, 6–7
 float plans, 4
 great-circle, 6, 16, 17, 112, 114,
 243–45
 itinerary for, 4
 rhumb-line, 16, 17
 in squalls, **39–41**
 weather patterns along, 5, **6**
 rowboat team, 145–46

S

Sagittarius, **106**, 108
Sailing Directions (British Admiralty),
 5, 130, 131, **213**, 259
Saiph, **161**, **163**
 same-name stars, **50**
 San Diego, 126–27
 San Francisco, **45**, 112–14, **113**
 SART (search-and-rescue
 transponder), 4
 satellite phones, 5–6, **8**
 satellites, 114
 satellite tracking system, 5
 Saturn, **106**
Scheat, **53**, 54
 Schenk, Bobby, 170, 175, 245
 Schreiber, David, 177
 Scorpio, 44, 52, 58–59, **106**, 108
 sea conditions
 currents and, 131
 steering accuracy and, 25–26
 steering by, 23–24
 search-and-rescue transponder
 (SART), 4
 sea shadow, **206**
 seasons, 10–11, 44, 75–76
Secrets of the Viking Navigators
 (Karlsen), 121, 254
Self-Contained Celestial Navigation
with H.O. 208 (Letcher), 230, 253
 Seven Sisters, **56**
 sextant
 accuracy of position without, 14
 backup gear kit, 5, 7
 corrections to sights, 155–56
 emergency value of, 3, 13, 14
 makeshift devices, 83–85, 174–78
 navigating without, 234–40, **238**,
239
 plumb-bob, 152–54, **153**, 169–70
 sun width measurement, 97
 shadow pegboard, **87**, **89**, **90**, 175
 shadow pinboard, 94, **95**, 175, 245
 shadows, finding, 115
 shadow-tip method, 86–87, **89–92**
 shipping lanes, 6–7

sight reductions, 236–37, **238**, **239**,
 242–45
 sight reduction tables
 backup gear kit, 5, 7
 emergency value of, 13
 navigating without, 240–45, **242**,
243
 Pub. 229 and Pub. 249, 236, 238,
 240, 259
 SIM (subscriber identity module)
 card, **8**
Sirius
 declination of, 67
 finding time from sights of, 230–33
 horizon sights of, 235
 magnitude of, 51
 steering by, **56**, **58**, 61
 solar charger, 5, **8**
 solar time, 13
 method for steering by moon,
 100–105, **102**, **103**, **104**
 method for steering by sun, 86–88,
 94
 setting watch to, 83
 solstices, 75–76, 77, 79–80, **172**, **173**,
 178–79
 south, locating
Achernar, **61**, **62**
Canopus, **61**, **62**
Gemini-Procyon line, 57–58
 Magellanic Clouds, **61–62**
 moon, 105–6
 Scorpio, 58–59
 Southern Cross, 59–61
 Southern Cross, 59–61, **150**, **151**, **165**
 Southern Hemisphere and latitudes
 backed wind, 109
 circumpolar stars, 49–51, **50**
 current patterns, **125**, 130
 frontal systems and wind shifts, **38**
 latitudes to define, **10**
 moon waxing vs. waning, 102
 Orion in, 45–46, 56
 seasons, 11
 star movement in, 60, 64, 65, 165
 stars visible in, 15

Southern Hemisphere and latitudes (*cont.*):
 sun crossing due east or west, 93–94
 sun path, **79**, 81
 sun rising and setting angles, **79–80**
 true direction and compass check, 20
 southern stars, **46**, 51, 64
 south pole, 48, 49–51, **50**, 60–**62**, 65,
165
 spar, 98, 121
 speed of vessel
 accuracy of, 138–39
 calculating, **134–35**
 DR and, 133, 135–36
 errors in, 136, 137–39, **138**
 leeway and, 143
 wind speed and, 31–32
 speed over ground (SOG), 145
Spica, **45**
 squalls, **39–41**
 standard time, 12
 star constellations, 47–48, **106**
 Star Finder, 2102-D, 97, 108, 220,
 245–**46**
Star Finder Book, The (Burch), 97,
 246, 252
 star paths, **70–72**
 stars. *See also* steering by stars
 amplitude, **69**
 bearing of, 3, 43, 72–74, **73**
 brightness of, **51–52**
 color of, 52
 declination of, **45–46**, 64, 67–72
 declination of, memorizing, 162, **163**
 distances between, 47, **48**, 52, **53**, 54,
150–51, 185
 height of, 3, 148–**56**
 high-altitude sights, 241–**42**, **243**
 horizon-grazing, 162, 164–69, **165**,
168, 241
 horizon sights of, 235
 latitude, finding from, 14, 46, 47, 148,
 156–70, **158**, **160**, **161**, **163**, **165**,
168, 241
 learning the sky, 42–**46**
 relative measurements of, 14
 resources about, 252

true direction and compass check, 20
 visibility of, 49–52, **50**, **51**, 168–69
 stars, movement of
 around poles, 47, 48, 49, 60
 circumpolar stars, 49–51, **50**
 leading stars, 47–48
 low stars, timing, 72–74, **73**
 nightly progression of, 43–**44**
 overhead stars, 62–64, **63**
 rate of, **63**
 rising and setting of stars, 43–**44**,
46, 48
 rising and setting of stars and
 latitude, 56–57, 67–**69**, **184–85**
 seasons and, 44
 steering by stars and, 43
 steel vessels, 21
 steering
 by airplanes, 99, 108, 112–14, **113**,
204
 by birds, 99, 108, 112, 203–4
 by clouds, 23, **28–29**, 99, 108,
109–12, **202–3**
 day vs. night, 32, 75
 errors, tracking, 24–26, **25**
 errors and course direction, 136, **138**,
 139–**40**, **141**
 in reduced visibility, 115–23, **120**,
122
 by satellites, 114
 in squalls, **39–41**
 streaming a line, 119–21, **120**
 temporary marks, 27–**29**
 by wind and swells, 23–24, 27–29,
 32–34, **33**, 36, 97, **205–6**
 without a compass, 21–26, **22**
 steering by planets
 challenges of, 99
 Jupiter, **107–8**
 Mars, 106
 Mercury, 106
 moon, 99–**106**
 Saturn, 106
 Venus, **107–8**
 steering by stars. *See also individual
 stars and constellations*

accuracy of, 23–25, 42
 averaging results of, 23
 bearing of low stars, 72–74, **73**
 bearing of rising and setting stars, 43
 Half-Latitude Rule, 64–**66**, 71
 learning the sky and, 42–**46**
 low stars, timing, 72–74, **73**
 overhead stars, 62–64, **63**, 241–**42**,
243
 star paths, **70–72**
 in tropics, 11, **70–72**
 Tropics Rule, 66–**69**
 zenith stars, 64–**69**
 steering by sun
 accuracy of, 23–24
 challenges of, 75
 local apparent noon, 82–**88**
 rising and setting angles, **78–82**
 shadow-tip method, **89–92**
 solar time method, 86–**88**, 94
 sun compass, 94–98, **95**, **96**
 sun crossing due east or west, 93–94
 sunrise, direction of, 75–78, **76**, **77**
 in tropics, 93
 Tropics Rule, 78, 93
 stick (as navigation tool)
 east-west, locating, 57, 64
 emergency value of, 2
 north, locating, **55**, 65
 North Star corrections, 157–**58**
 plumb line and zenith stars,
161–62
 shadow-tip method, **89–91**
 sun height tracking with, 86–**87**, **96**
 sunrise location, 57, 78–79, 80–**81**
 storms, **109**, 135–36
 streaming a line, 119–21, **120**,
 143–**44**
 summer solstice, 75–76, 77, **172**, **173**,
 178–79
 Summer Triangle, 53–54
 sun. *See also* steering by sun
 amplitude of, 76–78, 77, **79–80**, 93
 analemma, **196**
 brightness of and height
 measurements, 84, 96–97

declination of, 75–76, 93, 108, 170–73
 finding latitude with, 170–78
 finding longitude with, 186–96, 247
 finding when obscured, 98, 115–23, **122**
 GHA of, 228, 246–48
 height of, 87, 94–98, **95, 96**
 height of, measuring, **153, 154, 173–78, 179**
 horizon sights of, 234–37, **238, 239**
 photo sextant sights, 237, **239–40**
 size appearance of, 97
 sun, movement of
 due east or west crossing of, 93–94
 eastward slip, 100
 latitude regions and, **10–11**
 local apparent noon, 82–88
 path of, 78, 79, 81
 rate of, 80–81, **87, 88, 187**
 shadow tips and, **89–92**
 solar time method, 86–88, 94
 true direction and compass check, 20
 sun, rising and setting of
 angles of, latitude and, 57
 bearing on, 76, 78
 LAN, finding from, 82–83
 latitude and setting angle of, 57
 longitude and, 14, 187–89
 rising and setting angles, **78–82**
 sunrise defined, 82
 sunrise direction, 75–78, **76, 77**
 sunset defined, 82–83
 sunset direction, 78
 sunset time, 44
 Venus as reference for, 22
 sun and star almanac. *See* almanacs
 sun compass, 94–98, **95, 96**
 sunglasses, polarized, 98, 115, 121–23, **122**
 sunrise-sunset tables, 3, 85–86, 180–81, 187–89, **190**
 sunshade, 84, 96
 sunstones, 98, 121
 surf, 37, 128
 surface wind, **109, 110**

Survive the Savage Sea (Robertson), 128
 swells
 characteristics of, 35, 36
 data sources, 36–37
 direction and size of, 34–35, 36
 identifying, 36
 reading wind direction from, 34, **35**
 reflected patterns, **205–6**
 refracted patterns, **206**
 steering by, 23–24, 27–29, 36, 97, **205–6**
 temporary, 37
 waves compared to, 35
 wind shifts and, 37
 swing the ship, 21
T
 Tahiti, 67
 Taurus, 52, **56, 57, 163**
 telltales, **30, 31, 32, 90, 245**
 temperate latitudes, **10, 11**
Theta Aurigae, 52, **53**
 thunderheads, 111
 tidal currents, 128–29
Tidal Currents Tables (NOAA), 128
 tide tables, 3. *See also* sunrise-sunset tables
 time. *See also* solar time; watches
 accuracy of, 200
 converting to UTC, 12, 187–89, 223, 226
 Equation of, 189, **191–96, 248, 249**
 finding from moon sights, 228–34, **232, 233**
 judging at sea, 133
 longitude and, 186–87, 197
 navigating with only, 249
 sources of accurate, 12, 223
 types of, 12, 13
 tin-can lid, 117
 Titicaca, Lake, 67
 toward and away courses, 18–20, **19**
 trade winds, 29, 34, **109**
 trailing stars, 47
 tropics, **10–11, 70–72, 88, 93, 125**
 Tropics Rule, 66–69, 78, 93

true direction, 20
 true wind, 30–32, **31**
 tube quadrant, **153, 177**
 twilight, 57
U
 universal coordinated time (UTC), 12, 85, 186, 226, 249. *See also* time
 Ursa Major. *See* Big Dipper
 Ursa Minor. *See* Little Dipper
 U.S. Coast Guard resources, 259
U.S. Coast Pilots (NOAA), 5, **33, 128, 131**. *See also* pilot charts
U.S. Pilot Charts (NGA), 5, **6, 125, 126, 259**. *See also* pilot charts
U.S. Sailing Directions (NGA), 5, 128
U.S. Tide Tables, 85, 103, 105, 188
V
Vega, **45, 51, 53–54, 166–68**
 Venus, 22, 68–69, **106, 107–8, 235**
 VHF radios, 226
 Viking navigators, 98, 121
 visible-range formula, **207–8, 209**
W
 Wake Island, **45**
 watch duty, 7
 watches
 accuracy of, 4, 12, 197, 200
 backup gear kit, 5, 7
 changing while at sea, 12, 82, 223, 226
 as chronometer, 12
 converting time to UTC, 12, 223, 226
 DR and, 133, 134, 139
 emergency value of, 3, 4, 13, 14, 249
 good and very good types, 197
 logging watch errors, 223
 setting time, 12, 200
 timing errors, 137
 watch time, 12
 waves
 causes of, 34
 characteristics of, **35**
 data sources, 36–37
 direction and size of, 34, 35

wave (*cont.*):
 reading wind direction from, 32, 34, **35**
 swells compared to, 35
 wind shifts and, 37–38

weather
 broadcasts, monitoring, 5
 data sources, 5, **6**
 resources about, 257–58
 squalls, **39–41**
 steering accuracy and, 26
 storms, 135–36
 storm tracks, **109**
 wind shifts and, **38–41**

weather radio broadcasts, 226–27

Weems, P.V.H., 237

west, finding. *See* east-west, locating

western stars, 56–57

wind
 aloft, 34, **109–12**
 apparent vs. true, 30–32, **31**
 backed, 109
 clouds, reading direction from, **109–12**
 compass error checks and, 19
 currents and, 15–**16**, 26, 126, 129–30, 145, **146–47**
 data sources, 5, **6**, **33**
 measuring direction of, 21, **22**
 prevailing, 32–34, **33**, **109–10**
 reading direction of, **30–32**, 34, **35**
 steering by, 23–24, 32–34, **33**, 97
 surface, **109**
 surface vs. aloft, 110

understanding of, 16
 veered, 109

wind shifts
 signs of, **35**, 37–38
 squalls and, **39–41**
 of steady winds, 29, 34
 weather patterns and, **38**

windward sailing, 16–17, **31**, 32

winter solstice, 75–**76**, **77**, 79–80, **172**, **173**, 178–79

Z

zenith stars
 defined, 64, 159
 finding latitude with, 159–62, **160**, **161**
 identifying, 160–62, **161**
 as star paths, 71
 steering by, 64–**69**