

ORIGAMI BOXES

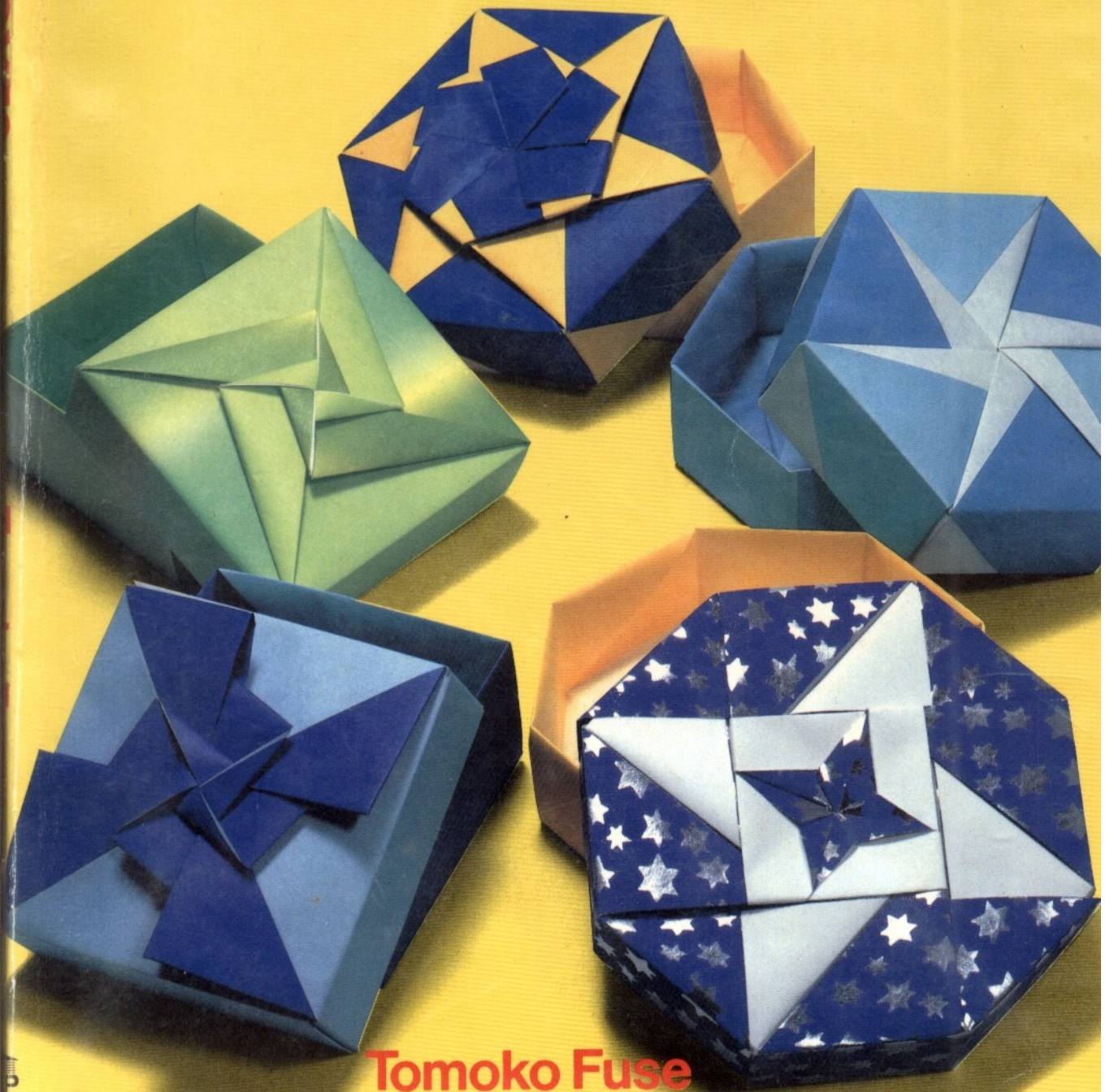

Tomoko Fuse

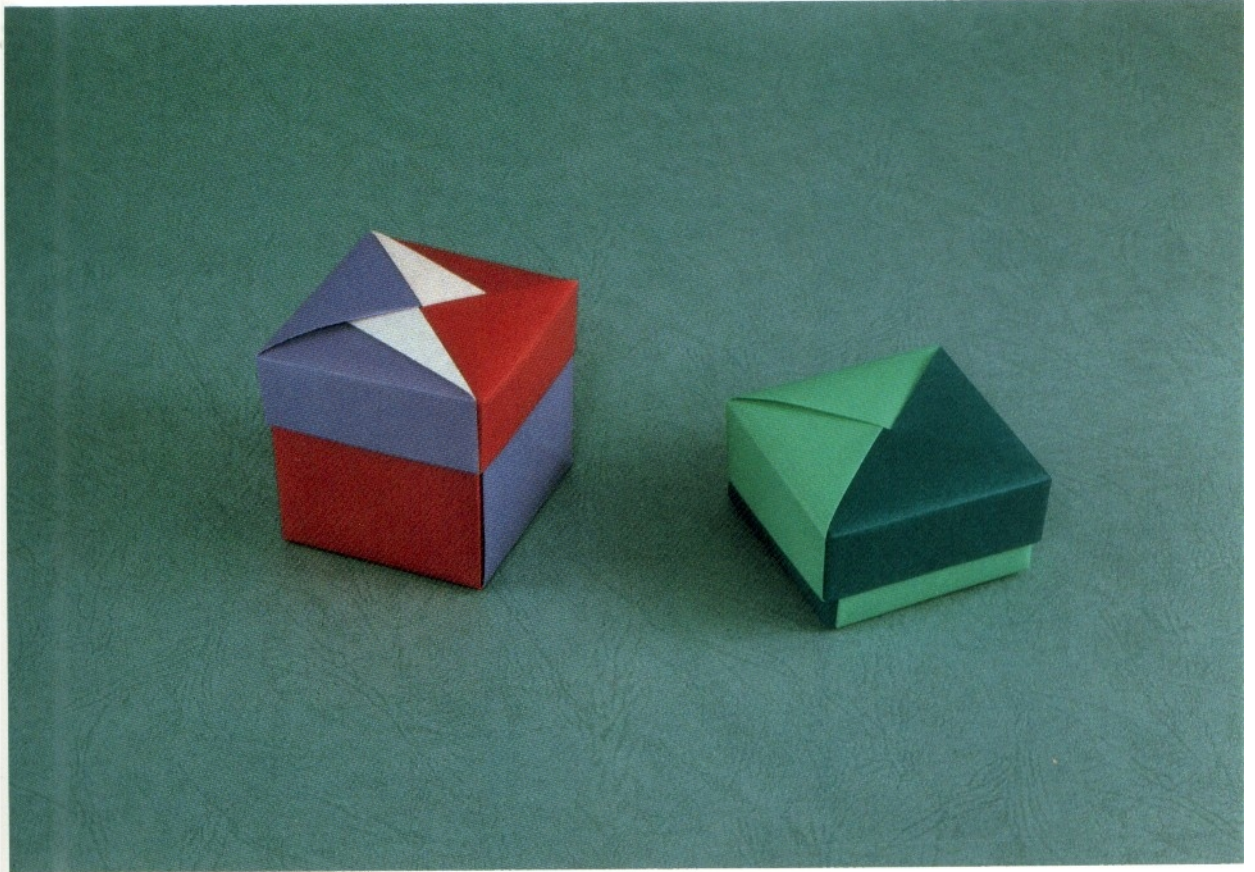

Left, *tsuzura* (lid : pp. 12 - 15 ; base : pp. 16 - 18)

Right, variation, a smaller *tsuzura*. Basically units are folded almost in the same way as the larger one, except that you begin with a diagonal instead of a line that divides side lines in half.

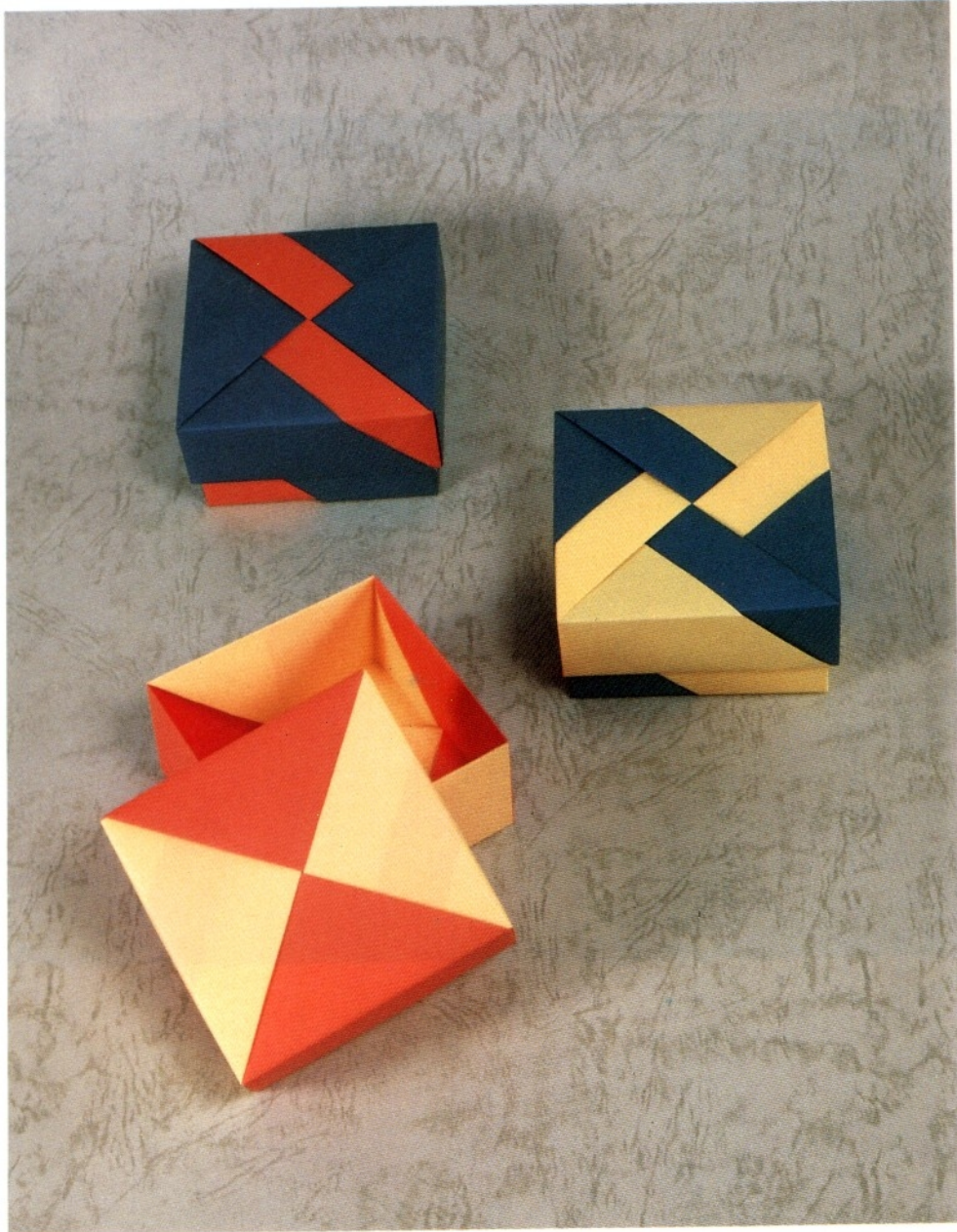

Square boxes : below, 'bow knot'; right, 'wheel'; above, 'lightning' (lids : pp. 24 - 26 ; base : pp. 19 - 23).

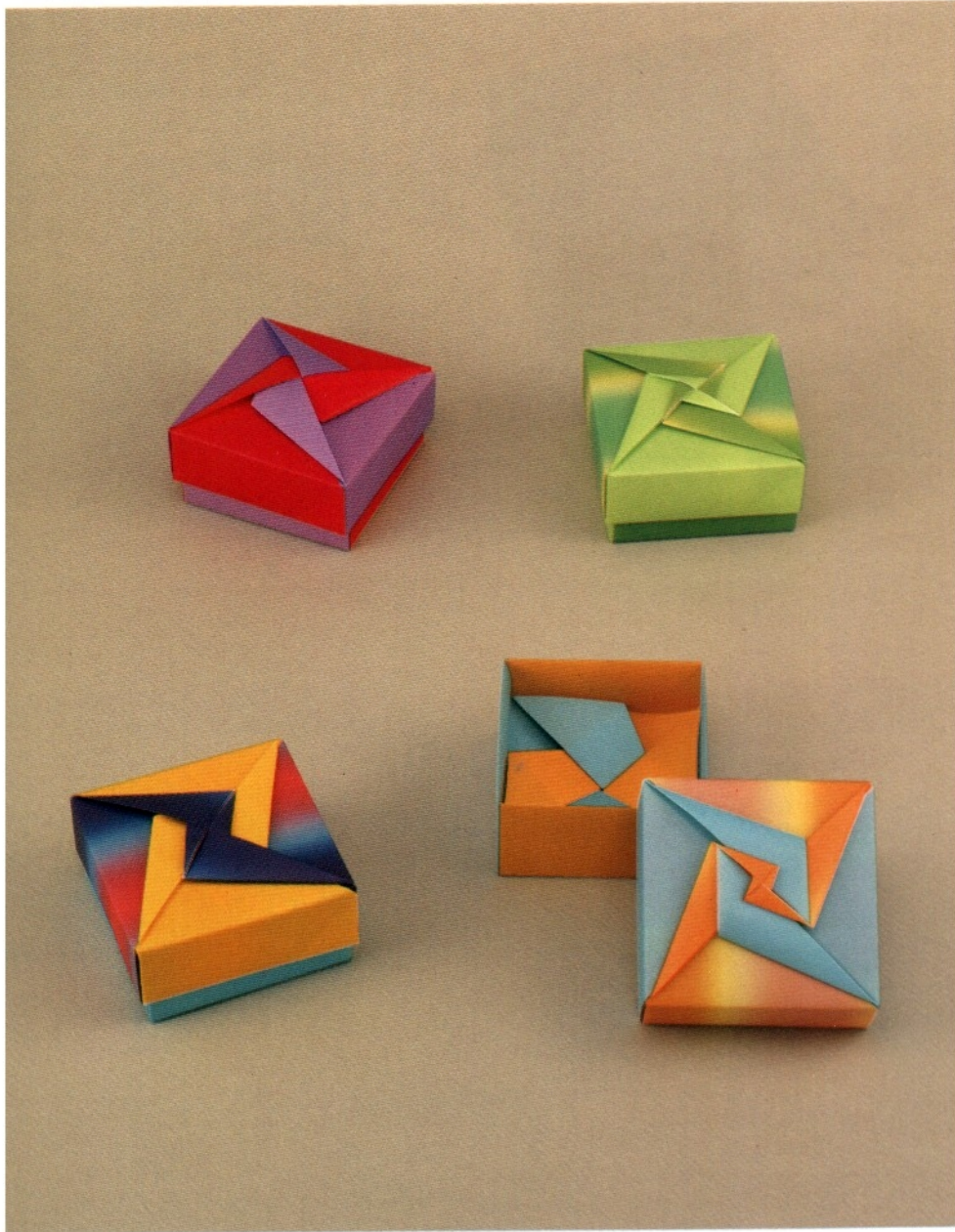

Lids of square boxes : with 'pinwheels' on both sides
(pp. 34 - 40).
The base below right has the same pattern as *B* on
p. 33.



Above, lid of a square box :
'lozenge' (pp. 27-28).

Below, bases of a square
box : left to right, A ; C ;
combination of A and C
(pp. 30-33).

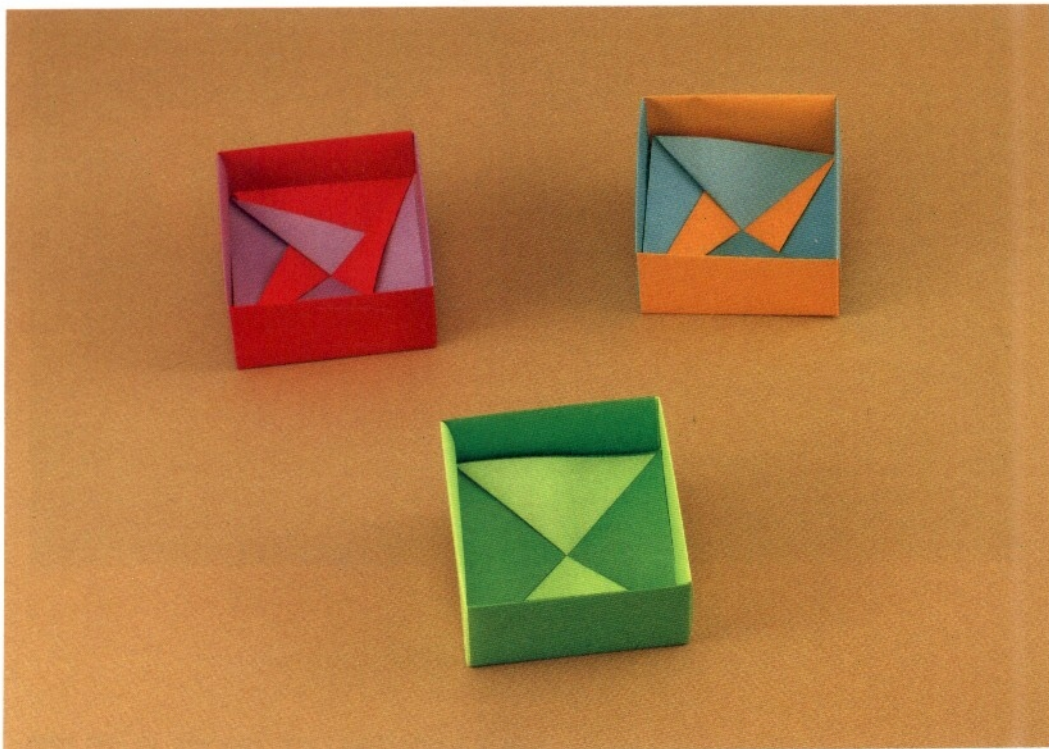

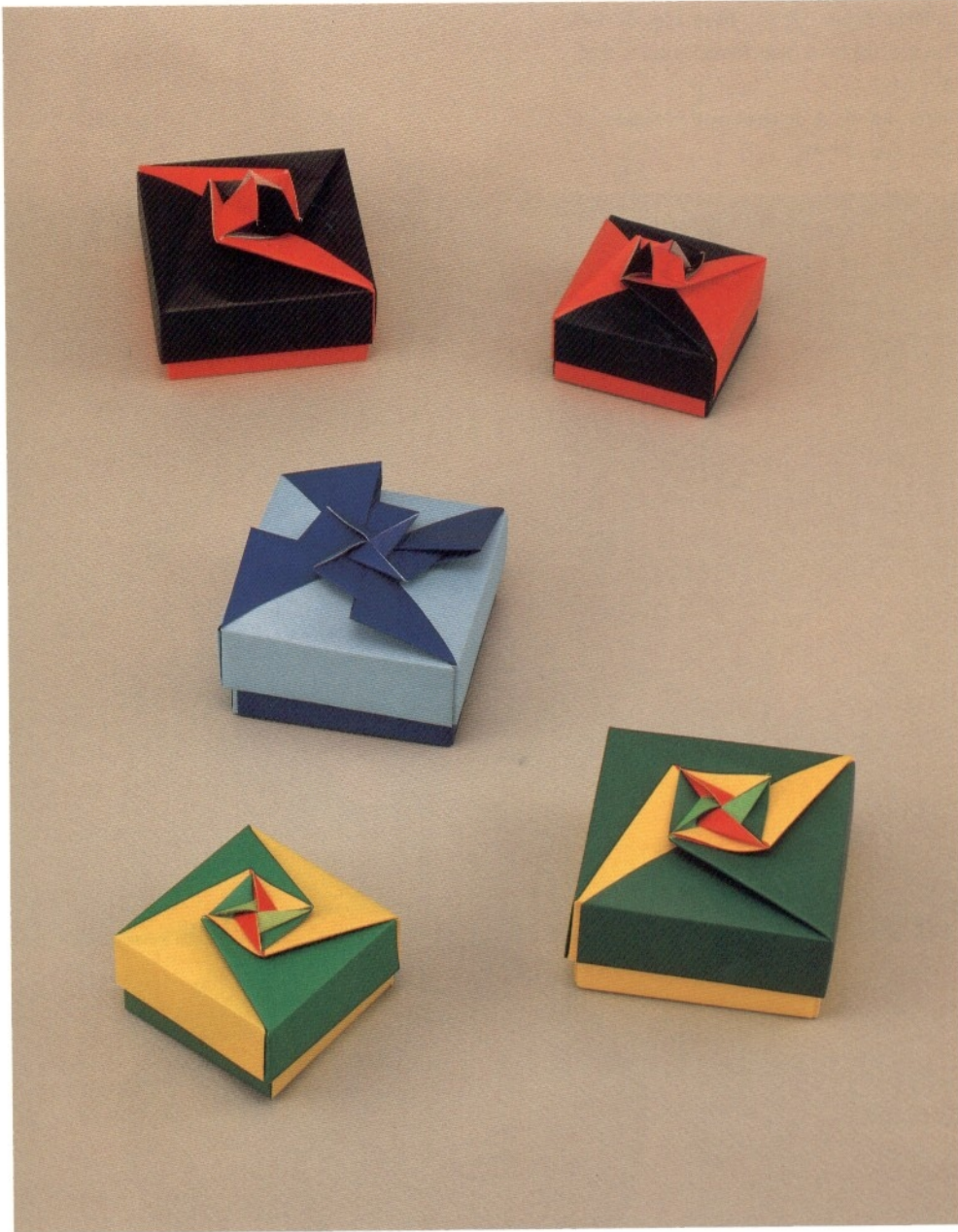

Center, lid of a square box : 'fancy pinwheel' (pp. 41-43). The other four lids are variations and are folded differently from ⑩ on p. 36.

Above left, lid of an octagon box : 'little flower' (pp.44-46) made of *chiyogami* (colorful paper). Right, base (pp. 50-54). The box contains four folded inserts that fit nicely.

Below, lid of an octagon box : 'double stars' (pp. 47-49).

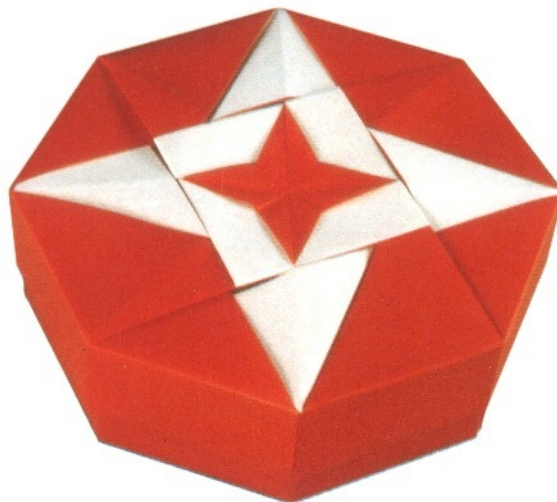

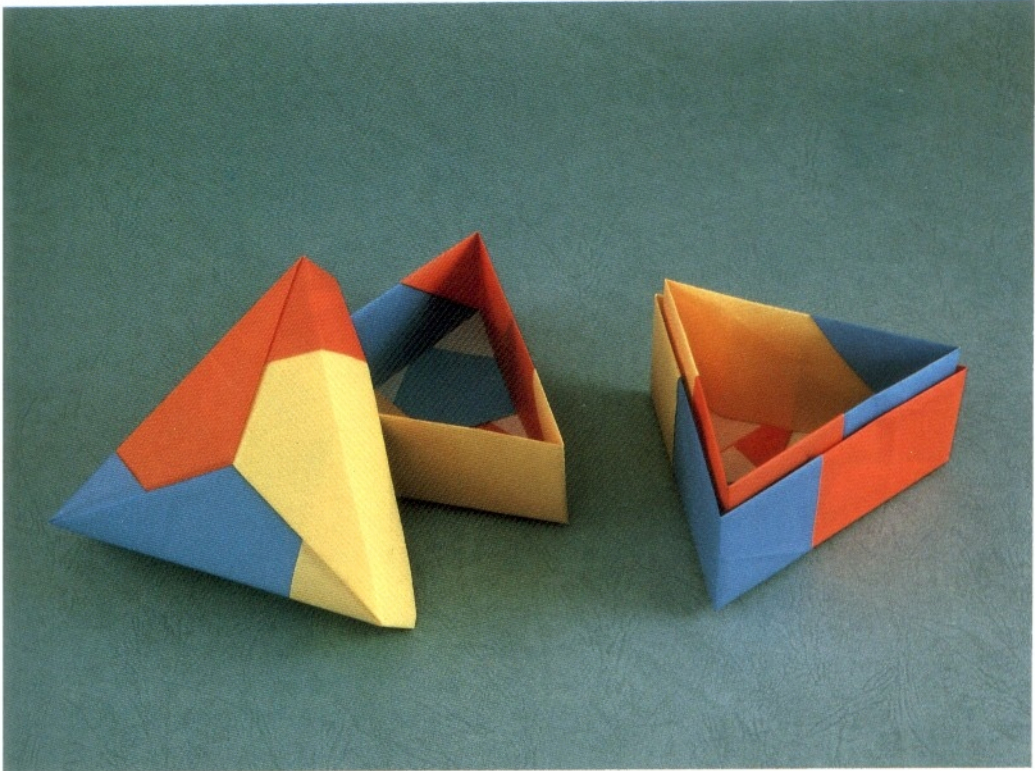

Triangle boxes (pp. 55-61).

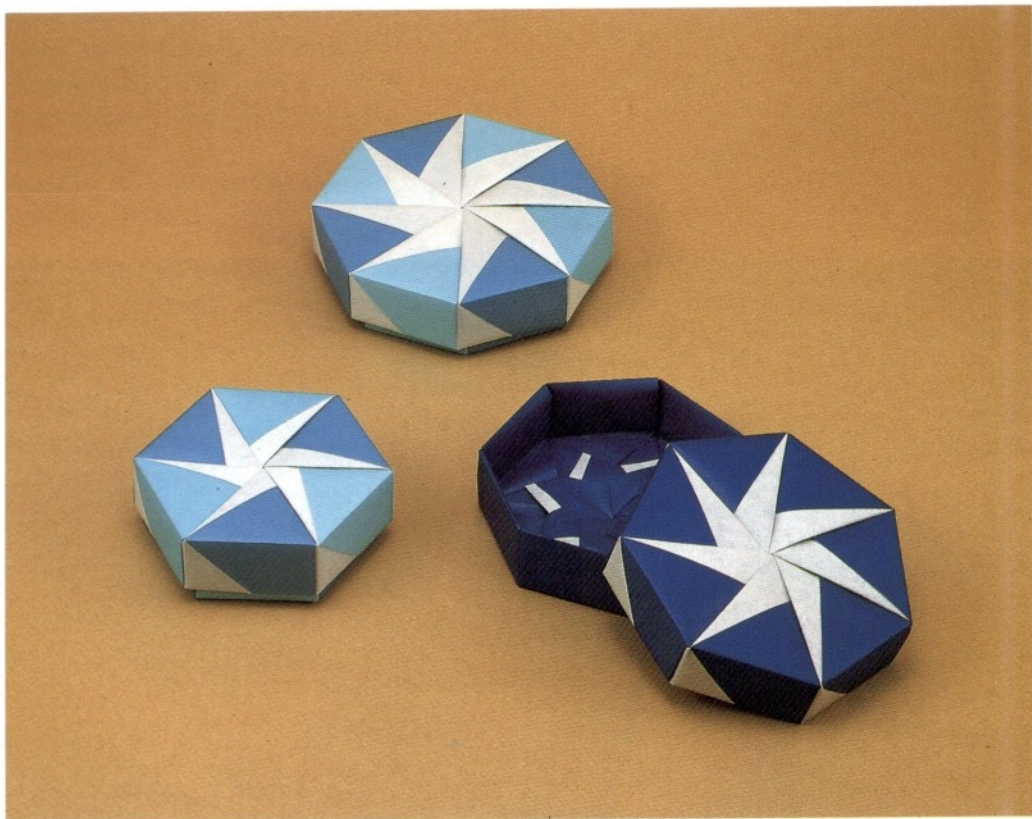

Above left, lid of a hexagon box : 'six-petal pinwheel' (pp. 62-65 ; base : pp. 68-71). By devising different ways of folding, you can make a seven- or eight-sided box.
Below, lid of a hexagon box : 'flower and star' (pp. 66-67).

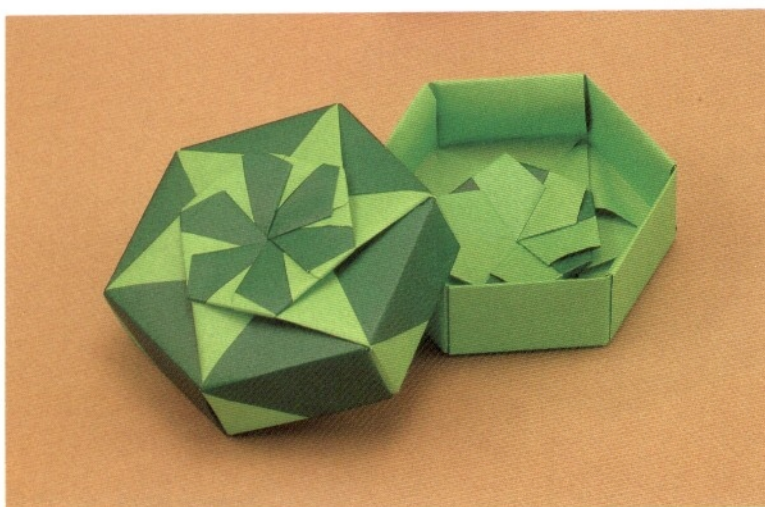

Contents

<i>Preface</i>	11
<i>Signs used in the illustrations</i>	11
Lid of <i>tsuzura</i> (wicker clothes-box)	12
Base of <i>tsuzura</i>	16
Square boxes: first series	19
Lids of square boxes	24
Variation: lozenge	27
Square boxes: second series	30
Lids of square boxes with pinwheels on both sides	34
Lid of a square box: fancy pinwheel	41
Lid of an octagon box: little flower	44
Lid of an octagon box: double stars	47
Base of an octagon box	50
Triangle box: medium size	55
Triangle box: large size	58
Triangle box: small size	60
Lid of a hexagon box with six-petal pinwheel	62
Lid of a hexagon box: flower and star	66
Base of a hexagon box	68
<i>Postscript</i>	73

Lid of *tsuzura* (wicker clothes-box)

© 1983

By folding according to *A*, you can produce this pattern on the lid. *B* is plain. Both are made of two pieces of paper.

(For the base of the box that matches these lids, see pp. 16-18.)

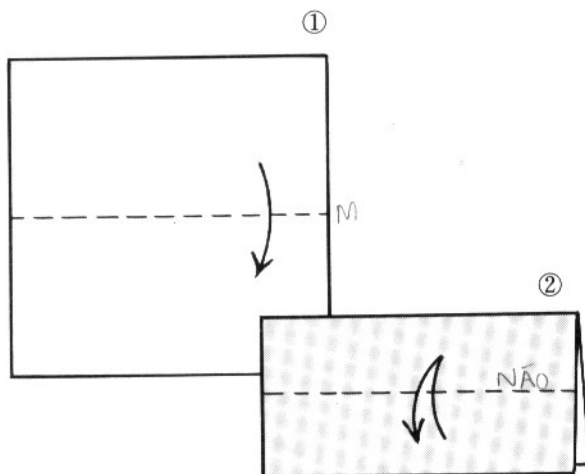
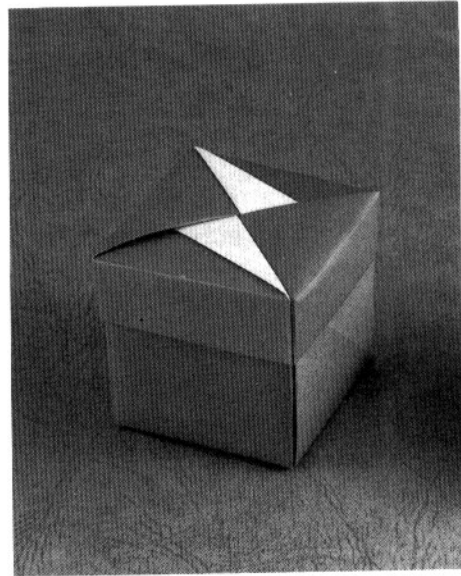

Mark a folding line on the upper layer only.

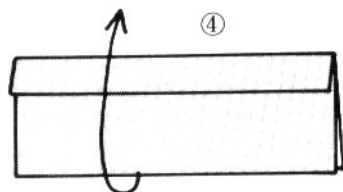
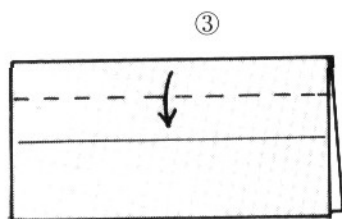

A

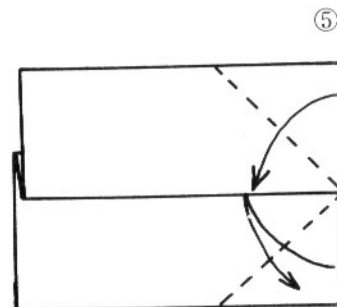

B

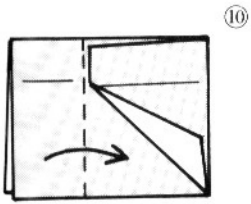

⑩

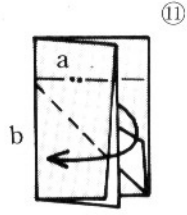

⑪

Place a along b.

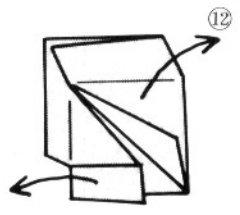

⑫

Unfold back to ⑨.

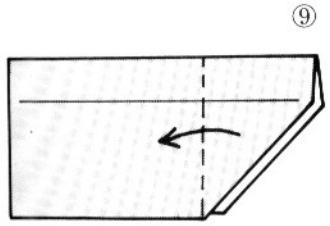

⑨

Continued on the next page. ⇒

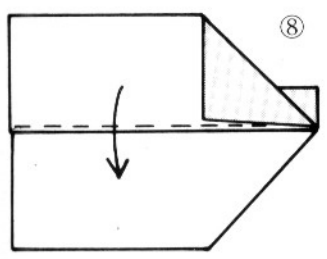

⑧

Go to ⑨.

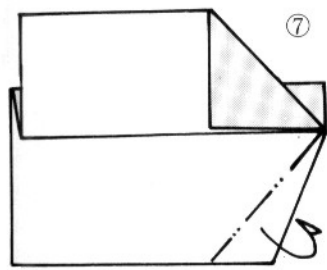

⑦

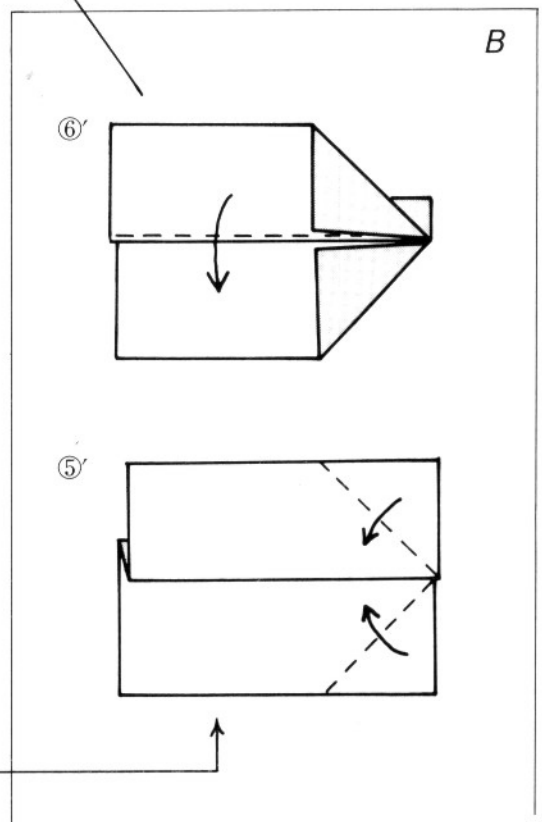

B

⑥'

⑤'

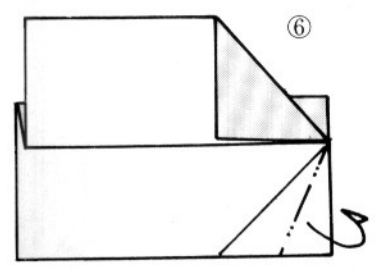

⑥

13

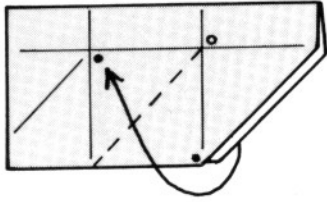

Fold up to the ○ mark, matching ● marks.

14

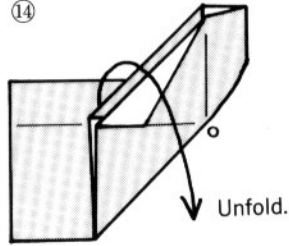

15

Fold the upper layer only.

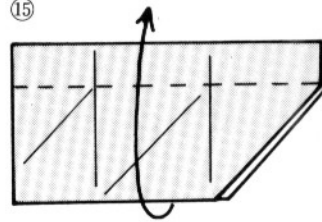

17

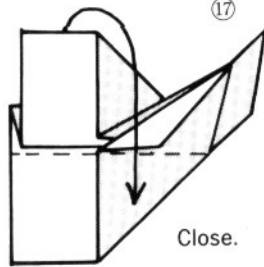

Close.

16

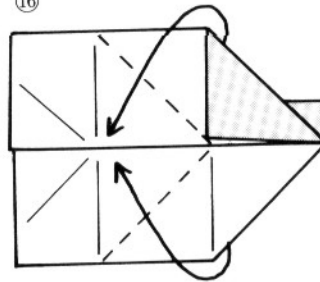

Make the right side stand upright.

90°

18

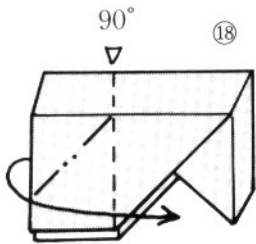

Pleat along the lines already marked.

19

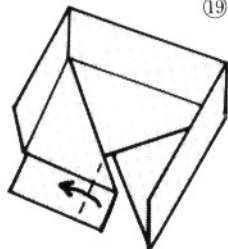

Fold along the center line.

Finished unit.

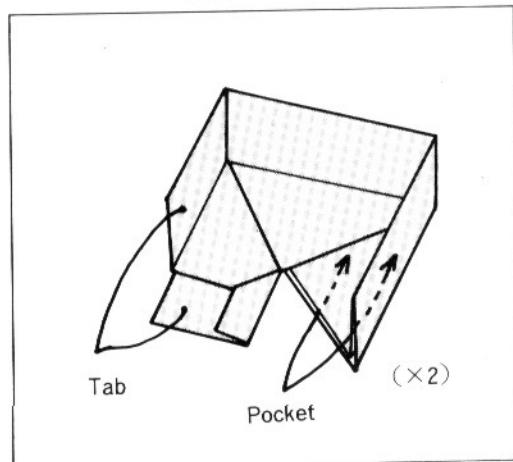

Tab

Pocket

(x2)

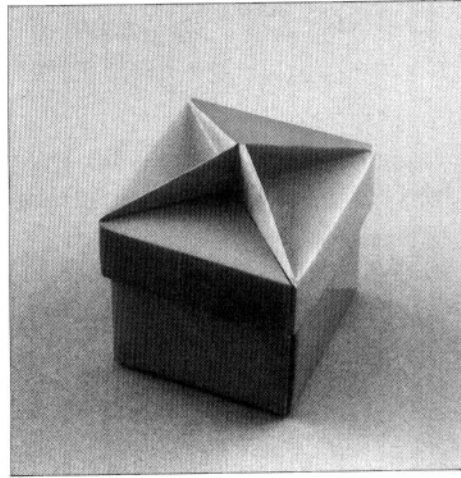
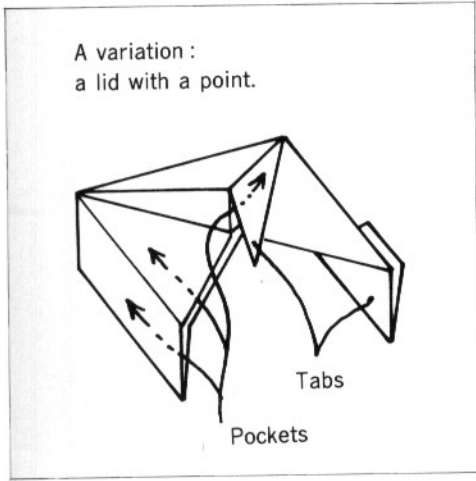

By changing the folding a little as illustrated, you can make a lid with a raised point like the above photo. See if you can make it.

Join as in the drawing.

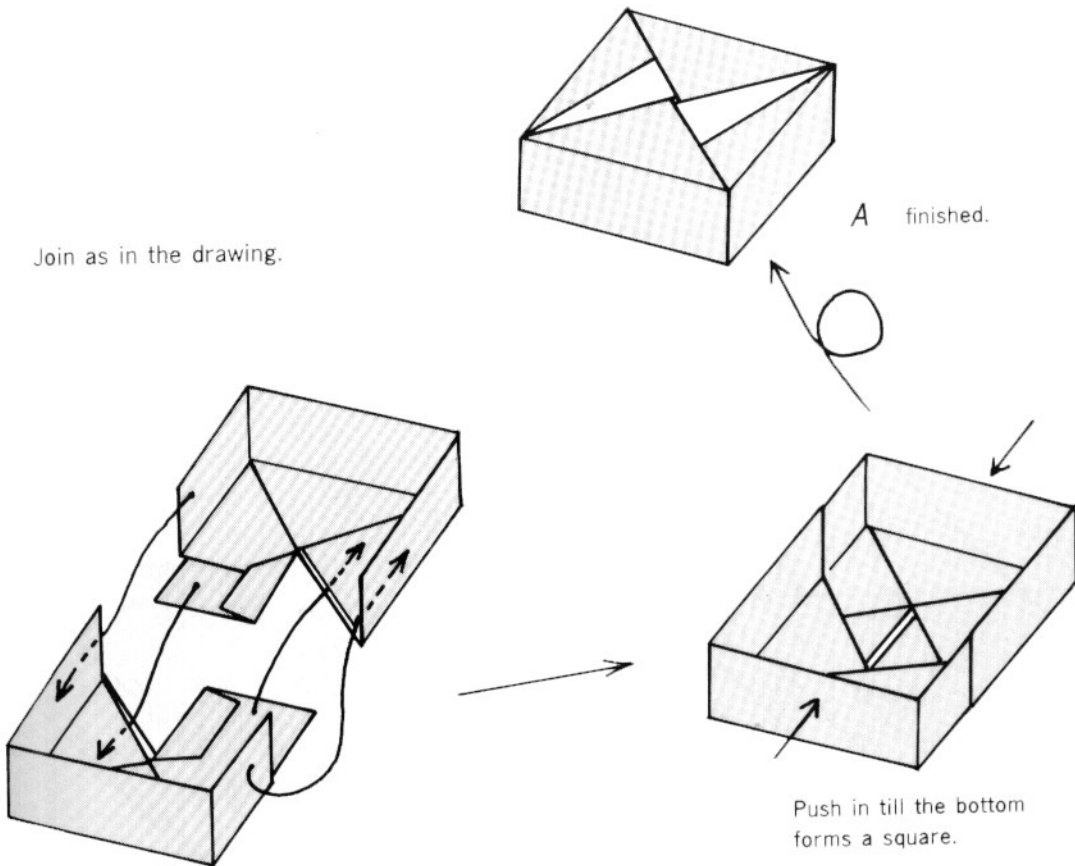

Base of *tsuzura*

© 1983

I am very fond of this crisp little box. Its folds look so simple, but try separating the units for a friend and ask them to reassemble the base of the box. It's quite a brain teaser!

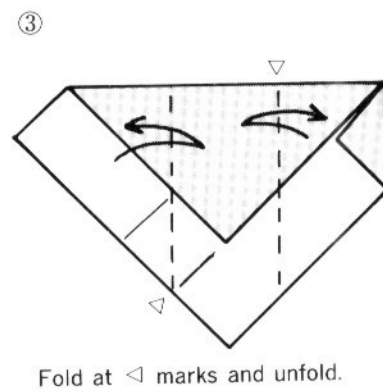
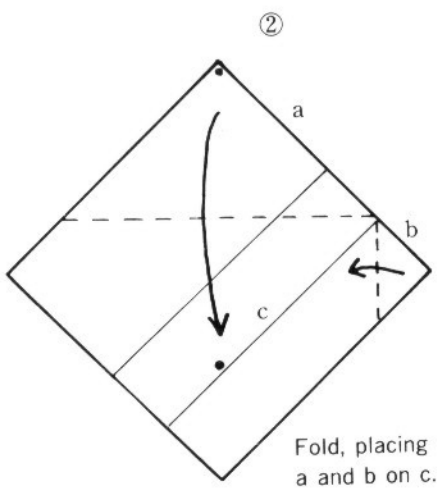
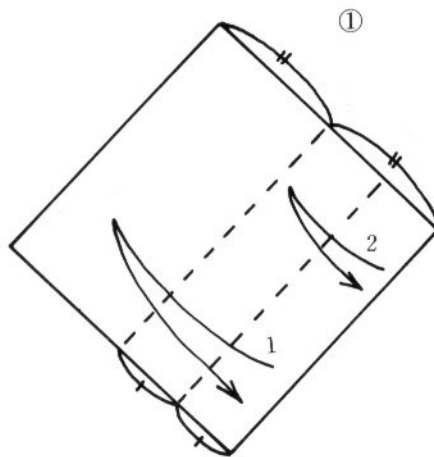
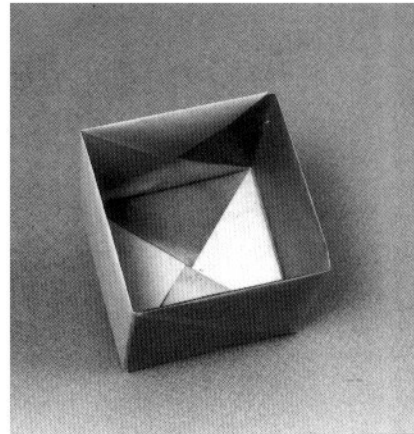

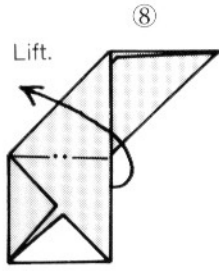
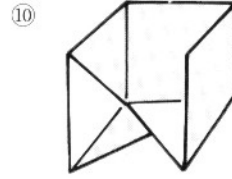
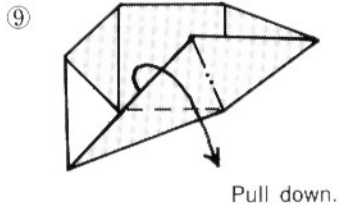

To join the units,
see the next page. ⇒

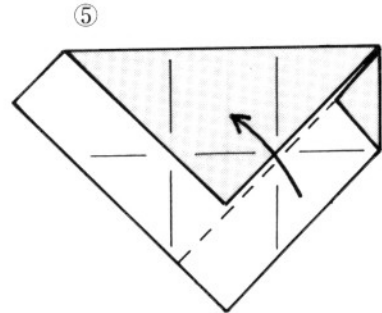
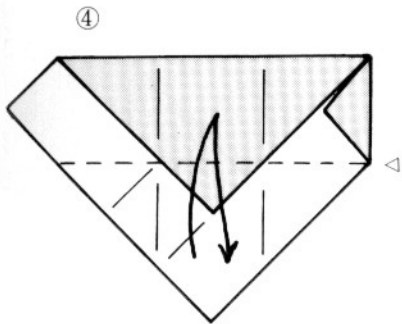
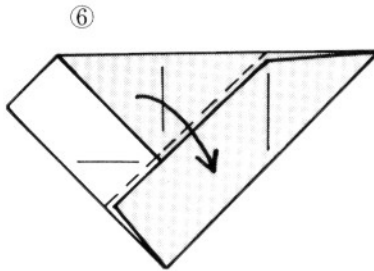
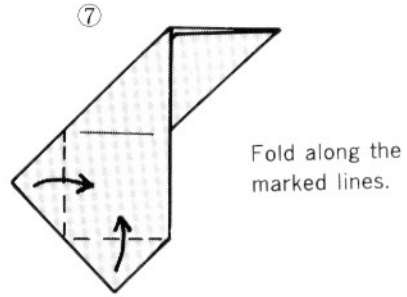

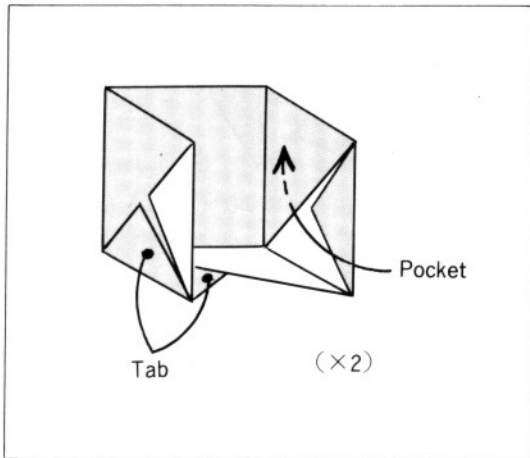

Finished unit.

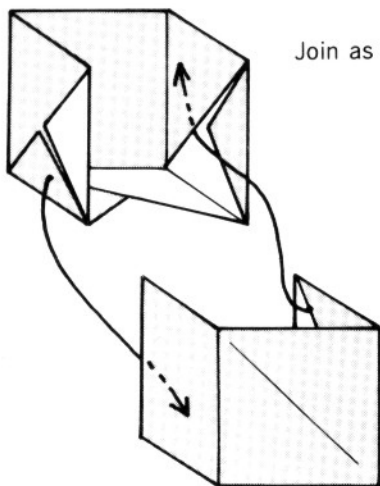

Join as in the drawing.

The units with their loose flaps may be a little difficult to join. See if you can do it by carefully following the illustrations.

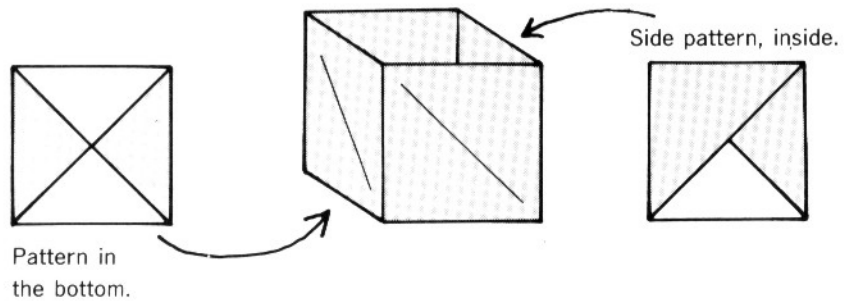

Square boxes : first series

© 1986

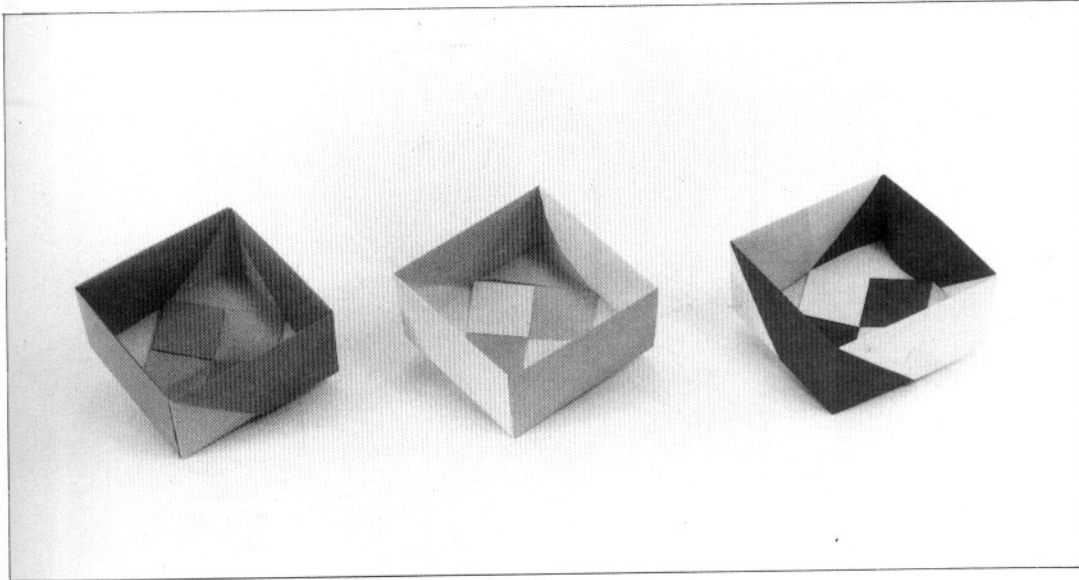

Left to right: 'lightning' (p. 23), 'bow knot' (p. 22), 'wheel' (p. 21).

By just joining the same units differently you will find that new patterns appear like magic. Here are two such patterns, and a third, a combination of the first two.

Both folding and joining are very simple. We use four units. Let us first fold the units as follows.

①

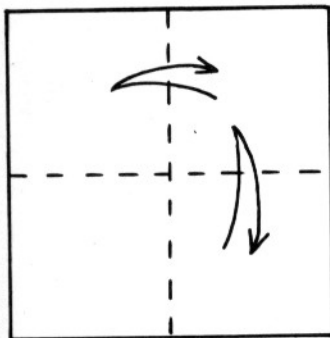

②

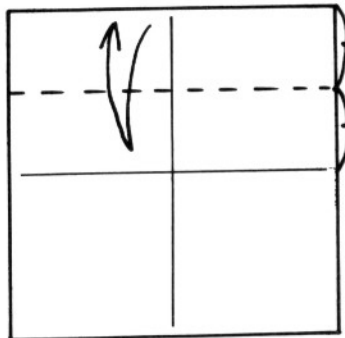

⇒
Continued on
the next page.

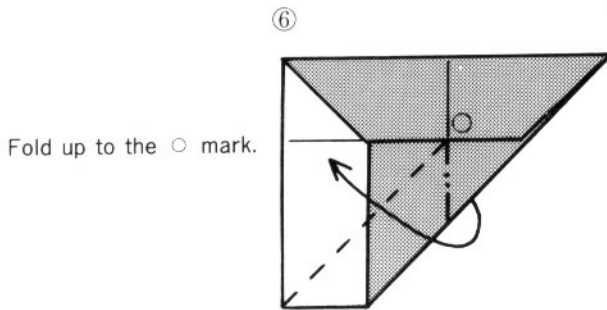
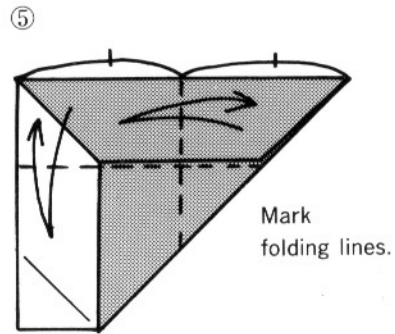
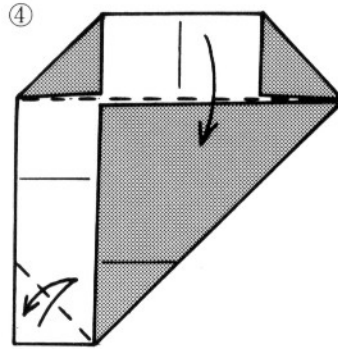
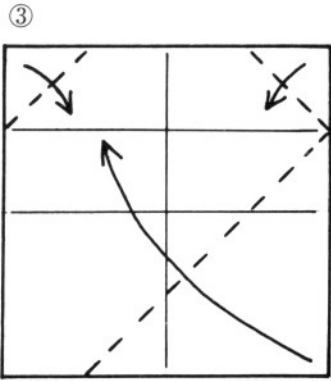

Join as in the drawing. →

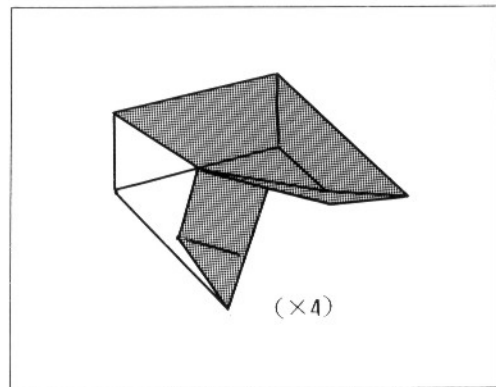
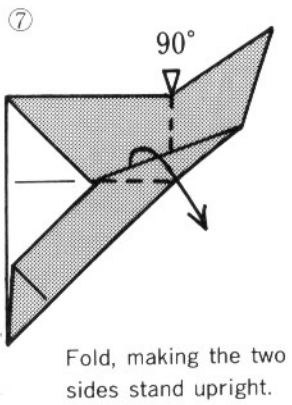

Finished unit.

How to join the 'wheel' units.

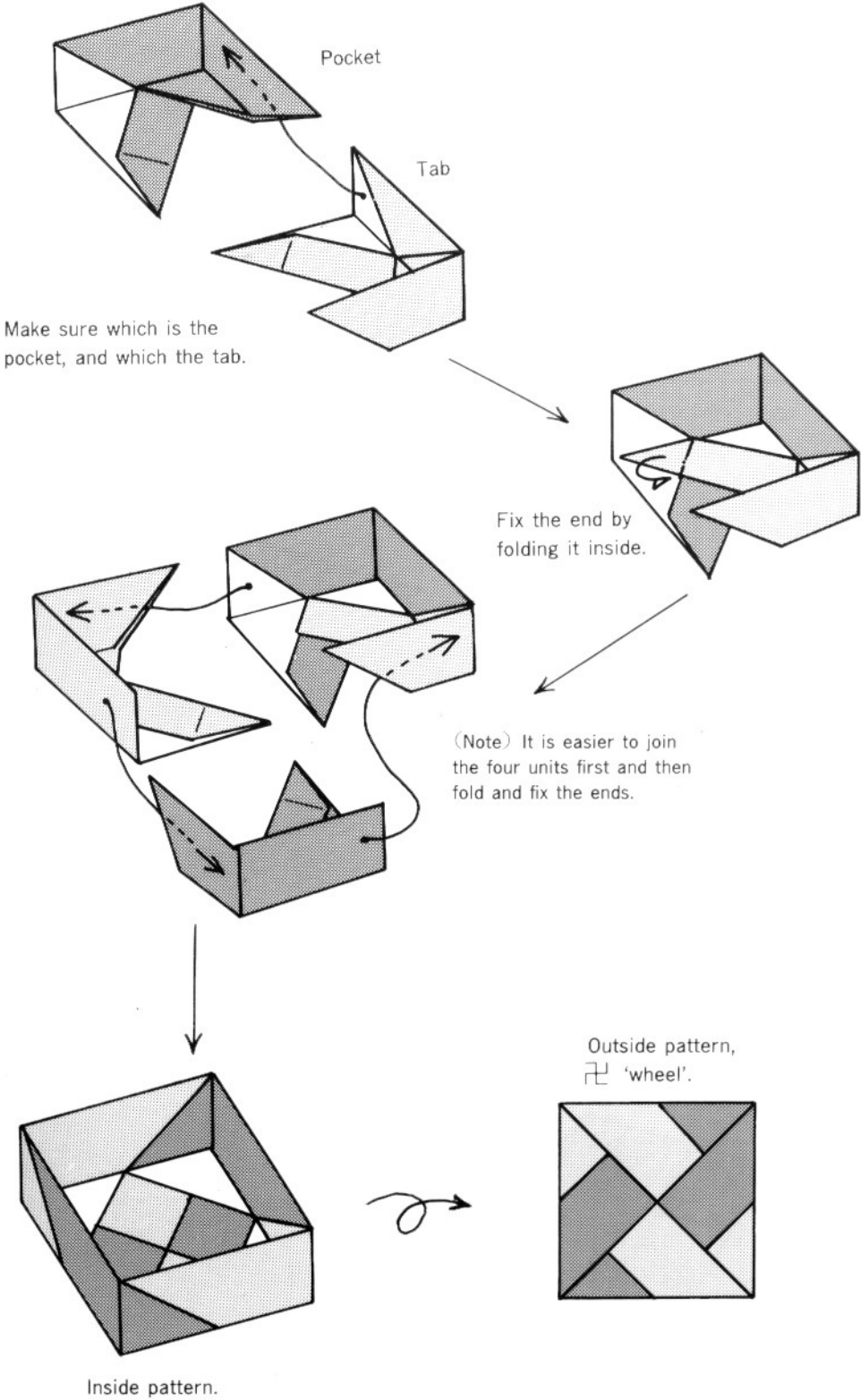

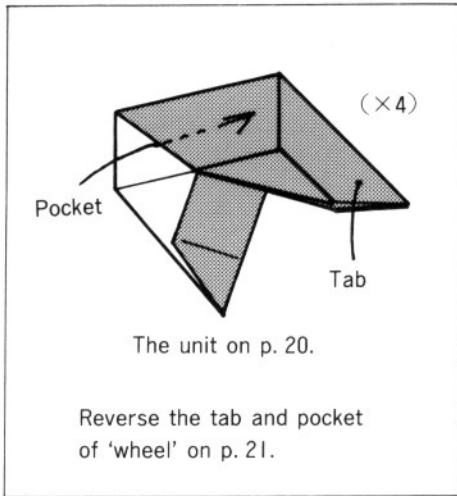

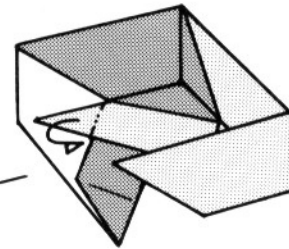
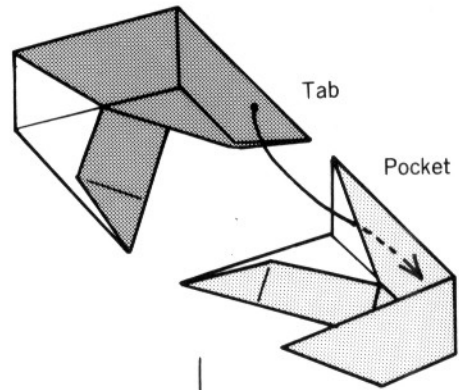

How to join the 'bow knot' units.

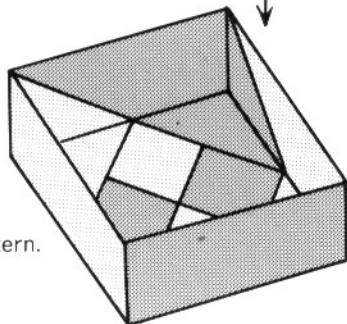
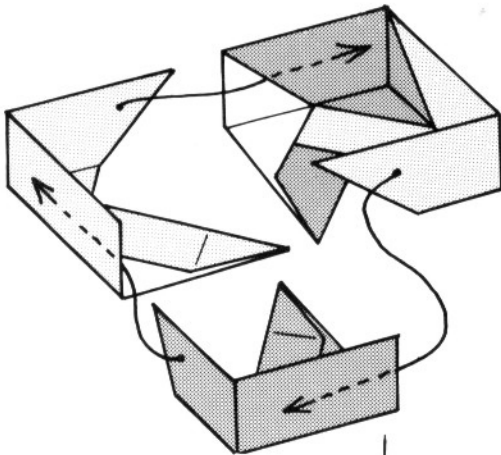

Fix the end by folding it inside.



Inside pattern.

Outside pattern,
 'bow knot'.

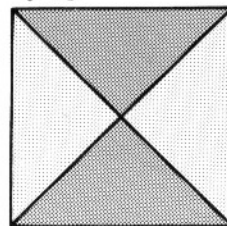

How to join the 'lightning' units.

Unlike the 'wheel' and 'bow knot', the units that make the 'lightning' pattern are joined by using both ends of two units as tabs, and both ends of remaining two units as pockets.

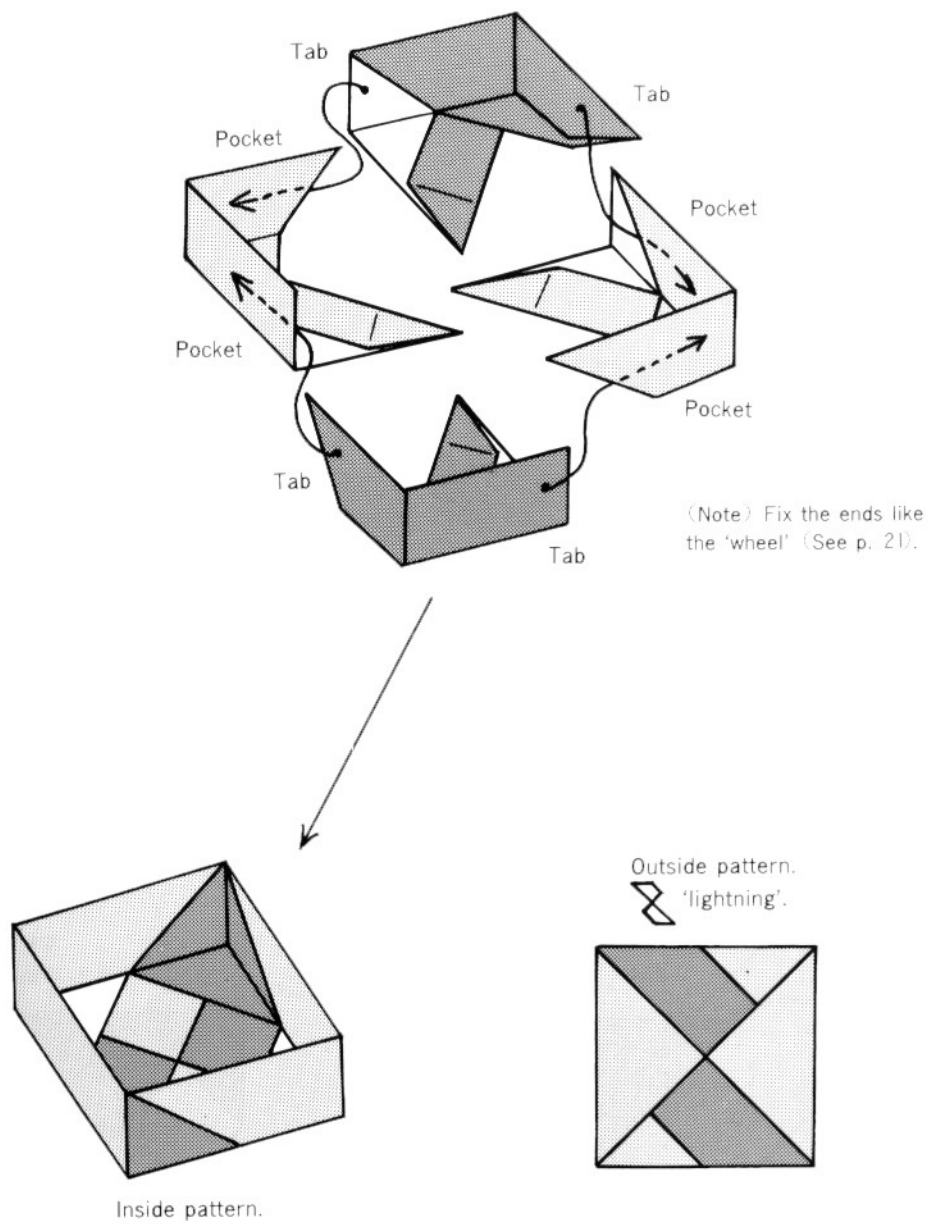

Lids of square boxes

© 1986

Now let us make lids for the boxes we have made. As with the boxes, two different lid patterns can be made from the same units, and their combination makes a third pattern. The outside patterns of the lids match those of the boxes.

The joining of the third pattern is not illustrated, but it is the same as the joining of the lightning-patterned box on p. 23.

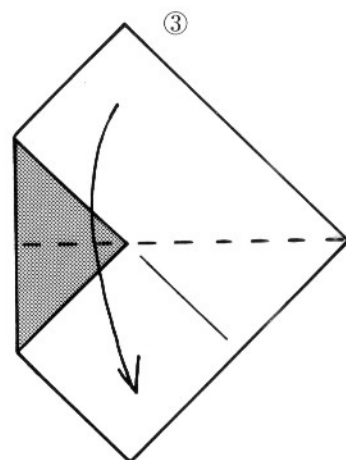
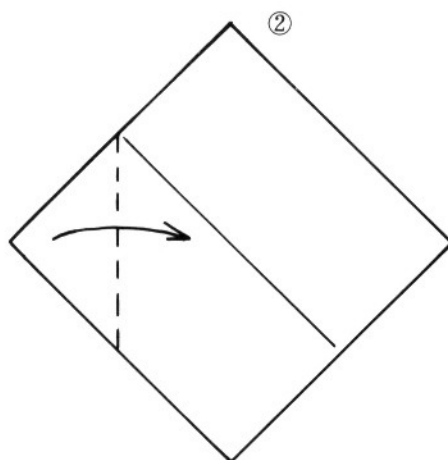
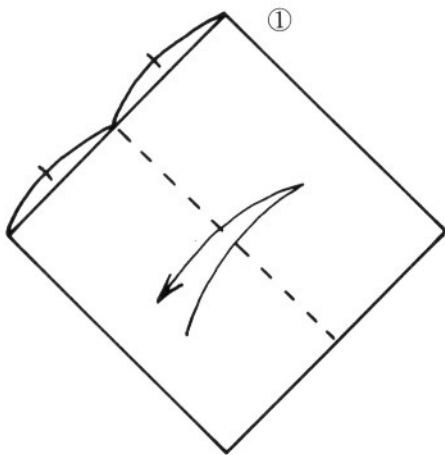

Finished units.

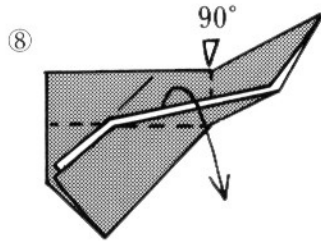
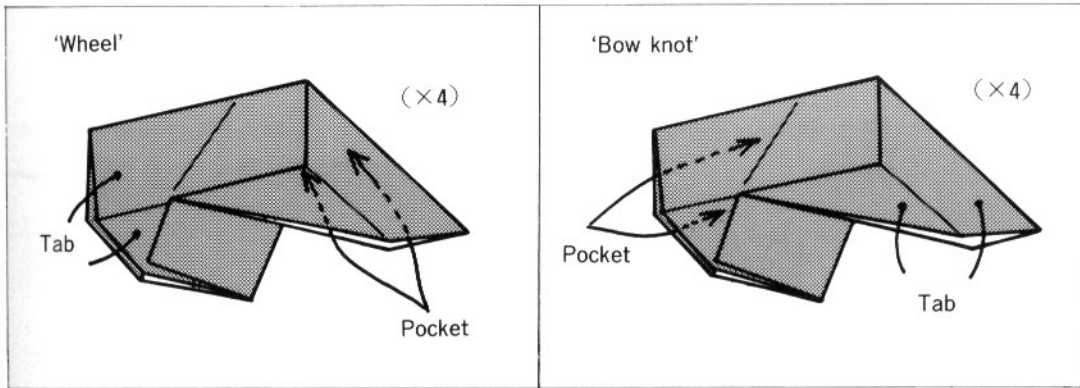

⑧ Fold, making the sides stand upright as above.

For joining, see the next page. →

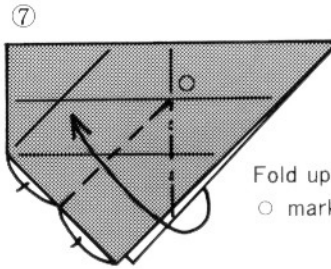

⑦ Fold up to the ○ mark.

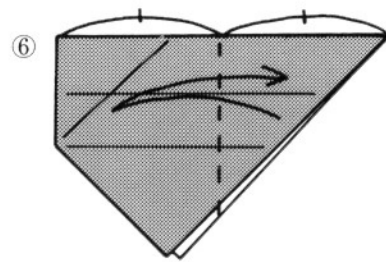

Mark a folding line on the upper layer only.

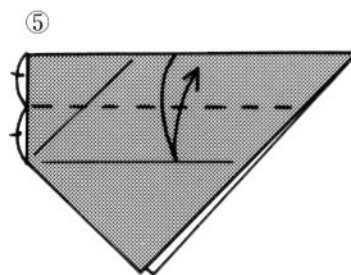
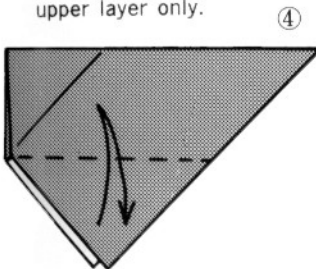

Joining the 'wheel'.

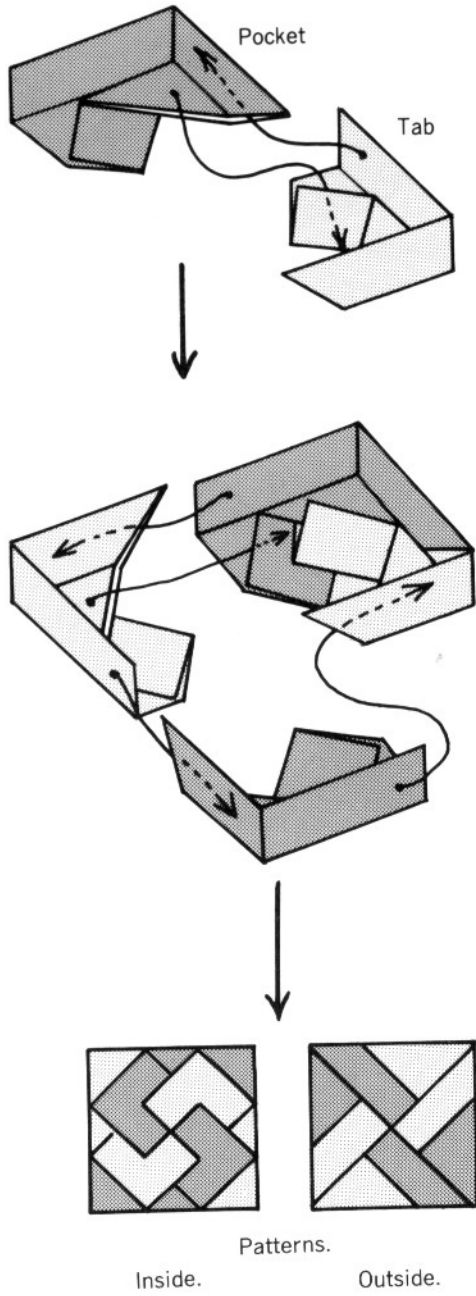

Joining the 'bow knot'.

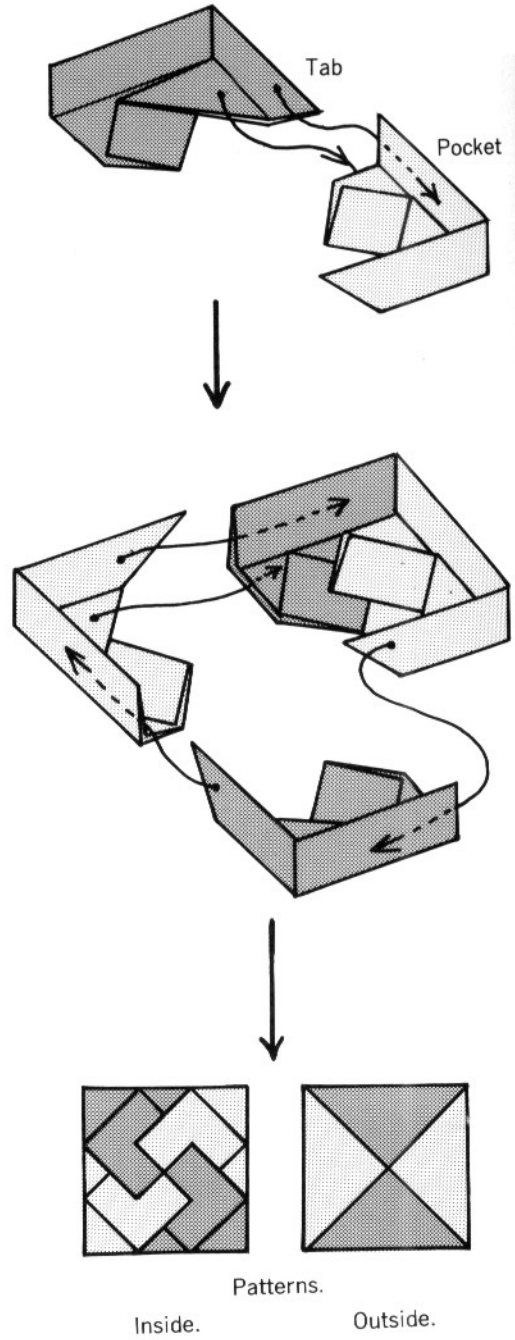

Lid of a square box. Variation : lozenge

© 1986

At a certain point (④), change the folding on page 25 slightly and you will have a lid with a different pattern.

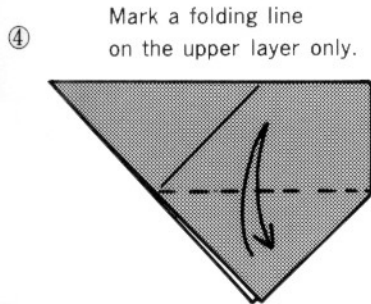
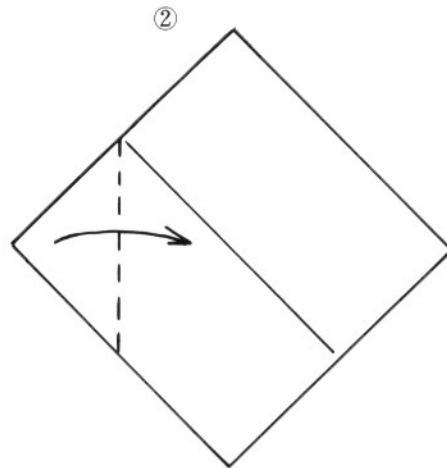
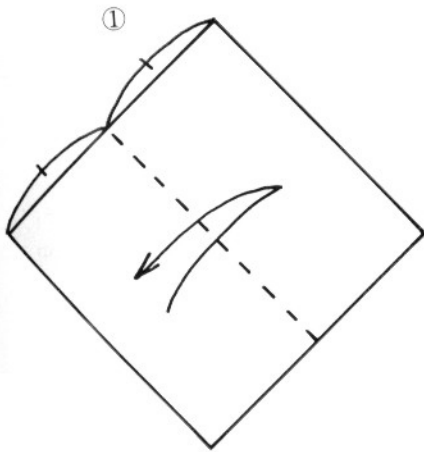

Turn over.

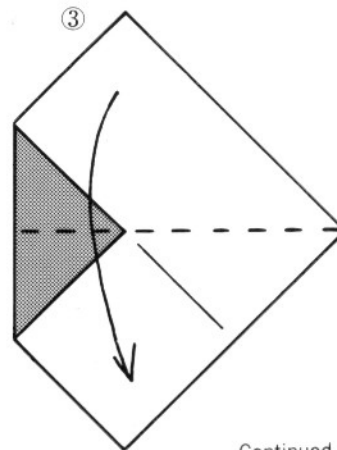

Continued on the next page. →

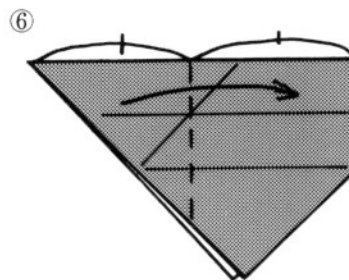
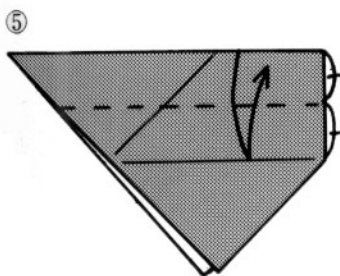

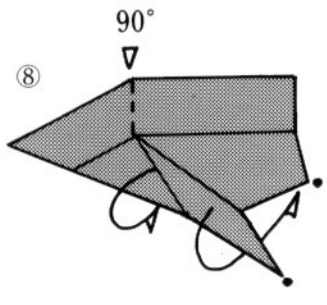
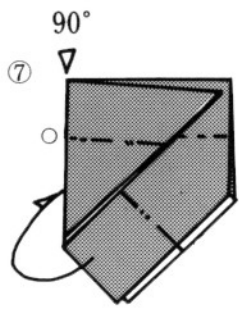

Match • marks.

Fold the marked line to the wrong side, up to the o mark, matching • marks in ⑧. Fold only the inner layers.

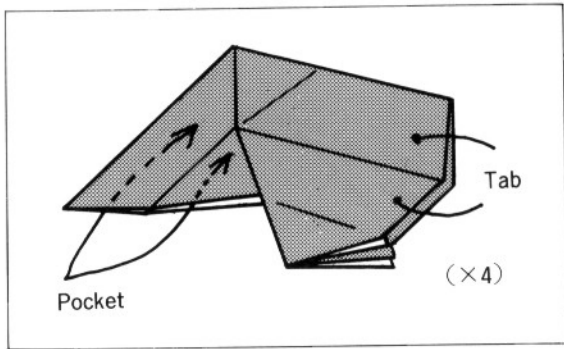

Finished unit.

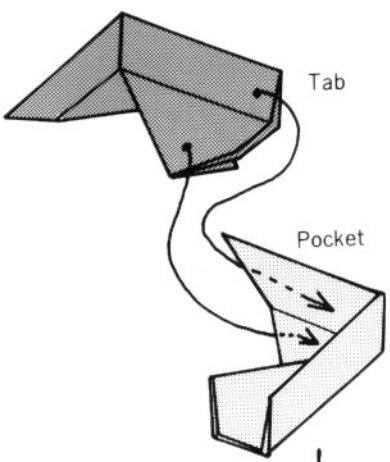

Join as in the drawing.

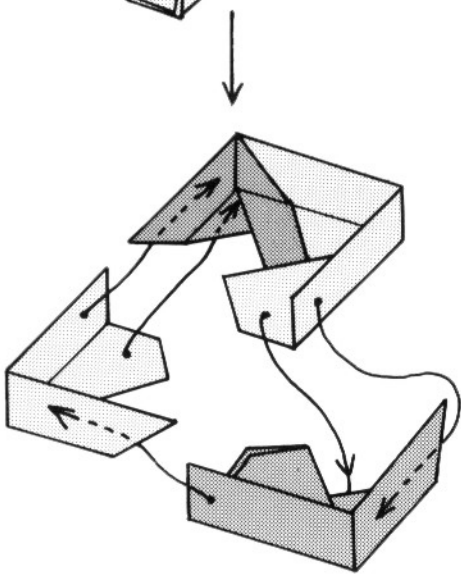

Patterns.

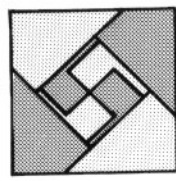

Outside.

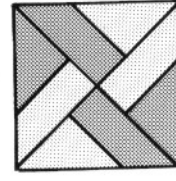

Inside.

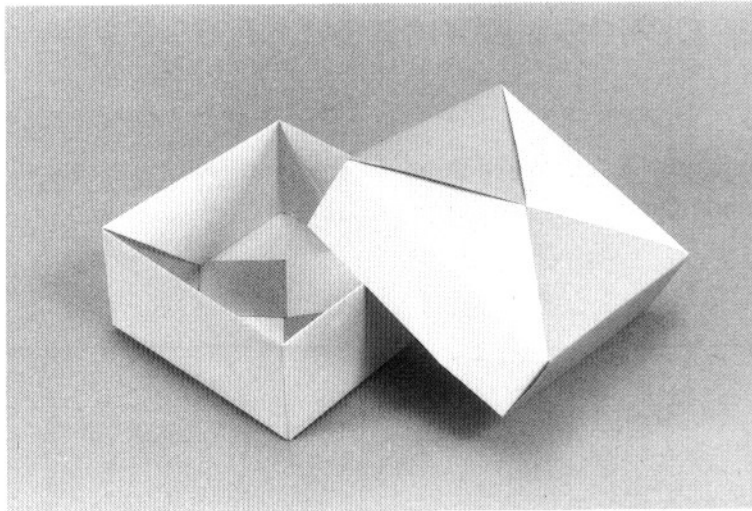

'Bow knot' (p. 26).

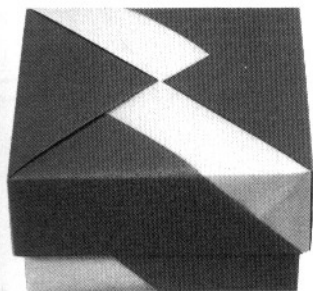

'Lightning'.

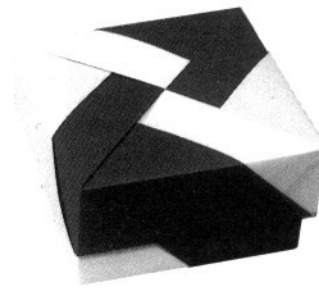

'Wheel' (p. 26).

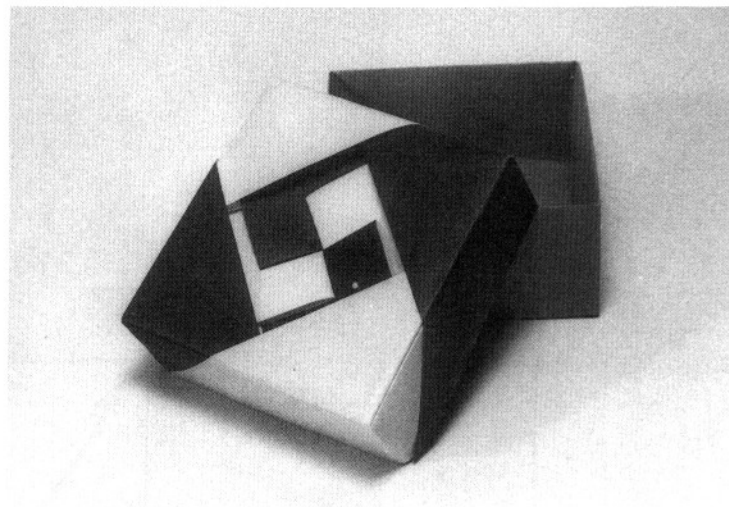

'Lozenge' (p. 28).

Square boxes : second series

© 1988

Fold as illustrated. You can make three different patterns, A, B and C. It is all very simple, and such fun !

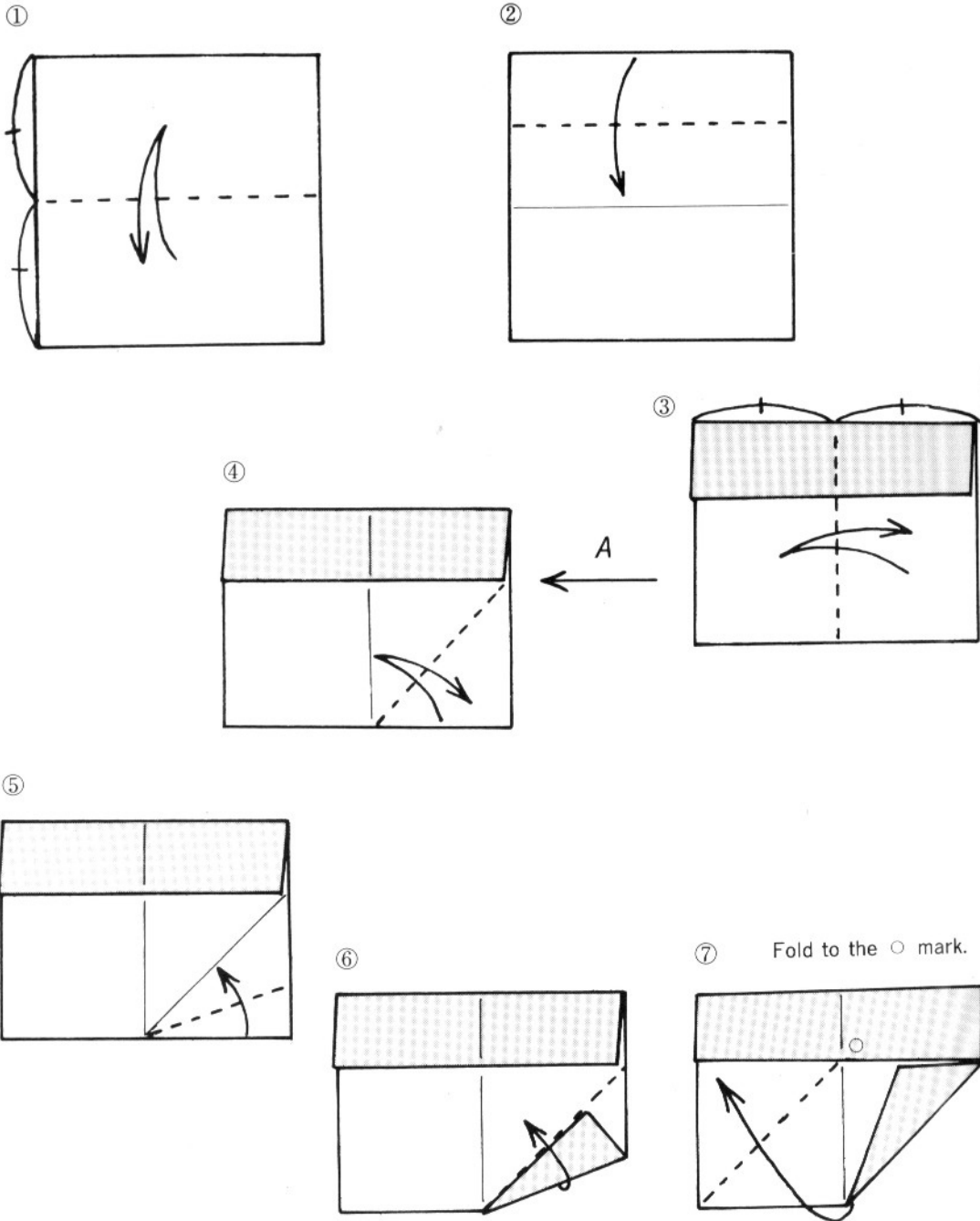

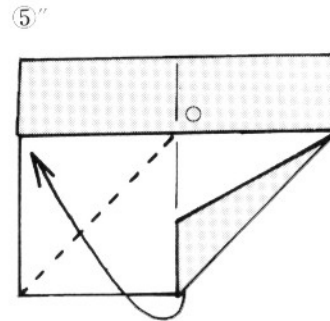
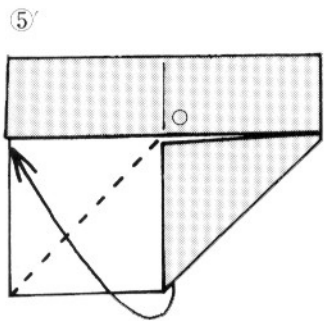
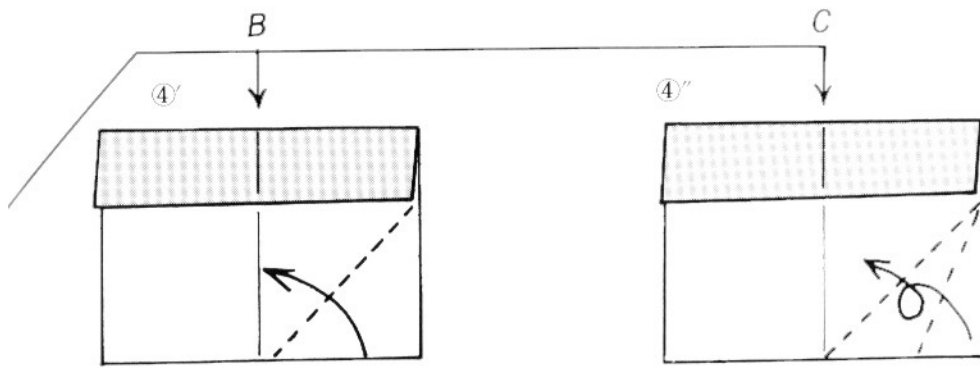

Go to ⑧.

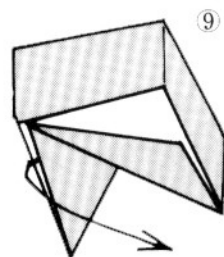
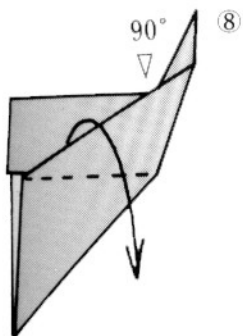

Unfold back to ⑥.

Continued on the next page. →

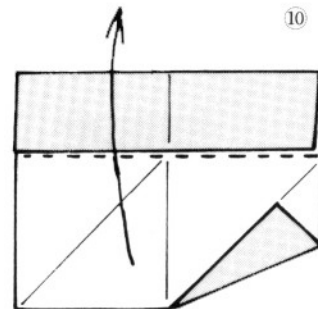

①

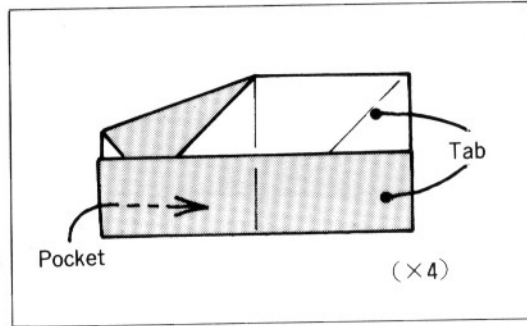
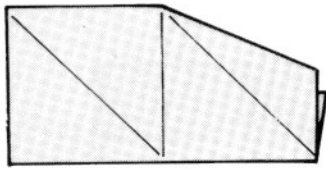

Finished unit.

Join the four units into a circle.

Push in to the angle lines.

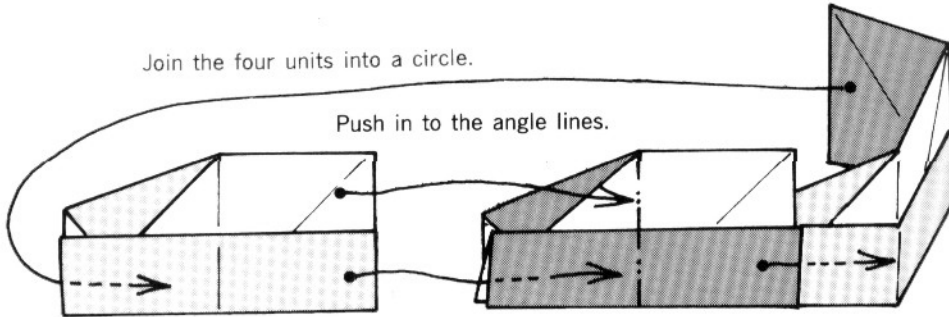

Join as in the drawing.

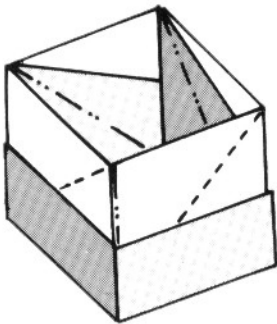

Fold two layers together along the marked lines.

Twist down and make the bottom.

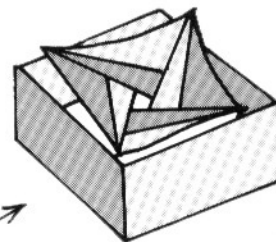
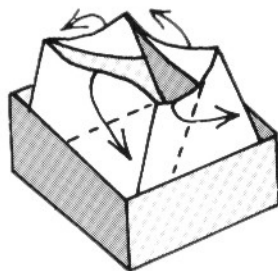

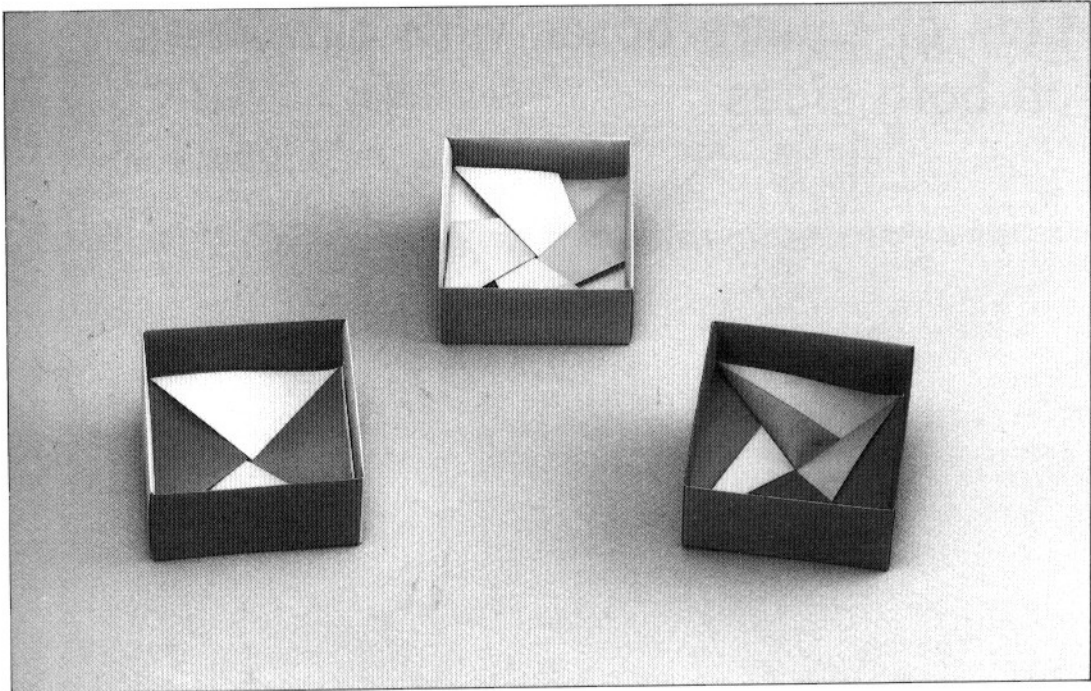

Left to right: C, B, A.

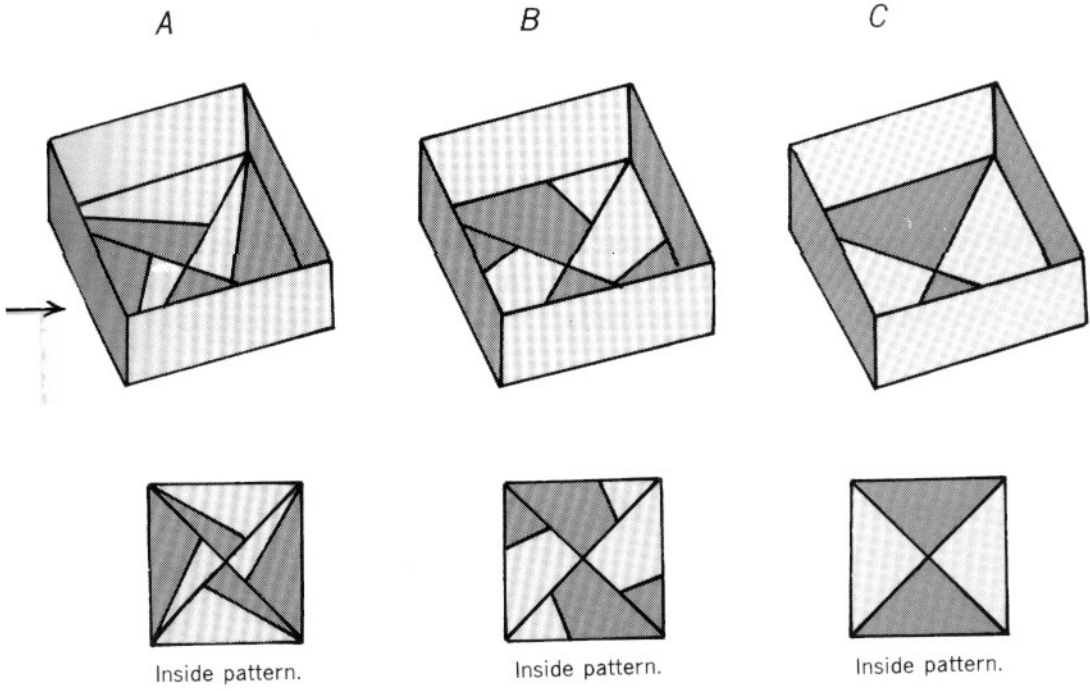

Lids of square boxes with pinwheels on both sides

© 1988

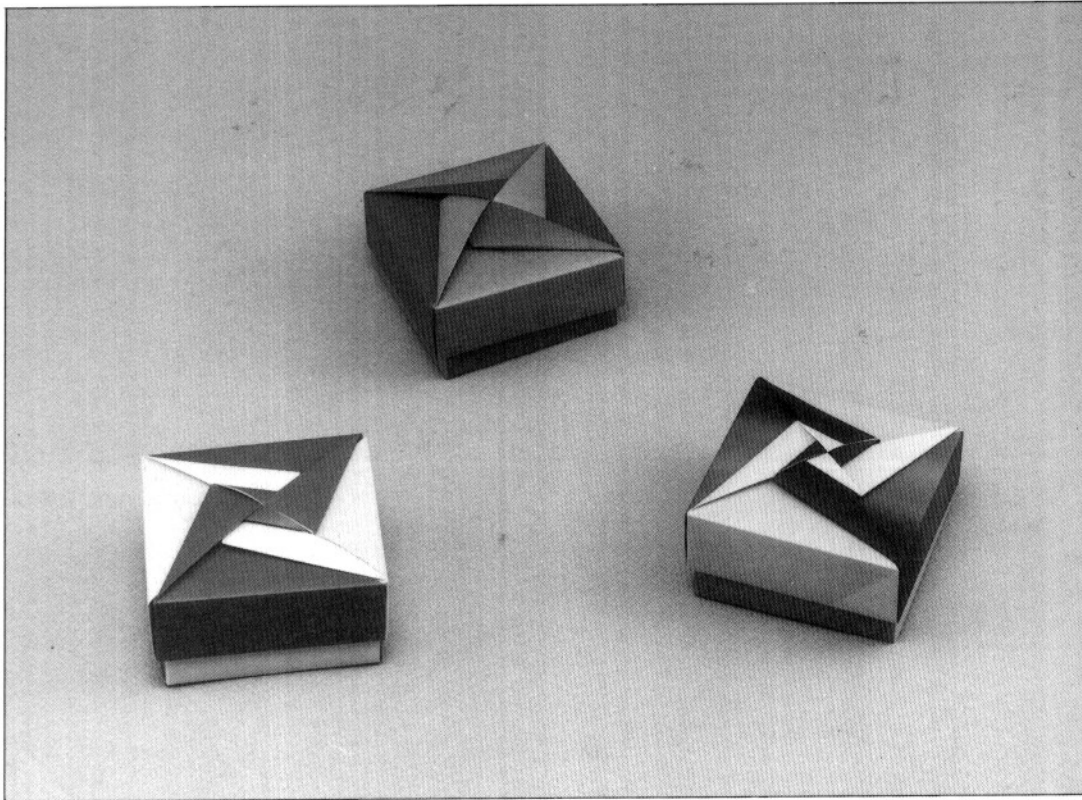

Left to right: combination of A and B, B, A.

These lids have pinwheel patterns inside and outside. The joined A- and B- types are illustrated here, but you can join the units so that you have different patterns inside and out. You can also finish the main pattern in different ways. Experiment!

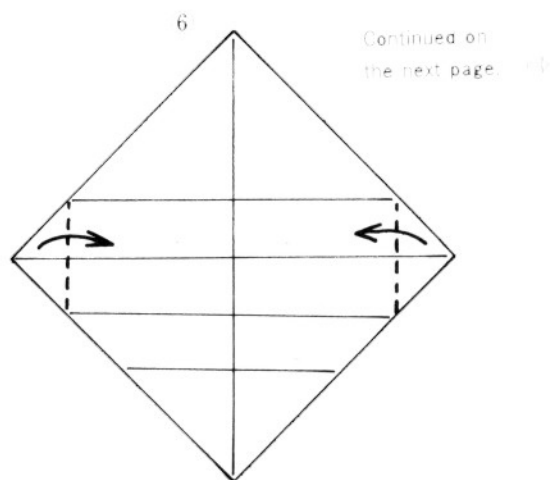
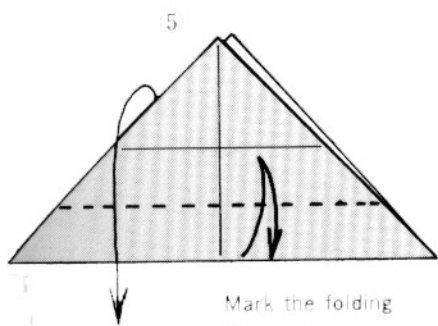
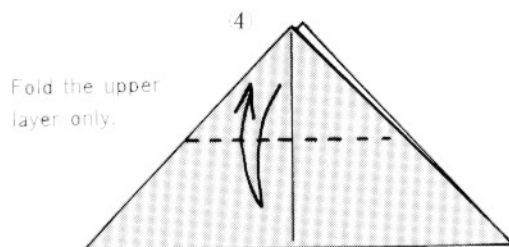
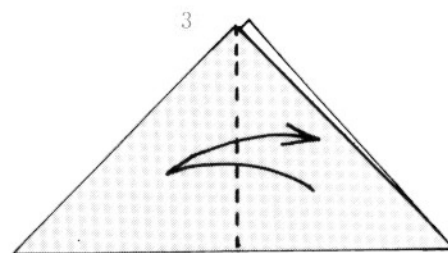
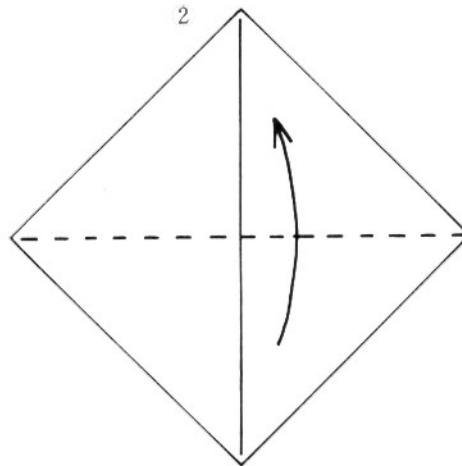
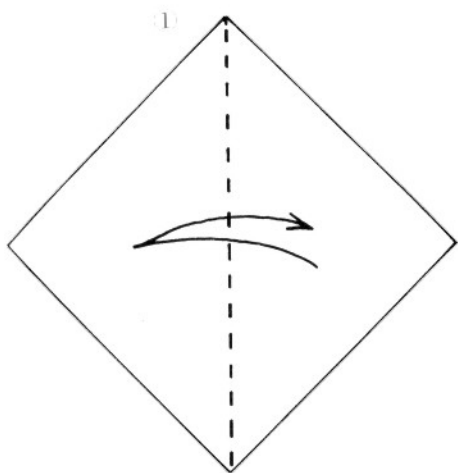

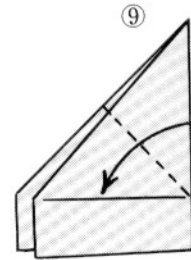
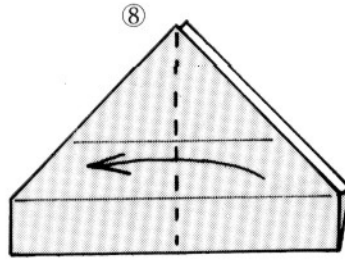
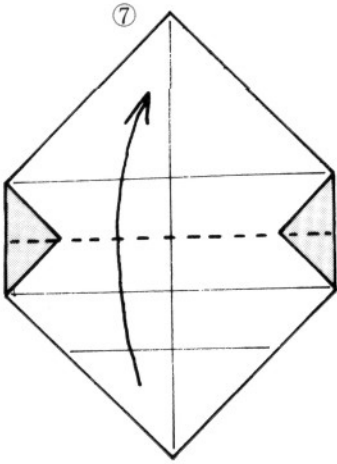

Reverse
the position.

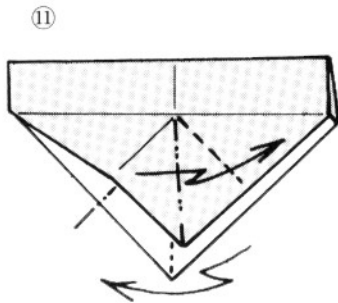
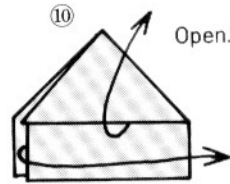

Pleat the upper and lower layers.

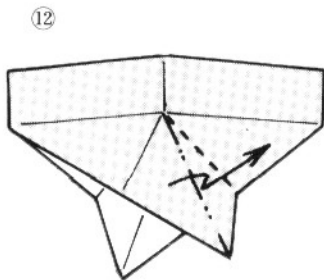

Making the pleat.

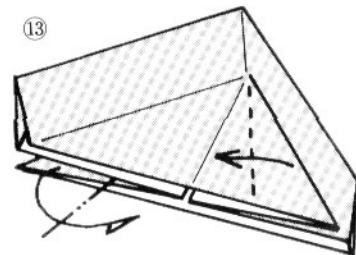

Ordinary boxes have no designs on the bottom or inside their lids, but with unit origami you can make boxes with these wonderful patterns on inner surfaces. The pleasure on first seeing these charming little boxes increases when you look inside! This delight in finding unexpected patterns is the result of unit origami.

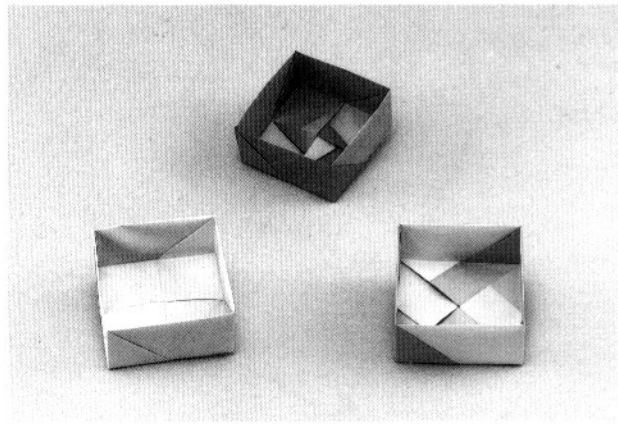

To join the units,
see the next page. →

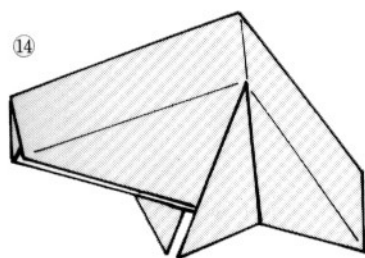

Finished unit.

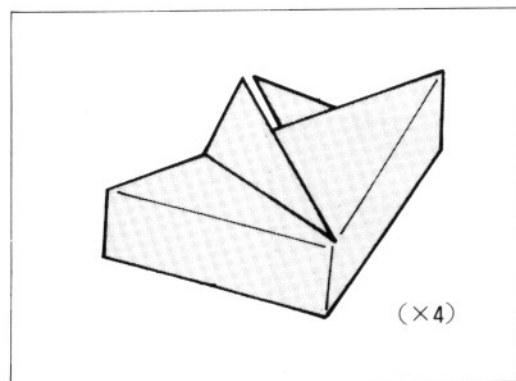

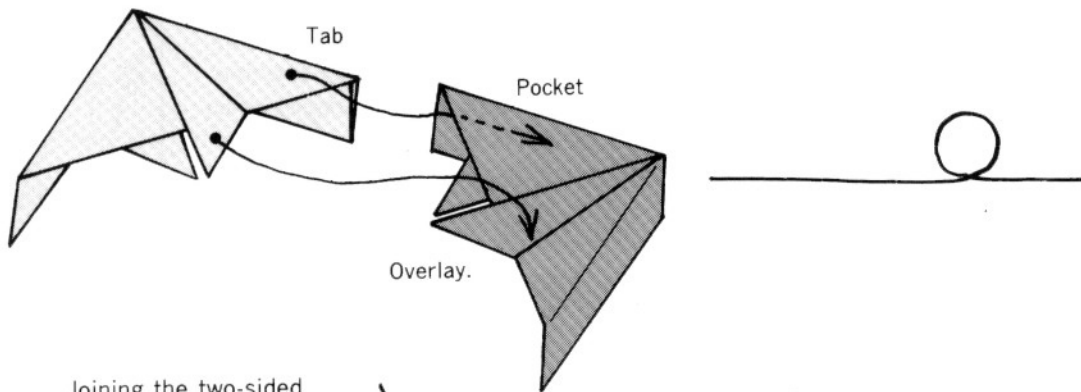

Joining the two-sided
pinwheel A.

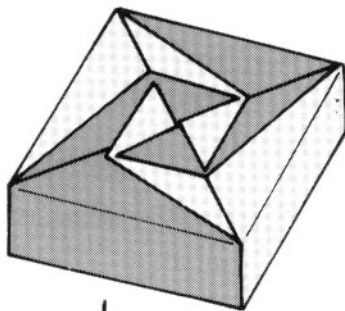
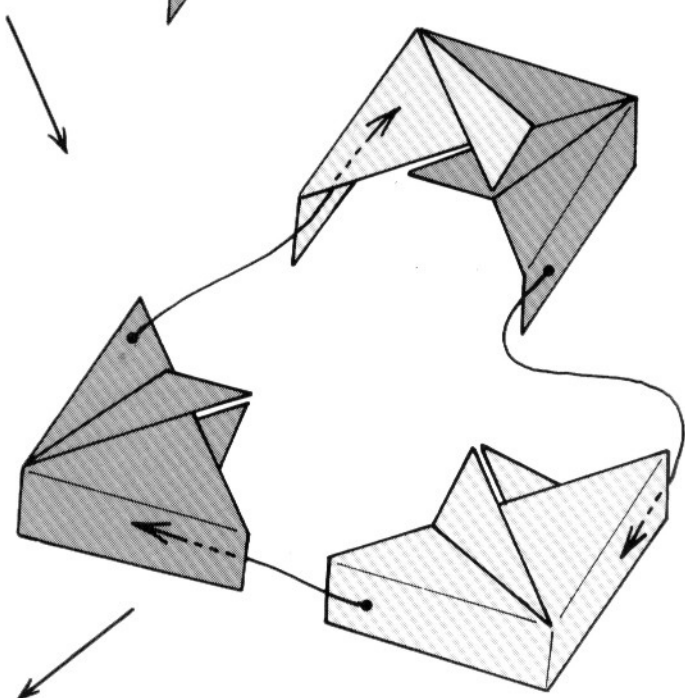

Finish the outer center as follows.

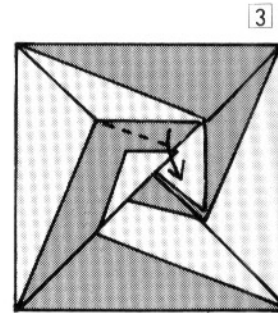
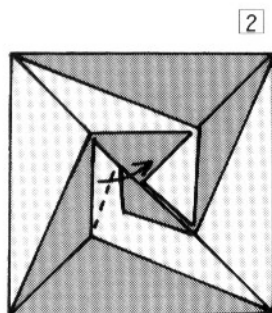
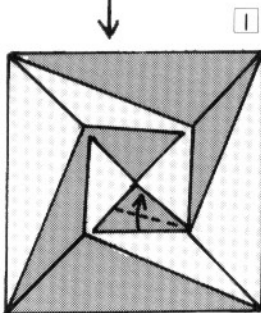

[Joining : inside.]

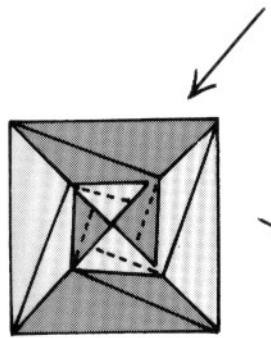
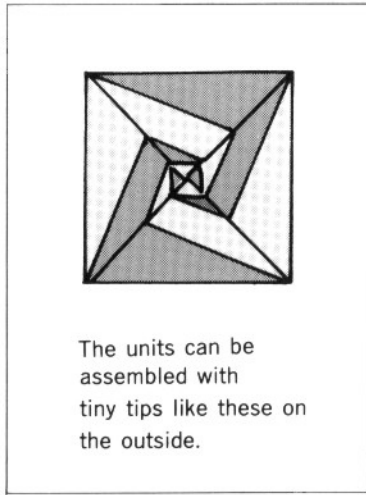
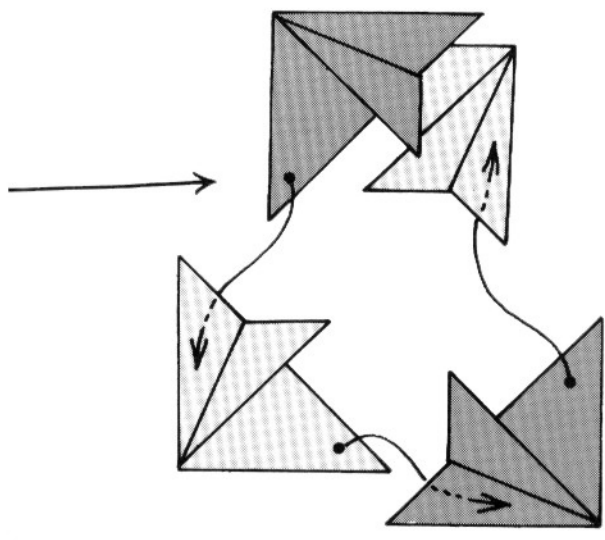

Finish the inside center as outside (1~5).

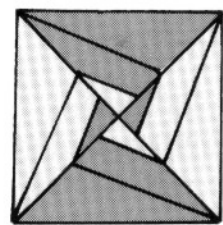

Inside pattern.

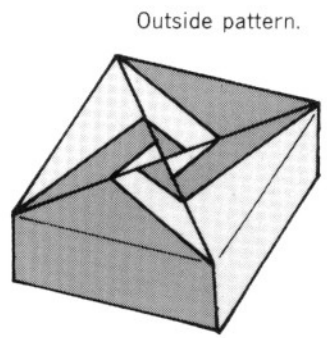

Outside pattern.

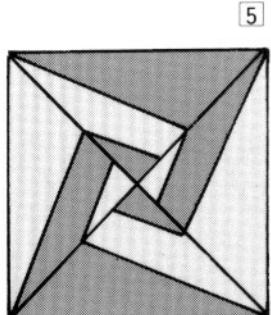
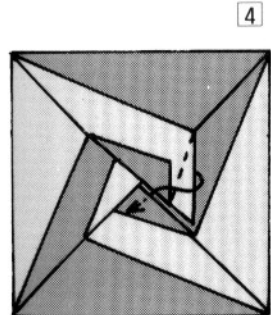

(4. Tuck the end in the fold made in 1.)

Joining two-sided pinwheel B.

[Joining outside.]

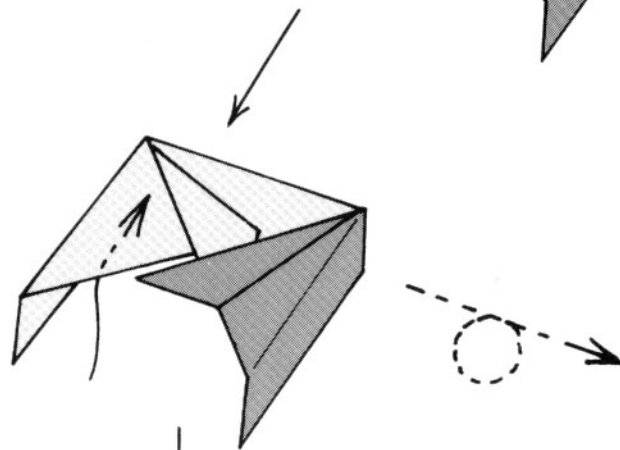
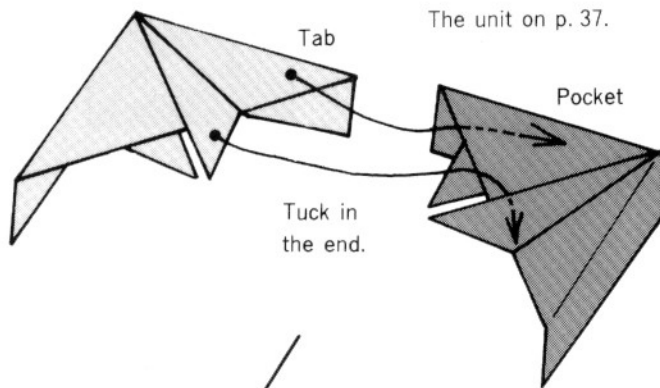

Join the two other units in the same way.

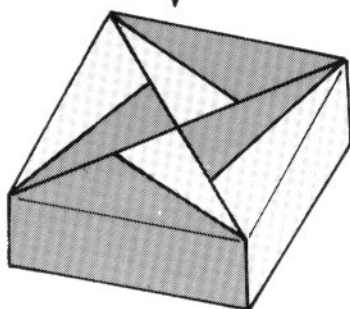

Outside pattern.

[Joining inside.]

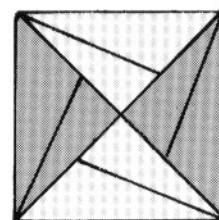
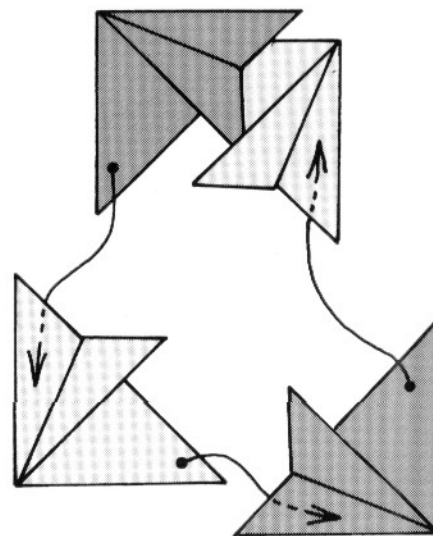

Inside pattern.

Lid of a square box : fancy pinwheel

© 1988

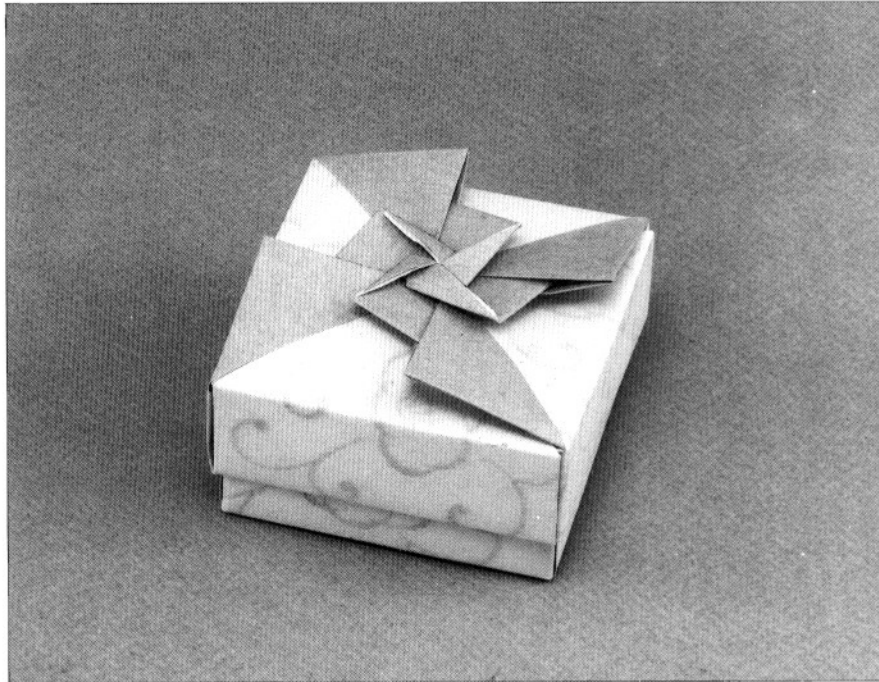

To make this lid, you fold and join in almost the same way as has already been done (pp. 34-40), but the result is something unique. For best effect, use paper with one side colored differently than the other.

From ⑩ on p. 36.

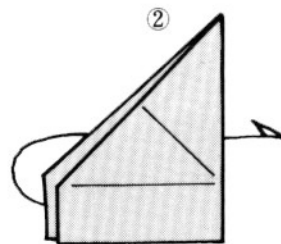
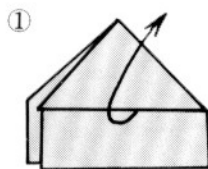

Continued on
the next page. ⇒

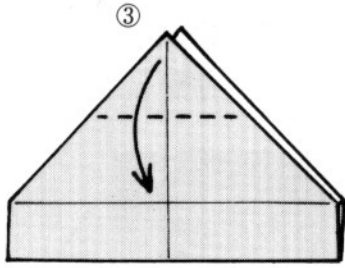

Fold the upper layer only.

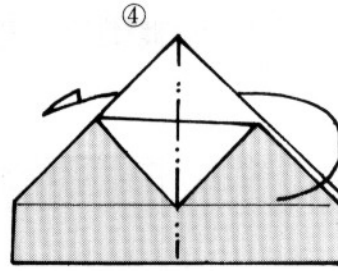

Fold along the center line.

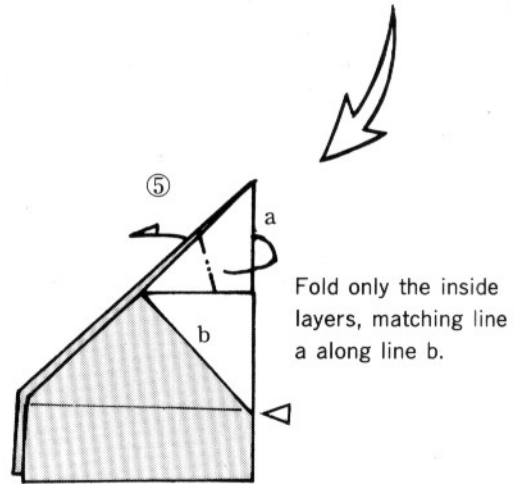

Fold only the inside layers, matching line a along line b.

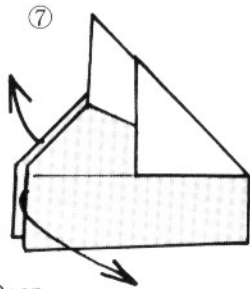
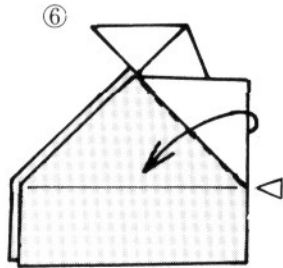

Open.

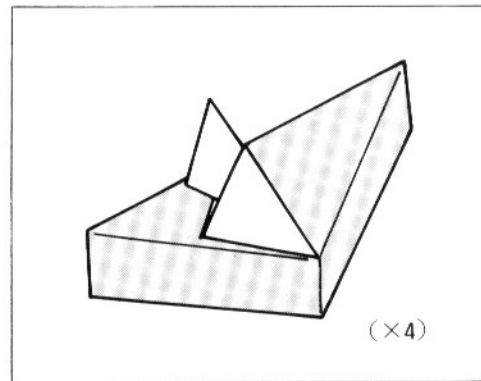

Finished unit.

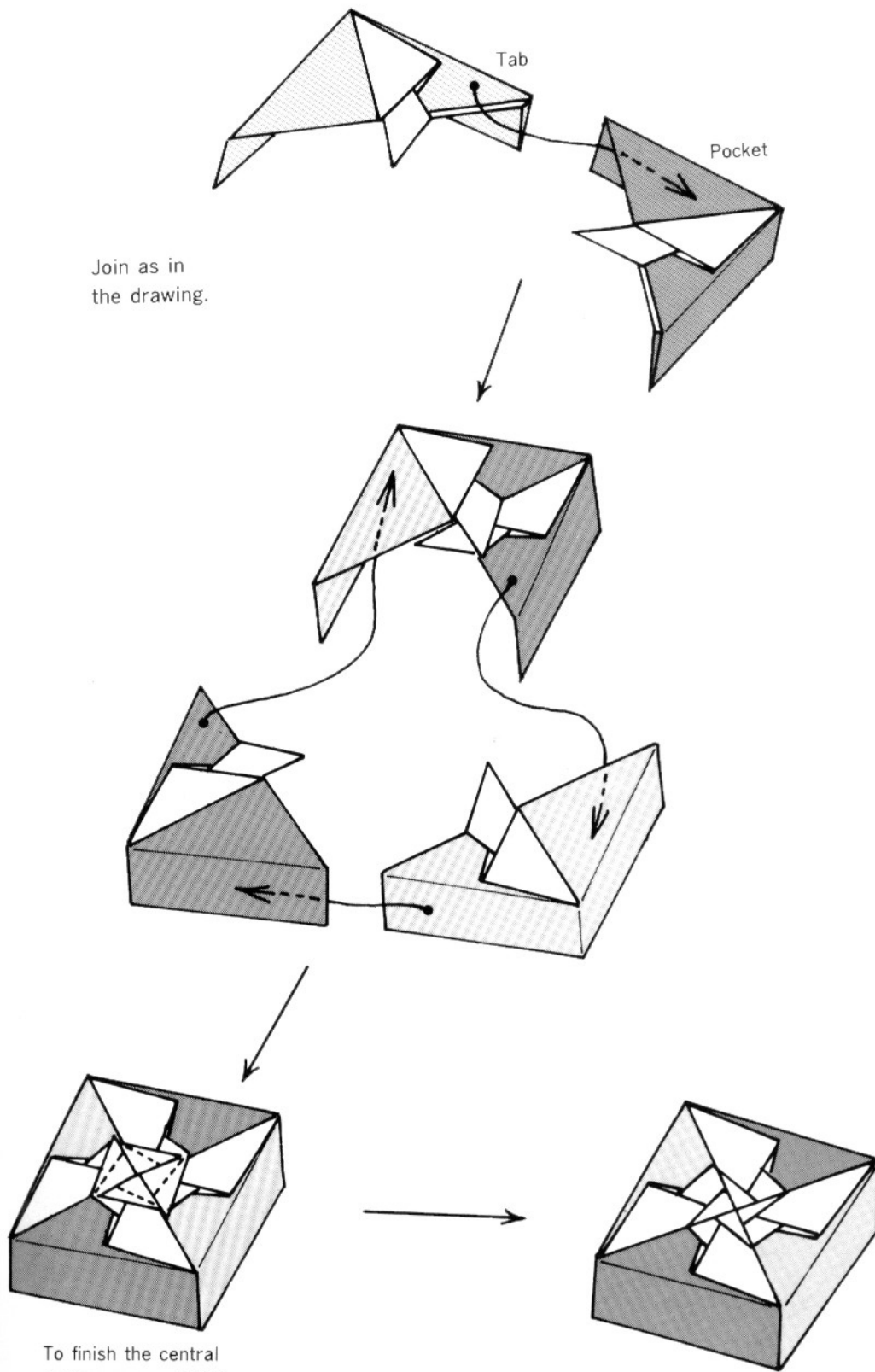

Lid of an octagon box : little flower

© 1983

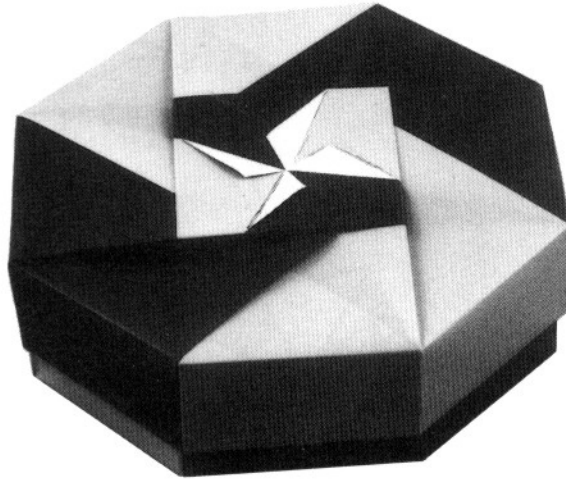

(To fold the base, refer to p. 50.)

Now let us make an octagon lid, using four units. When the lid is joined, the white back of the paper appears in the center like a little flower, hence the box's name.

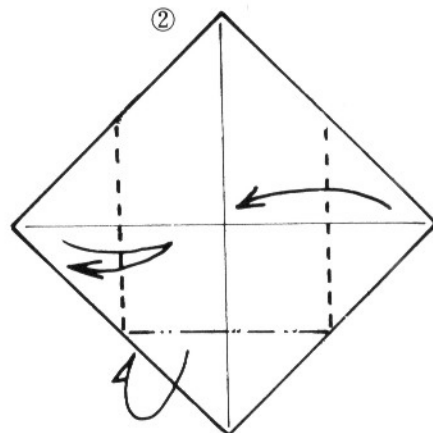
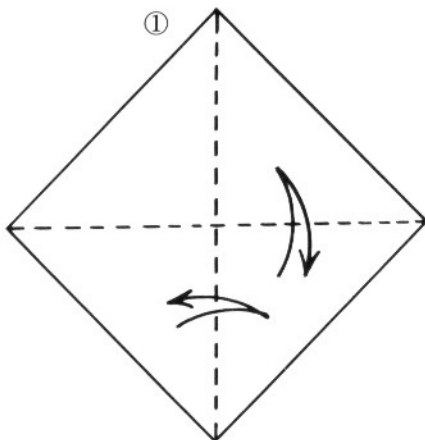

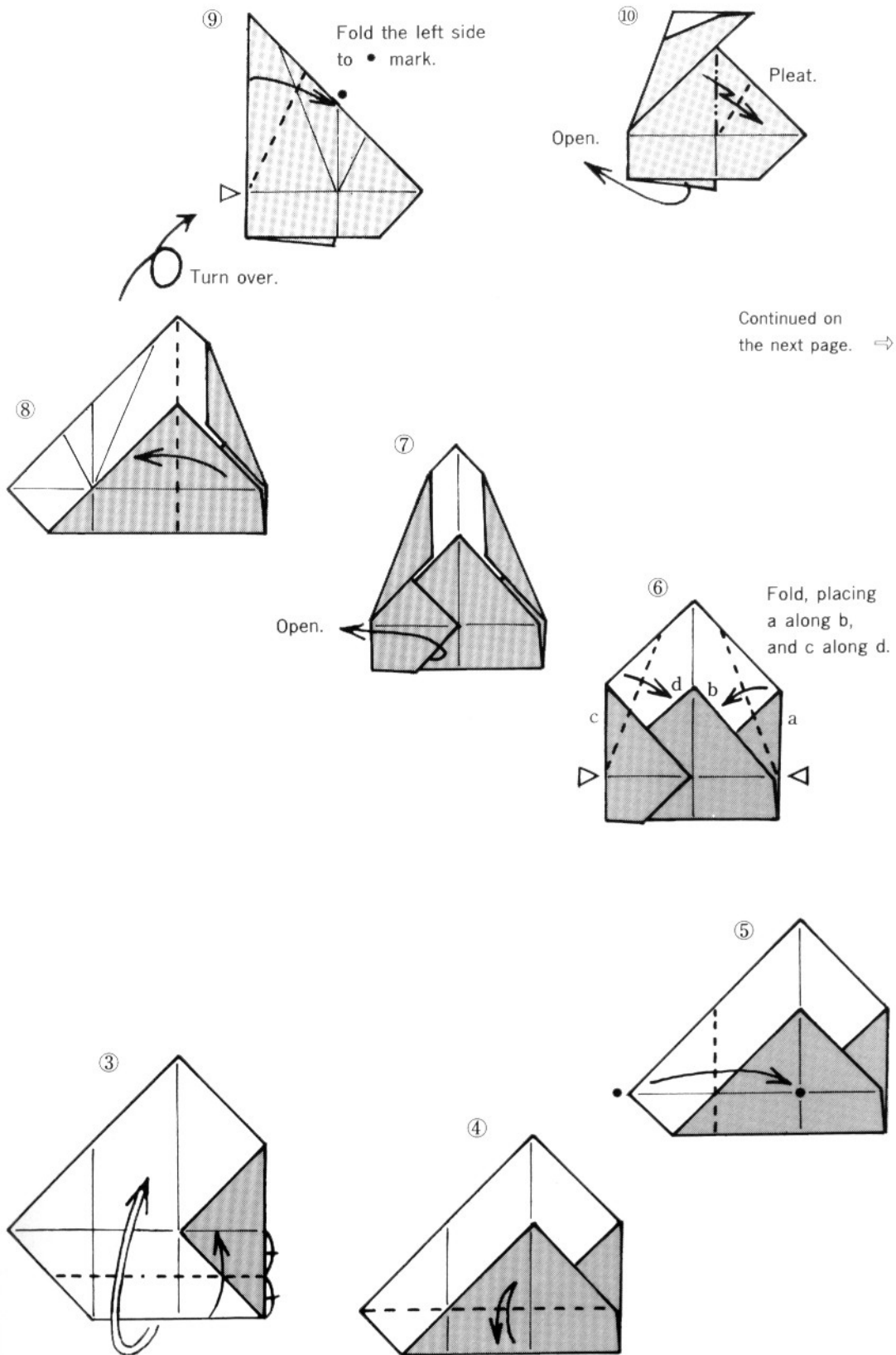

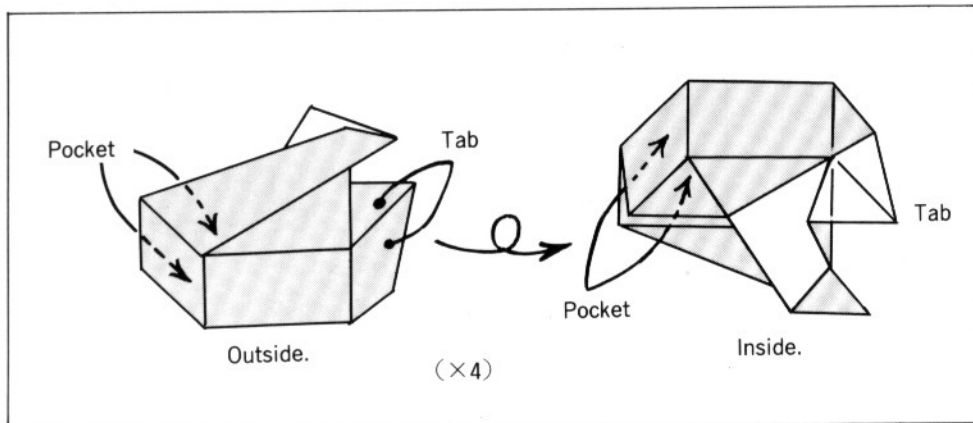

Finished unit.

Join as in the drawing.

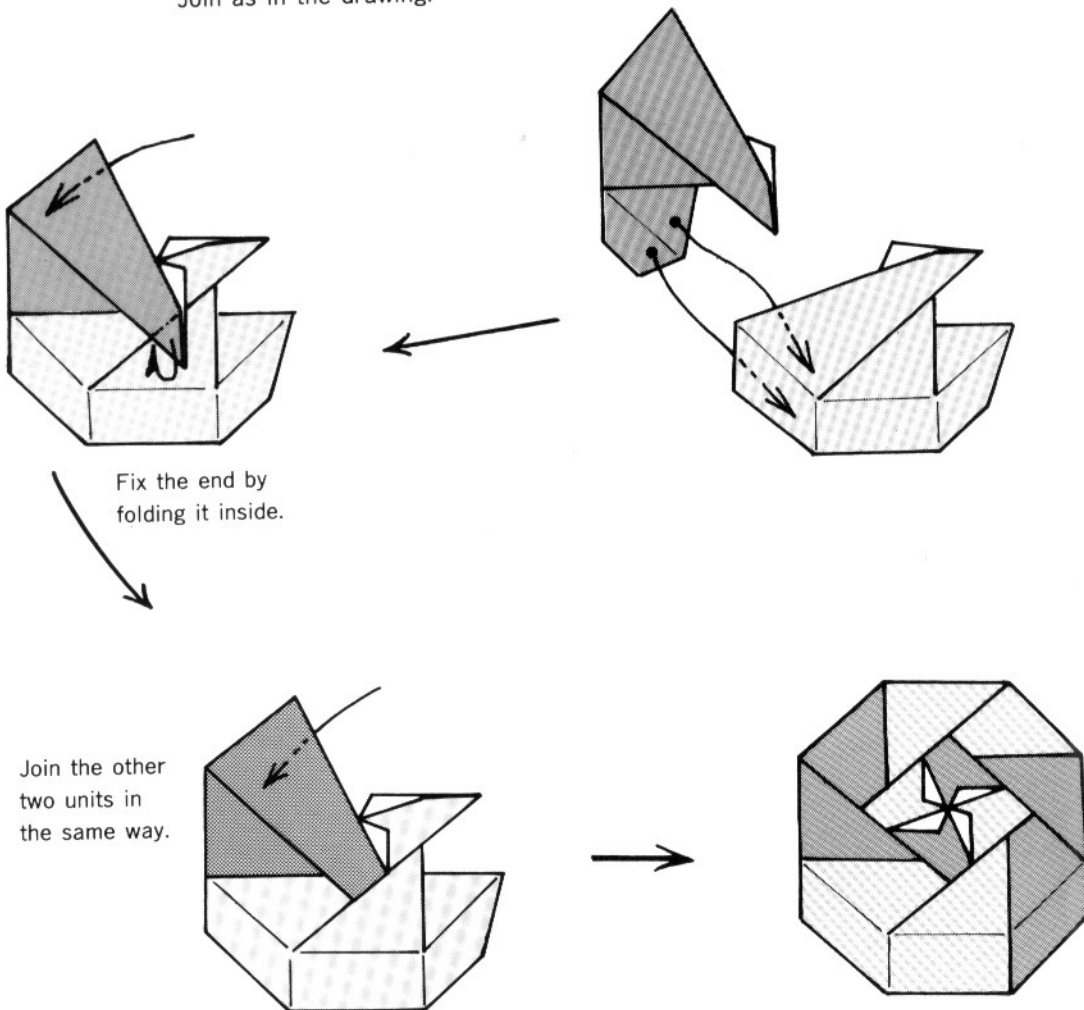

Lid of an octagon box : double stars

© 1983

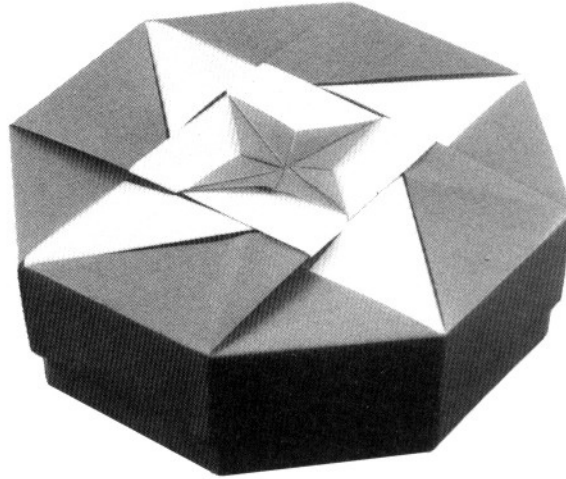

Fold the 'little flower' units inside out, and you will see the birth of twin stars, one colored, the other white. You can create such a change by just reversing the folding. Such is the fascination of origami! The little flower had the twin stars hidden in it.

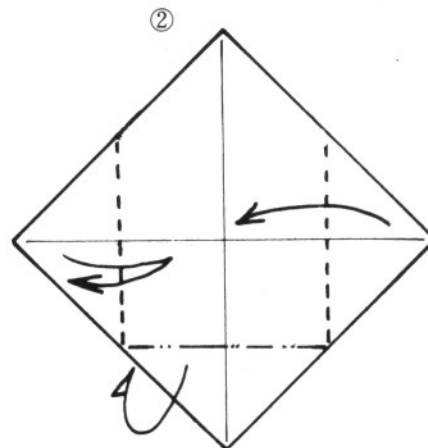
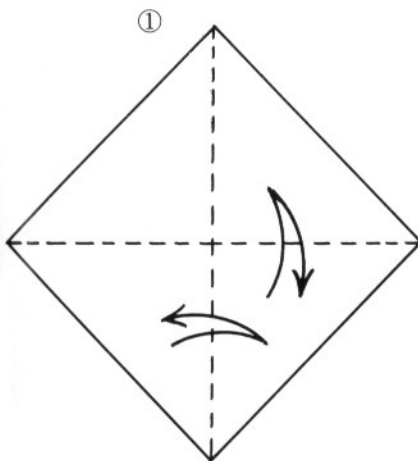

Continued on
the next page. →

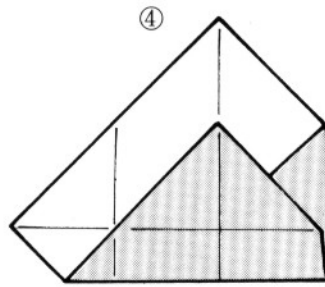
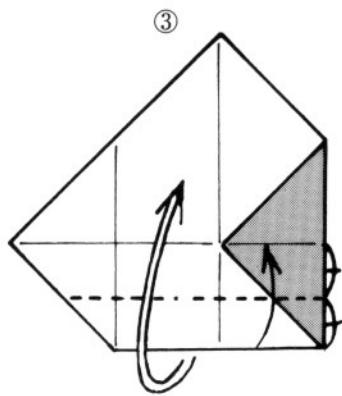

Turn over.

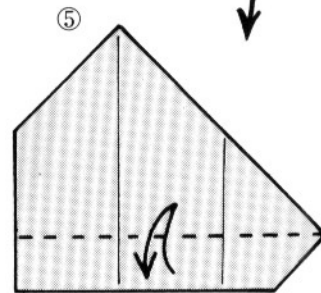

Fold the upper layer only, placing a along b.

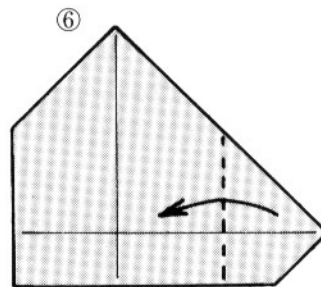
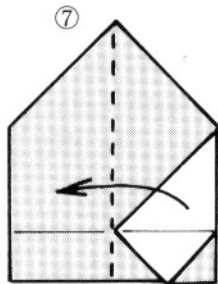
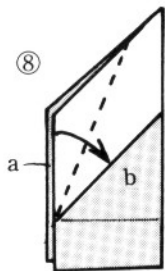

Fold, placing the left side along a.



Turn over.

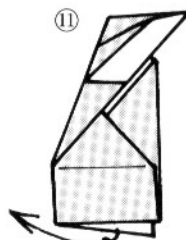

Open.

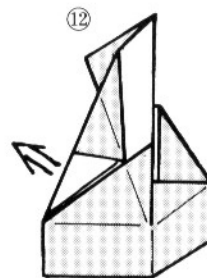

Pull out the inner flap.

Join the other two units
in the same way.

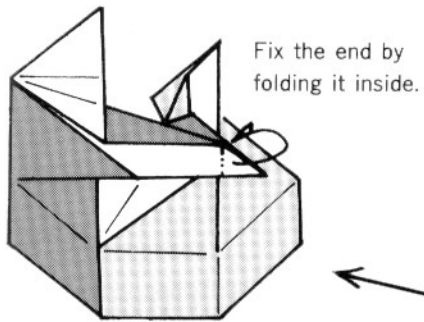
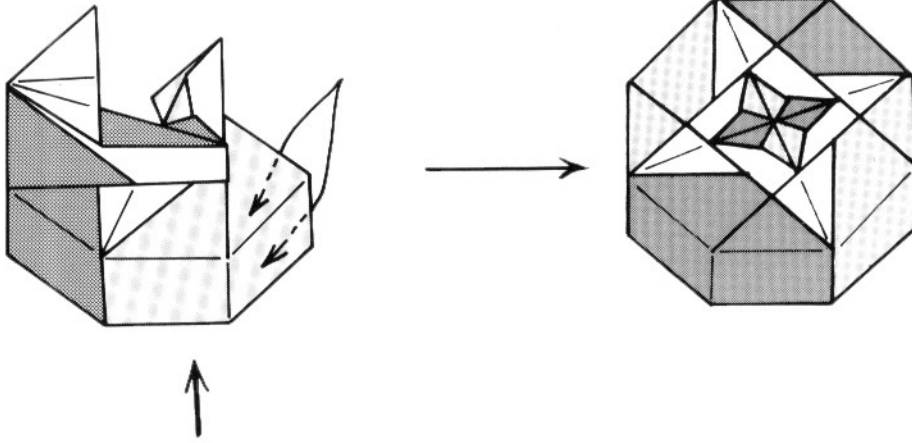

Join as in the drawing.

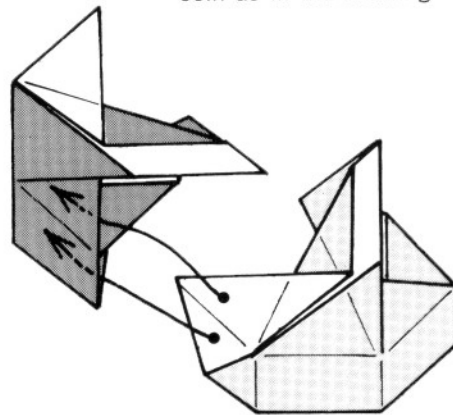

Finished unit.

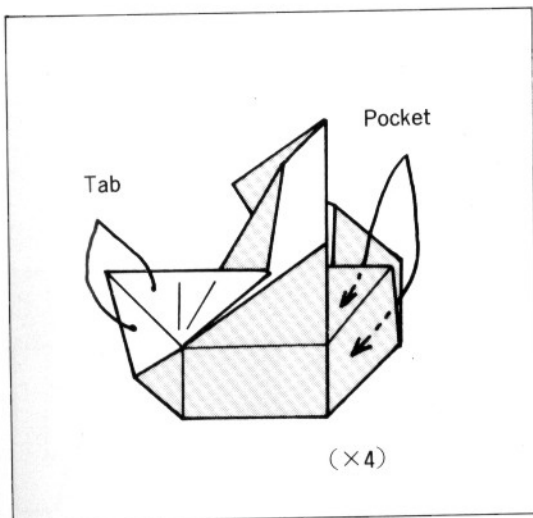

Base of an octagon box

© 1988

The base of this box is rather complicated both to fold and to join. You fold and unfold at many places. Proceed slowly and with patience, carefully following the illustrations.

①

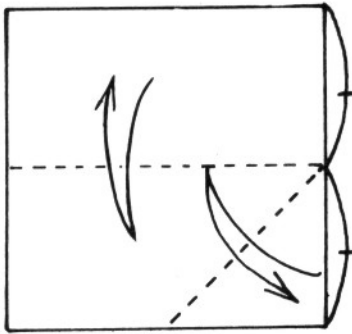

②

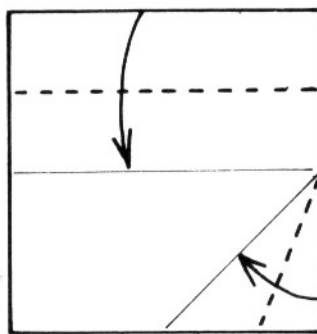

③

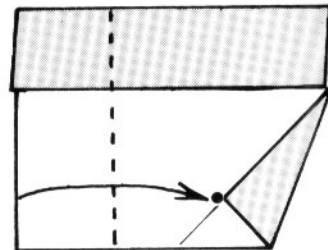

Fold the left side to the • mark.

④

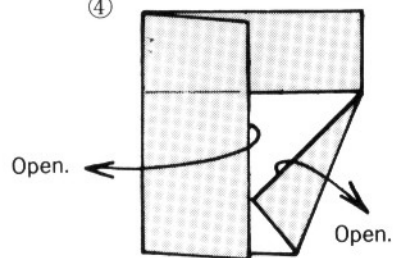

⑤

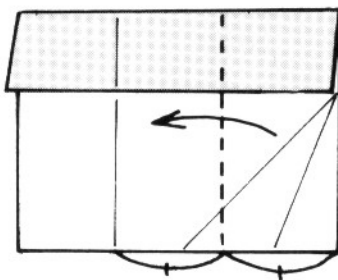

⑥

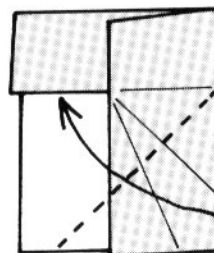

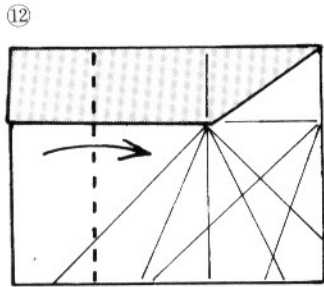

Fold along the line marked in ③.

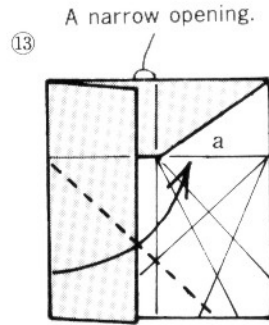

Fold the left side to line a.

⇒
Continued on
the next page.

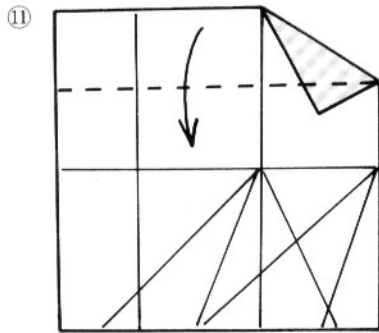

Fold along the line marked in ②.

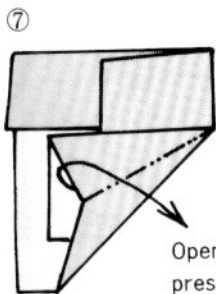
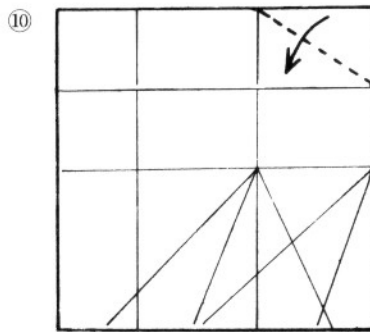

Open and
press down.

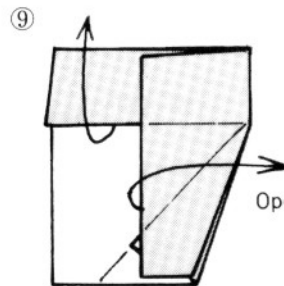
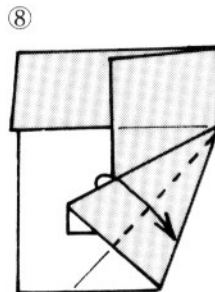

Open all the way.

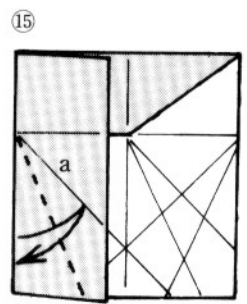
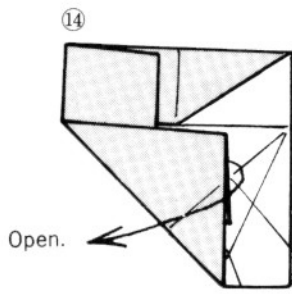

Fold the left side along line a and then unfold.

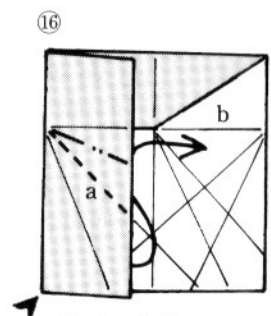

Pleat, placing a along line b.

Fold along this line.

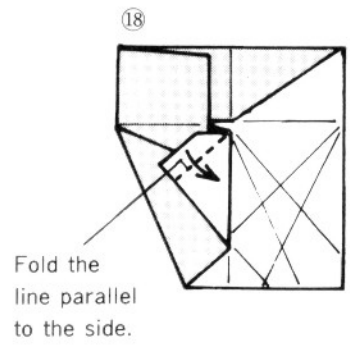
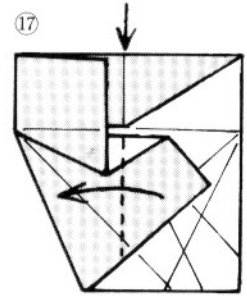

Fold the line parallel to the side.

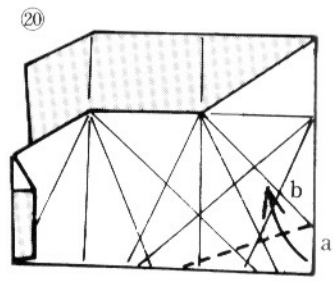
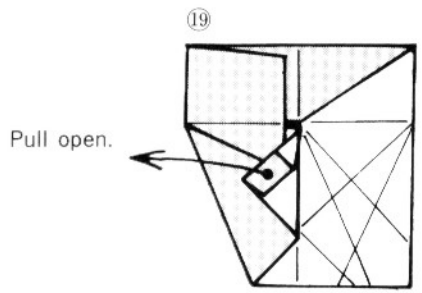

Place a along line b.

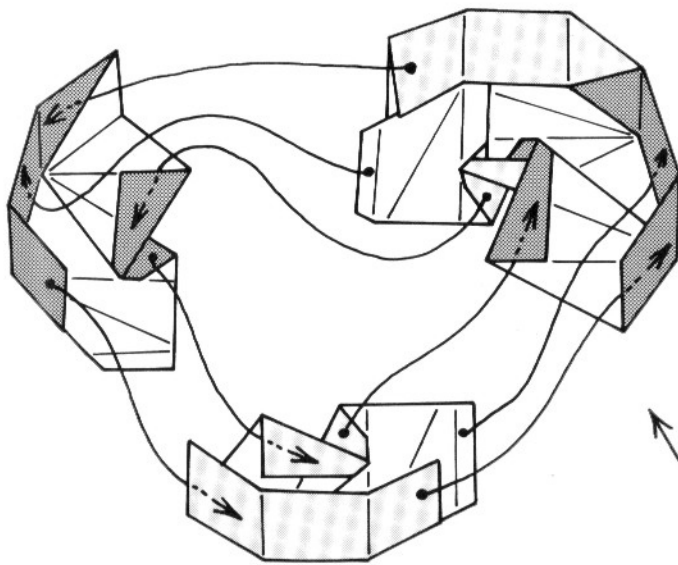

Continued on
the next page. →

Join as in the drawing.

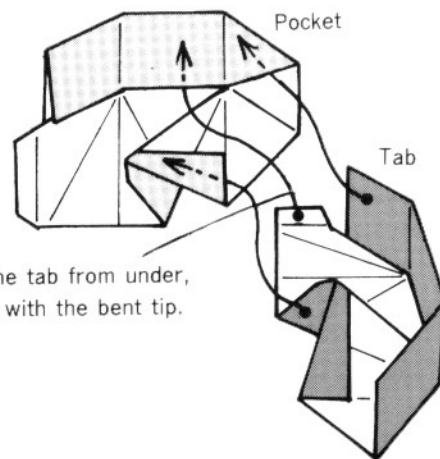

Insert the tab from under,
hooking with the bent tip.

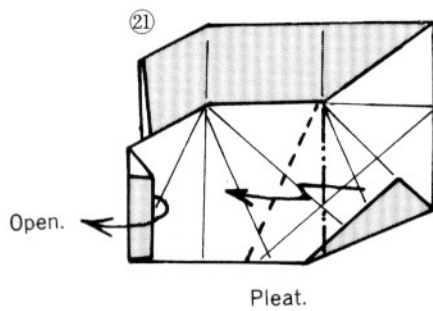

Pleat.

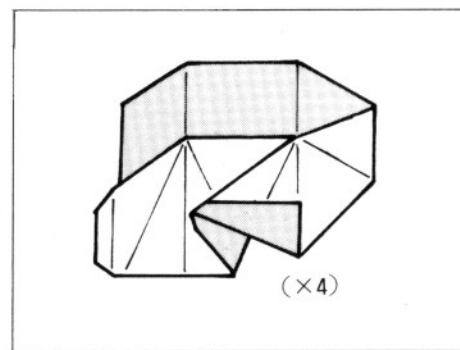

Finished unit.

[Finish : inside.]

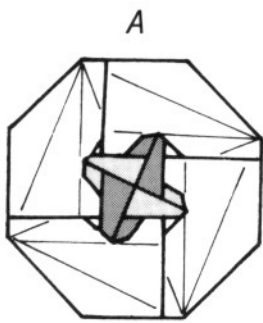

A

Good as it is.

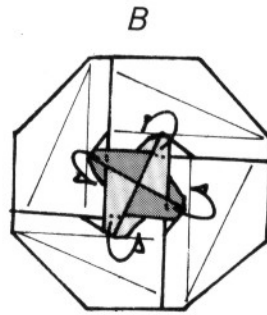

B

Fix the ends,
bending them
inside.

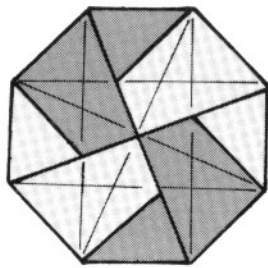

Outside pattern.

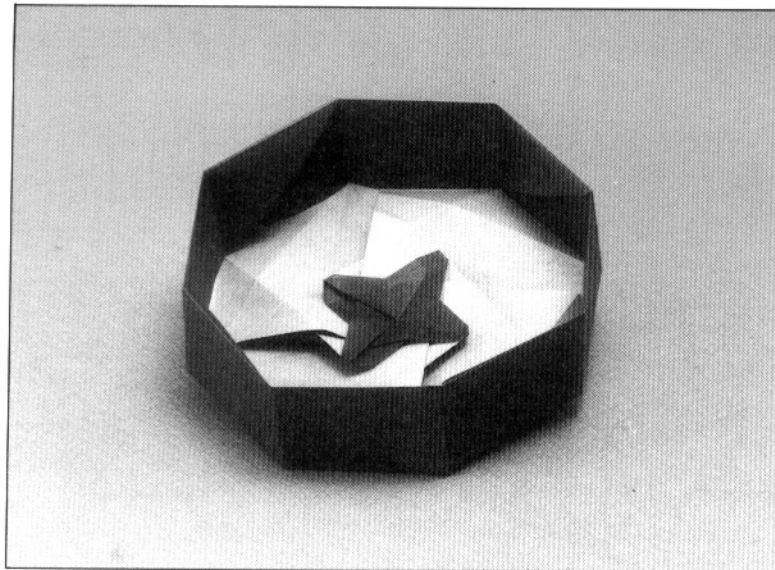
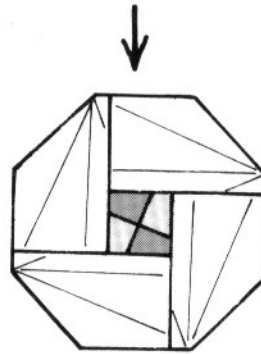

Inside pattern of A.

Triangle box : medium size

© 1983

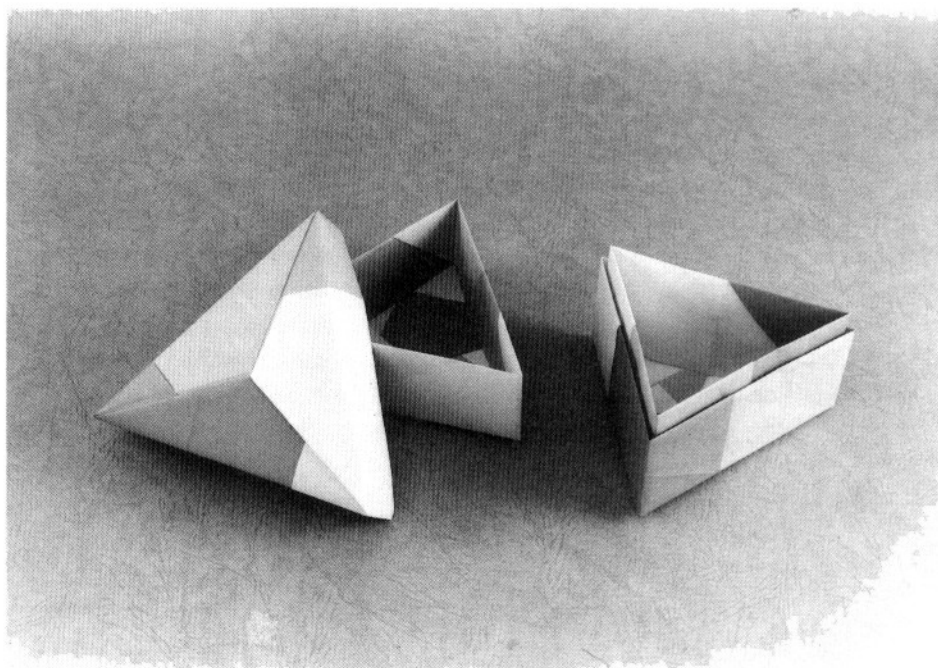

We seldom come across a triangle box, but with units of folded paper we can make wonderful ones. Let us make three such boxes of different sizes and use larger ones as lids.

Continued on
the next page. ⇒

①

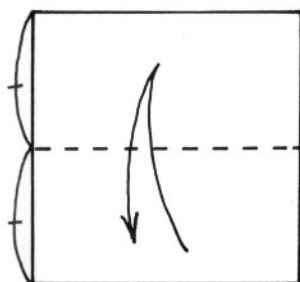

②

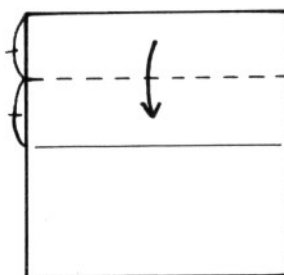

③

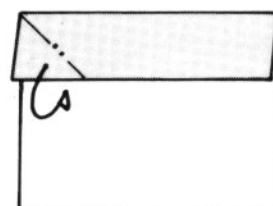

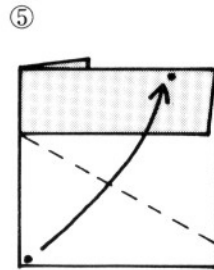
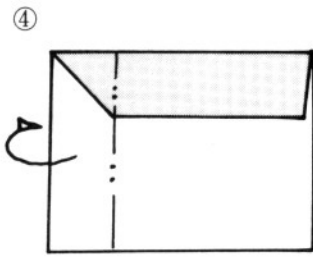

Match the bottom left corner to the top line.

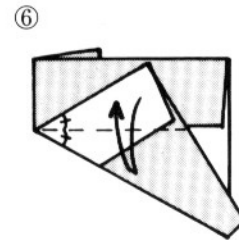

Mark the folding line and unfold to ④.

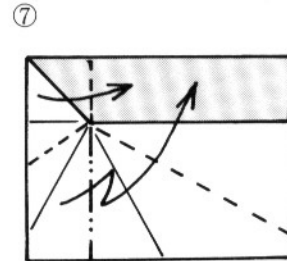

Fold correctly.

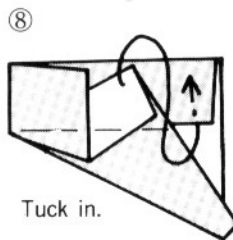

Tuck in.

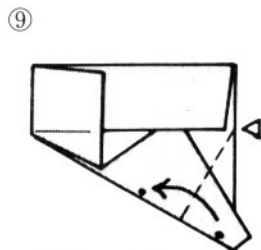

Fold, matching the dotted lines.

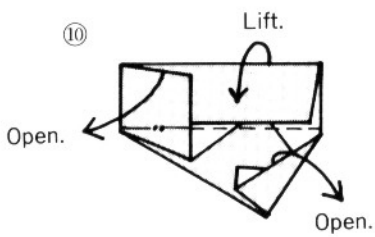

Unit of the medium box finished.

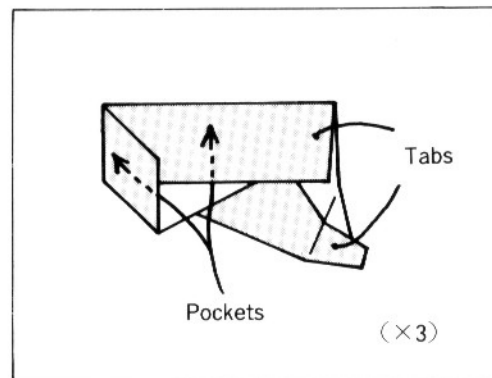

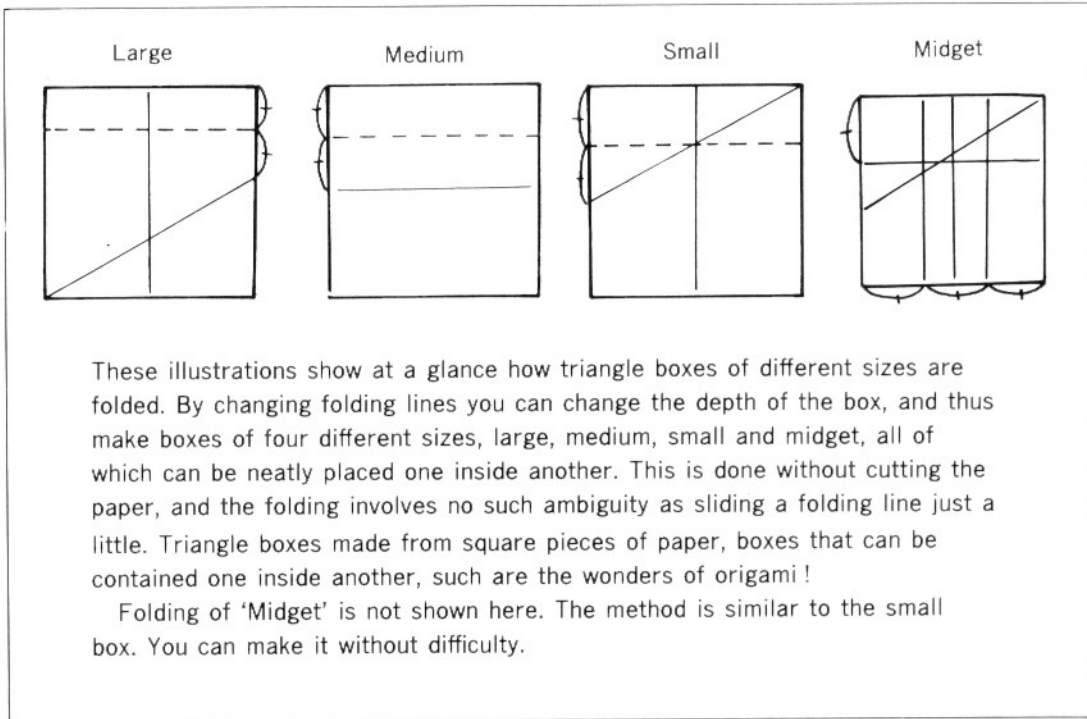

Join as in the drawing.

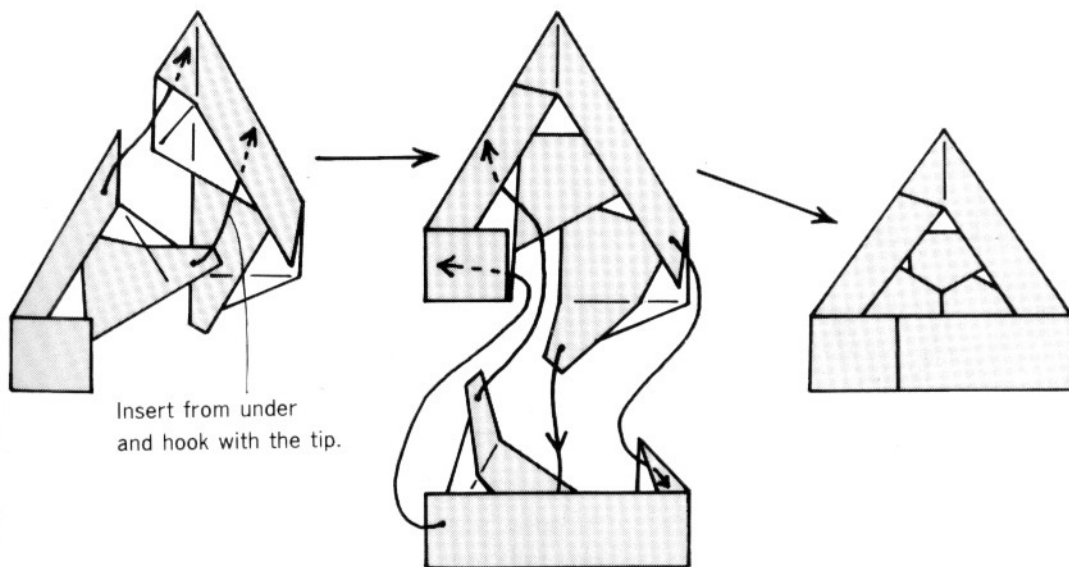

Triangle box : large size

© 1983

①

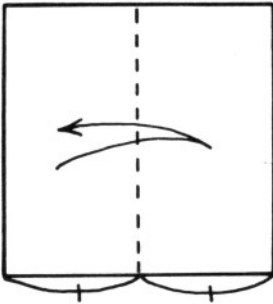

②

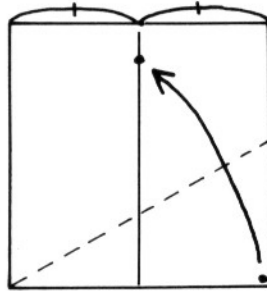

Match the bottom right corner to the center line.

③

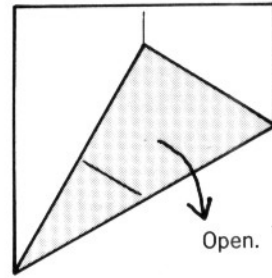

④

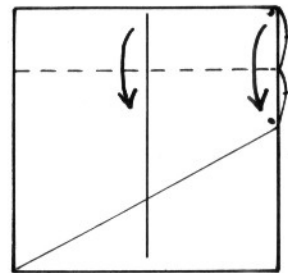

⑤

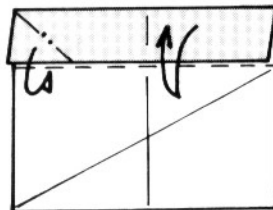

⑥

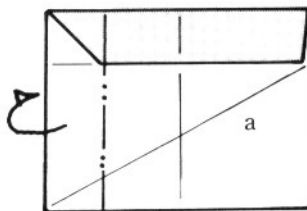

Fold along line a in ⑥.

⑦

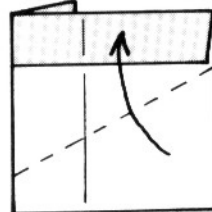

⑧

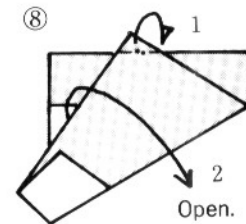

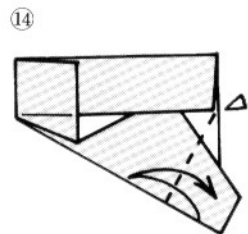
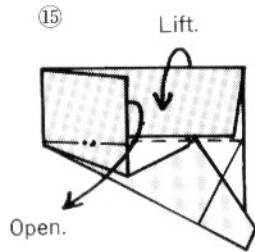

Fold, matching the divided bottom lines, then unfold.

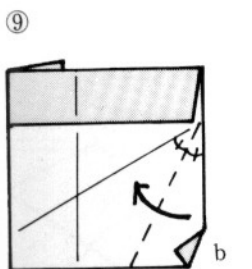
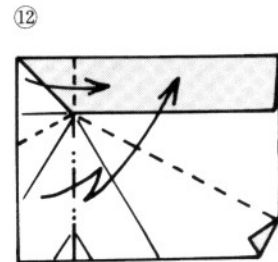
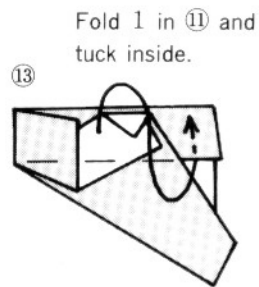

Divide the angle in half.

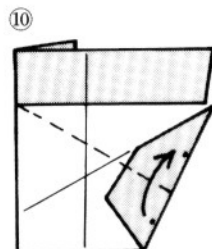

Fold, matching the dotted lines.

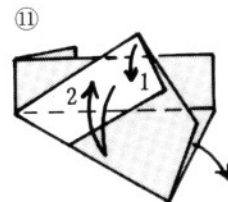

Mark the folding line, then unfold to ⑥ with b folded as in ⑨.

Unit of large-sized box finished.

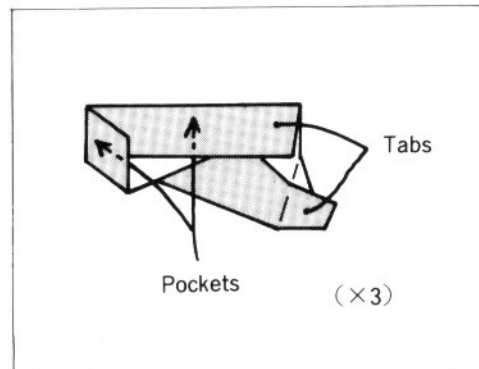

Join the units like the middle-sized box. (See p. 57.)

Triangle box : small size

© 1983

①

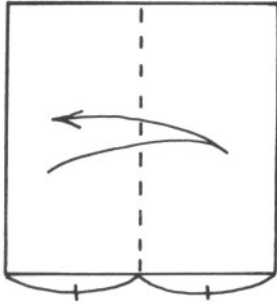

②

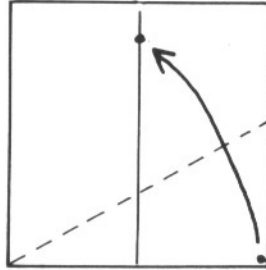

Match the bottom right corner to the center line.

③

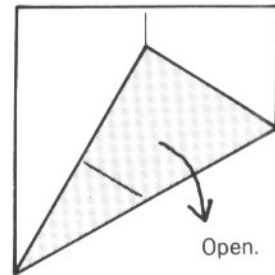

④

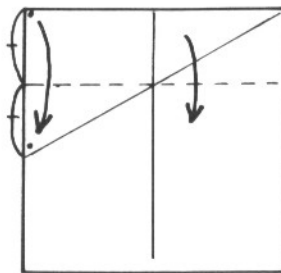

Turn upside down.

⑤

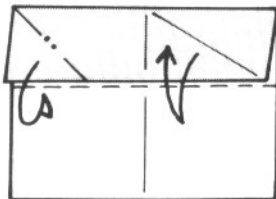

⑥

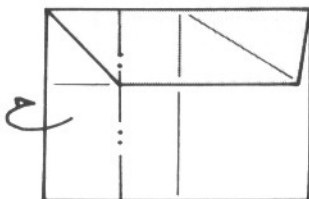

⑦

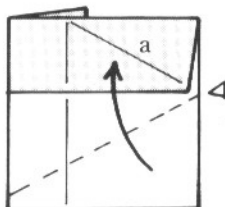

Fold the right side along the marked line a.

⑧

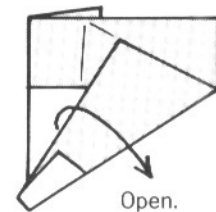

Unit of small box finished.

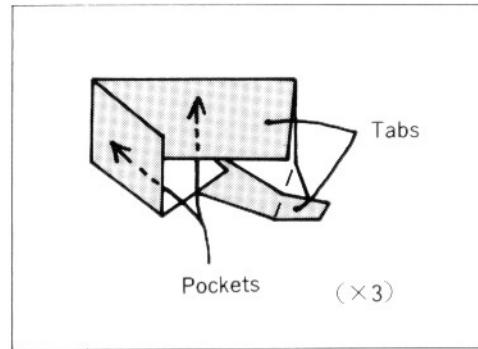

Join the units like the middle-sized box. (See p. 57.)

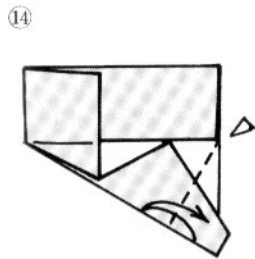
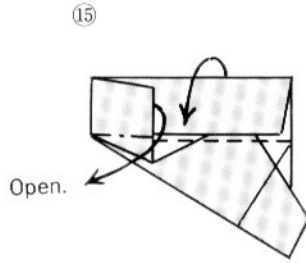

Fold, matching the divided bottom lines and unfold.

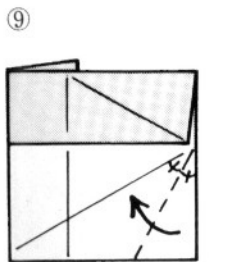
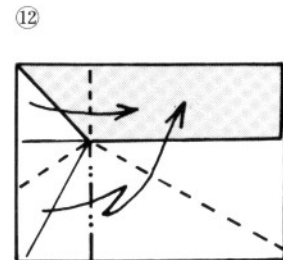
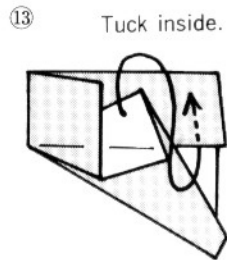

Divide the angle in half.

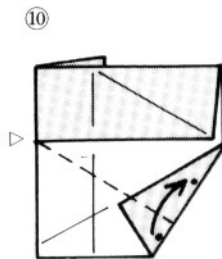

Fold, matching the dotted lines.

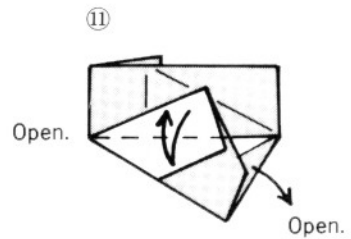

Mark the folding line and unfold to ⑥.

Lid of a hexagon box with six-petal pinwheel

© 1988

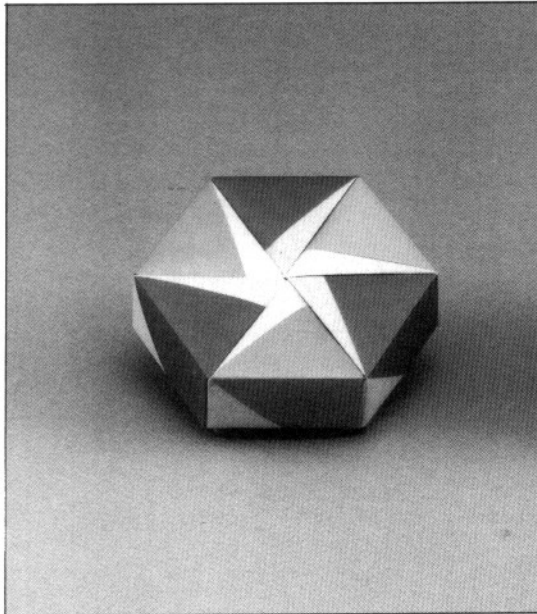

Now let us make a hexagon box. When the units are assembled, the white back of the paper appears in a clear-cut flower pattern.

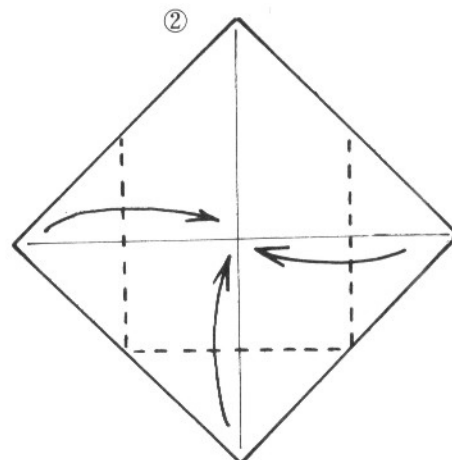
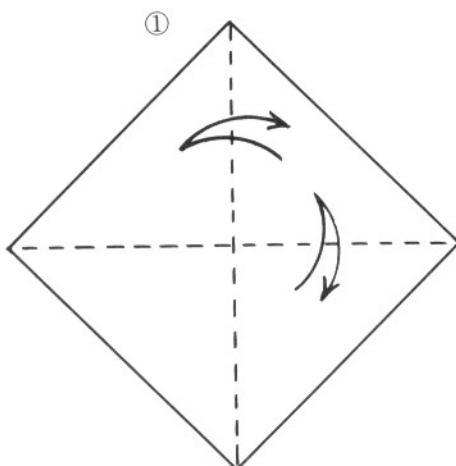

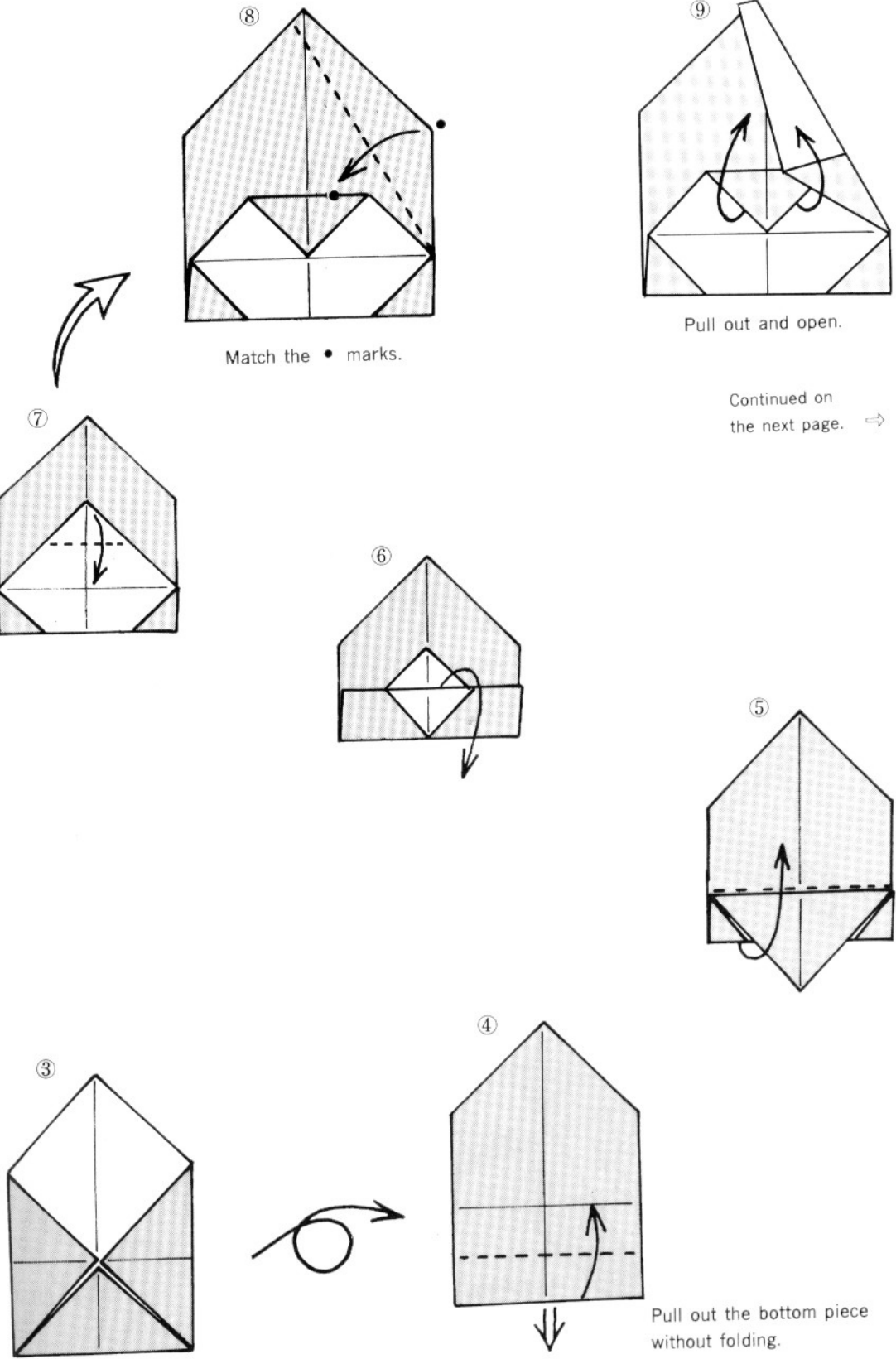

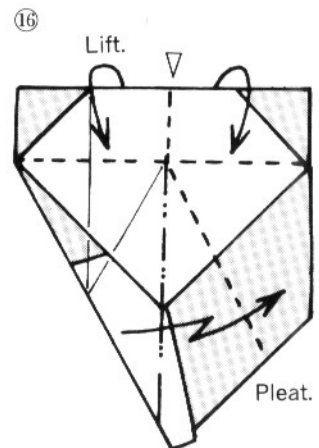
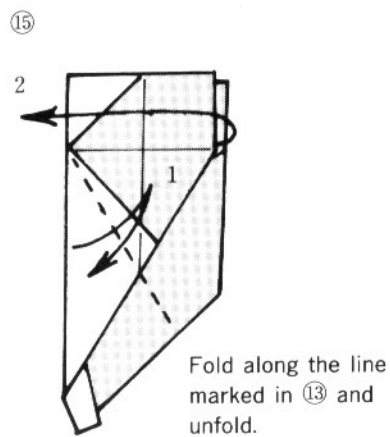
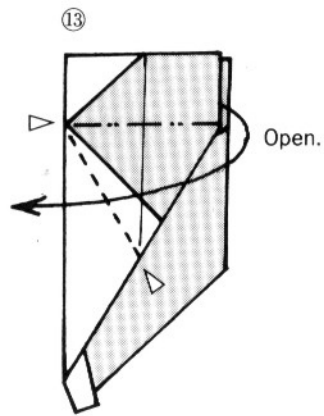
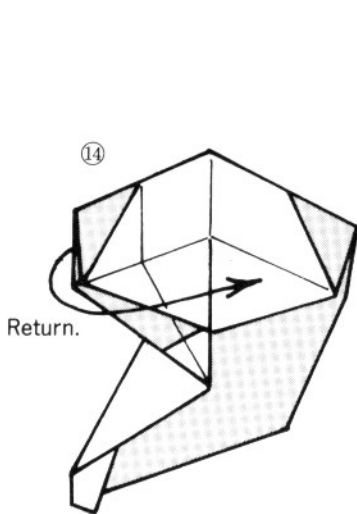
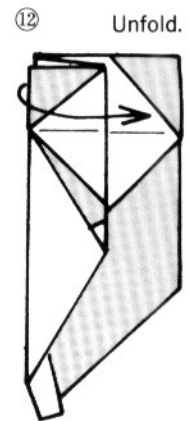
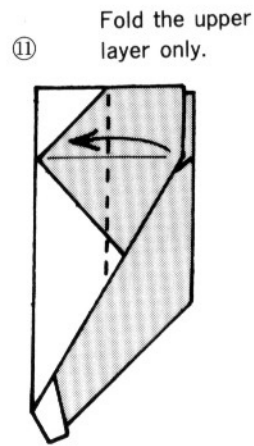
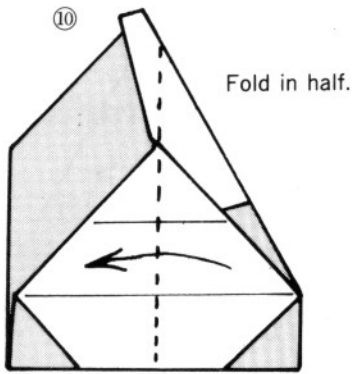

Inside pattern.

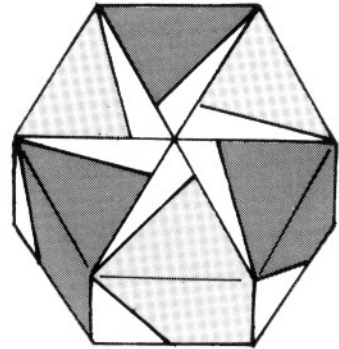
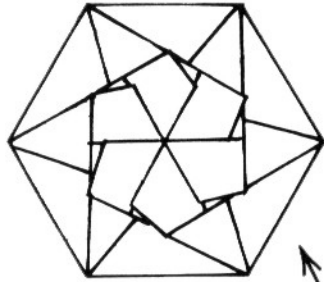

Outside pattern.

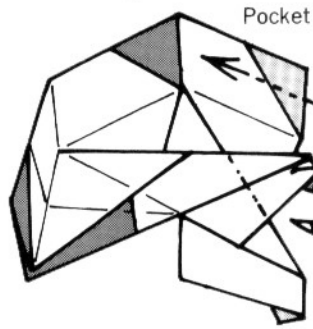

Join the six units as illustrated.

Tab

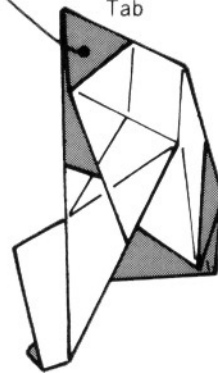

(Note) It is better to fold and fix the ends after all six units are joined.

Fix the end by folding it inside.

Tab

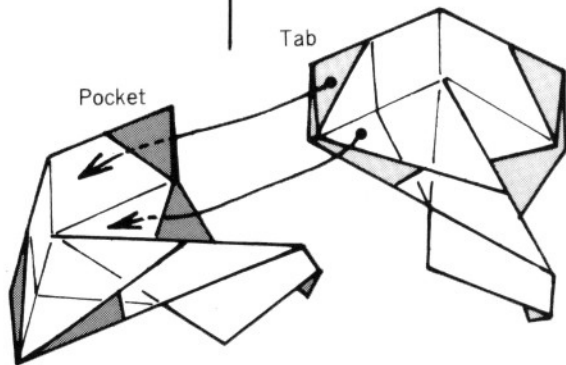

Join as in the drawing.

Finished unit.

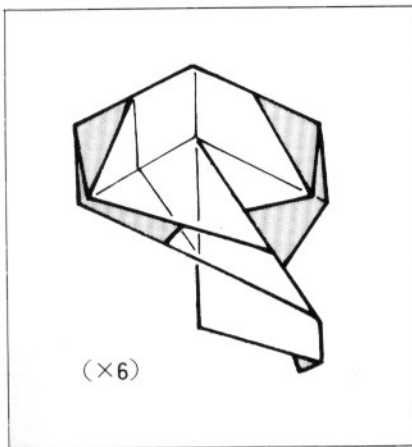

Lid of a hexagon box : flower and star

© 1988

Change the folding of the units of the six-petal pinwheel box so that the inside pattern of the box appears outside.

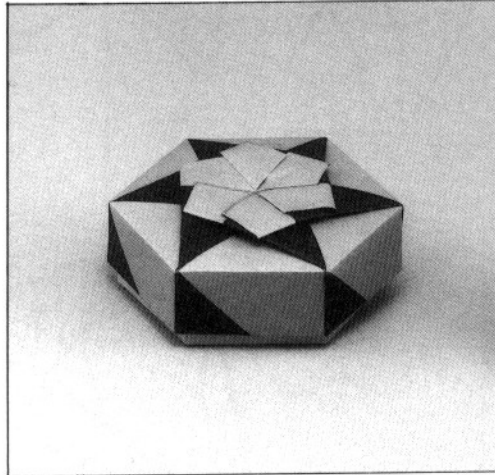

From ⑭ on page 64.

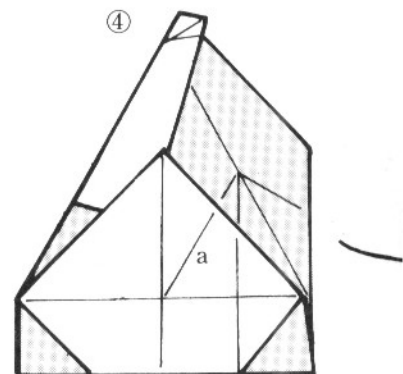
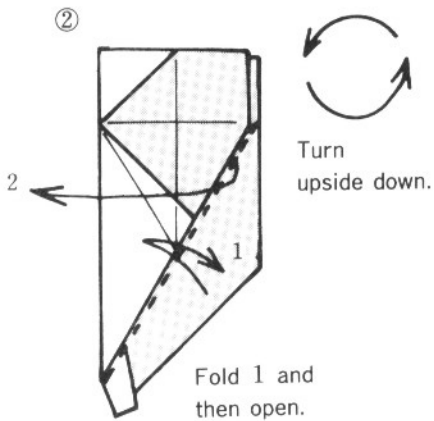
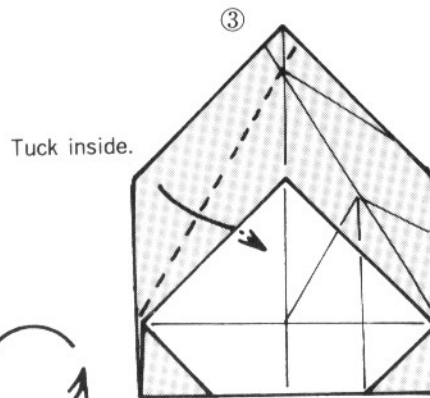
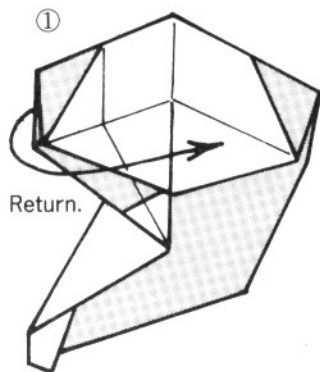

Outside pattern.

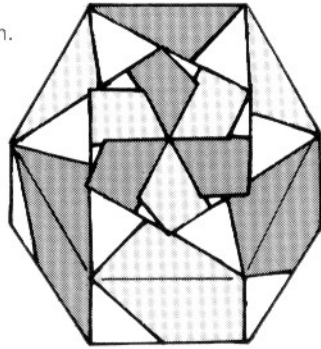

Inside pattern.

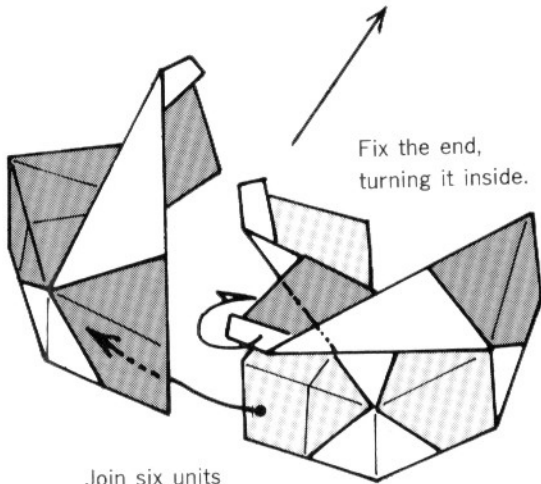
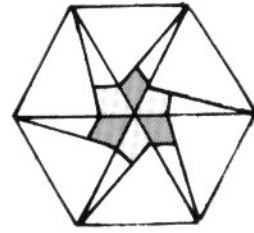

Fix the end, turning it inside.

Join six units as illustrated.

(Note) Like the six-petal pinwheel, it is better to join first and then fold the ends.

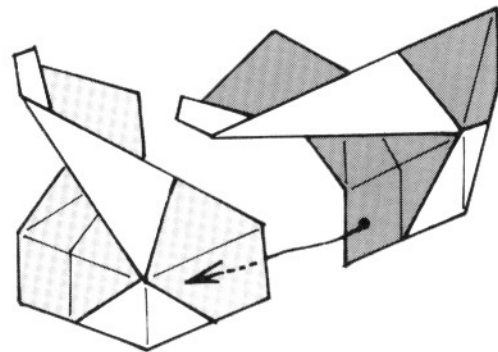

Join the units as in the drawing.

⑤

Pleat along the line a in ④.

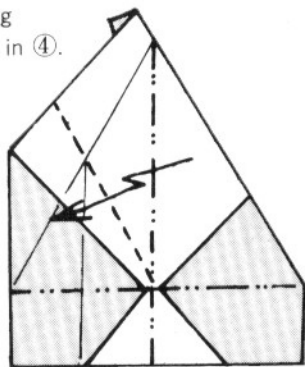

Finished unit.

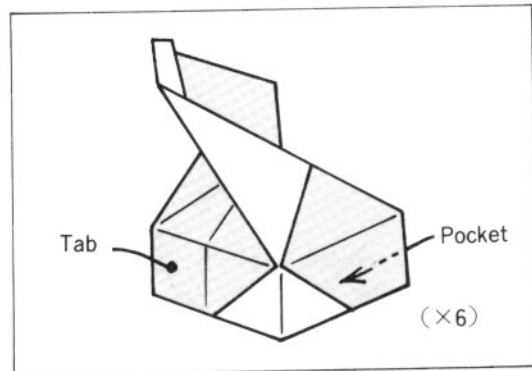

Base of a hexagon box

© 1988

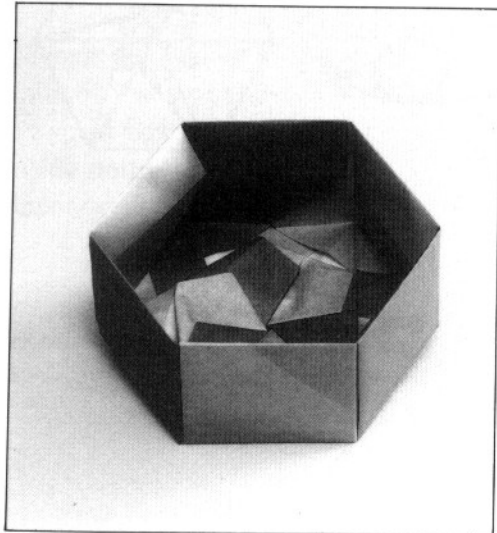

Now we are going to make the bases for the two lids just made. In order to match the bases with the lids, the length of its six sides must be made shorter. The paper is folded up to ⑧ on the next page with this in mind. It is delicate work, so go slowly and patiently.

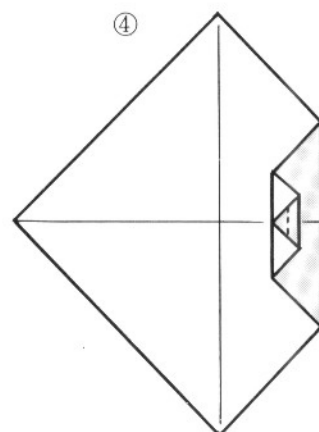
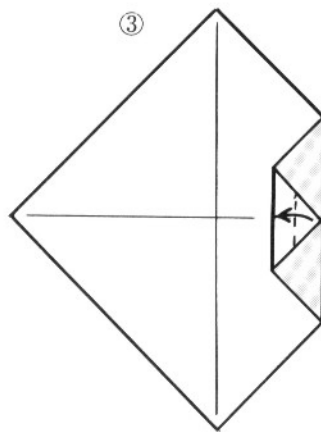
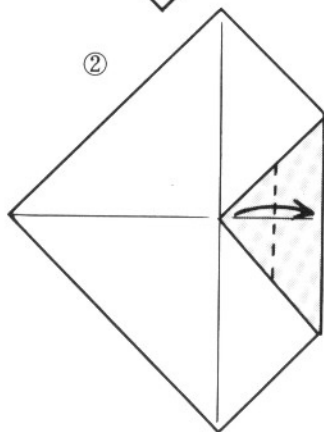
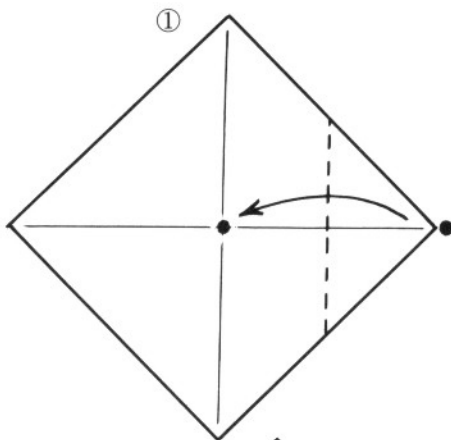

Fold the end once more.

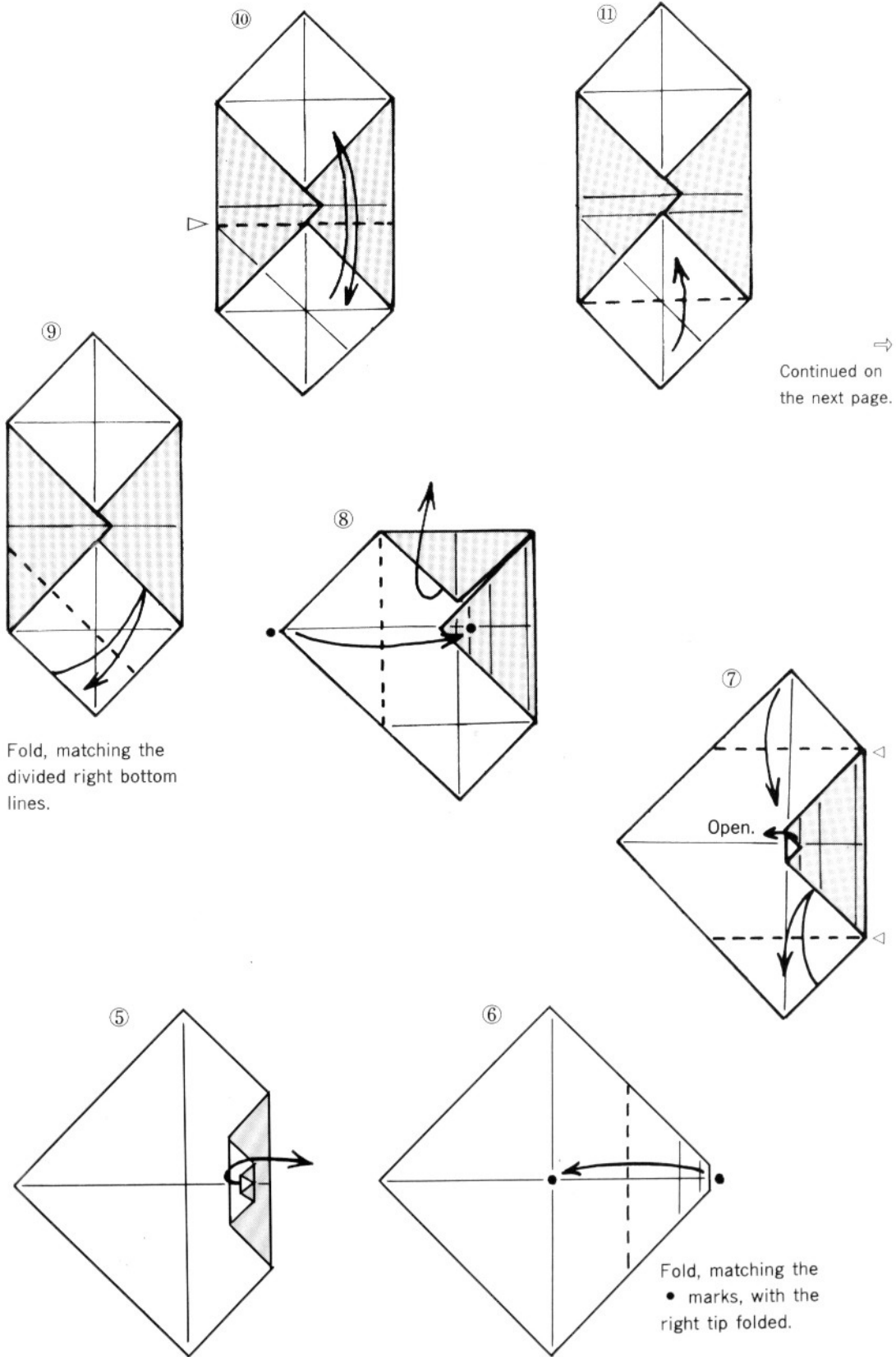

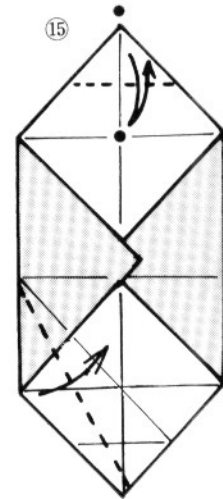
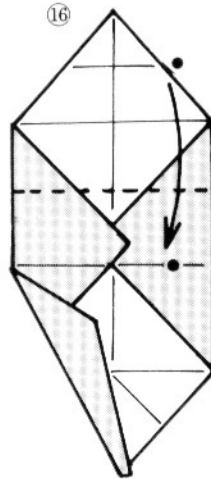
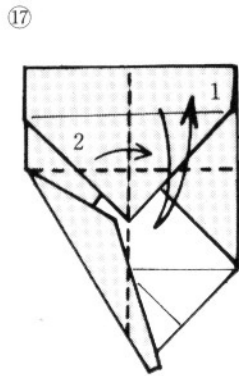
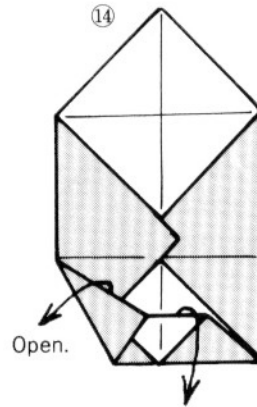
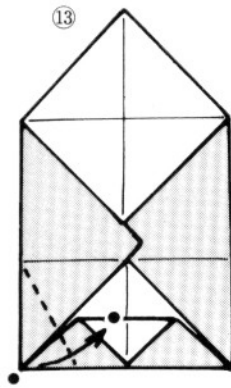
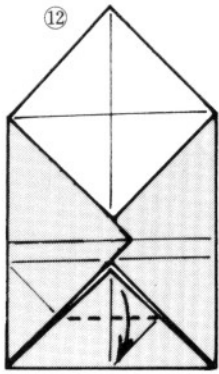

Fold along the line marked in ⑬.

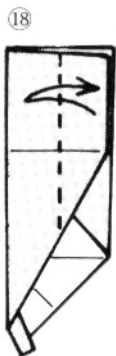

Fold the upper layer only.

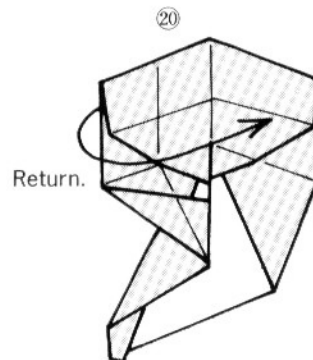
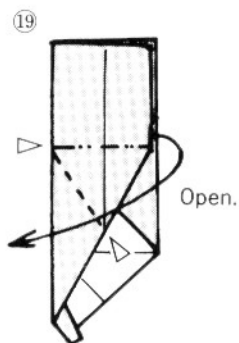

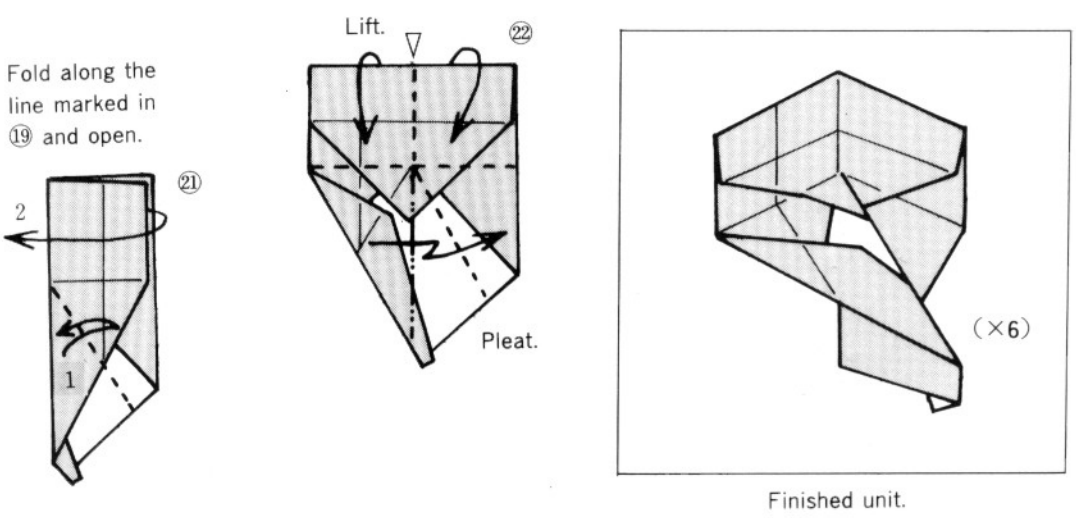
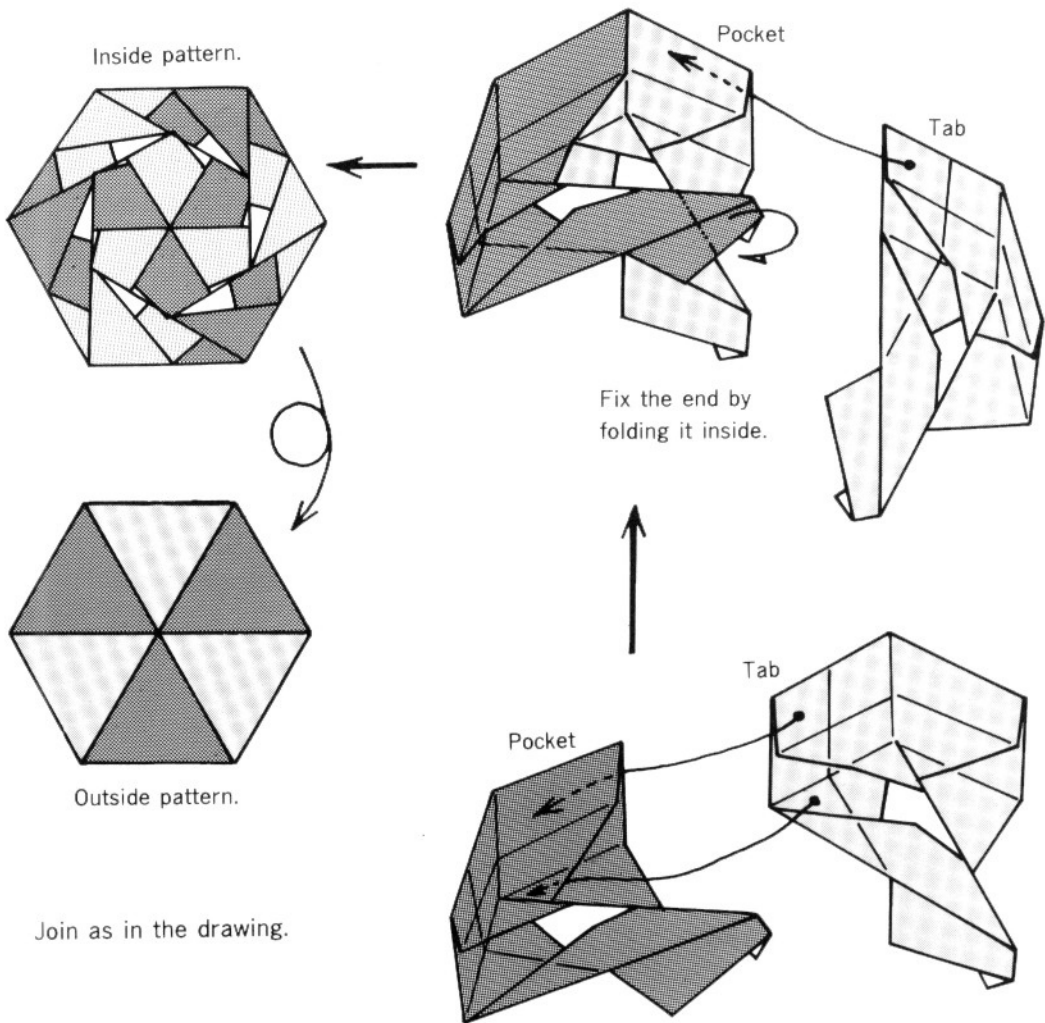

Here is how to fold the base of a hexagon box neatly with less time and trouble.

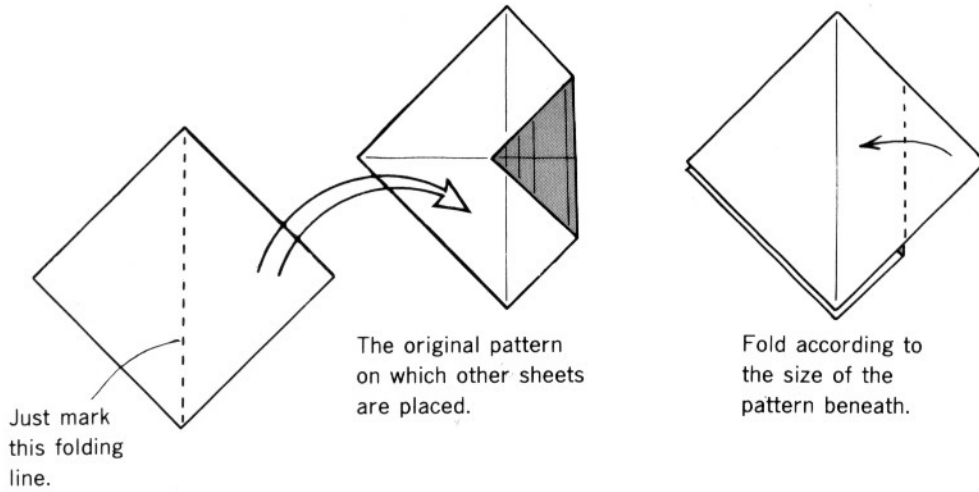

When folding the base of a hexagon box, fold just one sheet up to ⑦ on page 69, use it as the original pattern, placing other sheets on it, and fold them according to the pattern beneath. This saves trouble. Moreover you do a neat job without folding unnecessary lines.