

3D ORIGAMI

STEP-BY-STEP ILLUSTRATIONS

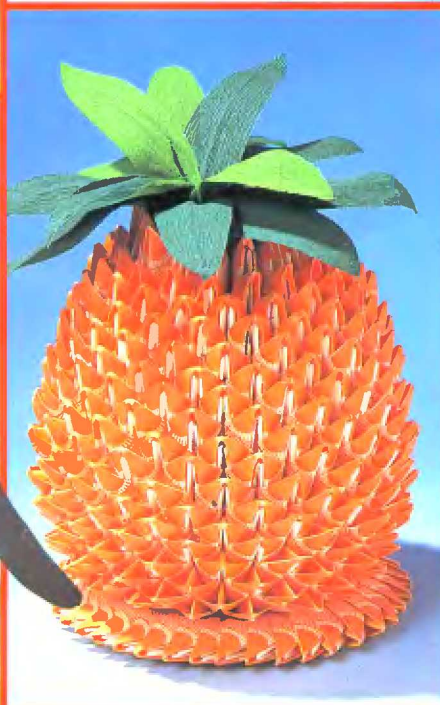
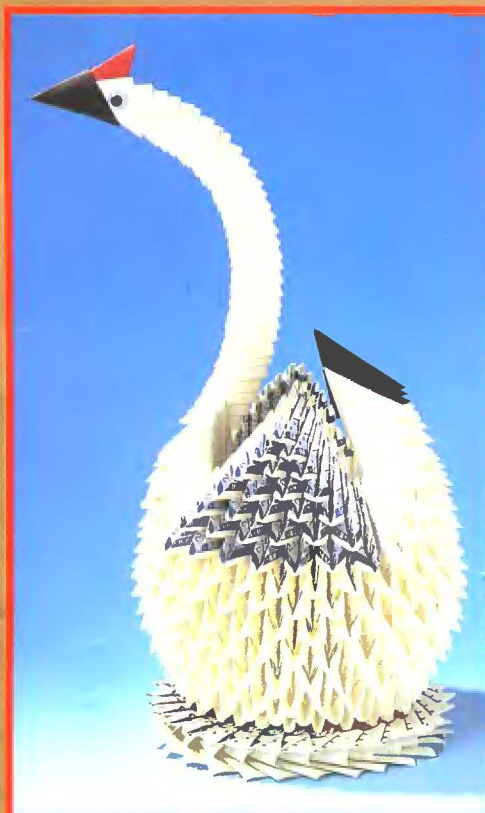

CONTENTS

Introduction 3

GRANNY OWL 3

Enjoy Recycling Papers 4

TO BEGIN 6

ORNAMENT STAND 6 TWO-TONE RING 7 CHRISTMAS TREE 7

EASY HORIZONTAL ASSEMBLY 8

TORTOISE 8 GOLDFISH 10 FISH 10 SOARING CRANE 10
KINGFISHER 11 SWALLOW 11 SUNFLOWER 12

THREE-DIMENSIONAL ASSEMBLY 14

BASKET 14 TOOTHPICK HOLDER 15 HAT 15 PINEAPPLE 16
MINI PINEAPPLE 16 WATERMELON 17 LEMON 17 STRAWBERRY 17
ELEGANT CRANE 18 BABY SWAN 19 SWAN 19 PEACOCK 20
DANCING CRANE 20 RED-CROWNED CRANE 21 PEDESTAL 21
METALLIC URN 22 *TEMARI* BALL 22 GOOD-LUCK *HYOTAN* (GOURD) 23 OWL 24
WINGED OWL 24 *KAPPA* 25 PENGUIN 25 KITTEN 25 RABBIT 25
OWL WEDDING (BRIDEGROOM BRIDE RING BEARER FLOWER GIRL) 26

How to Make Triangular Pieces 27

Using origami paper 27 Using flyer or wrapping paper 28 Using craft paper 29

Instructions 30

Photographer: Yasuyuki Okada

Translator: Yoko Ishiguro

Project editor: Ikuko Mitsuoka

English editor: Mieko Baba

Introduction

#1

GRANNY OWL

Instructions: P.79



Origami, or paper folding, has long been recognized as a hobby for children. It is fun to create a familiar figure simply by folding a square of origami paper, and when a project is done, you might want to keep it as a decoration. However, authentic origami figures are so light-weight and fragile they don't last long nor stand by themselves, and they were meant to be thrown away after all.

This book introduces you to an innovative approach to origami craft. The projects are heavy-weight and stable so you can keep them as ornaments. A small rectangular piece of paper is folded into a tiny, "magic" triangle. Make as many pieces as you can and build the figures or structures you fancy. You can suit your own sense by changing colors and numbers of pieces in certain rows, and by using paper of different thicknesses or textures. The possibilities are endless.

Origami is quite a time-consuming craft, but you need no special tools or workplace. With just paper and scissors, 3D origami is fun for all ages. In Japan, it has also become popular among people recovering after all illnesses. Everybody can enjoy folding and interlocking the "magic" triangles just as you would patchwork, knit or build with Lego® blocks.

DISTRIBUTORS

United States: Kodansha America, Inc. through Oxford University Press, 198 Madison Avenue, New York, NY 10016

Canada: Fitzhenry & Whiteside Ltd., 195 Allstate Parkway, Markham, Ontario L3R 4T8

United Kingdom and Europe: Premier Book Marketing Ltd., Clarendon House, 52, Cornmarket Street, Oxford, OX1 3HJ England

Australia and New Zealand: Bookwise International, 54 Crittenden Road, Findon, South Australia 5023

The Far East and Japan: Japan Publications Trading Co.,Ltd., 1-2-1, Sarugaku-cho, Chiyoda-ku, Tokyo 101-0064 Japan

First Edition July 2000

Original Copyright©1999 Boutique-sha

World rights reserved by JOIE, INC., 1-8-3, Hirakawa-cho, Chiyoda-ku, Tokyo 102-0093 Japan

No part of this book or portions thereof may be reproduced in any form or by any means including electronic retrieval systems without prior written approval from the author or publisher.

Printed in Japan

ISBN4-88996-057-0

ENJOY RECYCLING PAPERS

Our daily life is filled with various kinds of paper that are destined to be thrown away; catalogs, wrapping paper, magazines, tickets, flyers, etc. Before just getting rid of them, why don't you consider recycling them by creating delightful 3D figures? Save glossy, thick papers, patterned or solid, for later use.

**GOOD-LUCK
HYOTAN(GOURD): P.23**

RED-CROWNED CRANE: P.21

PEDESTAL: P.21

HAT: P.15

**TOOTHPICK
HOLDER: P.15**

FISH: P.10

TORTOISE: P.8

Since each basic rectangle should be less than 2" x 4", you can cut any size of used paper down to that size out some from any used paper. Surprisingly beautiful effects will be obtained when patterned pieces are obtained when patterned pieces are assembled together. This handicraft will be satisfying to you in a number of ways, learning a new skill, a constructive use of your time, and recycling unwanted paper into an artful new form.

BASKET: P.14



KINGFISHER: P.11

USING A VARIETY OF PAPERS



① Fold in half.



⑧ Stack by inserting the points of triangles.



② Fold in half again.



⑦ Prepare necessary number of triangles.



③ Make a triangle at the center. (See P.28 for details).



⑥ Fold in half again.



④ Fold in bottom corners.

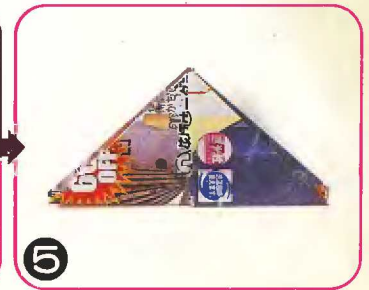

⑤ Fold in half.

TO BEGIN

Any 3D origami project begins with a small triangular piece. First, let's see how the basic triangle is folded.

This is an easy example to give you the idea of how the basic piece is formed. See P.27-29 for more detailed instructions.

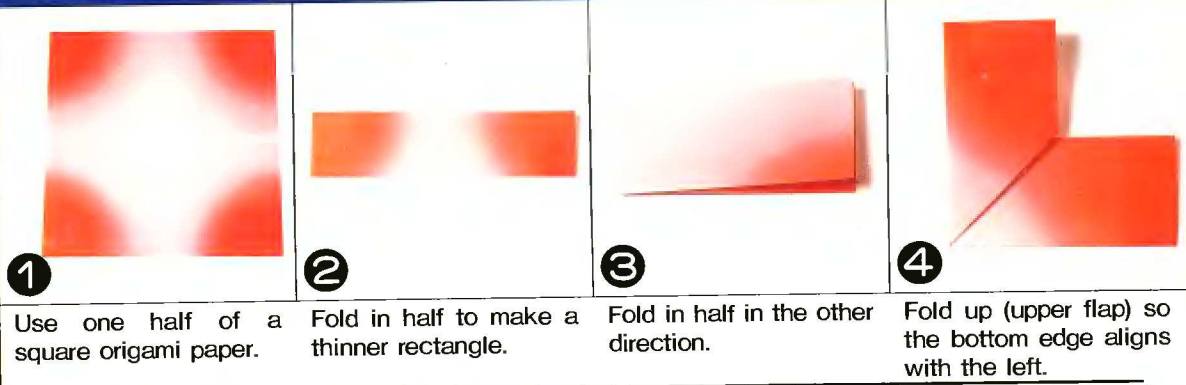

1 Use one half of a square origami paper. **2** Fold in half to make a thinner rectangle. **3** Fold in half in the other direction. **4** Fold up (upper flap) so the bottom edge aligns with the left.

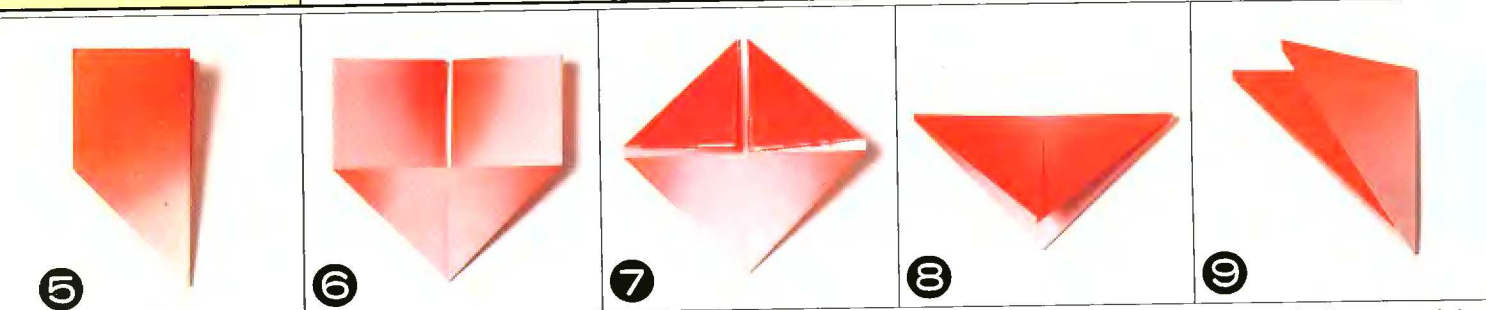

5 Turn over and fold in the same manner. **6** Open as shown. **7** Fold down upper corners. **8** Fold down in half. **9** Fold in half to complete a basic triangular piece.

There are 3 types of triangle, according to the project. See P.27-29 for more details.

Each of the three sides of the triangle has a different form of edge, which enables the crafter to vary the direction of inserting more pieces, creating 2D or 3D designs.

ORNAMENT STAND

Instructions for #2 & #3: P.32

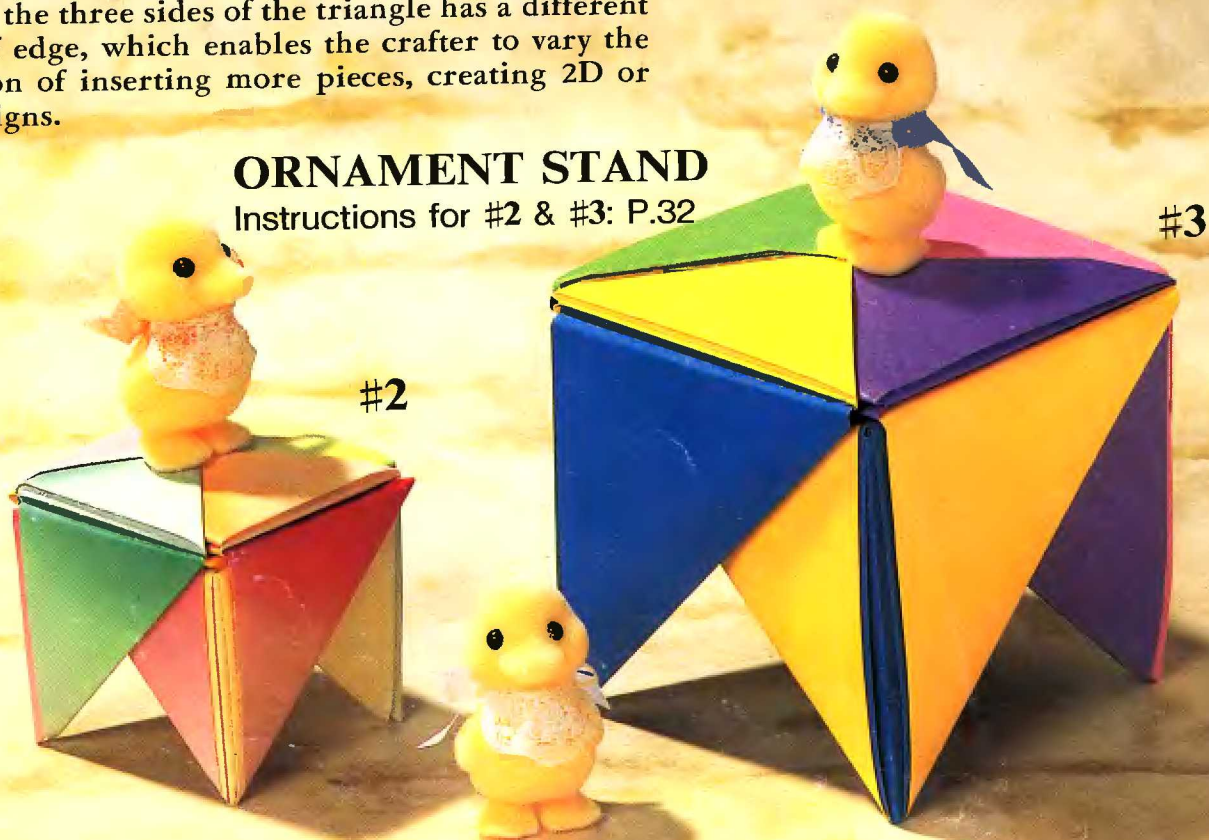

#2

#3

TWO-TONE RING

#5 TWO-TONE RING AND FROG

Instructions: P.30



#6 TWO-TONE RING AND GOLDFISH

Instructions: P.31

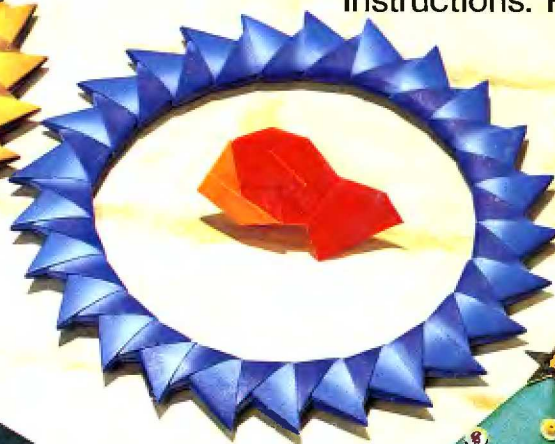

#4 TWO-TONE RING AND CRANE

Instructions: P.30



CHRISTMAS TREE

#7 FIR TREE

Instructions: P.33



#8 TREE WITH LIGHTS

Instructions: P.33

1 RING ASSEMBLY



Hold the first piece with your left hand, the pockets facing you.

2

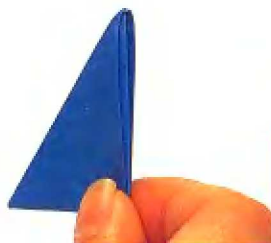

Hold the second piece with your right hand so two pointed points face left.

3

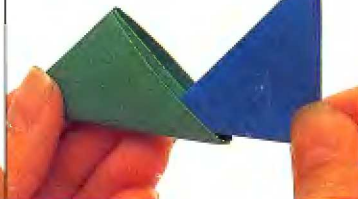

Insert two points into double pocket of the first piece.

4

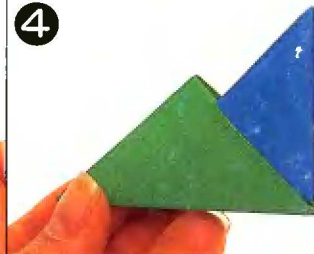

Insert deeply as shown.

5

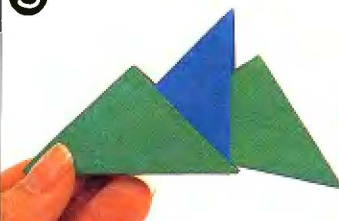

Insert two points of the third piece into double pocket.

6

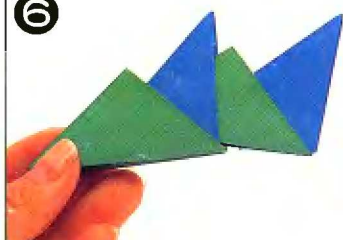

Continue so the pocket side alternates its angle, vertically and diagonally.

7

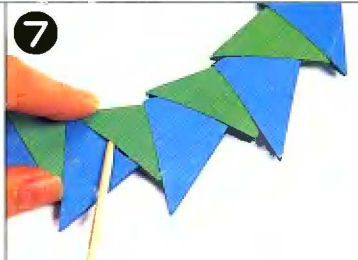

Apply a dash of glue between pieces, adjusting the shape.

8

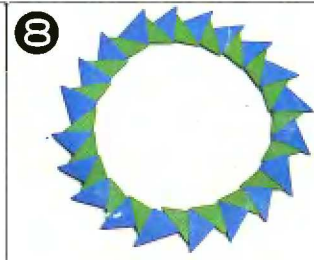

Completed RING.

EASY HORIZONTAL ASSEMBLY

Make as many as 40 triangles to create a beautiful tortoise. All you have to do is insert in the same direction. It's easy yet creative.

#9

#10



The above is made of wrapping paper.

TORTOISE

Instructions for #9-#15: P.5

TORTOISE ASSEMBLY

Different colors are used here for easy comprehension.



①

Make 40 triangular pcs.



②

Place 3 pcs. as Row 1, double pockets down. Join them with 4 pcs. by inserting double points into adjoining pockets of 2 pcs.



③

Row 3: Insert 5 pcs.



④

Row 4: Insert 6 pcs.



⑤

Row 5: Insert 5 pcs., leaving side triangles unworked .



⑥

Row 6: Insert 4 pcs.



⑦

Row 7: Insert 3 pcs.

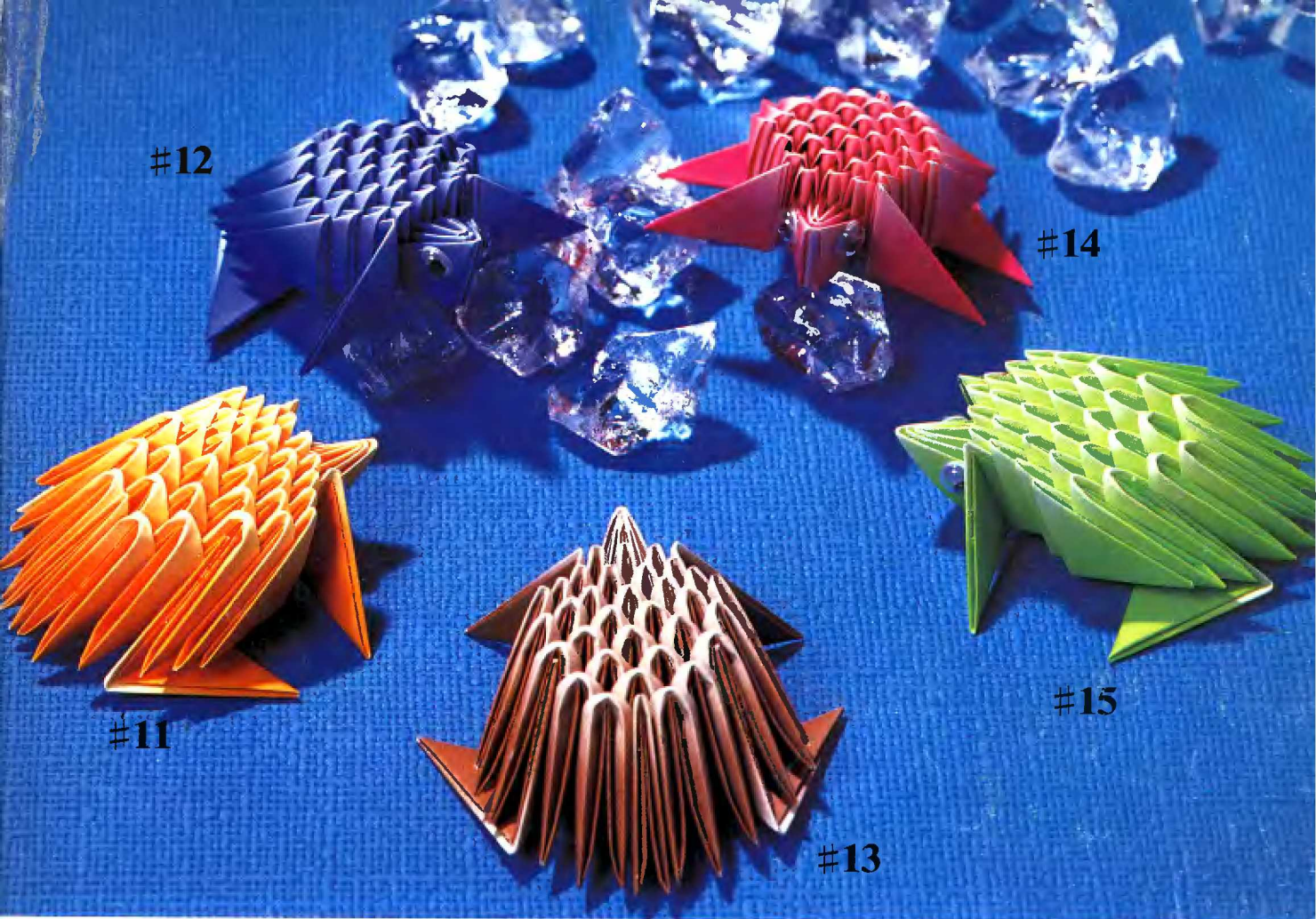

8 Row 8: Insert 2 pcs.



9 Row 9: Put 1 pc. between 2 pcs. of Row 8, and glue to secure.



10 Head: Insert 1 pc. into center piece of Row 1.



11 Cover with 1 pc. inserting into adjoining pockets.



12 Cover it again with 1 pc., inserting into outer pockets.

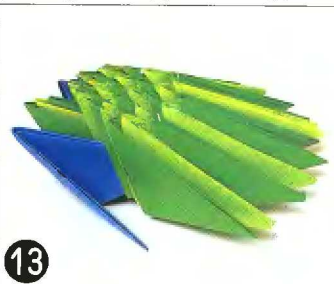

13 Fore legs: Open 1 pc. and insert one point into an outer pocket of Row 2. Repeat on the other side.



14 Hind legs: Open 1 pc. and insert one point into an outer pocket of Row 6. Glue to secure. Repeat on the other side.



15 Glue on eyes to finish.

EASY HORIZONTAL ASSEMBLY

This is an ideal project for beginners. By joining pieces in one direction will teach you how the triangular pieces work with each other.

#16



GOLDFISH

#17



FISH

#18



#19



Instructions for #16–#19: P.34

#20
SOARING CRANE
Instructions: P.36





#21



#22

KINGFISHER

Instructions for #21 & #22: P.38



#23

SWALLOW

Instructions: P.39



EASY HORIZONTAL ASSEMBLY

Most larger projects are constructed on a round base. Once you have learned the trick of the triangular pieces, this sunflower can be a good basis from which to start to proceed to more complicated designs. The more pieces you start with, the more easily you can join them, although the center hole will be enlarged as well. It is useful to practice joining small numbers of pieces securely.

#24



SUNFLOWER

instructions for #24 & #25: P.13

#25



Completed size
6" diameter

Materials

- #24: 54 2"x 3 1/2" rectangles of craft paper (yellow)
- 48 2"x 3 1/2" rectangles of craft paper (brown)
- #25: 54 2"x 3 1/2" rectangles of craft paper (yellow)
- 24 2"x 3 1/2" rectangles of craft paper (black)
- 24 2"x 3 1/2" rectangles of craft paper (ocher)

Note

The completed project may look different depending on the thickness of the paper used.

SUNFLOWER ASSEMBLY (#25)

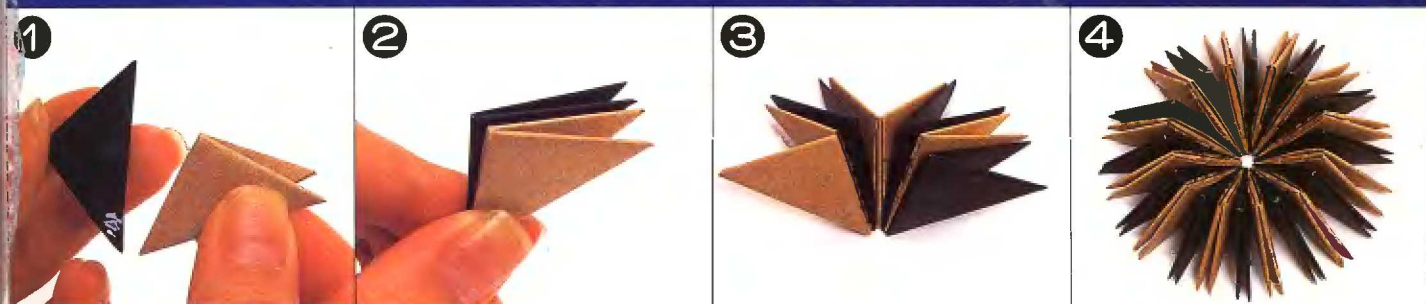

1 Apply a dab of glue onto the tip of the single point of a triangular piece.

2 Press 2 pcs. to secure.

3 Repeat to make a 5-6 pc. cluster.

4 Make several clusters until 24 pcs. are joined. Join into a ring and glue to secure.



5 Interlock 1 pc. so as to covering the adjoining points.

6 3 pcs. are joined to the far side.

7 24 pcs. are joined all around.

8 Holding the double pocket side of a yellow piece, insert its points into adjoining pockets.

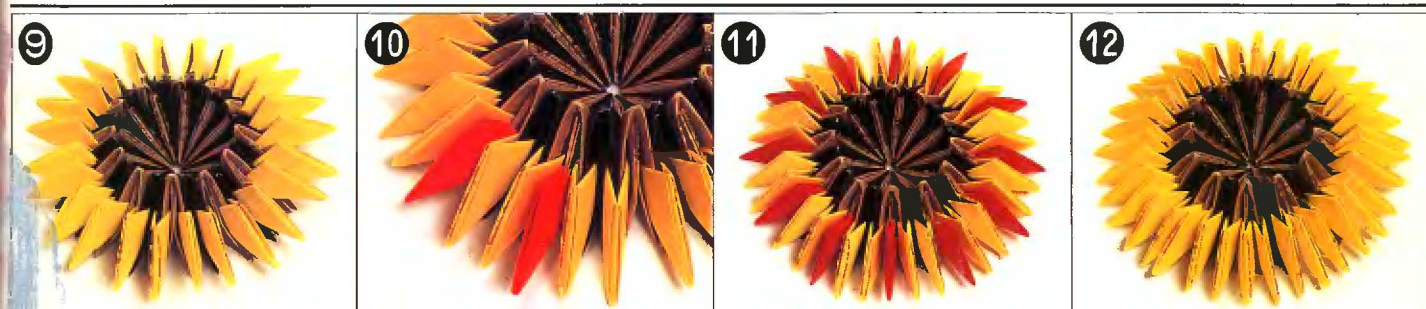

9 24 pcs. are inserted all around.

10 Increase petals by inserting 1 pc. into the opening between every 2 pcs.

11 Keep adding until 12 pcs. are inserted.

12 Now, the real color petals, 36 in all.

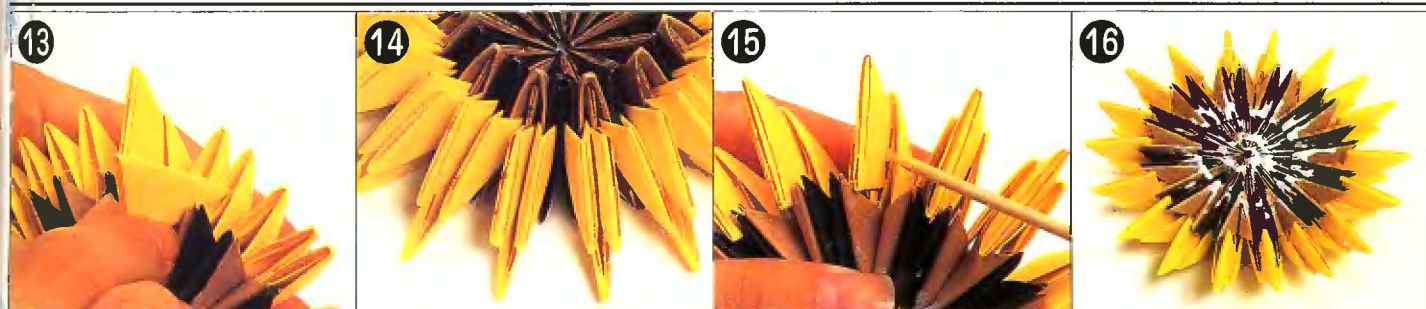

13 Hold the flower downside up, and insert a piece held at the double pocket into adjacent openings.

14 When 18 pcs. are added, turn over and adjust the angles of petals.

15 Secure by gluing the final row pieces from the back side.

16 Apply glue all over the back side and attach onto a cardboard.

THREE-DIMENSIONAL ASSEMBLY

First make a circular base with triangular pieces. Then stack upward to create a 3D project. Once you have mastered the construction of the first piece, which is a little tricky, various shapes can be constructed as you wish. Start with a small number of pieces and proceed to more elaborate designs using a larger number of pieces.

#27



#26



BASKET

Instructions for #26 & #27: P.40

TOOTHPICK HOLDER

Instructions for #28 - #30: P.35



#28



#29



#30

HAT

Instructions for #31 - #33: P.41

#31

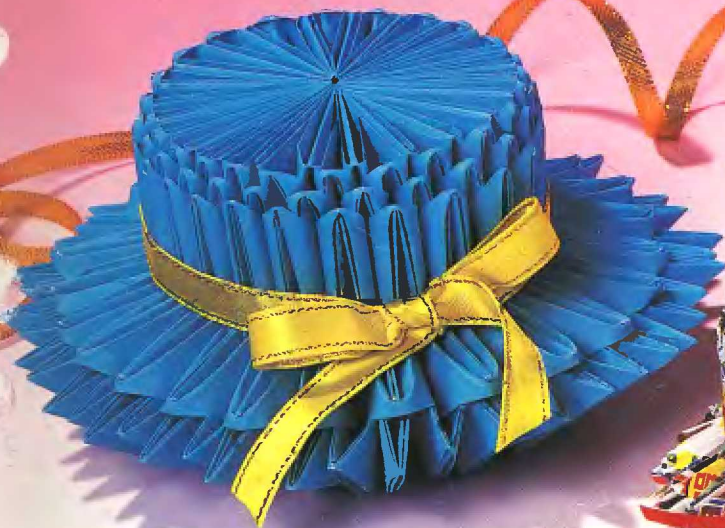

#32



#33



THREE-DIMENSIONAL ASSEMBLY

Fold and save triangular pieces in your spare time, in assorted colors or patterns, and challenge yourself to grander projects shown here and on the following pages.



PINEAPPLE

Instructions for #34 & #35: P.42

#34

#35



#36

#37

MINI PINEAPPLE

Instructions for #36 & #37: P.44

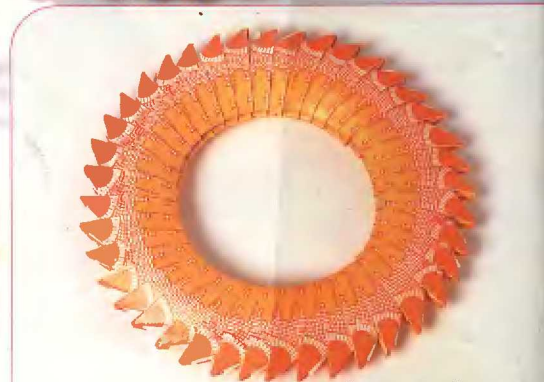

Pedestal for Pineapple

FRUIT COMBO

#38
WATERMELON
Instructions: P.46



#39
LEMON
Instructions: P.67



#40
STRAWBERRY
Instructions: P.47



THREE-DIMENSIONAL ASSEMBLY



#41

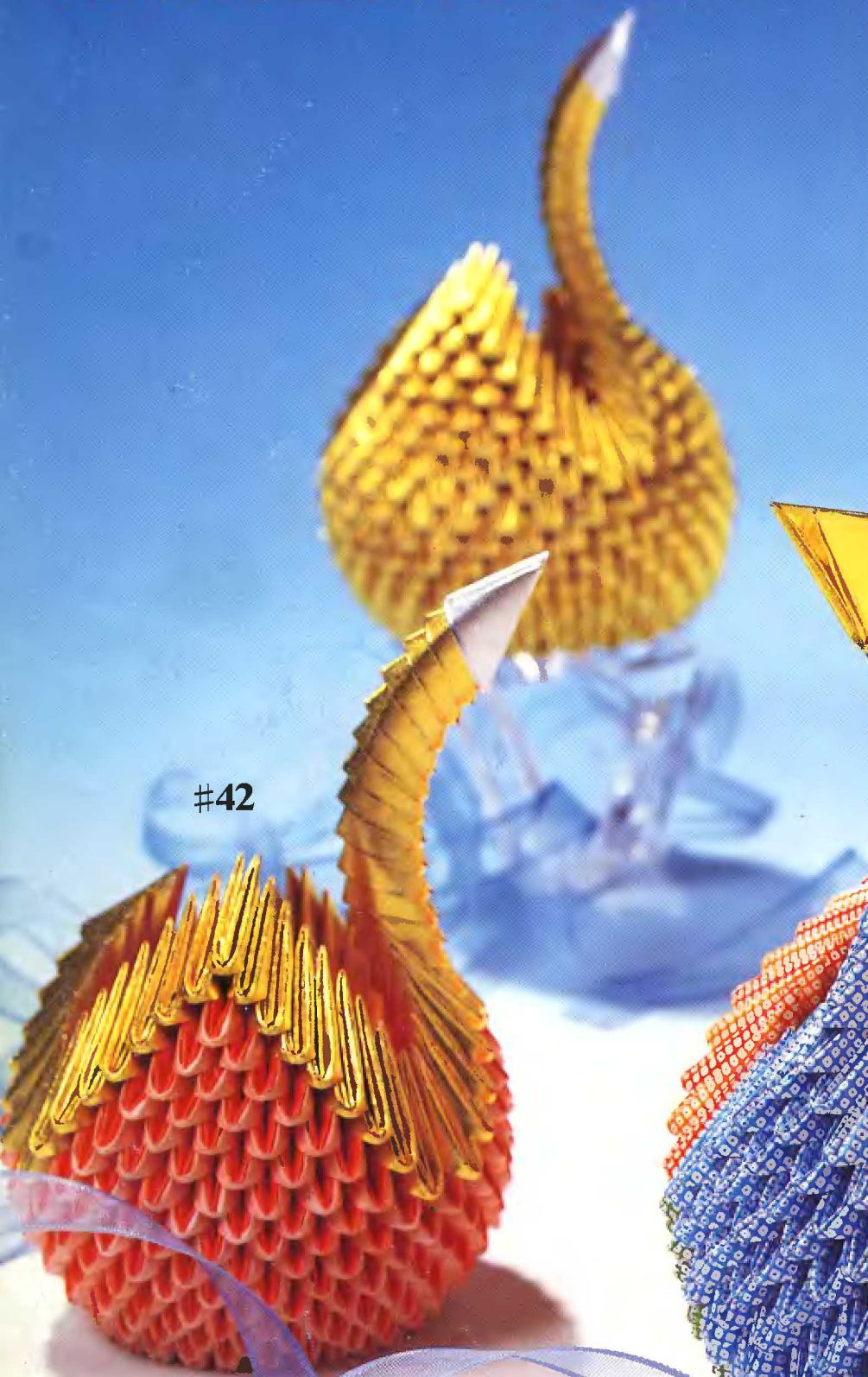

#42



#43

ELEGANT CRANE

Instructions for #41 - #43: P.48

#44



#45



BABY SWAN

Instructions for #44 & #45: P.54

#46



#47



#48



SWAN

Instructions for #46 - #48: P.56

THREE-DIMENSIONAL ASSEMBLY

PEACOCK

Instructions for #49 & #50: P.60

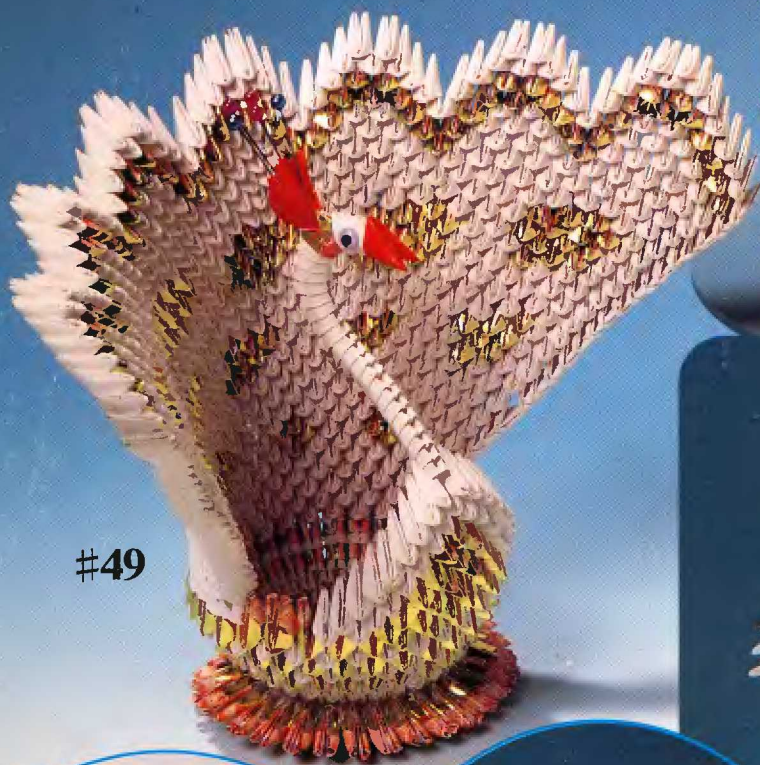

#49

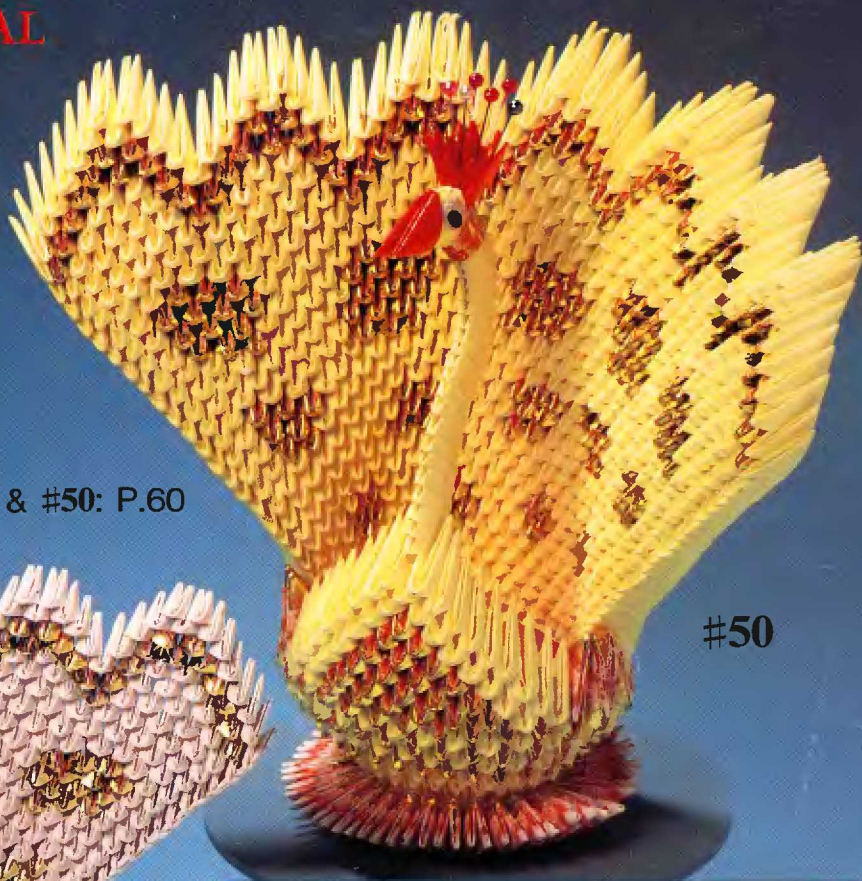

#50

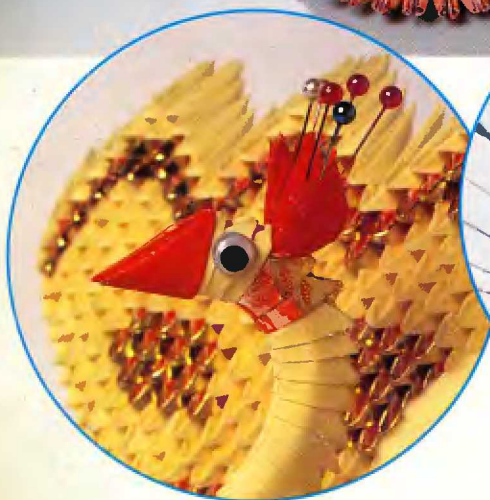

#51

DANCING CRANE

Instructions: P.62

RED-CROWNED CRANE

Instructions for #52 & #53: P.52



#52



#53

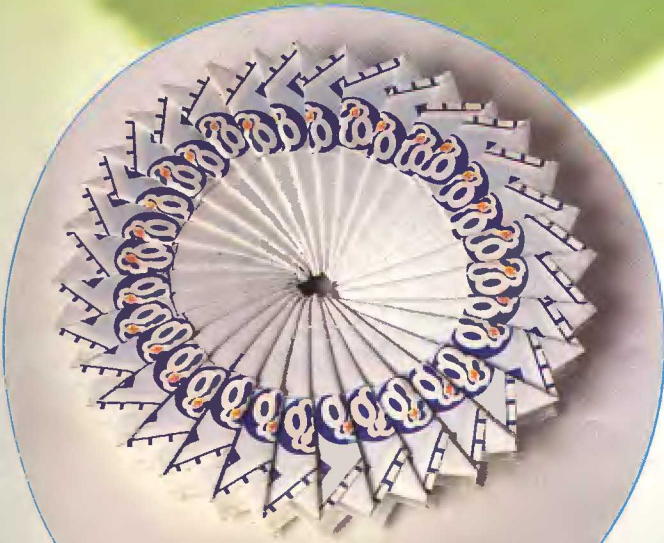

#54

PEDESTAL

Instructions: P.53



#55



#56

METALLIC URN

Instructions for #55 & #56: P.88



TEMARI BALL

Instructions for #49 & #50: P.68



#58



#57

THREE-DIMENSIONAL ASSEMBLY

GOOD-LUCK *HYOTAN* (GOURD)

Instructions for #59 – #61: P.70



#59

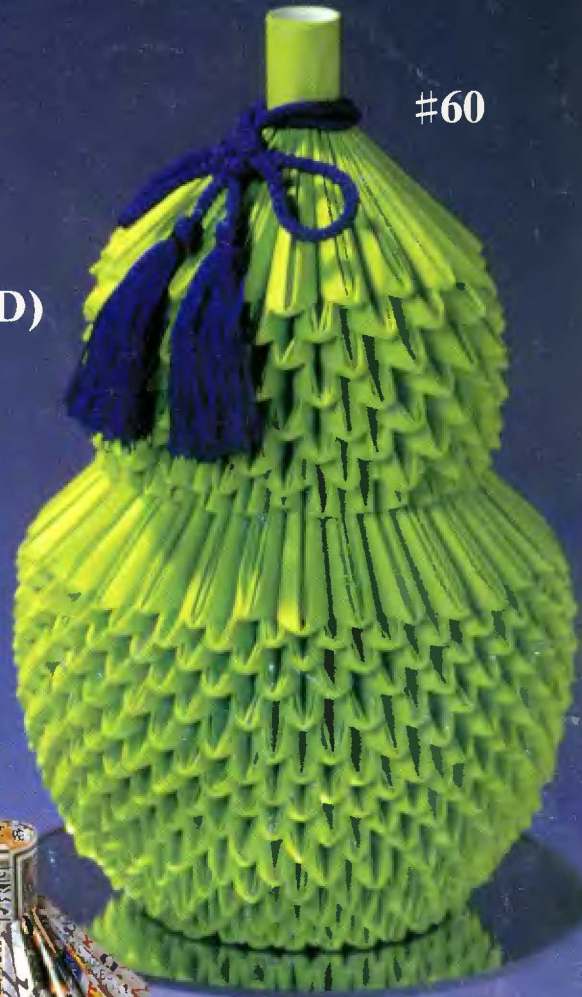

#60



#61

THREE-DIMENSIONAL ASSEMBLY

OWL

Instructions for #62–#64: P.7



#62



#63



#64

#65



#66



#67

WINGED OWL

Instructions for #65–#67: P.72

#68

KAPPA

Instructions: P.80



PENGUIN

Instructions for #69 & #70: P.82



#70

#69

#71



#72

#73



#74

KITTEN

Instructions for #71 & #72: P.84

RABBIT

Instructions for #73 & #74: P.86



#75
BRIDEGROOM
Instructions: P.74



#76
BRIDE
Instructions: P.75

THREE-DIMENSIONAL ASSEMBLY

OWL WEDDING



#77
RING BEARER
Instructions: P.78



#78



#79
FLOWER GIRL
Instructions: P.78

HOW TO MAKE TRIANGULAR PIECES

Using origami paper: Type "A"

The rectangular piece for Type "A" has an exact ratio of 2 : 1 for length to width because it is a half of square origami paper. Some projects require other types which have a slightly different ratio. (See P.28-29.)

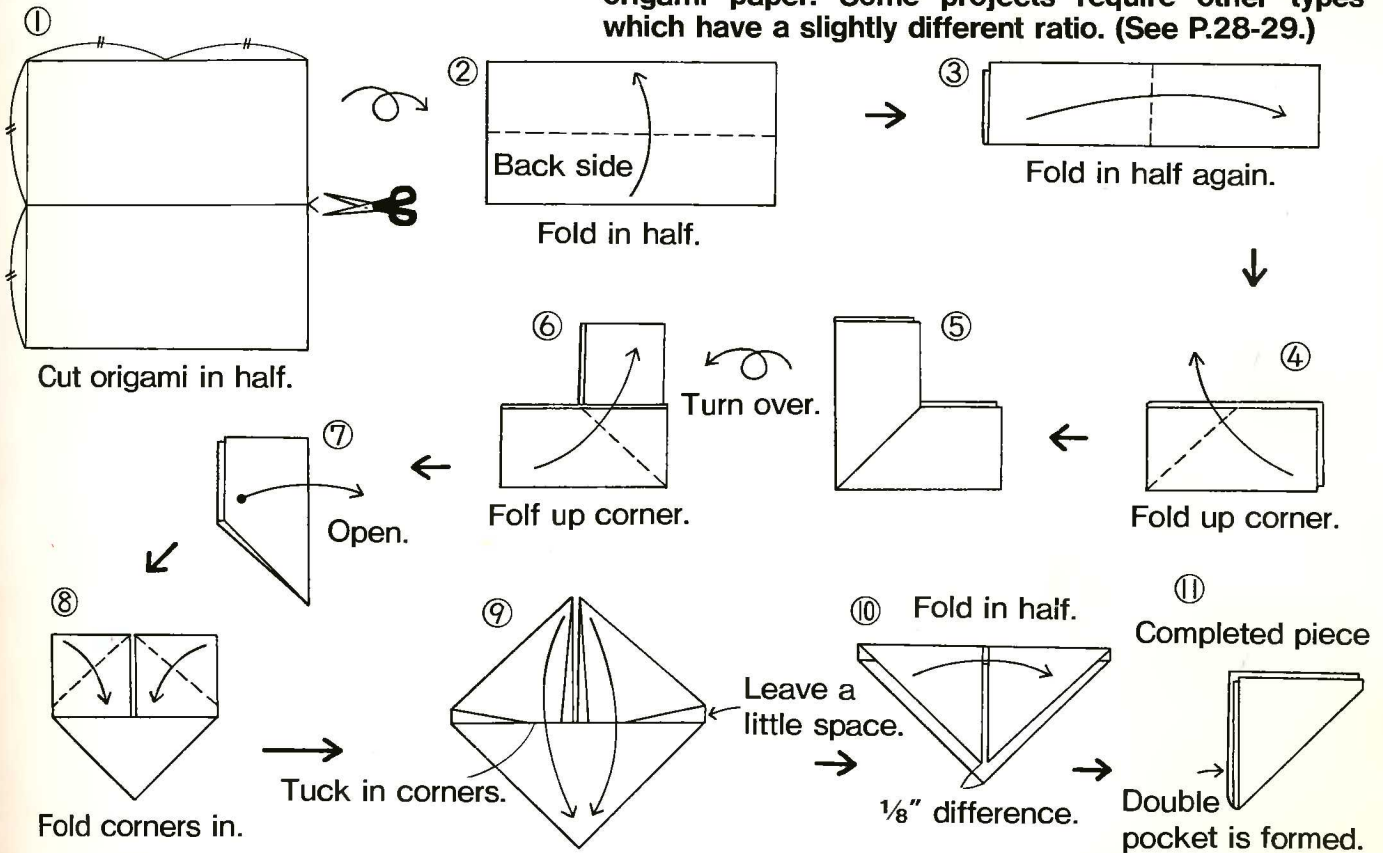

★Basic Assembly

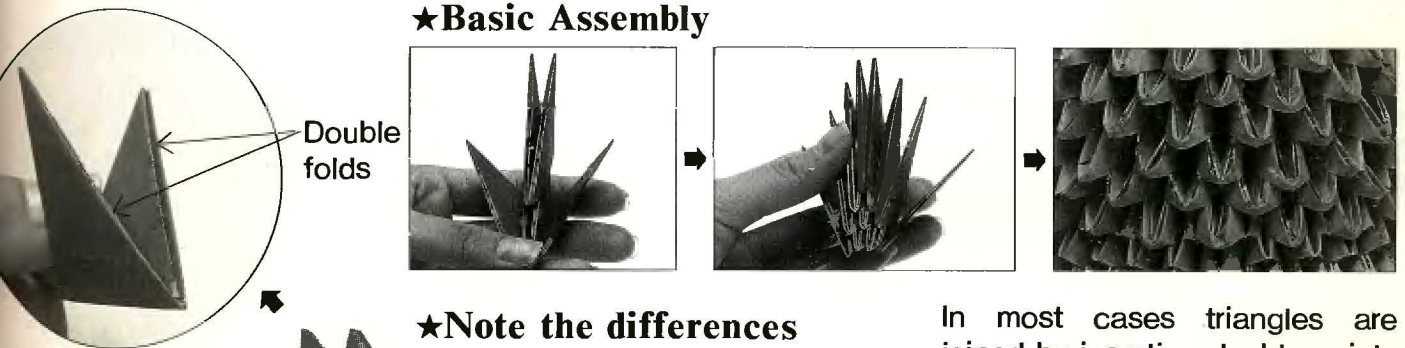

★Note the differences between the three sides.

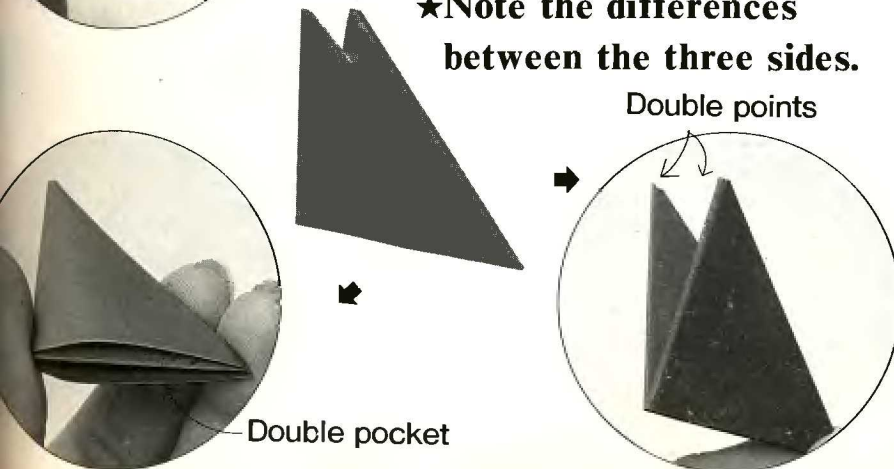

In most cases triangles are joined by inserting double points of a triangle into the double pockets of new triangles. Hold two pieces together, double points facing up, then stack on a new piece by inserting the middle points into the double pockets. This makes the second row that connects the pieces of the first row at the same time.

HOW TO MAKE TRIANGULAR PIECES

●Using flyer or wrapping paper: Type "B" Usually commercial paper does not have the exact ratio of 2 to 1 for its length to width. So the width of Type "B" rectangle is slightly longer than a half of the length. This type piece is often useful.

[Cut into rectangles]

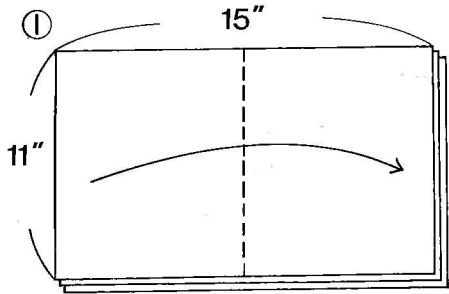

Layer several sheets aligning edges. Fold and cut into halves.

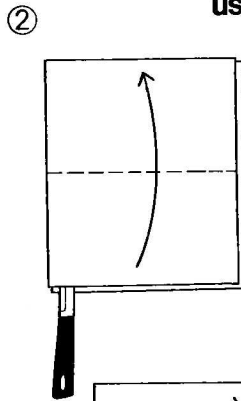

Fold and cut into halves again.

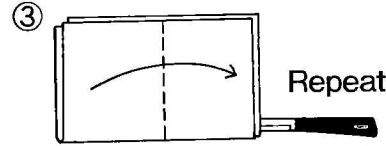

Repeat.

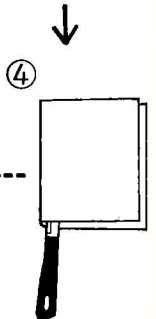

8 rectangles are made.

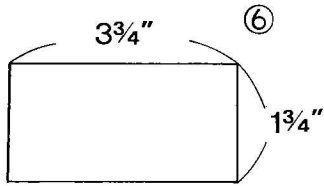

Basic rectangle

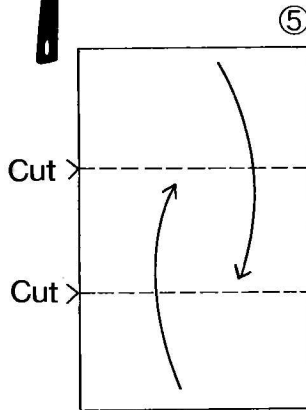

Precisely fold each into 1/3 rectangle, and cut.

Enlarged.

[Fold into triangles]

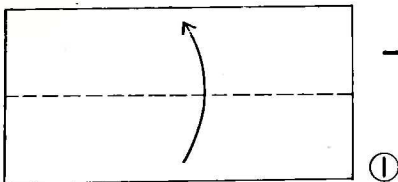

Fold in half.

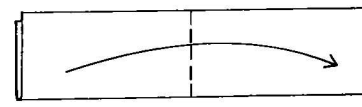

Fold in half again.

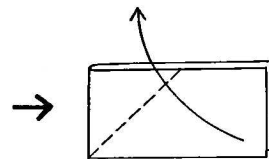

Fold up corner.

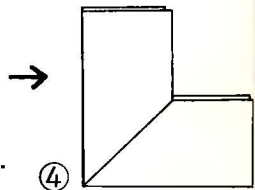

Fold corners in.

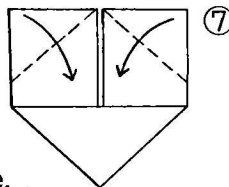

Leave a little space.

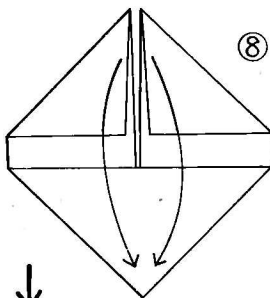

Fold down.

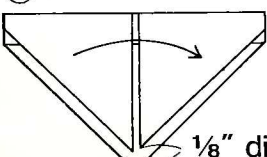

Double pocket is formed.

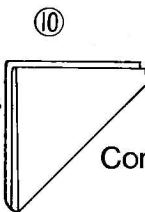

Completed piece

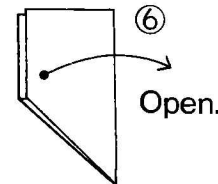

Open.

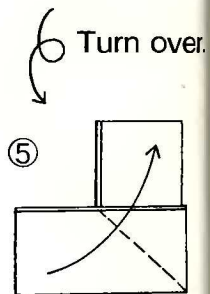

Fold up corner.

HOW TO MAKE TRIANGULAR PIECES

Using craft paper: Type "C"

Commercial rectangular papers are available at handicraft shops. This Type "C" rectangle has a width slightly less than a half of the length.

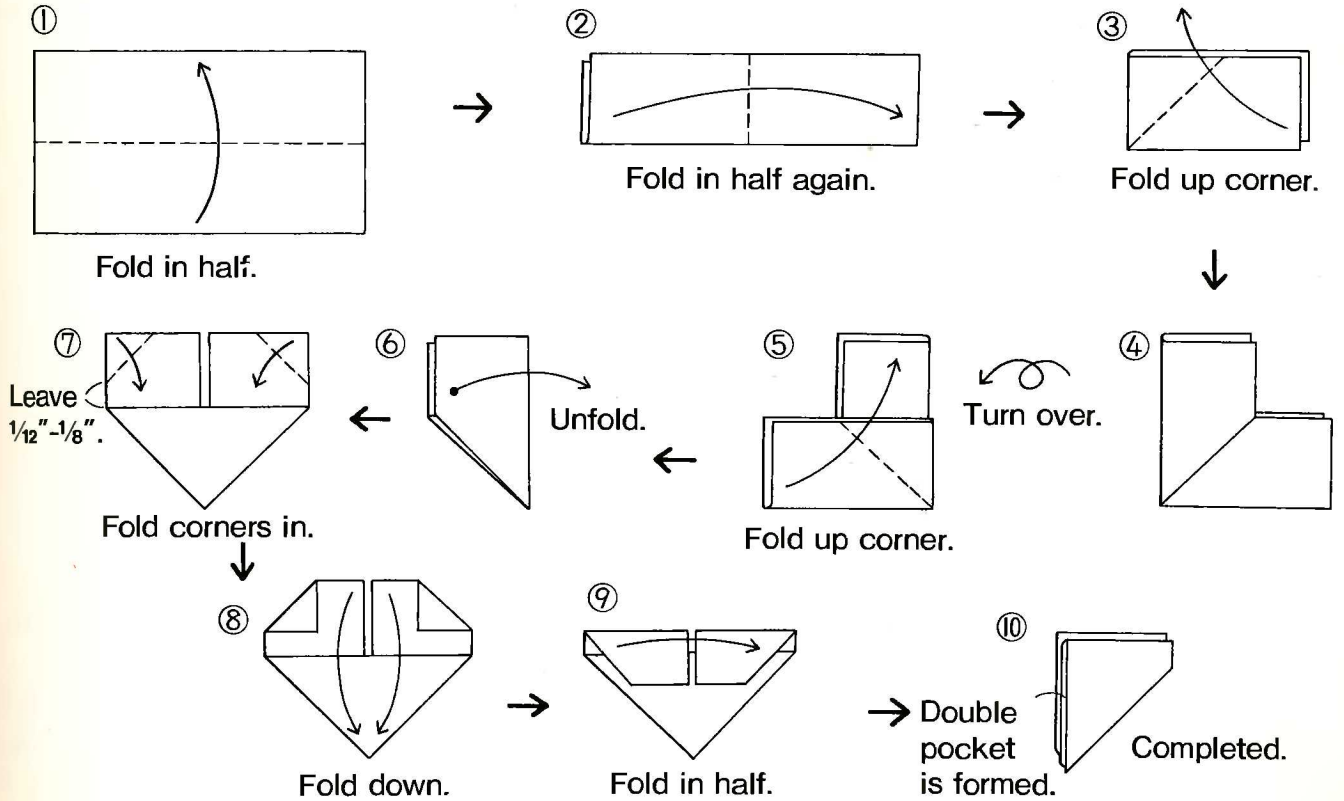

UTENSILS

- ① Cutting board
- ② Flyer
- ③ Ruler
- ④ Scissors
- ⑤ Paper cutter
- ⑥ Bamboo skewer to apply glue
- ⑦ Wood glue
- ⑧⑨⑩ Craft papers



HOW TO MAKE TRIANGULAR PIECES

●Using flyer or wrapping paper: Type "B"

Usually commercial paper does not have the exact ratio of 2 to 1 for its length to width. So the width of Type "B" rectangle is slightly longer than a half of the length. This type piece is often useful.

[Cut into rectangles]

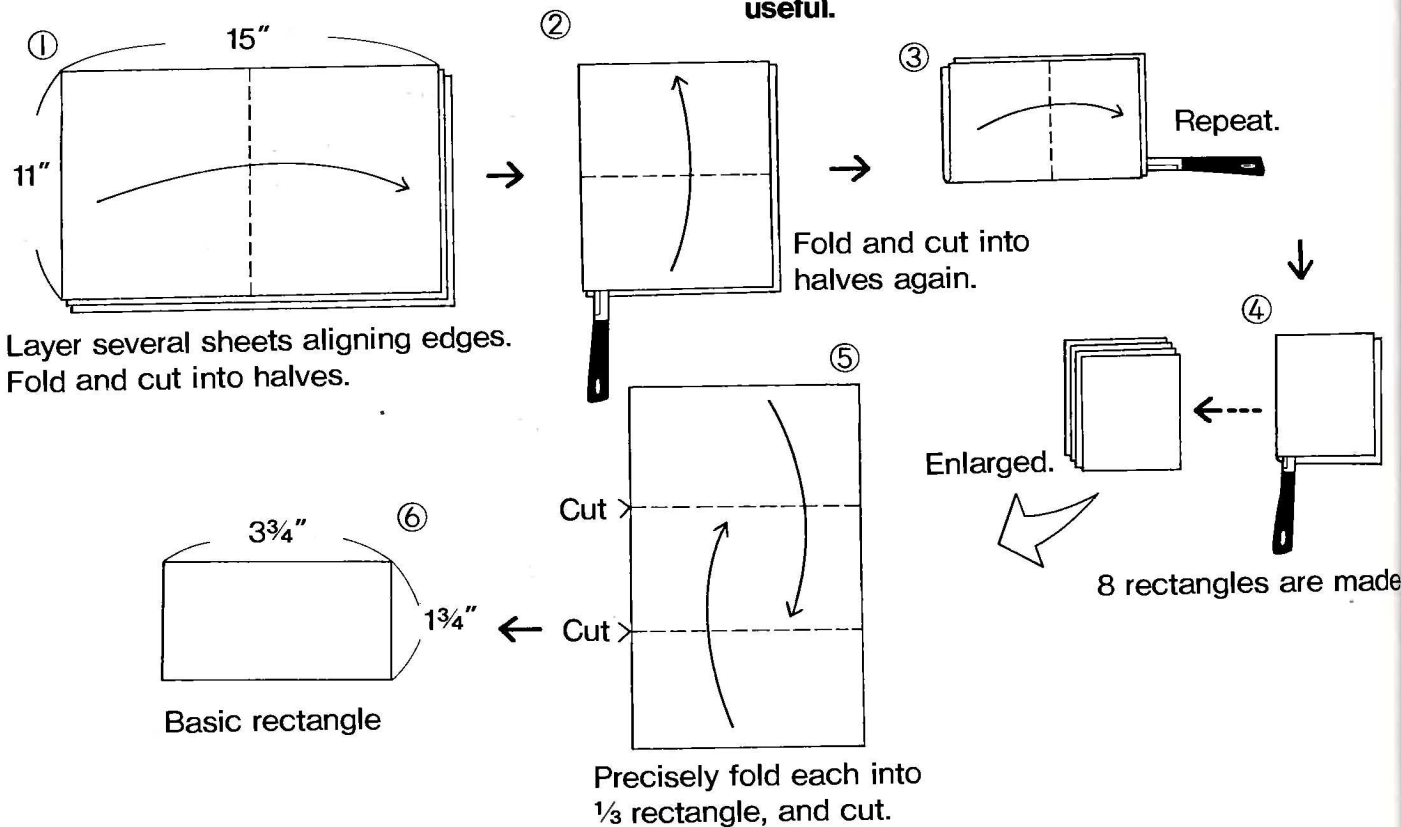

[Fold into triangles]

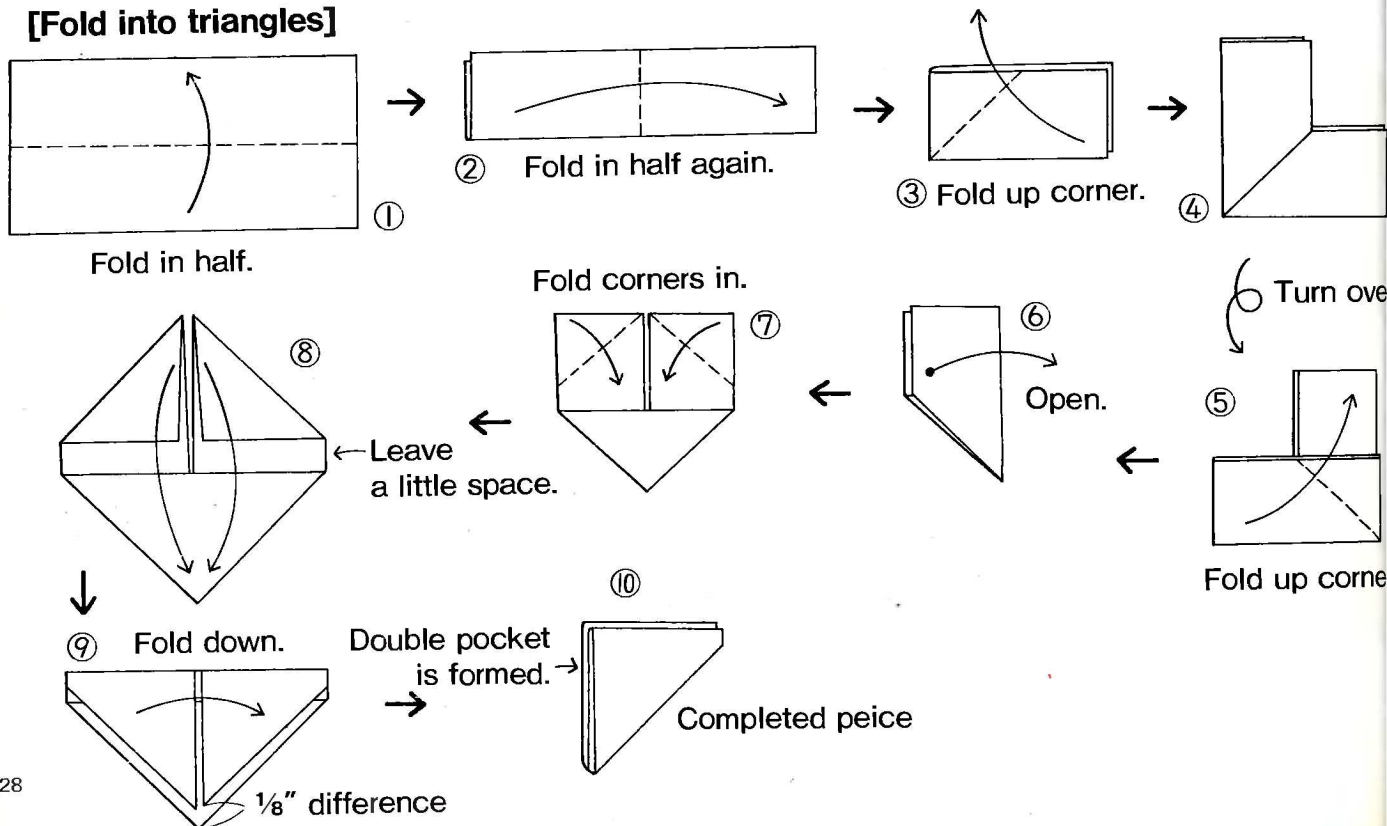

HOW TO MAKE TRIANGULAR PIECES

●Using craft paper: Type "C"

Commercial rectangular papers are available at handicraft shops. This Type "C" rectangle has a width slightly less than a half of the length.

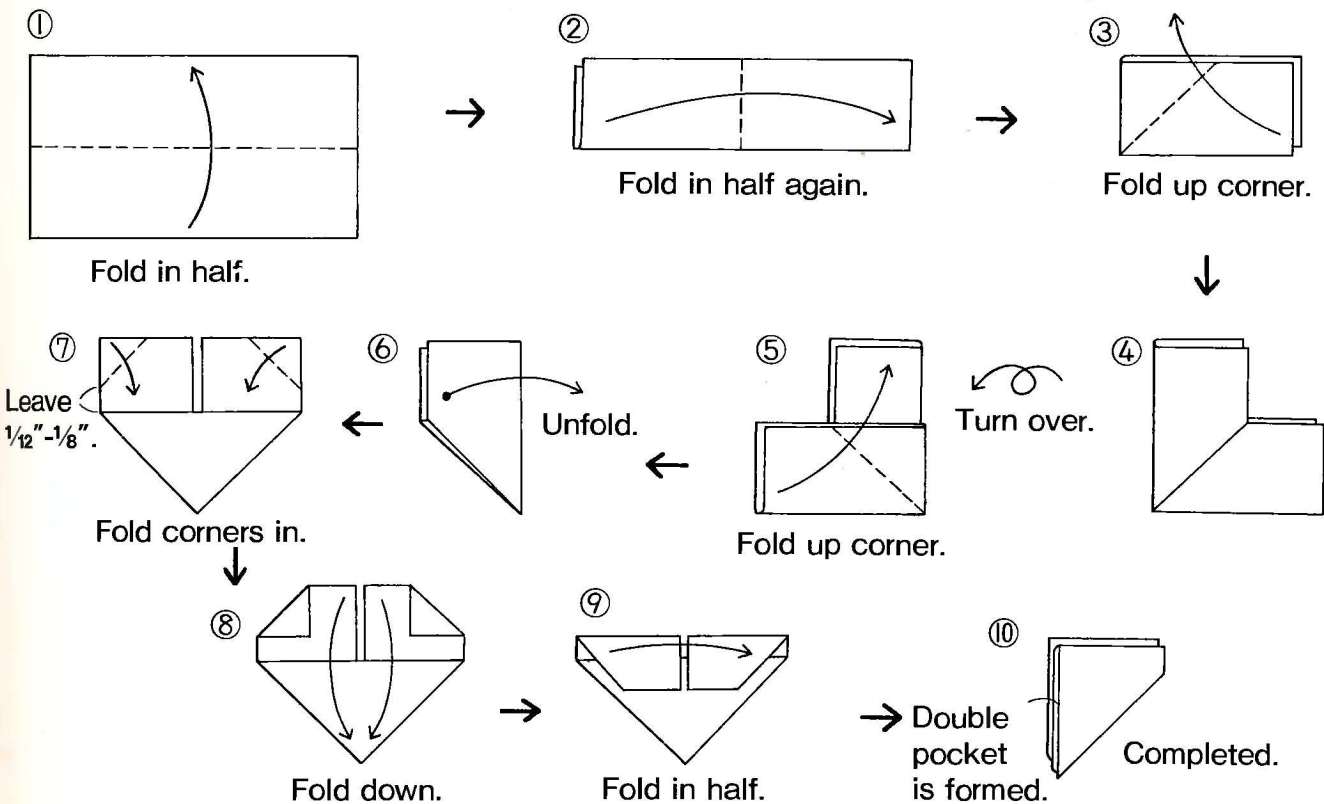

UTENSILS

- ① Cutting board
- ② Flyer
- ③ Ruler
- ④ Scissors
- ⑤ Paper cutter
- ⑥ Bamboo skewer to apply glue
- ⑦ Wood glue
- ⑧⑨⑩ Craft papers

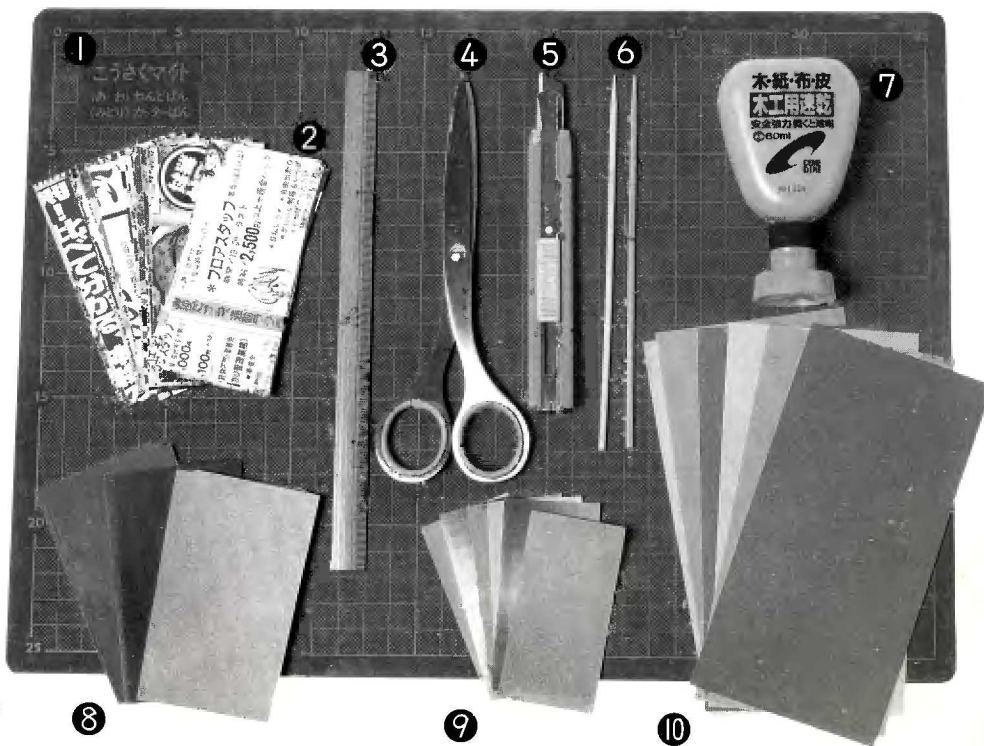



#4 TWO-TONE RING WITH CRANE (P.7)

Completed
5" diameter

Materials RING: 50 1½"×3" rectangles of origami paper (gradated color)
 CRANE: 1 3" square origami (solid color)
Note See P.7 for "RING" instructions.

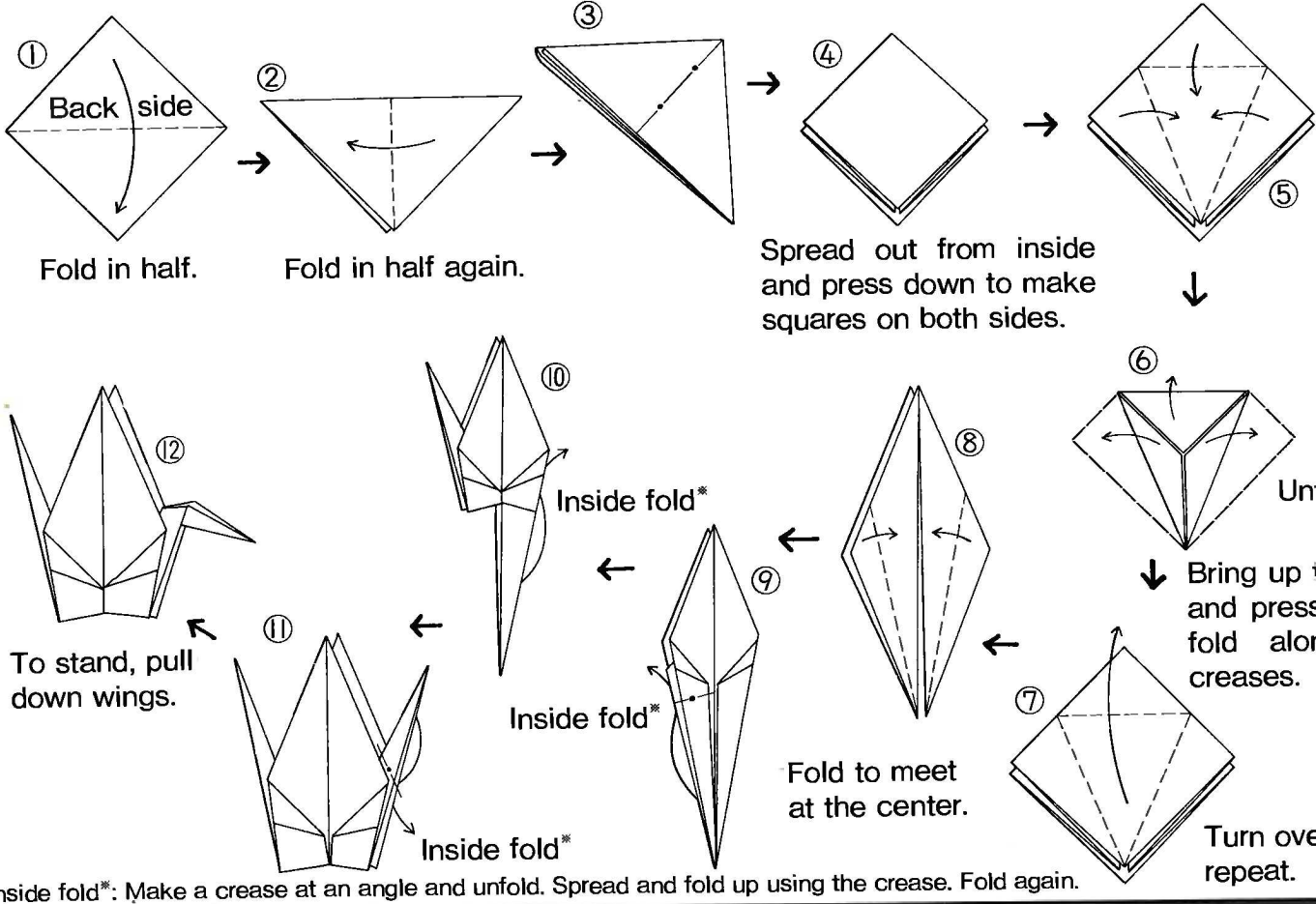

#5 TWO-TONE RING WITH FROG (P.7)

Completed
5" diameter

Materials RING: 52 1½"×3" rectangles of origami paper (gradated color)
 FROG: 1 3" square origami (green, colored on both sides)
Note See P.7 for "RING" instructions.

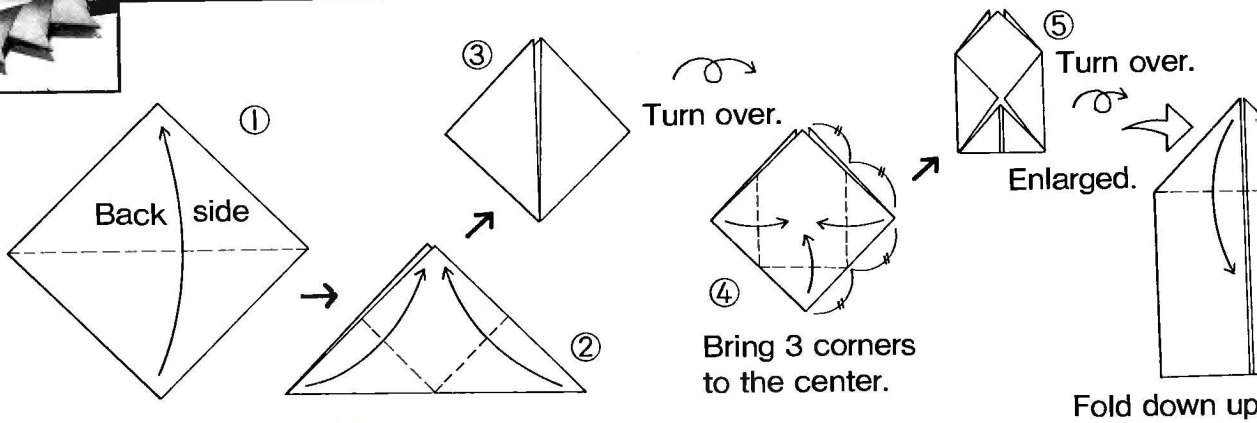

#6 TWO-TONE RING WITH GOLDFISH (P.7)

Completed size
5" diameter

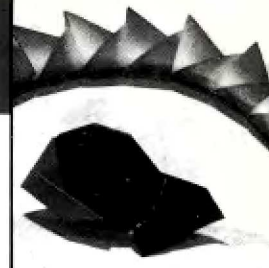

Materials RING: 50 1½" × 3" rectangles of origami paper (gradated color)

GOLDFISH: 1 3" square origami (red, colored on both sides)

Note See P.7 for "RING" instructions.

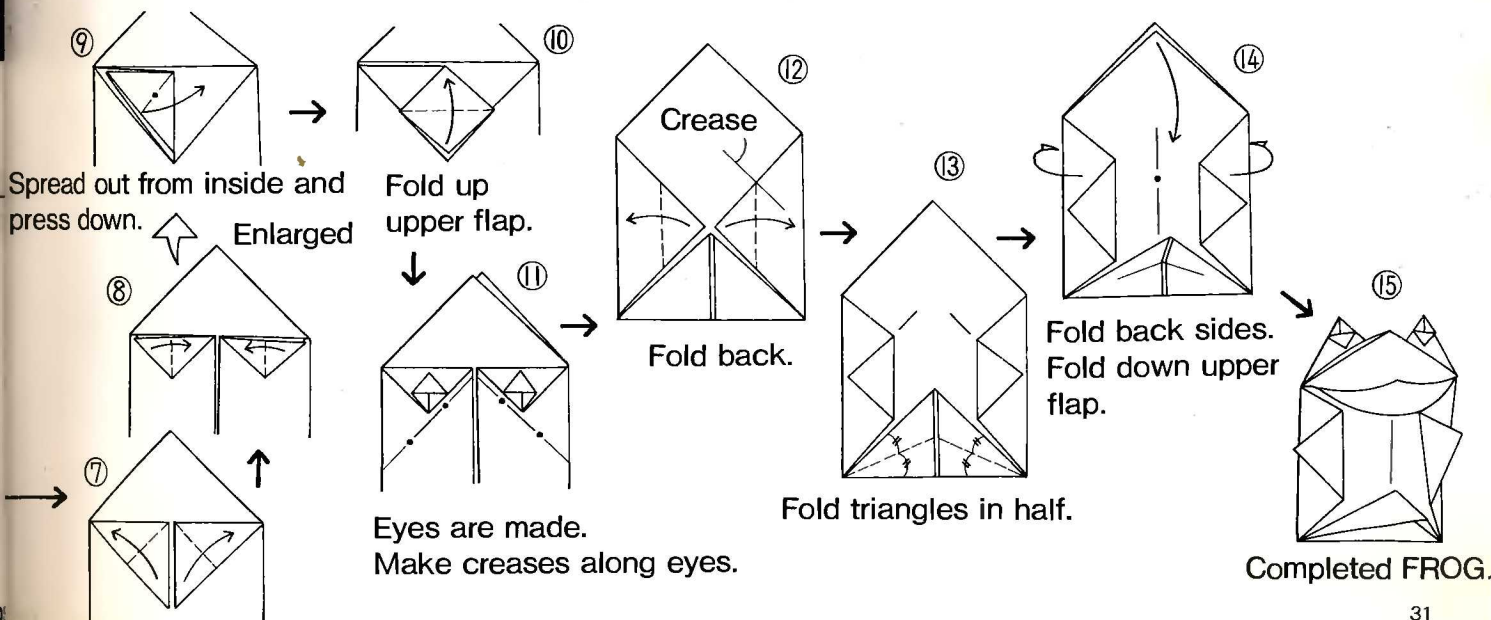
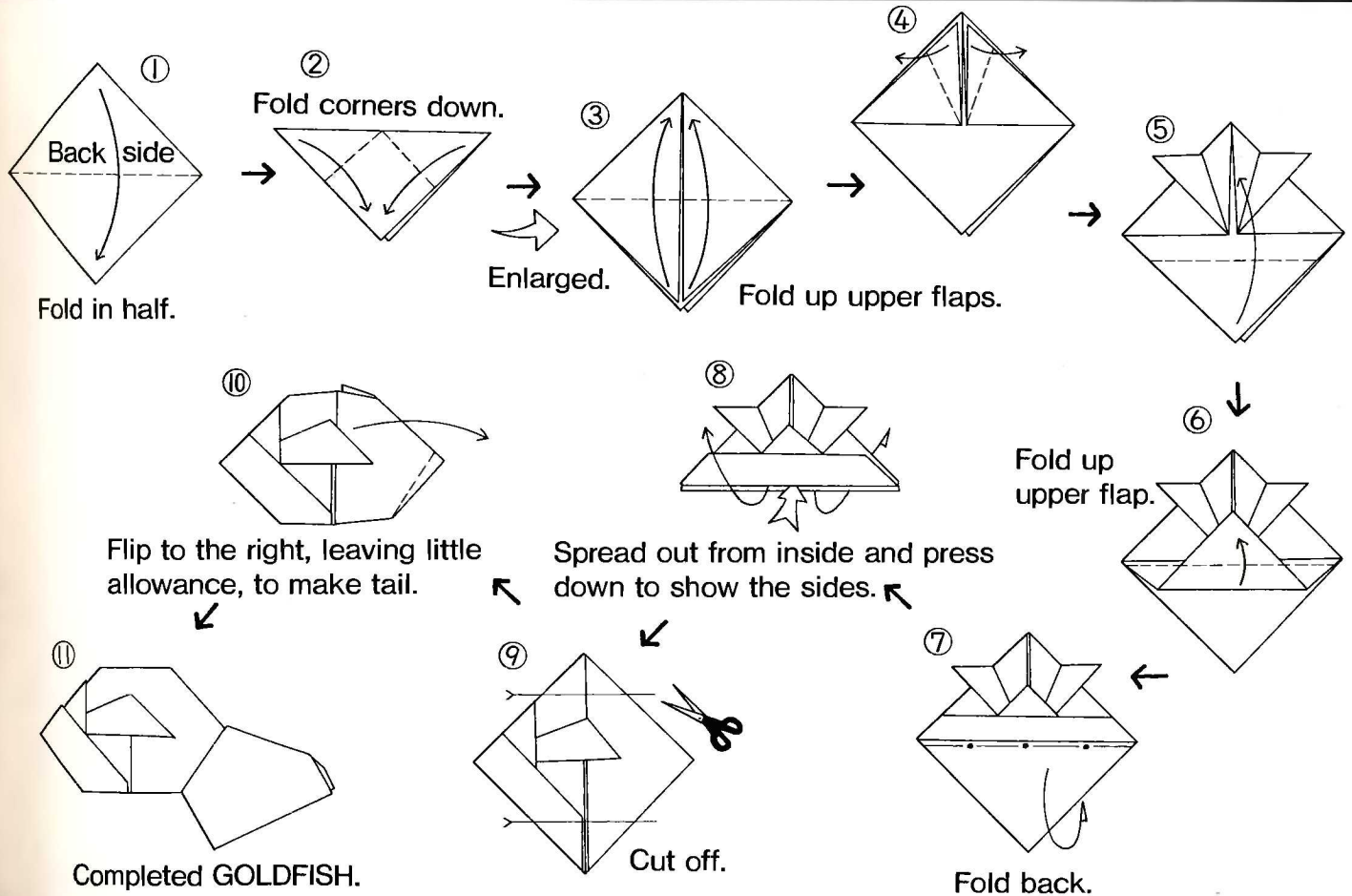

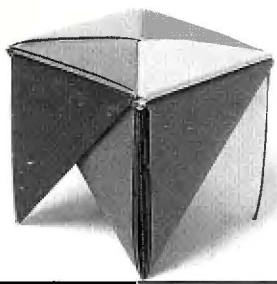

#2 & #3 ORNAMENT STAND (P.6)

Completed

#2: 1 3/4" high

#3: 2 3/4" high

Materials #2: 12 3" x 6" rectangles of origami paper (gradated color)

#3: 12 4 3/4" x 9 1/2" rectangles of origami paper (6 colors)

Note The completed project may look different depending on the thickness of the paper used.

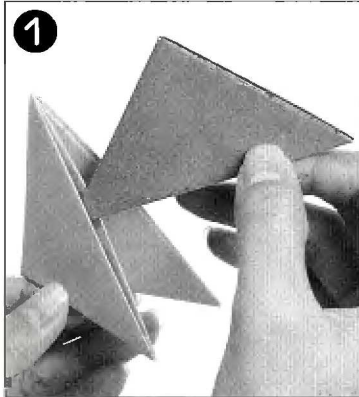

Holding the first piece double pocket facing left, insert the points of the second piece into the longer pockets, not too deeply.

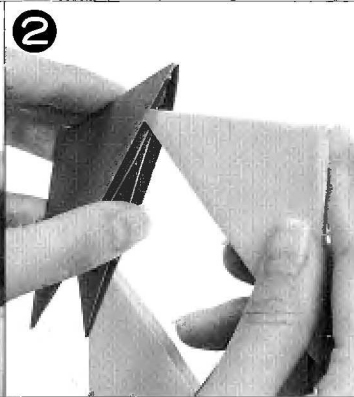

Insert the third piece into the second.

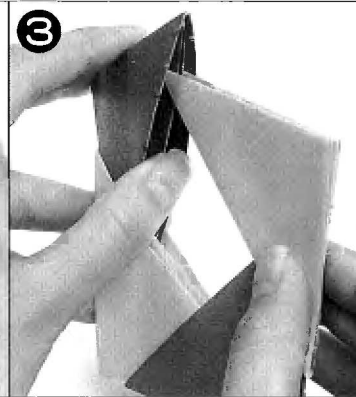

Insert the fourth piece into the third.

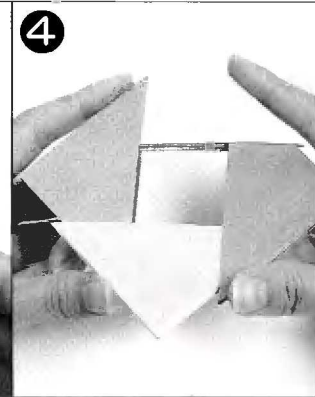

Insert the points of the first piece into the fourth.

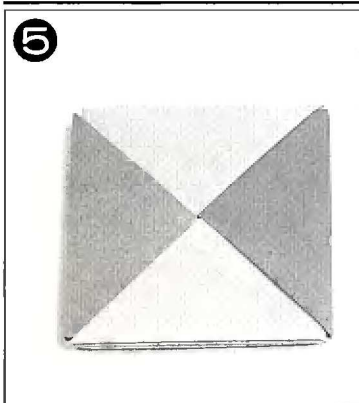

Push the corners inward to make table top.

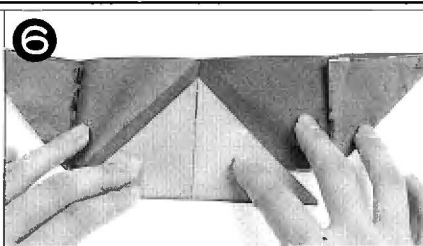

Make legs. Unfold a triangular piece. Place another unfolded piece in the center.

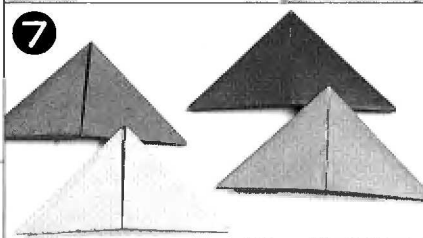

Fold again to make reinforced leg. Make 4.

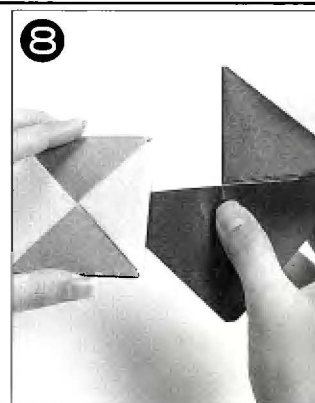

Unfold one triangle of a leg and insert into the lower pocket of table top.

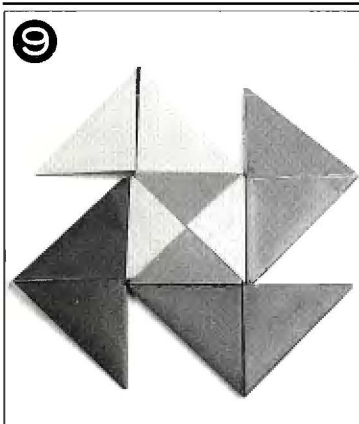

Repeat with the remaining legs.

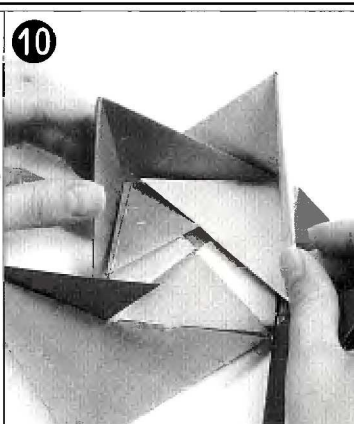

Bring the triangular flap onto the "table top". Repeat with remaining legs.

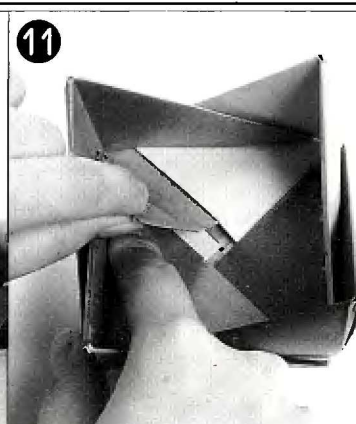

Insert the final flap under the first triangle.

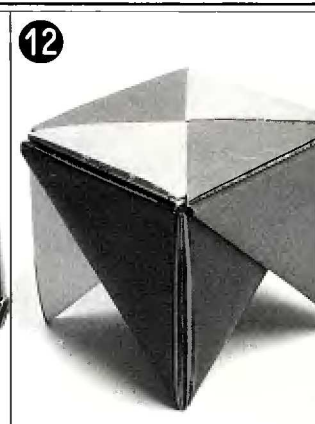

Completed ORNAMENT STAND.

#7 & #8 CHRISTMAS TREE (P.7)

Completed size
#7: 5" high
#8: 4" high



- Materials**
- #7: 9 3" x 6" rectangles of origami paper (dark green)
 - 1 3" x 6" rectangle of origami paper (brown)
 - #8: 5 3" x 6" rectangles of origami paper (green)
 - 1 3" x 6" rectangle of origami paper (brown)
 - 11 sequins and beads

Make trunk

See left, ① to ⑥.

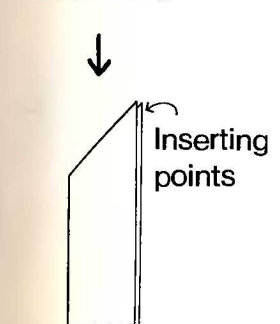
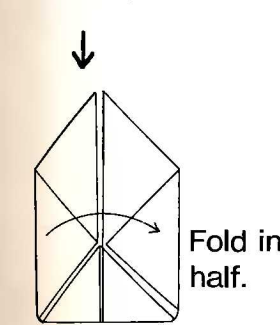
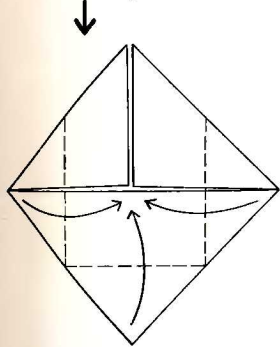
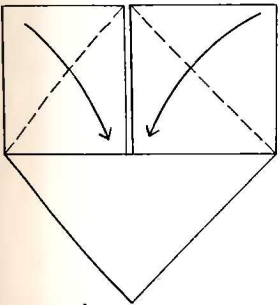

Make triangles for leaves.

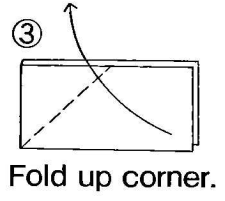
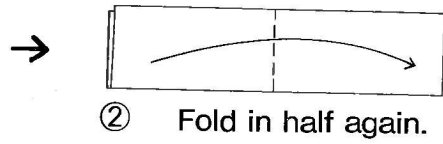
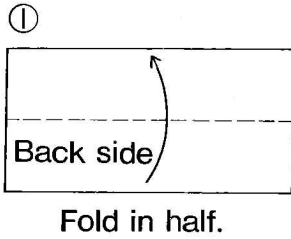

⑦ Fold corners in.

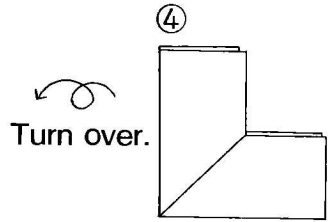
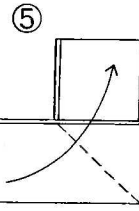
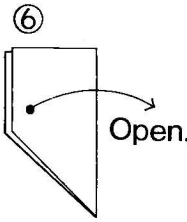
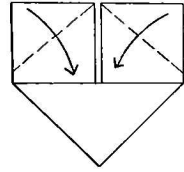

Tuck in corner.

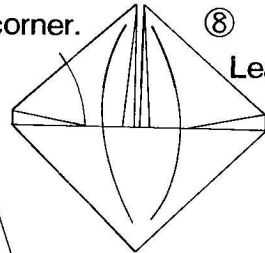

⑨ Fold in half.

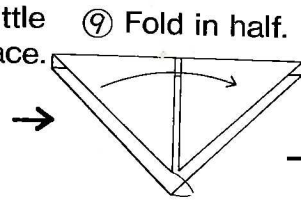

⑩ Completed piece

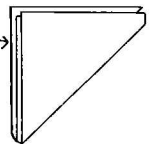

9 pcs. are used for FIR TREE.

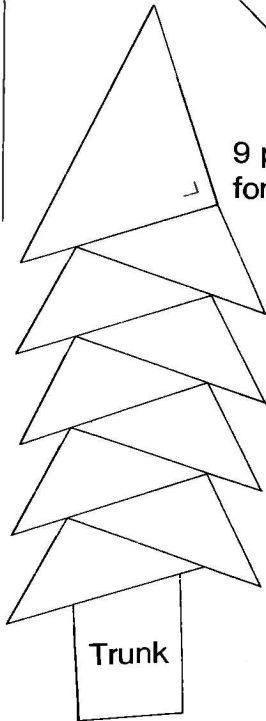

FIR TREE

Glue on sequins and beads.

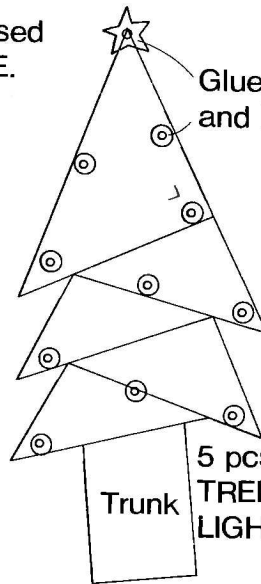

5 pcs. are used for TREE WITH LIGHTS.

TREE WITH LIGHTS

Trunk assembly

Insert and glue.

Double pocket

Double pocket

Double pocket

#16-#19 GOLDFISH (P.10)



Completed size #16 & #17: 2" wide, 5" long #18 & #19: 1 1/8" wide, 3 1/8" long

Materials #16: 16 3" x 6" rectangles of origami paper (gradated color)

12 3" x 6" rectangles of origami paper (solid)

#17: 28 3" x 6" rectangles of origami paper (assorted colors)

#18 & #19: 28 1 3/4" x 3 3/4" rectangles of glossy paper (from magazine)

2 1/4" diam. plastic eyes each

* See opposite page for diagram.

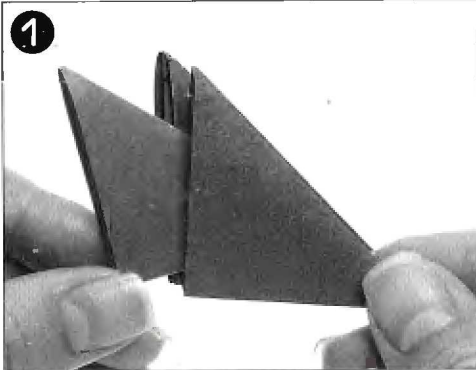

Hold the first piece double pocket facing the left, and insert its points into the adjoining pockets of two pcs. to form Row 2.

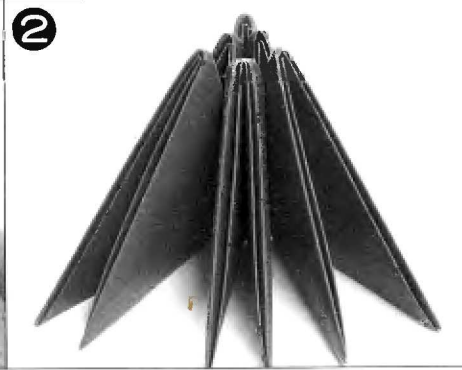

Insert into 3 pcs. to make Row 3.



Join 4 pcs. as Row 4, then 5 pcs. as Row 5.



Join 4 pcs. as Row 6. Open side triangles of Row 5 to form fins.

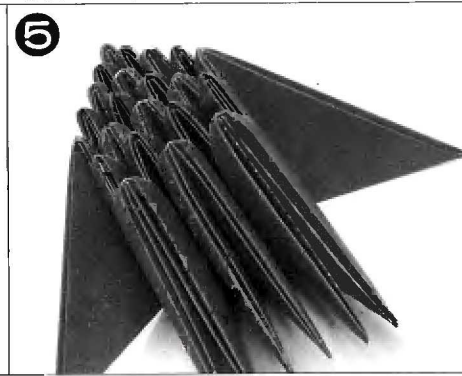

Join 3 pcs. as Row 7. Insert side flaps of Row 6 into the outer pockets.



Insert the center 4 points into 1 pc. to form Row 8.

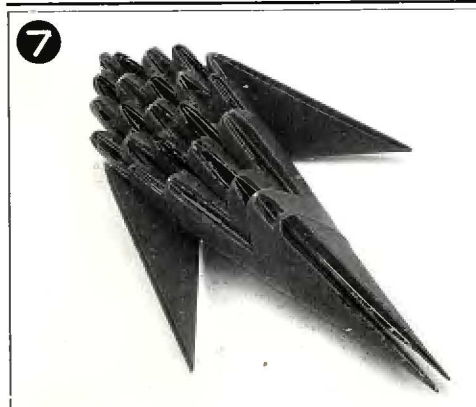

Insert all points into 1 pc. Repeat Row 10 so the tail tapers.

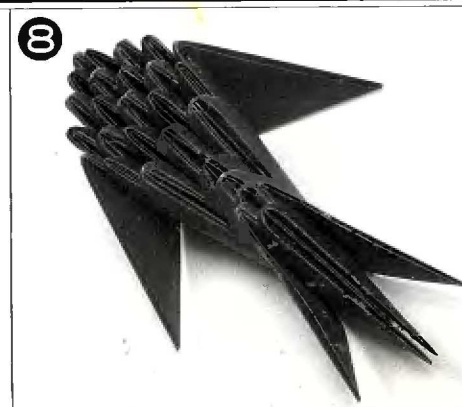

Make tail fin: Join 2 pcs. to make Row 11, and 1 pc. for Row 12.



Glue on eyes to finish.

#28-#30 TOOTHPICK HOLDER (P.15)

Completed size #28 & #30: 2" high, 1 1/4" wide #29: 2 1/2" high, 2" wide

Materials #28: 64 1 1/2" x 3" rectangles of patterned washi paper

5 1 1/2" x 3" rectangles of solid washi paper

#29: 69 1 3/4" x 3 3/4" rectangles of glossy paper (from magazine)

#30: 69 1 1/2" x 3" rectangles of patterned washi paper

Note The completed project may look different depending on the thickness of the paper used.



#16-#19 GOLDFISH & FISH

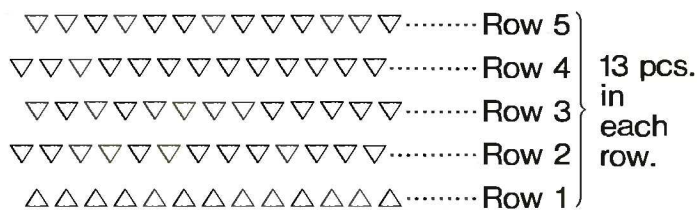
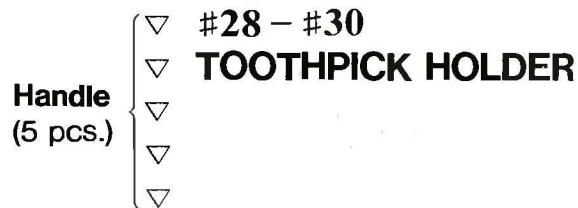
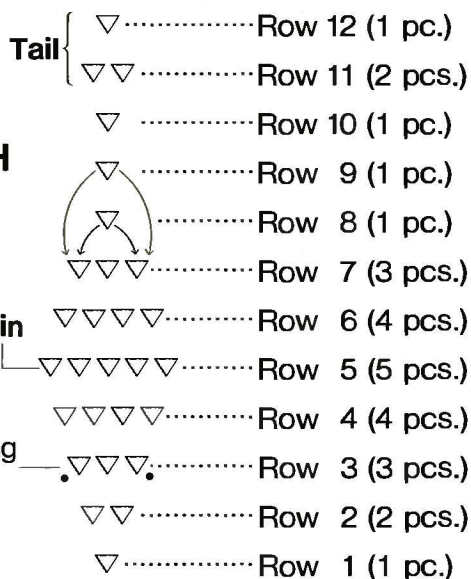

Join ends to form a ring of 13 pcs.

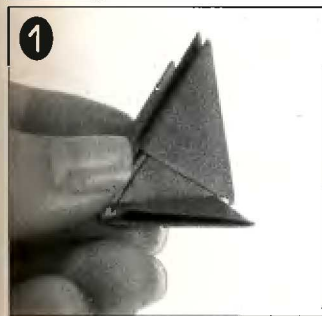

1 Hold a pair of pieces, double pockets down and the right angles away from you. Join them with a piece, the right angle facing you. Repeat to make 6 3-pc sets.



2 Join all sets by inserting adjoining points into a new piece.



3 Join into a ring. 13 pcs. are used for Row 1.



4 Rows 3-5: Join in the same direction. The center of bottom is somewhat twisted.



5 Insert any 2 adjoining points into a piece of handle.



6 Secure handle with glue.

#20 SOARING CRANE (P.10)

Completed 8" wide, 6 1/4"

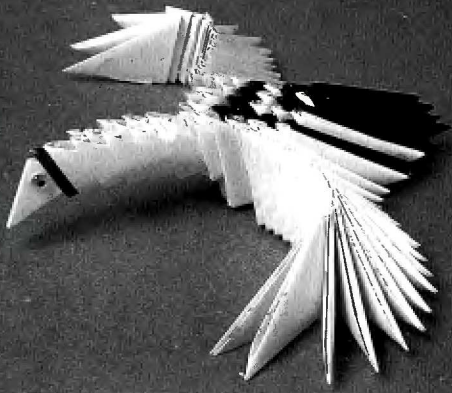

Materials

- 53 3" x 6" rectangles of origami paper (white)
- 15 3" x 6" rectangles of origami paper (black)
- 16 2" x 3 1/2" rectangles of origami paper (white)
- 1 2" x 3 1/2" rectangle of origami paper (red)
- 2 1/4" diam. plastic eyes

Note

The completed project may look different depending on the thickness of the paper used.

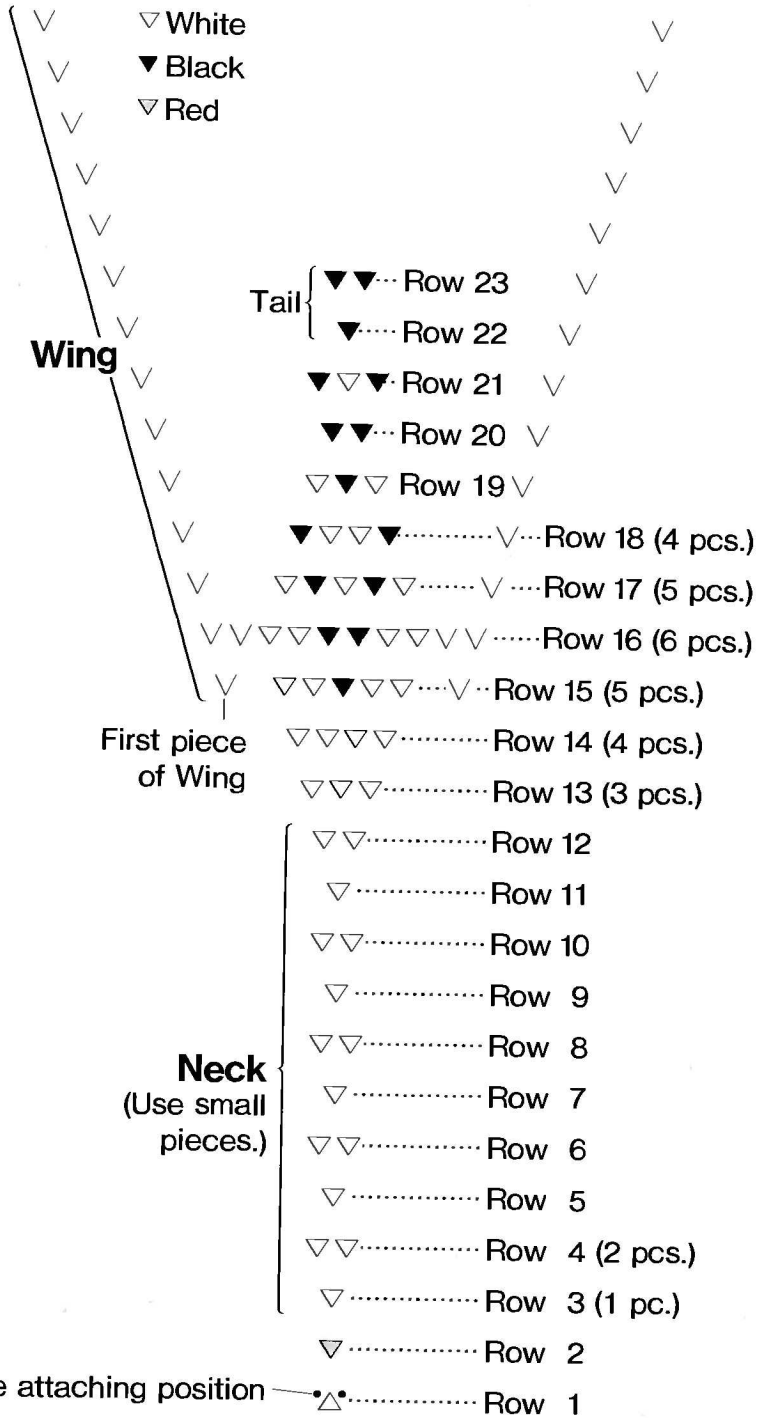

Head/Neck

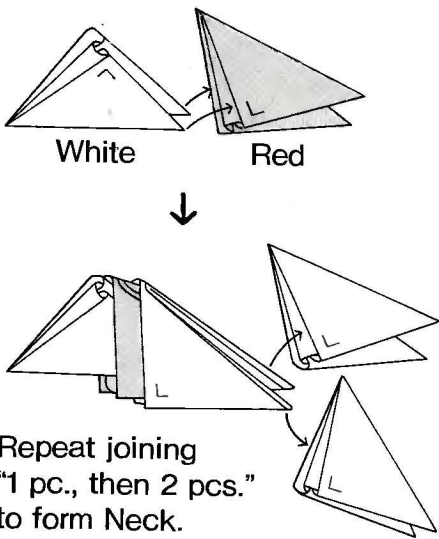

Signs for piece direction

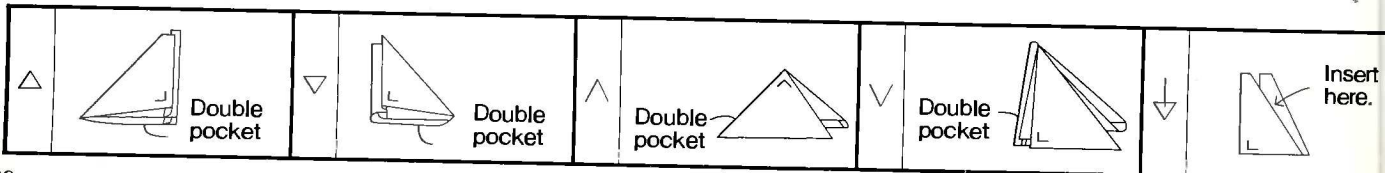

#23 SWALLOW (P.11)

Completed size
6" wide, 6" long



Materials

61 3" x 6" rectangles of origami paper (black)
24 3" x 6" rectangles of origami paper (gradated gray)
2 1/4" diam. plastic eyes

Note

The completed project may look different depending on the thickness of the paper used.

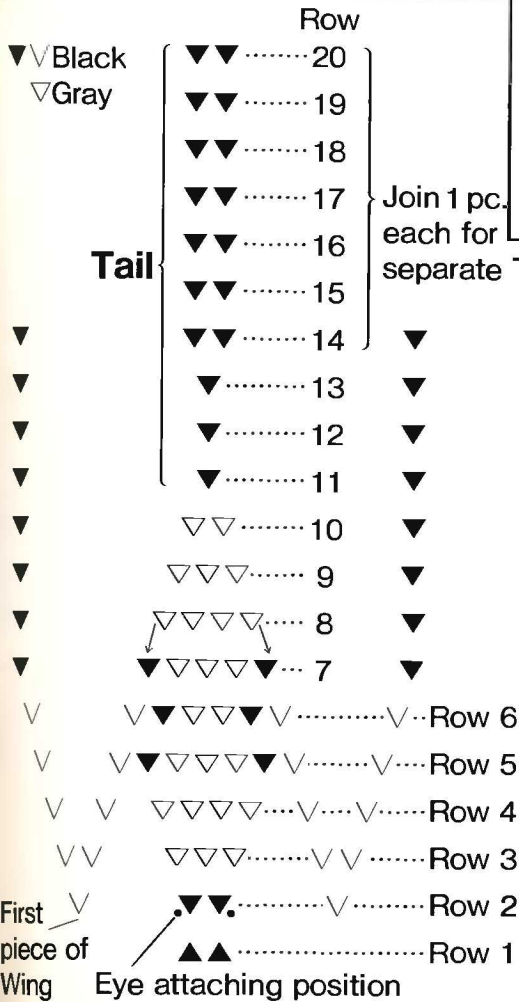

Head

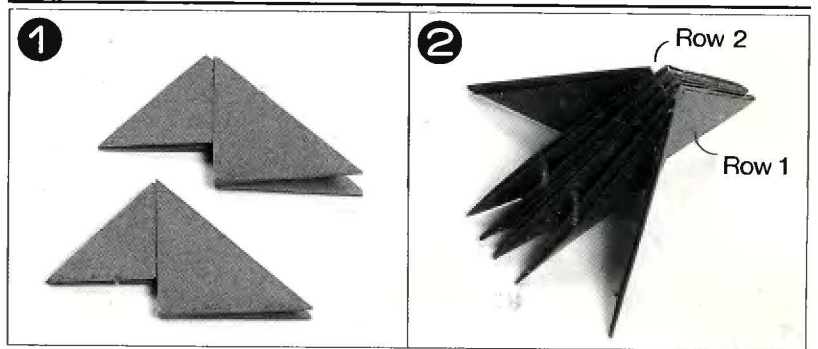
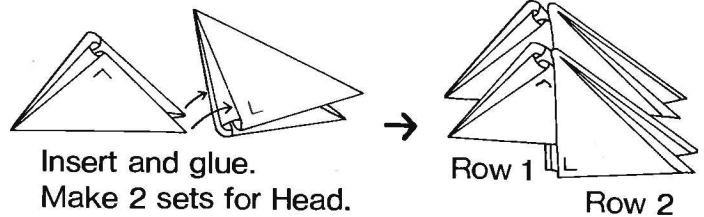

Make head referring to figure above. Make 2 sets.

Join 3 pcs. to form Row 3.



3
Rows 4-7:
Work as directed above.
Row 8:
Join by covering side flaps of previous row.

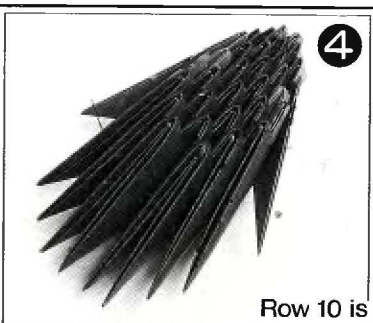

Row 10 is done.



5
Make tail base by joining 1 pc. in the next 3 rows.



6
Split the tail and join 1 pc. each in Row 7.

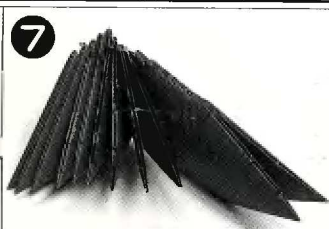

7
Make wing. Insert 1 basic piece into 2 pcs. Join 1 pc. only to one side for Row 4, inserting the point into outer pocket. Join 1 pc. covering previous row in Row 8.

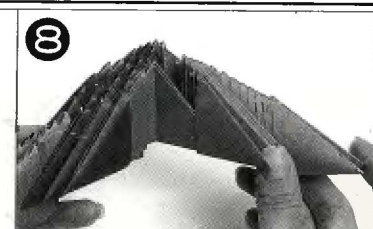

8
Make 2 wings. Join by inserting side flap of Row 5 into the wing.



9
Attach eyes to finish.



#26 & #27 BASKET (P.14)

Completed size:
6 1/4" wide, 8" h

Materials (for each item)
163 2 3/4" x 6" rectangles of patterned paper

Note
The completed project may look different depending on the thickness of the paper used.

* Basket and hat are made in a similar way. The procedure is the same until Step 5, on the opposite page.

BASKET

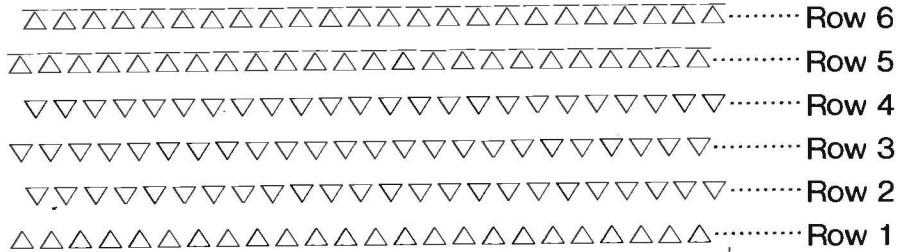

Join ends to form a ring of 24 pcs.

Make a pair and join with top pc.

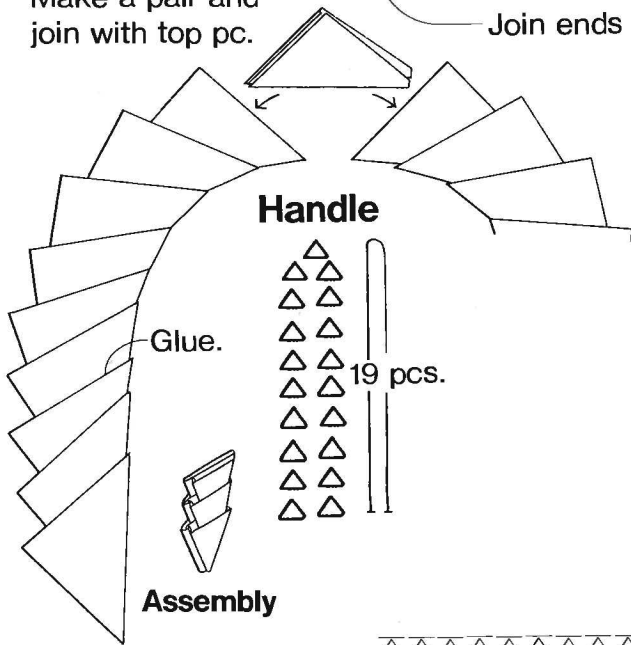

△ assembly

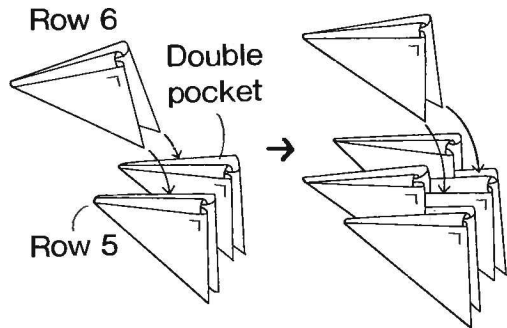

Insert between 2 pcs. to increase to 48 pcs.

HAT

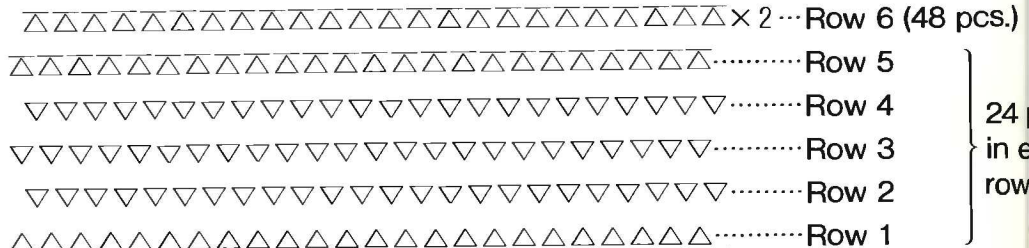

Join ends to form a ring of 24 pcs.

Signs for piece direction

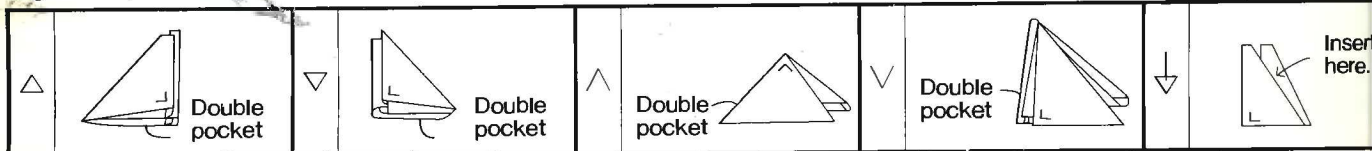

#31-#33 HAT (p.15)

Completed size

#31 & #32: 6¼" wide, 3⅛" high

#33: 3½" wide, 2" high

Materials

#31: 168 3"×6" rectangles of origami paper (blue)

#32: 168 3"×6" rectangles of origami paper (black)

#33: 168 1¼"×3¾" rectangles of glossy paper (from magazine)

Note

The completed project may look different depending on the thickness of the paper used.



Apply glue onto tips and join 6 pcs. Make 4 sets.

Join into a ring by gluing points.

Insert each 24 pcs. for Rows 2-4.

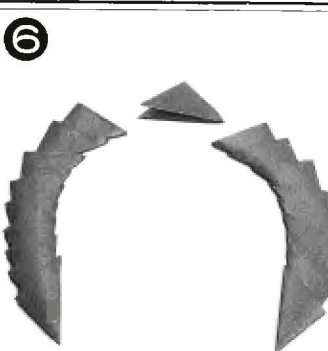

Join Row 5 by holding a piece double pocket facing up and the right angle facing in.

Work Row 6 in the same manner. (Proceed to Step 9 for HAT.)

Make handle referring to the figure on the opposite page.

Insert ends of handle into BASKET and glue to secure.



Fill between pieces by inserting 1 pc., all around.

Check the shape and glue several hidden points to secure.

Tie ribbon around to finish.

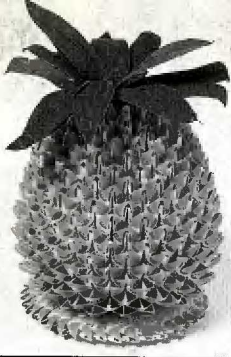

#34 & #35 PINEAPPLE (P.16)

Completed size
 #34: 5" wide, 6¾" high
 #35: 4½" wide, 5½" high

- Materials** #34: 375 2¾" × 6¾" rectangles of patterned paper (green)
 #35: 375 2¾" × 6¾" rectangles of patterned paper (orange)
 1 20" × 12" crepe paper (green)
 7 14" #28 wrapped wire (green)
 4" 1/12" thick craft wire
 60" 1/2" floral tape

* Materials except rectangular paper are for each item.

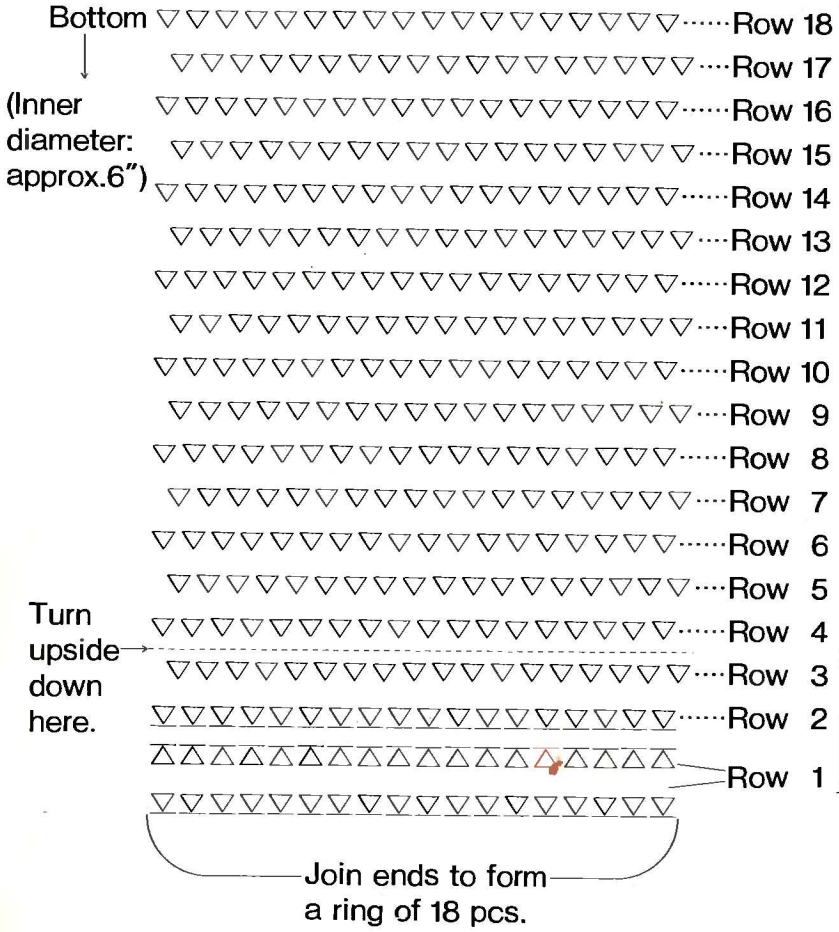

Leaf (Make 14 pcs.)

(Actual size)

Glue wire onto back side.

Fruit
 18 pcs. in each row

Pedestal assembly

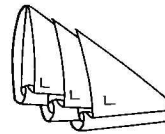

Wire can be attached front side

Row 1 to Row 2 assembly

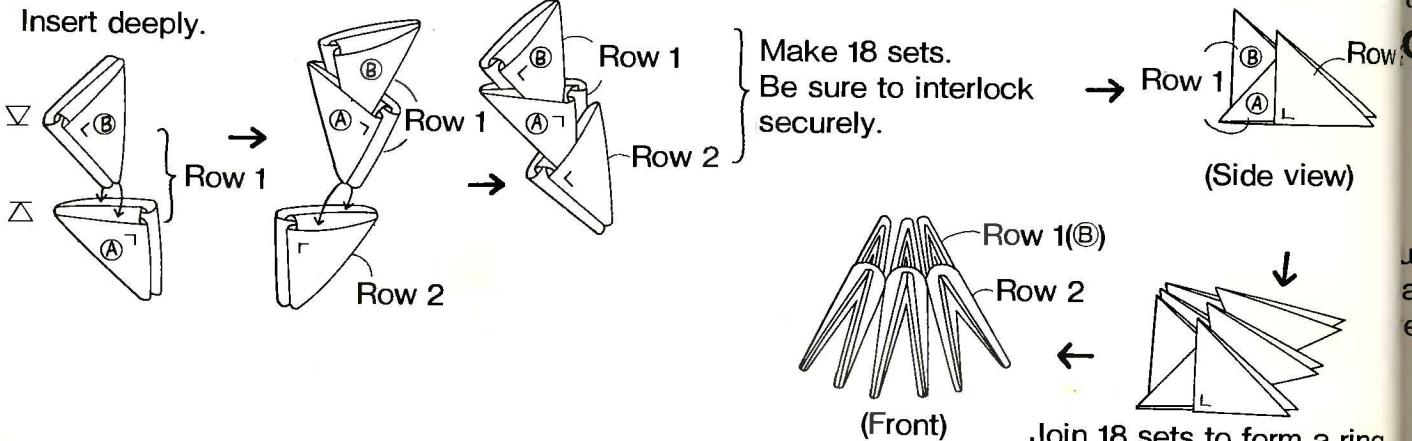

Join 18 sets to form a ring. (See Step 2, opposite page)

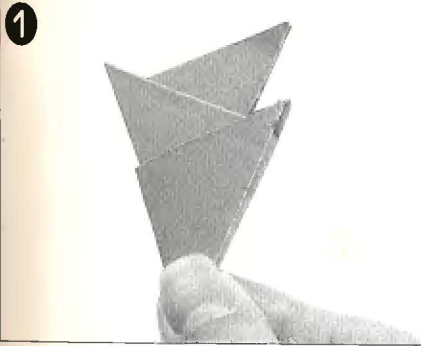

1 Referring to the figures on the opposite page, join 3 pcs. and glue to secure. Make 18 sets.

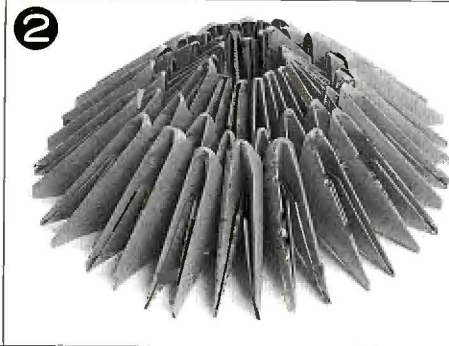

2 Join 2 sets by inserting their adjoining points into a new piece. Continue to form a ring.

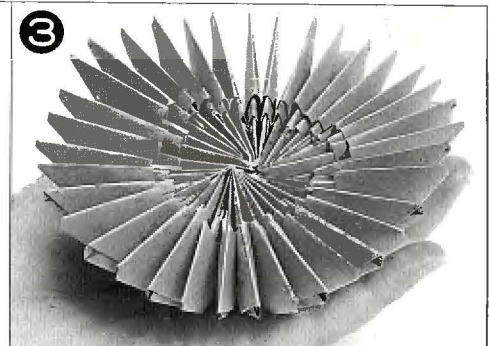

3 Turn over and hold in your hand.



4 For Row 4 to Row 18, join the pieces at an angle to form a pineapple shape.

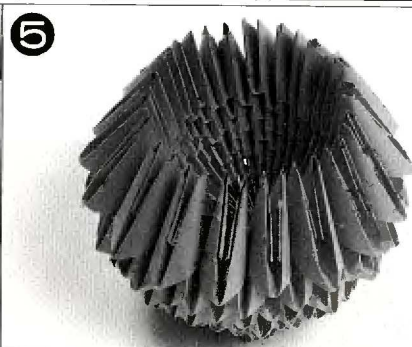

5 Row 18 is completed.

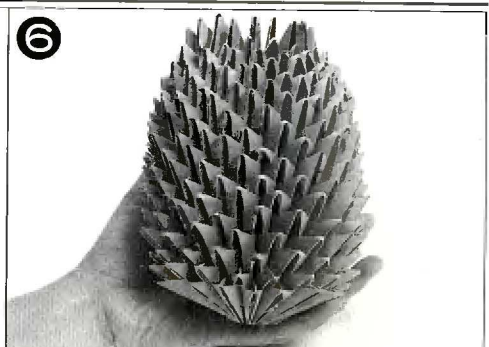

6 Turn upside down so the 1st row comes on top.

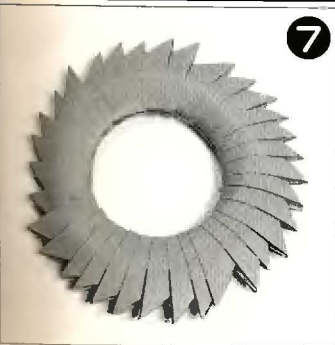

7 Make pedestal referring to the diagram on the opposite page.



8 Form leaves as illustrated below.

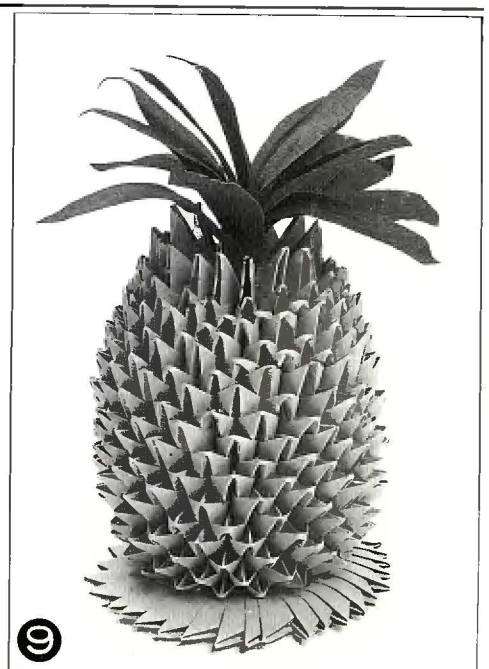

9 Insert stem into the top and place on the pedestal.

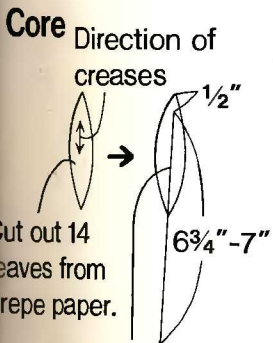

Cover top 1/2" with floral tape.

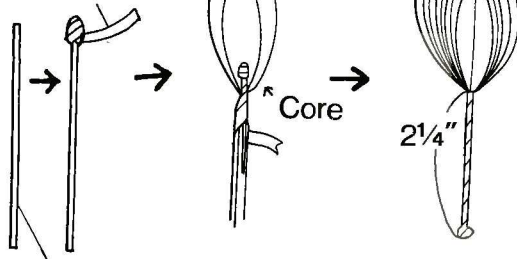

Glue wrapped wire onto back side.

Craft wire (2 3/4" - 3")

Using floral tape, attach leaves around wire, 2-3 pcs. at a time.

Add 2-3 leaves binding with floral tape. Repeat until all leaves are attached. Bind down the tape and make a lump at the end. Insert into the top of the fruit.



#36 & #37 MINI PINEAPPLE (P.16)

Completed size
 #36: 2" wide, 2³/₈"
 #37: 2¹/₄" wide, 2³/₈"

Materials #36: 118 1¹/₂" x 3" rectangles of origami paper (yellow)
 26 1¹/₂" x 3" rectangles of origami paper (green)
 12 1¹/₂" x 3" rectangles of origami paper (brown)
 #37: 123 1¹/₂" x 3" rectangles of origami paper (yellow, 4 colors)
 28 1¹/₂" x 3" rectangles of origami paper (green)
 21 1¹/₂" x 3" rectangles of origami paper (brown)
 10 1¹/₂" x 3" rectangles of origami paper (pale green)

#37
 ▼ Yellow
 ▼ Brown
 ▼ Pale green

#36
 ▼ Yellow
 ▼ Brown

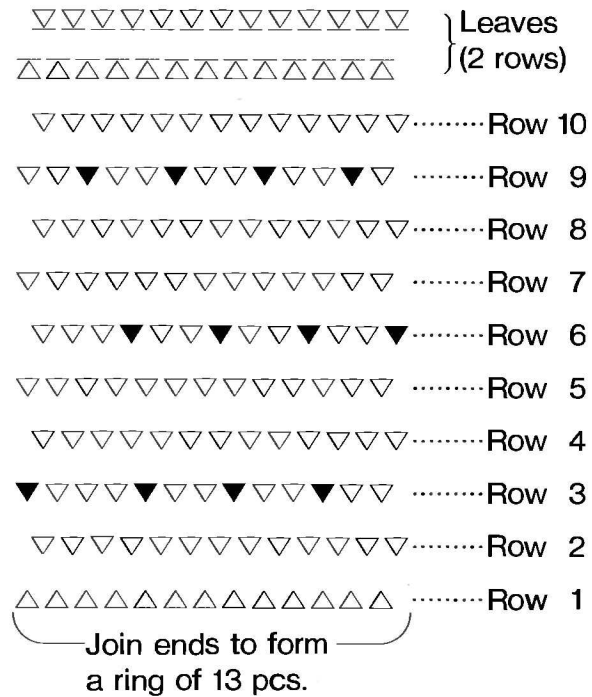
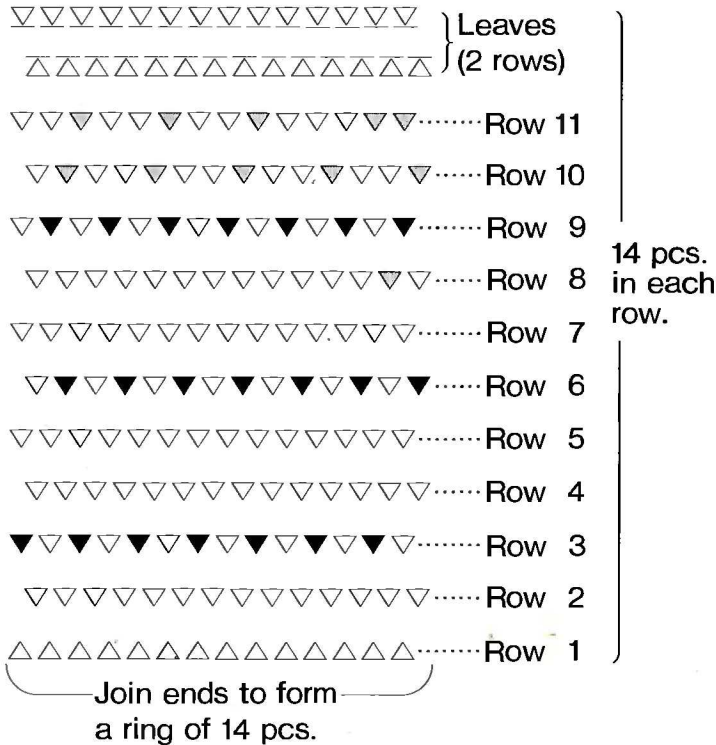

Signs of direction

Leaf assembly

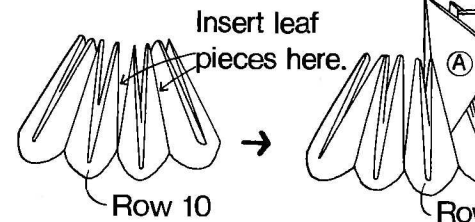
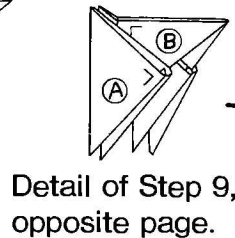
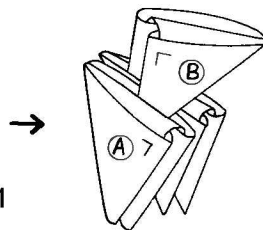
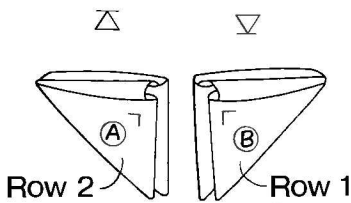

Signs for piece direction

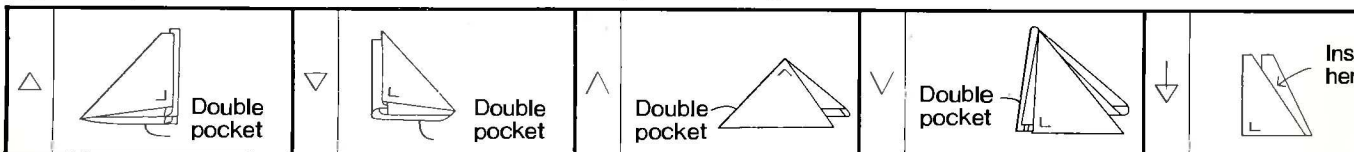

#37 MINI PINEAPPLE (P.16)



1 Hold a pair of pieces, double pockets down and the right angles away from you. Join them with a piece, right angle facing you.



2 Make another set, and join them with 1 piece.

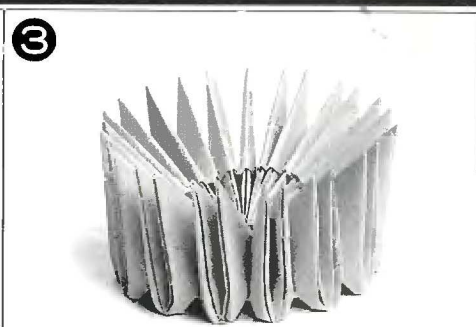

3 Repeat and join into a ring. The center of bottom can look somewhat twisted.

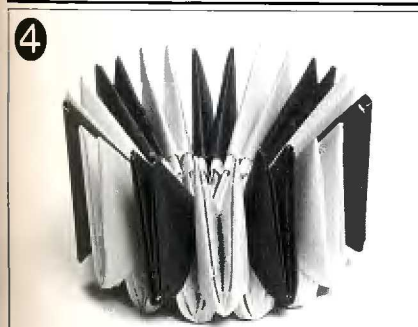

4 Row 3: Insert yellow and brown pieces alternately, all around.



5 Rows 4-5: Join yellow pcs. all around. Row 6: Work the same as Row 3.



6 Row 7: Join yellow pcs. all around. Row 8: Join yellow pcs., plus one pale green.



7 Row 9: Work the same as Row 2.



8 Rows 10-11: Work as directed in the diagram shown on the opposite page.



9 Make top: Interlock 3 green pcs. as shown on the opposite page. Make 7 sets.



10 Insert each set of leaves into the fruit as shown on the opposite page.



11 Join 2 adjacent sets by inserting a new piece all around.

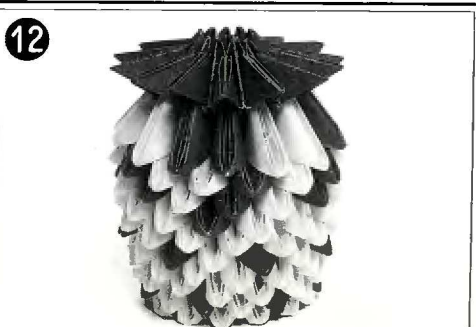

12 Check the shape of leaves and glue to secure.

#38 WATERMELON (P.17)

Completed size
4" wide, 4 3/4" high

- Materials** 114 1 1/2" x 3" rectangles of origami paper (red)
 66 1 1/2" x 3" rectangles of origami paper (green)
 17 1 1/2" x 3" rectangles of origami paper (white)
 16 1 1/2" x 3" rectangles of origami paper (black)

Note The completed project may look different depending on the thickness of the paper

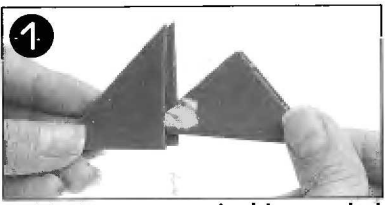
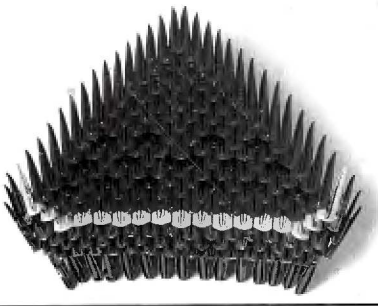

Hold 1 pc. so double pocket faces right. Apply some glue onto points of another piece and insert into the pockets.

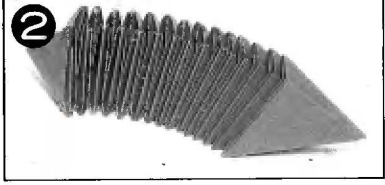

Repeat until Row 1 and 2 are constructed.



Row 3: Join 15 pcs., tucking in side flaps of the bottom row.

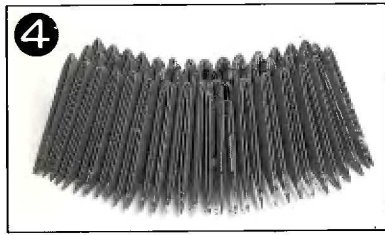

Join Rows 2 and 3 as directed. (Turn upside down)

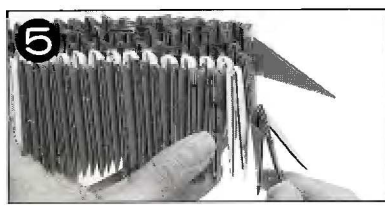

Work Row 5 by changing colors as directed in the diagram, and add 1 green pc. to each side.

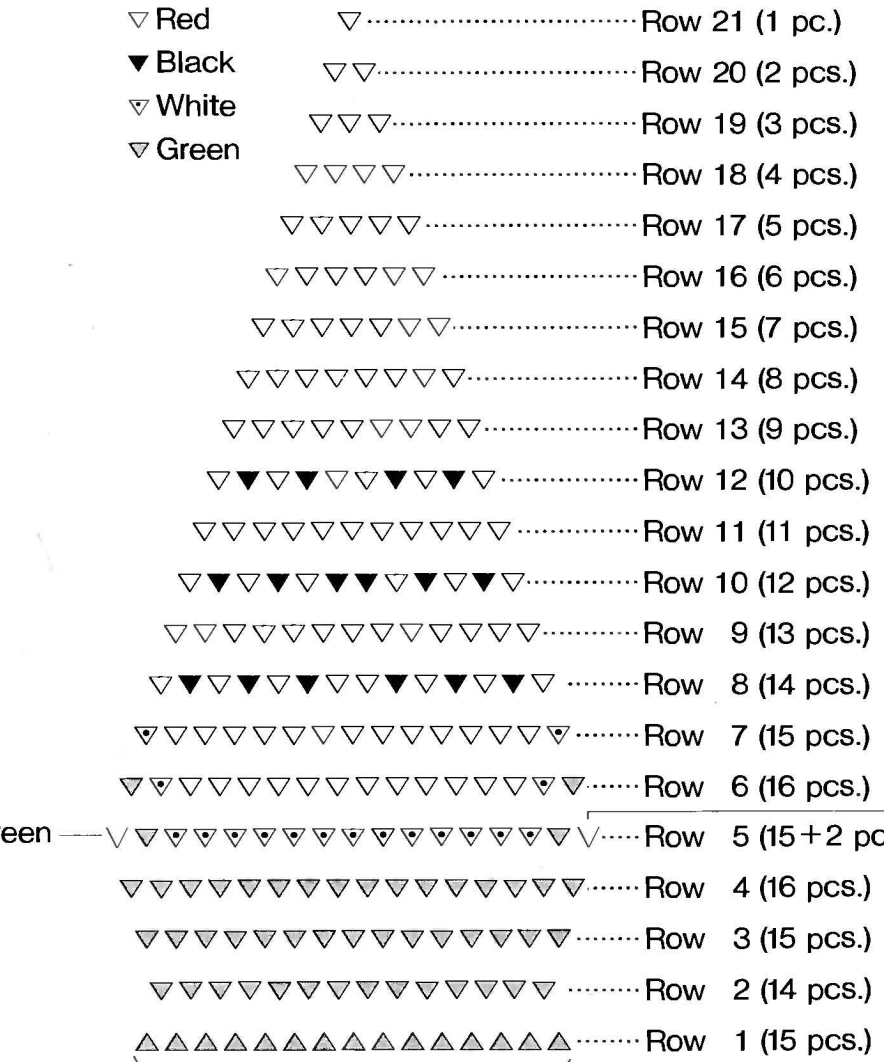

Join ends to form a ring of 15 pcs.



Row 6: Work as directed.
 Row 7: Work with white and red.
 Row 8: Work with red and black.

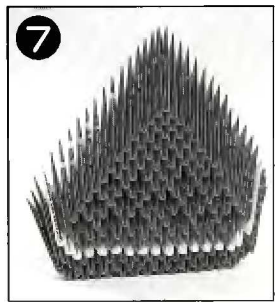

Rows 9-21: Work as directed in the diagram. Glue green pieces to each other to finish.

#40 STRAWBERRY (P.17)

Completed size
1 3/4" wide, 2" long

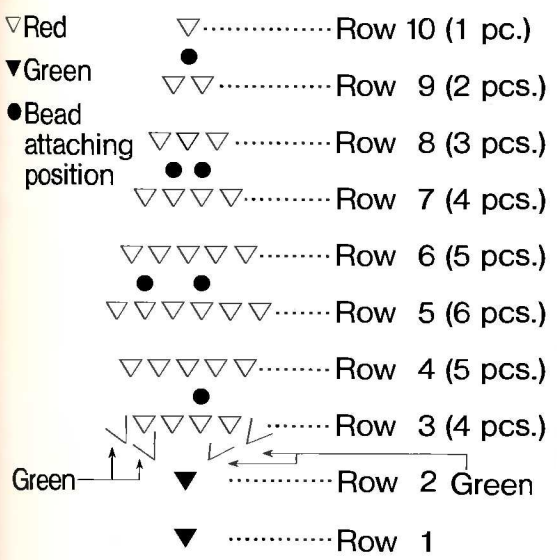

Materials (for 3 strawberries)
 90 1 1/2 x 3" rectangles of origami paper (red)
 18 1 1/2 x 3" rectangles of origami paper (green)
 18 black beads
Note
 The completed project may look different depending on the thickness of the paper used.

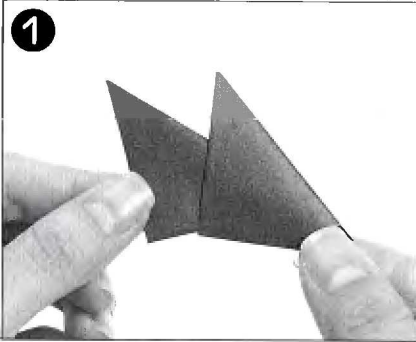

1 Holding 2 green pcs., double folds down, and insert one into the other.

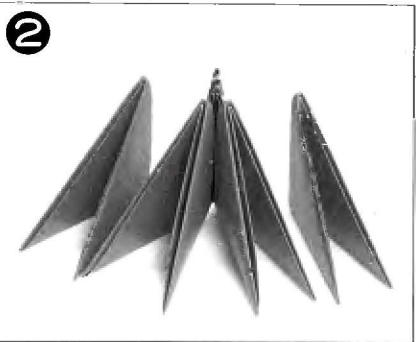

2 Insert points of green into double pockets of 2 red pcs. Place 1 pc. on each side.



3 Join them with 5 pcs. to complete Row 5.



4 Join 6 pcs. to complete Row 6.

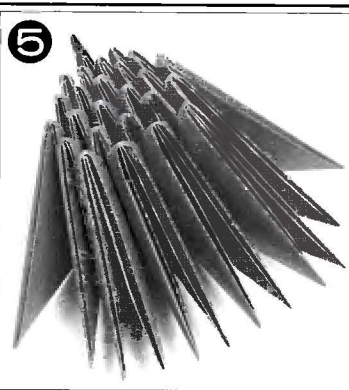

5 Row 7: Join 5 pcs. Row 7: Join 4 pcs.



6 Row 8: Join 3 pcs.

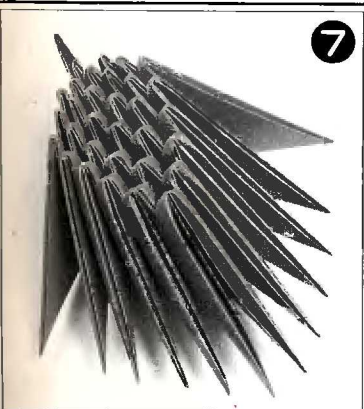

7 Row 9: Join 2 pcs. Row 10: Join 1 pc.

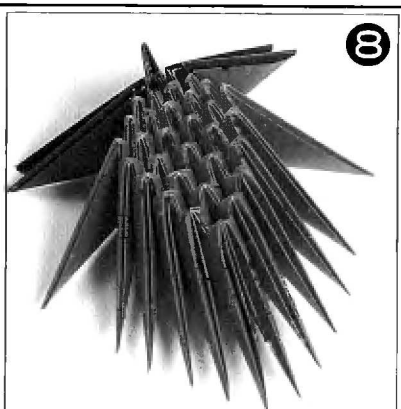

8 Make top: Insert a point of green piece into Row 3. Add 3 more green pcs.



9 Glue on black beads to finish.

#41-#43 ELEGANT CRANE (P.18)

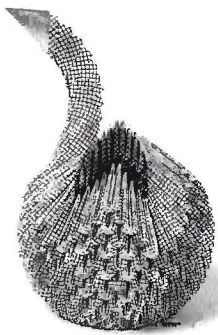

Materials

- #41: 388 1"×2" rectangles of origami paper (gold *washi*)
 4 1"×2" rectangles of origami paper (silver *washi*)
 #42: 329 1½"×3" rectangles of origami paper (gradated red *washi*)
 62 1½"×3" rectangles of origami paper (gold *washi*)
 1 1½"×3" rectangle of origami paper (silver *washi*)

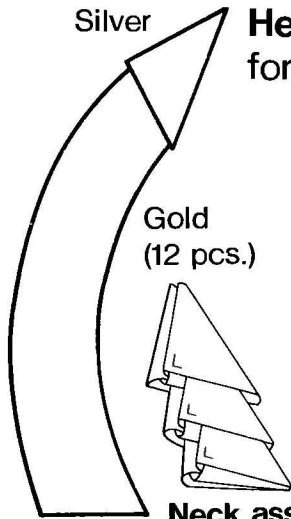

Head/Neck for #41

▽ Red for #42

▼ Gold for #42

Use gold for the Body of #41.

#41 & #42

Wing

Head attaching position

Tail

Use 3 silver pcs. for #41.

Chest ▼

Wing ▼

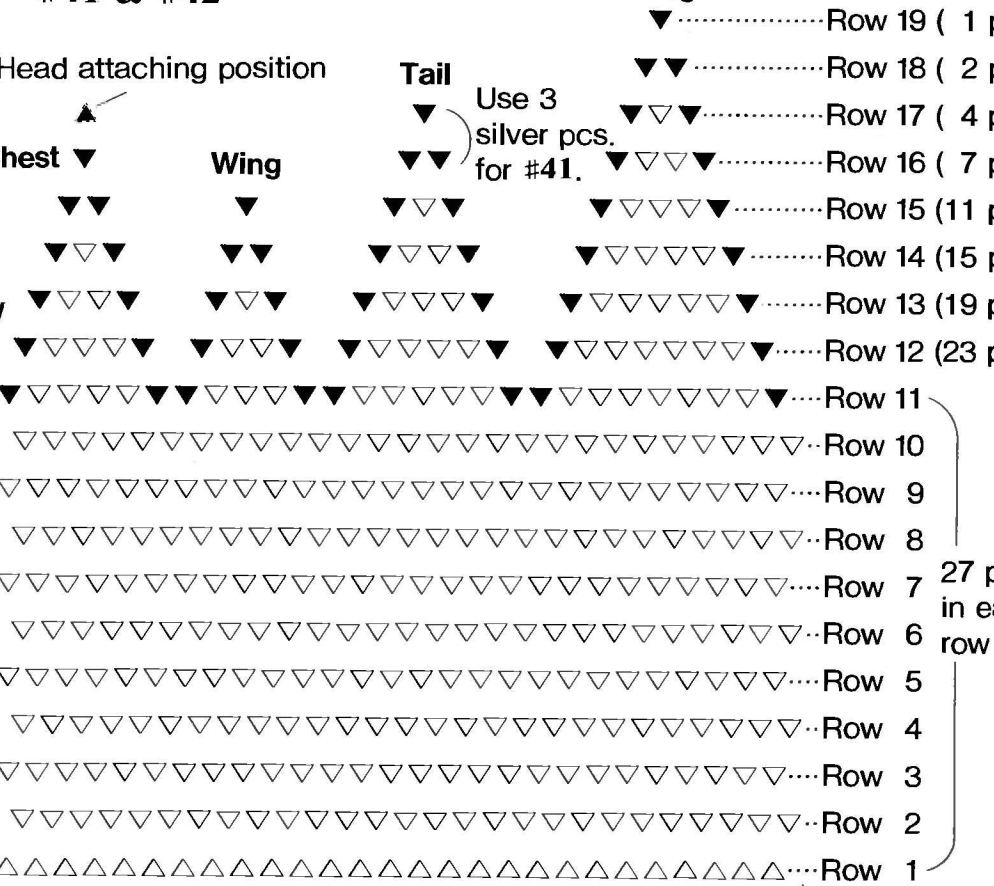

(Actual size)

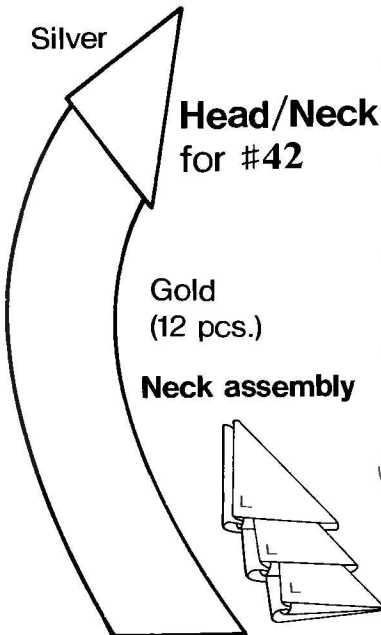

Head/Neck for #42

27 pcs in each row

Join ends to form a ring of 27 pcs.

In Row 11, divide pieces into four groups:
 6 pcs. for Chest, 5 for Left wing, 7 for Tail, and 9 for Right wing.

Signs for piece direction

➡ See P.50 for step-by-step instruction

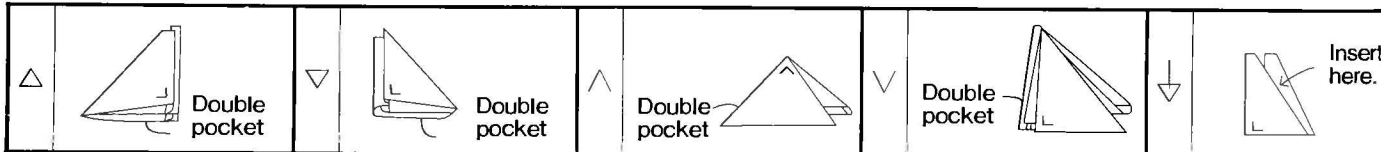

- #43: 60 1¼" × 3½" rectangles of *washi* paper (red)
- 79 1¼" × 3½" rectangles of *washi* paper (green)
- 75 1¼" × 3½" rectangles of *washi* paper (purple)
- 74 1¼" × 3½" rectangles of *washi* paper (blue)
- 4 1¼" × 3½" rectangles of *washi* paper (gold)

Note

The completed project may look different depending on the thickness of the paper used.

➔ See P.50 for step-by-step instructions.

Head/Neck for #43

#43

- ▽ Red
- ▽ Purple
- ▽ Blue
- ▼ Green
- ▽ Gold

Head attaching position **Tail**

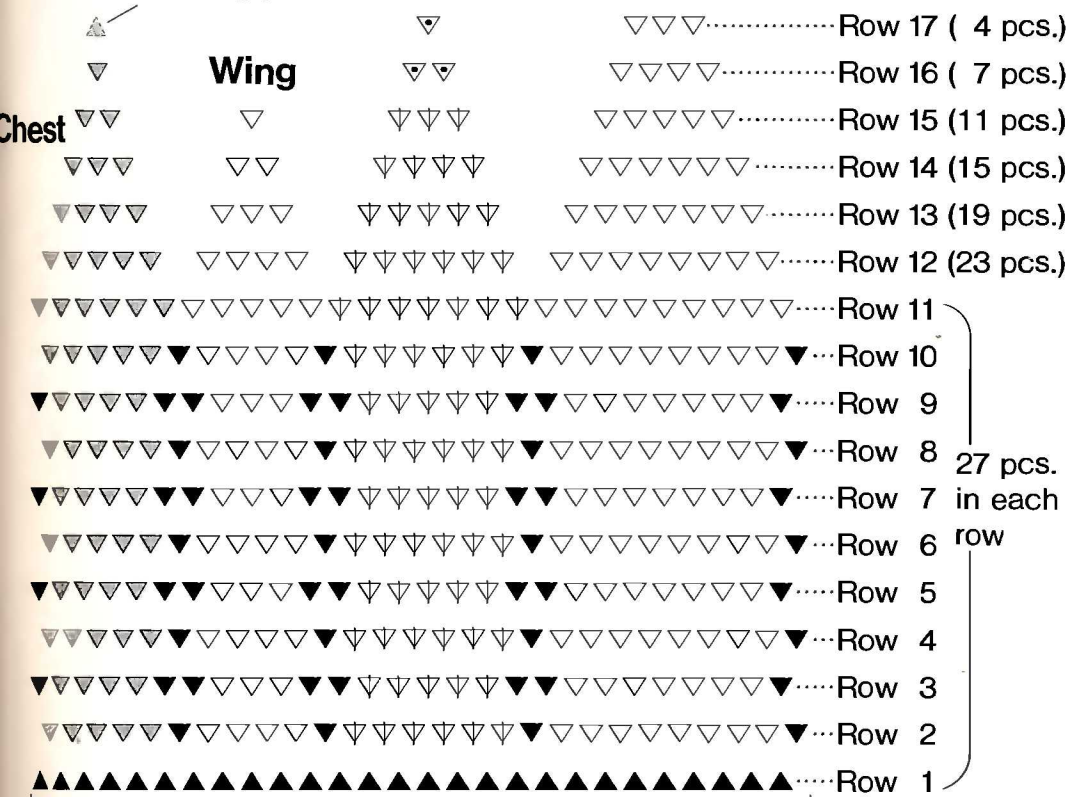

Join ends to form a ring of 27 pcs.

Wing

- ▽ Row 19 (1 pc.)
- ▽▽ Row 18 (2 pcs.)
- ▽▽▽ Row 17 (4 pcs.)
- ▽▽▽▽ Row 16 (7 pcs.)
- ▽▽▽▽▽ Row 15 (11 pcs.)
- ▽▽▽▽▽▽ Row 14 (15 pcs.)
- ▽▽▽▽▽▽▽ Row 13 (19 pcs.)
- ▽▽▽▽▽▽▽▽ Row 12 (23 pcs.)
- ▽▽▽▽▽▽▽▽▽ Row 11
- ▽▽▽▽▽▽▽▽▽▽ Row 10
- ▽▽▽▽▽▽▽▽▽▽▽ Row 9
- ▽▽▽▽▽▽▽▽▽▽▽▽ Row 8
- ▽▽▽▽▽▽▽▽▽▽▽▽▽ Row 7
- ▽▽▽▽▽▽▽▽▽▽▽▽▽ Row 6
- ▽▽▽▽▽▽▽▽▽▽▽▽▽ Row 5
- ▽▽▽▽▽▽▽▽▽▽▽▽▽ Row 4
- ▽▽▽▽▽▽▽▽▽▽▽▽▽ Row 3
- ▽▽▽▽▽▽▽▽▽▽▽▽▽ Row 2
- ▲▲▲▲▲▲▲▲▲▲▲▲▲▲▲ Row 1

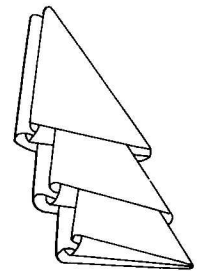
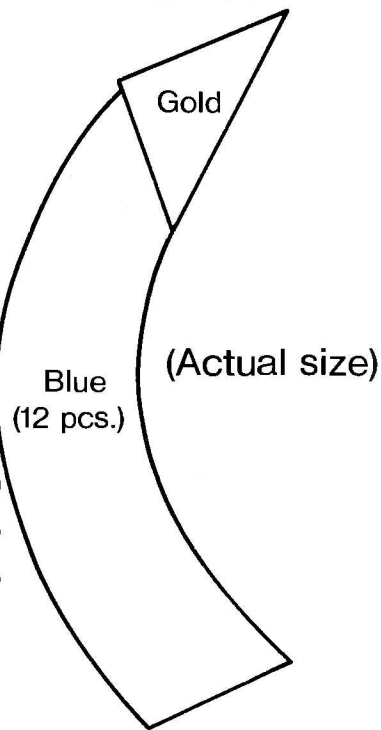

Neck assembly

In Row 11, divide pieces into four groups:
6 pcs. for Chest, 5 for Left wing, 7 for Tail, and 9 for Right wing.

#41-#43 ELEGANT CRANE (P.18)

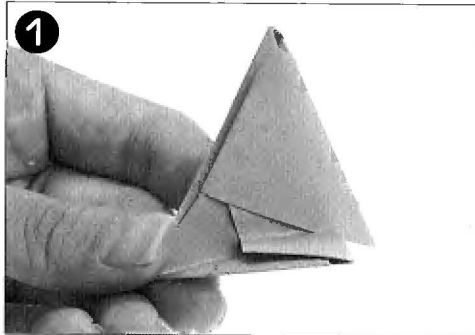

① Holding pieces double pockets down, interlock vertically, alternating the direction of the right angle, until 27 pcs. are joined.

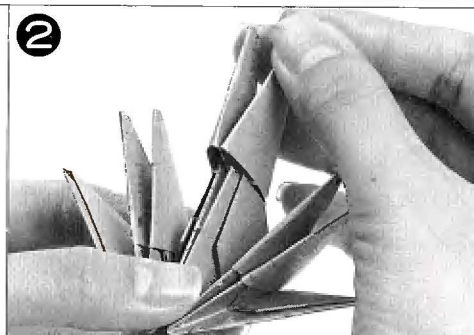

② Row 3: Cover adjoining points of Row 2 with 1 pc.

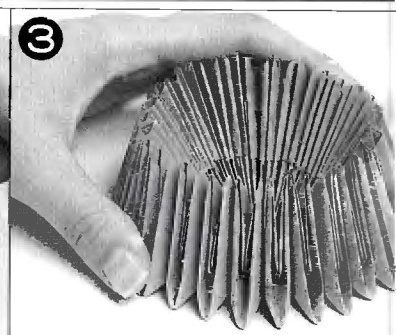

③ Continue all around to make a circle of 27 pcs. (See diagram on the previous page for color layout.)

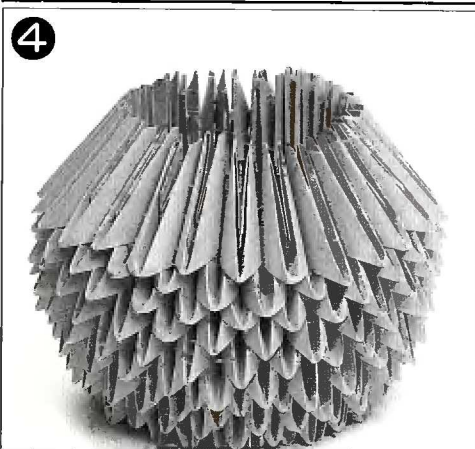

④ Work as directed in the diagram until 11 rows are done.

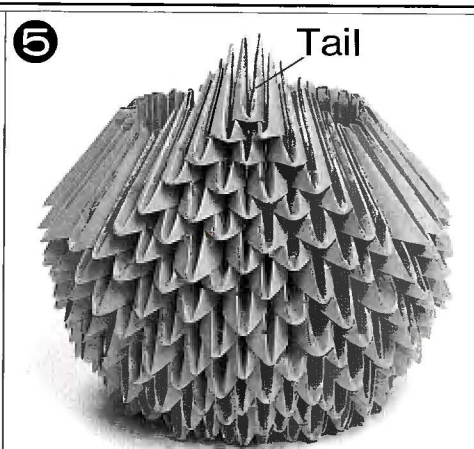

⑤ Divide pieces into chest(6), left wing(5), tail(7) and right wing(9). Work on tail part as directed.



⑥ Then work on the left wing.

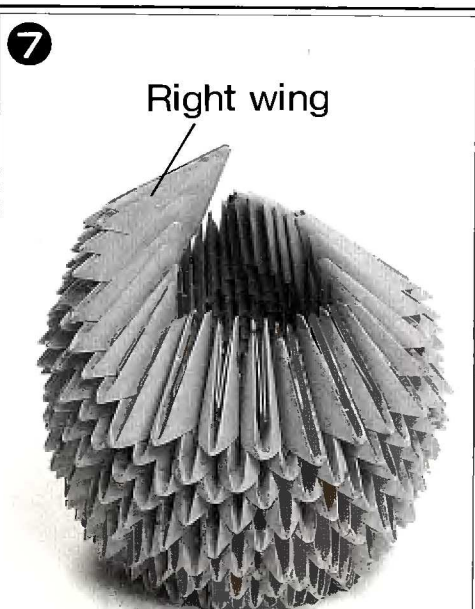

⑦ Work on the right wing.

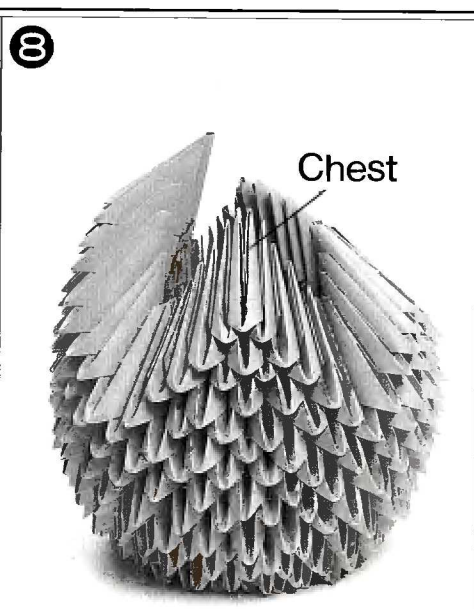

⑧ Work on the chest.

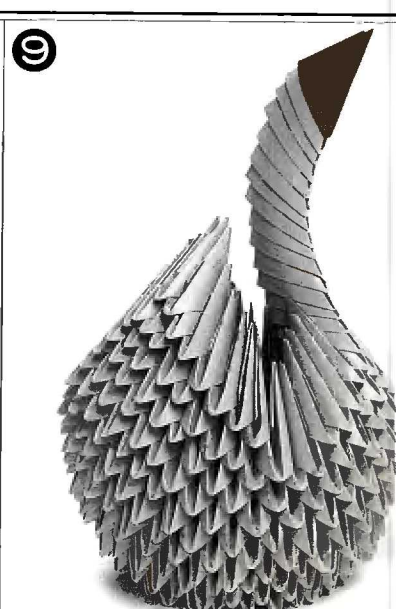

⑨ Make neck referring to the figure on the previous page, and insert into top of chest.

#9-#15 TORTOISE (P.8-9)

#9

Insert 1 pc. in the middle.

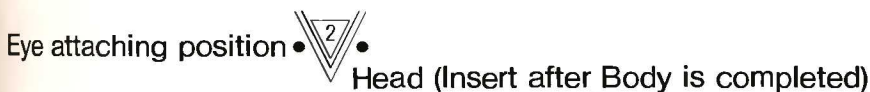
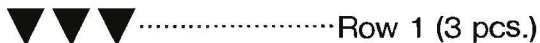
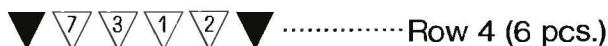
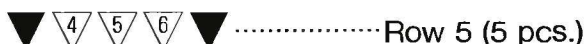
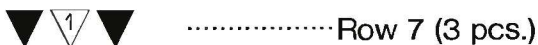
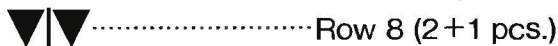

Eyes: Cardboard (black, cut into 1/8" diam. circles)

#10

Insert 1 pc. in the middle.

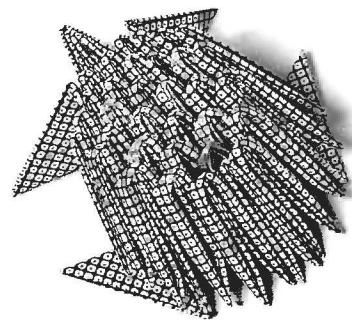
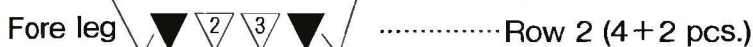
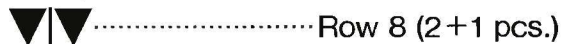

#9

Completed size

2 3/4" wide, 2 3/8" long

Materials

- 24 1 1/2" x 3" rectangles of origami paper (silver)
- 4 1 1/2" x 3" rectangles of origami paper (brown)
- 2 1 1/2" x 3" rectangles of origami paper (green, blue, black, purple, orange, gold)
- 2 1/8" diam. eyes (black cardboard)

#10

Completed size

2 3/4" wide, 2 3/8" long

Materials

- 25 1 3/4" x 3 1/2" rectangles of paper (green)
- 5 1 3/4" x 3 1/2" rectangles of paper (orange)
- 5 1 3/4" x 3 1/2" rectangles of paper (red)
- 2 1 3/4" x 3 1/2" rectangles of paper (blue)
- 2 1 3/4" x 3 1/2" rectangles of paper (purple)
- 1 1 3/4" x 3 1/2" rectangle of paper (gold)
- 2 1/8" diam. eyes (black cardboard)
- * Patterned *washi* paper is used here.

#11-#15

Completed size

2 3/8" wide, 2 3/8" long

Materials

- 40 1 1/2" x 3" rectangles of origami paper (blue for #11, red for #12, orange for #13, brown for #14, pale green for #15)
- 2 1/8" diam. plastic eyes each
- * Graded origami paper is used here.

◀ See P.8-9 for step-by-step instructions.

#52 & #53 RED CROWNED CRANE (P.21)

Completed size
 #52: 6" wide, 12" high
 #53: 5" wide, 10" high

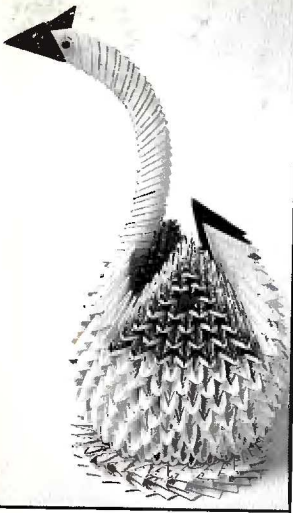

Materials

- #52: 365 3 1/4" x 4 1/2" rectangles of 1-ply board (white)
 3 3 1/4" x 4 1/2" rectangles of textured paper (black)
 31 2 3/4" x 4 1/2" rectangles of 1-ply board (white)
 1 2 3/4" x 4 1/2" rectangle of textured paper (black)
 1 2 3/4" x 4 1/2" rectangle of textured paper (red)
 2 1/8" diam. plastic eyes

- #53: 309 2 3/8" x 4 1/4" rectangles of 1-ply board
 56 2 3/8" x 4 1/4" rectangles of 1-ply board
 3 2 3/8" x 4 1/4" rectangles of textured paper
 31 2" x 3 1/2" rectangles of 1-ply board
 1 2" x 3 1/2" rectangle of textured paper
 1 2" x 3 1/2" rectangle of textured paper
 2 1/8" diam. plastic eyes

Head/Neck for #53 (Actual size)

Eye attaching position

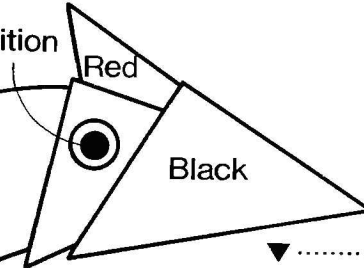

- ▼ Black
- ▽ Blue
- ▽ White

For #53, use white pieces for W

White (33 pcs.)

Wing

Tail

Wing

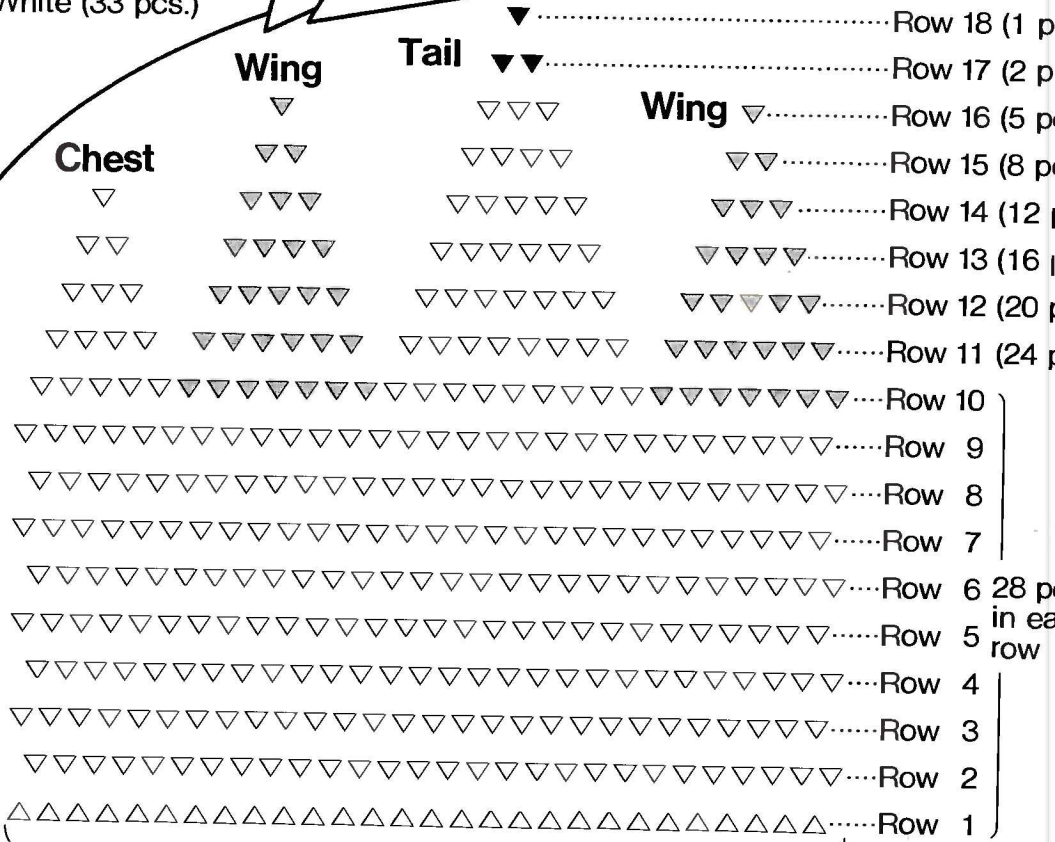

Join ends to form a ring of 28 pcs.

In Row 10, divide pieces into four groups:

5 pcs. for Chest, 7 for Left wing, 9 for Tail, and 7 for Right wing.

Signs for piece direction

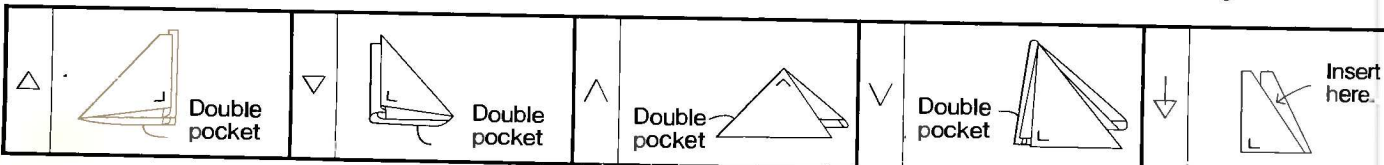

#54 PEDESTAL (P.21)

Completed size
7" diameter

Materials

For #52: 32 3½" × 5" rectangles of 1-ply board

For #53: 28 3½" × 5" rectangles of 1-ply board

Note

The completed project may look different depending on the thickness of the paper used.

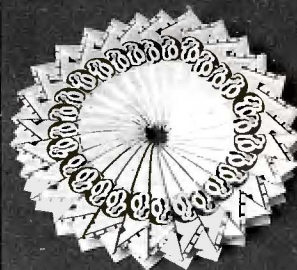

Head/Neck for #52 (Actual size)

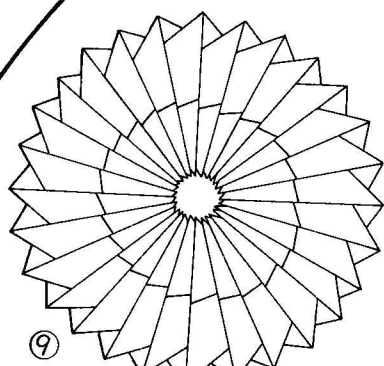
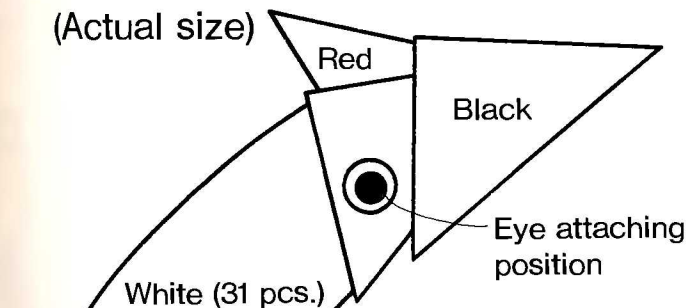

32 pcs. for #52
28 pcs. for #53 ↑

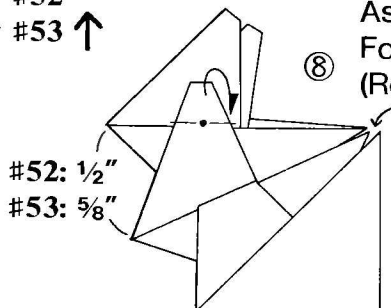

Assemble points.
Fold the edges under
(Repeat on the back side).

How to fold pieces

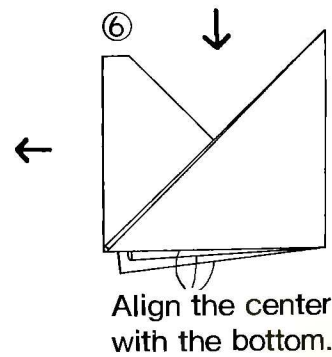
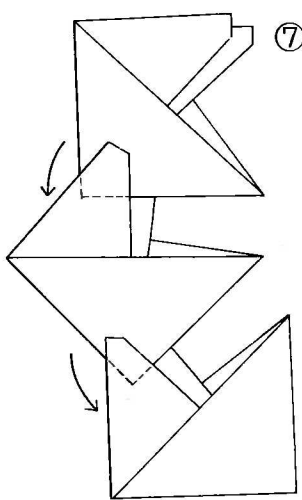
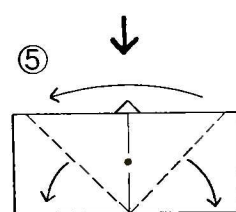
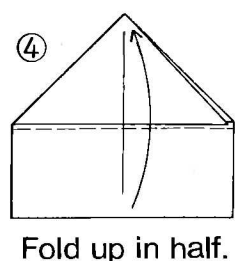
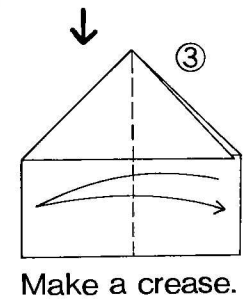
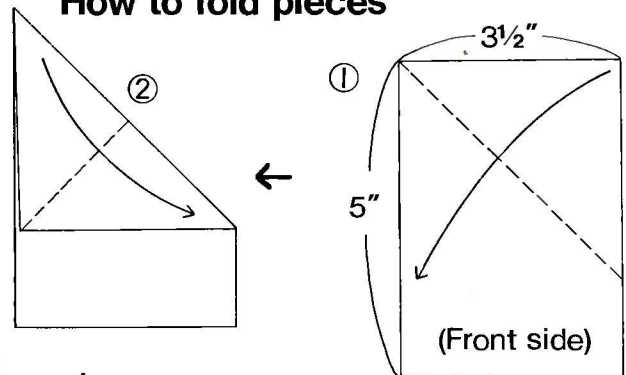



#44 & #45 BABY SWAN (P.19)

Comple
4 1/4" wi

Materials

- #44: 285 1 1/2" x 3" rectangles of craft paper (black)
- 52 1 1/2" x 3" rectangles of craft paper (white)
- 1 1 1/2" x 3" rectangle of craft paper (red)
- #45: 286 1 1/2" x 3" rectangles of craft paper (red)
- 52 1 1/2" x 3" rectangles of craft paper (white)

16" 1/4" ribbon

1 1/2" diam. sequins

1 pearl-headed marking pin

*Materials except rectangular paper each item.

Note

The completed project may vary depending on the thickness of the paper.

26 pcs. for Neck

Head/Neck (Actual size)

△ Black for #44/Red for #45

▲ White △ Red

- △ Eye attaching position
- △
- △
- △
- △
- △
- △
- △
- △
- △
- △
- △
- △
- △
- ▲
- △ Bow/sequin attaching position
- ▲
- △ First piece of Neck
- △
- △
- △
- △
- △

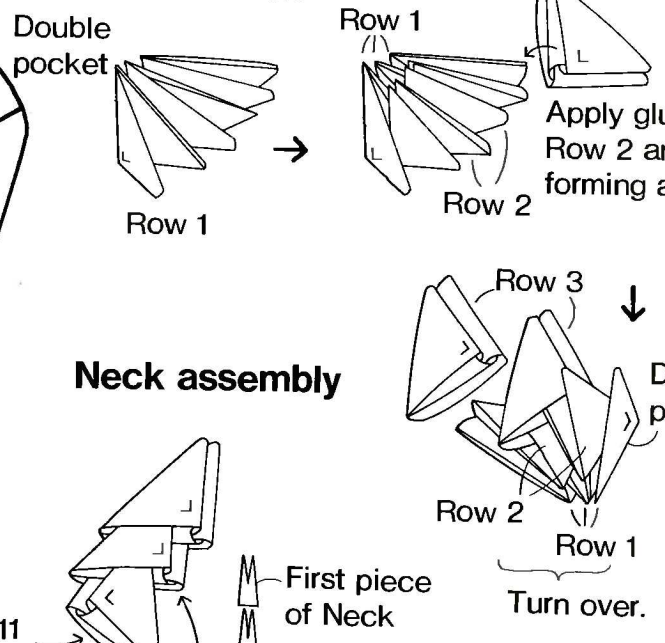
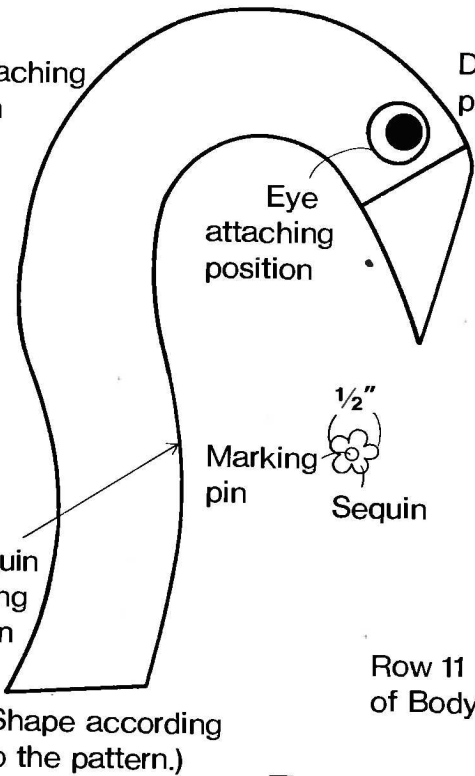

Neck assembly

Tie ribbon around Neck into a bow, and secure the knot with marking pin.

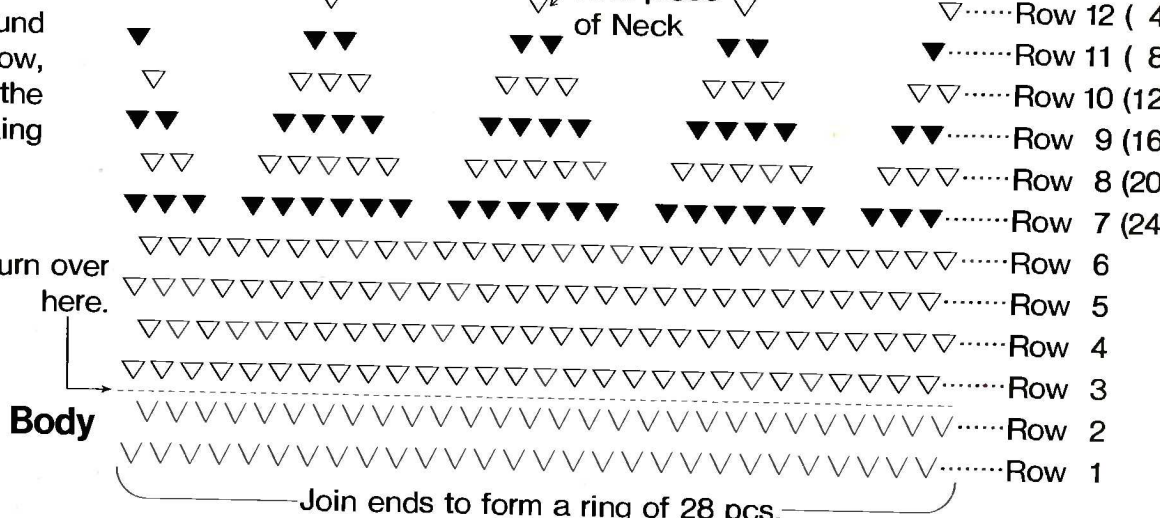
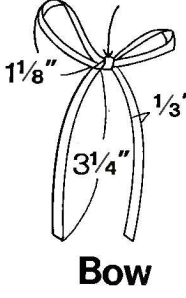

Join ends to form a ring of 28 pcs.

Pedestal

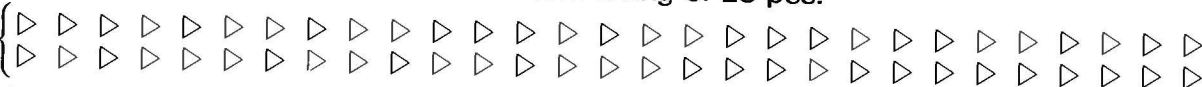

Using 30 pcs., make 2 rings of 1 3/4" inner diameter. Glue each other.

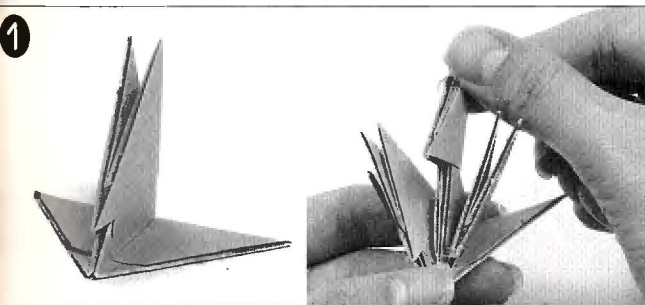

1 Row 1: Put a pair, double pockets down. Apply glue onto center 2 points and insert them into a piece held in the same direction. Make 14 of this 3-pc set. Row 2: Join 2 sets with 1 piece held in the same direction. Continue to join all sets.



2 Turn over and join into a ring with a piece.

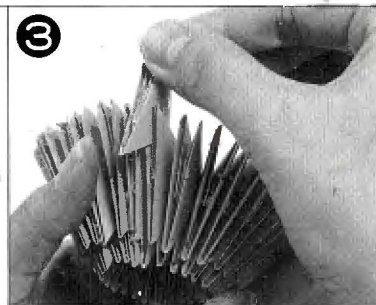

3 Turn over and work Row 3 as directed in the diagram on opposite page, interlocking at an angle so as to form a ball shape.



4 Work Rows 4-6 in the same manner. All pieces are glued together.



5 Divide into quarters, and join 6 pcs. to each, in a contrasting color.

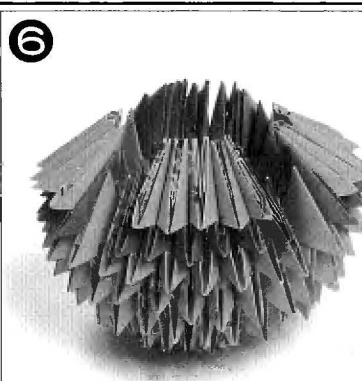

6 Rows 8-12: Decrease the number of pieces as directed, changing color as well.

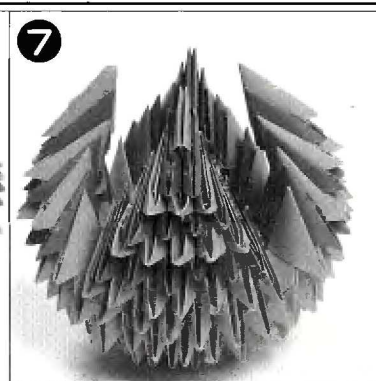

7 Onto 1 point, add 1 piece in opposite direction to make base of neck.



8 Form neck interlocking 25 pcs. as directed.



9 Tie ribbon around neck and make a bow. Attach a sequin by pushing marking pin into the knot.

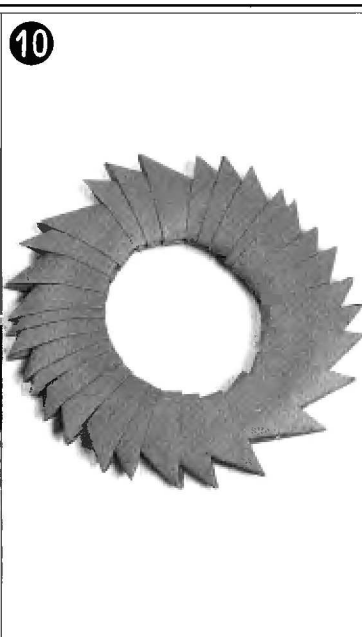

10 Make a pair of pedestals and glue them together.



11 Place SWAN on the pedestal and glue to secure.

1

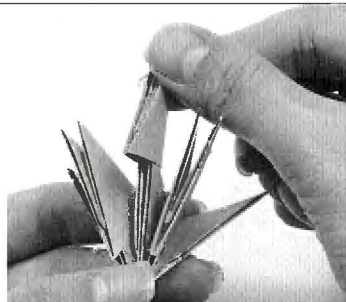
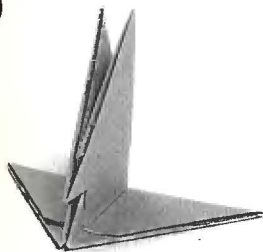

Row 1: Put a pair, double pockets down. Apply glue onto center 2 points and insert them into a piece held in the same direction. Make 14 of this 3-pc set. Row 2: Join 2 sets with 1 piece held in the same direction. Continue to join all sets.

2

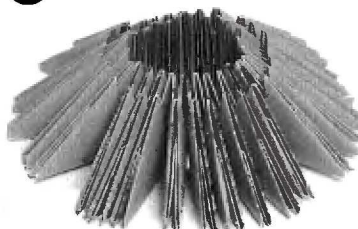

Turn over and join into a ring with a piece.

3

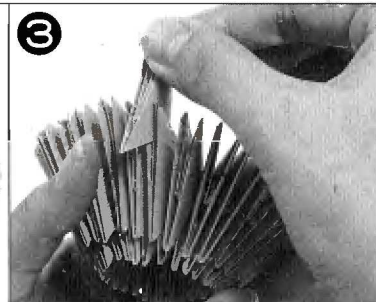

Turn over and work Row 3 as directed in the diagram on opposite page, interlocking at an angle so as to form a ball shape.

4



Work Rows 4-6 in the same manner. All pieces are glued together.

5

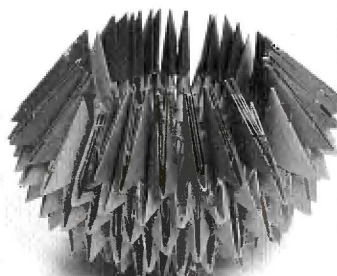

Divide into quarters, and join 6 pcs. to each, in a contrasting color.

6

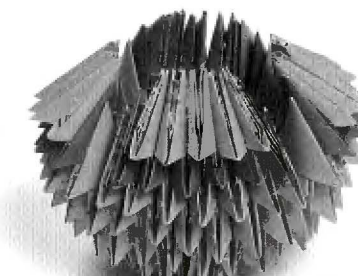

Rows 8-12: Decrease the number of pieces as directed, changing color as well.

7

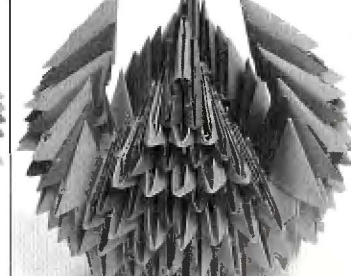

Onto 1 point, add 1 piece in opposite direction to make base of neck.

8

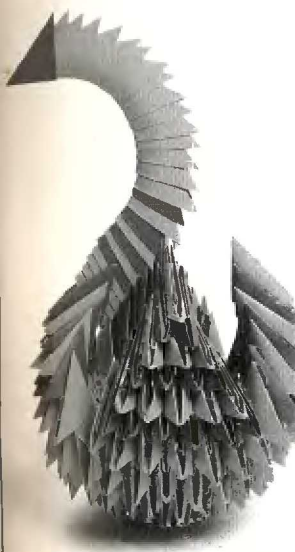

Form neck interlocking 25 pcs. as directed.

9



Tie ribbon around neck and make a bow. Attach a sequin by pushing marking pin into the knot.

10

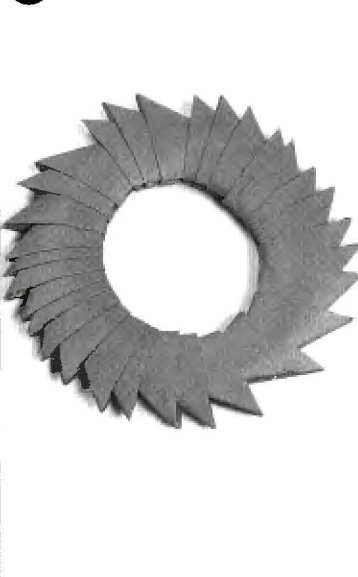

Make a pair of pedestals and glue them together.

11



Place SWAN on the pedestal and glue to secure.

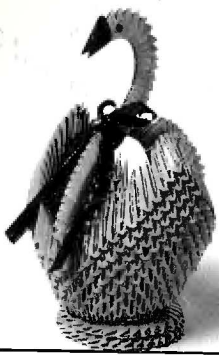

#46-#48 SWAN (P.19)

Comple
6" wide

Materials

- 519 1 1/2" x 3" rectangles of craft paper
(patterned gold-red for #46, pink for #47, white for #48)
- 1 1 1/2" x 3" rectangle of craft paper (red)
- 16" 1/4" ribbon
- 1 1/2" diam. sequin
- 1 pearl-headed marking pin
- * Materials except rectangular paper count for each item.

Bow

Tie ribbon around Neck into a bow, and secure the knot with marking pin.

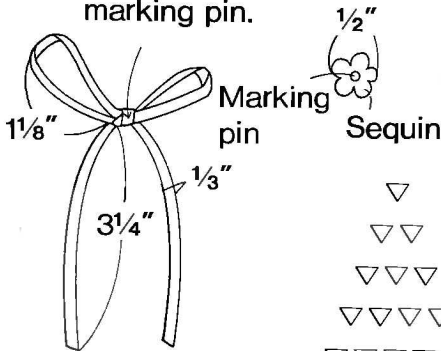

Neck assembly

- △ Gold-red for #46
- △ Pink for #47
- △ White for #48
- △ Red

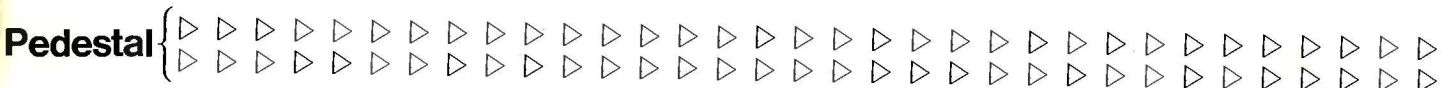
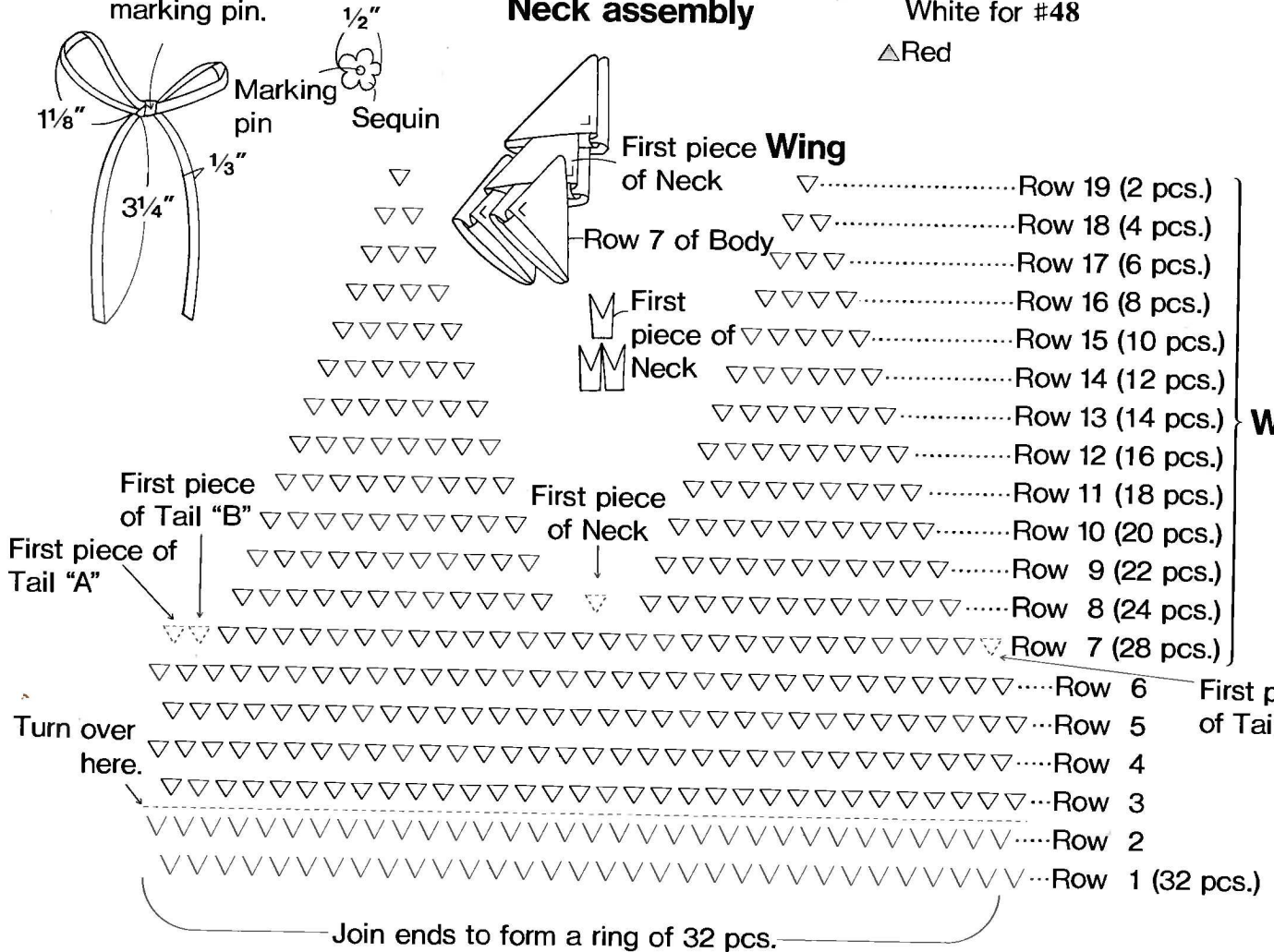

Using 35 pcs., make 2 rings of 1 3/4" inner diameter. Glue each other.

Signs for piece direction

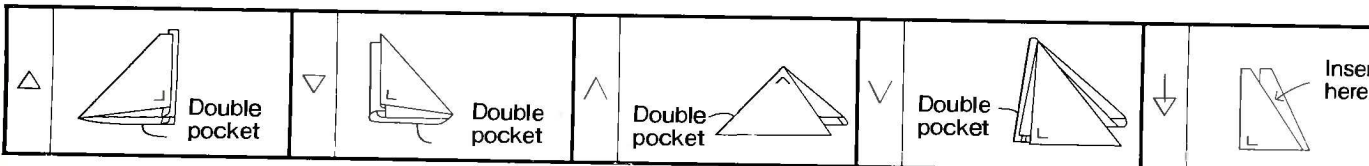

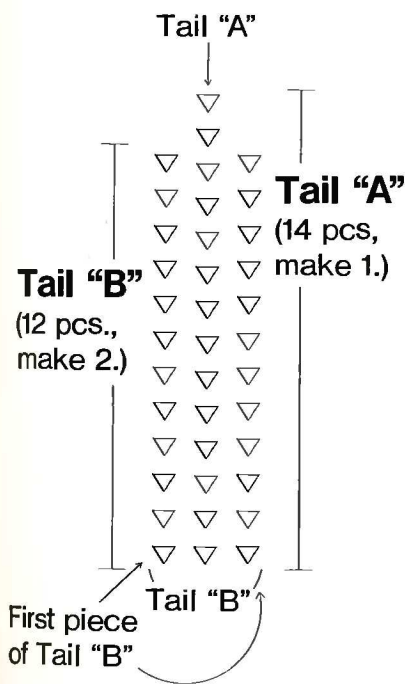

36 pcs. for Neck
(Shape according to the pattern.)

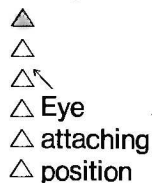

Bow/sequin attaching position

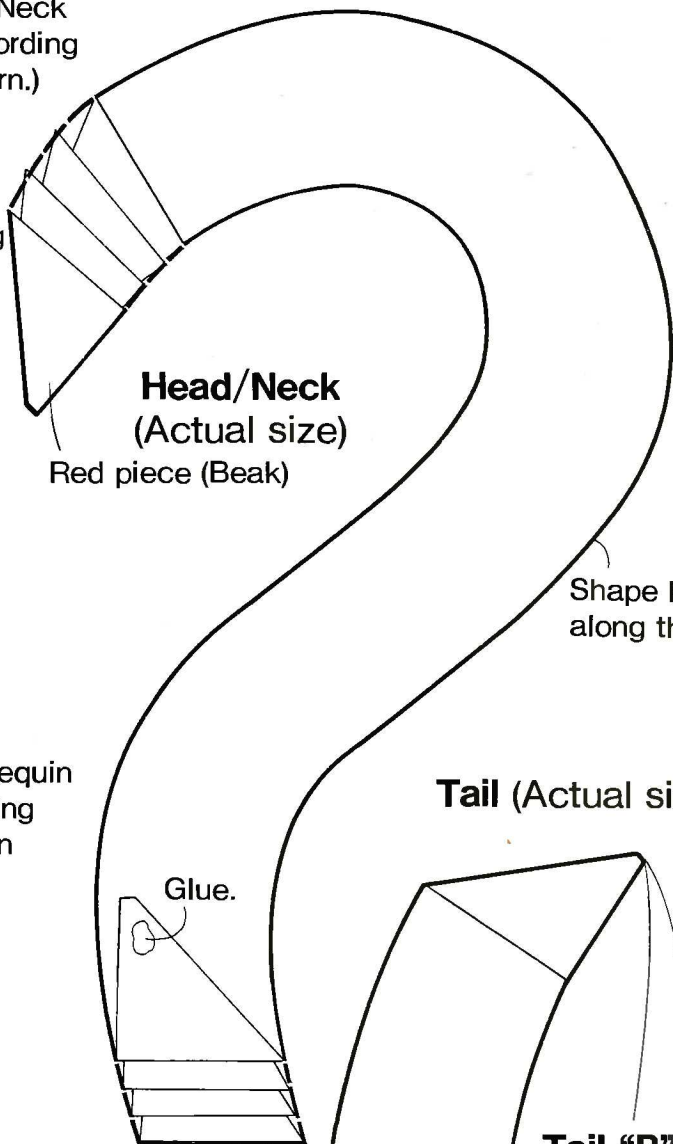

Head/Neck
(Actual size)

Red piece (Beak)

Shape Neck along this line.

Tail (Actual size)

Tail "A" & "B" assembly

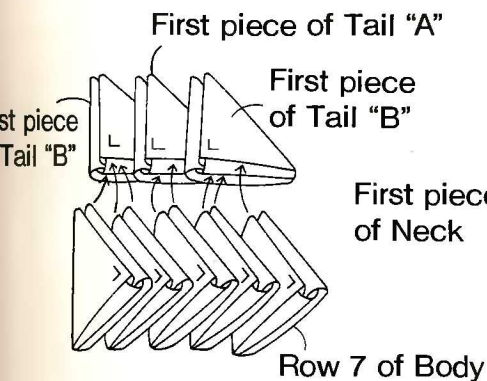
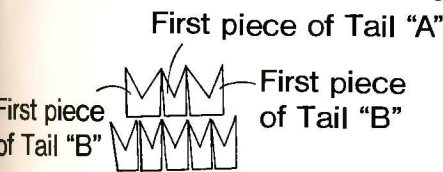

Row 7 of Body

Rows 1-3 assembly

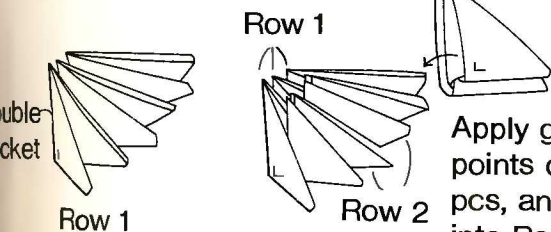

Apply glue onto points of Row 1 pcs, and insert into Row 2 pcs. Form into a ring.

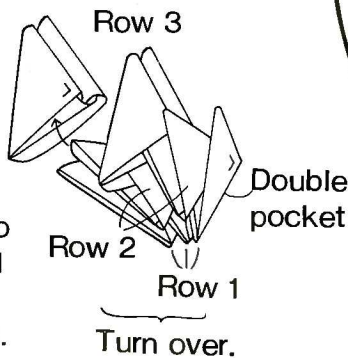

Tail "B"
(12 pcs, make 2.)

Tail "A"
(14 pcs., make 1.)

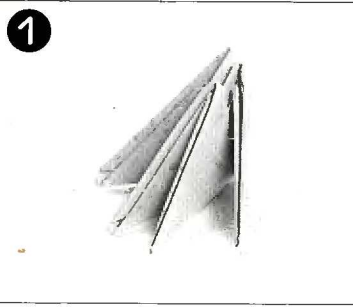

Put 2 pcs. double folds down. Join them by inserting the adjoining points into 1 pc. held in the same direction.

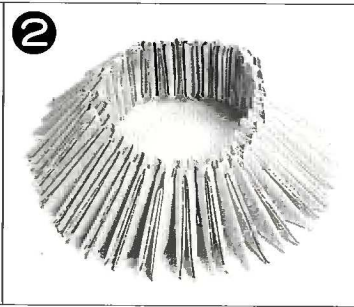

Make 16 sets. Join them in the same manner as Step 1, and form into a ring with 32 pcs.

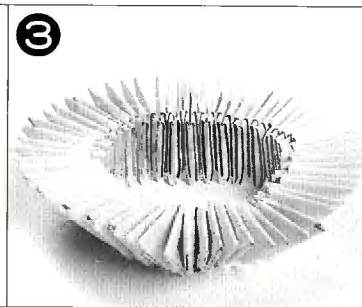

Turn over so Row 1 faces up.

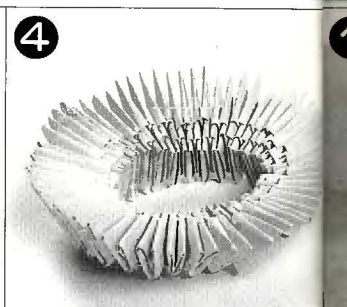

Work on Row 3 as directed in the diagram on previous page.



When Row 6 is done, divide pieces into three: Right wing (14), neck(1), left wing(14) and tail(3).

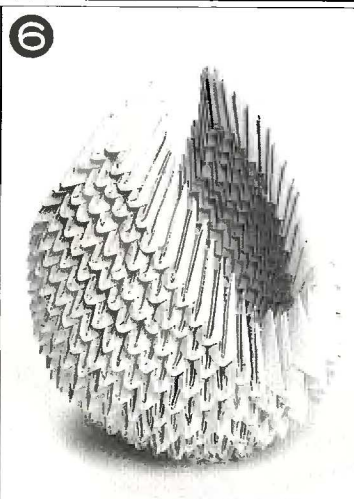

Form wings as directed in the diagram, forming a curvy outline.

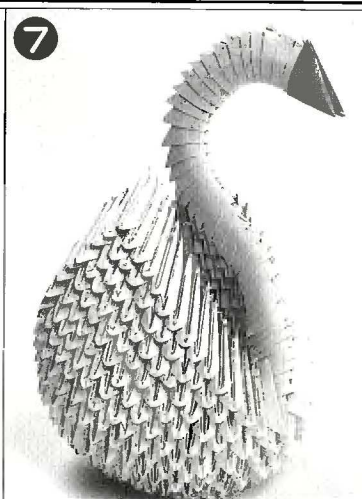

Make neck and head as directed and interlock with body.



Make three tails as directed according to the actual size pattern.

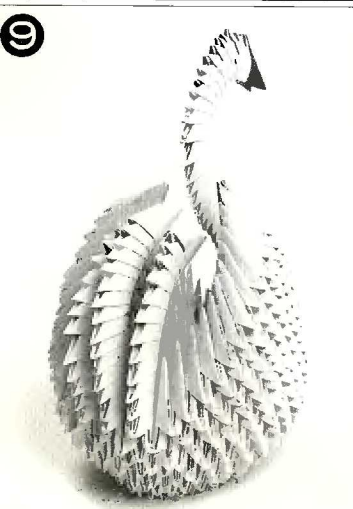

Attach tails as shown.

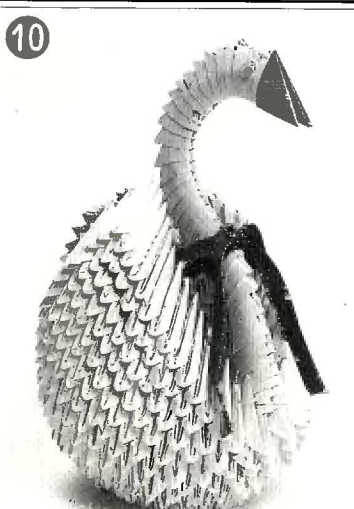

Tie ribbon around neck. Attach a sequin by pushing a marking pin into the knot. Attach eyes.

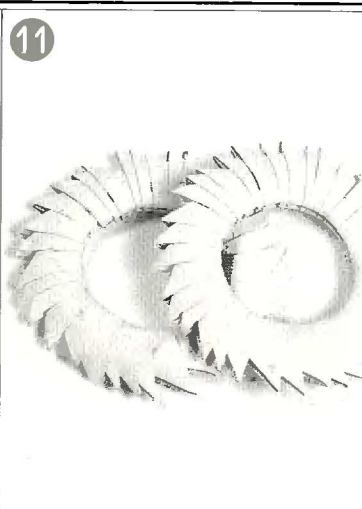

Make two pedestals and glue together.



Place SWAN on the pedestals and glue to secure.

49 & #50 PEACOCK (P.20)

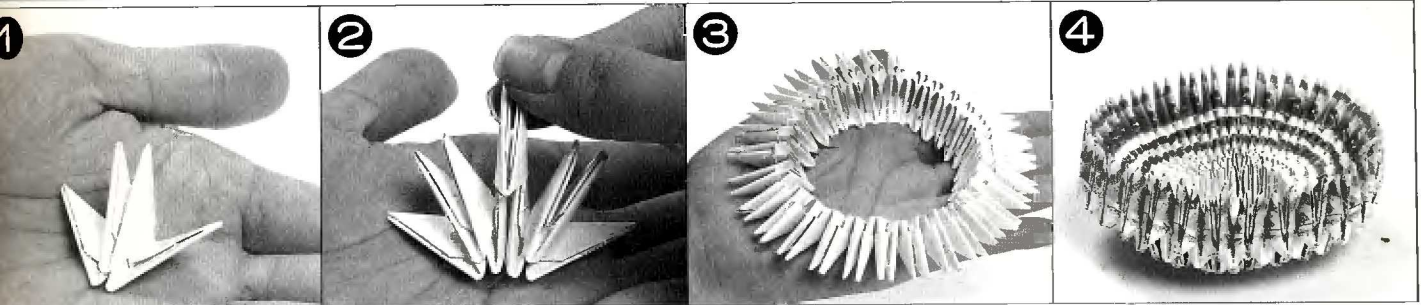

1 Place a pair of pieces double pockets down.

2 Join them with a piece held in the same direction. Make another 3-pc set and join with a piece as shown.

3 Make 15 sets in all and form a ring. Turn over.

4 Applying glue, work Row 3 to Row 8 as directed in the diagram overleaf, changing colors as well.

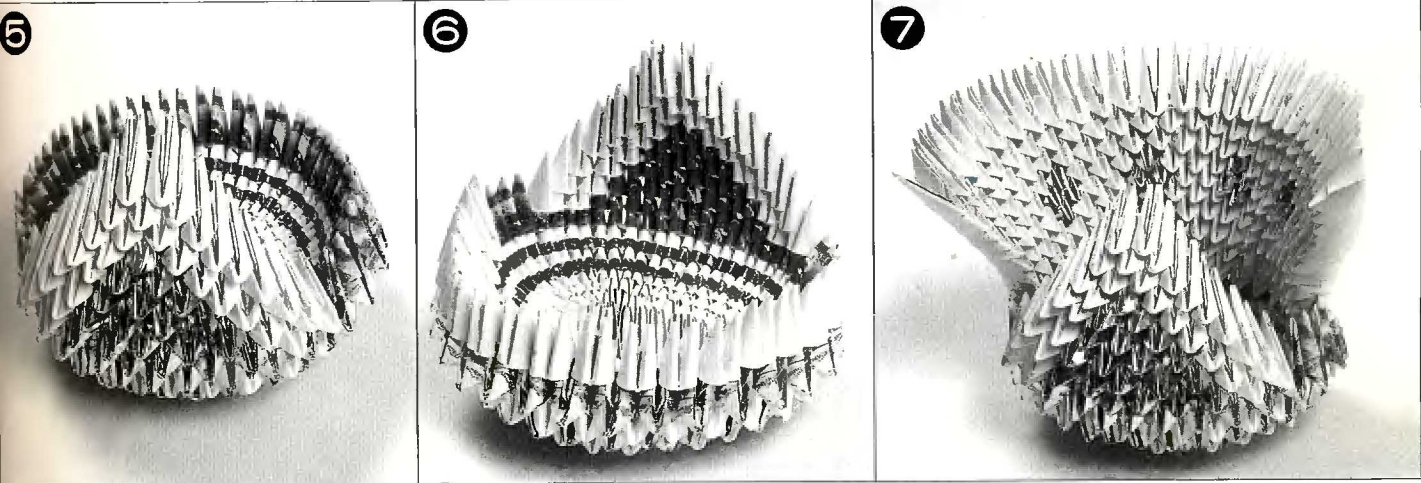

5 Row 9: Make chest. Join 6 patterned pcs. and add 2 solid (white) pcs. onto each side. Work as directed.

6 Row 9: Make tail feathers. Join 16 pcs., leaving 2 pcs. of previous row unworked, on each side.

7 Rows 10-32: Construct fanned feathers by increasing 1 pc. on every row, altering colors as directed.

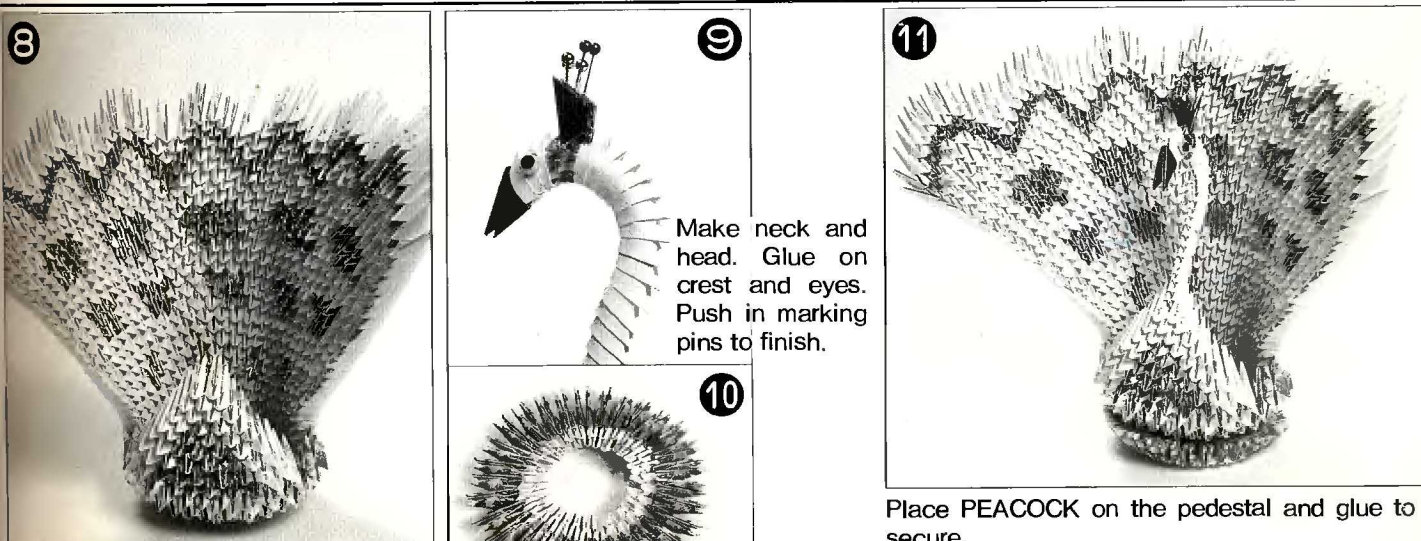

8 Rows 33-39: Decrease 1 pc. in every row as directed. Tail feather is completed.

9 Make neck and head. Glue on crest and eyes. Push in marking pins to finish.

10 Make pedestal in the same manner as Rows 1 to 3.

11 Place PEACOCK on the pedestal and glue to secure.

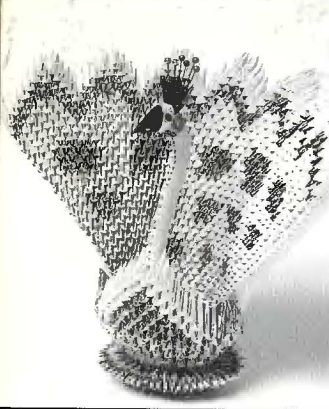

#49 & #50 PEACOCK (P.20)

Completed size
 #49: 8" wide
 #50: 10" wide

Materials

- #49: 954 3/4" x 1 1/4" rectangles of craft paper (white)
- 313 3/4" x 1 1/4" rectangles of craft paper (patterned red)
- 3 3/4" x 1 1/4" rectangles of craft paper (red for beak and crest)
- 2 1/8" diam. plastic eyes
- 5 pearl-headed marking pins (assorted colors)
- #50: 954 1 1/4" x 2 3/8" rectangles of craft paper (cream)
- 317 1 1/4" x 2 3/8" rectangles of craft paper (patterned red)
- 3 1 1/4" x 2 3/8" rectangles of craft paper (red for beak and crest)

2 1/4" diam. plas
 6 pearl-headed
 (assorted color)

Neck assembly

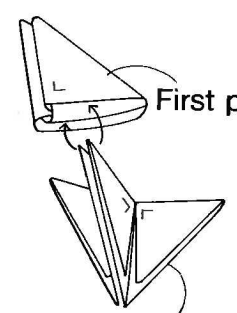

First piece of Neck



First piece of Neck



First piece of Neck

▽△▽ White for #49 / Cream for #50

▽▲▽ Patterned red

△ Red

Head/Neck

26 pcs.
 (For shaping, see P.54.)
 Crest attaching position

Row 17 of Chest

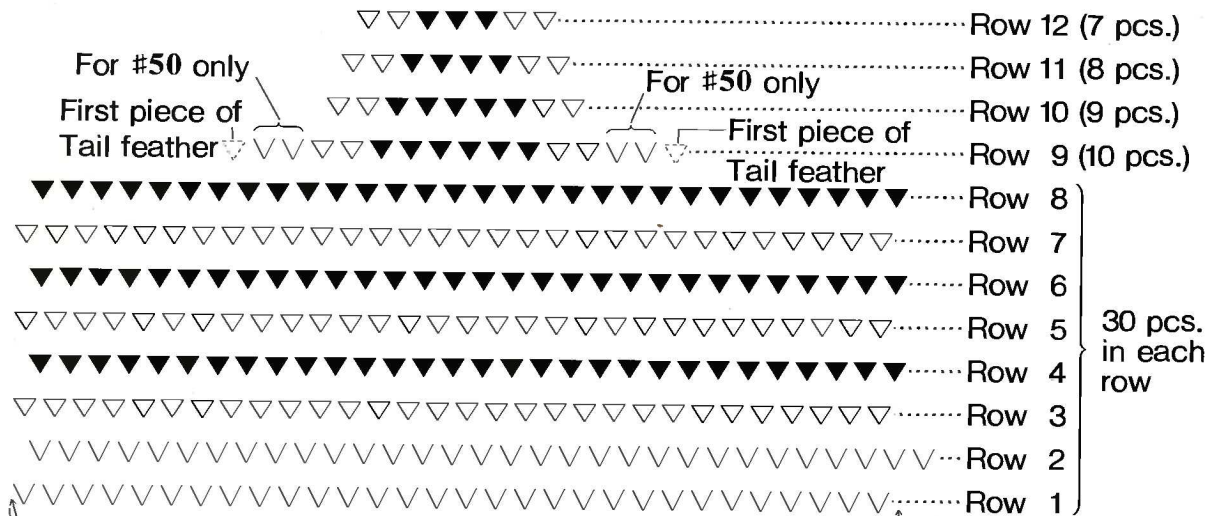

Join ends to form a ring of 30 pcs. (31 pcs.)

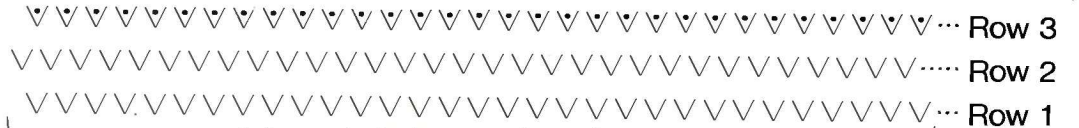

Pedestal

Join ends to form a ring of 31 pcs., about 2" inner diameter.

Signs for piece di

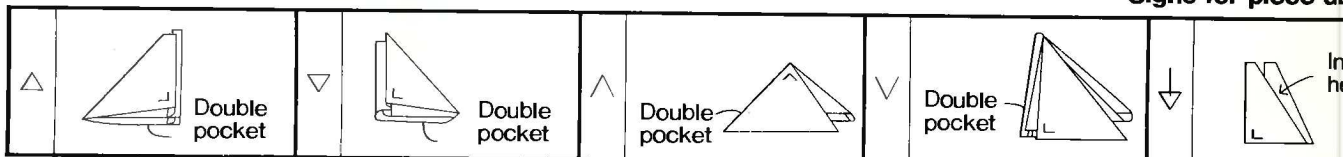

Tail feathers

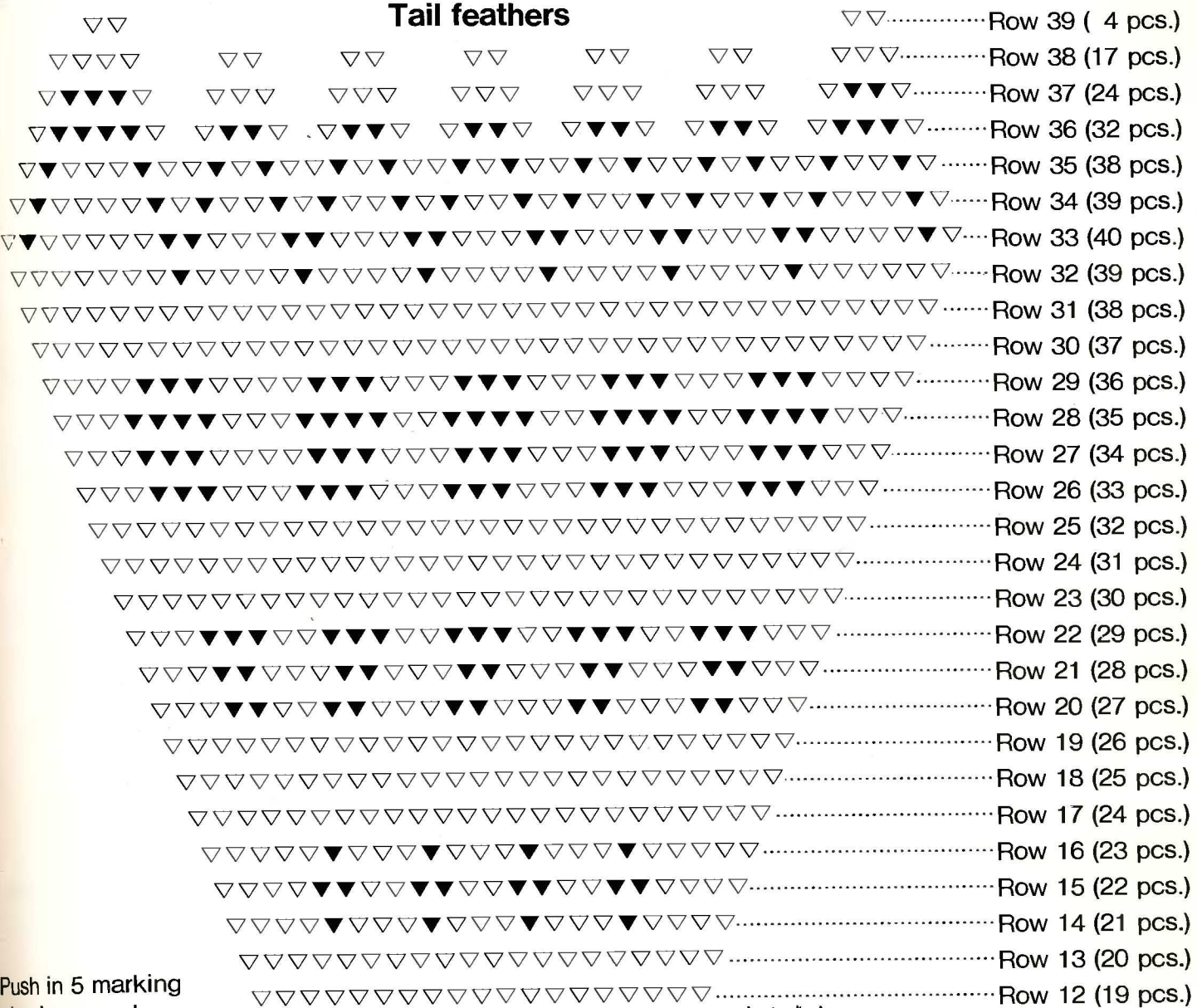

Push in 5 marking pins in a good proportion.

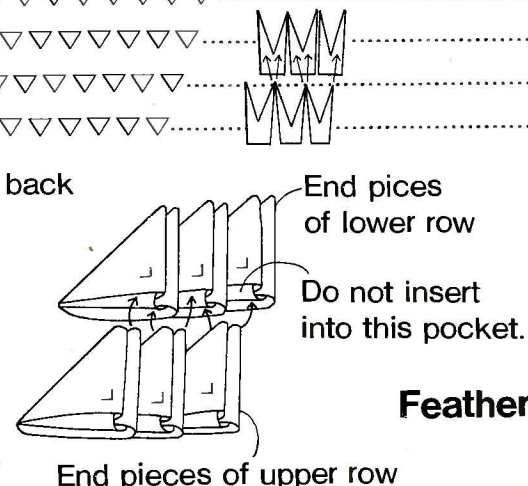
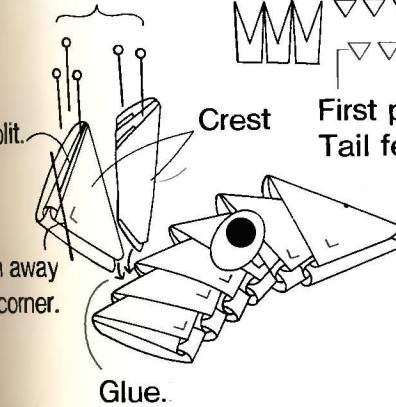
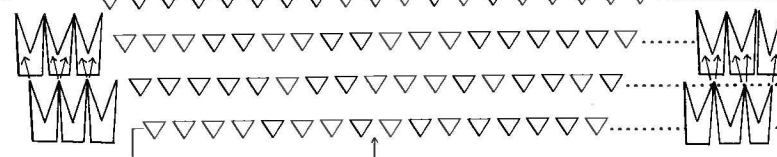

(Directions are reversed so you can work with the Front facing you)

Feather assembly

◀ See P.59 for step-by-step instructions.



#51 DANCING CRANE (P.20)

Completed size
5 1/2" wide, 13" high

Materials

- 288 1 1/2" x 2 3/4" rectangles of craft paper (white)
- 35 1 1/8" x 2 1/4" rectangles of craft paper (black)
- 32 1 1/8" x 2 1/4" rectangles of craft paper (white)
- 7 2 1/4" x 4" rectangles of craft paper (black)
- 1 1 1/2" x 1 1/2" rectangle of craft paper (yellow)
- 1 1 1/8" x 2 1/4" rectangle of craft paper (red)

- 2 1/8" diam. plastic eyes
- 20" 1/8" diam. cord
- 4 ft. 1/16" diam. wire
- 26" 1/20" diam. wire
- 7 ft. 1/2" floral tape
- 2 B3 boards
- Tissue paper

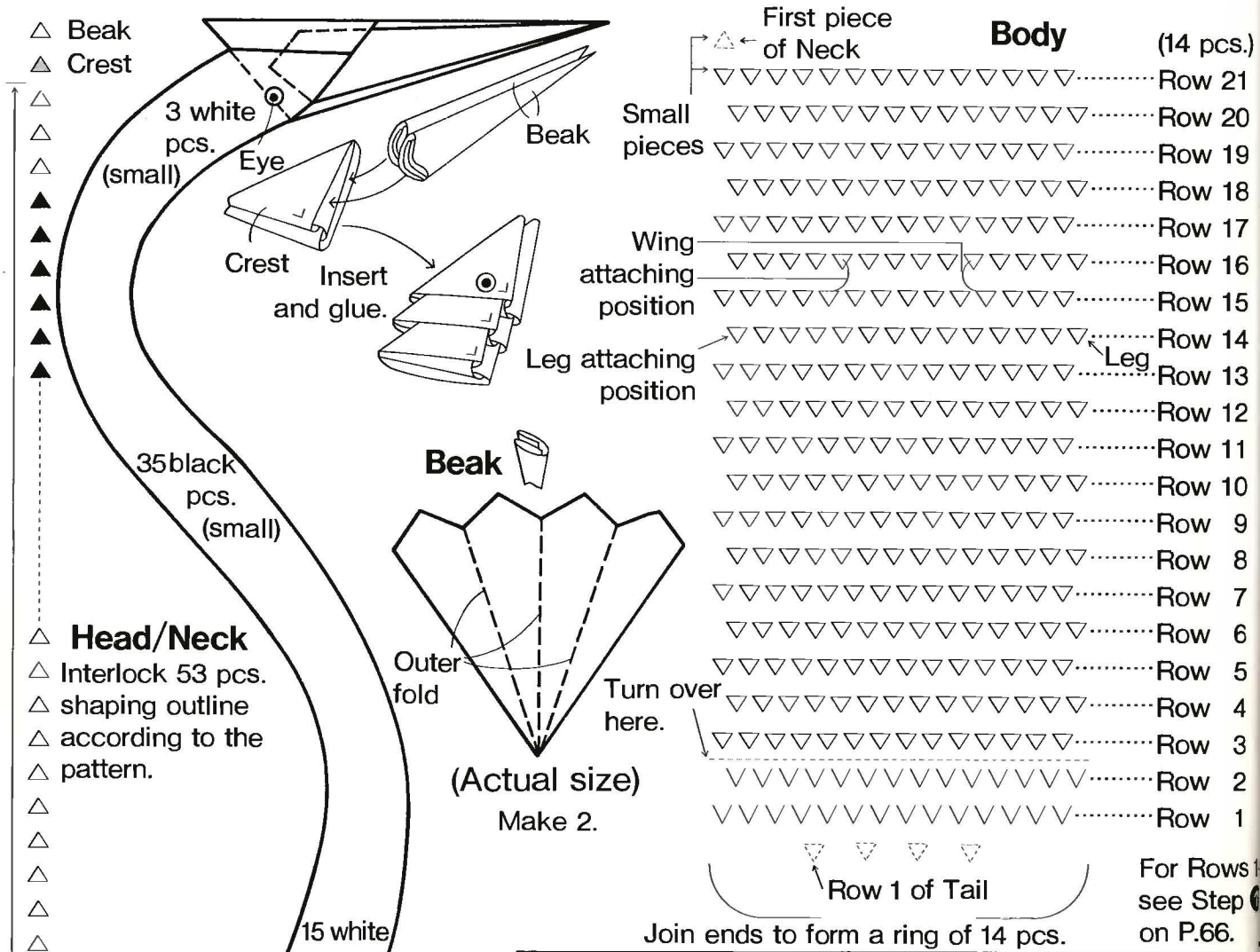

- △▽ White
- ▲▼ Black
- △ Red

Fold a sheet of tissue in half. Cut.

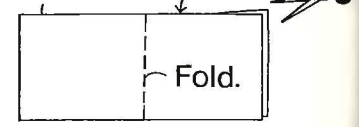

Leg

- 8 1/16" x 6" wire
- 2 sheets facial tissue
- Floral tape (brown)

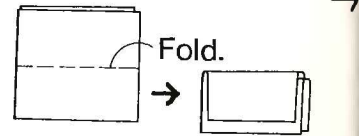

Slide 1 sheet to form a smooth edge

1 Make 2 copies of Wing ③ (Overleaf).

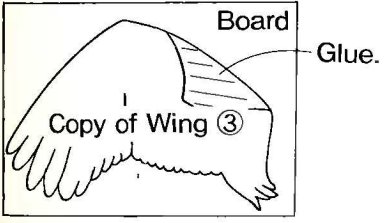

2 Cut out Wings, 2 pairs in all.

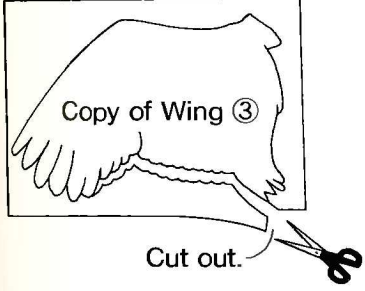

3 Layer front and back side of Wing, and glue.

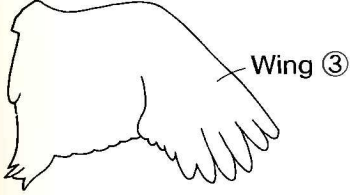

4 Make slits into Wing ③. Slit only into lower feathers. Do not slit top layer.

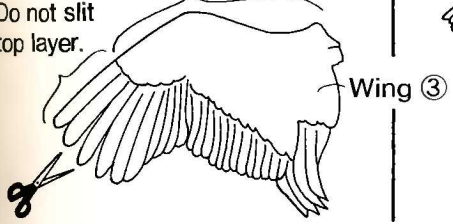

5 Make 2 copies of Wing ① and ②.

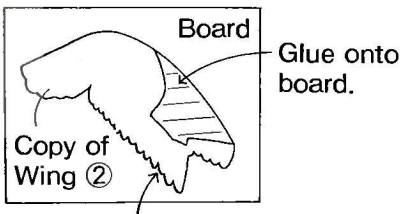

Cut out and make a pair.

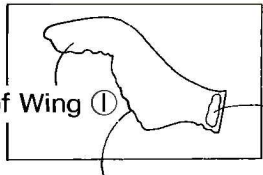

Cut out and make a pair.

6 Make slits into Wings ① and ②.

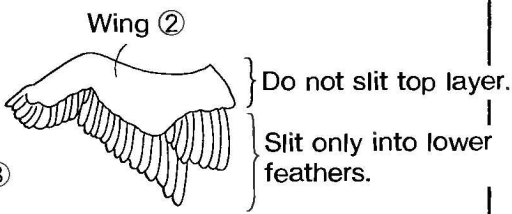

7 Glue Wing ① and Wing ②, front sides up.

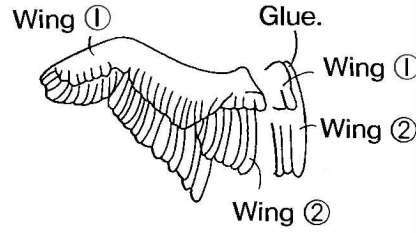

8 Shape wire to align with upper curve of Wing ③.

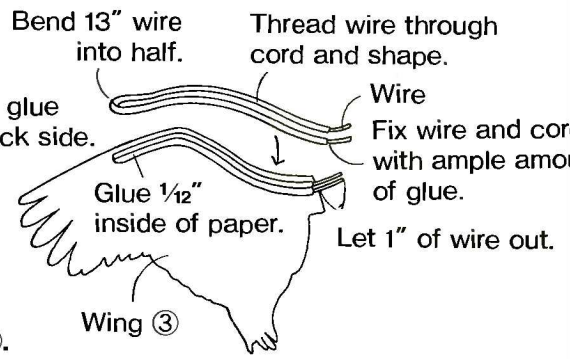

9 Glue Wings made in Step 7 (above) onto Wing ③.

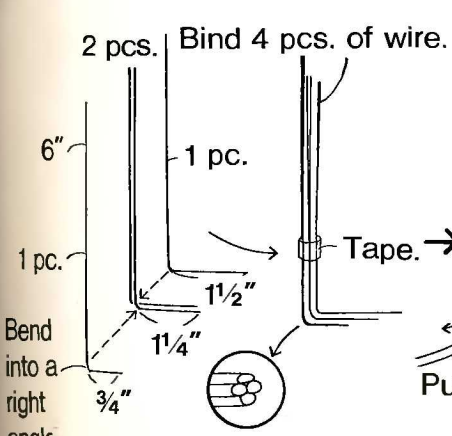
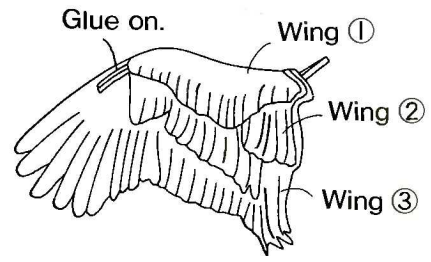

Secure with adhesive tape.

Wrap with floral tape: Tape around the bend 2-3 times tightly, then wrap up for 3 1/2".

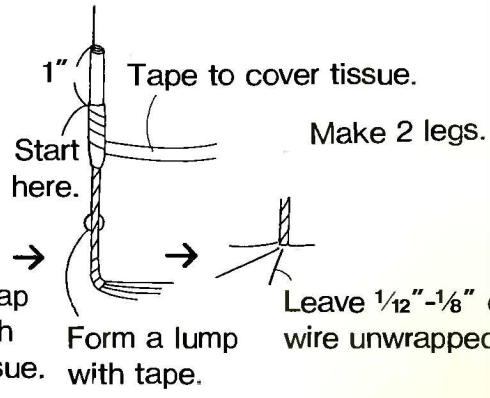

#51 DANCING CRANE (P.20)

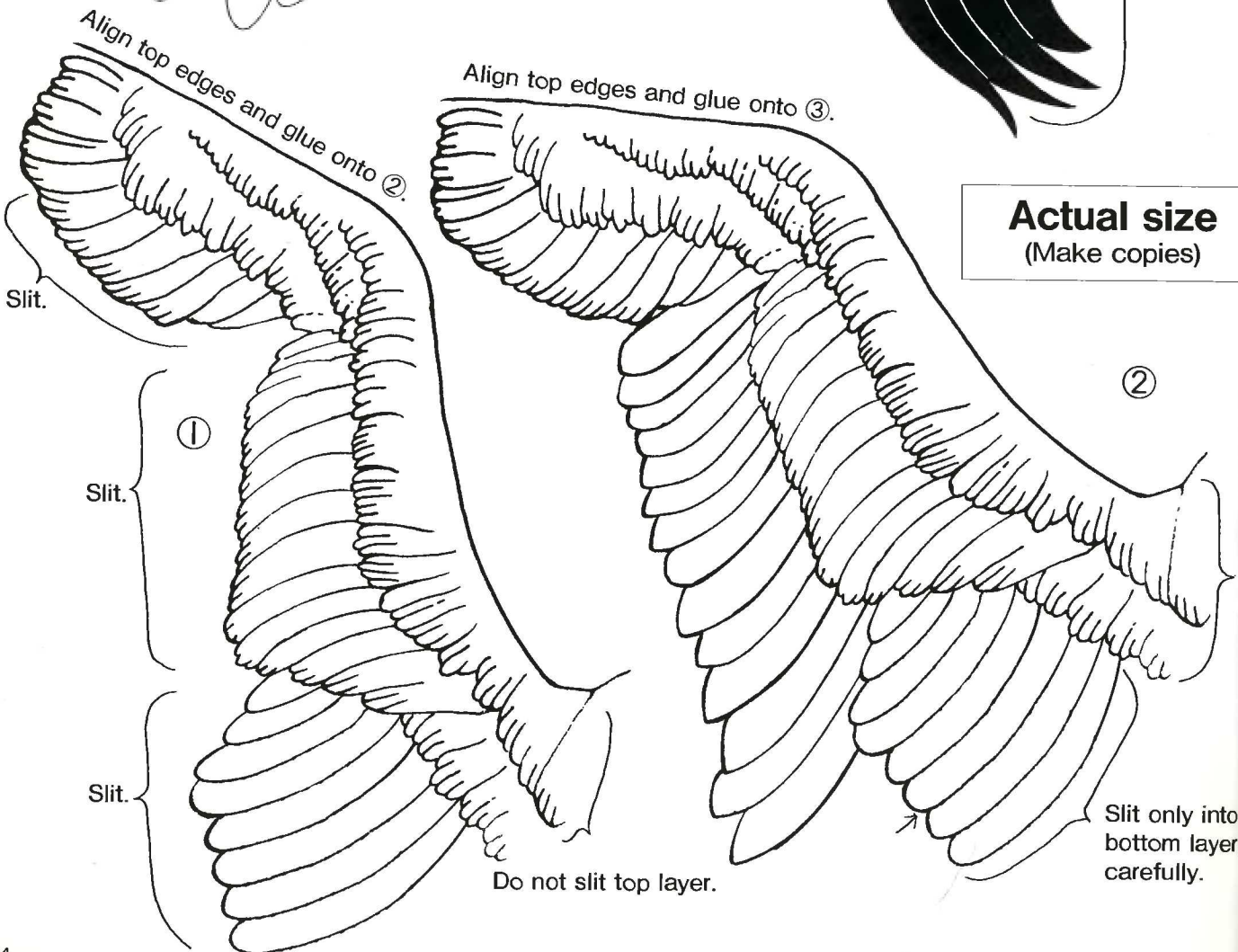
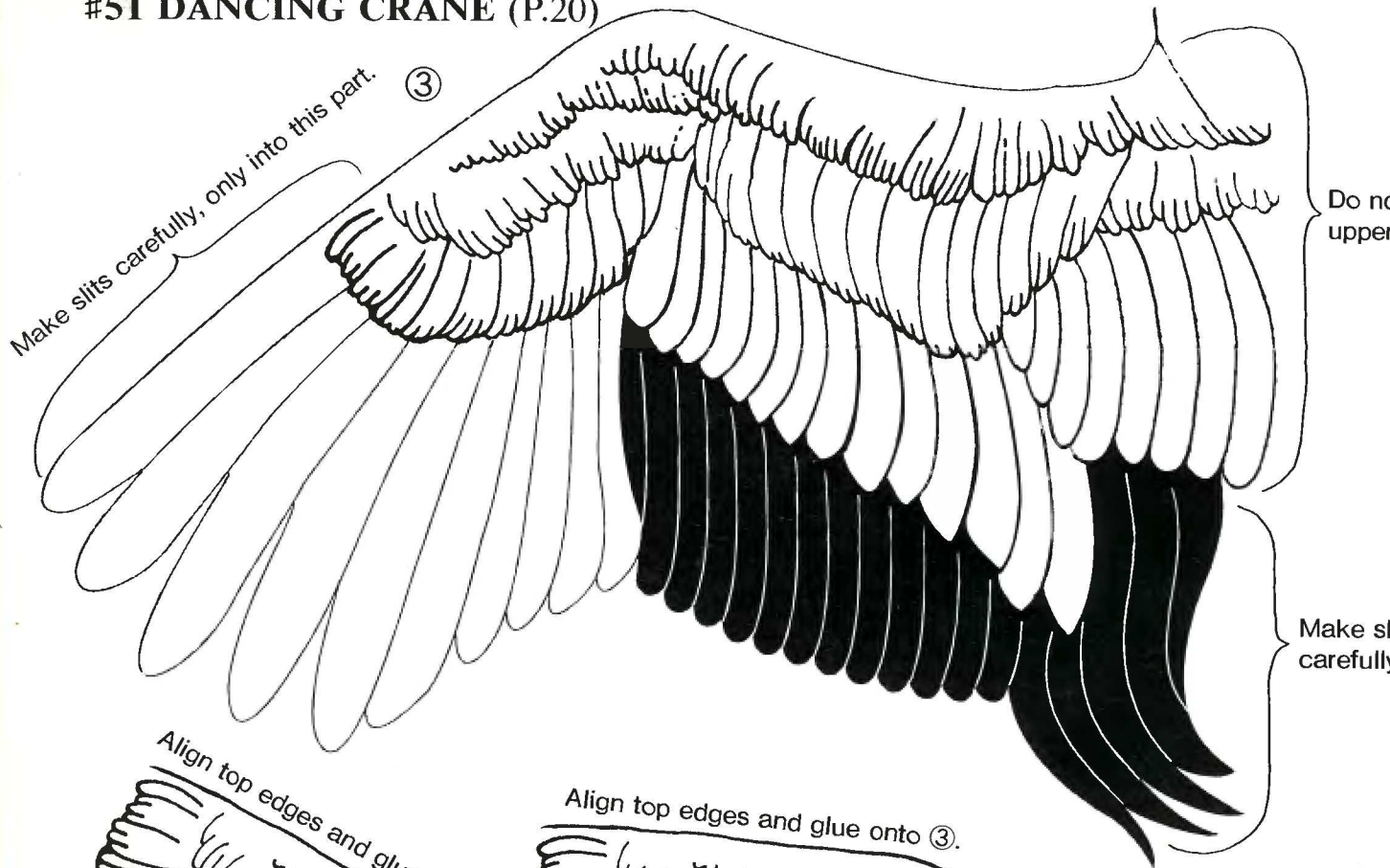

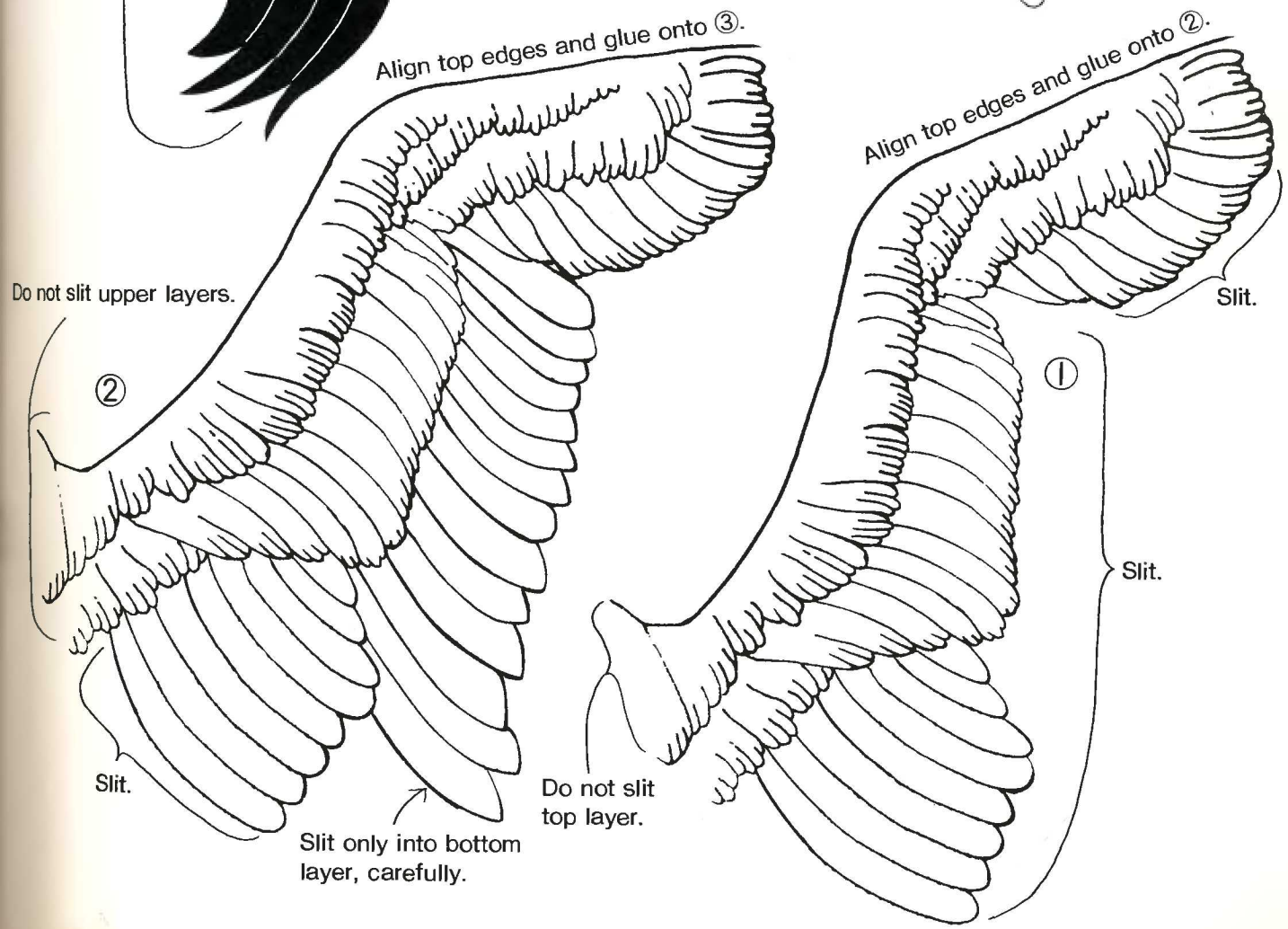
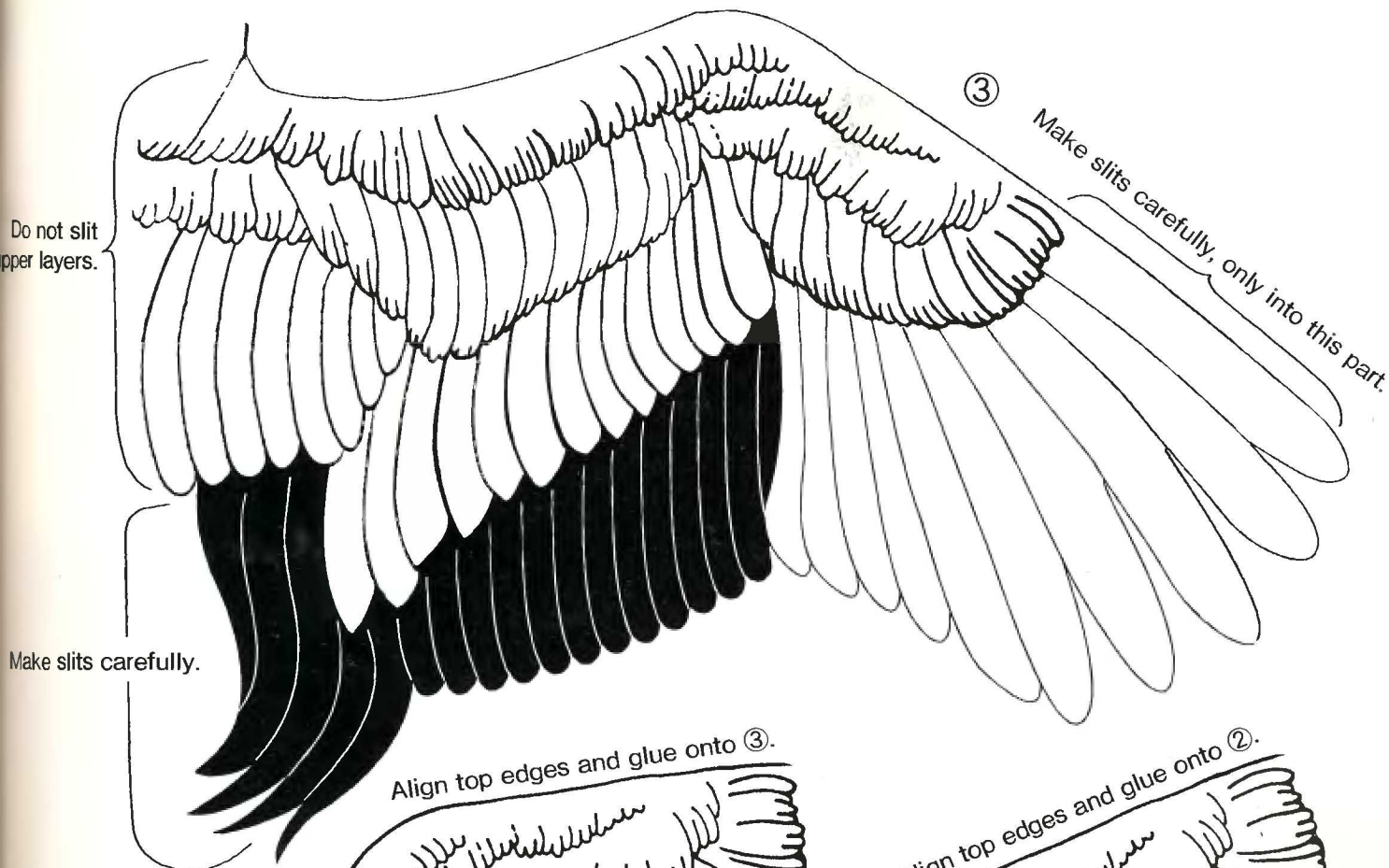

#51 DANCING CRANE (P.20)

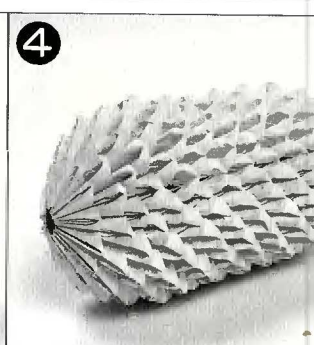
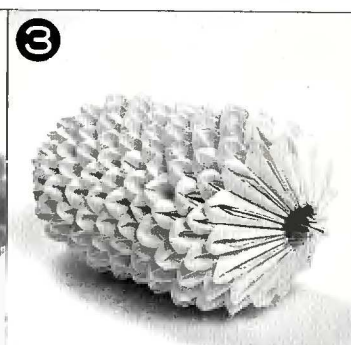
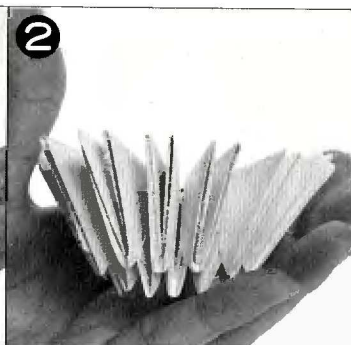
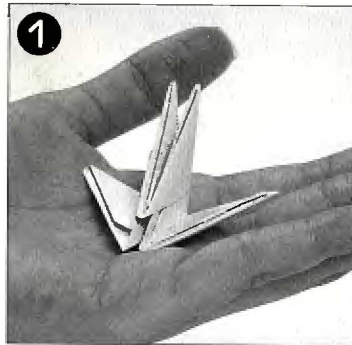

Put a pair of pieces double pockets down. Join them with a piece held in the same direction. Make 7 sets. (14 pcs. on Rows 1 and 2)

Join into a ring, by covering end pieces with a new piece.

Rows 3-20: Applying glue each time, interlock 14 pcs. in each row, shaping the body.

Row:21: Join 14 small without glue.

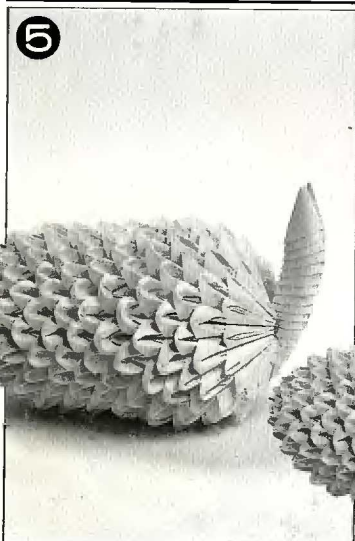

Make neck by interlocking 15 pcs. with glue. Attach to body so as to conceal the hole.

Form upper neck and head referring to diagram on P.62. Attach crest, eyes and beak.

Make legs as directed on P.63, and insert into the indicated positions with glue.

Make tail and glue onto at indicated position.



Make copies of wings (P.64-65) and form as directed. Pierce 2 holds at the indicated positions and insert completed wings.

Tail assembly

Apply glue between pieces.

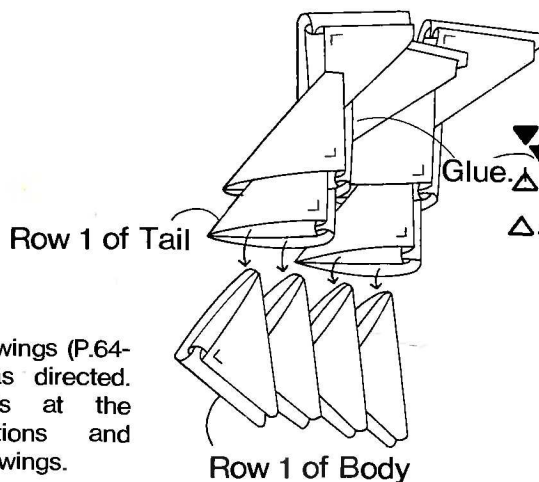

▼▼▼▼ } Row 3 (7 pcs.)
 ▲▲▲▲ } Row 2 (4 pcs.)
 ▲▲▲▲ } Row 1 (4 pcs.)

Row
 Row
 Row
 of T
 Row
 c 3

#39 LEMON (P.17)

Completed size
2 1/4" wide, 1 3/4" high

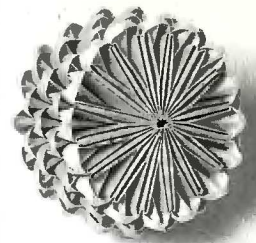

Materials

- 80 1 1/2" x 3" rectangles of origami paper (yellow)
- 16 1 1/2" x 3" rectangles of origami paper (white)

Note

The completed project may look different depending on the thickness of the paper used.

▽ Yellow ▼ White

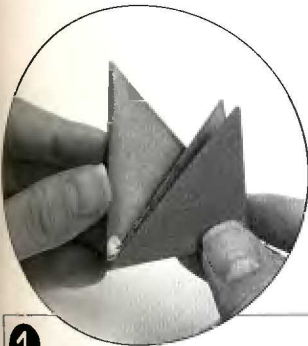
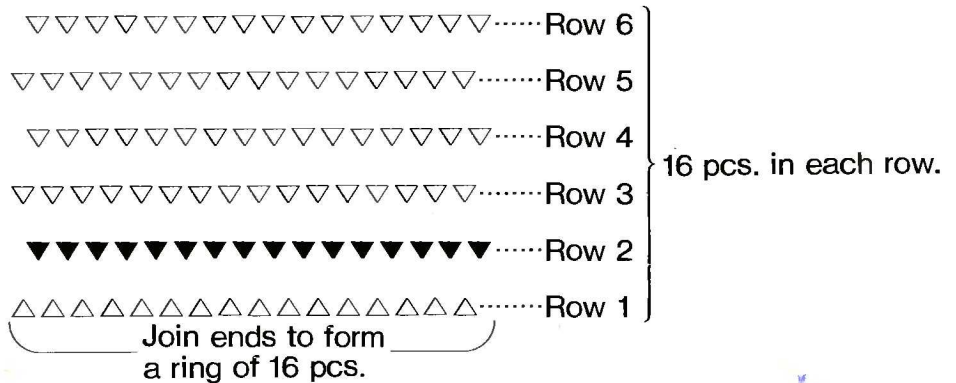

* Pieces used in the actual project are smaller.



1 Apply a dab of glue on single points of 3-4 yellow pcs., and paste them together.
2 Continue until 16 pcs. are pasted. Join into a circle and put on double pockets.
3 Row 2: Insert adjoining points into double pocket of a white piece. Continue.



4 Row 3: Repeat with yellow pieces.
5 Rows 4-6: Continue joining the same number of pieces, interlocking at an angle to shape. Glue top to secure.
6 Turn over for completed LEMON.

#57-#58 TEMARI BALL (P.16)

Completed size
#22: 2" wide, 2"
#23: 6" wide, 6"

58
#23



57
#22



Materials

#22: 52 each 1½"×3" rectangles of origami paper (4 colors)
26 1½"×3" rectangles of origami paper (1 color)
13 1½"×3" rectangles of origami paper (1 color)
8" ½" ribbon

#23: 60 each 2"×3" rectangles of origami paper (10 colors)
12" 1" ribbon
1 miniature bell

Note

The completed project may look different depending on the thickness of the paper used.

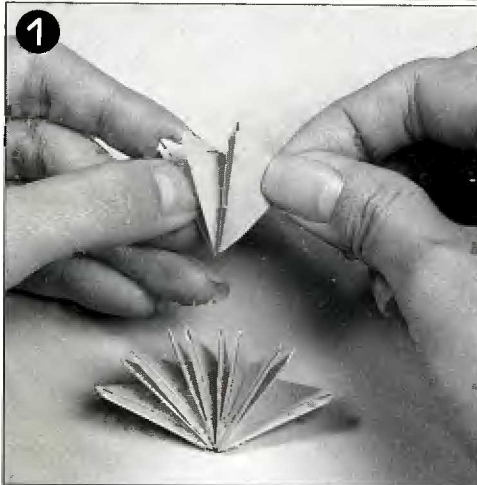

1
Apply a dab of glue on single points of 4-5 pcs., and paste them together. Make several sets.



2
When 19(30 for #58) pcs. are used, paste each other and join into a circle.



3
Row 2: Insert adjoining points of Row 2 into the double pocket of a piece. Continue all around.

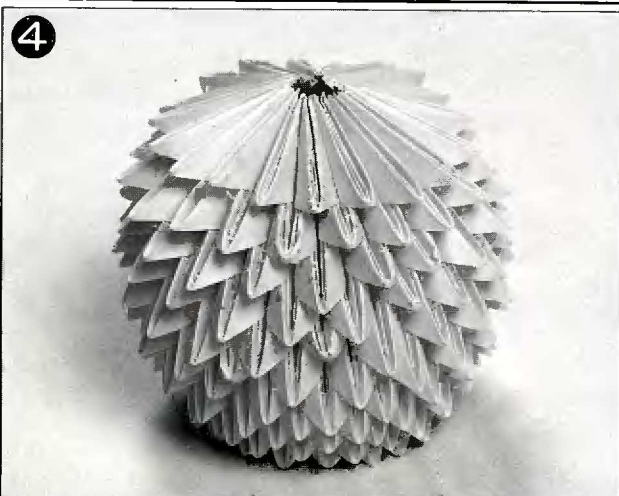

4
Row 3-18: Continue, altering colors as directed on the left page, and shaping into a ball with as small opening as possible.

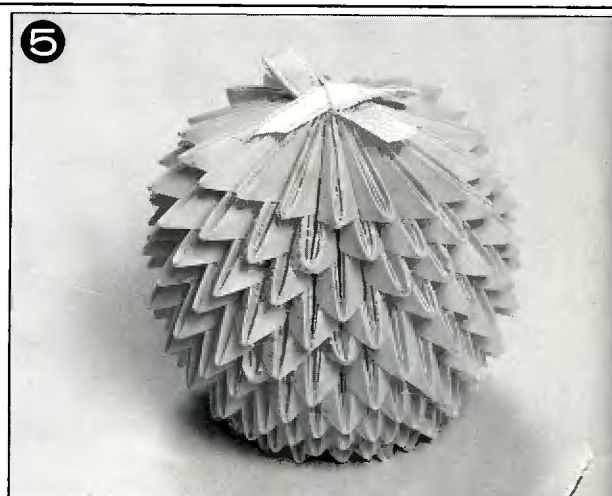

5
Cover the top with a bow. (Sew a miniature bell onto wrong side of the bow before attaching.)

#22

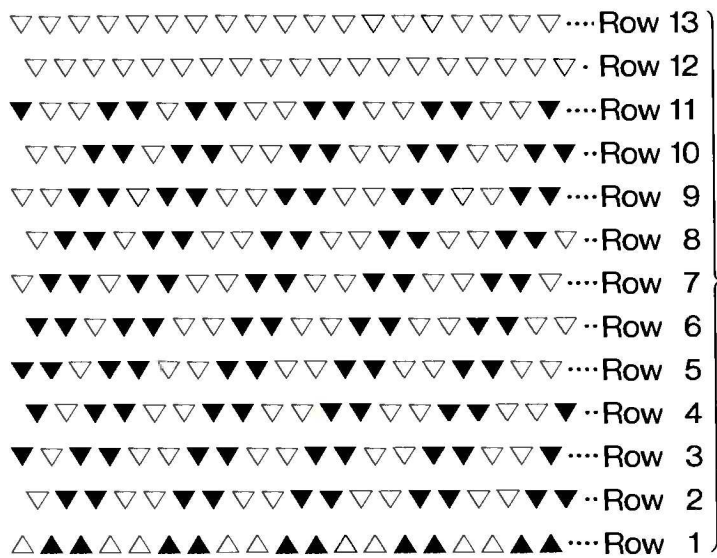

19 pcs. in each row.
 Color is alternated every 2 pcs.

Join ends to form a ring of 19 pcs.

A repeated pattern consists of 10 colors.

Make your favorite stripes by arranging the color chart.

#23

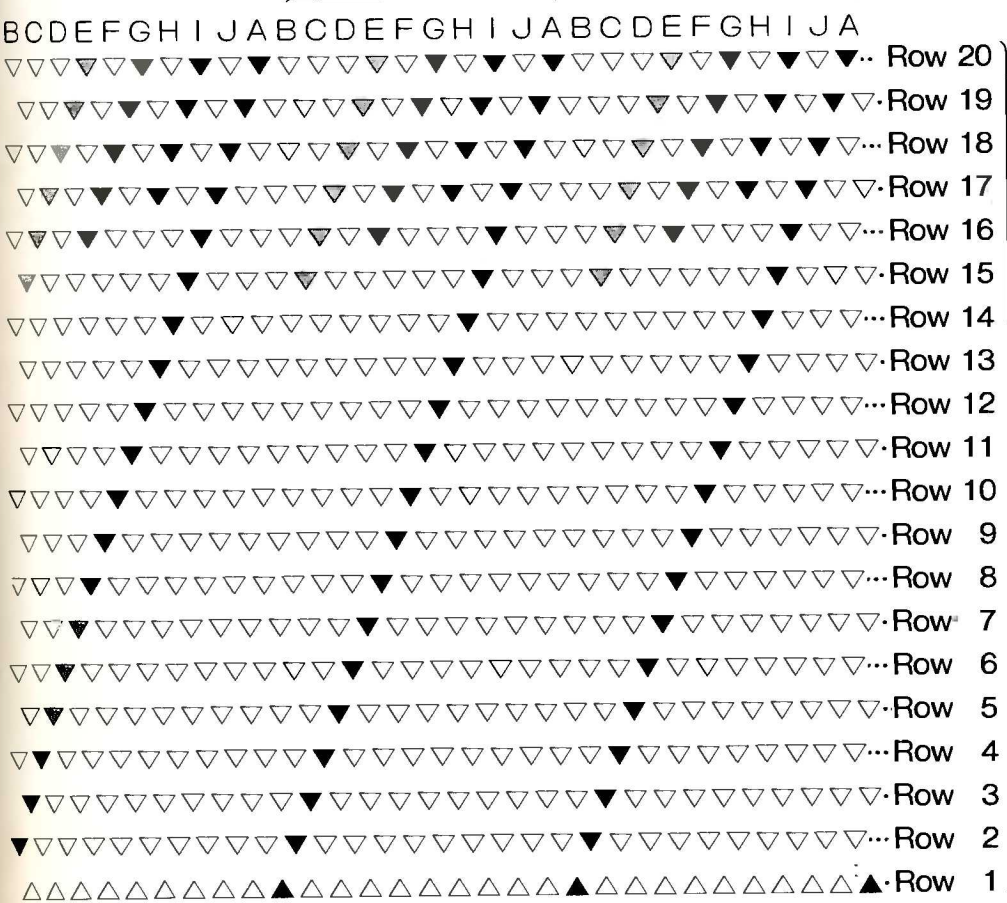

30 pcs. in each row.

Join ends to form a ring of 30 pcs.



#59-#61 GOOD-LUCK HYOTAN (GOURD)

Completed size

#59: 5½" wide, 10" high #60: 5¼" wide, 9" high #61: 4¼" wide, 7" high

Materials

#59: 762 2¾" × 4¾" rectangles of *washi* paper (silver)
3 ft. cord with fringe

#60: 762 3" × 6" rectangles of origami paper (pale green)
½ ft. cord with fringe

#61: 762 1¾" × 3¾" glossy paper (from magazine)
½ ft. cord with fringe

Row 19 & 20: Work in opposite direction.

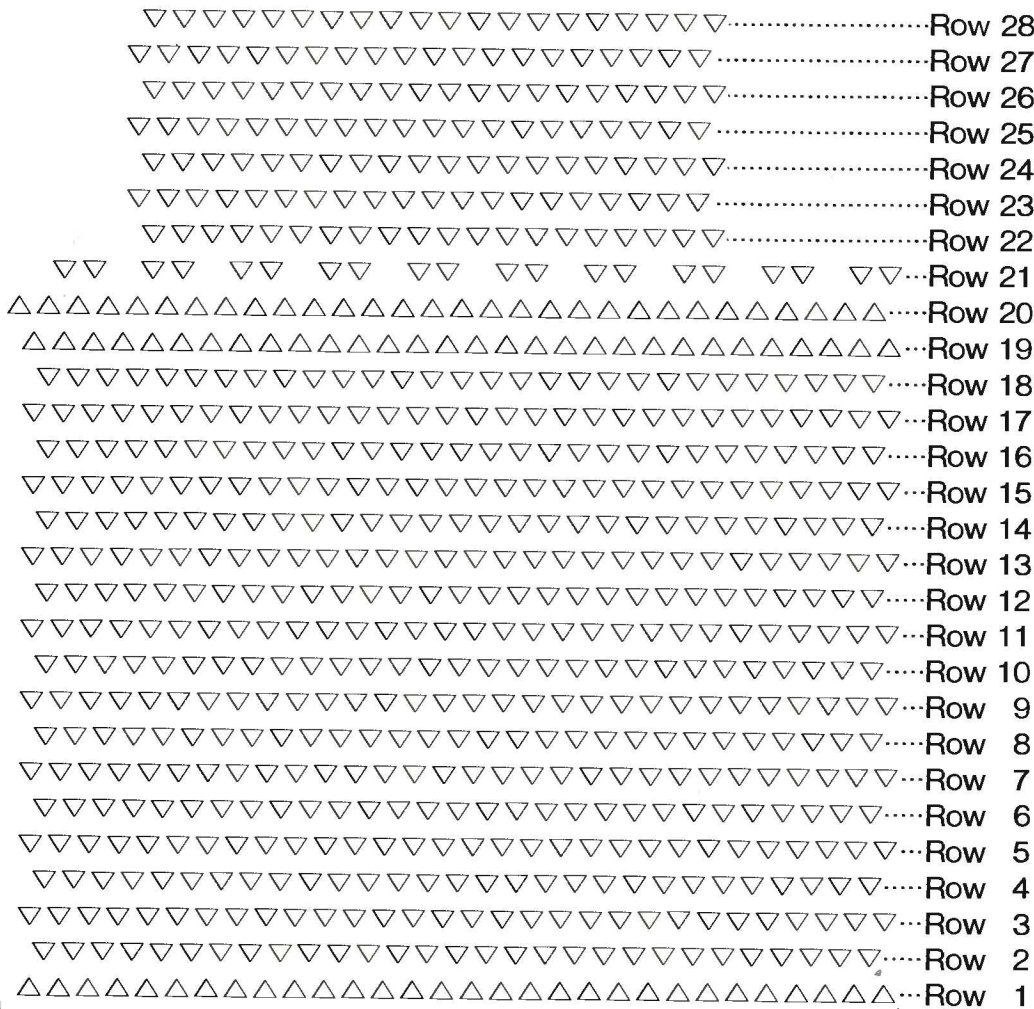

20 pcs. in each row

How to make s



Cut rectangular paper



Layer 4 sheets

30 pcs. in each row

Roll up and

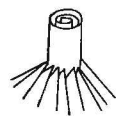

Insert into center an

Join ends to form a ring of 30 pcs.

How to reduce in Row 21

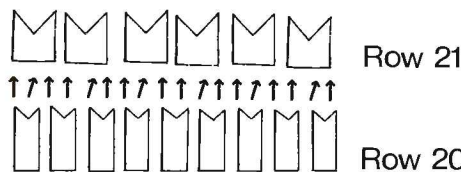

Repeat this to decrease the number of pcs., from 30 to 20.

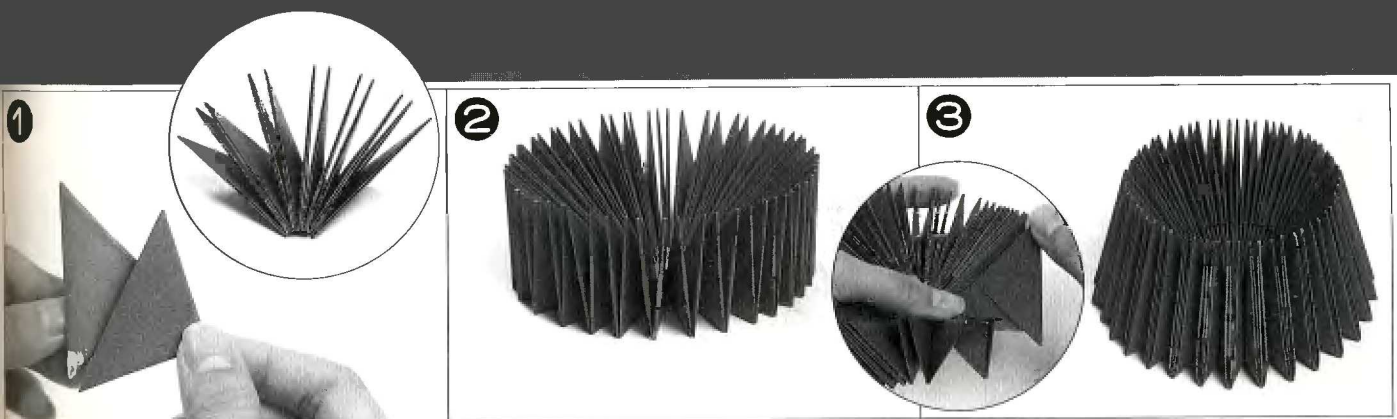

1 Apply a dab of glue on single points of 5-6 pcs., and paste them together. Repeat to make this set until 30 pcs. are used.

2 Paste each other and join into a circle of 30 pcs. (Row 1).

3 Row 2: Insert adjoining points of Row 1 into double pocket of a piece, double points facing up. Continue all around.

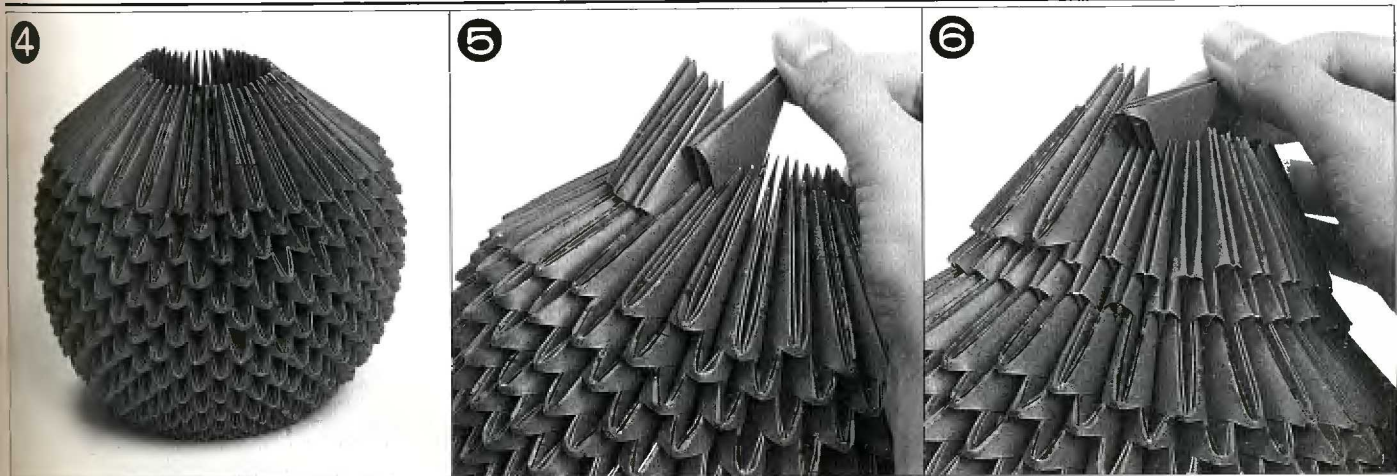

4 Rows 3-18: Work in the same manner interlocking at an angle so as to form a ball.

5 Row 19: Change the direction of pieces.

6 Row 20: Work as for Row 18. Row 20: Change the direction of pieces again.

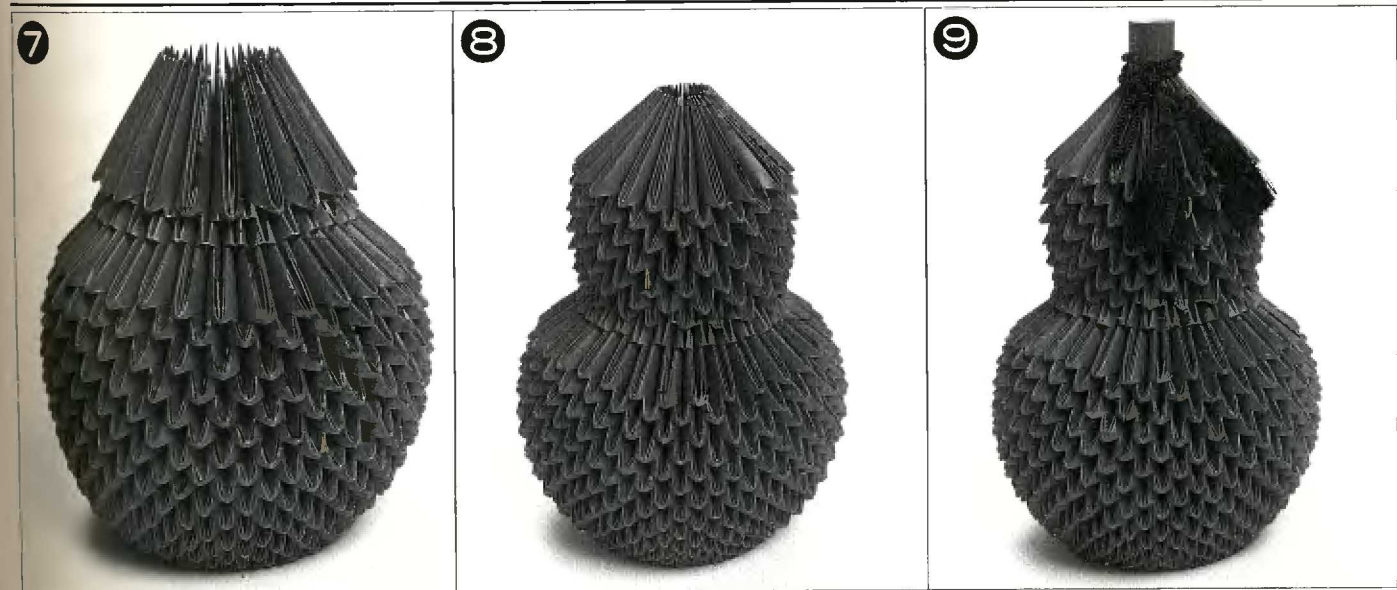

7 Row 21: Decrease the number of pieces to 20. Insert 3 points into a double pocket so that 2 pcs. cover 3 pcs.

8 Rows 22-28: Work with 20 pcs. on every row.

9 Layer 4 rectangles and roll up to form stem. Glue onto top of gourd, and tie cord around the stem, into a bow.



#65-#67 WINGED OWL (P.24)

Completed size
7" wide, 6 3/4" high

Materials

- | | | |
|---|----------------------------|--------------|
| 317 2 3/8" x 4 1/4" rectangles of craft paper | <#65> [brown] | {#67} |
| 81 2 3/8" x 4 1/4" rectangles of craft paper | <white> [white] | {white} |
| 2 2 3/8" x 4 1/4" rectangles of craft paper | <dark brown> [dark brown] | {dark brown} |
| 1 2 3/8" x 4 1/4" rectangle of craft paper | <pin> [pink] | {pink} |
| 1 pearl-headed marking pin | <blue> [white] | {yellow} |
| 3/8" wide ribbon | <3" moss green> [8" green] | {3" green} |
| 2 1/2" diam. plastic eyes each | | |
| 1 1/2" diam. bead wheel each | | |

- △ Black for #65
- Brown for #66
- Green for #67
- ▲ White

Wing (Make 2)

- △△△△..... Row 6 (4 pcs)
- ▽▽▽▽..... Row 5 (5 pcs)
- ▽▽▽..... Row 4 (4 pcs)
- ▽▽▽..... Row 3 (3 pcs)
- ▽▽..... Row 2 (2 pcs)
- ▽..... Row 1 (1 pc.)

Bow

#65: Black #67: Moss green

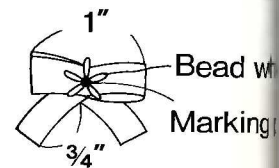

#66

Bead wheel 1 1/8"

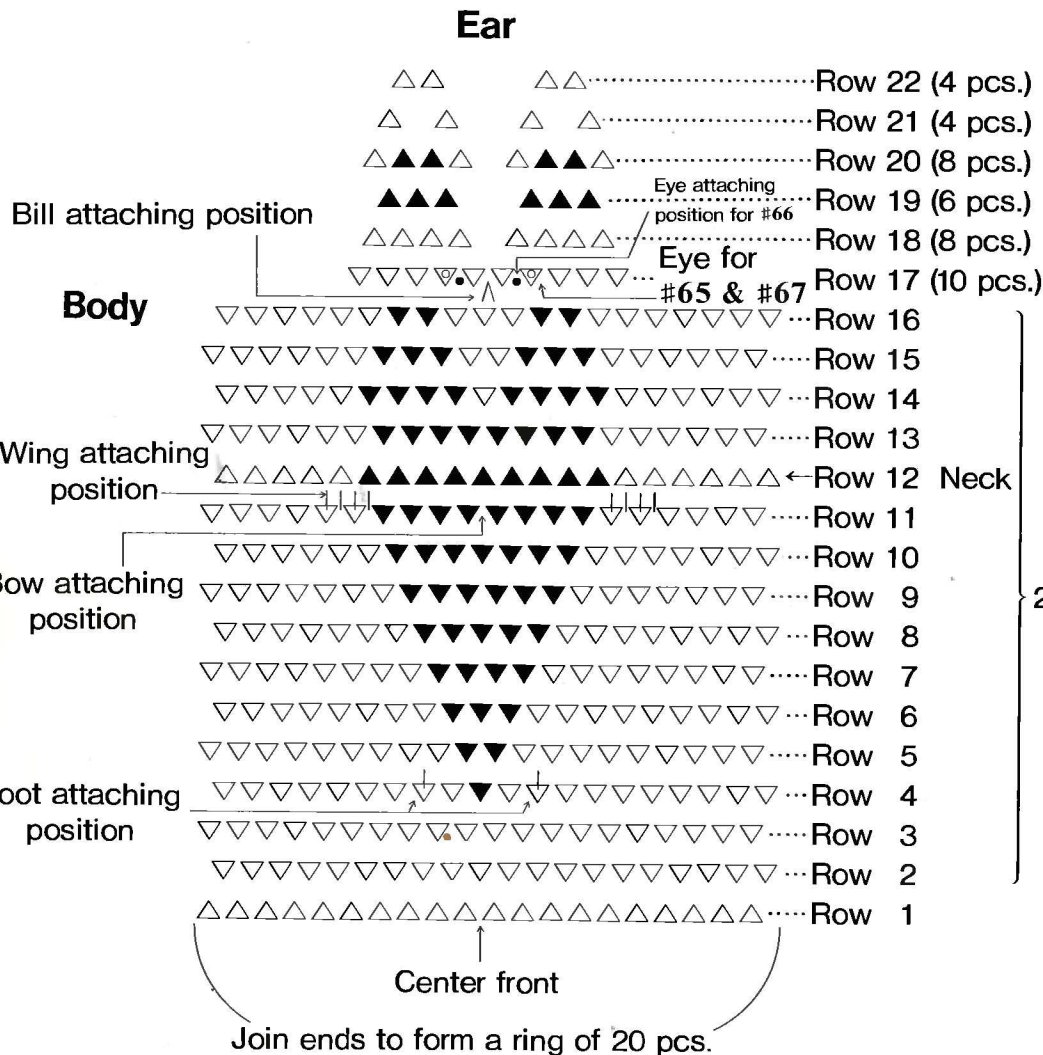
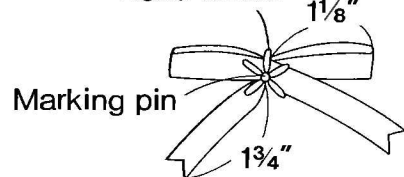

Signs for piece direction

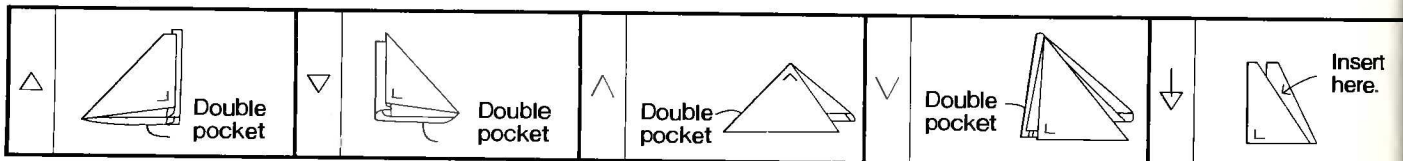

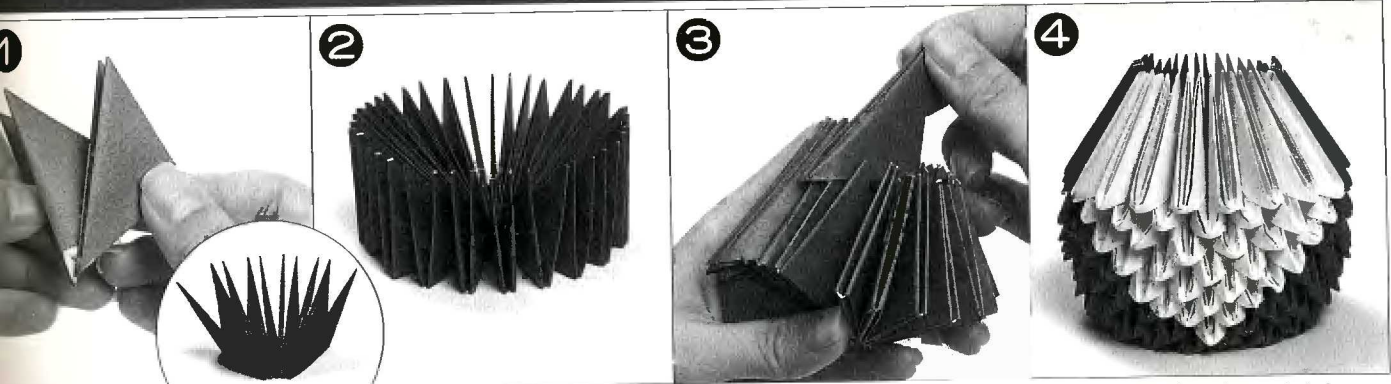

Apply a dab of glue on single points of 5-6 pcs., and paste them together. Repeat to make this set until 20 pcs. are used.

Paste each other and join into a circle of 20 pcs. (Row 1).

Row 2: Insert adjoining points of Row 1 into double pocket of a piece, double points facing up. Continue all around.

Rows 3-11: Continue joining the same number of pieces, altering color as directed on the opposite page.

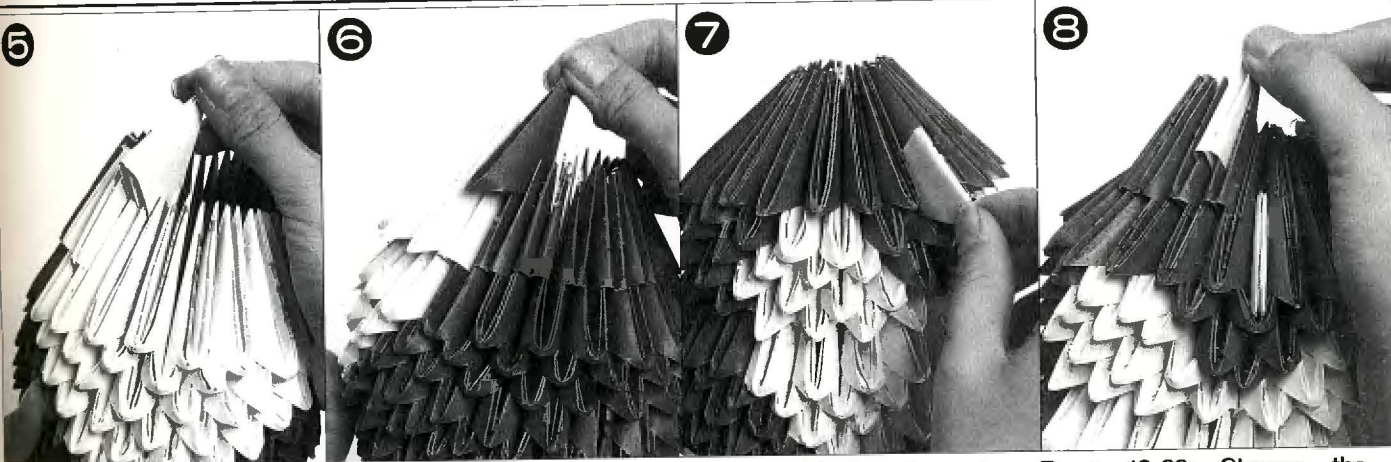

Row 12: Change the direction of pieces so the right angles face outward. See diagram for color layout.

Rows 13-16: Change the direction of pieces again so the right angles face inward. See diagram for color layout.

Row 17: Begin at center front; join 5 pcs. each rightward and leftward. Insert a pink piece into center front.

Rows 18-22: Change the direction of pieces again and form ears, one by one.

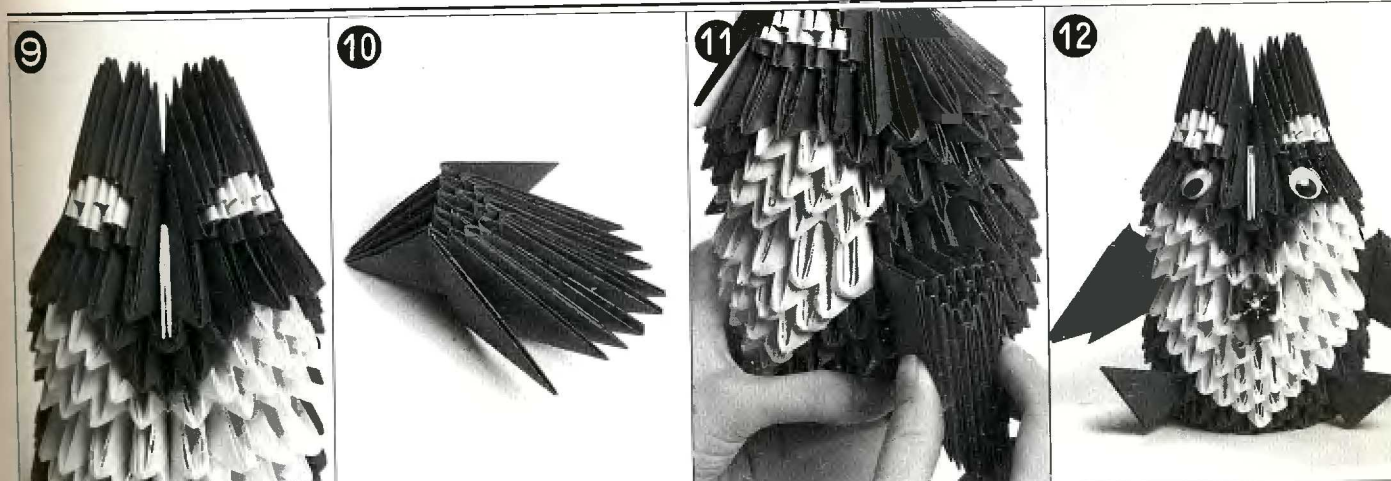

Both ears are completed.

Make a wing referring to the diagram. Make 2.

Insert wings into indicated positions.

Insert feet into indicated positions. Attach eyes and bow to finish.

#75 BRIDEGROOM (P.26)

Completed size
4 1/4" wide, 5 1/2" high



Materials

274 2 5/8" x 4 3/4" rectangles of craft paper (purple)

102 2 5/8" x 4 3/4" rectangles of craft paper (gray)

62 2 5/8" x 4 3/4" rectangles of craft paper (white)

1 2 5/8" x 4 3/4" rectangle of craft paper (pink)

2 pearl-headed marking pins (purple & white)

12" 1/4" ribbon (purple) 2 1/2" diam. plastic eyes

1 1/2" diam. bead wheel

2 silk flowers

- ▽ Purple
- ▼ Gray
- ▽ White

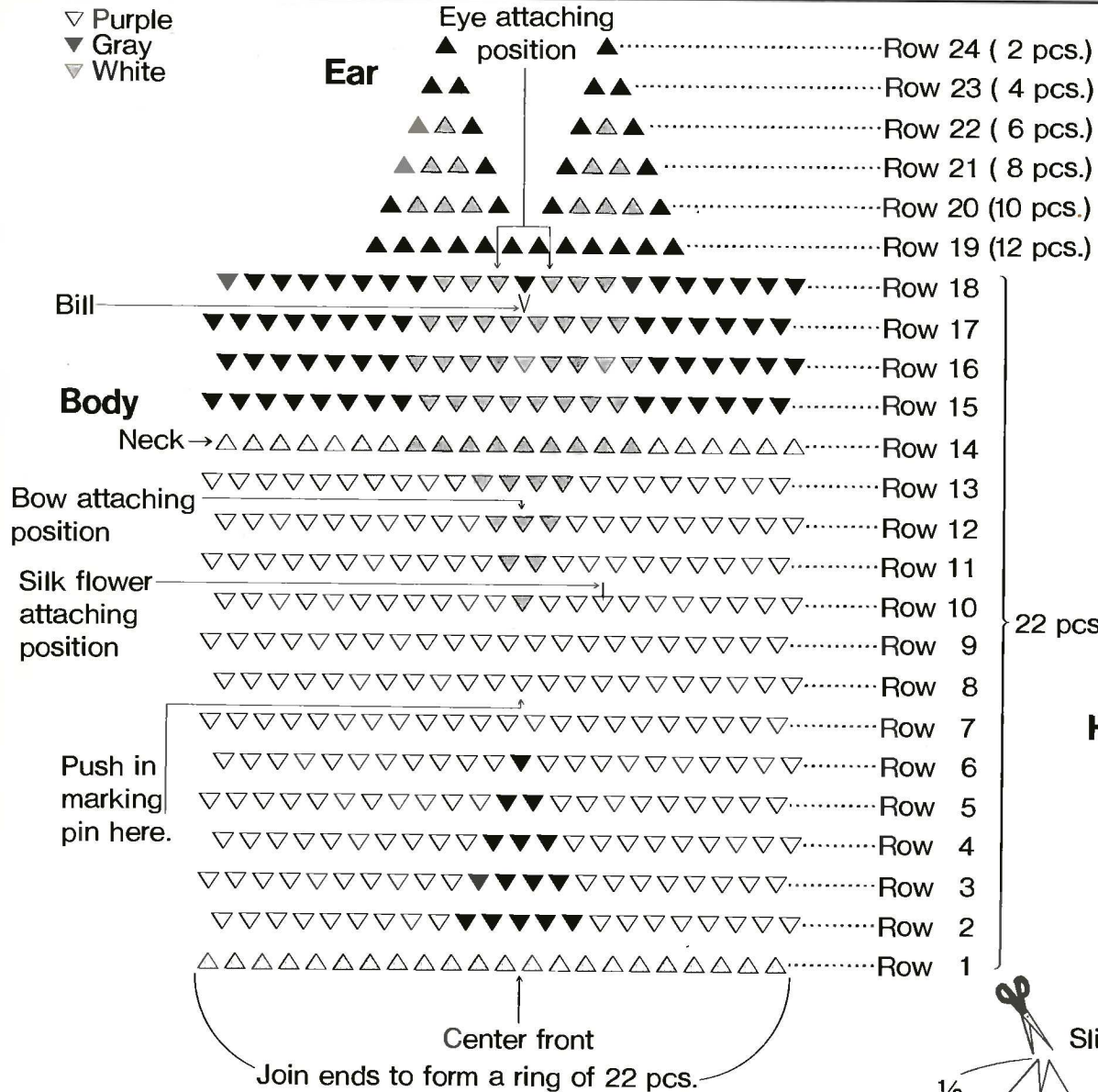

Bow

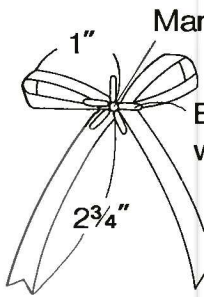

How to make

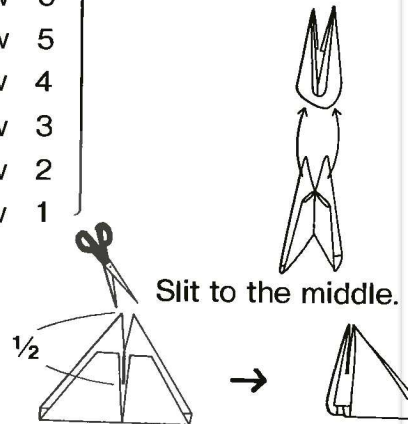

Signs for piece direction

➔ See P.77 for step-by-step instructions

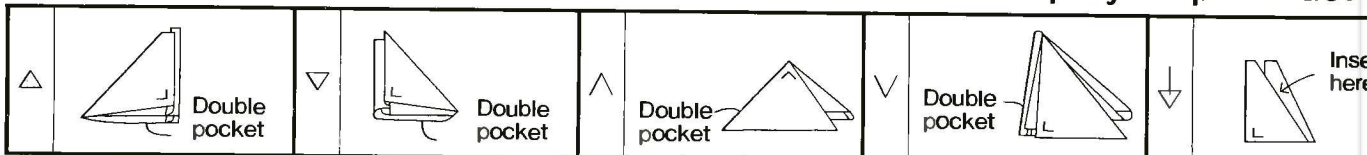

#76 BRIDE (P.26)

Completed size
4 1/4" wide, 6" high

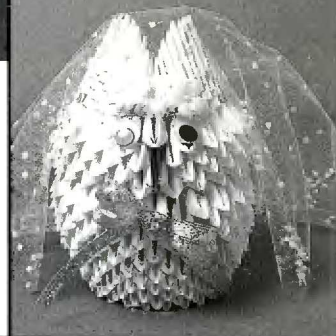

Materials

- 399 2 3/8" x 4 3/4" rectangles of craft paper (white)
- 75 2 3/8" x 4 3/4" rectangles of craft paper (pink)
- 1 2 3/8" x 4 3/4" rectangle of craft paper (gold)
- 1 2 3/8" x 4 3/4" rectangle of craft paper (red)
- 2 1/2" diam. plastic eyes
- 1 pearl-headed marking pin (white)

- 16" 1/4" ribbon (silver)
- 115 1/8" diam. perl beads
- 1 1/2" diam. bead wheel
- 3 silk flowers (pink)
- 12" x 13" dotted tulle

Sew on beads omitting the center of veil, in a flower pattern (See bottom).

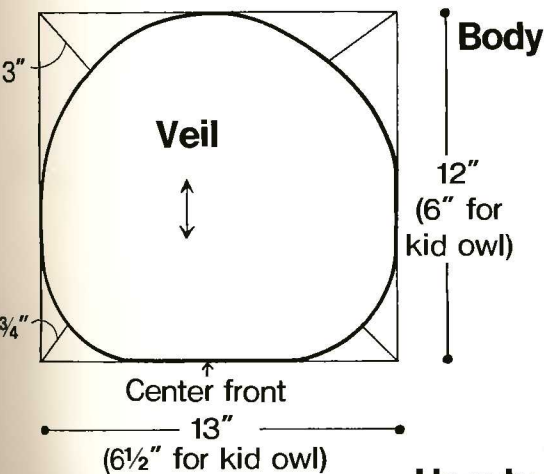
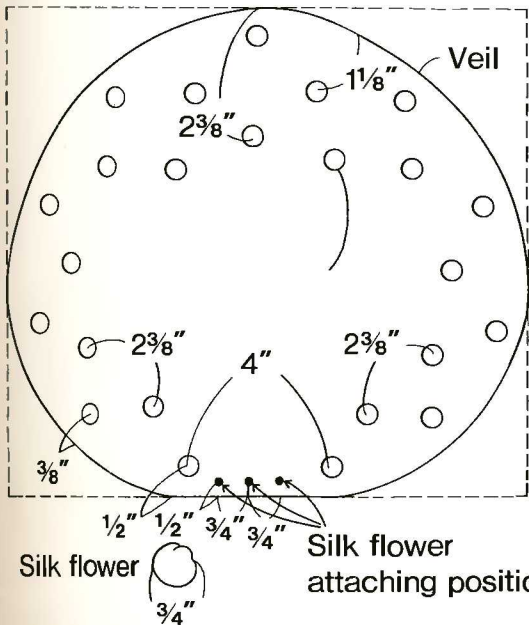

△ White
▲ Pink
△ Gold

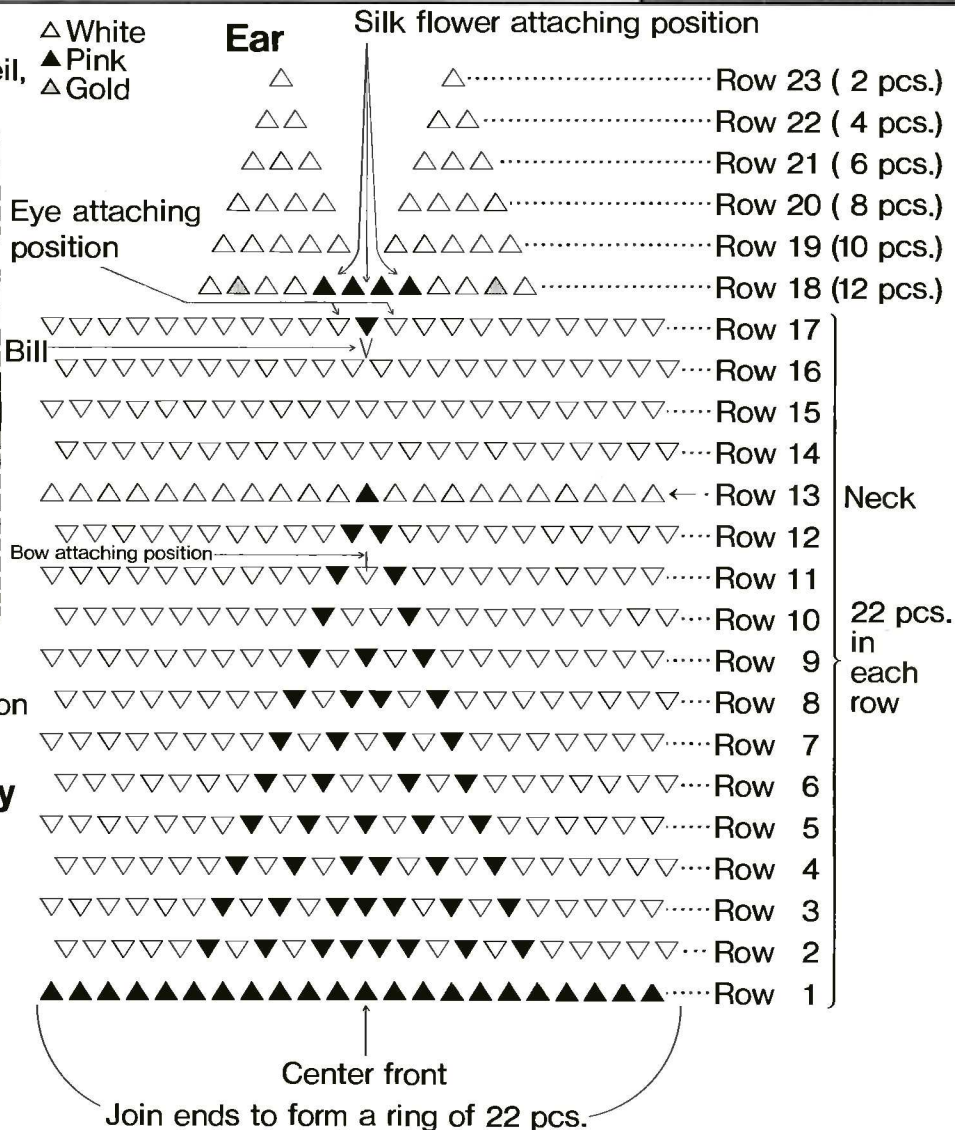

➔ See P.77 for step-by-step instructions.

Bead embroidery pattern

How to secure beads

- ① Using a threaded needle, sew on bead twice.
- ② Apply a dab of glue onto the first stitch.

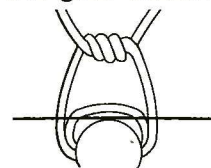
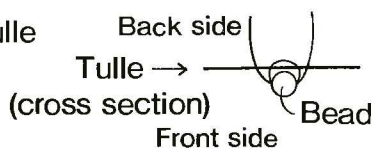

- ③ Tie into a knot winding twice, before the glue becomes dry.
- ④ When the glue is dry, trim away excess thread.

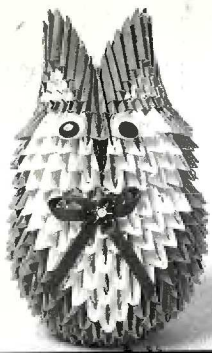

#62-#64 OWL (P.24)

Completed size
4" wide, 6½" high

Materials

328 2" x 3½" rectangles of craft paper	<yellow> [blue] [pink]
88 2" x 3½" rectangles of craft paper	<white> [white] [white]
1 2" x 3½" rectangle of craft paper	<red> [red] [red]
1 pearl-headed marking pin	<white> [white] [white]
8" ¼" ribbon	<yellow> [blue] [pink]
1 ½" diam. bead wheel	<white> [blue] [pink]
2 ½" diam. plastic eyes each	

△ Yellow for #62
Blue for #63
Pink for #64
▲ White

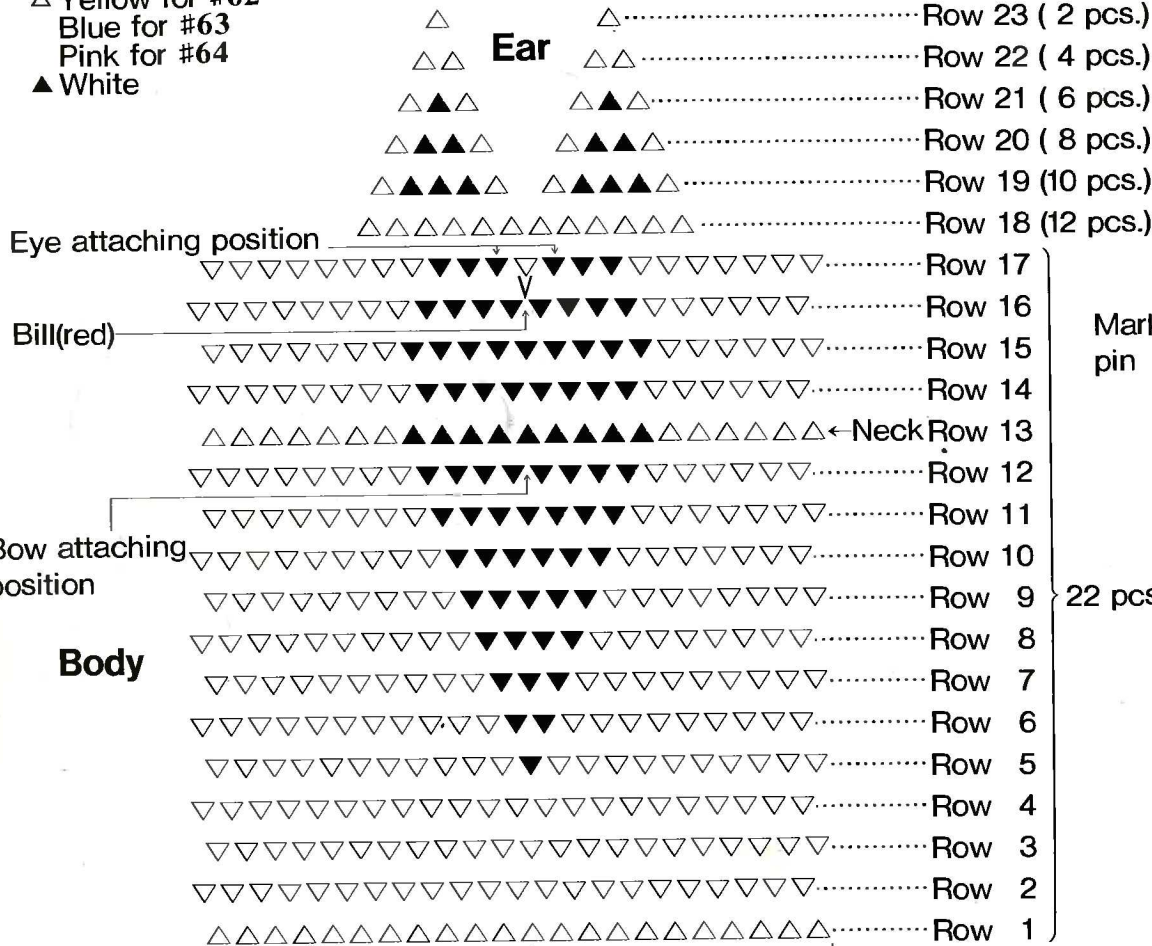

Bow

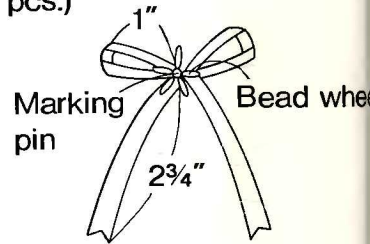

How to make Bill

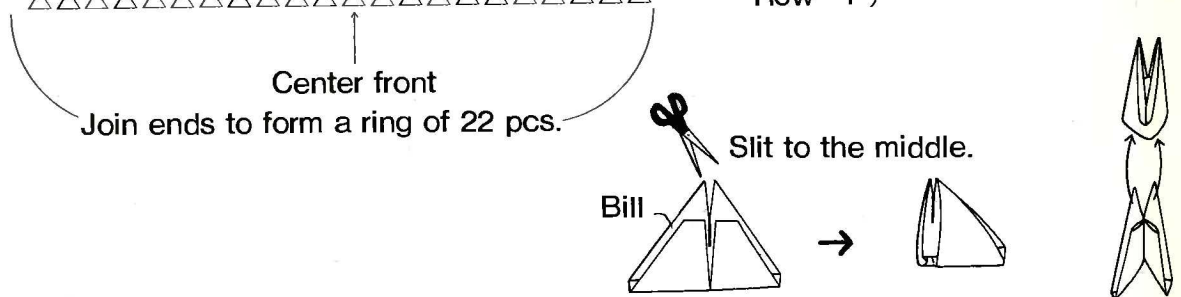

Signs for piece direction

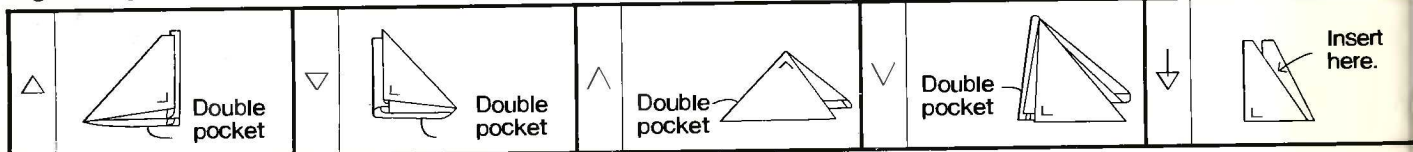



1 Apply a dab of glue on single points of 5-6 pcs., and paste them together. Repeat to make this set until 22 pcs. are used.



2 Paste each other and join into a circle of 22 pcs. (Row 1).

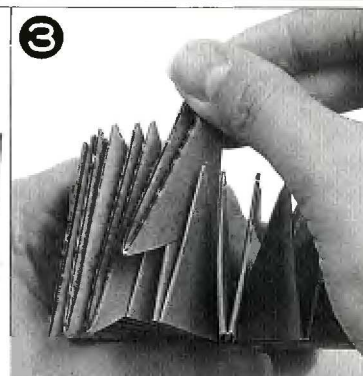

3 Row 2: Insert adjoining points of Row 1 into double pocket of a piece, double points facing up. Continue all around.

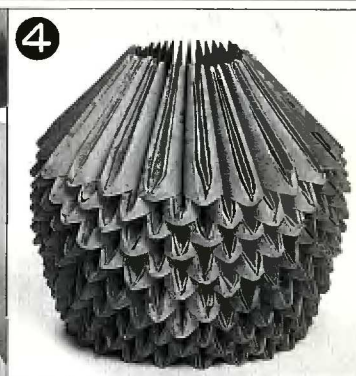

4 Rows 3-12: Continue joining the same number of pieces, altering color as directed on the opposite page.



5 Row 13: Shape neck by changing direction of pieces, the right angles facing outward. See diagram for colors.



6 Rows 14-16: Change direction of pieces again, and work as directed on the color chart.



7 Insert bill (red) into Row 16.

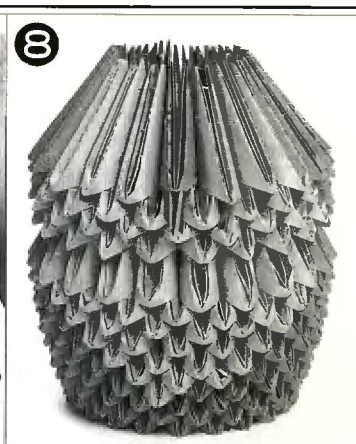

8 Row 17: Work in the same manner as the previous row.



9 Row 18: Form ears; change direction of pieces and work only on ears.

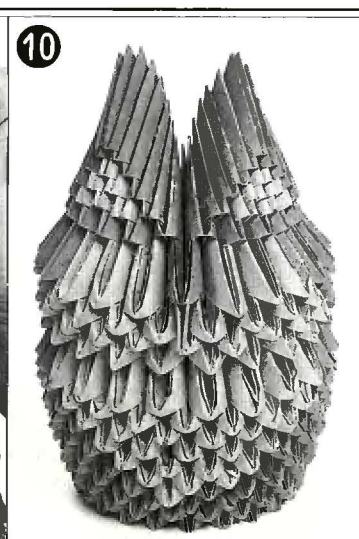

10 Both ears are completed.

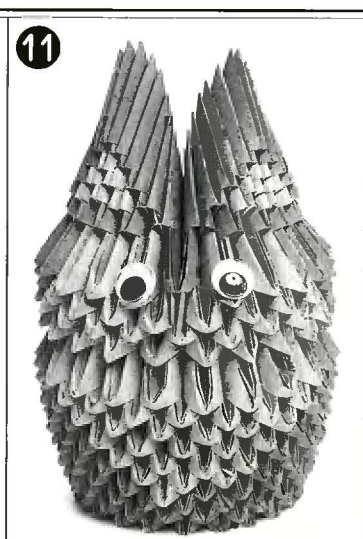

11 Glue on eyes.

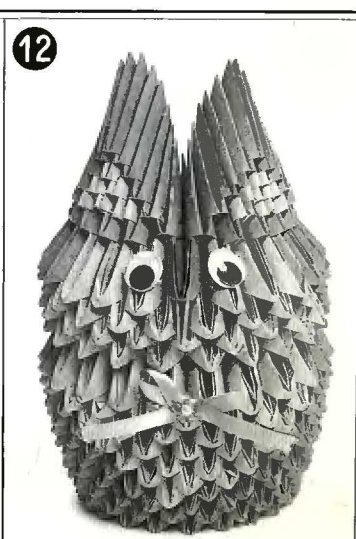

12 Attach bow and bead wheel by pushing in marking pin.

#77-#79 FLOWER GIRL & RING BEARER (P.26)

Completed size
2 3/4" wide, 3" high

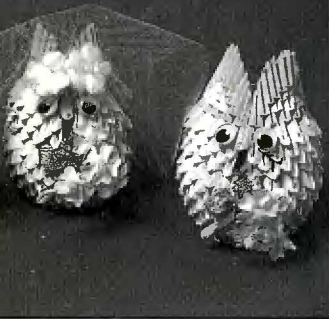

Materials

- | | | | | |
|-----|--|----------|----------|----------|
| | <#77> | [#78] | {#79} | |
| 274 | 1 1/8" x 2 1/8" rectangles of craft paper | <yellow> | [blue] | {pink} |
| 88 | 1 1/8" x 2 1/8" rectangles of craft paper | <white> | [white] | {white} |
| 1 | 1 1/8" x 2 1/8" rectangle of craft paper | <red> | [red] | {red} |
| 1 | pearl-headed marking pin | <yellow> | [blue] | {pink} |
| 3" | 1/3" ribbon | <silver> | [silver] | {silver} |
| 1 | 1/2" diam. bead wheel | <gold> | [gold] | {gold} |
| 5 | stemmed silk flowers plus 1 stemmed bud each | | | |

- 2 1/2" diam. plastic eyes each
- 5" x 8" tulle (for #79)
- 2 silk flowers (for #79)

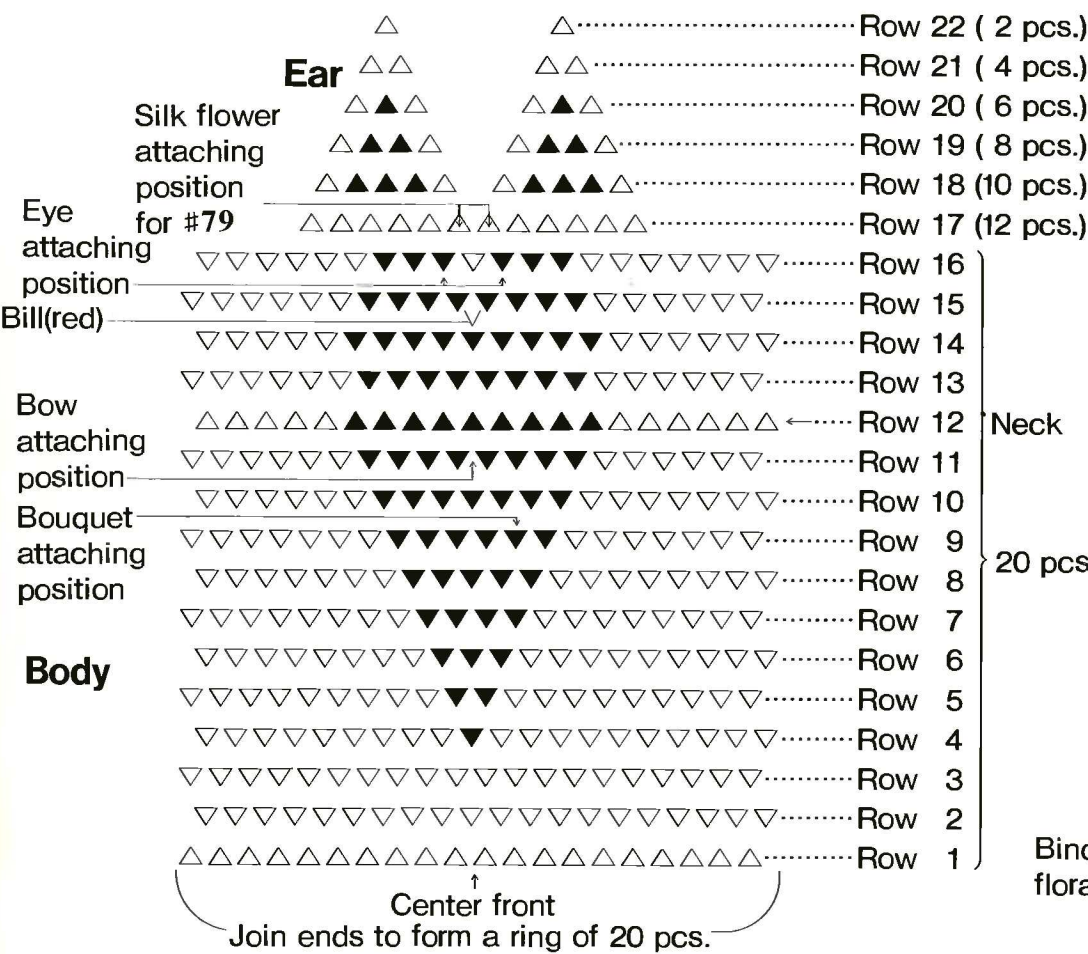

- △ Yellow for #77
- Blue for #78
- Pink for #79
- ▲ White

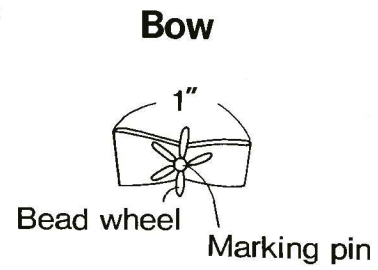

Neck

20 pcs. in each row

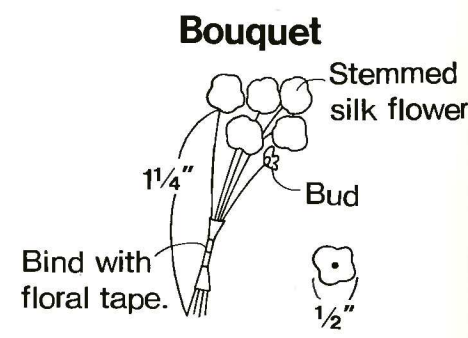

☞ See P.77 for step-by-step instructions.

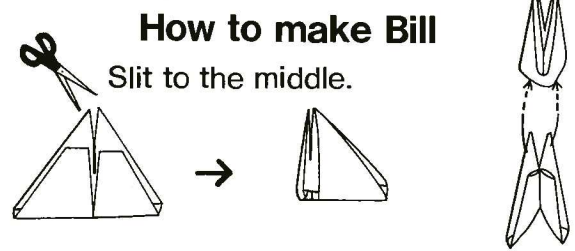

● For veil, see P.75
Signs for piece direction

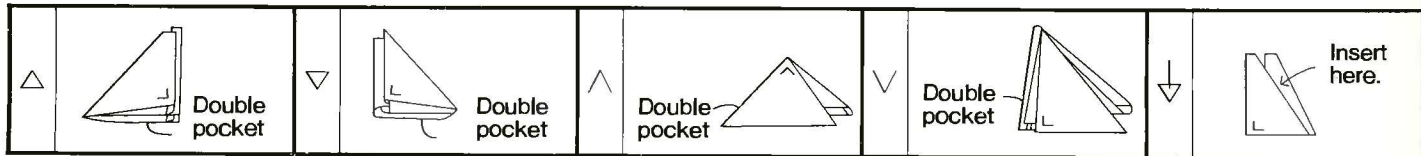

#1 GRANNY OWL (P.3)

Completed size
2 1/4" wide, 4" high

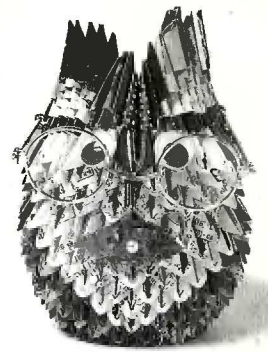

Materials

- 328 1 1/2" x 2 1/4" rectangles of glossy paper (black shades)
- 88 1 1/2" x 2 1/4" rectangles of glossy paper (white base)
- 1 1 1/2" x 2 1/4" rectangle of glossy paper (red shades)
- 2 1/2" diam. plastic eyes
- 1 pearl-headed marking pin (white)
- 2" #28 wrapped wire (green)
- 1 pair doll's glasses

- △ Magazine paper in black shades
- ▲ Magazine paper with white base

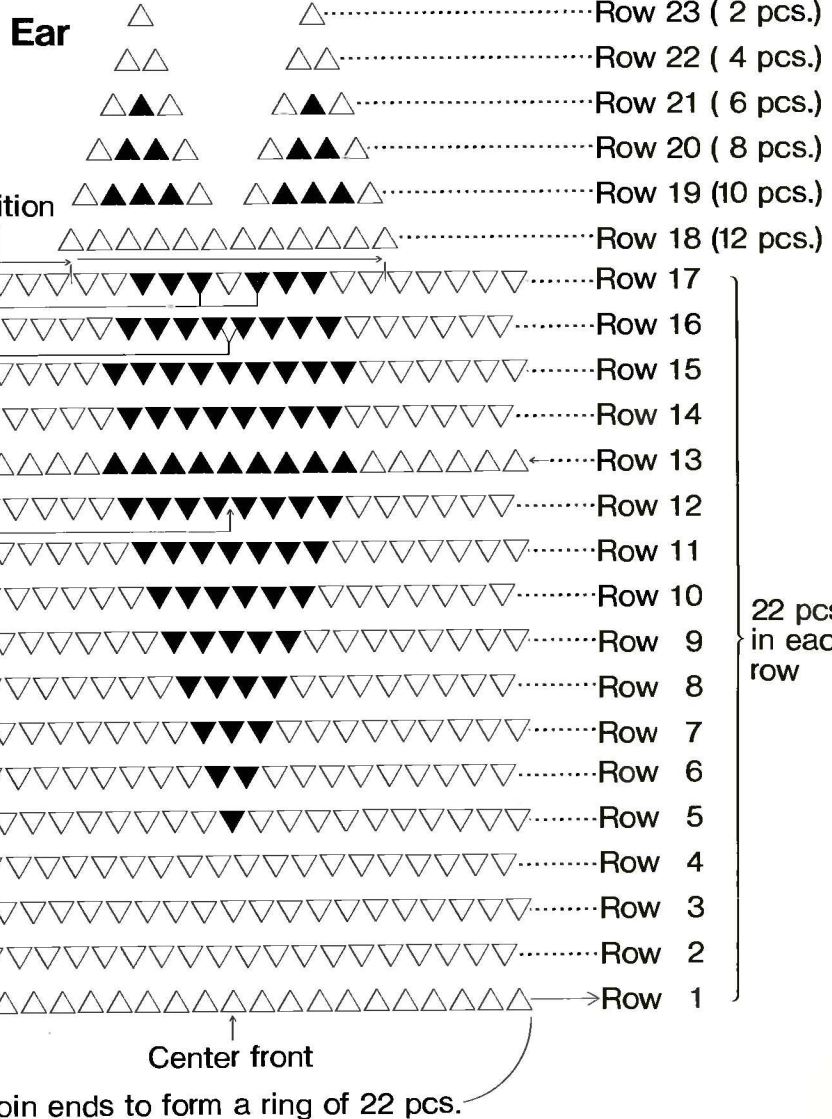

Leaf (Actual size)

Attach with marking pin. Bill (red)

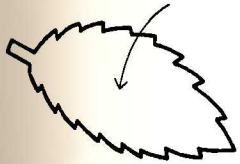

Body

Leaf attaching position

Reading glasses

Doll's glasses are used here, but if not available, make a pair with a piece of wire.

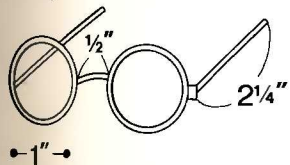

How to attach hook for glasses

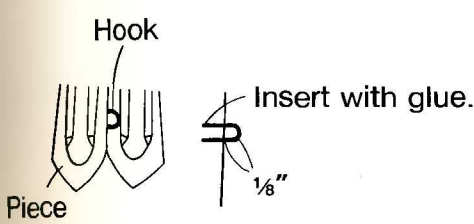

Join pieces in the same manner as for #62-64 OWL on P.77.

How to make Bill

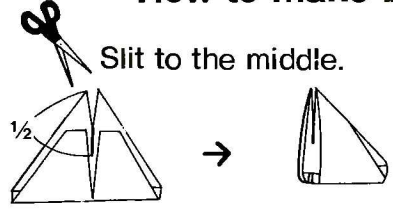

See P.77 for step-by-step instructions.

#68 KAPPA (P.25)

Completed size
3 1/2" wide, 5" high

Materials

- 250 2 3/8" x 4 1/4" rectangles of craft paper (pale green)
- 75 2 3/8" x 4 1/4" rectangles of craft paper (black)
- 58 2 3/8" x 4 1/4" rectangles of craft paper (yellow) + 2 pcs. for hands
- 20 1 1/8" x 4 1/4" rectangles of craft paper (yellow, for rain hat)
- 1 1 1/2" x 4" rectangle of craft paper (black, for hair ornament)
- 55 4 1/4" x 1 1/8" rectangles of tissue paper (black)
- 8" 1/16" cord (purple)
- Felt (black) for nostrils and navel
- 1 ft. 1/16" wire (bronze)

*55 of 75 black pcs. are used to construct back of body. When folding these pieces, layer black tissue paper to give thickness.
*When folding pieces for rain hat as instructed on P.29, cut rectangles lengthwise in half, omit the first folding, and start from Step 2.

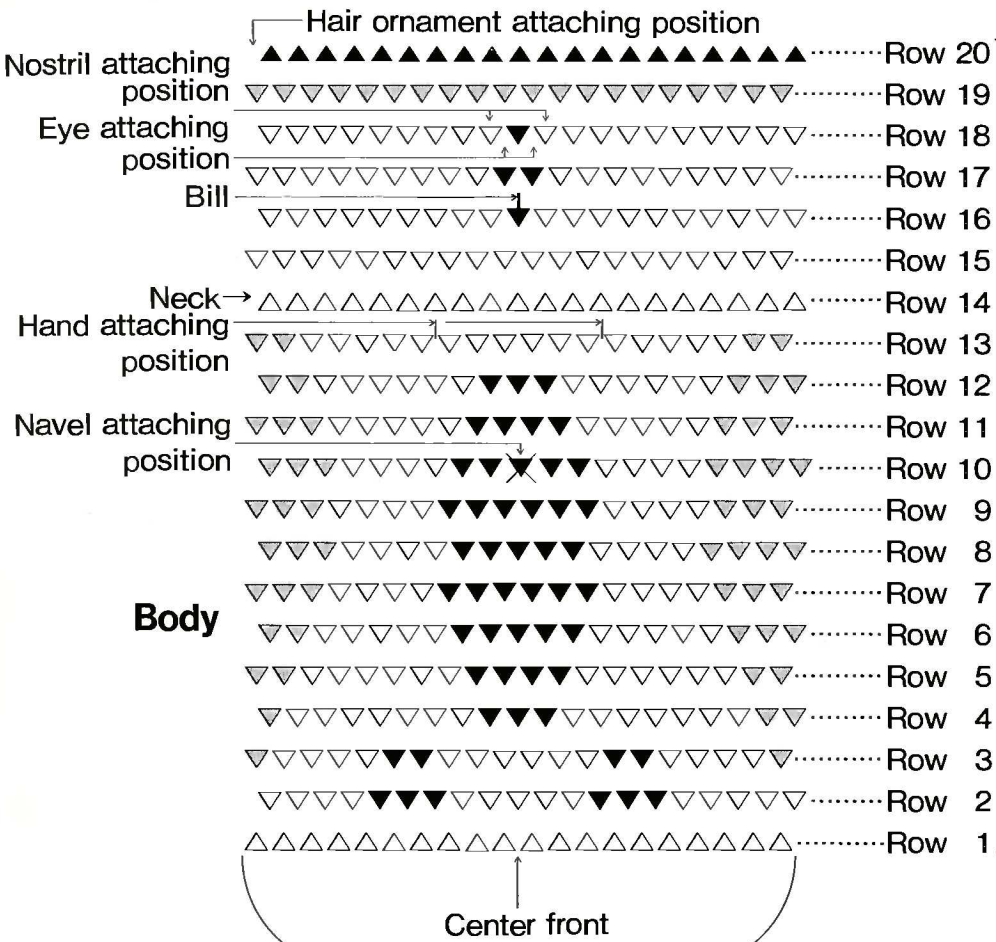

- ▽ Pale green
- ▽ Yellow
- ▽ Black

How to make Arms

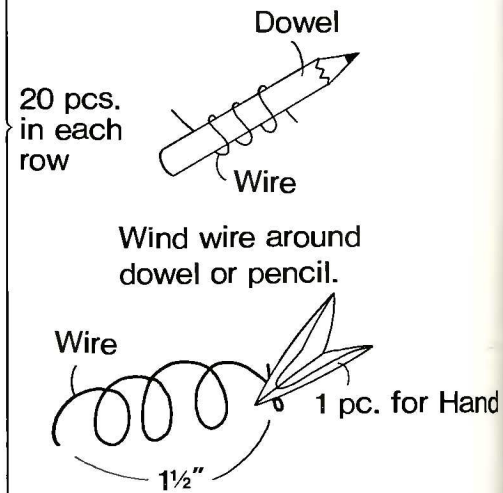

Hair ornament

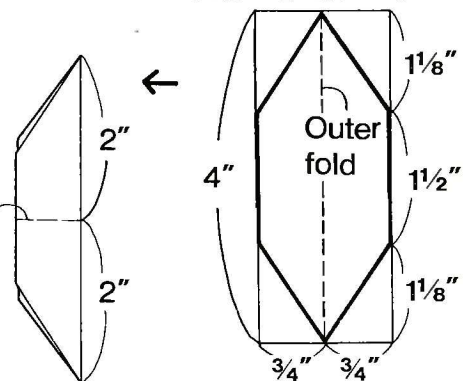

(Actual size) Join ends to form a ring of 20 pcs.



Nostril (Make 2)

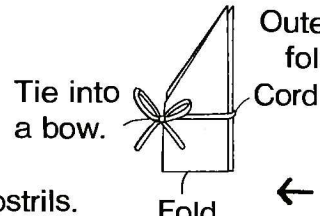
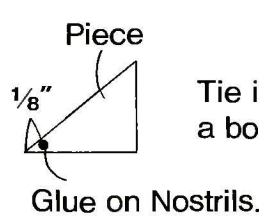

Navel ○ Felt
Signs for piece direction

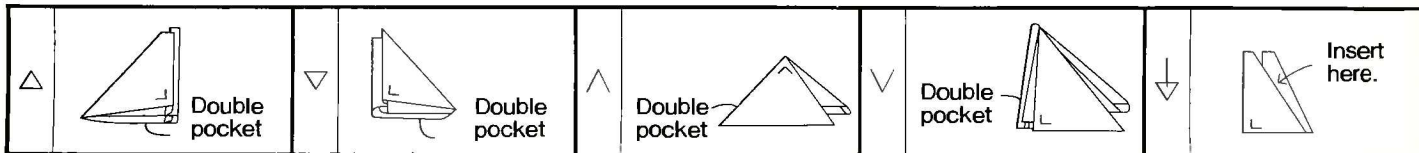



1 Apply a dab of glue on single points of 5-6 pcs., and paste them together. Repeat to make this set until 20 pcs. are used.



2 Paste each other and join into a circle of 20 pcs. (Row 1).



3 Row 2: Insert adjoining points of Row 1 into double pocket of a piece, double points facing up. Continue all around.

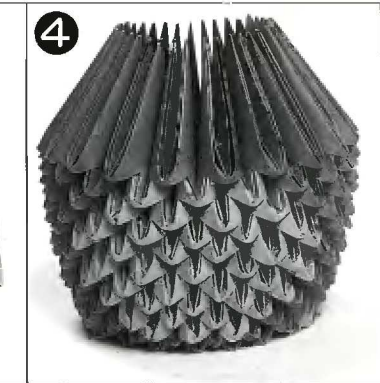

4 Rows 3-13: Continue joining the same number of pieces, altering color as directed on the opposite page.

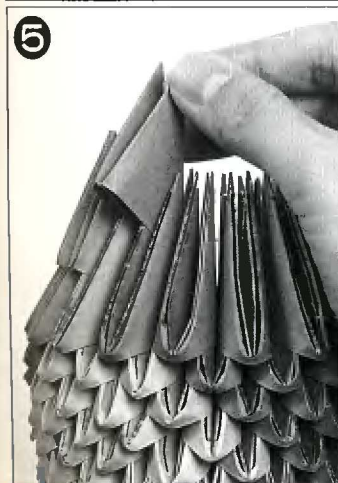

5 Row 14: Shape neck by changing direction of pieces, the right angles facing outward.



6 Rows 15-17: Change direction of pieces again, and work as directed. Insert bill (yellow) into Row 17.

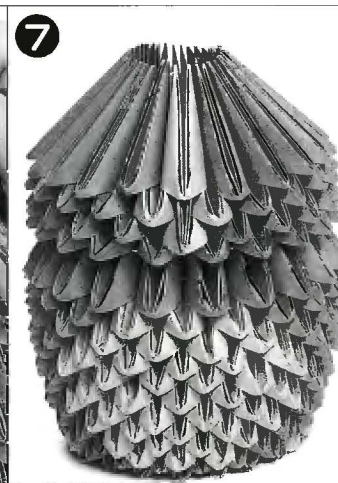

7 Row 18: Work in the same manner as the previous row, altering colors as directed.

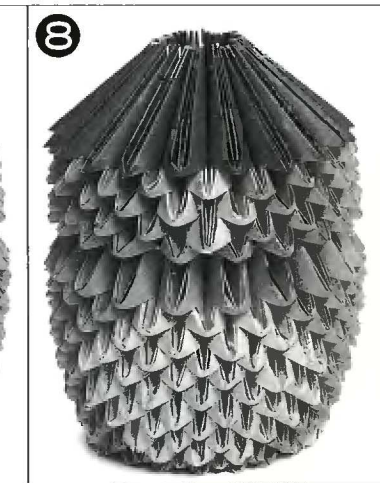

8 Row 19: Make hair by joining 20 black pcs.



9 Row 20: Make rain hat by joining 20 yellow pcs.



10 Insert hair ornament into center back of Row 20.



11 Glue on eyes and felt nostrils. Glue felt navel onto Row 10.



12 Make arms and hands with wire and triangles, and insert into body.



#69 & #70 PENGUIN (P.25)

Completed size
4 3/4" wide, 6 1/4" high

Materials

- 304 2 3/8" x 4 1/4" rectangles of craft paper <#69> [black] <#70> [blue]
 48 2 3/8" x 4 1/4" rectangles of craft paper <#69> [blue] <#70> [white]
 7 2 3/8" x 4 1/4" rectangles of craft paper <#69> [yellow] <#70> [yellow]
 3 2 3/8" x 4 1/4" rectangles of craft paper <#69> [black] <#70> [blue]

- (Following materials are for each item.)
 4" 1/3" ribbon (red)
 2 1/2" diam. plastic eyes
 1 straw hat for dolls

for wing and feet

- 1 1 1/4" x 2 3/4" rectangle of craft paper <#69> [yellow] <#70> [yellow] for bill

Bill attaching position

Eye attaching position

Eye attaching position

Body

Wing attaching position

Bow attaching position

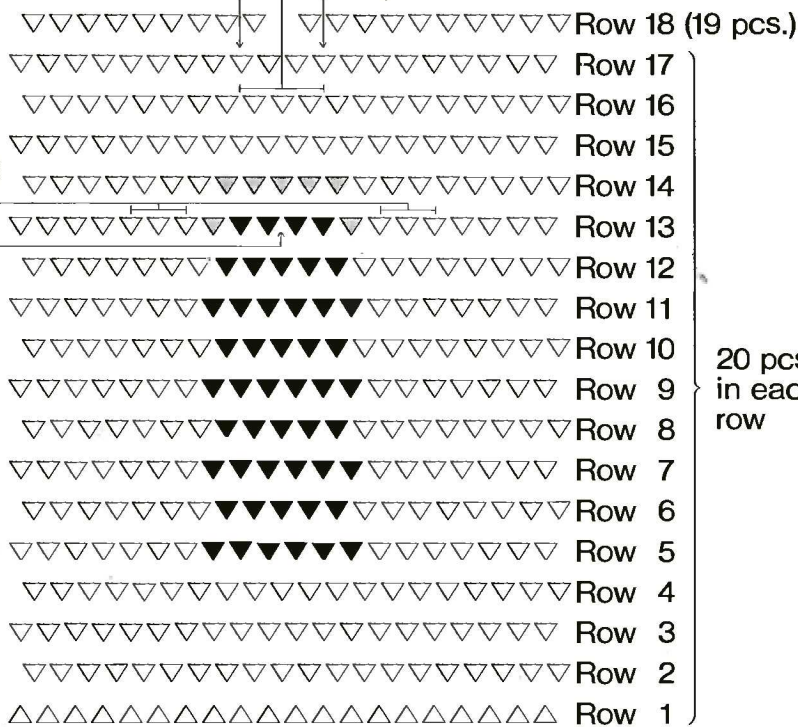

20 pcs. in each row

Center front

Join ends to form a ring of 20 pcs.

- ▽ Black for #69/Blue for #70
- ▼ Blue for #69/White for #70
- ▽ Yellow

Bow tie

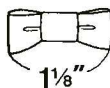

Paste 2 layers of sheets and cut out.

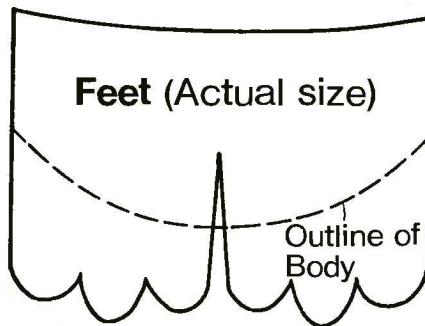

Section for gluing

Feet

Paste 2 layers together.

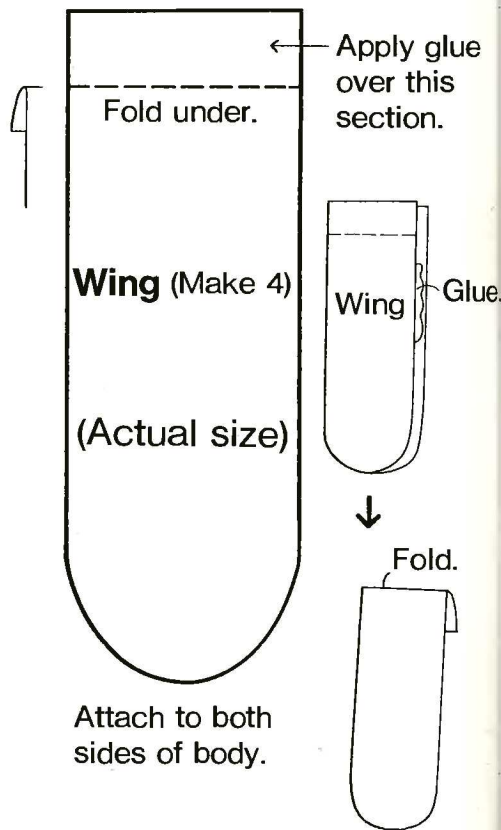

Signs for piece direction

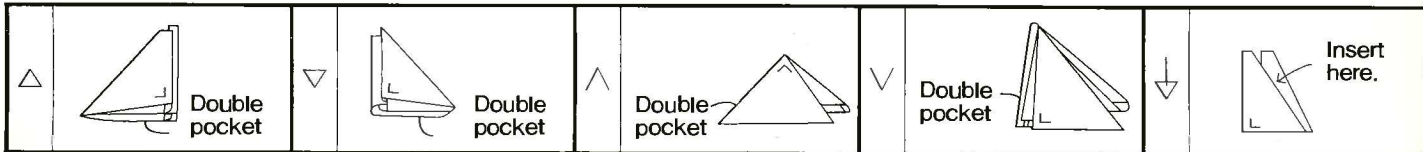

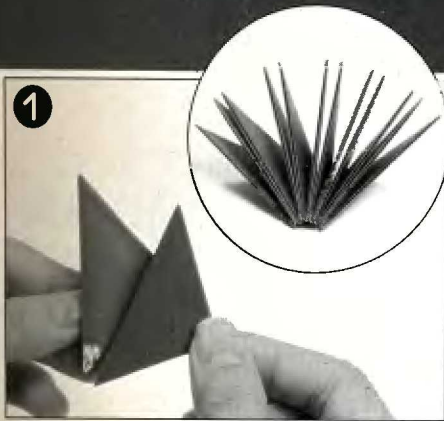

1 Apply a dab of glue on single points of 5-6 pcs., and paste them together. Repeat to make this set until 20 pcs. are used.

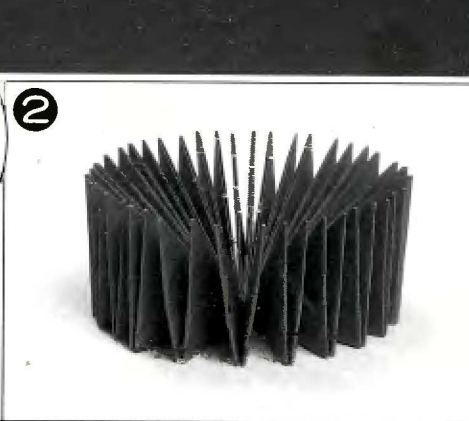

2 Paste each other and join into a circle of 20 pcs. (Row 1).



3 Row 2: Insert adjoining points of Row 1 into double pocket of a piece, double points facing up. Continue all around.



4 Rows 3-18: Join 20 each pcs. in the same manner, altering colors as directed in the diagram.



5 Check the shape. Interlock so the top opening is as small as possible.



6 Glue on eyes and bow tie.



7 Make bill as directed below, and glue onto the indicated position.



8 Make wings and feet. Glue onto body.



9 Glue on straw hat to finish.

How to make Bill

Fold a $1\frac{1}{4}'' \times 2\frac{3}{4}''$ rectangular paper in half.

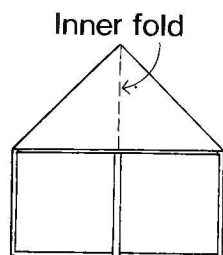
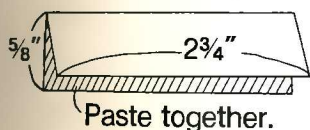

Fold down corners to meet at the center bottom, and secure upper half with glue.

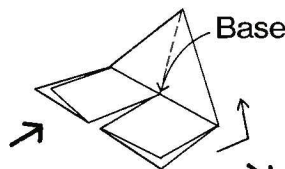

Fold down in half and unfold.

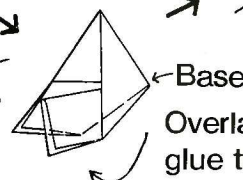

Overlap squares and glue together.



#71 & #72 KITTEN (P.25)

Completed size
4" wide, 5 1/2" high

Materials

220 2 3/8" x 4 1/4" rectangles of craft paper <yellow> [green]
 134 2" x 3 1/2" rectangles of craft paper <yellow> [green]
 1 3/4" x 3/4" rectangle of craft paper <black> [black] for ear
 6" wired tinsel <yellow> [brown]

(Following materials are for each item.)
 20" 1/3" ribbon (pink)
 2 1/2" diam. plastic eyes
 1 miniature bell
 1 1/2 ft. #28 wrapped wire
 (white, for whiskers)
 1 1/3" diam. button (black)

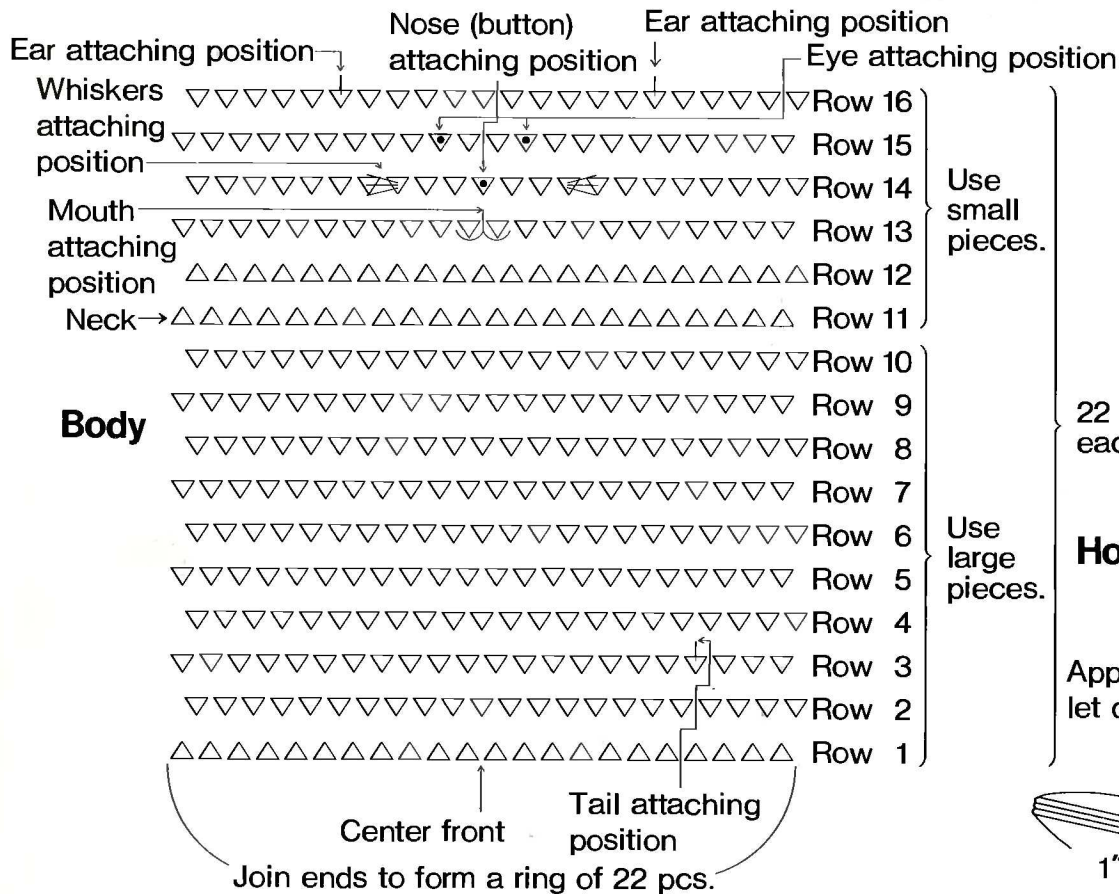

How to join a piece in Row 11

Use small pieces.



22 pcs. in each row

Use large pieces.

How to make Whiskers

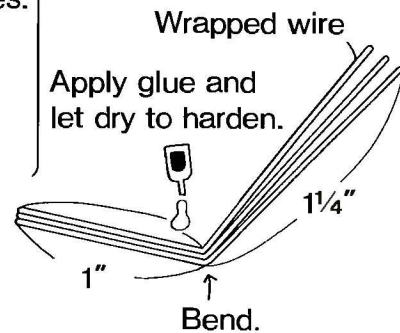

How to make Ear

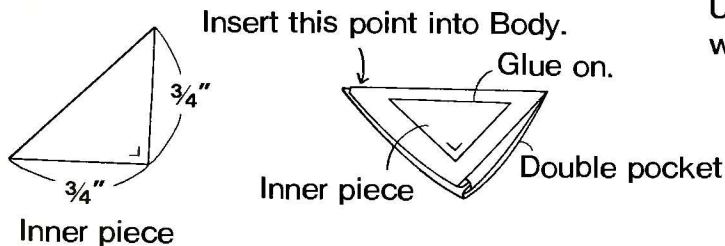

How to make Mouth

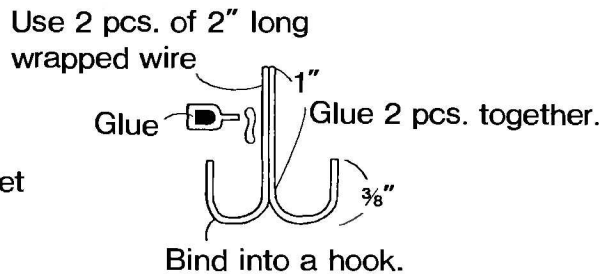

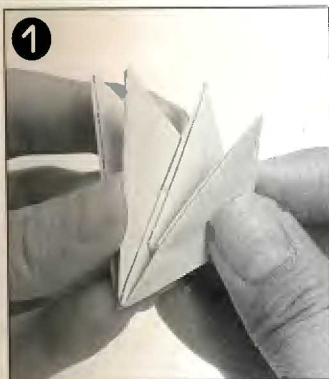

1 Apply a dab of glue on single points of 5-6 large pcs., and paste them together. Repeat to make this set until 22 pcs. are used.



2 Paste each other and join into a circle of 22 pcs. (Row 1).



3 Row 2: Insert adjoining points of Row 1 into double pocket of a piece, double points facing up. Continue all around.

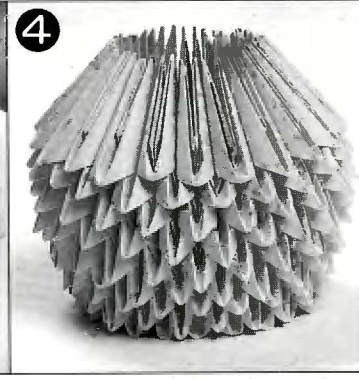

4 Rows 3-10: Join 22 each pcs. in the same manner.



5 Row 11: Using small pieces, shape neck by changing direction of pieces, so the right angles face outward.

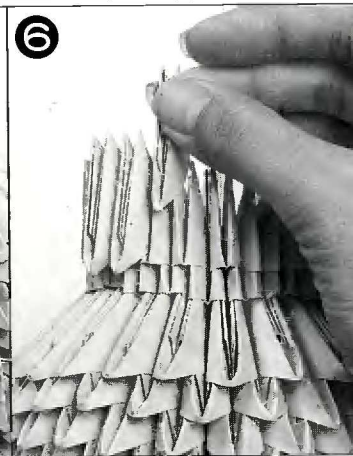

6 Row 12: Work as for Row 11 with small pieces. Row 13: Change direction of pieces again.

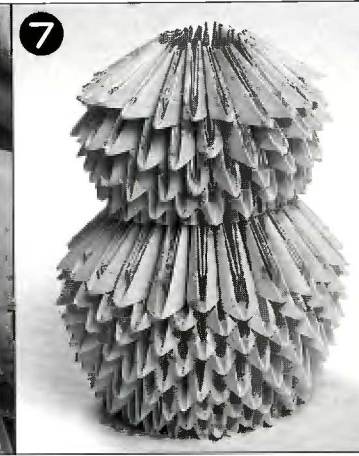

7 Rows 13-17: Work in the same manner with small pieces, shaping into a ball.

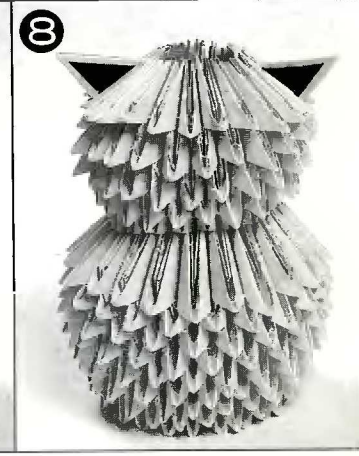

8 Make ears as directed and insert between 4th and 5th pcs. from center front of Row 17.

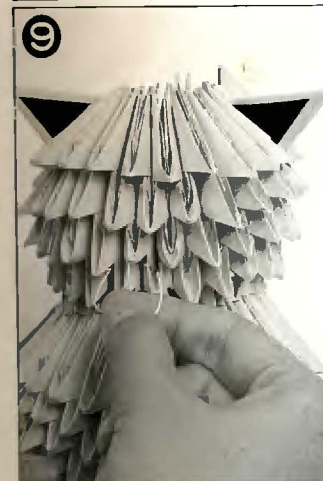

9 Make mouth with wire as directed, and insert into center front of Row 14.



10 Make 2 whiskers using wire, and insert into both sides of nose.

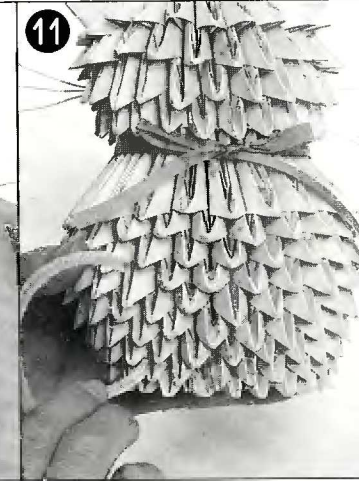

11 Attach bell onto center of ribbon, and tie around neck into a bow. Insert wired tinsel as tail.

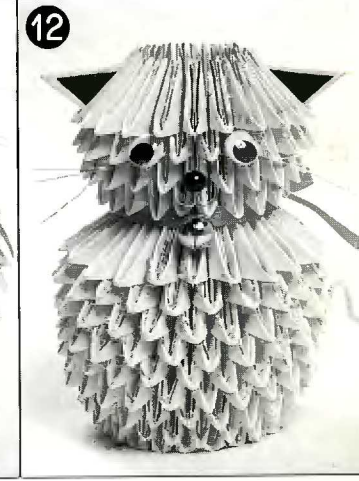

12 Glue eyes and nose onto indicated positions.



#73 & #74 RABBIT (P.25)

Completed size
3½" wide, 5½" high

Materials

- 292 2" × 3½" rectangles of craft paper
- 14 2" × 3½" rectangles of thin craft paper
- 1 2" × 3½" rectangle of craft paper
- 1 pearl-headed marking pin
- (Following materials are for each item.)
- 1 ½" diam. button (black)
- 2 ½" diam. buttons (red)
- 8" ¼" ribbon (red)

- <#73> [#74]
- <white> [pale pink]
- <pink> [pink]
- <red> [red]
- <white> [pink]

- 1½ ft. #28 wrapped wire (white, for whiskers)
- 1 ½" bead wheel (gold)

*When folding thin craft paper as instructed on P.29, cut rectangles lengthwise in half, omit the first folding, and start from Step 2.

Nose attaching position

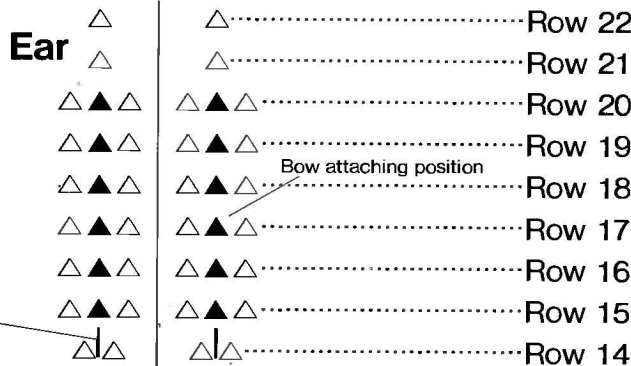

△ White for #73
Pale pink for #74

▲ Pink

Direction of ear pieces

Whiskers attaching position

Eye attaching position

Lips (red)

Body

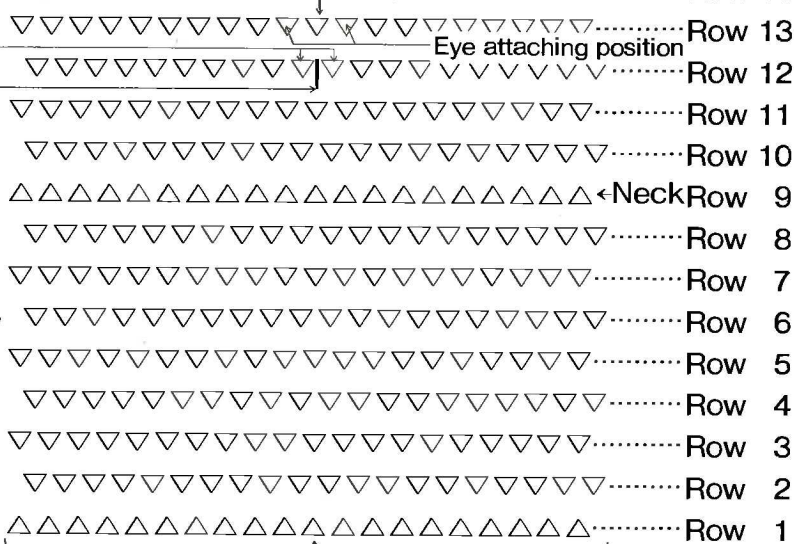

Center front
Join ends to form a ring of 20 pcs.

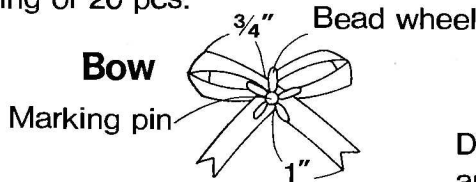

Bow

Marking pin

How to make Whiskers

Apply glue and let dry to harden.

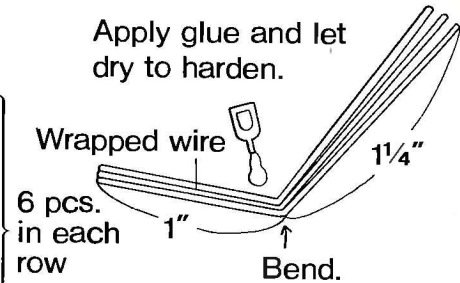

Ear

Insert pink piece between pale pink pieces.

20 pcs. in each row

Row 1 of Ear

Row 13 of Body

Just push in pink piece between the 2.

Divide 3 pcs. into 2 (3 points each) and insert into 2 pcs.

Signs for piece direction

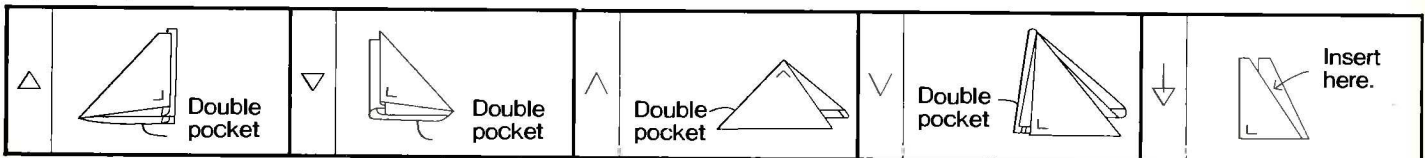



1 Apply a dab of glue on single points of 5-6 pcs., and paste them together. Repeat to make this set until 20 pcs. are used.



2 Paste all sets together and join into a circle of 20 pcs. (Row 1).



3 Row 2: Insert adjoining points of Row 1 into double pocket of a piece, double points facing up. Continue all around.



4 Rows 3-8: Join 20 each pieces in the same manner.



5 Row 9: Shape neck by changing direction of pieces.



6 Rows 10-12: Change direction of pieces again, and continue in the same manner.



7 Push in a beak piece (red) between center 2 pcs. of Row 12.



8 Row 13: Work in the same manner, using 20 pcs.



9 Shape ears by changing direction of pieces. Join 2 each pcs., sandwiching 1 pink piece.



10 Rows 21-22: Join 1 pc. each, covering only the center 2 points.



11 Glue on eyes and nose. Make whiskers referring to the figure on the opposite page, and insert into the sides of lips.



12 Attach bow and bead wheel using a marking pin.

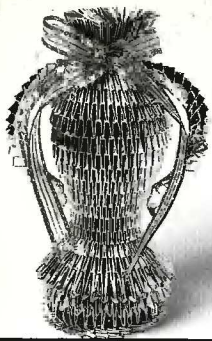

#55 & #56 METALLIC URN (P.22)

Completed size
5½" wide, 8½" high

Materials

- #55: 916 1½" × 2¾" rectangles of craft paper (gold)
2 ft. ¾" ribbon (gold)
- #56: 916 1½" × 2¾" rectangles of craft paper (silver)
2 ft. ¾" ribbon (silver)

Note

The completed project may look different depending on the thickness of the paper used.

URN

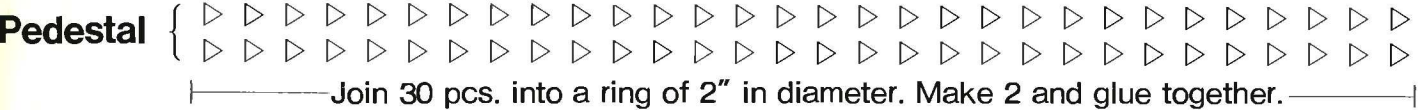

Pedestal assembly



Place URN on the pedestal and secure with glue.

➡ See P.90 for step-by step instructions.

Signs for piece direction

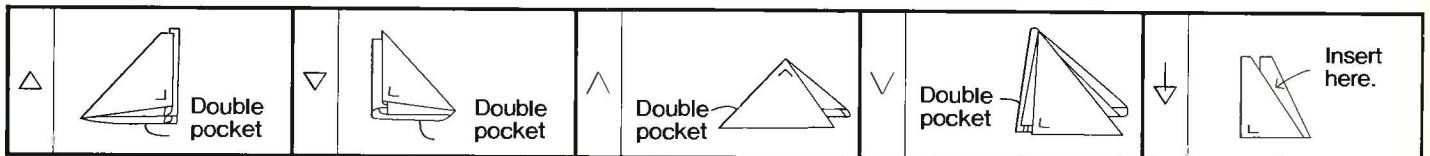

Rows 1-2 assembly

Direction of pieces

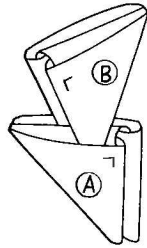
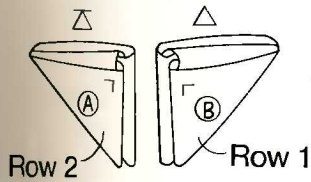

This side becomes the bottom.

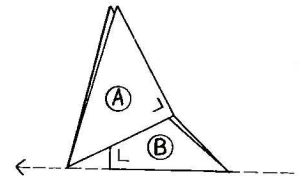
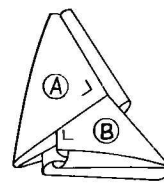
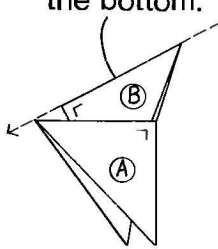

Turn upside down.
This pair makes 1 pc. for Row 1.
Make 40 pairs and join into a ring.

How to decrease number of pieces

Repeat this pattern.

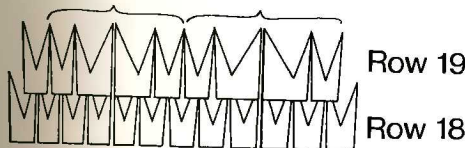

Row 3 assembly

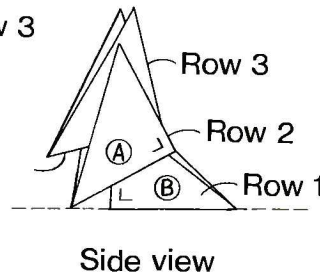

Row 5 assembly

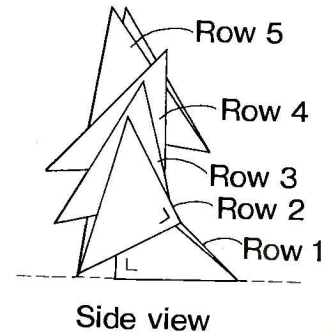

Handle (20 pcs.)

How to attach Handle

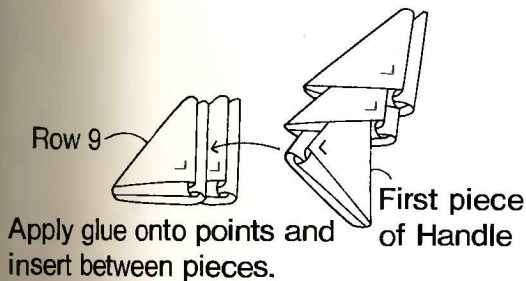
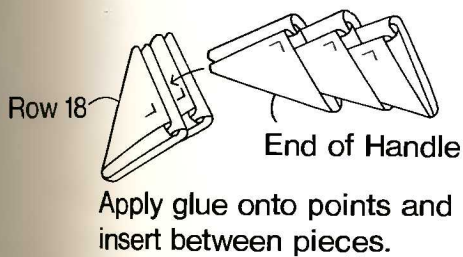

Shape according to the pattern (right)

First piece of Handle

Handle assembly

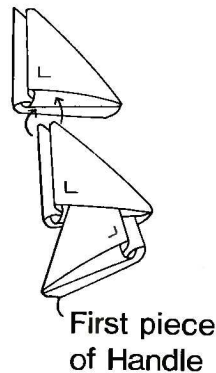

Handle
(Actual size)

(Make 2)

Rows 1-2 assembly

Direction of pieces

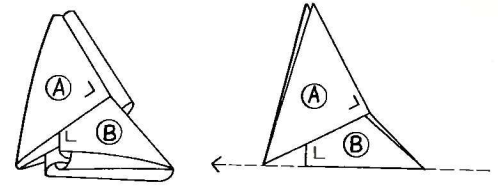
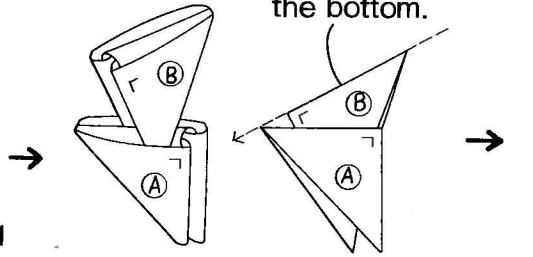
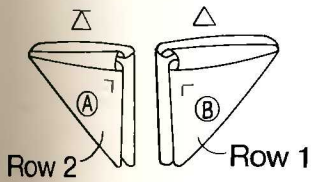

Turn upside down.
This pair makes 1 pc. for Row 1.
Make 40 pairs and join into a ring.

How to decrease number of pieces

Repeat this pattern.

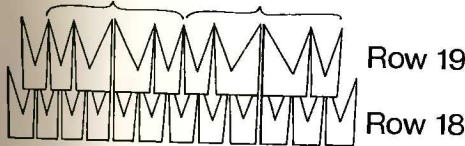

Row 3 assembly

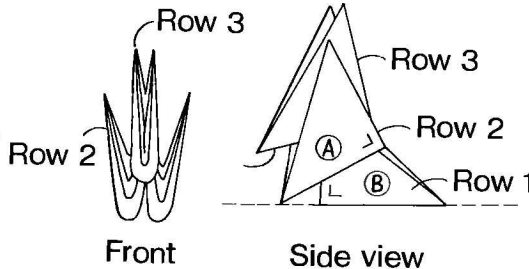

Row 5 assembly

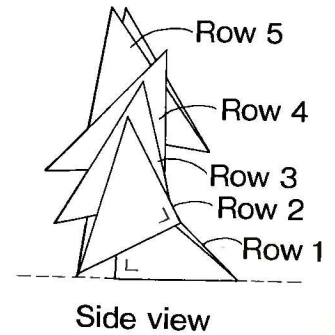

Handle (20 pcs.)

How to attach Handle

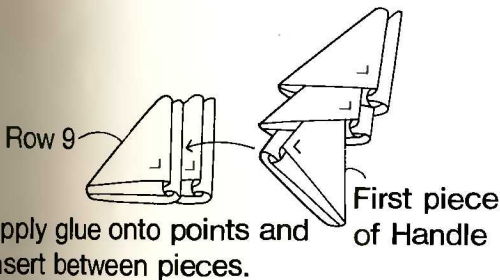
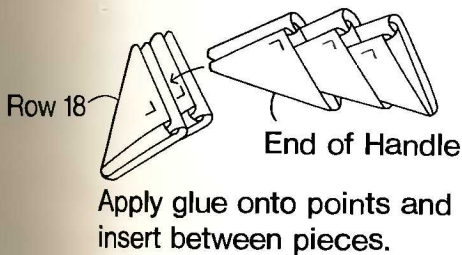

Shape according to the pattern (right)
First piece of Handle

Handle assembly

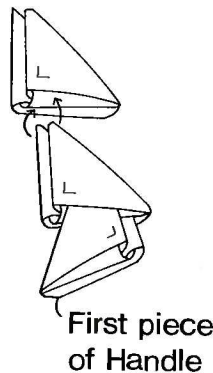

Handle
(Actual size)

(Make 2)

#55-#56 METALLIC URN (P.22)

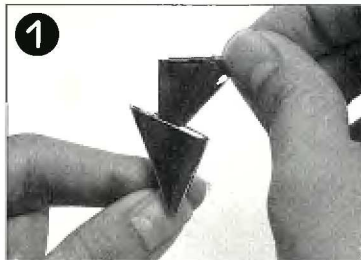

1 Make a 2-pc. set interlocked as directed overleaf. Repeat and prepare 40 sets.

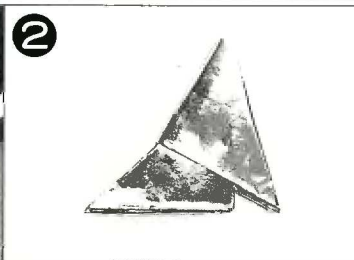

2 Put a set upside down. This makes Row 1 and Row 2.

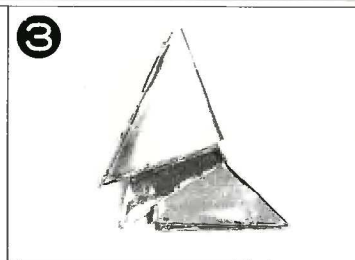

3 Showing the interlocking direction of a Row 3 piece.

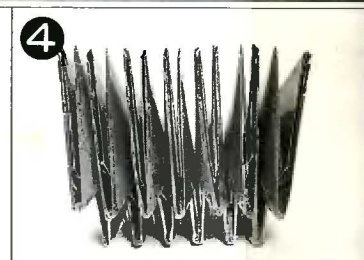

4 Join a pair of set by inserting adjoining points into a new piece.



5 Continue to join all 40 sets, into a ring.

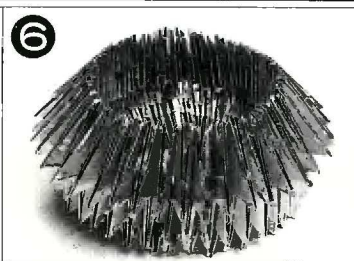

6 Row 4: Work in the same manner, with 40 pcs.

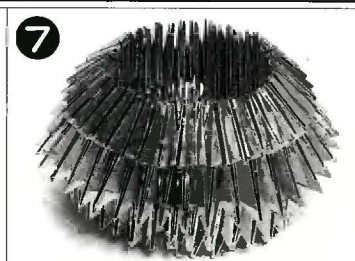

7 Row 5: Change the direction of pieces, the right angles facing out.

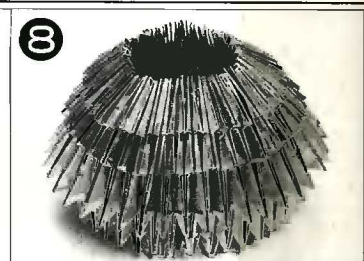

8 Rows 5-6: Join pieces at an angle so the opening is 1 3/4"-2" in diam., securing with glue.

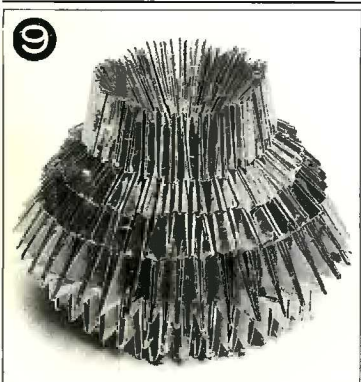

9 Row 7: Pieces are joined almost vertically.

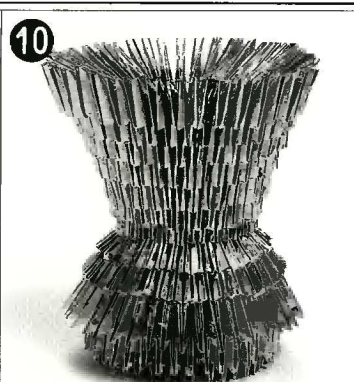

10 Rows 8-13: Work in the same manner, this time expanding the diam. gradually.

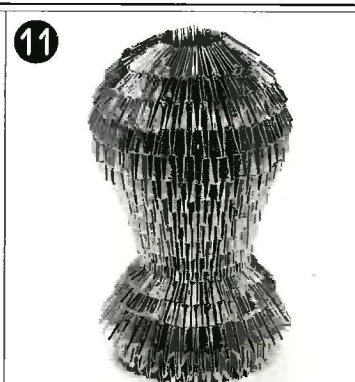

11 Rows 14-18: Work in the same manner, reducing the diam.



12 Rows 19-20: Decrease the number of pieces to 32, referring to the figure overleaf.

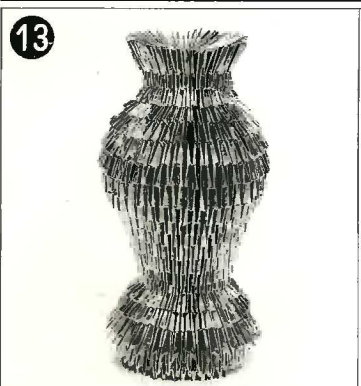

13 Row 21: Work in the same manner, slightly enlarging the opening to form rim.



14 Make pedestal and handles as directed.

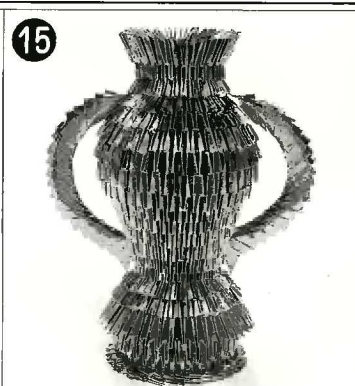

15 Attach handles to sides. Glue pedestal and the bottom of the URN together.



16 Tie a ribbon around the neck to finish.



0 1 cm 2 cm 3 cm 4 cm 5 cm 6 cm 7 cm 8 cm 9 cm 10 cm 11 cm 12 cm 13 cm 14 cm 15 cm

Linear Measures

inches \times 2.54 = centimeters

centimeters \times 0.39 = inches

INCHES	CENTIMETERS (nearest equivalent)	INCHES	CENTIMETERS (nearest equivalent)
$\frac{1}{8}$ "	$\frac{1}{4}$ cm	$4\frac{1}{4}$ "	11 cm
$\frac{1}{4}$ "	$\frac{3}{4}$ cm	$4\frac{3}{4}$ "	12 cm
$\frac{3}{8}$ "	1 cm	5"	13 cm
$\frac{1}{2}$ "	$1\frac{1}{2}$ cm	$5\frac{1}{2}$ "	14 cm
$\frac{3}{4}$ "	2 cm	6"	15 cm
1"	$2\frac{1}{2}$ cm	$6\frac{1}{4}$ "	16 cm
$1\frac{1}{8}$ "	3 cm	7"	18 cm
$1\frac{1}{2}$ "	4 cm	8"	20 cm
$1\frac{3}{4}$ "	$4\frac{1}{2}$ cm	9"	22 cm
2"	5 cm	10"	25 cm
$2\frac{3}{8}$ "	6 cm	1 ft. 12"	30 cm
3"	$7\frac{1}{2}$ cm	1½ ft. 18"	45 cm
$3\frac{1}{2}$ "	9 cm	20"	50 cm
4"	10 cm	2 ft. 24"	60 cm

0 1" 2" 3" 4" 5" 6"



US\$17.00

3D ORIGAMI

STEP-BY-STEP ILLUSTRATIONS



Origami is created by folding small squares of paper into various shapes. *3D Origami* takes that tradition to the next level by combining smaller origami projects into three-dimensional structures.

These impressive and seemingly difficult sculptures are deceptively easy to make. Each solid object is formed from simple folded units. The works include cranes, swans, turtles, owls, penguins, pineapples, sunflowers, baskets, hats, urns, kittens, rabbits, and others. Most of the processes are illustrated with photographs and step-by-step illustrations.

3D Origami is sure to engage fans of the craft and open up a new world of delight to origami devotees.

JOIE / JAPAN PUBLICATIONS

ISBN 4-88996-057-0



PRINTED IN JAPAN