

Agrodok 36

Preparation of dairy products

Pauline Ebing
Karin Rutgers

This publication is sponsored by: ICCO, Interchurch organisation for development co-operation

© Agromisa Foundation and CTA, Wageningen, 2006.

All rights reserved. No part of this book may be reproduced in any form, by print, photocopy, microfilm or any other means, without written permission from the publisher.

First English edition: 1985
Sixth revised edition: 2006

Authors: Pauline Ebing, Karin Rutgers
Editor: Tineke van der Haven
Illustrator: Bertha Valois
Design: Eva Kok
Translation: W.J. Guijt (revision: Catharina de Kat-Reynen)
Printed by: Digigrafi, Wageningen, the Netherlands

ISBN Agromisa: 90-8573-062-7

ISBN CTA: 978-92-9081-341-5

Foreword

This Agrodok is meant to serve as a manual for those who want to start small-scale production of dairy products in developing countries. The booklet introduces the reader to small-scale dairy production using simple techniques. It also gives an idea of the opportunities available to earn some income through cheese making. Locally there is often much knowledge available on production of dairy products. We would advise you to get acquainted with such methods in your area before starting on your own. We would also suggest that you not introduce Western dairy products if there is no need to do so, especially if local dairy products are already being made.

The authors have used information provided by the late J.C.T. van den Berg of the Wageningen Agricultural University in the Netherlands, who had much experience with factory production of dairy products in the tropics. The recipes described in this Agrodok have been drawn from various sources. We would greatly appreciate it if you would write to us about your experiences with the recipes in this book and with information on other local recipes. Where possible, they will be included in a future revised edition.

The sixth, revised edition has been updated with some technological knowledge about dairy science and dairying techniques and experience in extension service. However it is utterly impossible to cover the whole field of dairy technology. To do this, one needs basic knowledge of dairy chemistry, physics and microbiology, in addition to hygiene and handling of the milk on farm level. Therefore this booklet has to be considered as an introduction. Interested readers have to extend their knowledge by means of further reading and professional training in some important dairy techniques. The list of literature references and useful addresses may be of help.

Tineke van der Haven
Wageningen, August 2006

Contents

1	Introduction	6
1.1	What is this booklet about?	6
1.2	Why process milk?	6
1.3	What problems can arise?	8
2	Significance of milk and dairy products for humans	10
2.1	Milk as food	10
2.2	Composition and characteristics of various types of milk	12
2.3	Infant nutrition	13
2.4	Lactose intolerance	15
2.5	Milk and dairy products in the diet	16
3	Hygiene	18
3.1	Deterioration due to micro-organisms	18
3.2	Contamination of milk with extraneous matter	22
3.3	Hygienic production, storage and processing of milk	22
4	Processing techniques	28
4.1	Pasteurisation	29
4.2	Cooling	31
4.3	Souring by fermentation or acidification	33
4.4	Creaming	33
5	Starter cultures	35
5.1	The development of lactic acid bacteria	35
5.2	Cultivation of starter cultures of lactic acid bacteria	36
5.3	Growth of starter cultures	37
5.4	Maintenance of starter cultures	40
5.5	Preparing your own culture	41
6	Recipes	44
6.1	Cream	45
6.2	Sour cream	46

6.3	Butter	46
6.4	Buttermilk and sour milk	50
6.5	Ghee	51
6.6	Koa	52
6.7	Rabi	52
6.8	Yoghurt	53
6.9	Kefir	55
7	Cheese	59
7.1	Utensils for making cheese	62
7.2	The quality of milk used to make cheese	64
7.3	Coagulation of the milk	64
7.4	Separating curd and whey	67
7.5	The use of cheese whey	68
7.6	Collection and preservation of the curd	69
7.7	Maturation of the cheese	71
7.8	Cheese recipes	73
	Further reading	82
	Useful addresses	83
	Appendix 1: Measures	86

1 Introduction

1.1 What is this booklet about?

Livestock is usually kept for various reasons in the tropics such as traction, the provision of meat, wool, hair, skins and manure which, when dried, can be used as fuel. Milk is often no more than a by-product of animal husbandry, although it is a valuable foodstuff. Furthermore, keeping livestock can be a way of saving. In the event of an emergency, animals can be sold to provide money. As such, animal husbandry is also a kind of insurance against, for example, disease and crop failure.

It is not by accident that a certain kind of milk-producing animal is kept in a specific area. This is due to climatic conditions, locally prevalent diseases, available fodder, the possibilities for the owner to take risks, additional tasks that the animal is expected to do, religion and tradition and the preference for products that the animal produces.

Keeping dairy animals often leads to a surplus of milk. If milk production is higher than consumption in a certain area, the surplus can either be sold on the market, or it can be processed so that it does not go off. If the quantity of milk to be processed is small (up to 100 litres at a time), this activity is considered to be small scale. This Agrodok deals with the small-scale processing of milk using simple equipment.

1.2 Why process milk?

There are many reasons to process milk into dairy products, such as the following:

- Many dairy products can be kept longer than fresh milk, therefore the milk does not have to be consumed immediately.
- The demand for fresh milk may be limited, and there may be more interest in dairy products.

- If the daily amount of fresh milk for sale is limited, it may be more economical to process the milk into less perishable products, store them, and sell them later in greater quantities.
- There may be no market for fresh milk close by, and only preserved products can be sold at markets at a greater distance.
- Greater financial gain may be obtained.

Apart from these reasons, it should also be realised that many population groups in Asia and Africa cannot or can hardly consume milk because of so-called lactose intolerance. Lactose intolerance implies that the body is almost or entirely unable to digest the milk sugar, lactose, which is found in milk. Only small amounts of milk (up to 200 ml) consumed several times a day can be digested. Dairy products in which a proportion of the milk sugar is converted during production, such as cheese, curd, yoghurt and sour milk or buttermilk, do not cause many problems in this respect.

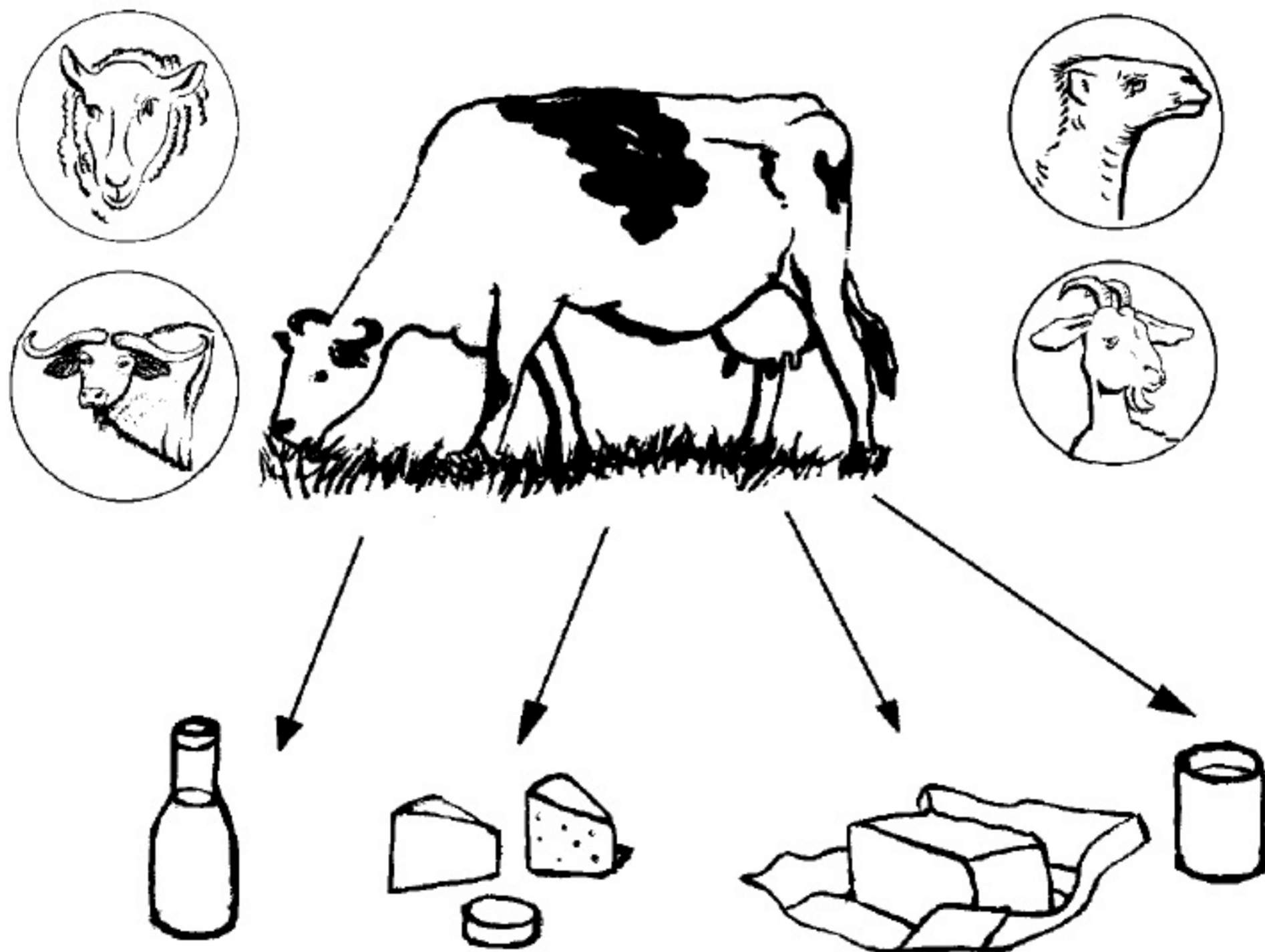

Figure 1: Milk products

Before processing surplus milk, one must consider whether it is profitable to do so. The processing is not always easy and there may be losses. For example, a waste product of cheese making is whey, which contains many valuable nutrients. If the whey is not used, a valuable part of the milk is lost. Furthermore, while milk is being processed quality deterioration may occur and it can go off. Only when milk is drunk immediately can you be sure that nothing is lost.

1.3 What problems can arise?

Small-scale processing of milk means the processing of small quantities of milk, up to 100 litres at a time, using simple implements and as little extra equipment as possible. Processing milk in the tropics can be difficult because of the high temperatures and high relative humidity often found there. These conditions present special problems in choosing the right kind of dairy products. Their storage life must always be taken into account.

High temperatures are bad for cheese making, especially for maturing cheeses. High temperatures also cause the bacteria already present in milk to multiply quickly. Milk sugar then turns sour, leading to the curdling of milk. However, these lactic acid bacteria are not harmful to humans.

Thorough cleaning of dairy utensils and equipment is essential. Anyone handling milk must also pay great attention to hygiene. Lack of hygiene can contaminate milk with other types of bacteria, which turn it sour and reduce its storage life. The prevention of contamination is especially difficult when milk is collected from various places and processed centrally. Addition of even a small quantity of infected milk contaminates the total quantity of the milk.

A further problem is the lack of equipment. One has to try to manage with simple dairy equipment, but even this can be difficult to find for small-scale milk processing. Electricity is usually not available so electric equipment (e.g. for cooling) cannot be used unless a generator

is installed. Additives such as rennet for cheese making are often difficult to obtain in the tropics.

The following chapters discuss the importance of milk in the diet, hygiene and milk processing techniques.

The second part of the booklet gives guidelines for heating, cooling and fermentation and for the processing of cream, butter, ghee, sour dairy products and cheese.



Figure 2: Sheep provide milk, meat, wool, skin, pelts and manure

2 Significance of milk and dairy products for humans

2.1 Milk as food

Milk contains components that are essential to humans such as proteins, carbohydrates, fat, water, all the B-vitamins, vitamins A and D, calcium and phosphorus. It also provides energy.

An important protein in milk is casein (in many cases 80% of the milk protein). This is the base for cheese making. Casein is linked to calcium phosphate, which is why milk contains a relatively large amount of this salt that is a very important nutrient for humans and animals.

In addition to casein, milk contains whey proteins (20% of the milk protein). The whey proteins are in most cases not incorporated in the cheese; they remain in the whey. Whey proteins (globulins and albumins) have a very high nutritive value.

Milk protein is of a high quality. This means that the human body can use a large part of the protein efficiently. Proteins in various other foodstuffs have a complementary effect. In combination with cereals, potatoes, meat, eggs or nuts in one meal, the body can use an even greater percentage of the milk protein.

Apart from milk, there are other animal protein sources such as fish and meat. Vegetable protein, which is also important in making the body's proteins, is found in cereals and pulses. Protein is needed by

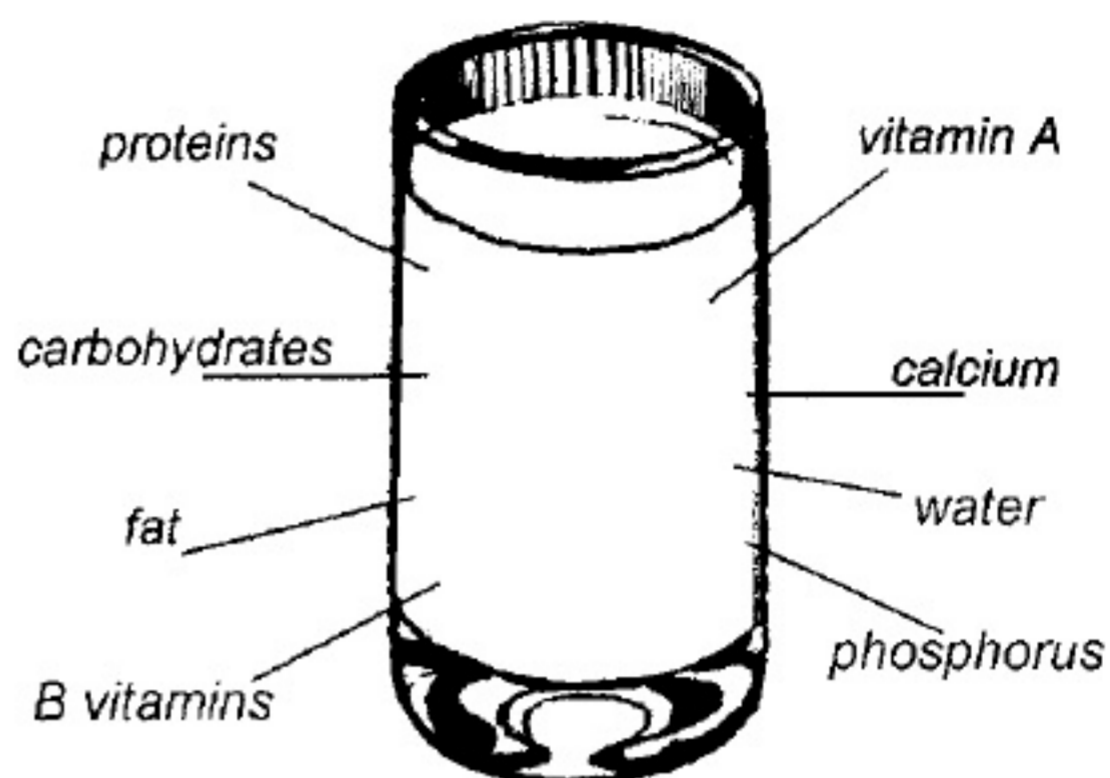

Figure 3: Main components of milk

the body for growth, replacement of worn-out body proteins and the production of compounds that the body needs.

Milk sugar (lactose) is a carbohydrate, a necessary component to keep the body going. Our bodies burn carbohydrates in the same way an oven burns wood. Through this combustion, energy is released which is used by our bodies for many kinds of activities.

Milk fat is present in the form of small fat globules, which have a lower weight than the other components of the milk. When cow milk is allowed to stand, these globules collect on top of the milk and form a layer of cream. Buffalo milk also forms some cream on top, but other kinds of milk, such as that of sheep and goats, hardly form a layer of fat at all. For these types of milk one needs to separate the cream from the milk. Milk fat is easy to digest. The body uses fat as a fuel or stores it as fat reserves.

Milk is also an important source of minerals and vitamins. It contains large quantities of calcium, which can easily be absorbed by the body after digestion and is important for the formation of bones (the skeleton). Milk is also an important source of vitamin B2 (Riboflavin), but there is little vitamin C in milk. Therefore a person's diet must also include vegetables and fruits in order to ensure a sufficient supply of vitamin C.

Milk is able to compensate for a lack of certain nutrients in a monotonous diet because of the great diversity of nutrients it contains and the high value of milk protein. It can therefore greatly improve the quality of the diet. Products derived from milk contain these nutrients to a greater or lesser extent. Milk is especially desirable for vulnerable groups, for instance babies, toddlers, children and pregnant and nursing mothers. Always strive for a healthy, varied diet, which apart from milk also includes cereals, pulses, vegetables, fruits and if possible meat or fish.

The various types of milk differ in various ways, including nutritional value. In the next pages this is dealt with in more detail.

2.2 Composition and characteristics of various types of milk

The composition of mother's milk and milk from cow, buffalo, goat, sheep, camel, donkey and lama is shown in table 1. The figures in table 1 show that the composition of the milk of non-ruminants, e.g. mother's milk and mare milk, differs distinctly from the milk of ruminants (cow, goat, sheep, etc.). This may be partly explained by differences in the digestive system of the two groups.

Apart from the differences in cream formation there are other differences between the various kinds of milk. There is a lot of pro-vitamin A (carotene) in cow milk, giving it its yellow colour, but not in buffalo, goat or sheep milk. In the milk of goats and sheep the carotenoids are already converted into the colourless vitamin A. This is why only cow milk is yellow in colour.

Table 1: Composition of various types of milk (source: FAO Nutritional Studies 27)

Milk source	fat (%)	protein (%)	lactose (%)	calcium (%)	energy (cal/100g)
Human (mother's) milk	4.6	1.2	7.0	0.0	73
Friesian cow	3.5	3.3	4.6	0.1	62
Guernsey cow	4.7	3.2	4.7	0.1	75
Indian buffalo	7.5	3.8	4.9	0.2	100
Goat	4.5	3.3	4.4	0.1	71
Sheep	7.5	5.6	4.4	0.2	105
Mare	1.6	2.2	6.0	0.1	47
Donkey	1.5	2.1	6.2	0.1	46
Camel	4.2	3.7	4.1	?	70
Lama	3.2	3.9	5.3	?	65

Buffalo milk curdles sooner than cow milk. Unless the preparation is adjusted, cheese made from buffalo milk will mature more slowly and have a drier consistency than cheese made from cow milk. Goat milk can have an unpleasant smell; this can be prevented by boiling the milk as soon as possible after milking. Between some goats or breeds of goats there may be a difference in the taste of the milk.

Cow milk accounts for 91% of the world's milk production. Buffalo, goat and sheep milk account for 5.9%, 1.6% and 1.7% respectively.

Although there are enormous regional differences we can generally say that, if it is to be drunk, milk from cows or buffaloes is preferred to that from goats and sheep. This is because of the more neutral flavour of cow milk and buffalo milk.

Goat and sheep milk are, just like the milk of cows and buffaloes, popular for making cheese and soured milk products (especially sheep milk). Camel milk is usually drunk. Mother's milk is the most ideal food for a suckling infant. Nonetheless, many substitutes have been developed which find a ready demand. We shall pay more attention to infant nutrition in the next section.

2.3 Infant nutrition

Mother's milk is best suited to the needs of a baby, and contains certain components that protect an infant against infectious diseases. All the nutrients a baby needs, except iron and vitamin C, are to be found in sufficient quantities in mother's milk. At birth, a baby has a store of iron in its liver, which it uses up during its first 6 months. Any kind of supplementary feeding is only necessary after 3 months, as the mother's milk then no longer supplies all the nutrients the infant needs. Fruit juice and mashed fruit provide additional vitamin C, which the infant then needs. Supplementary feeding of energy-giving foods is also desirable. Mixing small quantities of milk powder into mashed food can considerably improve the food's value (especially the value of its protein).

It is advisable to continue breastfeeding as long as possible because mother's milk is often the only source of animal protein for a baby. If the mother cannot breastfeed, does not have enough milk or dies, bottle feeding is a solution and the best substitute. However, in practice often too much water is added to the (artificial) baby food, which is usually bought in powder form. It becomes too watery and is therefore not nutritious enough. Moreover, artificial foods are costly and require good hygiene. Dilution with water is often a cause of infection because the available water may be polluted. Water used for bottle feeding must first be boiled, but sterilising water by boiling uses a lot of fuel, which is often in short supply. By using a cup or a spoon it is easier to maintain the necessary hygiene rather than a bottle because they are easier to clean.



Figure 4: Breastfeeding is the healthiest and most hygienic way to feed a baby

Money might be better spent on essential necessities of life than on artificial infant food if the latter is not strictly necessary. If a baby cannot digest milk, you will be forced to use milk products, which do not contain lactose. This is the case with inherited lactose intolerance. We shall discuss this in more detail.

2.4 Lactose intolerance

Lactose intolerance means that the human body is almost, or entirely, unable to digest the milk sugar, lactose, which is present in milk because the body lacks the enzyme lactase. Lactase splits the lactose into glucose and galactose. The latter two mono-saccharides can easily be absorbed in the intestine.

Undigested lactose can be converted by the microbial flora in the intestine into lactic acid and gases. Consumption of larger quantities of milk thus causes flatulence, stomach cramps and diarrhoea. 'Lactose intolerance' is thus often called 'lactase deficiency'.

There are different forms of lactose intolerance among children:

- Congenital lactose intolerance. In this case, a baby cannot digest milk because the baby lacks the enzyme lactase, necessary for the breakdown of lactose into glucose and galactose.
- Lactose intolerance among children who are 2-5 years old. From the age of two years lactase activity in a child decreases and the child may have problems due to insufficient lactase by the time he or she is 4-5 years old. Consumption of small quantities of milk (one glass at a time) usually does not cause any problem. It is also possible to prevent problems by eating fermented milk products, in which part of the milk sugar has been converted, such as cheese, yoghurt and buttermilk.
- Lactose intolerance as a result of intestinal disease and/or malnutrition, especially in babies and toddlers. The lactase activity is temporarily decreased making it necessary to use lactose-free milk products for a short time. Cheese and fermented products like yoghurt, in which milk sugar has been converted, are also suitable.

Apart from lactose intolerance, the use of milk also depends on other factors, which we will now discuss.

2.5 Milk and dairy products in the diet

Diet refers to the way people feed themselves and the foodstuffs they use to do so. This is strongly influenced by people's traditions and religion, their economic position, their place in society and the possibilities offered by their natural surroundings. It is not surprising that each population group has its own diet. The use of milk and dairy products can also be looked at when examining the diet.

Here are a few examples of how the factors mentioned above can influence the role and form of milk and dairy products in the diet.

- The cow is a sacred animal in India; therefore the rennet used in cheese making may not be taken from a calf's stomach.
- If milk or dairy products have to be bought, money is needed.
- In densely populated areas, people are forced to use all available land for crops that give a maximum yield, or crops that can be directly consumed by the people. This limits the land available for dairy farming.
- It may not be possible to keep cattle in certain regions, e.g. the humid tropics, due to the natural environment. For example, in humid areas of West Africa cattle cannot be kept because they are the host of the tsetse fly, which transmits sleeping sickness.

For these reasons, milk and dairy products in the diet can be of greater or lesser importance in one area or another. Economic and social situations are especially subject to change and dietary patterns change with them.

New foodstuffs may be introduced to (partly) substitute others. Adoption of new products is often no easy matter; sometimes centuries-old traditions may have to change. Also, taste and other characteristics such as texture are important in the acceptance of new kinds of food. Something that may be considered very tasty in one place, may not be appreciated elsewhere.

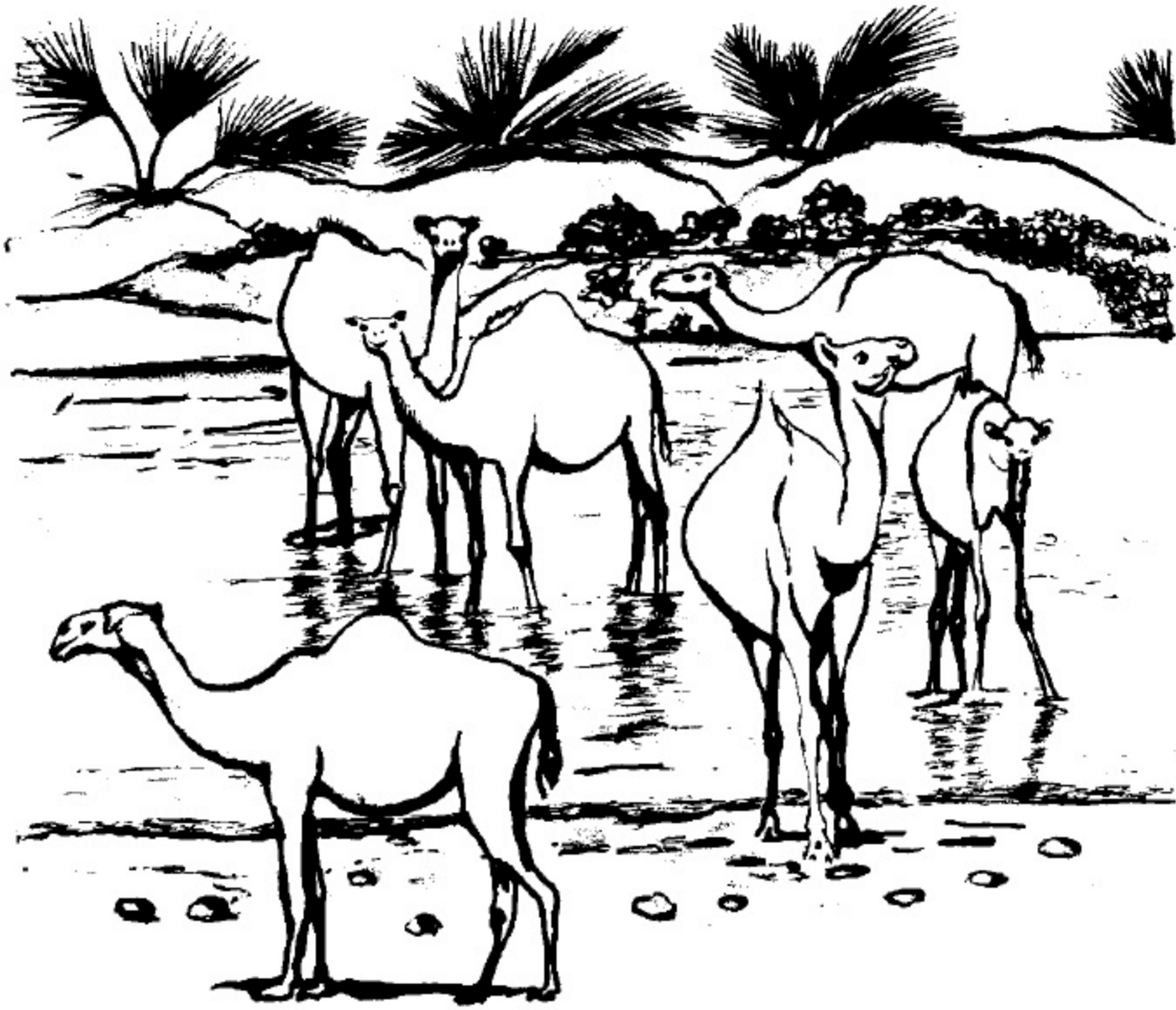

Figure 5: Camel milk is a very popular food in parts of Africa and the Middle east

3 Hygiene

Milk should be handled with care. There are several factors that can make milk go off and become unsuitable for further consumption. These include:

- the presence of too many micro-organisms in the milk
- contamination by diseased animals (tuberculosis, brucellosis) and/or people
- bacterial and/or chemical conversion of certain substances in the milk
- contamination of the milk with antibiotics (used for treatment of diseased animals), disinfectants, pesticides and so on.

The above-mentioned factors always cause some deterioration of milk. In some cases it is only the flavour that is affected, but usually the structure and smell of milk also change. In the case of contamination with antibiotics and disinfectants, the milk's appearance does not change, but fermentation, which is necessary for processing the milk, is inhibited.

We will first discuss the way micro-organisms cause the deterioration of milk. Then precautions which can be taken to minimise the impact of these factors will be explained, and some suggestions for cleaning and disinfection will be given.

3.1 Deterioration due to micro-organisms

Bacteria, yeasts and moulds are all called: micro-organisms.

Micro-organisms are very small and cannot be seen with the naked eye. They are found everywhere in nature: in the air, water, and soil and also in food and milk. Micro-organisms can multiply very rapidly.

Milk in the udder of a healthy animal contains almost no micro-organisms (aside from lactic acid bacteria). After the milk leaves the

udder contamination with, sometimes harmful, micro-organisms will take place during milking, milk handling, transport and storage. Milk may be contaminated with micro-organisms originating from the skin of the animal, the milker's hands, the milking utensils or the air.

Most micro-organisms are not harmful, but some can cause diseases like salmonella infection, dysentery, tuberculosis (in man and in animals), diphtheria and typhoid. These disease-causing micro-organisms are called pathogenic bacteria. Through inadequate hygiene, diseases can be transmitted from person or animal to person.

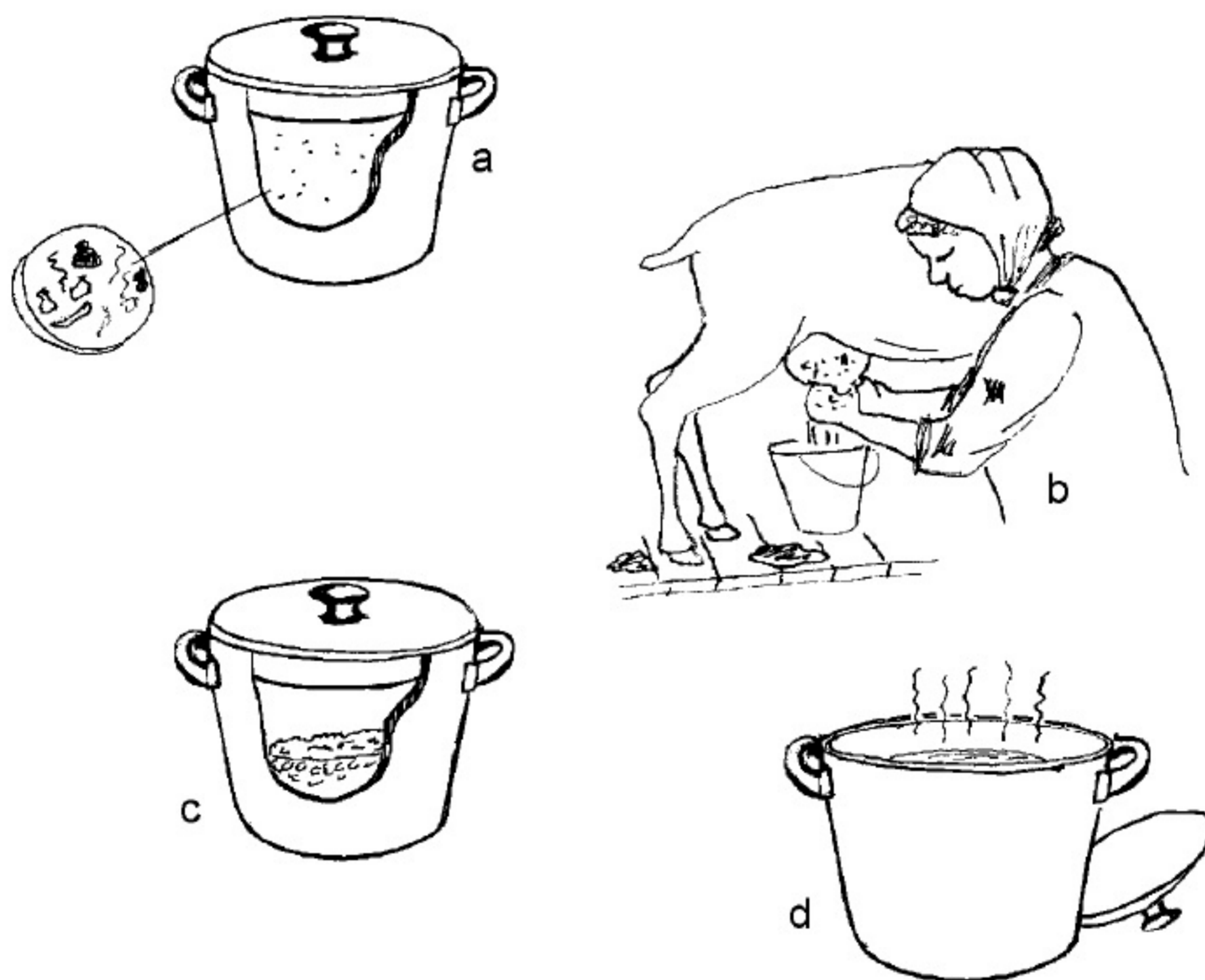

Figure 6: Diverse sources of contamination: a shows badly cleaned utensils contaminating milk; b improper milking is also a source of contamination; c shows multiplication of micro-organisms during storage; d heating kills the micro-organisms.

Micro-organisms can multiply very rapidly in milk. Temperature plays an important role in the life of micro-organisms. Their growth can start at a temperature of about 4°C. It is therefore very important to

store milk or milk products at a temperature no higher than 4°C; otherwise deterioration will take place rapidly. Above 20°C, bacteria multiply at an incredible speed.

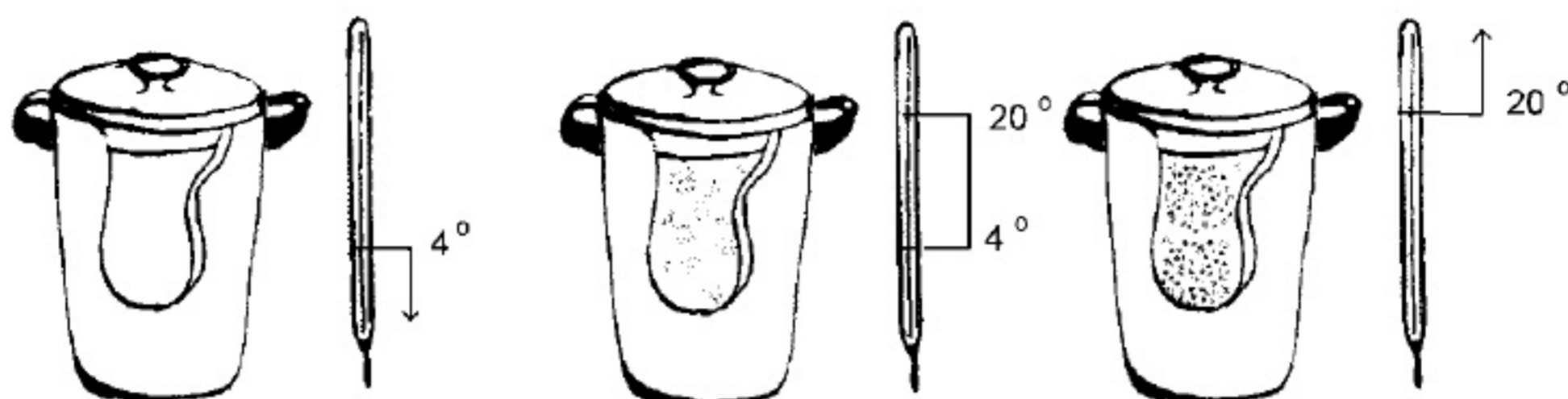

Figure 7: Temperature and deterioration

Most micro-organisms are killed during pasteurisation, e.g. at a temperature above 63°C for a period of at least 30 minutes. But a few, the so-called spore-forming bacteria, will survive more intense heating. They can give problems like off flavours and coagulation in pasteurised milk.

Yeasts and moulds

Yeasts are micro-organisms that can ferment sugars into alcohol, gas and other substances. They are about 5-10 times larger than bacteria. Reproduction usually takes place through budding. Yeasts usually grow in an acid environment; they need oxygen and they can withstand rather high concentrations of acids.

In dairy products, yeasts are usually found in soured products like sour milk or buttermilk, sour whey, butter, and curd and on the surface of cheese. When present in large numbers, they produce gas and they cause undesirable off flavours of the product.

Moulds are string-like micro-organisms. The fine threads, called mycelium, are large enough to be seen with the naked eye. To develop they need atmospheric oxygen, and they thrive best in humid and acid conditions. Moulds multiply by forming spores. These float easily through the air and can often be found on poorly maintained ceilings

and walls. Their mobility makes them an important source of infection.

Moulds can be seen on the surface of butter or cheese in the form of coloured spots. For some soft cheeses (like Camembert and Brie) moulds are essential for ripening. In general, moulds are harmless, but some produce poisonous toxins (mycotoxins), such as aflatoxin in peanut products.

Cells and spores of moulds and yeasts are destroyed by pasteurisation (heating the milk 30 minutes at 63°C or 20 seconds at 72°C).

Bacteria

Bacteria are single-cell micro-organisms that multiply by cell division. Raw milk and many dairy products contain many different kinds of bacteria. Environmental conditions (such as acidity, temperature, humidity or amount of oxygen) can change, making conditions less attractive for one group of bacteria but at the same time creating optimal conditions for another type. This is why some families of bacteria will always be found in milk or dairy products (lactic acid bacteria).

An exception must be noted, which is dried products like milk powder. Micro-organisms cannot grow without water and therefore the number of bacteria in uncontaminated milk powder will be low.

Bacteria found in milk can be divided into two groups: useful and harmful. Lactic acid bacteria (e.g. *Streptococcus lactis*) are useful. They produce lactic acid, which is not harmful and gives milk a fresh, sour taste. Moreover lactic acid is a good preservative for the sour products. Pathogenic bacteria (those that cause diseases in humans) cannot grow in acid products. When producing certain dairy products like soured milk, yoghurt and cheese, good use is made of these specific properties (see chapter 5).

Sometimes milk is spoiled by the growth of bacteria that do not produce lactic acid. In this case, certain disease-causing bacteria can develop and whey separates from the milk. This usually happens after long storage of pasteurised milk. The smell is unpleasant and the taste bitter. Such milk should not be consumed.

3.2 Contamination of milk with extraneous matter

Extraneous substances must be prevented from entering into the milk. These can be dangerous to one's health or cause unpleasant flavours and smells, reducing the suitability of milk for further processing. Some examples are cleaning and disinfecting agents, medicine, pesticides and pieces of metal or glass. The feed given to animals, such as some weeds, onions and cabbage, can also influence the taste of the milk. This can be avoided by feeding the animals after milking. Good hygiene can reduce deterioration. How to achieve a good level of hygiene will be discussed in the following pages.

3.3 Hygienic production, storage and processing of milk

Contamination occurs when micro-organisms enter into the milk. Possible sources of contamination during production, storage and processing are:

- inflammation of the udder (mastitis)
- the animal itself: skin of teats and udder
- conditions at the milking place (floor, dung, dust, dirty water, etc.)
- the person milking
- utensils and equipment used during processing
- the air and environment

It is no easy task to keep micro-organisms out of milk. Much depends on the person who is milking, the care taken of the animals and the cleanliness of the utensils. If everything is well sanitised and kept clean, relatively few micro-organisms will enter into the milk. Good

hygiene is of major importance. In addition, milk - if not used or processed immediately - should be cooled after milking and kept cool.

Good hygiene measures therefore:

- Prevent contamination of the milk.
- Prevent bacterial growth through good refrigeration of the milk.

Hygiene during milking

There are several possible causes of contamination during milking.

In a normal, healthy cow very low numbers of bacteria are found inside the udder and the teats. Cows possess various mechanisms to prevent the entry of bacteria. To avoid problems while milking, it is important that an animal become accustomed to the activity. It will then know that it will be milked, and will react positively to it. Such positive behaviour can start if, for instance, it hears milk cans clanging, feels its udder being cleaned, etc. Then the animal is easier to milk and gives more milk. Stress and unrest make the cows move too much and kick; consequently more dirt and manure can enter into the milk.

When a cow has an udder infection (mastitis), its milk will be contaminated with the bacteria that cause the udder infection, and that may produce pus and sometimes blood. Milk from these animals should not be used in any way. Mastitis can be prevented by maintaining good hygiene and avoiding injury to the teats during milking. An infected udder is not always easy to see. When an udder infection occurs, it is advisable to remove milk from the udder very frequently (e.g. every 3 hours by hand). The number of micro-organisms in the udder is thus reduced. Be aware, however, that milking an infected udder by machine or by hand is often painful for the animal. The animal will kick frequently and this can be an important source of contamination of healthy cows.

Bacteria can be transferred from the skin or teats to the milk, even with healthy dairy cattle. It is therefore important to clean the udder

before milking. Wipe the udder clean with a dry, clean, preferably disposable cloth to prevent infection. If the teats or udder are really dirty, they must first be washed with clean, hand-warm water and a clean cloth and then dried with a clean towel. Cleaning the udder improves the cleanliness of the milk and makes milking easier. Skin and hair can also be sources of infection.

Do not feed animals first before milking, it may create a lot of dust. See to it that the floor is clean, and be careful when clearing dung, mud or dust. A clean, well-illuminated milking place and fresh surrounding air are essential to maintaining good hygiene. Insects such as flies and cockroaches can also be sources of infection. Try to control them as they can carry many bacteria and viruses.

When milking, the milk is caught in a pail or bucket. Dirty milking equipment is the main source of infection of milk.

If residues of milk remain in the equipment because of improper cleaning and drying, bacteria will develop in these residues. These bacteria are already accustomed to the milk and will multiply rather quickly during transport and storage of milk in the equipment. Use pails and buckets that are smooth on the inside, for instance seamless metal buckets.

All milking equipment should be thoroughly cleaned immediately after each use. Use soap or other detergents if necessary. Make sure that the water used is clean. If you are in doubt, boil it for several minutes or add chlorine. Very important: after cleaning, the equipment should be stored upside down in such a way that the inside of the buckets and cans dry. This prevents the remaining bacteria from growing.

The person milking plays the most important part in maintaining proper hygiene during production. He or she keeps an eye on the condition of the animal, chooses the milking place and cleans all the equipment. He or she should have clean hands and wear clean clothes.

If the milker suffers from tuberculosis, salmonella infection, dysentery or some other disease, the risk of contamination of the milk becomes very high; it would be wise to have somebody else take over. This is also the case if the milker has open wounds or ulcers.

Hygiene during storage and processing

By now you should know that milk should be processed as quickly as possible after milking and that it should be properly stored in order to minimise its chances of spoiling.

It is best to filter fresh milk through a filter or clean cloth. This will remove visible dirt that might have entered into the milk. Clean or replace the cloth during filtering or filter the milk several times. The cloth should be thoroughly cleaned after use and then left to dry in the sun.

In tropical conditions, raw milk, i.e. non-pasteurised milk, goes off within a few hours. It must therefore be kept cool and quickly pasteurised and again cooled to a temperature of 4°C if possible. Properly pasteurised and cooled milk can be kept for a few days, even in a warm climate.

If you are not able to cool milk below 10°C, then do not mix different batches. Even if the older milk is still good, you will end up with an increase in bacterial growth and reduction of the overall quality. Use clean equipment for storage. Containers that are clear, such as glass, should be stored in the dark as light reduces the quality of milk. Clean your equipment with clean water.

Cleaning and disinfection

Utensils must be cleaned in such a way that all dirt, food residues, feed and micro-organisms are removed from the surface of the equipment. Dirty saucepans, jugs, milking equipment and utensils should be cleaned immediately after use. Washing soda (sodium carbonate) dissolved in hot water is an excellent cleaning agent. It may be useful to disinfect equipment in order to kill any remaining

harmful micro-organisms. You can use a chloride solution such as bleach (sodium hypochlorite).

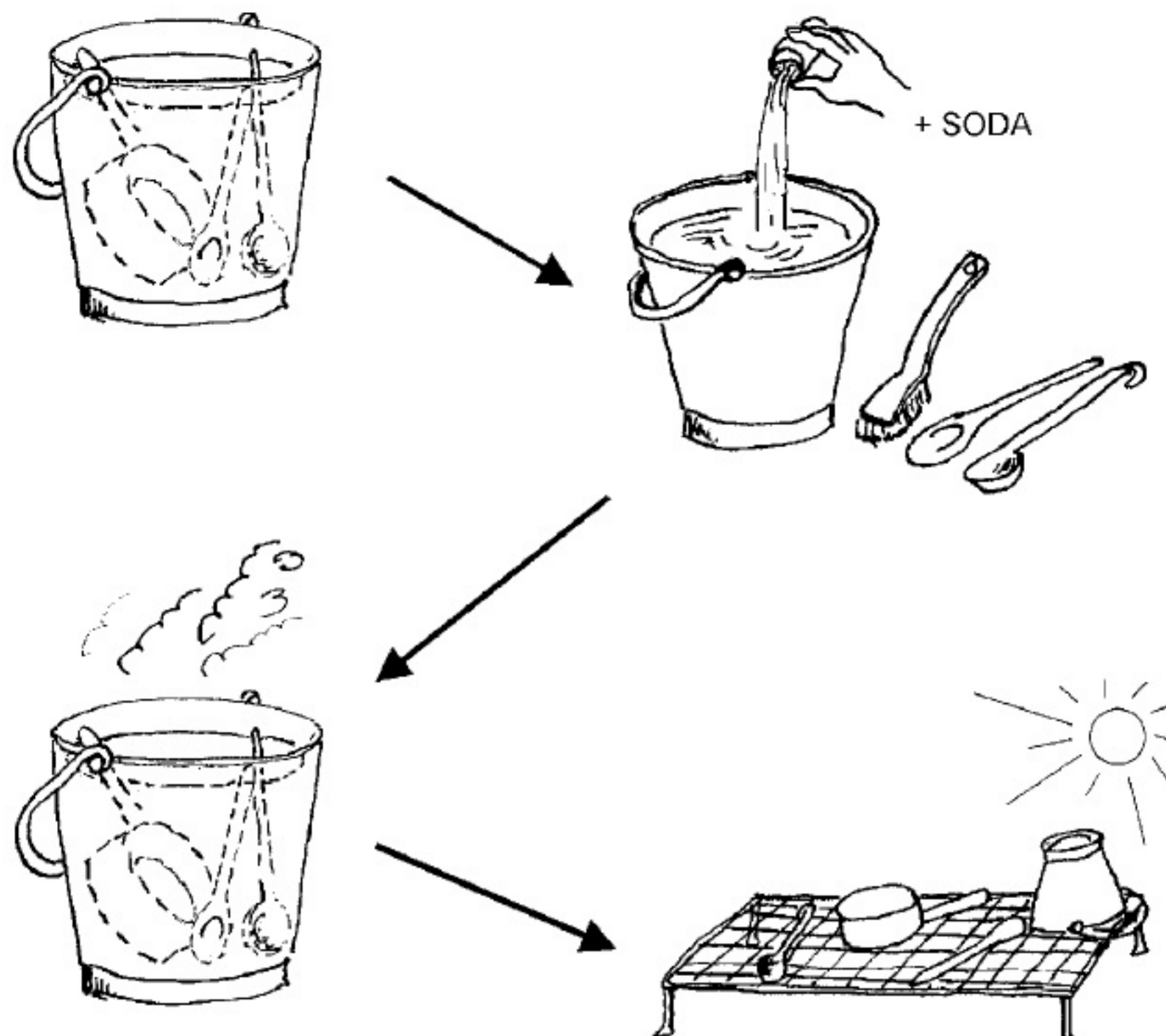

Figure 8: Cleaning utensils

A proper way of cleaning your equipment is the following:

- Start cleaning immediately after milking, so that milk residues will not dry and stick on the buckets and utensils.
- Rinse well with water.
- Scrub the tools in a hot soda solution (1.5 tablespoons of soda to 5 litres of water), using a small amount of water to dissolve the soda before adding it to the rest of the water.
- Rinse well with hot water.
- Buckets, tubs, etc., should be turned upside down on a rack during storage; the water can then drain and no dirt or dust can enter. Let the utensils dry to prevent bacterial growth.

Well-cleaned tools are nearly sterile, only a small part of the bacteria remains on the tools. If these tools dry during storage hardly any bacteria will be present. In that case disinfection is not necessary.

Tools which are used for storage of pasteurised milk or for cheese making and which do not get a heat treatment together with the milk can be disinfected after cleaning or before use. Proceed as follows:

- Clean all your equipment properly. The following step will be ineffective if the utensils are not clean to start with.
- Disinfect in a chloride or bleach solution after cleaning or shortly before use. Add 2 tablespoons of bleach per 4.5 litres of water.

It is advisable to use stainless steel equipment, cheesecloth and wooden utensils. Tools or any other equipment made from aluminium should not be washed in a strong soda solution, as soda attacks aluminium. Iron utensils will rust in a strong chloride solution. Therefore rinse and dry these utensils immediately after cleaning and disinfection.

If you have no cleaning agents -like soda- or disinfectants, you can disinfect your equipment as follows:

- Thoroughly clean the utensils using clean water.
- Rinse with a soap solution.
- Dry the equipment on a rack in the sun upside down or rinse with boiling water.

WARNING: Take care that acid cleaning agents (e.g. nitric acid) and chlorine never come in contact with each other as very poisonous fumes can be formed.

Cleaning agents and disinfectants are chemicals that - if not diluted - can irritate the skin. Direct contact should therefore be avoided; wear gloves, if possible. Do not use any disinfectants other than chloride (bleach). As cleaning agents and disinfectants are dangerous products, they should be locked away in a safe place, where no unauthorised person can get at them. Label the bottles clearly.

4 Processing techniques

Milk can be stored longer if it has been processed. Extended storage is possible if you are able to control the growth of micro-organisms. The processing technique used will determine the storage life of the milk and dairy products. The following rules should be followed during the production, storage and processing of milk.

- Always wash your hands and avoid putting them in the milk if not necessary.
- See to it that all equipment used during processing is properly cleaned and disinfected if needed.
- Take care that no dirt particles or insects enter into the milk.
- Try to prevent the use of copper utensils. (Copper can give off flavours in butter and milk.)
- Do not expose milk to sunlight; store it in a dark place.
- The use of a thermometer is recommended.
- Make sure that milk used for consumption has always been boiled or pasteurised.
- Never store raw (i.e. unheated) milk if it is not immediately cooled below 4°C.
- Never drink raw milk because it may contain pathogenic bacteria like tubercular bacteria and salmonella.

The following processing techniques will be dealt with in this chapter:

- pasteurisation
- cooling
- souring (acidification)
- creaming.

Heating and cooling are in fact ways to preserve milk, but for convenience we will deal with them under the heading of processing techniques.

4.1 Pasteurisation

As you by now know, milk contains certain micro-organisms that can spoil it. These bacteria grow best at temperatures between 10°C and 40°C. It is therefore important to cool milk as quickly as possible. This can be difficult in the tropics if no cold water or refrigerators are available.

Most bacteria will be destroyed during heating. The most effective temperature depends on the heating time. In other words, heating for a longer period at a lower temperature can be as effective as heating for a shorter period but at a higher temperature.

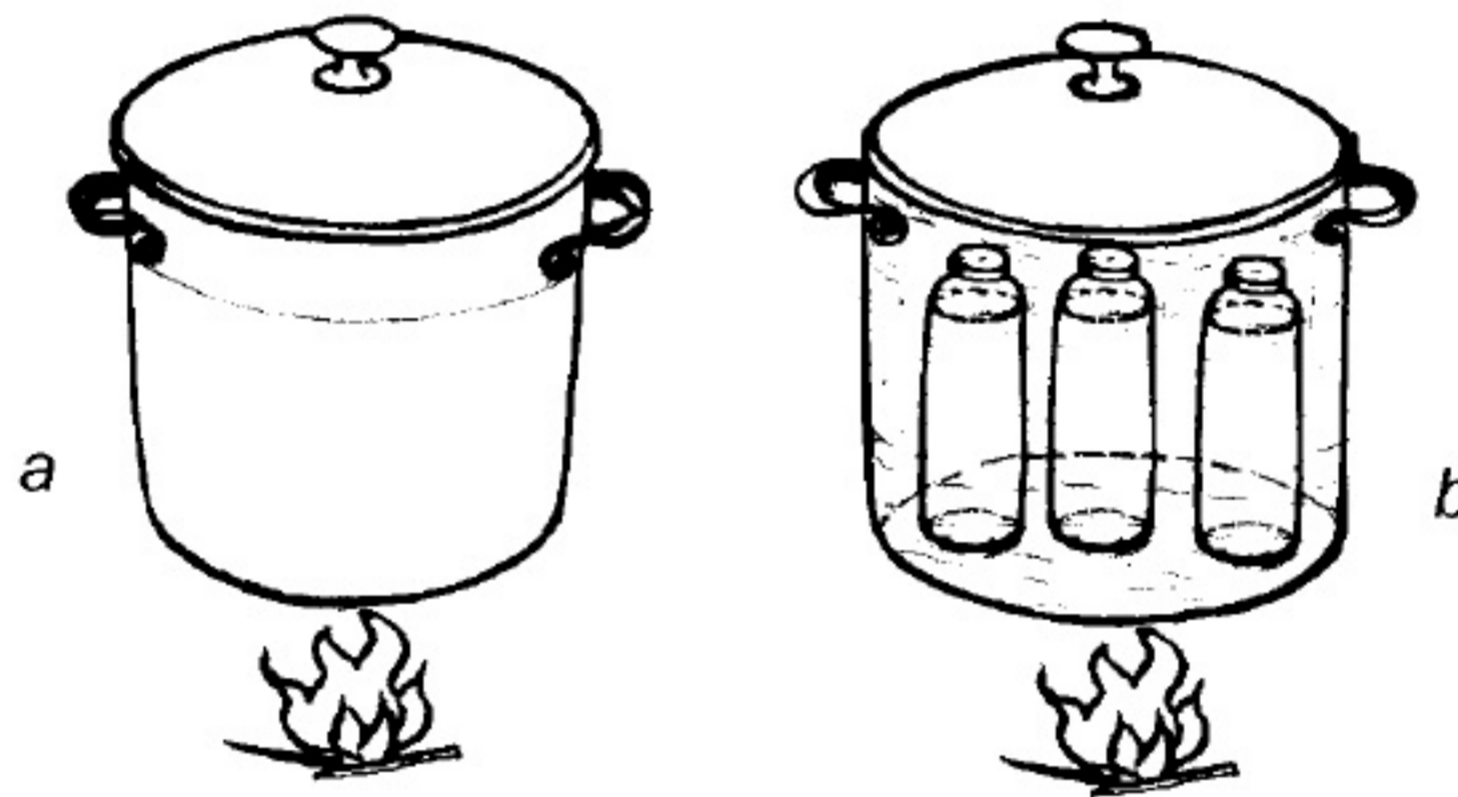

Figure 9: Pasteurisation

In figure 9, we see:

- a** Direct pasteurisation of milk in a saucepan (method A below)
- b** Pasteurisation of milk in bottles (method B below)

Pasteurisation improves the safety and storage life of a product, while the taste hardly changes and the loss of vitamins is minimal. A distinction is made between low and high pasteurisation (see table 2). Although high pasteurisation initially kills more bacteria, the resulting milk can usually not be kept as long, because the high pasteurisation temperature stimulates spores of some bacteria to germinate. Moreover, the taste of high pasteurised milk has more or less the

flavour of boiled milk. Pasteurised milk can be kept for about one week at 4-6°C if no re-infection takes place.

The pasteurisation temperature to be used depends on the product to be made of the milk.

- Low pasteurisation is used for milk for direct consumption and cheese.
- High pasteurisation is used for yoghurt, butter and kefir.

Table 2: Time–temperature combinations for pasteurising milk

	time	temperature	remarks
low pasteurising	30 minutes	63°C	quantities >5 litres
	3 minutes	68°C	small quantities
	20 seconds	72°C *)	industrial equipment
high pasteurising	2 minutes	82°C	
	20 seconds	85°C *)	
*) continuous flow system; not for small-scale processing			

If there is no thermometer to measure the exact temperature, heat the milk to its boiling point.

Pasteurisation methods

The following method A is suitable if you are able to accurately control both temperature and time. Method B is more hygienic, if the exact temperature of the milk is unknown.

You will need:

- raw milk, a heat source, a saucepan with a thick bottom that is smooth on the inside, a thermometer and a means of cooling the milk that has been heated
- for method A: a clean wooden spoon
- for method B: glass jars with lids or bottles with tops, or plastic bags and sealing equipment.

Method A

Put the milk in a clean saucepan and heat it to 68°C, stirring continuously. Keep the milk at that temperature for at least 3 minutes.

Method B

Clean the glass jars with lids or bottles with tops. Fill them with milk and close the lids. Submerge the jars and bottles in a large pan filled with water. Heat everything to 80°C and keep it at that temperature for at least 10 minutes.

When using method A, let the milk cool down as quickly as possible. The best storage temperature is 4°C. The proper storage temperature for a soured milk product or cheese can be found in chapters 6 and 7.

If you are using method B but are not able to maintain a constant temperature of 80°C, the best alternative is to heat the water in the pan until it boils and keep it boiling for some time. It is important to store the pasteurised or boiled milk at 4°C. At this temperature it can be kept up to one week. Handle the boiled or pasteurised milk with care to prevent re-infection.

4.2 Cooling

Storing milk at a low temperature will greatly reduce the growth of bacteria. Bacteria develop much slower in cold milk. The best storage temperature is 4°C. If this temperature cannot be achieved, store the milk in a dark place at the lowest temperature possible: see table 3.

Table 3: Quality of raw milk after storage for 24 hours under different temperature and hygiene conditions

Storage temperature (°C)	Very hygienic conditions	Hygienic conditions	Unhygienic conditions
4	good	good	poor
10	good	poor	poor
20	poor	poor	bad
35	bad	bad	bad

Without cooling, raw milk will spoil within a day.

Put the hot pasteurised or boiled milk in a clean container (the high temperature will disinfect the container). Let it cool down as quickly as possible, preferably in a large pan with cold water (refresh the water if it warms up). The best temperature for storage is 4°C. Cooling down in air, e.g. in a cold cellar or a refrigerator is very ineffective as the transfer of cold by air is very slow. If you use a pan with cold water make sure that no water enters into the milk because it would contaminate the milk again. Add ice cubes to the cooling water, if available. Stir both the water and the milk during cooling with a clean spoon, using different spoons. Figure 10 shows how to cool milk.

As mentioned above, properly pasteurised or boiled milk can be kept for about one week if stored at 4°C. At 10°C it will spoil quickly; if it is 15°C or warmer, it should be consumed the same day (see table 3).

- 1: large pan with cold water
- 2: small pan with pasteurized milk
- 3: spoon for stirring the milk
- 4: spoon for stirring the water

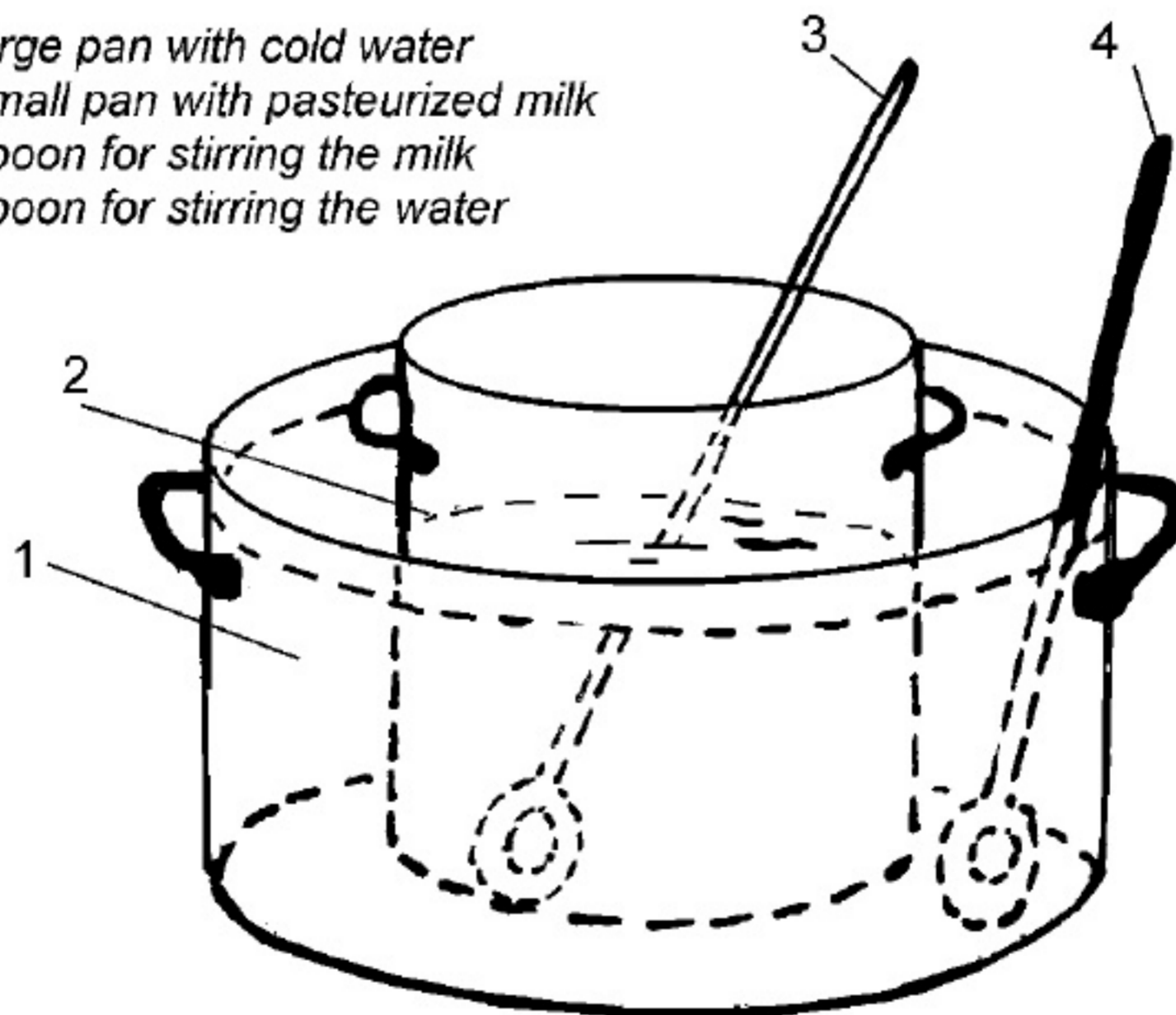

Figure 10: Cooling pasteurised milk

4.3 Souring by fermentation or acidification

Another way of increasing the shelf-life of milk is to ferment it into soured milk products. Part of the milk sugar is converted into lactic acid by bacteria, for example by the yoghurt bacteria *Streptococcus thermophilus* and *Lactobacillus bulgaricus* or the bacteria that grows at room temperature *Streptococcus lactis*.

Fresh raw milk can be left to sour spontaneously, but then you cannot control which bacteria are growing. It is better to sour the milk with the help of specific lactic acid bacteria as a starter culture after the milk has been pasteurised. Quality and taste are influenced by the products that the different lactic acid bacteria produce.

4.4 Creaming

Cream is made from the fat that rises to the surface of cow milk. A layer of fat forms on the surface of the milk after it has been left to stand for at least half a day. After a day this layer contains about 20% fat. The simplest way of collecting it is by skimming it off the top of the milk. Sheep and goat milk do not cream easily. You will need a creamer or centrifugal separator to obtain good results. You should be able to get about 1 - 2 litres of cream from 10 litres of milk.

The skimmed milk which remains after the removal of the cream is still very nutritious, because it contains nearly all the protein of the milk. You can either drink it or use it for the production of sour milk or cheese.

Sour (fermented) cream and sour (fermented) milk are produced by incubation of inoculated fresh cream or fresh milk. A culture of lactic acid bacteria is used for inoculation of the fresh milk or the fresh cream.

Butter (80% fat) and buttermilk are made by churning cream or milk. One hundred litres of milk with a 4% fat content produces 20 - 30 litres of cream, which yields about 4 kg of butter. However, butter is

not an important product in tropical countries because it melts easily at high temperatures and it is expensive. There is generally little demand for butter. Butter and cream can be used to make ghee. Ghee keeps better than cream and butter as it contains practically no moisture; it is almost pure milk fat.



Figure 11: The milk of buffaloes is rich in fat

5 Starter cultures

In tropical countries it is often difficult to prevent raw milk from spoiling before consumption. One way to avoid this is to allow the milk to acidify or ferment. This is done by adding lactic acid bacteria to fresh milk. The addition of lactic acid bacteria is called inoculation.

There are several groups of fermented milks. The principal differences between these groups are:

- type of milk used (cow, goat, sheep, buffalo, camel or mare)
- type of fermenting flora
- the way the milk is processed either before or after fermentation.

Various kinds of lactic acid bacteria produce various kinds of sour milk. Yoghurt, dahi, laban, nono, kefir and koumiss are all produced in this way. These products differ in flavour, colour and consistency.

5.1 The development of lactic acid bacteria

Bacterial growth shows a specific pattern comprising the following consecutive stages: adaptation phase (A), a period of rapid multiplication (B), a stabilisation period (C) and a decreasing phase (D). See figure 12.

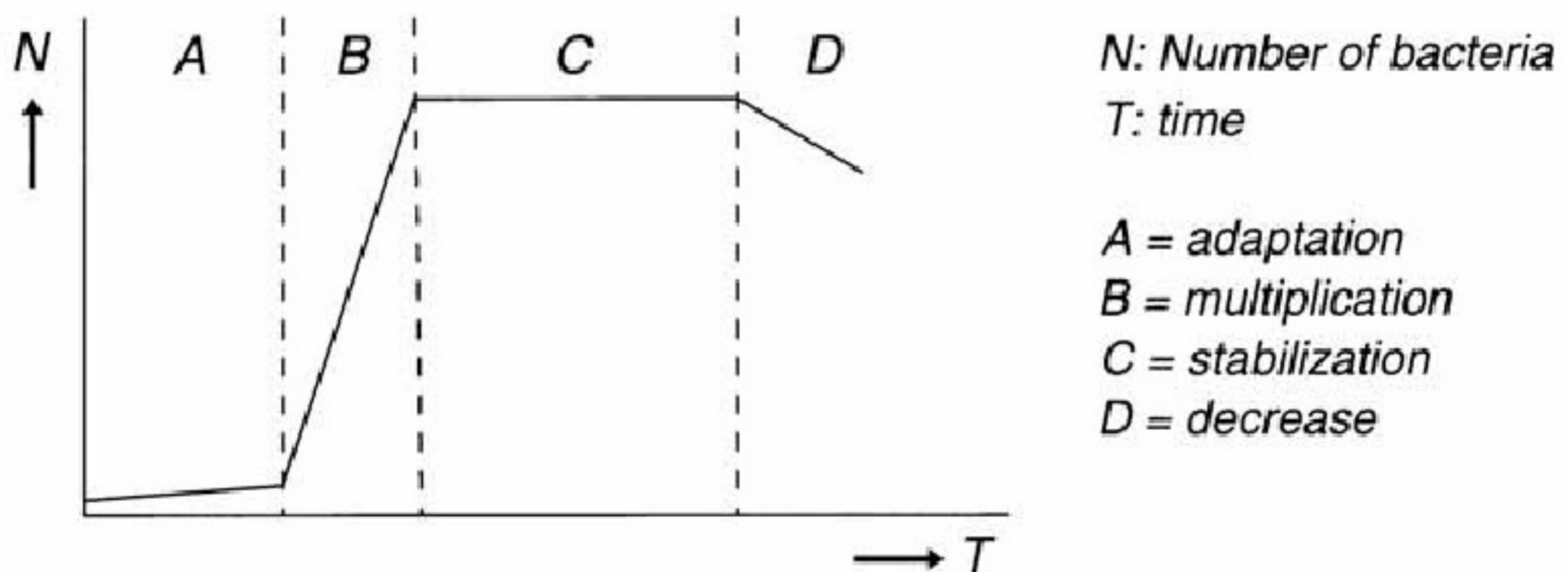

Figure 12: Development of lactic acid bacteria

After inoculation with the bacteria, the milk starts souring. In practice the whole souring cycle takes one to two days. In this period one can recognise the four growth phases of bacteria as follows.

Adaptation phase

During this period, bacteria, of which only a relatively small number is present, have to adapt to their new environment. Multiplication is still very slow. The length of the adaptation period depends on the type of bacteria, their viability, the temperature of the milk and whether there are any bacterial growth inhibiting factors present.

Period of rapid multiplication

The bacteria, after adjusting to their new environment, multiply rapidly and start fermenting milk sugar (lactose) into lactic acid. The milk gets thicker because of coagulation of the proteins and the taste becomes sour.

Stabilisation period

During this stage, the number of bacteria remains constant. The reason for this is that they do not thrive in the acidic milk.

Decrease of the number of bacteria

Due to the exhaustion of the nutrients of the food source and the production of lactic acid, the bacteria become inactive and die after some time.

Note: The gradual inactivation of the bacteria is the reason why you must not wait too long before adding part of a desirable bacterial culture to fresh milk (inoculation).

5.2 Cultivation of starter cultures of lactic acid bacteria

Starter cultures of lactic acid bacteria can be obtained from specialised firms and laboratories or from other dairy plants. Most of the starter

cultures from the laboratories and specialised firms are freeze-dried; dairy plants generally have fresh (liquid) starter cultures available.

If starter cultures cannot be obtained easily, it is recommended that you cultivate and maintain your own cultures. That way it is not necessary to buy a fresh starter culture each time you want to make cheese or a soured milk product. If fresh raw milk is stored at ambient temperatures the bacteria in the milk (including the lactic acid bacteria) will develop, after some time acid will be formed and the milk will curdle. The lactic acid bacteria that develops can be used for the fermentation of the product; see section 5.5.

During this spontaneous souring, however, undesirable micro-organisms could contaminate the milk. It is therefore better to use a commercial starter culture. When small quantities of products are made, a small amount of fresh yoghurt, whey or sour milk (or buttermilk) can be used as a starter culture. Experience has shown that the use of a starter culture produces a more consistent and better product than the use of naturally soured milk.

It is difficult to keep the starter culture fresh and active, especially under tropical conditions and with limited resources. The cultivation of the culture requires good hygiene and proper temperatures.

Different products, such as yoghurt and cheese, require different cultures of lactic acid bacteria. If you can obtain a freeze-dried powder culture, follow the instructions on the package. Once the seal of the package has been broken, the bacteria will not survive for a long time, in any case not longer than 6 months.

5.3 Growth of starter cultures

To make a starter culture you will need:

- fresh milk
- a thermometer
- a heat source

- a normal size (1 to 2 litre) pan with a lid
- a fresh starter culture or a freeze-dried starter culture
- a place to store the culture that has a constant warm temperature (e.g. an insulated box)
- a spoon or a small measuring cup
- glass pots that can be closed properly.

The equipment can be sterilised by immersing spoons, ladles and lids in boiling water for at least 5 minutes.

Milk used for the production of a starter culture should be handled under very hygienic conditions. Either whole or skimmed milk can be used as a base, but as the fat in the milk has no use, it is more economical to use skimmed milk. Boil the (skimmed) milk for at least 5 minutes in a saucepan. Transfer the boiled milk into a clean glass (use only glass!) jar, which can be properly closed. Normal clay pottery is porous and therefore more difficult to clean, so it can easily become a source of bacterial contamination. Cool the milk to the proper fermentation temperature. This temperature can be found in the instructions for use on the package of the starter culture.

For the production of the first starter culture you must use a freeze-dried culture or an active fresh liquid culture. If a freeze-dried powder is used: mix the powder with a small quantity of milk to make a smooth paste (everything coming into contact with the starter paste should be disinfected). Add more cold, boiled milk (follow the instructions on the package) and leave the mixture at the proper temperature as indicated in the instructions for using the powder. Dry starters are usually weaker than fresh cultures and should therefore preferably be re-inoculated and incubated one time more before being used to make other products (see figure 13).

If you start with a fresh liquid culture a quantity of 1 to 3% has to be added to the milk for inoculation. For freeze-dried starters follow the instructions on the package. The inoculated milk has to be incubated at a certain specific temperature for some time (generally 20 - 24

hours at a temperature of 18 – 20°C). In that time the bacteria multiply and the milk ferments.

Different products, like cheese and yoghurt, require different starter cultures. Incubation time for yoghurt is much shorter, generally 3 - 6 hours at temperatures between respectively 45 and 38°C.

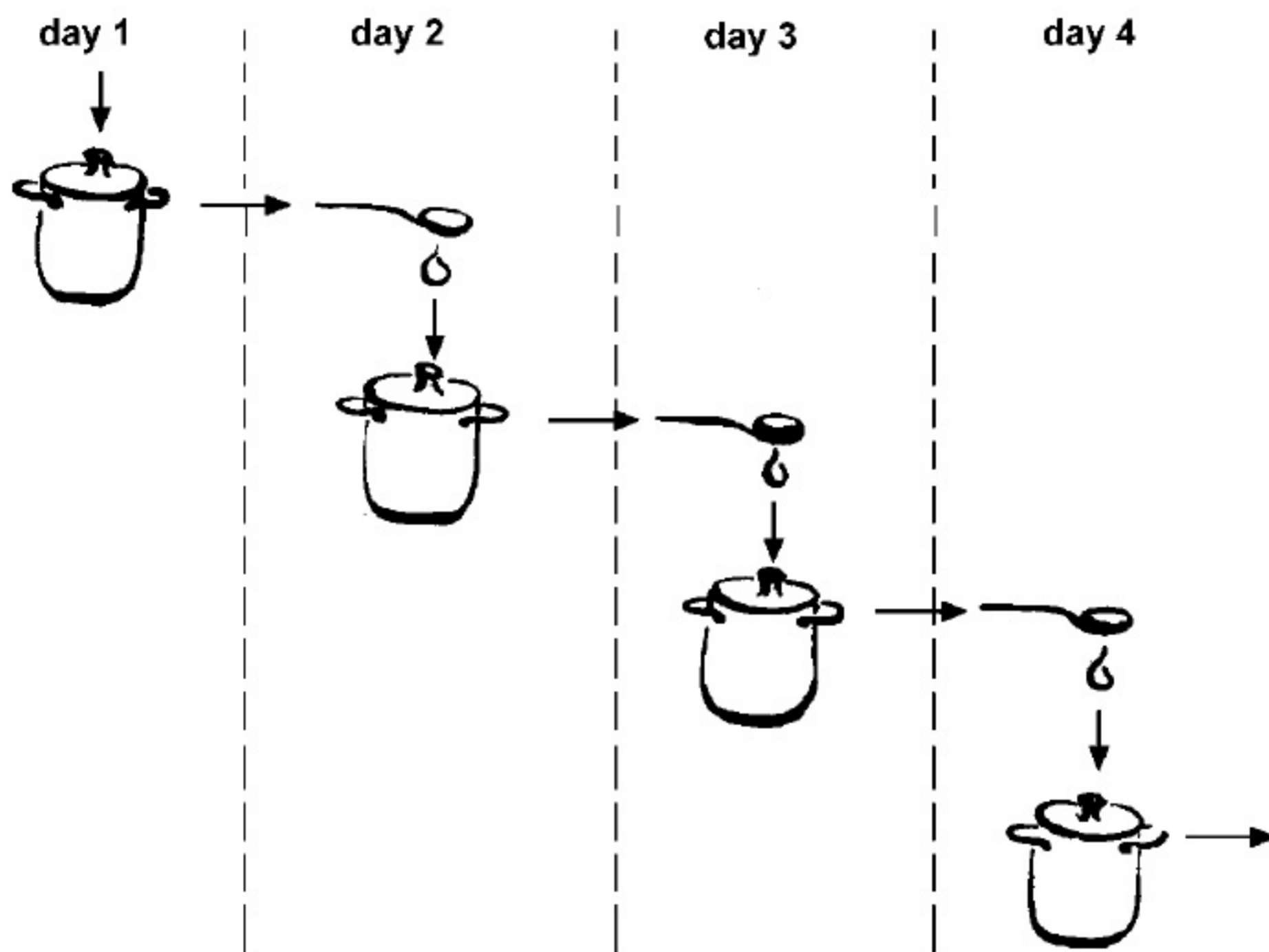

Figure 13: Cultivation of a starter culture

Bacterial growth starts at the moment the starter culture has been mixed through the milk. From this point, a constant and correct temperature must be maintained. There are a number of ways to keep the culture at the desired temperature. It can be poured into a sterilised thermos flask while warm, or an insulated box can be used to incubate a jar containing the souring milk. Covering the closed saucepan with a blanket or placing the closed pot under the bed covers will also help to keep the temperature constant.

Once the culture has been fermented, it can be used to make sour milk products and cheese.

5.4 Maintenance of starter cultures

Maintenance of the culture involves daily transfer of the existing culture to freshly boiled and cooled milk. Use skimmed milk if possible. This process is needed to prevent the bacteria from becoming too weak and thus useless. Part of the existing culture is used to inoculate fresh milk, which in turn is fermented to become the new 'mother culture'. The rest of the original culture can be used to make products such as yoghurt, cheese and buttermilk. The addition of 1 – 3% culture to the milk should be adequate. After incubation the milk has to be cooled, e.g., by putting it in a refrigerator, and incubated again for 20 - 24 hours. If a refrigerator is available, inoculation could be done on a weekly basis, but it is better to refresh the starter 2 times per week. The mother culture must be kept properly cooled.

If the culture is not used immediately, it can be kept, without transferring, for one week at most in a cool place, e.g. a refrigerator. After repeated use, the culture may become less active or its quality may decrease because it may not have the desirable fresh, sour flavour any more. If it appears that the activity of the culture is decreasing after some time, a fresh starter should be used.

A general guideline is to discard the culture when it takes longer than 10 hours to make yoghurt at 40 - 45°C, or 30 hours for milk to become sour after the addition of the starter culture to the milk (temperature at 20°C). If the fermentation seems slow, the coagulum is rather thin and does not have a fresh smell, you may be sure that the starter bacteria are weakened.

Instead of using milk, one can also use milk powder. It is absolutely essential to use clean, well-boiled water to dissolve the milk powder. Instead of a culture, a portion of the ready-made product (yoghurt, sour milk or buttermilk) can be used if this product was made shortly

beforehand, but this method is not very dependable. The safest but also most expensive method is to use a new starter each time, certainly when fermented milk products are made irregularly, i.e. not every month. This will save the effort of frequent inoculation of a new culture.

5.5 Preparing your own culture

If starters cannot be obtained easily, it is possible to cultivate simple lactic acid starters from raw milk (see figure 14). Store raw milk at ambient temperature until it has developed sufficient acid to curdle. For instance: leave 1 litre of fresh, raw milk to stand for 24 - 48 hours at 20-30°C.

After souring of this milk, a second quantity of milk is then boiled and cooled to the temperature at which the milk is usually fermented in the production process. The top layer of the available sour milk is skimmed off with a spoon or ladle (to remove micro-organisms, which stick to the fat globules) and this cream is thrown away. Add a small quantity of this soured milk (called inoculum) to the boiled milk (about 2 - 5%) and mix them.

After 24 hours of incubation at ambient temperature, again a fresh quantity of boiled milk with a temperature of about 20°C is inoculated with a small quantity (1-2%) of the second batch of sour milk (see figure 14). This procedure is repeated daily for about one week.

Fermentation of the milk should take place in a jar or a bottle, which must be closed with a clean cover that is also dust free. It is essential that all the utensils and tools used (jars, spoons, etc.) are clean and disinfected. Prevent contamination after disinfection!

After this period of cultivation the sour milk can be used as a starter, because the lactic acid bacteria will have overgrown other bacteria almost completely.

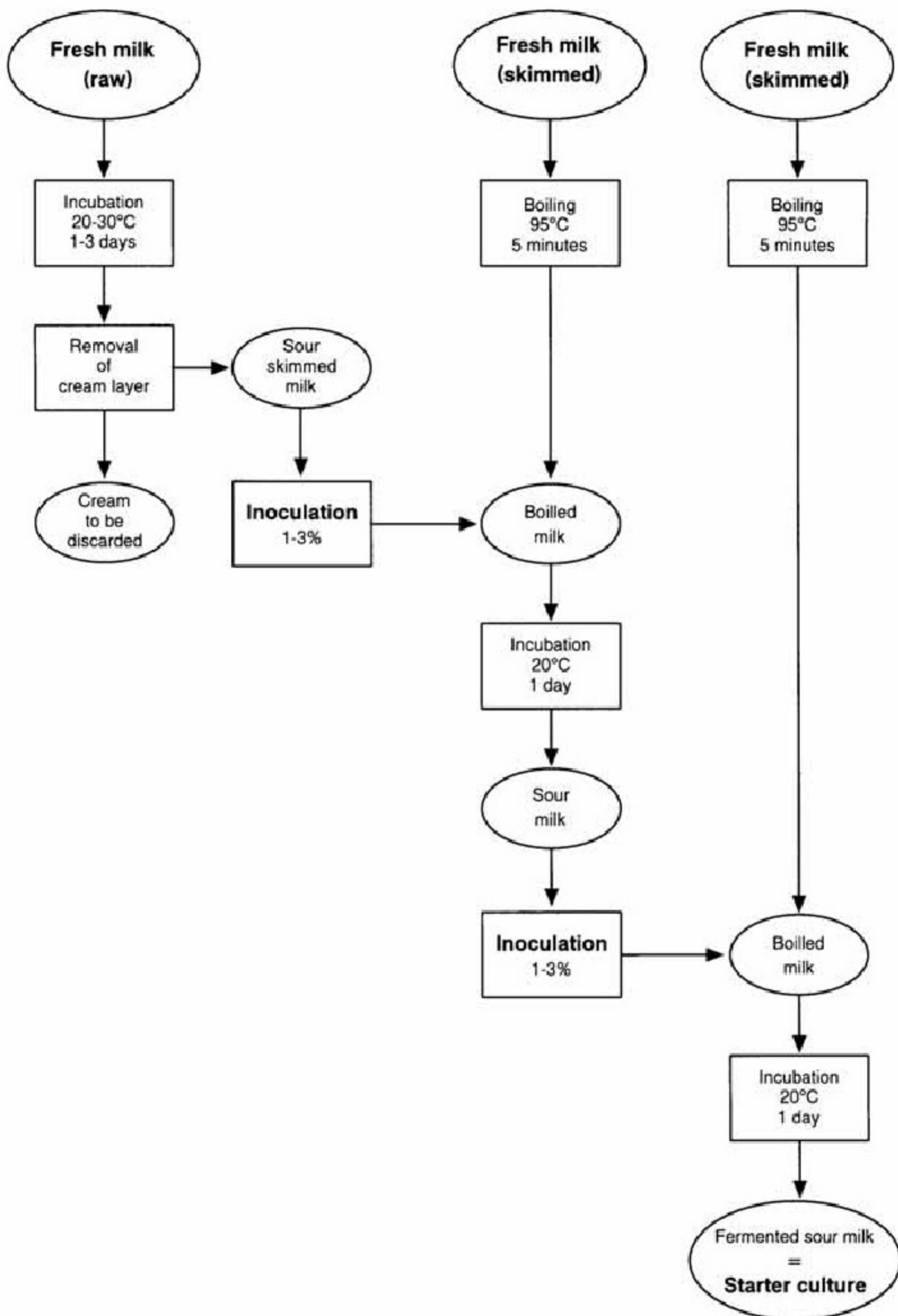

Figure 14: Isolation and production of a simple starter culture; the final starter culture can be used for inoculation at 1 – 3% and so on

Problems with the fermentation can have the following causes:

- The milk contains antibiotics, e.g. penicillin (because the cow had been treated with antibiotics).
- The milk has been contaminated with hydrogen peroxide or disinfectants; this slows down fermentation.
- The incubation temperature of the milk is too low (below 18°C).
- The temperature of the milk at the moment of the inoculation was too high (above 40°C).

6 Recipes

Figure 15 gives a rough overview of the different dairy products that can be made from milk.

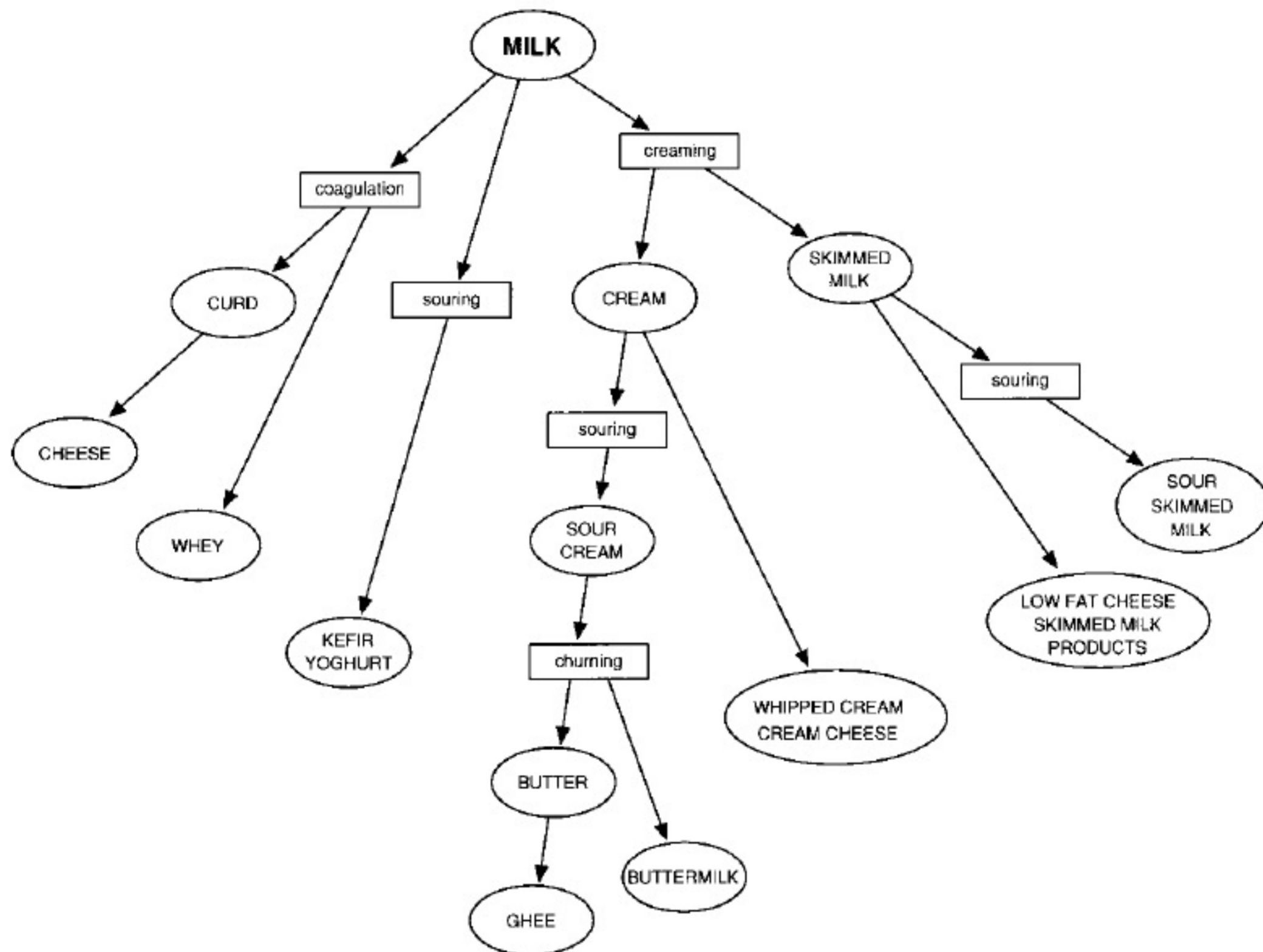

Figure 15: Manufacturing of milk into dairy products

Every recipe in this chapter starts with a list of the ingredients and equipment needed. The actual preparation is then described. Success depends on a lot of factors, so do not give up if you do not end up with the desired results the first time. Experimentation is necessary and you will probably have to adapt the recipes.

Several preservation techniques, like cooling, heating, drying, souring, salting, etc., are relevant to most recipes. Different types of milk can

be used, which give different results. Take great care when cleaning all pans, dishes and utensils; see chapter 3.

6.1 Cream

You will need raw milk and a heat source.

Method A

After leaving milk to stand for about 24 hours at as low a temperature as possible (4-12°C), the cream can be skimmed off using a spoon or saucer. This method makes use of the fact that cream rises and then stays on top of the milk. It contains most of the milk fat. Only cow milk readily produces cream this way; other kinds of milk need a hand creamer (centrifugal milk separator) to separate cream and milk.

Method B

Materials: a hand creamer (milk separator), two big bowls.

Heat the milk slightly to a little over 40°C and pour it into the upper bowl of the separator. It is important to turn the handle at a constant speed during the separation. After separating the cream from the milk, pasteurise both cream and skimmed milk.

The use of a separator produces more cream and leaves skimmed milk with less fat. A disadvantage is that the separator has to be cleaned thoroughly, including the disks, which takes much time. A hand creamer is a complex tool. Never buy a second-hand creamer before having checked that it works well. It might lack some irreplaceable parts or may be corroded or damaged.

The cream can be kept for a few days if it has been pasteurised. It can also be used for the preparation of various recipes. Cream can be used to make butter, for example.

The skimmed milk that is left after the cream has been removed still contains a lot of nutrients (protein, fat, milk sugar, etc.) and can be

used for direct consumption or for the production of soured milk or low-fat cheese.

6.2 Sour cream

You will need:

- fresh pasteurised cream
- a saucepan
- a thermometer
- a metal or wooden spoon
- a starter culture or fresh fermented milk

Cool the cream after pasteurisation to 18°C. Add 10 – 30 ml (1 – 3%; equal to 1 - 2 tablespoons) of sour milk or a starter culture to one litre of cream while stirring. Let the mixture become sour at a temperature of between 16 and 18°C, stirring it once after a number of hours to allow it to ferment evenly. After 24 hours the cream should be sufficiently sour and ready for consumption.

6.3 Butter

You will need:

- pasteurised cream, sour cream or sour milk
- a heat source
- a pan
- a thermometer
- cold water
- sour milk or a starter culture
- a container for churning
- a sieve
- a bowl
- a tray for kneading
- wooden spoons
- fine salt if available (optional)
- packing material, e.g. greaseproof paper or a jar
- clean water

Butter is made by churning one of the following products: cream, sour cream, or sour milk. If you do not have enough milk from which to skim off the cream, the milk can be soured and churned as a whole (provided that the fat content of the milk is rather high; above 4%). But sour cream is better to churn than sour milk.

It is only possible to manufacture sweet cream butter if the production and handling of the milk, cream and butter are exceptionally hygienic and the cream has undergone after pasteurisation a cold treatment by storing it for at least 12 hours at temperatures below 10°C.

Heating and souring

Heat the milk or cream to a temperature of 85°C. Let it cool down to 18°C as quickly as possible (use a thermometer) using cold running water on the outside of the pan.

Add 10 - 30 ml (about 1 - 2 tablespoons) of fresh fermented sour milk or a starter culture to one litre of milk or cream and stir. After about 24 hours at 16 to 18°C, the mixture will become thick and sour enough to be churned.

Churning

During churning the cream, sour cream or sour milk will be mixed intensively with air. This process causes fat globules to flocculate (or stick together), producing butter and buttermilk.

The simplest way to make butter from small quantities of milk is by using a bottle or a jar that can be covered with a well-closing lid or a simple bowl with beaters. If large quantities of milk or cream are available, you should consider acquiring a real churn. There are several types available. The churn tub is a simple method, which is often used in the tropics. A cheap and practical domestic churn is a glass pot with a paddle attached to a screw top. The paddle can be turned manually. This churn is difficult to clean. It is best to rinse it with water before use, in order to prevent the butter from sticking to the sides.

Churns should not be filled more than one third with soured milk or sour cream. Churn with a regular up and down or sideways movement. Stop churning when the butter particles reach the size of rice grains or peas and the buttermilk looks rather liquid. If, after 30 minutes, no grains have yet been formed, you can change the temperature by adding a little clean cold or warm water. See also the remarks at the end of this chapter. The amount of added water should never be more than 25% of the total amount of churned cream or milk.

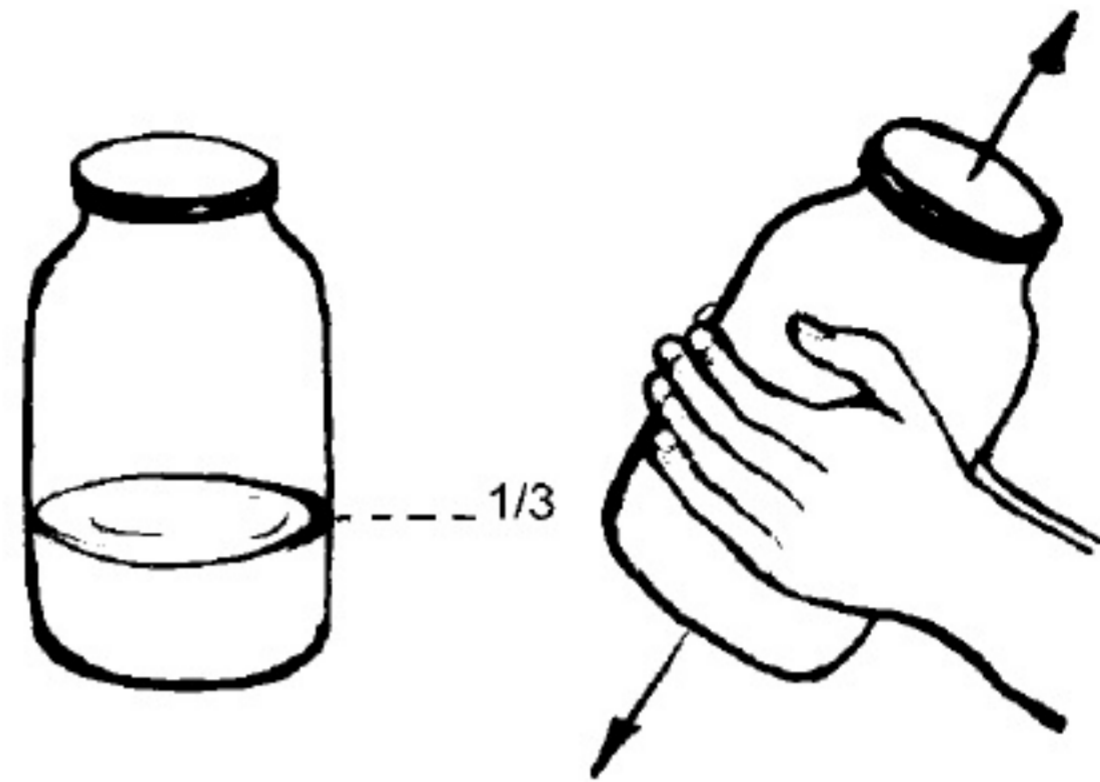

Figure 16: Using a jar to make butter

The butter particles will float to the top of the buttermilk, because butter is lighter than buttermilk. This makes it easier to separate the two products by pouring off the buttermilk through a coarse sieve. Never add too much water, otherwise the buttermilk will become too watery.

Washing

Washing of the butter grains is not necessary. However, if very clean water is available, it can improve butter quality.

Washing the butter can be done in two ways:

- 1 Fill the churn $\frac{2}{5}$ full with clean, cold water. Wash the butter by churning it for about 3 minutes. This can be repeated, if necessary. The idea is to remove part of the remaining buttermilk from the butter particles. It is important to remove as much as possible in order to produce butter that can be kept for a longer period. After washing, the butter particles can be skimmed off or the buttermilk can be drained.

2 If small quantities are available, the butter particles can be washed using a sieve. Put the sieve on top of a bowl and pour the mixture through it. Make sure that during churning the butter does not become one big lump, otherwise it will be difficult to wash - in case you want to do this.

Salting (if preferred)

Salting is not necessary for preservation; many people, however, like the taste of salted butter. The butter can be slightly salted (according to taste) by kneading in about 10 grams of salt to each kilogram of butter. Mix the butter again the next day in order to allow the salt grains to dissolve.

Kneading

Kneading the butter is important in order to get a nice, smooth product. It helps to distribute the moisture and this improves quality and shelf life, provided that kneading is done in a hygienic way.

Use a clean, well-rinsed kneading board. Knead the butter with the back of two wooden spoons until drops of water and buttermilk are not perceivable any more and the butter has a nice, smooth surface. Remove drops of buttermilk during this process. Instead of a wooden spoon, a wet roller or bottle can be used. If none of these are available, just use clean hands to knead.

Storage

Butter should be stored in a cool, dark place. Put it in a pot or wrap it up in greaseproof paper or aluminium foil. After some time, one to two weeks, the surface of the butter can be covered with moulds. This mould formation can be partially prevented by sprinkling salt on the surface or by wrapping the butter air tight. Moulds only grow if oxygen is available.

Butter can also be frozen. However, after defrosting the butter will rather soon have an off-taste. It is therefore a good idea to divide the

butter into smaller portions before freezing. Salted butter is less suitable for freezing.

Remarks

- 1 If milk has gone sour without the use of a starter, but it still tastes and smells fresh, it can still be churned.
- 2 Churning can take from 5 to as much as 60 minutes. A number of factors may influence the time needed, for instance:
 - type of animal the milk came from
 - the fat content of the cream
 - treatment of the cream; the cream must have had enough time (at least 12 hours at 10 – 18°C) before churning for crystallisation of part of the fat to take place
 - feed eaten by the animal; feed influences the crystallisation (= melting point) of the fat
 - the temperature of the cream during churning.
This last aspect is also dependent on the melting point of the fat. If the cream is too cold, the fat globules do not easily stick together and churning will take longer. If the temperature of the cream is too high, churning will go quickly and the butter grains will not stick together and butter will not be formed. A good churning temperature is 15 – 20°C.
- 3 Butter has a limited shelf life. It can become mouldy or rancid. An unpleasant cheese-like flavour may develop due to the deterioration of its protein. An alternative is ghee (see below), which does not spoil as quickly as butter. Ghee is produced by removing the last water remnants from butter by heating the butter and letting the water evaporate, or by melting butter and draining the water, which separates from the fat.

6.4 Buttermilk and sour milk

Buttermilk is a by-product of the butter-making process. The taste can be more or less sour depending on the sourness of the cream or the milk, which is used for butter making, or on the degree to which it sours after churning.

It is also possible to make a product like soured buttermilk using milk or skimmed milk, by inoculating it with sour milk and letting it ferment for one day. For the fermented milk you will need: fresh (skimmed) milk, a heat source, a wooden spoon, fresh fermented milk or buttermilk or a starter culture, a saucepan with a thick bottom, and a thermometer.

Heat the fresh (skimmed) milk to boiling point, stirring all the time. Cool it down to 18 – 20°C, for instance in a large pan with cold water. Add 10 – 30 ml of sour milk or buttermilk or a starter culture per each litre of milk (1%). Leave for it 18 - 24 hours at room temperature (18 – 20°C); if the surrounding temperature is higher, fermentation time will be somewhat shorter. After this the sour milk is ready. Store it in a cold place (cool basement or a refrigerator), if you want to keep it for some days.

6.5 Ghee

To make ghee, you will need:

- butter
- a heat source
- a pan
- a metal spoon.

Heat the butter until water and fat form separate layers; the fat will float on top. There are two ways to remove the water:

- It can be removed by further heating. The water present will evaporate.
- It is possible to remove the layer of fat with a spoon. This fat should then be heated again. The scum, which will form, has to be skimmed off regularly, preferably with a skimmer. The colour of ghee can vary from almost white to dark brown. A rancid flavour is acceptable, but if it tastes burnt it should be discarded.

6.6 Koa

Koa or khoa is a type of concentrated milk. You will need:

- fresh (unboiled) whole or skimmed milk
- a heat source
- a shallow, clean, wide, iron pan with a thick, flat bottom
- a flat, clean metal utensil to stir with (e.g. a flat pancake spatula).

Fill the pan with the milk up to 30 to 50% of its capacity. Bring the milk to boiling, stirring continuously. The water will evaporate and after some time the milk will reach a certain viscosity, this means the milk will thicken. Take great care to scrape the sides of the pan during stirring. Once the milk has reached a dough-like consistency and stirring does not prevent the mass from sticking to the side of the pan, you can remove it from the heat source and lower the temperature by at least 20°C. At this point the water content should have been reduced to about 40% of what it was. Take the lump of koa out of the pan, put it on a cold surface and flatten it. After cooling, the koa will be firm and can be cut into squares. It will have a sweet, nutty flavour. Koa can be kept only for about 2 - 5 days because of possible re-infection.

The preparation of koa requires much time (a few hours) and fuel, on top of which 1 litre of milk produces only 0.4 litres of koa.

6.7 Rabi

Rabi is sweetened, concentrated milk. During concentrating, sugar is added from time to time. You will need:

- (unboiled) milk
- a heat source
- a wide, shallow iron pan with a thick bottom
- a flat metal scoop
- sugar
- scales.

Add sugar to the milk during the heating process (maximum 300 g per litre of milk) and follow the same procedure as for koa. Lumps of sugar will often be found in the end product.

6.8 Yoghurt

Yoghurt is produced when milk is soured by certain lactic acid bacteria, which prefer growing temperatures far above room temperature: 37 – 45°C. The milk should first be heated to 85°C or higher. A high pasteurisation temperature (above 72°C) gives a better consistency (thickness) to the final product. After the milk has been soured, the resulting yoghurt can be used to make more fresh yoghurt by adding it to fresh milk.

Basic recipe for yoghurt

You will need:

- fresh raw milk
- a heat source
- a saucepan
- a spoon
- a thermometer
- cooling facility
(e.g. a large pan with cold water)
- a cool place (refrigerator or cellar)
- starter culture for yoghurt or some fresh yoghurt
- thermos flask or a box covered with a blanket



Heat the milk to 85°C or higher and keep it at this temperature for 3 minutes. Cool the milk to 45°C. Add 30 ml (2 - 3 tablespoons) of fresh yoghurt to each litre of milk; the yoghurt should not be more than 2 days old. Instead of fresh yoghurt you can use a yoghurt starter culture. Mix the milk and the starter and leave it to ferment. The time required for the milk to turn sour depends on the temperature. To give you an idea:

- at 40 - 45°C it takes about 3 to 6 hours

- at 35 - 37°C it takes about 20 to 15 hours
- at 30°C it takes about 24 hours

The ideal temperature to make pleasant-tasting yoghurt with a firm consistency is 40 - 45°C. It is not possible to produce yoghurt at temperatures below 30°C or above 50°C. The correct temperature can be maintained using an insulated box or a blanket. Yoghurt is ready for consumption once the incubation period is finished. If cooled, yoghurt can be kept for one week.

Using a thermos flask

Heat the milk to at least 85°C, then cool it to 45°C. Pour 90% of the milk into a thermos flask, which has been rinsed with hot water. Mix 1 - 2 tablespoons of fresh prepared yoghurt (or yoghurt culture) with the rest of the milk and add this to the thermos flask. Close the flask well and leave to stand for 3 - 6 hours. Remove the yoghurt from the thermos flask and store in a cool place. Yoghurt made of sheep milk is very firm and therefore not suitable for fermentation in a thermos flask.

Yoghurt made from milk powder

Make milk from milk powder according to the instructions on the package, but add 10 to 15% extra milk powder. Dissolve the milk powder in water, heat it to boiling point and let it cool down to 45°C. Stir in 1 - 3 tablespoons of fresh yoghurt or a yoghurt culture per litre of milk. Cover the saucepan and put it in a warm, insulated place. After 3 - 6 hours this (firm and concentrated) yoghurt should be ready for consumption.

Remarks

- It is best to use fresh milk to make yoghurt. Milk powder can also be used. Sterilised milk may give a thinner yoghurt than pasteurised milk.
- After incubation, cooling is desirable, preferably below 10°C, so that souring is stopped (this retains the pleasant taste) and the

bacteria remain more viable, allowing the yoghurt to be used to inoculate milk again.

- Make sure the milk ferments as quickly as possible, preferably at 40 - 45°C rather than 30°C. Harmful bacteria have less opportunity to develop if the fermentation process goes faster.
- Thicker yoghurt can be produced by adding 2 to 3 tablespoons of milk powder to each litre of milk before heating it to 85°C.
- It is not advisable to use fruit yoghurt from a shop as a starter culture because it contains a lot of additives. Plain yoghurt from a shop can be used if it is not too old. Sterilised yoghurt is not suitable either, because the yoghurt bacteria have been killed by the sterilisation process.
- When using yoghurt from a carton or a pot as a starter, first remove the top layer and take the yoghurt from the centre to make fresh yoghurt. This is because the bacteria in the middle are probably the most diverse and active.
- Stir the product as little as possible before removing some, to avoid the extra risk of incorporating undesirable bacteria.

6.9 Kefir

Kefir, like yoghurt, is a milk product first discovered by the nomadic tribes living in the cold areas of the Caucasus. When making kefir, acid, gas and some alcohol are produced. Like sour milk and buttermilk, it has a special aroma which is different from that of yoghurt. Kefir is made by using a 'yoghurt plant', which is actually a misleading name as it is not a plant and it has nothing to do with yoghurt.

The 'yoghurt plant' is in fact a cauliflower-like lump of chalky crystals and micro-organisms consisting of yeasts and bacteria. The yeasts produce alcohol and gas, while the bacteria convert the milk sugar into lactic acid. You may be able to obtain a piece of this from someone who regularly makes kefir. If not, get some dried kefir granules at the local market.

You will need: fresh raw milk, a saucepan, a heat source, a thermometer, a clean pan, a glass bottle with wide neck, a bottle which can be closed tightly, kefir granules or a 'yoghurt plant', a sieve, cooling facilities, clean water, a teaspoon, and a cool place to store the product.



Figure 17: Kefir is a thick, creamy, frothy drink with a sour taste and smell

Boil the milk and put it into a bottle, which has been thoroughly cleaned and rinsed with hot water. Do not fill the bottle completely; let the milk cool down to 20°C (use a thermometer). Add one tablespoon of kefir granules soaked in water to each half litre of milk in the bottle and cover it loosely so that the gas produced can escape. You can use a fresh yoghurt plant instead of the soaked granules. Keep the bottle at a temperature of 16 to 18°C. After 24 hours the milk will have become a little thicker, forming some froth: this is kefir. Sieve the kefir and use the (washed with clean water) granules, which remain in the sieve to make fresh kefir again. The kefir is now ready for consumption or can ripen for some days to get more flavour.

Ripening of the kefir

The kefir can be left to 'ripen', during which time further fermentation takes place. This is essential to create kefir's characteristic qualities. Pour the kefir into a well-cleaned bottle, which can be closed, or a bottle with a clip fastening and do not fill more than 3/4 because gas forms during ripening.

Leave the bottle at about 15°C, but do not store it for more than 3 days. Towards the end of the ripening process the whey separates and can be incorporated again by stirring or turning the bottle. The end product is a thick, creamy, frothy drink with a sour taste and smell and the produced carbon dioxide is perceivable. If the kefir is left to ripen for more than 3 days, the milk may curdle and the drink becomes too sour. The temperature and the time are important as they determine the flavour. The kefir can be kept in a refrigerator or a cellar for a few days.

Storage of the kefir granules

If kefir production is stopped for some time, the kefir granules can be dried as follows: Put them into a sieve and rinse well with clean water until all remaining milk is removed. Place them on a clean cloth and leave to dry in a clean place, but not in the sun, until the granules have shrivelled up. The granules can be kept in a closed bottle in a cool place for 12 to 18 months. The rinsed granules can also be kept in a freezer.

Kefir granules can also be kept in a pot with water at 4°C, but they become inactive after 8 to 10 days.

Remarks

- There is a greater chance of failure with kefir than with yoghurt. The end product may not only taste bad, it can also be unhealthy. In order to produce good kefir, the appropriate hygiene should be applied. Care should also be taken not to work at too high temperatures.
- The shelf life of kefir is the same as for yoghurt, sour milk and buttermilk: its quality will rapidly decrease if it is stored too long. At 5° C, soured products can be kept for about ten days; at 10°C this is three days, and 20°C is too high.
- Kefir may be too sour or too yeasty (due to an incorrect balance between the activity of the bacteria and yeasts). A fishy or ammonia-like taste can be the result of a breakdown of proteins by undesirable bacteria, which enter due to insufficient hygiene.

Koumiss

Koumiss is a sour milk product similar to Kefir. It is manufactured from mare milk.

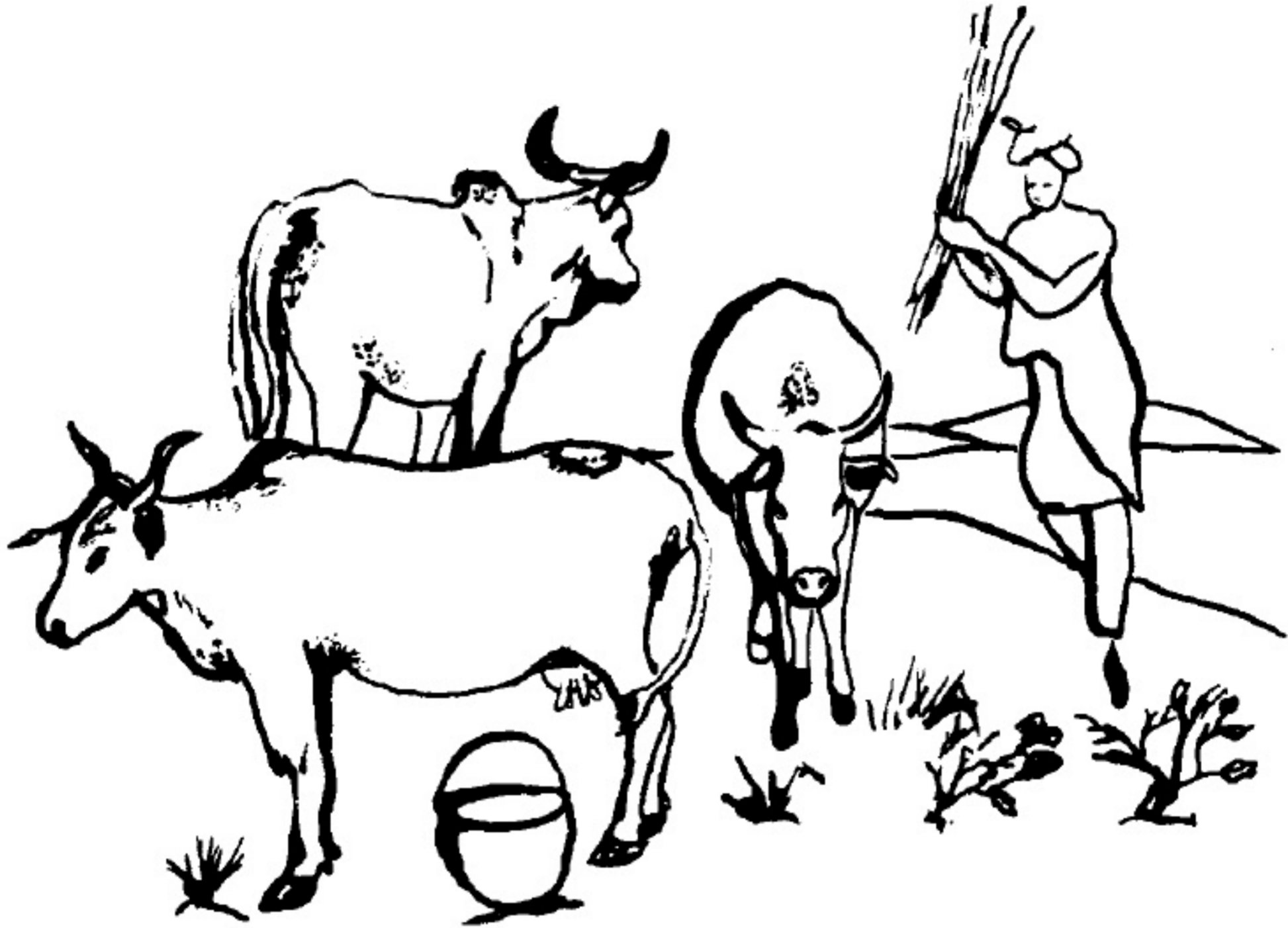

Figure 18: Cow milk accounts for 91% of the world's milk production (see section 2.2)

7 Cheese

Cheese is a product that has been made for centuries. Virtually all the nutrients present in milk are concentrated in cheese (see table 4).

There is a huge assortment of cheeses. They can have various compositions; we make a rough distinction between fresh cheese and matured cheese, and between soft cheese and hard cheese. Fresh cheese can be consumed immediately after production, whereas matured cheese has to be stored after processing to develop flavour and a good consistency. Soft cheese has a higher water content than hard cheese; moreover hard (or semi-hard) cheese generally has a clean, dry rind. Soft cheeses and hard cheeses can be matured for some weeks or even up to a number of years.

Table 4: Rough composition of milk and some types of cheese

Product	Content (in % weight) of			
	Water	Fat	Protein	Salt (sodium chloride, NaCl)
Milk	87.5	3.5	3	less than 0.1
Skimmed milk	91	0.1	3	less than 0.1
Fresh cheese (whole fat)	73	10	10	less than 0.1
Fresh cheese (low fat)	83	0.2	13	less than 0.1
Cream cheese (fresh)	57	32	9	0.5
Soft cheese	51	25	19	2
Semi-hard cheese	42	30	25	2 – 2.5
Hard cheese	30	35	30	2 – 2.3

Cheese production in the tropics is typified by specific problems; consequently, production processes and end products differ from those in Western Europe.

- Outside the temperate zones, high temperatures and very high air humidity must be taken into consideration. Both these factors are unfavourable for cheese making, in particular for the maturation of cheese.

- Milk is often available in small quantities, while its quality may not be up to standard. In particular, its hygienic quality and composition may leave much to be desired.
- Hard and semi-hard cheeses require good-quality milk and hygienic processing. Moderate temperatures are needed for good ripening and storage of these cheeses. In warm and hot climates most cheeses are produced on a small scale and cannot be stored for a long time. Therefore generally these are soft cheeses.
- In many tropical and subtropical countries, very matured cheese is not very popular. Most consumers are not used to the distinct flavour and smell of such cheese.

The shelf life of cheese can vary from several days to some months and even to some years, depending on its processing.

Fresh cheese can, like fermented products, be stored for only a short time; it must be consumed immediately or within a few days. The keeping quality of such cheese can be improved by cold storage and salting. Fresh cheese generally does not have a rind and is packed in a wrapping or a package. Most of the fresh cheese has been curdled using only an acid; it cannot be ripened and it should be consumed within a couple of days.

Soft cheese is processed by using acid and rennet, in most cases it matures for some weeks or even some months. Soft cheese generally has a rind and often also a microbiological flora on the surface of the rind (like Camembert and Brie).

Semi-hard and hard cheese can be kept well for 3-4 months or more. Cheese which is able to continue ripening should not be kept in a refrigerator, but in a cellar or cool place at 10-15°C. Where applicable, information and instructions will be given in the following recipes on keeping qualities and ways of storing products.

Cheese making has three main goals:

- 1 Concentration of the milk into curd, whereby a great deal of the liquid part of the milk, the whey, is removed.
- 2 Preservation of the curd. Acidification of the curd and the salting process are important, along with a well-closed cheese rind or effective wrapping of the cheese.
- 3 Maturation of the cheese, in order to get a good taste, flavour and consistency.

The cheese-making process has some essential steps. These are:

- 1 coagulation of protein of the milk, whereby the fat is incorporated in the coagulated protein
- 2 draining of the whey
- 3 acidification of the curd
- 4 collection of the curd and combined growth into a cheese
- 5 salting
- 6 maturation

The processing of fresh cheese follows steps 1 to 3; matured cheese needs steps 1 to 6.

The basic operations in cheese making will be discussed in this chapter:

- the treatment and quality of the milk used to make cheese (pasteurisation and/or standardisation)
- the coagulation (curdling) of the milk using acid or enzymes
- the separation of the curd and whey
- the collection and preservation of the curd (heating, collection, pressing and salting)
- the maturation (ripening) of the cheese.

7.1 Utensils for making cheese

When making cheese, you will not always need all the utensils described below. Decide beforehand which you will use, and make sure that they are clean and rinsed with clean water. It is preferable to use utensils made of stainless steel or glass.



Figure 19: Utensils for cheese making

The utensils used during cheese making are:

- 1 a thermometer with a range of 20 – 100°C
- 2 a measuring cup
- 3 a bucket for coagulation of the milk
- 4 cheese moulds, which can be made in various ways (see below)
- 5 cheesecloth, its size depends on the size of the mould
- 6 cutlery and other tools such as:
 - spoons to measure rennet and/or acids
 - a knife to cut curdled milk
 - a skimmer to scoop curd out of whey, or a colander.

Cheese moulds can be made from various materials e.g. wood, plastic or metal. Metal materials should be non-rusting. Do not use plastic tubing used in construction as it can release poisonous substances. Cut the moulds lengthwise and drill holes from the inside out. Plastic moulds for the production of soft cheese are also commercially available. Wooden cheese moulds can be used as well.

Cheese that will have a closed rind after pressing is never placed directly into a mould. Instead, a clean cloth of linen or cotton is first placed in the mould and it is then filled with curd. The cheesecloth is then folded closed.

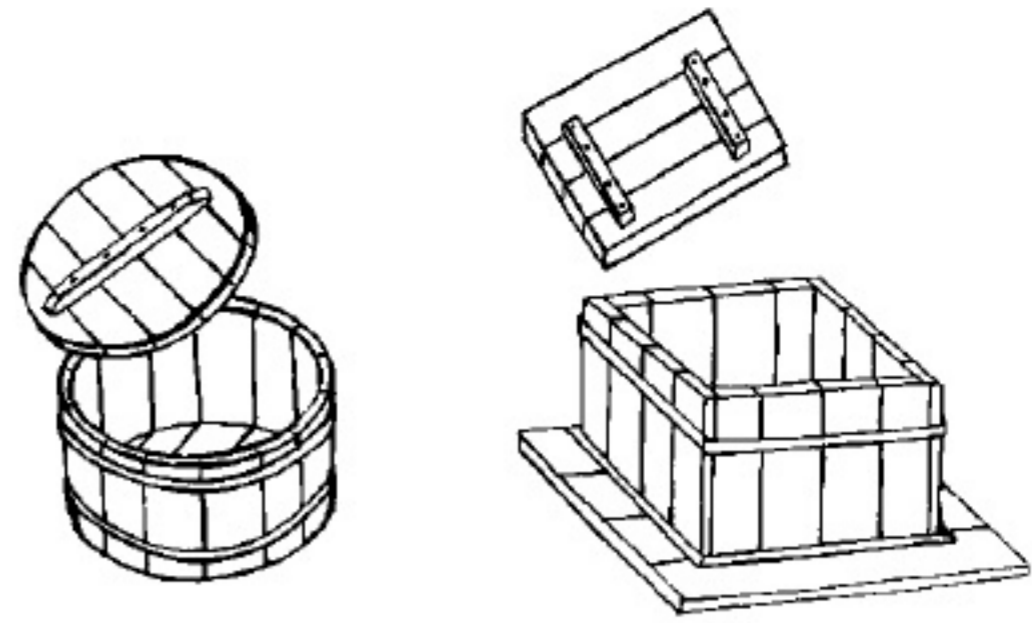

Figure 20: Cheese moulds

To make hard or semi-hard cheese you will also need the following:

- a curd knife to cut the renneted milk
- a cheese press

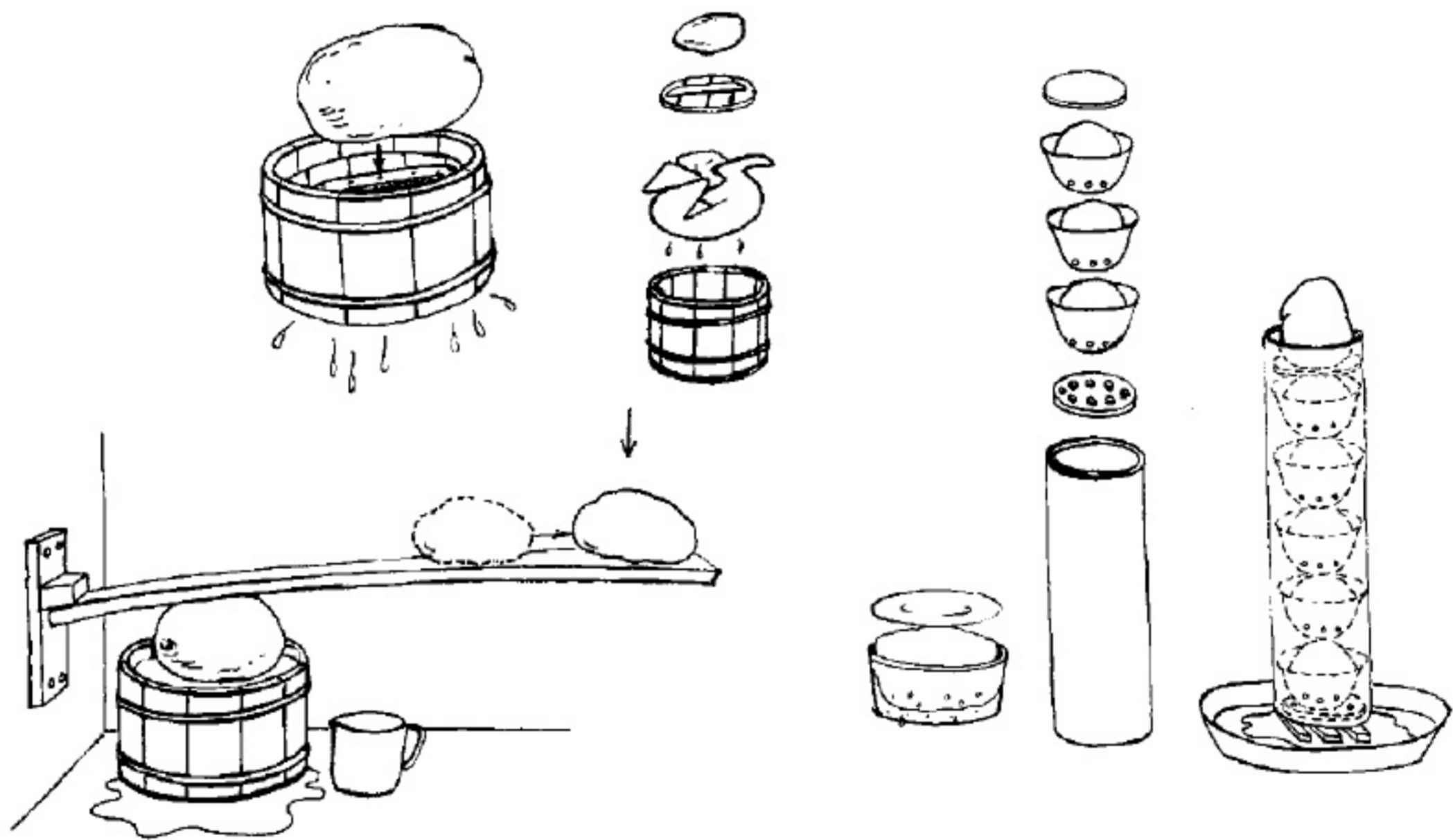

Figure 21: Some examples of cheese presses

Buy these second-hand if possible or make your own simple press, paying special attention to the following:

- The materials used must not be poisonous.
- It must be possible to easily clean the materials.
- It must be possible to build up sufficient pressure (0.1 to 0.4 kg/cm² or 2 - 5 x the weight of the cheese).

7.2 The quality of milk used to make cheese

Cheese making begins with hygienic milking. The quality of the milk used greatly influences the smell, taste and keeping qualities of cheese. The composition of milk can vary greatly. Just before a cow is set dry – the period in which a cow is not milked – and just after calving, the cow milk has a different taste and composition. Milk from a cow with an udder infection is not suitable for human consumption, and therefore cannot be used for making cheese.

Apart from the usual measures taken to ensure good hygiene during milking, attention must be paid to the following points:

- 1 Clean the equipment very well.
- 2 Disinfectants and cleaning agents must never be left in or on equipment. Disinfectants inhibit the growth of the bacteria of the starter or souring agent.
- 3 The room in which cheese is prepared must be kept properly clean.
- 4 The milk used for cheese making should preferably be pasteurised (15 seconds at 72°C or 30 minutes at 63°C). More intense heating is not desirable because it reduces the curdling of milk. More rennet or calcium chloride (CaCl_2) is then needed.
- 5 For the above reasons, milk powder which is strongly heated during its production (high-heat milk powder) is less suitable for cheese processing. Only low-heat milk powder can be used.
- 6 Sour milk neutralised with sodium bicarbonate will not curdle well.

7.3 Coagulation of the milk

The principle of cheese processing is based on the coagulation of the protein in milk, during which about 90% of the milk fat is encapsulated. The coagulated mass is called curd, the remaining liquid is called whey. Curd consists mainly of milk proteins (casein) and milk fat; while whey mainly contains water, milk sugar (lactose), protein (serum proteins) and B-vitamins.

There are two basic ways to cause milk to coagulate:

- using an acid
- using a rennet (enzyme coagulation)

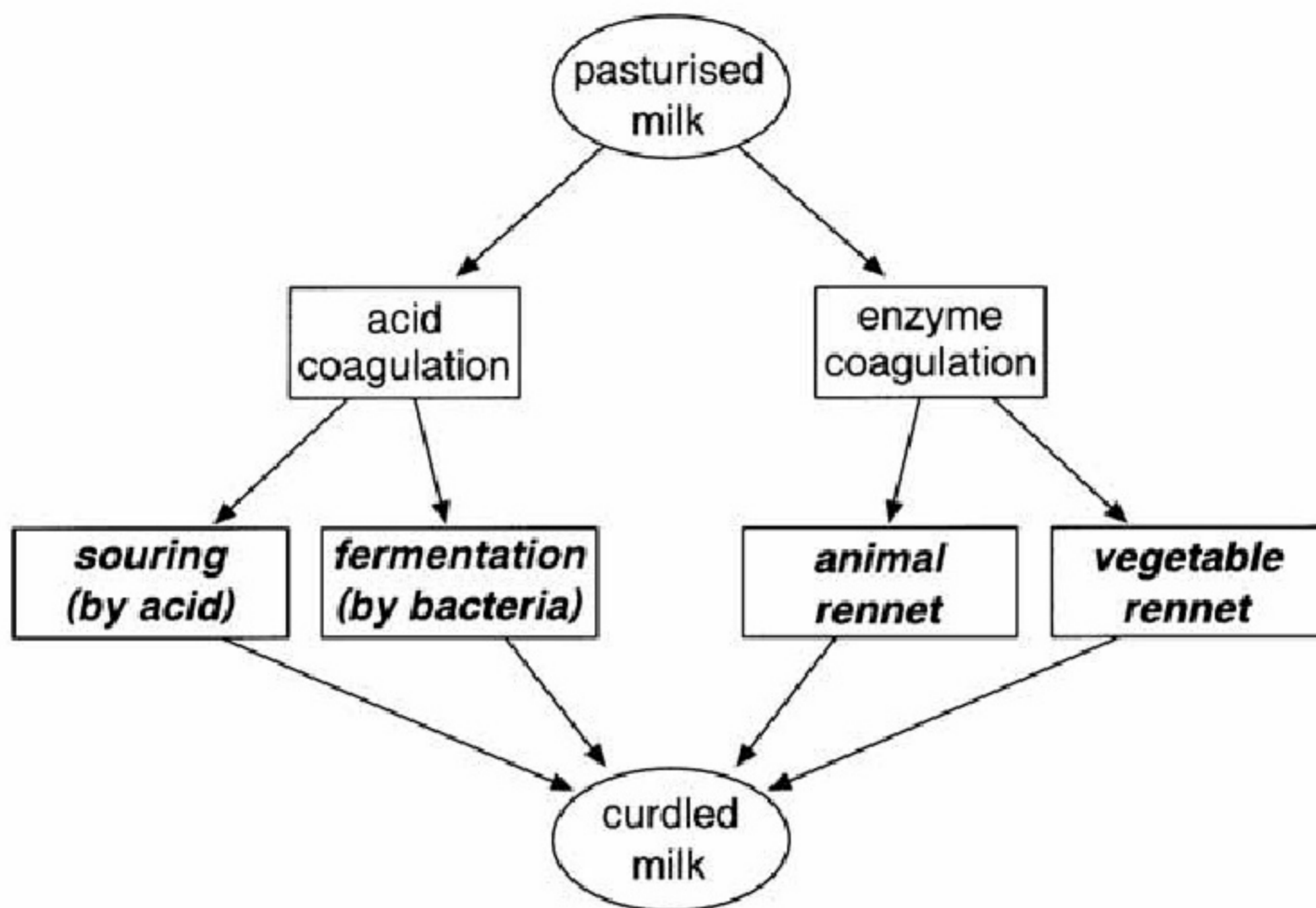

Figure 22: Four methods of curdling milk

Acid coagulation

This is mainly used to make fresh cheese. The acid can come from bacteria from the starter culture or from an acid added to the milk. When using a culture, pasteurised milk is inoculated. Inoculating agents can be a specific cheese starter culture, whey or sour milk.

Curdling time depends on the amount of inoculating agent added (0.1 - 5% of the milk used to make cheese), temperature (20 - 35°C) and the starter culture used. It takes 2 -16 hours. When the curd is firm, the curdling is finished.

When using an added acid, you can use pure vinegar acid, lactic acid, citric acid or any other harmless organic acid. Sometimes a natural acid such as lemon juice is added. The acid can be added drop by drop to warm milk (about 80 - 90°C, just after boiling). Milk curdles much quicker at a high temperature.

The curd is collected by straining the curdled milk through a coarse cloth. Sometimes the collected curd is pressed a little bit, and sometimes no pressure is applied. These products are consumed fresh.

Rennet

Rennet used in cheese processing can be of animal, vegetable or microbial origin. The rennet in cheese has two functions.

- Rennet causes the milk to coagulate.
- During ripening, rennet causes milk protein to break down, giving the typical cheese taste.

Rennet is available in liquid form and as a dried powder. As it is an enzyme and therefore a biological product, the strength of the liquid product decreases during storage. Therefore, it is preferable to use the dried form.

The concentration of the rennet is written on the package. The amount of rennet to be added depends on the strength of the rennet and on the kind of cheese you are going to make. When making soft cheese, sometimes no rennet is needed; if rennet is added, only a little is needed (0.1 ml of rennet to 10 litres of milk). For hard or semi-hard cheeses, about 1.5 ml of rennet is added to 10 litres of milk; assuming the rennet concentration is 1:10,000. A starter is almost always added before or while adding rennet.

A number of factors influence coagulation:

- Amount of rennet or acid added.
- Curdling temperature. When using rennet a small rise in temperature (for example from 30°C to 33°C) can significantly reduce coagulation time.

- Intensity of pasteurisation. Curdling is reduced when milk has been strongly heated. This effect can be neutralised by adding a small amount of CaCl_2 ; for example 7 grams of CaCl_2 per 100 litres of milk.
- Fat percentage of the milk. A high fat percentage means more fat must be encapsulated and curdling occurs a little bit slower.

Preparation of rennet

Rennet from animal origin is prepared from the stomach of suckling calves or lambs. It is obtained by extraction of the stomachs in a salt solution with a preservative.

A traditional method formerly used in The Netherlands can be applied in the tropics:

- Take 9 litres of boiled water.
- Add 26 carved calf stomachs, 500 gram sodium chloride (salt) and 200 gram boric acid.
- Store these for at least 10 days and stir once per day.
- After ten days, remove the stomachs from the solution, add another 500 gram salt to the solution and store it for some days more.
- Then, pour it into clean bottles, close these and store the bottles in a cool and dark place. Your rennet is ready.

You have to try out the strength of the rennet. Also, the keeping quality of these rennets is usually poor.

Sometimes the stomachs of the young animals are kept after cleaning, salting and drying. The dried stomachs are easy to transport and are used by some nomadic tribes. In cheese making a piece of dried stomach is then added to the milk.

7.4 Separating curd and whey

Three methods can be followed to separate curd from whey:

- hanging the curd/whey mixture up in a clean cloth (see figure 23);

- putting the curd/whey mixture in cheese moulds, or in cylindrical forms with perforated sides;
- first cutting and stirring the curd/whey mixture, putting the curd in the cheese moulds and then pressing the cheese.

When making fresh cheese, the first or second method is usually used. As the whey drains through the cloth or the mould, the volume of the curd will reduce to 1/2 or 1/3. When making ripened cheese, the last method has to be used to remove sufficient whey from the curd. The effect of cutting and pressing is described below.



Figure 23: Letting soft cheese drain

7.5 The use of cheese whey

Whey is the by-product of cheese making. The acidity and the composition vary widely with the type of cheese and manufacturing process used. Whey from rennet-coagulated cheeses is less acid than whey of acid-coagulated cheeses. Also, the content of solids varies depending on the method of cheese making. If the content of solids is high, e.g. in the case of the processing of sheep cheese or in the case of rough curd treatment, the solids of the whey can be processed to a whey cheese. A rather well-known type of whey cheese is the Italian product Ricotta.

Manufacture of Ricotta from cheese whey

- 1 Heat the acidified whey till at least 85 °C or boil it for some time till the whey proteins have coagulated.
- 2 Add some salt (0.1%) if desired.
- 3 Collect the coagulated curd by filtering the mass through a towel or a filter.
- 4 If you press the curd you will get a hard cheese; if the curd is pressed lightly or not at all, the cheese is consumed fresh.

- 5 Add some salt if you like (if you did not do so before)
- 6 Store the cheese in the fridge.

Whey as animal feed

If whey is discarded it can cause serious problems as a dairy effluent. Therefore it is far better to use the whey as an animal feed. It has a good feeding value because of the presence of some of the whey proteins. It can be used for feeding pigs or young animals like calves or lambs. Even adult cows or fattening cows can be fed with whey.

It is important that the whey used for animal feed is acid (completely acidified) at the moment of feeding, otherwise the animals can get intestinal problems because of the lactose content of the whey.

7.6 Collection and preservation of the curd

The amount of whey (water) in the curd has a great influence on the cheese properties. Maturation time, flavour, consistency, keeping quality of cheese, etc., all depend on the water content.

Whey contains milk sugar or lactose. This sugar has to be converted into lactic acid by the lactic acid bacteria of the added starter.

If a great deal of the whey is removed from the curd, you get cheese with little moisture, therefore a dry and hard cheese, which has to mature a rather long time. If little whey is removed from the curd, you get cheese with a lot of moisture, therefore a soft cheese. This cheese has in most cases a sour taste. Since the curd treatment of fresh cheese and ripened cheese is quite different, they will be discussed separately.

It is important during this step of cheese making that the curd does not cool down and remains at about 30 – 36°C. The curd treatment can be started when the coagulated milk forms a firm mass. You can determine this by moving a small strip through the curd: if a smooth clear cut develops when the curd breaks it has coagulated sufficiently.

Curd treatment for fresh cheese

As a rule, to make fresh cheese little whey is removed. After curdling the milk, the curd/whey mass is hung in a cloth or placed in cheese moulds. After 24 hours, enough whey has leaked out and the curd is cooled down. The cheese is then ready for consumption. The separation of the whey can be stimulated by piling the cloths or cotton sacks on top of each other so that more whey is pressed out of the cheese.

Curd treatment for ripened cheese

After coagulation of the milk, the coagulated mass is cut with a sharp knife into square cubes of about 1.5 cm: see figure 24. It is important that the cubes are more or less of the same size and that the cutting is done very gently.

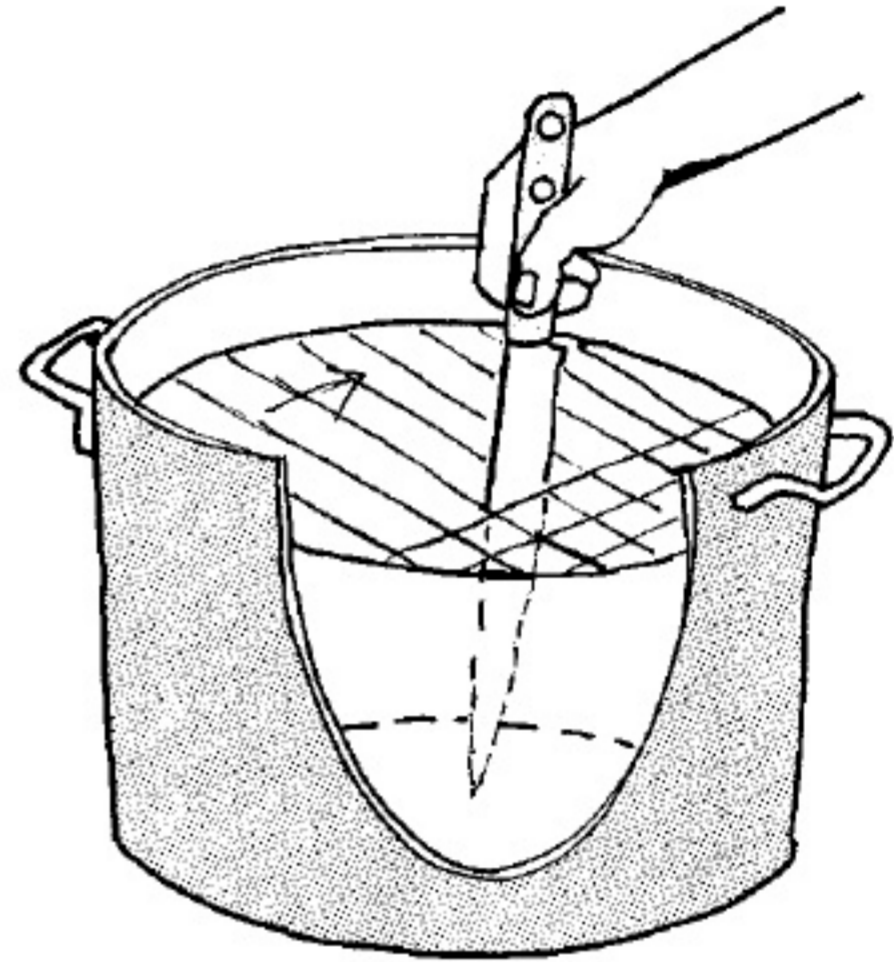

Figure 24: Cutting the curd

After cutting, the curd/whey mixture is briefly left to stand, for about 10 minutes, after which it is carefully stirred. After some time it can be stirred a little bit more vigorously. Most of the whey is removed from the cheese vat and the curd is placed in the cheese moulds. The curd is then pressed (0.1 kg/cm^2). After about one hour the pressure can be increased to 0.4 kg/cm^2 . Other ways of determining the pressure are respectively 2 times and then 5 times the curd's own weight.

After being pressed, the cheese is left for some time (4 - 20 hours) at $20 - 25^\circ\text{C}$. In the meantime the lactose present in the cheese is completely converted into lactic acid. Then the cheese can be salted.

Trying to produce cheese of a Gouda or Edam type in this way will be disappointing, because the cheese will become very firm, crumbly and acid. The reason for this is that the curd – after fermentation by the lactic acid bacteria - contains too much lactic acid. Therefore Gouda

cheese makers add 15 to 20% of hot water to the curd and whey after stirring for about 30 minutes. The temperature of the water is such that after addition of the water the temperature of the curd and whey is 35 – 36°C. (Water temperature is about 65 – 70°C. Before adding the hot water, part of the whey (30%) is drained off). After adding hot water the curd-and-whey mixture has to be stirred again for at least 20 minutes.

Salting the cheese

Salting can be done in several ways:

- 1 Stir the salt through the curd; add 30 grams of salt per kilogram of curd. This reduces the effect of the bacteria of the starter, but potentially damaging micro-organisms are also inhibited at an early stage.
- 2 After pressing the cheese, rub it in with salt. Rub both sides in and then turn the cheese. This must be done every day for 3 days; in total 20 grams of salt is needed per kilogram of cheese.
- 3 Place the cheese in brine of 200 grams of salt per litre of water at 12 - 16°C. During this pickling, the cheese absorbs salt and secretes lactic acid. The brine becomes more sour and improves in quality; it should therefore not be thrown away. Salt must be added regularly to the brine; 20 grams of salt is removed from the brine by each kilogram of cheese. For a small cheese, e.g. less than 1 kg, pickling time is about 12 hours. During pickling, the cheese must be turned once.

7.7 Maturation of the cheese

During the maturation of the cheese, protein and fat are partly broken down, causing a change in structure and flavour. The older the cheese, the more flavour it will have. Sometimes, after more than one year the structure becomes crumbly because of the protein breakdown. Maturation is caused primarily by the enzymes in the cheese. To mature cheese, it can be stored in a cool room. This is a good method but technically rather difficult in the tropics. After salting or pickling, cheese is ripened on a wooden shelf in a cool environment (12 - 20°C)

with a not too high relative humidity (about 80%). Cheese must be turned regularly: initially, i.e. during the first 2 to 3 weeks, daily and later once a week. If mould grows on the cheese, it can be removed with water or vinegar.

In addition to this method, the following treatments can be carried out on curd:

- Curd can be smoked over a fire (see figure 25).
- Curd can be boiled in brine.
- You can salt curd, make little balls of it and leave them to dry in the sun.

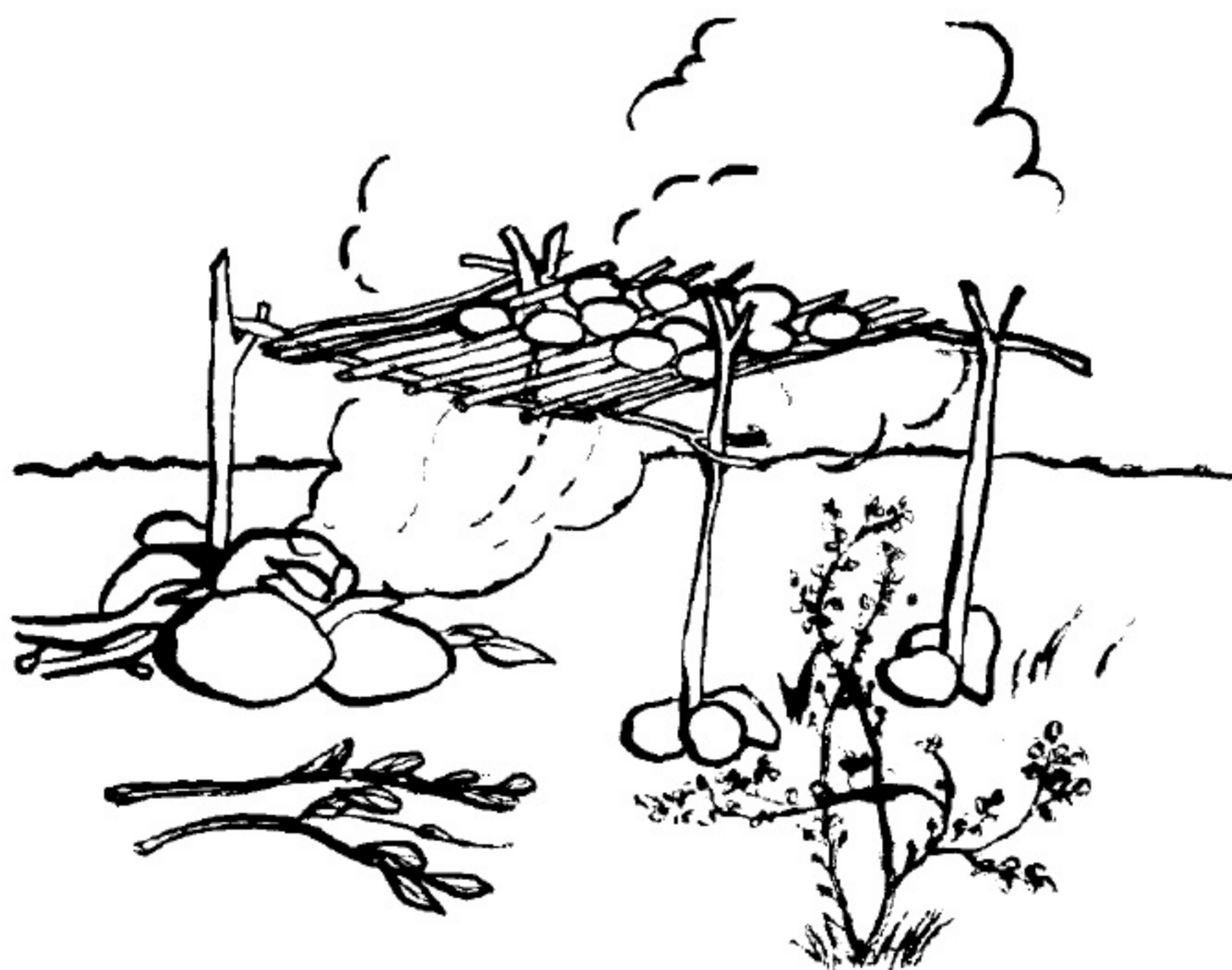

Figure 25: Smoking curd over a fire

The products which result are particularly suitable to be processed in other foods. After boiling, cheese will not ripen anymore because the enzymes inside the cheese are destroyed by heating.

7.8 Cheese recipes



There are many variations in cheese making. To make a good product, it may be necessary to adjust the recipe. Therefore you should have a good method of recording exactly how the cheese is made.

Your records can include the following aspects:

- date and surrounding temperature
- quality of the milk and pasteurisation temperature
- amount of milk
- ingredients, amount of starter culture, acid or rennet added
- temperature at which starter culture, acid or rennet was added
- coagulation time
- temperatures during the cheese making process
- temperature at the end of coagulation
- pressure applied, length of time applied, etc.
- salting time
- storage time and conditions during storage

The following recipes should be seen as guidelines for making cheese. Instead of cow milk, you can often use goat, sheep or buffalo milk. Start by making rather simple products like yoghurt, fresh cheese, etc.

Fresh cheese

Fresh or unripened cheese has a high moisture content of about 75%; it can be consumed directly after preparation. It is made by removing the whey from soured, skimmed milk. The milk is usually coagulated by souring. Sometimes a small amount of rennet is added; this is done to facilitate the draining of the whey. However, addition of rennet is not essential.

A well-known kind of fresh cheese is curd, known in various countries by the following names: *Frischkäse*, *fromage frais*, quarg, and baker's cheese. The differences between these cheeses are their fat levels.

You can make curd by souring fresh milk, cream or skimmed milk into sour milk, sour cream or sour skimmed milk and then draining the thick sour milk in a bag or cloth. Sometimes bags are placed on top of each other to increase the removal of whey. After draining, the curd has a crumbly structure. By stirring or using a blender you can make the product smooth again. There are various kinds of curd cheese in which moisture, fat and salt content and size of curd particles vary.

Fresh cheese has a fresh sour taste, especially when it is prepared from skimmed milk. By adding cream, the taste will become milder and richer.

Curd can be kept for only a short time and must be stored at cool temperatures. During storage, further whey separation can occur; this is the result of further souring of the product.

Curd from whole milk

Pasteurise the milk 30 minutes at 63°C and then cool it to 20°C. Add per 10 litres of milk $\frac{1}{4}$ - $\frac{1}{2}$ litre of starter culture or fresh sour milk or buttermilk; yoghurt can be added if desired. Add 2 drops of rennet - if available. It is advisable to dilute this small amount of rennet with several ml of water to improve its distribution through the milk.

After stirring well, leave the inoculated milk to stand for 24 hours at 18 – 20°C. During those 24 hours, souring and coagulation will take place; the milk becomes a rather firm mass. This thick mass is subsequently poured into a cotton or linen cloth or a bag so that the whey can drain through the cloth. The cloth is placed into a large colander or cheese mould beforehand so that the whey can thoroughly drain. After 24 hours, sufficient whey will have leaked out and the remaining curd can then be mixed, for example with a spoon or blender, until it becomes a homogenous mass. The curd can now be consumed. When kept in a refrigerator, curd can be stored for 1 - 2 weeks.

Bag cheese

You will need a sieve, small basket or cheese mould and a cheesecloth or tea towel.

Let 10 litres of buttermilk with low fat content drain through a cheesecloth until 1.5 litres of bag cheese, or curd, remain. Place a cheesecloth in a sieve, small basket or cheese mould and press the curd firmly into it. Let the curd drain for several hours, then turn it. About 1.5 kg of bag cheese has then been made, which contains no salt and hardly any fat. It can be kept for only a rather short time: 1 to 2 weeks. Keep it cool, preferably in a refrigerator.



Figure 26: Bag cheese

Krut

For making krut one needs buttermilk, cheesecloth and salt.

This is a way to make cheese from any leftover milk. Add some sour milk or buttermilk to the leftover milk and mix. Boil the mixture until the milk curdles. Separate the curd from the whey by pouring it through a cheesecloth. The curd is then kneaded with 2 - 4% salt and dried in the sun.

Rasagollas

You will need raw milk, a fire, pan, spoon, lemon juice or sour whey, cheesecloth, bowl, knife and concentrated sugar water.

Rasagollas is a sweet dairy product originally from India. Traditionally it was formed into sweet curd balls, but because of the way it is prepared here, the curd can only be cut into cubes and not formed into balls.

The milk is boiled with lemon juice (10 tablespoons or 150 ml per 10 litres of milk) or sour whey (1.5 litres per 10 litres of milk) while stirring continuously. Sour whey can be obtained from drained sour milk after the production of curd. The curd is separated from the whey by pouring the mixture into a cheesecloth, which has been placed over a bowl. The slightly elastic curd is cut into cubes with sides of about 2.5 cm. These are then boiled for about an hour in a sugar solution of 600 g per litre of water. 1 litre of sugar solution is needed for each kilogram of curd. The cubes can be stored quite some time and are very sweet.

Feta

You will need sheep, goat or cow milk, starter culture or fresh sour milk, rennet, cooking-salt, knife, cheese moulds, cheesecloths and cans or a plastic container to store the cheese.



Feta is a sharp, salty cheese originally from Greece that is made of sheep and goat milk. You can also use a mixture of sheep and cow milk, but then the cheese will not have its typical white colour. Feta is kept in a solution of whey and brine.

Heat 10 litres of pasteurised milk mixed with 200 ml of a starter culture, sour milk or buttermilk to 30°C. After 1 - 2 hours, rennet is added; use 2 ml of rennet per 10 litres of milk. After allowing it to coagulate for about one hour, the curd is cut into cubes of about 2.5 cm, after which it is carefully stirred for another 20 minutes.

The curd must then be carefully transferred to the tubs covered with cheesecloth. This can be done either by scooping the curd directly out of the whey into the moulds lined with cheesecloth, or by letting the curd settle, pouring off the whey and only then putting the curd in the cheese moulds.

After a few hours the cheese must be turned. The curd mass is carefully removed from the cheesecloth and replaced upside down.

After one day, the lumps of curd are cut into cubes of about 10 cm. Salting can be done by sprinkling the blocks several times with salt or by placing the blocks in brine for 24 hours.

If the cheese is kept for several days at about 18°C, it must be turned regularly and washed with cold water at the end of the storage period. The cheese can be kept for some time by piling blocks of cheese closely on top of each other and covering them with brine. The cheese should have a smooth and soft consistency.

Queso blanco

The so-called *queso blanco* is manufactured in many ways in Latin America. Typical for this cheese is that salt is added directly to the whey/curd mixture. This has the advantage that slightly soured milk can be used to make *queso blanco*.

A much-used method is the following:

Take raw (unheated) soured milk of 32°C, or take 10 litres of pasteurised milk and add 50 ml of sour milk, buttermilk or starter culture. Add 1.5 ml of rennet. After 45 minutes the curd is cut and stirred. Leave the whey/curd mixture to settle for another 30 minutes at 30 - 36°C. Pour off the whey and compress the curd to remove more whey. Mix 30 - 50 grams of salt through the curd. The salt can also be dissolved in water before being added. 100 grams of salt dissolved in 50 ml of water must then be added for each 10 litres of milk.

Transfer the salted curd into cheese moulds and press the cheese. During the first hours, turn the cheeses occasionally. Press them until the following day. To improve rind formation, pour whey heated at 50°C over the cheese while being pressed (after one hour). Cheese made with rennet can be kept for 2 months at 10 - 15°C.

As a variation to this method, you can add acid instead of a starter culture and use no rennet. Take raw milk, which may already be a little bit sour. Heat it to almost boiling. Acidify it with 300 ml vinegar per 10 litres of milk until a precipitate is formed. The acid can be

partly neutralised with the addition of some sodium bicarbonate (double soda). Pour off the whey. Proceed further preparation as above.

Fresh goat cheese (in oil)

You will need pasteurised goat milk, a heat source, a pan with lid, a thermometer, sour milk (or buttermilk or starter culture), rennet, a spoon, an insulated box or blanket or newspapers, cheesecloth, salt, cheese moulds, a cool storage place, greaseproof paper (if available), a large pot, herbs and olive oil.



Bring the pasteurised goat milk to a temperature of 20°C. Per 10 litres of milk, add 0.5 litre of fresh starter or sour milk or buttermilk. Take 20 drops of rennet per litre of milk, dilute this in a little water and stir this through the milk.

Place the pan in the insulated box or in the blanket or the newspapers to prevent it from cooling down. Check the next day to see if the milk has curdled sufficiently; a little whey on top is acceptable.

Cut the curd into cubes the size of a matchbox. After 2 hours transfer the mass into a cheesecloth and let it drain for 12 hours at room temperature. Mix the dry curd with some salt and put the cubes into cheese moulds. Press the curd into the moulds so that no air holes remain and place the moulds in a cool (15°C) place.

The next day remove the cheese carefully from the cheesecloth and replace it upside down in the cheesecloth and mould. Leave the cheese for a further 24 hours in a cool place. Remove the cheeses from cloth and mould and turn them daily. Should they become too dry, wrap them tightly, for example in greaseproof paper. If you wish to store the fresh goat cheese cubes for several weeks, place them in a large (glass) jar, which can be closed. Sprinkle a mixture of different herbs over them, such as rosemary, basil, thyme, bruised juniper berries, a finely chopped piece of garlic, several pepper kernels and a chopped

up hot pepper. Other herbs can also be used. Pour olive oil over the cheeses until they are just covered and add a few twigs of dill or rosemary to the oil. Close the jar and put it away in a cool and dark place. Before using the cheeses, let them drain well. Use the leftover oil for salad dressing.

Fresh goat cheese (salted)

You will need pasteurised goat milk, a heat source, pan with lid, thermometer, sour milk (or buttermilk or starter culture), acid, spoon, rennet, knife, colander or cheesecloth, cheese moulds, pressing equipment and salt.

Heat the pasteurised milk in a pan to 30°C, stirring continuously. For each 10 litres of milk, add 0.2 - 0.5 litres of sour milk or buttermilk or 0.2 litres of a starter culture and 30 drops of rennet (diluted in water). After 45 minutes, cut the coagulated curd with a knife; after another 10 minutes, the curd will be the size of a marble. The top layer of whey can be poured off after leaving the mixture to stand a bit.

Leave the curd in the carefully closed pan with the rest of the whey for a further 30 - 45 minutes. Then transfer the curd into cheese moulds in which cheesecloth has been placed. Press the curd; one hour is sufficient. The cheeses must then be pickled in brine. For a cheese of 500 grams, 10 hours of pickling is long enough.

Fresh sheep cheese

You will need pasteurised sheep milk, a heat source, a pan, a thermometer, a starter culture or fresh sour milk or buttermilk, rennet, a spoon, a knife, a cheesecloth, some salt (if desired) and cheese moulds.

Sheep milk contains more fat and protein than cow milk and therefore only 4 - 4.5 litres of sheep milk are needed to make 1 kg of cheese. Because of the higher content of dry matter in the milk, sheep milk coagulates firmer than cow milk.

Heat the pasteurised milk to about 30°C, stirring continuously. Add 300 ml of a starter culture and 40 drops of rennet to each 10 litres of milk. After 45 minutes the milk will have coagulated sufficiently to be cut. Cut the curdled, thick mass carefully; continue till the curd particles have the size of a pea. Bring the curd into a cheesecloth. If desired mix in some salt, and let the cloth hang until the cheese has the desired firmness. You can speed up the draining of the whey by opening the cheesecloth after several hours, scraping the thick part from the cloth, and mixing it in with the rest of the curd.

You may want to make a less sour sheep cheese, which is a little bit firmer and with some lower moisture content. For this, you must leave the curd for a longer time: about 15 - 30 minutes in the cheese vat where the curd treatment is done. After a short period of rest, pour off part of the whey, stir the curd carefully again and fill the cheese mould using a cheesecloth. Add some salt to the curd, if desired. Press the curd: about 4 hours of light pressing is sufficient. Store in a cool place. Sheep cheese can be kept for at least one week in the refrigerator.

Matured sheep cheese

You will need pasteurised sheep milk, a heat source, a pan, a thermometer, sour milk (buttermilk or starter culture), rennet, a spoon, a knife, colander, a cheesecloth, cheese moulds and pressing equipment, salt, a tightly sealed pickling tub, coarse cheesecloth and a cool storage place.

10 litres of sheep milk yields about 2 kg of ripened cheese. After adding 60 ml of starter culture or sour milk (or buttermilk), leave the milk to stand at 30°C for 30 - 45 minutes. Only then add 60 drops of rennet, diluted with a little water, per 10 litres of milk, and stir it thoroughly through the milk. After allowing it to curdle for 1 hour, cut the coagulated milk for about 15 minutes until it is divided into particles of about 1 - 2 cm. Then stir it for 10 minutes, pour half of the whey off and heat the curd to 35°C by adding hot water with a temperature of 80-100°C. Stir the mixture again for about 15 minutes, after which time the curd must be left to stand for 30 minutes in the pan. Keep the pan warm as well as possible but never place it on a

fire. Remove the whey that has separated, and pour the curd with the remaining whey into a colander. After the first draining, the curd must be transferred by hand into cheese moulds covered with cheesecloth. Press the cheese for 15 minutes with its own weight and turn the cheese. Spread the cloth in the mould again, press the cheese in place and fold the corners of the cloth over it again. Press the cheese for 2 to 3 hours, initially with a weight that is twice that of the cheese, later on with a weight 3 - 5 times as heavy. Subsequently pickle the cheese in brine (1 kg for a maximum of 24 hours). Then move it to a cool place where it must ripen for 5 to 8 weeks.



Further reading

Berg, J.C.T.van den. **Dairy technology in the tropics and subtropics.** Pudoc Publishers, Wageningen, 1988. ISBN 90-220-0927-0

Berg, J.C.T. van den. **Strategy for dairy development in the tropics and subtropics.** Pudoc Publishers, Wageningen, 1990. ISBN 90-220-1005-8

French, M.H. **Observations on the goat.** FAO Rome 1970 (FAO studies nr 80, FAO Animal production and health series no. 14) ISBN 92-5-100848-5

Kon, S.K. **Milk and milk products in human nutrition.** FAO Nutrition Studies no. 27. 1972, Rome.

Kosikowski, F.V. **Cheese and fermented milk foods.** 1977, Michigan, USA. ISBN 0-9602322-6-5

Walstra, P. and R. Jenness. **Dairy chemistry and Physics.** John Wiley & Sons, New York 1984. ISBN 0-471-09779-9

Walstra, P. J.T.M. Wouters and T. J. Geurts. **Dairy Science and Technology.** 2nd ed. CRC Press, Taylor & Francis Group, Boca Raton 2006. ISBN 0-8247-2763-0

Useful addresses



PTC+ is an international training institute that focuses on all the links in the production chain, plant and animal commodities, (agricultural) technology, (food) technology and natural areas.

Training programmes are practice-oriented and mix theory with practical classes. PTC+ offers open entry programmes, tailor-made programmes and consultancy. Programmes are offered in the Netherlands and/or on location.

It is the policy of PTC+ to search for partnerships and co-operation programmes with national and international institutions abroad.

PTC+ Head Office

PO Box 160

NL-6710 BD Ede

THE NETHERLANDS

T + 31 318 645700

F + 31 318 595869

W www.ptcplus.com

E info@ptcplus.com

Starter cultures, coagulants

Chr. Hansen

Chr. Hansen develops natural ingredient solutions for dairy industries, in close cooperation with customers and partners. Customers can profit from its specialist strategy by receiving quick access to high level specialist knowledge, support and customized solutions.

The firm has locations worldwide and its product catalogue is available in English, French and Spanish.

W www.chr-hansen.com

Protex International / BIOPROX

The following bio-products can be ordered from BIOPROX for the dairy industry (milk, cheese, butter, yoghurt): lactic culture (mesophilic and/or thermophilic), culture medium, growth factor, pH corrector, lactic culture activator, cleaning products.

BP 177

F- 92305

Levallois – Paris

FRANCE (also in Morocco, United Kingdom, Portugal and Spain)

T + 33 (0) 1 41 34 14 00

F + 33 (0) 1 41 34 14 16

E postmaster@protex-international.com

W www.protex-international.com/products/food-flavouring.html

Gebr. Rademaker

A supplier of cheese making equipment.

Oostzijde 30

1426 AE De Hoef

THE NETHERLANDS

T +31 297 593213

T +31 297 593261

Dairy processing equipment

C. van 't Riet Dairy Technology BV

Dorpsstraat 25

NL- 2445 AJ Aarlanderveen

THE NETHERLANDS

E: info@rietdairy.nl

W: www.rietdairy.nl

(Applied) research

Food and Agricultural Organization of the United Nations (FAO)

Viale delle Terme di Caracalla

00100 Rome

ITALY

E: FAO-HQ@fao.org

W: www.fao.org/ag/AGA/AGAP/LPS/dairy/intro.htm

International Livestock Research Institute (ILRI)

PO Box 30709

Nairobi

KENYA

E: ILRI-Kenya@cgiar.org

W: www.ilri.cgiar.org

ILRI's mission is to develop animal health and productivity in the poorest regions of the world through scientific research and multilateral cooperation.

Intermediate Technology Development Group (ITDG)

Bourton Hall, Bourton on Dunsmore

CV23 9QZ Rugby

Warwickshire, UNITED KINGDOM

W: www.itdg.org

E: infoserv@itdg.org.uk

Technical briefs on **Dairy processing** and **Yoghurt production**

E: infoserv@practicalaction.org.uk

Appendix 1: Measures

1 drop	=	0.05 ml
20 drops	=	1 ml
1 tablespoon	=	15 ml
1 cup	=	250 ml
1,000 ml	=	1 l