

*LIBRARY OF  
COAL MINING  
AND  
ENGINEERING*

California  
onal  
ity

**ANNEX**



THE LIBRARY  
OF  
THE UNIVERSITY  
OF CALIFORNIA  
LOS ANGELES

GIFT OF

Santa Monica  
Public Library

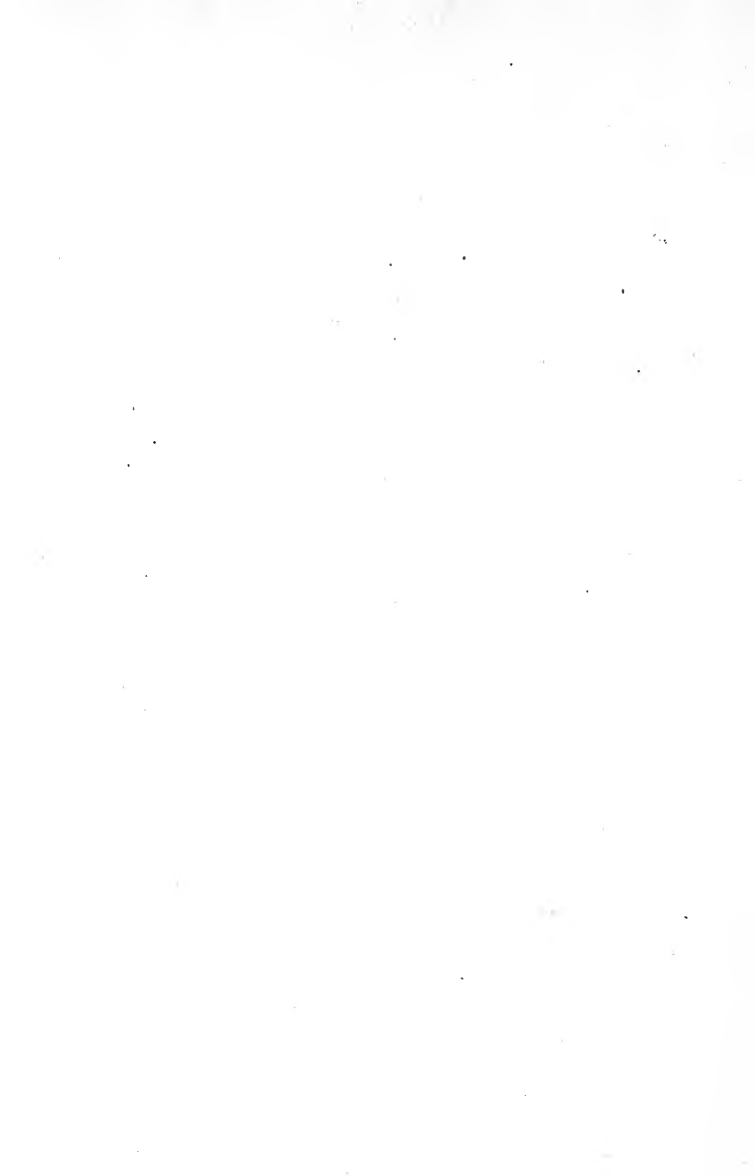



**LIBRARY**  
**OF**  
**COAL MINING AND ENGINEERING**

2-1

# McGraw-Hill Book Company

*Publishers of Books for*

Electrical World	The Engineering and Mining Journal
Engineering Record	Engineering News
Railway Age Gazette	American Machinist
Signal Engineer	American Engineer
Electric Railway Journal	Coal Age
Metallurgical and Chemical Engineering	Power

# COAL MINE SURVEYING

BY

A. T. SHURICK

ASSOCIATE EDITOR, COAL AGE

## MINING METHODS

SELECTED FROM

“MINING WITHOUT TIMBER”

BY

ROBERT BRUCE BRINSMADE, B. S., M. E.

## PRACTICAL SHAFT SINKING

BY

FRANCIS DONALDSON, M. E.

CHIEF ENGINEER, THE T. A. GILLESPIE COMPANY

McGRAW-HILL BOOK COMPANY, Inc.

239 WEST 39TH STREET, NEW YORK

6 BOUVERIE STREET, LONDON, E. C.





Engineering  
Library

TN  
275  
S56c

# COAL MINE SURVEYING

BY

A. T. SHURICK

ASSOCIATE EDITOR, COAL AGE

COPYRIGHT, 1914, BY  
A. T. SHURICK

## PREFACE

It has not been attempted to make this book a "treatise" in any sense of the word. With due respect to the numerous comprehensive works on this subject it has been the experience of the author that too little consideration is given to the problems arising in the commonplace routine of every-day work. In this respect it is believed the subject has been handled in a distinctive manner. Average practice has in every case been given preference to abnormal conditions involving problems in precise surveying. Space has been freely devoted to what may seem unimportant details, but which are none the less items that will do much to facilitate the work in the mines.

Particular emphasis has been placed on the proper care and adjustment of instruments regarding which there is a surprising lack of thorough knowledge among most engineers. While the modern instruments of reputable manufacturers seems to have attained the acme of perfection, the transit and level are still delicate mechanisms susceptible to many inaccuracies. Their relatively high cost, and more especially, the peculiarly hard usage to which they are subjected in underground work seems to justify considerable elaboration along this line. Believing that the best information of this kind is obtained at the point of manufacture, the instrument makers have been quoted exclusively in this portion of the work.

In reviewing the manuscript for this book as it is turned over to the printer, the author feels that he has little claim to authorship. Opinions and methods described in the various technical journals and other publications have been freely quoted except where of local interest only. But in all such cases a judicious selection of accepted authorities only have been used, and the author's prerogative of wielding the blue pencil has been freely exercised.

A. T. SHURICK.

NEW YORK, *March*, 1914.



# CONTENTS

	PAGE
PREFACE . . . . .	vii

## CHAPTER I

### PRINCIPLES OF SURVEYING

AZIMUTHS, BEARINGS AND COURSES. . . . .	1
Azimuths—Bearings and Courses.	
LATITUDES AND DEPARTURES. . . . .	2
LEVELING. . . . .	8
Vertical Angle Method—Direct Method by the Level.	

## CHAPTER II

### SURVEYING INSTRUMENTS AND ACCESSORIES

THE TRANSIT . . . . .	10
The Telescope—The Cross Wires—The Vernier Graduations on the Horizontal Circle.	
THE LEVEL . . . . .	18
The Telescope—Level Bar and Telescope Wye—The Tangent Clamp Screw—The Leveling Head.	
LEVEL ROD . . . . .	20
STEEL TAPES. . . . .	23
PLUMB BOBS. . . . .	24

## CHAPTER III

### CARE OF INSTRUMENTS

IN GENERAL. . . . .	26
CARE OF CENTERS AND GRADUATIONS. . . . .	29
TELESCOPE LENS. . . . .	30
LUBRICATING. . . . .	31
LEVEL BUBBLES. . . . .	33
Mounting Spirit Levels.	
REPLACING CROSS WIRES . . . . .	35
ACCIDENTS AND PRECAUTIONS IN THE USE OF INSTRUMENTS. . . . .	36
TRANSPORTATION OF INSTRUMENTS. . . . .	39

## CHAPTER IV

## ADJUSTMENT OF INSTRUMENTS

	PAGE
THE TRANSIT . . . . .	42
The Bubbles—To Make the Adjustment for Parallax—To Make the Vertical Cross Wire Perpendicular to the Plane of the Horizontal Axis—To Adjust the Vertical Wire—To Determine Whether the Standards are the Same Height—To Adjust the Level to the Line of Collimation of the Horizontal Wire.	
THE LEVEL . . . . .	45
To Make the Adjustment of the Horizontal Wire—To Center the Eyepiece—To Adjust the Spirit Level to the Telescope—To Make the Lateral Adjustment of the Spirit Level—To Make the Adjustment of the Level Bar—To Adjust the Horizontal Wire so that the Line of Sight will be Parallel to the Spirit Level.	

## CHAPTER V

## ORGANIZING AND EQUIPPING THE FIELD PARTY

The Chief of the Party—The Transitman—Chainman and Backsight.	48
---------------------------------------------------------------	----

## CHAPTER VI

## ENTRY SURVEYING

Picking up the Starting Stations—Setting Up the Transit—Turning Angles—Straight Line Work—Chaining—Taking Side Notes—Making Checks—Kinds of Stations—Painting Stations—Numbering Stations.	52
--------------------------------------------------------------------------------------------------------------------------------------------------------------------------------------------	----

## CHAPTER VII

## KEEPING SURVEY NOTES

TRANSIT NOTES . . . . .	65
LEVEL NOTES . . . . .	72

## CHAPTER VIII

## SOME PROBLEMS IN SURVEYING

Selected Problems Commonly Met in Coal Mine Surveying . . . .	76
---------------------------------------------------------------	----

# COAL MINE SURVEYING

## CHAPTER I

### PRINCIPLES OF SURVEYING

The art of surveying consists essentially in the relative location of different points with respect to each other. The average mining man is too prone to look upon the work of the engineer (or surveyor as he is perhaps more commonly termed in the mining regions) as something uncanny and bordering on the supernatural. He is usually regarded as an expensive luxury, or a necessary evil. No tangible evidence of his labors is notable on the tonnage sheets of the mine he is working in—in fact, it is more often the case that he leaves a trail of profane “skinners” who have been delayed, in his wake. Nevertheless he has come to stay and each year finds him occupying a stronger foothold, until now one of the best criterions of an efficient management is shown in the excellence of its engineering practice.

#### AZIMUTHS, BEARINGS AND COURSES

To determine the location of a point it is obvious that two things are required, the direction and distance from an already known point. Directions are designated as azimuths, bearings and courses. For convenience and in order to have a worldwide standard, so that all surveys of whatever character may be readily adjusted to each other, the true north and south meridian has been adopted as the basis from which all computations referring to direction are made.

**Azimuths.**—In Fig. 1, it will be noted that azimuths cover the entire range of the circle from  $0^{\circ}$  to  $360^{\circ}$ . It is the angle which the line makes with the true meridian, measured to the right in the same direction as the hands of a watch. Thus as will be noted in the figure, line *C* lies  $98^{\circ} 18'$  to the right of the meridian; line *B*,  $205^{\circ} 30'$  and line *A*  $338^{\circ} 21'$ . It is important that the student thoroughly master the principle of azimuths for the reason that they greatly simplify certain processes in surveying which are to be described later.

**Bearings and Courses.**—These are terms that are used indis-

criminally to designate the direction of a line in one of the four quadrants of the circle, as, northeast, northwest, southeast, and southwest. Sometimes the expression also implies distance as well as direction, as for instance the bearing 276 ft. N.  $46^{\circ} 18' E$ . Bearings differ from azimuths in that they are measured both to the east and west of the north and south meridian and that they never exceed  $90^{\circ}$  in value. Thus in Fig. 1 the bearing of  $C$  equals the angle  $SOC$ , or the difference between the azimuth of  $SO$  ( $180^{\circ}$ ) and  $OC$  ( $98^{\circ} 18'$ ) which equals  $81^{\circ} 42'$ ; and since the line lies between

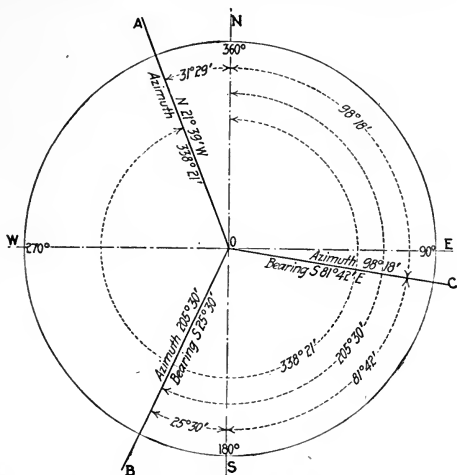

FIG. 1. SKETCH SHOWING VARIOUS AZIMUTHS AND BEARINGS.

the due east and due south meridians the bearing is obviously S.  $81^{\circ} 42' E$ . The bearings of the other lines in the figure are arrived at by the same process.

### LATITUDES AND DEPARTURES

When the survey of a mine has been completed the problem then arises of making an exact and accurate reproduction of the mine workings on a small scale. In other words, building the map. There are two general methods of accomplishing this. By plotting with a protractor and by computing the latitudes and departures and plotting the survey from them.



Plotting by means of a protractor was at one time a popular method of working but it is now obsolete and has been practically abandoned. The possibility for error is too great by this method unless great care is exercised and even then it is not to be relied upon for any very extended work. The method is still used in laying out short or approximate surveys but it is rather dangerous for the reason that any mistakes in plotting one chord are carried through the balance of the work, and are accumulative.

In latitudes and departures the northing or southing and the easting or westing of each bearing is computed by means of sines and cosines; that is the distance due north or south and due east or west (depending upon which direction the bearing is in). The algebraic sums of all the bearings in the survey are then obtained and each station plotted according to its distance due north or south and due east or west of an assumed zero point, termed the zero of coordinates. The method is probably best described by means of an example.

Referring to the accompanying Table I it will be assumed that the field notes for a survey as given in the columns under "Sta.," "Azimuth" and "Distance" have been turned into the office and it is desired to traverse them and find the latitude and departure of each station. It is first necessary to reduce the azimuths to bearings, this having been already explained.

The latitude and departure of each course is then found by multiplying the length of the course by the cosine and sine, respectively. Thus, the latitude of the first course being a northing ( $N$ ) and the departure an easting ( $E$ ), they are found as follows:

$$N = 145 \cos 43^{\circ} 18' = 145 \times 0.72777 = 105.53 \text{ ft.}$$

$$E = 145 \sin 43^{\circ} 18' = 145 \times 0.68582 = 99.44 \text{ ft.}$$

In this manner, the northing or southing and the easting or westing of each course is calculated and written in the proper column under "Singles" as shown in the table.

Having found all the single latitudes and departures for all the bearings we next proceed to obtain the "Doubles." The single latitudes and departures are the distances which that particular course goes north or south and east or west, while the doubles are the total distances north or south and east or west of each point from the zero of coordinates. The doubles are obtained by simply adding or subtracting the singles, as the case may be.

Referring to Fig. 2 which is a plot of the survey under consideration, the lines  $NS$  and  $WE$  are due north and south, and east and west,



respectively. Their intersection is the assumed zero of coordinates and is therefore the point that has neither a northing, southing, easting or westing. Sta. 0, which is the starting point of the survey, is known from a previous survey to have a northing of 108.00 ft. and a westing of 138.00 ft. as will be observed by reference to the map. Accordingly we set down 108.00 in the northing column under the doubles and 138.00 in the westing column.

From Sta. 0 to 1, according to the single latitude and departure for this course, we go 105.53 ft. north and since the double latitude is

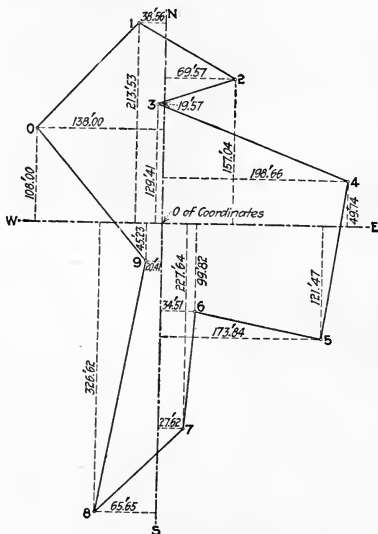

FIG. 2. SKETCH OF A SURVEY PLOTTED BY LATITUDES AND DEPARTURES.

already north this is added to it, giving a latitude of 213.53 ft. as will be noted on both the table and map. Similarly, the course 0 to 1 takes us 99.44 ft. east. In this case, however, our double is a westing so that we subtract instead of adding as in the previous instance. Thus we have the rule: When the single latitude or departure is in the same direction as the double it is always added and when different it is always subtracted.

On the plot, Fig. 2, all of the latitudes and departures of the

different points have been noted. Beginning at Sta. 1 and following around to Sta. 4 it will be noted that the stations lie to the north of the east and west line and hence are northings as will be observed by reference to the double latitude and departures. Between Stas. 4 and 5 the traverse crosses to the south and continues there up to Sta. 9 as will be seen by reference to both the map and the table. Following the departures around in a similar manner we find that the survey crosses from a westing to an easting between Stas. 1 and 2, shows another small westing at Sta. 3 and then continues an easting up to Sta. 7; between Stas. 7 and 8 it changes to a westing and remains so the remainder of the survey. It will also be noted that this is a tie survey; that is it completes a circuit and ends at the point of beginning and therefore must balance. Referring to the double latitudes and departures we find that the final coordinates for the Sta. 0 correspond exactly with those at the beginning, and therefore a perfect check has been obtained. It might be well to add that a survey in practice which checked perfectly would be open to suspicion as such a tie is seldom or never obtained.

The following is a description of the Consolidation Coal Co's. methods of computing latitudes and departures:

The first step in the office work is to reduce all slope measurements to horizontals. These calculations are performed in duplicate, one set by a table of Gurden and Naturals and the other by logarithms and the results check one against the other. The transitman in the meantime transfers his data as far as possible to traverse sheets, copy of which is shown herewith. Usually each mine entry has an individual traverse sheet for the stations it contains. After the horizontals are copied into the notebook and checked, the courses and corresponding distances are then copied into a separate set of calculation books and the latitude and departure differences worked out by the same method employed for horizontals, and also checked. The results are copied on the traverse sheets and the total latitude and departures worked out and checked before plotting.

No survey is permitted to stand until approved by the division engineer in charge. His approval is shown on the space provided for his signature at the bottom of the traverse sheet. All sheets are carefully referenced from one to another when the surveys have any connections whatever. A separate folio or binder is used to hold the sheets for each mine and they are numbered consecutively from "one up"; the sheets are of course all indexed.

Form 182 500 P 24805  
 THE CONSOLIDATION COAL COMPANY. ENGINEERING DEPARTMENT—TRAVERSE SHEET No. . . . . FOR. . . . . MINE.

Vol.	Station	Hor. angle		Slope dis- tance	Meas. angle.	Hor. dis- tance	Vert. angle	Cor. rod	True vert. dist.		Eleva- tion	Lat. dif- ference		Dep. dif- ference	Total lati- tude	Total dep.	Station	Remarks		
		Azi- muth	Quadrant						Plus	Minus		N	S						E	W
420	36	327	102°30	171.32	0°30'	171.31	North	No. 3	6	Butt		North	West	See Sheet No. 5						
	613	12°45	25.01	25.01	.....	25.01	These spaces used for working up elevations on outside surveys from vertical angles				24.39	37.07	167.23	1964.26	E 117.13	613				
	614	282°31	182.22	182.22	0°50'	182.22					39.49	5.52	177.89	2028.14	W 55.24	614	See Sheet No. 5.			
											2028.06	55.18*	2028.06	55.18*						
													Tie =	+ 0.08	+ 0.06				* Worked up values from other stations. Division Engineer.	
	Calculations	by.....	and.....	.....	.....	.....	.....	.....	Copied by.....	.....	.....	.....	.....	.....	.....	.....	.....	.....	.....	.....

FIG. 3. STANDARD TRAVERSE SHEET OF THE CONSOLIDATION COAL CO.

## LEVELING

In addition to the location of points in a horizontal plane there is also the necessity of determining the relative elevation of different portions of the mine workings. This branch of surveying has not received so much attention as the other and in fact is often entirely neglected unless some special occasion arises where it is required. It is none the less important however and will no doubt find a more general application in time.

There are two distinct methods of leveling—indirectly by vertical angles and directly by the level, an instrument designed especially for this work. The vertical angle method is not in much favor on outside work and except in special cases it is seldom or never used. But in the narrow confines of a heavily pitching seam of coal the adoption of this system becomes imperative so that the coal engineer must be prepared to handle it.

**Vertical Angle Method.**—In this system the difference in elevation between any two points is arrived at by measuring the vertical angle between them by means of an ordinary transit, and the slope distance. We then have the hypotenuse of a right angled triangle and one angle given so that the vertical distance is easily computed by multiplying the sine of the angle by the distance. It should be remembered in this connection that the average transit is not usually equipped with a sufficiently accurate vertical arc to insure absolute correct results on work of this kind. In fact the arc should be as large and rigid as in the case of the horizontal plates where equally accurate results are desired. In ordering an instrument it is well to consider the geological features of the district carefully and where the measures are steeply inclined a special vertical arc should be specified.

**Direct Method by the Level.**—As already noted this is the system in most general use and the one to be given the preference where accuracy is desired and the inclinations not too abrupt. It consists essentially in carrying forward a series of horizontal planes, either up or down as the case may be, as shown in Fig. 4.

When properly adjusted the level is an instrument that may be turned in any direction in a horizontal plane and will always show identically the same elevation. Thus in Fig. 4 let it be assumed that it is desired to ascertain the difference in elevation between the points *A* and *E* on a hillside. The instrument is set up at any point *B* not too high so that the rod will not be seen, and a reading on the latter taken at *A*. Say this reading shows 11.58 ft.;

it is clear then that the instrument is this distance above the point.

The rod is then moved ahead to another point at about the same elevation as the instrument and another reading taken. Assuming the reading at this point to be 0.42 ft. this indicates that the new point *C* is this distance below the instrument and the difference between 11.58 ft. and 0.42 ft. or 11.16 ft. above the starting point *A*. Moving the instrument up to *D* this time, the operation is repeated

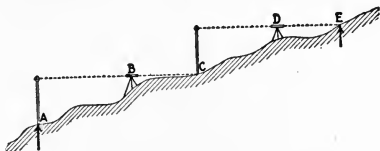

FIG. 4. SKETCH SHOWING LEVELING PROCESS.

as follows: Assuming the rod reading on *C* from the new set-up at *D* shows 10.50 the height of the instrument above the initial point is then 11.16 plus 10.50 or 21.66 ft. Finally placing the rod on the desired point *E* we find this to be say 0.12 ft. below the instrument so that the difference in elevation between *A* and *E* is 21.66 minus 0.12 or 21.54 ft. And so the operation may be extended indefinitely.

## CHAPTER II

### SURVEYING INSTRUMENTS AND ACCESSORIES

In the ordinary surveying, as practised in the coal mines of this country, comparatively simple equipment suffices; in fact it might be said the simpler, the better. The principal instruments used are the transit and level, together with such accessories as leveling rods, sight rods, plumb bobs, steel tapes, etc.

The average layman invariably has the compass also associated with anything in connection with surveying. As a matter of fact, the compass has been practically abandoned altogether for use in this connection, and could be dispensed with entirely with little inconvenience. However, it is of some use as an approximate check on the work with the vernier, and is still a part of nearly all transits probably more because it has become a custom and also because the space so utilized could not be applied to an advantage in any other way.

#### THE TRANSIT

The most important, and at the same time most complicated and expensive instrument used on the mine survey is the transit. Illustrations of two popular makes of transits are shown herewith. The first, Fig. 5, is a halftone of the Kueffel & Esser instrument, while the second, Fig. 6, is a cross section through the center of a C. L. Berger transit. In both illustrations all the parts of the two instruments are numbered, and the names of these will be found in accompanying tables.

The transit is an instrument designed for measuring angles in both horizontal and vertical planes, although its use is more commonly confined entirely to the former. To adequately fulfil its purpose, the instrument must be rigidly constructed, with all parts in absolute adjustment. Rapid advances in the method of manufacturing instruments have been made in the past decade, with the result that the modern transit is a model of accuracy and convenience and will successfully withstand as much ill usage as may reasonably be expected from so delicate a machine.

Beginning at the bottom and working up, it will be noted on refer-



ring to the drawing, Fig. 6, that the tripod head is shown at 1 with various parts of the tripod at 2, 3, 4 and 5. The tripod is entirely distinct from the instrument, but the head, 1, is equipped with screw threads, as shown in the drawing, on to which the instrument foot plate screws. The foot plate, or tripod plate, is shown at 6 in Fig. 6, and 13 in Fig. 5.

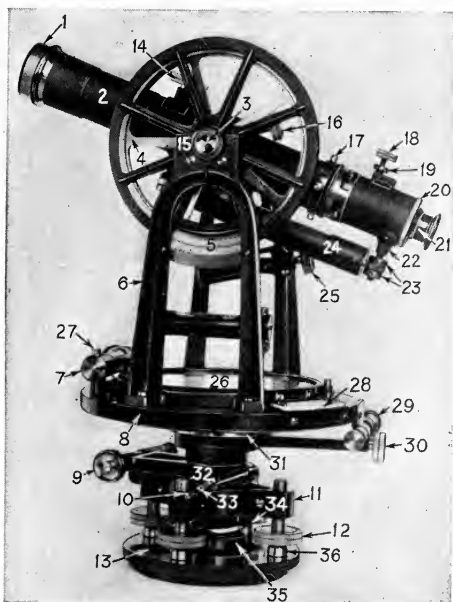

1. Objective head
2. Telescope
3. Telescope axis end cap
4. Vertical circle
5. Vertical circle vernier
6. Standard
7. Plate level
8. Horizontal limb
9. Lower clamp tangent screw
10. Lower clamp
11. Leveling head
12. Leveling screws
13. Tripod plate
14. Pinion head (object focusing screw)
15. Standard cap
16. Telescope clamp
17. Reticule adjusting screw
18. Eyepiece focusing screw
19. Eyepiece focusing lock nut
20. Eye end ring
21. Eyepiece cap
22. Telescope level support
23. Telescope level adjusting screw
24. Telescope level
25. Telescope clamp tangent screw
26. Compass cover glass
27. Capston head pinion
28. Vernier cover glass
29. Upper clamp tangent screw
30. Upper clamp
31. Upper clamp collar
32. Clamp collar
33. Lower clamp screw
34. Half ball joint
35. Shifting plate
36. Leveling screw shoe

FIG. 5. TYPICAL TRANSIT.

The shifting plate of the instrument in Fig. 6 is shown at 11. The purpose of this is to permit of the final movement necessary to get the instrument precisely over or under the point, this being accomplished by loosening the level screws 9, so that the plate hangs relatively loose. To avoid indentations in the foot plate, by the leveling screws turning directly upon the plate, leveling screw

cups are provided, as shown at 10. Turning to Fig. 5, the leveling screw, and cups are shown at 12 and 36, respectively.

The plumb bob suspending cup with the accompanying chain and hook are shown at 12 and 13, respectively, in Fig. 6; these are arranged so that a bob hung in the hook 13 will hang precisely under

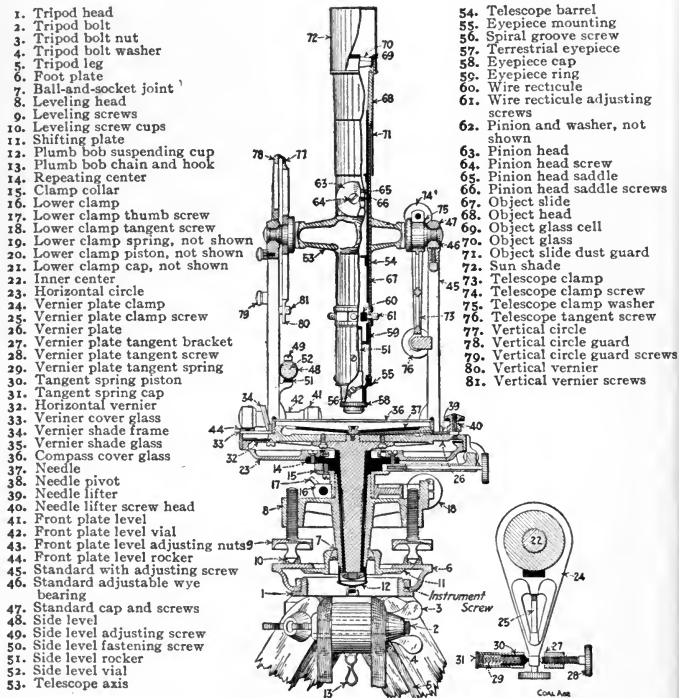

FIG. 6. CROSS SECTION OF A TRANSIT.

the theoretical center line of the instrument. The ball-and-socket joint, which is something on the order of a flexible coupling, is shown at 7 in Fig. 6, and 34 in Fig. 5. This allows the upper part of the instrument to assume any necessary angle of inclination to the tripod plates, so that it will be absolutely level.

The leveling head, through which the leveling screws work, is

shown at 11 in Fig. 5, and 8 in Fig. 6. In Fig. 5 the lower clamp for clamping the horizontal plate is shown at 33, and the tangent screw at 9, these same devices being shown at 17 and 18, respectively in Fig. 6. The upper or vernier plate clamp is shown at 30, with the tangent screw at 29, in Fig. 5, the same thing being shown at 25 and 28 in the separate detail in Fig. 6.

This latter detail also shows the principle upon which the slow motion screws work. It will be noticed that this is essentially a small cylinder containing a spring 29, held in place at one end by the milled head cap 31, and at the other by the tangent spring piston 30. The tendency is naturally to push the piston out so that the latter is constantly bearing against the clamp upon which it acts. Thus by turning the tangent screw 28, the cylinder is either forced in or out as the case may be. By this means, an infinitesimal movement of the vernier plate can be obtained so small that it cannot be detected by the naked eye.

At 23 in Fig. 6 is shown the horizontal plate or limb which is also shown in Fig. 5 at 8. The vernier plate is shown at 26 in Fig. 6, with the vernier at 32, and the vernier glass at 33, this latter being shown in Fig. 5 at 28. The vernier shade is shown at 34 in Fig. 6, this being removed on Fig. 5.

**The compass needle** is shown in Fig. 6 at 37, and the lifter, which brings the needle tight against the compass glass when not in use, so as to save it from unnecessary wear, is shown at 39, the screw head by which this is accomplished being shown at 40, and the glass at 36, this latter also being shown in Fig. 5 at 26.

All transits are equipped with two level bubbles, placed at right angles to each other so that the instrument can be leveled in both directions. In Fig. 6, these levels are shown at 41 and 48, and their relative positions may be more adequately noted in Fig. 5, one being shown at 7, and the other about halfway up the standard 6. The standard in Fig. 6 is shown at 45, and the adjustable wye bearings for correcting the bearing adjustment are shown at 46, with the cap at 47; this latter is also shown in Fig. 5 at 15.

In Fig. 5 the vertical circle for measuring vertical angles is shown at 4, with the vernier at 5; this is also shown in section in Fig. 6, the vertical circle itself at 77, the surrounding guard for protecting the circle, which will also be observed in Fig. 5, at 78, and the vernier with its adjusting screws at 80 and 81, respectively. The vertical circle guard is held in place by milled head screws, one of which is shown at 79.

The **telescope clamp** for clamping the telescope in any vertical position desired is shown at 16 in Fig. 5, and the tangent or slow motion screw for setting same accurately in place at 25. This arrangement is also shown in Fig. 6, the clamp at 73, with the clamp screw at 74, and the tangent screw at 76.

The **telescope** is shown at 2 in Fig. 5, the objective head at 1, and the eyepiece cap at 21. The eyepiece focusing screw is shown at 18, the lock nut for same at 19, and the eye end ring at 20. The reticule screws for adjusting the cross wires are shown at 17. Underneath the telescope and attached to it is the telescope level 24 which must always be leveled up with the other bubbles when setting the instrument up under a station. The telescope level support and adjusting screws are shown at 22 and 23, respectively.

The telescope as shown in Fig. 6 gives greater details. The eyepiece cap is shown at 58, the mounting for the eyepiece at 55, and the spiral, groove screw at 56. The reticule for carrying the cross

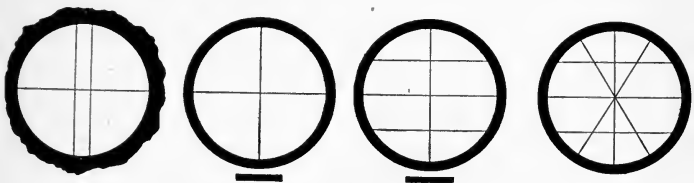

FIG. 7. TYPES OF CROSS WIRES USED IN LEVELS AND TRANSITS.

wires is shown at 60, and the screws for adjusting these to their proper position at 61. The barrel of the telescope is shown at 54, with the object slide just inside of it at 67. The pinion head for adjusting the telescope for any length of sight is shown at 63, with the pinion saddle at 65. The slide dust guard for preventing foreign matter from getting inside the telescope is shown at 71, and the object head at 68, with the object glass at 70, and the barrel for holding same at 69. The sun shade for preventing the sun from shining directly on the object glass when taking a sight is shown at 72.

**Cross Wires.**—Some of the different styles of cross wires used in the present-day instruments are shown in the accompanying illustration, Fig. 7. The first style on the left is an unusual type of cross hair used in wye levels, the idea of the two vertical wires being to check up the rodman in holding his rod plumb. The second illus-

tration from the left represents the simplest form of cross wire used, and one that is also quite popular; it consists of only a single vertical and horizontal wire. Next to this is the stadia wire, which is identical with the one just described, except that two additional hori-

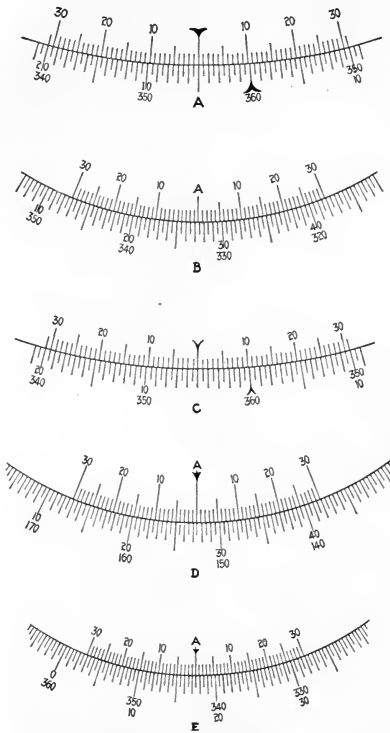

FIG. 8. TYPES OF VERNIERS.

zonal wires have been added for making stadia measurements. The last figure on the right shows the stadia wires as just described with diagonal wires added, the idea of the latter being to help locate either the vertical or horizontal wire when working in the mine. This is a valuable addition in this respect, and one that might be used to advantage on all mine transits.

**The Vernier.**—The vernier is a device for accurately measuring fractions of subdivisions on any kind of a scale. Verniers on transits designed for reading to 1' are shown in the accompanying illustration, Fig. 8. This is the typical style used on ordinary mine surveys; in fact, it might be said that it is used almost to the exclusion of any other graduation.

These verniers depend upon the principle that if 29 subdivisions on the outer circle equal 30 subdivisions on the inner circle, the difference in length between a subdivision on each scale is equal to  $\frac{1}{30}$  of the outer subdivision; since the outer subdivisions in this case are equal to  $\frac{1}{2}^\circ$  or 30' this value is therefore 1'.

With this principle once clear in the mind, reading the vernier becomes a comparatively simple problem. Thus referring to the vernier *B* in Fig. 8, and assuming that it is desired to know the reading on the outer circle of figures we first select the closest even degree, which in this case is obviously  $332^\circ$ , the smallest divisions on the outer circle being  $\frac{1}{2}^\circ$  and the next larger full degrees. It is also clear that the zero on the vernier (which is the inside scale) is something more than a  $\frac{1}{2}^\circ$  or 30' greater than  $332^\circ$ , so that we have this additional quantity and all that remains to be obtained is the odd minutes. To obtain these, we look along the graduations on the vernier itself, in the same direction in which the reading is being made, that is, to the left in this case, until we find a line that exactly coincides with a line on the outer circle, which in this case is the fourth subdivision. This indicates that the zero on the vernier is  $\frac{4}{30}$  of the distance between the two subdivisions on the outer circle, which as was already explained equals 4'.

Referring to vernier *A*, we find that this reads to even degrees, the zero on the outer circle exactly corresponding with the zero on the vernier. Vernier *C* is the same, except that this reads exactly  $5^\circ$ . In vernier *D*, however, we again find a reading to odd minutes. Assuming that it is again desired to read the outer circle of figures it is readily noted that the reading is somewhat greater than  $152\frac{1}{2}^\circ$  or  $152^\circ 30'$ . Glancing along the inner circle from the zero to the left we find the first line to correspond at 5, which is of course, as already explained, equal to 5', and the reading is therefore  $152^\circ 35'$ . In the same way, we find the reading of vernier *E* to be  $342^\circ 35'$ . The verniers here given are typical of those used on the average instruments.

**Graduations on the Horizontal Circle.**—The accompanying illustration, Fig. 9, shows two types of graduation commonly used on the

mine transits. The outer one is graduated from  $0^{\circ}$  to  $360^{\circ}$  in both directions, that is, both to the left and right. The inner graduation is the one necessary for running continuous vernier, as will be described later, and should be on all mining transits. The graduation on the outer circle is of no particular value unless it should some time prove desirable to work with the telescope reversed.

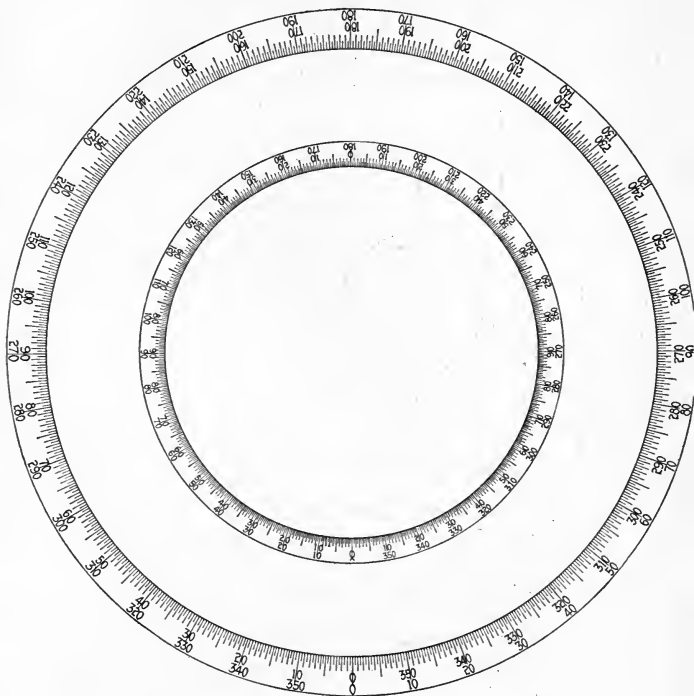

FIG. 9. METHODS OF GRADUATING HORIZONTAL CIRCLES.

The smaller or inner circle of graduations is perhaps the most useful for general mining practice there is. As will be noticed the outer circle of figures is graduated for the continuous vernier as already mentioned, while the inner one is graduated for reading courses direct, that is the graduations run both ways from 0 at

both the north and south ends terminating at 90 on both the east and west. Where it is the practice (as for instance in the engineering department of the Consolidation Coal Co.) for the instrument-man to read both the azimuth and bearing of all sights, this style of graduation is essential. It is also more convenient when turning rights and lefts as is practised in railroad surveys, and is useful as well in laying out right-angle work in the mine.

By referring to the accompanying illustration, Fig. 10, which represents the method of lettering a compass it will be observed that the east and west marks are the reverse of what they actually are. Thus

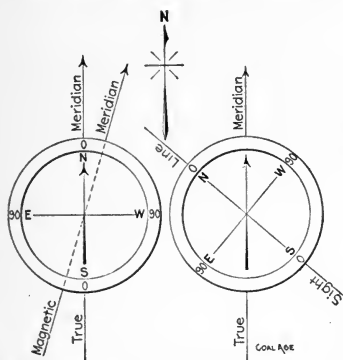

FIG. 10. METHOD OF LETTERING THE COMPASS.

when the needle is pointing to the north, as shown in the left-hand illustration, east would be to the right where the *W* is and west to the left where the *E* is. This is done as a matter of convenience and to avoid the possibility of error in reading. Referring to the right-hand illustration in Fig. 10, let it be assumed that the line of sight being taken is in the direction indicated, the needle pointing to the true north, as is also shown. It is clear that the line of sight is to the left or northwest, which is also the reading shown, that is, the needle falls between the *N* and the *W* indicating a northwest reading; were the lettering placed in the reverse order as is the case on most small pocket compasses, the reading would have been northeast, which would of course have been wrong. This same condition applies to vernier readings taken on the horizontal circle of a transit and explains why the graduations are arranged as they are.

### THE LEVEL

As has already been mentioned, the level is an instrument for determining relative elevations. When properly adjusted, it turns in a horizontal plane showing exactly the same elevation in whatever direction the telescope may be pointed.



The accompanying illustration, Fig. 11, shows a typical Keuffel & Esser level, one of the popular makes in the market to-day. As will be observed, the different parts are numbered, the subjoined table giving the technical name for each. It will also be noted that many of the names for the different parts correspond to those already given in the description of the transit. Most of the concealed parts, as, for instance, the interior of the telescope, and the half-ball socket joint are the same as in the transit, and reference to the line drawing, Fig. 6, may be made for determining these.

**The Telescope.**—At 1, in Fig. 11, is the objective of the telescope and 7 the eyepiece tube, with the micrometer focusing screw and adjusting nut at 20 and 19 respectively. The adjusting screws for correcting any error in the cross wires are shown at 6. One of the wye yokes is shown at 2, 3 and 4, the spring lock being at 2, the spring contact at 3, and the yoke catch at 4. These yokes may be thrown back, and the telescope lifted out, as is necessary when making adjustments. At 5 is shown the rack and pinion thumb-screw for focusing the telescope.

**The level bubble tube** by which the instrument is leveled up is shown at 12. It is first set across one opposite pair of leveling screws and leveled, and then swung across the other two, and the operation repeated until the bubble is exactly level in whatever position the telescope may be turned. The bubble is always adjusted with regard to the line of sight through the instrument, such adjustment being effected by means of three screws, one on the left at 11 and two on the right at 24 and 25.

**Level Bar and Telescope Wye.**—The level bar is shown at 13, at each end of which are the two wyes for supporting the telescope. At 9 and 10, and 22 and 23 are shown the two sets of adjusting nuts for making corrections in the elevation of the wyes. At 21 is the stop lever to prevent the telescope from revolving around in the wyes.

**The tangent clamp screw** is shown at 26, and the collar at 14. This is useful occasionally when it is necessary to take a series of sights on a rod at some particular point, or in some certain direction. The tangent screw for slowly shifting the range of the telescope is shown at 27.

**The leveling head** of the instrument is shown at 15, with one of the leveling screws at 16, and a leveling screw shoe at 17. This part of the instrument corresponds almost identically with that already described for the transit. At 28 is the half ball socket joint

which allows the horizontal line of the instrument to be at any angle with the tripod head, shown at 18. The top of the tripod is seen below.

### LEVEL ROD

In the illustration, Fig. 12, is shown one of the modern mine level rods, a product of the Keuffel & Esser Co. This rod is a trifle

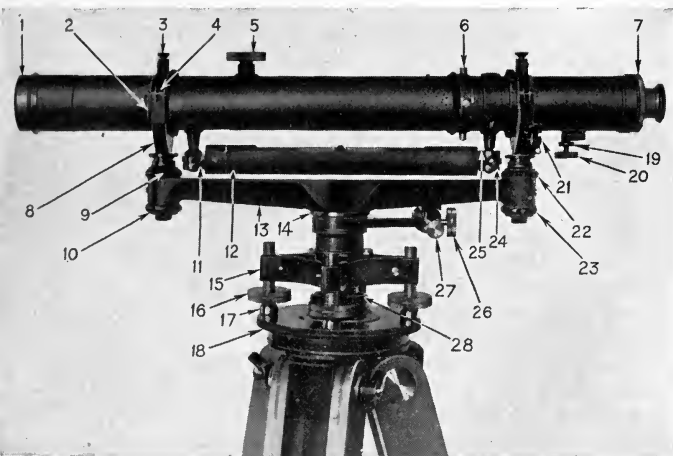

FIG. 11. TYPICAL WYE LEVEL USED ON MINE WORK.

- |                                                 |                                |
|-------------------------------------------------|--------------------------------|
| 1. Objective                                    | 15. Leveling head              |
| 2. Spring lock lever for wye yokes              | 16. Leveling screw             |
| 3. Spring contact                               | 17. Leveling screw shoe        |
| 4. Wye yoke catch                               | 18. Tripod head                |
| 5. Rack and pinion thumb-screw (focusing screw) | 19. Adjusting nut              |
| 6. Adjusting screws for cross-wires             | 20. Micrometer focusing screw  |
| 7. Eyepiece tube                                | 21. Stop-lever                 |
| 8. Telescope wye                                | 22. Wye adjusting nut          |
| 9. Wye adjusting nut                            | 23. Wye adjusting nut          |
| 10. Wye adjusting nut                           | 24. Level bubble adjusting nut |
| 11. Level bubble adjusting nut                  | 25. Level bubble adjusting nut |
| 12. Level bubble tube                           | 26. Tangent clamp screw        |
| 13. Level bar                                   | 27. Tangent screw              |
| 14. Tangent clamp collar                        | 28. Half ball socket joint     |

over 3 ft. long, overall, and can be extended to 5 ft. This is one of the most common, in fact it might be said, practically the only type of level rod used on mine work.

Referring to Fig. 12 which shows the completed rod, the target will be observed near the top, and a set screw arrangement for clamping the rod in position when extended is shown at *A*. Near the bottom of the rod at *D* is a metal sleeve which is a part of the telescoping arrangement, being attached to the back half of the rod and sliding along the front part. The extreme bottom of the rod at *F* is bound with a substantial iron ferrule which provides against any important wear and consequent inaccuracy to this much abused part. As will be noted, the graduations on the rod extend from zero at the bottom to 3 ft. at the top, the decimal system of tenths and hundredths of course being used instead of inches. The tenths of feet are plain black figures, the even foot marks being indicated by a slightly larger figure in red.

In Fig. 13 is shown an enlarged view of the target. The target is simply a circular disk with an oblong portion removed in the center. The zero of the target is indicated by sharp changes in the color arrangement in order to bring this out prominently, the two colors most commonly used being red and white, as indicated on the half-tone by *R* and *W* respectively. To the right at *C* will be noted a slit and small circular hole in the target which is used on underground work only. The rodman, by holding his light behind the target and allowing it to shine through this slit brings out a sharply defined isolated mark which the instrumentman cannot fail to readily locate.

A modern helpful addition to the target is the device shown at *B*. This is a slow motion arrangement by which the target is more conveniently set at the exact joint. On mine work, particularly, the damp atmosphere results in a certain swelling of the wood so that the target is often stiff, and with the rodman endeavoring to hold the light with one hand and move the target an infinitesimal amount, while at the same time holding the rod plumb, the results are often trying on the patience of all concerned.

To obtain the reading of the target, set at any point on the rod, first note the nearest foot mark beneath the target which gives the full number of feet in the required reading. Next observe what



FIG. 12.

tenth mark on the rod cuts the small scale on the target, this being 1 in the illustration, Fig. 13. Finally, note the reading on this small scale at the before mentioned tenth mark which in this case is .07, or to be more exact about .073 if it is desired to carry the readings to thousandths. The even foot mark in this illustration obviously occurs between the 9 and the 1 on the rod and is therefore covered

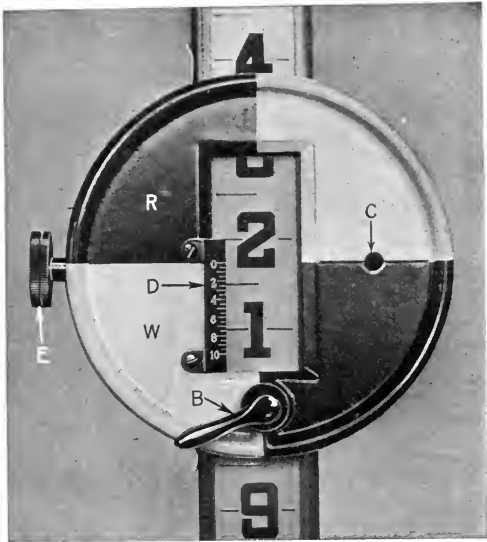

FIG. 13. DETAIL OF TARGET ON THE MINE LEVEL ROD.

by the target. Assuming this to be 2 we then have a reading of 2.173 ft.

When it becomes necessary to use "long rod" the target is run up as far as it will go, which is to the 3-ft. mark (see Fig. 12) and clamped tight. The set screw *A* is then loosened, the rod extended to the required height and the set screw again clamped. On the back of the rod will be found another small scale the same as in the target and the reading is taken in the same way, except that it is made from the top down, instead of from the bottom up as in the first case.

## STEEL TAPES

Unusual conditions obtain in mine surveying that accentuate the possibility of error in chaining and the difficulty in obtaining reliable results. Where the average engineer doing outside work is liable to lose his temper should a thoughtless chainman inadvertently drag the tape through mud or water, the inside man has long since accepted this as a matter of course. The outside engineer is doing his work in broad daylight where the most casual attention only is required, while the inside man is working in a pitch blackness where kinks in the tapes are seldom found until too late, where it is difficult to tell if the tape swings free and truly on the line, and where the limited working room requires constant winding and unwinding of the tape.

As a result of these abnormal conditions, a distinctive style of tape has been developed on mining work. This is the ribbon or flat wire tape, as shown in Fig. 14. These tapes are ordinarily  $\frac{1}{8}$  in. wide,



FIG. 14. FLAT WIRE OR RIBBON TAPE USED IN MINE SURVEYING.

and usually about 300 ft. long. Some engineers prefer even a lighter tape only  $\frac{3}{8}$  in. wide, and have them in lengths up to 500 ft., and even more on occasions.

As noted in Fig. 14, the graduations on this type of tape are stamped on brass sleeves, which have been either clamped or soldered onto the tape. The figures indicating the number of feet from zero are noted, together with a line and a notch on each side at the exact point. These graduations are usually put on every 5 ft. although sometimes 3 ft. is used. The less there are, the more accurate the tape will be, and the less expensive. The 5-ft. graduations are therefore probably the best, particularly as the experienced man soon becomes so accustomed to this style that he can handle it as rapidly as the 3-ft. graduations.

These tapes are made of the toughest flexible steel ribbon, carefully tempered, so as to withstand breaking under the hardest usage. They are graduated according to the standard of the National Bureau of Standards, and are correct at 62° F. On the ordinary mine surveying work, it is not necessary to make corrections for temperature or the tension on the tape. Another advantage of these

tapes is the facility with which they can be repaired. This latter contingency is one that must be anticipated and prepared for even with the well-trained corps. The following method of effecting repairs, selected from a number appearing in *Engineering News* several years ago, will be found convenient:

Small pieces of copper, or tin from an old tin can, are cut into strips say  $\frac{5}{8}$  in. wide, and then cut crosswise of a size that will lap around the tape to be mended and just about meet on the flat side of the tape—not the edge. These, with an ordinary candle, a piece of solder and some stick flux (both of which latter may be obtained from any electric plant), a small flat file and a pair of small nippers complete the outfit. These may all be put into a small sack and carried in the pocket, where they are always ready, and when a tape is broken it can be repaired in the field in five minutes, thus saving time and the inconvenience of using a broken tape, or going a long distance to get it repaired.

One end of the tape is used as a “form” about which the clasp is bent. The tape and clasp should be brightened with the file before the clasp is bent into the proper shape. When the tape is put together, clamp the clasp tightly about it with the nippers; heat in the candle and put sufficient flux on to run under the clasp; then hold the solder on the splice until it has melted and run under and about the clasp; allow it to cool without movement of the ends of the tape and the work is done.

The above “outfit” does not weigh over a pound, and is all that will be needed, thus doing away with a machine shop for doing a little tape splicing. Tapes can easily be mended in this manner so that they will hold all a man can pull. The stick flux is much more convenient than a bottle of acid and zinc, as it cannot be broken, and does the work as well as the acid.

### PLUMB BOBS

Plumb bobs are used in mine work for giving sights, but more particularly for setting up the instrument. There is little choice in the matter of bobs, Figs. 15 and 16 showing the two principal varieties on the market. Fig. 15 shows the standard type of plumb bob most commonly used. It conforms to the general plan adopted since plumb bobs were first made, and has successfully maintained its leadership to the present day. Fig. 16 shows a relative new type of bob made of nickel steel instead of brass, as is the one shown in Fig.

15. This new type is much preferred by many colliery engineers who claim that it offers much less resistance to the rapid air current prevailing in some parts of our mines, and it is much easier to work with



FIG. 15



FIG. 16

under such conditions. Some also find the cylindrical form more convenient for handling as compared with the conical form of the old style bob.

## CHAPTER III

### CARE OF INSTRUMENTS

Note.—Abstracted from publications of the C. L. Berger Co.

The first requisites in the outfit of the engineer are the engineering instruments, transit, level, rods, tapes, etc. The perfect instrument becomes a part of the operator, like his skillful hand and educated brain, and in like manner can be depended upon. To make such an instrument requires long experience, great skill, and the use of delicate and expensive machinery. Some of the machinery, like the automatic dividing engines, require many years of construction and perfection.

Before purchasing of any particular manufacturer, consult engineers of long experience and high standing, as to the merits of the instruments of different makers. A certain high quality in instruments is requisite to do good work quickly. Do not let the matter of a few dollars in the difference in price influence you to purchase that for which you may soon have to apologize. Patronize a firm that has a well-established record for fair dealing and for reliable work that will give you full value for your money.

The perfect instrument is so made that every part is designed with reference to every other part. Strength, weight, rigidity, and stability under wind pressure, are carefully considered, as well as in the form, the material, the life and the action of the tripod, movement, centers, bearings, leveling and tangent screws, telescope slides, the power and clearness of the telescope, the sensitiveness of the levels, the accuracy of the graduations, and the simplicity of the manipulation. The instrument must be constructed so that it can be used in all climates and under all conditions, and when exposed to wind pressure all tremor and vibration is eliminated, and lines and angles can be laid out and measured correctly without any anxiety as regards results and nervousness therein on the part of the manipulator.

#### IN GENERAL

Do not allow the legs of your tripod to play loose on the tripod head; keep nuts and bolts always well tightened up against the



wood. Examine the shoes from time to time, and sharpen them if necessary, also screw the shoes tight, if wear and tear loosen them. Be sure your instrument is well secured to its tripod before using it. Bring all four leveling screws to a seat before shouldering instrument. Let the needle down upon its pivot as gently as possible, and allow it to play only when in use; if too far out from its course, check movements of needle carefully by means of lifter. Never permit playing with the needle, especially not with knives, keys, etc. Be sure to arrest the needle after use, and screw it well up against the glass cover before shouldering the instrument.

Do not clean the glass cover or the lenses with a silk handkerchief; breathe over the compass glass and reading lens if one is used, after cleaning. To clean the object glass and the lenses use a fine camel-hair brush. If dust or sticky or fatty matter cannot be removed with the brush, take an old clean piece of soft linen, and carefully wipe it off. Do not unscrew the object glass unnecessarily as this is apt to disturb the adjustment of line of collimation. The lens nearest the eye of eyepiece, as well as the front side of the object glass, need careful brushing with fine brush from time to time.

If dust settles on cross hairs and becomes troublesome, unscrew the eyepiece and object glass, and gently blow through the telescope tube, cover up both ends and wait a few minutes before inserting the eyepiece and object glass. Be sure to have the object glass cell screwed well up against its shoulder, and then examine the adjustment for the line of collimation. Do not grease the object slide of telescope, or screws that are exposed to dust; use a stiff toothbrush to clean slides or threads if dusty.

If the focussing slide seems to work too hard, everything else being right, it is generally caused by the lubricant on the pinion hardening in cold weather, and the same cause may also make the focussing slide work too freely in hot weather by softening, *i.e.*, when not staying in place when in a vertical position. Fretting of the focussing slide is usually due to the inrush of air carrying dust and grit when slide is being run out causing momentarily a rarefied space. This may be prevented by wrapping a piece of chamois skin over the barrel in shape of tubular form and fasten by means of rubber bands or sewing. In an emergency fine watch-oil may be used to grease the slide should it continue to fret, until the instrument can be sent to the maker. In case of rain during non-use, place the telescope vertical, object end up, and no water can enter the telescope.

Never use emery in any form about any part of a transit or a level,

whether tangent screws, slides or centers. If anything must be used, a very little powdered pumice-stone mixed with fine watch-oil is all that is advisable, and after grinding, then clean thoroughly. The uninitiated are advised to do no grinding whatever. As a rule more harm than good comes to the instrument. It is only in case of emergency that such heroic treatment should be resorted to. When cleaning the slide and inside of main tube great care must be taken not to break the wires.

To clean the threads of leveling or tangent screws when *working hard*, use a stiff toothbrush to remove all dust, then apply a little oil, and work the screw in and out with alternate brushing to remove dirt and all oil until it moves perfectly free and smooth.

Screws for the adjustment of cross hairs should not be strained any more than necessary to insure a firm seat; all straining of such screws beyond this simply impairs the accuracy of instrument and reliability of adjustment.

When in the field always carry a Gossamer water-proof to put over the instrument in case of a shower or dust cloud. On reaching office, after use of instrument, dust it off generally with another fine brush; examine the centers and all other principal movements to see if they run perfectly free and easy, and oil them if necessary; also examine the adjustments. This will save expense and many hours of vexation in the field.

In field use, an instrument has to be necessarily exposed to the heat of the sun, and to the action of dust and water; all of these, however, singly or combined, have a tendency to affect its accuracy and endurance. While good instruments are designed to guard against injuries resulting from exposure of this kind, yet glaring abuses, such as to allow it to stand for hours in the hot sun, etc., without a covering or shelter of some sort, may often lead to a permanent injury to its most vital parts. To preserve the finer qualities of an instrument, viz., the telescope slide, the lenses, the edge of the graduation and verniers, the centers, etc., any undue unequal expansion of the different parts should be prevented. A bag thrown over the instrument when not in use, or any shelter that can be had, is to be recommended. While in use, an umbrella or screen held over it will insure greater permanency of its adjustments, and the results obtained will be more accurate and uniform than when carelessly exposed.

To protect an instrument from the effects of salt water, a fine film of watch-oil rubbed over the exposed parts will often prevent the

appearance of oxyd. To remove such oxyd-spots as well as possible, apply some watch-oil and allow it to remain for a few hours, then rub dry with a soft piece of linen. To preserve the outer appearance of an instrument, never use anything for dusting except a fine camel's hair brush. To remove water and dust spots, first use the camel's hair brush, and then rub off with fine watch-oil, and wipe dry; to let the oil remain would tend to accumulate dust on the instrument.

#### CARE OF THE CENTERS AND GRADUATIONS

If it is found that the centers do not revolve freely, as is often the case after exposure to extremes of temperature, take the instrument apart and proceed as follows:

Take a fine camel's hair brush, and with it clean the graduation, the verniers and the inner part of the instrument, but do not rub the graduation, especially not its edge. Then take a stick of about the same taper as the inner center, wrap some wash-leather slightly soaked in fine oil around it, and clean the insides of the sockets as carefully as possible and then wrap a fresh piece without oil around the stick and clean dry. Proceed similarly with the centers and their flanges.

Before applying fresh and pure watch-oil, care should be taken that not a particle of dust or other foreign matter is left, in the sockets, on the centers, or on the graduation. This caution having been taken, the fresh oil should be well distributed on all the bearing parts. It will be well to also examine the arm of the clamp screw of the circle and telescope axis, and if necessary clean by removing washer. After the instrument is thoroughly cleaned and oiled, the nuts and springs screwed back to a firm seat, the instrument must turn perfectly free and yield at the slightest touch of the hand.

To remove dirt and oxyd that may have accumulated on the surface of a solid silver graduation, apply some fine watch-oil, and allow it to remain for a few hours; take a soft piece of old linen and slightly rub until dry, but without touching the edge of the graduations. If, after cleaning, the solid silver surface should show alternately brighter spots, which would interfere somewhat with the accurate reading of the graduation, barely moisten the finger with vaseline and apply the same to the surface; then wipe the finger dry and lightly rub it once or twice around the graduation. Avoid touching the edges as much as possible. Such cleaning, however, must only be resorted to when absolutely necessary, and then only

with the greatest care, as it is too apt to reduce the minuteness of the graduation, and spoil its fine appearance. If, after such cleaning, dirt and grease has accumulated on the inner edge of the graduation and verniers, gently wipe clean before restoring the vernier-plate to its place. Remember, also, that the centering of the graduations of the circle and verniers is a most delicate adjustment to make. These should never be unscrewed from their flanges by anybody except a maker.

### TELESCOPE LENSES

As dust and moisture, as well as perspiration from the hands, will settle on the surface of the lenses of a telescope, it becomes necessary that they should be cleaned at times. A neglect to keep the lenses free from any film, scratches, etc., greatly impairs the clear sight through the telescope. To remove the dimness produced by such a film, proceed thus:

Brush each lens carefully with a camel's hair brush, wipe gently with a clean piece of chamois leather moistened with alcohol, and wipe dry using a clean part of the chamois skin on every portion of the lens, to avoid grinding and scratching. When perfectly transparent brush again to remove any fiber that may adhere to the lens. The tubes in which the lenses fit should be brushed, and if damp should be dried; this done, restore each lens to its original place as marked. To remove dampness in the main tube of the telescope, take out the eyepiece, cover the open end with cloth and leave the instrument in a dry room for some time.

If an instrument has been exposed to a damp atmosphere, or water has penetrated the telescope, moisture may settle between the crown and flint glass of which the object glass is composed. If such is the case expose the instrument to the sun for a few hours, but if in the winter, leave it in a warm room some distance from the stove, the moisture will then generally evaporate. However, if not successful, unscrew the object glass from the telescope, and heat it slightly over a stove or open fire. If a film settles between these glasses nothing can be done except sending the instrument to the maker. The two glasses form one lens only and must not be disturbed, as upon their relation to each other the definition and achromaticity of the telescope depends. Much depends also on the stability, with which these lenses are mounted in their cell, as any looseness between them or the cell will affect the adjustment of line of collimation.

Of course, if at any time the object glass has been unscrewed from the telescope, this latter adjustment must again be verified before the instrument is used.

When the object glass, or telescope is returned after the cleaning or cementing of its lenses, the cross-wire, spirit level, and vertical arc adjustments of the instrument will require a thorough verification before it should be used. In case the whole instrument has been sent to the maker, these adjustments are attended to by him. If the object glass has been cemented, the telescope should be watched for a year to see that there is no distortion of the image. If there is a distortion, it will indicate that the object glass has been too tightly fitted, of which fact the makers should be informed, as also whether after cementing the object glass the instrument retains its cross-wire adjustment the same as before. If the cross-wire adjustments have to be more frequently made than before the lenses were cemented, it indicates that the object glass is not tightly fitted to its cell; and if such is the case it should be returned and more tightly fitted, after a lapse of about ten or twelve months, when the cement will have sufficiently hardened to allow of a tighter fit.

### LUBRICATING

An instrument used in a tropical or semi-tropical country, or during the warm season in a northern latitude, requires more frequent cleaning and oiling than in the more temperate climes and seasons; but so long as an instrument works well and the centers revolve freely, it is best not to disturb it.

The centers of a transit should always be lubricated with fine watch-oil only, and after a careful cleaning; never apply fresh oil before thoroughly wiping off old grit and oil. Rendered marrow is a most excellent lubricant for instruments made of brass and the many kindred alloys of copper and tin. In the varying climes of our northern latitudes this lubricant becomes rigid in cold weather, and an instrument so treated will often become unmanageable in the field. Its application, particularly to the centers of a transit, is therefore restricted to the warmer zones. The use of watch-oil for the finer parts of an instrument, involving freedom of motion, is imperative in our latitudes.

Many parts of an instrument, especially those whose metal compositions are closely related to each other, may sometimes cause trouble if simply oiled. If they begin to fret and grind, but are other-

wise free from grit, etc., the judicious application of a little marrow may prove beneficial, but it should be cleaned off again as much as possible. The rack and pinion motion and the telescope clamp should always be greased with marrow, but the clamp, tangent and leveling screws, should receive as little of it as possible in the Northern States.

Vaseline, not having as great a tendency to solidify under similar circumstances, may prove an excellent substitute for marrow, and may often be applied to level-centers, where watch-oil would not give the necessary rigidity in the use of the more ordinary instruments, but it must be renewed quite often. In the finer class of leveling instruments, the centers should be lubricated with oil only, as in transits.

A great deal of annoyance is caused if the eyepiece or the object slide of the telescope move too freely in their tubes, requiring a re-focussing of the cross wires and object at every revolution of the telescope in altitude. If the eyepiece can be retained in its socket, with sufficient friction to keep it focussed to the cross wires, no matter how much it may wobble otherwise, this imperfection (in old instruments) will not lead to any inaccuracy, but if there is not sufficient friction to keep it focussed to the wires, a little rendered tallow or marrow applied to its bearing surfaces in most cases will remedy this evil.

Wabbling in the object slide, however, leading to inaccuracy of collimation, or back-lash in its rack and pinion motion, can be remedied only by a maker; but if the object slide moves too freely in and out of its tube only, this may be remedied by applying a little tallow to the bearing parts of the rack and pinion, or by tightening the screw in the pinion-head. If not entirely successful, a thin disk made of parchment, or a thin leather washer, both greased with tallow, and inserted between the flanges of the pinion-head and its socket, will insure the desired result.

These latter remarks apply to transit and level telescopes of the customary design. In telescopes, where the object glass is mounted permanently to the telescope tube, the eyepiece tube, containing the cross wires, becomes the slide with which to focus the object. Its motion must be in a line parallel to the optical axis. Any wabbling in this eyepiece slide would lead to inaccuracy in sighting through the telescope, hence it requires the most careful treatment on the part of the engineer.

## LEVEL BUBBLES

Spirit levels are very susceptible to the least change in temperature, as will be readily seen by the difference in the length of its bubble in varying temperatures. Hence, to guard against inaccuracies from this source, it is necessary that the bubble should lengthen symmetrically from the center of its graduated scale (supposed to be put on by the maker), and that both of its ends should be read. Sufficient time must also be allowed for the bubble to settle before reading is made.

The fluid ordinarily used for levels is pure alcohol, and requires, according to curvature, diameter and length of tube and length of bubble, from twenty seconds to one minute to attain its equilibrium. The composition fluid used in some levels for field instruments requires only from five to fifteen seconds of time; those filled with pure ether, a few seconds only.

A great source of error in spirit levels, however, increasing with their greater sensitiveness, is occasioned by an unequal heating of the level-tube, as the bubble will always move toward the warmer spot or end, thereby imparting to the instrument an inaccurate position. This must be attributed to a changed condition in the adhesiveness of the fluid in the level-tube, and not to a change in the form of the tube itself. Therefore, to guard against inaccuracy resulting from sudden changes of temperature, a spirit level, while in use, should be protected from the sun, and no part of it or its mounting should ever be touched with bare fingers; neither should it be breathed upon, nor the face of the observer come too close to it. For this reason, in the finer instruments the mountings of some spirit-levels are cloth-finished, and if the levels are detachable they are provided with wooden handles, as the case may require, and glass covers are placed over them whenever deemed necessary.

If at any time during the progress of field-work a spirit level has been improperly exposed, it is best to cover it with a cloth for from five to fifteen minutes, before proceeding with further work.

**Mounting Spirit Levels.**—To prevent any undue strain and change of curvature in spirit levels used in astronomical instruments, they are mounted by some makers in wyes and are protected from injury, or inaccuracy caused by the breath of the observer and other air currents, by a cover of glass placed over them. Such a mounting, while most suitable for such delicate levels, would, however, require

constant attention and expose a spirit level to breakage in field instruments. To guard against this danger and to lessen the expense and weight, the spirit levels for field instruments are mounted in a brass tube; but owing to the difference existing in the expansion and contraction of glass and brass at different temperatures, a spirit-level so mounted may sometimes become loose, involving inaccuracy and unreliability of adjustment.

Upon finding that the adjustment of a spirit level in an even temperature is not as stable as desirable, the level fastenings, tube, screws, etc., should be examined, to see if any of them are loose. If the trouble is in the screws, tighten them up; but if the spirit level can be shifted in its tube by a touch of the finger, take it apart; soften the plaster of Paris in water, and remove it with a sharp pointed stick of wood. Cautiously move the spirit level with your finger, at first only a trifle to and fro, increasing the length of stroke little by little, until it can be safely taken out without breaking. Clean thoroughly and then cut pieces of white paper, of the width of the radius of the tube, and somewhat shorter than the length of the spirit level, but longer than the opening in the brass tube, and insert these of sufficient quantity at the bottom of the brass tube, to fill up the space intervening between the glass and the brass tube. The uppermost layer of paper should, however, be so wide, as to envelop the spirit level up to the opening in the brass tube.

Now insert the spirit level, taking care not to touch the glass ends that are sealed up, and place the division or other marks, indicating where the level has been ground to a true curvature, uppermost in the brass tube. The level must be pushed in with sufficient friction to prevent slipping in the tube, yet not so tight as to cause a crack at a subsequent low temperature, as brass will contract more than glass. No part of the spirit level should touch any part of the metal tube. Now prepare some plaster of Paris with water, of the consistency of paste, and pour in at each end enough to fill up the space between the end-pieces and the glass, stirring it sufficiently to make a perfect contact by it and the glass and the brass, but leaving the spirit level ends exposed. Now put the level together, and adjust as described elsewhere.

There are other causes, such as centers and flanges that have been bent by falls, etc., or that have been worn out—unequal expansion or contraction in different temperatures of the metals employed in the construction of an instrument, or a non-symmetrical lengthening or shortening of the air-bubble at different temperatures—all of



which, singly or combined, tend to impair the adjustment of spirit-levels on instruments.

Being assured that the level is mounted as explained above, it is advisable not to meddle too frequently with the adjustment. Though it may appear to be out one day, it may be in perfect adjustment other days. It is the function of a spirit level to indicate the changes taking place in an instrument, so that the engineer may make proper allowance and apply his corrections, as the character of his work may require. The finer an instrument, the more sensitive the spirit levels must be, in order to admit of corrections to arrive at closer results. As a rule, a spirit level that does not indicate changes taking place in an instrument, is too insensitive for the character of the instrument, and in many cases entirely unfit for reasonably good work.

#### REPLACING CROSS WIRES

Remove the reticule frame and clean it of all foreign matter; put it on a sheet of white paper with the cuts on its surface uppermost. Prepare a little shellac by dissolving it in the best alcohol and waiting until it is of the consistency of oil. From the spider's cocoon (those from a small black wood-spider preferred), which the engineer has prudently secured at some previous time, select two or three webs, each about 2 in. long and of the same appearance. Attach each end of these webs to a bit of paper or wood to act as weights, and immerse them in water for five or ten minutes. Remove one web from the water, and very gently pass it between the forefinger and thumb nails, holding it vertically to remove any particles of moisture or dirt. Stretch the web carefully over two of the opposite cuts in the reticule frame. Fasten one end by a drop of the shellac, dropped gently from a bit of pointed wood or the blade of a penknife. Wait a moment for this drop of shellac to harden. See that the web is stretched tight across the frame, and apply another drop of the shellac to the opposite cut with its enclosed web. Wait several minutes before cutting off the two ends of the web, and then proceed in the same manner with the web which is to be placed at right angles to this one.

One of the best spider-webs for this purpose is obtained from the cocoons of a species of spider found in Michigan. These threads are almost opaque, and not apt to relax their tightness if properly placed on the diaphragm, and as they retain their elasticity, they are preferable to platinum wires, which have a tendency to break, owing

to their great brittleness. The best spider-threads are those of which the spider makes its nest. These nests are yellowish-brown balls, which may be found hanging on shrubs, etc., in the late fall or early winter. The nest should be torn open and the eggs removed; if this is not done, the young spiders, when hatched, will eat the threads. The fibers next to the eggs are to be preferred on account of their fineness and darker color. As it is important to get the proper kind of spider-web, the following letter on this subject from Prof. J. B. Davis, University of Michigan, Ann Arbor, Mich., is of interest:

“The species of spider of which I send you cocoons is not difficult to find in Ann Arbor—Lat.  $42^{\circ} 26' N.$ —as far as my experience goes, and is numerous on Beaver Island, out in Lake Michigan—about  $46^{\circ} N.$ —at St. James. I have also always succeeded in hunting it in our Michigan woods, in places of concealment—under bark of dead trees, in cracks and holes, about old stumps, logs, and the like. It is especially partial to painted woodwork. It roosts high—the higher the gable the more numerous the cocoons; but it is also found on fences quite numerously, as I am led to think it is quiet rather than security this spider seeks. The body of the female is about three-fourths of an inch long, and nearly half an inch wide across the abdomen. The male is about the same length, but far slimmer. They are both entirely harmless. I never knew any one to get bitten by either, and many persons in my observation have had them freely crawling over their hands, face and body. They may be certainly gently handled without the least harm. They both (male and female) bear a plain escutcheon design on the back of the abdomen; female much the more beautiful—in browns. Colors all brown and yellowish-brown. The cocoon is a snarl of webs, and is attached under ledges of window-sills, cornices, projections of gables, and the like partly sheltered places. The color of the threads you have is of a light corn-color, distinctly separating it from the white cotton-like cocoons so common everywhere. The threads are silky, not like cotton. Of late years I keep one or two nice cocoons where they can be reached. You know one can wrap them in a bit of paper and carry them in the pocket, or any such place, and they are always ready.”

#### ACCIDENTS AND PRECAUTIONS IN THE USE OF INSTRUMENTS

It cannot be denied that instruments frequently meet with serious accidents which, with a little care on the part of the operator, could

be prevented. It certainly does not betoken proper care to leave it standing unguarded in a street, road, or pasture, or in close vicinity to blasting, or to expose it unnecessarily to the burning rays of the sun, or to dust, dampness, or rain at any time. Such carelessness must inevitably result in deterioration of the accuracy and efficiency, not to speak of the durability, of an instrument. It should be borne in mind that there are many parts of an instrument which, if once impaired, cannot be restored to their original efficiency.

**Tripods.**—Legs of tripods, if fitting too loose or too tight, and dull shoes are frequent sources of falls, and loose shoes tend to make an unsteady instrument. The test of the proper degree of the tightness of the legs is if the leg is raised to a horizontal position and left free, it should gradually sink to the ground. If it drops abruptly it is too loose; if it does not sink it is too tight.

**Mounting the Instrument.**—When taking an instrument from its box, it is not immaterial where and how to take hold of it. To lift it by the telescope, circles, standards, or wyes is improper, and while it may not be attended at once with any serious consequences, yet it may sometimes lead to some permanent injury, and it certainly is always fraught with danger to the permanency of the adjustments. In handling, it is always best to place the hand beneath the leveling base.

When mounting an instrument on the screw of its tripod, or screwing any of its parts together, it is important to turn the part in the direction of unscrewing until it is perceived by a slight jar that the threads have come to the point where they enter; the motion may then be reversed, and the parts screwed together.

To secure an even wear of tangent and micrometer screws, they should be used equally on all portions of their lengths.

Carrying an instrument in cold weather into a warm room, without the protection of its box or bag, will cause a sudden exchange of air within the hollow spaces, and carry with it dust and other substances through the minutest openings. The vapor, also, that will thus condense on the metal surfaces, if it were not protected, will have a tendency to settle a film on exposed graduations, making them indistinct and difficult to read.

**Protection of Lenses.**—Failure to protect the lenses of the eyepiece and object glass of a telescope, when not in actual use, from the effects of moisture, dust, etc., by the covers provided for them (eyepiece lid and cap) will result in a more frequent settling of a thin film, which, like the fatty substance left by the touch of the

fingers, greatly impairs the clearness of vision. That the too frequent cleaning of the lenses must in the course of time be detrimental to their brilliant polish, and lead to a corresponding loss of transparency, so essential to the proper working of a good telescope, is apparent. Too much care cannot be taken to guard the lenses, and particularly the inner surfaces of the lenses comprising the objective, against any film that may settle on them. The ill effects of such a film are especially noticeable in high-powered telescopes of first-class geodetic and astronomical instruments. In short, it should be remembered that the slightest film, scratch, or dirt will, according to their nature and location, impair the sight through a telescope, and often render it unfit for accurate work.

**Glass Parts.**—The glass covers protecting the compass, arc, and verniers from exposure need very careful brushing and cleaning, the same as the lenses, as any scratch or film will impair their transparency. If at any time the ground-glass shades should lose their pure whiteness, by either dirt or film, and will not act as illuminators of the verniers and graduation, take them out of their frames and simply wash them with soap and water.

**The Needle.**—To prevent loss of magnetism in the needle of instruments provided with a compass: when storing away, allow the needle to assume magnetic north and south; then, by means of the lifter, raise it from the center-point against the glass cover.

If an instrument has met with a fall, bending centers and plates, etc., it should not be revolved any more, in order to preserve the graduations from still further injury, but recourse should be had at once to the nearest competent maker.

**Instrument Boxes.**—If the box or tripod should have become wet, they should be rubbed dry, and the varnish should be renewed whenever found wanting. Loose or detached resting-blocks in the instrument-box, or any looseness of the instrument in them, are very detrimental to the instrument and its adjustments. Cracks in the instrument-box, the absence of rubber cushions under it, worn-out straps and defective buckles, hinges, locks, and hooks, should never be tolerated, as the remedy is so easily applied by any mechanic. Such defects and imperfections are known to lead to injury of the instrument.

**Storing Instruments.**—The place where instruments are kept or stored away should be thoroughly dry and free from gases. The placing of fused chloride of calcium, or caustic lime, in an open vessel in the instrument-box is to be recommended where there is

dampness; and if the presence of sulphureted hydrogen is suspected, then, cotton saturated with vinegar of lead, placed in the box, will prove a preventive against the tarnishing of solid silver graduations.

#### TRANSPORTATION OF INSTRUMENTS

During the progress of field work the more ordinary and portable transits and leveling instruments, etc., can generally be carried on their tripods for ease and dispatch. Nothing in the way of precise instructions, however, as to the best method of carrying an instrument, whether on the tripod, in the arm without the tripod, placing the hand beneath the leveling base, or in the box, can be suggested here. The nature of the ground, the surroundings, the size and weight, and the distance to be traveled over, and last but not least the fineness of the instrument, will dictate to the engineer the best means of conveying it from point to point in order to protect it from injury, and its adjustments from derangement.

Carrying an instrument on its tripod without slightly clamping its principal motions, will wear out the centers. When carrying on its tripod, clamp telescope in the transit, when placed on a line with its centers and in the level when hanging down.

**Placing in the Box.**—When carrying an instrument in the box it is important that it be placed therein exactly in the position and manner designated by the maker. Therefore, upon receiving a new instrument, the first step should be to study its mode of packing, and if necessary a memorandum should be made for future guidance and pasted in the box. This will save time and vexation, as some of the boxes for field instruments must necessarily be crowded to be light and portable.

Before placing an instrument with four leveling screws in its box, the foot-plate should be made parallel to the instrument proper, and then brought to a firm bearing by the leveling screws. The instrument must also be well screwed to the slide-board, if one is provided. Having put the instrument in the box in such a position, that no part of it will touch the sides, the principal motions are now to be checked by the clamp screws, to prevent motion and striking against the box. With instruments not standing erect in their boxes, but which are laid on their sides in resting places, padded with cloth, specially provided for that purpose, their principal motions must not be clamped until the instrument has been secured in a complete state of repose in these receptacles, so as to be entirely free from any strain. Care must be taken, too, that all of the detached parts of an

instrument, as well as its accessories, are properly secured to their receptacles before shutting the box.

**Shipping.**—When shipping an instrument over a long distance it is commendable to fill the hollow space between it and its box with small soft cushions made of paper, or of excelsior or shavings wrapped in soft paper, taking care not to scratch the metal surfaces, nor to bend exposed parts, nor to press against any adjusting screws.

For greater safety in transportation by express, the instrument-box itself should always be packed in a pine-wood box one inch larger all around. For the ordinary size of field instrument the packing-case should be provided with a strong rope handle, which, like the strap of the instrument box, should pass over the top of the case and through holes in the sides, the knots being within the case and strongly secured. In cases where the gross weight of the entire package, as prepared for shipment in the above manner, exceeds 40 or 50 lb., then two men should handle it, and two strong rope handles, one at each end of the packing case, should be provided. In order to check jars and vibrations while en route, the loose space between the instrument box and the packing case is to be filled with dry and loose shavings.

The cover bearing the directions should always be screwed on and marked in large black letters. The upper halves of the four sides also should have "*care*" and "*keep dry*" marked in large letters on them. These precautions are indispensable for safe conveyance while in the hands of inexperienced persons, as without them messengers will often carry them wrong side up.

The tripod needs packing simply in a close-fitting box. If not placed in a box, it often happens that legs or shoes are broken off while en route, or that the tripod head becomes bent.

Many hundreds of instruments, packed as explained above, have been shipped, travelling thousands of miles, over rough roads, on stages and on horseback; and the instances are so rare where one has become injured (and then only through gross carelessness), that this mode of packing must be regarded as the only proper one for conveying instruments of precision by express or other public carriers.

Arriving at its destination, an instrument should not remain packed up with cushions, etc., any longer than necessary. The atmosphere in such boxes naturally must be close and often moist, and consequently has a tendency to produce the ill effects by moisture mentioned in preceding paragraphs.

## CHAPTER IV

### ADJUSTMENT OF INSTRUMENTS

NOTE.—Abstracted from publications of the C. L. Berger Co.

The mechanical and optical condition of instruments used in geodesy, and their adjustments, although satisfactory when they leave the maker's hand, are liable to become disturbed by use. It is therefore of vital importance that the person using an instrument should be perfectly familiar with its manipulations and adjustments. He should be able to test and correct the adjustments himself at any time, in order to save trouble and expense, as well as to possess a thorough knowledge of the condition of the instrument. It is evident that if the character of an instrument is not properly understood or if the adjustments are considerably out, the benefit due to superior design and workmanship may be entirely lost. Under these circumstances an expensive instrument may be little better than one of lower grade.

In the best types of modern instruments the principal parts are so arranged that they can be adjusted by the method of reversion. This method shows an existing error at double its actual amount, and renders its correction easy by taking one-half the apparent error. Thus errors of eccentricity and inaccuracy in the graduations are readily eliminated by reading opposite verniers and reversing the vernier plate  $180^\circ$  on the vertical center and taking the mean of the readings, and by repeating the measurement of an angle by changing the position of the limb so that the measurement will come on different parts of the graduation. The striding levels and levels mounted on a metal base are readily tested by reversing their position end for end. In the transit plate levels the adjustment is assured by turning the vernier plate  $180^\circ$ . Errors of the line of collimation are detected or eliminated by reversing the telescope over the bearings, or through the standards, as the case may be. In short, an instrument, the important parts of which are not capable of reversing in one way or another, cannot be examined quickly and accurately.

## THE TRANSIT

If the instrument is out of adjustment generally, the engineer will find it profitable to follow the makers in not completing each single adjustment at once, but rather bring the whole instrument to a nice adjustment by repeating the whole series.

**The Bubbles.**—After setting up, bring the two small levels each parallel to a line joining two of the opposing leveling screws. Bring both bubbles to the center of the level tubes, by means of the leveling screws. Now turn the instrument  $180^\circ$  in azimuth. If the small levels still have their bubbles in the center of their tubes, these levels are adjusted, and the circles are respectively as nearly horizontal and vertical as the maker intended them to be.

If the bubbles, however, are not in the center of their tubes, then bring them half way back by means of the leveling screws, and the remaining half by means of the adjusting screw at the end of each of the level tubes. It may be necessary to repeat this adjustment several times, but when made, the instrument once leveled will have its small levels in the center of their tubes through an entire rotation of the circle.

**To Make the Adjustment for Parallax.**—This adjustment common to all telescopes used in surveying instruments is that of bringing the cross hairs to a sharp focus, at the same time with the object under examination. Point the telescope to the sky, and move the eyepiece until the cross hairs are sharp and distinct. Since the eye itself may have slightly accommodated itself to the eyepiece, test the adjustment by looking with the unaided eye at some distant point, and while still looking, bring the eyepiece of the telescope before the eye. If the cross hairs are sharp at the first glance, the adjustment is made. Now focus in the usual manner upon any object, bringing the cross hairs and image to a sharp focus by the rack-work alone. A point should remain bisected when the eye is moved from one side of the eyepiece to the other.

**To make the Vertical Cross Wire Perpendicular to the Plane of the Horizontal Axis.**—Bisect some point at the lower edge of the field of view of the telescope by means of the tangent screw and note whether it continues bisected by this cross line throughout its entire length when the telescope is moved in altitude. If it does not, and the point is to the right of the line in the upper part of the field, the adjustment is made by loosening the four capstan-headed screws, and rotating the reticule in the direction of a left-handed screw,



until the point remains bisected and then tighten all four adjusting screws. Again, bisect the point by means of the tangent screw. It should now remain bisected throughout the length of the cross wire, if not, this operation must be repeated.

**To Adjust the Vertical Wire.**—When that is to be alone adjusted in the field, it is usually done according to the following simple directions: Level up the instrument approximately and select two distant points in opposite directions, preferably in the same horizontal plane, such that the vertical cross line will bisect them both when the telescope is pointed upon one, and then the telescope is reversed on its horizontal axis. After bisecting the second point selected, revolve the instrument in azimuth and bisect the first point again by means of the tangent screw. Reverse the telescope on its horizontal axis again, and if the second point is now bisected the adjustment for collimation of the vertical wire is correct. If it is not bisected, move the vertical wire one-fourth of the distance between its present position and the point previously bisected. Again bisect the first point selected, reverse the telescope and find a new point precisely in the new line of sight of the telescope; these two points will now remain bisected when the instrument is pointed upon them in the manner described above, if the adjustment is correctly made. If the two points are not now both bisected, the adjustment must be repeated until this be the case.

**To Determine Whether the Standards are of the Same Height.**—Suspend a plumb bob by means of a long cord from a height say of from 30 to 40 ft. The plumb bob may swing in a bucket of water to keep it steady. (Instead of a plumb line the reflection of a church spire or edge of a tall building or any other convenient object may be viewed in a bucket of water.) Level the instrument carefully, and point upon the plumb line at its base. If the plumb line remains bisected throughout its entire length when the telescope is moved in altitude, and then the telescope reversed and again made to bisect the line throughout its length from its base upward, the adjustment is correct.

Otherwise make the adjustment by means of the capstan-headed screw directly under one of the telescope wyes. Loosen the screws in the pivot caps and turn the vertical adjusting screw right handed to raise the wye bearing one-quarter of the error to be corrected. If the telescope's axis is already too high, the vertical adjusting screw should be loosened a little more than needed and then by the screws of the pivot cap the wye bearing should be lowered until it just

touches the vertical adjusting screw. The screws of the pivot cap must now again be loosened and the wye bearing raised by a right-hand turn of the vertical adjusting screw, as explained above, until the telescope's axis is in the correct position. If this is not done the adjustable bearing is likely to stick and not rest on the adjusting screw, thus causing liability to derangement. The screws in the pivot cap should then be turned down just enough to prevent looseness in the bearings.

Instead of using a plumb line a simpler method having the advantage of not requiring the instrument to be leveled up carefully is as follows: Set up the instrument as near as may be convenient to a building, say about 20 ft., in order to get as high an altitude as possible. Level up only approximately, clamp and bisect a point at the base by the tangent screw. Then elevate the telescope and find a well-defined object as high as possible, only using the telescope's horizontal axis. Now reverse telescope and move instrument on its vertical center, again clamp, and bi-sect the point at the base. If when the telescope is elevated it bi-sects the high object selected the adjustment is correct. If it does not, proceed as described in the above method.

**To Adjust the Level to the Line of Collimation of the Horizontal Wire.**—One method is to use a sheet of water, or where that is not available, two stakes which are driven with their surfaces in the same level plane. Level up the transit half-way between two points lying nearly in a horizontal line, and say 300 ft. apart. Drive a stake at one of these points, place the rod on it and take a reading, first bringing the bubble to the middle of its tube. Point the telescope in the opposite direction, again bring the bubble to the middle of its tube, and drive a second stake at the second point selected until the rod held upon the second stake gives the same reading as when held upon the first stake. The tops of these two stakes now lie in the same level line.

Take up the transit and set it outside in line, as near as it can be focussed on the first stake and level up. Now read the rod upon the first stake with the bubble in the center and then upon the second. If the two readings agree, and the bubble is in the middle of its tube, the adjustment is correct. If the two readings do not agree, then by means of the telescope's tangent screw elevate or depress the telescope the amount required until the horizontal wire reads the same on the distant rod. Next refocus on the near rod, take a reading, then focus on the distant rod and see if the readings are the same,

if not, by means of the tangent screw again make the horizontal wire read the same as on the near rod. Repeat this operation until both rods read the same. Now with the horizontal wire bisecting the distant reading make the adjustment of the level by its capstan-headed nuts until the bubble is in the middle of its tube when the level will be parallel to the line of collimation.

### THE LEVEL

**The Telescope.**—After the engineer has set up the instrument and adjusted the eyepiece for parallax, as described under the engineer's transit, the horizontal cross wire had better be made to lie in the plane of the azimuthal rotation of the instrument. This may be accomplished by rotating the reticule, after loosening the capstan-headed screws, until a point remains bisected throughout the length of the wire when the telescope is moved in azimuth. In making this adjustment, the level tube is to be kept directly beneath the telescope tube. When made, the small set-screw attached to one of the wyes may be set so that by simply bringing the projecting pin from the telescope against it, the cross wires will be respectively parallel and perpendicular to the motion of the telescope in azimuth.

The first collimating of the telescope may be made using an edge of some building, or any profile which is vertical. Make the vertical cross wire tangent to any such profile, and then turn the telescope halfway round in its wyes. If the vertical cross wire is still tangent to the edge selected, the vertical cross wire is collimated.

**To Make the Adjustment of the Horizontal Wire.**—Select some horizontal line, and cause the horizontal cross wire to be brought tangent to it. Again rotate the telescope halfway round in its wyes, and if the horizontal cross wire is still tangent to the edge selected, the horizontal cross wire is collimated.

Having adjusted the two wires separately in this manner, select some well-defined point which the cross wires are made to bisect. Now rotate the telescope halfway round in its wyes. If the point is still bisected, the telescope is collimated. A very excellent mark to use is the intersection of the cross wires of a transit instrument using same as a collimator.

**To Center the Eyepiece.**—This is done by moving the opposite screws in the same direction until a distant object under observation is without the appearance of a rise or fall throughout an entire rotation of the telescope in its wyes. The telescope is now adjusted.

**To Adjust the Spirit Level to the Telescope.**—Bring the level bar over two of the leveling screws, focus the telescope upon some object about 300 ft. distant, and put on the sun-shade. These precautions are necessary to a nice adjustment of the level tube. Throw open the two arms which hold the telescope down in its wyes, and carefully level the instrument over the two level screws parallel to the telescope. Lift the telescope out of its wyes, turn it end for end and carefully replace it. If the level tube is adjusted, the level will indicate the same reading as before. If it does not, correct half the deviation by the two leveling screws and the remainder by moving the level tube vertically by means of the two adjusting nuts which secure the level tube to the telescope tube at its eyepiece end. Loosen the upper nut with an adjusting pin, and then raise or lower the lower nut as the case requires, and finally clamp that end of the level tube by bringing home the upper nut. This adjustment may require several repetitions before it is perfect.

**To Make the Lateral Adjustment of the Spirit Level.**—The level is now to be adjusted so that its axis may be parallel to the axis of the telescope. Rotate the telescope about  $20^{\circ}$  in its wyes, and note whether the level bubble has the same reading as when the bubble was under the telescope. If it has, this adjustment is made. If it has not the same reading, move the end of the level tube nearest the object glass in a horizontal direction, when the telescope is in its proper position, by means of the two small horizontal capstan-headed screws which secure that end of the level to the telescope tube. If the level bubble goes to the object-glass end when that end is to the engineer's right hand, upon rotating the telescope level toward him, then these screws are to be turned in the direction of a left-handed screw, as the engineer sees them, and *vice versa*. This accomplished the vertical adjustment of the spirit level for parallelism with the line of collimation of the horizontal wire must now again be verified.

**To Make the Adjustment of the Level Bar.**—Level the instrument carefully over two of its leveling screws, the other two being set as nearly level as may be; turn the instrument  $180^{\circ}$  in azimuth, and if the level indicates the same inclination, the level bar is adjusted. If the level bubble indicates a change of inclination of the telescope in turning  $180^{\circ}$ , correct half the amount of the change by the two level screws, and the remainder by the two capstan-headed nuts at the end of the level bar. Turn both nuts in the same direction, an equal part of a revolution, starting that nut first which is in the direction

of the desired movement of the level bar. Many engineers consider this adjustment of little importance, preferring to bring the level bubble in the middle of its tube at each sight by means of the leveling screws alone, rather than to give any great consideration to this adjustment, should it require to be made.

**To Adjust the Horizontal Wire so that the Line of Sight will be Parallel to the Spirit Level.**—To make the adjustment with the stakes, set up the level halfway between two points lying very nearly in a horizontal line, and say 300 ft. apart. Drive a stake at one of these points, place the rod on it and take a reading, first bringing the bubble to the middle of its tube. Point the telescope in the opposite direction, again bring the bubble to the middle of its tube, and drive a second stake at the second point selected until the rod held upon the second stake gives the same reading as when held upon the first stake. The tops of these two stakes now lie in the same level line.

Take up the level and set it outside in line as near as it can be focussed on the first stake and level up. Now read the rod upon the first stake, and then upon the second. If the two readings agree, and the bubble is in the middle of its tube, the collimation is correct. If the two readings do not agree, change the horizontal wire to read the same on the distant rod by means of the capstan-headed screws near the eyepiece in the inverting telescope and furthest from the eyepiece in the erecting telescope. Refocus on the nearest rod, take a reading, then focus on the distant rod and again, by means of the capstan-headed adjusting screws, make the horizontal wire read the same. Repeat this operation until both rods read the same, with the bubble in the middle of its tube.

## CHAPTER V

### ORGANIZING AND EQUIPPING THE FIELD PARTY

The mine surveying party varies widely according to the practice of the different companies and in different parts of the country. The party may be made up of anywhere from two to four or five men. Occasionally, the engineer is called upon to do general surveys with only one assistant, but this is one of the most flagrant examples of lack of economy that it is possible to conceive. However, the two-man party is not without its uses, as for instance, in doing rough room sighting and in leveling; two men are all that can ordinarily work to advantage on such work as this, and it is unnecessary to provide more.

The three-man party makes a well-balanced and efficient corps. For general surveying it is the most economical and no doubt the one in most general use. It consists of the transit man, and two chainmen or backsight and foresight as they are sometimes called. With a rapid instrumentman in charge, there will be little delay in such a party as this, each man having practically about all he can do to keep up his end of the work.

Occasionally, where greater speed is necessary, as well as more detail, a four- or even five-man party is used. Such a corps, however, is usually split into two divisions. Thus, one section, including the chief of the party, takes the lead, establishing the stations, measuring the distances, and taking the necessary side notes. The second section, which is the transit party, follows, turning the various angles, and also, as a rule, measuring the distances as a check on the work of the first party.

An organization such as this has obvious advantages over the smaller party. Thus the transitman can confine his entire attention to his instrument, which will do much to eliminate the inaccuracies in this work; the possibilities for error are greatly enlarged where the transitman is obliged to divide his attention between his instrument and directing the work of the other members of the party; particularly is this so where his assistants are untrained. The larger party is also able to cover the work in greater detail. On the other

hand, a corps of this size is liable to be unwieldy and is a rather cumbersome proposition to handle underground; it is obviously less economical than the three-man party.

The five-man party is confined more particularly to the anthracite fields, where the conditions vary widely from the ordinary bituminous practice. The methods of the Lehigh Valley Coal Co. were described in the *Engineering and Mining Journal* as follows:

A mine-surveying corps is generally composed of five men, backsight, foresight, second-noteman, first-noteman and transitman, the latter being in charge of the party. The backsight carries a single rod, transit plumb-bob, an extra supply of bob cord and a two-quart can of oil. His duties are to help the second-noteman orient or "set up" the transit over the "spot" established by suspending the bob from the station. This is the temporary or trial set-up. The backsight then inserts his rod into the station hole suspending the bob over the transit-head point on the telescope, while the transitman by means of the shifting plate permanently orients the transit.

The foresight carries a single rod with a cast-iron bob, paint can and brush. He selects the most advantageous position for each station, both as to extension and good roof, sounding the top rock with his rod or T-drill. It is also the foresight's duty to help the second-noteman measure roof distance and record seam sections, besides giving sight to height of instrument for vertical angle, and painting the station number on the roof near the station.

The second-noteman is provided with an 8- or 10-ft. measuring pole which he uses to estimate the offsets at all ribs and intermediate points. The first-noteman acts as assistant transitman and records such notes, other than transit observations as are required. While the backsight and second-noteman are setting up the instrument, the transitman looks up his references and backsight course, and records at least some of the notes for the section connected with the previous survey.

**Chief of the Party.**—By this term is meant the man in charge of a four- or five-man corps. The first qualification of such a man is a broad underground engineering experience. It is essential that he be thoroughly familiar with idiosyncrasies of the underground workings, so that he will be able to judge promptly and accurately the best method of procedure in the face of the unprecedented obstacles which are always arising on mine work.

The chief of the party leads the way, accompanied by one or two chainmen. It is preferable that one of these latter be a workman

in that particular mine or section of the mine, so that he will be perfectly familiar with the workings and able to give the chief any information he may require. The chief proceeds with his party, establishing the stations at the most advantageous points, to insure the greatest rapidity in covering the ground. This party also usually measures the distances between stations and takes the side notes. It is possible to exercise a great deal of ingenuity in the location of the stations so as to accelerate the work, as for instance, it is clear that these should be as far apart as practicable, so as to insure the minimum number of setups of the instrument.

**Transitman.**—It is becoming difficult in modern times to obtain good, efficient and reliable men on instrument work in the mines. Underground work is naturally not attractive to the average young engineer, although when once broken in he usually prefers to be inside during extremes of weather, either hot or cold. However, the work is more or less underpaid, considering the qualifications demanded, and as a rule the engineer scarcely becomes proficient on his work till he is either advanced into the operating department or branches out into some other line.

It is desirable, but by no means necessary, that the transitman be a college graduate, although, as a matter of fact, the practical man who has fought his way up by hard knocks will have a certain advantage around the mines. The most essential qualifications of a good instrumentman are experience and an unlimited patience. While it is a comparatively simple matter to learn how to run a transit and read the vernier, no one can become really proficient and accurate without long experience. In fact, it might be said that there is a great deal of intuition about running an instrument on mine work. The experienced transitman is instinctively and perhaps unknowingly applying continual little checks and tests to his instrument, his work and himself, that perhaps while unimportant in themselves, when all combined, they determine the real character of the man's work.

As his name implies, the transitman handles the instrument work of the party exclusively. He carries (or at least should carry) his instrument, and is responsible for its condition. Upon him and the head chainman or foresight depends the entire speed of the party; if the roof is hard so that the foresightman is delayed in getting in the new stations, the party may be obliged to wait on him, but as a rule, unless the instrumentman is very rapid, the reverse is true.

In the five-man party the transitman is relieved of a great deal of



responsibility and is thus able to give the actual instrument work closer attention. But in the three-man party the necessity of directing the location of the new stations, assisting with, and in fact quite often doing the chaining himself, as well as taking the side notes and providing ways and means for overcoming an unending series of unexpected contingencies, devolves on the instrumentman. They are apt to have a serious effect upon the accuracy of his work, especially if he is of an irascible disposition.

**Chainman and Backsight.**—The embryo transitman must always serve an apprenticeship on chain and sight work. He may be either an ambitious young chap around the mine, or a recent graduate from a mining school. The head chainman on the three-man party should be an active intelligent man and one who can be relied upon to hold the tape accurately. The brunt of the work usually falls upon him. He must go ahead establishing the new stations, raising intervening curtains, and exercise care and judgment in selecting the location of the stations. Unless he works rapidly the transitman will have the backsight taken before the foresight is ready. The head chain is favored, however, in many little ways, such as being "permitted" to carry the instrument occasionally, and also practise in setting it up during intervals when the party is waiting the passage of a trip or some other contingency. The rear chainman or backsight's duty consists only of following the party and giving an occasional backsight.

## CHAPTER VI

### ENTRY SURVEYING

**Picking up the Starting Stations.**—Having the party finally organized they proceed to the entry in the mine where their work is to start. The transitman or chief of the party refers to the notes of the last survey in this entry which may be either in the current book for that mine, or the one preceding. The party then proceeds in the entry to the last two stations of the previous survey, these being located by their proximity to certain rooms, cross cuts, or side entries, as shown in the side notes of the previous survey. Thus according to the side notes the next to last station may be 18 ft. outside of room No. 32, and the last station 41 ft. inside of the second cross cut inside of room No. 32. The stations are further checked up by the rights and lefts according to the side notes. Occasionally where heavy timbering is being done a station may be shifted 2 or 3 ft. from its original location, and yet to all appearances be the same. Such a contingency does not happen often without effecting the distance between stations, so that checking this will usually suffice to prove that they are intact. In exceptionally bad ground, however, it is well to set up the instrument at the next to last station and turn the last angle of the previous survey to insure complete accuracy.

**Setting up the Transit.**—There are two ways of setting up the instrument on mine work, either directly under the station or by plumbing down from the station and establishing a point accurately below it and then setting up over this point. When using this latter method, it is the duty of the foresight to set the point on the floor while he is giving the sight on his station. This method is slower than setting up directly under the station and is more liable to inaccuracies; it is not to be recommended.

Setting up under a station appears to the beginner as an exceedingly difficult, if not hopeless, task. However, a little experience with this method soon makes a man proficient at it, and, if he expects to follow mining work, he will do well to master this in the beginning. When setting up over a point, it happens quite often that in moving around and setting the transit leg, the point established on the floor is disturbed; when this occurs, it is necessary to pull the transit up

and reset the point. Sometimes, after the instrument is entirely set up, it may be thought that the point has been moved when it really has not. In addition to this, when setting up under the station, the instrumentman has both the point and the bubbles directly under observation all the time, whereas, in setting up over, he must either have two lights or take the one out of his cap and put it down to the plumb bob to see how his center is.

When setting up under the station, the instrumentman first hangs his plumb bob in the station, having the point at about the height which he wishes to set the instrument. The tripod plate is then brought as nearly horizontal as it is possible to judge by the eye. In doing this, it will be found that the instrument as a whole has been moved to one side from the station. This is where the difficulty arises in setting up under the station. Leveling up always displaces the point and, *vice versa*, in getting under the point, the instrument is thrown out of level. It is, therefore, necessarily a cut-and-try procedure. With a little experience, however, a man soon becomes remarkably adept.

In setting up under the station, it is, of course, necessary that the instrument be provided with a point on the telescope exactly over the theoretical center; nearly all mining transits now have such a point. This will, of course, only be over the exact center when both the horizontal plate and telescope of the instrument are exactly level. The first time the instrument is leveled up, the telescope bubble should also be leveled at the same time, and then clamped securely in place. After that, it is only necessary to level with the lower bubbles. When the instrument has been brought within about half an inch of the exact point, the remainder can be gained by loosening the lower level screws and shifting the head bodily.

The new transitman is very prone to waste time in unnecessary accuracy in setting up the instrument. On the other hand, he may be lacking in accuracy when same is essential, and it is well for him to investigate just what refinement is necessary along this line. Thus, for instance, in a sight 100 ft. long, an error in reading of 1 min. means a difference of .029 ft., or about  $\frac{3}{8}$  of an inch; in a sight 50 ft. long, 1 min. amounts to .0125 ft., or about  $\frac{3}{16}$  of an inch. With a sight 25 ft. in length, as may occasionally occur in a very crooked entry, or in taking a sight through a cross cut for a check, 1 min. amounts to only .00625 ft., or about  $\frac{1}{16}$  of an inch. It is therefore seen that the shorter the sight, the greater care and accuracy must be exercised in setting up the instrument.

Another difficulty which often troubles the beginner on instrument work is locating the cross hairs when sighting along a dark entry. An interesting discussion occurred in *Coal Age* on this subject, started by an engineer of the Great Western Coal & Coke Co., who said in substance:

In discussing practical problems in mine surveying with several engineers in this district, I find that many of them are still using sheets of white paper torn from note books, etc., to reflect the light upon the plumb bob in taking "sights" below ground. This method requires the illumination of the cross hairs in the instrument.

I find that a small piece of tracing cloth about  $6 \times 9$  in., held 2 in. behind the plumb bob or string and illuminated from behind, will show good results in sighting up to 300 ft. (depending on power of telescope), and no illumination of cross hairs is necessary. They will stand out clear upon the illuminated tracing cloth. The cloth will easily last one or two days.

To which an Indiana engineer, speaking of the same method, says:

I first used this practice about three years ago, at the mines of the Rock Island Coal Mining Co., Hartshorne, Okla.; and we are using the same method at the present time in surveying the mines of the Consolidated Indiana Coal Co., Hymera, Ind. The method is an old European practice and is explained in some European textbooks on mine surveying.

While a Tennessee engineer offers the following improvement:

Referring to the illuminating of cross hairs in a surveying telescope, I would suggest the following improvement: Obtain an embroidery ring and insert a sheet of tracing cloth between the rings and clamp it. It is as tight as a drumhead and you can see the cross hairs and plumb-bob string with no illumination other than a lamp held behind the screen.

A Hibbing, Minn., engineer, in the *Engineering and Mining Journal*, found: that tracing cloth held behind a plumb-bob string works well when the mine is dry, but if there is any water dripping, the cloth soon becomes soaked and useless. To overcome this difficulty I use the heavy-oiled sheet in which the blueprint paper is wrapped by the manufacturer. I find that the water has little effect on it and that it lasts much longer than tracing cloth does under the circumstances. Moreover, it gives just as good results. The method is especially good when an acetylene lamp is used behind the paper instead of a candle.

But another writer in the *Engineering and Mining Journal* found even a better method for use with the acetylene lamp as follows:

The time-honored method of giving a sight for the underground transit, has been to use a piece of tracing cloth held between the plumb-bob cord and the candle. With the growing use of the acetylene lamp for surveying, this method is not wholly satisfactory. The hot, jet flame of the lamp, unless closely watched, is destructive of the tracing cloth. One method of avoiding the difficulty is to use the hemispherical reflector with its surface somewhat dulled. A skillful helper can so hold a lamp thus equipped as to conceal the flame behind the bob while the top part of the reflector forms a white background for the head of the bob and the string. It is difficult, however, to keep the reflector clean of soot and rust on the one hand and not too dazzlingly brilliant on the other. Obviously, a device designed for the purpose of giving sights would be more satisfactory, and such a device, Fig. 17, is now offered for sale.

It is constructed of sheet iron 2 in. wide and  $7\frac{1}{2}$  in. long bent to an elliptical curve so that all parts are well illuminated, and painted with a white enamel. It has a hole in the center through which the lamp burner

projects. A small piece riveted to the back consists of a nipple to slip over and grip the lamp burner and two eyes, to which is attached a strap embracing the lamp and holding the reflector on. As seen, the reflector has its long dimension horizontal when the lamp is upright. This permits it to be worn in the cap without danger of its striking the back. In use, the lamp is tipped on its side and the flame being concealed by the bob so as to eliminate all glare, the reflector then forms a white strip, showing the top and bottom of the bob and an inch or so of cord. The lamp in this horizontal position will burn long enough to give a sight. If desired, the reflector can be easily detached and carried in the pocket.

Not only is this device quicker and neater than the tracing cloth method, but it also gives a clearer sight and can be manipulated with one hand. The only precautions necessary are to hold the reflector plumb and to keep the lamp flame concealed.

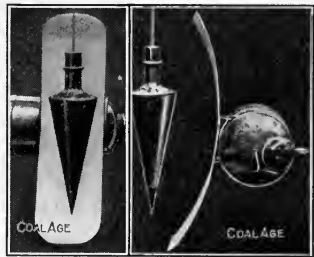

FIG. 17. REFLECTOR FOR THE ACETYLENE LAMP.

**Turning Angles.**—There are three general methods of turning angles, only two of which are considered good practice in mine surveying. Occasionally, where some railroad man has been placed in charge of mine surveys, we find that he adheres to the old method of turning simple rights and lefts. Thus, he sets the vernier on zero, reverses the telescope, takes his backsight, plunges the telescope, and turns either a right or left, as the case may be. This method has the disadvantage in that inaccuracies may occur in setting the instrument on zero each time, and it does not permit of carrying the azimuth as the work proceeds. It has also been found that a great deal of confusion often occurs as to whether the sight is a "right" or a "left."

The system of doubling angles, while rather slow, is very accurate and has a great deal to recommend it, although it also has the disadvantage of not giving the azimuth which is often so essential to have on mine work. However, azimuths can be computed as the survey is run along if necessary, although it is well to eliminate all work of this kind with the field party, since it involves unnecessary delays and possible inaccuracies.

In doubling angles, the vernier is set on zero, the backsight taken, and the complete horizontal angle turned to the foresight. The angle is then read, the lower clamp loosened, and another backsight taken without disturbing the vernier. The plates are then loosened and the complete horizontal angle turned again as before by taking another foresight. Obviously, the reading of this second angle should be twice that of the first.

Assuming that the first reading was  $174^{\circ} 20'$ , the second would, of course, be  $348^{\circ} 40'$ . Or, if the first reading was greater than  $180^{\circ}$ , say for instance,  $186^{\circ} 25'$ , the second must necessarily exceed  $360^{\circ}$  by twice as much as the first was greater than  $180^{\circ}$ , or, in this instance,  $12^{\circ} 50'$ . In the practical use of this method it is often found that a discrepancy of one minute occurs in the two readings, so it is generally advisable to turn the angle three times in order to determine which way this one minute should be thrown, as it is not customary to carry fractions of a minute in ordinary mine work. In addition to eliminating inaccuracies in reading angles, this method also insures against any poor adjustment of the instrument for collimation which is often quite an item with some instruments that are found around coal mines.

The method of continuous vernier is by far the most rapid and accurate system when in the hands of a good man equipped with a well-adjusted instrument. It also has a peculiar advantage in that

it is impossible for accumulative errors to creep in on a long survey as is the case with either of the two previously described methods. In this system the instrumentman, instead of setting the vernier on the zero, places it on the azimuth of the two stations he is starting from. Thus, for instance, assume the azimuth of these stations to be  $184^{\circ} 12'$ ; the vernier is accordingly set on this angle and the backsight taken with the telescope reversed. Turning the telescope over, the instrument is then pointing on the true azimuth and the party is ready to proceed. The foresight is taken and the instrument picked up and moved ahead to the new station without disturbing the vernier, the angle, of course, having been read and recorded. Setting up at the new station, the backsight is taken with the telescope reversed, and the operation repeated as before.

It will thus be seen that the entire operation of the survey is carried forward without it being necessary for the instrumentman to be obliged to set his vernier, with the single exception of at the starting point. By the other methods, where the instrument is set at zero, each time a mistake of say a quarter of a minute in each setting, or in reading the final angle, would make possible an ultimate error of five minutes in a survey of twenty setups. Such a contingency could not occur in the continuous vernier method. Furthermore, a mistake in reading one angle would not affect the accuracy of the succeeding ones. In using this method the principal inaccuracy to guard against is the chance of the vernier being moved when the change is made from one station to another as may inadvertently occur when setting up or passing through a curtain when the slow-motion screw is liable to be moved.

**Straight Line Work.**—A great deal of the mine work, particularly in flat seams, consists simply of straight line work, and instead of running a meander survey, the instrument is used only for projecting straight lines ahead or turning occasional angles for starting off new entries. Work of this character varies a great deal in the accuracy required. In a rope haulageway the engineer must exercise the greatest caution to avoid the possibility of any deviation from an absolutely straight line. This also applies to the more important main headings.

On such work it is well to test the accuracy of the instrument continually. When setting up at the last station, the line should be checked by taking more than one backsight, particularly where there is a possibility of the station having been disturbed, as is the case where the roof is bad. In projecting the line ahead, it is also well to check the instrument. When one point has been set ahead, the

telescope should be reversed and plunged in the opposite direction, in order to assure that there is no inaccuracy in adjustment.

It is not well to try to attempt to set line sights at too great a distance; after one point has been obtained near the face the instrumentman should move up there and set two stations from that point for the use of the workmen. On butt entries, which are relatively short, such a refinement in lining is seldom necessary.

The practice of the Consolidation Coal Co. in setting sights or pointers was described in *Coal Age* as follows:

"Pointers" are set as often as required to facilitate good alignment. These "pointers" consist of two steel spads, shown in Fig. 18, placed in the roof in wooden plugs driven into holes drilled for that

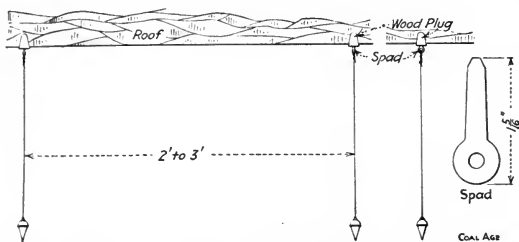

FIG. 18. METHOD OF SETTING "POINTERS," CONSOLIDATION COAL CO.

purpose. They are spaced not over 3 ft. apart in order that the strings hung from the spads may be easily seen when one light is used in lining over them. All "pointers" indicate the center line of the heading.

It is sometimes the practice to place the sights close to one rib which compels the miners to drive their places with great accuracy. Commenting on this method *Coal Age* says:

The question of whether the sight line should be located in the center of the entry or at the rib is one of preference. Most entry drivers prefer the sight line located about 1 ft. from the off rib of the entry, or on the opposite side from the entry cross cuts. When the line is located in the center of the entry the sights are often disturbed and frequently lost. In this position also, it is more difficult to keep the entry straight than when the line of sight is close to the rib.

To which an engineer of the Lehigh Valley Coal Co. added the following:

Referring to the question of the best location for placing sights



when driving an entry, permit me to say that I believe a location 1 ft. off the rib is proper in pitching or chute places, where the line would then be over the manway and readily accessible not only for the foreman or miner, in lining up the place, but also for the engineer, who may be called on to extend the line farther up the breast.

In a flat seam or roadway, however, I believe that the line should be set at about 8 ft. from either rib, assuming the places are driven 16 ft. wide; the sight line would then be in the center of the entry. My reasons for choosing this position are: First, if the seam is dirty, the refuse must be gobbled on the rib, and 8 ft. will allow the sight line to clear the gob easily. Second, if the sights are any distance from the face, the brattice extended from the inside cross cut toward the face is liable to interfere with the line of sight, unless it is kept at a sufficient distance from the rib. In this case, allowing 5 or 6 ft. for the width of the brattice, a distance of 8 ft. will give a good clearance for the sight line.

**Chaining.**—The term chaining is rather a misnomer as applied to mine surveying. The chain proper is a relic of the older days, and is used entirely on outside work, principally railroad surveying; it is entirely out of place in the mine. Instead, a thin flat wire tape, such as has already been described, usually from 300 to 500 ft. in length, and equipped with a good practical reel, capable of withstanding considerable rough handling, is used. These tapes are usually only graduated every 5 ft., although occasionally some are found 3 ft. and even 2 ft. With good chainmen 5 ft. is sufficient.

With the three-man party, when the foresight goes ahead to put in his new station, he should take the large end of the tape, with the reel, ahead with him. After the angle has been read he selects the nearest 5-ft. graduation, which he holds accurately at the plumb-bob string and the instrumentman pulls the tape taut, taking care to see that it is free its entire length, and catches the exact distance on the tape with his finger; he then measures to the nearest 5-ft. mark with a small self-winding 5-ft. steel tape graduated to hundredths. The head chainman calls out the mark he is holding, and the transitman makes the necessary addition or subtraction and records the distance.

Accurate measuring underground is rather difficult, particularly when the chainmen are not experienced or are unreliable. It is necessary that the tape be stretched very tight in order to eliminate the inaccuracy due to sagging, and, since it is usually little more than a thin wire, it is difficult to hold it accurately on the point. At the

end having the handle, this can, of course, be gripped firmly, but the man at the other end must depend upon his hands alone. Some devices have been put on the market for overcoming this, with more or less good results, and half a turn of the tape around the waist is also of great assistance. The instrumentman usually prefers to read the tape himself and take his own measurements in so far as he is able to do so, unless he has perfectly reliable chainmen.

All measurements must be taken in a horizontal plane, and where this is impossible, as, for instance, on a slope, the angle of inclination is taken with the transit and the slope distance measured. Thus, the head chainman usually sets his plumb bob at the height he wishes to measure and gives the transitman a sight at the top of it. When the measurement is taken, he then holds the tape at the same point and the transitman measures to the instrument. Having given the angle of inclination and the slope distance the horizontal distance is easily computed.

Some companies still continue to measure to only tenths of a foot, but, as a rule, most of them now measure to hundredths. This, of course, depends a great deal on the character of the work. In a small mine of comparatively limited area and life, a tenth of a foot is sufficiently close for all practical purposes, but, with a large colliery, the accumulated error where only tenths are used, might become so large in time as to involve serious possibilities. Furthermore, when it is understood by the men of the party that the accuracy demanded is so fine, it has a beneficial psychological effect.

**Taking Side Notes.**—The measurement having been completed, the party then proceeds to take the side notes, that is, locate all rooms, crosscuts, side entries, and the ribs of the entry along which the survey is being made. The tape is first stretched accurately on line, the zero end being held exactly at the instrument. One of the chainmen proceeds along the entry, stopping at each room, crosscut, or any other feature which it is desired to locate, and reading the tape at that point. He calls this out to the instrumentman, and also gives the right and left, that is, the distance from the tape to each rib at that point.

Sometimes these rights and lefts are measured, but more ordinarily they are simply estimated by stepping; this depends on the scale to which the map is drawn and on the general standard which it is desired to maintain. Where a map is drawn to a scale of 200 ft. to the inch, it is not possible to show the rights and lefts along an entry with sufficient accuracy to justify any particular pains in taking them.

**Making Checks.**—As the survey proceeds, the instrumentman should utilize every possible opportunity for testing and checking the accuracy of his work. Also it is well to make all measurements twice. With unreliable chainmen this will serve to make them more cautious about their work. It is also well to take a needle reading with the compass every few stations; of course, this cannot be accepted as the basis for any readjustment in the instrument work, due to the possibility of the needle being attracted, but it will often serve to pick up a large error of a number of degrees.

Where surveys are being carried in two parallel entries, an occasional check should be made through the last crosscut, say about every 1000 ft. This does not require much time, and establishes the accuracy of the work beyond all question. It is also well, when the opportunity is afforded, to make a tie survey between adjoining sets of entries when a room or a connection of some kind has been made. This affords a supplementary check in addition to that obtained between the two parallel entries, and further verifies the work. A good engineer will never fail to accept an opportunity to check up his work.

**Kinds of Stations.**—The character of station used varies generally according to roof conditions. The station most commonly used consists of an ordinary horseshoe nail flattened out, preferably under a steam hammer, and with a hole punched about the center, sufficiently large to permit the plumb bob string to be inserted without any trouble. Sometimes, where roof conditions are particularly favorable, that is, a firm tenaceous shale, these horseshoe nails, or as they are commonly termed, spads, are driven directly into the roof, a small hole, about  $\frac{1}{8}$  in. in diameter, being drilled for their accommodation by means of a small jigger drill.

More commonly, however, the spads are inserted in wooden plugs driven in the roof. Sometimes these plugs are round and about  $\frac{5}{8}$  in. in diameter, and the hole in which they are placed is drilled by means of an ordinary carpenter's brace equipped with a special chisel bit; they are usually drilled from 1 to 2 in. deep. In addition to this, some districts use a plug about 2 in. square, made usually by cutting a 2×4 in two pieces, and about 2 in. long with a sharp but rather abrupt point. Holes for these plugs are made with an ordinary miner's pick, and the principal advantage of this type of station is that the party is not obliged to be overburdened with any excess tools.

A writer in the *Engineering and Mining Journal* describes another

type of station and drew the following interesting conclusions on this subject:

For a number of years the standard spad for underground surveying was a horseshoe nail with the head flattened and punched or slotted to receive the plumb bob cord. A few years ago, a substitute was proposed consisting of a wire nail with a triangular file-cut half-

way through the rim of the head, the nail being inclined when driven, so as to bring the notch on the upper edge of the head. Considerable experience with both types has brought out the following points:

(1) The wire nail is stronger and better resists chance blows or blasting, if set near the face.

(2) It is cheaper and easier to make.

(3) It makes the plumb bob easier to hang in the first place, but slower to adjust for height.

(4) It is more accurate. Any one size of plumb bob cord can occupy but one position, whereas in a hole the cord can climb the side and be off-center by a small fraction of an inch.

(5) It is not suitable when it must be set in a position difficult to reach. In such cases, it is customary, with the old-style spad, to hang a permanent loop of cord down to a point within easy access. This is not possible with the wire nail.

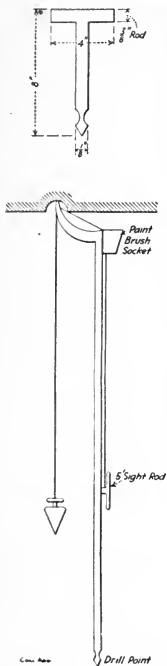

FIG. 19.

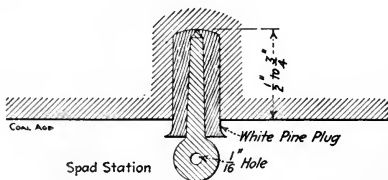

FIG. 20. DETAILS OF THE SPAD STATION.

The unusual physical conditions prevailing in the anthracite regions has resulted in a distinctive type of station being adopted there. The practice of the Lehigh Valley Coal Co., as described in *The Engineering and Mining Journal* several years ago, was as follows:

Two general methods of putting survey stations in a mine have

been successfully used; the first is the "drill-hole" station, and second, the "spad" station. The drill-hole station is made by means of a small "T"-shaped drill with a  $\frac{1}{8}$ -in. bit; the latter may be mounted at the bottom end of the single rod, Fig. 19. The spad station, Fig. 20, consists of a spad (either steel, copper or bronze) driven into a white-pine plug wedged into a  $\frac{3}{8}$ -in. drill hole, from  $\frac{1}{2}$  to  $\frac{3}{4}$  in. deep. The advantages of the drill-hole station over the spad station have been substantially proved.

**Painting Stations.**—As a rule, most engineers paint a circle around the stations and the number so that they may be found readily and also reduce the liability getting the wrong station. Such a plan has much to commend it but it also has the disadvantage of attracting the attention of mischievous drivers or trapper boys who will occasionally destroy the station. Should it be desired to do this, however, a writer in *Coal Age* offers the following suggestion:

The indistinctness with which engineers' centers and bench marks are painted on the roof and ribs in coal mines, would largely be corrected were slaked lime used in place of white lead as a pigment. The lime must be well slaked or it will burn the brush. The objections to lime are the greater weight to be carried and the change of condition, which takes place as it begins to set, often changing a too liquid mixture to one that is too stiff. These are the advantages: A legible mark of an intense white which will last for years, which is scarcely dimmed by smoke, and the use of a material which can be found in almost any plant and which costs but little. Some people prefer to add salt to the water in which the lime is slaked. Whiting does not appear to be preferable to lime. If possible, it would be well to repaint the lime marks after a few minutes' time have elapsed, with the idea of making them more strong and more prominent, but this is not by any means necessary.

With the Consolidation Coal Co. stations are marked with a painted white circle around the spad and the number on the nearest rib. Pointers or sights are designated by crosses, the center of the cross being the spad.

**Numbering Stations.**—Although many engineers believe that the same station numbers may be used in different entries or different parts of the same mine, this is not generally considered as good practice. It occasionally happens that the physical conditions in some mines are such that there is little probability of confusion, but numbers are cheap and to remove any possibility whatever of trouble in this connection, it is just as well to have no two stations in the same

mine with the same number. The following method of the Consolidation Coal Co., as described in *Coal Age*, is an excellent system to adopt.

Each mine has its individual set of station numbers, beginning with one and running up consecutively, except in room work where the stations are more or less temporary, and where a continuous system would cause a too rapid increase of station numbers. In front of each room is set a station, and designated in the notebook by a fraction, the numerator of which indicates the room number on that heading and the denominator the station number. Thus  $\frac{6}{1}$  indicates the first station placed for room number six,  $\frac{7}{3}$  indicates the third station in room number seven of that particular heading.

Station numbers need not follow consecutively on any particular heading, neither are they spaced at particular distances, except when turning off entries. The plus system of numbering stations is never used. Thus there may be three or four consecutive numbers on one heading and the next higher station number will be in an entry in an entirely different section of the mine. However, as each mine has all its survey notes recorded in a book for that particular mine alone, it is no trouble to locate the last station number used.

## CHAPTER VII

### KEEPING SURVEY NOTES

#### TRANSIT NOTES

The accompanying illustration, Fig. 21, shows a good system of keeping field notes on a continuous vernier survey. It might be well to state here that there are almost innumerable ways of recording mine survey notes, and each engineer usually works out a system according to his individual ideas on the subject. However, the method here shown is a good practical system, and one that might be adopted by all engineers with few variations.

The heading "Survey of the Thirteenth South Entry" with the personnel of the party and date, is similar to that explained later for leveling. The first column is used for the station number; that is, the two stations for which the azimuth and distance are determined. The second column is for the azimuth, and the third for the bearing, this latter seldom being used in actual practice in the field, although occasionally it is convenient to note the needle reading in order to serve as a check on the azimuth. The fourth column is used for recording the vertical angle when measuring on highly inclined seams, and the fifth column the tape reading of the same. The last column is used for recording the horizontal distance which, as will be noted, is that most commonly given.

Care should be exercised in checking and noting the starting stations. Thus it is well to note at the beginning of each survey, as shown in the figure, the station from which the work is started; in this case it is shown that the instrument was set up at station 1361, and that the backsight was taken on station 1360, reference to which was found in book 9, page 64. In order to avoid any possibility of error or misunderstanding, the azimuth and distance of the starting stations are also recorded at the beginning of each new survey.

As will be observed the notes for the survey of the main entry are first given, after which a similar line is run in the air course. It will also be noted that the survey in the main and air course were tied through the last crosscut; this is good practice, and all surveys should be balanced up in this way at certain prescribed intervals; it

does not necessarily involve much time as the next to last station can be placed in front of this crosscut, and an extra sight taken through, while on the regular entry survey. The notes for this work can be readily followed out, and it will be observed that a tie of zero degrees, one minute, has been effected.

Most engineer's field books have the right-hand page ruled in a somewhat similar way to cross-section paper. On this page the side-notes corresponding to the survey notes on the opposite page are

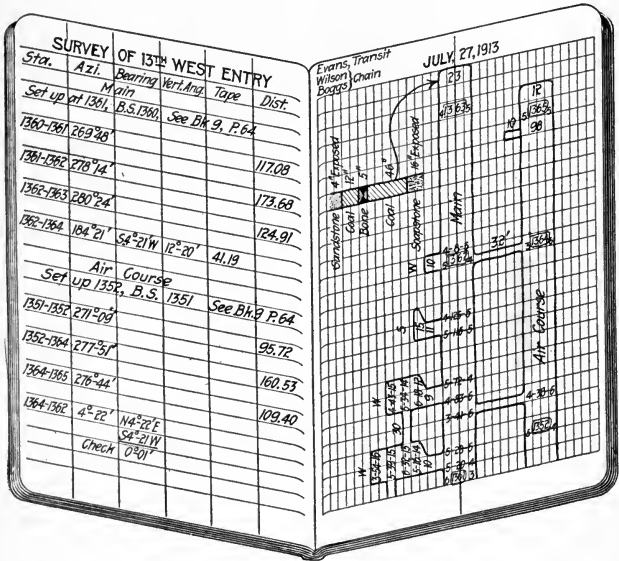

FIG. 21. SKETCH SHOWING A TYPICAL METHOD OF RECORDING MINE SURVEY NOTES.

usually kept. Thus it will be noted that the survey of the main entry started at station 1361, which is inclosed in order to distinguish it from the other figures indicating distances. After the measurement has been taken, the tape is laid on the bottom and the chainman goes along and picks off the distances to all the points which it is desired to locate. In this instance, we find that he comes to the first rib of a room at 20 ft., the second at 28 ft., while a crosscut is found at 41 ft.; another room at 83, and so on. The chainman



at the same time calls out the "rights and lefts"; that is, the distance from the chain to the side of the entry on each side. And so the party proceeds along the entry, gathering all of this supplementary data which, filled in on the skeleton of the mine survey, makes the completed mine map.

The rooms are measured and sidenotes taken in a similar fashion, it being customary where great accuracy is desired to set the instrument up in front of each room and take a rough sight to the face; this is hardly necessary, however, in a well-systematized mine since these rooms should all be driven on centers. Where the rooms are working, that is, still being driven, it is well to put a "W" at the face, as noted in the sketch, Fig. 21, and an "S" where they have been stopped, as will be noted in the next to the last room which has evidently been stopped for some reasons. A great many companies also require their engineer to take a section of the coal at the face of the entry at the time of the survey. A convenient method of sketching such a section is also shown. Where no regular maps are kept for recording sections of the seam such information may prove of some value at times, and it is well for the engineer to acquire the habit of doing this.

The methods of keeping notes in the anthracite regions vary considerably from that in the bituminous mines. The practice of the Lehigh Valley Coal Co., which may be accepted as typical of the hard-coal districts in general, was described in the *Engineering and Mining Journal* as follows:

A special volume is kept for transit readings, while "offset" notes are recorded in a separate book. Fig. 22 represents a page of notes as recorded by the first-noteman. The date, seam and organization is noted at the foot of the page and all observations recorded reading from bottom to top.

The figures along the left margin [(a) Fig. 22], indicate the plusses on the tape with 0 at station 450. Figures to the right and left of the dotted line (transit line) indicate offsets to ribs. The measured distance between stations 450 to 462 is also recorded. At the face, station 462 + 10, a dip of  $10^{\circ}$  "in and to the left" is indicated; it is also noted that section 60 (S-60) was taken on the right rib at face. Offsets are taken at 20-ft. intervals and are called out to the first-noteman who records the figures.

Vein-section measurements are noted by the second-noteman and verified by the first-noteman, as is also the dip, direction and strike of the seam. The sections are recorded in the back of the

side-note book, writing forward, fully referenced. As for example, S-60, page —, station 462 + 10. A section of seam is recorded as follows:

## HARD SANDSTONE ROOF

	Coal.	Slate or Bone.
= Benches have no parting		0'.4
0.4 < Boney coal		
2.7 = Coal	2'.3	
= Benches have parting		0.4
3.1 = Slate		
4.1 < Coal	1.0	
4.9 = Boney coal (streaked)		0.8
7.9 < Coal	<u>3.0</u>	
	6.3	1.6
Total.....		7.9

10		$10^\circ$	16	7	S60	15		Roll		$16^\circ$
462	83.90	24'	13	9		463	84.51	8	10	13
80			14	8		82		12	12	26'
60			11	12		75		13	10	
42			13	10		70		10	12	
35			10			53		12	10	
30				12		40		10	12	
25			8	13		22		12	10	
20			10	12		10		10	12	
450	Feb. 1, 1908 Ross Vein					455				
Perry & Smith										
a						b		COAL AGE		

FIG. 22. METHOD OF TAKING SIDENOTES IN THE ANTHRACITE REGIONS.

The notes in (b), Fig. 22, indicate a roll or fault from station 455 + 53 to + 88 along left rib. Also a roll in the face dipping  $16^\circ$  and in a diagonal direction from right to left, and indicated as a down-throw.

The transit, after set-up is satisfactory, is sighted to the backsight station, and then the new station is observed and readings recorded as shown in the accompanying table:



As will be noted the horizontal angle is measured in azimuth, with  $0^\circ$  as south,  $90^\circ$  = west,  $180^\circ$  = north and  $270^\circ$  = east.

Station 450 is the set-up station, and 318 the backsight station. The roof distance, in order to obtain new datum for the levels, is

3 <sup>rd</sup> Quarterly Posting - Sept 20, 1913				
3 <sup>rd</sup> North - 6 Butt				
	Set up [327 B.S. [326			
327 - 326	282°30	Vol 420	P.32	
327 - Spad	102°30	O.K		
327 - 613	102°30	S77°30E	S77 E	171.32
			0°30	
	+25 & 35 = Rm #7 Rt.	+35 R6 L4	+31.20 =	
	$\frac{7}{7}$ +80 & 91 = xcL	+80 R5 L7	+84 & 96	
	Rm #8 Rt.	+92.10 = $\frac{8}{7}$	+142 & 153 = Rm. #9	
	in 10' +153 Rt.	7 R2L7	+149.30 = $\frac{8}{7}$	
	+165 & 174 xcl	+174 R5 L5	+192 - R6 L4	face Wkg.
613 - 614	12°45	N12°45E	N13°E	2501
			0°00	
614 - Pts.	102°30	102°30	S77°30E	S77 E
	+5 Cor	R5 L4	+20 =	face R5 L5 Wkg.
614 - 328	282°31	N77°29 W	N78°W	182.24
			0°50	
328 - 317	282°29	N77°31 W	Tie +0°01'	Vol.420 P.18
$\frac{7}{7}$ - Pts.	192°30	S12°30 W	S13°W	
	+15 R10 L5	+25 R13 L5		face Wkg.
$\frac{8}{7}$ - Pts	192°30	S12°30 W	S13°	

\* [ is symbol for station

COAL AGE

FIG. 23. THE CONSOLIDATION COAL CO.'S METHOD OF KEEPING MINE-SURVEY NOTES.

measured and recorded. In the third column the magnetic bearing of the line connecting the two stations is recorded; this is worked out during spare moments in the mine and is obtained by deducting  $336^\circ 55'$  from  $360^\circ = s$ . Readings between  $0$  and  $90^\circ$  are direct courses; between  $90^\circ$  and  $180^\circ$  are deducted from  $180^\circ$ ; between

180 and 270° deduct 180, and between 270° and 360° are deducted from 360°. The differences are the magnetic courses for corresponding quadrants.

In the fourth column for stations 450-462 will be noted  $\frac{+1.54 \text{ ft.}}{+5^{\circ} 15'}$ . This indicates that the vertical angle  $+5^{\circ} 15'$  was read at 1.54 ft. above H. I. (height of instrument), and the corrections are applied in the office work for calculating the correct "difference in elevation." This is obtained in the following manner: The cosine of  $5^{\circ} 15'$  times the tape distance 83.90 equals horizontal distance 83.55 ft., and the sine times the tape distance equals 7.68 ft., the vertical distance, but as the angle was measured 1.54 ft. above H. I. the true distance in elevation is  $7.68 - 1.54 = 6.14$  ft. Similarly a correction of 1 ft. is necessary for difference in elevation for stations 401-464, where the angle was measured 1 ft. below H. I. The sine for the distance and angle equals 5.73 ft., therefore the true difference in elevation is  $5.73 + 1.0 = 6.73$  ft. The algebraic

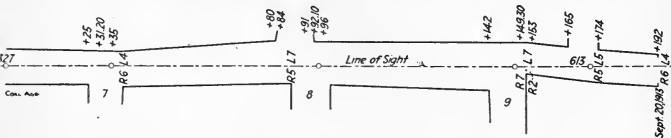

FIG. 24. PLOTTED NOTES SHOWN IN FIG. 22.

sign for these corrections represents the field operation and is the reverse of the algebraic correction.

The methods of recording sidenotes vary widely in all parts of the country and even in different mines in the same district.

The Consolidation Coal Co.'s method of recording sidenotes was described in *Coal Age* as follows:

In locating the various features of the mine work, sidenotes are taken from the established line of sight. The page of survey notes shown in Fig. 23 demonstrates this more clearly. It will be noted from these records that sights, or courses, are always checked between stations in order to make sure that the stations still occupy the same positions they did when they were set and the readings taken; also to catch up the possibility of an error being made when the stations were set. The accompanying Fig. 24 shows the entry plotted from these notes. At the face the date of the survey is marked to show the position the heading occupied at that time.

## LEVEL NOTES

The illustration, Fig. 25, shows the most approved method of keeping level notes. The notes are divided into five columns, the first being for the station numbers, the second "B. S." for the back-sight, the third "H. I." the height of instrument, the fourth, "F. S." the foresight, and the fifth, the elevation.

Sta.	B.S.	H.I.	F.S.	Eleva.
1517	(-1.13)	1320.04		
	0.53	16.38		1321.17
	0.14	10.92	(4.19)	15.85 ✓
	1.03	7.02	5.60	10.78
	0.31	1302.21	4.93	5.99
	0.71	1297.71	5.12	1301.90
1521	(0.23)	93.16	5.21	1297.00
	2.72		4.78	92.93 ✓
			(+1.28)	94.44
			25.64	
			2.72	1315.85
			22.92	1292.93
				22.92

Evans, Inst.  
Boggs, Rod.

NOV. 12, 1913

Reversed Rod on Sta. 1517. See Bk. 9 P. 124

Point of Frog Rm. 28

Oppo. 1st X cut I.S. Rm. 30

Point of Frog. Slant D.S. Rm. 34

Top of Rail between Rms. 37 & 38

Oppo. Rm. 40

30' I.S. 1st X cut I.S. of Rm. 42

Reversed Rod on Sta. 1521

FIG. 25. SKETCH SHOWING THE CUSTOMARY METHOD OF RECORDING MINE LEVEL NOTES.

Let it be assumed that instructions have been issued to extend the levels in the 15th South entry into the face, no special data being required, just the general elevations incident to the ordinary leveling process. The engineer refers to the notes of the last levels and finds that they were concluded on station 1517. He accordingly proceeds in the entry, locates the required station and, after assuring himself in every possible way that it has not been disturbed, he is ready to proceed with the new work.

Before starting he carefully arranges the headings in his notebook

as shown. Too much importance cannot be laid on the necessity for careful references and cross references of all kinds. First, the "Levels in 15th South" is of course essential to show where the work is performed. Next it is well to note the personnel of the party as "Evans, instrument" and "Boggs, rod." One of the chief reasons for giving such close attention to this matter is that grave questions may at times hinge on the accuracy with which the engineer's work has been performed. In all organizations of any importance, there are always men who establish a record for accuracy and conscientious work, and it is to be regretted that there are some just the opposite. Obviously, therefore, it is often a matter of great importance who the work was done by.

After setting down the date, the engineer then proceeds to note carefully the initial or starting point for his work, which, in this case, is station 1517, or as noted: "Reversed rod on Sta. 1517, see bk. 9, p. 124." This data should be carefully noted for the reason that should subsequent work show the elevation for this Sta. 1517 to be in error, it is, of course, essential that this be known in order to make the proper corrections in the succeeding work. The elevation of Sta. 1517 as obtained from bk. 9, p. 124 was found to be 1321.17, and this is accordingly set down in the column under elevation. The instrument is then set up and a reversed rod reading taken on the station.

This idea of establishing "bench marks" on the mine stations in the roof varies entirely from anything practised on surface work. The reason for this is that it is exceedingly difficult to get any reliable permanent points on the bottom which are not in danger of being disturbed. The bottom in a live mine is more or less constantly on the move, due to varying roof loads, and is also liable to be taken up in order to gain more head room. So it has become the accepted practice to establish all permanent reference points in the roof.

While it is customary to add all backsights to the elevation in order to obtain the height of instrument, this operation is, of course, the opposite where a reversed rod reading is used, the backsight being subtracted from the elevation instead of added. With the reversed rod reading of minus 1.13, as noted, the height of instrument therefore becomes 1320.04. The rodman then moves as far ahead as the levelman can see him, which, in this case, is at Room 28. For convenience, and as a possible future check, he holds the rod on the point of frog of this room. The reading at this point is found to be 4.19, which indicates that the new station is that distance beneath

the height of the instrument, and, accordingly, the difference between the two gives the new elevation 15.85. In keeping level notes, it is not the practice to carry the hundreds of feet along in either the height of instrument or elevation column, and these are accordingly omitted except where a change occurs as from 1300 to 1200 as is noted. The instrumentman now moves his instrument up ahead of the rod as far as he can see, and, taking a backsight, obtains a reading of 0.53, which means that his instrument is this amount above the station and the new height of instrument is, therefore, 16.38.

And so the operation is continued until we come to the face of the entry, at which point another bench mark is taken on Sta. 1521 for use in making future extensions. As in the previous case, this is a reversed rod reading, so that instead of subtracting the foresight, as we ordinarily do, this is added.

Now we arrive at the method of balancing the leveling notes. A little consideration of the level notes will show the reader that the difference between all the foresights added together, and all the backsights, must give the difference in elevation between the starting point and the concluding stations. But the reversed rod readings introduce complications in this method; however, since these are confined entirely to the initial and concluding stations of the survey, we may disregard them and confine our check to the intervening stations. Accordingly, adding up the backsights and omitting those having a circle (reversed rod readings), we get 2.72, and doing the same with the foresights, we obtain 25.64, the difference between these two being 22.92. Now, subtracting the difference between the second elevation from each end. that is, 1315.85 and 1292.93, we obtain a perfect check, 22.92.

Leveling practice of the Consolidation Coal Co. was described in *Coal Age* as follows:

All elevations on the inside are run by precise levels starting from bench marks on the outside established from U. S. G. S. bench marks. The readings are taken on the bottom of the seam every 100 ft. and in some localities closer, depending upon the irregularity of the coal. Every six months the levels are advanced to the breasts of the working places, no elevations being taken in rooms except for special purposes. Bench marks are also established ahead, usually being placed on a station or pointer in the roof and B. M. marked on the rib opposite. The method of recording inside level notes is shown in Fig. 26.



Levels in No. 1. North Heading June 20, 1909			(Left hand page)	(Right hand page)		
			{ Smith Jones         }			
B.M.	3.070	910.371		913.441	Spad in Roof at 3 <sup>rd</sup> Rt. =	[237 Vol. 420 P. 30
			4.20	Bottom at +1300		
			3.90	" " +1400		
T.P.	3.123	909.704	2.456	Spad in Roof = [503		
			3.10	Bottom at +1500		
T.P.	2.501	910.115	2.912	Spad in Roof = [504		
T.P.	4.113	910.615	3.613	Top of Rail at Switch		
			2.781	[237 Above		
			913.441			
			0045 = Tie		* [ is symbol for station	

Coal. Ace

FIG. 26. SYSTEM OF RECORDING LEVEL NOTES, CONSOLIDATION COAL CO.

## CHAPTER VIII

### SOME PROBLEMS IN SURVEYING

The following problems have been selected from among those submitted to *Coal Age* in the past two years; they represent a typical assortment of the many computations that the colliery engineer is apt to encounter.

**Problem 1.**—Given the data shown in Fig. 27 and it is desired to know:

- (a) The length of a proposed incline  $AB$
- (b) The depth of a vertical shaft  $BC$
- (c) The distance  $DC$  from the foot of the shaft to the mouth of the drift in the lower seam.

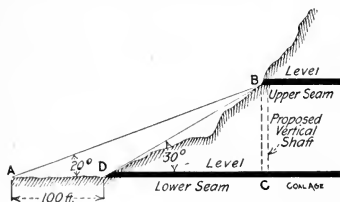

FIG. 27.

According to the law of sines we know that: The ratio of any two sides of a triangle is equal to the ratio of the sines of the opposite angles.

In the triangle  $ADB$ , designate the angles by the large letters  $A$ ,  $D$  and  $B$ , respectively; then:

$$\begin{aligned} A &= 20^\circ \\ D &= 180 - 30 = 150^\circ \\ B &= 30 - 20 = 10^\circ \end{aligned}$$

By the law of sines

$$\frac{AB}{AD} = \frac{\sin D}{\sin B} = \frac{\sin 150^\circ}{\sin 10^\circ}$$

But since the sine of an angle is equal to the sine of its supplement and *vice versa*, and  $AD = 100$

$$\frac{AB}{100} = \frac{\sin 30^\circ}{\sin 10^\circ} = \frac{0.5}{0.17365}$$

The length of the incline is then

$$AB = \frac{100 \times 0.5}{0.17365} = 287.93 \text{ ft.}$$

The depth of the vertical shaft  $BC$  is now easily calculated from the right triangle  $ABC$ ; thus:

$$\begin{aligned} BC &= AB \times \sin A = 287.93 \times \sin 20^\circ \\ &= 287.93 \times 0.34202 = 98.48 \text{ ft.} \end{aligned}$$

The distance  $DC$ , from the mouth of the drift to the point where the upraise should be started, can then be calculated from the triangle  $ABC$  by subtracting 100 from the distance  $AC$  thus found, as follows:

$DC = AB \cos 20^\circ - 100 = 287.93 \times 0.9397 - 100 = 170.57 \text{ ft.}$   
or, directly from the triangle  $DBC$ , thus:

$$DC = \frac{BC}{\tan 30^\circ} = \frac{98.48}{0.57735} = 170.57 \text{ ft.}$$

**Problem 2.**—(a) If the course of a main entry is due north, what is the course of a face entry turned off to the right, at an angle of

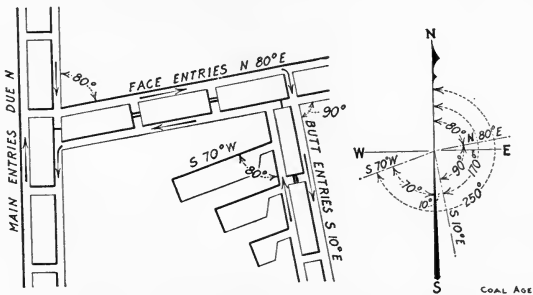

FIG. 28. PLAN OF MAIN, FACE AND BUTT ENTRIES, AND DIAGRAM SHOWING THE CORRESPONDING COURSES.

$80^\circ$ ? (b) What is the course of a butt entry turned off the face entry to the right, at an angle of  $90^\circ$ ? (c) What is the course of a room turned off the butt entry, at an angle of  $80^\circ$  to the right?

(a) In Fig. 28 the general position and direction of the main entries, face entries, butt entries and the rooms turned off the butt entries are shown. The course of the main entries being due north and the face entries being turned to the right an angle of  $80^\circ$ , the course of these entries will lie in the northeast quadrant, as shown on the right of the figure, and its bearing is  $N 80^\circ E$ .

(b) The butt entries being turned  $90^\circ$ , again, to the right, the azimuth of their course is  $80 + 90 = 170^\circ$ . Since this azimuth lies

between  $90^\circ$  and  $180^\circ$ , the course of the butt entries lies in the southeast quadrant. All bearings in the southeast and southwest quadrants being estimated from the south end of the meridian, the angle of bearing, in this case, is found by subtracting the azimuth from  $180^\circ$ . Thus,  $180 - 170 = 10^\circ$ . The bearing of the butt entries is then S  $10^\circ$  E.

(c) The rooms being turned  $80^\circ$  to the right of the butt entry, the azimuth of the rooms is  $170 + 80 = 250^\circ$ . Since this angle lies between  $180^\circ$  and  $270^\circ$ , the course of the rooms lies in the southwest quadrant, and the angle of bearing measured from the south end of the meridian is  $250 - 180 = 70^\circ$ . The course of the rooms is, therefore, S  $70^\circ$  W.

**Problem 3.**—An approximate method of measuring across a stream by use of a transit and tape but without reference to a book of tables.

*First Method.*—Where it is possible to cross over the stream, the following method may be used, which will give approximate results: Referring to Fig. 29, set up the instrument at  $A$  and sight to a point  $B$ . Then, by means of the 3, 4, 5 method, often called the 3, 7, 12 method, set off the right angle  $OBT$ . To do this, first line in the point  $O$ , on the line  $AB$ , with the instrument, making the distance  $OB$  3 ft. or any multiple thereof, and place a surveying pin at  $O$ . With  $B$  as a center and a radius of 4 ft., describe an arc;

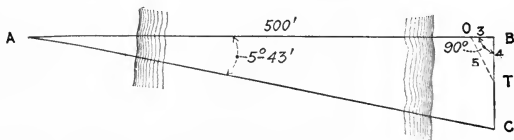

FIG. 29. METHOD OF MEASURING DISTANCE ACROSS A RIVER.

and with  $O$  as a center and a radius of 5 ft., describe another arc intersecting the first at  $T$ . The angle  $OBT$  will then be a right angle.

By the 3, 7, 12 method, the end of the tape is fastened at  $O$ , and the tape is then carried around the triangle  $OBT$  and back to  $O$ . The distance around the triangle  $OBTO$  is 12 ft. Now, holding the end and the 12-ft. mark at  $O$ , with the 3-ft. mark at  $B$ , pull out the tape with a pin at the 7-ft. mark, which will establish the point  $T$ , making the angle  $OBT$  a right angle.

With the instrument at  $A$ , turn off the angle  $BAC$  equal to  $5^\circ 43'$ ,

and line in the point  $C$  on the line  $BC$ . Now, since the tangent of  $5^\circ 43'$  is 0.1, the distance  $AB$  will be ten times the distance  $BC$ . Thus, if the distance  $BC$  equals 50 ft.,  $AC$  will be  $10 \times 50 = 500$  ft.

*Second Method.*—When it is not possible to cross to the opposite side of the stream, the following method can be used: Referring to Fig. 30, establish the line  $CD$  more or less parallel to the stream,

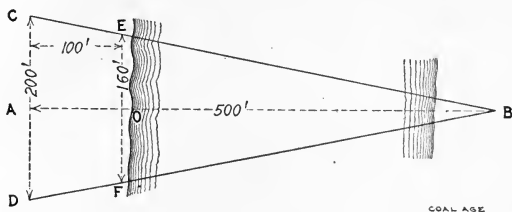

FIG. 30. ANOTHER METHOD OF MEASURING ACROSS A STREAM.

and another line  $EF$  parallel to the first, and at any distance  $AO$  from it. Now, select a well-defined point or object,  $B$ , on the opposite bank and line in the point  $E$  on the line  $CB$ , and likewise the point  $F$  on the line  $DB$ . Measure  $CD$  and  $EF$  carefully. The distance  $AB$  is then calculated as follows:

$$AB = \frac{CD}{CD - EF} \times AO$$

If the several distances are as indicated in Fig. 30, the calculation is as follows:

$$AB = \frac{200}{200 - 160} \times 100 = \frac{200}{40} \times 100 = 500 \text{ ft.}$$

**Problem 4.**—If the backsight  $BA$  (Fig. 31), is  $N. 40^\circ E.$ , 1230 ft., and the foresight  $BC$  is  $S. 60^\circ E.$ , 3042 ft.; what is the length and bearing of the closing side  $CA$ ?

Starting from  $A$ , the bearings and length of the courses, together with the latitudes and departures, are as follows:

Bearing	Distance	Latitude	Departure
$S 40^\circ W$	1230	942.18 S	790.64 W
$S 60^\circ E$	3042	1521.00 S	2634.37 E
		2463.18 S	1843.73 E

The total latitude or southing is, therefore, 2463.18 ft., and the total

net easting 1843.73 ft. In order to close this survey, the line  $CA$  must, therefore, have a northing of 2463.18 ft., and a westing of 1843.73 ft.

To find the bearing of this closing course, call the angle of the bearing  $a$ ; then,

$$\tan a = \frac{1843.73}{2463.18} = 0.7485$$

and  $a = 36^\circ 49'$ . The bearing of the closing course is, therefore, N.  $36^\circ 49'$  W.

The length of the closing course is then found as follows:

$$\frac{2463.18}{\cos 36^\circ 49'} = \frac{2463.18}{0.80056} = 3076.8 \text{ ft.}$$

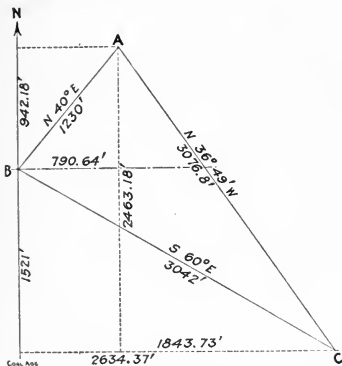

FIG. 31. PLATE OF SURVEY, SHOWING THE COORDINATE SYSTEM OF CALCULATING THE CLOSING COURSE.

length of a drift rising  $1\frac{1}{2}$  in. per yard, that will cut the seam beyond the fault?

The combined dip of the seam and rise of the drift is  $4 + 1.5 = 5.5$  in. per yard. Assuming horizontal measurements in the seam and the drift alike, the horizontal length of the drift, measured from the fault to the place where it cuts the seam, would be:

$$\frac{60 \times 12}{5.5} = 130.9 \text{ yd.}$$

Fig. 32 shows the relative position of the fault, the seam on each side of the fault, and the stone drift driven to the rise, across the strata, to connect the seam at the fault with the seam beyond.

**Problem 6.**—A method of turning off an entry at right angles without the use of a compass.

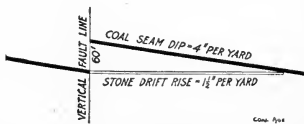

FIG. 32. SHOWING A VERTICAL UPTHROW OF 60 FT.

Suspend a bob from each of the two respective points or stations *A* and *B* (Fig. 33) of the entry survey.

Stretch a string carefully in line with these bobs or points. By means of this string, line in the points *O* and *P* opposite the centers of the respective cross entries. Also line in the points *a* and *b*, respectively, at any convenient equal distances, on each side of *O*. Then from these points *a* and *b* as centers and with any fixed radius *ac*, greater than *aO*, describe in turn the intersecting arcs which determine the point *c* and the line *OX* at right angles to *AB*. These

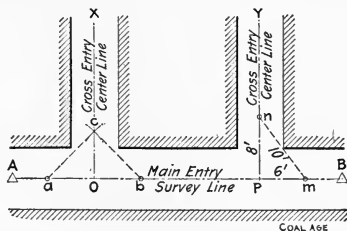

FIG. 33. SHOWING TWO METHODS OF SETTING OFF A RIGHT ANGLE WITHOUT USING A COMPASS.

lines can often be laid off with chalk on the roof, but the work requires care.

In a similar manner the triangle *Pmn* may be laid out, using the numbers 3, 4, 5 or any multiple of these more convenient, as 6, 8, 10 ft. This gives a right triangle, because

$$6^2 + 8^2 = 10^2$$

and makes the line *PY* at right angles to *AB*.

It is important to remember that all measurements must be made in the horizontal plane for any angle other than a right angle, which can be laid out on the pitch.





# MINING METHODS

BY

ROBERT BRUCE BRINSMADÉ, B. S., E. M.

COPYRIGHT, 1911, BY THE  
MCGRAW-HILL BOOK COMPANY, INC.

# CONTENTS

PAGE

## CHAPTER I

Explosives and Their Use in Mining . . . . .

## CHAPTER II

Principles of Blasting Ground. . . . . 18

## CHAPTER III

Compressed Air for Mining. . . . . 29

## CHAPTER IV

Principles for Controlling Excavations . . . . . 33

## CHAPTER V

Principles of Mine Drainage . . . . . 41

## CHAPTER XVIII

Principles of Mining Seams . . . . . 62-7

(a) Comparison of Longwall and Pillar Systems. . . . . 63

(b) Comparison of Advancing and Retreating. . . . . 63

(c) Mining by Roof-pressure . . . . . 63

## CHAPTER XIX

Advancing Longwall Systems for Seams . . . . . 72-9

Example 49.—Spring Valley Collieries, Ill. . . . . 73

Example 50.—Montour Iron Mines, Danville, Pa. . . . . 73

Example 51.—Bull's Head Colliery, Eastern, Pa. . . . . 73

Example 52.—Vinton Colliery, Vintondale, Pa. . . . . 78

Example 53.—Drummond Colliery, Westville, N. S. . . . . 78

## CHAPTER XX

Pillar Systems for Seams . . . . . 94-10

Example 54.—Advancing System Layouts . . . . . 94

Example 55.—Nelms' Retreating System . . . . . 94

Example 56.—Nelms' Advancing-retreating System . . . . . 100

Example 57.—Connellsville District, Western Pennsylvania. . . . . 100

Example 58.—Pittsburg District, Western Pennsylvania . . . . . 100

## CHAPTER XXI

Flushing System for Filling Seams and Recovering Pillars . . . . . 110-11

Example 59.—Anthracite District, Eastern Pennsylvania. . . . . 110

Example 60.—Robinson Mine, Transvaal. . . . . 110

INDEX . . . . . 111



# MINING METHODS

---

## CHAPTER I

### EXPLOSIVES AND THEIR USE IN MINING

An explosion may be defined as a sudden expansion of gas. The substances which we call explosives are so unstable when exposed to a suitable flame or shock that they suddenly change into many times their original volume of gas with the evolution of heat. If the change to a gas takes place in the open, there is a flame and a whiff or a report. It is only, however, when explosives are set off in confined spaces like drill-holes that they do their chief work in mining. Consequently a blast or explosion may be said to be a rapid combustion in a confined space.

Explosives have two essential constituents, namely, combustibles and oxidizers. They may be broadly divided into three classes according to the relation which the combustibles bear to the oxidizers. Class I includes the mechanical explosives, or those in which the ingredients constitute a mechanical mixture; class II includes the chemical explosives or those in which the ingredients are in chemical combination; class III includes the mechanico-chemical explosives which are formed of a mixture of class II and an absorber.

#### METHODS OF FIRING EXPLOSIVES

Explosives are set off by two means—ignition and detonation. Because through ignition the combustion is transmitted by heat alone, it gives a slower explosion than one started by detonation which transmits the reaction by the rapidity of vibrant motion. By their nature class I is adapted to ignition, and classes II and III to detonation.

Ignition is commonly performed by squibs, fuse or electric igniters. A squib is really a self-impelling slow match, made by filling one-half of a thin roll of paper with black powder and the other half with sulphur. For their use in blasting, a drill-hole *ab*, Fig. 1, is loaded with an explosive *bc* and before filling the hole with the tamping *cd*, a needle *ac* is inserted into the explosive so that when it is withdrawn, a hole of a larger diameter than the squib is left through the tamping from *a* to *c*.

The squib is then inserted in this hole with the sulphur end out, and when lit the slow-burning sulphur allows time for the miner to escape before the powder of the squib takes fire and its reaction forces the squib along the holes to ignite the powder at *c*.

A fuse is merely a thread of black powder wrapped with one or more thicknesses of tape. In loading the hole, Fig. 1, the fuse would be

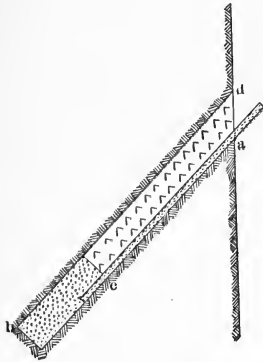

FIG. 1.—Drill-hole section.

inserted in place of the needle *ac*. A fuse burns commonly at the rate of 2 ft. a minute. Therefore a sufficient length should be used in the hole to allow the miner to retire in safety, after splitting and lighting the outer end, before the flame reaches the explosive at *c*.

The electric igniter consists of a shell *a*, Fig. 2, enclosing a charge of fulminate mixture in *b* and of sulphur cement in *e*. The copper wires *c* pass through *f* and enter *b* where they are connected by a platinum bridge at *d*. For ignition, the shell *a* is made of pasteboard and the igniter is placed within the explosive while the wires extend outside the hole to a

blasting machine. The last is simply a small armature revolving between its poles and sending a current through the igniters in the circuit when its handle is shoved down. All the common electric igniters on one circuit are exploded simultaneously, but a recent invention is a delay-action igniter which permits electric firing in sequence.

Detonation is performed by fuse and cap or by electric caps. A blasting cap is simply a cylindrical copper cup with a small charge of fulminate mixture in its bottom, the fuse being inserted into the cup and fastened to it by crimping pincers. The cap is then inserted into one cartridge of the explosive and its attached fuse tied firmly to it by a string, in order to make a primer which is placed near or on the top of the explosive. The loaded hole will then resemble Fig. 1, the explosive being in *bc*, the cap and primer at *c*, and the fuse along *ca*. Lighting the fuse is the same as for ignition, only the fuse now fires the cap whose explosion detonates the explosive.



FIG. 2.—Electric exploder.

The electric cap resembles the electric igniter, Fig. 2, but has a copper instead of a pasteboard case *a* and the quantity of charge of fulminate mixture at *b* is increased as the sensitiveness of the explosive diminishes. The electric cap is inserted in and fastened to a primer-cartridge like

fuse and cap, the electric cap being fired by a blasting battery in the same way as the electric igniter.

### LOADING AND TAMPING

A mechanical explosive like black powder usually comes in bulk. For loading it is poured into a cartridge (the size of the hole) which is made by rolling a piece of paper around a pick handle. For damp holes the cartridge must be oiled or soaped on the outside. This paper cartridge is pressed down into the hole by a soft iron tamping bar whose tip should be an expanding copper cone grooved on the edge for the purpose of allowing the copper loading needle or fuse to pass. Tamping bars with iron tips or iron needles are highly dangerous in formations containing pyrite or other hard minerals, on which the iron might strike a spark, and their use is therefore prohibited by law in many places.

A mining explosive of class II or III is handled in paper cartridges which can be ordered of a diameter to fit the hole. Before loading they are slit around lengthwise to permit of the explosive taking the shape of the hole when it is pressed down by a tamping bar which should be of wood for these explosives, instead of copper-tipped iron, on account of their being more sensitive to any shock than black powder.

In coal mines, coal dust is commonly used for tamping black powder, but this is a very unsafe practice in dangerous mines, for a windy or blown-out shot will have its normal flame increased, both in length and duration, by the ignition of the tamping. The best materials for tamping are a fine plastic clay or loam and ground brick or shale, and although sand is too porous to do well for black powder, it answers for higher explosives but must be confined in paper cartridges for use in uppers.

Water is used as tamping for nitro-glycerine and high explosives in wet down-holes, but it is little better than nothing. The fact that higher explosives will break rock without any tamping has caused many miners to abandon tamping them altogether on account of the ease of recapping untamped charges in case of a misfire. Mechanical explosives must be tightly tamped, nearly to the collar of the hole, or they will blow out instead of breaking the rock, and although the tamping may be shortened with detonating explosives, as they become quicker and stronger, a short length of tamping adds to the efficiency of the highest explosives.

Where only quick-acting explosives of classes II or III are at hand and it is desired to blast with the slow action of class I, the object can be partially obtained by special methods of loading. These methods provide an air cushion between the explosive and the rock and tamping by either having the stick of explosive of considerably smaller diameter than the drill hole or by having a very porous cellular tamping to separate the tight tamping from the explosive.

Before examining the various mine explosives in detail, let us consider an illustration of the method of calculating,<sup>1</sup> from the chemical equation of an explosive, its calorific power, its temperature, and the number of expansions and its consequent exploding pressure. Let us assume the simplest case of a mechanical mixture of hydrogen and oxygen at a temperature of 0° C. and at sea-level pressure of 760 mm. of mercury. Then the chemical equation for complete combustion is



the molecular weights being  $4 + 32 = 36$ . (2)

If  $t$  = thermometer temperature in degrees centigrade of the explosion;

$T$  = absolute temperature in degrees centigrade of the explosion;

$\Sigma$  = sign for summation;

$WW_1W_2$ , etc. = weights in grams of various combustibles of the explosive;

$CC_1C_2$ , etc = calorific power in calories of various products of combustion of the explosive;

$ww_1w_2$ , etc. = weights in grams of various products of combustion of the explosive;

$ss_1s_2$ , etc. = specific heat in calories of various products of combustion of the explosive;

$V$  = volume of explosive originally;

$V_1$  = volume of explosive due to chemical reaction alone;

$V_2$  = volume of explosive due to chemical reaction and resulting temperature,  $t$ ;

$P$  = pressure of explosive originally;

$P_2$  = pressure of explosive finally;

then we have from thermo-chemistry,

$$T = \frac{WC + W_1C_1 + W_2C_2, \text{ etc.}}{ws + w_1s_1 + w_2s_2, \text{ etc.}} = \frac{\Sigma WC}{\Sigma ws} \quad (3)$$

For the given problem we have from equation (2),

$W = 4$  grams of H gas;

$w = 36$  grams of  $\text{H}_2\text{O}$  vapor.

From thermo-chemistry we have,

$C = 28,780$  cal. for H;

$s = 0.4805$  cal. for  $\text{H}_2\text{O}$  vapor;

substitute in (3) and

$$T = \frac{4 \times 28,780}{36 \times 0.4805} = 6660^\circ \text{ C.}$$

Then, from Avogadro's law, that the molecules of equal volumes of all gases under like conditions occupy the same volume, we have from (1),

$$2 \text{ vols. H} + 1 \text{ vol. O} = 2 \text{ vols. H}_2\text{O},$$

or

$$V_1 = 2/3V. \quad (4)$$

<sup>1</sup> See "Metallurgical Calculations," by J. W. Richards.



From Charles' law, the volumes of gases vary directly as their absolute temperature we have thus

$$\frac{V_2}{V_1} = \frac{T}{0 + 273}$$

or

$$V_2 = \frac{6660V_1}{273};$$

substitute from (4) and we have

$$V_2 = \frac{6660 \times 2V}{273 \times 3} = 16.2 V \quad (5)$$

From Boyle's law, if the gas of volume  $V_2$  is prevented from expanding beyond volume  $V$ , we have for the final pressure  $P_2$  in the explosive chamber  $P$ ,

$$\frac{P_2}{P} = \frac{V_2}{V}$$

or

$$P_2 = \frac{V_2}{V} P \quad (6)$$

Substitute in (6) from (5) and, as  $P = 1$  atmosphere = 14.7 lbs. per sq. in., we have

$$P_2 = \frac{16.2VP}{V} = 16.2 \text{ atmospheres.}$$

or 238 lbs. per sq. in

From physics,  $T = t + 273$ ,

hence

$$t = T - 273 = 6660 - 273 = 6387^\circ \text{ C.}$$

In practice, this theoretical pressure and temperature, resulting from the explosion, would have to be multiplied by a fractional factor of efficiency to allow for imperfect combustion and loss of heat through radiation and leakage. In large charges, these losses are proportionally less than in the case of small charges. This fact, coupled with the greater likelihood of their meeting weak places in the blast's burden, accounts for the higher efficiency of the former. These theoretical calculations are especially useful in comparing the relative strength of different explosives of the same type. In France, they are used extensively in the inspection of permissible explosives to determine if their final temperature is sufficiently low for use in dangerous coal mines.

The practical usefulness of explosives depends upon (1) their cost of manufacture; (2) their safety and convenience as regards transportation

and storage; (3) method necessary for their loading and exploding; (4) their exploding pressure; (5) the rapidity with which they explode; (6) the length and temperature of the flame. These six factors will now be discussed seriatim. Factor (1), or the cost, is often the most important factor in commercial operations like mining, although for purposes of war it is often little considered. Factor (2) or safety, affects the desirability for all purposes, the more sensitive the explosive, the higher the freight rate by rail or boat, and if sensitive beyond a certain point, it cannot be shipped thus at all. Those explosives which, like dynamite, freeze at ordinary winter temperatures are at a disadvantage as are also those which, like black powder, are handled loose and can be easily ignited by a spark struck by a hob-nailed shoe on a floor spike. Some explosives, like imperfectly washed guncotton, are liable to explode by spontaneously generated heat, while others become dangerously sensitive if exposed to the sun during shipment. The desirability of explosives belonging to either of these last two mentioned classes is plainly discounted because of these attributes. The next factor (3) or loading and exploding, is important in connection with conditions such as prevail in dangerous coal mines (where an open light is prohibited), in subaqueous blasting (where both explosive and exploder must be unaffected by water), or where misfires could not be corrected. Factor (4), or the pressure, is what determined the real effective breaking force of the explosion, but it is modified in practice by (5), or the rapidity of the explosion. Slow and fast explosives are comparable to presses and hammers for forging steel. The former exerts its pressure gradually until the strain exceeds the tensile strength of the material and the rock gives way along a surface of fracture. The latter gives a sharp quick blow which will shatter the surface of rock exposed to the explosive before any fracturing action is exerted on the blast's burden of rock.

The slow explosive will detach the rock in large masses while the fast type may crush it to bits. Black powder is an example of the first and nitro-glycerine of the second. Explosives with all graduations of rapidity between these extremes are on the market. The fastest explosives are applicable where the rock is very hard to drill as, for example, in the case of certain Lake Superior hematites, or where a tremendous force must be exerted from confined spaces as in breaking the cut for development passages; also where a shattering rather than a fracturing action is needed, as in chambering the bottom of drill holes or in shooting oil wells. The slowest explosives are used in quarrying, for the purpose of detaching monoliths, or in consolidated or soft rock which can be fractured by a slow, pressing movement but only dented by a quick hammer blow.

Factor (6), or the flame and temperature, is an important consideration for blasting in gassy or dusty coal mines. The so-called "permis-

sibles" are explosives made to fall below a minimum legal requirement as regards length and temperature of flame. When one considers that a permissible like carbonite gives, in practice, a flame height of 15.8 in. and a flame duration of 0.0003 seconds, as compared with 50.2 in. and 0.1500 seconds respectively, for black powder, we can see how much safer the permissible is to use.

We will now consider the properties of the three classes of explosives:

### CLASS I, OR MECHANICAL EXPLOSIVES

The common representatives of this class are black powder and mechanical permissible explosives. Black powder was discovered before 600 A. D. by the Chinese, and by Roger Bacon in 1270, but it was not used for mining until Martin Weigel introduced it at Freiberg in 1613. It can be made from a single combustible, charcoal, mixed with an alkaline-nitrate oxidizer, but in order to lower its ignition temperature for blasting to about 275° C., part of the charcoal is replaced by sulphur. For the cheaper blasting powders, the oxidizer is sodium nitrate which, being easily affected by dampness, is replaced in the higher grade powders by potassium nitrate. The ingredients are first ground then mixed thoroughly while moist and finally pressed in cakes, dried, broken and sized. Assuming the equation for the complete combustion of black powder to be.

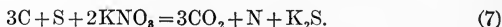

We have by calculation for its percentage composition,

$$\begin{array}{r} \text{carbon} = 13.4 \\ \text{sulphur} = 11.8 \\ \text{sodium nitrate} = \underline{74.8} \\ 100.0 \end{array}$$

and for the percentage composition by volume of its resulting gas,

$$\begin{array}{r} CO_2 = 75 \\ N = \underline{25} \\ 100 \end{array}$$

The theoretical exploding temperature is 4560° C. and the pressure is 5820 atmospheres. In practice the composition is varied according to the experience of each maker. As the combustion is imperfect, poisonous and combustible gases like carbon monoxide, hydrogen sulphide and hydrogen and unpleasant vapors, like the sulphide, sulphate, hypsulphite, nitrate and carbonate of potassium, are given off by the explosion and sometimes render breathing or the carrying of open lights in the fumes a dangerous procedure. In fact, Bunsen's experiments proved

that only one-third of the ignited gunpowder really followed the reaction of equation (7).

Black powder is sold in grains which vary in size from the fine sporting gunpowder to the 2-in. balls of artillery powder. For blasting, the grains vary in diameter from one-eighth to one-half of an inch, and the rapidity of the explosion decreases with an increased diameter of grain. The grains should be of uniform size, quite dry and thoroughly tamped in the hole in order to get good results. The specific gravity of lightly shaken black powder is about the same as water. Its cheapness, non-freezing, comparative safety for shipping and handling, easy explosion by ignition and slow action are the favorable qualities of black powder which cause its wide use. For coal mines free from dangerous gases and dust, it is a better explosive than detonating permissibles whose quicker action breaks up the coal and injures the roof more. Black powder is rendered inefficient for many other purposes, however, because of its necessitating much tamping, its low power, the readiness with which it is spoiled by moisture and its long flame.

Of the mechanical permissibles bobbinite has been extensively used in England. Its percentage composition is,

Potassium nitrate	=65.0
Charcoal	=20.0
Sulphur	=2.0
Paraffin wax	= 2.5
Starch	= 8.0
Water	= 2.5
	100.0

It is thus chemically very close to black powder excepting that it contains more charcoal and less sulphur and makes up that discrepancy by the addition of wax, starch and water. The lack of sulphur raises its ignition temperature while the wax forms a waterproof coating for the grains of powder. The starch and water absorb heat, shorten the flame and decrease the exploding temperature to under 1500° C. It is handled in compressed cartridges with wax coverings. It has a central hole to admit the fuse, for ignition by squib is not allowed in dangerous coal mines.

## CLASS II, OR CHEMICAL EXPLOSIVES

The five common explosives of this class are guncotton, nitro-glycerine, nitro-gelatin, fulminates and picrates. They all contain nitryl (NO<sub>2</sub>) and their detonation is made possible by the unstable quality of nitryl compounds.

*Guncotton*.—This was discovered by Schönbein in 1846, but it was little used until it was found that its dangerous instability was not

inherent but due solely to the surplus acid left in its tissue by imperfect washing methods during its manufacture. The equation for making it is,

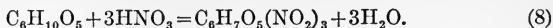

cotton + nitric acid = guncotton + water.

The ingredients are allowed to stand in a cold place for some time before the washing out of the free acid is begun.

The reaction on exploding is,

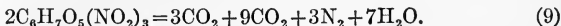

Equation (9) shows that the explosion gives no solid product like the  $\text{K}_2\text{S}$  of equation (7) and that the percentage composition by volume of the resulting gas is,

$$\begin{array}{r} \text{CO}_2 = 13.7 \\ \text{CO} = 40.8 \\ \text{N} = 13.7 \\ \text{H}_2\text{O} = 31.8 \\ \hline 100.0 \end{array}$$

By the method of calculation already explained, it is found that guncotton theoretically has an exploding temperature of  $5340^\circ \text{C}$ . and a pressure of 20,344 atmospheres.

The combustible qualities of the large percentage of carbon monoxide resulting from its explosion render guncotton unfit for use in coal mines, and its poisonous qualities make it unsuitable for any underground use. For surface work, it is very powerful, smokeless, does not freeze and is not volatilized or decomposed by atmospheric temperature. It ignites between  $270$  and  $400^\circ \text{F}$ . and if unconfined will then burn quietly. When dry, it is sensitive to percussion and friction, but under water it is insensible to ordinary shocks. Immersed, it absorbs from 10 to 15 per cent. of water, but even then it can be exploded without drying by the use of an extraordinarily strong detonator. Its chief disadvantage above ground is its high cost and the fact that it comes in hard compressed cartridges (specific gravity about 1.2) which fit drill holes only imperfectly and therefore lose in efficiency. For any destructive work without the use of drill holes, like demolishing walls, dams and the like, the sharp, sledge-hammer blow of its explosion renders it very efficacious.

*Nitro-glycerine or "Oil."*—This was discovered by Sabrero in 1847, but did not become commercially valuable until 1863 under the direction of Alfred Nobel. The equation for its making is,



glycerine + nitric acid = nitro-glycerine + water.

Strong sulphuric acid is an ingredient of the mixture, but it does not take part in the reaction, which must take place at a moderate tempera-

ture to be safe. The resulting "oil" is much easier to wash than gun-cotton and consequently is cheaper. It is a yellow, sweetish liquid poisonous both to the blood and the stomach. Its specific gravity is 1.6. Its freezing-point is about 45° F. and to insure against freezing the temperature must be above 52° F. When frozen, it is insensible to ordinary shocks, as is also the case when it is dissolved in alcohol or ether. It is, therefore, commonly shipped either in tin cans, packed in ice, or in solution in wood alcohol. It can be precipitated from the latter before use by an excess of water.

Nitro-glycerine does not evolve nitrous fumes until 230° F. As it begins to vaporize at about 100° F., it is important in thawing it not to exceed this temperature. Thawing, therefore, is only safely done by heating the explosive over a water bath at less than 90° F., or by leaving it in a room of the same temperature for some time. The explosive ignites at only 356° F. and if then pure and free from all pressure, jar or vibration, it will burn quietly. These safe-igniting conditions, however, are difficult to obtain, for a small depth of liquid causes sufficient pressure to explode it when ignited. Thus a film of it, heated on a tin plate, burned without an explosion only if under one-fourth inch thick. The exploding temperature is 380° F. This 24° margin above the igniting temperature accounts for the numerous cases of conflagration without explosion. The reaction of the explosion is,

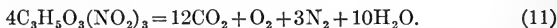

From equation (11) the explosive product is gaseous and its percentage composition by volume is

$$\begin{array}{r} CO_2 = 46.0 \\ O = 3.8 \\ N = 11.8 \\ H_2O = \underline{38.4} \\ 100.0 \end{array}$$

By the previous calculating method, it is found that theoretically the exploding temperature is 6730° C. and the pressure is 29,107 atmospheres. From the fact that its explosive product contains no carbon monoxide, "oil" can be used underground, but only when mixed with an absorber. Alone, it is too sensitive to be safe, while being liquid, if unconfined, it would leak from holes in porous rock, and if confined in canisters it will not fill the drill hole. With its great speed and strength it also tends to shatter locally any enclosing rock, except the toughest, rather than detach it. These characteristics render it inefficient for most mining work.

For shooting oil wells, however, its shattering quality renders it peculiarly suitable. For this purpose, a cylindrical canister of a diameter to fit the well and containing from 100 to 200 lbs. of nitro-glycerine,

is carried to the well swung from the body of a spring buggy. After filling the well with water, the canister is topped with a cap and lowered to the proper depths by a rope, along which a weight, called a "go-devil," is dropped onto the cap to cause the explosion.

*Nitro-gelatin.*—This was discovered by Nobel in 1875 and is a yellowish jelly of considerable toughness, but easily cut with a knife. It is made by dissolving guncotton in nitro-glycerine. Authorities differ in the proportion of guncotton, some recommending only 7 per cent. To balance all the free oxygen of the nitro-glycerine by the excess carbon of the guncotton alone, takes 87.3 per cent. of the former to 12.7 per cent. of the latter and gives the following equation:

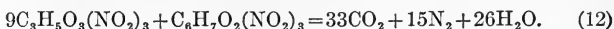

From equation (12) the percentage composition of the solely gaseous product is,

$$\begin{aligned} CO_2 &= 44.6 \\ N &= 20.2 \\ H_2O &= 35.2 \end{aligned}$$

By the theoretical calculation, the exploding temperature is 7080° C. and the pressure is 27,100 atmospheres. The last figure shows nitro-gelatin to be only 7 per cent. weaker by weight than nitro-glycerine, while its somewhat higher cost is due to its guncotton ingredient. When used alone for military purposes, about 4 per cent. of camphor is dissolved in the nitro-glycerine along with the guncotton to make a product called military gelatin. The last explosive is so insensitive that it can be punctured without effect by a rifle bullet. The common nitro-gelatin is much less sensitive than No. 1 dynamite, to shock or friction, and unaffected by a short immersion in water at 158° F. and by an 8-day immersion at 113° F.

It will not exude nitro-glycerine under a high pressure or any atmospheric temperature. Its specific gravity is 1.6 and it can be set off only by a strong detonation. It ignites at 399° F. and will then only burn when unconfined. When it freezes, which is between 35 and 40° F., it becomes more sensitive than normally owing probably to the partial freeing of the nitro-glycerine ingredient.

Nitro-gelatin is now used for mining wherever the highest power explosive is needed and is especially adapted to wet or subaqueous blasting, either alone or as "gelatin" dynamite.

*Fulminates.*—Mercuric fulminate is the common commercial salt. It is made as follows from mercuric nitrate and alcohol:

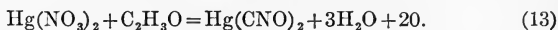

The explosive reaction is



Equation (14) shows that mercuric fulminate is a poor explosive because it produces the poisonous fumes of Hg and CO as well as unburned carbon. If a little damp, it explodes very feebly and if quite wet, not at all. However, its non-freezing quality, its quick hammer-like vibrant explosion and its uniform sensitiveness to ignition or shock cause its use as the chief ingredient of percussion-cap mixtures for detonating other explosives. Its exploding temperature is 305° F.

*Picrates.*—These salts are founded on picric acid, which is made by mixing carbolic and nitric acid according to the equation,

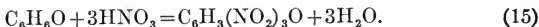

Its explosive reaction is



Picric acid comes in yellow crystals which are soluble in hot water or alcohol, and melt at 230° F. It is used very largely in dyeing. It is expensive to make and difficult to explode. Equation (16) indicates that it produces much of the poisonous carbon monoxide which shows incomplete combustion and consequently a decreased power. Picrates are the basis of the military explosive lyddite, but the recent commercial failure of the excellent mining picrate "joveite" may discourage future attempts to adapt them to blasting.

### CLASS III, MECHANICO-CHEMICAL EXPLOSIVES

This class will be considered under five groups: (1) guncotton; (2) nitro-glycerine; (3) nitro-gelatin; (4) fulminate; (5) nitro-benzol. Detonating permissibles for coal mining fall mainly under groups (2) and (5) and will be considered last.

*Guncotton Group.*—The evaporating of guncotton, after it has been dissolved in a suitable solvent such as alcohol or acetone, produces a hard, horny material which is the basis of most modern smokeless gunpowder. Its chief blasting powder, however, is tonite which is formed by adding enough barium nitrate to guncotton to just completely oxidize the gases caused by the explosion as follows:



The percentage composition, by volume, of the gaseous product of equation (17) is,

$$\begin{array}{r} CO_2 = 50.4 \\ N = 20.2 \\ H_2O = 29.4 \\ \hline 100.0 \end{array}$$

By calculation, the exploding temperature is 5,730° C. and the pressure is 13,840 atmospheres, which are fifteen-fourteenths and two-thirds,



respectively, of the corresponding figures for guncotton. As an offset to lessened powder tonite is plastic, cheaper than guncotton and 50 per cent. denser. Its harmless fumes adapt it to underground use and, like dynamite, it is packed in paper cartridges. It has been extensively used in England, where it is shipped under the same safety regulations as black powder. It is hard to ignite and when alight, it normally burns slowly without explosion. Tonite, like guncotton, is non-freezable and is detonated only by a strong cap. Potassium nitrate has been used, instead of barium nitrate, as the oxidizer, in another guncotton mixture of similar properties which is called potentite.

*Nitro-glycerine Group.*—These mixtures are called dynamites. They were introduced by Nobel to lessen the sensitiveness of nitro-glycerine and at the same time retain its other good qualities. The absorber of the "oil" is called the "dope," which may be selected to be either *inert* or *active* in the explosion.

The freezing temperature of all dynamite is that of nitro-glycerine, as is also its behavior when frozen and its method for being safely thawed. Dynamite that does not leak nitro-glycerine under the conditions under which it is to be used is one of the safest explosives known. It should not be shipped, however, in rigid metallic cases, which accentuate shocks and vibrations, but in wooden boxes in paper cartridges packed in sawdust. Thus packed, it has failed to explode when dropped on the rocks from a considerable height or when struck by heavy weights.

Dynamite can be heated with less danger than nitro-glycerine. If set on fire, it will usually burn quietly unless unfavorable conditions are present. If the dynamite is in a closed box, its smoke cannot escape and consequently the pressure may be raised enough to cause an explosion. If caps or gunpowder are present, the fire will explode them and the resultant shock will detonate the dynamite. If the heat from the fire causes the "oil" to exude from the cartridges, this "oil," if under a static head, will explode when ignited, as explained above. Again, the heat from the burning dynamite may heat the adjoining unlighted cartridges to the exploding temperature of 380° F. before they get sufficiently exposed to the air to ignite. Heated gradually in the open so much of the "oil" may be evaporated that a mere whiff ensues when the exploding temperature is finally reached.

In spite of all these dangerous contingencies, several instances are on record where several tons of dynamite have burned in conflagrations without exploding. If afire in cartridges, it burns slowly like sulphur, but if loose it will burn quickly like chaff.

The dope first used was inert infusorial earth or kieselguhr, which will safely absorb three times its weight of nitro-glycerine. The resulting kieselguhr dynamite when strongest contains 75 per cent. "oil." It is a pasty, plastic, unctuous, odorless mass of a yellowish color with a specific

gravity of 1.4. The effect of the dope is to cushion the "oil" so that the shock to explode it must be stronger as the percentage of dope becomes greater. It is not possible to explode kieselguhr dynamites which contain under 40 per cent. of "oil" and even with 60 per cent. it takes a strong cap.

The disadvantage of 75 per cent. dynamite is the exudation of "oil" on a warm day or under water so that dangers may arise from having to deal with the sensitive "oil" before suspecting its presence. It is thus ordinarily unsafe to ship or use and the 60 per cent. strength is now commonly sold as No. 1. The strength of kieselguhr dynamite is almost equal to that of its contained "oil."

The active-dope dynamites have no such narrow limitations as the inert types and not only may numerous absorbers be used, but the percentage of nitro-glycerine may vary from 4 to 70 per cent. These explosives go under various names. The common active absorbents are such combustibles as wood meal or fiber, rosin, pitch, sugar, coal, charcoal, or sulphur, and such oxidizers as the alkaline nitrates or chlorates. The chemical composition of the oil-dope mixture should be such as to give only completely oxidized products on combustion. The strength of this type is equal to that of the "oil" plus that of the explosive dope when *completely* burned. In other words, black powder mixed with enough "oil" to detonate it would *all* burn as shown by the reaction of equation (7), thus giving several times more power than when ignited alone. The density and appearance, as well as the necessary strength, varies with the dope and the percentage of "oil." The commercial method of rating dynamite, by its percentage of "oil," is misleading as no account is taken of the varying strength of the explosive dopes.

*Nitro-gelatin Group.*—A mixture of this group is called a *gelatin* dynamite. Somewhat more expensive than nitro-glycerine, it is preferable wherever the highest power is desired and, being unaffected by water, it is the best powder for subaqueous use. It is more plastic and less sensitive than common dynamite and therefore easier to load and safer to transport, but it requires a stronger cap for exploding. The military powder gelnite, a favorite in England and Japan, and forcite come under this group.

*Fulminate Group.*—For percussion-cap filling, mercuric fulminate is mixed with a sufficient amount of some oxidizer to insure complete combustion on exploding. Alkaline-nitrate oxidizers may be used but potassium chlorate is the favorite. The latter gives the following exploding reaction:

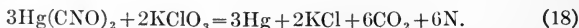

Equation (18) shows that potassium chlorate should form 22 per cent. by weight of the mixture, which also contains a little gum to give

coherence. Caps are designated by numbers or letters according to the amount of fulminate contained. The common series is.

Cap No.	Hg (CNO) <sub>2</sub> Grains.
1	4.5
2	6.0
3	8.0
4	10.0
5	12.0
6	15.0
6.5	19.0
7	23.0
8	30.9

The larger the cap, the more expensive, but if the cap selected is too small to insure perfect detonation of the explosive, incomplete combustion will ensue with noxious fumes and loss of power. In general, dynamite requires stronger caps as the percentage of nitro-glycerine or the temperature decreases.

*Nitro-benzol Group.*—Although nitro-benzol contains nitril it does not contain sufficient oxygen to be an explosive and, when unmixed with its oxidizer, it can be shipped as an ordinary chemical. On this account, the nitro-benzol or Sprengel group is especially adapted for use in isolated places far from dynamite factories. The favorite Sprengel explosive is rackarock, which is a mixture of nitro-benzol with the chlorate or nitrate of potassium or with sodium nitrate, as an oxidizer. By mixing 77.6 per cent. of mononitro-benzol with 22.4 per cent. of sodium nitrate, we can get the following reaction on detonation:

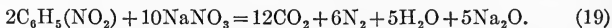

From equation (19) the percentage composition, by volume, of the gaseous product is,

$$\begin{array}{r} \text{CO}_2 = 52.2 \\ \text{N} = 26.1 \\ \text{H}_2\text{O} = 21.7 \\ \hline 100.0 \end{array}$$

By calculation, the theoretical temperature is 5300° C. and the pressure is 13,800 atmospheres. Unlike ignited black powder, rackarock, when properly detonated, follows closely its theoretical reaction which shows harmless gases and a temperature of 79 per cent. and a pressure of 47 per cent. of the figures for nitro-glycerine. For practical use, the oxidizer of rackarock is handled alone in wax-paper cartridges and the required quantity of nitro-benzol is not poured into a cartridge until just before charging the drill hole.

*Detonating Permissibles.*—These explosives practically all contain either nitro-glycerine, nitro-gelatin, nnitro-bezol or ammonium nitrate as the detonated ingredient and some contain two or more of them. Their exact composition is usually kept secret by the manufacturers, but they must pass the government tests for temperature and flame. These explosives are made of various strengths and require stronger caps than common dynamites. Detonation means a quick generation of a small quantity of hot gas while the ignition of black powder means the slow production of a large quantity of impure gases and vapors. A large quantity of fine, unstable salt like magnesium carbonate, of a steam-generating salt like ammonium nitrate, or of a substance with much hygroscopic moisture like wood meal, are the ingredients relied upon to cool the quick small flame of permissibles. The compositions of a few typical permissibles are as follows:

Name.	Nitro-benzol.	NH <sub>4</sub> NO <sub>3</sub>	Ground Wood.	Water.
Amvis .....	4.50	90.0	5.0	0.50
Ammonite.....	12.00	88.0	...	....
Electronite..... 19.0 Ba(NO <sub>3</sub> ) <sub>2</sub> ..	.....	73.0	7.5	0.50
Westfalit, No. 1. 4.5 (rosin) <sup>3</sup> ...	.....	95.0	...	0.50
Bellite, No. 3.....	5.25	94.0	...	0.75
Carbonite..... 25.0("oil")...	0.50(soda)	34.0 (NaNO <sub>3</sub> )	40.5	....

### MISFIRES

The cause of misfire depends upon both explosive and the manner of firing. The three classes of explosives with their methods of firing will now be considered.

*Mechanical Powders of Class I.*—In breaking coal with igniting powders, it is inadvisable to attempt to use a missed hole if the tamping must first be dug out, therefore a new hole is bored, charged and fired alongside the first. In rock breaking, where boring holes is expensive, the tamping may be dug out safely if only copper tools are used when approaching the powder. However, if the explosives are well selected, and kept dry, and care is taken in locating and loading the holes, misfires will seldom occur.

With *squib-ignition* misfires may be caused by (a) wetness of powder; (b) dampness of squib; (c) loss of powder from squib; (d) squib-hole clogged by dirt; (e) hole too long for squib to recoil and reach powder.

With *fuse-ignition* misfires may be due to (a) damp powder; (b) cutting of fuse in tamping; (c) imperfect fuse; (d) damp fuse; (e) loss of powder from end of fuse.

With *ignition by electric igniter* misfires may occur from (a) imperfect igniter; (b) damp igniter; (c) wire broken in tamping; (d) circuit imperfectly wired; (e) current leakage from poor insulation; (f) current deficiency from imperfect or overloaded blasting machine. The com-

pleteness of the circuit can be tested before the exploding by passing a feeble current through a galvanometer placed in the circuit.

*Detonating Powders of Classes II and III.*—In breaking coal with these powders it is better, as with igniting powders, to bore and load a new hole than to dig out the tamping from a missed hole. In rock work, it is good practice to dig out the tamping from a missed hole to within only half an inch of the powder and then insert a new primer cartridge with detonator and retamp. The excavation of tamping should be cautiously done when approaching the powder and care be taken not to strike the cap.

Dynamite should not be allowed to remain long before firing in water holes, for the water may displace the "oil" and perhaps cause a misfire or the escape of "oil" into adjoining crevices when it may later be struck by a pick or drill and explode. Powder should never be used when even partly frozen, for the thawed portion may explode alone and leave the frozen residue in the hole or blow it out into the muck to become in either case a source of danger for the next shift of miners.

In firing a round of holes in sequence, the explosion of one hole may blow off the primer of an adjoining hole whose remaining charge is therefore left unexploded in the hole-stump. Except for the last contingency, and that of two holes exploding simultaneously, the counting of the exploding reports gives a check on detonating in sequence which is lacking in simultaneously firing by electricity. An electric cap may be damp and conduct the current through the circuit, without exploding itself, and a missed hole will thus result. A fuse may have a broken thread of powder whose wrapping may catch fire and smoulder some time before igniting the powder beyond the break. For all these reasons the stumps of blasted holes should be carefully examined before resuming work, and where misfires are suspected a half-hour interval should elapse before revisiting the broken face.

*Fuse and cap detonation* has the last four causes of misfires already given for fuse ignition and, in addition, is liable to failure of the cap, either from dampness, imperfection, or insufficient strength for the given explosive.

The causes of misfires already given for electric ignition can be made to read correctly as the causes with *electric detonation* by simply substituting the word *cap* for *igniter* and adding the requirement that the cap must be of adequate strength.

## CHAPTER II

### PRINCIPLES OF BLASTING GROUND

It is only in recent years that engineers have had much to do with the details of underground excavation, as it was thought that all the schooling necessary for the successful miner could be gained by practice with a drill and shovel. It is evident, however, that where rock breaking forms such an important item of expense as it does in most mines, it will well repay study to ascertain if science cannot duplicate here the same success it has gained over empiricism in other departments.

After an explosion of powder in the bore hole, Fig. 3, the sudden expansion of the resulting gases will exert its force equally in all directions on the bore hole, until either the enclosing rock or the tamping yields

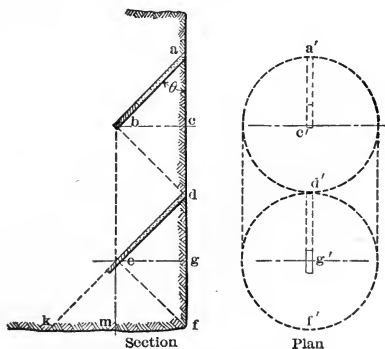

FIG. 3.—Cones of blasting rock.

and the gases escape. The rock will yield along what is called the line of least resistance, which would be  $bc$  in the assumed homogenous rock of Fig. 3. It is evident that the angle  $\theta$ , which the hole  $ab$  makes with the exposed surface or the free face of the rock, can vary from nothing to 90 deg. At  $\theta=0$  deg., there would be no hole and at 90 deg. the hole would be in the position  $bc$ , the line of least resistance, and would give a blown-out shot. The quantity of rock thrown out by the explosion would have the volume of a cone with an altitude  $bc$  or  $h$ , and a base with a radius  $ac$ , whose volume  $v=1/3 h\pi(ac)^2$  and where  $\theta=45$  deg. (the usual condition for the maximum volume)  $ac=h$  and we have  $v=\frac{\pi h^3}{3}=(\text{nearly}) h^3$ , or if  $m$  is a constant, depending on rock, then  $v=mh^3$ .

For a case with two free rock faces if the powder charge be placed at  $e$ , with the lines of least resistance  $eg$  and  $em$  of equal length, the explosion will break out two cones  $def$  and  $fek$ , or nearly double the volume for one free face, so that  $v=2mh^3$ . It is similar for three or more free faces, so that as a general equation we have, if  $n$ =the number of free faces,  $v=nmh^3$ .

From this formula it can be seen that a system of mining should be adopted which utilizes as many free faces as possible in breaking. In development work for vertical, horizontal or inclined drives or passages, we start each round of holes with one free face and with our cut holes break out either a cone or a wedge whose surface forms another free face for the benefit of the other holes of the round. In stoping work, which must be started from a drive, we can always manage to maintain two and often three free faces in homogeneous rock, and in stratified formations sometimes four or more faces, as a bedding plane is often nearly the equivalent of a free face.

In stratified formations the correct principles of breaking are especially important for economy's sake. The simplest case is that of beds 2 to 4 ft. thick. Here the holes should be drilled in a plane parallel to the beds because it is evident that we can more easily separate two wet coins on a table by sliding one sideways than by trying to lift it off vertically. Also these parallel holes do not weaken the blast by allowing the powder gases to escape through the bedding seam. Where the beds are thin, say under 8 in., we encounter the possibility, with holes parallel to the bedding, of having only the small bed blown out that contains the hole. For this reason it is advisable to first make a cut by driving holes across the bedding planes and then break to the cut with the balance of the holes drilled parallel to the bedding plane, but which now exert their maximum force perpendicular instead of parallel to the beds.

The method of firing also affects the pointing and the necessary number of holes to drill for breaking. There is a great advantage in simultaneous or electric firing wherever a weak roof or the greater danger from misfires with unskilled miners do not militate against it. In Fig. 3 it is evident that only the cone  $abd$  and the double cone  $dek$  would be broken out by the charges at  $b$  and  $e$  fired separately, but if  $b$  and  $e$  are not too far apart and are fired together the line of detachment will be along the lines  $abek$  instead of  $abdek$  and the extra volume  $bde$  will be broken with no extra powder or drilling. In any case of breaking, the pressure  $p$  produced by the explosive multiplied by the area of its section  $a$  (taken along the axis of the hole) must equal the ultimate tensile or shearing strength  $T$  of the rock multiplied by the area of its surface of fracture  $S$  or  $pa=TS$ .

If  $pa$  is greater than  $TS$  it means an excess of explosive over that

required for detaching the burden. This excess causes a "windy" shot, resulting in a greater air blast, a louder report and a longer, hotter flame than from a normal shot. A normal charge leaves traces of the drill hole, but an insufficient charge leaves "candlesticks" in the rock and loose pieces of the burden have to be blasted off.

### UNDERGROUND DEVELOPMENT

In illustrating we will take the case of driving horizontal headings or drifts as the same principles of breaking apply equally well for inclined and vertical shafts and raises. The practical difference in the latter arises from the setting of the drills and the handling of the muck and the water, and the fact that the length of the section in shafts generally makes the central cut advisable. We will also assume, to simplify the illustrations, a heading small and soft enough to allow its breakage by rounds of nine holes in three rows of three holes each, although often nine holes are more effective in four rows, one of three and the balance of two holes each. For larger headings with harder rock, the same principles would apply, but more holes must be added for breaking the round. On this basis we will now consider the following six cases of formation.

*Case I. Homogeneous Rock Free from Bedding Planes or Joints in the Face of the Heading.*—Since this formation breaks equally well in any direction, the holes should be placed for the most convenient drilling and mucking. For setting the bar horizontally, as is usual where it is desired to begin drilling before the muck from the last round is cleaned up, the placing of Fig. 4 (a) is a favorite. Here the adjustable arm is unnecessary and the first setting of the bar is at A to drill the upper and middle rows with the machine above the bar. The second setting of the bar is at B and the machine is turned under it for drilling the bottom row 3 of lifters. The horizontal rows of holes are usually fired in the order 1, 2, 3, Fig. 4 (a).

FIG. 4.—Holes for headings with horizontal bar.

The side instead of the bottom cut is handiest if we wish to set the bar vertically. We first set up at A, Fig. 5, and drill row 1, then at B with the machine on one side to drill row 2 and on the other to drill row 3. Here the vertical rows of holes are fired in the order 1, 2, 3, Fig. 5 plan. In other to keep the passage straight, the cut holes of row 1 will be put for the next round on the opposite side to what is shown, so that the finished sides have a zig-zag appearance, alternately right and

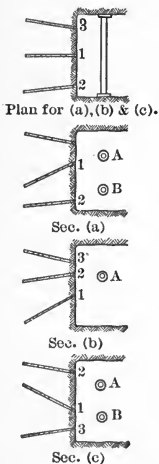



left as shown in the plan of Fig. 5. The middle hole of vertical row 1 points downward, like hole *c*, instead of flat-wise, like the balance of horizontal row 1, so as to throw out a bottom cut and avoid a horizontal inclination to the face too acute for rapid progress in a narrow heading.

For large tunnel headings, 8 ft. square, in hard homogeneous rock, the cone or "Leyner" center-cut system has recently permitted of very

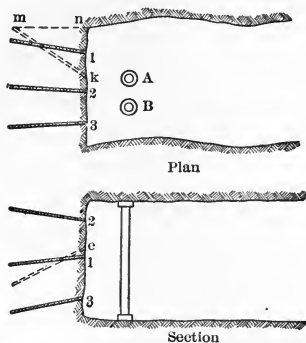

FIG. 5.—Holes for headings with vertical bar.

fast driving in western metal mines. It is especially adapted to the water Leyner drill on account of the many upper holes used and the fact that this drill is short enough to allow the sharp pointing of the holes with two settings of the bar. For hard steel ore and jasper in a Michigan iron mine, this system was thus applied.

In Fig. 6, *A* is the bar in first position for two machines and from its

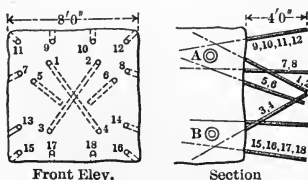

FIG. 6.—Holes for Leyner tunnel cut.

top the four back holes, Nos. 9, 10, 11 and 12, are drilled. The machines are then tipped forward until the crank can just turn and clear the back or top of the drift for drilling the top center cut holes Nos. 1 and 2, while finally they are turned under the bar for side holes Nos. 5, 6, 7 and 8. The bar is then changed to position *B*, the machines are set up on top and side holes Nos. 13 and 14 are drilled. Then, after turning the

machines under the bar, they are tipped up in front so the crank just clears the bottom of the drift and holes Nos. 3 and 4 are drilled about to meet Nos. 1 and 2 in the center of the heading. The four lifters, Nos. 15, 16, 17 and 18, are the final holes. In softer and better-breaking ground, cut holes Nos. 5 and 6, one lifter and one back hole can be left out, but the four cut-holes, Nos. 1, 2, 3 and 4, are nearly always used and are pitched up and down and in, to meet about in the center.

The five remaining cases are given for regularly stratified rock, but the joints or cracks of massive rock may, like bedding planes, often be utilized for breaking.

*Case II. Rock in Horizontal Beds; (a) Medium Thick Beds.*—Here the best results from the powder can be got by two settings of the bar vertically and following the drilling and firing directions given above for the method illustrated by Fig. 5. In the disseminated lead mines of southeastern Missouri (Example 10, Chapter VIII), this method is modified as follows:

For a drift 10 ft. wide by 6 1/2 to 7 ft. high, 12 to 13 holes are needed, placed in three rows horizontally by four rows vertically. The bar is set up once to drill each vertical row of holes, four set-ups being necessary to complete a round. Each vertical row is fired separately by fuse and dynamite and as only three or four holes are fired at a time, not enough smoke or broken rock is produced to prevent the drillers from setting up again very soon after blasting. This method with three shifts of two drill men each allows an advance of 5 to 7 ft. in 24 hours with 2 3/4-in. drills. By the former center-cut system, two drills and four men were able to advance only 10 to 15 per cent. faster than by the one drill and the side-cut method just described, all loading and tramping, in each case, having been done by muckers.

*(b) Thin Beds.*—Here, as already explained, the cut-holes must cross the bedding planes. A bottom cut is advisable. The bar is set horizontally at A, Fig. 4 (b). Often all three rows can be drilled direct although sometimes the use of the adjustable arm on the bar is necessary to get the correct pointing of the holes. The holes of row 1 are fired first and break out the cut to the bedding plane on the floor of the heading. Before loading the row of cut-holes, it is often helpful to stop up their bedding planes, around the powder, with clay but this precaution is unnecessary in the two upper rows where the holes are parallel to the beds.

*Case III.—Rocks in Vertical Beds Parallel to Heading; (a) Medium Thick Beds.*—This case requires the bottom cut of Fig. 4 (a) which has already been described under *Case I*. The use of this method in the vertical copper veins of Butte, Mont., is as follows: The placing of holes is shown in Fig. 7 for the 12-hole system, although for most rock nine holes are ample, the center holes of rows 2, 3, and 4 being omitted. For this arrangement the drill bar (with adjustable arm) need only be set

up once vertically, as shown. The round of holes is usually loaded and fired at one time and goes off in the order of 1, 2, 3, 4. Some of the miners regulate the explosions by cutting the fuse of different lengths and spitting them simultaneously while held together in the hand, and others by cutting all the fuse of the same length and spitting them separately in the required order.

(b) *Thin Beds.*—The solution of this case follows Fig. 5 and also resembles *Case II (b)* except that here the side instead of the bottom cut is used. With one setting of the bar, the three vertical rows *K*, 2 and 3 may be drilled and shot in the same order, row *K* breaking out the cut, along a side bedding plane, *mn*, and rows 2 and 3 breaking to the cut.

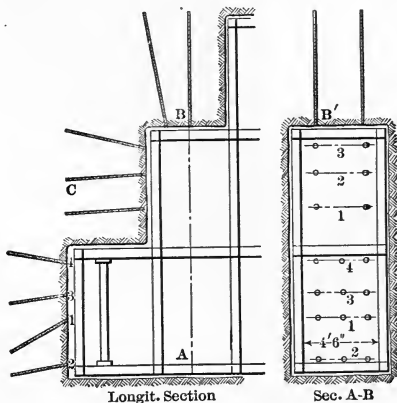

FIG. 7.—Holes for stoping.

Here it is not so necessary for alignment, as in *Case II (a)*, to alternate the cut on each side of the heading, but it is often an advantage especially where the vertical bedding planes are ill defined.

*Case IV.—Rocks in Vertical Beds Cutting the Heading at an Angle; (a) Medium Thick Beds.*—If the cutting angle which the bedding plane makes with the side of the heading is 45 deg. or less, the method of Fig. 4 (a) is usually preferable. If the cutting angle is more than 45 deg., the choice between the methods of Fig. 4 (a) and of Fig. 5 will often be merely a question of convenience in setting the bar horizontally or vertically, respectively.

(b) *Thin Beds.*—With a cutting angle of 45 deg. or less the method of Fig. 5 is the best. Where the cutting angle is more than 45 deg., the choice between the methods of Fig. 4 (a) and Fig. 5 depends on setting the bar as in *Case IV (a)*.

*Case V.—Rocks in Inclined Beds Dipping Toward the Floor of the Heading.*—For either medium thick or thin beds the method of Fig. 4 (a) is the best. Care must be taken, however, in the case of beds dipping over 45 deg. to stop the holes of the horizontal row 1 at the last bedding plane which intersects the face of the heading above the floor.

*Case VI.—Rocks in Inclined Beds Dipping Away from the Floor of the Heading.*—For either medium thick or thin beds the method of Fig. 4 (c) should be used. The bar is set up at *A* for row 2 and at *B* for rows 1 and 3. The order of firing the horizontal rows of holes is 1, 2 and finally 3. The end of the holes in row 1 should be stopped beneath the last bedding plane intersecting the face of the tunnel under the roof in order to utilize this plane as a free face in breaking.

### SURFACE EXCAVATION AND UNDERGROUND STOPING

In some kinds of deposits, especially the huge copper-bearing porphyry lenses and the Lake Superior iron mines, much time is often saved by drilling all the holes possible in the periphery of a heading in the ore from the same set-ups that are used in drilling the face. These peripheral holes can then be left untouched until the stoping of that section begins, when they can be easily loaded and fired.

Holes for stoping may be placed according to the direction in three groups, (1) down holes (2) flat-holes, and (3) uppers. A dip of about 45 deg. downward and upward can be assumed to make the limit between groups (1) and (2) and of (2) and (3) respectively, although the division between (2) and (3) is really marked by the angle of repose of the cuttings, that is, when the hole becomes self-cleaning, which may often mean a steeper dip than 45 deg. The speed of cutting with reciprocating drills depends on the removal of cuttings after each stroke to expose a fresh face. Therefore with these drills down holes drill easiest, then uppers, and lastly flats. Using the hammer drills with hollow bits cleaned by water or air-jets, there is less difference in drilling speed for different directions of pointing.

*Down Holes; Underground.*—Down holes are used underground in the underhand benches of tunnels or metal mines. To start this system, a heading *ah*, Fig. 8, is run at the top of the tunnel or stope and the down holes put in its floor for the first bench. The depth of this bench is limited by the length of the bit which can be inserted in the hole and that depends on the height of the heading which is usually around 7 ft. so that the ordinary railroad tunnel, 20 to 25 ft. high, requires two benches and two settings of the tripod at *a* and *b*, Fig. 8 to reach the bottom. These bench holes point downward anyhow but often an advantage may be taken of the structure. Thus with horizontal beds, the holes of the first bench can be terminated at a bedding plane which the gases

from the explosion will enter and thus exert a lifting action on the mass to be broken off.

Where there is a choice of plans, a heading can often be given in a direction that will take the maximum advantage of the bedding and joint planes for breaking, both in driving and stoping. On this principle, the rooms of coal mines are usually laid out perpendicular to the line of the main joint planes of the coal seam or to the "face cleat."

*Down Holes; at Surface.*—Above ground the only limit to the depth of the hole is the capacity of the drill. In considering breaking from deep holes we have a choice of two methods (a) multi-charging, (b) chambering.

In the drill hole *ab* of Fig. 9, it is evident that a charge of explosive at any point *b* will only break out a cone like *cbd* where *eb* is the line of

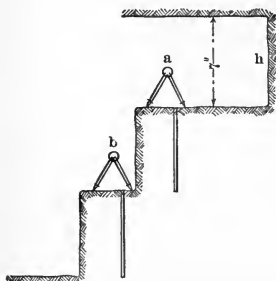

FIG. 8.—Holes for underhand stoping.

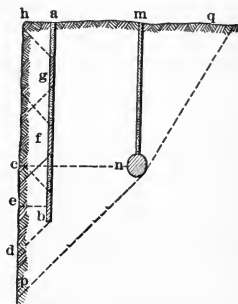

FIG. 9.—Holes for high bench.

least resistance. In order to break the whole length *ab* by multi-charging, other charges of explosives as *f* and *g* would be placed along the hole, with tamping between, and all be set off by simultaneous firing. In this way the whole mass *abd* would be detached.

By chambering, the breaking from a long hole would be achieved differently. Instead of the hole being placed near the face *hd* of the bench as is the hole *ab* (because of its small section for developing explosive pressure), the hole *mn* would be placed back from the face so that *nc*, the line of least resistance in homogeneous rock, would be only a little shorter than the length of the hole above the chamber at *n*. The chambering is effected by shattering the bottom of the hole with high-power dynamite so that the final shape of the chamber approaches a sphere. In France this chambering, in limestone, is performed with hydrochloric acid, each dose of neutralized acid being washed out and a new one poured in until the chamber is of the required size. When the chamber is filled with gunpowder or low-power dynamite and exploded,

it will exert nearly as much force upward as horizontally and will break out a mass along the surface of fracture *qnp*.

The choice between multi-charging and chambering depends on the varying conditions of formation, drilling and exploding. In a fissured formation, chambering has often an advantage because the explosive may be localized in a solid portion of the rock, although it often needs the use of two kinds of explosives, one for chambering and the other for breaking. Where it is desired to break off only a thin slice like *hab*, Fig. 4, from the cliff, it is evident that multi-charging should be resorted to. When an even topography will allow the handling of the portable steam or electric churn drill for a 3-in. to 12-in. hole (instead of the reciprocating drill for a 1 1/2-in. hole), the multi-charging method will permit the drilling and breaking of a much longer hole than would be feasible by chambering.

*Flat Holes; Underground.*—Of the three groups, flat holes are the most difficult to drill, especially those which are pointed above the horizontal for the reason that they neither hold water or discharge their cuttings by gravity. This group is much used in the overhead stoping system with piston drills as the drill tripod can be set on the broken rock. Thus flat water holes which are easier to load than uppers and free from their dust can be drilled at a fair speed. In overhand stoping with a weak back, as in the vertical veins of Butte, Mont., flat holes have also an advantage over uppers as the timber sets can be carried next to the back and the drilling can proceed under the lagging. Thus in Fig. 7 at *C* rows 1 and 2 are water holes and only row 3 need be drilled dry.

In the zinc district of Joplin, Mo., flat holes are used instead of the usual down holes to break the benches below the heading of the underhand stoping system as described under Example 10 of Chapter VIII.

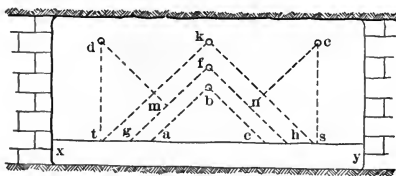

FIG. 10.—Holes for seam.

In driving coal headings or rooms by "blasting off the solid," flat holes bored by augers are generally used and are placed similarly to those shown for headings in flatly bedded rock in Fig. 5. In the location of the horizontal rows of holes, the character of the bedding planes between the coal seam and its roof and floor must be considered. If the roof is "tight," the shot must exert a strong shearing force to separate it. This is achieved by slanting the row of holes sharply upward and ter-

minating them at the tight plane. A similar remedy is applied to a tight floor. In many seams the coal is cut up into cubes by two sets of joint-planes perpendicular to the bedding planes, called the "face" and "end" cleats, which condition makes breaking easy.

The shearing of a coal face, before shooting, takes the place of the cut holes in blasting off the solid and the smaller charges allowable for the former method not only save explosive but prevent the shattering of the roof. With coal sheared vertically along one rib of a heading, the holes for breaking would be placed like vertical rows 2 and 3, Fig. 5. Where the shear is made horizontally as in the undercut  $xy$ , Fig. 10, it is customary in a thick seam of coal to place the first or "buster" shot at  $b$  in order to break out the triangular prism of coal  $abc$ . Then when the shattered strip  $gfh$  has been removed by the pick, we have  $dm$  and  $cn$  instead of  $dt$  and  $cs$  for the line of least resistance from the corner holes  $d$  and  $e$ , by which last the balance of the undercut coal can now be easily shot down. For a thin vein of coal, the "buster" shot would be located at  $K$  on a level with the corner holes and it would break out the triangular prism  $tKs$  as thick as the seam.

The undercut shown in Fig. 10 is that made by a hand or power pick. Being a height of 12 in. or so in front with a downward slope to 4 in. in the back, its shape allows the "buster" shot to throw much of the coal out of the undercut, so that the strip  $gfh$  can be easily extracted by the pick to prepare for the corner shots. When the undercut, however, is made by a chain machine, it is of uniform height of only about 4 in., and the "buster" shot may not throw the coal outward. It is then often advisable to place an extra "snubbing" shot at  $f$  to flatten down the detached prism  $abc$  so that the shots  $d$  and  $c$  can be made effective without first cleaning out the broken coal underneath.

*Flat Hole; Surface.*—In loosening huge banks of placer gravel in California before hydraulicking, small adits have been used with cross-cuts at their ends to hold the explosive. From a breaking stand-point, these adits correspond to flat drill-holes with chambered ends. The same method has also been employed for breaking great masses of rock in quarries or excavations. Often a shaft has been sunk as an entrance to the explosive chamber instead of an adit. Sometimes two cross-cuts from the adit may be made for explosive chambers, as shown in Fig. 11. There only the crosscuts  $cd$  and  $ab$  would be packed with gunpowder or low-power dynamite, while the adit itself would be blocked with timber or masonry bulkheads wherever it met the crosscuts. Elsewhere it would

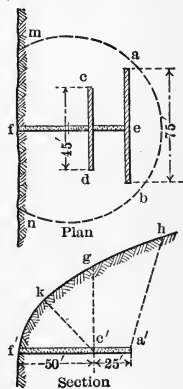

FIG. 11.—Blasting by tunnels.

be packed with sand. For firing, electric fuzes or caps would be placed in the explosive at intervals of about 10 ft. Finally they would all be connected by wiring in order that they might be fired simultaneously by electricity  $c^1k$  being the line of least resistance. The chamber  $cd$  would break out the cone  $gc^1f^1$ , and the chamber  $ab$  would break out the prism  $ha^1c^1g$ , the plan of the line of fracture being  $mabn$ .

The same breaking equation,  $pa = TS$ , applies as in the case of drill holes, the factor  $a$  being the area of the cross section of the explosive taken along the axis of the crosscut.

*Uppers.*—Uppers are seldom used on the surface but are common in underground work not only in tunnel headings and raises, but also in overhand stoping. In excavating overhand stopes with square-set timbering, it is sometimes more efficient to drill the back with uppers as at  $B$ , Fig. 7, instead of the flats at  $C$  used in Butte practice. In the great stopes of the Portland mine, at Cripple Creek, Colo., where the pay shoot was in places 120 ft. wide and 400 ft. long, the ore hard and the back strong enough to stay up across the vein for several sets ahead of the timbermen, it was found that the fastest breaking was accomplished by drilling uppers from piston drills set on tripods, one drill being used in every set across the stope.



## CHAPTER III

### COMPRESSED AIR FOR MINING

In drilling with piston rock drills a high pressure gives a stronger withdrawing force on the bit which tends to prevent sticking in fissured ground and thus greatly increases the speed of boring. In hard, tough ground, like specular hematite or certain intrusives, a high air pressure is necessary, if it is desired to strike a blow, severe enough to cut the rock, with a light portable machine. In a certain mine, using 40 drills in hard and fissured ground the rock broken per machine was increased about 20 per cent. by the simple expedient of advancing the air pressure from 75 to 100 pounds. A low pressure system requires larger pipes to deliver the same power and heavier pumps and hoists in the mine to accomplish a given amount of work than an equivalent equipment working under high pressure.

The economical limit of pressure depends in a given case on commercial considerations, costs of fuel, labor and supplies, which in turn are governed in considerable degree by the mechanical efficiency of the plant. The high pressure limit, except for haulage purposes is about 120 pounds.

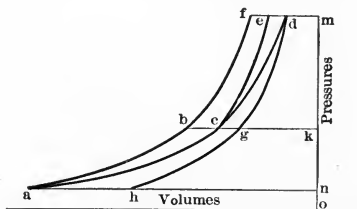

FIG. 12.—Relations of volume and pressure in air compression.

It is wasteful to heat the air during compression to a higher temperature than that of the mine, as radiation in the pipe-line will cool any warmer air before it reaches the motor. A proof of this statement follows: Let  $V$  and  $P$  be respectively the volume and pressure of free air at the beginning of compression, and in the theoretical indicator card, Fig. 12, in which  $O$  is the origin of coördinates, let the abscissa of point  $a$  be  $V$  and the ordinate be  $P$ . Let  $V$  and  $P$  be the volume and pressure of air at any point of the stroke, during its compression by a reciprocating piston. Then if the temperature due to the heat of internal friction is

retained in the air, we have adiabatic compression and get the curve  $a b f$ , the equation of which is

$$p = PV^y \left( \frac{1}{v^y} \right),$$

the value of  $y$  being 1.406 for dry air and somewhat less for the ordinary atmosphere, and  $p$  being the resultant pressure and  $v$  the resultant volume.

If the temperature is kept constant during compression, by removing the internal heat as fast as generated, we have isothermal compression and get the curve  $a c d$ , the equation for which is  $p = PV \left( \frac{1}{v} \right)$ . Finally, the work lost by cooling the air, from the final adiabatic temperature to that of the free air, is measured by the area  $a c d f b$ , the total work of compression for one stroke of the piston being area  $a f m n$ .

#### THEORY OF THE INTERCOOLER

Although isothermal compression is the ideal, practical difficulties prevent its attainment. The air can be cooled in the compression cylinder by a water spray, but this method requires too slow a machine to compete with dry compression and external cooling. It can be easily shown, mathematically or by an indicator card, that water-jacketing the compression cylinder has practically no effect in cooling the air, although it is useful in keeping the bearing surfaces cool enough for lubrication.

In Fig. 12, the adiabatic and isothermal curves get farther apart as the pressure increases, so that the work lost by adiabatic compression increases at a faster ratio than the pressure. To avoid this increase for high pressures, a compression in two stages, with a surface intercooler between the high- and low-pressure cylinders, is frequently used. Unfortunately, few of the standard machines have a large enough intercooler to insure that the compressed air, entering the high-pressure cylinder, is as cool as the free air entering the low-pressure cylinder when the machine is running full speed. It will aid the intercooler, if the free air is sucked into the low-pressure cylinder from the coolest available place.

In the diagram, Fig. 12,  $K$  is the pressure at which the air leaves the low-pressure cylinder to pass through the intercooler and enter the high-pressure cylinder. The following cycle then takes place with a perfect intercooler. In the low-pressure cylinder the air is compressed adiabatically from  $a$  to  $b$ , reduced in the intercooler to the volume at point  $c$  and then compressed adiabatically in the high-pressure cylinder from  $c$  to  $e$ , the total work of compression being the area  $a b c e m n$ . Thus the saving of work by the use of the intercooler is represented by the area  $c e f b$ , from which must be deducted any work expended in circulating

the cooling water. In the design of the machine, the ratio of the diameters of the low-pressure cylinder and the high-pressure cylinder are taken so that the area  $a b k n$  is equal to area  $c e m k$  for average conditions.

There need be little difference in the efficiency of the steam ends between high- and low-pressure compression. With a cross-compound air end, the steam end can also be compound and for a single-stage air end the machine can be tandem-compound. The air-pressure governor has now been perfected and for the usual variable loads of mine work, is indispensable for any pressure, though it requires a duplex machine to avoid a stoppage on dead center with no load.

### PREHEATERS

In the case of the air motor, the compression process is reversed. The air on entering the motor in the mine has the pressure and volume of point  $d$  (Fig. 12) and in a simple, unheated motor cylinder will expand adiabatically along the line  $d g h$ . Should the air be preheated to the volume of point  $f$  it will then expand along the adiabatic line  $f b a$  with a gain of work, over the unheated case, equal to area  $a h d f$ .

With two-stage expansion, the air may be preheated before entering the low-pressure cylinder to  $e$ , then expand adiabatically to  $c$ , next pass through an interheater so as to reach  $b$  on entering the high-pressure cylinder and finally expand adiabatically to  $a$ . Heating during expansion, like cooling during compression, gains in its relative effect on the efficiency, the higher the pressure. Aside from its gain in work, heating is often necessary to prevent freezing of the exhaust when the air is damp and cold on entering the motor.

Owing to the small size and portability of rock drills preheaters are for this service out of place, but for large hoists and pumps, with high-pressure air, they are always to be recommended. In the operation of the preheater the compressed air passes through a vessel containing heated tubes of sufficient radiating surface for the purpose. These tubes may be heated by a coal, coke or oil fire, but, since smoke contaminates the atmosphere of the mine, steam-heating is often both convenient and economical. In an air heater it is possible to utilize steam more efficiently than in the best condensing engine, for both the latent and visible heat of the steam are absorbed by the air and turned into work without frictional losses greater than the motor would suffer with unheated air. With steam heating the only important loss is that due to radiation in the supply pipe from the boilers, and by proper covering this can be made small. In the 500-gal. Dickson pumps, installed in the Anaconda mines at Butte in 1899, the air was successfully heated by steam in both the preheaters and the interheaters for the compound cylinders.

High-pressure pipe-lines, though smaller in diameter, require more care to keep them tight than lines for low pressure, and the velocity of exit of air from a leak varies directly as the square of the pressure.

The loss of power from the common practice of blowing out powder smoke with the air hose is the greater the higher the pressure, for the ventilating efficiency depends only on the quality of free air discharged. With pipes properly proportioned for the quantity of air to be delivered the frictional line losses will be moderate with either pressure, if care be taken to avoid unnecessary bends and to use gate valves instead of globe valves.

The compressor should discharge its air into a receiver the cooling action of which will not only at once reduce the volume to that which it will have in the mine, but will also precipitate any extra moisture and keep it from entering the pipe-lines. A good device for the surface receiver is a condemned boiler, set in a wooden tank in which is water circulating through the boiler tubes, while the compressed air fills the shell. Underground the receivers need only be plain steel shells for storage, but they must be numerous and large enough to preserve the pressure constant under the variable power requirements. Preheaters in use serve as receivers.

When air is used for haulage it needs a special piping system to hold the requisite pressure of 1000 lbs. upward. This piping also serves as a receiver and accumulator of air between locomotive chargings so that the compressors can be run under a constant load. It is evident that the piping system will need a lesser proportionate capacity as receiver the greater the number of locomotives supplied, for each charging will involve a less relative displacement of air. Under the usual traffic and air pressure a pipe line of 6 to 12-in. dia. is amply large, both for distribution and storage of air, without placing tank receivers at the stations.

The air ends of compressors for haulage systems should be at least 4-stage, of moderate speed and with ample intercooling surfaces; for Fig. 12 shows how fast the power loss due to inefficient cooling increases with the pressure. Until recently the locomotives were single-stage and had consequently a low efficiency and capacity; but the new compound, Porter locomotive obviates these troubles and gives air-haulage a chance for extension beyond its present special field of gaseous or dusty coal mines.

## CHAPTER IV

### PRINCIPLES FOR CONTROLLING EXCAVATIONS

The art of timbering is not synonymous with that of the control of ground as some suppose; a good carpenter can frame timber better than any miner, but unless he places it underground as directed by the latter, his accurately jointed sets are liable to prove worthless for the purpose intended. The subject of ground control naturally divides itself under two topics: I. The control of the roof of an excavation; II. The control of the sides and floor of an excavation and of the whole overlying formation. Both topics will be considered separately before their inter-relation will be discussed. In practice, we have not only to consider the freshly broken surfaces of an excavation, but their future conditions after exposure to the weathering action of the mine atmosphere.

#### CONTROL OF THE ROOF

(a) *Roof over a Horizontal Room.*—This case is the simplest and occurs in mining horizontal seams or beds. Let  $abb'a'$ , Fig. 13, represent the cross-section of a rectangular room excavated in a team of the thick-

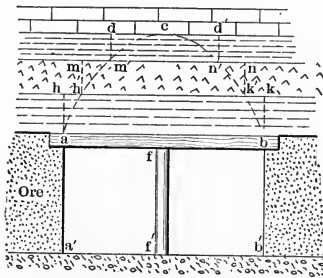

FIG. 13.—Homogeneous or horizontally-bedded roof.

ness  $aa'$ . Then the support of the roof over the opening  $ab$  depends upon the immediately overlying formation. The structure of the last falls usually under one of the five following cases: (1) homogeneous, (2) horizontally bedded, (3) weakly-consolidated, (4) non-conformable, (5) broken.

With case (1) or a *homogeneous* roof stratum, either massive or in a sufficiently thick bed to act as such, the lines of vertical pressure far

above  $ab$  tend to combine themselves into resultants which follow a surface  $acb$  and throw the downward pressure onto the walls at  $a$  and  $b$ . The resultant surface takes the form of an arch, over a tunnel, or of an arch with domed ends, in a room of limited length. This means that the sub-arch block  $acb$  is all the weight that has to be supported to maintain the roof intact, and that its stability depends first, on its strength as a beam of continuous width to bear its own weight across the span  $ab$  and second, on its being held in place by the tensile strength of the rock area along the arch, or potential surface of fracture,  $acb$ . In case (1) the natural arching is usually sufficiently convex so that the sub-arch-block has sufficient depth  $cf$  to make it self-sustaining as a beam across  $ab$  except in soft rocks like certain shales which may not only need the support of a cap like  $ab$  but also must be lagged.

In old mine workings where the sub-arch block  $acb$  has fallen out so that the shape of the natural surface of equilibrium  $acb$  can be discerned, it appears as an arch whose proportions vary with the width of the room and the nature of the roof. Fayal gives as working rules for limited areas like rooms:

If  $w$  = width of room (as  $ab$  in Fig. 13);

$h$  = height of arch (as  $cf$  in Fig. 13);

If  $w$  is less than 6 ft.,  $h$  may be as much as  $2w$  (Fayol's first rule);

If  $w$  is more than 6 ft.,  $h$  may be as much as  $4w$  (Fayol's second rule).

In railroad or mine tunnels, a homogeneous roof can be made self-sustaining by excavating it, at the start, along the natural arch form. In the rooms of coal seams, however, or in iron-ore beds, the sub-arch block must be sustained intact until the mineral beneath is removed and the room abandoned. The tensile strength of the arched surface is seldom sufficient to accomplish this unaided, except in narrow rooms. In wider rooms, a cross-beam  $ab$ , or one or more props like  $ff'$  must be put in whose strength, however, need only equal the difference between the weight of the sub-arch block  $acb$  and the tensile strength of the arched surface  $acb$ , provided that  $ff'$  is inserted before the surface  $acb$  has begun to fracture. Should the latter accident have taken place, the weight of the whole sub-arch block may have to be sustained by props and thus a heavy unnecessary expense be incurred.

With case (2) or where the roof is in beds thinner than the sub-arch block so that bedding planes like  $hk$  and  $mn$  (Fig. 13) intersect the surface  $acb$ , a different condition arises from case (1). It is evident that now the sub-arch block instead of being a single stone beam  $acb$  is divided into three stone beams  $ahkb$ ,  $h'mnk'$  and  $m'dd'n'$ , so that for a self-sustaining roof, the lowest beam  $ahkb$  must be strong enough to sustain the weight of the two beams above it, the central beam  $h'mnk'$  must sustain the top beam  $m'dd'n'$  and the tensile strength of the sub-arch surface  $acb$  must be, as before, sufficiently strong to hold up the whole sub-arch

block. It is, therefore, likely that a room would need stronger props in case (2) than in case (1) because the lowest sustaining beam of case (2) has a depth at the middle of  $ha$ , which is only a fraction of the corresponding depth  $cf$  for case (1), and the cross breaking strength of a beam increases directly as the square of the depth. Also we now do not have a uniform tensile strength for one surface of fracture  $acb$ , but a different strength for each of the three beds which  $acb$  intersects. Hence for case (2) we have to ascertain both the cross breaking and the tensile strengths of all beds in the sub-arch block before we can ascertain how much propping is required to sustain the roof across a room of a given width. A roof of an elastic nature like slate may at first simply bow downward from an excess of pressure instead of fracturing as a beam. This may cause it to fail by shear at the abutments. For the maximum strength of a roof it is important to exclude water from the bedding planes in order to prevent the slipping and weakness caused by its presence.

Case (3) often occurs in coal mines where the roof stratum is "clod" or a kind of soft shale containing concretions of considerable size. A common device is to leave the upper layer of the coal seam under it which then acts as the lowest beam  $ahkb$  of case (2) to partially sustain the clod-stratum. Where all the seam must be removed beneath the clod, the roof can only be kept intact by excavating the mineral with little or no blasting and keeping the supports close to the working face. Props, cross-pieces and lagging may all have to be used. If the clod stratum is thicker than the room's natural arch, masses may fall out from above the surface  $acb$ , after the sub-arch block has been taken down, so that roofs must be arched higher than the clod in order to stand permanently unsupported.

Where the roof is a weakly consolidated stratum of more uniformly sized stones, like a conglomerate, the problem of support is similar. Practically the whole weight of the sub-arch block must be held in place by artificial supports, and in addition the beam  $acb$  itself must be reinforced by cross-beams of props or by both. Where the roof stratum is so weakly consolidated as to be incoherent it requires close lagging, and where quite loose an advance can only be made by driving fore-poles ahead of the timber sets right up to the working face. Loose sand, if dry or only moist, can be sustained, like loose gravel, by close fore-poling, but if it is wet enough to flow freely like quicksand the case is hopeless except by the use of some such system as that of the pneumatic shield recently employed in the Hudson river tunnels at New York.

It is evident, however, that while the quicksand roof of a railroad tunnel might be penetrated and sustained by the expensive pneumatic shield and its follower, a cast-iron tube lining, such a device would be commercially unpractical for ordinary ore deposits. For the latter the only hope for overcoming quicksand is sufficient drainage so that the

sand loses its fluidity and takes the compact condition of its merely moist state. If drainage of the quicksand covering is not feasible and the ore body cannot be mined by some subaqueous method, it is worthless, at was recently proved for a huge hematite deposit under a swamp on the Mesabi range, Minn., which was abandoned after wasting a large sum in attempting to open a mine in it.

Even if the bed or pocket of quicksand does not rest directly on the ore body, but is separated from it by a rock stratum, great care has to be taken against it. The only safe plan is to open the mine excavations of small size and with sufficient support to keep the rock roof intact, for otherwise vertical cracks may develop reaching to the quicksand. When the quicksand once begins to flow into the mine, the results may

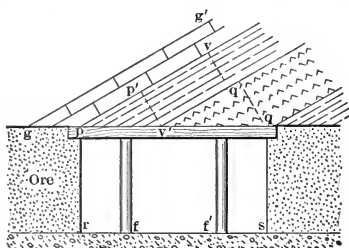

FIG. 14.—Non-conformable roof.

be far-reaching for its escape from its matrix may mean the collapse of the latter and consequent disastrous movements of the whole overlying cover.

In case (4) the *non-conformable* roof strata may dip in any direction with reference to the underlying mineral seam. If the roof strata strike along the long axis of the room as in the cross section of Fig. 14, then it is evident that conditions will not produce an arch of fracture as in Fig. 13. The upper stratum  $g'gpv$  is entirely above the room opening and bridges it slantingly from one side to the other, while the two lower strata,  $vpv'q'$  and  $q'v'q$ , have their lower ends unsupported and projecting like cantilever beams. Then the natural surfaces of fracture will be normal to the bedding planes and will be  $qq'$  for the lowest and  $q'v$  for the middle stratum. The tensile strength of surface  $qq'$  must be enough to hold the weight of projection  $q'v'q$  and any unbalanced pressure from above, while surface  $vq'$  must hold its end  $vpv'q'$  and any weight above. A line of props at  $t$  strong enough to sustain the excess of strain over the resisting strength of surface  $qq'$ , will hold up the roof without a second line at  $t$  provided that surface  $v'p'$  is strong enough to sustain the weight on it from the projection  $p'pv'$ .





free blocks like  $amnb$ , they can only be kept in the roof by sustaining their entire weight artificially, and fore-poling will have to be used for excavating beneath a roof surface containing them.

(b) *Roof Over an Inclined Room.*—This case occurs in mining seams on a dip which may vary up to 90 deg. from the horizontal. Let  $abb'a'$ , Fig. 15, represent the cross-section of a room in a seam of the thickness  $bb'$ , which has the usual horizontal floor  $aa'$  for tramming. It is evident that the principles of roof support similar to the previous case of horizontal rooms apply here, but the action of the superincumbent weight in the roof is affected by the angle of dip. Thus in the diagram of Fig. 15, if  $W$  = superincumbent weight;  $\theta$  = angle of dip;  $N$  = normal pressure on roof;  $T$  = tangential pressure on roof; then

$$N = W \cos \theta \dots \dots \dots (1)$$

$$\text{and } T = W \sin \theta \dots \dots \dots (2)$$

For homogeneous strata the weight of the overlying formation would be thrown onto the pillars at  $a$  and  $b$  and the potential surface of fracture would be the arch  $acb$ . Thus the span  $ab$  has only to sustain the normal pressure of the sub-arch block  $acb$  acting both in tension on the surface  $acb$  and in cross-breaking strain on the beam  $acb$  as described for case (a) in Fig. 13. The back of the ore should also fall on the arch line  $bdb'$  instead of a straight line from  $b$  to  $b'$ . A prop to hold up the roof will be subjected to the least pressure and be of shortest length if it is placed in a line  $gfe$  drawn normal to the hanging wall from the center of gravity of the sub-arch block at  $g$ . Because of possible shrinkage of prop or movement of ground, however, which would cause a normal prop to fall out, the usual practice is to incline it about 10 deg. downward from the normal line as  $ff'$ . The sub-arch block  $acb$  can also be sustained by a cap  $ab$  from the back to the floor, or by both prop and cap. With the roof-strata bedded parallel to the seam, the surface of fracture assumes the stepped-arch form  $ahh'mm'k'kb$ . In comparing the strains and the support of the bedded roof, as well as of the weakly-consolidated, of the non-conformable and the broken roofs with those of the homogeneous roof, the same differences arise as already explained for case (a)

#### CONTROL OF THE OVERLYING FORMATIONS

It is evident that when part of a bed is removed, the balance left as pillars must sustain the whole overlying formation. There are three factors that enter into pillar calculations, the roof, the pillars or sides and the floor. The stability of the room does not depend alone on the strength of the pillars as columns for an excess of pressure may force a sound pillar into a roof or floor of insufficient compressive strength and cause a settling. This happens with materials like clay which are hard

when dry and become soft when moist, so unless they can be kept dry during mining, the pillar calculations must guard against their moist state. An excess of pressure on a plastic floor will cause it to spread laterally and rise from under the lower periphery of the pillar, thus exerting a horizontal rending force on the latter which tends to disrupt its edges.

Any downward bowing of an elastic roof over the rooms must be compensated for by an upward bowing over the interior of the pillars. This causes an oblique pressure at the upper edges of the latter which tends to shear them off as the roof bends more and more. The obliquity of this roof pressure on the pillar edges is also often increased by a rolling floor.

Thus a mine floor and roof act not only vertically on the areas of contact with the pillars, but also laterally, while the bowing of the roof produces strains parallel to the strata that tend to separate them along their bedding planes, and thus weaken the cross breaking strength of the roof. For these reasons, a mine pillar will stand best and can be made of the minimum volume when its base and capital meet floor and roof in broadly spreading tangential curves, which are concave in profile.

Sometimes the roof and floor beds, in direct contact with the seam, are themselves quite hard, but so thin that they bend and transmit the pressure on the pillars to an adjoining soft stratum and force it out through any fissures that may be in the roof or floor. When the pillars themselves are too weak for the pressure, what is called a "squeeze" (failure of pillars) begins, by a shelling off of the outer surface, and later a collapse occurs, which may be a gradual sinking, with elastic strata like some coals and shales or a sudden fracturing in masses with hard blocky rock-like limestone or quartz. Some substances, like coal, pyrite and easily weathered rocks, loose strength on exposure to mine air and this fact must be considered if durable pillars are to be made of them. The minimum fraction of a bed necessary to leave for pillars may be thus calculated:

Let  $x$  = fraction of area to be left in pillars;

$h$  = depth of cover in feet;

$w$  = specific weight of cover in pounds per cu. ft.;

$s$  = ultimate compressive strength in pounds per square foot of least resistant stratum adjoining pillar;

$m$  = factor of safety,

Then, weight held by 1 sq. ft. of seam =  $hw$ , and compressive strength of corresponding pillar =  $xms$ , hence  $hw = xms$ .

$$\text{or } x = \frac{hw}{ms} \dots \dots \dots (3)$$

If excavation is inclined at an angle as in Fig. 15, then the pressure is

$hw \cos \theta$ , so that  $hw \cos \theta = xms$  or  $x = \frac{hw \cos \theta}{ms} \dots \dots \dots (4)$

It is difficult to get the real strength of the floor, pillar and roof beds because the beds themselves are seldom free from planes of weakness which would not be appreciable in the small blocks that must be used in the testing machines for compression, tension or shear. For this reason the factor of safety  $m$  of equations (3) and (4) is taken at from 2 to 10, varying with the nature of the strata and of the mine layout.

It is only by close watching on the changing conditions that movements of the formation over wide excavations can be prevented even in well laid out mines. An incipient "squeeze" of pillars may sometimes be checked by building up stone-filled wooden cribs along their edges, but this remedy may merely shift the pressure and transfer the "squeeze" elsewhere. Often it is better to localize rather than to attempt to support a squeeze and this can be affected by allowing the roof to cave over the disturbed section, assisting the fall where necessary by blasting the roof and pillars. The volume of roof thus made to fall will be that under the dome of fracture as  $acb$  of Fig. 13, the span  $ab$  in this case not being the width of a single room, but of the whole disturbed section. If the seam is thin in proportion to the height of the falling dome, the broken rock, as it occupies more space than when solid, will fill up the space under the surface of fracture and form a sufficient support to prevent any further strain on the overlying formation.

The caving of the roof over the disturbed area is also a remedy for "creep" (oozing of roof or floor into excavations), but if the ground surface is to remain intact a safer plan is to fill the excavation solid with rock. Where a supply of fine material like mill tailing or sand can be obtained cheaply, the filling is best done by mixing it with water and running it into the workings through pipes by the flushing system of the Pennsylvania anthracite regions as described in Examples 59 and 60.

The caving of the roof, locally, by blasting can be easiest affected by reversing the methods already explained for roof support. If pulling or blasting out all artificial supports does not bring down the roof, any rock pillars in the area should be drilled and blasted by simultaneous firing. The next procedure is to drill holes into the roof so as to cut a groove around the springing line of the dome  $acb$  in Fig. 13. The work of the drill men around the edges of the excavation will be safe and the circumferential groove can thus easily be widened and carried higher until the central bell of the sub-arch dome has so much of its sustaining surface  $acb$  cut away that it drops out.

#### EFFECT OF CAVING ON OVERLYING OBJECTS

In working superimposed beds simultaneously, it is necessary to determine the proper relative position of pillars in the various beds.

Pillars must also be located, in caving mines, where it is desired to protect valuable surface structures. In modern coal mining, both the long-wall and usually the room and pillar method involve the caving of the excavations.

How far up an underground subsidence will reach depends on a number of conditions, such as area, height and manner of making of excavation, nature of overlying formation, presence of faults and dikes, etc. By Fayol's second rule, the height affected by subsidence would not exceed four times the width of the excavation, but this only holds good for a limited area whose sub-arch roof block can scale off at leisure. When large areas are excavated, complex stresses arise which are apt to cause sudden irresistible strains on the roof which cause it to develop long cracks and fractures analogous to faults. If the overlying strata contain many strong rock beds, these may act as beams which rest on the broken caved formation beneath them and prevent any effect above. Thus at Sunderland, England, where half of the strata are hard rock, coal seams have

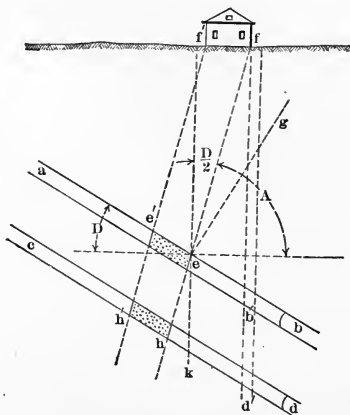

FIG. 16.—Effect of excavation on overlying bed and on surface.

been mined and caved at the depths of 1600 ft. without affecting the surface. In the Transvaal gold beds, dipping at around 40 deg., caves may occur over areas of several acres at depths over 1000 ft. without surface movement. With a formation of soft friable strata, like shale or glacial drift, however, there is nothing to arrest a subsidence beneath, and under such roofs the effect of caving coal mines, 2000 ft. deep, has depressed surface structures.

Fayol's third rule applies to excavations of large area and is "where the area is infinite and the beds are chiefly sandstone with a dip less than

40 deg., the height of the zone of subsidence is less than 200 times the height of the excavation." This means that the caving of an excavation, 6 ft. high, would not affect the surface if over 1200 ft. below it. The third rule is based on the height of excavation rather than on its width, like the other rules, and depends on the principle already mentioned that the strong strata tend to rest solidly, ultimately, on the caved ground below.

Subsidence does not break strata perpendicular to their bedding planes. For defining the disturbed area over excavations under unbroken stratified formations two rules are used, the first for slightly and the second for steeply dipping roofs. Thus in Fig. 16,

if  $D$  = dip of roof strata in degrees

$A$  = dip of angle of fracture,

for roofs under 30 deg. dip Richardson<sup>1</sup> gives,

$$A = 90 \text{ deg.} - 1/2 D. \dots\dots\dots (5)$$

which signifies that the plane of fracture  $ef$  (Fig. 16) of bed  $ab$  lies half way between the vertical and the plane  $eg$  (normal to the dip line of the roof).

For roofs over 30 deg. dip Hausse<sup>1</sup> gives,

$$\tan A = \cotan 2D + 3 \operatorname{cosec} 2D. \dots\dots\dots (6)$$

Formula (6) gives for a 30-deg. roof only a slightly larger angle of fracture than formula (5), but as the dip gets steeper the difference between the two formulas steadily increases while a maximum  $A$  is reached with formula (6) when  $D$  is between 50 deg. and 60 deg. as shown in the following table:

Dip $D$	Angle $A$ , degs.	
	Formula (5)	Formula (6)
0 deg.	90	90.0
10 deg.	85	85.2
20 deg.	80	80.5
30 deg.	75	76.2
40 deg.	70	73.0
50 deg.	65	70.8
60 deg.	60	71.0
70 deg.	55	74.0
80 deg.	50	80.8
90 deg.	45	90.0

These formulæ can only be considered as general guides to the probable location of the plane of fracture and they must be modified in practice by a consideration of the surface topography, of the structure of the formation and of natural breaks like joints and faults. Where thick dikes cut across the roof strata, the plane of fracture is more apt to follow along the surface of the dike than to break it.

<sup>1</sup> Eng. and Min. Journal, Aug. 3, 1907, p. 196.

*Protection of Surface.*—The practical use of these formulæ is shown in Fig. 16 where it is desired to protect the building at  $fb'$  when mining the veins  $ab$  and  $cd$ . Here  $h'f'$  and  $hf$  are planes drawn parallel to the plane of fracture  $ef$  and their intersection with the beds defines the inside boundaries of the pillars  $e'e$  and  $h'h$ . The margin of safety to be left around these inside limits of the pillars for "draw" varies with the importance of the building and how closely the strata have been observed to follow the fracturing formulæ.

*Protection of Overlying Beds.*—Where the veins  $cd$  and  $ab$  are being mined simultaneously, it is evident that the pillars to be left in  $cd$  to protect pillar  $e'e$  must not be the ground vertically beneath, as  $hk$ , but that enclosed between the same planes of roof fracture as  $h'h$  with a due allowance added for "draw." In excavating, also, the direction of the roof fracture  $ef$  must be taken instead of the vertical plane as the guide to relative operations in the upper and the lower beds. Thus for safety the bed  $ab$  would be stopped "ahead" (measuring from the plane  $ef$ ) of bed  $cd$ ; except in the case where  $cd$  was being filled, when the slight subsidence of the floor of  $ab$ , caused by the settling of  $cd$  (when "ahead") on its filling, would render the breaking of  $ab$  easier.

In mining the superincumbent parallel anthracite seams of the Lehigh Valley Coal Co., by the room and pillar system, the pillars must overlay each other when the parting is thin. A neglect of this precaution, with the usual parting, is liable to result in the squeezing of the overlying pillars down into the rooms of the seam below. When the parting is over 40 ft. thick, however, it is only necessary to have the panel pillars (at ten-room intervals) of adjoining seams superincumbent, and to lay out the entries and room axes of both seams approximately parallel to each other; in this way the work in different seams can be pursued more independently and just as safely.

*Shaft Pillars.*—The same principles and formulæ can be applied to the design of pillars for protection of shafts. In Fig. 16 the vertical shaft  $fd$  will need a pillar in each seam extending to the intersection with the plane of fracture passing through the shaft collar at  $f$ . Thus the minimum upper limit of these pillars must be at  $e$  and  $h$ , which for considerable depth, would mean many hundred feet away from the shaft. But this involves only a moderate loss of ore because the pillar may be narrow and need extend only a short distance down the dip to  $b$  and  $d$ . The distances  $b'b$ ,  $d'd$  and the width of the shaft pillar along the strike of the seam may be estimated by formula (4).

For inclined shafts following the mineral seam, the protecting pillars should be continuous strips on each side with break-throughs only for the loading stations. The width of these strips, if estimated by formula (4), should increase gradually from the surface downward. Although this

last requirement is seldom fulfilled in practice, it gives the minimum loss of ore for the maintenance of a stable roof.

### SUPPORT OF EXCAVATIONS

*Curved Sections.*—A tunnel section may be supported by the circular lining 1 (Fig. 17) against external pressure from any direction since the portion of the ring taking the ground pressure will be an arch to transmit its load to the balance of the ring acting like arch abutments. If we consider only the keeping open of a given area with the least material, the circular lining may be replaced with advantage by the elliptical, when the pressure is greater in one direction than in another, by placing the long axis of the ellipse parallel to the direction of greatest pressure. Thus if the greatest pressure comes from roof or floor, the ellipse should be vertical as 2 in Fig. 17, and if from the sides, the ellipse should be horizontal as

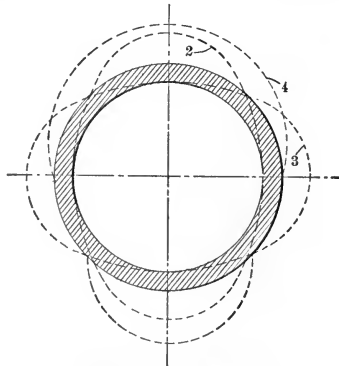

FIG. 17.—Tunnel sections.

in 3. The circular lining is most economical when the external pressure is equally distributed, or where it comes in an oblique direction, for an oblique ellipse would be generally unsuitable for use. The oblique pressure is apt to occur when driving along the strike of inclined beds. Other considerations, besides economy of lining, usually prevail in practice so that circular sections are less used than elliptical ones, which fit cars more closely in transportation tunnels, or egg-shaped ones, like 4, which have a lesser hydraulic gradient for water conduits or drains. The material most used for curved linings is cast iron or some kind of masonry, though steel shapes are also formed to fit, and timber polygons to approximate curved sections. To merely support the ground, it is clear that only that part of the tunnel section need be lined which has weak walls so that we see in practice linings on the roof alone, on the roof and one



side, or on three sides, the ends of the lining resting in each case against abutments of solid rock.

*Rectangular Sections.*—The greatest available area in transportation tunnels for the minimum volume of excavation is obtained by using the rectangular instead of the curved section. Ordinary brick or stone masonry, having little tensile strength, is unsuitable for lining any part of the rectangular section subject to cross-breaking strains. Therefore it is not used except for side walls. Timber or steel beams and re-enforced concrete are the common linings for rectangular sections. With a weak roof and strong sides only the piece *ab* (Fig. 18), which is called a cap or a "quarter-set" is put in; with both roof and one side weak the cap *ab* and the post *bc*, called a "half set," are needed; with roof and both

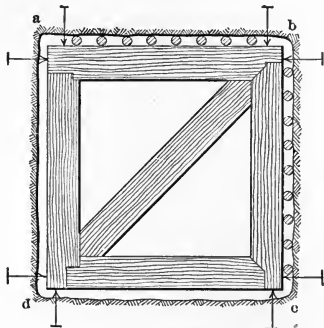

FIG. 18.—Tunnel lining with timber.

sides weak a cap and two side posts, or a "three-quarter set," is used; while with four weak walls a cap, two posts and a floor sill, or a "full set," is required.

The attempt will not be made here to discuss methods of framing except as they are affected by ground pressure. With a predominating vertical pressure a good joint for square timber is at *a* (Fig. 18), and for a round timber at *b*. Where the main pressure is horizontal a joint for square timber is shown at *d* and one for round timber at *c*. A rectangular frame can resist pressure acting parallel to its sides, but tends to collapse under oblique pressure. It is to make them more stable under oblique pressure that tunnel sets have outward-battered instead of vertical posts.

*Slope Sections.*—In keeping open the large stopes of some metal mines with the framed cubical cells of the square-set system, the same precautions of properly designed joints and of uniformly spaced points of contact with the surrounding rock must be observed. Miners have found to their sorrow that it is useless to attempt to keep open square-setted stopes under oblique pressure unless diagonal braces (like *bd*) are inserted par-

allel to the direction of pressure, for transforming the unstable squares of the frame into stable triangles.

### ZONES OF FRACTURE AND FLOWAGE

Wooden or steel frames will only keep the peripheral surface of excavations intact against the pressure of loose pieces or sub-arch blocks like *acb* in Fig. 13. For the support of the overlying formation, even masonry is only of limited commercial utility, therefore rock pillars or filling with waste must be relied upon. Beyond a certain depth, or below the "zone of fracture" of geologists, we have the "zone of flowage," where no opening can be maintained permanently owing to the inability of any fraction of the rock, left as pillars, to sustain the superincumbent pressure.

Transposing formula (3) we have for  $h'$  (the depth of the zone of fracture):

$$h' = \frac{smx}{w},$$

but for the zone of flowage both  $m$  and  $x$  are = 1 and substituting these values we have

$$h' = \frac{s}{w} \dots \dots \dots (7)$$

From equation (7) it is evident that the depth  $h'$  depends solely on the compressive strength of the basal rock and the specific gravity of the overlying formation. Assuming the specific weight  $w$  of the earth's crust to be 150 lb. per cu. ft. and the compressive strength of the basal rock to be 3,000,000 lb. per sq. ft., we have by substitution in (7)

$$h' = \frac{3,000,000}{150} = 20,000 \text{ ft., or about 4 miles.}$$

Recently it has been shown by Profs. Adams and King<sup>1</sup> that bore-holes in test-cylinders of granite remain unchanged even when long subjected (at a temperature of 550° C.) to crushing stresses of 14,000,000 lbs. per sq. ft. This indicates that the value hitherto assumed for  $s$  in equation (7) is much too small and that the zone of flowage in granite would lie deeper than 14 miles from the surface.

<sup>1</sup> Journal of Geology, Vol. XX, pp. 97-138.

## CHAPTER V

### PRINCIPLES OF MINE DRAINAGE

Those miners who talk much of pumping but little of drainage resemble those old-fashioned doctors who spend all their time on remedies and neglect diagnosis. Instead of studying water conditions beforehand as a basis for drainage equipment, a too common way is to try to fit the pumping plant to the in-flow after it has appeared. This policy may mean a drowned mine, and weeks of delay for the installation of larger pumps and the clearing from water; it may mean a set of makeshift pumps of the wrong size and of low efficiency which may really be wholly unnecessary owing to the feasibility of natural drainage.

Problems of drainage involve chiefly the four sciences of meteorology, geology, hydraulics and mechanics. From the first we may determine the quantity of rain likely to fall on our mine watershed; from the second the conditions affecting the behavior of underground water in the rocks; from the third the laws governing the pressure and flow of water; and from the fourth the mechanical methods of unwatering.

#### ESTIMATE OF WATER TO BE DRAINED

There are multitudinous mineral deposits, each with a special problem of drainage of which only some general features will be discussed here under three cases: I. Deposits in unconsolidated rock; II. Deposits in stratified rock; III. Deposits in massive rock. For any type the water encountered in mining operations will depend on four factors: (1) the area of contributory watershed; (2) the moisture falling on watershed; (3) the moisture percolating the surface of watershed; (4) the facilities for underground water to enter the mine.

*Case I. Deposits in Unconsolidated Rocks.*—In Fig. 19 is shown a cross-section of a gentle syndinal rock trough *ab* filled with alluvium up to the surface *cd*. It is proposed to lower the "water table" or ground water<sup>1</sup> level *wt* down to sump *s* in order to mine a placer deposit extending from *a* to *b*. The conditions which determine the quantity of water to be handled depend on two items; namely, the quantity of ground water, and its velocity of entrance into the workings. For the first item we have to calculate the area, rainfall and percolation of the contributory watershed, while for the second item the fact that it will be affected by the method of drainage will have to be taken into consideration. The area and rainfall are also the basis of the calculations of the water-supply

<sup>1</sup> "Ground Waters" by J. F. Kemp, Trans. Min. Eng., Feb., 1913.

engineer, but the latter reckons rather with the run-off than with the percolation which concerns the miner.

With underground conditions as represented in Fig. 19, the area of the contributory watershed evidently extends in width from *e* to *f*, and in length from the sump *s* to the head of the valley, if *cd* is a river trough, or to the bounding contour of the watershed if *cd* lies in a lake basin. In general the contributory watershed is all the ground area that drains toward the surface lying over the sump, wherever the surface is connected with the sump by pervious strata as in Fig. 19. The depth

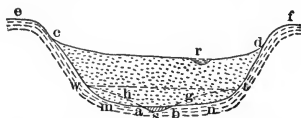

FIG. 19.—Drainage in unconsolidated rock.

of current rainfall is recorded for most localities in civilized countries at the government meteorological stations; and in solving drainage problems, these records should be scrutinized for the maximum, mean and minimum rainfalls both by months and years. From this data, we have the rainfall in the wettest year or season in contrast with that of drouths, but it is important also to note what part of the moisture falls as snow and the melting seasons of the latter.

The whole rainfall, however, does not concern the miner. He is concerned only with that fraction of it which sinks into or percolates the ground after evaporation and run-off have taken their tolls. Then if

area of a watershed  $= A$  sq. ft.

depth of moisture falling on a watershed  $= D$  ft.

volume of moisture falling on a watershed  $= Q$  cu. ft.

volume of moisture running off from a watershed  $= R$  cu. ft.

volume of moisture evaporating from a watershed  $= E$  cu. ft.

volume of moisture percolating a watershed  $= P$  cu. ft.

fraction of moisture  $Q$  evaporating, or evaporation factor  $= e$

fraction of moisture  $Q$  running off, or run-off factor  $= r$

we have,

$$Q = E + R + P \quad (1)$$

but  $E = eQ$  and  $R = rQ$

so substitute in (1) and

$$Q = eQ + rQ + P \text{ or } P = Q(I - e - r) \quad (2)$$

but  $Q = AD$   $(3)$

hence  $P = AD(I - e - r)$   $(4)$

Evaporation is dependent on the state of the atmosphere and the covering and texture of the soil. The atmosphere affects evaporation

by its changes in humidity and in movement. Both dryness and high winds hasten evaporation which is usually compared for different atmospheres by observing water surfaces. Thus, in the United States the mean annual evaporation varies from 40 in. in the Middle Atlantic states to 25 in. on the Gulf of Mexico, and 95 in. at Yuma, Arizona.

In the same locality the rate of evaporation which is approximately equal for all bare soils, is greatly increased by a cover of vegetation. Thus a 5-year trial at Geneva, New York, with an average rainfall of 23.7 in., gave its evaporative factor ( $e$  in Equation (4)) as 0.64 for bare cultivated soil, as 0.71 for bare undisturbed soil, and as 0.85 for sod. Not only the heat of summer but its vegetation increases evaporation, while the ground surface in winter acts much like bare soil unless covered by snow or ice, the daily evaporation rate of which in New England is .02 in. and .06 in. respectively. A less proportion of severe rains is evaporated than of drizzling rains, for as a given area has only a limited rate of evaporation any excess moisture must either run off or percolate.

The common method of estimating the run-off is from measurements of the quantity of water flowing in the streams of the watershed. When the bed of a stream is once mapped in section, a record of its surface-height readings renders possible a calculation of its sectional area which, combined with corresponding readings of a current meter, gives the data for computation of flow. The percentage of rainfall found in streams, evaporation being neglected, depends both on the slope of the surface and on its covering. For gently rolling land as in Iowa, the run-off factor ( $r$  in Equation (4)) is 0.33, for the rougher surface of the Middle Atlantic States it is 0.40 to 0.50, while in the mountain states of Colorado and Montana it is 0.60 to 0.70. The surface covering most favorable to a heavy flow is frozen snow over which over 90 per cent. of the rainfall may run into the streams, while the melting of the winter's snow by warm rains causes the freshets and floods of spring. Where the surface is irregular so that the rainfall collects in ponds and swamps instead of reaching streams, the run-off is lessened, and the evaporation and percolation is correspondingly increased.

The beds of surface streams must be relatively impervious, for if they were freely percolated by water, there would soon be no visible flow. Where a stream's bed is partially porous, much of the water sinks to the first impervious stratum and there forms an invisible stream called the underflow which often contains more water than its parent overhead. Where a stream has not naturally a channel of impervious rock or clay, the tendency is for it to stop the pores of a sandy or other pervious bed with sediment; especially is this so in alluvial valleys like that of Fig. 19, where there might be no visible stream at all had the river at  $r$  not a clay-coated bottom.

For our drainage problem of Fig. 19, we have now discussed how to

ascertain the area of watershed  $A$ , the depth of rainfall  $D$ , the evaporative and run-off factors  $e$  and  $r$ , and by substituting these values in equation (4) we have the percolation  $P$ . The result from solving Equation (4) can be compared with the following table which gives for the percentage of total rainfall percolating various surfaces:

sand = 60 to 70
chalk or gravelly loam = 35
sandstone = 25
limestone = 15
clay or granite = 15 and less

We do not have to provide at  $s$  for the drainage of volume  $P$ , but only for that portion of it which is not drained off elsewhere, does not reascend to evaporate at the surface or is not held in the pores of the subsoil. The drainage elsewhere would be nil in a lake basin with impervious bottom, but in the usual self-draining basin it would constantly tend to lower the water table.

The lake-basin condition is well exemplified at both Bisbee and Tombstone, Arizona. These camps lying in the Mule Mountains, where the annual rainfall is under 12 in. and the evaporative factor large, would be casually reckoned as having dry mines, but the very opposite is the case. The ore bodies in each camp are found in limestone and shale beds which are so folded as to form, with the adjoining intrusive rocks, an impervious basin which catches all the rain percolating the surface over a large watershed. The present water in the basins represents the accumulation of years, so to lower it has taken more pumping than would be necessary in a very wet valley whose ground water was dependent solely on current rainfall. At Bisbee in 1906 the water level had been permanently lowered, for three years' pumping by several companies had reduced the inflow at the Calumet and Pittsburg shaft from 3000 to 1500 gal. per min.; but at Tombstone in 1911, where nine years of pumping of the Contention shaft had little affected the original flow of 3000 gal. per min., it was deemed unprofitable to struggle further and the pumps were pulled. The excess of water in the Tombstone basin probably comes from an adjoining watershed through underground channels.

The loss of ground water by evaporation increases with a damp soil and a high water table. Consequently, in self-draining ground the evaporation is greater if the rainfall is evenly rather than sporadically distributed. Evaporation, however, usually affects the water table only slightly as compared with the capacity of the formation for the storage, surrender and passage of water.

In Fig. 19, the section of the water-storage area between  $wt$  and bed-rock is not the whole area  $wmnt$ , but this area multiplied by the factor

for "voids" or the proportion of intergranular spaces in the formation. The void factor depends less on the size of rock grains than on their uniformity, and varies from 0.2 to 0.5. Yet another item must be included, in estimating the quantity of water that must be drained to lower *wt*, and that is the factor for surrender or yield which depends on the capillarity or fineness of the grain of the formation. The yield factor is almost nil for clay, 0.5 to 0.6 for porous soil, 0.6 to 0.7 for sand, and nearly 1.0 for clean gravel or boulders. A low yield factor means not only the retention of rainfall in a porous formation until it is saturated, but a long delay before a heavy shower begins to be noticed underground. From the above, if

$W$  = volume in cu. ft. of water-bearing formation tributary to sump  $s$

$W'$  = volume in cu. ft. of water the water-bearing formation yields tributary to sump  $s$

$x$  = factor for voids in formation

$y$  = factor for water-yield of formation

then  $W' = xyW$ . (5)

To free our placer *ab* from water, it will not be necessary to lower the water table to the profile *wmnt*, but only to the profile *whabgt* where *wha* and *bgt* are the profiles of the hydraulic gradient toward the sump  $s$ . The hydraulic gradient increases with the fineness of grain, though very small in gravel, it is 30 to 50 ft. per mile in sand and in a large basin, it would thus considerably decrease the volume of water tributary to sump  $s$ .

The hydraulic gradient for a given formation can be directly measured by digging two wells in the same line of water drainage, at some distance apart, and then recording their water levels. The hydraulic gradient will then be the difference of water level divided by the distance between the wells.

Hazen<sup>1</sup> gives as a formula for the velocity of passage of ground water

$$V = KD^2S \quad (6)$$

where  $V$  = velocity in ft. per sec. of flow through ground pores

$K = 0.29$  (a constant)

$D$  = diameter in mm. of sand grain "effective" (*i.e.*, 90 per cent. of grains must be larger than  $D$ ). Formula (6) is inapplicable when  $d$  is less than 3

$S$  = sine of slope of the hydraulic gradient

Then if  $B$  = area in sq. ft. of a vertical surface enclosing mine openings extending from water surface in pump to water table. Height of surface  $B$  should be small for use of formula (6)

$f$  = volume of water in cu. ft. entering placer per sq. ft. of area  $B$

$F$  = total volume in cu. ft. entering placer over total area  $B$

$k'$  = fractional factor for voids in walls of area  $B$

<sup>1</sup> Massachusetts State, Reports on Water Supply.

It is evident that

$$f = k'V \text{ and } F = k'BV$$

Substitute for  $V$  from Equation (6) and

$$F = kK'BD^2S \quad (7)$$

In practice the possibility of keeping the placer dry enough to permit miners to work would of course depend not only on the means of drainage available to keep sump  $s$  clear, but also on  $f$  or the rate of inflow at the mining face. As  $f$  increased beyond a certain figure, the miners would find themselves working in a heavy spray and standing in a gurgling pond. In such a case, unless the inflow could be controlled by a cofferdam, subaqueous mining would have to be resorted to.

*Case II. Deposits in Stratified Rock.*—An example of this case is shown in Fig. 20, a cross-section of a coal seam  $A$  in a synclinal basin. Beneath the coal is a thin layer of clay  $B$  resting on a sandstone  $C$ , and

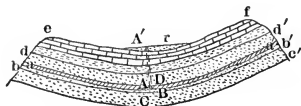

FIG. 20.—Drainage in stratified rock.

above it are strata of sandstone  $D$ , shale  $G$ , and limestone  $H$ . Along the surface runs a river  $r$  over a valley-filling of alluvial soil. Then the percolation into a coal mine at  $A$  will depend not only on the coal itself whose bedding and joint planes may be somewhat permeable, but on the nature of the adjoining rocks.

Clay and shale are not only relatively impermeable but plastic, and tend to close in any openings made in any way by orogenic movements. Sandstones vary in their structure, some have a coarse texture as porous as free sand, while the grains of others are closely cemented and almost impermeable. Limestones, especially if dolomitic, abound in irregular channels and pot-holes, often large enough to contain underground rivers or ponds. Should the rocks of Fig. 20 be subjected to metamorphism, their permeability would be much diminished, or perhaps entirely destroyed, as pores and bedding planes were obscured, until we approached as the limit the massive formation of Case III. Clay and shale, when metamorphosed, become dense and strong slate or schist, sandstone solidifies into impermeable quartzite, and limestone changes into crystalline marble.

From these considerations, it can be seen that the stratum of shale at  $G$ , provided it has not been pierced by orogenic movements or human hand, acts as a screen to keep out any water which may percolate into the limestone from the watershed  $ef$ . As the strata outcrop, however,



beyond the summits *e* and *f* of the synclinal basin, the coal seam will be exposed to percolation from watersheds *ec* and *fc'*.

As long as the impermeable clay floor *B* of the coal is uncracked, the watersheds contributory to the coal seam will extend only from *e* to *b* and from *f* to *b'* and not all of their percolation will reach the coal, because the shale stratum *G* will seal off any surface water that may enter the limestone layer *H* between the crests *e* and *f* and the roof of *G*. Should the floor *B* be cracked or feathered out in places, it may be serious from a drainage standpoint, for the coal seam will then be open to a flood from the hydrostatic water in sandstone *C*. Thus in the rock formation of Fig. 20, the ground water would not occur in a connected body as in Fig. 19, but each porous zone would contain its own pool separated from the others by an impermeable stratum. The equivalent of the water table *wt* of Fig. 19 would be found here in the limestone *H*, but it would circulate there in irregular open channels instead of in intergranular pores. The contributory watersheds having been thus measured, we have only then to gather the other meteorological and physical constants, as explained for Case I, in order to solve Equations (1) to (7) for the drainage of Fig. 20.

*Case III. Deposits in Massive Rock.*—In Fig. 21, let *cd* be the cross-section through a fissure vein in massive rock, which is either of igneous

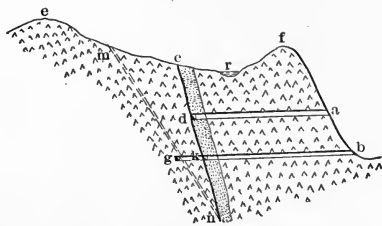

FIG. 21.—Drainage in massive rock.

origin or so metamorphosed that its sedimentary pores and bedding planes are practically obliterated. This formation, then, instead of being quite porous like that of Case I or irregularly porous like that of Case II, is in its original condition, more or less impermeable, but in mining regions it has usually been so cracked by earth movements as to abound in openings which grade from wide fissures, both long and deep, to such minute fracture planes as those of the Bingham copper porphyry which scarcely pass seepage water. When rainfall can only percolate the surface of Fig. 21, through irregularly spaced crevices or joints instead of through a porous zone, there can be nothing like a general ground water level except within areas whose crevices are all connected. Thus each crevice system has a height of water table varying according to the size and nature

of its contributory watershed. The mineral veins themselves have often trunk channels along their walls which receive water from numerous branch cracks and fissures.

The watershed tributary to vein *cd* of Fig. 21 will not extend laterally from *e* to *f* as in Case I unless all the intermediate fissure systems lead to the vein, but it may cover a much wider area owing to the possible juncture of subterranean streams with *cd*, which streams in mountainous regions may be under a high hydrostatic head. In fact, only the mapping of the region's underground water channels, and this could seldom be done except in an extensively developed district, would enable an engineer to satisfactorily solve Equations (1) to (7) as in the two previous cases. In mining *cd*, care would have to be taken on the hanging side, for by the tapping of natural blind crevices or by allowing the hangwall to move and crack, the river *r* might be precipitated into the workings.

It is probable that some of the hot water found in mining such igneous formations as the Comstock lode comes, not from rainfall, but directly from the occluded moisture of cooling magmas. According to the nebular hypothesis, all surface water had originally an igneous origin. The miner who operates in a region of magmatic water cannot estimate its quantity beforehand, as in the case of meteoric inflows, but must simply handle it as it appears.

As mines get deeper and rock pressures become greater, fissures and other open spaces tend to close up and long before the bottom of the zone of crust fracture is reached, at a depth of somewhere around 4 miles, there is little free water in the rocks. At the Calumet and Hecla Copper mine, Mich., in a conglomerate lode bedded between amygdaloids, the maximum water flow is at 1800 ft. along the 38 deg. dip, while at 3000 ft. the water flow is insufficient even to supply the drills.

### CONTROL OF WATER

This topic naturally divides itself into surface and underground control.

*Surface Diversion.*—It is much better to keep water out of a mine than to use the most approved method of drainage after its unnecessary entrance. Surface run-off is kept out of a mine ditching around shafts and vein outcrops as *C* in Fig. 21. Often it is best to refrain from stoping a vein out quite up to the surface in order to keep rain out of the workings. A stream above the mine, which seeps badly into its bed or whose bottom may be cracked by caving operations, can often be diverted to another channel or carried in a flume over the dangerous stretch.

*Underground Diversion.*—In Fig. 20 the penetration of the impermeable shale layer *G* by the shaft *AA'* will eventually drain the wet limestone layer *H* into the mine at *A* unless some precaution is taken. Two

remedies suggest themselves, the first, a concrete shaft-lining from the surface down to a sealed footing in the shale; the second, the usual pervious shaft-lining provided with a water ditch or "ring" around the shaft, in the roof of the shale, which catches the water from above and leads it to a sump, which has means for drainage, on the same level.

In ore deposits in hilly regions, an impervious floor sometimes has below it a sandstone or other porous stratum which dips toward an outcrop, on a hillside at a lower level, and is thus self-draining. In such a case, diamond-drill holes or a winze through the floor of the mine sump into the porous stratum will effectively drain the workings.

*Natural Dams.*—Rock barriers are highly useful in the control of water in mines. As already explained, where tight strata cut off the mine from wet formations, such natural seals should be left undisturbed if possible. Pillars of mineral are often left between adjoining mines to keep their water systems distinct, and in many states a barrier about 50 ft. wide must be left unmined around the boundary of coal properties.

The Lehigh Valley Coal Co. is now mining, near Hazleton, Pa., a synclinal trough containing parallel anthracite seams which extends for several miles and dips for about 3000 ft. vertically in that distance. The trough has been divided into three drainage basins by leaving a transversal barrier pillar of coal, 100 ft. wide, below each. The barriers are at altitudes of 1084, 1250, and 4000 ft. respectively and each has its own unwatering system. Each barrier is pierced by boreholes lined with pipes whose valves can be opened to drain the basin above into the one below in case of an emergency.

It is often necessary to penetrate water barriers in order to drain old mines, and where the dammed-up water is under a high head it is best tapped by drilling. Boring long holes for tapping can be done in any direction by a diamond drill. A customary safe-guard against heavy pressure is to bore the first few feet of the hole large enough for

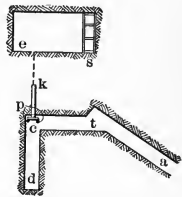

FIG. 22.—Tapping sump at Iron Mt. Mine, Montana.

a pipe lining *ck*, Fig. 22, whose exterior is made to fit the rock tightly by a packing of lamp-wick, wound spirally, or of cement. When it is necessary to regulate the flow from the hole, a valve *v* is put on the lining pipe whose end must then be anchored to posts *p*. Such a valve on a drill-hole flow, small anyhow, allows the cautious emptying of old workings where a sudden release of water might damage the shaft or other important pillars.

For short distances, tapping can be well performed with a percussive drill and a typical recent case can be cited at the Iron Mt. Mine, Montana, where the new drainage adit was connected with the old shaft-workings which contained some 100,000,000 gal. of water under a head of 900 ft.

When the face of the tunnel *ta*, Fig. 22, arrived near the old shaft *s*, a 6x7-ft. cross-cut *tc* was run for 30 ft., parallel to the shaft station, and from *c* a taildrift was carried back for 30 ft. to *d*. Next a 3-in. percussive drill was set up at *c* and a hole drilled in for 10 ft. to admit a 4-in. pipe lining *ck* which was then well cemented and anchored in. Drilling was proceeded beyond the lining with a 1 3/4-in. bit when, at *e*, 23 ft. from the collar, the point holed through. On loosening the chuck, the bit was shot back by the water pressure against the end *c*, and was followed by a swift stream of water, but as a low dam had been erected across the crosscut at *t*, the men climbed over it and safely reached the adit mouth, a mile and a half distant.

*Artificial Dams.*—Many dams are built underground: for making sumps out of old headings or stopes; for regulating the flow to the pumps; for isolating the water of abandoned workings; and for confining water to

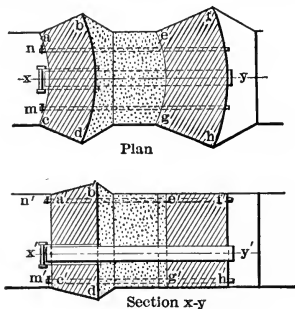

FIG. 23.—Artificial dams.

certain localities, as in the case of flooding mine fires or of filling seams by the flushing system. Mine dams differ from those on the surface in the fact that they often stop openings of small height relative to the pressure of water to be sustained. In such cases, mine dams must have a solid footing all around their periphery, instead of just at the base and sides like a river dam. Favorite materials for dams are wood, brick, stone and concrete.

A diverting dam whose crest is higher than the water surface it sustains can be built light and like a surface structure; but precautions must be taken to successfully sustain a high water-head (which causes a pressure of 0.434 lb. per sq. in. for each foot of height), and the arch is a favorite form for this purpose. Fig. 23 shows a composite plan and section of a dam, to back up water at *y* across a heading or shaft, which is made of two arches, *ab* and *cd*, with a filling between of puddled clay or concrete. It will be noticed that the heading walls are cut out to give indented skew-backs for the arches except at *e'f'* and *g'h'* where a plastic roof and floor

might make indentation unnecessary if the swelling wood construction, to be described later, were used.

Both drain-pipe at *m* and air-escape at *n* are provided with valves and sealed tightly in the structure. The manhole pipe *xy* is anchored to the dam and is as essential during construction as afterward. With moderate pressure one arch, like *eh*, is enough; and to build it of wood, each piece should be the length of *eh* and tapered wedge-shape like an arch stone. A tight joint can be made between wood and walls by tarred felt and small wedges, and the pipes can be sealed in with wedges. When of masonry, the arches are laid over wooden centers, the under one of which is left in permanently if the dam is across a shaft. Masonry dams are kept tight by a concrete or clay backing, and as the latter needs to be confined under heavy pressure, the double arches of Fig. 23, with clay between, are then especially suitable. Flat wooden dams are often used and usually they are held by posts with ends hitched into the walls. The wooden lining is made of several layers of planks and, with walls too soft for its support by posts at intervals in hitches, the lining itself may be extended into brick-lined hitches cut in the walls, and its central portion be backed by a timber set whose battered posts are set in the direction of pressure and rest in hitches cut in the heading's walls.

At the Chapin iron mine, Michigan, dams have been helpful in the control of a big inflow of water. The Chapin ore-body is a hematite lense appearing in cross-section about like *cd* in Fig. 21. It is enclosed by slate walls but has an extensive dolomite formation about 100 yards' distant on the hanging side. The author found on his visit in 1908 that the flow at the 1000-ft. level had not been appreciably lessened in spite of pumping 2000 to 3000 gal. per min. for the previous seven years. The water proceeds from channels, in the dolomite hangwall, which are believed to connect with two small lakes several miles to the northeast. If the originally impermeable slate hangwall, that cut off the ore from the water-bearing dolomite, had not been cracked for over 300 ft. from the surface (by the caving operations), the drainage problem could easily have been solved by keeping shafts and cross-cuts entirely in foot-wall.

The No. 2 Hamilton, vertical shaft, then used for pumping, had been sunk in the hanging dolomite and great difficulty had been encountered in driving the 1000-ft. and lower cross-cuts because of the water crevices encountered. In starting the 1000-ft. cross-cut a compound station pump was first installed; but, nevertheless, the first water crevice struck had to be dammed with masonry, and the pressure gauge showed a static head there from a water level within 300 ft. of the surface. Next, a branch drift, some distance back from dam No. 1, was begun; but this also struck a crevice and had to be dammed.

A second branch drift was then started and dammed (after only a

short advance) and a second compound pump installed at the station. This last dam was fitted with a water-tight iron door opening outward, so when drifting was continued beyond it (to make a chamber for diamond drilling) the excavated earth could be passed back in boxes. With the diamond drill, the space yet to transverse to reach the vein was searched for a cross-cut opening free from crevices; but as none was found the cross-cut had finally to be finished anyhow by the aid of strenuous pumping.

#### DAMMING BY DEPOSITION

E. B. Kirby has devised a method (U. S. Pat. No. 900,683) of sealing the rock crevices of mine workings by the deposition therein of sediment. Finely divided clay is preferable but other materials may be used such as sand, mill tailing or slime, cement, saw-dust, horse manure, chopped hay or fiber. The injection of the water bearing this material in suspension may be made by force-pumps, or by stand-pipes extending far enough toward the surface to furnish the necessary pressure.

The suspended particles, when put in a cavity containing water in motion toward exits in the mine, are seized and carried toward such exits, settling, accumulating in, and choking at various points the contributory passages. The moving currents automatically select those passages which are discharging water into the mine and require sealing; they disregard other passages because the water is not in motion in them. The choking which occurs in the outflowing passages is gradual and at those most favorable points where the passages are smallest and the flow most diffused. In fact large passages cannot be thus choked but must by dammed.

When the flowing passages are choked the process ceases even though other passages are still open. If by the choking of one or more passages the current is deflected to others, the deposition is there automatically resumed. At any choked locality the water pressure holds the choking particles firmly in place and produces a perfect seal by shutting off the threads of water in every contributing passage.

*Adits.*—These are tunnels run in from a low surface point to drain underground workings. In Fig. 21, it is evident that the adit *ad* would drain all of vein *cd* above level *d* and that adit *bk* would drain everything above level *k*. The water-bearing fissure *mn* cuts the vein at *n*, and to drive an adit at the level *n* would obviously be impractical with the given topography; but nothing would hinder the extension of adit *bk* to the fissure, and the running of a drift *g* along its footwall, as far as necessary, to intercept all the water drainage into the mine at *n*. This scheme was employed to supplement the lower adit of the Horn Silver mine in Utah.

The following remarks apply to all drainways, whether adits proper, debouching at the surface, or merely interior tunnels emptying into a

sump. The minimum grade for long modern adits with unlined ditches is 1/4 of 1 per cent. The carrying power of water channels can be thus estimated:

If

Sine of slope of hydraulic gradient of water flowing in channel	= $S$
Area of cross-section of water flowing in channel	= $a$ sq. ft.
Velocity per sec. of water flowing in channel	= $v$ ft.
Wetted perimeter of the containing surface of channel	= $P$ ft.
Constant, increasing with smoothness of containing surface of channel	= $c$
Quantity of water flowing per sec. in channel	= $q$ cu. ft.

then from Merriman's "Hydraulics"

$$v = c \sqrt{\frac{aS}{p}} \tag{8}$$

but  $q = av$

$$\text{hence } q = ac \sqrt{\frac{aS}{p}} \tag{9}$$

In those cases where adits are only to be used for drainage, a circular section is often preferable; because it carries, when running half full or more, the most water for a given volume of excavation; is stable against external pressure; and is readily adaptable to masonry lining, which, being smoother than wooden sets, gives a larger value for  $c$  in formula (9), and consequently passes more water. Where the water deposits sediment, the egg-shaped section of Fig. 17 (4), used for sewers, best enables a uniform carrying power to be maintained as the height of water fluctuates.

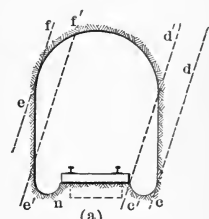

When adits serve for haulage as well as drainage, the economical shape is usually oval or rectangular. The oval shape is best for weaker walls with external pressure mainly vertical, and it can easily be lined, where necessary, by masonry. The rectangular shape is common where the adit follows some flat stratum like a coal seam with a strong roof, that will stand without arching; or where most of the length has to be supported by timber or metal sets which are ill adapted to curved sections.

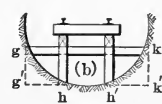

FIG. 24.—Adit sections.

A compromise section for an adit is shown in Fig. 24 (a) with a self-sustaining arched roof and a flat bottom to give a cheap footing for the track ties. With a moderate amount of water it can be carried in a side ditch which is easier to watch and clean than one under the track. Where the adit of Fig. 24 (a) is in a narrow vein of width from  $f'$  to  $d'$ , the ditch

is best placed along that side whose cutting-out, to give space for the adit, will admit the least water from the walls. The tightness of the ditch's bottom rock against seepage should also be considered, if there are to be workings underneath it, and sometimes a wooden or concrete lining may be necessary as commonly it is for sumps. Where the adit can be placed between vein walls as *ef* and *ed* without cutting them, it is usually best to have the main ditch along the footwall at *c*; and connect it, if necessary, by cross ditches to an auxiliary ditch along the hangwall at *e'*.

Both ditches and sumps should be covered in hot mines like those of the Comstock lode in order to prevent any unnecessary humidifying of the air.

The new Roosevelt adit at Cripple Creek, Colo., will be over 3 miles long and used only for drainage. This gold mining district lies in an igneous formation, and as it occupies an area of about 8 sq. miles, it is estimated that each foot in height of its ground water means 60,000,000 gal. of water. The adit was started with a section like Fig. 24 (a), 10 ft. high and 6 ft. wide, but it has been changed to one 6 ft. high by 10 ft. wide to give space for a curved ditch, 6 ft. wide by 3 ft. deep, and a narrow track along one wall.

Where side ditches are inconvenient or inadequate, they can be replaced or supplemented by a central ditch *nc'* (shown dotted in Fig. 24 (a)) cut under the rails. For heavy flows, however, the whole bottom of the adit may be utilized. In that case, it should be cut round, as *ghh'k* in Fig. 24 (b), in order to obtain the cheapest rock breaking and the maximum carrying power for a given sectional area; unless a flat-bedded formation makes the excavation of the larger square area *gg'k'k* just as economical. The track ties may be spiked to stringers which are set on posts or brick piers, *h* and *h'*, of sufficient height to keep the ties above the high-water flow. In double track adits, three rows of stringers on piers are sufficient if long ties are used. Where the track is far above the rock bottom and the adit is narrow, cross beams like *gk*, hitched into the walls, may be the cheapest supports for the stringers.

Adits are especially advantageous in mountainous regions of steep slopes, where a great height can be drained with a short adit. The only drainage expense with adits is for interest and maintenance, and if well constructed, they are not subject to the breakdowns of mechanical apparatus at critical moments. When the adit mouth is some distance higher than the stream into which it drains, the escaping water can be effectively utilized for power. In a wet district of large producing mines whose drainways can easily be connected, it is often advisable to drive a very long adit for general drainage.

Notable among such modern American adits are, in Colorado, the Roosevelt and the 5-mile Newhouse at Idaho Springs; and in the an-



thracite region of Pennsylvania, the 5-mile Jeddo-Basin in Luzerne Co., the 1-mile Oneida in Schuylkill Co., and the 1 1/2-mile Lausanne near Mauch Chunk. The last named drains 13 miles of underground tunnels and 14 different collieries.

*Siphons.*—In mining flat coal and other seams, convex rolls often occur in the floor of the gangways which dam up the drainage. It is feasible to pass a low roll by deepening the water ditch; but a high roll, unless it is advantageous to also cut the whole gangway through it to obtain a uniform haulage grade, is often better surmounted by a siphon. A siphon consists of a vertically-curved pipe with both ends set in sumps, of which the outlet sump must have the lowest water-level.

Mine siphons are usually made from welded iron pipe and water can be carried horizontally in them for considerable distances provided they are tight. The limit of vertical lift, from surface of intake to highest point on the pipe of any siphon, is the height of the water barometer minus the total loss of water head, due to internal friction, etc., in the siphon itself. This limit is usually below 26 ft. Several rolls can be passed by one siphon if escape valves for air are put on the pipe at the high point of each vertical bend. It is also possible to drain several sumps or "swamps" along a gangway with one siphon, by running a branch pipe, with a valve on its end, down from the main siphon into each swamp. A siphon is best rigged with a valve at inlet and outlet; and with its highest point joined by a small pipe, with valve, to a water-barrel from which it can easily be filled before a run.

#### MECHANICAL UNWATERING

Apparatus for mechanical drainage can be grouped into two classes. First, those moving water in buckets, and second, those moving water through pipes. In the first class, water-cars are moved horizontally by the same tractors as ore-cars, while tanks or kibbles are hoisted in shafts or slopes by similar engines to those used for hoisting ore in skips. The second class includes all types of pumps. The first class is often preferable for intermittent unwatering, even if it has a higher operating cost, for where the existing ore-hauling and hoisting equipment can be utilized to move the water-buckets, the heavy expense of installing pumps is obviated. Where air compressors are already installed, the Pohlé air-lift system can cheaply be applied for unwatering the upper levels.

#### EDITOR'S NOTE

Chapters VI to XVII of Mr. Brinsmade's treatise "Mining Without Timber" have been omitted from this Library because the editor has not felt that they would be of sufficiently definite value to men engaged in the mining of coal. The complete work is a standard treatise on timberless methods of mining and is recommended to all who wish to carry their studies further.

## CHAPTER XVIII

### PRINCIPLES OF MINING SEAMS

#### (a) COMPARISON OF LONGWALL AND PILLAR SYSTEMS

In the mining of seams of coal or of other bedded deposits of similar regular thickness over large areas like iron ore, gypsum, salt, etc., the two systems largely used are "longwall" and "room and pillar" or simply "pillar." The longwall system extracts all the coal in the first operation along a long stretch of "wall" or face and allows the roof to settle gradually behind the miners upon a "gob" or partial waste filling. The only excavation kept open besides a narrow passage at the working face are a few roads, to the bottom of the shaft or other exit, for ventilation and for the tramping of coal and supplies. In the pillar system, on the contrary, the first operation consists of driving roadways to extract only part of the seam in rooms, while leaving the balance in the form of pillars to sustain the roof. Later the pillars are drawn or "robbed" so as to finally recover as much of the seam as possible.

Either system may be pursued "advancing" or "retreating." If advancing, the attack of the longwall or the robbing of the pillar system begins next the safety pillar, left to protect the shaft or other entrance, and advances outwardly toward the boundry; while if retreating, the roadways of the longwall or the roads and rooms of the pillar system are driven to the outer boundary of the mine before the "attack of face" or the "robbing of pillars," respectively, is begun.

The two broad divisions of the longwall system are "continuous-face," in which the face is kept in the form of a circle or similar closed figure, and "panel" where the face is handled in panels or blocks, along a sufficient stretch for free roof subsidence, without forming a closed figure. These divisions have each several varieties and often shade into each other.

The pillar system has three varieties: "room and pillar," where the rooms are wider than the pillars; "stall and pillar," where the stall or room is narrower than the pillar; and "panel," where the mine is divided into sections or panels, separated from each other by peripheral pillars, and each is divided into a number of rooms with corresponding pillars. In some mines it has been found advantageous to combine the longwall and pillar systems or even to operate them separately in different portions of the property.

The longwall system is adapted only to uniform seams with roofs of

an elastic material like shale or sandstone rather than those with a blocky fracture like limestone. Hitherto, longwall has been most used for working seams of coal, but it is likely hereafter to be widely applied to other deposits like the Appalachian iron beds, the Michigan copper amygdaloids, or the Transvaal gold banket, in order to overcome the obstacles incident to great depth. In coal mining, longwall has a particular advantage in thin seams over the pillar system, because the robbing of pillars in such seams is usually unprofitable, and longwall reduces to a minimum the expense of driving and maintaining the roadways. Longwall also gains in desirability with increasing depth where the pillars of the rival system must continually widen and thus proportionately be dearer to recover.

Longwall is adapted to beds containing considerable waste, for the waste can all be stored underground and if suitable for pack walls will obviate the use of timber cogs. In Europe, with plenty of waste for gobs and packs, seams as thick as 10 ft. have been worked in one slice by longwall. Less timber is consumed in the longwall than in the pillar system because in the latter the props can seldom be used again. The subsidence of the longwall roof is gradual so that it does not inflict such breaks in the formation, to let in water or to damage surface structure, as ensue from pillar-robbing. By longwall, a mine can be developed more quickly and more cheaply, and more lump coal and a higher percentage of the seam can be excavated in less time than by pillar work. In longwall, the ventilation system is cheaper to construct and to maintain, for the mine's resistance is less; few or no explosives are needed; and there is less danger from falls of the roof. Longwall requires better trained miners than pillar work but a miner's output is greater. After a strike of nearly six months recently in a Western coal district, it cost the pillar mines nine times as much to clean up and to get started again as it did similar mines where the longwall system prevailed. This result was strictly opposite to the opinion previously held by many on the subject. Longwall, however, is unsuited to fluctuating outputs, for the roof, when being moved at all, should subside uniformly along the face. For coal mining, longwall is gradually superseding pillar work in Europe wherever conditions are suitable. America is bound to follow suit as soon as her mines become deeper.

#### (b) COMPARISON OF THE RETREATING AND ADVANCING SYSTEMS

The retreating system of mining seams is rapidly supplanting its rival, the advancing system, in European mines, but in America the author knows of no case of its use in longwall and of comparatively few cases in pillar working. On inquiring why the advancing system is still preferred, the only two reasons to be found for its use in opening a mine

are that it requires less capital and less time. Everything else is against the advancing system which has a smaller percentage of mineral recovery, a worse control of roof, ventilation, and drainage, a greater liability to gas and dust explosions, a higher cost of maintenance of roadways, a larger timber consumption, and a smaller output from an equal developed area at the face.

The mistake of sacrificing safety, mineral and profit per acre in order to get an output quickly at minimum cost may be unavoidable for small weak enterprises, but no valid excuses can be made by strong companies which continue to pursue such a penny-wise, pound-foolish policy. The driving of entries to the boundary to inaugurate the retreating system for either longwall or pillar working completely explores the traversed territory. These entries expose the seam's faults, rolls and irregularities, and thus indicate both the lowest points of the floor for the location of sumps and pumps, and the high points of the roof where may be placed churn-drill holes for the escape of gas or safety shafts with ladders to serve as natural ventilators when the fan is idle.

With the retreating system not only are there no old gobbed areas within the active workings to generate foul gases and fires, but before stoping begins and fills up the mine with men, the seam has been perforated everywhere by the entries, and most of its water-channels and pockets or feeders of gas have been discovered and placed under control. In retreating, when stoping begins, drainage, ventilation and tramming are covering the whole area of the property, and are at a maximum; and all, especially the two latter, tend to grow less as the working area is contracted, while the advancing system implies a continual extension of the area covered by each. The maintenance of entries is a serious expense in an advancing system, as they must not only be constantly re-brushed, but are liable to develop irregularities from squeeze which make uniform tramming grades difficult to maintain. The final capital cost of entries is the same in either system but the cost of maintenance for retreating is only a fraction of that for advancing. This gain alone will often more than offset the earlier outgo of capital requisite for the former system.

With the advancing system, coal is apt to be lost even by longwall, while the history of even recent pillar working in America indicates that an average of hardly 70 per cent. of the seam is recovered. To obviate the only two drawbacks to retreating, the need of much capital and time, the two systems can, in pillar working, be easily combined temporarily, by opening off enough rooms from the advancing entries to maintain a modest output until the boundary is reached, where pillar-drawing can then be started, and the regular retreating system inaugurated. In longwall working, the combination of advancing and retreating is less simple because of the complications it is liable to cause in the control of

roof, especially with the continuous face method; but with the panel layout, it can be effected in those cases where the roof is flexible enough to permit the longwall operation of isolated panels of moderate size.

The longwall practice cited in the next chapter is all on the advancing system owing to the lack of retreating examples in America, but the advance layouts described can readily be transformed into those for retreat by merely starting the initial longwall face at the boundary of the property instead of at its entrance.

### (c) MINING BY ROOF-PRESSURE

Blasting must ever be a danger in a colliery; and all practical substitutes not involving the creation of flame or high-temperature gases are to be welcomed. The different forms of wedges, hydraulic cartridges, lime cartridges, and other appliances of like purpose have all received full attention, but little has been written on Nature's own solution of the difficulty; viz., roof pressure, and its systematic and scientific utilization.

Any bed or seam is subjected to a certain compressive force owing to the weight of the superincumbent strata: if a portion of the bed is removed and no artificial means of supporting the excavation attempted, a "center of relief" is established, the roof and floor of the cavity move together, and the coal (or other material) round and about the cavity is cracked and crushed by the roof weight, and eventually some of it forced out into the open space. If the coal surrounding the excavation had been undercut, it would have fallen under the action of the roof weight sooner and in better condition; but, had the undercut been too deep, the coal would have fallen en masse, and have necessitated manual labor in breaking to a size suitable for removal.

The cleavage of the coal must be studied in order to determine its behavior under roof pressure. The terms bord (or face) and end (or butt) are pretty universally employed in application to a coal face advancing with its length parallel to the planes of main cleavage or cleat, and perpendicular to those planes respectively. It is well known to every collier that bordways is the easiest direction of advance; but coal so hewn is most likely to result in a high proportion of slack. On the other hand, the coal is strongest end-on; is hardest to hew, but is most likely to result in a large percentage of lump when so obtained.

The mode of fracture of the roof also needs attention. The forces which induced the cleat into the coal had, in the generality of cases, a similar effect on the strata above, causing an incipient cleavage in it coincident in direction with the cleat of the coal. For this reason, the maintenance of a long straight face absolutely bord is almost an impossibility; at such a face the roof would be beyond control, would break

off "short" against the face (Fig. 108), and would not only be a constant source of danger, but would take most of the useful weight from the face.

This last fact was recognized very early by coal miners and wishing to combine the easy bord direction of advance with a better control of roof, they instituted the stepped face (Fig. 119). Since the mean line of advance in the case shown in the figure runs some 30 deg. from bord, it follows that the roof will break parallel to this line. Stepped longwall has many disadvantages; first among which must be placed the fact that the stepped face is unsuited to machine holing. Secondly, outstanding points of coal, such as *K*, Fig. 119, receive an undue roof weight and become crushed. While at the other extreme we have points such

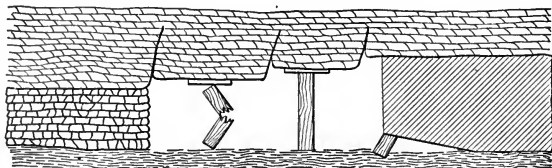

FIG. 108.—Effect of pressure on roof.

as *m*, Fig. 119, too far back and too well protected for the roof weight to act usefully there, where also the coal is bound on two sides (along the face and down the step), and correspondingly hard to hew. Again, since the packs have to be built close against the side of the step to support the coal (the space between the two is seldom more than 2 ft., often less) the ventilating current suffers from such restrictions—an effect which is further augmented by a frictional loss brought in by the air being forced to travel a zig-zag path. Stepped longwall is giving way in places to the straight "half-on" face, which allows of machine holing and a well-controlled roof.

Further factors which must receive consideration in a discussion of the effects of roof pressure, beyond those outlined above, are:

1. The nature of the seam.
2. The nature of the floor and roof.
3. The rate of advance of the face.
4. The amount of dip of the strata and the direction of dip as compared with the direction of the cleat.

To utilize the roof weight to the best advantage, the coal must be undercut to a certain uniform depth, such that when the sprags are withdrawn the coal falls with a vertical fracture from the back of the undercut, without any extraneous aid by blasting, or even wedging.

To achieve this, the undercut must generally be deeper than what is

considered advisable by hand; hence, we must depend on the machine to make this desideratum an actuality. At the Altofts Colliery, Northampton, Yorkshire, they have succeeded in almost dispensing with blasting by holing 5 ft. 6 in. under in a flat 3 ft. 3 in. seam, 1500 ft. below the surface. With a hard seam a much deeper undercut than 5 1/2 ft.—perhaps 7 1/2 ft. or 8 ft. in some cases—would be found necessary if blasting were to be abolished; such a depth would if it became anything like general, cause the abandonment of disk machines in favor of those of either the bar or “puncher” type.

A most important advantage of the coal-cutting machine lies in the straightness and length of face necessary for successful application: the straightness of the face enables the timbering to be absolutely systematic; and this factor together with the great length of the face allows of the roof pressure to be controlled and utilized with precision. Where faults are absent, the longer the longwall face, the more effectively may the roof pressure be employed as the means of breaking down the coal.

The weight of the roof is not the only force in action on the coal; before the coal is worked the pressure of the floor is exactly equal and opposite to that of the roof on the seam; when an excavation is made in the seam, the floor, expanding on being relieved of much of its compression, exerts an upward force which at first is of the same intensity as the roof pressure but which becomes dissipated sooner than the latter; nevertheless the floor pressure is often of service to the miner and is taken advantage of at many collieries where, owing to there being a suitable band of dirt at or near the top of the seam, overcutting is resorted to in lieu of undercutting. Coal so obtained often is in better condition than coal obtained by undercutting.

A treacherous roof, which breaks and falls immediately the weight comes on it, rendering timber of little avail, is an undoubted evil. Much may be done in the way of palliation, however, by quickening the rate of advance of the face, and proportionally shortening it to maintain a uniform output (the same is also advisable in the case of a soft seam). It has often been found effective in keeping up a bad roof to leave a thin strip of coal against the roof. The device seems to act something like a plaster on a wound: it has an effect out of all proportion to the slight increment of strength it supplies: its action is to prevent the slacking and slipping of the roof; to maintain it in its entirety.

Just previous to installing machine cutting into a colliery, experiments must be made to ascertain the depth of holing, such that when the sprags are withdrawn the roof pressure, aided by the weight of the coal undercut, is sufficient to break off the coal at the back of the holing. The result arrived at will be somewhat (6 in. or a foot) short of the correct figure, inasmuch as the coal face, when undercut by machine, will advance two or three times as speedily as when the holing is done by

hand, and hence the roof, not having the time to weigh so heavily will require a larger surface on which to act.

The coal when the sprags or wedges are removed must fall not in a solid block (Fig. 109), but well cleaved (Fig. 110) and ready for immediate

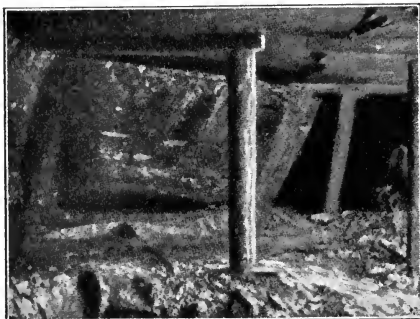

FIG. 109.—Undercut coal, fallen en masse.

filling. Should the coal fall as exemplified by Fig. 109, the defect can generally be remedied by turning the face more toward bord, or by lessening the rate of advance (the former method in preference), and experiment in that direction should be made at once.



FIG. 110.—Undercut coal, fallen in blocks.

Judging from present-day experience, little need be feared on the count of coal cutting when the depths of our mines become excessive; indeed, under the heavy roof pressures then in action the use of explosives at the coal face is likely to be abolished, and the depth of holing



necessary will, if anything, be less than that at present in vogue. In very deep mines, however, it has been found that, although the character of the seam remains the same, the percentage of slack increases with the depth. Before the Royal Commission on Coal Supplies, Mr. Martin opined that an increase of depth from 1200 to 2400 ft. would result in an increase in the percentage of slack from the same seam of 5 per cent.; and at Pendleton Colliery, while the coal was worked at depths of less than 2 500 ft., the percentage of slack was 21.5, but when the workings had reached the depth of between 3000 and 3500 ft., the proportion had increased to 39 per cent. This is merely another way of stating that the

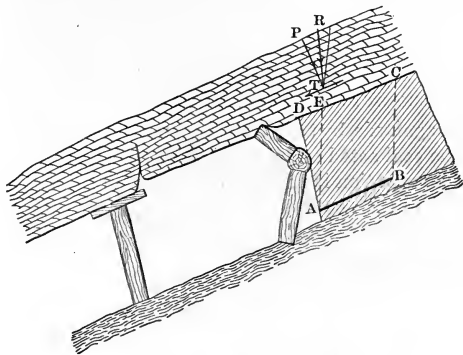

FIG. 111.—Roof pressure when mining to rise.

roof pressure has been too severe for the coal, and to mitigate such an effect the coal should be got, as far as possible, by machine, working end-on, and with a rapid rate of advance.

The effects of dip on the action of the roof pressure is important. In a working proceeding full rise, experience tells us that, other things being equal:

1. Hewing is easier.
2. Work is more dangerous (from falls of roof and face).
3. More slack is produced than in a similar working in a flat seam.

Hewing is easier for the reason that both the roof pressure and the weight of the coal have more total useful effect in a rise working than in any other. In Fig. 111, by means of the undercut  $A B$  a wedge-shaped block of coal  $A B C D$  is undermined, if sprags or wedges be placed under the mouth of the undercut, the triangular block  $A D E$  is still unsupported, giving us at once the reason for the liability to falls of face in such a working, and also demonstrating the need for the cocker sprag (shown) or equivalent means of supporting the face. The action of the roof is two fold. There is a pressure  $P$ , acting normally to the plane

of the seam; there is a thrust  $T$ , acting in the direction of dip, tending to make the roof slide over the face toward the empty space behind it.

The force  $T$  is evidenced in the fact that a fracture in the roof of a rise working "gapes," owing to the lower side having moved slightly down under the influence of  $T$ . Thus it is that falls of roof are more prevalent in rise workings than in any other; the side thrust  $T$ , not only quickly breaking up the roof, but also widening the joints the better to allow severed slabs to fall.

It is largely to this side thrust that we owe the production of slack which is one of the disadvantages of rise working; grinding is introduced, a far more effective slack producer than mere normal pressure.

The resultant action of the forces  $P$  and  $T$  on the coal may be best represented by the single force  $R$ . The direction of  $R$  cannot be accurately assigned, but it lies somewhere between the normal ( $P$ ) and the perpendicular (shown dotted), and its position is probably somewhere as shown; its magnitude, by the parallelogram of forces is simply  $\sqrt{P^2 + T^2}$ . Considering the coal acted on by  $R$  aided by the weight of the coal itself, no further demonstration is needed of the reason of the ease experienced in working coal to the rise

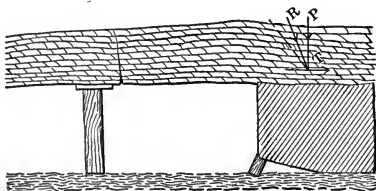

FIG. 112.—Roof pressure when mining to dip.

Rise working would be rendered safer, and less slack would be produced if a rapid rate of advance were maintained, and to compensate for the lessening of roof pressure which would result, a deeper undercut would be necessitated. Carefully built pack walls are also highly advisable in a seam liable to produce slack, and thus especially in rise workings.

In the dip working (Fig. 112), the action of  $T$ , the side thrust, is much less important; the tendency is there, but the action, so far as the grinding of the coal is concerned, is nil. Also, any line of break appearing in the roof is closed, instead of opened, by the slight lateral movement of the roof over the gob or goaf: hence, working to the dip of the seam is, generally speaking, the safest of all directions of working the coal. As before the resultant roof pressure acts slightly down-hill (shown at  $R$ ), causing the coal in this case to be difficult to hew.

The coincidence or noncoincidence of the direction of cleavage and the direction of dip is a factor of importance, influencing the behavior of

the coal under the roof pressures. If the directions bord and dip coincide a rise working is doubly easy, but the face will need stepping or the roof will be beyond control; also, under these conditions, dip working will be facilitated, and generally the face in such a working may be maintained straight, owing to the side thrust closing the jointings in the roof. On the other hand, should the directions end and dip coincide, the easiest mode of advance will not be full rise but in some direction between that line and the strike of the seam, while the difficulty of working directly to the dip will be intensified. Intermediate between these extremes there is an infinite number of angles at which the directions of dip and cleat may lie, every case needing special consideration and experiment.

## CHAPTER XIX

### ADVANCING LONGWALL SYSTEMS FOR SEAMS

EXAMPLE 49.—SPRING VALLEY BITUMINOUS COLLIERIES, BUREAU COUNTY, ILLINOIS

(See also Example 5.)

*Thin Flat Seam at 500-ft. Depth. Advancing with Continuous Face by Scotch System. Loading into Cars.*—The Illinois coal reports show that over 5,000,000 tons are produced in the longwall field or about 12 per cent. of the States' total output. Most of the longwall mining is done in the prairie-like counties of Bureau, Grundy, and La Salle. Here the coalseams are remarkable not only for their variety and quality, but in their freedom from horse-back, faults, and other irregularities, which are encountered elsewhere. The mines are developing a 3 1/2-ft. seam, called commercially "third-vein coal," which is 350 to 500 ft. beneath the surface. Overlying the seam is a flexible shale 4 to 9 in. thick and underlying it is 6 to 24 in. of fireclay.

The Scotch system extracts all the coal in the first operation, commencing at the periphery of the shaft pillar and mining out the whole seam toward the property limits. In Fig. 113, the ideal plan of the layout of a Spring Valley mine 350 ft. deep, *h* is the hoisting, *a* the air-shaft, and *km* the shaft pillar, 600 ft. square, over which are located the shaft house, shops, and other necessary surface structures. To open out the seam for longwalling, the pillar is first cross-cut by the two headings *gn* and *pq*, the former being double-tracked to permit the handling of cars to and from shaft *h*. Roads are uniformly 9 ft. wide, excepting at the partings where they are 14 ft. wide to hold two tracks. These peripheral headings are driven from the points *g*, *n*, *p*, and *q*, and by widening them inbye, the first longwall face is begun. At first the face is not continuous, but in arcs like those dotted around points *g*, *n*, *p* and *q*, but as the arcs move inbye they finally meet and form one continuous circle. Soon the face has advanced sufficiently to allow the first break to be made in the roof around the shaft pillar, so that thereafter advantage can be taken of the pressure from the descending roof to mine the coal as in Fig. 114.

Fig. 113, shows the longwall face after it has advanced some distance from the shaft-pillars and appears as the circle 1-4-7-10. The face is reached through the main roadways 1, 2, 3, etc., by which it is divided into approximately equal spaces. The essential feature of the Scotch

system by which it differs from the other continuous-face longwall system, "the Rectangular," is the turning off of cross-roads at 45-deg., angles from the main directions for roads, *g-n* and *p-q*. The road *e-3* was formerly the extension of *gk*, but its present position makes possible a gentler curve for haulage into *gh* and permits the use of the 40-deg. frog of the other 45-deg. turnouts. The layout of roads is based on a room about 42 ft. wide at the face (as at *f*) which corresponds to 60 ft. along the road,

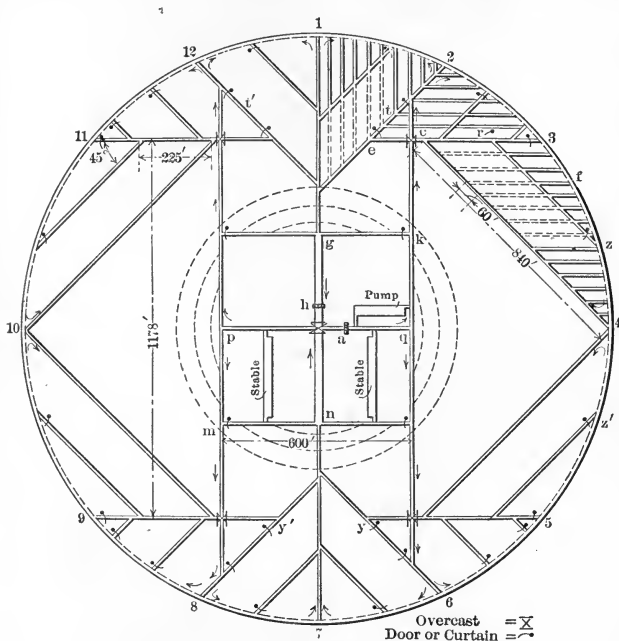

FIG. 113.—Plan of Scotch Longwall system, Illinois.

*c-4*. The angle-roads are turned off at 225-ft. intervals from a cross-road as *e-3*. Experience has shown that a room can not exceed a length of 225 ft. with out having its track rebrushed before completion. Hence, the rooms of an angle-road like *cd* are abandoned as soon as they are cut off by the next road *r-4*. Crossroads *e-3* and *y-5* are 1178 ft. apart, so that angle-roads *c-d* and *d-g* can each be 840 ft. long to contain exactly 14 rooms.

The direction of the air current is shown by arrows. The shaft *a* is the downcast, the shaft *h* is the upcast; roads 12, 2, 6, and 8 are intake, and the other roads are return airways along their inbye portions. In the intake

roads, double doors are placed at  $t, t', y,$  and  $y'$  while single doors are placed at points with strong draft like  $z, z',$  etc., to hold the air along the working face. Fire-proof burlap curtains are used in rooms where the draft is not strong enough to force them up. The ventilation is excellent and easily regulated. Trap boys are stationed at the double doors and also at cross-roads where collisions are liable to occur from trains approaching in opposite directions.



FIG. 114.—Roof sinking behind Longwall face.

For haulage the grade is nearly level; big mules are used on the main roads and small ones for gathering. At No. 4 mine, 7 gathering mules with two cars apiece haul 250 cars daily from the face to the second parting, thence 4 mules haul trains of 30 cars to the first parting whence they are hauled in similar 4-mule trains to the shaft bottom. The total output of 1000 tons is hauled in the day shift by about 40 mules, the face being about a mile distant from the shaft. The cars are of wood, weigh 1100 lb., hold 2700 lb., of coal and run on a track of 42-in. gauge, laid with 16-lb. rails except at the bottom of the shaft.

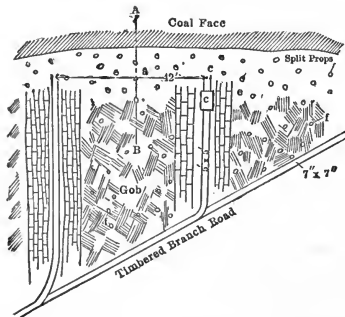

FIG. 115.—Plan of packs and tracks at Longwall face.

Fig. 115 is a plan at the face showing two room "gateways," or room roads with tracks turned off at 45 deg. from the "Timbered Branch Road." Halfway between the gateways is the "mark"  $a$  which separates a room into two 21-ft. halves, each assigned to one miner who both mines and loads his coal into a car on the nearest track at  $c$ . The undercut is made by hand pick, from a crouching position, in the floor; when the latter is of sandstone, the coal itself must be grooved. If the roof is working

properly, which is ascertained by sounding the face with a hammer, the undercut need only be 20 in. deep. Otherwise a depth of 5 ft. is sometimes necessary. The clay cuttings are thrown back into the gob.

The packwalls along the gateways are 6 ft. wide and do not approach nearer than 2 ft. to the face in order not to obstruct the air-current. They are built of slate brushed from the roof (see Fig. 109), by a hand pick to a height of about 6 1/2 ft. above the tracks. The roof of the haulage roads sinks as the face advances and must be continually rebrushed for slate, which is partly stored in an abandoned room and partly hoisted in cars to the extent of 10 per cent. of the coal-car hoist. The rebrushing of the roads, the repair of the track and the retimbering, is done by company men on day's pay, but initially the miners brush the gateways, lay the tracks, build up the packwalls, and set the props in their own rooms as part of their contract price per ton of coal loaded.

The undercut is held up by sprags (see Fig. 116) until the whole 42-ft. face of a room has been completed. When the sprags are knocked out

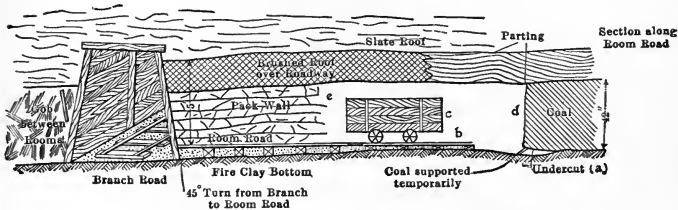

FIG. 116.—Section of Longwall face, gateway and branch road.

and the undercut coal does not fall, it is wedged down in two layers by steel wedges starting from a shear made at the breast center or "mark." To reach the car from the mark, the coal must be reshovelled twice in the narrow alley between props and face. Lines of 8-in. by 4 1/2-ft. props, about 3 ft. apart, are set along the face (see Fig. 114) at necessary intervals and some of these are not recovered. The haulageways are timbered with three-quarter sets which in certain places are seen to be cribbed 10 ft. high above the caps to catch up roof-caves that broke down the original timbering. Steel I beams are used for caps over some of the double track partings and the shaft bottom road is walled with masonry. Wooden cogs are placed at acute road corners as *c* (Fig. 113) and also to replace props along the coal face where the roof is unusually weak.

Work can cease on part of the coal face without injury to the balance if care be taken to keep the whole face regular and convexly curved, for trouble ensues if corners or concavities are allowed to develop. A fall or creep of roof at the face, which closes up the space between gob and coal, may occur from uneven advances, from failure to build up the pack

walls, from unusually weak spots in the roof, or from long shutdowns. The face is reopened as "yardage" work by driving the gateway into the coal and turning off a heading along the face with a 2-ft. rib between it and the old gob.

The haulageways are simply gateways selected because they occur at the proper intervals of the layout of Fig. 113. Near the face, rooms are always advancing in two directions which intersect each other at a 45-deg. angle. Thus room *zf*, as it advances, is cutting off all the rooms between *r-4* and *zf* which are then abandoned and their occupants assigned new working places. It is always arranged to give an experienced miner a 21-ft. face to work for himself, but occasionally he takes a green hand as helper and pupil. There is little gas, though two fire-bosses are employed. The mining and hoisting is all done on day shift. The output of coal is about 2 1/2 tons per man employed above and below ground.

#### EXAMPLE 50.—MONTOUR IRON MINES, DANVILLE, PA.

*Thin, Sloping, Shallow Beds. Loading into Cars.*—The long-wall method of mining when introduced into these mines was but little used in this country, and seldom in beds as thick as these, with breasts frequently 4 to 5 ft. high. Figs. 117 and 118 show the general method.

Levels are driven 90 ft. apart, and the face of each gangway should be kept in advance of all higher gangways, so that of the gangways *C*, *E*, and *H*, for instance, the face of *C* should be the farthest from the slope or the mouth of the drift; but in fact this is seldom done here, as it necessitates the outlay of large capital before any return is realized.

The gangways are driven 7 to 10 ft. wide and 5 1/2 to 7 ft. high, so a man or mule can go erect. The lowest gangway *C*, Fig. 117, is known as a "fast-end" gangway, as it is driven entirely in the solid, while *E*, *H*, etc., are "loose-end" gangways, with but one side in the solid and the other side formed by the stowing. The face of the gangway *C* should be kept far enough ahead so that blasting there will not interfere with the workmen in the breast *D*, and the same consideration should determine the distance of the breast *F* from the face of *E*.

To facilitate the loading of the ore into cars from chutes, the gangways are so driven that the roof of the bed will lie at the top of the upper rib, Fig. 118, and to secure the proper gangway height the bottom rock must be taken up. In doing this along the lower gangway *C* a drainage-ditch is left upon the lower side. When first driven, the gangway *C* is timbered upon the upper side, but, as settling takes place, the props are usually broken, and it is necessary generally to renew them and to blow down the roof of the gangway, which frequently settles sufficiently to obstruct the haulage-way. Often, however, the stowing becomes so tightly packed in settling that retimbering is unnecessary. In the soft



ore, by reason of the creeping of the bottom, the gangway-props must sometimes be renewed several times. Breasts or rooms *D* and *F* are turned off at an angle of 35 to 45 deg. with the direction of the gangway, depending on the dip of the bed. The breasts are 24 to 30 ft. long, and usually there are five breasts in a tier between two gangways. The height of the breast varies, with the nature of the ore, from 2 to 5 ft. In the hard limestone-ore are three streaks of ore which are taken out if sufficiently rich; but if the ore is lean the central streak alone is taken out, with just enough rock to allow the mine to work his breast. The hard limestone-ore and the block-ore have to be blasted, but the soft-ore is scraped out in the form of mud.

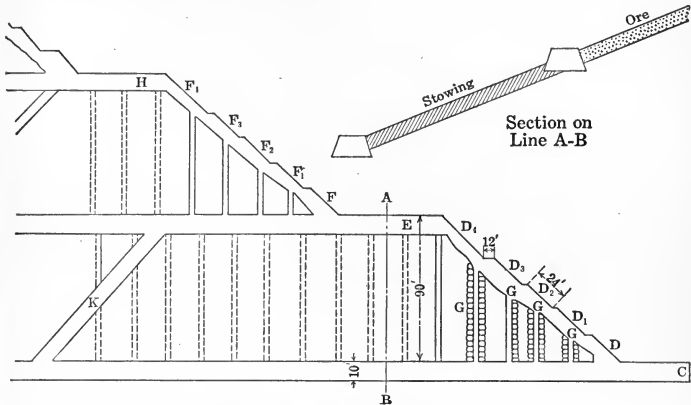

FIGS. 117 AND 118.

FIG. 117.—Long section of stope, Montour mine.  
 FIG. 118.—Cross-section of stope, Montour mine.

Each breast is worked by a miner and one laborer; or two miners will combine and work two breasts; and, sometimes, one miner and two or three laborers will work two breasts. The miner working the top breast of a tier, such as *D*<sub>4</sub>, Fig. 117, also drives the gangway *E*, takes up the bottom rock to give sufficient height for haulage, piles the stowing carefully on the lower side of the gangway, and prepares the road-bed for the track-layers, for which additional work he is paid extra.

A ditch is not left along the loose-end gangway, as the water should drain through the stowing to the fast-end gangway *C*. The gob is thrown loosely between the breast and gangway below, excepting along the chutes *G*, where it is carefully piled to support the roof. A chute or gateway *G*, 2 1/3 ft. wide, is left for each breast, down which the ore is thrown to the gangway below; it is sometimes lined with boards, but generally a carefully-built dry wall of gob suffices. The ore from each

breast is carried to the chute by hand, and drawn out from its bottom into cars as desired.

There is usually a platform at the chute bottom to facilitate the loading; in the soft ore it is placed directly above the car, but it is nearer the bottom in the hard ore, and sometimes the ore is simply allowed to pile up along the gangway. When necessary to prevent the air-current drawing up a chute, a canvas curtain is hung loosely over its mouth; but ordinarily only the last five inside chutes are kept open, the others being boarded up and filled with gob when the gangway *E* has advanced enough to receive the ore from the next higher tier of breasts. The gangways *E*, *H*, etc., are connected with the fast-end gangway *C* by "pitching gangways" *K* driven through the gob, and back of these last the gangways *E* and *H* are abandoned, so that the fast-end gangway *C* is the only one kept open through its entire length. The gangways in the soft-ore are timbered and lagged on sides and top, but in the hard limestone-ore and in the block-ore it is generally necessary to timber the sides only, as the roof is of good slate or sandstone.

The props are placed 2 to 6 ft. apart, depending upon the nature of the roof. In the hard fossil-ore and in the block-ore the breasts are not timbered, excepting when necessary to protect the chutes, as the gob fills up the space and supports the top. In the soft fossil-ore small props, 3 to 5-in. dia., are used to keep up the top, as the gob does not fill more than one-third of the vacant space. Heavy timbers are usually placed along all chutes. The timber is furnished by the company, but the miners set it, both in the breasts and along the gangway, and as it is cut on company property it is cheap.

All general work, such as track-laying, the clearing away of "falls," etc., is done by miners, detailed for each separate piece of work, instead of by laborers, and for such work the miners are paid *per diem*. All drilling is done by hand, and the ventilation is secured by natural draft through chimneys. In the drifts, the cars are either pushed by hand or hauled by mules to the mouth, while in the slopes the mine-cars are hoisted to the top by second-motion engines.

The mine-cars are 2 ft. deep, 4 ft. long, and 3 1/2 ft. wide, and hold about one ton of ore. The gauge is 30 in. and the wheels are 14-in. dia. and loose.

*Cost of Mining.*—For breast-work, miners are paid by the ton and for gangway-work they are paid tonnage and yardage.

Tonnage payments depend upon:

- (1) The nature of the ore.
- (2) The height of the breast.

Yardage payments depend upon:

- (1) The nature of the ore.
- (2) The kind of gangway.

Since the nature of the ore in the fossil-beds and the height of breast vary so irregularly, it is almost impossible to give exact figures so that chiefly ratios will be given. Upon a basis of \$1 per ton for mining block ore, the following are the prices paid during the past 15 years:

Block ore per ton .....	\$1.00
Block ore per yard, fast-end gangway.....	4.00
Block ore per yard, loose-end gangway.....	1.70
Hard fossil ore per ton.....	0.95
Hard fossil ore per yard, fast-end gangway.....	6.25
Hard fossil ore per yard, loose-end gangway.....	2.40
Unskilled labor per day .....	0.73

Soft ore costs to mine one-third to one-half the above hard ore prices.

One ton per day for each man working in a breast is considered an average output for a shift of 10 hours. The miner pays his laborer, or laborers, *per diem*, at the above rate. In gangway-work the average rate of advance was 15 ft. per month for loose-end gangways and 7 ft. per month for fast-end gangways. Owing to the many conditions affecting the rate of advance along the gangways, it was necessary to employ a system of "allowances" in payment of gangway-yardage so as to equalize as nearly as possible the pay of gangway-miners.

EXAMPLE 51.—BULL'S HEAD ANTHRACITE COLLIERY,  
PROVIDENCE, EASTERN PA.

(See also Examples 5 and 59.)

*Thin, Sloping, Shallow Seam; Panel System; Loading into Buggies on Endless Rope.*—The coal property is about 1200 ft. square, and a section of the measures just above and below the seam being mined longwall is approximately as follows:

- 20 ft., slate and soil;
- 2 1/2 ft., fireclay;
- 1 ft., bone;
- 5 ft., coal seam;
- 40 ft., slate;
- 2 ft., sandstone;
- 6 in., slate;
- "30 - in." coal seam;
- 18 in., hard slate;
- 9 ft., soft shale;
- 18 in., hard slate;
- 3 1/2 ft., coal, 4-ft. seam;
- 90 ft., sandstone and slate;
- 8 ft., coal, Diamond seam.

Below the Diamond seam occur the Rock seam, the Fourteen-foot, and the Clark, all of which and also including the Four-foot and Diamond seams had been worked out by room and pillar prior to beginning to mine the Thirty-inch seam by longwall.

Consequently, the rock above and below the Thirty-inch seam was cracked and in many cases out of place, the cracks often extending to the surface. In consequence the footing for props was most insecure, and although the cover above the Thirty-inch seam was only about 75 ft., it was impossible to hold it by timbering and it would have been probably impossible to take out the coal by room and pillar. The longwall method of working as developed by Supt. Vipond is shown in Fig. 119. A rock slope was driven up from the Four-foot seam at a slight pitch so

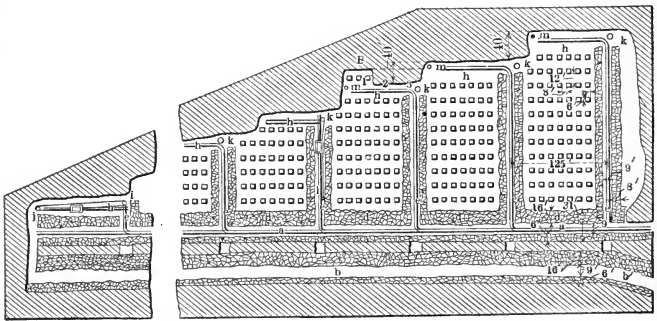

Fig. 119.—Plan of Longwall system, Bull's Head colliery.

that empty cars can be hauled up the pitch by mules. From the head of this pitch the gangway *a* was driven 31 ft. wide and 5 to 6 ft. high, bottom rock being taken up to give sufficient height. At the same time the parallel airway *b* was driven and ventilation secured by means of the headings shown through the gangway pillars. The airway *b* connects by a passageway *b'* with a ventilation shaft from the underlying Four-foot seam. The rock obtained in driving the airway is piled in walls along both sides of the airway. The rock resulting from taking up the bottom during the driving of the gangway is built into a continuous wall *c* along the lower side of the gangway and into walls *d* 16 ft. wide along the upper side of the gangway. Through the upper walls *d* are passageways *e* which are 9 ft. wide and are spaced 125 ft. between centers. These passageways, called gateways, have loose walls *b* 8 ft. wide on each side, thus making the total width of the gateway and the walled space 25 ft. The gateways are driven the same height as the gangway for a short distance in from the gangway so as to provide a place for the mine car to stand while it is being loaded and

out of the way of traffic along the gangway. This distance depends upon conditions, but is usually not over 40 ft. Above this point the gateway is made only the height of the coal and the overlying slate, that is, about 36 in. The coal is overlaid by about 6 in. of slate which is always taken down, and it is this which furnishes the greater part of the material needed for building the pack walls along the greater length of the gateways and along the face as will be described later.

The method of opening out a face is shown at *A*. Strips are taken off the face parallel to the gangway and the gangway walls *d*, and as soon as sufficient width is secured between the gangway wall *d* and the face of the coal, a track *h* is laid as near to the face as possible so that it will not interfere with the work of the miners. This track has a gauge

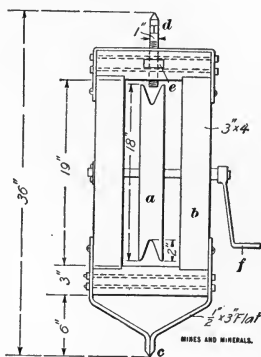

FIG. 120.—Single winch, Bull's Head colliery.

of 2 ft. 3 in., is laid with 25-lb. rails, which are 10 ft. long. The rail sections are joined by two fish-plates, one placed on each side of the flange. The rails are held together by iron bridles which are laid directly on the bottom. On this track is a small buggy into which the coal is shoveled. This buggy is moved by an endless wire-rope operated from a point *i* on the gateway as follows: A cast-iron wheel *a*, Fig. 120, 18 in. in diameter and having a groove 2 in. deep, is held in a wooden frame *b*. At the bottom is a pointed iron *c* fixed on the frame. This rests upon the bottom rock. At the top is an adjustable pointed round iron *d* the lower 9 in. of which is threaded so that by means of the nut *e* countersunk as shown in the frame, when a wrench is applied to the squared portion above the thread the point can be forced up against the roof and the frame thus held securely in place. A 3/8-in. wire rope is wound two or three times around the wheel *a* so as to give it sufficient grip on the wheel. At the other end of the track along the face at *j* this rope passes

through an ordinary 6-in. iron block and tackle which is hooked to a chain placed around the prop. One end of the rope is attached to the front end of the buggy and the other to the back end of the buggy. By turning the handle *f* of the wheel, the buggy can be moved forward and backward along the face. This buggy is made of timber, holds about 20 cu. ft., and one side is 20 in. high and the other 18 in., this difference being made to allow room for loading over the side. The wheels are 6 in. in diameter placed on 1 1/4-in. axles. In the bottom there is an iron plate which slides in and out sideways, being moved by a handle. The track *h* along the face *A* which is just being started extends out over the track *e* and by pulling out the slide in the bottom of the buggy the coal is dumped from the buggy into the mine car standing on the track *e*.

The coal is not undercut, and in general does not need to be drilled or blasted, the weight of the cover being generally sufficient to loosen the coal with an occasional shot when the roof pressure is not sufficient. Owing to the broken conditions of the measures due to the mining out of the underlying seams the coal in many places is loose and simply needs to be picked out. Six men work along each face, three miners and three laborers who load the coal into the buggies. The face is worked in several sections as shown at *B*, each section being taken out for a certain distance, about 12 yd. depending upon the ease with which the coal can be broken down; but no section of one face is allowed to get far ahead of any other no matter how easily the coal can be mined. By the time section 3 has been mined out the coal in section 1 will have again loosened by the weight of the cover and can then be taken out after the cogs have been built. The track *h* is moved near the face after each section is mined and a row of cogs is kept close up to the track. Each face of coal is kept about 40 ft. in advance of the next following face. The cogs are 6 ft. square and the rows are 8 ft. apart parallel to the face and 12 ft. apart perpendicular to the face. These cogs are built from the slate overlying the coal, and as it comes down in large slabs a very firm cog is formed. The space between the large rocks is filled in with dirt and a perfectly solid cog thus formed.

As already noted, after the gateways *e* have been driven in full height, a distance sufficient to allow the mine car to be placed in the gateway out of the way of the haulage on the main gangway, the height of the gateway is decreased to the thickness of the seam and overlying slate, that is, about 36 in. The coal is moved from the face to the car at the mouth of the gateway by means of a buggy similar to that used along the face and already described, but instead of the winch shown in Fig. 120, it is moved by means of a double winch placed at the point *h*, Fig. 119, on the gateway where the height is decreased to the height of the seam. This winch, Fig. 121, has two drums *a* and *a'* which run loosely on the axle *b*, but by means of the clutches *c* and *c'* by means of a lever not shown, either drum

may be made to turn when the handle *d* is moved. If the load is too great to be moved by turning the handle *d* the winch may be operated on second motion by means of a pinion *e* attached to a movable axle *f*. One box of this axle at *g* is loosely bolted to the framework allowing a little play of the axle, while in box *h* is an elliptical instead of a circular hole through which axle *f* passes so that it can be pushed over to the dotted position *f'* throwing pinion *e* out of gear. The winch is set on a framework of timbers one end of which rests directly on the bottom, while the other end is let into a groove in a prop. There are two ropes

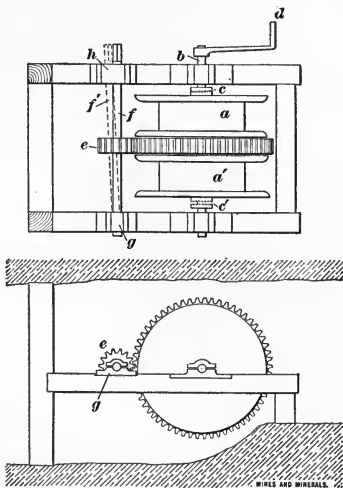

FIG. 121.—Double winch, Bull's Head colliery.

which wind upon the drums *a* and *a'*. One of these is attached to one end of the buggy, while the other passes to the upper end of the gateway, thence through a small 6-in. iron block and tackle *k* fastened to a prop by a chain and back to the other end of the buggy, or by means of guide pulleys or rollers at the inby end of the gateway the rope may be carried along the face to a return pulley *m* at the extreme end of the face and the gateway buggy taken along the face and the coal brought directly from the face to the gangway.

The conditions for operating the longwall system of mining are particularly unfavorable, for the bottom is badly broken and a stable footing for props is often unobtainable. At the face of one of the gateways at the time of our visit the bottom had dropped away entirely from beneath the coal leaving the coal supported only by contact with the overlying

slate. The top is also badly broken, allowing the surface water to enter the mine and giving a roof that cannot be controlled. This roof settles down over the gangway packs about 2 ft. so that while the gangway is driven about 6 ft. high it is only about 4 ft. high after the workings have settled. Over the gateways and cogs the roof settles about 2 ft. Thus far an output of 1800 tons per foot-acre has been obtained, a much better yield than is usually obtained in anthracite mining.

EXAMPLE 52.—VINTON BITUMINOUS COLLIERY, VINTONDALE, PENN.

*Thin Stopping Seam, 800 ft. Deep; Panel System; Loading into Pan Conveyors.*—Transporting coal from the working face to main haulage roads by means of mechanical conveyors is a comparatively recent departure from ordinary mining methods. This system, which was first introduced in England, was early recognized by leading operators there as possessing superior advantages over the usual manner of working, especially in thin coal seams where the roof has to be brushed to allow all but the tiniest cars to reach the longwall face.

The coal worked at Vintondale is bound tight to roof and floor and is the "B" or Lower Kittanning seam, 42 in. in thickness, which lies on a pitch of 8 per cent., with an average of 200 feet of cover. The coal is of a soft and friable nature, free from slate bands and bony coal, but interspersed with sulphur pyrites, which, at times, cause considerable annoyance in cutting and drilling. The bottom is a mixture of coal and fireclay, while the roof is composed of from 8 to 12 ft. of black slate, overlaid with sandstone. The slips in the slate are well marked, and lie at an angle of 25 deg. with the line of greatest dip; the longwall face is kept normal to these slips. The present panel modification of longwall mining was first started in No. 3 mine in 1900. At the outset cars were run around the working face and loaded. This method brought only fair results, owing to the necessity of using small cars, steep grades, and difficulty in keeping roadways open.

Arrangements were then made for the placing of a conveyor along the face, allowing the cars to be run under the head-end to be loaded. The first conveyor, which was made entirely of wood, was a cumbersome affair, and much time was consumed in moving it laterally along the face after the cut had been loaded out; but, after a year's trial, the results obtained were so gratifying that metal conveyors were designed and ordered, and preparations were made to employ this system on a much larger scale (Fig. 122).

The metal conveyor consists of a trough or pan, made of sheet steel 1/8 in. thick, 12 in. wide at the bottom, 18 in. wide at the top, and 6 in. high, set on strap-iron standards as shown in detail in Fig. 123. A conveyor is made up in sections of 6-, 12-, 15-, and 18-ft. lengths, connected



together by means of 1/2-in. flatheaded bolts, countersunk. The front is inclined for a distance of 45 ft. to allow clearance for mine cars to pass under (see Fig. 114). The rear end is inclined for 15 ft. to compensate for the size of sprocket wheel. A return runway for the chain is afforded below the pans by angle irons.

A cast-iron driving sprocket, 18 in. in diameter and 13-in. face, is

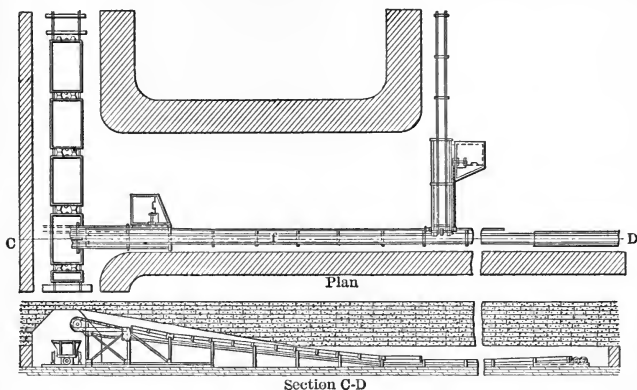

FIG. 122.—Plan and section of Vinton conveyor system showing head of main conveyor.

attached to the front end. On the shaft of this sprocket, which is extended 12 in. beyond one of the bearings, is keyed a 12-tooth, 16-in. diameter sprocket, which connects with the driving mechanism. The rear-end section (c) consists of a framework made up of two I-beams, 6 ft. long and strongly braced, on which rest the take-up boxes for keeping the chain in adjustment, and the rear sprocket wheel over which the

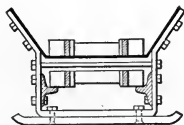

FIG. 123.—Cross section of conveyor, Vinton colliery.

chain returns. There are two conveyor chains, held apart, the width of the trough, by crossbolts which act as scrapers to replace the usual plates. The chains are of steel and are designed for quick repairing.

The triple conveyor system (Fig. 124), was finally designed and installed as an improvement over the single type. In laying out a mine for this system, the main entry and airway are driven up or down the

pitch, and cross-headings are driven off them at intervals of 400 ft. at such an angle as will give a 2-per-cent. grade; 75-ft. barrier pillars are left on each side of the main entries. The cross-heading is driven 20 ft. wide and gobbed on the lower side. The air-course, which afterward is used as the panel or block face, is driven 20 ft. wide, but no bottom is lifted; a 40-ft. pillar is maintained. Block headings are run perpendicular to cross-headings at 518-ft. centers; they are driven 18 ft. wide, with bottom lifted in the center 5 ft. wide, and deep enough for a 5-ft. clearance.

When the block is ready for operation, a conveyor 350 ft. long is placed in the block heading, and along the face of the air-course on each

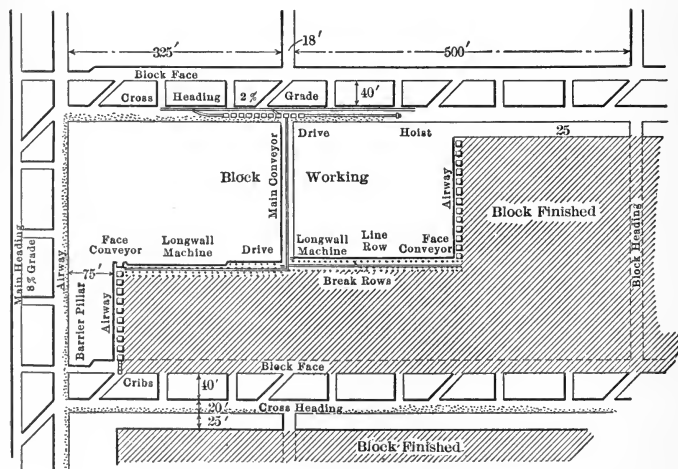

FIG. 124.—Plan triple conveyor system, Vinton colliery.

side is placed a conveyor 250 ft. long, with delivery ends directly over the main conveyor, one being 5 ft. in advance of the other. Each conveyor is driven by a 20-horsepower, 250-volt, series-wound motor, encased in a sheet-iron frame mounted on steel shoes, so as to be easily moved.

Airways are maintained on the blocks by driving two places slightly in advance of the block face, 6 and 4 ft. wide, respectively, with a 10-ft. pillar between. The first place acts as a stable for the machine, and is driven by the machine. The airway is pick-mined, and one man manages to keep these places going on the rear end of both blocks. By this arrangement no cribbing is necessary.

The blocks are worked to within 25 ft. of the cross-heading, when

the conveyors are removed to another block. The remaining pillar is brought back along with the heading stumps.

The power is carried to the top of the block heading by a 00 wire. Here are attached two insulated twin cables, one to furnish power to the machines, the other for the drives and hoist.

The cables are carried down the block heading, one on each side of the main conveyor, being attached to it by means of malleable-iron brackets. At the junction of the conveyors connections are made with the drives, also with a cable that is attached to each of the face conveyors.

Stations are established 50 ft. apart on the face conveyor cables, to which connections are made with the short cable attached to the longwall machines and electric drills. Switches are placed at the head-end of the main conveyor, by which the power is controlled.

The method of handling the cars to the conveyor is simple. A side track is laid 300 ft. long, of which the block heading is the center. Connection is made with the main track at the lower end, and a cross-over switch is placed directly under the conveyor. At the upper end of the siding is placed an electric hoist. A trip of 14 cars is shoved into the empty track, and the rope is attached and the trip pulled up to the conveyor. Signal wires are hung between the conveyor and the hoist, and as each car is loaded the trip is pulled forward. When loaded, trip is dropped on the loaded siding, the rope disengaged and attached to the empties.

The crew operating a double block consists of 17 men, *i. e.*, block boss, machine runner and helper, driller, shooter, two conveyor men, hoist boy, five loaders, and four timbermen. Two longwall machines of Jeffrey or Sullivan make are used, one for each side, although one machine can keep up the work in case of emergency. The machine men finish cutting one block, in five hours, and then put the machine in position to start back on the cut and move over to the next block and begin cutting. They are followed by the shooter and loaders.

When a block is cleaned up, the timbermen move up the conveyor.

This consists of setting a line of props, called the line row, about 8 ft. apart, and a distance from the conveyor equal to the depth of the undercut. As these are placed the old line row, which is now against the conveyor, is withdrawn. The pulling jacks for moving the conveyor are distributed along the block 40 ft. apart and placed in position.

The shot firer keeps closely after the machine, and is through shooting shortly after the undercut is finished. The driller then starts from the far end of the block to drill holes in the new face. It usually takes him about two hours to drill the entire width of the block.

Each loader is supplied with a pick and shovel and a piece of sheet iron 9 in. wide and 6 ft. long, which he attaches to the conveyor to act as a sideboard. As each loader cleans up his place he moves forward to

the head of the line. This continues until the coal is loaded out, which usually requires about six and a half hours.

When cleaned up, the drive is reversed and the timber which has arrived on the last trip is run through on the conveyor to such points on the block where it is required. When this is accomplished the power is shut off, and the conveyor is moved up to the line row. This lateral move of the conveyor requires very little time, very seldom exceeding five minutes. A break row, consisting of two rows of props set 2 ft. apart, is now placed along the lower side of the conveyor. These props are set on a cap piece, placed on a small pile of slack, and wedged at the top. Two break rows are all that is necessary to protect the block. In the meantime, a portion of the crew are engaged in pulling out the extra break row. This is the most hazardous work on the block, and is given personal attention by the block boss. Axes are used in this operation, and about 75 per cent. of the props recovered are practically uninjured.

While part of the crew are employed timbering, the rest make the necessary connections, and go along the conveyor with a pump jack and level it up. They also build a crib at the head end, which is placed to prevent the roof from breaking over into the block heading. All the dead work is taken care of by the four timbermen, thus not hindering the steady flow of coal, which averages 150 tons daily, from a 5-ft. undercut.

For the purpose of keeping the machinery in as good shape as possible, a skilled mechanic is attached to each mine. He assumes charge in case of an accident and makes necessary repairs, although most of the breakdowns are easily taken care of by the block boss and machine man.

In the starting of a block is where the best results are obtained, as the roof requires little attention until about 100 ft. have been extracted. It then begins to weigh heavy on the posts, and it is found necessary to carry three or four double break-rows with cogs in anticipation of what is called the "big break." This usually occurs when the block is advanced from 100 to 150 ft., although in several instances a 500-ft. face has been carried up 200 ft. before the overhanging strata broke. After the sand rock is down, only two break rows are carried, and the roof keeps breaking behind the last row as the face is extended.

The men are paid day wages and, as they become accustomed to the work and machinery, are advanced accordingly. The "block" boss, as an incentive to secure the best results, is paid a small bonus per ton besides his regular day rate. The cost averages for the last two years show that block coal is loaded on the mine cars 35 per cent. cheaper than the district mining rate for pick work with loading into cars.

The above conditions prevailed in Nov., 1907, but on the author's visit in Sept., 1910, he found the longwall system superseded by the former room and pillar system for the following assigned reasons. 1. The frequent breakage of the conveyors caused a very irregular output.

2. The miners preferred the contract payments of room and pillar to the time wages of the longwall system. 3. The timber consumption was excessive, because many of the props could not be recovered.

None of these disadvantages are irremediable, and the cost of timber can always be obviated wherever enough slate can be cheaply got from the floor, parting, or roof to build pack walls to replace part of the props and cogs. The conveyor-longwall system has proved profitable for thin seams in Europe, and the Vintondale method should prove commercially successful in other American fields where the natural conditions are suitable.

EXAMPLE 53.—DRUMMOND BITUMINOUS COLLIERY, WESTVILLE, N. S.

*Thick Stopping Seam at 2000-ft. Depth. Loading into Cars handled on "Jigs."*—When coal workings extend beyond a vertical depth of 1500 ft., it generally becomes unprofitable, if not impossible, to work by one of the "pillar" methods, for the enormous weight of the overlying strata will not only break and crush the timber, but will also either crush the pillars or force them into the strata immediately above or below the seam, resulting in a "creep" and the closing up of roads.

The size of the pillars must increase with the depth, until at about the depth noted above, the pillars become so large and the amount of coal that can be safely worked so small, especially if it is of a friable nature, that the operations become unprofitable, and another method must be adopted or the mine closed up.

Such was the situation in 1896 at this mine in working by the room and pillar method a 17-ft. seam of friable, gaseous coal, with a very weak roof of black carboniferous shale, the seam dipping from 18 to 27 deg.

The mine had been developed by two parallel slopes on the dip, and from these double-entry "lifts" were turned off every 400 ft. These entries or levels were 9 ft. wide by 7 ft. high, and as depth was gained it was found difficult to support their roofs. At a depth of 1200 ft., the first "chocks" or cogs had to be built on each side of the level. In the next lift, 400 ft. below, it became necessary to change the working system if the coal were to be mined at a profit. The change was made without great expense, any interruption of the regular output or any considerable variation in the ventilation, etc.

The advancing panel system of longwall was adopted and it has proved quite successful considering the depth reached, which is 7,870 ft. on the slopes or over 2000 ft. vertically. The new system has been particularly free from fatal accidents at the face, those occurring happening in the roadways, etc. The slopes are sunk as formerly, diverging slightly to increase the pillar of solid coal between them. They are supported on either side by pillars also increasing in width with depth so that they are now about 350 ft. wide.

Either one or both of these slopes is used as the intake airway, Fig. 125, while return airways are maintained, one on each side along the slope pillars. Two levels are driven as formerly which form a lift with about 400 ft. of solid coal between pairs of levels. The upper level of each pair is used as a haulage road, and the lower level forms the intake airway for each lift. This intake carries fresh air from the slope, where it is split, to the inner workings first; from there, returning and ascending, it passes through each of the working places to the lift above, and thence to the return airway; it is also used for drainage, and generally there is a dam built on it near the slope which catches all the water from the lift.

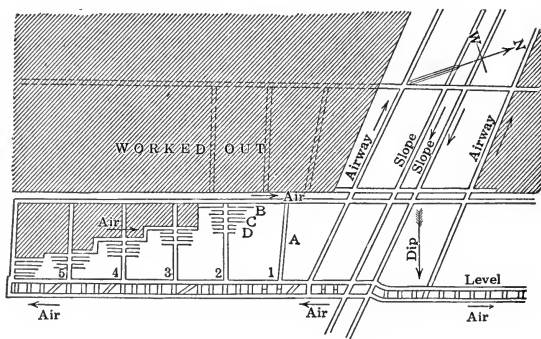

FIG. 125.—Plan of layout, Drummond colliery.

The levels are driven as nearly parallel as possible, rising about 1 ft. in 130 ft. with from 15 to 20 ft. of solid coal between the chocks. This pillar is often removed and the space filled in with stone from the roof, the result of "brushing" which must be done very shortly after the levels are driven. These levels are driven 8 ft. wide and 8 ft. high, they are first made about 18 ft. wide and 7 ft. high. This leaves a "bench" on the bottom which is only cut in the case of roadways. On this bench chocks are built quite close together on each side, and about 8 ft. apart across the road, Figs. 126 and 127, with sided timber over them across the road about 3 ft. apart, and slabs over the timber to support the roof. The chocks are built of blocks of wood over 5 in. in thickness and 5 ft. in length, making them 5 ft. square. After these are built (similar to logs in a wharf) the bench is cut along the chocks and the bottom lifted to give the 8-ft. height.

Off these levels, "jigs" are driven up on the full pitch of the coal, Figs. 127 and 128, not more than 400 ft. apart; they are choaked as well as all other roadways. An airway 5 ft. wide is carried up on the side of this jig farthest from the slope, and the chocks on this side must be made

air-tight. This is done by filling them with stone and fine coal, etc. Owing to the very heavy pressure required in maintaining ventilation at this depth, canvas doors can only be used as a temporary arrangement. A wooden door is placed in an air-tight frame across the level to direct the air up this airway between the coal and the air-tight chocks, passing

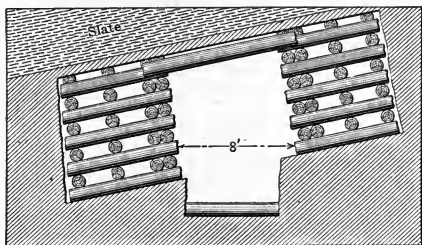

FIG. 126.—Cross section of road, Drummond colliery.

around the face and returning down the jig which is 8x8 ft., Fig. 127. This practice has been proved many times to be the only practical way, as the air will not pass up the large and down the smaller airway in sufficient quantity to keep the face clear of gas. This method is continued until the jig is driven through to the lower level of the lift above,

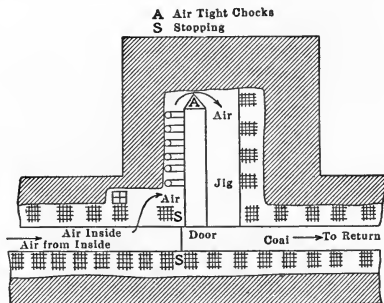

FIG. 127.—Plan of gateway and face, Drummond colliery.

when the door is removed and the air passes up the jig and out to the airway, and the airway along the chocks is allowed to cave.

*Working the Rooms.*—Beginning at the lower entry of the lift above on one of these jigs, rooms are broken off with about 41 ft. between the centers. The "gateway" or road in the rooms is much the same as the levels already described. They are timbered in the same way, Fig. 128,

except that the chocks are built about 2 ft. apart on each side, and only about 6 ft. apart across the road. When this gateway is driven in about 25 ft., work is started on the breast. From it the coal is all taken out to a thickness of 7 ft. and up to the room or level above. The breast is then timbered with upright timber props with cap-pieces between them and the roof. Sometimes sided timbers are placed with one end on the high-side chock of the roadway and props under the middle and upper end. The gateway is kept 15 ft. to 20 ft. ahead of the breast, the roof of which is allowed to fall in as the face advances; generally when about 40 ft. from the jigs the roof falls, often causing a great smashing of timber on the road below, the bottom rising up as well. The face of the

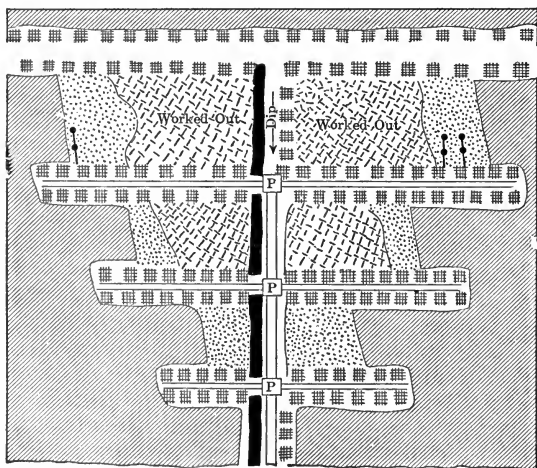

FIG. 128.—Plan of jig road, Drummond colliery.

gateway is kept a short distance ahead, for if the face of road were in line with the face of the breast, it would be very apt to fall solid across the face of the road as well, and take a week or more to get into working shape again. Through carelessness of the miners this sometimes happens. No explosives are used, for if these places are properly timbered and the weight thrown on the face the coal is easily worked with hand picks, but wedges are required in lifting the bench in the roadways.

Quite often the roof falls in solid to the face, then it is necessary to drive a heading up in the solid coal at the face and start the breast over again. This perhaps is the greatest difficulty met with in the whole operation, for when a fall like this takes place the ventilation is cut off and generally some gas accumulates and when the heading is started up,



the gas, also rising, follows the miner and causes trouble before it can be driven 20 ft. or 35 ft. to the place above.

Generally three of these rooms are worked on each side of the jig simultaneously, the upper ones leading and the others following in step-like order from 20 ft. to 40 ft. behind the preceding one. In this way the upper 7 ft. of the 17-ft. thickness of coal in the seam is taken out in one operation and in future years the balance may be mined similarly.

Three miners and a laborer work in each room, as the success of this method requires that the breasts be kept steadily, if slowly, advancing. With depth it is necessary to shorten the gateways in order that the coal may be all taken out before they become entirely closed up, for on every side may be seen examples of both squeeze and creep. The roof pressure is so great that thin clay partings in the coal squeeze out like clay from a brick-machine, while the lateral pressure on the coal walls reduces the space of the openings 30 per cent. in a few months. The combined pressures so break ordinary booming in about a month that it becomes necessary to brush and retimber again. Here places may be seen so closely timbered that neither rock nor coal are to be seen for long distances except at the working faces. Studies are constantly made of the faults, cleats and clay partings encountered, (so as to make the pressure mine the coal with the least labor), of the proper setting of timbers, of the breaking away of the ribs and how to avoid it; and of how to distinguish the actual sounds of danger as there is always some cracking of timbers heard in the working places. So expert do those extracting the coal from the breast become that they work on to the last minute before a fall takes place amid appalling conditions.

*Haulage.*—There is no mechanical haulage on the levels, the work being done by horses. At the bottom of the jigs and at the mouths of the rooms—which are opposite each other, three on each side of the jig—large metal plates are laid on timbers placed horizontally and made solid in that position. When laid they form a smooth surface from 6 to 8 ft. square. On these the cars can easily be turned in any direction.

The road on the jig is either a double track or three rails, with a passing turnout halfway (see Fig. 128). Over the two lower plates on the jig, lifting rails about 8 ft. long are fitted into clips. When running coal from the lower rooms, these rails are removed and a tail-rope the necessary length is attached with a safety hook. A drum, controlled by a boy, is placed at the top and the weight of the full car running down takes the empty car up. The cars run on their own wheels from the surface to the face, their gauge is  $2\frac{1}{3}$  ft., and their capacity is 1600 lb. of coal.

*Output and Timber Used.*—No timber is drawn, the great difficulty being to get enough timber in to keep sufficient room for the proper ventilation of the mine. The mine produces about 1200 tons of coal a day and consumes two thousand 5-ft. sticks, but of a small diameter.

## CHAPTER XX

### PILLAR SYSTEMS FOR SEAMS

#### EXAMPLE 54.—ADVANCING-SYSTEM LAYOUTS FOR ROOM AND PILLAR, PILLAR AND STALL, AND PANEL METHODS

*Room and Pillar System.*—The pillar system is also known as “room and pillar,” “pillar and chamber,” “bord and pillar,” etc. It is applicable to all classes and conditions of mining where the roof pressure is not such as to destroy pillars of reasonable sizes, subject, however, to such modifications as serve to adapt it to the varying conditions of weak

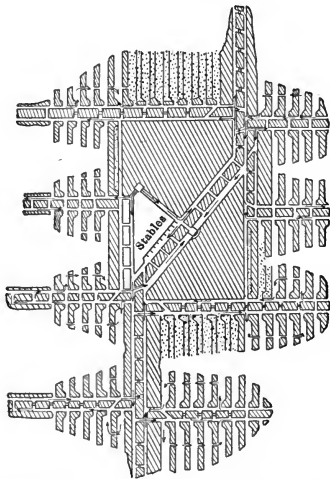

FIG. 129.—Layout for Room and Pillars system, flat seam.

or strong roof or floor; tough, friable, or gaseous coal; predominance of face or end cleats; inclination of the seam, etc. The features of the system are openings driven square from or at an angle to the haulway. Such opening may be driven wide or narrow, and may be a roadway, incline, or chute, as best adapted to the existing conditions.

*Room and Pillar System (proper).*—This layout as applied to flat seams, or where the inclination does not exceed 3 deg., is illustrated in Fig. 129. The shaft bottoms, including the stable, are here shown

crossing the shaft pillar at an angle conforming to the surface tracks, thereby giving a straight dump and tipple in line with the shaft. The stables are located close to the shaft bottom, where the mules can be rescued in case of accident, and where the daily feed and refuse can be conveniently handled. Free access is had to the stables from the main haulage roads without passing through a door; while immediate access is had close to the shaft through a curtain or canvas. Good ventilation is secured by a small separate split of fresh air, while the return air from the stables at once enters the return from the mine and passes up the shaft without contaminating the mine air. Another feature of the arrangement shown in Fig. 129, is the small number of doors. The coal coming from any room upon the main road of a pair of entries has no

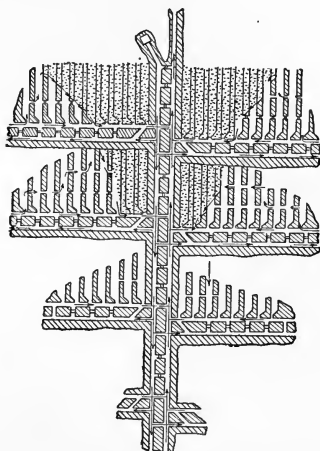

FIG. 130.—Layout for Room and Pillar system, sloping seam.

doors to pass through; while that coming from the back entry of each pair has but one door to pass through on its way to the shaft. This is a great saving of expense and trouble and may often avert possible disaster arising from the derangement of the ventilation by doors being left open. The chambers or rooms are here turned square with the entry narrow for a distance of 4 or 5 yards and then widened out inbye, the road in each room following the straight rib. The waste from the seam is stored in the room. The rooms are spaced, under normal conditions of roof and floor, from 40 to 45 feet apart, center to center. The breast is usually 8 yards wide and is driven up from 60 to 100 yards. When the breast is abandoned the miner starts to draw back his pillar unless for special reasons this is delayed for a while.

In Fig. 130 is shown the application of the room and pillar system to seams pitching from 3 to 5 deg. It differs from the method shown in Fig. 129 by turning rooms to the rise only. When the pitch of the seam is from 5 to 10 deg., the car may still be taken to the face and loaded by driving the rooms across the pitch, or at an angle with the level or gangway. This reduces the grade of the track in the rooms. When the inclination of the seam is still greater, buggies are sometimes used, the track being built upon the refuse of the seam and raised at its lower end where a tip is arranged by which the coal is dumped from the buggy into the mine car ready to receive it. Where the coal is soft, this method cannot be used. It is employed on pitches not exceeding 15 or 18 deg. in thick seams.

Seams pitching more than 15 deg. are usually worked by chutes or self-acting inclines. When the pitch is less than 30 deg. sheet iron is

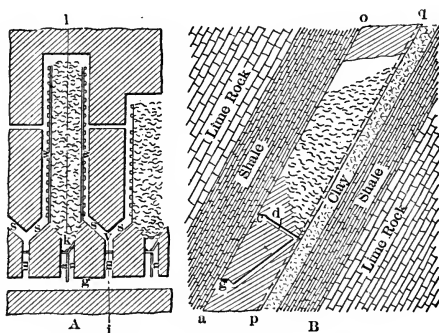

FIG. 131.—Room and Pillar system for steep seam.

usually laid in the chute as a floor, to enable the coal to slide more easily; but on inclinations of less than 20 deg. it is usually necessary to push the coal down the chute by hand or by mechanical means, as it does not slide readily. On pitches steeper than 30 deg. sheet iron is not necessary, as the coal will slide without. Fig. 131 shows, in plan *A* and section *B*, the arrangement of the breasts, chutes, and manways, and the position of the gangway and air-course at the roof of the seam, in thick, steep-pitching anthracite beds. This position of the gangway and air-course secures a better inclination of the loading chute and manways, and presents less danger from squeeze. In the figure, *g* is the gangway and *m* the manway leading to the dividing at the floor of the seam into two branches *s, s*, which lead to either breast. At this point, or slightly below it, a small cross-cut *d* is driven up to the airway *c*. This is bratticed off and used only in case of need, as the air is regularly conducted

up one breast manway and down the other side to the highest cross-cut and thence to the next breast. Brattices with small doors are also placed in the manways to keep the air from taking a short circuit through the manways. Small manways are bratticed off the side of each loading chute for the use of the loaders.

Self-acting inclines are used, sometimes, upon steep pitches in preference to chutes. In this case, butt headings are usually driven to the full rise and rooms set off on the strike from these rise headings, buggies being used in the rooms to convey the coal from the face to the incline. It is hardly necessary to state that dip inclines are rarely ever introduced as a permanent feature, it being better to sink the main slope far enough to permit another level from which the coal can be worked to the rise.

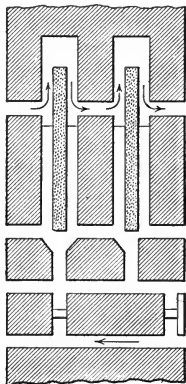

FIG. 132.—Single Stall system.

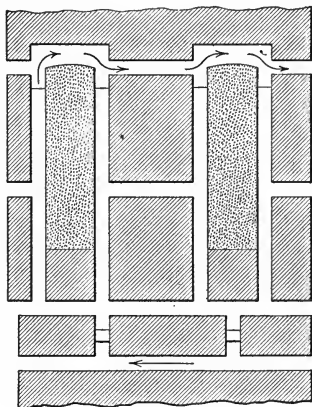

FIG. 133.—Double Stall system.

*Stall and Pillar System.*—This is similar to the system just described, except in the relative size of pillars and breasts. It is adapted to weak roof and floor, or strong roof and soft bottom, to a fragile coal, or to other similar conditions requiring ample support. The stall system is particularly useful in deep seams where the roof pressure is great. The stalls are usually opened narrow and widened inside to furnish a breast which varies, according to conditions of roof, floor, coal, depth, etc., from 4 to 6 yd. wide in the "single-stall" method. The pillars between the stalls are usually about the width of the breasts.

Fig. 132 shows the method by single stall and Fig. 133 that by double stall. The former is more applicable to flat seams or seams of small inclination; while the latter is used on steep pitches. The single-stall method affords but one road to a breast; and, hence, does not permit of

the concentration of men possible in double stalls where there are two roads to each breast. In the double stalls the breasts are wider, ranging from 12 to 15 yd.; while the pillars sometimes reach a width of 30 yd.

*Panel System.*—It is advisable to mine in panels: 1, When the seam contains much gas, making it essential that the ventilation of the entire mine be under absolute control; 2, when the coal is readily affected by the air, and disintegrates with long standing; 3, When the roof pressure or the conditions of the roof are such as to require extreme caution to prevent squeeze or creep. The panels are formed by driving entries and cross entries so as to intersect each other at regular intervals of, usually, about 100 yd. The entire field is thus ultimately divided into separate squares or panels, each of which has practically its own system of ventilation. Each alternate haulway may be made an intake to supply air to one tier of panels, while the next succeeding passageway may be used as the return to conduct the air from each panel to the foot of the upcast. If more air than usual is needed in any one panel, it can be obtained at once by enlarging the opening in the regulator which controls the air for that section. In case of an explosion in any one panel, it is not usually communicated to the other panels. Extractions can be commenced as soon as a panel is formed; and usually consist in driving a heading across the panel and opening the coal by single or double rooms or stalls. Next, the room pillars are carefully drawn and the roof inside the peripheral pillar of the panel is allowed to fall. A high extraction of coal can thus be safely secured with a small loss of timber.

#### EXAMPLE 55.—NELMS' RETREATING SYSTEM

*Room and Pillar Layout for Flat Coal Seams.*—This method insures the operator a greater amount of coal than when the seam is worked advancing on the room and pillar system. Since mining men in the United States now recognize that our supply of fuel is exhaustible, it certainly behooves all operators to mine every ton of coal possible.

In this retreating system, the main entries are driven 50-ft. centers with cross-cuts every 100 ft. The middle entry, in the three-entry system, is used for the haulage road, being also a main intake airway. After turning a pair of butt entries off the main, the second crosscut, 200 ft. from the last butt entry, should be a 45-deg. chute for motor haulage. The dotted lines on the main entry at the bottom of the butts show the position of the "parting." The motor, hauling 25 1/2-ton cars comes in the middle main entry, swinging its trip of empties in the chute, the motor running up the straight where the drivers have stocked their loaded coal. The motor can then pull its loaded trip outside and the drivers proceed to distribute their cars, two drivers going in each butt entry. The drivers make two trips, while the motor makes one.

The butt entries are driven on a 90-deg. angle from the main entries, and at a distance of 1400 ft., they intersect a set of three-face entries running parallel to the main entries. The butts are driven 50-ft. centers, with crosscuts every 100 ft. This system of turning butts off the mains is an ideal one for haulage and ventilation. Instead of driving rooms off the butts beginning near the main entry, the rooms are started from the face-entry side and all coal is worked toward the main entries.

Usually 60 ft. of solid coal is left to protect the face entries, and 60 ft. to also protect the mains. The rooms are started four at a time, and as soon as the first four have been driven 50 ft., the next four are started on both butts. The rooms are all driven on sights 90 deg. off the butt entry and driven 25 ft. wide for a distance of 240 ft., there being a 15-ft. pillar left in each room. The crosscuts in the rooms are from 80 to 100 ft. apart, and should be "staggered" across the different rooms so as not to make a weak place in the roof by having the breaks all opposite.

#### FOUR PAIRS OF BUTT ENTRIES WILL PRODUCE 1200 TONS OF COAL DAILY

After driving the rooms the full distance, they should be cut over to the next room by the mining machine, the cut being 20 ft. wide. The great advantage to be gained in this system is the method of not having work scattered all over a mining territory. Four pairs of butt entries, thus mined, will produce 1200 cars of coal each working day.

In Fig. 134, there are 32 "machine" rooms (Nos. 13 to 28 on each side) working on the pair of butts, and requiring 32 men (loaders), two men having two rooms and working them together. It is the general practice to clean up one room at a time and so always have coal to load in one room or the other. Each machine loader receives six cars, thereby producing 192 cars per day.

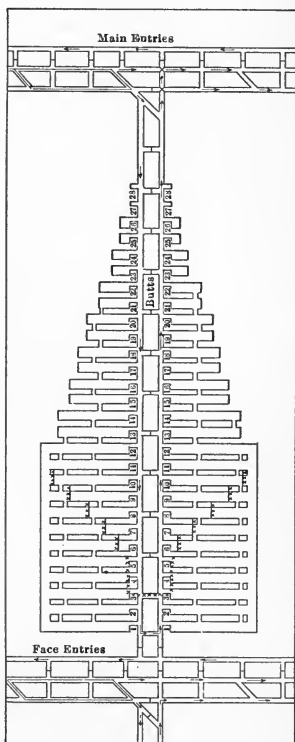

FIG. 134.—Plan of Nelms' Retreating system.

There are 10 pillars being robbed (Nos. 6 to 10 on each side), and these produce 30 cars of coal, as the pillars are worked by one man. In some places two men work the pillars. The "turn" in coal mines is such that a machine loader receives two cars to the pick miner's one, thereby equalling each other's wages, as pick costs about twice as much as machine coal. The chain pillar and stump will produce 12 cars, with four men working, and the two butts yield 234 cars per day.

The engineer can advance the work in such a standard way that his machine coal will always total to the proper amount. A mine foreman should find this an easy way to keep his men standardized, the machine loaders always having machine places and the pick men pick places, thereby increasing the safety factor of his mine, as his machine men would never have to do pick work.

The ventilation shown by the arrow heads is the most practical to use; the splits are shown and also the overcast at the bottom of the butt entry, there being a regulator in this overcast. The motor road is clear of doors on the main entries. The arrangement of chutes on the left side would be slightly different.

#### EXAMPLE 56.—NELMS' ADVANCING-RETREATING SYSTEM

*Room and Pillar Layout for Flat Coal Seams.*—The layout for the advancing-retreating system is as follows in Fig. 135: Three face entries, on 50-ft. centers, are driven parallel to the main entries at 1400-ft. intervals. The sectional area of the face entries is kept as nearly as possible to a 60-ft. standard in a 5-ft. seam.

It is advisable where possible to use all three entries for intake airways; then the middle entry can be used for a haulage road and should be confined to itself and not enter into the ventilation at all. No. 1 room on the butt entry can be driven 16 ft. wide and used as a return airway. When the No. 1 room is maintained for an airway, it should be widened toward the face or main entry and be driven on 70-ft. centers with the face entry. A 30-ft. pillar of solid coal should be left between No. 1 and No. 2 rooms; No. 1 rib can then be easily extracted when robbing is commenced on this butt entry.

The gob in No. 1 room should be kept as low as possible and if easily handled, it should all be loaded and dumped outside; the result is a return airway, 16x6 ft. = 96 sq. ft., which is usually large enough.

Butt entries should be turned every 450 ft. A chute is driven on a 60-deg. angle, from the middle main entry to the outside main for haulage. The butts are turned on a 90-deg. angle, and are driven on 50-ft. centers for a distance of 1400 ft. A 60-deg. chute should connect the butt entries at 25 ft. from the center of the outside main, for haulage from the butt entry. It is bad practice cutting corners off break-throughs.



Each butt entry should maintain a sectional area of about 50 sq. ft. and be driven perfectly straight so as to overcome the troubles of track laying, cars jumping track, etc. Entry sights should never be more than 180 ft. apart, so as to allow the mine foreman a good chance to keep his sights well up. In providing ventilation, two pairs of butts on one split are suitable. The rooms should be turned 90 deg. off butts and driven as shown in plan.

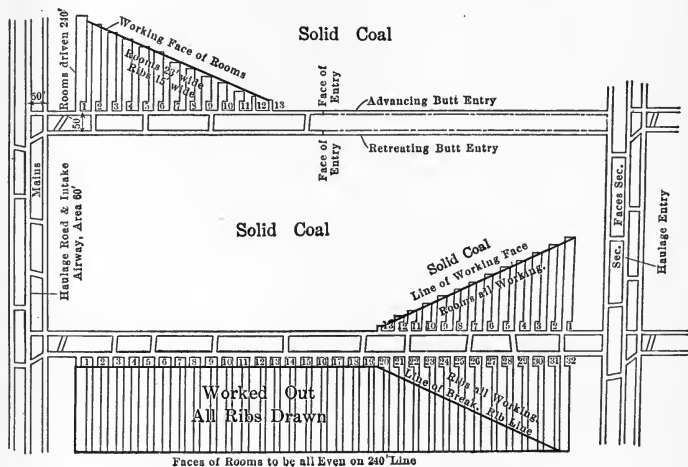

FIG. 135.—Plan of Nelms' Advancing-retreating system.

### GENERAL LAYOUT

No. 1 room should be started as soon as possible, then No. 2 and so on from the advancing butt entry. When No. 2 room is finished working on the face, No. 14 should just be started; when No. 2 rib is out, No. 14 room should be just finished and No. 27 room just starting. The ribs must be extracted as soon as each room is finished, no matter whether the next room on the advance side is finished or not; the rib is started while the next room is still 30 ft. from being finished. When No. 32 is finished working on the face, No. 19 rib is just finished, also No. 1 room on the retreating butt is about finished and No. 13 room just started. As soon as No. 2 rib on the retreating entry is finished, it is advisable to start extracting immediately the butt-entry stumps and chain pillar, bringing everything along with the retreating butt and closing entry in tight, knocking out the brattice in each succeeding break-through for ventilation.

This method allows the rib men and the machine loaders to be always separate, the workings are confined to the smallest space possible for a large tonnage, and ventilation is easy. The mine will not be dotted with old abandoned workings if the method is consistently maintained.

When a set of butts are thus worked out they are off the operator's hands. There is never any danger of a squeeze as every movement of the rock runs up against solid coal, and for this reason it is impossible to have a squeeze swing across a set of butts to another set, as it generally does where both entries are worked advancing. Five pairs of butts developed on this plan can produce from 1000 to 1500 cars of coal a day.

Small mule "partings" should be at the bottom of each pair of butt entries and the distance for mule haulage will then be at a minimum. The coal from these partings can be gathered by a 6- or 8-ton locomotive, and delivered to a longer parting whence a larger locomotive can take it outside.

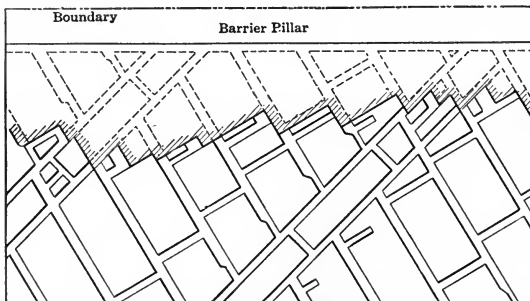

FIG. 136.—Plan for pillar-drawing, Connellsville.

EXAMPLE 57.—CONNELLSVILLE COKE DISTRICT, WESTERN PA.

(See also Example 58.)

*Retreating System on Thick, Flat Pittsburg Seam.*—The plan of mining in the Connellsville region has grown from the primitive methods, suitable to the favorable mining conditions when operations were first started, to the scientific methods which became necessary as the cover increased, and when most of the difficulties that are likely to be met in deep mining were encountered and overcome. The conditions here are that all the coal is coked so that fine coal is an advantage; no machines are used, but the coal is dug with pick; the seam averages 7 1/2 ft. of clean coal mined; the roof is friable and some coal is left in the top to support it; the overlying stratum is generally 6 to 10 ft. of slaty coal with sandstone above.

Where the acreage owned or assigned to each mine is too large to

admit of going to the extreme boundary before starting to draw the ribs, it is customary to divide the field into panels 1000 or 1500 ft. square, by face headings driven off the main butt headings as shown in Fig. 136. The coal is first removed from the extreme side of each panel away from the main butt headings, a diagonal break line is established, as shown, and the coal withdrawn, retreating toward the near corner, keeping the break line straight, and the coal between where the drawing is being carried on and the main butt headings as nearly solid as possible, the butt headings and rooms being drawn only fast enough to open up the coal for the drawings. The break line of roof is kept as nearly perpendicular as practical to direction of rooms. The recent tendency in the large mines is not to start pillar-drawing till the boundary is reached.

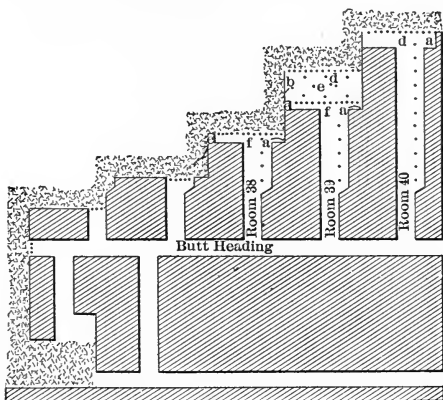

FIG. 137.—Pillar-drawing with thin cover, Connellsville.

The face of the coal in this region is well defined on a line running N 17° E. Where the grades are not too great all headings are driven square on the face or on the butt, and the rooms always on the face and only to the rise. The rooms are driven 10 or 12 ft. wide and a line of posts set as the room advances, as shown in Fig. 137, the posts being set about 4 or 5 ft. apart. A track of wooden or steel rails is laid by the miner close to the upper rib. The width of the pillar, which varies from 10 to 70 ft., is governed by the softness of the bottom and the thickness of the overlying strata.

There is some variation in the method of drawing the individual ribs but the principle is the same. On account of the nature of the roof, short falls are necessary, two or three being made before the overlying rock is broken. When the rock breaks it will crush posts so that it

is necessary to break the roof against the end of the ribs and not over posts. If care is taken the digger knows when to expect a fall and very few posts need be lost.

Fig. 137 shows the method in use when the overlying strata are under 200 ft. thick and where a curved track and track along the face are not put in. A slab *a* is taken off the right-hand rib, the whole of the left-hand rib is taken out excepting enough only left in to keep the gob from mixing with the coal as shown at *b*. A small shoulder *c* is left in the far corner of the rib to take the brunt of the weight. A row of posts *f* is set from this shoulder across the room to preserve a working face. The posts *e* in the back of this row and between it and the previous fall or break are drawn and any which cannot be drawn are cut so as to get a

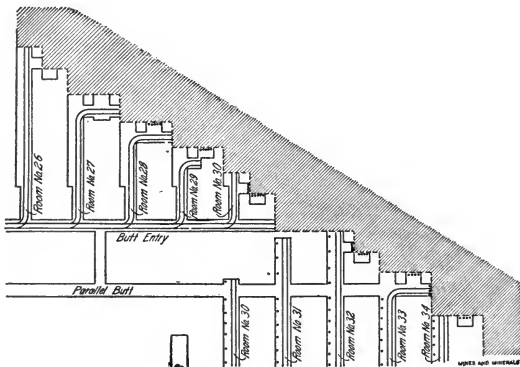

FIG. 138.—Pillar-drawing under thick cover, Connellsville.

good fall. Two men work in each room. Room 40 shows the situation in the last room of a tier of rooms along a butt heading. Slabs are being taken off each side pillar while the men are protected by the row of posts *d*.

Room 39 shows the condition of a room just before producing a fall by withdrawing the row of posts *d* and separate posts *e* between the rows *d* and *f*. The row of posts *f* and the stump of coal *c* protect the face during the fall. The stump *c* is next removed excepting for the small slab *b* and the work proceeds as shown at the face of room 40.

Fig. 138 shows a method of drawing pillars where there is over 200 ft. of surface above the coal and where a curve is used to run the track along the face. The rooms are driven 12 ft. wide while the pillars between the rooms vary from 34 ft. up to 60 ft. All of the pillars are driven on sights so that the pillars may be of uniform thickness. After the last room on the heading is driven the required length, which is about 300 ft., the pillar is cut across at the face of the room and 20 or 30 ft. removed

before drawing the posts and getting a fall of the roof. The usual method is then for two men to work on each pillar, while one man cuts back in the center of the pillar on the face of the coal as far as he can conveniently shovel as shown at *a*, room 27, the mine car being on track *b*, the other man is drawing stump *c* and shoveling into the same car.

When *c* is all removed a fall is made and the situation is similar to that shown in rooms 30 and 26, the curved track having been removed to one side and a straight one substituted. Now one man cuts into the side of the pillar 8 ft. from the end at *d* as shown while the other is removing the stump *e*. When this is accomplished a fall is made and the curve put in, the conditions being then as shown in room 29; the two men then continue to cut over toward the gob in the next room as shown in room 29, the curved track having meanwhile been put along the face. Room 28 shows the situation when the two men have driven this cut through to the gob in the adjoining room. Room 27 illustrates the next

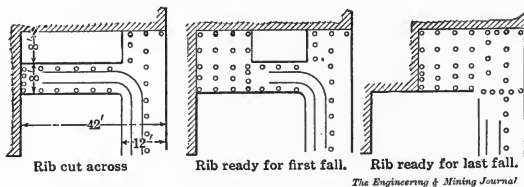

Fig. 139.—Second method—pillar-drawing under thick cover, Connellsville.

step. While one man works on the pillar *c* in the far corner of the room the other starts the cut *a* back into the face as shown. The curved track *b* is then lifted and a straight track put in as shown in room 26 in order to get out the pillar *e*. While one man is removing this pillar the other one starts to cut into the rib as shown at *d*, room 26.

When a fall is to be made posts are set 18 in. apart, as shown in room 26 across the end of the room and along the end of the hole into the pillar. All of the other posts beyond the break rows are drawn. The curved track is laid into the new cut in the side of the pillar at *d* and by the next morning the roof has fallen. In places where the rib is wider than shown on the plan a couple of falls can be made in the width of the pillars by placing break rows of props similar to those already described.

A third pillar-robbing method, for a heavy cover, is shown in Fig. 139. It cross-cuts the pillar for a track and uses the same curve as the previous method, but instead of cutting up the resulting pillar-slab into blocks, it begins at the gob and withdraws the slab gradually roomward, meanwhile recovering most of the props in the figure that were put in to protect the excavation of coal. A ratchet-chain puller for props is used where necessary. The use of this method at the Continental No. 1 mine

of the Frick Coal Company gives a recovery of about 90 per cent. of the coal. The losses arise from a 6-in. coal layer, impure with sulphur, left on the floor; a coal layer, of 4 in. in the rooms and 9 in. in the entries, left on the roof; and some occasional stumps lost in robbing the pillars.

The foremen of the district are guided by the following 10 rules in extracting pillars. (1) Pillar robbing must not be stopped or diverted from the line of fracture without the consent of the chief engineer. (2) Robbing must proceed from the new toward the older gob to prevent uncalculable pressure on the working face. (3) Ribs must be robbed within one month of driving rooms. (4) Room centers must be at the prescribed distance apart. (5) In robbing entry-pillars, a length of only 2 room-widths must be attacked at once along the line of fracture. (6) Water ditches must be made for entry-drainage and especial care must be taken on soft bottoms. (7) A 200-ft. pillar must be left on each side of the main or flat entry during its life. (8) A wide barrier pillar must be left and care must be taken in approaching a neighbor's boundary. (9) Before permitting a fall of the roof, all timber must be drawn and a passage left for the escape of the miners. (10) A miner should keep the pillar he is drawing between himself and the gob instead of working between gob and pillar.

EXAMPLE 58.—PITTSBURG BITUMINOUS DISTRICT, WESTERN PA.

(See also Example 57.)

*Advancing-retreating or Retreating System in Panels on Thick Flat Pittsburg Seam.*—In those mines of western Pennsylvania, extracting the thick Pittsburg coal seam for shipment to market, the mining layout is different from that of the coking district of Example 57. Since the policy of the market-coal mines is to obtain as much lump coal as possible, the bulk of the coal is obtained from the rooms, for pillar coal is bound to be more or less crushed. This policy requires wide rooms and narrow pillars and results in a lesser total recovery of coal, but as an offset, more coal can be won by machine cutters which work advantageously in this thick seam. By the deep and fast undercutting possible with machines, blasting, with its ensuing slack, is at a minimum; and progress is rapid enough to preserve the coal faces from long exposure to the atmosphere and to allow of systematic timbering and an even subsidence of the roof.

The Monongahela River Cons. Coal and Coke Company is a very large producer, and a composite drawing of its method of working is shown in Fig. 140. Above the upper "butts" or butt entries, the rooms have not advanced far from the "Face Entries." On the middle butts, the rooms have reached the end of the upper panel and pillar-drawing has advanced halfway. On the lower butts, the lower panel is being worked by retreating from the panel-end, the rooms are nearly completed,

and the line of roof-fracture, across both upper and lower panels, is following the pillar-drawing and is not far behind the finished rooms.

In the advancing system, the panels off the upper butt entry would be attacked first, and the rooms of this advancing panel would end in the old gob, while the rooms of the lower or retreating panel would end against the solid. As shown in the figure, the room-centers are 39 ft.

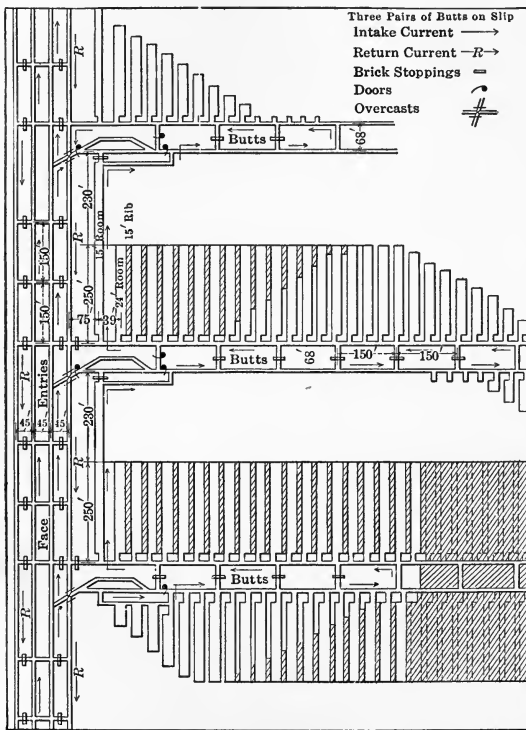

FIG. 140.—First layout (Monongahela collieries) at Pittsburg, Pa.

apart, of which space the pillars occupy 15 ft. It will be noticed that the room-stumps of each upper panel are left undisturbed on the advance so as to protect the return airway, but when the pillars of the lower panel are being drawn, the upper stumps are also pulled, as the receding line of roof-fracture passes them, along with the butt-entry pillars. The last pillars, however, must be left undisturbed in the advancing system along

their whole length until all the adjoining coal has been exhausted up to the boundary. The use of four main entries, by this method, allows the two outside gangways to be return-airways and the two intake-airways to be on the inside and thus gives an ample main-airway area and a minimum interference with transport. The room-work is in the fresh air and pillar-drawing is on the return-air side of it. The room-track is always laid along the straight rib, and in many mines the refuse between the track and the other rib fills the room nearly roof high.

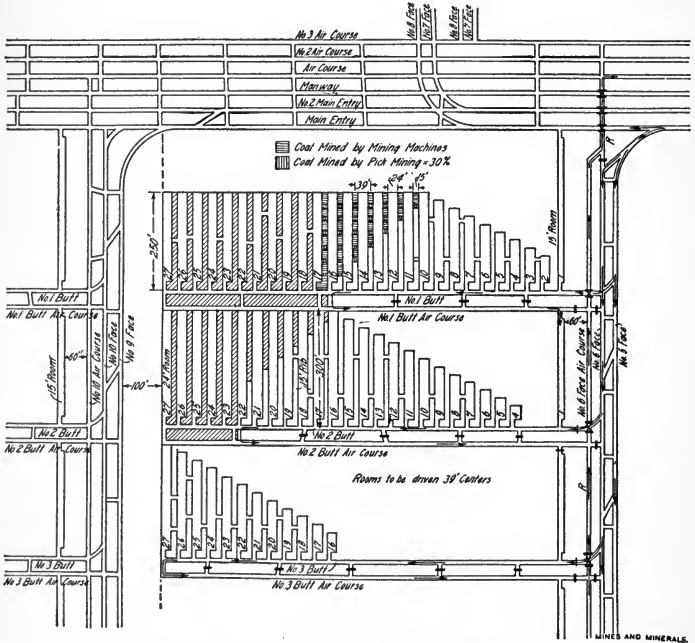

FIG. 141.—Second layout for large output, Pittsburg.

Fig. 141 shows a second layout for large output, used in the Pittsburg seam, with six main entries. There are three face entries, nominally, but four actually, as the nearest room on the butt is advanced along with them so as to give an additional airway. As shown, the rooms are only worked on the outbye side of the butts, and the first room is started from the far end of a panel and followed, at the proper distance on the retreat, by pillar-drawing. By starting work from No. 2 and the following butts at the proper time, it is possible to keep the line of roof-fracture



of a panel continuous, for entry-pillars and room-stumps are removed as shown from the panel-end back to the butts.

The method of Fig. 141 has permitted the extraction of 70 per cent. of the pillars by machine cutters under an average cover of 200-ft. thickness. For this purpose machine cross-cuts, 21 ft. wide, are made in the pillars so as to leave for each a stump only 9 ft. wide to be removed by hand-pick. This cross-cutting is shown by the different cross-hatching of the figure which also illustrates the overcasts and brattices for ventilation, and the chutes, etc., for transport.

A third method of attack by which one company mines over 2,500,000 tons yearly is shown in Fig. 142. Here the room pillars, after the room

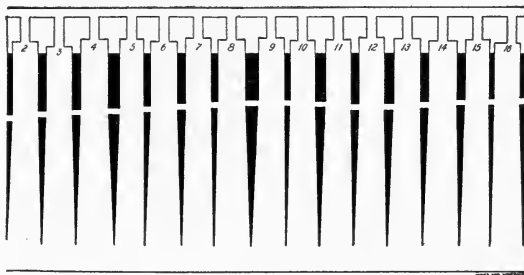

FIG. 142.—Third layout, with tapering pillars, Pittsburg.

has advanced 100 ft., or to the first break-through, are gradually tapered off to a point at the room-end. This causes the roof to fall along the tapered parts of the pillars and the latter are lost, but much of the thicker pillar near the room-neck can be recovered by subsequent careful pick-work. This method gets nearly all the coal by room-work, and a total recovery of 90 per cent. is claimed by its advocates. It is more dangerous, however, than the two previous systems, requires more timber, and squeezes are more liable to occur.

Where this high Pittsburg seam is dirty, so that much gob must be stowed along the rib on the advance, it is customary on drawing the pillars to leave a vertical shell of from 12 to 18 in. of coal next to the gob to prevent any pollution of the broken coal.

## CHAPTER XXI

### FLUSHING SYSTEM FOR FILLING SEAMS AND RECOVERING PILLARS

EXAMPLE 59.—ANTHRACITE DISTRICT, EASTERN PA.

(See also Examples 5, 51 and 59.)

*Parallel Seams of Various Thickness and Dip Filled with Refuse from Breakers and Dumps.*—The flushing system was first developed in 1885 at the Pardee No. 5 mine near Hazleton, Pa., and was later copied and extensively used in many German collieries. Three conditions made flushing a valuable innovation in the Pennsylvania anthracite region, namely, the numerous large dumps of waste available for filling, the parallel and superincumbent seams to be extracted, and the overlay of much workable coal by townsites. The gravity of the urban situation is evidenced by the report of April, 1911, made by the Scranton Commission.<sup>1</sup> This report states that a large part of Scranton is already undermined and that for the stability of the present dangerous area of 15 per cent. of the city and for the recovery of the coal pillars from the balance the flushing system is the only remedy.

The following description is based on the author's visits to mines of the following coal companies: Philadelphia and Reading; Delaware and Hudson; Delaware, Lackawanna and Western; Plymouth; and Lehigh Valley.

In mining the flat seams to the north of Wilkesbarre by the pillar system of Fig. 130 much of the waste broken with the coal can be left in the rooms; but in the seams of the southern districts where mining is done by "overhand stoping with shrinkage and chutes," as in Figs. 132 and 133, all the waste has to be hoisted. The crude coal reaching the surface is a mixture of pure coal, "slate," "slate-coal", and "bone." The "slate" corresponds to the shale and clay of the partings and beds of the bituminous regions, the "slate-coal" consists of lumps, part pure coal and part slate, and the "bone" is a coal containing too little carbon (present limit 60 per cent.) to be marketable. All crude coal is put through a dressing mill or "breaker" in which impure pieces are broken sufficiently to detach the slate and bone from the pure coal, so that all the latter may be screened for separation into commercial sizes and the former, along with the "culm" or coal dust, be sent to the waste dump or mine stopes.

<sup>1</sup>"Mine Caves under Scranton," by E. T. Conner. Trans. Min. Eng., Vol. 42, p. 246.

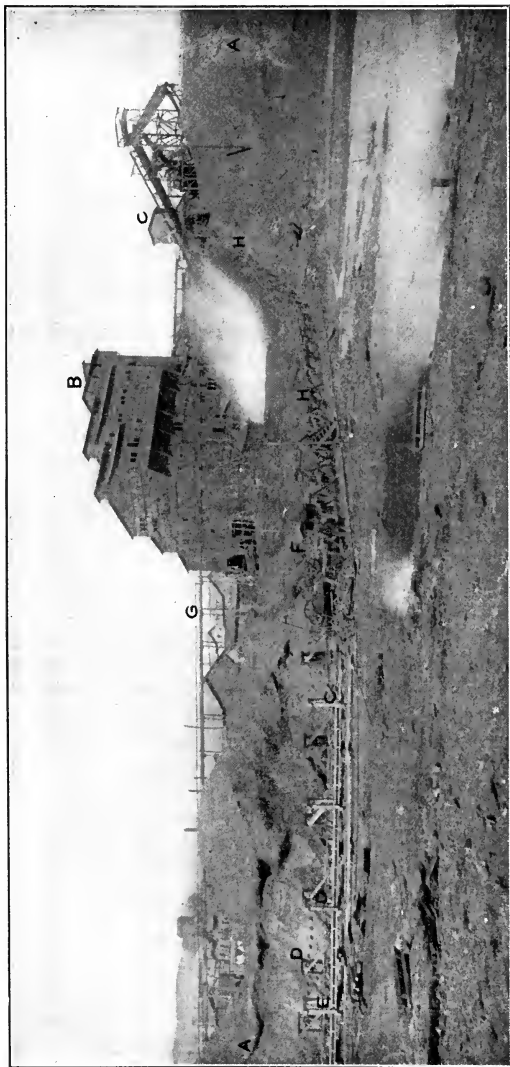

FIG. 143.—Breaker washery and culm-digging, Dodson colliery.

The limit of size between fine coal and unmarketable "culm" has so decreased in recent years that now all the fine sizes of the breakers, as well as many old waste dumps, are being washed over shaking screens in special mills called "washeries," for their content of fine coal of commercial value. The present upper limit for "culm" is a diameter varying from  $5/64$  to  $3/16$  in., but some independent operators use also some larger sizes for flushing. This rejected fine coal, as mixed with the slate and bone tailing from the breaker and the ashes from the boiler plant, forms "slush," the chief material now used in filling the mine stopes by the flushing system. At some mines, the larger pieces of bone are saved on a special dump as of possible future value. Fig. 143 shows the Dodson colliery at Plymouth, Pa., with the waste dump at *A*, the breaker at *B*, and the washery at *C*.

In digging an old waste dump for passage through a washery, in order to separate the marketable coal before flushing, a system of chain conveyors as at *D* and *H*, Fig. 143, is used. The usual conveyor has a single chain and drags its steel plate scrapers, 18 in. long, 12 in. high, and set 3 ft. apart, in a trapezoidal trough made by lapping the ends of 3-ft. lengths of steel or cast-iron plate. The maximum length of a single conveyor trough is about 500 ft. It is supported within square wooden frames, *E*, set 8 ft. apart, and built of 4x6-in. pieces. Near the top of the frames *E*, run two 25-lb. steel rails to support the scrapers on their return trip.

Each conveyor is run by an independent steam engine, as at *F*, connected by gearing to its head end, and its capacity of 100 to 200 tons of dry material per hour is fed in, anywhere along the trough, by hand shovels or by hydraulicing with hose. Obstacles between the dump and washery are passed by using several conveyors, set at an angle, of which only the conveyor at the feed end need be shifted as the dump dwindles. The driving engine is set on a timber frame so that it can be easily pushed into line, by screw jacks, when the conveyor is moved over by levers; both engine and conveyor are elevated on rollers before shifting. This is done by the regular attendants who consist of two men for feeding and one man at each driving engine.

So much fine marketable coal can now be saved from the present breaker-tailing and from the old "culm" dumps that the final rejected waste can fill only a fraction of the space left above the gob in the underground rooms. The huge dumps which formed such a prominent feature of the landscape, as late as the early nineties, are rapidly disappearing and filling is now being won even from river beds.

Thus the Plymouth Coal Co. has a plant to bring sand and fine mine waste, now settled at the bottom of the Susquehanna river, to its Dodson mine No. 12. A suction pump on a barge located across the river from the Dodson breaker delivers into a pipe which crosses the river on

barges and discharges into an elevator which lifts the material to the flushing flume for the mine.

As no pieces larger than 1-in. dia. and few over 1/4-in. dia. are used in flushing, the coarser pieces of bone and slate, from breaker or dump, are passed through a pulverizer usually of the Williams' or Jeffrey's type, before reaching the flume *G*, Fig. 143, where they mix with the fine waste from washery *C*. Enough water is put in the flume to transport the slush along the flat pipes above the stopes, so the liquid slush carries only about 20 per cent. of solids by weight. The descent of the slush is through wrought-iron pipes, 4 to 6 in. dia., following either a shaft or a special bore-hole into the workings, perhaps 1000 ft. beneath. Over the top of the descending pipe is placed a funnel and a screen with 1-in. holes, and at each flushing station are three gate valves, to regulate the flow into the stopes, connected by electric signals with the surface. One of these station valves regulates the flow horizontally, another cuts off the vertical column below, and by a third the column can be drained up to the nearest flowing point above, in case of a stoppage.

The pipes used for transport along the levels are 4 to 6 in. dia., and of either wrought-iron or wood. In upgrade levels or where the pipe is under much pressure, new iron pipes with screw or flange couplings must be used, but when these are somewhat worn they are transferred to the downgrade levels. In the latter, the iron pipe has standard couplings on tangents, but on curves it has 7-in. unthreaded nipples for couplings slipped over the pipe ends and made tight by wooden wedges. These wedged couplings enable the pipe to be rotated, when its bottom gets thin, so that it can be worn to a mere shell all around before rejection.

The wooden pipe is made in Elmira, N. Y., of tenoned maple staves about 2 1/2 in. thick which are bound with spiral steel hoops and coated with tar. It comes in 2- to 8-ft. lengths, with male and female ends for slip-jointing with cement. It can be joined to cast-iron fillings by inserting special cast-iron nipples in its ends, and its own joints can readily be made to follow easy curves. It is lighter and cheaper than iron pipe, is found to last well on downgrade levels, and is preferable for use with acid water. In one mine, the iron pipe is used on a 2-mile permanent transportation line and the wooden pipe in the neighborhood of the actual filling.

Plugged cast-iron tees are placed at 100-ft. intervals along all lines in the levels, so any obstruction can be easily located and removed. When a pipe is upgrade, a special precaution is taken against clogging by passing fresh water alone through it, for 15 min., before stopping the flow. Care must be taken to provide air escapes at high points of the lines in order to avoid water hammer.

The openings filled by flushing are old rooms opened on the pillar system of the last chapter. A room on a dip is easiest filled, as it requires

only one dam or barrier at its lower end. One disadvantage of increasing steepness is the greater strength of dam necessary to resist the correspondingly higher water head. In the Dorrance mine the old rooms had been opened on the rise from double flat entries as in Fig. 130. Every ten rooms along the entry were separated by panel-pillars following the dip. For filling, the flushing pipe was laid along the airway above the rooms and its discharge placed at the head of the central room of a panel of empty rooms. The latter had been prepared for filling by erecting dams across the necks at the room-bottoms and behind the break-through brattices of the ninth room's pillar, for the last room of the panel was to be left open as an air and manway. The brattices of the break-throughs of the intermediate rooms had been removed to permit of a free flow of filling along the panel.

Room dams are made of either stone or wood. The former are thick walls of roof slate laid up with mortar of slush and straw in a similar

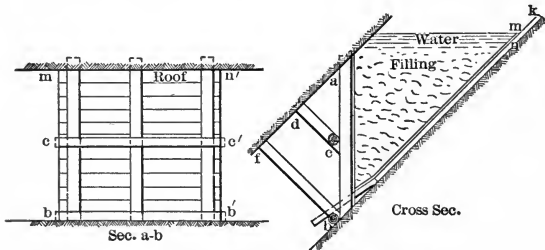

FIG. 144.—Dam for holding slush, Eastern Pa.

form to the wall of Fig. 145 described in the next Example. The favorite dams are of wood and a typical one is shown in Fig. 144. Round props *ab*, of sufficient size for the expected strain, are covered on their upper side with 2-in. plank and backed, as an extreme case, with stringers *bb'* and *cc'* with corresponding angle braces *bf* and *cd*. If the seam-walls are strong, the hitches alone will hold the props, so that the pieces *bb'* and *bf* can be omitted, and in thin seams even *cc'* and *cd* are left out.

When wetted, the seams between the planks soon close up sufficiently, but the irregular spaces around the periphery *mn'b'b* are caulked with straw in one mine, and in another, with a weak floor, the props are set in a low concrete wall, 12 in. wide. In one seam of the Dorrance mine on an 18-deg. slope with rooms 300 ft. long, the wooden dam of Fig. 144 is strengthened by a dry wall of roof slate, 3 to 5 ft. thick, laid above the plank *ab*. By slow flushing at first, this dry wall gets packed solid and keeps the plank from bulging under the heavy final pressure due to a vertical water head of 90 ft.

A room in the Dodson mine in the 22-ft. Red Ash seam was worked in two slices, the first taking only 8 ft. of coal from the floor. When preparing for flushing, the upper 14-ft. slice of coal was not taken down over the neck for 24 ft. from the room's lower end, so that the subsequent wooden dam needed to be only 8 ft. high. Holes are bored into the plank of the dams near the top, if necessary, to let the overflow water escape, but a better arrangement for steep dips is a wooden drain-laundry *bk* laid on the floor up through the dam into the room. The top *m* of the cover of laundry *bk* is kept a short distance above the top of the settled slush at *n* by adding new cover-boards as the filling rises. The overflow water then runs over into the laundry at *m* and descends into the gangway ditch at *g* to flow to the sump; whence it is pumped to the surface, where, being acid, it is not reused unless fresh water is scarce. At the Dorrance mine where the rooms were being filled on the advance by extending the flushing pipe from one panel of ten rooms to the next, it was the practice to give each panel another dose of slush, while withdrawing the pipe, in order to close up the many spaces between the settled slush and the roof that had developed since the advance. For nearly flat seams, dams are built in the openings all around a panel of rooms, and the end of the flushing pipe shifted around inside the panel, close to the roof, so as to fill all portions equally. More or less methane is given off if the slush is exposed to air currents, but these are feeble, the smaller the spaces left between slush and roof. As another safeguard against gas, the filled panels are connected with the return airways of the active mine.

In the considerable areas where a subsidence of the surface is immaterial, the anthracite seams are best worked to the boundary, by that pillar system of the last chapter most appropriate to the given conditions; and the pillars then recovered on the retreat, allowing the roof to fall. Under the river flats where roof-falls might cause a crack up to the surface and flood the workings, one company's mines are laid out with permanent pillars of a size just sufficient to sustain the roof indefinitely, which means 16-ft. pillars and 24-ft. rooms for depths of less than 400 ft.

Flushing as a preliminary to pillar-drawing is beneficial in the anthracite region under two conditions. First, where the workings are overlaid by virgin parallel seams, and second, where they are overlaid by townsites. Former market conditions made the thin seams unpayable, so that the proper method of exhausting overlying coal seams from the top downward was not applied. Now the pillars can only be recovered from the lower seams, without wrecking those above, by a preliminary filling of the adjoining rooms. Formerly, it was not thought that the pillars left under townsites would ever be worth recovering, but higher coal prices have made them valuable and filling must precede their recovery.

The aforementioned Scranton commission recommends that as slush

alone has insufficient crushing resistance for thick covers, sand should be used for filling under Scranton at depths beyond 500 ft. Also that filling should begin in the lowest seam of the series and continue upward until all are filled, care being taken to have the flushed areas over one another. After all the openings in all the seams have been filled, the pillars in the top seam may be removed and replaced at once by filling. The next seam below may not be attacked and handled in like manner until the pillars above, within a large panel, are removed and the overburden has come to rest on the new filling. In this manner several parallel seams could be robbed of pillars simultaneously, by panels retreating in vertical echelon, the robbing in the highest seam being farthest from, and that in the lowest seam nearest to the boundary.

In some mines with irregular layouts and small pillars, the formation had moved considerable before flushing was inaugurated. Thus in the 22-ft. Red Ash vein of the Dodson mine at Plymouth, the overlying formation moved so freely that gangways could only be kept open by using heavy timbers and brushing the floor. While in the Black Diamond mine at Luzerne, the walls of the 6-ft. Cooper seam were distorted with frequent roof-falls, and in the 8-ft. Bennett seam the roof had bent enough to badly squeeze many of the pillars.

The seams of the latter mine, which were excavated on the system of Fig. 130, dip about 10 deg. and the pillars of the flushed portion are now being robbed and replaced by slush. Where pillars are 20 ft. wide, or more, an 8-ft. heading is driven on one side of the pillar on the rise, often leaving a thin shell of coal next to the filling. Then, when the airway above is reached, the balance of the pillar is drawn on the retreat. The advance heading must be well propped, but the timber is mostly recovered on the retreat and, owing to the moving formation, the pillar coal is so squeezed that but little blasting is necessary. Too much roof pressure sometimes so crushes the coal that it falls to powder when extracted.

The Dorrance mine is under a suburb of Wilkesbarre and the policy of the owner, the Lehigh Coal Company, is to refrain from taking all the pillar coal, when robbing flushed areas under cities, because an unsupported cover will settle down at least 10 per cent. of the coal's thickness; and with flat seams, where filling close to the roof is impractical, the subsidence may be 20 per cent. In fact, the surface in some cases has subsided less from robbing pillars in open than in filled seams; for in the former case local breaks of roof may fill up the rooms with boulders and support the cover, while robbing pillars *completely* in the latter case starts the whole cover to subsiding as in the longwall system.

The flushed workings observed in the Dorrance mine were on a dip of 18 deg. and on a layout like Fig. 130 with rooms 20 ft. and pillars 40 ft. wide. A heading was first driven up in the pillar, to slab off 18 ft. of coal alongside the filling, and on the retreat from the room's upper end



a 24-ft. cross-cut was put through the pillar, halfway between the original 12-ft. break-throughs, 100 ft. apart. Thus after flushing the new pillar openings, the roof was left supported by a line of coal pillars 22 feet wide by 32 ft. along the dip.

Under Mahonoy City, the 22-ft. Mammoth seam, dipping 55 to 60 deg., is being worked in two slices by a system like that of Fig. 131. The lower slice of 15 ft. is taken out in the room on the advance and the upper 7-ft. slice allowed to fall into the chute, by pulling the props, on the retreat. After flushing, the pillar is taken out, likewise, in two slices, by driving a heading through its center, leaving only a thin shell of coal on each side to keep out the room-filling. The entry pillars are drawn on the retreat, and all the new openings are flushed. In spite of this extraction of practically all the pillars, the surface here is stable, for with seams of steep dip, the subsidence upon the filling is not so serious as it is in the case of the flatter seams under Wilkesbarre.

As already mentioned, the 22-ft. seam in the Dodson mine is also worked in two slices but with the thin slice below. The pillars here are 26 ft. and the room is 24 ft. wide. The lower slice of both room and pillar is mined on the advance and the upper slice is recovered on the retreat as described in the last paragraph, except that the layout follows Fig. 130 to suit the 12-deg. dip.

EXAMPLE 60.—ROBINSON GOLD MINE, RAND DISTRICT. TRANSVAAL

*Parallel Sloping Beds Filled with Mill Tailing*

In spite of the extensive areas excavated since 1885 in the conglomerate of the Rand, but little filling has yet been done. At a few rich outcrop mines, it is true, the rooms were packed with rock to enable the pillars to be recovered. But packing is too costly a method for most of the area. As the mines reach depths exceeding 4000 ft., the former sized pillars are proving too small, and several unexpected collapses have occurred. Recently the flushing system has been tried with success at the Robinson mine, to permit of the removal of some rich pillars just under the stamp mill, in the following manner.

The tailing is washed from the dump by a 1-in. water pipe into a launder, 6 in. sq., which runs to the top of a winze. Here the pulp enters a similar launder which descends along the 40- to 50-deg. dip of the seam floor to the ninth level of the mine. The stope to be filled has been dammed at the lower end by a dry wall *W*, see Fig. 145, strengthened by poles *P*, and similar partition walls are built at right angles to cut it up into longitudinal panels. The fine waste *B* is piled above *W*, and covered with old matting *M* from the cyanide tanks. When flushing begins, the sand settles quickly, the water filters through the matting and dams, whence it runs to the sump to be pumped to the surface.

This water is used again after a little lime has been added to neutralize its acidity and render any entrained colloids harmless to hinder a quick settling. To save water, the launders are kept on a minimum gradient of 10 deg. The water used is 6 to 10 per cent. of the tailing by weight. The cost of filling is given at 2.1 d per ton, but as only 100 tons of tailing are sent underground daily, this probably does not include wear of the launders. The filling sets hard in 2 or 3 days. When a stope is completely filled, it only settles 10 per cent. of its height when crushed by the formation after the pillars have been removed.

The residual cyanide of the tailing leaving the mill has been destroyed by exposure on the old dumps, so that no poisonous results have so far ensued from using tailing as mine filling. In order to utilize fresh tailing, the cyanide must first be rendered innocuous. This is not

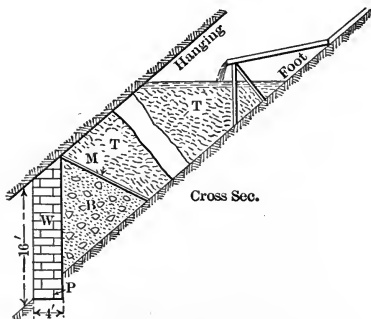

FIG. 145.—Dam for holding slush, Transvaal.

urgent at present, because the old tailing dumps are immense. Flushing the leading vats direct into the mine, however, would save the expense of conveying the tailing to the top of the very high dumps and of redigging it before flushing. Hence some mines are now getting ready for direct flushing.

The flushing system is now being freely used in the Rand to fill stopes *not* under buildings, in order to prevent the damage to the workings and the shaft pillars which is liable to ensue from pillar-drawing, especially as the mines get deeper. The rock tailing available for filling is much more resistant to crushing than the anthracite refuse of Example 59, and is strong enough for a filling at any workable depth. On the central Rand, there are two contiguous parallel beds, the Main Reef below, and the Main Reef Reader above, separated by a thin rock parting. As the Main Reef is the leaner, it has hitherto been neglected in many mines, but it is expected that the flushing system will now greatly facilitate its extraction under the worked-out stopes of the Main Reef Leader.

# INDEX

## A

- Adits, 58-59
- Advancing system, 63, 72, 76, 79, 84, 89, 94
  - retreating system, 64, 100, 106
- Africa, 41, 63, 117
- Air, compressed, 29-32
  - drill. See Drill.
  - fresh. See Ventilation.
- Altofts Colliery, Eng., 67
- Amvis, 16
- Anthracite district, Pa., 43, 55, 60, 110
- Appalachian beds, 63

## B

- Bacon, Roger, 7
- Barriers. See Dams.
- Black Diamond Mine, Pa., 116
- Blasting, calculations, 18
  - massive rock, 20
  - seams, 26, 87
  - stratified rock, 21-24
- Bobbinite, 8
- Boyles law, 5
- Brattices, 97-101
- Breaker, coal, 110
- Breast-stopping, 26, 77
- Brushing. See Roof.
- Buggies Mine, 81, 96
- Bulls Head Colliery, Pa., 79
- Bureau County, Ill., 117
- Butte, Mont., 26, 31, 39

## C

- Calumet and Hecla Mine, Mich., 54
- Caps, blasting, 2, 15
- Carbonite, 16
- Cars, coal, 74, 85, 93, 98
- Cartridge, 3
- Charles' law, 5
- Chocks. See Cribs.
- Chutes, loading, 78, 96
- Cleaning. See Coal and Sorting.
- Cleavage, 25, 65, 84, 103
- Clod, 35
- Coal breaker, 110
  - commission, 69, 110
  - cutting, hand, 69, 74, 82, 86, 100
  - machine, 26, 66, 87, 92, 100, 106, 109
  - mining, 26, 35, 41, 43, 62-76, 79-117
- Cogs. See Cribs.
- Colliery. See Coal.
- Comparison systems, 119-127
- Connellsville district, Pa., 102
- Continental Mine, Pa., 105
- Continuous-face. See Longwall.
- Conveyers, 84, 112
- Creep, 40, 75, 101
- Cribs, 75, 82, 88, 90
- Cripple Creek, Colo., 28, 59
- Culm, 110, 112.

## D

- Dams, artificial, 55, 61
  - deposition, 58
  - natural, 56, 114, 115, 117
- Danville Mines, Pa., 76
- Delaware & Hudson Coal Co., Pa., 110
- D. L. & W. Coal Co., Pa., 110
- Development, mine, 20
- Dip-working of seams, 70
- Dodson Colliery, Pa., 112, 115, 117
- Dowance Colliery, Pa., 114, 115, 116
- Drainage, calculating, 47
  - massive rock, 53

- Drainage, stratified rock, 52, 64, 76, 90. See also Adits, Pumps and Water.
- Drill, air-hammer, 21, 24
  - pointing, 20-27
  - prospecting, 64, 113
- Drummond Colliery, N. S., 89
- Drywalling, 70, 75, 77, 80, 82, 114, 117
- Dust, 26, 64
- Dynamites, 13. See also Blasting.

## E

- Electric blasting, 19, 28
  - exploders, 2
  - power, 86. See also Haulage.
- England, 41, 67, 69, 84
- European Mines, 63, 89, 110
- Explosions, mine, 64, 108
- Explosives, calculating, 4
  - chemical, 8
  - detonating, 2
  - igniting, 1
  - loading, 3
  - mechanical, 7
  - chemical, 12. See also Blasting, Electric, Powder.

## F

- Fayal rules, 34, 41
- Filling seams, 75, 78, 82, 88, 100, 109, 117
- Flowage rock, 46
- Flushing pipe, 113
  - slush, 112, 117, 118
  - system, 110, 117. See also Filling and Roof.
- Forcite, 14
- Fracture. See Roof.
- Frick Coke Co., Pa., 106
- Fulminates, 11, 14
- Fuse, 2. See also Blasting.

## G

- Gas, 64, 76, 91, 115
- Gelignite, 14
- Geneva, N. Y., 49
- Gobbing. See Filling.
- Grundy County, Ill., 72
- Gulf of Mexico, 49
- Guncotton, 12

## H

- Haulage, air, 32
  - animal, 64, 74, 80, 93, 102
  - electric, 98, 102
  - endless rope, 81
  - tail rope, 93
- Hausse formulæ, 42
- Hazen formulæ, 51
- Hazleton, Pa., 110
- Headings, driving, 20-24
- Hoisting coal, 87, 93
- Horn Silver Mine, Utah, 58
- Hudson River tunnels, 35

## I

- Illinois, 72
- Inclines. See Jigs and Slopes.
- Intercoolers, 30, 32
- Iowa, 49
- Iron Mountain Mine, Mont., 55

## J

- Jeddo-Basin adit, Pa., 60
- Jeffrey Mfg. Co., Ohio, 87, 112

Jigs, haulage, 93, 96, 97  
 Joplin District, Mo., 26  
 Joveite, 12

## K

Kirby, E. B., 58

## L

Labor, coal mine, 63, 76, 82, 87, 99, 100  
 Lake-basins, 50, 57  
 Lake Superior, 24  
 La Salle County, Ill., 72  
 Lauenders, 112, 117  
 Lausanne adit, Pa., 60  
 Lehigh Valley Coal Co., Pa., 43, 55, 110, 116  
 Leyner drill, 21  
 Locomotives. See Haulage.  
 Longwall system, 63, 66, 72, 76, 84, 89  
 Luzerne, Pa., 116  
 Lyddite, 12

## M

Mahanoy City, Pa., 117  
 Maps. See Surveys.  
 Merriman formulae, 58  
 Misfires, 16  
 Missouri, 26  
 Monongahela River Coal Co., Pa., 106  
 Montour Mines, Pa., 76  
 Multi-charging, 25

## N

Nelms, H. J., 96, 100  
 Newhouse adit, Colo., 60  
 Nitro-benzol, 15  
   -gelatine, 11  
   -glycerine, 9  
 Nytryl, 8  
 Nobel, Alfred, 9, 11, 13

## O

Oil well. See Wells.  
 Oneida adit, Pa., 60  
 Overhand stoping, 28

## P

Pack-walls. See Drywalling.  
 Panel-system, longwall, 62, 79, 84, 89  
   pillar, 96, 100, 103  
 Pardee Colliery, Pa., 110  
 Pendleton Colliery, Eng., 67  
 Percolation. See Water.  
 Philadelphia & Reading Coal Co., Pa., 110  
 Pierates, 12  
 Pillar and stall. See Stall.  
   -drawing, seams, 95, 98, 104, 105, 107, 109,  
     116  
   -placing, 43, 72  
   -system, seams, 62, 80, 89, 94, 96, 98, 101, 102,  
     106, 115  
 Piping, 32, 61, 113, 116  
 Pittsburgh seam, Pa., 102, 106  
 Plymouth Coal Co., Pa., 110, 112  
 Porter locomotives, 32  
 Portland Mine, Colo., 28  
 Potentite, 13  
 Powder, black, 7  
   permissible, 8, 16  
   smokless, 12  
 Preheater, 31  
 Prop-puller, 105  
 Providence, Pa., 79  
 Pumping, 31, 50, 61, 112

## R

Rackarock, 18  
 Railroad. See Haulage, Cars, Track and Tunnels.  
 Rainfall, 15  
 Receiver, air, 32  
 Rectang, longwall, 73

Resistance, line of least, 18  
 Retracting systems, seams, 63, 98, 102, 106  
 Richardson formula, 42  
 Rise-working, seams, 69  
 Roburite, 16  
 Roof-brushing 75, 76, 90  
   -control, flat, 33-37, 65, 77  
     inclined, 38, 84  
   -pressure, 65-71, 75, 82, 93  
   -subsidence, 40, 41, 46, 63, 65, 75, 103, 106,  
     107, 109, 116, 118  
 Room and pillar. See Pillar.  
 Roosevelt adit, Colo., 59  
 Run-off. See Water.

## S

Scotch longwall, 72  
 Scranton, Pa., 110  
 Seams, mining. See Advancing, Blasting, Coal,  
   Longwall Panel, Pillar, Retracting Roof,  
   Slicing.  
   overlaying, 43, 115, 118  
   recovery of, 64, 69, 94, 106, 108, 110  
 Shafts, 43, 64, 72  
 Shops, 72  
 Siphons, 60  
 Skips, 61  
 Slicing system, 117  
 Slopes, 80, 89  
 Slush. See Flushing.  
 Sprengel explosives, 15  
 Spring Valley Collieries, Ill., 72  
 Squeeze, 40, 64, 96, 98, 109  
 Squibs, 1  
 Stables, 95  
 Stall and pillar, 62, 97  
 Stepped-face. See Longwall.  
 Stopping, 24-27  
 Subsidence. See Roof.  
 Sunderland, Eng., 41  
 Support, ground. See Roof, Drywalling and  
   Timbering.  
 Surface support, 43, 115  
 Surveys, 99, 101

## T

Tamping, 3  
 Timbering, seams, 75, 78, 87, 103  
 Tonite, 3  
 Top-slicing. See Slicing.  
 Track, coal, 81, 93, 96, 103, 105  
 Transvaal, 41, 63, 117  
 Tunnels, blast, 27  
   railroad, 34, 35

## U

Unwatering. See Drainage.

## V

Ventilation, seams, 63, 64, 80, 86, 91, 95, 96, 98,  
 100, 101, 108  
 Vinton Colliery, Pa., 84

## W

Walls. See Drywalling.  
 Water, diversion, 58, 58A.  
   evaporation, 49  
   percolation, 50  
   run-off, 49  
   supply, 47. See also Drainage and Dams  
 Weigel, Martin, 7  
 Wells, 10, 51  
 Westfalit, 16  
 Westville, N. S., 89  
 Wilkes-Barre, Pa., 110, 116, 117  
 Williams pulverizer, 113  
 Winches, 81, 82

## Z

Zones, flowage and fracture, 46

**PRACTICAL SHAFT SINKING**

**BY**

**FRANCIS DONALDSON, M. E.**

COPYRIGHT, 1910, 1912, BY THE  
MCGRAW-HILL BOOK COMPANY, INC.

## PREFACE TO THE FIRST EDITION

THE subject matter of this book was published as a series of articles in *Mines and Minerals*, during 1909 and 1910. It is reproduced, with some alterations and additions, through the courtesy of Mr. Rufus J. Foster, manager, and Mr. Eugene B. Wilson, editor of *Mines and Minerals*. The writer also wishes to acknowledge his indebtedness to Mr. H. H. Stoek, who was editor of *Mines and Minerals* when most of the articles came out.

September, 1910.

---

## PREFACE TO SECOND EDITION

SINCE the text of the first edition of "Practical Shaft Sinking" was written, cement grout has been used in several American shafts to cut off flows of water encountered in sinking, and its further use for this purpose will undoubtedly become more common. The writer, therefore, believes that a description of the methods used in grouting off flows of water in two of the city aqueduct shafts (Catskill Aqueduct Project) will make an interesting appendix. Such a description is given in Appendix A. It will be noted that in one of these shafts a stratum of loose sand prevented the entire exclusion of the water by grouting alone, that a concrete lining provided with drain pipes was placed, and that the shaft was finally made entirely dry by grouting this lining.

Several of the city aqueduct shafts in Brooklyn and the lower east side of Manhattan Island were sunk through great depths of water-bearing sand by the pneumatic caisson process. A section of one of these caissons, accompanied

by a description of the methods used in sinking it and sealing it to the rock, is shown in Appendix B.

One change has been made in the shaft records on page 83 to accommodate a new American record. Several footnotes have also been added, and one or two typographical errors corrected.



## CONTENTS

CHAPTER	PAGE
PREFACE . . . . .	iii
I SOME DEEP SHAFTS — FEATURES OF CONTRACTS FOR SINKING — FORM OF CONTRACT . . . . .	1
II PLANT REQUIRED — BOILERS, HOISTING ENGINES, HEAD-FRAME AND BUCKET — AIR COMPRESSORS . . . . .	16
III SINKING THROUGH SURFACE — SOFT GROUND — WOODEN SHEET- ING — STEEL SHEETING — CAISSONS OF STEEL, WOOD, OR CONCRETE . . . . .	33
IV SINKING THROUGH SOFT GROUND — PNEUMATIC PROCESS — SHIELD METHOD . . . . .	59
V SINKING IN ROCK — ARRANGEMENT OF HOLES — TOOLS AND METHODS USED IN DRILLING — COSTS AND SPEED . . . . .	66
VI THE SINKING-DRUM PROCESS — MAMMOTH PUMP — THE FREEZ- ING PROCESS . . . . .	85
VII THE KIND-CHAUDRON BORING PROCESS — CEMENTATION OF WATER-BEARING FISSURES . . . . .	97
VIII LIFTING WATER — HORIZONTAL VS. VERTICAL PUMPS — HAND- LING PUMPS IN SHAFT — CORNISH PUMPS . . . . .	107
IX SHAFT LININGS . . . . .	118
X CONCRETE LININGS — COSTS PER LINEAR FOOT FOR RECTANGU- LAR ELLIPTICAL, AND QUADRILATERAL SHAFTS . . . . .	129
APPENDIX A. GROUTING SHAFTS 4 AND 24, N.Y. CITY AQUEDUCT	140
“ B. . . . .	144



# PRACTICAL SHAFT SINKING

## CHAPTER I

### SOME DEEP SHAFTS — FEATURES OF CONTRACTS FOR SINKING — FORM OF CONTRACT

THE origin of mining is lost in the mists of antiquity, but it is certain that, since the beginning of history, metals and minerals have been sought after. The Egyptians operated gold, silver, and copper mines in Ethiopia and on the Arabian border; the Phœnicians found gold and iron in the islands of the Mediterranean and lead and silver in Spain. The earliest mines were probably surface workings, but the first historical mention of openings driven in the earth refers not to a drift or tunnel but to a shaft. In the Book of Job it is written of man that "He breaketh open a shaft away from where men sojourn; they are forgotten of the foot; they hang afar from men; they swing to and fro." Pliny describes cutting hitches in a shaft: "Elsewhere pathless rocks are cut away and are hollowed out to furnish a rest for beams. He who cuts is suspended with ropes."

Shaft sinking and tunnel operations in ancient times were confined to solid earth and rock. The Roman engineers drove rock tunnels that would seem long to-day; they originated the method of disintegrating rock by fire and they sunk shafts along the line of their tunnels from which to drive additional headings. Forty shafts — one of them 400 ft. deep — were used for the excavation of their longest tunnel.

For many centuries after the Roman Era nothing comparable to the Roman work was attempted, since the cost in labor and human life of the fire-and-water method was

terrific. The invention of gunpowder was the next step, but gunpowder was apparently not used for blasting purposes until 1679, at Malpas, France. Mines in the Hartz Mountains and in Cornwall had been worked to great depths in the seventeenth century before the steam engine was developed, but its application to hoisting of course made possible undreamed of speed in sinking. The first practical use of steam was, incidentally, to pump water from the Cornish shafts.

The invention of dynamite, the first commercial high explosive, in 1866, and the compressed-air drill in 1855, put rock shaft sinking on its present basis. Although from time to time special methods such as the freezing and the boring processes have been developed for special conditions, for ordinary shafts hand sinking is cheapest and best. Excepting the steam hoist, inventions have been confined to means for shattering the rock; steam shovels are sometimes used in tunnels, but shaft spoil is to-day loaded by hand into buckets, as in the days of the Romans.

Before the last half of the nineteenth century, soft-ground sinking was confined to material penetrable by forepoling. Although considerable depths have been reached in this way, where the ground is bad the method is at best slow and precarious. The Germans originated the hydraulically forced sinking drum and the freezing process. The pneumatic process was first used by Brunel in the Thames Tunnel. Recently, concrete sinking drums or open caissons have been extensively used.

The sizes and shapes of shafts are governed by the nature of the material to be hoisted through them, by the character of the ground to be penetrated, and also largely by local usage. Since mine cars and skips are approximately rectangular in plan, a rectangle is the most economical shape for a hoist shaft, giving the maximum usable area with the minimum excavation; this advantage, however, does not apply to an air shaft. The rectangular shape is also adapted to timbering, the cheapest form of lining, and is on this

account standard in America. In Europe, on the other hand, all shafts are circular or elliptical and are lined with brick or concrete masonry. This type has the disadvantage of high first cost, but a masonry lining is proof against decay and fire and explosions. In wet strata also, a circular shaft may be lined with iron tubing and thus kept entirely dry.

In large mines two openings are always advisable to secure satisfactory ventilation; in coal mines where explosive gases form they are absolutely necessary, and in most states are required by law. The hoist shaft may be upcast or downcast; in either case an airway is usually provided in addition to the hoist compartments. All mines worthy of the name have balanced cages requiring two hoistways; the airway makes a three-compartment shaft the most common type. In rectangular shafts, where several compartments are needed, a long shaft one compartment wide is easier to sink and timber than a short shaft two compartments wide; for instance, if four  $7 \times 10$  ft. compartments are desired, a shaft  $10 \times 28$  ft. is preferable to one  $20 \times 14$  ft.

In America, in the bituminous coal fields, hoist shafts are usually  $13 \times 26$  ft. in the rock, are lined with  $8 \times 10$  in. timber and have two  $7 \times 11$  ft. hoistways and a  $9 \times 11$  ft. airway. In wet mines a 5-ft. pipeway is added. The air shafts are  $13 \times 18$  ft., with a  $10 \times 11$  ft. airway and a 6-ft. stairway compartment. In the anthracite fields the deeper hoist shafts sometimes have four hoistways operating from several coal seams, besides air and pipe ways, and have sections  $12 \times 42$  ft. to  $14 \times 56$  ft. in the rock. European coal shafts are customarily 20 to 23 ft. in finished diameter. Coal shafts are almost always vertical.

In ore mines different conditions prevail. Ore is less bulky than coal, is harder to mine, and can be loaded through chutes without objectionable breakage. Large shafts are therefore unnecessary and the sizes range from  $7 \times 9$  ft. in the iron mines formerly operated at Boyertown, Pa.,

to  $9 \times 24$  ft. in the Michigan iron country. Ore shafts are usually sunk on the vein, and so may be found at any inclination with the vertical, but where natural conditions do not compel an inclination, a perpendicular shaft is preferable.

The deepest shaft in America, No. 3 Tamarack at Tamarack, Mich., is 5253 ft. deep and is used in mining copper. No. 5 shaft at Tamarack is 5180 ft. deep, Red Jacket shaft at Calumet, Mich., is 4900 ft. deep. These shafts are remarkable not only because they penetrate the earth for almost a mile, but also because of the remarkably powerful hoisting engines used — engines which hoist a total load of 17 tons at the rate of 6000 ft. per minute. All of these shafts are vertical.

In the Pennsylvania anthracite fields, where acid mine water quickly eats up pumps and piping, a number of shafts have been sunk for the purpose of hoisting water. The tanks used for hoisting fill and empty themselves automatically, discharging the water into a basin at the top of the shaft. Powerful hoist engines are provided. The most notable shaft of this type is owned by the D. L. & W. R. R., at Scranton, Pa. It is entirely automatic, requiring no engineer, and is operated through friction clutches by an 800-horse-power induction motor.

The driving of rock shafts and tunnels is very unlike the mining of coal; a different class of workmen, different foremen, and different tools are needed. It is seldom that a good coal-mine foreman is also a good sinker, and good sinkers, unattached, are not always easy to obtain. For these reasons it is customary for coal-mining companies to have a large part of their development work done by contract, and even the large anthracite corporations, who own the necessary surface equipment for sinking, prefer to have contractors do the sinking. In ore mines the foregoing does not apply; sinking shafts is part of the day's work and all the miners are rock men, but in opening a new mine the question of time is still to be considered. The loss of

interest on the investment in a large property before it is developed may amount to several hundred dollars a day, and every day lost in sinking adds that much to the cost of the shaft. Even when a mining company is so situated that it can sink its shaft cheaply, a responsible contractor possessing a plant and an organization can save enough time to more than pay his profit.

When it is decided to have a shaft sunk by contract, the first essential is to get trustworthy contractors to bid on the job; the second is to prepare a contract fair to both sides. While it is not well to leave loopholes whereby the contractor can escape from the plain provisions of the specifications, it is equally unwise to attempt to tie him down so tight in every detail that he is practically dared to find a flaw in the agreement. It is almost impossible to foresee every contingency, and an omission in a very tightly-drawn contract is harder to correct subsequently than an omission in a looser one.

A complete shaft contract form may be found in several text-books, or obtained elsewhere without difficulty; a form in common use is appended to this chapter. Among the specific points that warrant attention may be mentioned the following:

**Disposal of Spoil.** — The labor cost of a shaft is of course directly affected by the nature of the dump. It is also indirectly affected by it to an even greater extent. The delays to sinking caused by a long haul and an inconvenient dump, especially in bad weather, are likely to be more serious than the cost of the additional labor required. The specifications should, therefore, state where the spoil is to be dumped, or at least where it is not to be dumped. In one case where a contract contained the usual clause, "the spoil shall be placed where the engineer shall direct, the haul not to exceed 1500 ft.," no plans were available, and in the absence of any direct prohibition by the engineer, the contractor started to dump spoil in the vicinity of the shaft. After three months' sinking, the engineer discovered that

the dump was in his way and directed that the spoil be placed elsewhere. Subsequently he compelled the contractor, under the clause cited above, to move all the spoil dumped in the first three months. While in this case the engineer's order might have been successfully contested, much trouble could have been saved by proper care in drawing up the contract.

**Time Limit and Penalty.** — A time-limit clause is most properly a feature of nearly all sinking contracts, and the usual provision made to secure its enforcement is, "and in the event of the contractor failing to complete the work by this date, it is mutually agreed that he shall pay the contractee the sum of — dollars for every day thereafter until the work is completed, not as a penalty, but as liquidated damages." In spite of this definition, the courts have often held that the actual damages must be proven and the possibility of collecting the stated damages is not assured. Since the real damages to a mining company due to delay in getting started consist of the loss of interest on the investment, in every case where the company has its surface arrangements ready for work before its shafts are finished, it will gain as much per day by their completion ahead of time as it will lose by their non-completion. The writer therefore believes that where a penalty is to be collected for delay an equal premium should be paid for time saved, not only because this is fair but also because it is likely to expedite the work. An extension of time is usually, and should be, allowed the contractor on account of "unusual difficulties with water or quicksand."

**Acceptance.** — Where two shafts are sunk simultaneously under the same contract (as in opening a new coal mine), the first shaft down is usually accepted by the company upon completion. If this is not the intention it should be so stated in the contract.

**Risk of Water.** — It has been the practice in shaft contracts to throw the risk of encountering unusual quantities of water upon the contractor. With a fixed price per foot



for sinking, based upon usual conditions, the contractor will lose money if he strikes water exceeding, say, 150 gallons per minute. With greater quantities his loss is often measured only by his financial resources. This puts a responsible contractor at a disadvantage, especially in a new territory, for since he has the equipment and the money needed to fight large quantities of water, he must raise his price on all shafts to insure him against an occasional heavy loss. An irresponsible contractor, on the other hand, having little to lose, can afford to bid low, and if he does strike much water abandon the job. The water risk belongs properly not to the contractor nor the mine owners in general, but to the owners of the particular mine in question; for this reason a water clause is a feature of many recent contracts. The New York Board of Water Supply, in its contracts for the construction of the inverted siphons on the Catskill aqueduct, calls for a price for pumping each million gallons of water 1 ft. In these jobs the time schedules are so carefully worked out that there is little likelihood of the contractor pumping water for profit, but a form of water clause more acceptable to the average mining company is one in which the contractor makes an additional price per foot for every hundred gallons per minute pumped while sinking. He is thus paid nothing if the shaft is idle and is encouraged to make progress.

**Supplies and Machinery.**—Local conditions determine whether the mining company or the contractor should furnish the supplies or machinery. The larger anthracite companies, who hold extensive properties and open new mines upon them as the need arises, own sinking engines, boilers, and other equipment; at a new shaft they erect a surface plant complete, furnish timber and coal, and expect the contractor to supply only the air compressor and drills, small tools, and labor. In the bituminous fields and in many ore regions, the mining companies usually wish to develop new property as soon as it is acquired, and, in order to concentrate their efforts upon the permanent surface

plant, expect the shaft contractor to furnish everything he needs. A quicker start can be made in this way. If the shaft is to be timbered, however, the timber should be furnished by the company. Oak suitable for shaft linings is rapidly becoming unobtainable; yellow pine must be brought long distances and is not likely to arrive too soon if ordered when the shaft contract is let. Aside from the question of speed, the company by supplying timber will save itself the profit that the contractor adds to cost, and also occasional vexatious squabbles as to quality.

No matter how the shaft is sunk the permanent boiler plant should be made ready to operate as soon as is practicable. The possibility of striking water is the greatest hazard of sinking and, if water is encountered, the first requirement is plenty of steam. It is easier and quicker to procure and install any amount of pipe and any number of pumps than it is to build a boiler plant to run the pumps. Effective sinking pumps are so exceedingly wasteful of steam that the permanent mine boiler plant will be none too large and efficient to care for a large inflow of water; its early completion will insure against a long and costly delay.

The local flow of underground water is one of the most uncertain features of geology, and whether or not water will be encountered in a given shaft can seldom be predicted with certainty. Even when borings at the site of a shaft or other shafts sunk in the vicinity indicate that water will be struck, the amount is problematical. A few general remarks may be stated as follows:

Since the rainfall in mountains is high, the ground near them will have an opportunity to collect water. Geologic faults form passages whereby surface water finds its way into the ground, and the fissures caused by the strain to which the rock was subjected when the fault was made act as reservoirs. A shaft on or near a fault is sure to be wet below the ground-water level of the surrounding region. Natural water courses also form in soluble rock such as sandstone and limestone, especially the latter. An example

of a water course of this kind was afforded at the zinc mine at Friedensville, Pa., formerly drained by the "President," the largest Cornish pump ever built. This mine is located at the foot of a mountain.

Two shafts sunk in the Allegheny Mountains near South Fork, Pa., also encountered a water course. They were about 250 ft. apart and apparently were sunk directly on top of the water channel. What may be called the down-stream shaft was sunk first through the wet stratum; as the up-stream shaft was sunk the flow into it increased, while the flow into the down-stream shaft decreased at the same rate.

Shafts near streams are likely to strike water at the surface of the rock, but not necessarily below it if the rock is solid. In ordinary coal measures a feeder may be expected at the seam between an upper permeable rock like sandstone, and a lower bed of impervious shale or fireclay.

The uses of the diamond drill in prospecting for coal and ore are too well known to require comment, as far as the knowledge obtained of the rock is concerned. A hole near a proposed shaft will also give much information as to the ground-water conditions, even though, as has been said, the quantity cannot be determined. A diamond drill hole is not large enough to pump out, but the process may be reversed. If additional water can be pumped into a hole already full, the strata are evidently open enough to let water into a shaft. A bore hole, of course, may be pumped with a deep-well pump or air lift; it has in fact been suggested that wet ground be drained by pumping from a ring of bore holes around the shaft location, thus doing away entirely with pumps in the shaft.

Prospect holes should be located at one side of the shaft, so that if a pocket of water is drilled into at a considerable depth, it will not rise into the shaft through the hole. In this way pumps and piping need not be installed until the bottom of the shaft has almost reached the level of the pocket, and the depth of the wet sinking is reduced to a minimum.

CONTRACT AGREEMENT FOR SHAFT SINKING

This agreement made in duplicate this        day of  
 by and between the        Coal Co., a corporation chartered  
 and existing under the laws of the State of  
 party of the first part, and        the        Con-  
 tracting Co., a corporation chartered and existing under the  
 laws of the State of        , party of the second part,

WITNESSETH, That for and in consideration of the cove-  
 nants and payments hereinafter specified to be made and per-  
 formed by the party of the first part, the said party of the  
 second part doth hereby covenant and agree to build and  
 complete in the most substantial and workmanlike manner, a  
 hoisting shaft 13 × 26 ft., outside the timbers, and an air  
 shaft 13 × 18 ft., outside the timbers, each approximately 600  
 ft. deep, for the        Coal Co., at its property near

. The work is to be done in accordance with the  
 attached specifications and the plans furnished by the party  
 of the first part, which are hereby made a part of this agree-  
 ment; the party of the second part is to furnish all the labor  
 and materials necessary, except such as are particularly  
 noted in the specifications as being furnished by party of the  
 first part.

The said work is to be completed on or before the first  
 day of        , 19        .

And the party of the first part doth promise and agree  
 to pay the party of the second part the following prices for  
 the several kinds of work herein specified, of which the  
 following is a summary:

HOIST SHAFT

Excavation measured from top of natural ground to bottom of coal seam .....	\$	per vert. ft.
Framing and placing all timber and lagging .....	\$	per vert. ft.
Water rings complete .....	\$	each.

AIR SHAFT

Same as above.

The above prices contemplate a maximum of not more than 100 gallons of water per minute to be pumped from each shaft.

The following extra prices will be paid in each shaft for each 100 gallons per minute in excess of this amount, as follows:

Water Pumped; Gallons per Min.	Additional Price Paid per Foot
100 - 200.....	\$ 15
200 - 300.....	30
300 - 400.....	45
400 - 500.....	60
500 - 600.....	75
600 - 700.....	90
700 - 800.....	110
800 - 900.....	130
900 - 1000.....	150

If the volume of water should exceed 1,000 gallons per minute, a supplementary agreement will be made.

The payment for said work shall be made in the following manner:

An estimate will be made about the last day of every month of the amount of work done during the month, and 90 per cent. of the same will be paid on or before the 20th of the succeeding month, 10 per cent. of the total amount being retained until the entire completion of the work.

And when all the work embraced in this contract is completed, the party of the first part shall, upon notification from the party of the second part, make a final inspection; if the work is found to be in accordance with the specifications, there shall be a final estimate made of the value of said work, according to the terms of this agreement. The balance due the party of the second part shall be paid within thirty days thereafter, upon said contractor giving a release under seal to the party of the first part from all claims or demands whatsoever growing in any manner out of this agreement; and upon said contractor delivering to party of the first part full release in proper form and duly executed of all liens, claims, or demands from mechanics

and material men for work done on or about the shafts, or for materials furnished for the work under this contract.

It is further agreed between said parties that said party of the second part shall not transfer or sublet any part of this contract to any person (except for delivery of materials) without the consent of the party of the first part, and that the party of the second part will at all times give personal attention to the superintendence of the work.

It is further agreed that the work embraced in this contract shall be commenced within two (2) weeks of the date of this contract and prosecuted day and night (except Sundays) with as many men as can be worked to advantage. If, during the progress of the work, it is the opinion of the Engineer of the party of the first part that the party of the second part is not furnishing materials or appliances or labor of the right quality, or in sufficient quantity to complete the work within the time agreed on, the said Engineer may in either or both of the above-mentioned cases purchase such material and appliances or employ such labor as in his judgment may be necessary. And the said Engineer is authorized to pay such wages for labor and such prices for materials and appliances as may be found necessary or expedient, and to deduct the amount so paid from any moneys due the party of the second part from the party of the first part.

It is further agreed that the Engineer shall have the authority to order any additional work or materials not called for in the plans and specifications that he may deem necessary or advisable, but in case any such extra work or materials is required, the same shall be ordered by the Engineer in writing, and the price for said extra work or materials shall mutually be agreed upon in writing before said materials are furnished or said work is done.

IN WITNESS WHEREOF the parties herein have hereunto set their hands and seals, the day and date first above mentioned.

SPECIFICATIONS FOR SINKING AND LINING TWO SHAFTS  
FOR THE COAL COMPANY, AT

## GENERAL

**Meaning of Titles.**— The word Contractor, when hereinafter used, shall refer to the Contracting Company as in the attached Agreement. The word Engineer shall refer to the Chief Engineer of the Coal Company, or his representative.

**Labor and Materials Furnished.**— The Contractor shall furnish all machinery, tools, labor, materials, and supplies incidental to, or in any way connected with, the sinking and timbering of the two shafts hereinafter described, with the exception of the timber which will be furnished by the Coal Company free on board cars at .

**Location of Temporary Plant.**— The Contractor's hoisting apparatus and temporary machinery and buildings shall be so placed as not to interfere with the construction of the permanent head-frames, or the erection of the permanent plant.

## EXCAVATION

The dimensions of the hoist shaft shall be 13 × 26 ft. and of the air shaft 13 × 18 ft., outside of lagging. The excavation shall be carried down square and plumb from top to bottom and be large enough to give room for the proper wedging of the timber. Special care must be exercised in blasting to avoid shattering the walls of the shaft, and all loose material which might endanger the timbering or the men working below must be removed.

The Contractor shall keep his machinery and tools in good condition, and take every reasonable precaution to insure the safety of his men.

The Contractor shall deposit all material excavated from the shafts at places directed by the Engineer, to conform to the grades established adjacent to the shaft. Any overhaul exceeding 500 ft. shall be paid for at the rate of cents per cubic yard for each 100 ft. of overhaul.

The depth of the shafts shall be measured from the elevation of the original surface of the ground in the center of the shaft to the bottom of the coal seam.

#### TIMBERING

The shaft shall be timbered throughout with sound oak or yellow pine to be furnished by the Coal Company. It is to be framed accurately by the Contractor according to the Coal Company's plans and shall be placed in the shafts square, level, and to line.

Wall plates, end plates, buntons, and posts shall be  $8 \times 10$  in., and bearing or hitch timbers shall be  $8 \times 12$  in.; lagging shall be of 2-in. plank. The lagging shall rest on a  $2 \times 4$  in. oak piece placed horizontally in the middle of the back of each end and wall plate and well spiked; the space between the lagging and the rock shall be backed solid with sound slabs or other sound refuse timber.

Each corner of each ring of timbers and each wall plate at both ends of every buntion shall be thoroughly braced against the side of the shaft by blocks and wedges. The sets of timber shall be 5 ft. apart vertically, center to center. At intervals of 50 ft. vertically, bearing or hitch timbers shall be placed to serve as supports to the timbering above. The hitch or bearing in the rock at each end of each timber shall be strong enough to develop the full strength of the timber; in no case shall it be less than 8 in. in depth. The intervals of 50 ft. may in the judgment of the Engineer be varied, but no such variations shall be made by the Contractor without the consent of the Engineer.

The timbering shall be carried above the natural ground to the level indicated by the Engineer. Special timbering shall be placed at the shaft bottom in accordance with the plans furnished.

The air compartment shall be lined with 1-in. tongued and grooved yellow pine flooring, free from knots and well matched and joined on end and wall plates. The guides shall be  $6 \times 8$  in. yellow pine surfaced on all faces, and shall



be framed as shown on plan and placed exactly plumb, and straight and true to gage from top to bottom.

#### WATER RINGS

The water rings shall be constructed before the timbering is finally placed, and shall be as shown on the plans. The bottom of each ring shall have a water-tight floor of concrete. The number and location of the water rings shall be determined by the Engineer.

#### USE OF CONTRACTOR'S PLANT

The Coal Company shall have the privilege of renting the Contractor's hoisting and pumping plant after the completion of the shafts for a period of two (2) weeks. It shall pay the Contractor \$     per day as rental for said plant.

## CHAPTER II

### PLANT REQUIRED — BOILERS, HOISTING ENGINES, HEAD-FRAME AND BUCKETS — AIR COMPRESSORS

#### PLANT

IN considering the subject of shaft sinking from the mechanical side, the first and most important consideration is the proper design and arrangement of the surface plant. The underground plant comprises rock drills and pumps, and both above and below ground many tools and contrivances are required. The items included under surface plant will be treated first and the underground contrivances taken up later in connection with the work which they perform.

The elements of a modern surface plant are: Primary-power producer; hoisting apparatus; secondary-power producers; buildings, shops, etc.

**Primary-power Producer.** — Although in a few favored localities electric power may be cheaply bought and used directly, or converted into air power when needed, in nine tenths of the shafts sunk the primary power is steam. The boiler plant, in this case, is the backbone of the job; it must be put up to allow of expansion if necessary, and it must be absolutely reliable. In other forms of construction work, water, while always a source of trouble and expense, is not the implacable enemy that it is in sinking. The pumps which drain a cofferdam will also serve to empty it, and a breakdown delays the work only until repairs are made. In a wet shaft, on the other hand (particularly where the ordinary types of sinking pumps are used), an hour's lack of steam may submerge the pumps and allow the shaft to fill. It will then be necessary to get new pumps and piping and to fight the water down again from the top, and

weeks or months may elapse before sinking can be resumed.

For a wet shaft or for any shaft deeper than 250 or 300 ft., the bricked-in return-tubular boiler is the most satisfactory type. Such a boiler burns under normal firing 15 to 20 per cent. less coal than the ordinary portable boiler. The difference in the coal bill for 100 boiler horse-power, with coal at \$4.50 a ton, will, therefore, in three months, amount to \$300, which is about the cost of bricking in a 100 horse-power return-tubular boiler. The latter also costs less for repairs and is generally less trouble than the portable boiler.

For a short job the oil well, or locomotive type, boiler is the best. The size should be not smaller than 40 horse power; 60 horse-power is better, as in the small sizes the crown sheet has such a shallow covering of water that it is easily burned. The dome should be placed on the barrel of the boiler; if over the crown sheet, the long stay bolts connecting the crown sheet and the top of the dome are likely to give trouble. By utilizing the exhaust from a compressor or hoist engine, it is possible to force the locomotive boiler to make steam greatly in excess of its rated capacity, and this fact gives it a great advantage over other types.

At coal shafts the boilers should be set far enough away to make it impossible for a sudden flow of gas from the shaft to become ignited. They should always be placed so as to minimize the cost of handling coal and ashes. The ground at one end of the line of boilers should be clear of buildings or machinery, to allow of additional units being placed as required.

The piping should also be arranged to permit expansion, not only of the plant as a whole, but also the temperature expansion of the pipe itself. At the open end of the line of boilers the header should terminate in a valve, so that the additional boilers can be coupled on without shutting down the plant; if so many boilers have to be added that a second header is necessary, it should be connected with the first at both ends, forming a steam loop. Stiff connections between

the boilers and the header are objectionable and are likely to cause leaky joints.

A constant supply of feedwater must be assured. Duplicate feed-pumps or injectors, or a combination of the two, should be provided, and the pumps supplying water from a stream to the supply tank should also be in duplicate.

A good feedwater heater will cut the coal bill surprisingly; to be accurate, 1 per cent. for every 10 degrees the feedwater is raised. Assuming the feedwater at 50° F., originally, an open heater with plenty of exhaust steam will raise its temperature to 210° and reduce the fuel consumption 16 per cent. With coal at \$4.50 per ton, a heater will pay for

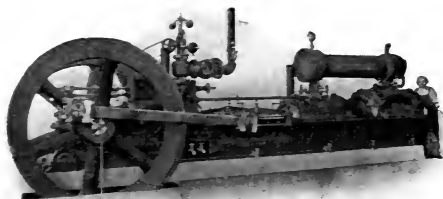

FIG. 1. — Ingersoll-Rand Two-stage Straight Line Air Compressor

itself in two months. An open heater as shown in Fig. 1 is more efficient than a closed heater and maintains its efficiency; it has no tubes to leak and become covered with scale; it saves the pure water formed by the condensed exhaust steam, and it is adapted to various systems of water purification. It must, however, be used in connection with a good separator for removing the oil from the exhaust.

A satisfactory feedwater system for a plant containing several boilers may be arranged as follows: Feed all boilers from a common header. Provide regulating valves, in addition to regular check- and boiler-stop valves in connections between header and boilers. Supply water to header with pump large enough to feed all boilers with piston speed of 50 ft. per minute. Use hard rubber, or

metal, pump valves. Use an open heater, placing it with base 6 ft. above the pump. As a reserve provide enough injectors to feed the boilers when the pump is shut down, connecting them into the feed-header. Provide valves between each injector and header, and between pump and

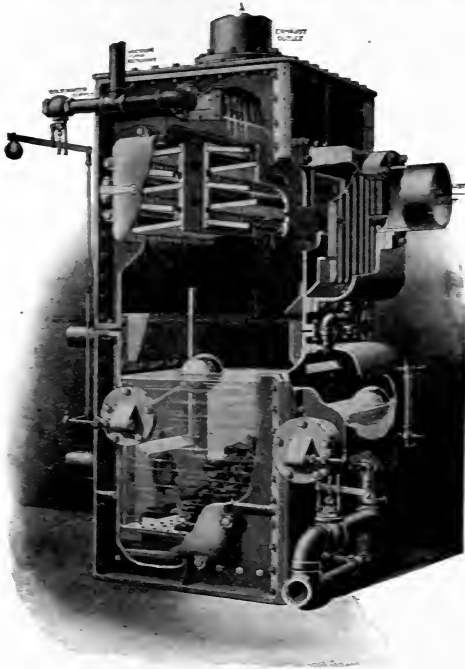

FIG. 2. — Cochrane Feedwater Heater

header. Take steam connections for injectors and pump from main steam line. Where freezing weather is possible, bury all outside water lines.

An ample power supply for a single dry shaft is 100 boiler horse-power. For a wet shaft the power required depends on the quantity of water to be pumped. Three

thousand boiler horse-power has been used for three very wet shafts, only two of them being worked at simultaneously.

**Hoisting Apparatus.** — For sinking a shaft through the surface soil, a small stiff-leg derrick is usually erected. This makes excavation and timbering cheaper than if done by hand, and it does not interfere with placing the surface concrete or add weight to the ground around the shaft. A derrick with a 40-ft. boom and a 30-ft. mast, built of  $12 \times 12$  in. timber, is large enough for sinking. It can be readily swung by two men at the end of a 10-ft. lever bolted to the mast. If any considerable depth is to be sunk, this lever should be secured by some kind of latch to prevent the derrick swinging while the bucket is in the shaft.

A double-drum friction engine is best for a derrick as it enables the engineer to raise and lower the boom, and also, with the help of a winchman, to swing the derrick;  $7 \times 10$  in. and  $8\frac{1}{2} \times 10$  in. are convenient engine sizes. A single-drum sinking engine may be used to advantage on a derrick with a fixed boom swung by hand. The fall line sheaves should be larger than are ordinarily used for a light derrick; never less than 18 in. outside diameter, preferably 24 in. A  $\frac{3}{4}$ -in. rope will work over a 24-in. sheave without undue wear.

Although a small shaft may be readily sunk with a derrick for 200 ft., it is better to put up a head-frame when the surface timbering or masonry is completed. Sinking head-frames are often built unnecessarily large and heavy. A head-frame 40 ft. high and  $8 \times 12$  ft. in plan is large enough for a sinking shaft. It may be built of timber, with  $8 \times 8$  in. posts,  $3 \times 8$  in. diagonal braces,  $8 \times 10$  in. caps, and  $10 \times 12$  in. sheave timbers, as shown in Fig. 3, or, if it is to be frequently moved, of steel. If built of steel,  $6 \times 6 \times \frac{1}{2}$ -in. angles will form posts strong enough to handle with safety a 5-ton pump. The sheave, as a rule, should not be smaller in diameter than the engine drum, but a 48-in. wheel will give good service with 1-in. rope.

Two methods are used for the disposal of the spoil hoisted by the head-frame. In the first a broad-gage

track is extended under the frame so that the rope passes between the rails; when a full bucket has been hoisted above the track, a truck carrying an empty bucket is pushed under it, the full bucket is set on the truck, and the empty one lifted. The truck is then pushed away and the bucket dumped by a gallows frame or other device. Three buckets are needed for this method so that one may be always in the bottom.

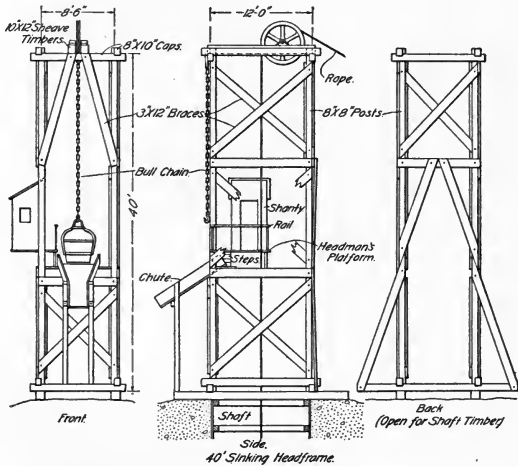

FIG. 3. — Sections of Sinking Head-frame

In the second and better method, tipping buckets must be used. At one side of the head-frame a chute is built, high and long enough to discharge spoil into a dump car, its upper end just clearing the bucket hanging free on the rope, Fig. 3. On the cap above the chute a "bull chain" is hung. The "head-man" stands on a platform level with the top of the chute and, when the bucket is hoisted within reach, hooks the bull chain into the bail. The bucket is lowered slightly, swings out over the chute, and is dumped. The complete operation may be performed in 30 seconds.

This method requires only two buckets. Three-quarter inch common chain will serve for the bull chain. Its hook should be provided with a handle. At a deep shaft, the bottom of the chute should be covered with pieces of old rail laid lengthwise, and in rock that breaks into large lumps a gate is advisable to protect the dump car. A small house is usually built for the head-man at the platform level.

To facilitate hooking the shaft rope to the bucket, 3 or 4 ft. of chain is inserted between the rope and the hook. The chain should be welded into a closed socket babbitted to the rope, and its links should be 6 in. long so as to afford a good hand grip. Safety catches are provided on the hook.

Shaft buckets are circular in plan and contain from  $\frac{1}{2}$  to 1 cubic yard, depending on the depth of the shaft and the size of the engine. A flared bucket, Fig. 6, discharges rock more freely than a cylindrical one; a convenient size is 3 ft. 6 in. top diameter and 2 ft. 10 in. bottom by 2 ft. 9 in. high. The bail is secured to the bucket trunnions by straps and bolts, so that it may be easily removed for repairs. A wooden inner bottom is sometimes used to cushion the blows from pieces of rock. Every bucket should have two latches, and two lugs to prevent its dumping in the wrong direction.

The dump car that will not be knocked to pieces by large rocks falling from the chute must be very strongly built. Its other qualifications depend on the nature of the dump. Ordinarily, where the dump is close to the shaft, and the car is pushed by hand, a 36-in. gage, all-around dump car, with wheels loose on the axle, is best. The simpler the construction the better.

A cheap and easily erected head-frame, for use when the regular plant is not available, consists of a tripod made of three poles bolted together at the top. This is set up over the excavation, a snatch block is attached at the top and another at the foot of one of the legs, and small buckets are hoisted by a team of mules, pulled to one side and dumped



on a platform by hand. The buckets are made out of a half oil barrel, fitted with extra hoops and a bail.

For depths of less than 500 ft., an  $8\frac{1}{4} \times 10$  in. double-cylinder end-friction hoisting engine with a 41-in. drum will do satisfactory work. The friction and brake levers are most convenient if set in a stand back of the drum, as is customary with larger engines. Both should have latches; on the brake lever a latch is imperative. An engine of this size will hoist a loaded bucket weighing 2500 lbs. 350 ft. in a minute; a round trip from this depth, including dumping the bucket, can be made in two and a half minutes.

At depths greater than 500 ft., the weight of the rope and the long hoist make a larger engine necessary. Reversible link-motion geared engines similar to that shown in Fig. 7 are generally used, the sizes varying from  $10 \times 12$  in. to  $14 \times 20$  in. First-motion engines are sometimes used for great depths. A  $10 \times 12$  in. geared engine running at a speed of 400 ft. per minute has a hoisting capacity of 4500 lbs., and will handle muck from a depth of 800 ft.

The drum should be grooved so that the rope will wind regularly and not cut itself. The size of rope used for sinking runs from  $\frac{3}{4}$  in. up, but sizes greater than 1 in. are unnecessary. A 1-in. crucible cast-steel rope has a breaking strength of 34 tons; it weighs 1.58 lbs. per foot, and therefore, when hoisting a 3000-lb. bucket, has a factor of safety of 11 at a depth of 2000 ft. This factor is ample, and there is no use in consuming power in hoisting additional weight.

Many lives depend on the brake of a sinking engine, and it should, therefore, be made large and strong beyond possibility of fracture. In the case of a band brake, the diameter of the part of the drum gripped by the band should be as great or greater than that of the drum itself, and the lever should tighten the band in the direction of the pull of the rope, the other end of the band being rigidly attached to the frame of the engine. A good brake, capable of stopping the drum every time within an inch of the mark, is not only a safeguard, but a great assistance to sinking,

especially in setting up the bar and machine or in handling timber.

Double-drum engines, necessarily friction operated, are built for sinking purposes, one drum being used for the bucket, the other for handling pumps, piping, etc. The second drum introduces another set of gears, causing additional friction and wear, even when running idle, and costs as much as a small independent engine, which is in every way preferable. A compound-gear, reversible link-motion engine, of the type used for swinging derricks, makes a good engine for handling pumps. The  $7 \times 8$  in. size will hoist 7000 lbs. on a single rope. The engine can be started and stopped just where desired, and there is no danger of a heavy load getting out of control.

Electric hoists are now built by several firms in sizes equivalent to their standard steam engines, and operate satisfactorily with various types of motors. Gas engines have found a very limited application to hoisting, but small gasoline hoists can be bought.

Signals are given the engineer by a "bell" in the engine house. It consists of a small whistle or a hammer striking a triangle, and is operated by a wire leading to a bell-crank on top of the shaft, thence to the bottom. A coil of wire is usually clamped to the horizontal arm of the bell-crank and paid out as the shaft deepens. The weight of the wire in the shaft is counterbalanced by weights hung on a third arm of the bell-crank or otherwise arranged. No. 6 galvanized-iron wire is good for a 500-ft. shaft; for greater depth  $\frac{1}{4}$ -in. strand is better. The bell-crank may be conveniently placed in the head-man's shanty.

Regular stopping places for the bucket, such as the "steady," are marked by the engineer by tying cotton cord around the rope. It is to enable him to see these marks more readily that the lever stand should be placed behind the engine.

After a shaft has reached a depth of about 200 ft., it becomes necessary to steady the bucket very carefully

before hoisting, to prevent its striking the timber. With a common rope the bucket also rotates rapidly on a long hoist. To avoid these effects, guides and a "billy," or "dummy," Fig 4, are installed. The billy is a light frame of wood or iron composed of two upright parts engaging the guides, and a cross-bar, through the middle of which the rope passes. It is carried by a buffer, clamped to the rope 4 or 5 ft. above the chain socket. The guides usually are terminated at the bottom of the last placed section of permanent lining, and buffer blocks stop the billy at this point, the rope running through the hole in the cross-piece as the bucket descends into the bottom. If the billy is made of wood, this hole should be lined with iron to prevent cutting. Old rubber pump valves make good buffers on the rope and on the stop-blocks.

Both wooden and wire-rope guides are used for the billy, but even where the permanent guide timbers

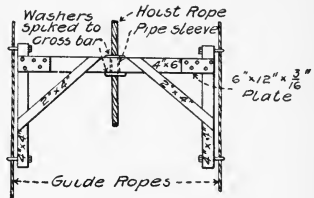

FIG. 4. — "Billy"

are available, rope is to be preferred. It can not only be placed more quickly and cheaply than timber, but it is safer. With timber there is a likelihood of the billy sticking, and then jarring loose and falling on the bucket; with wire rope this danger is avoided. At a shaft in Western Pennsylvania several years ago, the billy, after sticking on some ice on the wooden guides, fell and killed four men.

The use of a billy prevents any rotation of the bucket above the bottom of the guides, but below them the rotation seems intensified. To obviate this difficulty, non-rotating ropes have been devised. One form consists of a core and two layers of 7-wire strands wound right-handed and left-handed, respectively. The wires in the strands may be wound either common or lang-lay. These ropes fulfil their purpose (in fact are specified in some recent contracts), but

do not wear particularly well. It is impossible to use an ordinary lang-lay rope for sinking as it will entirely untwist.

**Secondary-power Producers.**—The most important of the secondary-power producers around the sinking plant is the air compressor. As yet, electricity has been unable to compete with steam or compressed air as a motive power for rock drills or sinking pumps; for underground work air has incidental advantages over electricity in that it assists ventilation and cannot ignite explosive gases.

The simple straight-line air compressor is the favorite for sinking. It is made by a number of firms; the Ingersoll-Rand Co.'s sizes range from 10-in. steam  $\times$  10 $\frac{1}{4}$ -in. air  $\times$  12-in. stroke to 24-in. steam  $\times$  24 $\frac{1}{4}$ -in. air  $\times$  30-in. stroke, with capacities of 177 and 1223 cu. ft. of free air per minute, respectively. It is more efficient mechanically than most small engines, and is wonderfully dependable with reasonable care. The 16  $\times$  16 $\frac{1}{4}$   $\times$  18-in. size is a convenient one for a pair of shafts; it has a capacity of 500 cu. ft. and will readily operate four drills and a small pump.

A straight-line compressor with a two-stage air end, Fig. 1, is made, which, according to the statements of the manufacturers, ought to be a good investment. With a steam consumption of 45 lbs. per indicated horse-power at half cut-off, the simple compressor has, for each indicated horse-power, a capacity of 5 cu. ft. of free air per minute compressed to 100 lbs. With the same steam consumption the two-stage compressor will deliver 15 per cent. more air. For 500 cu. ft. free air per minute, the saving of the two-stage over the simple type will therefore amount to 15 per cent.  $\times \frac{1}{5} \times 500$  cu. ft.  $\times 45 = 675$  lbs. steam or 150 lbs. coal per hour. With the compressor operating to capacity twenty hours per day, six days a week, the saving in three months, with coal at \$4.50 per ton, would thus be \$525. This is somewhat more than the difference in cost of the two machines.

On tunnels and similar work, where a number of shafts and headings are to be driven along a line, it is economical

to put up a central power plant at a point where coal can be most conveniently delivered and to pipe the air to the several openings. For installations of this kind, the cross-compound condensing steam, two-stage air compressor is best. A good-sized machine of this type, fitted with Corliss valves and a well-designed inter-cooler, has a steam consumption of 16 to 18 lbs. per indicated horse-power hour, and will compress 5.8 cu. ft. of air per minute per indicated horse-power. All the figures given for air-compressor power apply to 100 lbs. receiver pressure, the machines operating at sea level.

When the air is piped to a considerable distance, an after-cooler at the compressor will condense a large proportion of the water vapor carried, and thus prevent the formation of ice in the pipes and valve chests. Freezing is also prevented by the use of a reheater in the pipe where the air is to be used, which also increases the power obtainable from cold compressed air at a small expenditure of fuel. A good reheater will receive air at 60° and deliver it at 240°, thus raising the volume and the available power 25 per cent. with an insignificant coal consumption, if the air can be used before it cools.

Electric light is now essential for effective night work anywhere, and is particularly useful at a sinking shaft where the outside work must be carried on under all conditions of wind and weather, and the inside work sometimes under conditions (such as great quantities of falling water and explosive gases) that make the maintenance of an open flame impossible. Very little power is needed, as two arc lights and 30 incandescents will give abundant illumination in and around any single shaft. A 5-kilowatt generator is thus large enough to light a pair of shafts, but as it may be desirable to supply light to other work near the shafts, or to run one or two small motors, it is better to double this size. Small direct-connected units are made that are compact and easily handled but are expensive; and the care that machinery gets around construction work does not

warrant the use of a small and delicate high-speed engine. A cheap and satisfactory light plant is formed by an  $11\frac{1}{4}$  kilowatt generator, belt-connected to an  $8 \times 12$  in., horizontal, medium-speed, automatic engine. The voltage



FIG. 5. — Sinking Head-frame showing Dumping Arrangement

should not be higher than 220; even 110 will give quite a severe shock to a man who is soaking wet.

The outside wiring calls for no especial comment. In the shaft, however, very thorough insulation is required on account of the constant fall of water. In sinking, the bottom lights must be raised before every shot, and it is

most convenient to suspend them by their own wire from a reel. The reel may be kept on top of the shaft for 400 or 500 ft. of sinking, and then moved down to reduce the weight of hanging wire. A suitable reel may be cheaply built of wood by a carpenter. The two wires should wind on separate drums on the same shaft, so that they will hang entirely clear of each other. If a wooden shaft is used, the journals may be covered with copper strips, and made to serve as collecting rings.

Six 16 candle-power bulbs arranged as a cluster will light the shaft bottom. They should be set in waterproof sockets and protected against breakage by wire screens. An inverted dishpan hung above the cluster, with the wires passing through a hole in the middle, will shed falling water, and also act as a reflector. The wires must be heavily insulated where they pass through the pan.

Of the auxiliary mechanisms of a sinking plant, machine tools and small fans or blowers may be advantageously motor driven. If a large fan is necessary, it is simpler and safer to drive it direct by a separate engine. A very useful machine, that may be either engine or motor driven, is a swinging cut-off saw for cutting lagging to length. Such a machine will pay for itself on a single deep shaft.

**Buildings.** — After the machinery has been selected and set up, it is necessary to house it and the men that operate it. The cheap and obvious building materials for temporary work are 1-in. boards and tar paper. They are also highly inflammable, and on that account should be used with discretion when it comes to covering valuable machinery. It is surprising how completely the burning of a board shanty will wreck an engine inside it. Twenty-two gage corrugated iron can be bought and erected nearly as cheaply as boards and paper, and should at least be used for covering the compressors and engines. In cold weather it is hard to heat a corrugated iron building, hence boards are preferable for shifting shanties, etc.

The buildings needed around a sinking shaft are: Boiler

house; compressor and dynamo house; engine house; shift shanty; blacksmith and machine shop; powder house; oil house; powder thawing house; office and tool house.

The sizes and styles of these depend on the size of the job and the desires of the man who is running it. He may consolidate or omit some of them. In general, however, they all have different functions and should be separate.

If the boilers are under the same roof as the machinery, they should be divided from it by a tight partition to keep cinders and dirt out of the bearings. The shift shanty should be adjacent to the shaft, large enough for all the men

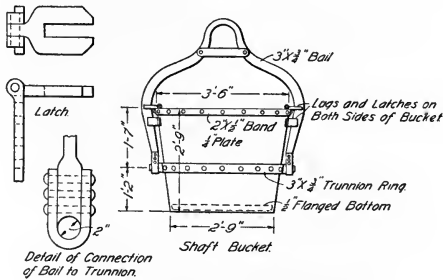

FIG. 6. — Details of Sinking Bucket

on the shift to change their clothes at once, and should have plenty of pegs for drying clothes, and a good stove or radiator.

The powder house and the oil house should be separated from each other and the former placed some distance from the job. They should be only large enough to contain the stocks of dynamite and oil actually needed, and should be built of iron to lessen the risk of fire and lighting. Caps and exploders should never be stored with dynamite. The powder thawing house is preferably a box or closet that will hold three or four boxes of dynamite, and is heated by steam coils. It should be so constructed that loose sticks of powder cannot come in contact with the hot pipes. Thawing boxes covered with manure are sometimes used, but are not safe, as manure is liable to spontaneous combustion.



The blacksmith and machine shop should contain a forge fitted with bellows or hand blower as well as a blast connection to the air line, benches with common and pipe vises, a grindstone, a small drill press, and, on a good-sized job, a pipe cutting and threading machine. The small tools should comprise blacksmith and drill-sharpening tools, pipe dies and cutters, bolt dies and taps, a ratchet drill, hacksaw, hammers, monkey and pipe wrenches, chain tongs, etc. A good assortment of miscellaneous pipe fittings and drill repairs should be kept on hand.

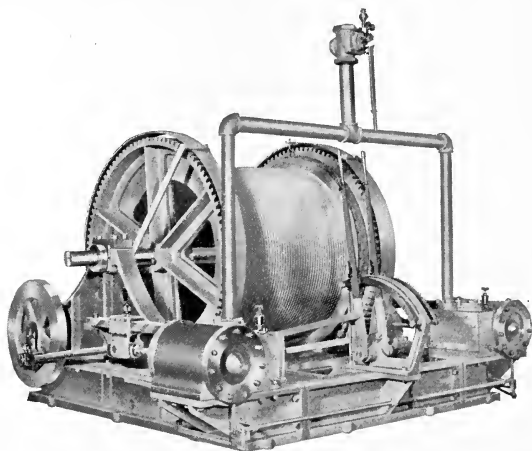

FIG. 7. — Double Spur Gear Reversible-link Motion Lidgerwood Hoist

The contents of the tool room also depend on the size of the job, but a good equipment saves money in the end. The following articles are either necessary or very useful: Good assortment of round and flat blacksmith iron, assorted nuts and washers, packing for engine and compressor glands and pumps, gasket, waste, oil cans, torches, crosscut saw, crowbars, striking hammers, picks and shovels, assorted nails, manila rope and blocks, cant hooks, lever jacks, etc.

The general layout of the job depends so largely on local

recommendations. The location of the boilers has already been discussed; if a railroad siding leads to the shaft, it is well to place the line of boilers parallel to it, so that coal can be unloaded directly into bunkers. The storage and subsequent handling of timber must also be considered. The temporary buildings should be so located that they will not be put into a hole by the encroachment of the dump; the position of the dump itself must be considered with relation to the drainage of the surrounding ground. The sinking engine, boilers, and machinery (as is usually specified) should not interfere with the erection of the permanent mining plant. Lastly, it may be again stated that too much attention cannot be given to the piping system all over the job as regards tightness, drainage, and insulation.

**Cost.** — The cost of a plant for a single shaft, assuming a depth of about 500 ft. and a moderate inflow of water, say 30 or 40 gallons a minute, is as follows:

Sinking engine .....	\$1,000
Two 80 horse-power boilers and setting .....	1,800
Pipe and auxiliaries .....	500
150 horse-power heater.....	300
14-inch compressor.....	1,750
Three drills and steel .....	1,000
Shaft bar and clamps .....	100
Derrick .....	400
Head-frame .....	500
Two buckets .....	150
Rope .....	150
Buildings .....	500
Dump cars and rail .....	300
Electric plant, 10 kilowatts .....	750
Two pumps .....	500
Small tools .....	500
<b>Total .....</b>	<b>\$10,200</b>

These figures are based on the cost of new machinery, and are large enough to include the necessary accessories. The cost of erecting and dismantling such a plant will be from \$1000 to \$2000, depending on location, labor conditions, etc.

## CHAPTER III

### SINKING THROUGH SURFACE — SOFT GROUND — WOODEN SHEETING — STEEL SHEETING — CAISSONS OF STEEL, WOOD, OR CONCRETE.

#### SINKING THROUGH SURFACE

IN most localities a certain amount of soil or soft ground overlies the ledge rock. Its depth varies from nothing to hundreds or even a thousand feet, and its nature is as varied as that of the rocks which it covers. The shaft sinker is interested chiefly in its consistency, which determines whether the penetration of the surface will be the easiest or the most arduous and expensive part of his job.

There is no hard and fast line of demarcation between firm ground and running ground; every degree of hardness or softness can be found from boulder clay to river silt, but ordinarily in sinking, ground is considered firm when the excavation can be carried ahead of the support, and soft when the support must be driven ahead of the excavation. In the first classification are included boulder clay, ordinary dry blue or yellow clay, cemented or clayey gravel and most loam soil; loose sand and gravel and silt come under the second.

The amount of water in the ground has a very great effect on its firmness, as is shown by the caving of excavations after a rain storm; conversely, soft wet ground may be made comparatively firm by removing the water. The commonest application of this principle is the use of compressed air for driving quicksand tunnels without the use of a shield. In this case the water is forced back away from the face into the surrounding ground, and timbering opera-

tions can be performed readily, which would be utterly impossible if the water were allowed to flow into the bore of the tunnel.

A trench in quicksand was recently driven at Gary, Ind., with very great success; here the water was drained in advance of the excavation through a number of small perforated pipes driven into the ground and connected at the

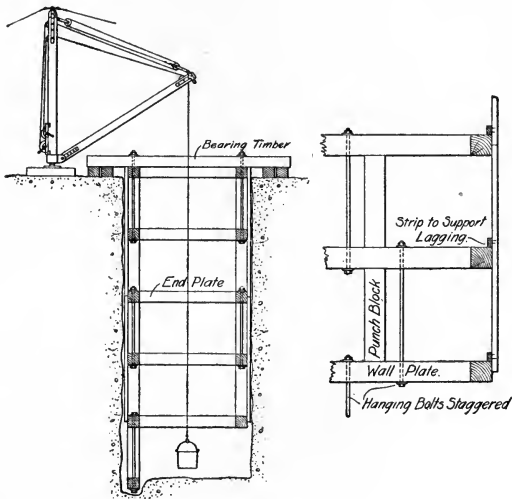

FIG. 8. — Hanging Timbers in Firm Earth

upper ends to the suction side of a pump. The writer knows of no case in which quicksand has been drained in advance of the excavation of a sinking shaft by driving small suction pipes into it, but in view of the success of the plan in the trench instanced above, he sees no reason why it could not be worked out for a shaft.

Compressed air is extensively used for sinking bridge piers and other caissons through soft ground; the application of this process to shafts will be considered later.

Concrete masonry is now almost entirely used for permanently supporting the sides of shafts in soft ground.

The methods in use for temporary support while sinking are:

Timbering; this heading includes the driving of wooden or steel sheet piling, as well as forepiling.

Caissons; these may be open drums, or closed drums sunk under compressed air.

Iron sinking drums and shoes, forced down hydraulically.

The freezing process.

The first method is applicable to comparatively easy surface conditions; the others to more difficult conditions. The last two have been developed in Europe for sinking through great depths of sand or mud, and are not extensively used in this country. The various methods will be treated in order.

**Timbering** — While sinking through ordinary surface ground the sides of the shaft are usually supported by square-framed horizontal sets of timbers with vertical lagging behind them. The distance between the sets depends upon the firmness of the ground, and varies from about 6 ft. as a maximum to nothing for "skin to skin" timbers in soft material. In square-framed sets the end and side pieces are termed "end plates" and "wall plates," respectively; the cross-struts, "buntions," and the posts which separate the sets, "punch blocks."

#### FIRM GROUND

The cheapest kind of sinking is afforded by earth that does not require blasting, yet is stiff enough to stand vertically for 4 or 5 ft. without support. In such material the usual procedure is to commence the excavation just large enough to admit the timber and lagging, and to carry the sides down vertically without support as far as it is safe to do so. The timbering is then started on the bottom and brought up to the surface of the ground. Two or more heavy bearing timbers, long enough to extend 4 or 5 ft.

beyond the lagging at each end, are laid across the shaft on the surface and their ends are supported by blocking them solidly against the ground, Fig. 8. The sets of timber are then hung from these bearing timbers by heavy rods, and sinking is resumed. As soon as 4 or 5 ft. of ground is removed, another set is placed on the bottom, hung with rods to the set above, and the lagging is worked in back of them in pieces just long enough to bear on both sets. The process is then repeated. Bearing timbers are usually placed over the end plates and over each row of buntons, and punch blocks are set at the corners and under the ends of all buntons.  $10 \times 12$  in. timber sets, spaced 4 ft. center to center and braced so that the longest span will not exceed 12 ft., will safely support firm earth for a depth of 60 or 70 ft. The weight of the timbers is partly carried by the friction of the earth against the lagging, and the hanging bolts are not subjected to great stress; they may sometimes be entirely omitted. A ledge of earth is in this case left under the bottom set, and the middle of the shaft excavated; inclined posts are then wedged between the shaft bottom and the timbers and the ledge removed. It is generally safer to use  $1\frac{1}{8}$  or  $1\frac{1}{4}$ -in. hanging bolts, however. Excavations of this character can be done for a total labor cost, including the placing of timber, of \$1.50 to \$2 per cubic yard. As the softness of the ground increases, the distance between sets is decreased. Sometimes the lagging is omitted and the lower set worked in immediately under the one above. The consideration of this plan properly belongs under soft-ground work.

#### SOFT GROUND

**Wooden Sheeting.** — When ground is so soft that it will not stand vertically at all, it becomes necessary to support it in advance of the excavation. The commonest method of doing this in any kind of pit is to enclose the area to be dug out with a coffer of sheet piling, driven by hand or power, Fig. 9, and to brace the inside of the coffer as the

material is removed. In starting a shaft, two sets of timber, one 5 ft. or so above the other, are set up as a guide frame, and the sheeting driven around them. The top soil is usually firm enough to enable these sets to be placed below the surface, but this is not, of course, essential. If the sets are placed above the surface, outside waling pieces are bolted through the sheeting at the top set in order to hold the top of the sheeting in line.

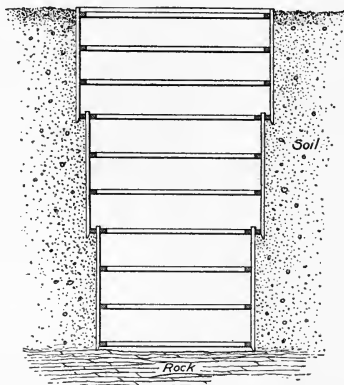

FIG. 9. — Successive Courses of Sheeting

In dry sand or other loose ground that does not contain much water, the sheeting is driven as the excavation progresses, and the points of the piles are kept only slightly below the bottom. Two-inch planks in 12 to 16 ft. lengths are commonly used in this case and are driven by hand with heavy wooden mauls. The heads should have beveled edges to prevent splitting, Fig. 10, and for hard driving, or with soft wood, a plate-iron cap may be used to advantage. By thus protecting their heads, the planks can be driven to their full length; a second course of sheeting is then driven inside the timbering of the first course, and so on until the required depth is reached. The economical limit for this

method, however, is about 50 ft., as it necessitates starting the shaft much larger than the minimum required size; some additional allowance must be made on every course for possible distortion and for inward bending of the sheeting at the points. Let us assume 50 ft. of surface, 10 × 10 in. timber, and 2-in. lagging, and a shaft 12 × 24 ft. with a 4-ft. concrete curb wall. Four courses of sheeting will be required, the last 20 ft. 4 in. × 32 ft. 4 in. outside, its wall plates to be buried in the concrete. Allowing 6 in. all around each time for distortion or squeezing, the third set will be 23 ft. 4 in. × 35 ft. 4 in., the second 26 ft. 4 in. ×

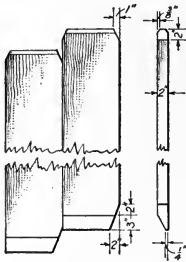

FIG. 10

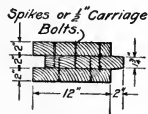

FIG. 11

38 ft. 4 in., and the first 29 ft. 4 in. × 41 ft. 4 in. The total excavation will thus be 40 per cent. in excess of that theoretically required for the curb wall. Any additional depth necessitating another course of sheeting will increase the percentage of useless excavation, and will require a larger quantity of heavy timber.

When many light sheet piles are to be driven, the work can be done more cheaply with some form of power driver than with mauls. A driver like an enlarged rock drill, Fig. 12, has been devised for this purpose, and a common drill fitted with a hammer instead of a bit will drive light sheeting satisfactorily. Either machine is suspended with blocks and falls from a trolley or tripod over the line of sheeting.



**Steel Sheeting.** — In quicksand or other wet running ground, sheeting must have joints that are almost watertight, and as it is impossible to drive common plank close enough to make a satisfactory coffer in such material without caulking, some form of interlocking piling should be used. Formerly tongued and grooved, splined, or Wakefield piling, Fig. 11, were the only forms available, but now they



FIG. 12. — Sheet-pile Driver

have been superseded for difficult work by the interlocking steel sheet pile. A slight obstruction will cause wooden piling to separate at the bottom, whereas it is almost impossible to pull the steel piles apart. Steel piles, moreover, can be more easily driven, will penetrate most obstructions, and can be readily pulled and redriven. There are a dozen types on the market, each with its advocates, but the simplest shapes are those rolled by the Carnegie Steel Co., (a) Fig. 13, and by the Lackawanna Steel Co., (b) Fig. 13.

Both are strong and satisfactory and, though not water-tight when first driven, will soon become so in most ground.

An additional advantage that steel piles possess is that they can be obtained in lengths up to 60 ft. and can be completely driven before excavation is started. When the ground is very bad, they should be made to reach rock so as to prevent material from flowing under their points. In one case a hole  $36 \times 27$  ft. 6 in. in plan and 27 ft. deep was needed for a furnace pit; the material was soft quicksand and rock lay at an unknown depth. Steel sheet piling 48 ft. long was obtained and successfully driven entirely around the pit and followed down 4 ft. below the surface. The first 20 ft. of sand was easily removed, but as the depth increased, sand began to flow in under the piling and gradually bent their points inward, throwing a terrific strain on the lowest set of timber. A complete wreck was finally prevented by filling the hole with sacks of concrete which sank into the sand and supported the lower end of the piling. This enabled the desired depth to be reached, but it would have been practically impossible to reach rock if the hole had been intended for a shaft.

Steel piles and heavy wooden sheet piles must, of course, be driven by machinery. While a discussion of pile driving would be out of place in an article on shafts, it may be said that, in the writer's opinion, a steam hammer is preferable to a drop hammer for sheet piling, whether used in regular or suspended leads. Sometimes a water jet is necessary; with a jet piles can be easily sunk by the weight of the hammer through sands into which they cannot be driven at all.

The chief trouble in driving a steel-pile coffer is in making a good closure. Sometimes the last pile exactly fills the gap, but more often a lap joint is made which is caulked with hay or junk. With care a good joint can be made in this way. Steel piling in short lengths is used for cutting off thin strata of quicksand encountered some distance below the surface. In this case the piles are locked together all

the way around and each is driven only 2 or 3 ft. at a time until all reach the rock.

Steel piling can be driven through logs, strata of cemented gravel, etc., but in ground containing large hard boulders some other method must be used. At a quicksand shaft in Michigan, boulders were encountered, but steel piles were driven until they had apparently reached the desired depth. The coffer, however, could not be excavated, as the sand in some way flowed in as fast as it was removed. Compressed air was finally applied, and when the points of the piles were reached, they were found to be torn apart by the boulders. Several piles, bent through a full half circle, were pointing up the shaft.

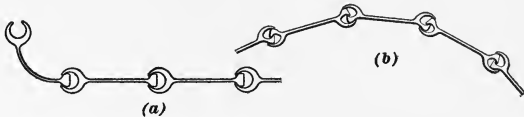

FIG. 13. — Sheet Steel Piling

**Forepoling.** — Forepoling was formerly used for shafts in soft ground of any nature, and depths of 100 ft. have been reached in the worst kind of material. Under such conditions forepoling is very slow and expensive, and although it has been largely, if not entirely, superseded by the steel sheet pile or caisson methods, some discussion of it is of interest. Forepoling is still widely used for soft-ground tunnels.

In starting a shaft which is to be forepoled through difficult ground, strong trusses are used for bearing timbers and the ring timbers are suspended from them by heavy bolts. The trusses span the shaft, Fig. 14, and their ends are supported by broad cribs or piers set well back from the edge of the shaft. They are built strong enough to carry the weight of all the surface timbering and also of the head-frame, if one is used. After the head-frame, or derrick, is ready, digging is started and the sides of the shaft are supported by short piles or poling boards driven on a

slant so that they bear against the outer face of the bottom set of timbers and the inner face of the one above. The poling boards are made twice as long as the distance between the sets (or longer), so when one course is driven home, enough ground can be dug out to enable another set of timbers to be placed. The worse the ground, the longer must the poling boards be made to prevent it flowing under them. The most troublesome places are the corners where the boards are divergent, and the spaces back of the buntons where a board is necessarily omitted. These openings are closed by short transverse boards placed as the excavation proceeds.

After a depth of about 40 ft. has been reached, the pressure of running ground becomes so great that single sets of timber, spaced so the poling boards can be driven between them, will not support it. Two or more timbers must then be placed "skin to skin" to form the wall and end plates, and as the depth increases the spacing of these compound sets must be reduced until the poling boards have to be driven nearly horizontal, and therefore fail to prevent the ground from rising in the shaft. This is where troubles with the forepoling method really begin. Every inrush of material causes a settlement of the ground around the shaft, throws the shaft itself out of line, and puts very great stresses on the timbers and the hanging bolts. In some cases heavy timbers driven with a ram have been used for poling boards. They were thus driven deep enough, and the successive courses were separated sufficiently, to permit very heavy ring timbers.

Among the other plans that have been devised to keep the bottom down may be mentioned:

Drainage of the ground ahead of the excavation by means of a perforated iron drum, jacked down and used as a sump for pump suction. A short stoppage of the pumps will allow the ground to become saturated again and start a run, and besides it is very hard to keep pumps running steadily with sandy water.

Drainage of the ground by means of a timbered sump combined with a system of floor boards similar to the breast boards used in soft ground tunnels. This method is very slow and laborious.

Sinking quantities of hay and brush into the ground around the shaft by loading them with pig iron. This stiffens the ground to some extent and tends to prevent runs. It is a help with any style of timbering in quicksand, and may even be necessary in sinking a caisson.

**Caissons.** — In the last ten years many American engineers have adopted the sinking drum or open caisson for penetrating soft ground. A hollow cylinder of masonry is constructed on the surface with its axis vertical and its walls tapered outward at the bottom to a cutting edge. The outer surfaces of the walls should be smooth and vertical, and the cutting edge should be slightly larger than the rest of the cylinder. After the masonry has hardened the earth is excavated on the inside, and the caisson sinks of its own weight. It is kept plumb by digging out under the high side. When the top reaches ground level, another section is added and this continues until the cutting edge reaches rock. This method has long been employed in Germany, the caissons being constructed of brick or stone; in this country timber caissons have occasionally been used. The low tensile strength of brick or stone and the difficulty of sinking wood in bad ground made these materials unsatisfactory. Concrete, combining weight with strength, is almost ideal, and as it is not only better than timber and brick, but also cheaper, it has displaced them both for building caissons.

**Rectangular Caissons.** — Caissons are ordinarily circular, but sometimes are made rectangular of reinforced concrete. A noteworthy example of this type is a shaft recently sunk for the D., L. & W. R. R., on the flats opposite Wilkesbarre, Pa. This shaft, 48 ft. 10 in.  $\times$  14 ft. in the clear, was sunk through very wet quicksand to a depth of 70 ft., in four months, including the time lost in sealing the

caisson to the rock. It thus affords a decided contrast to the Pettibone shaft near by, which, sunk by forepoling, took eight years. Cost figures are unobtainable but seem unnecessary. The walls of the D., L. & W. caisson are 5 ft. 4 in. thick at the bottom, 2 ft. 8 in. at the top, and are plumb on the outside. Two reënforced cross-walls serve as buntons and also support the side walls.

Several rectangular caissons have been sunk along the Monongahela River in the flats above Brownsville, Pa. The ground is not very bad, but contains enough soft clay and quicksand to make timbering very difficult. Two of these were coal shafts and were sunk through 50 ft. of surface in two months in the winter of 1908-09.

**Circular Caissons.** — A circular caisson was sunk in the autumn of 1908 for Shaft No. 2 on the Rondout Siphon of the Catskill Aqueduct. The surface was about 60 ft. thick, of which 6 ft. was sandy loam. The balance was a wet material that resembled blue clay when dried out, but which in the ground was completely saturated. It flowed slowly like cold molasses, and was very sticky. Overlying the rock and entirely surrounded by the muck were quantities of hard boulders of all sizes, which had to be blasted from under the cutting edge of the caisson. The combination made as difficult ground to sink through as can well be conceived.

The shaft desired was a three-compartment shaft, 10 × 22 ft. outside the timbers, with two hoistways. The caisson was made 21 ft. inside diameter, Fig. 15, giving ample room for the hoistways and a ladderway; the area for air is of course in excess of that afforded by the rectangular shaft. This caisson was built and sunk to rock in two months, and a description of the method used for it will give a good idea of the process in general:

It was decided that a caisson with 30-in. walls would be strong enough and heavy enough to sink to rock, and a steel shoe or cutting edge 26 ft. in outside diameter was obtained. This shoe was formed of two  $\frac{1}{2}$  × 20 in. plates riveted

together at the bottom and flared at the top to include the lower part of the concrete wall. It was anchored to the concrete by about eighty  $\frac{3}{4}$  in.  $\times$  8 ft. countersunk-head bolts.

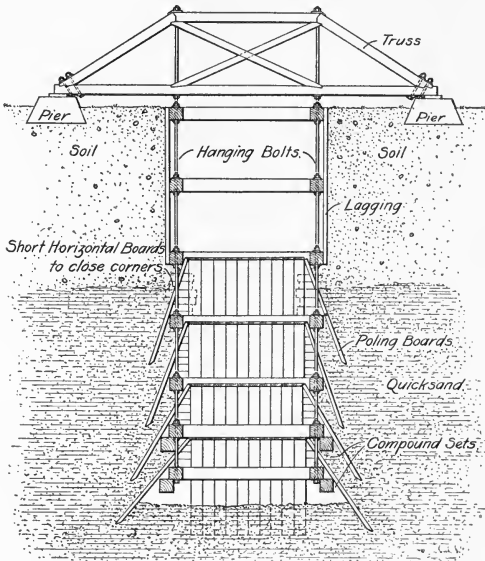

FIG. 14. — Forepoling

The shaft site was leveled, the shoe assembled upon short planks laid on the ground, and forms for the concrete were started. The forms were built of vertical 2-in. lagging in 4-ft. lengths, supported inside and out by rings of  $4 \times 3$  in. angles tied together by  $\frac{5}{8}$ -in. rods. Five feet of 1:2:5 concrete was placed and allowed to set for a week to obviate the possibility of settlement cracks above the cutting edge; 10 ft. more was then placed and, as soon as it had hardened sufficiently to permit of the forms being removed, sinking was commenced. The mud was loaded into shaft buckets

by men standing upon plank rafts and was hoisted with a derrick. Sometimes the mud had to be bailed with water buckets, but usually shovels could be used.

When the top of the first 15 ft. of concrete reached the ground level, 10 ft. more were added and excavation commenced again. Thus far the cutting edge had been very little in advance of the excavation, but at this point the caisson suddenly dropped 7 ft. and the mud inside rose 12 ft. The cutting edge was seen no more until it had almost reached rock. After the drop 20 ft. of concrete were added before excavation was started. Before this had been sunk to ground level, a stratum of very soft mud was encountered which ran in under the shoe and caused the surface to cave on the side next the derrick. The caisson gradually leaned toward the caving ground until it was nearly 2 ft. out of plumb. Sinking was then stopped, 10 ft. of concrete added, a trench dug through the 6 ft. of surface clay on the high side of the caisson, and the dirt banked against the caisson over the cave-in. When sinking was started the caisson began to right itself. It soon stopped moving, however, and the cutting edge was found to be resting on large boulders which had to be broken with dynamite. In the meantime the mud ran in almost as fast as it could be hoisted out, and the caving continued. When the cutting edge was within about 6 ft. of rock, the caisson literally stuck in the mud and refused to move even when the boulders were blasted out all around. A heavy timber platform was then built on top of the concrete and loaded with 200 tons of clay. As the caisson still stuck, the surrounding mud was agitated by blowing compressed air into it through 1½-in. pipes which had previously been built into the wall; a 1½-in. pipe was also used as a jet and worked down to its full length on the outside. This was done over and over again all the way around. After a few hours the drum started to sink and reached rock without further trouble.

The trouble in this case was due to the great stickiness



of the mud. An additional thickness of 6 in. in the walls would have probably caused the caisson to sink without delay. As it was, only forty-eight days elapsed from the erection of the shoe to the commencement of rock excavation, an average progress of 1.2 ft. per day.

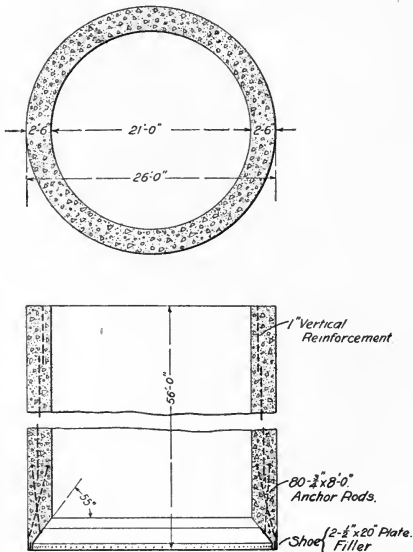

FIG. 15. — Circular Concrete Caisson

Fig. 16 shows the shoe and the lower part of the form, Fig. 17 shows the derrick, mixer, and general layout, and Fig. 18 shows the dump composed of mud spread out over an acre or more of ground.

All caissons should have some vertical reënforcement, so that if the upper part sticks the lower part cannot drop away from it. The absence of this has caused several wrecks.

Steel shoes are only necessary in ground containing boulders. A concrete cutting edge properly reënforced is strong enough to penetrate sand or clay with safety.

A number of points must be considered in deciding whether to use a rectangular or a circular caisson in a given shaft. The circular shape is easier to build and sink, and, owing to arch action, thinner walls can be used. No horizontal reënforcement or cross-braces are needed, and therefore

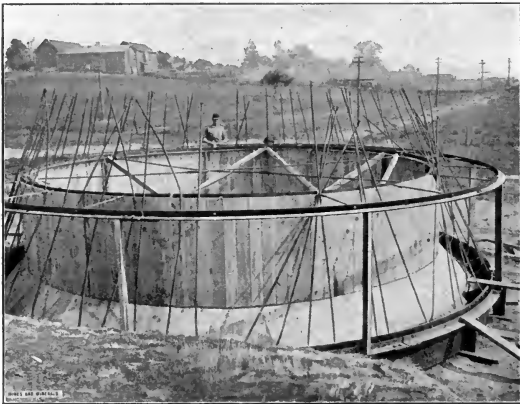

FIG. 16. — Shoe, Lower Part of Form, and Reinforcement, Rondout Caisson

a grab bucket can be used to advantage. The rectangular shape, on the other hand, requires less excavation, and the walls of any caisson must be made thicker than are needed for strength to give weight for sinking. In general it is probable that the circular shape is better for a one- or two-compartment shaft, and for a three-compartment shaft in very bad ground; the rectangular for a three-compartment shaft in ordinary soft ground. For long shafts, a rectangular caisson is a necessity.

An allowance should always be made for a possible tilt from the vertical that may amount to from 18 in. to 2 ft.,

either by battering or stepping the walls on the inside, or by making the caisson larger than the neat size required. In a rectangular caisson the side walls should be braced with temporary struts while sinking, and the permanent buntons or cross-walls placed after it has reached its final bearing on the rock; it may otherwise be impossible to line the guides up plumb.

The relative costs of piling, forepoling, and caisson are influenced by local conditions and by the type of shaft desired. For instance, a permanent shaft, such as the D., L. & W. shaft at Wilkesbarre, must have a masonry



FIG. 17. — Derrick and Head Works Rondout Caisson

lining through the surface anyhow, and it is therefore not fair to charge against the excavation the cost of the concrete in the caisson. In a temporary shaft, on the other hand, the excess of the cost of the caisson over the cost of a timber lining must be charged against the excavation. The writer believes, nevertheless, that wherever the ground is not firm enough to support itself for one set in advance of the timber lining, a caisson is safest and cheapest in the long run. A possible exception may be made to this statement in the case of a moderate depth of very wet ground where the work is done by a contractor who owns the equipment for driving steel piles and can recover them after the masonry lining is completed and use them on other work.

The costs given below should be fairly representative for the different methods of work:

1. Shaft excavated  $14 \times 20\frac{1}{2}$  ft. through 6 ft. of soil and 14 ft. of quicksand, not very wet. Sides supported by 2-in. oak sheeting driven by mauls and braced by five sets of  $10 \times 12$  in. timber.



FIG. 18. — Dump, Rondout Caisson, Showing Flowing Nature of Material

	Per Foot	Per Cubic Yard
Labor .....	\$27.25	\$2.57
Lumber, 6600 feet B. M. at \$30 .....	9.90	.93
Erection of derrick, etc.....	3.00	.29
Superintendence .....	3.00	.29
Sundry .....	2.00	.18
Coal and pumping .....	5.00	.47
Total .....	\$50.15	\$4.73

2. Shaft excavated  $12 \times 20$  ft. 3 in. through 45 ft. of clay and gravel. Sides supported by sets of  $10 \times 10$  in. pine timber spaced  $4\frac{1}{2}$ -ft. centers and hung from top.  $1\frac{1}{2}$ -in. lagging:

	Per Foot	Per Cubic Yard
Labor .....	\$19.50	\$2.17
Lumber, 240 feet per foot at \$25 .....	6.00	.66
Bolts, 15 pounds per foot at \$0.03.....	.45	.05
Erection of head-frame, etc. ....	2.00	.22
Superintendence .....	2.00	.22
Power .....	1.50	.17
Sundry .....	1.00	.11
Total .....	\$32.45	\$3.60

3. Shaft excavated 15 × 37 ft. through 21 ft. of dry sand. Sides supported by interlocking steel sheet piling driven with steam hammer and braced with sets of 8 × 10 in. timber:

Labor Costs Only	Per Foot	Per Cubic Yard
Driving sheeting .....	\$ 6.55	\$ .32
Removing sheeting .....	1.85	.09
Timbering .....	2.05	.10
Excavation .....	8.20	.40
Total .....	<u>\$18.65</u>	<u>\$ .91</u>

The cost of superintendence, sundries, and plant rental would amount to about \$10 per ft. or .50 per yard at a low estimate, and the cost of the steel sheet piling, if charged entirely to this job, would amount to \$110 per ft., or \$5.30 per yard.

4. Caisson 26 ft. outside diameter, 21 ft. inside diameter, sunk through 56 ft. semi-liquid mud and boulders:

	Per Foot	Per Cubic Yard Excavation	
Concrete {	Materials .....	\$ 27.00	\$1.35
	Labor .....	7.00	.35
	Forms and shoe .....	23.00	1.15
Sinking caisson .....	38.00	1.90	
Plant erection .....	3.00	.15	
Superintendence .....	5.00	.25	
Sundry .....	5.00	.25	
Coal and power .....	6.00	.30	
Total .....	<u>\$114.00</u>	<u>\$5.70</u>	

#### SEALING THE CAISSON TO ROCK

After the cutting edge of a caisson has reached rock, it is still necessary to construct a seal to permanently exclude sand and water. Often a stratum of stiff clay or disintegrated shale is found under the soft material and immediately over the rock. If this occurs the cutting edge will sink into it, automatically shutting out water until a concrete wall is built; if not, the making of the seal will be very troublesome.

Running mud may be checked long enough to allow it to harden by caulking under the shoe with blocks of wood and old sacks. Streams of water and quicksand require a wedging curb of some kind. The English method of sealing tubbing to rock can be applied; this may be done, Fig. 19, by cutting out the rock under the shoe until the pipe cutting edge attains a fair bearing all around, then driving numerous wooden wedges into the crack until the water is blocked back. Another plan, Fig. 20, is to lead the water to the center of the shaft through pipes set opposite the main

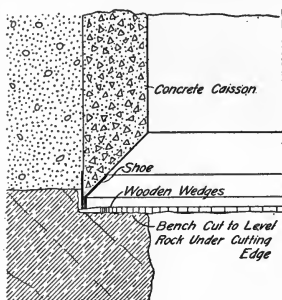

FIG. 19

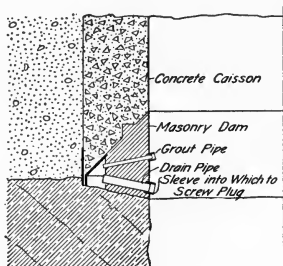

FIG. 20

feeders. A brick or concrete wall is then built from the rock to the caisson, surrounding the pipes and forcing all the water through them. When this masonry has set hard enough to stand the water pressure, the pipes are plugged. Several small pipes should also be built into the wall so that grout can be pumped back of it to take up small leaks. With either method great care is necessary, in commencing the rock excavation, to avoid opening up a new leak.

Sometimes the quantity of water may be so great that it cannot be shut off as described. If it is anticipated that the ground will be very wet, provision should be made in the design of the caisson for the use of compressed air as described below. This provision was made in the

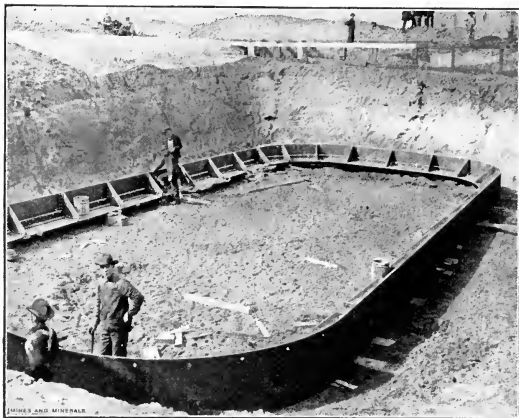

FIG. 21. — Steel Shoe for D., L. & W. Caisson



FIG. 22. — Shoe and Form for Bottom of D., L. & W. Caisson

D., L. & W. caisson referred to above, although air was not used.

The following notes on D., L. & W. caisson, taken from the *Engineering News* for September 28, 1908, are of interest.

In sinking the shaft, after the surface had been removed with plows and scrapers and the bottom of the excavation

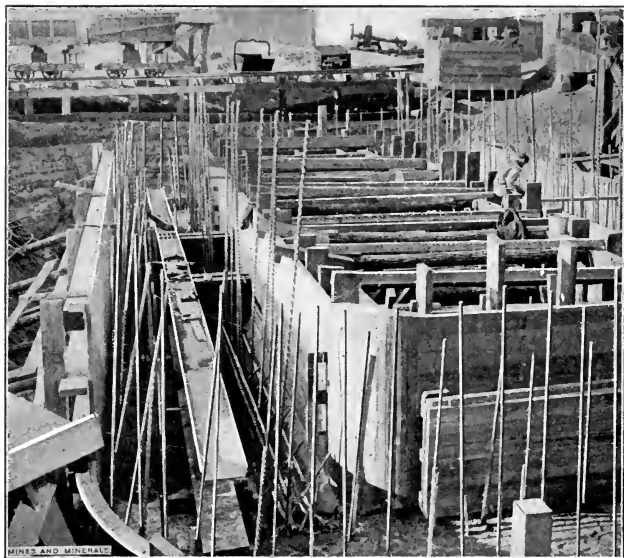

FIG. 23. — Showing Reënforcement for D., L. & W. Concrete Caisson

made perfectly level, a steel shoe, shown in Fig. 21, was placed on the bottom of the excavation. This was made of  $\frac{3}{4}$ -in. plate, was 24 in. wide, 32 in. high, and reënforced, as shown, with riveted angles. The shelf which formed the base for the concrete was placed 8 in. above the toe of the vertical plate. The outside dimensions of the cutting shoe were  $28 \times 59$  ft. 5 in. The outside form for the concrete was built up flush with the outside edge of the shoe. The



inside form at the bottom was inclined as shown in Fig. 22, being given a batter until the wall was 7 ft. thick on the sides and 5 ft. on the ends, when vertical forms were put in place. The concrete was reënforced with tie-rods, as shown in Fig. 23, and the walls were decreased in thickness in steps, as shown in Fig. 25, until they reached a uniform thickness of 2 ft. 8 in. at the top. When a height of 20 ft. of the concrete was reached, the bottom forms were removed

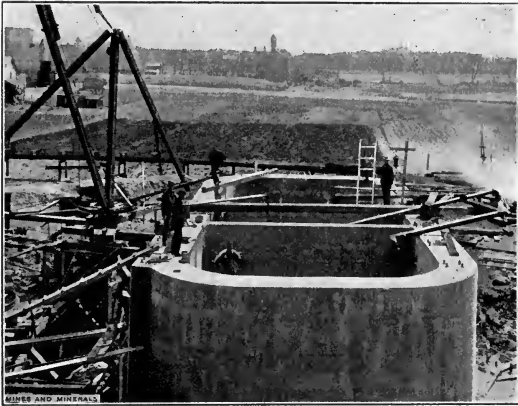
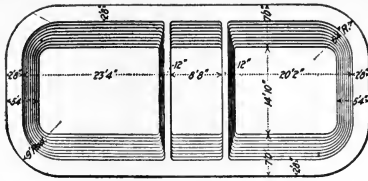

FIG. 24. — D., L. & W. Caisson Ready for Sinking

and the concrete caisson then carefully leveled preparatory to sinking. In order to provide for the contingency of having to resort to compressed air in sinking in case the inflow of water proved too great to be handled by pumps, arrangements were made to put in an air deck in case of necessity. Sinking was carried on day and night, and the excavating gang consisted of a foreman and sixteen men to each shift. The materials were hoisted in buckets by means of derricks, as shown in Fig. 24. Just as the caisson reached the rock which was being cleaned off preparatory to putting in the seal, the river rose and the shaft was



Plan.

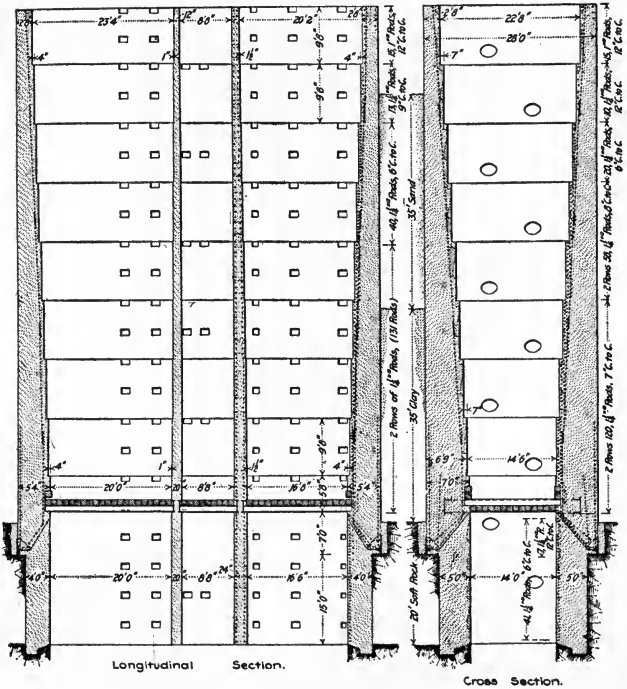

FIG. 25. — Plan and Sections of D., L. & W. Caisson Walls

flooded. It was found impossible to pump it out and the shaft was allowed to fill, to remain full until the river had subsided. When the caisson had sunk to the level of the rock, it was found that a temporary seal would have to be put in place during the construction of the permanent seal. This temporary seal was made of yellow pine blocks,  $12 \times 12$  in. in size, and wedges *a*, Fig. 26. Six-inch bleeder pipes were left to drain off the water while the seal was being

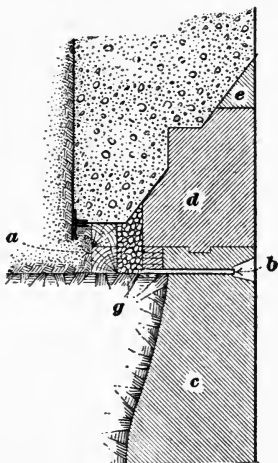

FIG. 26

put in place. The pipes were closed after the temporary seal had been completed.

To provide a place for the permanent seal it was necessary to take out rock for a depth of 20 ft., so as to build a wall to carry the caisson. During the blasting of this rock great care had to be taken to prevent jarring out the temporary seal. As the rock was being excavated a grout was forced back of the temporary blocking by means of a grout pump with an air pressure of 80 lbs.

In order to give a firm footing for the concrete wall the

rock was recessed so as to form a toe for the wall, and in order to give good contact between the underpinning wall and the caisson, the lower edge of the caisson was roughened. Fig. 26 shows the method of making the permanent seal between the caisson and the concrete foundation. The concrete *c* was put in place as soon as possible after the rock excavation had been completed, and was of the form shown. Next the ring of concrete *d* was placed, and grout was then pumped into the pipes after the concrete *c* and *d* had set. The final wedge of concrete *e* was laid after the concrete lower down had set and everything below had been made thoroughly tight, the edge between *e* and *d* being caulked after the pipe had been grouted; *g* is broken stone packed in between a brick dam and the wooden seal; the brick dam is intended to lead the water to the pipes *b*.

## CHAPTER IV

### SINKING THROUGH SOFT GROUND—PNEUMATIC PROCESS — SHIELD METHOD.

#### SOFT GROUND

FOR sinking through soft ground containing more water than can be pumped, the three methods referred to in Chapter III have been developed in this country and abroad. They may be described as follows:

#### THE PNEUMATIC PROCESS

The pneumatic caisson is an application of the principle of the diving bell that has been widely used for founding deep piers. It is also used for soft-ground shafts, particularly construction shafts from which tunnels are to be driven under compressed air. A caisson is constructed similar to the open caissons already described, except that an airtight deck is built over the entire opening 8 or 10 ft. above the cutting edge, Fig. 26. The deck is made strong enough to resist an air pressure equivalent to the hydrostatic head at the depth which the caisson is expected to reach. One or more openings in the deck are provided, fitted with air locks which retain air pressure but permit the entrance of men and the removal of spoil.

The caisson is constructed above the surface and sunk by excavating under the cutting edge as in the open type. The air pressure is raised as the caisson sinks and is always kept slightly in excess of the water pressure at the cutting edge. Water is absolutely excluded — no matter how wet and soft the material the work is done in the dry. In this way shafts can be sunk through river silt and flowing quick-sands that cannot be handled in the open.

The cost of excavation under compressed air is in general much higher than that of open work. In the first place grab buckets cannot be hoisted through an air lock, so hand digging is necessary; second, a special class of high-priced laborers must be employed whose wages increase with the depth, while the length of the shifts must be reduced; third, the air locks applicable to caissons are costly to build, and as their construction is covered by patents controlled by one or two corporations, they are quite costly to rent; fourth, the masonry of the caissons must be made very heavy to overcome the upward pressure of the air. Some grounds, however, can be "blown" out of the caisson and very little digging is necessary; in this case excavation is cheap. The limit for pneumatic sinking in loose ground is, in general, 100 ft. below water level, as men cannot stand a pressure greater than that corresponding to this depth.

The deck in a shaft caisson must be removable, and is, therefore, made of timber or steel, fitted into a recess left in the wall. Two openings should be provided, one in the middle for the excavation lock and another for the man lock. American locks are now standardized to fit a 36-in. circular opening. Small openings must also be made in the deck for the air connections and the "blow pipe."

A man lock consists of a steel cylinder, about 4 ft. in diameter and 8 ft. long, with flanged head. Eighteen-inch openings in the head are fitted with doors which swing downwards in opening, and close against a rubber gasket. A small hole in each head, closed by a stop-cock inside the lock, permits the entrance of compressed air from the caisson and its escape to the atmosphere. The lower door and stop-cock being closed, the upper door is opened and several men enter the lock. The upper door is then closed from outside, and a lock-tender standing inside the lock closes the upper and opens the lower stop-cock. When the pressure in the lock has become equal to that in the caisson, he opens the lower door and the men climb down a

ladder to the bottom. In letting men out the process is reversed.

The locking through of men is the most precarious part of compressed-air work. Too quick an application of pressure causes "blocking of the ears" — intolerable pain in the ears and head due to unequal pressure on the two sides of the ear drum — and too quick a reduction of pressure

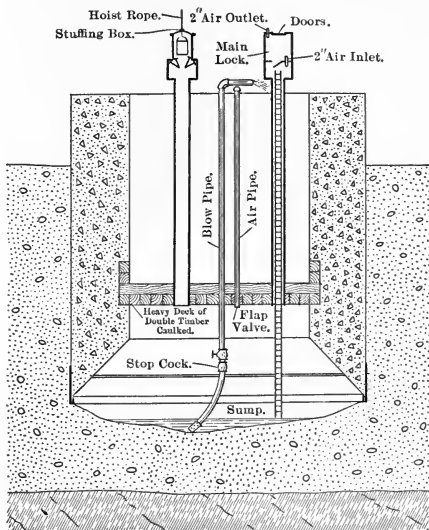

FIG. 27. — Pneumatic Caisson

may cause the "bends" — caisson workers' paralysis — always dangerous and sometimes fatal. For pressures below 20 lbs., men accustomed to the work can be locked through safely in two or three minutes and can work eight-hour shifts; at higher pressures the locking time must be increased and the length of the shifts decreased. With 45 lbs. of air, forty-five-minute shifts are worked and twenty-five minutes must be taken in locking through.

The principle of the excavation lock is the same as that of the man lock, but the doors and valves are all controlled from outside. The patented "straight-through" lock is the best type, in fact the only satisfactory type for caisson work. Several forms are made, all of which require the bucket to be hoisted on a single rope. In the "pot-lid" lock the rope passes through a stuffing-box in the middle of the upper door, which is literally a lid fastened to the lock by six heavy bolts hinged to the lock and engaging slots in the edge of the door. The door is carried by a buffer at the lower end of the rope. When a bucket is lowered into the lock, the upper door is also lowered on to its seat. The lock-tender, who stands outside, raises the hinge bolts into their slots and tightens the nuts before opening the lower door. In consequence of the continual tightening and loosening of the bolts this lock is rather slow in operation, but it is very simple.

Other forms of the straight-through lock have the upper door in two halves which close upon a stuffing-box on the rope. In this way only the stuffing-box is lifted instead of the entire door, and the operation is much quicker. In one type the doors are operated by high-pressure air cylinders.

The air pumped into the caisson by the compressors escapes by forcing its way out through the ground close under the cutting edge. As it is often necessary to excavate several feet below the cutting edge to sink the caisson, some provision must be made to remove the water that collects in the depression. This can of course be done with a pump driven by high-pressure air, but it is also possible to blow the water out directly. A 4 to 6 in. pipe, closed by a stop-cock at the lower end, is led through the deck and out over the top of the caisson, and a suction hose reaching the sump is attached to the lower side of the stop-cock. An opening, closed by a small valve or a wooden plug, is made in the pipe above the stop-cock. When the stop-cock is open the air pressure lifts the water into the pipe; the small



valve is opened at the same time and a quantity of air flows in and mixes with the stream of water, decreasing its specific gravity until the weight of the whole column of water is less than the air pressure. The water is then driven completely out of the caisson. By replacing the valve with a small high-pressure air connection it has been possible to raise water out of a caisson 70 ft. deep with 13 lbs. of air.

Fine sand and silt containing much water can be blown out through the pipe, and caissons have been sunk without hoisting a bucket of dirt.

The use of compressed air makes it very much easier to seal the caisson to rock. There is of course no trouble about keeping the water out; the difficulty is to prevent the air from blowing the grout out of the concrete, leaving it porous. One plan is to lay a strip of heavy duck over the crack, nailing one edge to the caisson and the other to the rock. Concrete is then laid on top of this duck.

Some kinds of very wet ground possess considerable viscosity. In these the pneumatic process can be worked to a greater depth than is theoretically possible by reducing the pressure and blowing out the mud and water that flow in under the cutting edge. One example of this has been cited — where water was raised 70 ft. with 13 lbs. of air; in England recently several piers were founded at a depth of 130 ft. below water level with 45 lbs. of air pressure. Under such conditions the difference between the hydrostatic pressure and the air pressure is accounted for by internal friction of the water and the ground. It is probable also that the actual hydrostatic head is reduced by the air bubbles which escape under the cutting edge into the surrounding ground.

#### THE SHIELD METHOD

Shields, similar in principle to those so extensively used for subaqueous soft-ground tunnels, have also been applied to soft-ground shafts, Fig. 28. A shoe is constructed with a cutting edge slightly larger than the outside of the com-

pleted shaft lining; a vertical lap plate or shield is attached to the outer perimeter of the shoe, and a number of screw (or hydraulic) jacks are set on top of the shoe and inside the shield plate. The frame of the shoe is sometimes made of wood, but steel is preferable. The shield is made of  $\frac{1}{4}$  to  $\frac{1}{2}$ -in. plate iron and extends from 18 in. to 3 ft. above

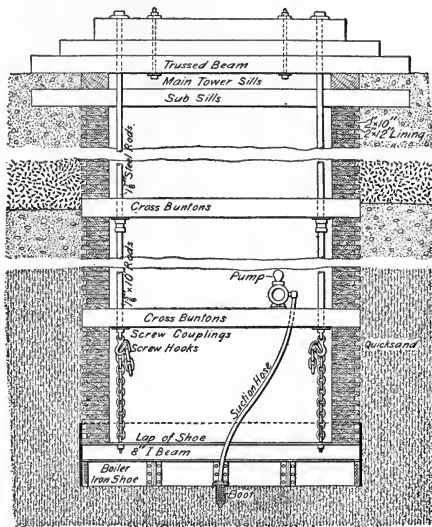

FIG. 28.\* — Shield Method of Sinking

the top of the shoe proper. The method of operation is as follows:

As soon as the shaft is started, bearing timbers or trusses are constructed to hang the lining from as previously described in connection with forepoling. The shoe is assembled in place with jacks screwed down, and the shaft lining is completed from the surface to the heads of the

\* Figs. 28, 34, 36, 37, and 47 are reproduced from the copyrighted instruction papers and bound volumes of the International Correspondence Schools by special permission of the International Textbook Company.

jacks. Excavation is then started and the shoe sinks until enough distance is gained to allow another course of lining to be placed beneath the completed section and inside the shield. If the jacks are used to force the shoe down, they must be withdrawn before the course of lining can be placed.

The upper edge of the shield must always be kept above the lower edge of the completed lining, and to insure this in bad ground it is necessary to hang the shoe from the bearing timbers with chains and ratchet jacks. Sometimes shoes are made so that the opening can be completely closed with steel plates to prevent an inrush of sand.

Tunnels driven with shields are circular and lined with rings of cast-iron segments 2 ft. wide. Many European shafts are lined this way, but the American shafts to which the shield method has been applied are rectangular and lined with "skin-to-skin" timbers or plank laid flat.

The chief disadvantage of a shield, even at a moderate depth, is its liability to hang up on a boulder on one side while the other side settles, thus wedging itself and throwing the shaft out of line. This tendency can be largely overcome by the proper suspension of the shield, but the depth which can be reached is limited when the ground is soft and wet enough to exert fluid pressure. At 100 ft. below ground-water level, for example, the pressure of wet quicksand will at least be 45 lbs. per square inch, sufficient to force enough sand and water to flood the shaft through a very small opening. It is impossible to jack a closed shoe down, displacing the ground under it.

## CHAPTER V

### SINKING IN ROCK — ARRANGEMENT OF HOLES — TOOLS AND METHODS USED IN DRILLING — COSTS AND SPEED

DYNAMITE and the power drill have made solid rock the easiest material through which to sink a shaft, and practically all American mining shafts are in rock for the greater part of their depth. As has been said before, hand sinking is the cheapest and quickest method; although a boring process has been developed, it is only applied where such immense quantities of water are encountered that hand sinking is impossible.

Outside of the boring process, the improvements in rock sinking have all related to breaking the rock and hoisting it. No practicable mechanical excavator or loader has yet been devised. Grab buckets that work well in soft ground are failures in blasted rock. A steam shovel, useful in a tunnel, is of course out of the question in the bottom of a sinking shaft.

**Drilling and Blasting.** — The universal method of shaft sinking in rock is to drill a number of holes in the bottom, charge them with dynamite and shoot them, and to load the broken rock by hand into shaft buckets which are then hoisted out. When all the loose rock has been removed the process is repeated. As it is very difficult to drill holes through loose rock, the broken material must be all removed before the next round of holes is started. This creates an additional difficulty for the mechanical digger, for while a grab might be made to remove most of the loose rock after a blast, hand work would still have to be resorted to to get the bottom ready for drilling.

Shafts are drilled on the "center-cut" principle. Eight

or ten holes are drilled on a slant, separated at the top but converging, thus forming a wedge known as the "sump." "Reliever," or bench, holes are drilled back of the sump holes, each row being more nearly vertical; the end or outside holes point slightly away from the vertical and toward the wall line of the shaft. The sump is first shot and the broken rock removed or "mucked" out, forming a cavity into which the bench rounds can be successively shot. All muck should be removed before each succeeding round is shot.

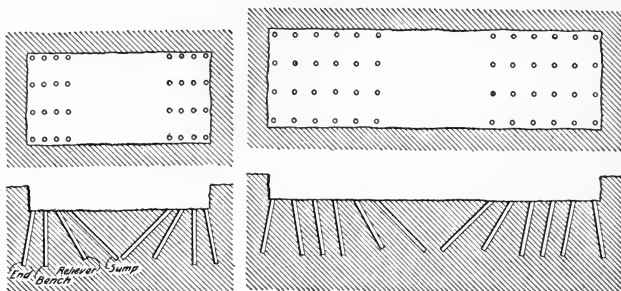

FIG. 29. — Shaft (a)

FIG. 30. — Shaft (b)

Two systems of drilling and mucking exist. In the first the holes for the entire cut — sump and benches — are drilled at one time, the sump is shot, and then the benches as required. In the second the sump only is drilled and shot, and the benches are drilled while the sump is being mucked. The first plan is particularly applicable to small shafts and to circular shafts; a rectangular or elliptical shape is needed to give room for simultaneous drilling and mucking.

Fumeless, or gelatine, dynamite should in all cases be used for underground work. The fumes from ordinary glycerine dynamite make it impossible for the men to get back to work promptly after a shot. The strength of the dynamite used depends on the character of the rock, but

40 and 60 per cent. gelatine are the most common strengths used.

The number and depth of the holes and the quantities of powder loaded vary so greatly with the size of the shaft and the nature of the rock that no general rules can be stated. The systems actually used at several shafts were as follows:

(a) Shaft 13 × 26 ft., through Western Pennsylvania coal measures: Shale, slate, and limestone; horizontal stratification; holes as in Fig. 29; 40 per cent. gelatine:

	Number	Depth	Inclination with Vertical	Loaded with
		Feet	Degrees	Pounds
Sump .....	8	10	35	4
Relievers .....	8	8	25	3
Benches .....	8	8	0	2½
End .....	8	8	10 back	2½
Total charge .....	—	—	—	96

Average gain per cut, 6 feet.

Average gain per week of 19 shifts, 24 feet (no timber).

Mucking and drilling simultaneous; 2 drills used on 1 bar.

(b) Shaft 14 × 48 ft., through anthracite measures: Red sandstone; stratification horizontal; holes as in Fig. 30; 40 per cent. gelatine:

	Number	Depth	Inclination	Loaded with
		Feet	Degrees	Pounds
Sump .....	8	10	35	5
Relievers .....	8	8	25	4
Benches .....	24	8	10 to 0	3
End .....	8	8	10 back	3
Total charge per round .....	—	—	—	168

Average gain per cut, 6 feet.

Average gain per week of 18 shifts, 16 feet.

Mucking and drilling simultaneous; 2 drills used on 1 bar.

(c) Shaft 10 × 22 ft., through quartz conglomerate (Shawangunk grit); horizontal stratification, but very few bedding planes; holes as in Fig. 31; 60 per cent. gelatine:

	Number	Depth	Inclination	Loaded with
		Feet	Degree	Pounds
Sump .....	8	10	35	3½
Sump .....	4	8	0	3½
Relievers .....	8	9	25	2½
Benches .....	8	8	0	2
End .....	8	8	10 back	2
Total charge per round .....	—	—	—	94

Average gain per cut, 5½ feet.

Average gain per week of 20 shifts, 22 feet.

Mucking and drilling simultaneous; 5 drills used on 2 bars.

The four additional sump holes shown were used on account of extra hardness of the rock.

(d) Shaft elliptical, 19 ft. 4 in. × 33 ft., through West Virginia coal measures: Hard gray sandstone; 40 per cent. gelatine; holes as in Fig. 32; horizontal stratification:

	Number	Depth	Inclination	Loaded with
		Feet	Degrees	Pounds
Sump .....	10	12	35	5
Relievers .....	8	10	25	4
Benches .....	14	10	10	4
End .....	6	10	10 back	3
Total charge per round .....	—	—	—	156

Average gain per cut, 8 feet.

Average gain per week of 20 shifts, 18 feet.

Mucking and drilling simultaneous; 3 drills used on 1 long bar, 1 short bar.

(e) Shaft circular, 17 ft. diameter, through Hamilton and Marcellus shales: Rock distorted; stratification irregular; holes as in Fig. 33, but about 45 degrees; 60 per cent. gelatine:

	Number	Depth	Inclination	Loaded with
		Feet	Degrees	Pounds
Sump .....	6	8	35	2½
Relievers .....	8	6	20	1½
Rib. ....	16	6	10 back	1
Total charge per round .....	—	—	—	43

Average gain per cut, 5½ feet.

Average gain per week of 19 shifts, 33 feet.

All drilling on one shift, mucking on two shifts; 5 drills used on 5 tripods.

**Drilling Tools.** — Hand drilling, once universal, has been entirely superseded in the United State by compressed-air drilling, and it is in fact difficult to obtain hammer men.

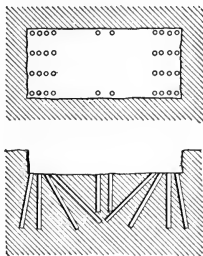

FIG. 31. — Shaft (c)

In other countries where labor is cheap, drilling is still done by hand. In the commonest method, a drill or “jumper”

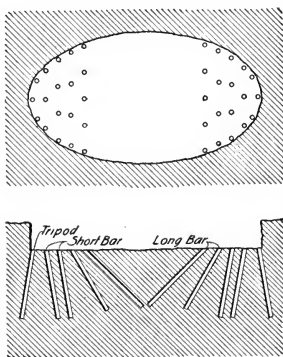

FIG. 32. — Shaft (d)

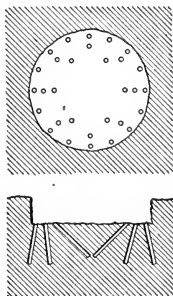

FIG. 33. — Shaft (e)

of 1-in. steel is turned by one man and struck by one or two others with 8-lb., double-faced hammers, Fig. 34*a*. Americans and Europeans use a 30-in. stiff handle; the Southern negro prefers to “drive steel” with a slightly longer



handle whittled down until it bends like a whip. Jumpers are given a single cutting edge, usually curved, Fig. 40. Two men should strike each steel wherever practicable, as they can obviously drill twice as fast as a single striker at three-fourths the cost. As much depends on the man that turns the steel as on the striker, for considerable skill is needed to produce a round, straight hole. Three good men can drill  $1\frac{1}{4}$ -in. holes in hard sandstone at the rate of 2 ft. per hour.

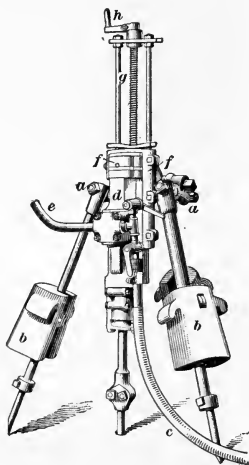

FIG. 34



FIG. 34a



FIG. 34b

In the Tyrol a system of single-handed drilling has been developed. The driller turns a light steel with one hand and wields a 4-lb. hammer, Fig. 34b, with the other. A skilful man can thus drill 3-ft. holes quite rapidly, but the holes are too small for regular shaft sinking.

For slate, churn drills, Fig. 38, are often used. The drill consists of a straight bar, 6 to 12 ft. long, with a bit at each end. An iron weight is sometimes welded around or forged into the drill 2 ft. from one end, thus increasing the weight

of the drill without increasing its length or diameter. The drill is handled by two or three men. When the weighted drill is used, the hole is started with the short end, and when it has reached a depth of 2 ft. the drill is reversed.

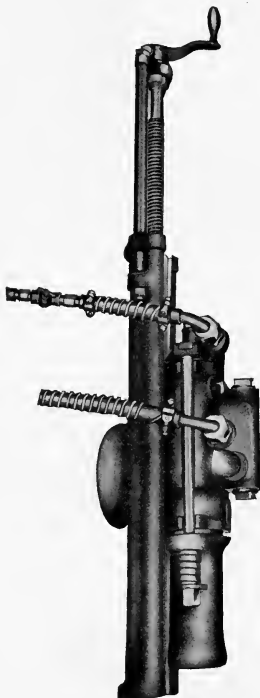

FIG. 35

The reciprocating, compressed air drill is the most widely used machine for drilling rock. It was first put into practical use by Mr. Fowle, of Boston, in the construction of the Hoosac tunnel, and since then has steadily grown in popularity. It is turned out by the thousands by the

Ingersoll-Rand Co., the Sullivan Machinery Co., the McKiernan Drill Co., and others, and although each maker has certain features of his own, especially in the valve arrangement, the general design is standardized and the general features are shown in Fig. 36. Piston and rod are turned out of a single billet of special steel, and to the end of the rod the drill steel is rigidly attached by a U-bolt chuck. The cylinder is made of cast-iron and slides longitudinally in a guide frame (or shell) clamped to the drill mounting. As the drill cuts into the rock, the cylinder is fed forward by a square-thread screw mounted on the frame. The piston is rotated mechanically by a "rifle bar" and ratchet so that the cutting edge of the bit will not strike two successive blows in the same spot. This rotative effect is necessary to drill a round hole.

The machine commonly used for shaft sinking has a  $3\frac{1}{4}$ -in. cylinder and a  $6\frac{1}{2}$ -in. stroke, weighs 280 lbs., and will drill down holes in hard rock at the rate of about 7 ft. per hour, including time lost in changing steels. The length of feed is 24 in., hence the drills must be changed every 2 ft. The starter is 2 ft. long beyond the shank (the portion of the drill grasped by the chuck), and the following steels are 4 ft., 6 ft., 8 ft., etc., respectively. (See Fig. 39.) Drill steels are usually sharpened with a + bit, although X bits and straight I bits are sometimes used. Where a large number of drills are in operation a sharpening machine may be used to advantage.

Two types of valve motion can be obtained. In the first, the valve which controls the piston is thrown by a tappet struck by the piston itself; the Rand "Little Giant" is an example of this. In the second, a piston valve is used which is thrown by a difference in air pressure on the two ends. The Sullivan "Slugger" is a drill of this type. The Sergeant drill is a compromise, having an auxiliary valve, driven by contact with the piston, which governs the air pressure on the ends of the main piston valve. The Slugger type strikes a hard, uncushioned blow and is adapted to

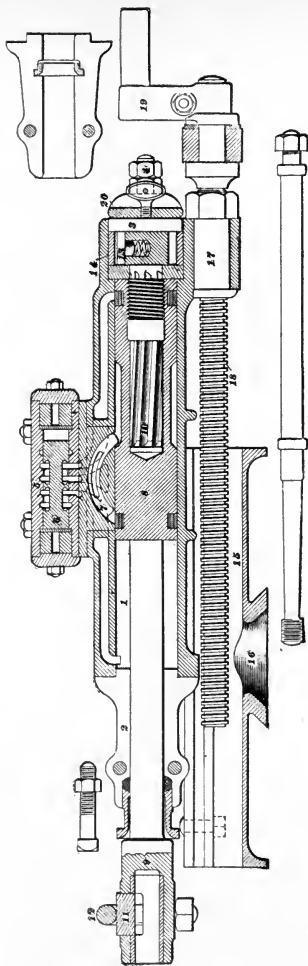

FIG. 36

use in hard rock with compressed air. Wet steam will not operate the valve readily, and the drill is slow if wet steam is used. The tappet drill, on the other hand, having a positive valve motion will do good work on wet steam. Its blow is slightly cushioned. The auxiliary-valve drill strikes a hard blow, will run by steam, and in addition has the advantage of a variable stroke. This feature makes it easier to start a hole.

A good many types of air-hammer drill have been recently developed, and have replaced the reciprocating types for light work. In these the drill steel is struck by a reciprocating hammer and has very little motion of its own. The drill steel is hollow, and the powdered rock is blown out of the hole by a portion of the exhaust air led to the cutting face through the hole in the steel. The Water Leyner drill, Fig. 35, which is now built to compete with the larger sizes of reciprocating drills, works on the hammer principle. In this the cuttings are removed by a stream of water pumped through the hollow steel to the cutting face; a portion of the exhaust air is allowed to mix with the water. This drill has made some remarkable records in hard rock tunnels in the West. A great advantage of the drill is that no dust is created in drilling up-holes in tunnels, making this work very much more healthy for the drill runners.

In rectangular shafts, drills are mounted on "shaft bars," or single screw columns, Fig. 37. The drill itself is held by a clamp, which, when its bolts are loosened, can be slid along or revolved around the bar, at the same time permitting the drill to be swung sidewise to any angle. When the clamp bolts are tightened the drill is rigidly held in position. The bar is set horizontally across the shaft, wooden blocking being used to form a good bearing between its ends and the walls of the shaft. Two and sometimes three drills are mounted on each bar. "Column arms," used for offsetting the drill, do not work satisfactorily with a shaft bar, and besides are unnecessary in a rectangular shaft.

In circular shafts it is difficult to cover the area to be drilled with a straight bar, and in the writer's opinion it is best to mount the drills on tripods, Fig. 34. The tripod, while it possesses all the adjustability of other forms of mounting, is less rigid and more cumbersome. To do good work all loose rock should be removed and the legs set on solid rock. This feature, however, is not objectionable in a shaft where mucking and drilling are not carried on simultaneously.

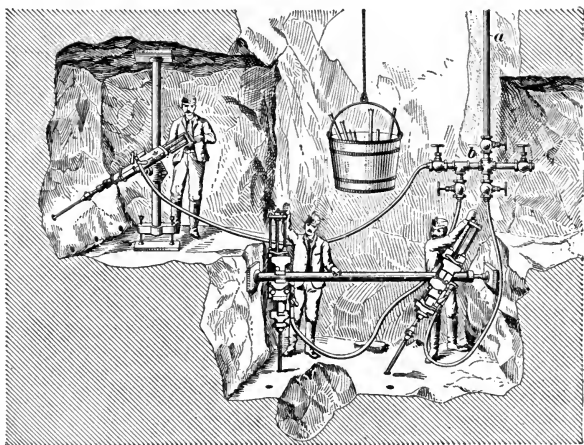

FIG. 37

Before blasting, the drills and mountings must of course be hoisted out of the shaft. In England, a drilling frame for use in circular shafts has been patented. This consists of a ring from which six bars, on which the drills are mounted, project radially. The ring is supported by legs and held rigid by jack-screws in the ends of the six bars. The chief advantage of this frame is that it is unnecessary to detach all the drills before blasting; the whole can be hoisted off the bottom and hung in the shaft without hindering the



FIG. 38

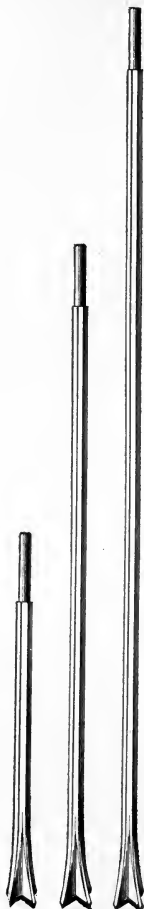

FIG. 39



FIG. 40

passage of the bucket which passes up and down through the ring. Another advantage of the frame is that the manifold is attached to it, the drills being connected to the manifold by short pieces of hose. It is thus necessary to have only one main air hose hanging in the shaft instead of a small hose for each machine.

The best grade of canvas and rubber hose should be used for the drills, wire wound for air, and marlin wound for steam. "Steam hose" should be ordered always for use with steam, as "air hose" will not stand heat. A section of 1-in. hose 50 ft. long is used for operating each drill.

**Operation.** — Shaft sinking is usually carried on twenty-four hours a day. The inside work is done by three shifts of men working eight hours each, the outside by three 8-hour or two 12-hour shifts. The 12-hour outside shift is customary in the coal fields; elsewhere, the 8-hour shift for every one is prevalent. Shifts are usually changed at 7 A.M. and 3 and 11 P.M., sometimes an hour later. The men are given twenty minutes for lunch in the middle of each shift.

Wages vary with the locality, but in general men are paid better for drilling and mucking in a shaft than in any other kind of rock excavation. On account of the high wages paid in America machine drilling is universal, and the shifts are limited to the number of men that can be worked to the best advantage. Speed is not attempted at the expense of efficiency. In South Africa, on the other hand, Kaffir labor is cheap, hand drilling is usual, and as many men are worked as the shafts will hold.

The great depth of the shafts on the Rand makes the highest possible speed desirable, even at an increased cost. In both countries speed is increased without an increase of cost by the payment of a bonus to the sinkers as a reward for additional progress.

The size of the shifts for any given shaft depends upon the number of drills required and upon the experience and ability of the sinkers obtainable. With first-class men,



the men on each shift at the  $13 \times 26$  ft. shaft referred to before as (a) would be as follows:

Inside men, 8 hours: One shift boss, at \$3; two drillers, at \$2.75; two helpers, at \$2.50; six muckers, at \$2.25.

Outside men, 12 hours: One engineer; one head tender; three car men on dump; one fireman; one compressor man.

General outside, 10 hours: One foreman; one mechanic; two carpenters (on timber); one blacksmith and helper.

The 17-ft. circular shaft (e) would require:

Drilling shift: One shift boss; five drillers; five helpers; one extra man.

Mucking shifts: One shift boss; nine muckers.

Outside same as shaft (a).

In South African shafts, which are usually about  $9 \times 26$  ft., when drilling is done by hand, each shift consists of one white shift boss and about 35 Kaffir laborers who drill or muck as may be required.

Thorough organization is essential to progress and economy. Each man must know his place and take it without losing time in getting started. Any condition that prevents systematic work is fatal to economy. For instance an inflow of water, sufficient to cause a loss of time after every blast while the bottom is being pumped dry, will lessen the rate of sinking far more than can be calculated by adding together the actual delays.

**Ventilation.** — Foul air and powder smoke in the shaft bottom hinder work almost as much as water. As a rule vertical shafts ventilate themselves surprisingly well to a depth of 400 to 500 ft., but at greater depths and sometimes at much lesser depths, artificial ventilation must be resorted to. The cheapest method, where the natural draft needs only a slight assistance, is an "air box," or wooden pipe carried up one compartment of the shaft; into this box is turned a jet of air or steam or the exhaust of the pump, if one is used. The box is built of  $1 \times 12$  in. boards. Another way to help natural ventilation in a rectangular shaft is to

divide the shaft into two compartments with a brattice attached to a row of buntons; one compartment will then establish itself as an upcast, the other as a downcast. If all steam pipes to pumps are kept in one compartment this action is certain to occur. In any case steam pipes should be kept together in one end of the shaft.

In deep shafts positive ventilation is best assured by the use of a fan or blower discharging into a large air pipe carried down the shaft and lengthened from time to time as the shaft deepens. A 15-in. standard volume blower, engine- or motor-driven, is sufficient to ventilate a shaft to any ordinary depth. The pipe may be made of boards, canvas, or light, galvanized sheet iron. The latter, although more expensive than wood or canvas, is air-tight and is not liable to injury from concussion.

**Progress.** — Progress in shaft sinking is influenced by so many different conditions — quality of rock, size and shape of the shaft, presence or absence of water, efficiency of labor and plant — that it is very hard to make any general statements concerning it. The best progress records are made in deep rectangular shafts on the Rand, in Transvaal, South Africa. These shafts, as has been said before, have a section about  $9 \times 26$  ft. in the rock; work is carried on by three 8-hour shifts 7 days a week; two compartments are used for hoisting, and every man that can be worked is put into the shaft. Kaffir labor is not only cheap, but the Kaffir will work under conditions of crowding to which a white man will not submit. The records made in several South African shafts are given in Table 1: the average progress is seen to be about 135 ft. per month, and the maximum 213.5 ft.

The progress in this country under normal conditions ranges from 60 to 80 ft. for rectangular timbered shafts, although very much higher speeds are sometimes reported. The soft shale in the coal fields of the Middle Western states is easy to drill and shoot. Good records are made in Kansas and Southern Illinois. An account of a shaft near Atchison,

Kan., published in the *Engineering and Mining Journal* for July 26, 1902, states that the daily progress in soft shale was 7 ft. No monthly figures were given. A good record was recently made on a 17-ft. circular shaft in the "Hudson River shale" (dark blue sandstone and sandy slate) on the New York Aqueduct. The system of drilling and mucking used at this shaft is described above under (e); the rock was quite hard but broke readily. The average progress made here is shown in the tabulation of American shafts, Table 2. The best month's work is 177 ft. No work was done on Sundays. The writer believes this to be a record for American shafts.\*

The rate of progress in the European circular shafts lies between the American and the African rate. The rock penetrated is in general softer than that found in this country.

Tables 1 and 2 give the dimensions of a number of shafts and the progress made in them. Wherever obtainable, the nature of the rock penetrated and the cost per foot is given. The figures were obtained from various articles in the technical papers, from the proceedings of various mining institutes, and from the writer's own records; some of the South African data were taken from the "Deep Level Mines of the Rand," by G. A. Denny, 1902.

**Cost.** — Cost figures cover a wider range than progress figures and are harder to get. The cheapest shaft on record is the one near Atchison, referred to above, the cost of which, as stated, was \$7 per foot. This cost stands alone in its glory as the tabulated figures show. Mr. Henry Rawie published in *Mines and Minerals* an itemized statement of the costs of a shaft sunk in West Virginia, in 1906. These ran as follows:

\* Since the above was written, the Breakneck Shaft on the New York Aqueduct was sunk 183 ft. in a month. The rock was hard granite. The system used was the same as at No. 1 Moodna, but six 3½" drills on tripods were used on the drilling shift. One mucking shift only was worked on Sunday; no drilling shift.

## HOIST SHAFT, 14 FT. × 22 FT., 180 FT. DEEP

	Per Foot
Labor, sinking and timbering .....	\$24.70
Plant .....	5.55
Superintendence .....	
Explosives .....	3.88
Coal .....	2.55
Timber .....	6.67
Miscellaneous .....	5.55
	<u>\$48.90</u>

The sinking costs of a pair of shafts sunk in Western Pennsylvania a year later were as follows:

## HOIST SHAFT, 13 FT. × 26 FT., 422 FT. DEEP

	Per Foot
Labor, sinking .....	\$51.00
Plant .....	2.40
Superintendence .....	4.35
Explosives .....	2.75
Coal .....	5.50
Oil .....	.60
Freight .....	.50
Miscellaneous .....	7.90
Total .....	<u>\$75.00</u>

## AIR SHAFT, 13 FT. × 22 FT., 383 FT. DEEP

	Per Foot
Labor, sinking .....	\$57.50
Plant .....	2.40
Superintendence .....	4.90
Explosives .....	3.00
Coal .....	6.05
Oil .....	.60
Freight .....	.50
Miscellaneous .....	7.14
Total .....	<u>\$82.09</u>

Water per minute: Hoist shaft, 50 gallons; air shaft, 120 gallons.

Costs have risen greatly in the last decade, since no substantial improvements in methods or machinery have been made to offset the increase in wages. Contract prices are

TABLE 1. PROGRESS IN SINKING SOUTH AFRICAN SHAFTS

	Kind of Rock	Size	Depths Between Which Average Progress is Figured, Feet	Cost per Foot	Average Progress per Month
Cinderella Deep	Quartzite or dike	9' 8" × 33' 6"	0 to 3900	\$104.45	90.0
Angelo Deep	Quartzite or dike	9' 4" × 24' 4"	0 to 239	81.80	119.5
Simmer West	Quartzite or dike	9' 4" × 28' 4"	0 to 120	99.70	120.0
Knights Central	Quartzite or dike	9' 4" × 29' 4"	0 to 264	80.90	132.0
Catlin	Quartzitic sandstone	9' 8" × 29' 8"	0 to 1839	—	145.0
Howard	Quartzitic sandstone	9' 8" × 29' 8"	0 to 1767	77.86	146.0
Rudd	Quartzitic sandstone	9' 8" × 29' 8"	0 to 1326	—	175.0
Wilmer	Quartzitic sandstone	9' 8" × 29' 8"	0 to 1504	—	187.0
Nigel Deep (incline)	—	7' × 14'	511 to 1206	—	173.7
New Kleinfountain Co.	—	—	558 total	—	171.6

Best monthly records: Howard Deep, 203 ft.; New Kleinfountain, 213.5.

TABLE 2. PROGRESS IN SINKING AMERICAN SHAFTS

	Kind of Rock	Size	Depth Feet	Cost per Foot	Average Progress per Month
Lincoln Gold Mine, Cal.	Greenstone and slate	9' 8" × 18' 8"	740	\$37.92	61.0
Federal Lead Co., S. E. Missouri	Magnesian limestone	13' 8" × 23' 8"	418	—	69.7
Tamarack, Mich.	Trap	10' 6" × 31' 0"	4580	99.36	70.5
United States Coal and Coke Co., }	Sandstone (hard gray)	19' 4" × 33' 0"	170	75.00	69.3
Tug River, W. Va.	—	elliptical	—	(unlined)	—
Selinsgrove, W. Va.	Sandstone and slate	14' 9" × 30' 4"	202	—	86.5
Old Dominion Copper Mining and Smelting Co.	—	9' 4" × 28' 4"	1025	87.00	41.0
M. R. C. C. and C. Co., Fayette City, Pa.	Slate	10' × 16' 4"	207	54.00	102.0
Struthers Coal and Coke Co., New Salem, Pa.	Slate and limestone	12' 6" × 26'	529	—	70.0
New York City Aqueduct, No. 1 Rondout Siphon.	Shale	17' circular	166 to 593	—	107.0
New York City Aqueduct, No. 1 Moodna Siphon.	Hudson R. shale	17' circular	200 to 585	—	143.0
New York City Aqueduct, Breakneck Shaft	Storm King granite	17' circular	10 to 568	—	151.0

Best monthly records: No. 1 Rondout, 138 ft.; No. 1 Moodna, 177 ft.; Breakneck, 183 ft. \* Lining not included.

not generally obtainable, as most shafts are put down by private corporations, but prices high enough to include a good profit to the contractor eight to ten years ago would not cover his costs to-day.

Twenty-five shafts ranging in depth from 350 to over 1000 ft. are required for the portion of the New York Aqueduct now under construction. All but two of these have been let by contract, and the bid prices are public property. The bids, however, are unbalanced in every case, and do not give a fair idea of shaft prices. They range from \$175 to \$350 per foot.

## CHAPTER VI

### THE SINKING-DRUM PROCESS. MAMMOTH PUMP. THE FREEZING PROCESS

**Sinking-drum Process.** — For sinking through the very great depths of water-bearing sand and clay that exist in some of the German mining districts, a method has been developed that does not require any hand work in the shaft bottom until the lining is completed to rock. The shafts are necessarily circular and are lined with cast-iron tubing. A heavy masonry caisson, with an inside diameter, somewhat greater than that of the finished shaft desired, is first constructed and sunk for 50 or 60 ft., as described in a previous chapter. If the ground beneath the cutting edge is sufficiently firm, it is leveled off and a foundation ring of masonry built under the tapered part of the wall. If not, a concrete floor is laid over the bottom (under water if necessary) and the caisson is pumped out. A heavy iron ring projecting inside the face of the wall all around is built into the masonry foundation ring or into a groove cut in the wall above the concrete floor. A second ring, placed near the top of the caisson, is connected to the first with heavy iron rods, and the space between the rings and around the rods is filled with masonry, forming an inner tube. The upper ring projects inside this inner tube and serves as a base for a circle of powerful hydraulic jacks acting downward.

A very strong cast-steel shoe or cutting edge with an outside diameter slightly less than the inside diameter of the tube is then assembled on the shaft bottom, and rings of cast-iron tubing bolted together are built up from the top of the shoe to the heads of the jacks. If a concrete floor has been laid it is broken up with a huge churn drill, excavation

is started with a grab bucket or some other mechanical digger, and the shoe and tubbing commence to sink of their own weight. The inner masonry lining acts as a guide for the iron sinking drum, and must therefore be built with its axis exactly vertical, correcting any deviation that may have occurred in sinking the caisson. The rubbing surface is usually formed by I-beams built into the masonry.

When motion ceases, the jacks are brought into play and the drum is forced down, additional rings of tubbing being built up under the heads of the jacks. When the first drum can be forced no farther, the bottom of the shaft is plugged with concrete, the water is pumped out, and a second sinking drum built up inside the first. The concrete is broken up as before, the jacks shifted so as to engage the top of the inner drum, and sinking is resumed. As many as four drums have been used, reaching in one place a depth of 508 ft.

The three methods used for excavation under water inside the drum are:

**The Grab Bucket.** — The action of a clam-shell or orange-peel bucket is too well known to require explanation. Either bucket will handle coarse sand, gravel, and boulders to advantage, but will not retain fine wet sand through a long hoist, and will not dig tough clay.

**The Sack Borer.** — This is a gigantic auger with the rigid stem extending up the center of the shaft, Fig. 41. The stem is constructed of heavy flanged pipes bolted together, and is terminated at the upper end by a splined section which serves as the shaft of a large horizontal worm-wheel. A hoisting rope, leading to a powerful engine and attached to a swivel at the top of the splined section, suspends the borer.

The stem is turned by an engine acting through the worm-gear and its worm, and is lowered gradually by the hoisting rope. When the top of the splined section reaches the worm-gear, it is disconnected from the stem proper and raised, and another section of standard pipe is added beneath it. Cross-arms, fitted with rollers at their ends, are attached



to the stem at intervals; the rollers bear against the sides of the completed shaft and prevent the stem from buckling.

The material cut by the borer is collected in two heavy

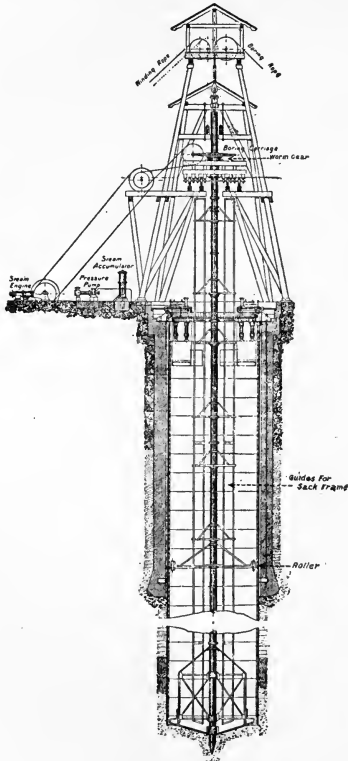

FIG. 41. — Sack Borer

canvas sacks fastened to the backs of the cutters. Formerly they were rigidly attached, and the whole apparatus was hoisted every time the sacks were filled. Now, however, the sacks are mounted on frames sliding on two pairs of

guides attached to the cross-arms on the stem, and are hoisted by light, independent engines. The sack borer is adapted to clay and sand.

**The Mammoth Pump.**— This is an application of the air lift, used in conjunction with a percussion borer or large churn drill, Fig. 43. A discharge pipe *A*, open at both ends, is carried down along the boring rod from the surface and is terminated just above the point of the borer. A compressed-air pipe *B* is also carried down the rod and connected into the discharge or suction pipe *A* near the bottom. The

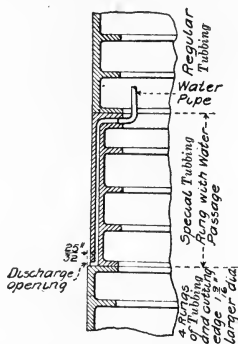

FIG. 42.—Construction of Sinking Drum for Hydraulic Flushing Process

borer being in operation, the air is turned on and a stream of water, mud, and sand is lifted through the discharge pipe. The pump will handle practically any material that will enter the discharge pipe.

The chief difficulty with the sinking drum has been the thickness of iron required to withstand the earth pressure at great depth, and uncertain strains caused by boulders under the cutting edge. The internal flanges on the tubbing cannot be made very wide without interfering with the free passage of boring tools in the shaft, hence the strength of the lining depends on its thickness alone. This has reached  $3\frac{1}{2}$  in., and at that thickness collapse has occurred in several

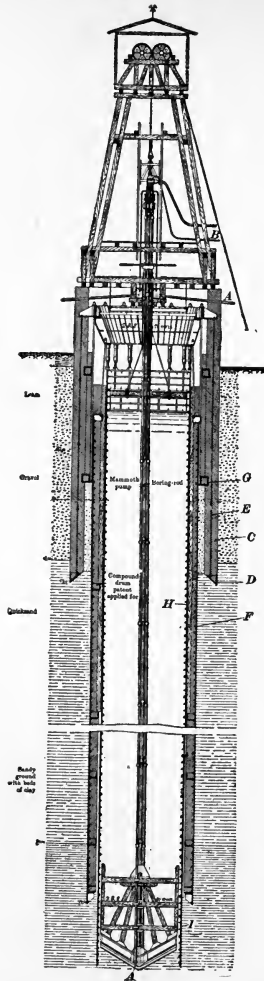

FIG. 43. — Compound Drum and Mammoth Pump and Borer

*A*, Suction Pipe and Overflow of Muddy Water; *B*, Compressed Air;  
*C*, Masonry Caisson; *D*, Shoe, Acting on Anchoring Ring; *E*, Anchor Rods.

cases. Further increase is not practicable on account of the weight of the segments and the difficulty of handling them. The cost would also be excessive.

The compound sinking drum (patented in Germany by Mr. Pattberg) is a decided improvement. In this, occasional rings of tubing are provided with broad internal flanges, and the space between these is filled with concrete or brick, leaving the interior of the shaft perfectly smooth. The masonry not only strengthens the tubing, but also adds weight where it will do the most good, and expedites sinking.

The friction and adhesion between the ground and the drum have been lessened by hydraulic flushing. For this, the shoe and three or four rings of tubing immediately above it are made slightly larger than the rest of the lining. In the upper side of the shoulder thus formed, water passages are provided which are connected to a pressure pump. While sinking, the pump is operated and the drum is partially surrounded by a film of water. This expedient has been very successful. (See Fig. 42.)

The sinking drum is sealed to the solid measures by forcing the cutting edge into them by the full power of the jacks. If necessary the shaft can be bored into the rock by the Kind-Chaudron method, as will be explained later. The entire process will probably be made clearer by a short description of an actual piece of work.

Shaft 5, of the Rheinpreussen Colliery, Homburg-am-Rhein, Germany, was expected to penetrate nearly 500 ft. of quicksand and mud. Sinking was started with a brick caisson *C*, Fig. 43, 29.2 ft. inside diameter, with walls about 3.5 ft. thick. This reached a depth of 65 ft. Nine feet of concrete was placed on the bottom under water and the shaft pumped out. The anchor ring *D*, anchor rods *E*, and pressure ring, designed for a maximum pressure of 3000 tons, were erected and a brick inner lining built around the rods, reducing the diameter of the shaft to 25.68 ft.

A compound drum *F*, with an outside diameter of 25.52

ft., and a diameter inside the broad flanges and the brick lining of 21.32 ft., was now built and sinking was started with a percussion borer and mammoth pump. The concrete was bored through in four days, and an average advance of about 5 ft. a day was made in the soft ground. The progress was, in fact, limited by the rate at which tubbing and walling could be built up under the heads of the jacks.

It was possible to force the compound drum to a depth of 245 ft. The shaft was then filled for 60 ft. with sand and gravel instead of concrete, was pumped out, and an inner iron drum,  $3\frac{1}{2}$  in. thick and 19.35 ft. in inside diameter, was built up to the jacks. This drum stuck at a depth of 315 ft., 60 ft. of gravel was again filled into the shaft, and a third drum, 17.38 ft. in inside diameter, was built up to the jacks. This was forced to a depth of 343 ft., where the cutting edge stuck in clay solid enough to permit the shaft to be pumped out. A fourth drum, 15.3 ft. in inside diameter, was then built, which reached the solid coal measures at a depth of 508 ft.

Shaft 4 was sunk simultaneously, with exactly similar drums. The third drum reached a depth of 433 ft. before the shaft could be pumped out. The completion of both shafts to the rock took three years.

**The Freezing Process.** — The great depth to which frost penetrates the ground in Siberia and other cold countries enables shafts to be sunk through soft ground to considerable depths during the winter months. Continued freezing gives the sides all the support that is necessary until rock is reached and a permanent lining built up.

It occurred to F. H. Poetsch in 1883 that this condition could be imitated artificially. His method is to bore a number of holes around and somewhat outside of the periphery of the proposed shaft, and to case them through the soft strata to the rock. A freezing plant is erected at the shaft head, and the brine or freezing solution is circulated down interior pipes and up through the bore-hole casings until the surrounding ground is frozen to a solid mass. The

holes are bored 'about 3 ft. apart; the form of the frozen ground is consequently cylindrical. At first the cylinder is hollow, but as the freezing continues, it gradually becomes solid ice. Excavation is then commenced, the frozen material being loosened with picks or light charges of explosives.

In Europe 70 or 80 shafts have been sunk by the freezing process, the thickness of the soft ground in some cases reaching 300 ft. Most of these shafts are in France, Belgium, or Germany; a few have been frozen in England by continental contractors. In the United States the process has so far found a very limited application. One shaft in Michigan was frozen through about 100 ft. of quicksand, and an unsuccessful attempt was made to freeze a shaft in Pennsylvania.

A number of European shafts started by the freezing method have been completely lost through some accident. Notwithstanding this, the method is being improved and greater and greater depths are attempted and reached. Water-bearing rock strata are successfully frozen. A shaft in Belgium has been sunk by freezing through 700 ft. of soft ground and wet rock.

A detailed description of the freezing process, written by Mr. Sidney F. Walker, may be found in the August, 1909 issue of *Mines and Minerals*.

The chief difficulties met with in freezing, especially in deep freezing, are deviation of the bore holes, salts in solution in the ground water, bursting freezing pipes, and the tendency of ice to flow under pressure. The first trouble can be met by measuring the drift of the holes, and by boring additional holes when the divergence of those already bored is too great. Salt solutions are of course very hard to freeze, and their presence in the ground necessitates a much longer freezing period than would otherwise be necessary. A burst pipe allows the freezing solution itself to flow into the ground, forming a soft spot that it is almost impossible to freeze at all. The obvious way to prevent this is to use very strong

tested pipe, and it is now found advisable not to circulate the freezing solution through the bore hole casing itself, but to insert an inner and outer freezing tube and to withdraw the casing. The flowage of ice cannot be prevented and limits the depth for which the freezing process is feasible. Hard freezing checks this tendency.

A freezing period long enough to thoroughly solidify the ground is the first essential for successful sinking. The smallest crack or seam which will admit a few drops of water will soon enlarge itself until a disastrous break-through occurs. It is also necessary, from time to time as the shaft is excavated, to support the sides with some form of suspended lining.

The Anhalt Government Salt Mine, at Leopolds-Hall, Stassfurt, is an example of a successful application of the freezing process. Drilling was commenced early in 1899 and 26 holes about 5 in. in outside diameter were drilled on a 26.25 ft. circle and cased to a depth of 325 ft. The drilling was difficult, and was not completed until June, 1900. By this time the freezing plant (which consists at most shafts of two 75 horse-power ammonia compressors) was ready and it was started June 22. Sinking was commenced on September 2, and on September 19, at a depth of 30 ft., a small leak which existed in the middle of the bottom broke through and flooded the shaft. Freezing was then continued until the end of November, and sinking was again started. By the end of February, 1901, 202 ft. had been sunk, and the shaft was then lined with iron tubing. The space between the tubing and the rock was filled with concrete mixed with a solution of calcined soda. Periods of sinking and lining then alternated, until on July 4, the shaft was lined complete to the bottom of the frozen wall. The total time required for a depth of 325 ft. was therefore two and one-half years, an average progress of 11 ft. per month.

The Chapin Mine Co., Iron Mountain, Mich., decided to sink a shaft in the center of a small valley crossing its property. Attempts to sink by ordinary methods having failed,

in 1887 a contract was let to the Poetsch-Sooysmith Freezing Co. to sink the shaft by the freezing process. At the site of the shaft the rock was covered by 95 ft. of quicksand, gravel, and boulders. The sand had some clay mixed with it, contained 1 per cent. of water, and would flow almost like water.

The installation of the freezing pipes was performed by the Chapin Mine Co. itself, and was finished in the summer of 1888. Twenty-six 10-in. bore holes, spaced evenly on 29-ft. circle, were driven and cased to rock, great difficulty being experienced in keeping them vertical on account of the boulders. Eight-inch freezing pipes  $\frac{3}{8}$  in. thick, flush inside and out and closed at the bottom, were lowered into the holes and the casings were then withdrawn. Inner tubes  $1\frac{1}{2}$  in. in diameter were lowered into the freezing tubes, their lower ends being kept 8 in. above the bottom. The upper ends of the tubes were connected, as shown in Fig. 44, to the brine pipes of a 50-ton-per-day capacity Linde freezing plant operated by a 55 horse-power engine, driven by compressed air. Two hundred cubic feet of brine consisting of a 25 per cent. solution of calcium chloride was used for the freezing fluid, the entire quantity making a circuit every thirty-three minutes.

Excavation and timbering were started fifteen days after freezing was begun and were continued for seventy-eight days, when rock was reached in one end of the shaft. During this period two and a half days were lost by the interruption of the air supply to the engine. Some water had been finding its way up through the unfrozen core in the middle of the shaft; the quantity now increased and sand began to come in with it. The shaft was at once filled with water and an additional freezing pipe put down. Four months and a half after freezing was begun the shaft was sunk 7 or 8 ft. into the rock. At this point enough water found its way through the fissures in the rock to thaw out the sand at the rock surface, and it was necessary to again flood the shaft. Before this was done, however, a coil of pipe was



suspended at the rock surface and connected to the freezing machine. This successfully stopped the leak, but six weeks more were lost. The shaft was sealed to rock, and the ice machine shut down on June 6, 1889, after running just two hundred days.

The shaft was sunk rectangular 15 ft. 6 in.  $\times$  16 ft. 6 in.

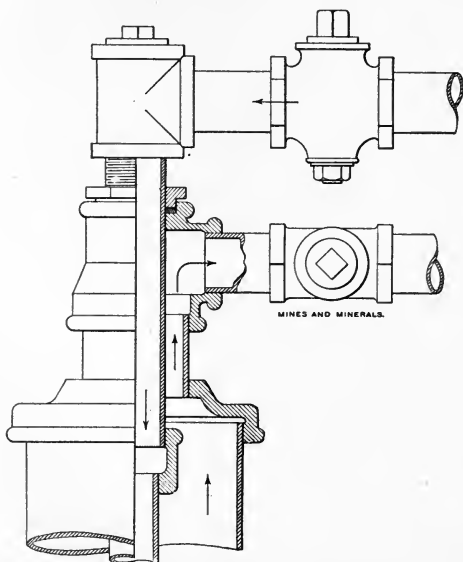

FIG. 44. — Connections of Top of Freezing Tube, Chapin Shaft

in plan, and was lined with 16  $\times$  16 in. timber sets spaced about 4-ft. centers on top, and skin to skin at the bottom. The frozen sand was blasted out with lime, black powder, and finally dynamite.

In 1889 the Mt. Lookout Coal Co. started to sink two shafts near Wyoming, Pa. The test holes showed 32 ft. of dry gravel and 70 ft. of quicksand over the rock. While the first shaft was being sunk by the pneumatic process, an

attempt was made to sink the second by the freezing process. Bore holes were put down from 5 to 7 ft. apart in a circle around the proposed shaft, and cased through the surface and 5 ft. into the rock. A freezing mixture was then circulated in the pipe for seven weeks, at which time the caisson of the first shaft reached rock. It was then discovered that the rock, instead of being solid as supposed, was fissured for 18 ft. below the surface. As a large inflow of water occurred in the fissures, the company decided that it would be impossible to successfully seal off the water in the second shaft with the freezing tubes only 5 ft. in the rock, and the attempt was abandoned. The shaft was then sunk by the pneumatic process, and although some time had elapsed between the abandonment of the freezing and the sinking of the caisson, the ground was found to be still frozen hard.

The writer wishes to acknowledge his indebtedness to Mr. J. Riemer, from whose book, "Shaft Sinking in Difficult Cases,"\* he got many facts about the sinking drum and freezing processes in general, and a description of the European applications. The descriptions of the American freezings were abstracted from the Transactions American Society Civil Engineers for June, 1904.

\* "Shaft Sinking in Difficult Cases," by J. Riemer, translated from the German by J. W. Brough. J. B. Lippincott & Co., Philadelphia, 1907.

## CHAPTER VII

### THE KIND-CHAUDRON BORING PROCESS. CEMENTATION OF WATER-BEARING FISSURES

SINKING in wet rock may be accomplished in two ways: mechanically, by breaking and removing the rock under water; by hand, by closing the seams in the rock, thus preventing the inflow of water, or by lifting the water as fast as it flows in.

The first plan can be carried out in one way only — the boring process.

The second is accomplished by the freezing process, already described, and by direct cementation of the fissures of the rock: water is most frequently lifted by sinking pumps suspended in the shaft, although the old Cornish "spear-rod" pump is still sometimes used for large quantities of water. A system of water hoisting has also been developed.

**The Boring Process.** — The Kind-Chaudron boring process has previously been referred to as a process devised for sinking through rock measures containing such quantities of water that hand sinking is impossible. It is exclusively a European method, and so far no shafts have been bored in this country. The process was originated by M. Kind, a well borer, in 1849. Between that date and 1854 he attempted to sink three shafts in Moselle and in Westphalia, but failed owing to the inadequacy of wooden tubbing. The scheme was then taken up by M. J. Chaudron, a Belgian engineer in France, and was improved by him to such an extent that his name is now always associated with that of Kind. Subsequent improvements of value have been made by Riemer and others, and have been patented in Europe; at present the firm of Haniel &

Lueg, of Dusseldorf, controls many of these patents and is best equipped for boring shafts.

Kind's original plan was to bore the shaft in one operation. The difficulty of collecting the broken rock made it advisable to bore in two stages, and a small hole, having a diameter one-third to one-half that of the finished shaft, is now bored in advance. The muck in this is removed by a special bucket with flap valves in the bottom, so arranged that as the bucket is lowered the muck will enter. When the bucket is raised the valves close.

The small shaft serves as a guide for the large boring tool, as well as for a collector for muck, and it is usually bored about 100 ft. ahead of the large boring. The cutting edges of the large borer slope down toward the center; the borings, therefore, slide into the small shaft. The large tool thus has always a clean surface to work on.

Boring is usually adopted as a last resort. In regions where large flows of underground water are expected, the shaft is sunk by hand until the water-bearing strata are reached and is then cleared for boring. Care must be taken to keep the shaft free from timbers, permanently fastened pumps, and pipes, etc., so that when it is flooded all impediments to boring can be hoisted out. If this is not done, it will be necessary to cover the bottom of the shaft with a thick layer of concrete, deposited under water with a grab bucket, in order to permit the shaft to be pumped out and cleared.

When boring is started, it is carried through the water-bearing strata and some distance into the impervious ground beneath. The shaft is then lined with rings of cast-iron tubing; the placing of this tubing is the most ingenious feature of the boring process. (See Fig. 45.)

After the shaft has been cleaned out and the boring tools removed, a heavy platform is built over the shaft and upon it the "moss box" is erected. This consists of two rings of heavy tubing, forming a large stuffing-box which is filled with moss, and is so designed that an upward pres-

sure on the lower ring will force the moss out against the sides of the shaft. The moss is covered with wire netting to keep it in place, and the diameter of the whole is slightly less than that of the shaft. On top of the moss box is bolted a ring, fitted with a heavy arched bulkhead that closes the

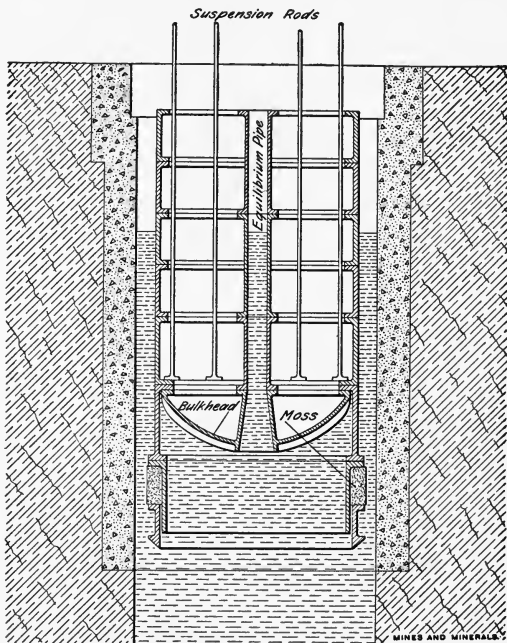

FIG. 45. — Tubbing and Moss Box

shaft. The whole structure is then lifted by heavy jackscrews and, after the platform is removed, is lowered into the shaft. It is then hung from beams placed across the shaft, the jackscrews are disconnected and withdrawn, another ring of tubbing placed on the beams, and the jackscrews reconnected. The beams are taken out and the

ring is lowered into place and bolted up. The process is then repeated.

Since each ring of tubbing weighs less than the water it displaces, after enough have been added the whole column of tubbing will float. The hanging rods are then dispensed with and, as each ring is bolted on, the tubbing is sunk by admitting water. This is continued until the moss box reaches the bottom of the shaft. The whole column is then allowed to fill with water, and, all buoyancy being removed, the entire weight of the tubbing serves to crush the moss outward against the sides of the shaft. A water-tight joint is thus made at the bottom.

The space between the tubbing and the sides of the shaft is then filled with concrete, and, after this has set long enough to thoroughly harden, the shaft is pumped out and the bulkhead removed. The concrete is usually placed with small flat buckets lowered with ropes.

The boring tools, borers or "trepanns," Fig. 46, are made of cast steel provided with inserted teeth, and weigh about 10 tons for the small and 20 tons for the large tool. They are suspended by heavy timber rods from a walking beam operated by a single large, vertical steam cylinder. Between the walking beam and the rods a chain connection is provided, by means of which the borers can be lowered as the hole deepens. At the "bore master's" platform on top of the shaft there is a swivel connection and a long lever for rotating the borer slightly between blows.

The head-house is a tall structure with two wings in which are stored the various tools. All are hung from small trucks which can be readily run out over the shaft. Two hoist engines and cables are provided, one for the bucket and the other for the borers and tools.

Considerable difficulty is encountered in boring through fissured ground and through strata of soft material. In the first case the teeth of the borers are liable to breakage; in the second, large masses of material fall out of the sides of the shaft, sometimes burying the borer. A special tool has

been devised for fishing out broken teeth, large pieces of rock, etc. A falling in of material is prevented by sheet-iron cylinders, lowered from the top and suspended by flat ropes. These cylinders have no hydrostatic pressure to resist, hence need not be heavy. They are built of  $\frac{3}{4}$ -in. plate, in lengths up to 60 ft.

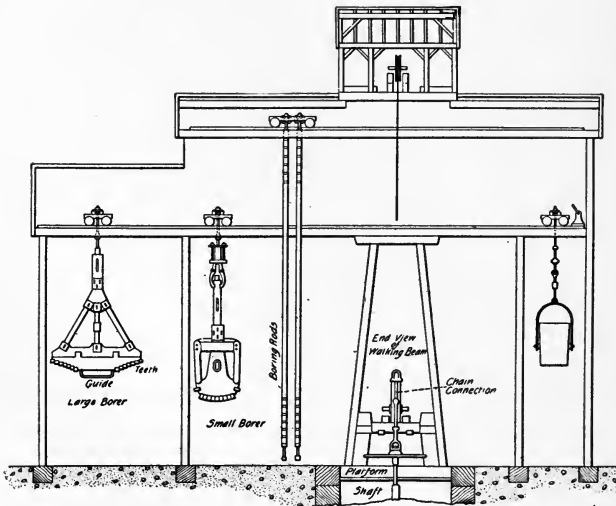

FIG. 46. — Cross-section of Boring Tower

It has not been found practicable to use segmental tubbing rings for lining bored shafts, owing to the difficulty of making the vertical joints water-tight. The maximum diameter at present, therefore, is limited by the size of the single ring which can be transported — about 14 ft. diameter. The boring is made 18 in. to 3 ft. larger, depending upon the character of the ground. Ordinarily the small borer is about 8 ft. across, and the large one  $15\frac{1}{2}$  ft. for 14-ft. tubbing, but if much bad ground is expected and the use of

several sheet-iron cylinders is contemplated, the large borer is made  $16\frac{1}{2}$  ft. or 17 ft. across to start with.

The speed made in boring shafts has varied so greatly that it is hard to give definite figures. Under favorable conditions the small tool will advance 20 in. per day, and the large one 7 or 8 in. If to the time required for actual boring is added that taken for lowering sheet-iron cylinders and tubing, it will be seen that an average progress of 8 to 10 ft. per month is all that can be expected. The costs of the boring process are, in consequence, exceedingly high, but for the very difficult sinking conditions obtaining in some parts of Europe it is the only process that is unfailingly successful.\*

**Direct Cementation.** — The injection of cement grout under pressure into fissured rock has been attempted only recently. Immediately around the proposed shaft a number of holes are drilled through the fissured rock into the solid measures beneath, and grout is forced into them until all crevices are filled. It is then allowed to set, and, if the work has been properly done, sinking can be continued in the dry.

The water-bearing fissures can best be located by using core drills rather than percussion drills in boring the holes. If only one crevice exists, the grout will flow directly into it; if, however, the rock is fissured for some distance, while grout is flowing into the upper cracks, the hole beneath them may become blocked before the lower cracks are filled. In this case the water will not be completely shut off.

Up to the present time the blocking of the fissures in any considerable depth of rock has only been accomplished by successive cementations. This was done in the two cases described below. The writer believes, however, that if the holes are bored entirely through the wet rock, a method can be devised for filling the cracks from the bottom up. A plan that might be worked out would be to case the holes

\* For detailed information on this process see: "Shaft Sinking in Difficult Cases," by J. Riemer.



with flush-joint pipes to the bottom, then to gradually withdraw the pipes as the grout is pumped in. The grouting apparatus would have to be so arranged as to permit quick disconnection and reconnection upon the removal of each length of pipe, to avoid the possibility of the grout setting in the pipe while the flow is interrupted.

The following account of the cementation of a shaft sunk by the Mining Society of Lens is an abstract from an account published by C. Dinoire in Volume XXXI of the Transactions of the Institute of Mining Engineers (English):

The Mining Society of Lens decided in October, 1904, to sink two shafts, one by the freezing method and one by hand. The water encountered in the second exceeded the expectations to such an extent that it could not be pumped and the feeders had to be stopped by direct cementation.

This shaft was sunk to a depth of 166 ft. before an inflow of 2200 gallons per minute made cementation necessary. The pumps were worked very hard to hold the water down as low as possible, and two lines of 2-in. pipe, extending from the surface to the bottom of the shaft, were installed. As some of the water came in through a nearly vertical fissure in the shaft bottom, and some through a horizontal seam, one of the pipes was driven into the fissures for 9 ft. and the other was terminated opposite to the seam, Fig. 46. Four 8-in. bore holes, 197 ft. deep, were then put down outside the shaft area. They were spaced evenly 13 ft. from the circumference of the shaft. At a depth of 190 ft. they passed through a bed of very seamy rock. A hand pump was put on each of these holes in order to pump out all sand and mud caused by boring.

Three hundred and sixty sacks of cement mixed as a thin grout were then run into the pipe which terminated opposite the horizontal seam. This took seven hours; the grout mixer was then connected to the other pipe to give the grout in the bottom of the shaft a chance to set. Two hundred and ninety sacks were run into this pipe in three hours, when the lower end became blocked. Ninety sacks

were then run into the first pipe, completely filling it, after which the bore holes were filled. This required 475 sacks. The pumps on the bore holes were worked continuously while the pipes were being grouted.

The grout was allowed to set for nineteen days before the water was pumped out of the shaft. It was then found that the leak was completely closed and a 2½-ft. layer of

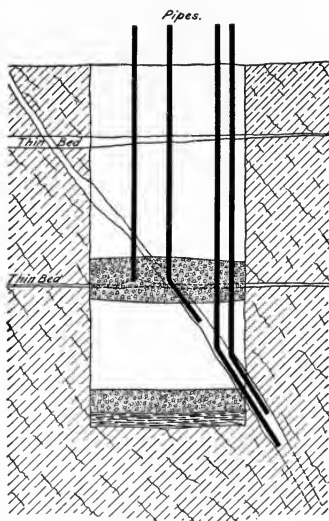

FIG. 47. — Location of Pipes and Fissures in Lens Shaft

grout had formed on the bottom. The rest of the grout, amounting to 282 cu. ft., had run into the fissures.

The bed of grout was sunk through very carefully, and the shaft deepened to 170 ft. and lined to the bottom. At 185 ft. a second inflow was encountered, the water breaking in through the vertical fissure referred to above. Two more grout pipes were inserted, their lower ends being driven 3 and 6 ft. into the fissure. Nine hundred sacks of cement

were run into the longer pipe in nine hours, when the lower ends of both pipes became closed.

After twenty-eight days the water was pumped out and sinking was resumed. The large fissure was found to be this time thoroughly cemented, and further sinking and lining was carried on without particular difficulty.

It was found in the first cementation, where the mixer discharged directly into 2-in. pipes, that considerable air was carried down with the grout. This hindered the flow very greatly, so that in the second cementation the grout pipes were made  $1\frac{1}{4}$  in. diameter above water and  $2\frac{3}{4}$  in. under water, a high narrow tank was connected with the top of the grout pipe, and a valve was provided to regulate the flow from the tank, which was kept full. The mixer discharged into the tank through a trough, with gratings for removing air.

The more important conclusions reached were:

1. Fissures in rock can be cemented through pipes or bore holes.
2. Sand, marl, boulders, clay, and slime cannot be cemented.
3. Thin beds presenting continuous openings can be cemented by pumping from bore holes outside the shaft.

Direct cementation has also been applied at the Anzin and the Bethune collieries in Europe.

Direct cementation has only been attempted in America in one instance. No. 4 shaft on the Rondout siphon of the Catskill Aqueduct encountered a flow of water of 750 gallons per minute at a depth of 270 ft. The shaft is rectangular with three compartments, measures only 8 ft. 4 in.  $\times$  20 ft. 4 in. in the clear, and thus affords very little opportunity for handling large pumps. In addition to this fact the water was strongly charged with sulphureted hydrogen gas, which acted very painfully upon the eyes of the sinkers.

After no progress had been made for several weeks, it was decided to try grouting. Most of the water came directly out of the bottom. The water level was held within

about 5 ft. of the bottom and a number of holes from 10 to 18 ft. deep were drilled with rock drills. Two-inch pipes were connected to these holes, and about 1500 sacks of cement, mixed as neat grout, were forced into them. This reduced the flow of water in the bottom from 525 to about 50 gallons per minute.

In order to block the fissures below the shaft bottom, a diamond drill was set up on a platform at the top of the shaft, and six holes were drilled, each about 95 ft. deep. A column of 3-in. pipe extending from the top to the bottom of the shaft served in each case as a guide for the drill rod. These holes passed entirely through the water-bearing rock, which consisted of a badly fissured sandstone, and penetrated an impervious stratum of grit beneath. Two-inch grout pipes were now connected to these diamond-drill holes and 183 sacks of cement were forced into them. This entirely cut off the water in the bottom.

It was found upon pumping out the water that all the upper fissures were completely filled. When sinking was resumed, however, it was further found that the drill holes had become blocked before the lower fissures were completely filled, and the water, therefore, was not altogether shut off. After the cementation it was, nevertheless, possible to handle the water with pumps and sink about 10 ft. a week in the ordinary way.

In filling all the holes the grout pipes were carried to the top of the shaft. The grout was mixed and fed into a tank attached to the top of each pipe. When no more grout would flow by gravity, the opening in the tank was closed, and air pressure applied on top of the liquid grout. The pressure ranged from 80 lbs. to a maximum of 300 lbs. per square inch, which last was obtained by means of a special air compressor.

NOTE.—For further information about methods of grouting see Appendix A.

## CHAPTER VIII

### LIFTING WATER. HORIZONTAL VS. VERTICAL PUMPS. HANDLING PUMPS IN SHAFT. CORNISH PUMPS

MODERATE quantities of water are ordinarily raised from the bottom of a sinking shaft by one or more pumps, suspended or supported in the shaft just above the bottom, and lowered from time to time as the shaft is deepened. The usual motive power is steam or compressed air; electric pumps are being developed, but so far have not been successful.

The work that a sinking pump is called upon to do is exceedingly arduous. It must first of all be reliable; it must run on gritty water or a mixture of water and air, or sometimes on air alone for a while without injury. The valves, packing, and wearing parts must be readily accessible. It must occupy a minimum space in the shaft, and at the same time be strong and heavy enough to endure collisions with the sides in hoisting and lowering, and blows from flying fragments of rock.

Any one in this country who has tried to sink a wet shaft is more or less familiar with the features of the leading American sinking pumps. Of these the Cameron is the best known, and the Cameron pattern, Fig. 48, now manufactured by a number of firms, certainly comes nearest to filling the requirements. This is built in both vertical and horizontal piston and outside-packed plunger styles, and is marked by the absence of outside valve gear, by the thickness and strength of the castings, and by the accessibility of the water valves and packing.

The manufacturers as a rule recommend the vertical pump for sinking, but the writer's experience has taught

him otherwise. When there is only a slight inflow of water, a small vertical pump with hose connections is certainly very easy to hang in the shaft; on the other hand, a horizontal pump, with a capacity of 150 gallons per minute

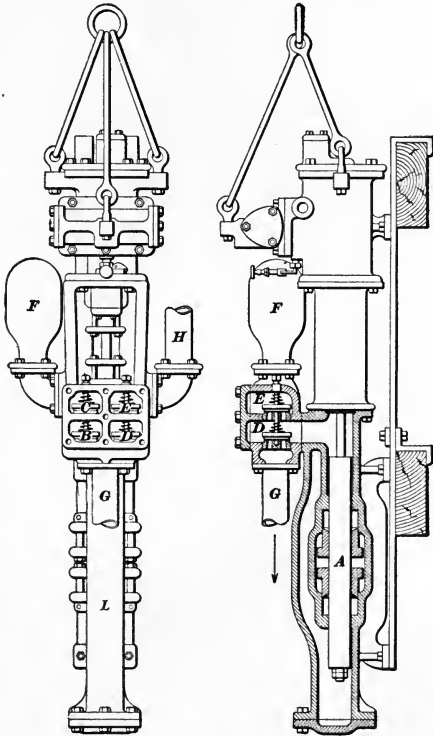

FIG. 48. — Vertical Sinking Pump

or less, will work perfectly when hung with a bridle. Where there is a considerable flow of water, and where the shaft is large enough to accommodate a horizontal pump or pumps of the required capacity, this is the type to use. Where the

shaft is so small that there is not room in it for enough horizontal pumps to take care of the water, a vertical pump is of course a necessity.

The writer's reasons for preferring the horizontal pump are:

1. The horizontal pump is lighter than a vertical of the same capacity.

2. In the larger sizes the horizontal pump is much more accessible, since a man can walk around it and work at any part of it on a level platform. It is necessary to climb 6 or 8 ft. to get from the water end to the steam end of a big vertical pump.

3. By providing a proper bridle, the horizontal pump can be hooked on to and lifted as easily as the vertical.

4. For a pump discharging over 300 gallons per minute, the recoil at every stroke is so severe that hose or other flexible connections will not stand when the pump is hung freely. This applies to the American style of vertical sinking pump, where the center line of neither suction nor discharge coincides with the center of suspension, as well as to a horizontal pump. In both cases it is necessary to furnish rigid support, and it is as easy to set two hitch timbers in a horizontal plane for a horizontal pump as it is to set them in a vertical plane for a vertical pump.

In sinking several shafts in which the flow of water in the bottom varied from 800 to 1500 gallons per minute, the writer has obtained the best results by working along the following lines:

Provide an absolutely reliable boiler plant of ample capacity. Sinking pumps are frightfully uneconomical, requiring from 200 to 250 lbs. of steam per actual horse-power hour; a shaft in which 1000 gallons per minute must be lifted 300 ft. will, therefore, require  $\frac{1000 \times 8\frac{1}{3} \times 300 \text{ ft.}}{33,000}$

$\times \frac{200}{30} = 505$  horse-power of boilers for pumping alone.

Put in a water ring, Fig. 49, and a stationary pump

wherever it is possible to reduce the water in the bottom by so doing. When the water-bearing stratum has been sunk through, open up a "lodgment" or reservoir in one end of the shaft and install a compound pump.

For handling water in the bottom provide at least 50 per cent. extra pumping capacity; say, four 350-gallon

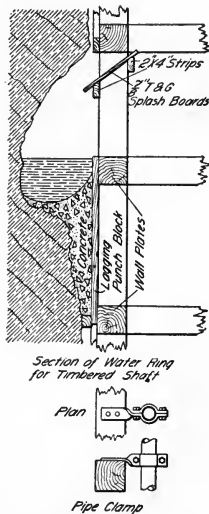

FIG. 49. — Section of Water Ring for Timbered Shaft

pumps for 900 gallons per minute, two in each end of the shaft. Set bearing timbers, Fig. 50, as close to the bottom as is safe, and lower pumps alternately 10 ft. at a time, keeping 10-ft. and 20-ft. flanged lengths of steam, exhaust, and water pipes ready to put on. If each new set of timbers is placed 10 ft. from the bottom of the shaft, the maximum suction lift at any time will thus be 20 ft. Make swinging joints on all pipe lines at the pumps, to take care of vibration and expansion and of variations in the spacing of the



hitch timbers. Do not attempt to lift pumps when blasting; remove suction hose only and shoot carefully.

Provide an independent column pipe for each pump, and keep the pipes in the hoistway. Main steam and exhaust lines should be kept in one end of the shaft for the greater part of their length in order to create an upward current of

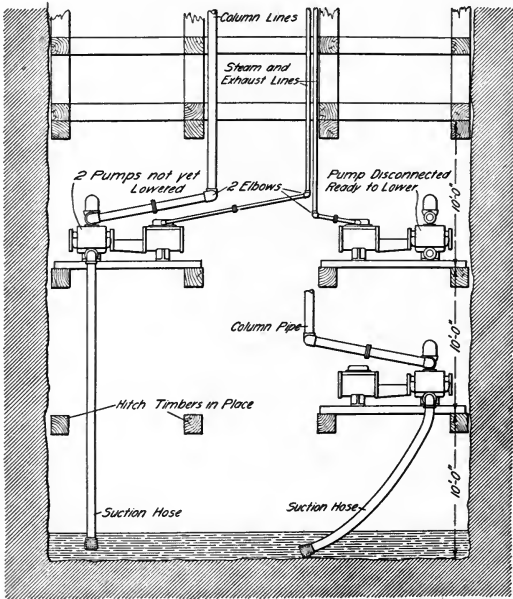

FIG. 50. — Arrangement of Pumps for Sinking

air in that end and assist ventilation. Handle pumps with independent engine, arranged to hoist from any compartment. Clamp pipes to timber every three lengths.

Too much care cannot be taken to obtain tight joints in all pipes, to fasten them securely to the timbers, to keep the pumps in good repair and plenty of spare parts (valves,

stems, packing, etc.) on hand, and to keep the follower bolts and nuts tight. It is advisable to fasten these securely with cotter pins, or by drilling through the heads and wiring them together.

Pumps will run satisfactorily on compressed air if the air is reheated sufficiently to prevent freezing. As a rule, the cost of the air plant makes it imperative to use steam on the pumps. Both steam pipes and exhaust pipes should be lagged with some water-proof covering.

At best, many delays will occur when water is handled. For a shaft making 800 to 900 gallons per minute, 15 to 20 ft. per month is good progress; the labor cost may easily reach \$150 to \$200 per foot. Sinking with insufficient machinery is impossible.

In this country water is usually regarded as an unfortunate accident, and when encountered is met by begrudged additions to the plant. As a result much time and money are wasted. In Europe, on the other hand, the mining districts have been more fully explored and developed, and the position of water-bearing strata is known. Preparations are made in advance for handling large quantities of water. The shafts are circular and are lined in sections as the sinking proceeds with brick or water-tight iron tubing; their large diameter and freedom from cross-braces make it possible to use more powerful pumps. An actual measured flow of from 2000 to 2500 gallons per minute in the shaft bottom is as much as has been successfully taken care of in America. In the two English cases cited below two to three times this much water was pumped.

In the Transactions of the Federated Institute of Mining Engineers, Volume III, page 513, Mr. W. H. Chambers describes the sinking of two shafts at Conisboro, Yorkshire. Eight 30 ft.  $\times$  7 ft. 6 in. Lancashire boilers were installed, and sinking was then commenced in both shafts simultaneously. The water was handled by pulsometers to a depth of 156 ft., when an inflow of water occurred that made it necessary to put in very much more powerful pumps.

The sinking pumps, Fig. 51, were made by Baily & Co., of Salford, and were designed to run suspended in the shaft without other support than two suspension ropes which also carried all pipe lines. A telescopic suction pipe is provided instead of suction hose, and the axes of both suction and discharge pipes coincide with the axis of suspension. All vibrations caused by the strokes of the pump are, therefore, vertical and cause no dangerous sideways motion in the pipe lines. The pump itself "consists of three hollow plungers; the upper pair are stationary and over them slide barrels which are connected to the steam piston. The third barrel is secured, together with the pair of stationary plungers, to the steam cylinder by means of connecting rods." The pump is thus what is here known as the differential plunger type. Two discharge pipes are led from the top of the upper stationary plungers alongside the steam cylinder, and are joined above it by a tee from which the column pipe rises.

The two suspension ropes are led over pulleys at the shafthead to the drum of a hoisting (or capstan) engine, and the pump and all piping are hoisted and lowered together. A telescopic joint is put on the steam pipe at the shaft head, the discharge pipe is turned sideways over a trough, and the exhaust pipe stands straight up. The arrangement of pump and pipes in the shaft is shown in Fig. 52 and the method of supporting the pipes is shown in horizontal section in Fig. 52a.

Six pumps of this type, each with a capacity of 50,000 to 70,000 Imperial gallons per hour at 35 strokes per minute, were needed to sink the shafts to a depth of 300 ft. In this depth the maximum quantity of water discharged from both shafts amounted to 6600 gallons per minute, although the tubbing was carried along with the sinking. Two more pumps were then obtained, and the eight were arranged to lift the water in two stages, as 300 ft. was the maximum lift of each pump. The water was finally shut off at a depth of 395 ft. in one shaft and 369 ft. in the other.

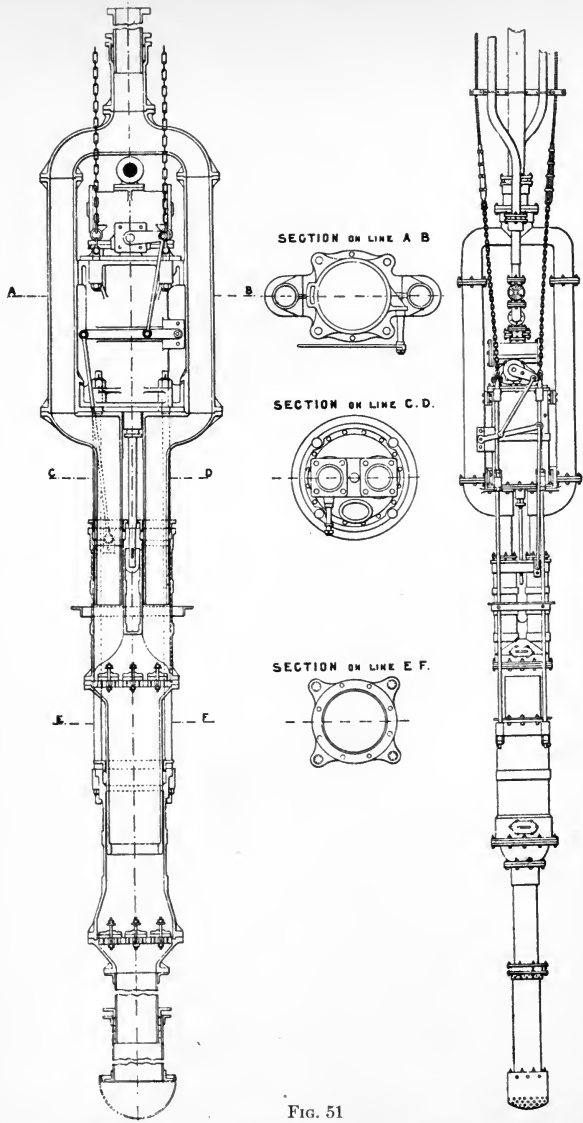

FIG. 51

Mr. Chambers describes the operation of the pumps as follows:

“As the sinking progressed, after the suction pipe was

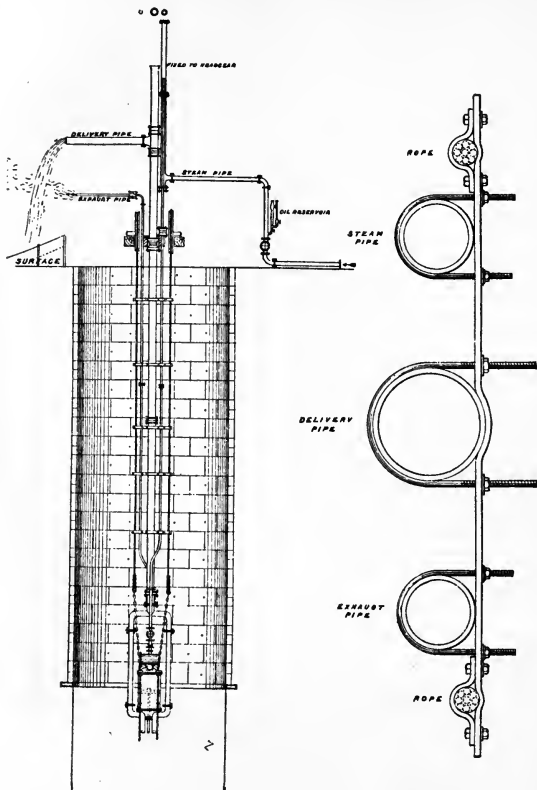

FIG. 52

FIG. 52a

drawn out to its full extent, the pump with the columns of pipe was lowered by running the ropes off the capstan, and exhaust and water pipes were built as required on top; the

steam pipe, after being drawn its full length out of the stuffing-box, was pushed back and another length inserted.

“A stop valve and a lubricator were placed in the fixed steam pipe on the surface. A lad was in charge to regulate the supply of steam as required, he being in communication with the sinkers in the shaft by means of a signal bell. The speed of the pumps was thus controlled and lubrication effected without any one being in the shaft for these purposes.”

Perhaps the most remarkable achievement in the line of wet-shaft sinking that was ever accomplished was the sinking at the Horden colliery in Southeast Durhamshire. This work is described at length in a very interesting paper by Mr. J. J. Prest, the engineer in charge. The paper is published in the Proceedings of the Institution of Civil Engineers, Volume CLXXIII, Part 3.

At this colliery three shafts were sunk, two of them simultaneously; the third was put down to the level at which the greatest flow of water occurred, and there stopped until the other two reached the coal measures. Mr. Prest, after careful consideration, determined to use the old-style Cornish pump and installed a very remarkable plant, comprising over 3000 boiler horse-power and no less than four sets of 30-in. bore by 6-ft. stroke pumps. Each set consisted of a pair of pump cylinders hung so as to balance each other, and capable of being arranged as a high-and a low-lift set. The pumps were driven by the permanent hoisting engines, provided with an extra jack-shaft and gearing.

The maximum quantity of water handled simultaneously from all three shafts amounted to 9230 Imperial gallons per minute, and the maximum from one shaft to 6310 gallons per minute, this quantity being pumped from a depth of 300 ft. The shafts reached an average depth of about 540 ft. before the coal measures were reached and it was finally possible to tub back the water.

A system has been developed in England for hoisting water from a sinking shaft without the use of any high-

pressure pumps. It is known as the Tomson water-winding process. Mr. Tomson puts in his permanent hoisting engine, places guides in the shaft as the sinking proceeds, and uses large tanks for lifting the water. The tanks are filled by low-pressure pumps driven by compressed air and attached to the tanks. This system has been very successful in some instances, but has not been used where the quantities of water were as great as those at Conisboro or Horden.

## CHAPTER IX

### SHAFT LININGS

SHAFTS are usually lined; either in order to exclude water, or to support the sides and prevent the falling of fragments of rock.

The most common lining material—in fact until recently almost the only lining material—used for American mine shafts is timber, ordinarily framed in square sets and lagged with plank. Such a lining cannot be made water-tight and acts only as a support or shield. Wooden caissons and coffers used in bad surface ground are of course built to exclude water, but this construction is not feasible at considerable depths.

European shafts are usually lined with brick walls, built upon cast-iron curb rings set into the sides of the shaft at intervals. The circular and elliptical sections universal in Europe are in fact accounted for by the necessity for arch action in a brick lining. The walls are not designed to absolutely exclude water, but to lead it to water rings at the curbs and prevent it from dripping in the shaft. A brick lining is fire-proof and durable.

Where it is desired to block back large feeders of water, cast-iron tubing is used. This has already been referred to in connection with the Boring Process. Two styles of it are used in Europe, known respectively as English and German tubing; the writer knows of no case where it has been used for a mining shaft in this country, but miles of subaqueous tunnel around New York City are lined with bolted cast-iron segments.

In the last decade, concrete has come to the front as a material for lining shafts. It is gradually being realized



that, when properly handled, concrete can be made as water tight as iron; it is stronger than brick and as durable, and is cheaper than either iron or brick. The first shaft in America to be entirely lined with concrete was sunk by the U. S. Coal and Coke Co. at Tug River, West Virginia, in 1903. Since then this construction has been adopted for a dozen shafts or more.<sup>7</sup>

Of the various kinds of shaft lining, timber is the easiest to place and in America is still the cheapest in first cost. This advantage, however, diminishes every year; good timber is scarce and dear to-day, and ten or fifteen years hence — the life of a timber lining — will be scarcer and dearer. A timbered shaft in a mine whose life is expected to exceed the life of the original timber is thus a very doubtful investment.

Considerations of safety present a stronger argument against the use of timber in coal mine shafts. A severe explosion in the mine will wreck the lining and fill the shaft with twisted timber, thus cutting off all hope of escape or rescue from the men imprisoned below. This danger has long been avoided in Europe by the use of walled shafts, and before many years public sentiment in America will demand that it be avoided here. A Pennsylvania law now on the statute books prohibits the use of wood in permanent tipples or breakers within 200 ft. of the shaft head; why should not this law be logically extended to cover timber in the shafts itself?

In ore shafts and construction shafts the same objection to timber does not apply, although the possibility of fire must be considered. This is not often a serious danger as the timbers are usually so wet that nothing short of an explosion could ignite them. A system of reinforced concrete "timbers" which has been proposed and patented is intended to retain the advantages of a rectangular timbered shaft, and at the same time provide a fire-proof lining that is easily placed. It has never been used.

**Timbering. Buntons.** — In rock that is hard enough to stand without support and is not affected by frost and



may be dropped into place. The buntons are usually set on 5-ft. centers vertically, so that workmen standing on a platform on one row of timbers can cut the hitches for the next row without scaffolding. (See Fig. 54.)

After the buntons are placed in the hitches they are secured and held in line by oak wedges driven in tight. The hitches are cut just enough larger than the timber to allow for wedging. The depth depends upon the rock; specifications usually call for 12 to 18-in. hitches, but, as a matter of fact, in any rock hard enough to stand without support a 4-in. hitch will break the timber.

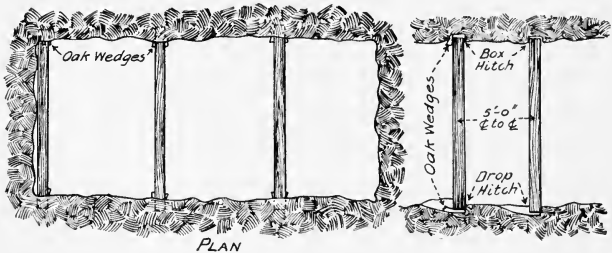

FIG. 54. — Shaft Timbered with Buntons Only

Hitches are usually cut by hand with hammer and bull point, but pneumatic hammers can be used to advantage in hard rock. When working by hand a pair of men (hammersman and holder) should finish a pair of hitches in an eight-hour shift. The labor cost per timber is thus about \$5 net, or \$7 including headmen, engineers, etc.

**Ring Timber.** — The commonest form of timber lining, and the one that is used in all large shafts, consists of horizontal square-framed sets, spaced 4 to 6 ft. centers and lagged with 2 to 3 in. plank. (See Fig. 53.)

In a previous chapter, the terms buntton, end plate, wall plate, and punch block were defined as the cross struts, end timbers, side timbers, and posts, respectively, in a square-framed set of timber. Each set consists of two wall plates

and two end plates halved at the corners, and one or more buntons, butted against the inner faces of the wall plates to serve as struts. The buntons also divide the shafts into the requisite number of compartments and afford support for guides, etc. The sets are separated by posts or punch blocks placed at the corners and at the end of the buntons.

Lagging plank are set vertical and close together. They are usually placed back of the timber, and are held by cord wood or slabs packed into the space between them and the rock. This packing also acts as a support for the sides of the excavation. To prevent plank from falling in case of displacement of the packing, they should be well spiked to the timbers top and bottom. The best construction is effected by spiking  $2 \times 2$  in. strips horizontally in the middle of the outer faces of the wall and the end plates; the lagging boards are then cut two inches short of the center to center spacing of the sets, and are inserted between the strips.

In hard rock packing is not necessary, but lagging is usually needed to prevent water from splashing into the shaft and to lead it to the rings. In this case, the lagging boards are placed between the timber sets and are held by strips nailed to the top and bottom faces of the timbers. Sometimes these strips are beveled so as to lead water to the back side.

When a shaft has been sunk without support as far as the condition of the sides will permit — say 50 to 100 ft. — a set of hitch timbers (dead logs or bearing timbers) is placed as a foundation, and the timbering is built up through the unlined section. The hitch timbers are set into hitches cut in the rock as described above, and must be perfectly level and in line. Since they are to carry a great weight the hitches must be deep enough to afford a bearing equal in strength to the timber. The hitch timbers are often made deeper than the ring timbers;  $8 \times 12$  in. hitch timbers, for instance, for  $8 \times 10$  in. ring timbers. A heavy floor is built over the hitch timbers between the first set of timber and the wall, to carry the packing. (See Fig. 58.)

Each set of timbers must be securely blocked and wedged in the corners and opposite the edge of the buntions. The lagging and packing are then finished before the timbers for the next set are lowered. The workmen stand on planks laid across the buntions and raised as each set is completed. In order to avoid splicing, the wall plates for the two or three closing sets (joining to completed timbering above) must be lowered into the shaft, laid upon the timbers already placed, and then raised horizontally.

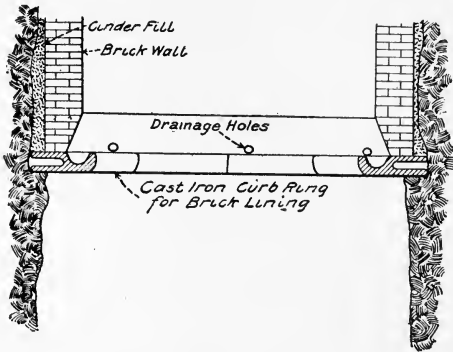

FIG. 55.— Brick Shaft Lining

Corner joints should be framed so as to develop the full strength of the timbers. Punch blocks and buntions are usually notched into the wall plates, being thus secured laterally; the punch blocks are allowed to extend out under the ends of the buntions to provide vertical support. In addition, keystone shape notches are often cut in the wall plates, into which the ends of the buntions are fitted.

The cost of placing ring timbers of this type varies from \$20 to \$30 per M. ft. B.M.

In small shafts, the lagging plank are often placed horizontally and spiked together, and are notched into each other at the corners. This gives all the support that is required in a small square shaft or well; in a compartment

shaft, pairs of vertical timbers serving both as posts and girders are placed against the side, and buntons are set between them. Vertical nailing strips are also put in the corners. (See Fig. 58a.)

**Brick.** — The thickness of a brick lining varies from 9 to 18 in., depending on the size of the shaft and the nature of the rock. A 13-in. wall is the usual thickness for a 16-ft. shaft. The wall is built in sections 50 to 100 ft. long, each of which is founded on a curb of wood or iron built in segments and set into a groove in the side of the shaft. This groove is cut by hand, the bottom being made perfectly level, and the curb is carefully wedged into shape exactly concentric with the shaft. If much water leaks into the shaft in the section that is to be lined, the curb is made of iron and the space behind it is filled with wooden blocks and wedges driven in tight, as will be described in detail later. A water ring is cast on the inside of the curb, and drainage pipes leading through the lining to the ring are provided. (See Fig. 55.)

The work of setting the curb and building the wall is done on a suspended scaffold which is raised as required by a special engine at the surface. The wall is built very rapidly as several masons can work without interference — six masons, if kept supplied with brick and mortar, can easily build 6 to 8 ft. of wall per shift.

In deep shafts recently sunk in England, the work has been so arranged that sinking and lining are carried on simultaneously. Two buckets are used, one of which hangs in the center of the shaft, and passes through a hole in the walling scaffold. The other hangs sufficiently off center to clear the sinking bucket, and is used for supplying material to the masons. The ropes which suspend the scaffold also serve as guides for the buckets. This method is only feasible for large shafts.

The brick should be made of good clay, burned hard enough to withstand the action of water. Mortar is made of quick-setting Portland or hydraulic cement and is used

as sparingly as possible. The space back of the wall is filled with concrete, tamped clay, or cinders.

**Iron Tubbing.**—Both English and German tubbing consists of cast-iron segments and is built up in rings. The

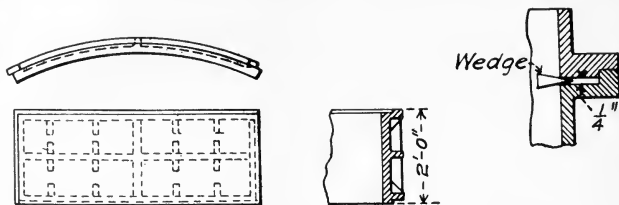

FIG. 56.—English Tubbing Segment — 15 to Circumference

English segments, however, have rough edges and no bolts and are made water-tight by wedging the cracks with wood, whereas the German have machined edges provided with flanges and are bolted together. Lead gaskets are used to make a tight joint. English segments are about 2 ft. and German about 5 ft. high.

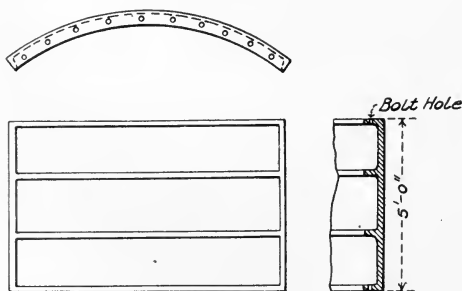

FIG. 57.—German Tubbing Segment — 8 to Circumference

The process of setting a wedging curb and building up English tubbing in wet rock is described by Mr. J. J. Prest as follows:

“The shaft was sunk about 9 or 10 ft. into the impermeable stratum, of the full diameter of, say, 23 ft., and then decreased abruptly to the finished size of the shaft, say 20 ft., and the sinking was continued a further distance of 6 or 8 ft. The cradle (walling scaffold) was then lowered

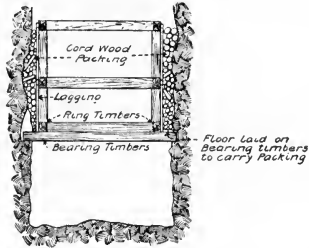

FIG. 58

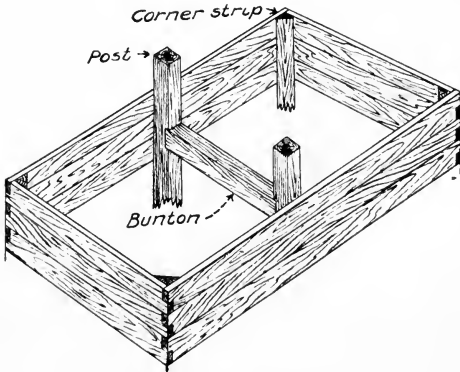

FIG. 58a. — Timber Sketches

into the pit bottom and a temporary wood water-ring was fixed on dowels about 9 or 10 ft. above the site selected for the bed of the wedging curb. The whole of the water running from the sides of the shaft was then collected in this temporary water-ring and allowed to run off in canvas hogges or trunks at two or three different positions to the pumps.



“The cradle having been fixed in position, the sinkers proceeded to level the surface of the rock bed with mat-tocks, and when this was accomplished to the satisfaction of the engineer, a wedging curb, three segments of which were fitted with valves to pass gas or air accumulated behind the tubbing, was laid on the bare rock, seasoned red-wood sheeting  $\frac{3}{8}$  in. thick was placed between all end joints, and the spaces between the back of the curb and the rock were filled with dry-wood gluts to bring the inside of the curb up to the finished diameter of the shaft. Afterwards well-seasoned tapered dry-wood wedges were driven into the wood packing between the back of the curb and the strata until steel chisel points refused to enter. Then a layer of  $\frac{3}{8}$ -in. horizontal sheeting was placed on the top of the wedging curb, and the 2-ft. foundation course of tubbing was put on, breaking joints with the curb,  $\frac{3}{8}$ -in. red-wood sheeting being placed between the end and horizontal joints, and the course was brought up to the correct radius of the shaft by means of wood packing. Next one or two courses of plain tubbing were put on, the fourth course usually containing three or more special segments (technically termed ‘valve-segments’), cast with holes 4 to 6 in. in diameter in the center, with the object of permitting the water to pass from the back to the front side of the tubbing, and so to the pumps, when the temporary wood water-ring was removed.

“The next operation was to wedge lightly the vertical joints of the three or four courses of tubbing, and to run the whole up solid with good cement grout. The temporary water-ring was then removed, and additional courses of ordinary tubbing were built on, to a total height of about 60 ft. The joints were now lightly wedged, commencing from the top with the vertical joints, and from the bottom with the horizontal seams, using red-wood wedges. Additional courses of segments of suitable height being used to close up to the wedging curb above, the vertical and horizontal seams were again twice wedged alternately as before, and the small center holes in each segment were

plugged. Finally the large holes in the valve segments passing the feeders were plugged simultaneously with long tapered plugs of wood, the excess being sawn off flush with the front side of the orifice, the cast-iron caps were bolted on to the flanges and the shafts was rendered dry if the work had been well carried out."

German tubbing is started from a wedging curb and is bolted together as built up. When the rock itself is treacherous as well as wet, under-hanging tubbing is sometimes employed. In this case a wedging curb, faced on the bottom and provided with bolt holes, is set just above the shaft bottom. The segments are lowered to the bottom, and are grasped one at a time with a special pair of tongs and raised to the under side of the curb. Each segment is then suspended by two bolts with long threads and the tongs are removed. The lead gasket is inserted; the segment is raised to place by screwing up the nuts on the long bolts, and is then bolted up tight. The process is repeated as soon as the shaft has been deepened sufficiently. After each ring has been bolted up, the opening at the bottom between it and the rock is closed with plates and wedges, and the space behind is filled with cement grout poured in through holes in the segments.

## CHAPTER X

### CONCRETE LININGS. COSTS PER LINEAR FOOT FOR RECTANGULAR, ELLIPTICAL, AND QUADRILATERAL SHAFTS

Two types of concreted shafts are to be considered: the circular or elliptical, with unsupported lining; and the rectangular, with reinforced concrete lining supported by steel beams, concrete buntons, or walls. In both, the concrete is placed directly against the rock walls and an inner form only is required. From a construction standpoint the types are equally feasible, and the choice depends upon the cost. In several cases known to the writer a compromise has been effected by shaping the shaft as a quadrilateral with sides formed of circular arcs.

For a single compartment air shaft the circular shape is in every way the most desirable, not only because the circular shaft is cheaper to sink than a square shaft of equal area, but also because a circular ring of plain concrete is the strongest lining possible with a given amount of material.

In the case of a shaft with two or more compartments, the selection of the most economical shape requires some calculation. At first sight it would seem that a simple rectangular shaft, surrounded by a concrete wall only thick enough to be as strong as the usual timber lining, would be a satisfactory, as well as a cheap, shape, but this is not the case. A concrete lining, even when provided with weep holes, must resist some hydrostatic pressure; a timber lining has none to resist. Furthermore, permanent weep holes are most undesirable; the concrete should exclude the water entirely, and hence must be designed to bear very great pressure at considerable depth. Just what amount the theoretical pressure is reduced by the adhesion of the

concrete to the shaft walls and by the blocking of the fissures with grout cannot be calculated. In solid rock, where the

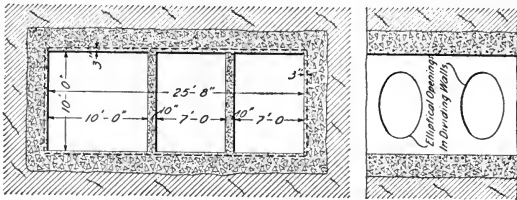

FIG. 59. — Rectangular Concrete Lined Shaft

water enters in well-defined springs, the proper grouting of the springs will relieve the lining of all pressure. In very

TABLE 1. QUANTITIES AND COSTS OF RECTANGULAR SHAFT

	20	50	100	150	200
Depth in feet . . . . .	20	50	100	150	200
Total thickness of lining in inches	14	21	28	34	39
Quantities per linear foot:					
Concrete to neat line in cu. yds.	3.90	5.70	7.60	9.30	10.70
Concrete, actual in cu. yds. . . . .	5.80	7.70	9.70	11.50	13.00
Excavation to neat line in cu. yds. . . . .	12.80	14.60	16.50	18.20	19.70
Excavation, actual in cu. yds. . . . .	14.70	16.60	18.60	20.40	22.00
Weight reinforcing steel in pounds . . . . .	256	443	650	845	1,030
Costs per linear foot:					
Forms . . . . .	\$ 25.00	\$ 25.00	\$ 25.00	\$ 25.00	\$ 25.00
Concrete at \$5 cu. yd. . . . .	29.00	38.50	48.50	57.50	65.00
Excavation (see note *) . . . . .	49.60	53.20	57.00	60.40	63.40
Reinforcing steel at \$.02 lb. . . . .	5.10	8.90	13.0	16.90	20.60
Total . . . . .	\$108.70	\$125.60	\$143.50	\$159.80	\$174.00

seamy rock, on the other hand, the lining may have to bear paretically the full hydrostatic pressure.

In order to compare the costs of the different shapes, let

\* NOTE. — Cost of excavation figured on basis of \$4 per cubic yard for section containing 12 yards per linear foot; additional excavation at \$2 per cubic yard. Thus, cost of 16 cubic-yard section =  $12 \times \$4 + 4 \times \$2 = \$56$ . These unit costs are for purposes of comparison only and should not be used for estimating.

us consider in detail three designs for a shaft with two  $7 \times 10$  ft. hoistways and an airway with an area of 100

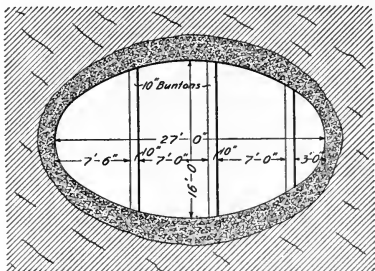

FIG. 60. — Elliptical Concrete Lined Shaft

sq. ft. As the whole area of a hoist shaft is ordinarily used for the passage of air, the size of the air compartment

TABLE 2. QUANTITIES AND COSTS OF ELLIPTICAL SHAFT

	{ 0 to 100	150	200	250	300	400
Depth in feet, . . . . .						
Thickness of lining in inches, ends . . . . .	12	12	12	12	12	12
Thickness of lining in inches, sides . . . . .	12	18	24	29	34	42
Quantities per linear foot:						
Concrete to neat line, cu. yds. . . . .	2.60	3.40	4.30	5.00	5.70	6.80
Concrete, actual in cu. yds.	4.40	5.20	6.10	6.80	7.50	8.60
Excavation to neat line in cu. yds. . . . .	15.20	16.00	16.90	17.60	18.30	19.40
Excavation, actual in cu. yds. . . . .	17.00	17.80	18.70	19.40	20.10	21.20
Costs per linear foot:						
Forms . . . . .	\$15.00	\$15.00	\$15.00	\$15.00	\$15.00	\$15.00
Concrete at \$5 cu. yd. . . .	22.00	26.00	30.50	34.00	37.50	43.00
Excavation (see note*) . . .	54.40	56.00	57.80	59.20	60.60	62.80
Total . . . . .	\$91.40	\$97.00	\$103.30	\$108.20	\$113.10	\$120.80

may be reduced if the rest of the shaft is enlarged; the airway must, however, be large enough to contain pipes and

ladders and to provide in addition an ample passage for air if the hoistways are temporarily closed.

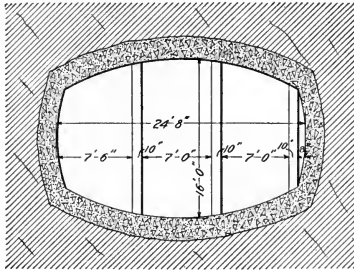

FIG. 61. — Quadrilateral Shaft

Let us assume a minimum thickness of 12 in. of concrete for a water-tight lining; also that in each case the lining

TABLE 3. QUANTITIES AND COSTS OF QUADRILATERAL SHAFT

Depth in feet . . . . .	0 to 100	150	200	250	300	400
Thickness of lining in inches . . . . .	12	19	26	32	39	52
Quantities per linear foot:						
Concrete to neat line in cu. yds. . . . .	2.70	4.40	6.20	7.90	9.90	13.90
Concrete, actual in cu. yds. . . . .	4.50	6.30	8.20	10.00	12.10	16.20
Excavation to neat line in cu. yds. . . . .	14.90	16.60	18.40	20.10	22.10	26.10
Excavation, actual in cu. yds. . . . .	16.70	18.50	20.40	22.20	24.30	28.40
Costs per linear foot:						
Forms . . . . .	\$15.00	\$15.00	\$15.00	\$15.00	\$15.00	\$15.00
Concrete at \$5 cu. yd. . . . .	22.50	31.50	41.00	50.00	60.50	81.00
Excavation (see note*) . . . . .	53.80	57.20	60.80	64.20	68.20	76.20
Total . . . . .	\$91.30	\$103.70	\$116.80	\$129.20	\$143.70	\$172.20

carries the entire hydrostatic pressure; then the specifications for the three forms of shafts will be as follows:

**Rectangular Shaft.** — Fig. 59. Two hoistways, 7 × 10 ft.;

one airway,  $10 \times 10$  ft. Ten-inch concrete dividing walls in place of buntons. Extreme inside dimensions,  $10 \times 25$  ft. 8 in. Area airway, 100-sq. ft.; total clear area, 240 sq. ft. Thickness of lining at any point made equal to depth of simple beam of 10-ft. span required to sustain hydrostatic pressure at that point. Resisting moment and weight of reinforcement calculated by Johnson's formula, factor of safety 3. (Ultimate tensile strength of steel, 65,000 lbs. per square inch, compressive strength of concrete in beam, 2500 per square inch.) Reinforcing steel set 3 in. inside of face of wall.

Cost of forms, Table 1, includes cost of forms for dividing walls, and is therefore greater than the cost in the elliptical shafts.

Excess of actual over theoretical quantity of excavation is estimated as 15 per cent. for 28-ft. shaft. This excess increases with the length of the shaft only, as the ends are drilled to line.

**Elliptical Shaft.** — Fig. 60. Extreme inside dimensions,  $16 \times 27$  ft. Area of airway, 78 sq. ft. Total clear area, allowing for 10-in. buntons, 304 sq. ft.

Strength of lining calculated on the assumption that the stress in the elliptical cylinder at any point is equal to that caused in a circular cylinder, with a radius equal to the radius of curvature of the ellipse at the given point, by the same hydrostatic pressure acting upon it. The lining is therefore made thicker at the sides than at the ends.

To prove this proposition, assume the lining to be constructed of a number of small portions, each the arc of a circle. The stress in each portion caused by the hydrostatic pressure of the film of water between it and the rock is directly proportional to the radius, and the thickness of each section should therefore be made proportional to the radius. Considering any portion, as *a-b*, Fig. 62, the skewback toward the side of the ellipse is formed entirely by the adjoining portion, while the skewback toward the end is formed partly by the adjoining portion and partly by the

rock. If the number of circular portions is indefinitely increased, the unbalanced end thrust of each will be taken up by the irregularities of the rock.

Ultimate compressive strength of concrete, 3000 lbs. per square inch; factor of safety, 3.

Excess of actual over theoretical excavation assumed as 12 per cent. for smallest section. As the length of the shaft does not vary, this excess is constant.

**Quadrilateral Shaft.** — Fig. 55. Inside dimensions, 16 × 24 ft. 8 in. Radius of ends and sides, 23 ft. Area of airway, 94 sq. ft. Total clear area, allowing for 10-in. buntons, 294 sq. ft.

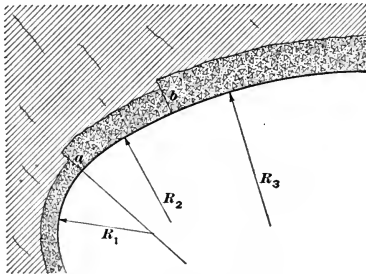

FIG. 62

For calculating stresses, sides and ends are considered as portions of a 46-ft. circular cylinder. Ultimate compressive strength of concrete, 3000 lbs. per square inch; factor of safety, 3.

Excess of actual over theoretical quantity of excavation assumed to be 12 per cent. for minimum length and to increase with the length.

**Methods of Working.** — The easiest way to concrete a shaft is to finish sinking, then start at the bottom and build up. Unfortunately this is feasible only for comparatively shallow shafts in hard dry rocks, and, ordinarily, successive lengths of lining must be placed as the shaft deepens, to protect the sides and cut off feeders of water.



When the shaft has been sunk as far as seems safe or desirable, hitches are cut in the sides, a set of bearing timbers is placed and a heavy plank floor laid upon them to support the concrete. In order to avoid injury to the concrete when sinking is resumed, the platform should be built 15 or 20 ft. above the shaft bottom. It is cheapest to cut the hitches near the bottom when the shaft is at the proper depth and then to sink three or four cuts further; scaffolding is thus made unnecessary as it is easy to place timbers in hitches already prepared. In a rectangular or elliptical shaft transverse bearing timbers are placed; in a circular shaft four timbers placed in the form of a square make the best platform. In any case an opening should be left in the bucket way so that the bottom is accessible.

Forms are started from the platform and are built in rings 5 to 10 ft. high. When each ring of forms is completed a temporary floor is laid on top of it. Concrete mixed at the top of the shaft is lowered in shaft buckets and dumped on the floor, whence it is shoveled behind the forms. To prevent loss of concrete the floor must be laid with tight joints, and this is most easily accomplished by making it in sections as large as can be lowered into the shaft. Another plan is to dump the concrete from the bucket into the forms direct through a movable chute; the necessity for laying the tight floor is thus obviated.

A  $\frac{1}{2}$ -yd. batch mixer (such as the Smith or Ransome) gives the best results. One-half yard of wet concrete is about all an ordinary shaft bucket will hold without spilling. The use of a batch mixer makes it possible to use only one bucket without losing time, as a batch is being lowered and dumped while the next is being mixed. The mixer should if possible be set below the ground level (see Fig. 63) to avoid elevating the materials. Below the mixer a platform is placed for supporting the bucket while it is being filled. This platform should be 3 ft. wide and so situated that a bucket hanging free on the rope will clear it 10 or 12 in., and should be provided with a hand rail except for

4 ft. immediately in front of the mixer. When concreting, two men stand on the platform, one on either side; the empty bucket is hoisted slightly above the platform level, is grasped

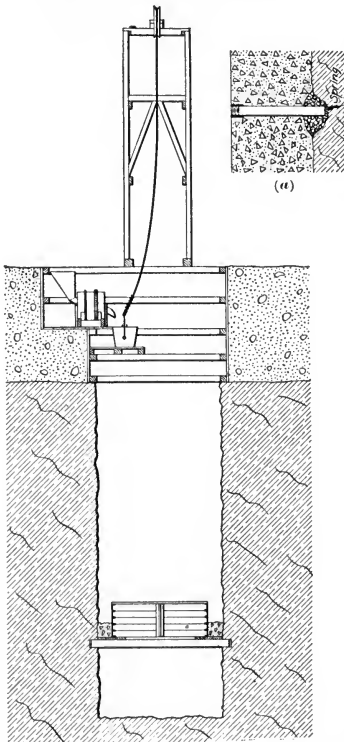

FIG. 63. — Lowering and Placing Concrete

by the two men and swung in under the discharge chute of the mixer, and is then lowered. When filled it is hoisted slightly, swings out over the shaft and is steadied by the men on the platform before being lowered.

By working as outlined above with a good organization it is easy to place 12 or 15 one-half yard batches per hour, and a shaft lining containing as much as 6 yds. of concrete per linear foot can thus be placed at the rate of more than a foot an hour — about as fast as timber. It is the time required to construct the foundation platform, to set the forms, and to connect a new section of lining to the one above it that makes the process slow.

Foundation platforms must be built and closures must be made; time can be saved only by reducing the number. Plenty of forms should therefore be provided, and the sections made as long as possible. The design of forms, both as regards strength and finish and facility of erection, demands careful consideration.

**Forms.** — The writer has had experience with three types of forms. The first, consisting of wooden slabs, was used for lining a  $17 \times 33$  ft. elliptical shaft at Tug River, W. Va. (*Engineering News*, November 7, 1904). The slabs were made of 2-in. vertical lagging planks nailed top and bottom to double  $2 \times 12$  in. centers. They were 5 ft. high, and 8 slabs made up a complete ring. These forms made a satisfactory wall, but were heavy and were greatly damaged by moving. Eight to ten hours were required to set one ring; the work was divided into two shifts, one setting forms and one concreting, so the progress made was only 5 ft. per day.

The second type, consisting of steel slabs, was used on several waterway shafts on the Catskill Aqueduct. These shafts are circular, about 14 ft. 6 in. in finished diameter, and a perfectly smooth surface is required. The slabs are 5 ft. high and are made four to a ring. Forty feet of forms were provided for each shaft. Two rings were erected at a time, the concrete being tamped and spaded with long-handled tools, and when new it was possible to erect and fill two rings in twelve hours. With use the forms become more difficult to set: the progress, including platforms and closures, averaged 10 ft. per day. A pair of wooden key

blocks is provided at opposite joints in each ring. These are chopped out to release the forms.

After a section of lining is finished, the steel slabs are usually left in place until the next section is ready and then moved down, a ring at a time. If the section to be concreted is longer than the available forms, a working platform may be suspended below the forms with ropes and the slabs taken off at the bottom and moved up. The slabs should always be cleaned and oiled before being used again.

The third type consists of angle-iron rings spaced 4-ft. centers and lagged with vertical 2-in. plank. Wooden nailing strips are bolted to the angles. These forms, although they make a surface inferior to the steel forms, are cheaper and easier to place. One ring at a time is set and filled, and by working continuously four or five can be completed in twenty-four hours. These forms are removed, taken to the surface and cleaned after each section of lining is finished.

**Placing.** — Concrete should be mixed wet, even though considerable water is present in the shaft, and should be thoroughly spaded next the forms. Springs of any volume appearing in a section that is to be lined should be taken care of in advance of the lining: this can be done by drilling a hole into the water-bearing seam, inserting a pipe long enough to carry the water out into the shaft, and caulking around the pipe. All springs should be piped through the forms into the shaft before concrete is placed, Fig. 63a, for if this precaution is neglected a very slight inflow may accumulate enough head to disrupt the green concrete and cave in the forms. The writer has known this to actually happen and has had to dig out about 80 sq. ft. of lining displaced in this way by the water from one tiny spring.

**Grouting.\***—The drainage pipes should be provided at the inner ends with sleeves set flush with the face of the wall. If the concrete has been properly placed and too much water has not been encountered, the shaft can be made dry by plugging the sleeves. If, however, the concrete is porous,

\* See Appendix A.

it may be necessary to force grout through the pipes until all crevices are filled. The grout is mixed very thin, and can be pumped in with a high-pressure pump or expelled from a tank and driven into the pipe by the use of high-pressure compressed air. Concrete can be made absolutely water-tight in this way if enough grout pipes are provided.

In closing, the writer wishes to express his gratitude to Mr. Evan Edwards, of Scranton, whose knowledge of practical shaft sinking has been of the greatest assistance in the preparation of this book.

## APPENDIX A

### GROUTING SHAFTS 4 AND 24, NEW YORK CITY AQUEDUCT

#### SHAFT 4

SHAFT 4 is concrete-lined circular shaft sunk through the Fordham Gneiss near Jerome Park Reservoir. The depth to tunnel invert is 242 ft.; the finished diameter of the concrete lining is 14' 0", and the effective average thickness of the lining in normal rock is 13". Sinking progressed without incident on the "one drilling and two mucking shift" plan until a depth of 149 feet was reached; in the first round drilled below this depth clear water was found in four of the thirty holes. The rock was solid and each hole was plugged with a wooden plug wrapped in sacking as soon as the bottom was reached.

It was thought that the water might be only a pocket, so after a proper pump had been placed one of the plugs was removed. Pumping was continued for two weeks, during which time the upper part of the shaft was lined and appliances for grouting obtained. As the flow was not appreciably diminished, it was then decided to grout the water-bearing crevice through the drill holes.

The grout mixer, which was of the air stirring type standard on the aqueduct, was lowered to the shaft bottom and coupled to the air line, and was then connected successively to the various wet holes. In order to make connections, pieces of 2-inch pipe 3 feet long with standard threads at one end were given a gradual taper at the other; as soon as a plug was drawn from a hole the tapered end of the pipe was wrapped with sacking and driven in tight, and a 2-inch stop cock screwed on. The mixer was attached to the holes by a heavy hose. The first series of holes was

grouted in one shift; the next day more holes were drilled and more clear water met with, and grouting was resumed that night. After 12 hours the holes refused to take any more grout, and operations were discontinued for 24 hours. Regular sinking was then resumed and no more water was met for a week. About 200 sacks of neat cement were used in blocking this fissure.

At a depth of 181 feet the water was again found in the sump holes, and grouting was once more necessary. This time the water was heavily charged with sand and pieces of disintegrated rock; the rock around the collars of the drill holes was seamy and it was harder both to make good connections and to force grout into the holes after the connections were made. Grouting was nevertheless persisted in and in three weeks 130 holes from 10 to 20 feet deep were drilled in the shaft bottom, and over 50 cubic yards of grout (mostly neat cement) was forced into the fissures at pressures up to 240 pounds per square inch. Almost every hole drilled met some water, and the usual procedure was to drill five or six holes, grout them, lay off a shift or two to permit the grout to set, and then to drill five or six more holes. The depth at which water was met gradually increased, and it was therefore possible to sink four feet during the three weeks of grouting. The leakage over the shaft bottom, however, gradually increased to 85 gallons a minute.

At the end of this period the shaft bottom was so thoroughly perforated that there was no sound rock left to drill into and, after an unsuccessful attempt to stop the leakage with a concrete blanket, sinking was resumed. It was found in passing through that the disintegrated area was a band varying from 1 to 5 feet in width, circling the shaft, 10 feet higher on the east than on the west side and twisted and folded in every direction. Below this was solid and perfectly sound rock.

The sand was compacted so thoroughly by the pressure

to which it had been subjected that it showed no tendency to wash out, and the flow into the shaft did not appreciably increase.

After excavating 10 feet below into the solid rock, the shaft was concreted; a special section with a minimum of 24 inches of concrete was placed for 20 feet, extending into the solid rock above and below. Reinforcing steel, consisting of 1-inch rods, 24 inches apart, vertically and horizontally, was placed 18 inches from the face to prevent cracking. The disintegrated area was first lined with thin sheet iron and the water was led through the forms before concreting. The space back of this sheet iron was packed with rock. Five days after concreting the holes were plugged, and the gauge showed 77 pounds per square inch pressure back of the lining. The leakage through the concrete after the holes were plugged was only one or two gallons per minute. When the concrete had set for a month this leakage was entirely cut off by grouting the holes.

#### SHAFT 24

Shaft 24 is of the same general construction as Shaft 4 and penetrates blocky and seamy granodiorite for its entire depth in the rock, Elevation-76 to Elevation-269. At intervals horizontal seams were encountered generally  $\frac{1}{4}$  inch to  $\frac{1}{2}$  inch thick which were filled with finely crushed rock that allowed water to flow into the shaft, usually in only one point of the seam. As\* the seams were encountered holes were drilled into them 2 or 3 feet deep wherever there was any leakage and when the shaft was concreted these holes were fitted with grout pipes and were grouted. No great quantity of water was met with until at Elevation-221, while drilling a round, a flow of 240 gallons a minute was struck, all the water coming out of one hole. This water was under the full hydrostatic pressure due to the head and flooded the shaft. After about a week's delay, in which



time large pumps were obtained, the shaft was emptied. Grouting was then commenced, using the same general methods as were used at Shaft 4. In all, 10 holes were drilled and 75 cubic yards of neat cement grouting was pumped in under pressures up to 400 pounds per square inch. The leakage into the shaft was reduced by this grouting to about 25 gallons per minute.

## APPENDIX B

SEVERAL of the shafts of the City Aqueduct on the lower east side of Manhattan Island and in Brooklyn were sunk through great depths of water-bearing sand by the pneumatic caisson method. The caissons are of two sizes, 15 feet 4 inches and 18 feet in diameter, and 2 feet and 3 feet thick respectively, and are heavily reinforced with vertical and horizontal rods. At the bottom of each a heavy steel shoe is imbedded to form a cutting edge. The vertical reinforcing rods are attached to the shoe. The roof of the working chamber is formed by a heavy reinforced concrete deck with two openings, to which the air shafts for the man lock and for the material lock are connected.

Each shaft chamber was first excavated and timbered square to about the ground water level, and the caisson was then started from the bottom of the chamber and built up to the full height before sinking. Steel forms were used throughout. The deepest caisson projected over 60 feet above the ground before sinking was started.

Excavated material was handled by a stiff-leg derrick. The caisson was loaded with pig iron, and the space between the shafting and the concrete filled with excavated sand for additional weight. Sinking proceeded rapidly in three shifts, at one of the shafts rock being reached through 55 feet of sand in five days.

The most difficult part of the operation is the sealing of the caisson into the rock, so that the air can be safely taken off. To accomplish this the ledge is leveled off and the rock excavated for several feet, the caisson meanwhile being supported on timber posts. The rock is then thoroughly cleaned with high pressure air, a one-to-two mortar collar is built around the shaft  $\frac{1}{8}$  of an inch back of the

outer edge of the shoe, and the posts are then shot out, allowing the caisson to sink through the collar into its final

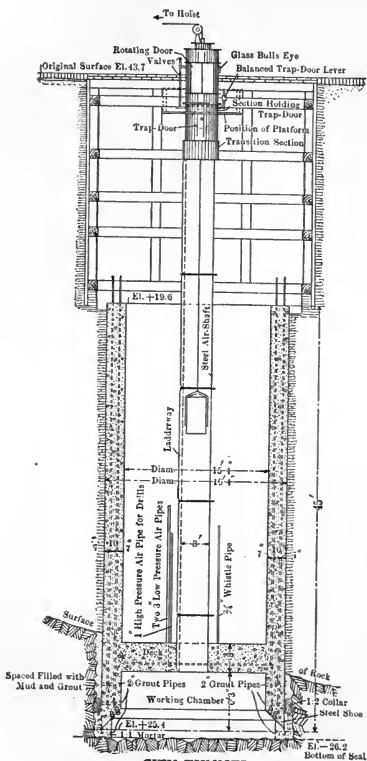

position. The space between the collar and the caisson is then grouted through pipes previously set in the collar.



## INDEX

- After-cooler, 27.  
Air-box ventilator, 79.  
Air compressor, Corliss, 27.  
    straight-line, 26.  
    two-stage, 26.  
Air-drills, 2, 72-75.  
    hose, 78.  
    lift, 88.  
    lock, 60.  
Anhalt Government Salt Mine, freezing, 93.  
Anzin colliery cementation, 105.
- Bearing timbers, 41.  
Bell, 24.  
Bench, 67.  
Bethune colliery cementation, 105.  
Billy, 25.  
Bits, drill, 70, 73.  
Blacksmith-shop tools, 31.  
Blasting, 66, 68, 69.  
Blowers, 29, 80.  
Blow pipe, 62.  
Boilers, 17.  
Bore holes, 9, 92-94.  
Borers, percussion, 88.  
    sack, 86.  
Boring process, 97-102.  
    progress, 102.  
    tools, 100, 101.  
Brakes, 23.  
Brick lining, 124.  
Buckets, 21, 22.  
Buildings, 29.  
Bull chain, 21.  
Buntons, 35, 119, 121.
- Caissons, 43-63  
    circular, 44.  
    open, 43-58.
- Caissons, pneumatic, 59-63.  
    rectangular, 43.  
Calumet shaft, 4.  
Carnegie steel sheet piling, 39.  
Central power plant, 27.  
Cementation, 102-106.  
Chambers, W. H., 112.  
Chapin Mine Company freezing, 93.  
Chaudron, M. J., 97.  
Churn drill, 71.  
Chute, 21.  
Circular concrete lined shaft, 129.  
Column, 75.  
    arm, 75.  
Compound sinking drum, 90.  
Compressors, air, 26.  
Concrete, 43, 129-139.  
    forms, 137, 138.  
    mixer, 135.  
    placing, 138.  
    shaft linings, 129-139.  
    timbers, 119.  
Conisboro sinking, 112.  
Contract, features of, 5, 6.  
    form of, 10-12.  
Contract prices, 84.  
Corliss air compressor, 27.  
Cost of concrete lining, 130-132.  
    plant, 32.  
    sinking in rock, 81-83.  
    sinking through surface, 49-51.  
    timber, 121, 123.  
Curb for brick lining, 124.
- D. L. & W. caisson, 43, 54-58.  
Derrick, 20.  
Direct cementation, 102-106.  
Drainage of rock water, 138.  
    surface water, 34, 42, 43.  
Drill, air, 2, 72-75.

- Drill, diamond, 9.  
     hand, 70, 71.  
 Drill holes, depth and inclination,  
     68, 69.  
 Drill mountings, 75, 76.  
     steel, 70, 73.  
 Drilling frame, 76.  
 Dummy, 25.  
 Dump car, 21, 22.  
 Dynamite, 2, 67.  
     thawing, 30.  
  
 Electric hoist, 4, 24.  
     light, 27, 29.  
 Elliptical shaft, 131, 133.  
 End plate, 35, 121.  
 Engines, hoist, 20, 23, 24.  
 Excavating lock, 62.  
 Excavation under air, 60.  
 Explosives, 2.  
  
 Fan, 29, 80.  
 Feed-pump, 18.  
 Feedwater heater, 18.  
 Fire and water excavating, 1.  
 Firm earth, 35, 36.  
 Fore poling, 41.  
 Forms, concrete, 137, 138.  
 Freezing period, 93.  
 Freezing process, 35, 91-96.  
  
 Gas engine, 24.  
 Gelatin, 67.  
 Generator, 27.  
 Grab bucket, 86.  
 Grout, 105, 138.  
     mixer, 105.  
     tank, 106.  
 Guides, 25.  
 Gunpowder, 2.  
  
 Hand drill, 70, 71.  
 Hanging bolts, 36.  
 Haniel & Lueg, 97.  
 Hammers, 71.  
 Hay, 43.  
 Head-frame, 20-22.  
 Historical mention, 1.  
  
 Hitches, 120.  
 Hitch timbers, 119, 122.  
 Hoisting apparatus, 20.  
     engines, 20, 23, 24.  
 Horden sinking, 116.  
 Hooks, 22.  
 Hose, 78.  
 Hydraulic jacks, 85.  
  
 Injector, 18.  
  
 Kind, 97.  
 Kind-Chaudron boring process, 97-  
     102.  
  
 Lackawanna steel sheet piling, 39.  
 Lagging, 36, 122.  
 Lens cementation, 103.  
 Leyner drill, 75.  
 Lifting water, 107-117.  
 Lining for shafts, 118-139.  
 Little giant drill, 73.  
 Locking through, 61.  
  
 Mammoth pump, 88.  
 Man-lock, 60.  
 Mixer, concrete, 135.  
     grout, 105.  
 Moss box, 98.  
 Mt. Lookout freezing, 95.  
  
 Non-rotating rope, 25.  
  
 Operation of concreting shaft, 134-  
     136.  
     pneumatic caisson, 62.  
     sinking shaft, 78.  
  
 Packing, 122.  
 Pile driving, 40.  
 Pile hammer, 40.  
 Piping, 17, 18, 110.  
 Plant, contractor's, 15.  
     cost of, 32.  
     location of, 32.  
     for sinking, 16-32.  
 Pneumatic process, 34, 59-63.  
     limit of, 60, 63.

- Pneumatic caisson, 59.  
 Poetsch, 91.  
 Poling boards, 42.  
 Powder house, 30.  
 Primary power, 16.  
 Progress, sinking caisson, 47.  
   sinking in rock, 80, 81, 83.  
 Prospect holes, 9.  
 Pulsometer, 112.  
 Punch blocks, 35, 121.  
 Pumps, sinking, 107, 113.  
 Pumping, 107-117.  
  
 Quadrilateral shaft, 132, 134.  
 Quicksand, 34, 60, 65.  
  
 Rectangular shaft, 2, 130, 132.  
 Reheater, 27.  
 Reenforcement, 44, 133.  
 Relievers, 67.  
 Rheinpreussen colliery sinking, 90.  
 Riemer, J., 96.  
 Ring timbers, 121.  
 Risk of water, 6.  
 Rondout caisson, 44.  
   cementation, 105.  
 Rope, 23, 25.  
  
 Sack borer, 86, 87.  
 Safety hook, 22.  
 Saw, 29.  
 Sealing caisson to rock, 51, 63.  
 Seals, details of, 52, 57.  
 Secondary power, 26.  
 Sergeant drill, 73.  
 Sheet piles, 37, 38.  
 Shafts, depths of, 4.  
   sizes and shapes of, 2, 3.  
 Shaft bar, 75.  
 Shaft linings, 118-139.  
 "Shaft sinking in difficult cases," 96.  
 Shield method, 63-65.  
 Shifts, 78.  
 Shoes, 45, 48, 63, 85.  
 Sinking-drum process, 85-91.  
 Sinking pumps, 107, 113.  
   in rock, 66-84.  
   in surface, 33-65.  
  
 Skin to skin timber, 42.  
 Slugger drill, 73.  
 Soft ground, 36-65.  
 Specifications, 13-15.  
 Speed of sinking caisson, 47.  
   in rock, 81, 83.  
 Spoil, 5.  
 Steam hammer, 40.  
 Steam hose, 78.  
 Steel sheet piles, 39.  
 Straight-line air compressors, 26.  
 "Straight through" air lock, 62.  
 Sump, 67.  
 Supplies, 7, 31.  
 Surface ground, 33-65.  
  
 Tamarack shaft, 4.  
 Thawing dynamite, 30.  
 Timber, supply of, 8.  
 Timbering firm earth, 35.  
   rock, 119-124.  
   soft ground, 36-42.  
 Time limit, 6.  
 Tool room, 31.  
 Tools for sinking, 31.  
 Tomson system, 117.  
 Tripods, 76.  
 Tubbing, English, 125.  
   for boring process, 99.  
   German, 128.  
  
 Underground water, 8.  
 Underhanging tubbing, 128.  
  
 Ventilation, 79.  
  
 Wages, 79.  
 Wall plate, 35, 121.  
 Water clause, 6, 11.  
 Water hoist, 4, 117.  
 Water in surface, 33.  
 Water Leyner drill, 75.  
 Water, pumping of, 107-116.  
 Water rings, 15, 109.  
   winding, 117.  
 Wedges, 123, 127.  
 Wedging curb, 127.  
 Wet sinking at Conisboro, 112.  
   Horden, 116.







TN  
275  
S56c

Shurick - Coal mine surveying

UNIVERSITY OF CALIFORNIA

TI

University of California  
SOUTHERN REGIONAL LIBRARY FACILITY  
405 Hilgard Avenue, Los Angeles, CA 90024-1388  
Return this material to the library  
from which it was borrowed.

MAY 19 1961

MAY 19 1961

JUN 2 1961

JUN 19 1961

RECEIVED  
OCT 19 1998  
OCT 07 1998

STAC

JAN 12

ANNE  
RECEIVE

OCT 13 1961

EMS LIBRAR

RECEIVED

OCT 15 1986

Form 10-10m-9, 54 (7)

STACK ANNE

**Engineering  
Library**

**AUXILIARY  
STACK**

**SEP '73**

UC SOUTHERN REGIONAL LIBRARY FACILITY



**A 000 195 842 0**



EX