

Steel Bridges

A Practical Approach to Design for Efficient Fabrication and Construction

By Alan Hayward, Neil Sadler and Derek Tordoff



Publication Number 34/02

Apart from any fair dealing for the purposes of research or private study or criticism or review, as permitted under the Copyright Design and Patents Act 1988, this publication may not be reproduced, stored or transmitted in any form by any means without the prior permission of the publishers or in the case of reprographic reproduction only in accordance with the terms of the licences issued by the UK Copyright Licensing Agency, or in accordance with the terms of licences issued by the appropriate Reproduction Rights Organisation outside the UK.

Enquiries concerning reproduction outside the terms stated here should be sent to the publishers, The British Constructional Steelwork Association Ltd at the address given below.

Although care has been taken to ensure, to the best of our knowledge, that all data and information contained herein are accurate to the extent that they relate to either matters of fact or accepted practice or matters of opinion at the time of publication, The British Constructional Steelwork Association Ltd, the authors and the reviewers assume no responsibility for any errors in or misinterpretation of such data and/or information or any loss or damage arising from or related to their use.

The British Constructional Steelwork Association Limited (BCSA) is the national organisation for the steel construction industry: its Member companies undertake the design, fabrication and erection of steelwork for all forms of construction in building and civil engineering. Associate Members are those principal companies involved in the purchase, design or supply of components, materials, services related to the industry. Corporate Members are clients, professional offices, educational establishments which support the development of national specifications, quality, fabrication and erection techniques, overall industry efficiency and good practice.

The principal objectives of the Association are to promote the use of structural steelwork; to assist specifiers and clients; to ensure that the capabilities and activities of the industry are widely understood and to provide members with professional services in technical, commercial, contractual and quality assurance matters. The Association's aim is to influence the trading environment in which member companies operate in order to improve their profitability.

A current list of members and a list of current publications and further membership details can be obtained from:

The British Constructional Steelwork Association Ltd

4 Whitehall Court, Westminster, London SW1A 2ES

Telephone: +44 (0) 20 7839 8566

Fax: +44 (0) 20 7976 1634

Email: postroom@steelconstruction.org

BCSA's website, www.SteelConstruction.org, can be used both to find information about steel construction companies and suppliers, and also to search for advice and information about steel construction related topics, view publications, etc.

Publication Number 34/02

First Edition March 1985

Second Impression March 1990

Third Impression April 1991

Second Edition December 2002

ISBN 0 85073 040 6

British Library Cataloguing-in-Publication Data

A catalogue record for this book is available from the British Library

© The British Constructional Steelwork Association Ltd

Designed and Printed by Box of Tricks www.bot.uk.com

STEEL BRIDGES

A Practical Approach to Design for Efficient Fabrication and Construction

PREFACE TO THE SECOND EDITION

Design of steel bridges is achieved most effectively when it is based on a sound understanding of both the material and the methods adopted in processing steelwork through to the final bridge form. The aim of this publication is to provide a basis for this understanding by reference to the factors which influence safe, practical and economic fabrication and erection of bridge steelwork.

The first edition of this publication was prompted by the need for the steel construction industry to give general guidance and information to designers of small and medium span steel bridges in the UK and was to provide an insight into the practical aspects of fabrication and erection that would help designers use steel more efficiently and economically to achieve their clients' requirements. That need is just as vital today, but since publication of the first edition in 1985 many changes in working practice have occurred that make a second edition essential.

The text has been amended and updated to reflect changes in procurement practice, the continuing European harmonisation of codes and standards, technological advances in manufacturing and construction, and modernisation of fabrication workshops. The original structure of the content has been retained: Chapters 1, 2 and 3 provide guidance on conceptual design, steel quality, and design of members; Chapters 4 and 6 give practical information on bolting and welding for connections, and on procedures for managing them in implementing the design; Chapter 5 discusses the accuracy of fabrication and its significance for the designer; some guidance on cost is given in Chapter 7 in qualitative terms. The guidance is supported with a new set of case studies illustrating 'good' deck layouts and cross-section arrangements, fabrication details and economic design solutions for some recent specific bridge requirements. A substantial reference list is included so that the reader may follow up the subject in greater depth to meet his particular needs.

Throughout the text there are many references to Codes of Practice, British Standards and other design documents – particularly the standards and advice notes contained in the Design Manual for Roads and Bridges issued on behalf of the highways overseeing organisation in England, Scotland, Wales and Northern Ireland. In a period of considerable change, the references relate to documents current in 2002, and their antecedents where relevant. Change will go on and in the life of this edition it is probable that the Eurocodes will be implemented. Given that most of the guidance and information is practical and technological, the reader should be confident in making continued use of the publication provided he has an awareness of changes in requirements which affect responsibilities, procedural arrangements, or quantitative values eg fabrication tolerances.

This second edition has been prepared by Cass Hayward & Partners for the BCSA, with substantial input from Alan C G Hayward and Neil Sadler; Alan Hayward also made significant contribution to the original text. Thanks are given to Ian E Hunter, Consultant - formerly Cleveland Bridge Ltd, for drafting parts of the text and an overall editorial review, and to Richard Thomas of Rowecord Engineering Ltd for drafting Chapter 6. The valued assistance of the following is also acknowledged:

C V Castledine	formerly Butterley Engineering Ltd
J Dale	Rowecord Engineering Ltd
N Iannetta	Fairfield-Mabey Ltd
A Jandu	Highways Agency
P Lloyd	Fairfield-Mabey Ltd
G M Mitchell MBE	BCSA
S Waters	Fairfield-Mabey Ltd
P J Williams	BCSA

PREFACE TO THE FIRST EDITION (Reproduced)

The aim of this publication is to provide guidance upon the practical aspects of fabrication that influence the efficient design of steel bridges. Extensive consultation has taken place with experts in the design, fabrication and erection of steel bridges and therefore this publication represents a compilation of many years' knowledge and experience.

The proof of the effectiveness of this approach is that a number of steel bridge designs based on these concepts have proved to be less expensive than the more traditional designs in concrete and steel. References are made to BS 5400 Part 3 (Code of practice for the design of steel bridges) and Part 6 (Specification for materials and workmanship, steel) and their application in practice is demonstrated.

Examples are given of 'good' deck layouts and cross sectional arrangements, fabrication details and economic design solutions to specific bridge requirements.

The author, Derek Tordoff, has worked on the design, construction and inspection of steel and concrete bridges both with consultants and with a contractor. He undertook research work at the University of Leeds on computer aided techniques for the efficient design of steel bridges. He joined BCSA in 1976 where he is now Director General with wide ranging responsibilities in the steel construction industry

ACKNOWLEDGEMENTS (First Edition - reproduced)

The author is indebted to JS Allen (NEI Thompson Ltd) and ACG Hayward (Cass Hayward & Partners) for their comments, advice and contributions to the text.

Acknowledgements for their assistance are also due to:

P H Allen	BCSA
J G Booth	John Booth & Sons (Bolton) Ltd
Prof F M Burdekin	University of Manchester Institute of Science & Technology
M M Chrimes	Institution of Civil Engineers
W R Cox	Sir William Arrol NEI Cranes Ltd
K Dixon	Cleveland Bridge and Engineering ex Fairfield Mabey Ltd
J E Evans	Robert Watson & Co (Constructional Engineers) Ltd
H J Gettins	BCSA
A N Hakin	Dorman Long Bridge & Engineering
J Kinsella	Butterley Engineering Ltd
F I Lees	NEI Thompson Ltd
J E Leeson	Horseley Bridge ex Redpath Dorman Long Ltd
J W Pask	Braithwaite & Co (Structural) Ltd
J L Pratt	BSC Sections and Commercial Steels
W R Ramsay	BSC Sections and Commercial Steels
D C Shenton	BSC Sections and Commercial Steels
T J Upstone	ex Redpath Dorman Long Ltd
F G Ward	ex Constrado
A Waterhouse	NEI Thompson Ltd Horseley Bridge

The diagrams, charts and figures have been prepared with the assistance of Cass Hayward & Partners.

CONTENTS

1. Design Conception

1.1	Introduction	1
1.2	Initial Conception	2
1.3	Cross-Sections for Highway Bridges	10
1.4	Cross-Sections for Railway Bridges	11
1.5	Cross-Sections for Footbridges	12
1.6	Camber	12
1.7	Dimensional Limitations	13
1.8	Erection	14
1.9	Repairs and Upgrading	15

2. Steel Qualities

2.1	Introduction	17
2.2	Brittle Fracture and Notch Toughness Requirements	17
2.3	Internal Discontinuities in Rolled Steel Products	17
2.4	Material Selection	19
2.5	Weathering Steels	20
2.5.1	Performance	20
2.5.2	Materials and Weldability	21
2.5.3	Bolting	21
2.5.4	Availability of Weathering Steel	22
2.5.5	Suitability	22

3. Design of Members

3.1	Introduction	23
3.2	Plate Girders	23
3.3	Box Girders	25
3.4	Bearings	26

4. Connections

4.1	Introduction	33
4.2	Bolted Connections	33
4.3	High Strength Friction Grip Bolts	33
4.4	The Friction Grip Joint	33
4.5	Installation of HSFG Bolts	34
4.5.1	Torque Control	34
4.5.2	Part-Turn Method	34
4.5.3	Direct Tension Indication	34
4.5.4	Sequence of Tightening	35
4.6	Inspection of HSFG Bolts	35
4.7	Welded Connections	35

5. Fabrication

5.1	Introduction	37
5.2	Fabrication Tolerances	38
5.3	Checking of Deviations	38
5.4	Causes of Fabrication Distortion	42
5.5	Methods of Control of Distortion	42
5.6	Effects of Design on Distortion	42
5.7	Distortion Effects and Control of Various Forms of Construction	43
5.8	Correction of Distortion	43
5.9	Trial Erection	43

6. Welding

6.1	Introduction	45
6.2	Principal Welding Standards	45
6.3	Types of Joint	45
6.4	Processes	46
6.5	Preparation of Welding Procedure Specifications	47
6.6	Procedure Trials	47
6.7	Avoidance of Hydrogen Cracking	48
6.8	Welder Approval	48
6.9	Inspection and Testing	49
6.10	Weld Quality Levels	50

7. Costs

7.1	Introduction	53
7.2	Project Requirements	53
7.2.1	Everything has to be paid for	53
7.2.2	Scope of Work	53
7.2.3	The Design	53
7.2.4	Specification	54
7.2.5	Programme	54
7.2.6	Conditions of Contract	55
7.2.7	Commercial Factors	55
7.3	The Fabrication Process	55
7.3.1	A Manufactured Product	55
7.3.2	Starting the Process	55
7.3.3	Planning	55
7.3.4	Drawings and Production Data	56
7.3.5	Material Procurement	56
7.3.6	Receipt of Material	56
7.3.7	Preparation	56
7.3.8	Marking	56
7.3.9	Cutting	57
7.3.10	Preparation of Edges	57
7.3.11	Drilling	57
7.3.12	Pressing	57
7.3.13	Assembly	57
7.3.14	Managing Change	58
7.4	Protective Treatment	58
7.5	Erection	59
7.6	Guidance on Costs	59
7.6.1	What is a useful measure of cost	59
7.6.2	Cost per Square Metre	60
7.6.3	Relative Cost per Tonne	60
7.7	Achieving Best Value	60

8. Case Studies

8.1	Introduction	61
8.2	Tonna Bridge Replacement	61
8.3	Road Bridge A34 Trunk Road – Newbury Bypass	65
8.4	Westgate Bridges Deck Replacement, Gloucester	67
8.5	Churn Valley Viaduct	69
8.6	A500 Basford Hough Shavington Bypass, London – Crewe Railway Bridge	71
8.7	Doncaster North Bridge	73
8.8	A69 Haltwhistle Bypass Railway Viaduct	75
8.9	River Exe Viaduct	77
8.10	Newark Dyke Rail Bridge Reconstruction over the River Trent	79

9. Competence in Steel Construction

9.1	Introduction	83
9.2	The Register of Qualified Steelwork Contractors	83
9.3	Bridgeworks Scheme	83
9.4	Use of the Bridgeworks Register	84

10. References

10.1	Codes and Standards referred to in this edition	85
10.2	Other documents, references, standards referred to in this edition	86
10.3	Suggested further reading and sources of information	86
10.4	References used within the text of the first edition	87
10.5	Articles about early steel bridges	87

LIST OF ILLUSTRATIONS AND TABLES

Figures	Title	
1	Composite I Girders – Guide to Bracing	5
2	Composite I Girders – Bracing Types	6
3	Composite I Girders – Guide to Make-Up	7
4	2-Lane Composite Cross Sections	8
5	Footbridge Cross Sections	10
6	Half-Through and Rail Bridge Cross Sections	12
7	Available Plate Lengths	22
8	Economy of Flange/Web Thickness Changes	28
9	Typical Single Span Girder	29
10	Typical Bolted & Welded Splices	30
11	Plate Girder Assembly	31
12	Detailing Do's & Don'ts	39
13	Orthotropic Plate Stiffeners	40
14	Weld Distortion and Correction	41
15	Tonna Bridge Replacement	62
16	A34 Newbury Bypass – Donnington Link	66
17	Westgate Bridges	68
18	Churn Valley Viaduct	70
19	A500 Basford Hough, Bridge over Railway	72
20	Doncaster North Bridge	74
21	A69 Haltwhistle Bypass Railway Viaduct	76
22	River Exe Viaduct	78
23	Newark Dyke Rail Bridge Reconstruction	81

Tables	Title	
1	Guide to Minimum Cambers in Universal Beams	13
2	Road Transport Length/Width Restrictions	13
3	Relative Efficiency and Limiting Thickness of Steel Grades	18
4	Weathering Steel Corrosion Allowance to BD7/01 Related to 120 Year Design Life	21
5	Compression Outstand Limit to Flanges	23

CHAPTER 1

DESIGN CONCEPTION

1.1 Introduction

Steel is usually the material best-suited to meet the requirements in the UK for highways and railway bridges, footbridges and moving bridges. Steel construction is, though, a peculiar part of civil engineering construction as all of the planning and preparation is done off site, most elements critical to the bridge are made in a remote factory, and indeed the work at site may last but a few days. Production of the bridgeworks in a factory has many advantages in terms of precision, quality, economy and safety but the differences from other civil engineering activities need to be understood if the potential of steel is to be exploited by the designer. The objective of this publication is to facilitate an understanding of those aspects of fabrication and erection that influence the quality and economics of steel bridgeworks so that the designer is able to achieve an optimum solution for his client.

Fabrication of the steelwork represents a significant part of the overall cost of a bridge. Each fabrication shop has a layout which has been developed with equipment appropriate to the types and scale of structures in which the company specialises. There is not always a single preferred method for fabricating a particular component or detail. Some details may suit automated fabrication processes but may be less appropriate for those companies which use more traditional practices - good quality work can be produced in highly automated shops, almost without the use of fabrication drawings, and also by skilled tradesmen in basic shops with modest equipment. However, there are certain limitations for most of the details and impractical arrangements to be avoided which, if anticipated knowledgeably at the design stage, will enable economical and easy fabrication.

Most of the advice given in this publication relates to highway, railway and pedestrian bridges in the UK of short and medium span of conventional types. Steel is eminently suitable for long span bridges, including suspension and cable-stayed spans, and for mechanical bridges which fall outside the scope of this book, though much of the content is relevant to them. Similarly the design of bridges for other countries, and of bridgeworks for export, involves considerations which are outside the scope of this book.

The production of a new bridge for its sponsor involves a team of organisations and individuals working together. Traditionally there was the Engineer and the Contractor, but with new forms of procurement these roles do not necessarily exist within a contract: so it is

convenient for the purpose of this book to use the terms 'designer' and 'steelwork contractor' to identify two of the key roles in building a steel bridge. However, removal of the term 'Engineer' from the text has not been possible since current British Standards, including BS 5400: Part 6, retain it. The term 'designer' is used to identify the organisation responsible for the design of the permanent works, whether employed by the client, main contractor or steelwork contractor, and whose responsibilities include all the technical matters involving design, decision-making and approval for the implementation of the design during the contract. The role of 'steelwork contractor' covers responsibility for fabrication and erection (and certainly these are best undertaken by one organisation even though it may choose to subcontract part): it includes responsibility for choosing fabrication methods, fabrication drawings, material procurement, erection method, construction engineering and temporary works design, protective treatment and, when required and appropriate, bearing supply.

The steelwork contractor and the designer for a steel project must understand each other's roles and responsibilities to obtain the best outcome economically and technically. The designer should have close contact with the steelwork contractor and be able to discuss ideas with him where they have a mutual bearing. Equally it is important that the steelwork contractor is free to raise points with the designer where the end product and the project outcome for the client will be improved. This is made easier when a design and construct contract is used, as has been demonstrated on many successful bridge projects over the last 20 years.

Design of bridges for the UK is currently carried out to BS 5400, with Part 3 covering design of steel bridges, Part 5 the design of composite bridges, and Part 6 the workmanship of steel bridges. For highway bridges reference has to be made to Departmental Standards and for railway bridges to Railtrack Group Standards; these standards are referred to in the text, as are many of the associated British Standards. Through the life of this edition it is certain that British Standards will be replaced by Euronorms and Eurocodes, but in most instances they will not invalidate the practical advice and technical information provided by the book. It is not clear how the implementation of the Eurocodes may affect practices, for example, in the definition of workmanship tolerances compatible with design assumptions, but the codes cannot change the essential characteristics of working with steel.

Sustainability is a crucial issue for today's construction industry. Construction has to be socially and environmentally responsible as well as economically viable. Steel is a sustainable construction material to use for bridgework and good design will enhance its sustainability characteristics which are very evident in the material itself, the manufacture of the structural components, and the relatively straightforward and swift construction of most steel bridges today:

- a) New steel plate and sections contain a significant proportion of recycled material, and they are fully recyclable at the end of the life of the structure.
- b) Innovation and technological advances - in fabrication, in equipment and infrastructure for delivery, and in construction plant and techniques - have enabled the move to more complete off-site manufacture so that typical bridge members are truly manufactured products, with all the advantages that brings. These include higher productivity, less waste, energy efficiency, better working conditions, and a more easily controlled process, with less adverse impact on the environment.
- c) Steel bridge construction is typically a brief and highly organised activity in the overall construction programme, utilising highly mobile equipment and a small workforce of skilled people. Delivery can be timed to minimise inconvenience; relatively little space is required to operate; the steelwork is clean, with no dust, little waste, and noise is not a major problem. Erection schemes can be designed readily to meet environmental constraints and concerns. The speed of the erection process means that any inconvenience or environmental impact is reduced to a minimum period.

Sustainability in the bridge project is an issue for both the steelwork contractor and the designer: it is another important quality aspect which benefits from the quality of the care and skill with which they fulfil their respective roles.

Since the publication of the first edition of this book, the regulatory environment for health and safety in construction has been much enhanced and health and safety considerations have become an integral part of design as well as planning and carrying out construction works - the Construction and Design (Management) Regulations have been a major factor in this development. Although this edition has not been extended specifically to cover such considerations, its underlying purpose is to improve the designer's understanding of steelwork and his competence in using it for bridge construction. So, for example, the designer must also consider issues such as designing for the work to be done in the workshop rather than on site, elastic instability of slender girders and access for site tasks. Similarly the client, with professional advice,

has to satisfy himself that the chosen steelwork contractor is competent to undertake the challenge of his design. The establishment of the independent Register of Qualified Steelwork Contractors (RQSC) addresses this by including those steelwork contractors who can demonstrate their relevant set of commercial and technical qualifications to undertake steel bridgeworks. The Register, which is described in Chapter 9, categorises the competent firms by size (turnover) and capability for different types of bridge: it is open to any company which can meet the objective criteria for competence assessed by independent engineers of standing. The Highways Agency now requires that only registered steelwork contractors are engaged for UK highway bridgeworks.

1.2 Initial Conception

For new build highways or railways the requirements for bridges are determined by the alignment, local terrain and the obstacles which are to be crossed. Ideally the designer should be involved at an early stage to optimise overall geometry for the bridge spans and the interfaces with earthworks taking account of the cost influences of sighting distances, skew, curvature and construction depth. At the time of construction of the early motorways from the 1950's to the 1980's greenfield conditions allowed considerable freedom of choice in alignments and methods of construction. However, with the growing urbanisation and traffic density in the UK and elsewhere from the 1980's considerable restrictions arose in the provision of new transport systems and the extension of existing systems. Thus the number of requirements for bridges across obstacles is increased and designers are often constrained to adopt curved, tapered or skewed structures with severe limitations on construction depth. Moreover, the public objections to traffic disruption mean that the methods and speed of construction heavily influence bridge design now.

These trends have encouraged a move towards prefabrication of elements favouring the use of structural steel as the primary medium for bridge spans, whilst capitalising on the merits of concrete and other materials in substructures, for formwork and in bridge deck slabs.

For replacement spans, or new bridges beneath existing highways or rail tracks, the form of construction will be dictated by the needs of a live highway or railway in keeping disruption of traffic to an absolute minimum. This favours prefabricated forms of construction which can be erected rapidly during possession, or which can be assembled adjacent to the highway or rail track for speedy installation by reliable sliding, rolling-in or wheeled transportation methods. Steel is ideal as the main structural material in these situations.

Where there is some freedom in the choice of span lengths it should be borne in mind that the optimum solutions for steel and concrete bridges are not always the same. For single span steel bridges a span length of 25 to 45m is economic, but this can extend to about 60m. It is far more economic in steel to use continuous multiple spans because fully rigid site joints, either welded or bolted, are easily achieved in steel and lead to savings in amounts of material, bracings, bearings and expansion joints. Cantilever and suspended spans can exceptionally be used where differential settlement of the foundations is predicted as being substantial. The optimum for multiple spans ranges from 30m to 80m. Continuous spans require much less maintenance of bearings and expansion joints, compared with simple spans, and offer improved appearance of the piers. Typically for continuous spans the end span should be about 80% of the penultimate span for economy, but may be decided by other factors.

Span lengths can be designated as:

Short up to 30m

Medium 30 to 80m

Long greater than 80m

A long span is demanded where a significant obstruction is to be crossed, such as a navigable waterway or deep valley. Multiple medium to long spans become necessary across river estuaries or where ground conditions demand very expensive foundations. For high level viaducts (with soffit more than say 8m above ground level) the costs of piers, erection and concreting increase and so economic span lengths tend to increase to balance superstructure and substructure costs.

For highway bridges Universal Beams with composite concrete slabs can be used for continuous spans of up to approximately 30m; however, because the maximum readily available length of UBs is 24m, plate girders are favoured for greater spans to avoid butt welds. For spans up to 100m, plate girders are usually cheaper than box girders; but box girders may sometimes be preferred for their cleaner aesthetic appearance or when curvature demands torsional rigidity. For long spans it is necessary to use box girders to avoid excessive flange thicknesses and to provide torsional resistance against aerodynamic effects. Cable-stayed bridges are suitable for (and in multi-stay form prove economical for) spans ranging from 200m to above 400m; recent international projects have used cable-stayed spans of over 800m; suspension bridges are used for all very long spans (up to 1990m to date). Through or half-through bridges are appropriate where construction depth is critical as in water-way crossings in flat terrain and for railway bridges: arch and truss types are suitable for medium spans, and half-through girders for short spans.

Steel is able to deal with skewed or curved alignments efficiently although, for single spans, it is often convenient to provide a straight bridge and to increase the width appropriately. This is likely to be economic where the width increase does not increase the gross plan area by more than say 5%. In other cases and especially for multiple spans the bridge should be curved. Where the radius of curvature is greater than say 800m, the girders are conveniently fabricated as straight chords between the locations of site splices. For continuous spans such splices are set at areas of minimum bending moment to minimise connection size, to facilitate erection, and to suit practicable length for economic delivery to site. If straight chords are chosen, curvature of the deck edge is achieved by variation of the concrete deck cantilevers. Lateral bracing needs to be provided adjacent to the splices where curvature is accommodated to cater for torsional effects. Typical bracing layouts are shown diagrammatically in Figure 1; where substantially curved girders are used more lateral bracings are generally required, but to some extent the extra cost is offset by reduction of cantilever slab costs.

In plate girder deck type bridges lateral bracing is usually necessary for erection stability of the compression flanges and during concreting of the deck slab. In the service condition lateral bracing may also be necessary to stabilise the bottom flange adjacent to intermediate supports of continuous spans. Some form of lateral bracing is usually required at the supports, and at the abutments this can be combined with a steel end trimmer supporting the deck slab. Often solutions for construction and in-service requirements can be combined especially where the design utilises bracing in wide decks (>20m) to assist in transverse distribution of concentrated live loadings. Lateral bracings are also a necessity where accidental impact forces on the bridge soffit must be designed for (bridges over highways where headroom is less than 5.7m).

Only in exceptional cases should temporary bracings beneath a completed deck slab be specified for removal on completion of construction because that is a potentially hazardous, as well as costly activity: indeed it should be utilised permanently to minimise girder sizes. In general, except for spans exceeding 60m, use of full length plan bracing systems should not be necessary, reliance being made upon the lateral strength of the connected girders to resist wind effects. During construction the girders can often be erected, and delivered, as braced pairs to achieve mutual stability: intermediate lateral bracings are used which serve to provide mutual torsional restraint. Temporary stabilisation of pairs of girders may be necessary during erection. Once erected the braced girders need to possess sufficient lateral strength against wind loading until the deck slab is sufficiently cured to provide the restraint, otherwise temporary plan bracing systems may be needed.

Figures 1 and 2 provide a guide to bracing of composite I-girders: Figure 1 shows layouts for simply supported and continuous spans with recommended spacing to suit flange sizes, and Figure 2 illustrates various types of bracing for use at supports and in span. The width of the top flange of plate girders is critical for stability during handling and construction and it is recommended that this should not be less than 400mm. Figure 3 provides a guide to the make-up of composite I-girders for various ranges of span up to 70m to optimise site splice locations and available material lengths consistent with the cost of making shop butt welds.

Use of steel allows a variety of pier shapes to be used to suit functional or aesthetic requirements. For wide decks spanning highways it is often preferable to avoid solid leaf type piers which give a "tunnel" effect to users of the highway below. Piers can be formed from steel or concrete prismatic or tapered columns, or portal frames. The number of columns within a pier can be reduced by the use of integral steel crossheads (see Figure 4), an early example being the M27 River Hamble Bridge built in 1974. More recent examples include the Thelwall Viaduct widening and viaducts on the approaches to the M4 Second Severn Crossing. Integral steel crossheads are expensive to fabricate and erect, particularly for curved and superelevated decks, so the benefits must be balanced against the extra cost and time required for them.

Movable bridges fall outside the scope of this publication, but are nearly always constructed in steel so as to minimise dead weight and thereby the substantial costs of the operating machinery, bridge operation and maintenance. Modern examples include bascule, swing, vertical lift, retractable bridges and roll-on/roll-off ramps as used in port areas and on highways where it is impracticable or uneconomic to provide a fixed bridge with enough navigation headroom. The type depends upon the required navigation width, height, deck width, frequency of opening and aesthetic requirements.

1.3 Cross Sections for Highway Bridges

For short and medium spans cross sections are generally of composite deck-type (as shown in Figure 4 for two-lane decks but applicable to multi-lane spans) but half-through type (as Figure 6) or through type are used where construction depth is critical. For deck type construction an economic construction excluding surfacing depth is generally about 1/20th of the span, but this can be reduced to about 1/30th of the span where necessary. It is usual to cantilever the deck slab beyond the outer girder, which has a number of advantages as it

- is visually attractive, giving a shadow line which reduces the apparent depth of the girder;

- protects the steelwork from rain washing and subsequent staining;
- reduces the width of piers; and
- optimises the deck slab design.

However, the deck cantilever should normally be restricted to 1.5m for minimising cost and be no longer than 2.5m to avoid high falsework costs. Where necessary the cantilever length can be increased by use of steel cantilever brackets in conjunction with cross girders between the main girders. Where it is necessary to use high containment (P6) parapets, then this will affect the overall design demanding a thickening of the deck slab locally and limitation of the length of edge cantilevers.

Figure 4 shows typical two-lane highway bridge composite cross sections, each of which may be economic in given situations. The simplest form is multiple Universal Beams for spans up to 24m. The number and spacing of the beams will depend upon the width of the deck, available construction depth and whether service troughs have to be provided. Universal Beams have relatively thick webs; therefore shear is not usually a problem rendering intermediate stiffeners unnecessary. Plate girders are generally more suitable and economic for spans greater than 20m. Generally an even number of girders should be used to facilitate optimisation on material ordering and to allow erection in braced pairs where appropriate. The most cost effective multigirder solution will have girders at 3.0 to 3.5m spacing.

An important aspect to be considered in the design and construction of plate girders is stability during erection and the possible need for temporary bracing. Figure 1 gives a guide to the location of bracings with consistent flange widths. The assumptions made in the design in relation to the sequence of erection, concreting, use of temporary bracing and method of support of falsework should be clearly stated on the drawings or otherwise specified. Generally the design assumption made is that the steelwork is self supporting and remains unpropped during concreting of the slab so that composite behaviour is utilised for superimposed loads and live loading only.

For medium spans, twin plate girders with cross girders ("ladder-deck" bridges) offer certain advantages for bridges up to about 24m in width, as shown in Figure 4 for a two-lane bridge - there are fewer main girders to fabricate and erect and there is economy of web material. Steel cantilevers are a feasible option with this cross section to achieve a deck cantilever greater than 2.5m. Ladder-decks are suited to erection of the complete deck structure by launching. For longer spans twin box girders with cross girders and cantilevers become a viable option.

SIMPLY SUPPORTED

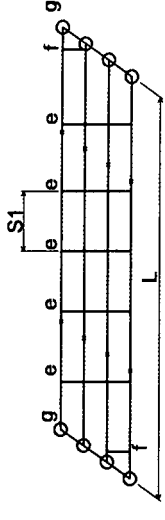
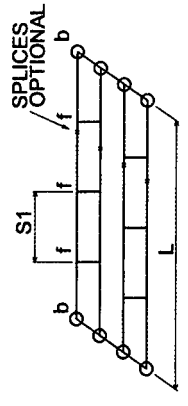
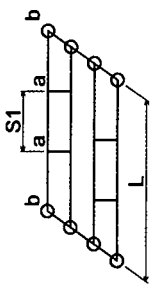
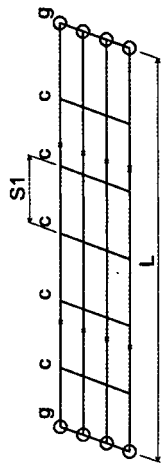
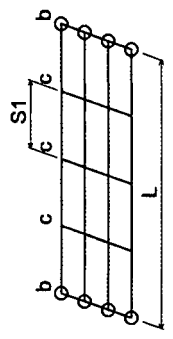
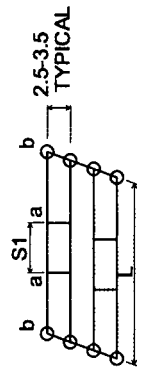

KEY
 --- SITE SPURCE
 --- BEARING
 ○ WIDTH OF TOP FLG
 ○ WIDTH OF BTM FLG
 wb BRACING TYPES
 abcdefg SEE FIG.2

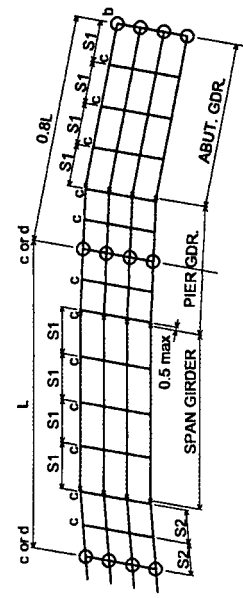
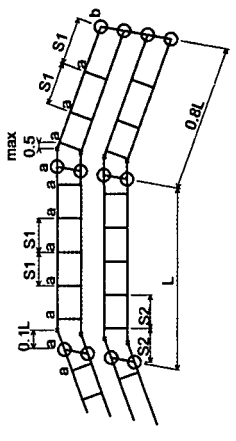

SKEW > 25°

CONTINUOUS

SKEW > 25°

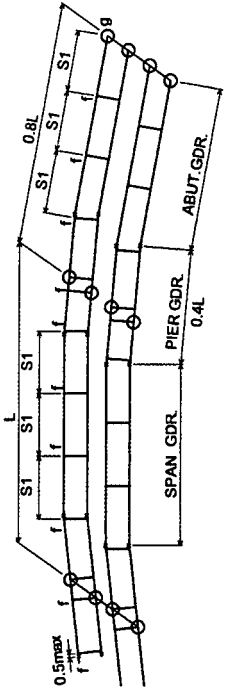

SPAN RANGE L(M)	S1 max	S2 max	wt. min
> 27	20 x wt.	—	$\frac{L}{70} < 400$
27 to 40	20 x wt.	—	$\frac{L}{70} < 400$
40 to 60	20 x wt.	—	CONSIDER BOWSTRING OR PAIRED ERECTION FOR STABILITY
> 27	20 x wt.	10 x wb.	$\frac{L}{100} < 400$
27 to 45 (Typical > 45 also)	20 x wt.	12 x wb.	$\frac{L}{100} < 400$

COMPOSITE I GIRDERS - GUIDE TO BRACING

FIG. 1

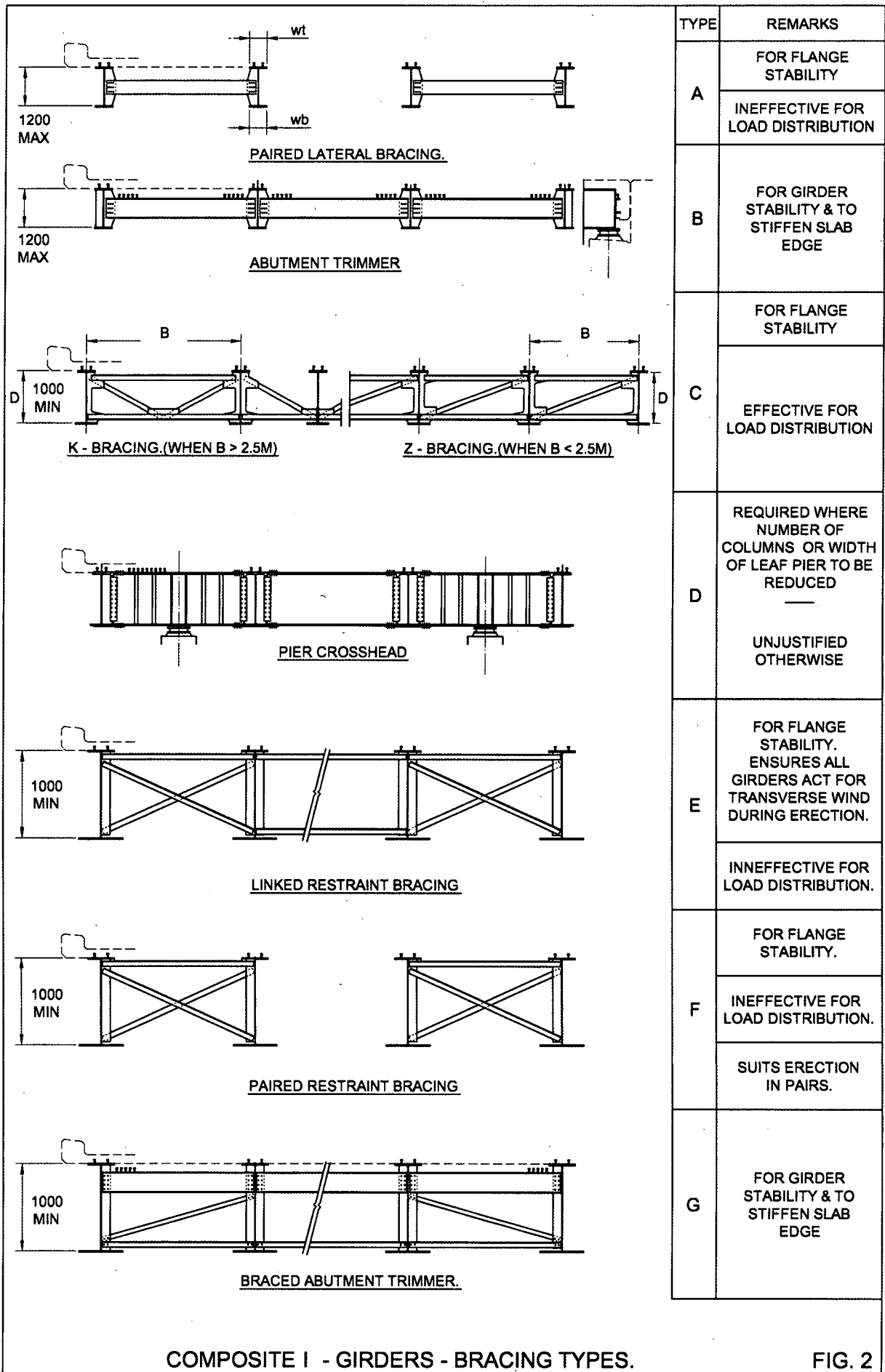

SIMPLY SUPPORTED

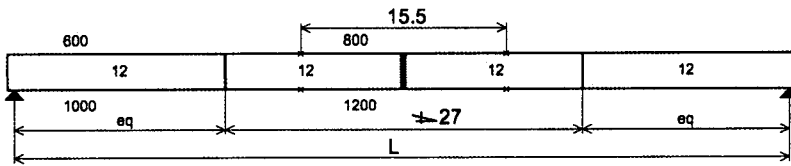
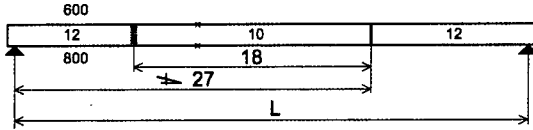
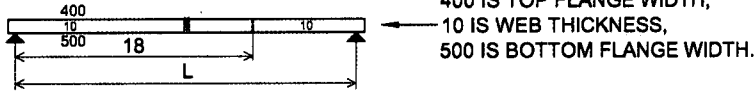
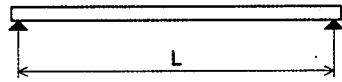

SPAN RANGE L(M)	U.B. or P.G.	GIDER DEPTH (M)
≠ 25	U.B. or P.G.	to 1.0
25 to 27	P.G.	1.0
27 to 40	P.G.	1.0 to 1.6
40 to 60	P.G.	1.6 to 2.7

CONTINUOUS

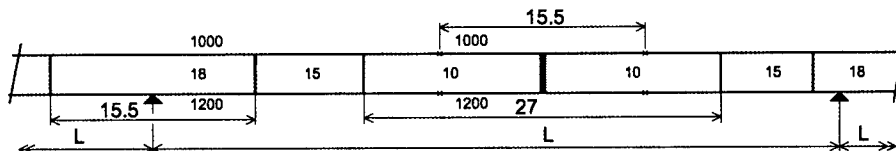
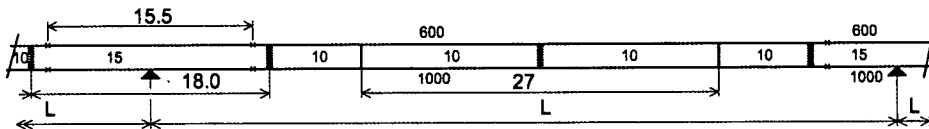
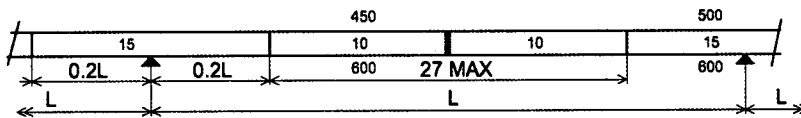
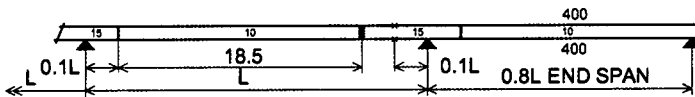
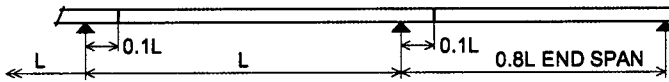

SPAN RANGE L(M)	U.B. or P.G.	GIRDER DEPTH (M)
≠ 25	U.B. or P.G.	to 1.0
25 to 27	P.G.	1.0
27 to 45	P.G.	1.8
45 to 52	P.G.	1.8 to 2.2
52 to 70	P.G.	2.2 to 3.3

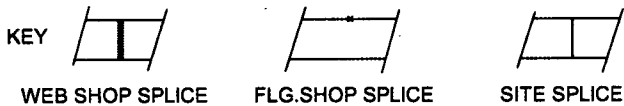

NOTE. FLANGE WIDTHS SHOWN ARE FOR TOP OF EACH SPAN RANGE, & GDR'S UPTO BUT NOT ABOVE 3.5M C/C

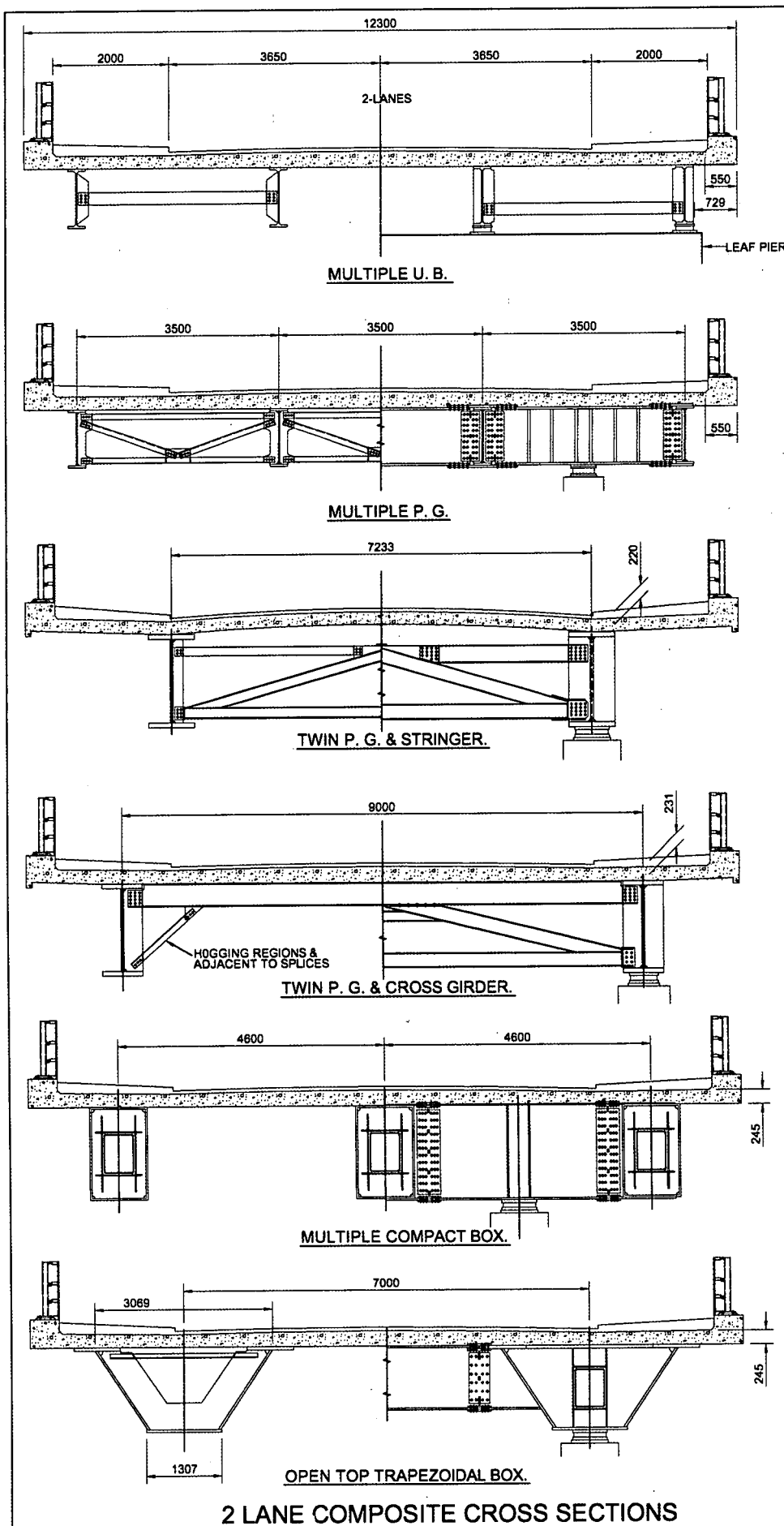

SPAN RANGE (METRES)	REMARKS.
15 TO 25	USE PLASTIC STRESS ANALYSIS FOR ECONOMY. MAY USE PIER CROSS-HEAD AS BELOW.
15 TO 100	STEEL CROSSHEADS SHOWN TO REDUCE No. OF COLUMNS. MAY USE LEAF PIER AS ABOVE.
35 TO 90	UNSUITABLE CURVED SOFFIT.
35 TO 90	SUITABLE CURVED SOFFIT.
35 TO 100	NO BRACING UP TO 80M SPAN. LESS ECONOMICAL UNLESS AESTHETICS GOVERN.
35 TO 100	STEEL CROSSHEADS SHOWN TO REDUCE No. OF COLUMNS.
35 TO 100	NO BRACING UP TO 60M SPAN. TEMPORARY PLAN BRACING REQUIRED.

2 LANE COMPOSITE CROSS SECTIONS

FIG. 4

Multiple box girders are suitable for medium spans where appearance of the bridge soffit is very important and the presence of bracings is deemed unacceptable as for example in a prominent urban area where pedestrians view the soffit. Open topped box girders are used extensively in North America and there are some examples in the UK, including the River Nene Bridge at Northampton and the A43 Towcester Bridge. Temporary lateral and plan bracing systems are, however, necessary to maintain stability during construction. Closed boxes, which are more stable during fabrication and erection, are also used, but current health and safety regulations for confined space working make work inside them very expensive.

For long spans where the weight of the deck becomes dominant, it is more appropriate to use an all steel orthotropic stiffened deck plate instead of a concrete slab. For the primary members either single or twin box girders are used. Such boxes and deck are assembled from separate stiffened plate elements at a construction yard convenient for the site, and transported to site for erection as large units. Such a procedure was used for example on the Severn Suspension Bridge and Humber Bridge.

To reduce site assembly and erection costs, where there is access from the sea, complete spans may be assembled in a shipyard or port and taken by barge transport for erection in place. Examples are the Foyle Bridge built in Belfast for erection in Londonderry, and Scalpay Bridge, which was taken complete to the Outer Hebrides.

1.4 Cross Sections for Railway Bridges

For replacements of existing spans cross sections are influenced by construction depth limitations because existing decks often have substandard ballasted track depth, or the rails are mounted directly via longitudinal timbers. Modern standards typically demand 300mm ballast depth beneath sleepers giving a total track depth of approximately 690mm below rail level, allowing 25mm for floor waterproofing. Half through construction is most usual for deck replacements and for new bridges beneath existing railways to avoid track lifting which may be impracticable or very costly. Spans are generally simply supported to permit piecemeal construction under traffic conditions.

Half through cross sections should, where possible, avoid centre girders which project in excess of 100mm above rail level within the "six foot" space between tracks. It is important to check that any part of the structure or furniture does not infringe the structure gauge or lateral clearance for walkways taking account of any curvature and cant, allowing for centre-throw and end-throw of rail vehicles. Modern standards recommend the provision of a robust kerb extending at

least 300mm above rail level to contain derailed vehicles, although many existing bridges do not possess this.

For short spans up to about 17m the girders need not project more than 110mm above rail level and each track can be supported by a separate deck, which facilitates piecemeal replacements and site delivery. The Railtrack Standard 'ZED' type bridge uses shallow plate girders of zed configuration, so that maintenance space is available between adjacent decks, with cross girders and enveloping deck slab. A variant is the Cass Hayward U-dëck which integrates the main girders with a deck of either all steel or composite form to achieve a single piece for fabrication and erection. Where practicable a robust kerb can be incorporated in these designs by deepening the outermost girders and locating them within the platform gauge.

For spans up to about 40m girders can be located so that they fit within the platform gauge extending not more than 915mm above rail level. The Railtrack standard box girder type bridge which covers a span range from 12m to 39m uses trapezoidal box girders with a transverse ribbed steel deck spanning between notionally pin-jointed shear plate connections: the box girders are stabilised by linear rocker bearings centred beneath the inner web. This design is particularly suited to piecemeal crane erection during track possession. For some recent projects, plate girder alternatives have proved economic where the site has sufficient width to accommodate them.

For spans exceeding about 40m the girder depth dictates that they are located outside the structure gauge, so increasing the span of the deck between the main girders. Half through plate girders or box girders can be used, plate girders often being modelled on the former type 'E' bridge with rolled section cross girders spanning between rigid shear plate bolted connections in line with external stiffeners to give 'U' frame stability. The deck can be either in situ concrete partially encasing the cross girders or of stiffened steel plate construction, depending on the envisaged erection method. For spans in excess of about 60m, through or half through trusses or bowstring girders become appropriate. Examples are bridge 70A at Stockport across the M63 and M64 motorways having a truss span of 120m, and the Newark Dyke bridge reconstruction with a braced arch span of 77m.

For new build railways it is often possible to adopt a deck type solution with the benefit of an efficient cross section of a concrete slab acting compositely with plate or box girders. Here the advice given in 1.3 for deck type highway bridges would generally apply. Where train speeds in excess of 125mph are envisaged special design criteria need to be applied concerning limits on vibration and deformation which may influence, in particular, the depth of construction and form of bridge deck.

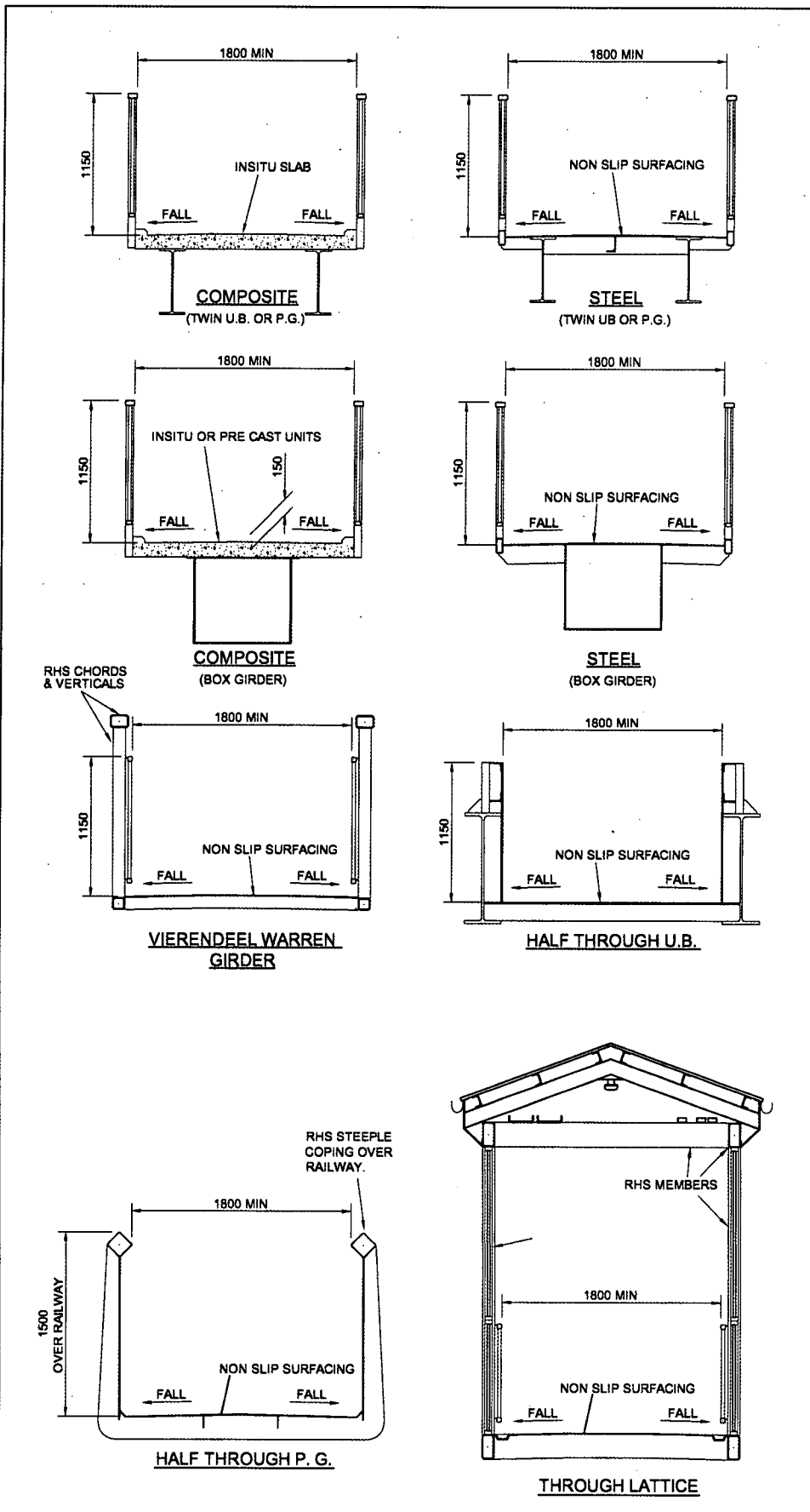

SPAN RANGE (METRES)	REMARKS
A 25	STEEL TYPE MAY BE ERECTED COMPLETE.
20 TO 50	STEEL TYPE MAY BE ERECTED COMPLETE.
A 25.5	USE WHERE CONSTRUCTION DEPTH CRITICAL.
A 40	P. G. SUITED OVER RAIL.
A 50	THROUGH SUITED TO INTERCONNECT BUILDINGS ETC. HALF THROUGH P.G. USED OVER RAILWAYS WHERE PARAPETS MUST BE IMPERMEABLE WITH UNCLIMABLE INSIDE FACE, 1500 MIN HEIGHT.

FOOTBRIDGE CROSS SECTIONS

FIG. 5

1.5 Cross Sections for Footbridges

Footbridges are economically constructed in steel for short and medium spans using all steel or concrete or timber decks. Figure 5 shows a variety of footbridge cross sections. Other information is given in the Corus publication "The Design of Steel Footbridges". The advantage in using a steel deck plate is that the whole cross section including parapets can be fabricated at the works for delivery and erection in complete spans of minimal weight. Deck type spans with twin Universal Beams, plate girders or a single box girder may be suitable. Half-through cross sections are popular to reduce the length of staircase or ramp approaches and may use warren girders, Vierendeel girders, universal beams or plate girders depending upon span. Through-type cross sections are suitable where the bridge is to be clad, such as when used to inter-connect buildings in motorway service areas or for foot passenger Ro-Ro linkspans. Cross sections are influenced by the form of parapets which need to be of solid form and increased height across railway tracks. It is usually convenient for the supporting columns of footbridges to be of steel using braced trestles or single tubular members. It is customary to use thinner material than in railway or highway bridges, such as 6mm or 8mm for deck plates. Fillet welds should be correspondingly lighter to reduce distortion during fabrication, in particular to prevent water ponding and unsightliness in parapets.

1.6 Camber

Changes take place in the shape of a girder from the start of assembly of the prepared plate components in the fabrication shop until the time it is in service in the bridge. The pre-fabrication shape of the girder must anticipate these changes if the required final profile is to be achieved. Allowances need to be considered for:

- (a) changes of shape during fabrication by shrinkage and distortion due to flame cutting, welding and assembly sequence;
- (b) deflection from the fabricated shape of the steelwork that takes place at site under its self-weight, the weight of the concrete slab, and the superimposed dead loads of surfacing and finishes. (For composite bridges the sequence of concrete pours will influence the deflection to some extent);
- (c) long term effects such as concrete deck shrinkage and creep; and
- (d) the shape of the specified vertical geometry of the road or railway carried.

A permanent pre-camber is also often specified for appearance reasons or to achieve positive drainage fall, especially on footbridges.

Fabrication precamber as in (a) needs to be allowed for by the steelwork contractor, often based on experience as well as theoretical calculations. The designer should define camber geometry to cover (b) (c) and (d) and supply the steelwork contractor with a camber or deflection diagram to the designer's assumed erection and concreting sequence. It is good practice to define the girder shape after erection is complete and before concreting begins so that it may be checked and verified at this handover stage. The main contractor may vary the concreting sequence, with the designer's approval, which would require recalculation of (b). For significantly skewed multiple plate girder beam bridges it may be necessary to specify a pre-twist at end supports – see 5.3.

Variations in camber can arise in practice for several reasons:

- fabrication pre-camber to allow for flame cutting and welding effects is difficult to achieve with precision due to the number of imponderables which are involved, including the residual stresses which exist in the material;
- "shake-out" of residual stresses may occur during transport and during erection, leading to changes in shape of components;
- for composite bridges the design assumptions made for continuous spans relating to cracking of concrete in tension areas may be inaccurate, leading to deflections not being as predicted;
- for composite bridges camber changes due to shrinkage and creep may be of a long term nature and are difficult to predict with accuracy; and
- temperature variations within the structure at the time of checking cambers on site.

For these reasons, tolerance should be permitted in specifying and approving cambers, although BS 5400 Part 6 contains no specific tolerances for camber. As a guide a tolerance of $\pm \text{SPAN}/1000$ is reasonable, but not less than 6mm or greater than 25mm in any one span. In some cases it may be convenient to specify a final upward camber of this magnitude so that a downward sagging profile does not result if camber errors occur up to the tolerance limit. Details should, where possible, permit some degree of camber variation between adjacent girders. For continuous spans, where fabricated lengths are joined at site, as assembly and erection proceed splice details should permit rotation tolerance by use of suitable details (see Figure 12), such as bolted joints with gaps and clearance holes. For welded joints some degree of trimming and fairing of joints will often be needed at site.

A typical camber diagram for a simply supported span is shown in Figure 9.

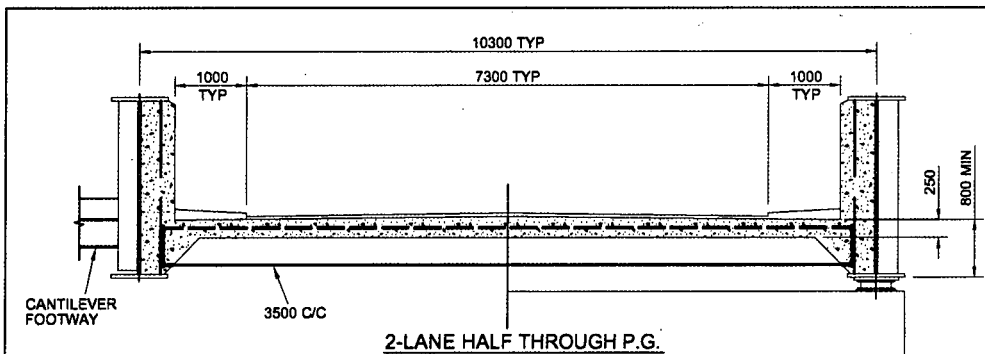

2-LANE HALF THROUGH P.G.

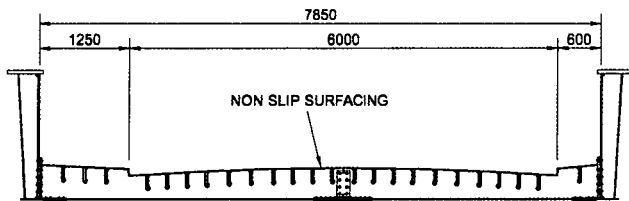

**2-LANE HALF THROUGH P.G.
ORTHOTROPIC PLATE.**

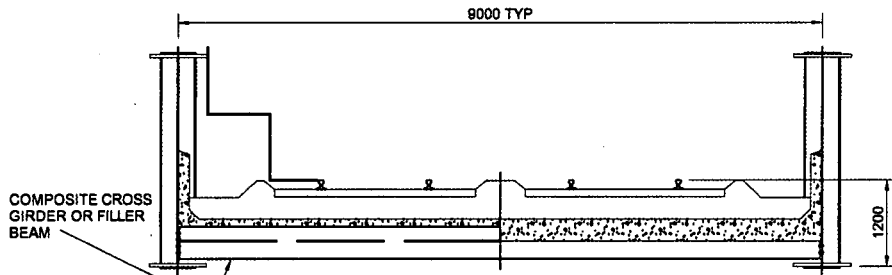

RAIL BRIDGE - HALF THROUGH PLATE GIRDERS.

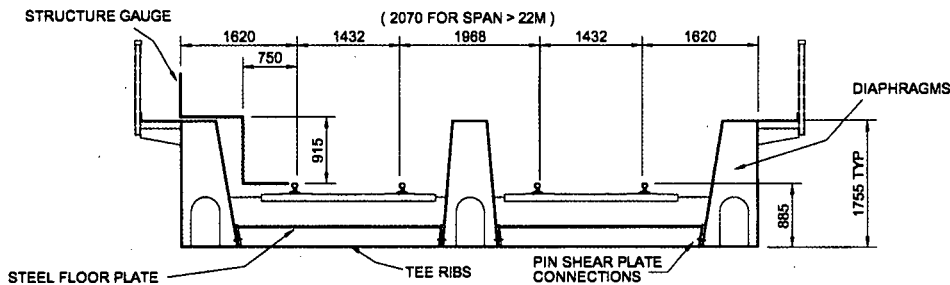

RAIL BRIDGE - HALF THROUGH BOX GIRDERS.

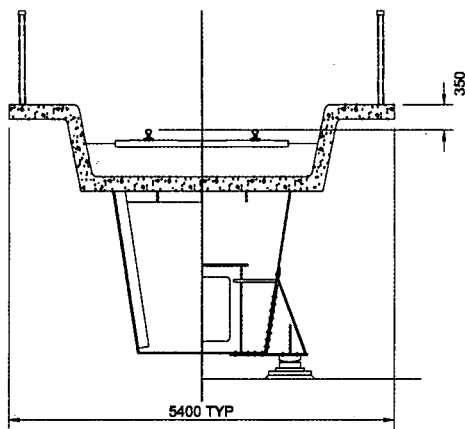

RAIL BRIDGE - DECK TYPE.

SPAN RANGE (METRES)	REMARKS.
35 TO 50	USE WHERE CONSTRUCTION DEPTH CRITICAL.
20 TO 50	USE WHERE CONSTRUCTION DEPTH CRITICAL. OR MINIMUM WEIGHT E.G RO-RO LINK SPAN, OR MOVABLE BRIDGE.
20 TO 40	
8 TO 25	USE WHERE CONSTRUCTION DEPTH CRITICAL. B.R. STANDARD TYPE.
25 TO 50	USE WHERE CONSTRUCTION DEPTH NOT CRITICAL.

HALF-THROUGH & RAIL BRIDGE CROSS SECTIONS

FIG. 6

TABLE 1. Guide to minimum cambers in Universal Beams

Beam Depth (mm)	Beam Length (metres)											
	26	24	23	21	20	18	17	15	14	12	11	9
914	95	-	75	-	57	-	38	32	25	19	-	-
834	100	-	83	-	63	-	44	38	32	25	-	-
762	115	-	89	-	70	-	50	38	32	25	-	-
686	127	-	101	-	75	-	50	44	38	32	-	-
610	127	-	115	-	82	-	63	50	38	32	-	-
533	-	127	-	114	-	82	-	57	44	38	25	20

Universal Beams can be cambered at the steel mill. The operation is performed by bending the beams cold to approximate a circular curve, but the beam may lose small amounts of this camber due to release of stresses put into the beam during the cambering operation. Alternatively, where only small pre-cambers are specified sufficient to counteract deflection (say SPAN/1000 or 25mm for a 25m long Universal Beam) then cambering by the steelwork contractor or other specialist will need to be carried out. For very short spans where appearance is not critical the designer should consider whether any cambering is justified.

As a guide only, Table 1 gives the minimum cambers in mm which are likely to remain permanent after cambering for beams cambered at the steel mill.

Greater accuracy can be achieved by cambering in a specialist rolling process, in which case cambering tolerances are $\pm 3\text{mm}$ or $+5 - 0\text{mm}$ on mid ordinate height, with no minimum camber as such.

1.7 Dimensional Limitations

For road transport of fabricated items within the UK the restrictions in Table 2 apply.

Maximum height depends upon vehicle height and shape of the load but generally items up to 3.0m high can be transported. For rail transport advice must be sought, but generally items up to 3.0m high, 2.9m wide and 30.0m long can be carried by arrangement: transport of steelwork by rail is currently extremely rare.

These restrictions and the requirements for erection have a considerable effect upon the member sizes and location of site splices. The Figures are for guidance only, eg 45m plate girders have been fabricated and

transported to site using a transporter with rear steerable bogies. The steelwork contractor should be allowed flexibility in fabricating in longer lengths provided he can obtain the necessary permission to transport such loads. Constraints at site or on the route to site may restrict delivery dimensions or weight so some flexibility to allow additional site splices may be required.

Except for very large projects it is usually uneconomic for large members (such as box girders) to be site assembled from individual elements. Generally, the longest possible members should be fabricated to achieve the minimum number of site joints. Erection costs are considerably influenced by unit weight so crane sizes should be optimised wherever possible: the crane size is determined by piece weight and the radius for lifting which is dictated by the site layout. A general guide is a maximum unit weight of 50 tonnes, although with modern cranes larger lifts can be achieved. In general site splices and girder lengths should be chosen to facilitate erection and the appropriate erection method for the particular site.

When galvanizing is specified for corrosion protection particular care must be adopted in the design and detailing of the steelwork. Means of access and drainage of the molten zinc and venting of the gases from internal compartments is essential for each assembly. During the galvanizing process (immersion at about 450°C for approximately five minutes) stress relief can sometimes cause distortion of light gauge steelwork. The stresses can arise from welding, cutting or cold working. As far as possible, each assembly should be symmetrical and the welding stresses balanced. Plate and box girders will tend to

TABLE 2. Road Transport length/width restrictions

Method of Transport	Max Width (metres)	Max Rigid Length (metres)	Max Laden Weight (tonnes)	Max Axle Weight (tonnes)
Free movement	2.9	18.6	38	10.5
Police to be informed – escort required	5.0	27.4	150	16.5
Special movement order (at least 8 weeks notice)	More than 5.0	More than 27.4		

twist longitudinally due to the release of welding stress: this is rarely an issue in assembly of plate girder bridges but it does need consideration on box girder bridges.

Consideration should also be given to factors (such as detailing, material grade, locked-in stresses, good fabrication practice) that will overcome the minimal risk of cracking arising from the galvanizing process (liquid metal assisted cracking or embrittlement). Advice is available from galvanizing companies and from the Galvanizers Association on these issues.

The maximum size and weight of assemblies that can be galvanized depends upon the size of the bath and craneage available. The largest baths, in 2001, are up to 21m long by 1.5 to 2.0m wide by 2.7 to 3.5m deep. By 'double dipping' (immersing part of the structure and then reversing it for length and depth) larger sizes can be galvanized subject to limitations on craneage capacity.

1.8 Erection

Prior to the 1970's the erection of small and medium span bridges required the steelwork contractor to exercise ingenuity and expertise to devise schemes using cranes of fairly limited capacity - a 50t derrick crane mounted on travelling bogies was the largest available. Extensive temporary works were common with steel trestles in span to support short members for splicing, or rolling in, cantilevering or launching schemes; and, on occasion using floating craft for cranes or girder movements. The steelwork contractor had a significant amount of construction engineering to do which, for launching and cantilevering schemes, involved analysis and modification of the permanent works design to suit. These schemes required much more activity at site to prepare and carry out, and would take weeks rather than days.

With the advent of larger, and yet larger, capacity mobile cranes from the 1970's and the ability to deliver longer components via the motorway system, erection of many major bridges could be carried out more rapidly and economically without resort to temporary supports. The introduction of composite construction in continuous multiple spans favoured delivery and erection in longer lengths too. These developments led to simpler quicker erection for many bridges but significant stresses could arise during construction, and elastic instability of steel members during construction became much more of an issue. This, together with modern safety legislation, means the designer has to anticipate the erection scheme and completion of deck slab construction in his design of the bridge. The production of method statements, safety plans and risk assessments is required of the designer as well as the steelwork contractor; and today the checking of steelwork strength and stability at all stages of erection, as well as of any temporary

works, is required to be rigorous and documented. The contractor is responsible for the erection scheme as well as its implementation: the designer has to anticipate it properly.

Erection of short and medium span steel bridges is most commonly carried out using road mobile or tracked crawler cranes. Road mobile cranes require firm ground conditions to get on to site and at the work positions where they use outriggers to develop full capacity. The largest cranes, and with derrick counterweight installed, have the capacity to lift more than 50 tonnes at 50m radius, or 100 tonnes at 28m radius: these cranes are suitable for erection of most small and many medium span bridge girders where a unit weight not exceeding 50 tonnes is involved. In poor but level ground conditions crawler cranes have flexibility in being able to travel with the load and, typically, can lift up to 15 tonnes at 50m radius travelling. Hire costs and crane assembly periods for mobile cranes increase substantially for the larger cranes, which may be demanded for example where 'I' girders are lifted in pairs, but it is advantageous if erection can be performed using the minimum number of lifts and crane positions. Crawler cranes are not economic for short hire periods, but are more cost effective than road mobile cranes for long periods. Ground supported temporary works are avoided wherever possible, and personnel access is assisted by use of mobile access platforms or cherry pickers. For heavy lifts, cranes may be used in tandem, subject to more severe lifting conditions, which can significantly increase the erection costs. Mobile cranes are usually hired by the steelwork contractor specifically for the erection, so it is most economic if all the steelwork within a bridge can be erected in one continuous operation. Girders are generally lifted on their centre of gravity using double slings connected to temporary lifting lugs welded to the top flange. Sling lengths are usually selected commensurate with stability of the girder, whilst being lifted, so as to limit the crane jib length needed and maximise on the crane capacity.

For single spans, up to say 60m in length, any splices whether bolted or welded would usually be made with the girders aligned on temporary stillages at ground level, before each girder is lifted complete. For continuous spans, then 'span' and 'pier' girders would be spliced similarly at ground level with erection proceeding span by span and oversailing each pier to avoid the need for any ground supported temporary works. For plate girders erected singly of length greater than about 40m then stability may demand use of bowstrings or other temporary works to reduce the effective flange length against buckling once the crane is released. These erection methods are economic and of little hindrance to other site operations for they allow construction to advance rapidly without need for substantial ground supported temporary works.

Erection by mobile cranes is generally the most economic method provided access and space is available for such cranes and for delivery of steelwork. Where temporary supports are required standard 'L' trestling is often used with foundations using timber sleepers or concrete, depending on ground conditions. For long span bridges significant temporary works will usually be necessary including the site pre-assembly of main members from separate flange and web elements. If welded splices need to be carried out in the final position rather than at ground level some form of temporary works and welding shelters with access for inspection and testing are necessary – that is rather more provision than for bolted connections.

Where erection has to be carried out during a limited period such as in a railway possession or road closure then lifting of complete bridge spans is preferable, even though this increases the size or number of cranes. Rail mounted cranes were much used in the past for rail bridge erection, but have limited capacity; they may be appropriate where no access is available for road mobile cranes, however they are of limited availability. Where crane access is not feasible or overly costly, such as for a waterway crossing, then other erection methods including launching or rolling-in may be called for: such schemes are less common today but, in the hands of competent steelwork contractors, are powerful ways of overcoming difficult obstacles or logistical constraints.

Launching is most suitable for new build highway or railway multiple continuous span bridges with constant height girders or trusses. Where possible the steelwork is assembled full length off one end of the bridge and launched forward on rollers or slide units mounted on tops of the permanent piers. A tapered launching nose is used to minimise stressing of the girders and remove the cantilever deflection of the leading end as it approaches each support. Propulsion may be by pulling with winches or strand jacks, or by incremental jacking, followed by jacking down on to the permanent bearings. Generally the steelwork alone is launched, followed by deck slab concreting, but launching of concreted spans can be advantageous. An important design check is the stability of the girder web or truss bottom chord above the roller or slide units; the camber shape of the girders to be taken into account; and the interface of the girders with the temporary works must suit the sliding or rolling action.

Lateral sliding in, rolling in or transporter units are used for bridge replacements. The whole structure is normally constructed and completed on temporary supports alongside the bridge before it is moved transversely and then jacked down onto its permanent bearings. Railway bridges have for many years been rolled in using 76mm (3") diameter steel balls running

on bullhead rails laid flat and surmounted by rolling carriages beneath the steelwork: with the advent of polytetrafluoroethylene (PTFE) and other low friction materials sliding in is increasingly favoured in that heavier loads can be carried. Propulsion is generally by strand jacks or incremental jacking, followed by jacking down onto permanent bearings. A combination of longitudinal launching and lateral sliding may be appropriate.

The large crane is not the universal solution: modern bridges of modest scale can still present very real challenges to the ingenuity of the steelwork contractor and the skill of the designer. For example, the Newark Dyke rail bridge, which required complete replacement in a three day closure of the East Coast main line at a site of very restricted access, was effected by firstly launching in turn the two braced arch girders across the river, traversing them to receive cross girders and deck concrete before the possession; then the lateral slide in of the complete bridge including tracks during the three days which included sliding out the existing structures for removal by pontoon.

The erection of steel bridges requires detailed consideration by the designer, for it has to be safe and practicable, and significant construction engineering on the part of the steelwork contractor who will develop and implement the scheme which is actually used. It should be noted that fabrication and erection may be carried out by different steelwork contractors, but it is generally desirable that one steelwork contractor is responsible for both. Site applied protective treatment is generally carried out after erection, and after deck concreting in the case of composite bridges; this work is usually sub-let by the steelwork contractor.

1.9 Repairs and Upgrading

The enormous increase of highway traffic since the 1980's and the influence of heavier commercial vehicles has led to revised bridge loading standards so that many modern bridges are now regarded as sub-standard. Major bridges strengthened since the early 1990's include the Avonmouth, Severn, Wye, Forth, Tay, Friarton and Tamar bridges, as well as smaller bridges of all types. Although railway loadings have not significantly changed, many rail bridges are well over 100 years old and are becoming life expired. The planned introduction of higher train speeds above 125mph has led to new design criteria against excessive vibration to maintain passenger comfort levels and ballast stability, and consequently some bridges require additional stiffness. All in all a significant volume of steel bridgework now involves repairs and upgrading.

Steel is particularly suitable for strengthening by added material or duplicate members using bolted or site welding where appropriate. In some cases such as the

M6 Thelwall Viaduct a composite riveted plate girder structure strengthening was achieved by bolting on of additional material and replacement of the existing deck using stronger concrete and additional shear connection. In other cases strengthening has consisted merely of replacement of bearings and minor works. Some bridges originally designed non compositely have been made composite by replacement of rivets by shear connectors.

Repairs to existing bridges have also been increasingly required due to accidental collision of vehicles with bridge soffits. Damage to steel members has generally been found to be fairly local without fracture or risk of overall collapse, due to the ductile properties of steel. Depending upon the severity of damage several girder bridges have, since 1999, been repaired by heat straightening processes, as an alternative to costly girder replacement: techniques as used in the USA have been developed by UK steelwork contractors for this work.

Designers and steelwork contractors undertaking repair and strengthening works can face challenges and hazards not met in new works; these can include understanding the structure and how it works, technical issues such as those presented by welding to older materials; and safety hazards with access, confined space working and the presence of potentially toxic lead-based paints and cadmium plating. Even the smallest of such projects should be undertaken only by engineers and organisations with the relevant knowledge and expertise.

CHAPTER 2

STEEL QUALITIES

2.1 Introduction

The performance requirements for materials for steel bridges are contained in BS 5400: Part 3 (Design) which requires the minimum UTS to be not less than 1.2 x the nominal yield stress, a ductility corresponding to a minimum elongation of 15% and a notch toughness to avoid brittle fracture. It is important to remember that the ductility is an important property of steel which allows it to be fabricated and shaped by normal workshop practices. The requirements are met using the appropriate strength grade and impact qualities given in material standards BS 7668, BS EN 10025, BS EN 10113, BS EN 10137, BS EN 10155 and BS EN 10210 and are specified by the designer. Grade S355 is the most common grade used in UK bridges. Strength grades higher than S460 are not covered by the design rules. BS 5400: Part 6 (Materials and Workmanship) contains detailed requirements for materials including laminar defect limits in critical areas, thickness tolerance, and performance requirements for steels to standards other than those above. The steel is required to be supplied with a manufacturer's certificate and to have details of ladle analysis provided, so that the steelwork contractor can check the details for welding procedures.

2.2 Brittle Fracture and Notch Toughness Requirements

The possibility of brittle fracture in steel structures is not confined to bridges for it has to be considered wherever stressed elements are used at low temperatures, especially in thick material where stresses are tensile, there are stress raising details and the loading is applied rapidly. Steel having adequate notch toughness properties at the design minimum temperature should be specified so that when stressed in the presence of a stress raising detail the steel will have a tendency to strain rather than fracture in a brittle manner. In fact, structural steelwork has a good history of very few brittle fracture failures. There are a number of contributory factors which help to prevent brittle fracture from occurring, eg the risk of brittle fracture is highest when the first high tensile stress coincides with a very low temperature – where the first high tensile stress occurs at a higher temperature, then some element of "proofing" takes place. The first UK limitation of notch toughness for steel in welded tension areas of steel bridges was introduced in BS 153 in the mid 1960's.

The standard Impact Test prescribed in EN 10045-1 provides a measure of the notch toughness of a steel.

The test specimen is usually of square section 10 x 10mm and 60mm long with a notch across the centre of one side: it is supported horizontally at each end in the test machine and hit on the face behind the notch by a pendulum hammer with a long sharp striking edge. A pointer moved by the pendulum over a scale indicates the energy used in breaking the specimen, which is expressed as the Charpy energy in Joules at the temperature of testing. The resistance of a steel reduces with temperature so the test is usually carried out at room temperature, and a range of low temperatures to suit the specified requirement, say, 0°C, -10°C, -15°C, -20°C.

In BS 5400: Part 3: 2000 the required impact quality is derived from an equation relating the maximum permitted thickness of a steel part to:

- steel grade,
- design minimum temperature (see BS 5400: Part 2),
- construction detail,
- stress level, whether tension or compression, and
- rate of loading.

A key part of the equation is a k-factor which classifies steel parts for fracture purposes.

For convenience table 3C in BS 5400: Part 3: 2000 gives maximum thickness limits for steels for k=1 which covers many situations where the design stresses exceed 0.5 s_y and are tensile. For typical UK minimum design temperatures the limiting thicknesses are shown in Table 3, which takes account of nominal yield strength variations with thickness.

Whilst stress relieving is generally allowed by the standards, it is normally impractical for bridges due to their large scale.

2.3 Internal Discontinuities in Rolled Steel Products

Internal discontinuities are imperfections lying within the thickness of the steel product. These may be planar or laminar imperfections, or inclusion bands or clusters. Typically such laminar imperfections run parallel to the surface of a rolled steel product. They can very occasionally originate from two main sources in the ingot or slab from which the plate or section is rolled:

- (a) entrapped non-metallic matter, such as steelmaking slag, refractories or other foreign bodies (NB: Such material may not necessarily form a 'lamination', if the body fragments into smaller pieces on rolling, they may appear as discrete or clusters of 'inclusions'.

Strength Grade	Quality		Former Grade in BS4360	Yield N/mm ² (16-40mm plate)	Material Cost / Yield (\$275 or 43A is 1.0)	Max thickness in mm for parts in tension										Main Use
	Grade	T ₂₇₅ °C				Design min temp °C										
S275	-	-	43A	265	1.0	0	-5	-10	-15	-20	-25	-30		Secondary Steel		
	J0	0	43C		1.05	-	77	70	60	55	0	0				
	J2	-20	43D		1.09		124	114	98	89	77	70				
	N1,M	-30	43DD		1.12		149	136	124	114	98	89				
S355	N1,ML	-50	43EE		1.22		229	224	191	174	149	136		Main Steel		
	-	-	50A	345	0.84	-	-	-	-	-	-	-				
	J0	0	50C		0.85		50	45	40	36	0	0				
	J2	-20	50D		0.86		74	68	59	54	50	45				
	K2	-30	50DD		0.89		93	85	74	68	59	54				
	N1,M	-30	50DD		0.89		33	85	74	68	59	54				
S460	N1,ML	-50	50EE		0.98		147	134	123	112	93	85		Main Steel		
	-	-	-	440												
	Q	-20	-				50	42	38	35	32	29				
	N1,M	-30	55C		0.89		60	55	50	46	42	37				
S355 (W/F)	QL	-40	-				77	64	58	53	46	42		Not commonly used		
	N1,ML	-50	55EE		0.91		96	88	77	71	60	55				
	QLI	-60	-				100	92	84	77	70	64				
	J0W	0	W/F50A	345	1.04		50	45	40	36	0	0				
S355 (W/F)	J2W	-20	W/F50C		1.05		74	68	59	54	50	45		Unpainted Structures		
	K2W	-30			1.07		93	85	74	68	59	554				

TABLE 3. Relative Efficiency and Limiting Thickness of Steel Grades

The distinction between a lamination and an inclusion is purely arbitrary);

(b) a pipe

or from non-uniform distribution of alloying elements, impurities or phases.

When an ingot solidifies it may contain shrinkage cavities known as pipes. Providing they are not exposed to the atmosphere during reheating for subsequent rolling, pipe cavities generally weld up during the rolling process to give sound material. If a pipe is exposed, say by trimming off the head of the ingot, then its surface will oxidise during subsequent reheating and this will prevent the cavity from welding up. The resulting 'lamination', consisting largely of iron oxide, is then a plane of weakness. Ingots are very rarely used now and almost all steel produced in Europe today is by the continuous casting process, which eliminates this source of discontinuity.

Where a 'lamination' is wholly within the body of a plate or section and is not excessively large it will not impede the load-bearing capacity for stresses which are wholly parallel to the main axes of the member. However, 'laminations' can cause problems if they are at or in close proximity to a welded joint: thus a 'lamination' will be a plane of weakness at a cruciform joint where it is subjected to stresses through the thickness of the plate or section. A related phenomenon is lamellar tearing, which may occasionally occur at joints in thicker sections subject to through-the-thickness stresses under conditions of restraint during welding. This results from a distribution of micro-inclusions, which link up under high through-thickness stresses resulting in a distinctive stepped internal crack. It is generally less common with modern steel-making practice which produces lower average sulphur contents than was the case up to the 1970's. In practice it is unlikely that failure will occur in service, but full penetration welded cruciform joints should generally be avoided because the heat inputs from multi-run welding and back gouging processes can cause a significant strain within the plate thickness, resulting in a tearing kind of failure. Cruciform welds should ideally have fillet welds or partial penetration welds reinforced if necessary by fillet welds. If joint details are such that lamellar tearing may be a problem, then steel with improved through-thickness ductility (eg Z-grades to BS EN 10164) should be specified. Such steels are produced with ultra low sulphur levels.

To reduce the risk of lamellar tearing, BS 5400: Part 6: 1999 specifies limits on laminar imperfections in accordance with BS 5996: 1993 (superseded by BS EN 10160 in 1999) in critical areas such as girder webs close to welded diaphragms and stiffeners, or to other areas which may be specified by the designer. BS EN 10160: 1999 has a number of acceptance classes:

classes S0 to S3 refer to decreasing sizes and population densities of discontinuities anywhere in the main area or body of a plate; and classes E0 to E4 refer to decreasing sizes and numbers of imperfections near the edges of a plate.

For bridge applications two classes of BS EN 10160: 1999 are relevant:

Class S1 which defines a maximum permitted area for an individual lamination of 1000mm² as detected with a scan over the whole body of a plate.

This is specified for the material in the vicinity of diaphragms, stiffeners or cruciform joints.

Class E1 which refers to a band 50mm, 75mm or 100mm wide (depending on the plate thickness) from the plate edge and no discontinuity over 50mm length, or 1000mm² area, is permitted in this zone. It also stipulates a maximum number of smaller discontinuities (between 25mm and 50mm long) per 1m length.

This is required for plate edges to be corner-welded (NOT butt welded).

Whilst BS EN 10160: 1999 refers to steel plate, it can also be applied to steel sections by special arrangement with the steel manufacturer. However, the ultrasonic testing of sections should really be specified to BS EN 10306: 2002.

2.4 Material Selection

Table 3 gives an indication of the relative efficiency (in terms of a base cost/yield ratio) of the various grades of steel. These are based on typical costs at the time of publication and on yield values for plates 16mm – 40mm thick. They may vary with market conditions but can be regarded as reasonably representative.

From Table 3 it can be seen that grade S355 steel is more economically attractive than grade S275 and so its use by designers and its availability have greatly increased: with a 30% strength/mass advantage grade S355 steel offers cost savings for transportation and erection too. Although grade S460 appears to be slightly more advantageous for NL, ML qualities, such qualities are usually only required for thicker plates. Grade S460 steel is less readily available than S355 steel, particularly for thick plates, and has yet to find widespread use in the UK. Fabrication costs, and the cost of consumables, increase with use of such higher strength grades as the requisite welding procedures become increasingly more demanding and the additional strength is of little benefit where fatigue or slenderness govern the design.

The availability of plate lengths in different widths is a function of the rolling process: Figure 7 shows the availability from Corus. The generally available maximum sizes of plate dimensions should be adopted as a guide in design; however, it is often possible to obtain larger sizes, subject to consultation with the rolling mills, at a cost premium. Butt welding shorter plates can be more cost effective than specifying a very large single plate.

It should be noted that high premiums are paid on steel orders (of one size and one quality for delivery from one works at one time to one destination) of low quantities, typically less than 5 tonnes. Therefore designers should try to standardise on material sizes to avoid cost penalties. Where small tonnages occur (say for gussets and packs) it is often more convenient to obtain material from a stockholder, even though costs are greater; normally only grades S275 and S355 are available so that other grades for such small items should be avoided.

2.5 Weathering Steels

Weathering steels (or weather resistant steels) are high strength low alloy steels originally developed by American steel makers to resist corrosion and abrasion in their own coke and ore wagons. They were first used for structural purposes in 1961 when the John Deere building was constructed in North America, with an exposed steelwork and glass exterior. The first weathering steel bridge in the United Kingdom was a footbridge at York University, built in 1967, and many more have been built since. The advantage of weathering steel is that the structure requires virtually no maintenance, apart from occasional inspection. The whole life costs of the structure are reduced because all the direct and consequential costs of initial protective treatment and of periodic repainting are eliminated. Examples of bridges constructed using weathering steels are shown in the Corus publication 'Weathering Steel Bridges' and advice on details is given in a ECCS publication 'The Use of Weathering Steel in Bridges'.

2.5.1 Performance

These steels owe their weathering resistance to the formation of a tightly adherent protective oxide film or 'patina' which seals the surface against further corrosion. The patina gradually darkens with time and assumes a pleasing texture and colour which ranges from dark brown to almost black, depending on conditions of exposure. The type of oxide film which forms on the steel is determined by the alloy content, the degree of contamination of the atmosphere and the frequency with which the surface is wet by dew and rainfall and dried by the wind and sun.

Steels with alloy elements in the proportions considered for weathering steels (up to about 3% total) generally corrode at much the same rates as mild steel if they are permanently immersed or buried. Their improved resistance to atmospheric corrosion is related to the nature of the rust layers formed. The atmospheric corrosion rate of newly-exposed weathering steel is initially similar to that of mild steel but it slows down as the patina builds up; significantly the degree of slowing down is greatest where the exposure conditions most markedly follow a repeated cycle of wetting and drying.

The formation of the protective oxide film or 'patina' is progressive with exposure to the atmosphere during and after construction. For the best appearance exposed surfaces should be blast cleaned to remove mill scale; and paint marks should be avoided to ensure uniform patina formation. For most structures, only the very visible exposed faces may need the cleaning treatment as it would serve little purpose to spend money cleaning the inner surface of a plate girder when that surface is not prominently seen - but mill scale must be removed to allow the patina to form. Piece marks and erection marks, normally painted on members by the steelwork contractor, must be placed where they will not normally be visible. Measures should be taken in design and construction to control run-off staining, especially during the initial weathering period to avoid staining of adjacent materials, for example by protection of supporting concrete piers and using steelwork details which encourage water run-off clear of the supports.

As with normal good design practice, crevices or ledges where water or debris can collect should be avoided, for these conditions may accelerate corrosion. In detailing care should be taken to keep water run-off from expansion joints clear of the steelwork. A useful expedient on deck type bridges is to use a full depth concrete diaphragm encasing the ends of girders there, or, alternatively protective treatment by painting can be applied to critical areas. For railway bridges measures should be taken to prevent continuously wet ballast from coming into contact with the steel by use of concrete encasement up to the top of ballast level, together with use of weather flats. Weathering steel should not be used in highly corrosive atmospheres, including up to 2km from coastal waters or where the headroom is less than 2.5m over waterways. Highways Agency Standard BD7/01 authorises its use for highway bridges subject to certain restrictions relating to the quality of the environment, where de-icing salts would lead to chloride being deposited on the steel, or where the steel would be continuously wet or damp. A long term corrosion allowance should be made as shown in Table 4.

TABLE 4 – Weathering Steel Corrosion Allowances to BD7/01 related to 120 year design life

	Atmospheric Condition under ISO 9223		
	Mild	Severe *	Interior of Sealed Box Sections
Corrosion allowance per exposed surface (mm)	1.0	1.5	0.5

* Including all bridges across highways subject to the use of de-icing salt.

A former restriction on use of weathering steel over highways with less than 7.5m headroom has been removed following the outcome of research into the corrosivity under bridges and in-service performance in the UK and elsewhere. There should therefore be no restriction on the use of weathering steel in bridges over highways or in rail underbridges subject to the requirements of BD7/01.

BD7/01 requires steel thickness measurements to be carried out over a series of principal inspections to confirm that the required slowing-down of the corrosion process is achieved. A useful development for such measurements is the 'EMA Probe' which can be used for measuring the thickness of sound steel below any rust layer using the generation of ultrasonic waves by electro-magnetic induction.

2.5.2 Materials and Weldability

BS EN 10155 1993 (for plates and sections) and BS 7668 (for hollow sections) specify the chemical composition and mechanical properties of weathering steel grades. An early weathering steel developed by the US Steel Corporation was called Corten; this is a patented name and the generic name is "weathering steel". Strength grade S355 is generally used for bridgework and is available in similar impact qualities to non weathering grades. Weathering steels have been proved amenable to the normal fabrication and welding procedures appropriate to structural steels of the same strength.

In common with other high yield steels for general structural applications, procedures and precautions for welding have to be adopted to avoid cracking and to obtain adequate joint properties. The total level of alloy additions is generally higher than for most high yield steels giving carbon equivalent values (cev) sometimes ranging as high as 0.53, although developments in steel making are generating significant improvements in weldability. Corus is currently able to offer steels up to 65mm thick with cev typically of 0.44 (0.47 max) and thicker plates of typical 0.5 (0.52 max). The higher the carbon and alloy content of a steel, the harder and more brittle the heat affected zone near a weld becomes and the more susceptible it is to cracking. 'Carbon equivalent' formulae are widely used as empirical guides relating composition and cracking tendency.

The formula adopted is:

$$CE = C + \frac{Mn}{6} + \frac{Cr + Mo + V}{5} + \frac{Ni + Cu}{15}$$

To determine the carbon equivalent of a steel the chemical symbols in the formula are replaced by the percentages of the respective elements in the steel.

The 'weldability' of a material can be considered as the facility with which it can be welded without the occurrence of cracking or other defects which render it unfit for the intended application. Long practical experience in the welding of weather resistant steels in North America and the UK has shown that they are readily weldable provided that the normal precautions applicable to steel of their strength level and carbon equivalent are taken.

For most applications of weathering steels the weathered appearance of the finished structure is one of its prime characteristics. It is important, therefore, that any welds which are exposed to public view should also, over a reasonably short period of time, weather in the same manner as the adjacent parent material. A wide range of electrodes is available with properties which are compatible with the parent steel.

It is not normally necessary to use electrodes with compatible weathering properties for small single pass welds, or for internal runs of multi-pass welds. In the former case, sufficient absorption of alloying elements from the base steel will give the weld metal a corrosion resistance and colouring similar to the base, whilst in the latter there is no need for the submerged runs to have such resistance. It is, of course, vital that electrodes with adequate mechanical properties are chosen.

2.5.3 Bolting

In a painted steel structure bolted connections are protected from the ingress of water by the paint coatings. This is not the case, however, with a weathering steel structure and as the connection is fully exposed it is inevitable that at least some ingress of water to the interior joint surfaces can occur. This may be minimised with suitable bolt spacings, edge distances and sealing but to avoid any electrochemical reaction it is important that the bolts, nuts and washers have a similar electro chemical potential to that of the

steel structural member. Appropriate specifications for these would have chemical compositions complying with ASTM A325, Type 3, Grade A. Bolt spacings should not exceed 14t (maximum 180mm) and edge distances should not be greater than 8t (maximum 130mm). Such connections have performed successfully over many years of service.

The designer should limit the connectors on a weathering steel structure to sizes M20, M24 or M30 for availability reasons, and M24 is the preferred size. For a structure using 100 tonnes of weathering structural steel, typically only 1–1.5 tonnes of connectors are required. This is far too small to justify a special rolling of bar in the steel mill; the production of nuts and bolts is dependent on the availability of right sizes of bar kept in stock by the fastener manufacturers or steel stockholders dealing in weathering steels. It is advantageous in design using M24 bolts to adopt spacings appropriate to 1" (25.4mm) diameter bolts (ie minimum spacing say 65mm) so as to permit procurement of bolts from the USA if necessary.

2.5.4 Availability of weathering steel

Plates are readily available from the mill.

The availability of sections should be checked at an early stage in the design. The minimum quantity for sections direct from the mill is typically 50t per size and weight. Smaller quantities may be available depending on the availability of suitable feedstock and gaps in the rolling programme, but this cannot be relied on at the

design stage. Hence, unless rationalisation of the design yields such quantities, it is often best to specify fabricated sections rather than the UB's or UC's. A limited range of weathering grade angles and channels suitable for bracing elements is currently held in stock in the UK, and is available in small quantities. For further details on availability contact Corus.

For hollow sections, the minimum quantity is 150t per order, as a cast has to be made specially.

2.5.5 Suitability

The selection of weathering steel for bridge structures is a matter of engineering judgement. Some of the factors to be evaluated are:

- environment: consideration of overall bridge site condition. Any geographic or site conditions which create continuous wetting and very high concentration of chlorides must be avoided.
- economics: comparison of the cost of initial painting in other steels versus the cost of weathering steels. Recent experience is that costs of weathering steel and painted steel bridges are similar taking into account the added thickness for long term corrosion with weathering steels. Overall, when commuted maintenance costs are taken into account, the weathering steel alternative is likely to be cheaper.
- safety: elimination of maintenance painting over traffic, and for box girders the elimination of much hazardous confined space working throughout the whole life of the bridge.

FIGURE 7. Available Plate Lengths

Plate Gauge (mm)	Plate Width (mm)										
	> 1250 ≤ 1500	> 1500 ≤ 1750	> 1750 ≤ 2000	> 2000 ≤ 2250	> 2250 ≤ 2500	> 2500 ≤ 2750	> 2750 ≤ 3000	> 3000 ≤ 3200	> 3200 ≤ 3500	> 3500 ≤ 3750	> 3750 ≤ 4000
10	18.3	18.3	18.3	18.3	18.3	18.3	18.3	18.3	10.0		
15	18.3	18.3	18.3	18.3	18.3	18.3	18.3	18.3	18.3		
20	18.3	18.3	18.3	18.3	18.3	18.3	18.3	18.3	18.3		
25	18.3	18.3	18.3	18.3	18.3	18.3	18.3	17.0	17.0	15.0	12.0
30	18.3	18.3	18.3	18.3	17.0	17.0	17.0	17.0	17.0	15.0	12.0
35	17.0	18.3	18.3	17.0	17.0	17.0	17.0	16.2	15.1	14.1	12.0
40	17.0	17.0	17.0	17.0	17.0	16.8	15.4	14.2	13.2	12.3	11.5
45	17.0	17.0	17.0	17.0	16.4	14.9	13.7	12.6	11.7	10.9	10.3
50	17.0	17.0	17.0	16.4	14.8	13.4	12.3	11.4	10.6	9.9	9.2
55	17.0	17.0	16.8	14.9	13.4	12.2	11.2	10.3	9.6	9.0	8.4
60	9.2	17.0	15.4	13.7	12.3	11.2	10.3	9.5	8.8	8.2	7.7
65	8.5	16.2	14.2	12.6	11.4	10.3	9.5	8.7	8.1	7.6	7.1
70	7.9	15.1	13.2	11.7	10.6	9.6	8.8	8.1	7.5	7.0	6.6
75	7.4	14.1	12.3	10.9	9.9	9.0	8.2	7.6	7.0	6.6	6.2
80	6.9	13.2	11.5	10.3	9.2	8.4	7.7	7.1	6.6	6.2	5.8
85		12.4	10.9	9.7	8.7	7.9	7.2	6.7	6.2	5.8	5.4

Notes:

1. Intermediate gauges are available
2. Plates may be available in longer lengths by arrangement
3. For precise details of plate availability, please contact Corus

CHAPTER 3

DESIGN OF MEMBERS

3.1 Introduction

This chapter deals with the various practical aspects of the design and selection of the appropriate form of the principal structural members in a steel or composite construction bridge.

The simplest form uses rolled section universal beams with little fabrication other than cutting to length, welding of bearing stiffeners (discussed in more detail below for plate girders), and welding of shear connectors. As a characteristic of the rolling process, most deep rolled beams have web thicknesses greater than needed for structural purposes. Consequently web stiffeners are rarely required; however, where they are needed, web stiffeners should not be full penetration butt welded to the webs of rolled sections because of the risk of lamination.

3.2 Plate Girders

Flange thicknesses limited to 75mm are generally advisable to avoid weld procedures needing excessive preheat; but flanges up to 100mm thickness or more can be used subject to notch toughness requirements and availability. Butt welds will be necessary for forming long flanges, allowing the use of smaller plates in regions of reduced moment; however, the number of

plate changes should be the minimum commensurate with plate availability and economy, because of the high cost of butt welds. Figure 8 is a guide as to where it is economic to change plate thicknesses within girder lengths. The Figure is typical for flanges or webs of medium size plate girders. The relative economy may vary in individual cases depending upon the welding processes used and general fabrication methods. It is usual to cut flange and web plates in multiple widths from economic wide plates supplied from the rolling mill.

Flanges should generally be as wide as possible commensurate with outstand limits imposed by BS 5400: Part 3, so as to give maximum lateral stability. Table 5 gives outstand limits for a common range of compression flange thickness. Tension flanges are limited to an outstand of twenty times thickness to ensure suitably robust construction.

A typical plate girder for a single span bridge is shown in Figure 9; because the span of 32.25m exceeded 27.4m an optional splice is shown towards one end. Suitable bolted or welded splices are shown in Figure 10. In cases where the steelwork contractor can deliver the girders to site in one length then the site splice would be unnecessary.

TABLE 5 - Compression Outstand limit to Flanges (BS 5400: Part 3: 2000 Clause 9.3.)

Strength Grade		Flange Thickness (mm)													
		15	20	25	30	35	40	45	50	55	60	65	70	75	
S275	σ_y (N/mm ²)	275	265					255					245		
	Outstand (mm)	205	278	347	417	486	556	637	708	779	850	939	1011	1083	
	Typ Fig	400	550	650	800	950	1100	1250	1400	1550	1700	1850	2000	2150	
S355	σ_y (N/mm ²)	355	345					335					325		
	Outstand (mm)	180	243	304	365	426	487	556	618	679	741	815	878	941	
	Typ Fig	350	450	600	700	850	950	1100	1200	1350	1450	1600	1750	1850	
S460	σ_y (N/mm ²)	460	440					430					410		
	Outstand (mm)	158	216	269	323	377	431	491	545	654	654	726	782	837	
	Typ Fig	300	400	500	650	750	850	1000	1100	1300	1300	1450	1550	1650	

The steelwork contractor usually butt welds the flanges and web plates to full length in the shop before assembly of the girder. This means that such shop joints can be in different positions in the two flanges and do not have to line up with any shop joint in the web.

The fabrication process for plate girders varies between steelwork contractors depending on how extensively their workshops are equipped, from basic facilities up to substantial automation. The alternatives are described in the following common sequence (see Figure 11) for plate girder preparation, assembly, and finishing:

A. Butt weld plates for flanges and webs into longer lengths as required, with the plate at full supplied width, if possible, to minimise butt weld testing requirements.

B. Mark ends and machine flame cut flanges to width and length. If the girder is curved in plan then the flange will need to be profiled to the correct cut shape. If it is possible with the equipment available, then drill bolt holes for flange connections and mark stiffener positions. If not, then these will need to be hand marked and drilled later.

C. Machine flame cut welds to profile and camber, including any fabrication precamber. If it is possible with the equipment available, then drill bolt holes for web connections and mark any longitudinal stiffener positions. If not, then these will need to be hand marked and drilled later.

D. Machine flame cut stiffeners to shape. If it is possible with the equipment available, then drill bolt holes for bracing connections and mark any plan bracing cleat positions. If not, then these will need to be hand marked and drilled later.

E. Assemble the girder

Either

Assemble flanges to web using tack welds, then semi-automatically weld the flanges to the web, rotating the girder as necessary to minimise distortion and obtain the necessary welding position. (This is used for very short girders, such as diaphragms, and highly shaped girders.)

or

If 'T + I' automatic girder assembly equipment is available, then automatically weld web to first flange to form a 'T' section before turning the 'T' section over to assemble and weld the second flange to the web forming the 'I' girder.

or

If automatic girder assembly equipment is available, then place the web horizontally between the two flanges and automatically weld the two uppermost

web to flange welds before turning the girder to weld the other side.

F. Tack in stiffeners (marking positions if necessary), then fillet weld in place using manual, semi-automatic or automatic (robotic) welding procedures as available and appropriate.

G. Check tolerances to specification for the fabricated girder.

H. Trial erect steelwork if required. With modern fabrication techniques trial erections should only be necessary if the implications of a minor problem on a single connection is so critical as to justify the expense. For example, any section of bridge being erected in possession of a motorway or railway would normally be trial erected and this should be specified by the designer. Trial erections should not normally be specified for 'green field' erection, but with some designs it may be necessary to trial erect and carry out the fitting and welding of some components before dismantling. Seek advice from steelwork contractors if necessary.

I. Blast steelwork and apply protective treatment to specification, if required.

J. Pre-assemble braced pairs or longer lengths prior to delivery to site, depending on erection method and site access. This can sometimes be combined with trial erection to minimise cost.

When designing plate girders, there is a temptation to minimise the weight of the girder by minimising the thickness of the web and introducing stiffeners at regular intervals along the web. This does not lead to the most cost-effective design, as the workmanship cost of profiling, fitting and welding these intermediate stiffeners can outweigh the material costs saved in reducing the web thickness. As a general rule, intermediate stiffeners should only be provided where permanent and temporary bracing members are required, at say 8m to 10m centres longitudinally for a multi girder design, with the web plate designed to meet loading requirements unstiffened between the bracing stiffeners - except at bearing or jacking positions. Ladder beam designs are stiffened at cross girder locations, generally 2.5m to 4.0m depending on formwork design.

In design and detailing of web stiffeners for plate girders, the welding should be carefully considered for both bearing stiffeners and intermediate stiffeners. Where stiffeners are closely spaced access for welding must be considered: a reasonable rule is that the space between two elements should be at least equal to their depth. Thus for example, two stiffeners 150mm wide should be separated by at least 150mm.

Bearing (and jacking) stiffeners should be attached to both flanges using fillet welds. These stiffeners should also be 'fitted' to the loaded flange (usually the bottom

flange) to ensure sufficient bearing contact is made between the stiffener and the flange. The stiffeners must be forced against the bearing flange before they are tack welded to the girder web. The welding sequence should be worked out so that the tendency is always to compress the fitted end of the stiffener against the loaded flange, so the fillet welds to the unloaded flange should be left until last. 'Fitting' stiffeners to both flanges should be avoided as it is very expensive and is rarely necessary in bridges. At the bottom flange it may be necessary to use heavy fillet welds or partial penetration welds because BS 5400: Part 10 does not allow direct bearing to be assumed in fatigue checks. However, full penetration welds should be avoided because distortion of the flange may be significant giving problems in fit of bearings. For stiffeners up to 10mm thick, say in a footbridge, the bearing load can be carried from the flange into the stiffener by the fillet welds; so this avoids fitting such small stiffeners to the flange.

Generally, intermediate web stiffeners do not need to extend to the tension flanges and may be terminated at a distance up to five times the web thickness from the flanges (BS 5400 Part 3). These stiffeners will usually be attached to the compression flange but, as they do not act in bearing, they need not be 'fitted' to ensure bearing contact with the flange, only fillet welded.

All stiffeners should be cut to clear web to flange welds. For painted bridges this should be achieved using a close fitting snipe, which is then welded over the web to flange weld. This detail avoids the need to apply the protective treatment system to the backs of cope holes, which are difficult to access properly, and makes for easier long term maintenance. For weathering steel bridges, the issues concerning the protective treatment system do not apply, and it is better to provide cope holes to ensure adequate drainage along the girder length and to prevent the collection of water on the bottom flanges at stiffener locations. The size of cope hole will vary with stiffener thickness, ranging from 30mm radius for stiffeners up to 12mm thick, to 50mm radius for stiffeners between 35mm and 50mm thick. The size of cope hole may further increase if stiffeners are skewed.

Welding of stiffeners to girder webs and flanges should be with fillet welds to avoid excessive distortion of the girder section. All stiffeners should be detailed to enable the weld connections to be continuous around the edges of the stiffener and flange without the need for preparation of the plates involved.

Changes in flange thickness should ideally occur at the outer faces allowing a constant web depth, but often this is not possible at top flange level due to conflict with slab details; and for girders which are to be launched this may be a consideration for the bottom flange. Designers should aim to avoid longitudinal web stiffeners although they may be necessary in the

support region of continuous deep girders of variable depth to satisfy the requirements of BS 5400: Part 3.

All details should be designed with a view to simplicity and minimum number of pieces to be welded or connected together. For example, where stiffeners need to be shaped so as to connect to bracings they should be cut from a single plate rather than being formed from separate rectangular pieces. All re-entrant corners should be radiused at 20mm or 1.25t minimum radius. Site connection details should provide angular and length tolerance, bearing in mind the earlier comments on camber prediction and variation between adjacent girders. Figure 12 shows some detailing DOs AND DON'Ts and the principles illustrated should be borne in mind throughout the design and detailing process. Some cusp distortion of flanges may occur due to the web to flange welds. However, this normally does not matter from a strength point of view, although care must be taken during fabrication at the location of the bearings to ensure proper fit-up and for this reason a separate bearing plate welded to the girder is desirable to ensure a flat interface with the bearing.

Bracings are normally of rolled angle section connected by HSFG bolts via one leg to web stiffeners. In detailing clearance gaps, a 30mm minimum should be allowed at ends of bracings for the stiffener welds, painting access and for camber variation between girders. Edge distance to bolts from member ends should be increased by 5mm above the minimum to allow for reaming or other adjustments which may become necessary. For example, for M24 bolts the minimum edge distance at member ends should be a minimum of $1.5 \times 26\text{mm hole} + 5\text{mm} = 44\text{mm}$, or say 45mm. This should be applied to all site bolted connections of lapped or cover plate type. Welded bracing frames should be avoided as they can easily cause problems in overcoming intolerance camber variations between erected girders.

3.3 Box Girders

Box girders tend to be used for long spans where plate girder flange sizes become excessive, or where torsion, curvature or aerodynamic considerations demand torsional rigidity. Other than in these cases plate girders will be a cheaper solution because assembly and welding of plate girders have been largely automated – they take up less space and time in the workshop compared with box girders.

Box girders of width exceeding 1.5m are usually made up of pre-welded stiffened plate panels. Web panels present situations very similar to webs in plate girders and, therefore, the stiffening tends to be similar. Top flanges generally need to be stiffened longitudinally to resist wheel loading on the bridge deck; for steel orthotropic deck plates various forms of stiffener can be used as shown in Figure 13. For normal highway

decks the stiffener to deck plate weld is highly fatigue sensitive, and an 80% partial penetration butt weld is essential: fillet welds for closed stiffeners may be sufficient for low utilisation decks on Ro-Ro ramps for example.

The shape of box girders needs to be retained during fabrication by diaphragms at intervals which act as formers, normally placed on one flange, followed by assembly of the webs and other flange to them. Such diaphragms should form bearing diaphragms and intermediate frames as part of the permanent design. A rough guide for maximum spacing is 3 x the box depth to ensure that distortion (or lozenging) of the box shape does not occur during fabrication or under action of deck traffic loading. If sufficient diaphragms are used then transverse bending of the longitudinal corner welds under such loading is negligible and partial penetration or fillet welds can be used. Full penetration welds in such situations are feasible, but are costly and less easy to guarantee. A suitable detail is to use a 6mm fillet weld inside the box (often done as part of the assembly process) with external welds being partial penetration single vee welds typically size 8mm. A further simplification is to oversail the top flange and to use fillet welds both internally and externally. Details should be devised to permit the maximum amount of fabrication and protective treatment prior to assembly of the box girders. Thus internal diaphragms should allow for longitudinal stiffeners to slot through. Diaphragms should incorporate access holes of suitable dimensions for final welding and to permit maintenance access with due regard for safety and emergency situations. In recognition of the designer's responsibilities under CDM regulations both during construction and in-service, reference to health and safety guidelines is necessary to confirm acceptable sizes of openings, depending upon overall dimensions of the box and length of escape routes. It is suggested that a minimum size should be 500mm wide and 600mm high. Wherever possible openings should be flush with the bottom flange to permit movement of a stretcher in emergency. Where a step is necessary, for example at a bearing diaphragm, the height of this should be minimised. During construction it should be recognised that further temporary access holes for welding may be necessary, often through webs; these normally need to be reinstated with full penetration welded infill plates on completion.

For small boxes, say less than 1.2m x 1.2m, the inside should be permanently sealed by welding. For flanges less than 1.2m wide, longitudinal stiffeners may be avoided, simplifying the fabrication. Bridges constructed of several such compact boxes can eliminate the need for any exposed lateral bracings.

The fit up and fabrication of box girders requires considerable skill and experience. For pre-fabricated

stiffened panels the longitudinal stiffeners are usually welded first giving long runs where fully automatic welding can be used to advantage. The plate must be clamped down to avoid the inevitable weld shrinkage on its upper surface from distorting the plate. The clamps are retained until the transverse stiffeners have been welded in. Some steelwork contractors use automated equipment to produce orthotropic stiffened plate panels in bulk economically to high quality.

For corner welds the box may have to be turned over in the shop, after making the first two welds, to complete the second pair.

The hollow towers of cable-stayed and suspension bridges as well as the ribs of some arch bridges undergo stresses predominantly in compression. The site joints can be made by machining the ends of the components and the load is then transferred by direct bearing, the bolts or site welds being nominal for location and to carry any shear forces. In these cases machining needs to be done after fabrication to overcome distortion due to welding. Drawings should clearly state that the end plate thickness quoted is "after machining".

3.4 Bearings

For many steel bridges it is convenient to use proprietary bearings, which are economic where sliding together with rotation about both axes is to be accommodated. The PTFE and/or elastomeric materials within these bearings are able to deal efficiently with low sliding friction (5% typical) and articulation. In cases where uplift, excessive rotation or restraint about one axis only has to be accommodated, steel fabricated bearings may be more economic and suitable. In cases of uplift, a separate device or fabrication which resists upward forces may be preferable, for example, in resisting vehicle impact on bridge soffits. Long span bridges generally require special bearings, such as pendel links or enlarged versions of proprietary disc or spherical type. All bearings must be capable of replacement during the design life of the bridge and it is prudent to provide for jacking at supports. Given the designer's obligations for maintenance under CDM he should provide sufficient space and support for jacking to be carried out, including jacking stiffeners on the steelwork if necessary.

Proprietary pot or disc type bearings are suitable for most short and medium span bridges at fixed and free locations. They occupy minimal space and are normally bolted to the steelwork through a tapered steel bearing plate, to take up longitudinal gradient of the girder due to camber and overall geometry, such that the bearing is truly horizontal in the completed bridge. The bearing plate accommodates any departures from flatness of the flange: it is machined so as to form the taper and to achieve a flat surface for

the bearing. They are usually welded to the girder, the bearing being attached by through bolts or tapped holes into the bearing plate. At fixed bearings the attachment bolts are likely to be significantly loaded such that tapped holes are not satisfactory without sufficient engagement length. In such cases a conservative assessment of the minimum engagement is, using grade 8.8 bolts and S355 bearing plate:

$$0.9d_x = 1.62d \text{ or } 39m \text{ for M24 bolts.}$$

This means that the bearing plate needs to be, say, 45mm thick at least. Through bolts are an alternative solution, but the effect of holes through the flange needs to be taken into account and taper washers may be required. It is good practice for a template of the bearing holes to be supplied to the steelwork contractor by the bearing manufacturer. Design of proprietary bearings is normally carried out by the manufacturer to BS 5400: Part 9.

At free bearings the effect of eccentricity of the reaction must be considered, assuming that the sliding interface is above the bearing interface as is the case with proprietary bearings unless they are inverted and provided with debris skirts. For all proprietary bearings it is important that full bearing details are supplied to the steelwork contractor at an early stage before fabrication starts in the shop: often the choice of bearing and manufacturer is entrusted to the main contractor such that bearings are not ordered until late in the construction stage and late information disrupts fabrication.

For small spans, or in footbridges, elastomeric bearings may be suitable. The bearings should be retained in place by keep strips top and bottom and mounted on a lower steel plate secured to the substructure, or as an alternative by the use of epoxy adhesives. For footbridges supported by steel columns bearings can often be dispensed with, the thermal movements and articulation being accommodated by column flexure. Footbridges should include holding down bolts into the superstructure to resist accidental impact or theft.

For fixed bearings, and where rotation occurs longitudinally only, steel fabricated knuckle bearings are appropriate. They are also suitable for all the bearings in abutment supported short spans up to about 20m where higher friction can be accepted, as in many railway bridges. They consist simply of a steel block with radiused upper surface welded on to a steel spreader plate bolted to the substructure. In cases of uplift a fabricated pin bearing is suitable. Where both longitudinal movement and uplift occurs a swing link pinned bearing can be used. Fabricated bearings which can accommodate larger rotations are used in articulating Ro-Ro linkspans and movable bridges. Design of fabricated bearings would normally be carried out by the bridge designer, possibly in collaboration with the steelwork contractor, or a bearing specialist. Roller bearings of hardened steel are suitable where only longitudinal rotation and movement occurs and are capable of achieving very low friction values down to 1%, suitable on slender piers: to reduce bearing height as special bearings the upper and lower curved surfaces can be radiused from different axes. Such fabricated bearings are used in the standard box girder rail bridges for spans greater than 20m.

THE FIGURE GIVES AN INDICATION OF THE MINIMUM LENGTH (L) FOR WHICH A SELECTED THICKNESS CHANGE WILL BE ECONOMIC FOR FLANGES AND WEBS OF GIRDERS. BELOW THIS LENGTH IT WILL BE MORE ECONOMIC TO CONTINUE THE THICKER PLATE (t1). PLEASE NOTE THAT THE COSTS/METRE OF WELD USED TO DERIVE THE FIGURE BELOW DO NOT INCLUDE THE COSTS ASSOCIATED WITH THE GRINDING OF BUTTS.

$$L = \frac{r \times 10^3}{7.85t/m^3 (t1-t2)} \quad \text{where } r = \frac{\text{Cost/m weld}}{\text{Cost/tonne of steel}}$$

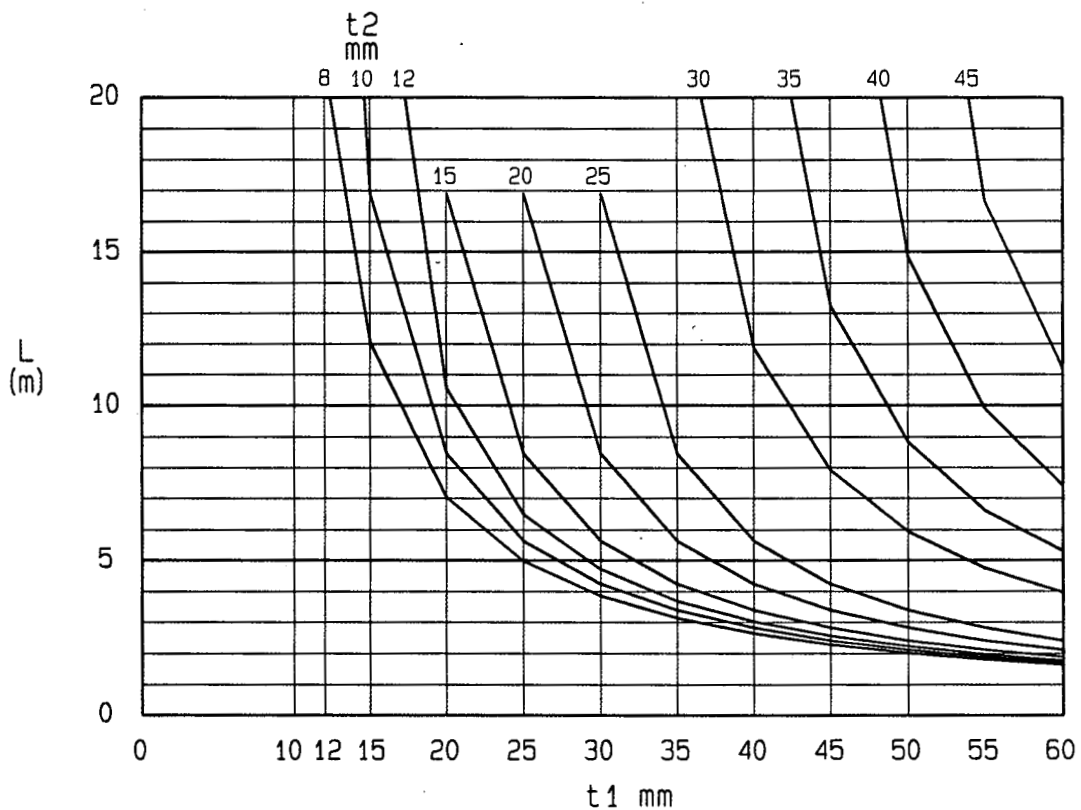
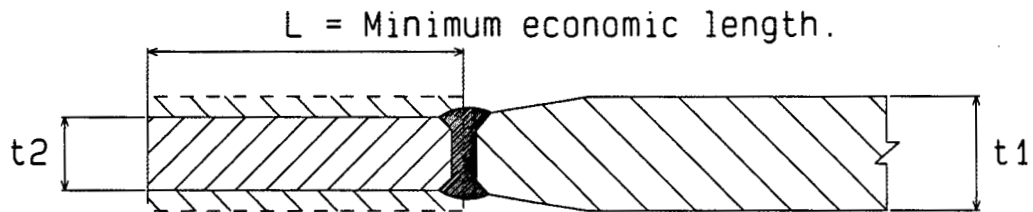

ECONOMY OF FLANGE/WEB THICKNESS CHANGES.

FIG. 8

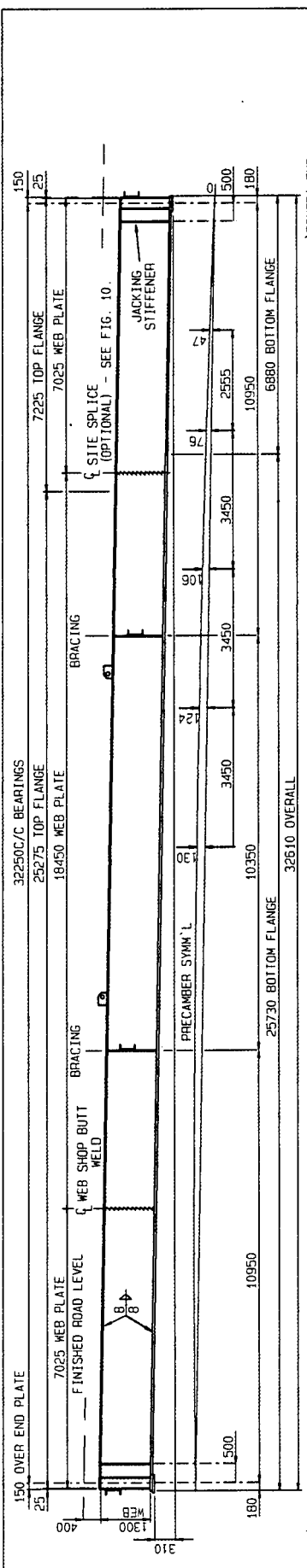

TYPICAL ELEVATION ON GIRDER

TOP FLG.	500x25 (S355J0)	1300x15	500x20 (S355J0)	1300x20
WEB	600x50	2 AT 300 CTRS.	600x40	4 AT 300 CTRS.
BTM. FLG.	1300x20	4 AT 300 CTRS.	600x40	4 AT 300 CTRS.
SHEAR STUDS	4 AT 300 CTRS. 8100	2 AT 300 CTRS. 12000	4 AT 300 CTRS. 8100	4 AT 200 CTRS. 200 CTRS.

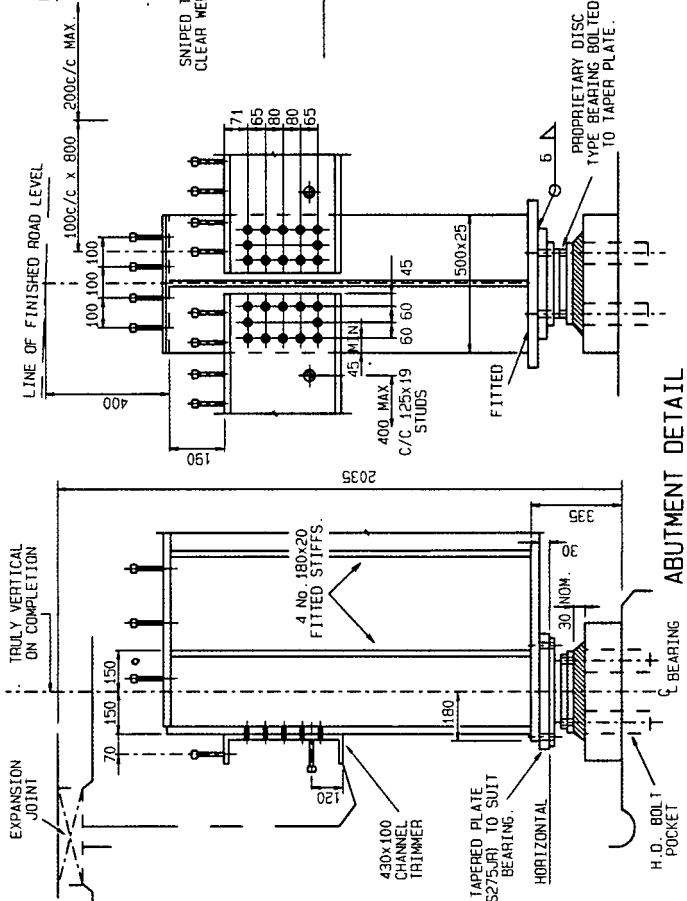

1. ALL STEEL GRADE S355J263 UNLESS STATED OTHERWISE
2. ALL JOINTS TO BE WELDED WITH CONTINUOUS WELDS ON BOTH SIDES. SIZE 6 FILLET
3. ALL BOLTS TO BE H.S.F.G. BOLTS TO BS4395 PART 1 DIA. M24 UNLESS STATED OTHERWISE
4. CAMBERS SHOWN DO NOT TAKE ACCOUNT OF FABRICATION EFFECTS & WELD SHRINKAGE.
5. CAMBER SHAPE SHALL APPROXIMATE TO A PARABOLIC CURVE
6. ALL SHEAR STUDS 19 DIA. x150 LONG.

PRECAMBER AT MID SPAN	
GIRDER WEIGHT	21
SLAB ETC.	62
FINISHES	15
SHRINKAGE	15
FINAL PRECAMBER	15
TOTAL	128
SPECIFIED PRECAMBER	130

INTERMEDIATE STIFFENERS (IF REQ'D)
(FOR EDGE GIRDERS STIFF'S TO BE ON INSIDE FACE)

TYPICAL SINGLE SPAN GIRDER FIG. 9.

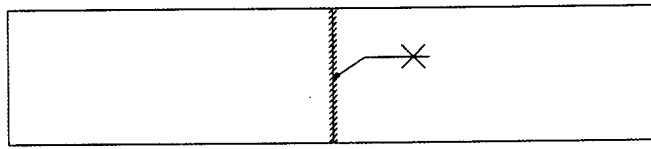

(A) BUTT WELD PLATES

ALL HOLES
PRE-DRILLED

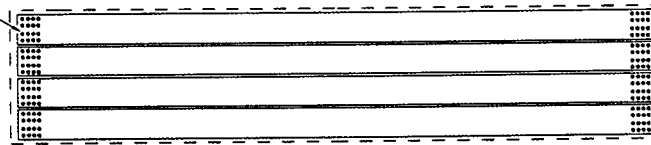

(B) CUT FLANGES

ALL HOLES
PRE-DRILLED

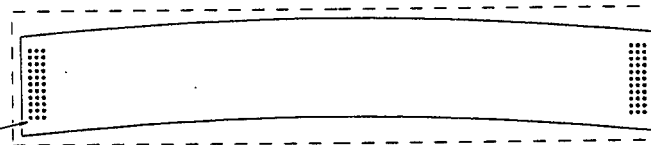

(C) CUT WEBS

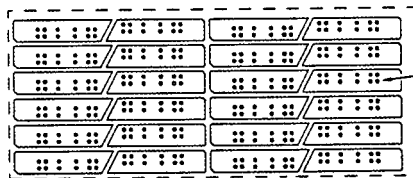

ALL HOLES
PRE-DRILLED

(D) CUT STIFFENERS

(E) EITHER

HAND ASSEMBLY & WELD

OR

AUTOMATIC T&I ASSEMBLY

OR

AUTOMATIC FLAT ASSEMBLY

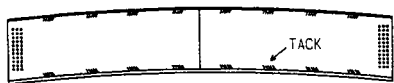

TURN AS REQUIRED

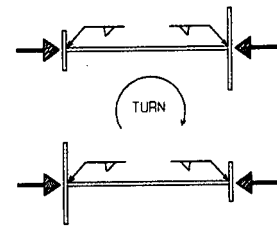
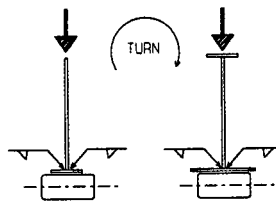
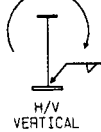
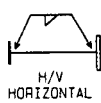

(F) WELD FITTINGS

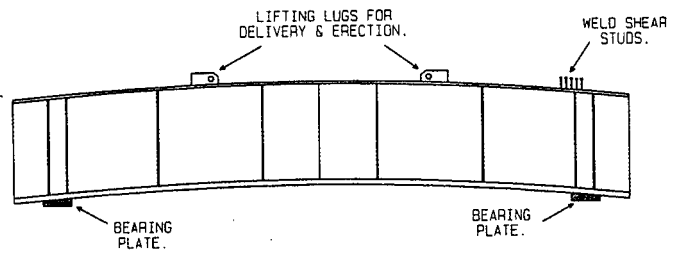
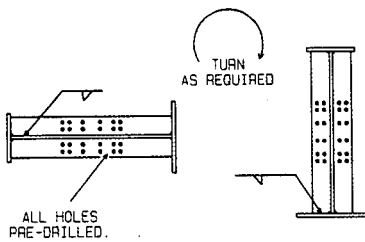

PLATE GIRDER ASSEMBLY

FIG. 11.

CHAPTER 4

CONNECTIONS

4.1 Introduction

In general shop connections for short and medium span steel bridges are made by welding and site connections by bolting. Bolting is generally to be preferred for the site connections for it can be carried out more quickly than welding, and with less interruption to the flow of erection. Where the job is large, all the impediments and costs of site welding, with its attendant plant, extra tradespeople, testing, protection of joints, temporary restraints and quality management can be spread sufficiently to achieve relative economy. For small jobs the Designer must have very good cause to specify site welding. Where welding is used for site connections then often this is for principal connections in main girders, whilst secondary members are more conveniently bolted. Typical site connections for a plate girder, either bolted or welded, are shown in Figure 10.

Much of the workmanship in steel bridge erection is taken up in assembling minor components and making the connections. It is important that the Designer, in making choices and detail design for connections, should visualise how all the components can be assembled and how the tradesmen can carry out the bolting or welding. In some arrangements it is easy to design components which cannot be fitted, bolts which cannot be tightened with standard equipment, and position welds which are very arduous for the welder and costly for the project. Where the Designer has difficulty in arriving at a practicable solution which meets his design criteria, he should consult an experienced steel bridge contractor.

4.2 Bolted Connections

The use of high strength friction grip (HSFG) bolts is mandatory under BS 5400 for all traffic loaded connections, to give full rigidity. Untensioned bolts of mild steel (grade 4.6) and high tensile steel (grade 8.8) in clearance holes may be used in footbridges, in elements which do not receive highway or railway traffic loading such as parapets, and for temporary works.

Countersunk HSFG bolts should not be used, except where a flush finish is absolutely essential for functional (not aesthetic) reasons. Similarly, the use of set screws or set bolts in tapped holes should be avoided because difficulties can arise in achieving accurate alignment and damage free holes and threads: difficulties may also arise in matching the strength of the threads in the main material with that of the threads on the fastener, particularly when using a high tensile

steel fastener for its strength in tension with small thread engagement.

All lapped or cover plate connections should have tolerance in length to allow for site adjustments: thus at member ends, including bracings and bolted girder splices, the minimum edge distance prescribed in BS 5400: Part 3 should be increased by at least 5mm as described in 3.2. End plate type connections are convenient for cross girders in half-through bridges where they can automatically square up the main girders during erection; but they are generally more costly to fabricate as end plates need machining to achieve proper contact. End plates do not give freedom in interconnection of multiple braced girders where camber differences may be critical to fit up.

4.3 High Strength Friction Grip Bolts

Two types of HSFG bolts (known as pre-loaded bolts in Eurocodes) are specified in BS 4395 :

- General Grade bolts to BS 4395: Part 1, which account for most of those used, and have a good compromise of high strength and ductility. Mechanical properties are similar to 8.8 grade for sizes up to and including M24; but to continue in this grade for larger sizes would mean the use of an alloy rather than a carbon steel and so the strength is reduced for sizes over M24 for economy. The bolts are tightened to give a shank tension of at least the specified proof load.
- Higher Grade bolts to BS 4395: Part 2 are made of 10.9 grade material which means the ductility is lower than for the general grade. The limited extensibility could lead to breakage or strain cracking in the threads from the combined action of axial tension and applied torque during tightening if the bolt were overstressed. BS 5400: Part 3 limits the assumed bolt tension to only 0.85 times the proof load of the bolt and reduces the slip factors by 10%. BS 4604: Part 2 covering the use of higher grade bolts restricts them to joints subjected to shear alone.

4.4 The Friction Grip Joint

The friction grip joint depends for its performance on the tightening of HSFG bolts to the specified shank tensions so that the adjoining plies are brought into close contact and the shear load is transferred by friction at the interfaces.

Frictional resistance at the interface is highly dependent on the surface conditions. Certain types of surface treatment result in very low slip factors and

should be avoided: for example, the slip factor for etch primer of 0.25 is too low for the economic transfer of shear loading by friction. It is also important that the faying surfaces are free from oil, grease, dust, dirt, loose rust, mill scale, paint (except in the case of a planned coating) or any other form of contamination, which is detrimental to the development of friction.

In weathering steel construction, mill scale must be removed from all surfaces, including the faying surfaces of friction grip joints. Minor rusting of weather resistant steel is not detrimental; and indeed that is true for faying surfaces of other steels.

BS 5400: Part 3 lists the following slip factors for various surface conditions:

- 0.45 for weathered surfaces clear of all mill scale and loose rust,
- 0.50 for surfaces blasted with shot or grit and with loose rust,
- 0.50 for surfaces sprayed with aluminium,
- 0.40 for surfaces sprayed with zinc,
- 0.35 for surfaces treated with zinc silicate paint, and
- 0.25 for surfaces treated with etch primer.

When BS 4395: Part 2 bolts are used these values must be reduced by 10%. This allows for the higher preload carried by Part 2 bolts and the fact that the slip factor is not independent of bolt preload.

Slip factors for surface conditions not listed in the Code must be established by slip tests as described in BS 4604 or obtained from other reliable sources at the discretion of the Supervising Authority.

On assembly of the joint at site, any contamination of the faying surfaces by oil or grease is best removed by suitable chemical means, as flame cleaning usually leaves harmful residues. If the joint cannot be assembled as soon as the surfaces have been treated, or as soon as any protective masking has been removed, it is sufficient to remove any thin films of rust or other loose material with a wire brush. During this process the surfaces must not be damaged or made smooth.

4.5 Installation of HSFG Bolts

Bolts may be tightened by three methods. Each aims at achieving at least the minimum specified shank tension.

4.5.1 Torque Control

This requires the use of a manual torque wrench or power tool fitted with a torque cut-out which must first be calibrated on a bolt from the job batch using a bolt load meter or similar device for determining bolt tension. The procedure in BS 4604 requires the test bolt to be tightened to a load 10% above minimum

shank tension, and the torque setting to obtain this tension is used for tightening the bolts in the structure. It will be appreciated that torque can vary very considerably from bolt to bolt, depending on a number of factors including the condition of the threads and nut/washer interface, and the amount of lubricant present on the threads. Consequently the Standard requires the wrench to be recalibrated frequently - at least once per shift, or more often if required by the contract supervisor, for each change of diameter or batch and as specified for changes in bolt lengths.

4.5.2 Part Turn Method

This method is for use with general grade bolts only. After assembly of the joint the bolts are given a preliminary tightening with an impact wrench to bring the surfaces together and to a prescribed bedding torque. This tightening is intended to impart the bolt tension to the point at which a power wrench commences solid impacting. A matching mark is then made on the nut and shank end. The nut is then turned relative to the shank until the specified rotation given by BS 4604 is achieved and this will give a tension in excess of the minimum proof load.

4.5.3 Direct Tension Indication

Direct tension indication is available by using either load indicating washers with standard bolts, or tension control bolts.

Load indicating washers to BS 7644: Part 1 (proprietary name 'Coronet') are specially hardened washers with nibs on one face. The nibs bear against the underside of the bolt head leaving a gap between the head and the load indicating face: as the bolt is tightened the nibs are compressed and the gap reduced. At a specified average gap measured by feeler gauge, the induced shank tension is at least equal to the minimum required by BS 4604. Provision can be made for the load indicating washer to be fitted under the nut, when this is more convenient using a nut faced washer to BS 7644: Part 2 and tightening the bolt with the head.

Load indicating washers are not suitable for use with weathering steel bridges since the remaining gaps are undesirable.

Tension control bolts, which are manufactured in accordance with Japanese standard JSS II-09: 1981, are HSFG bolts with a domed head and with the threaded shank extended to form a splined end. The assembly comprises a bolt, a nut and a hardened flat washer under the nut. Tightening is achieved using a special shear wrench with a socket which locates on the nut and spline: when the correct shank tension is reached the spline is sheared off. Tension control bolts originated in the UK in the 1950's as Torshear bolts but they were not widely used. TC bolts are of higher grade corresponding to BS 4395: Part 2. No torque is

applied to the bolt shank itself during tightening which mitigates the concern about higher grade bolts in tension. If the bolts are assumed to be general grade bolts it is satisfactory to use them to carry tension.

4.5.4 Sequence of Tightening

Whichever method of bolt tightening is chosen, bolts and nuts should always be tightened in a staggered pattern and when a bolt group comprises more than four bolts, tightening should be from the middle of the joint outwards and ensuring that all the plies are properly pulled together in full contact.

If due to any cause a bolt or nut is slackened off after final tightening, the bolt, nut and washer must be discarded and not reused.

4.6 Inspection of HSFG Bolts

Identification markings on the bolt head and nut should be checked and the use of an appropriate hardened washer under the rotated nut or bolt head verified. Where necessary, the use and correct positioning of taper washers should be checked.

With the part turn method it is necessary to ensure that the nut has been rotated sufficiently relative to the bolt.

With the torque control method a random sample of tightened bolts should be selected for checking, which is most easily carried out by re-calibrating the wrench to give the required shank tension and then setting the torque reading 5% above this figure. This should not move the nuts further.

With the 'Coronet' load indicator method it is necessary to ensure that the average specified gap between the load indicating washer and the bolt head has been reached.

In large bolt groups there is always a danger that on bedding down of the connected plies, some of the first bolts to be tightened may have lost some of their preload. This is not always apparent in the case of normal inspection procedures for Part Turn and Direct Tension Indication, so it is of paramount importance that tightening, inspection and any remedial measures in such situations are carried out in strict compliance with the contract supervisor's instructions.

4.7 Welded Connections

In-line web to web and flange to flange connections generally need to develop the full capacity of the elements and should be full penetration butt welds. If a section change occurs the larger plate should, for fatigue reasons, be tapered in thickness and width at a maximum slope of 1 in 4 down to that of the smaller. Where double-vee preparations are used it is unnecessary to form a taper where the 'step' is 2mm or less because this can be incorporated within the width of the weld. At changes of flange thickness the taper should be provided to one face only (see also 3.2

and Figure 10). Weld preparation form and details should normally be determined by the steelwork contractor, based on approved weld procedures. Unless absolutely vital for fatigue reasons or to remove corrosion traps on weathering steel, grinding flush at welds should not be specified because of restrictions in meeting safety legislation requirements: in most cases fatigue performance will be governed by other adjacent details such as web to flange and stiffener welds such that undressed welds are acceptable, - they also have the advantage of being visibly identifiable in-service.

At flange site welds a cope hole (see Figure 10) should be provided to the web with minimum radius of 40mm (or 1.25 x web thickness if greater) to allow welding access. Such cope holes should be left open on completion and not filled with a welded insert, which may cause excessive restraint effects.

Generally the designer should seek to use fillet welds for all other welded connections, rather than full penetration butt welds which usually are not justified except in exceptional cases for fatigue reasons. Full penetration welds tend to cause distortion, which is particularly critical for end plate type connections; and, they are relatively costly due to the operations involved in forming weld preparations, multiple weld runs involving back gouging, measures to reduce distortion, and requirements for testing. Where a design requires fillet welds larger than 15mm x 15mm it is preferable to use partial penetration butt welds, reinforced where necessary by fillet welds - for example at the lower ends of bearing stiffeners where the welds may be critical for fatigue.

Generally fillet welds should be at least 5mm or 6mm leg length other than in footbridges or parapet construction where smaller welds of maximum 2/3 x plate thickness will be more suitable to minimise distortion in the thinner sections. On long continuous welds, such as web to flange fillet welds, up to 10mm fillet may be the optimum and suitable for laying in a single pass using the submerged arc processes. Advantage should be taken of the penetration, which is achievable on fillet welds using automatic weld processes. Where procedure trials are able to show that a given penetration is consistently achieved then this can be included in the throat dimension assumed for design. BS 5400 Part 3 allows a root penetration of 0.2 x throat (but not more than 2mm) to be assumed without any need for trials if the submerged arc process is used.

CHAPTER 5

FABRICATION

5.1 Introduction

The object of this chapter is to discuss the accuracy of steel fabrication and its significance for the designer as well as for construction.

The dimensions of any artefact vary from those defined by the designer: such variations stem from the nature and behaviour of the material as much as from the process of making it. Modern steel fabrication involves the manufacture of large and often complex welded assemblies of components from rolled steel products: high temperature processes are used to make the steel products to form the components and join them together so dimensional variation from the design is inherent and unavoidable. This behaviour has implications for the designer, for the steelwork contractor, and for the bridge builder and each has to anticipate the variations in carrying out their role. The important questions are - which dimensional variations are significant, what limits must be put on those which are significant, and how should variations be managed to ensure that the design is implemented to meet its performance requirements without delay?

In steel bridge construction dimensional variation is significant in a number of ways for it involves precise mechanical components, structural steelwork manufactured remote from the site, and civil engineering works. These interface with each other and yet their precision varies from the highly accurate to the inaccuracies inherent in placing concrete. It is convenient to distinguish between:

- Mechanical fit which is vital for example for function between nut and bolt, between bearing and girder, between machined faces of compression members.
- Fit up of fabricated members which is essential for efficient assembly for example of a bolted site splice, yet the dimensional accuracy of the bolt group is immaterial to the strength.
- Deviation from flatness or straightness which affects the strength or function of components for example in reduced buckling capacity.
- Accuracy of assembly at site where steel spans must match the substructure positions and girder profiles must correspond to maintain deck slab thicknesses.
- Interface with substructures where the designer has to provide adjustment in construction, say by large H.D. bolt pockets and variable grout layers to accommodate relatively inaccurate concrete to precise steel components.

The control of dimension by tolerancing is fundamental to the mechanical engineering discipline without which no mechanism could work, no parts would be interchangeable: no mechanical drawing is complete without tolerances on all dimensions, limits and fits on mating parts, and flatness tolerances on surfaces. In contrast civil engineering construction has largely ignored the concept of tolerancing, depending on the calibration of its metrology to build the product satisfactorily in situ. Historically steel fabrication found a workable compromise making large manufactured products using workshop techniques which assured their efficient assembly at a remote site – tolerancing has not been part of that process as a rule, it was implicit in much of the work and explicit only for mechanical bridge parts. Indeed the level of accuracy common to a mechanical engineering workshop is generally unnecessary for steel bridgework – for which it has to be justified because it comes at a substantial cost and needs special facilities, including machining. For example the variation of flatness and thickness of a steel plate from the rolling mill is perfectly satisfactory for a girder, but it would be unacceptable for a machine part. With the widespread use of automated processes from the 1980's for plate preparation, hole drilling, girder assembly and welding, the geometrical accuracy to which steel fabrication can be made has much improved: this has been driven by the economics of practicable manufacture and the replacement of labour intensive traditional practice.

A demand for formal tolerances in steel bridge work was first put forward in 1968 when a committee was set up to revise the then bridge standard BS 153. The need was highlighted in the investigations following the collapse of the Milford Haven and West Gate (Yarra, Australia) box girder bridges in 1970 when the Merrison Committee produced the Interim Design Workmanship Rules (IDWR) in February 1973 for box girder bridges. These rules contained limits for imperfections including the flatness of plate panels and straightness of stiffeners which were shown to significantly affect the design capacity against buckling.

For each new job the steelwork contractor will assess the design to determine how best to undertake the fabrication and control dimensions to ensure proper fit up and assembly at site. For box girders in particular and large bridges with steel decks, this may well include a project-specific regime of dimensional tolerances on sub-assemblies such as deck panels: these would be compatible with the tolerances set by the designer for the finished bridge.

The following sections concentrate on the fabrication process, the behaviour of steel in fabrication, and those aspects of accuracy which bear particularly on the strength of members and the shape of components, and are of primary concern to the designer.

5.2 Fabrication Tolerances

The fabrication tolerances and workmanship levels defined explicitly in BS 5400 Part 6 have been developed from a considerable amount of theoretical and practical investigations. It should be appreciated that most of the tolerances as stated apply only to some elements of the structure and are required from considerations of strength only: by themselves they do not address the purposes of appearance and fit up, and it is for the individual steelwork contractor to choose his own additional standards for these. The tolerances in Table 5 of Part 6 are compatible with the design rules given in BS 5400 Part 3, but are generally enhanced by 20% to allow for any uncertainties in measurement and interpretation. The non dimensional presentation of the strength rules contained in Part 3 enable some of the tolerances to be related to the steel grade.

Plate flatness tolerances apply to the webs of plate and box girders and to the panels of stiffened compression flanges and box columns. The tolerance refers to the flatness at right angles to the plate surface, measured parallel to the longer side and a simple expression is given relating the tolerance to the gauge length of measurement. The tolerances in BS 5400 Part 6 are at least double the conservative values which had been specified by the Merrison Rules. Straightness tolerances are applied to longitudinal compression flange stiffeners in box girders, box columns and orthotropic decks and to all web stiffeners in plate and box girders. Measurements at the time of introduction of BS 5400: Part 6 on six bridges showed that 97.5% of stiffeners and plate panels would satisfy the tolerances.

The tolerance on the bow of compression members is linked with the assumptions made in the design and was developed from an extensive programme of practical tests and theoretical investigations based on an assumed sinusoidal bow of length/1000. The tolerance on the straightness of individual flanges of rolled and fabricated girders is related to the reduction in the strength of the girder due to lateral torsional buckling and the twisting moment at the support that can be caused by an overall bow of the girder. The tolerance on the flatness of rolled webs is related to the strength of the web acting as a strut under points of concentrated loading.

5.3 Checking of Deviations

The potential difficulty associated with working to

specified tolerances is the amount of checking required in the fabrication shop. The specification of reasonable tolerances should not increase fabrication costs as a good steelwork contractor should be able to comply with the values without special procedures or rectification measures. However, as well as the direct cost of checking, costs can be incurred when checking activities delay the work-piece from entering the next phase of production: checking adds time and cost to the overall fabrication process.

Normally all member components are visually examined by the steelwork contractor qualitatively for deviations in excess of the specified tolerances and any parts quantitatively checked where necessary. This is a safeguard to ensure that obvious excessive deviations, not caught within the representative 5% or 10% sampling specified by BS 5400: Part 6, do not escape. For those member components where only representative checks are required, the Engineer is required to specify the areas where half of the checks are to be made. These will be in critical areas where the steelwork is fully or nearly fully stressed and the strength is sensitive to imperfection. The remainder of the checks are to be made in areas selected at random by the Engineer. 100% checking is required for the overall straightness of columns, struts and girders, and the webs of rolled sections at internal supports.

In making any checks the scanning device is to be placed so that local surface irregularities do not influence the results. The checks are performed on completion of fabrication, and then at site on completion of each site joint; local checks have to be made on flatness of plate panels and straightness of stiffeners. It is clear that the verticality of webs at supports can only be checked during any trial erection of the steelwork or after erection at site. For the end supports of significantly skewed multiple I-beam bridges (skew angle exceeding say 30°) significant twist of the girders is likely to occur when dead loads are applied especially from concrete deck slabs. This arises from the incompatibility between the deflection of adjacent interconnected girders. In such cases the designer should either supply values for the predicted twist (along with the specified precamber information – see 1.6) for adding to the specified verticality tolerance, or alternatively specify that girders are to be pre-twisted at site so as to counteract the twist due to dead loads. For further advice refer to Steel Bridge Group Guidance Note 7.03.

Where the tolerances specified in BS 5400 Part 6 are exceeded remedial actions may be taken to remove the distortion such as by heat or other straightening measures. In some cases where this is difficult or impracticable the information is submitted to the designer for consideration. Often further analytical checks which consider the actual deviation may show that this is acceptable. In the case of plate panels,

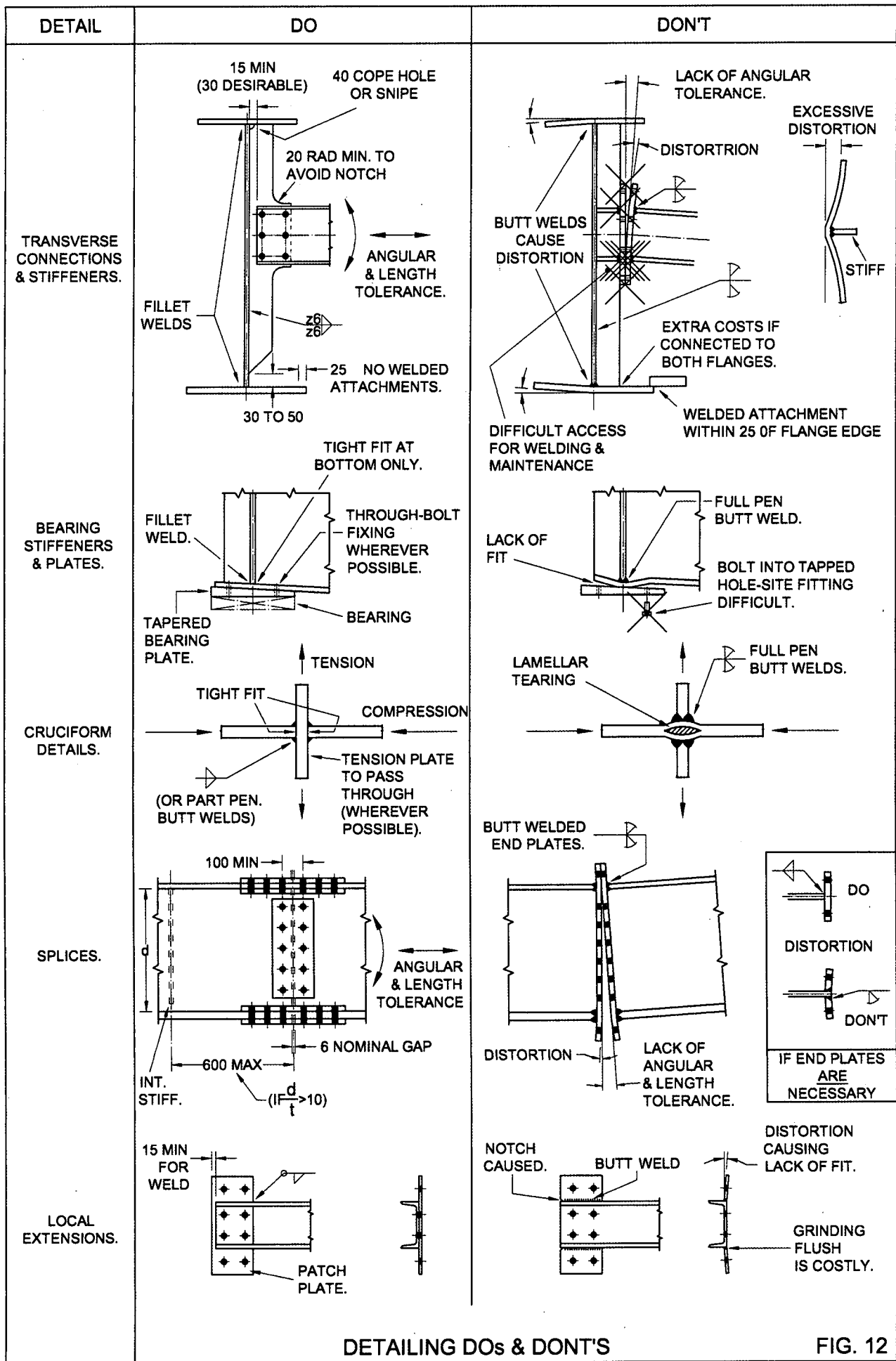

DETAILING DOs & DONT'S

FIG. 12

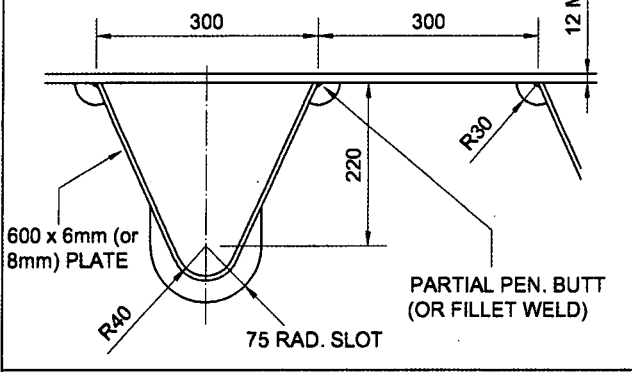
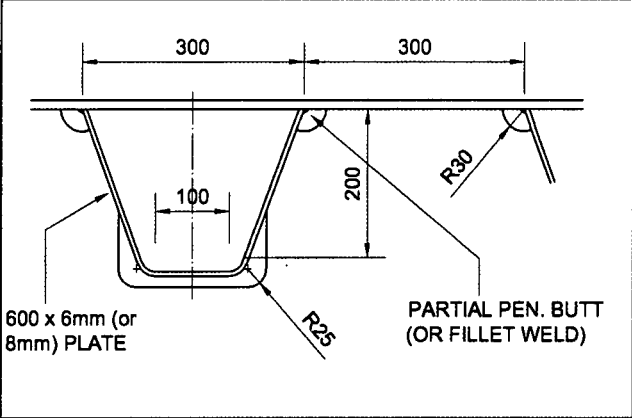
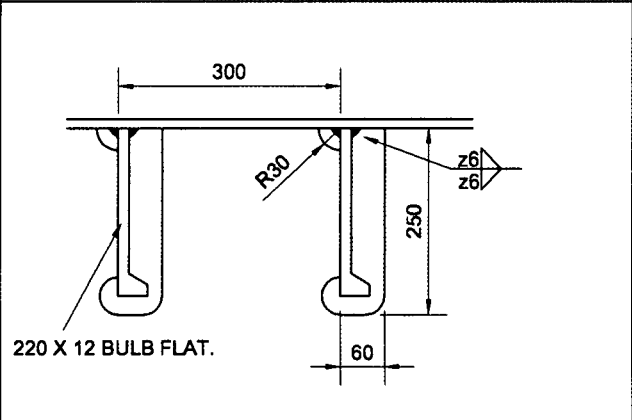
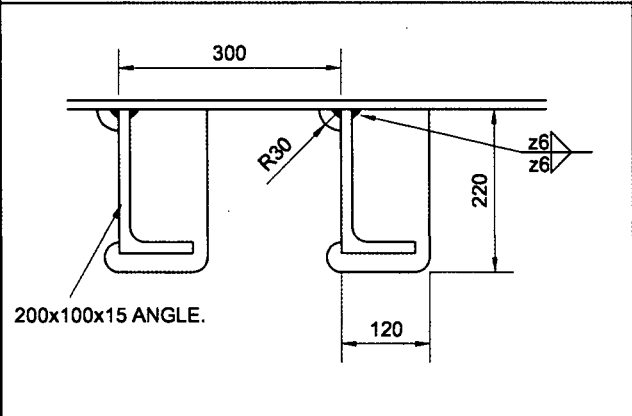
	TYPE	REMARKS
 <p>600 x 6mm (or 8mm) PLATE</p> <p>75 RAD. SLOT</p> <p>PARTIAL PEN. BUTT (OR FILLET WELD)</p> <p>28.3 kg/m</p>	<p>VEE-TROUGH</p> <p>28.3 kg/m</p>	<p>MAY BE ROLLED IN LONG LENGTHS FOR SLOTTING THROUGH TRANSVERSE MEMBERS.</p>
 <p>600 x 6mm (or 8mm) PLATE</p> <p>PARTIAL PEN. BUTT (OR FILLET WELD)</p> <p>28.3 kg/m</p>	<p>TRAPEZOIDAL TROUGH</p> <p>28.3 kg/m</p>	<p>PRESSED OR ROLLED LENGTH UPTO 16 METRES.</p>
 <p>220 X 12 BULB FLAT.</p> <p>52.4 kg/m</p>	<p>BULB FLATS</p> <p>52.4 kg/m</p>	<p>ALLOWS FILLET WELDS BOTH SIDES.</p> <p>GOOD ACCESS FOR PROTECTIVE TREATMENT.</p>
 <p>200x100x15 ANGLE.</p> <p>67.4 kg/m</p>	<p>ANGLES</p> <p>67.4 kg/m</p>	<p>ALLOWS FILLET WELDS BOTH SIDES.</p>

NOTE: ALL SECTIONS SUITABLE FOR SPAN APPROX 4500mm CENTRES OF TRANSVERSE MEMBERS UNDER HB LOADING. FATIGUE IN DECK PLATE MAY REQUIRE >12mm THICKNESS.

ORTHOTROPIC PLATE STIFFENERS

FIG. 13

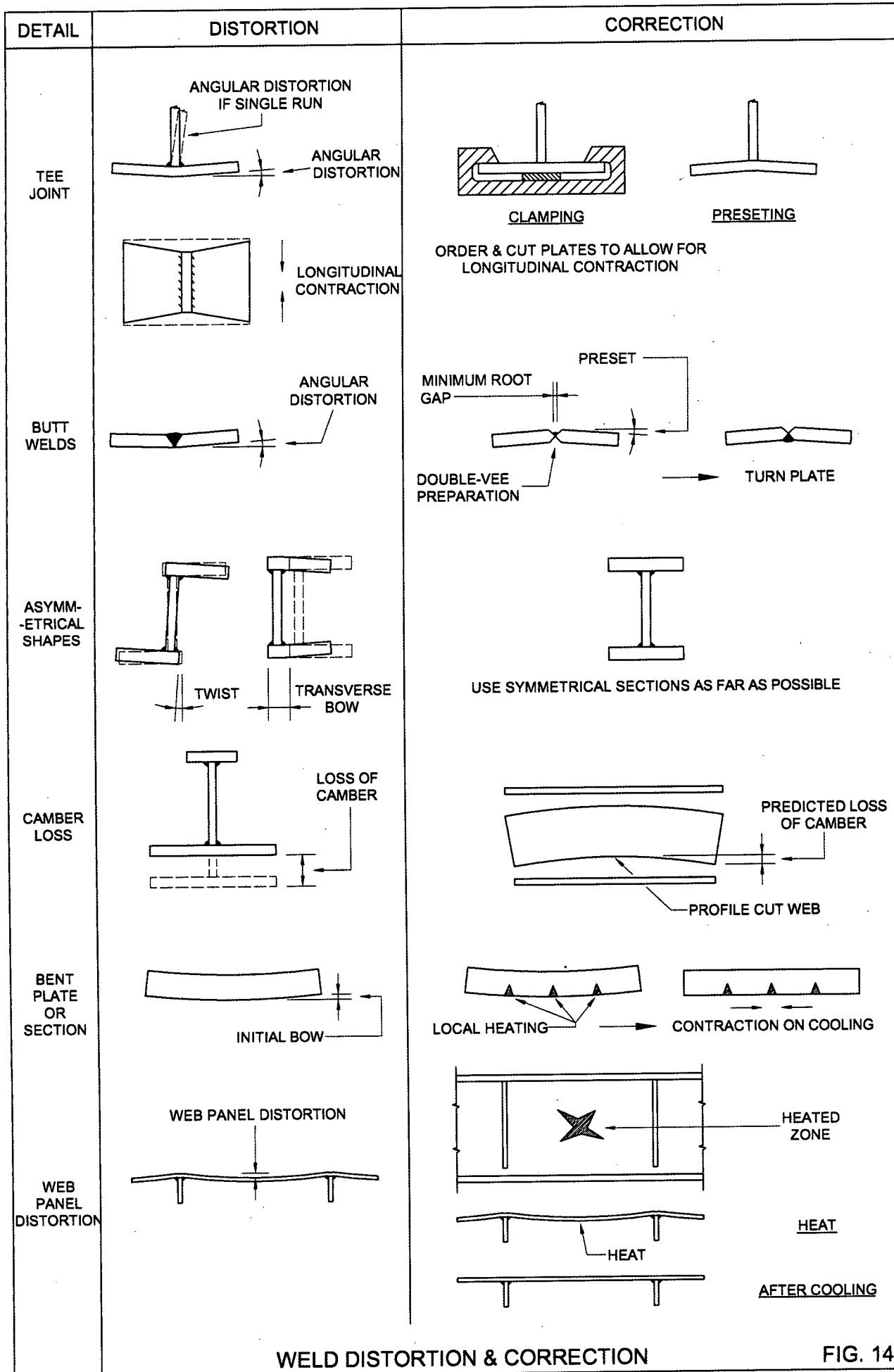

WELD DISTORTION & CORRECTION

FIG. 14

stiffeners, cross girders, cross frames and cantilevers, and webs of rolled girders, if 10% or more of the checks exceed the appropriate tolerances then the Engineer may call for additional checks.

5.4 Causes of Fabrication Distortion

Distortion is a general term used to describe the various movements and shrinkages that take place when heat is applied in cutting or welding processes. All welding causes a certain amount of shrinkage and in some situations will also cause deformation from the original shape. Longitudinal and transverse shrinkage in many circumstances may only be a minor problem but angular distortion, bowing and twisting can present considerable difficulties if the fabrication is not in experienced hands.

A full awareness of distortion is vital to all concerned with welding including the designer, detailer, shop foreman and the welders, as each in their actions can cause difficulties through lack of understanding and care. Weld sizes should be kept to the minimum required for the design in order to reduce distortion effects, eg in many cases partial penetration welds can be used in preference to full penetration welds. Figure 12 showing detailing DOs and DON'Ts illustrates how the effects of distortion may be avoided or reduced. Some distortion effects can be corrected, but it is much more satisfactory to plan to avoid distortion and thereby avoid the difficulties and costs of straightening to achieve final acceptability of the job. Consider a fillet weld (see Figure 14) made on a 'T' section. On cooling the weld metal will induce a longitudinal contraction, a transverse contraction and an angular distortion of the up-standing leg. A similar section with double weld runs will induce greater longitudinal and transverse contraction and the combined forces will produce an angular distortion or bowing of the table. The longitudinal shrinkage is likely to be about 1mm per 3m of weld and transverse contraction about 1mm provided the leg length of the weld does not exceed three quarters of the plate thickness.

The contractions produced by a single V butt weld (see Figure 14) induce longitudinal and transverse shrinkage producing angular distortion and possibly some bowing. The transverse contraction will be between 1.5mm and 3mm and the longitudinal contraction about 1mm in 3 metres. Angular distortion occurs after the first run of weld cools, contracts and draws the plates together. The second run has the same shrinkage effect but its contraction is restricted by the solidified first run, which acts as a fulcrum for angular distortion. Subsequent runs increase the effect. The angular distortion is a direct function of the number of filler runs and not the plate thickness, although of course the two are related.

The use of a double V preparation to balance the volume of weld about the centre of gravity of the

section will significantly reduce any angular distortion. To allow for the effect of back gouging, asymmetric preparations are often used to advantage, but it must be remembered that longitudinal and transverse contractions will still be present. The contractions in a structure can be assessed, but a number of factors will affect the result. The fit-up is most important as any excess gap will affect the weld volume and increase shrinkage. The largest size of electrodes should be used and where possible semi-automatic and automatic processes should be employed to reduce the total heat input and the shrinkage to a minimum.

In certain circumstances residual rolling stresses in the parent metal can have considerable effect and may cause otherwise similar sections to react differently. The extent of final distortion will be a combination of the inherent stresses and those introduced by welding.

5.5 Methods of Control of Distortion

All members which are welded will shrink in their length so each member should either be fabricated over-length and cut to length after welding, or an estimate of shrinkage should be added to anticipate the effect during the fabrication of the member. For the control of angular distortion and bowing there are two methods of control which can be considered if the distortion is likely to be of significance (see Figure 14):

Pre-setting. The section is bent in the opposite direction to that in which it is expected to distort and welding is then carried out under restraint. When cool, and the clamps are removed, the section should spring straight. Trials and experience can determine the extent of pre-bend for any particular member.

Clamping. The units are held straight by clamps whilst the welding is carried out which reduces the distortion to tolerable amounts.

5.6 Effect of Design on Distortion

A good design will use the minimum amount of weld metal consistent with the required strength. At changes in direction of flanges bending should be considered to avoid introduction of butt welds. Welded sections should, if possible, be designed with their welds balanced about the neutral axes of the sections; so welded asymmetric cross sections should be avoided. In these ways, little distortion will occur and only allowances for the overall contraction need be made (see Figure 14).

Over-welding is a serious risk and all details should be considered, even small cleats. The optimum size of weld should be specified on the drawing. The amount of distortion is directly proportional to the amount of weld metal and it is bad practice to specify 'weld on' or 'weld all round' without specifying the weld size, as the minimum necessary size – 6mm leg fillet-weld is practical for bridgework.

5.7 Distortion Effects and Control on Various Forms of Construction

Fabrication of girders. Butt joints in flanges or webs of girders should be completed before the girders are assembled wherever practical. Run-on/run-off pieces should be clamped at each end of these joints: they should be of the same thickness as the plate material and have the same weld preparation. Extension pieces are removed after the completion of the welding and the flange edges carefully dressed by grinding.

The direction of weld runs should be alternated to avoid the tendency for the joint to distort in plan. It may be necessary to balance the welding of the butt joints by making a number of runs in one side of the V preparation and then turning the flange over to make runs in the second side and so on. Back chipping or gouging must be carried out before commencing welding on the second side. The use of suitable rotating fixtures should be considered by the steelwork contractor to enable long flanges to be turned over without risk of cracking the weld when snatch lifted by cranes.

On completion of all web and flange butt joints the girder is assembled and, if automatic welding is to be used for the web to flange welds, the stiffeners are added after these welds are complete. If, to suit the available equipment the web is horizontal, it may be advisable to assemble flanges slightly out of square to allow for the greater effect of the welding of the first side fillet welds (see Figure 14). Where manual welding is used on girders it is normal practice to fit the stiffeners before the welding and these are usually sufficient to maintain the squareness of the flanges.

Distortion can come to the steelwork contractor's aid where bearing stiffeners need to be fitted. Local flange heating can be used to bow the flanges locally allowing insertion of the stiffener, the subsequent cooling causing the flanges to come into tight contact with the stiffener end. Such controlled heat input operations are part of the fabrication art and are generally not detrimental.

Box columns. Light sections, such as boxed channels or joists with welds balanced about the neutral axes, should give no difficulties provided suitable allowances have been made for overall shrinkage. Heavier boxes will have diaphragms and it is important that these are square before assembly: also the side plates must be free from twist. Such sections lend themselves to automatic welding. Provided that no stresses are introduced into the sections due to out of straight material or unsquared diaphragms, no difficulty should arise from welding but allowances must be made for overall shrinkage.

Site Welded Girder Splices. It is usual to weld the flange joints before the web, for the flange being thicker and requiring a greater number of runs of weld, will shrink more than the thinner web joint. Otherwise the web may buckle as a result of flange shrinkage. In the fabrication of such joints it is necessary to anticipate this procedure by fabricating the web joint with a root gap larger than that specified by the weld procedure by an amount equal to the expected weld shrinkage of the flange joint (see Figure 10). In heavy girder joints a variation of the procedure should be adopted whereby the flange joints are completed in balance to about two thirds of their weld volumes; at this stage the web joints may be welded and finally the flange welds. This method helps to minimise tensile stresses remaining in the web.

5.8 Correction of Distortion

Sections can be straightened with the aid of hydraulic presses or special bar bending or straightening machines. Some sections are too large for this type of straightening and it is necessary to adopt techniques involving the application of further heat: heat has to be applied to the side opposite to that carrying the welds which caused the distortion. The techniques are based on the fact that if heat is applied locally to a member, the heated area will tend to expand and be constricted by the surrounding area of cold metal which is stronger than the heated area: upon cooling, the metal in the heated area will become compressed plastically to a lesser volume than before heating thus causing the member to curve in the required direction.

The application of heat has to be carefully controlled to prescribed temperatures and considerable experience is required before it can be successfully applied – overheating will cause metallurgical problems. The method of heat application can also be used to straighten long strips of plate that have been oxyacetylene flame cut along one edge, where release of the internal residual rolling stresses and the effect of the heat of the cut have caused curving during cutting. The heat should be applied in triangular areas on the edge opposite to the flame cut edge (see Figure 14). Out-of-tolerance distortions in plate panels can be reduced by suitable local heating of the panel (see Figure 14), sometimes combined with jacking to provide restraints.

5.9 Trial Erection

Trial erection of bridge steelwork at the fabrication works is a traditional way of ensuring that fit-up and geometry can be achieved at site so reducing the risk of delays in erection or damage to protective treatment. With the much improved accuracy achieved by automated fabrication procedures the need for trial erection has been reduced in recent years. Today trial erection of most bridges is unnecessary and indeed complete trial erection of a

large structure may be impracticable. However, where delays in assembly at site are totally unacceptable or remedial measures would be extremely difficult trial erection is of considerable benefit, for example, for a railway or highway bridge to be erected during a limited possession. Partial trial erection involving complex or close fitting connections, such as in skewed integral crossheads or the shear plate connections of the standard rail underbridge box girders, is also justifiable. This may also enable the fabricator to position or adjust and weld some components of the connection, such as end plates during trial erection, as a practical way of achieving fit up. BS 5400: Part 6 Clause 5.9 requires trial erection where this is specified by the Engineer - generally the designer. The extent of trial erection should be considered, bearing in mind that simultaneous trial erection of a large bridge off site may be totally impracticable: full trial erection is on the critical path so, apart from the substantial costs, it adds considerable time to the fabrication programme. If a multiple span bridge is to be trial erected, partial or staged trial erections are appropriate and will depend upon the amount of space which the steelwork contractor has available. Depending upon the degree of repetition and the fabrication methodology, trial erection of a particular span only may be sufficient. Often the needs for full trial erection can be reduced or dispensed with once the early stages of erection have successfully been proved.

The designer, or specifier, in considering the need for trial erection needs to evaluate the risks and consequences of delay at site – who would be most at risk, is it worth the client in effect paying a large premium for assurance for the risk involved? For his part, the experienced steelwork contractor will plan his fabrication, fit-up and checking procedures to minimise the risk to himself and the project.

CHAPTER 6

WELDING

6.1 Introduction

Today welding is the primary joining process in steel bridge construction: virtually all shop joints, and frequently site joints, are welded. The output of the welding process is dependent on many factors and variables, so correct application and control are essential to assure weld integrity and achieve economic production levels.

Welding technology uses its own special terminology and its application to steel bridge construction is subject to an extensive range of British, European and International Standards, which are in process of change and development. The design of a weld through to its final acceptance is a process, which involves dialogue between designers, non-specialist engineers, and those directly executing welding operations. The aim of this chapter is to give some insight into this process, the terminology, the applicable standards, the common ways in which welds are made and the techniques for quality control.

The profusion of standards is confusing, particularly in the progressive change to European Standards, so a flowchart illustrates the respective functions and relationships between the standards in regular use.

6.2 Principal welding standards

Previous chapters have discussed the design of steel bridges and the development of the specification and performance requirements. The current UK specification for workmanship, BS 5400: Part 6:1999, states that metal-arc welding should comply with the requirements of BS 5135, unless otherwise specified by the Engineer. BS 5135 has been superseded by BS EN 1011: Welding - Recommendations for welding of metallic materials - Part 1: General guidance for arc welding, and Part 2: Arc welding of ferritic steels. The guidance and information in this specification is updated and substantially similar to the previous standard and to all intents and purposes can be directly applied; there are some exceptions and attention is drawn to these in this chapter. The assumption made in each standard is that execution of its provisions is entrusted to appropriately qualified, trained and experienced personnel.

The formulation and approval testing of welding procedures is necessary to establish methods and to anticipate and overcome any difficulties likely to be encountered in the fabrication process. Approval testing of welding procedures and welders is carried out in accordance with BS EN 288-3 and BS EN 287-1 respectively. Inspection and testing requirements and acceptance criteria, developed specifically for bridgework, are detailed in BS 5400: Part 6.

Additions and amendments to standards are often invoked through contract specifications. Highway and rail bridges in the UK invariably have additional requirements detailed in appendices and supplementary specifications.

6.3 Types of joint

Structural welded joints are described as either butt welds or fillet welds. Butt welds for bridgework are normally in-line plate joints in webs and flanges, either to accommodate a change of thickness or to make up available material to girder length. The positions of these joints are allowed for in the design, although material availability constraints or the erection scheme may require the Engineer and contractor to agree on final positions. Tee butt weld joints are only required where there are substantial loading or fatigue considerations in bearing stiffening or transverse connections.

Butt welds for bridges are full or partial penetration joints made between bevelled or chamfered materials. Full penetration joints are designed to transmit the full strength of the section. It is possible to weld these joints from one side but material thicknesses in bridges are such that they are usually welded from both sides to balance distortion effects, with an in-process backgouging and/or backgrinding operation to ensure the integrity of the root area. Single sided butt welds with backing strips, ceramic or permanent steel, are common for joining steel deck plates and where there are closed box sections or stiffeners, which can only be accessed for welding from one side. Fatigue considerations limit the use of partial penetration welds.

Every effort should be made to design out butt welding as far as possible due to the costs associated with preparation, welding time, higher welder skill levels and more stringent and time consuming testing requirements. In addition, butt welds tend to have larger volumes of deposited weld metal; this increases weld shrinkage effects and results in higher residual stress levels in the joint. Careful sequencing of welding operations is essential to balance shrinkage and to distribute residual stress thus minimizing distortion.

Most other joints on bridgework use fillet welds in a tee configuration. They include the web to flange joints and stiffener, bearing and bracing connections.

Weld sizes must be detailed on the project design drawings together with any fatigue classification design requirements. British practice uses leg length to define fillet weld size, but this is not universal as throat thickness is used in some foreign practice.

6.4 Processes

The four main processes in regular use in UK bridge manufacturing are described below; variations of these processes have been developed to suit individual manufacturer's practices and facilities. Other processes also have a place for specific applications.

The important factors for the steelwork contractor to consider when selecting a welding process are the ability to fulfil the design requirement and, from a productivity point of view, the deposition rate that can be achieved and the duty cycle or efficiency of the process. The efficiency is a ratio of actual welding or arcing time to the overall time a welder or operator is engaged in performing the welding task. The overall time includes setting up equipment, cleaning and checking of the completed weld.

Process numbers are defined in BS EN ISO 4063.

Submerged arc welding with electrode (SAW) - process 121

This is probably the most widely used process for welding bridge web to flange fillet welds and in-line butts in thick plate to make up flange and web lengths. The process feeds a continuous wire into a contact tip where it makes electrical contact with the power from the rectifier. The wire feeds into the weld area, where it arcs and forms a molten pool. The weld pool is submerged by flux fed from a hopper. The flux, immediately covering the molten weld pool, melts forming a slag protecting the weld during solidification; surplus flux is re-cycled. As the weld cools the slag freezes and peels away leaving high quality, good profile welds.

Solid wires of diameters from 1.6 to 4.0 mm are commonly used with granular fluxes. Mechanical properties of the joint and the chemistry of the weld are influenced by careful selection of the wire/flux combination.

The process is inherently safer than other processes as the arc is completely covered during welding, hence the term submerged; this also means that personal protection requirements are limited. High deposition rates are a feature of the process because it is normally mechanized on gantries, tractors or other purpose built equipment. This maintains control of parameters and provides guidance for accurate placement of welds.

The ability to exercise precise procedure control enables contractors to take advantage of the deep penetration characteristic of the process. The cross sectional profile of fillet welds deposited is such that to achieve a design throat thickness a smaller leg length weld is required. BS 5400: Part 3 provides appropriate design guidance.

Process variants include twin and tandem wire feeds and metal powder additions. These all increase deposition potential but the equipment requirements

become more complex. The process is better suited to shop production but site use can be justified where applications include long runs and/or thick plate joints and the area can be weather-proofed.

Metal-active gas welding (MAG) - process 135

This is the most widely used manually controlled process for shop fabrication work; it is sometimes known as semi-automatic or CO₂ welding. Continuous solid wire electrode is passed through a wire feed unit to the gun usually held and manipulated by the operator. Power is supplied from a rectifier/inverter source along interconnecting cables to the wire feed unit and gun cable; electrical connection to the wire is made in a contact tip at the end of the gun. The arc is protected by a shielding gas, which is directed to the weld area by a shroud or nozzle surrounding the contact tip. Shielding gases are normally a mixture of argon, carbon dioxide and possibly oxygen or helium.

Good deposition rates and duty cycles can be expected with the process, which can also be mechanised with simple motorised carriages. The gas shield is susceptible to being blown away by draughts, which can cause porosity and possible detrimental metallurgical changes in the weld metal. The process is therefore better suited to shop manufacture, although it is used on site where effective shelters can be provided. It is also more efficient in the flat and horizontal positions; welds in other positions are deposited with lower voltage and amperage parameters and are more prone to fusion defects.

Flux-cored wire metal-arc welding with active gas shield (FCAW) - process 136

This process utilizes the same equipment as MAG welding, however the consumable wire electrode is in the form of a small diameter tube filled with a flux. The advantage of using these wires is that higher deposition rates can be used particularly when welding "in position", ie vertical or overhead. The presence of thin slag assists in overcoming gravity and enables welds to be deposited in position with relatively high current and voltage thus reducing the possibility of fusion type defects. Flux additions also influence the weld chemistry and thus enhance the mechanical properties of the joint.

Metal-arc welding with covered electrode (MMA or stick welding) – process 111

This process remains the most versatile of all welding processes however its use in the modern workshop is limited. Alternating current transformers or DC rectifiers supply electrical power along a cable to an electrode holder or tongs. Electrical earthing is required to complete the circuit. A flux coated wire electrode (or "stick") is inserted in the holder and a welding arc is established at the tip of the electrode when it is struck against the work piece. The electrode melts at the tip into a molten pool, which fuses with the parent material forming the weld. The flux also melts forming a

protective slag and generating a gas shield to prevent contamination of the weld pool as it solidifies. Flux additions and the electrode core are used to influence the chemistry and the mechanical properties of the weld.

Hydrogen controlled basic coated electrodes are generally used for steel bridge welding. It is essential to store and handle these electrodes in accordance with the consumable manufacturer's recommendations in order to preserve their low hydrogen characteristics. This is achieved either by using drying ovens and heated quivers to store and handle the product, or to purchase electrodes in sealed packages specifically designed to maintain low hydrogen levels.

The disadvantages of the process are the relatively low deposition rate and the high levels of waste associated with the unusable end stubs of electrodes. Nevertheless it remains the main process for site welding and for difficult access areas where bulky equipment is unsuitable.

Shear stud connector welding

Composite bridges require the welding of shear stud connectors to the top flange of plate or box girders and other locations where steel to concrete composite action is required. The method of welding is known as the drawn-arc process and specialist equipment is required in the form of a heavy-duty rectifier and a purpose made gun. Studs are loaded into the gun and on making electrical contact with the work, the tipped end arcs and melts. The arc is timed to establish a molten state between the end of the stud and the parent material. At the appropriate moment the gun plunges the stud into the weld pool. A ceramic ferrule surrounds the stud to retain the molten metal in place and to allow gas generated by the process to escape. The ferrules are chipped off when the weld solidifies. Satisfactory welds have a clean "upset" completely surrounding the stud.

The equipment for stud welding is not particularly portable, so if only a few studs are to be installed or replaced at site, it is more economic to use a manual process.

6.5 Preparation of welding procedure specifications

The drawings detail the structural form, material selection and indicate welded joint connections. The steelwork contractor proposes methods of welding each joint configuration to achieve the performance required. Strength, notch toughness, ductility and fatigue are the significant metallurgical and mechanical properties to consider. The type of joint, the welding position and productivity and resource demands influence the selection of a suitable welding process.

The proposed method is presented on a welding procedure specification (WPS), which details the information necessary to instruct and guide welders to assure repeatable performance for each joint

configuration. An example format for a WPS is shown in BS EN 288-2.

Welding procedure specifications for shop and site welds are submitted to the Engineer for his approval before commencement of fabrication. It is necessary to support the submissions with evidence of satisfactory procedure trials in the form of a welding procedure approval record (WPAR). The guidance clauses of BS 5400: Part 6 confirm that consideration should be given to the results obtained from procedure trials undertaken on previous contracts to avoid the necessity of repeating trials for every project. The major UK steelwork contractors have pre-approved welding procedures capable of producing satisfactory welds in most joint configurations likely to be encountered in conventional bridgeworks.

For circumstances where previous trial data is not relevant it is necessary to conduct a welding procedure test or trial to establish and to confirm suitability of the proposed WPS. Note the conflict of terminology, BS 5400 uses the term trial whereas BS EN standards use test. The next sections use the terms within the context of the standard being discussed.

6.6 Procedure trials

When it becomes necessary to conduct a welding procedure trial, BS 5400: Part 6 refers to welding procedures complying with the requirements of BS 5135, BS EN 288-1, -2 and -3 and BS 4570, as appropriate. BS EN 1011 substitutes for BS 5135 with the various parts of BS EN 288 supporting detailed welding procedure testing. BS 4570 refers to the welding of steel castings.

Procedure trials on welded stud shear connectors are undertaken, when specified by the Engineer. BS 5400: Part 6 describes the metallographic and destructive test requirements to prove the integrity of stud welds.

There is an additional general requirement concerning procedure trials that where paint primers are to be applied to the work prior to fabrication, they are applied to the sample material used for the trials.

BS EN 288-3 defines the conditions for the execution of welding procedure tests and the limits of validity within the ranges of approval stated in the specification. The test commences with the preparation of a preliminary welding procedure specification (pWPS). For each joint configuration, either butt or fillet weld, consideration is given to the material thickness and anticipated fit up tolerances likely to be achieved in practice. Process selection is determined by the method of assembly, the welding position and whether mechanization is a viable proposition to improve productivity.

Joint preparation dimensions are dependent upon the choice of process, any access restrictions and the material thickness. Consumables are selected for material grade compatibility and to achieve the mechanical properties specified, primarily in terms of

strength and toughness. For S355 and higher grades of steel, hydrogen controlled products are used.

The risk of hydrogen cracking, lamellar tearing, solidification cracking or any other potential problem is assessed not only for the purpose of conducting the trial but also for the intended application of the welding procedure on the project. Appropriate measures such as the introduction of preheat or post heat are included in the pWPS.

Distortion control is maintained by correct sequencing of welding. Backgouging and/or backgrinding to achieve root weld integrity are introduced as necessary.

Welding voltage, current and speed ranges are noted to provide a guide to the optimum welding conditions.

The ranges of approval for material groups, thickness and type of joint within the specification are carefully considered to maximize the application of the pWPS. Test plates are prepared of sufficient size to extract the mechanical test specimens including any additional tests specified or necessary to enhance the applicability of the procedure. The plates and the pWPS are presented to the welder; the test is conducted in the presence of the examiner and a record maintained of the welding parameters and any modifications to the procedure needed.

Completed tests are submitted to the examiner for visual examination and non-destructive testing in accordance with BS EN 288-3: Table 1. Non-destructive testing techniques are normally ultrasonic testing for volumetric examination and magnetic particle inspection (MPI) for surface examination and crack detection. Satisfactory test plates are then submitted for destructive testing, again in accordance with Table 1 of BS EN 288-3.

There is a series of further standards detailing the preparation, machining and testing of all types of destructive test specimen. Normally specialist laboratories arrange for the preparation of test specimens and undertake the actual mechanical testing and reporting.

The completed test results are compiled into a WPAR endorsed by the examiner. Project specific welding procedures based upon the ranges of approval are then prepared for submission to the Engineer.

6.7 Avoidance of hydrogen cracking

Cracking can lead to brittle failure of the joint with potentially catastrophic results. Hydrogen (or cold) cracking can occur in the region of the parent metal adjacent to the fusion boundary of the weld, known as the heat affected zone (HAZ). Weld metal failure can also be triggered under certain conditions. The mechanisms that cause failure are complex and described in detail in specialist texts.

Recommended methods for avoiding hydrogen cracking are described in BS EN 1011: Part 2, Annex C. These methods determine a level of preheating to modify cooling rates and therefore to reduce the risk of

forming crack-susceptible microstructures in the HAZ. Preheating also lessens thermal shock and encourages the evolution of hydrogen from the weld, particularly if maintained as a post heat on completion of the joint.

One of the parameters required to calculate preheat is heat input. A notable change in the standard is to discontinue use of the term arc energy in favour of heat input to describe the energy introduced into the weld per unit run length. The calculation is based upon the welding voltage, current and travel speed and includes a thermal efficiency factor; the formula is detailed in Part 1 of the Standard.

High restraint and increased carbon equivalent values associated with thicker plates and higher steel grades may demand more stringent procedures. Low heat inputs associated with small welds may also necessitate preheating. Experienced steelwork contractors can accommodate this extra operation and allow for it accordingly.

BS EN 1011 confirms that the most effective assurance of avoiding hydrogen cracking is to reduce the hydrogen input to the weld metal from the welding consumables. Processes with inherently low hydrogen potential are effective as part of the strategy, as well as the adoption of strict storage and handling procedures of hydrogen controlled electrodes. Consumable suppliers' data and recommendations provide guidance to ensure the lowest possible hydrogen levels are achieved for the type of product selected in the procedure.

Further informative Annexes in BS EN 1011-2 describe the influence of welding conditions on HAZ toughness and hardness and give useful advice on avoiding solidification cracking and lamellar tearing.

6.8 Welder approval

There are no specific clauses in BS 5400: Part 6 concerning approval of welders. BS 5135 made specific reference to approval and testing of welders, however the new standard, BS EN 1011-1 Annex A, requires this information to be supplied by the purchaser. Clause 20 indicates the appropriate standard is the relevant part of BS EN 287; for steel bridges this is Part 1. The standard prescribes tests to approve welders based upon process, type of joint, position and material.

Welders undertaking successful procedure trials gain automatic approval within the ranges of approval in the standard.

Welder approvals are time limited and need re-validating depending on continuity of employment, engagement on work of a relevant technical nature and satisfactory performance. The success of all welding operations relies on the workforce having appropriate training and regular monitoring of competence by inspection and testing.

6.9 Inspection and testing

Procedure trials

Specimens for destructive testing are cut and machined from the test plate. Typical specimens for an in-line plate butt weld include transverse tensile tests, transverse bend tests, impact tests and a macro-examination piece on which hardness testing is performed.

Tensile tests are required to cover the full section thickness of the joint and under most specifications the result has to at least match the corresponding minimum strength of the parent material.

Root and face bend tests are to have the weld root and face respectively in tension, although for materials equal to or greater than 12mm side bend tests are preferred. Flaws greater than 3mm are not permitted, although those appearing at the corners of the specimen are to be ignored.

Hardness and impact testing criteria for bridgework are varied by BS 5400: Part 6, however it is wise to test all welding procedures to the limit of potential application to avoid repeating similar tests in the future.

The notch toughness of weld metal and HAZ is important as initiation of cracks could occur from defects located in these areas. The toughness requirements in BS 5400: Part 6 are specifically for Charpy V-notch impact tests for tension areas and are applied to butt welds including corner or T-butt welds parallel or transverse to the main tension stress. The notch toughness of weld metal and HAZ is important as initiation of cracks could occur from defects located in these areas. The toughness requirements in BS 5400: Part 6 are specifically Charpy V-notch impact tests for tension areas and are applied to butt welds including corner or T-butt welds parallel or transverse to the main tension stress. The minimum energy absorption requirements and the testing temperature are the same as those required for the parent material in the joint.

Other specifications may vary the Part 6 requirements. Care is needed to ensure the project requirements are fully understood.

The guidance clauses in BS 5400: Part 6 provide further information and discuss the acceptance criteria for hardness and impact testing in tension areas. Notch positions in impact specimens in the weld metal and heat-affected zones are shown for various joint configurations.

Examination of stud shear connector weld procedure tests is based on a sample of six studs. Three studs are bent sideways for a distance approximately half the length of the stud, and are required to be bent straight again without failure of the weld, the other three studs are used to prepare macro sections which must be free from macroscopic defects visible to the naked eye. Hardness values for the weld metal have to be in

the range 150-350 HV30 and the HAZ must not exceed 350 HV30.

Production tests

Production testing is specified as destructive or non-destructive. Destructive tests are mechanical tests on specimens taken from "run-off" plates generally attached to in-line butt welds. The "run-off" plates have to be larger than normal to accommodate the test specimens and any re-tests which may be required.

(a) Destructive testing:

Unless otherwise specified by the Engineer, production tests required in BS 5400 are approximately 1 in 5 transverse butt welds in tension flanges and 1 in 10 other butt welds.

Specimens for testing include transverse tensile and transverse bend tests. Charpy V-notch impact tests are required on the weld metal of butt welds transverse to and carrying the main tension stress and where specified by the Engineer on the fusion boundary region of the HAZ.

Transverse tensile tests are required to achieve a tensile strength of not less than the corresponding specified minimum value for the parent metal. Failure can occur in the parent or weld metal part of the specimen.

The transverse bend tests in thicknesses of 10mm and over are side bend tests; otherwise face and root bend tests are carried out as described under procedure trials. The former diameter and angle of bend are as required by BS EN 288-3. Defects revealed are to be investigated to establish cause prior to acceptance or rejection: this is to avoid costly repair of relatively insignificant discontinuities such as minor porosity. Slight tearing at the edges of the specimen is also not a cause for rejection.

Charpy V-notch impact tests are required to achieve the acceptance criteria specified for the procedure tests.

Further testing is permitted under the standard, however in the event of failure to meet test criteria the Engineer will determine the next course of action on all welds represented by the production test plate. Actions to consider may include additional non-destructive testing or a stress relieving post weld heat treatment. Rejected joints should be repaired in accordance with an approved procedure.

(b) Non-destructive testing:

BS 5400: Part 6 describes the methods and frequency of inspection and acceptance criteria for all joints on a project where the fatigue classification is other than B or C. Critical areas of the structure requiring a minimum fatigue classification are defined by the designer on the drawings. This influences the test procedures, the extent of inspection and the acceptance criteria. All testing of welds should take

place not less than 48 hours after welding.

The methods and acceptance criteria in Part 6 have been prepared especially for bridgework and are designed to achieve a level of performance based upon the fitness for purpose of production welds.

Surface inspection methods are visual and magnetic particle inspection; sub-surface inspection methods are radiography and ultrasonic inspection. Radiography demands stringent health and safety controls; it is relatively slow and needs specialist equipment and use of the process has declined on bridgework compared with the safe and more portable equipment associated with ultrasonic inspection. Safety exclusion zones are required, in works and on site, when radiography is in progress. The standard notes that radiography may be used in cases of dispute to clarify the nature, sizes or extent of multiple internal flaws detected ultrasonically. Specialist technicians with recognised training are required for all non-destructive testing methods.

All welds require 100% visual inspection. From a practical point of view welds should be visually inspected immediately after welding to ensure obvious surface defects are dealt with promptly.

Partial non-destructive inspections should be at least 300mm in length or the total length for shorter joints. The standard directs partial inspections to include areas where visual inspection has indicated that internal quality is suspect. Where unacceptable discontinuities are found the examination area is increased accordingly.

The extent of magnetic particle and ultrasonic inspection is defined and increases particularly where a minimum fatigue class requirement is shown on the drawings. Acceptance criteria are given for all methods of inspection but quality levels vary according to whether a minimum fatigue class is specified, the location of the joint and the type of discontinuity.

Production stud shear connector welds are ring tested by using a 2kg hammer to strike each stud. A selection of studs, nominally chosen by the Engineer and normally around 1 in 50, are tested by using a 6kg hammer to displace the stud sideways to a distance 0.25 x the height of the stud. The bent studs are not to be straightened. Failed studs are to be replaced in accordance with an approved procedure.

6.10 Weld quality levels

The effect of defects on the performance of welded joints depends upon the loading applied and upon material properties. It may also depend on the precise location and orientation of the defect, and upon such factors as service environment and temperature. The major effect of weld defects on the service performance of steel structures is to increase the risk of failure by fatigue or by brittle fracture. Types of welding defect can be classified under one of the general headings:

- (a) Cracks.
- (b) Planar defects other than cracks, e.g. lack of penetration, lack of fusion.
- (c) Slag inclusions.
- (d) Porosity, pores.
- (e) Undercut or profile defects.

Crack or planar defects penetrating the surface are potentially the most serious form of defect. Embedded slag inclusions and porosity are unlikely to initiate failure unless very excessive. Undercut is not normally a serious defect unless significant tensile stresses occur transverse to the joint.

In order to prevent brittle fracture the Engineer selects material with adequate notch toughness in accordance with the requirements of BS 5400: Part 3 from the standards listed in Part 6. This is of particular importance for thick joints and low temperature applications.

When a joint is subject to fatigue loading, and the correct precautions are taken for the selection of materials, the effect of any weld defects is primarily on the development of fatigue cracks.

In selecting the appropriate weld quality for a particular type of joint the following aspects are considered:

- (a) Type of joint (fillet, butt or tee-butt).
- (b) Direction of principal stresses at the joint in the plate and in the weld, relative to the length of the weld.
- (c) Magnitude of the stress range under fatigue loading and the specified load spectrum for the service life.

Where defects are detected as a result of inspection and testing, then repair may be necessary. Alternatively in many cases the particular defects may be assessed on the concept of 'fitness for purpose'. This is dependent upon the stress levels and the significance of fatigue at the location. The size, form and position of the defect are considered taking into account static strength, fatigue and brittle fracture criteria for the service life of the structure. This is a matter for speedy consultation between the contractor and designer for if acceptable, costly repairs can be avoided as well as other problems such as increased risk of distortion, the potential for introducing other defects in the repair and programme delay.

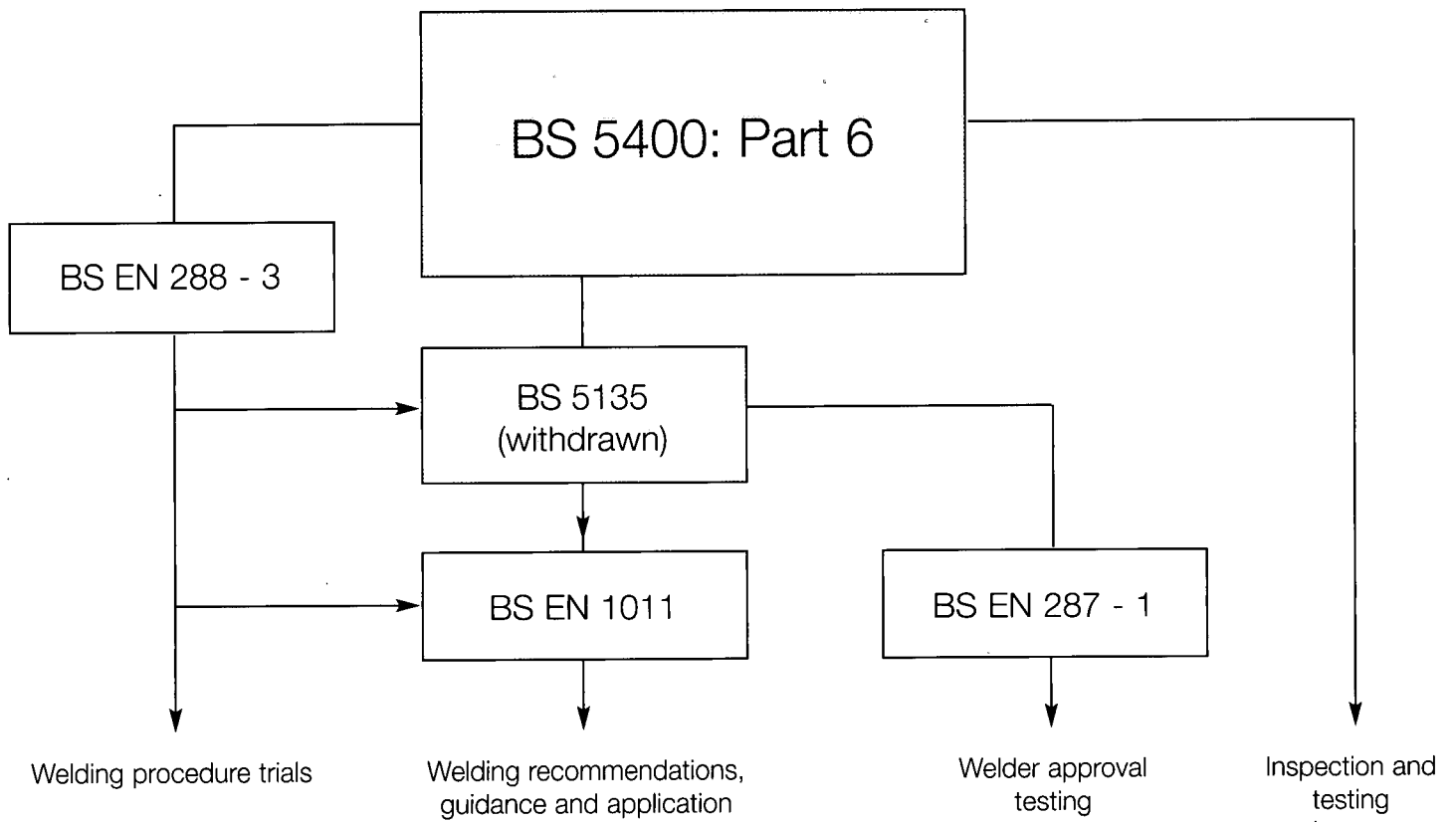

Flowchart showing the relationship between the principal workmanship and welding standards for bridgework

Submerged-arc welding process

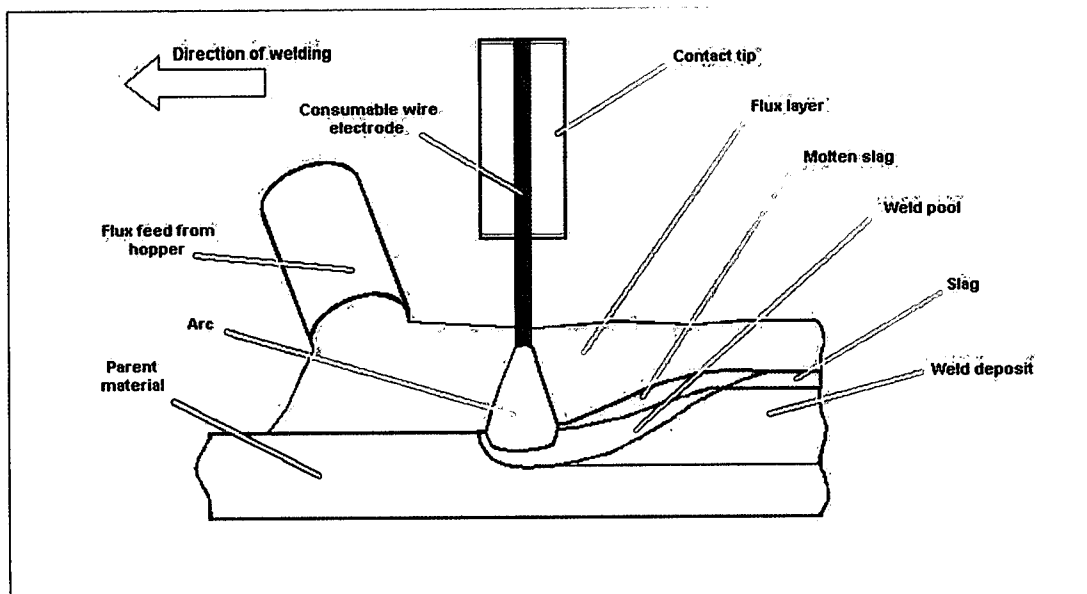

MAG or flux cored arc welding process

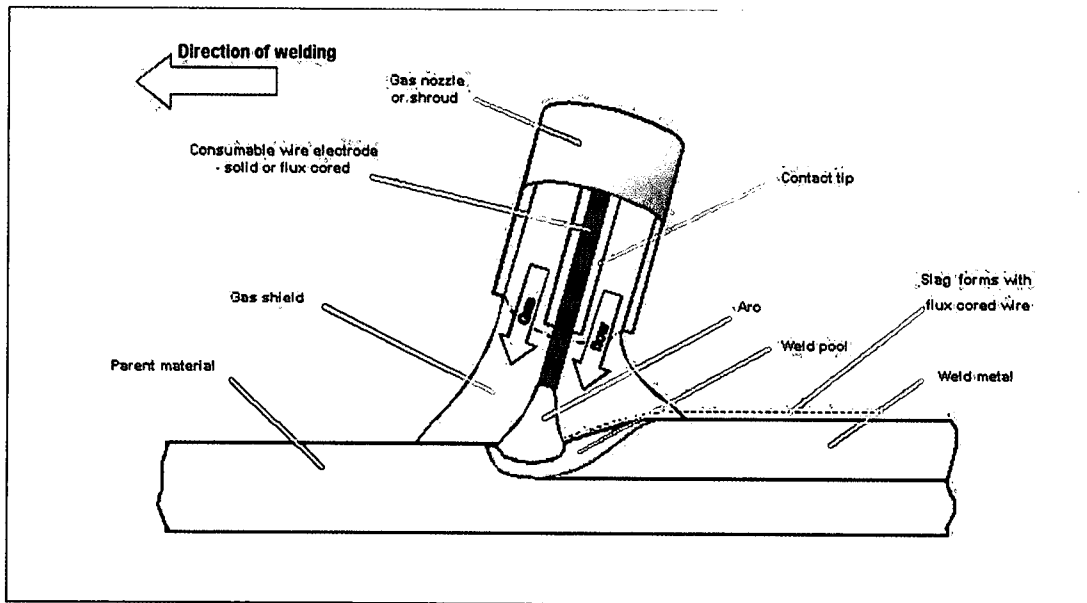

Manual metal arc welding process

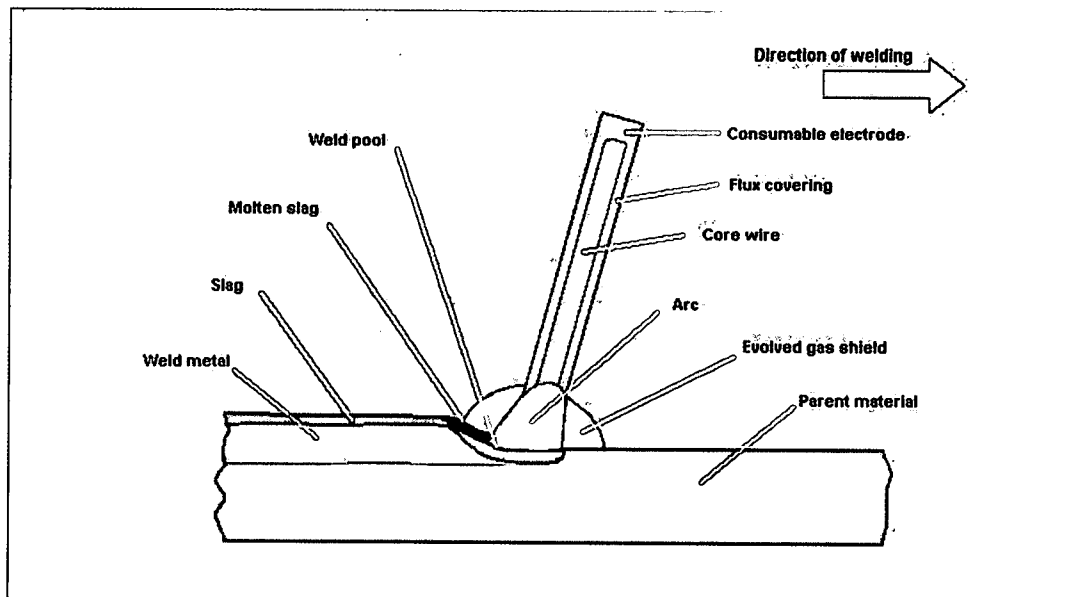

CHAPTER 7

COSTS

7.1 Introduction

The likely cost of steelwork is an important consideration in feasibility studies for a bridge project, as well as in planning and budgeting for the construction. Equally important for the client are the effects on the outturn price he will pay, of decisions taken in design and procurement of steelwork as part of the overall project.

Very little guidance is published on the cost of bridge steelwork because it is difficult to generalise for the wide range of bridge types and configurations found in the UK; and of course at any particular time prices reflect the state of the market. The price a client pays for the steelwork in a new bridge covers the cost of many activities and services as well as the basic cost of materials used and the direct workmanship in fabrication and erection. In this chapter the aim is to provide guidance on relative costs and, more importantly, to show how the decisions and actions of clients and designers can increase or reduce the cost of bridge steelwork irrespective of the value and quality of the finished product.

Understanding and anticipating the whole process of production from the outset of the project is essential for success; so in the following sections cost is discussed in relation to

- the defined project requirements,
- the production process for a typical bridge, and
- cooperation for efficiency and economy.

7.2 Project Requirements

7.2.1 Everything has to be paid for

The client's aim is to secure the new bridge to the desired standard as economically and efficiently as possible: to that end, whatever the contractual arrangements or procurement method, the steelwork contractor will start work with a defined set of project requirements. These will include a range of technical and commercial documents – drawings, specifications, bills of quantities, programme and conditions of contract – all of which bear on the cost of the work to be done and the price to be paid.

The requirements should be all that are appropriate, necessary and sufficient to achieve the client's aim and no more. To go beyond that may require services or activities which give no added value, or set limitations which inhibit enterprise or economy, and increase cost and price. It is worth reviewing each category of the requirements.

7.2.2 Scope of Work

The typical sub-contract scope of works for steel bridgework covers supply, fabrication, protective treatment and erection. Each of the UK steel bridge contractors, in its own particular way, is able to undertake additional activities beyond that basic scope. This can offer benefits for cost and risk management; for example if the provision of an in situ concrete deck on a small rail bridge is taken on by the steelwork contractor at the factory, or if the steelwork contractor were to supply and install the bearings.

The opportunity for synergy between main contractor and steelwork contractor depends on their respective skills and experience and requires thoughtful definition of contractual interfaces, for example, in the provision of groundworks and access for delivery and erection. Similarly if the steelwork contractor is required to undertake work outside its normal experience, risks for the project could increase, leading to higher costs - in time and money.

As a general rule, in defining the scope of work of each party, it is best to place control of costs and risk with the party which has most relevant experience and opportunity to deal with them. The scope of work will be defined in detail by the drawings, the specifications, the bill of quantities and the method of measurement for the project.

7.2.3 The Design

A bridge designer is challenged to produce a solution which meets all of a wide range of criteria, including the minimum cost consistent with all other criteria. He portrays the chosen solution primarily on the contract drawings with the support of the specification. In coming to an overall view of the relative cost of a particular design, the key issues are its efficiency, complexity and buildability.

Efficient design of steelwork aims at using the steel components to their safe design capacity within an overall economy of resources for fabrication and erection. Minimum cost design is very unlikely to be the lightest design and certainly it will not be the heaviest. Weight saving is not an end in itself; for example flange weights can be reduced at the expense of additional butt welds, or webs can be thinner if more stiffeners are added. Achieving the most efficient design requires careful selection of concept and layout, and judgement in drawing the balance between weight and workmanship in detail. Guidance on efficient design of composite plate girder highway bridges, including likely weights, has been published by Corus (Composite Steel Highway Bridges). The efficiency of a design has

to be judged against the particular project requirements of course; thus severe restriction of construction depth will increase the weight of the members, however efficient the design is.

In general more complex fabrication is more expensive, especially if measured on a cost per tonne basis. Fabrication is generally more economic if connections are simple, geometry is straightforward, and the amount of welding is minimised. The complexity of a design is the outcome of the designer's response to the imposed constraints and the choices he makes: thus for example, a viaduct may have to conform to complex highway geometry but a decision to use integral crossheads would compound the complexity and cost of fabrication and erection substantially. Modern CAD systems and CNC fabrication equipment can well accommodate such complex geometry to ease the drawing and production processes, but they cannot eliminate all the extra costs in workmanship, organisation and management. In detailing, every additional component, every extra weld adds to the cost so it pays the designer to consider the options and anticipate relative costs in making his choices.

The buildability of structural steelwork is a cost issue as well as a safety issue for the designer; indeed fulfilment of his obligations under CDM to reduce exposure to hazards should contribute to overall economy. Design for function and purpose has to anticipate the fabrication and erection processes. Good detailing is the first key to ensuring buildability – say in the fabrication of box girders to minimise hazardous and expensive internal activities, or in ensuring that bolts can be entered and readily tightened in site connections. And, secondly, for construction work on site the structural layout, member sizing, and connections need to be consistent with a practicable economic erection method: site constraints on time, say for rail or road closures, and physical restrictions on access, crane position, temporary supports and the like will determine what that method will be. Connections should be detailed to facilitate site fitting with some rotational and dimensional tolerance, bearing in mind the factors of camber prediction and fabrication tolerances: this is important for safety and cost, and can be met readily with bolted joints. In some circumstances extra stiffening or strength will need to be designed in to the members, say for launching or a big lift, and that will be less costly if done at the outset. The level of erection costs is determined by the potential difficulty of the site and the project constraints; the designer has real scope to increase or reduce that cost.

To achieve good quality design which satisfies all the criteria is not easy; it requires skill in the use of steel at the concept and detail stages of design. Some designers are more experienced in steel bridge design than others: greater experience should lead to simpler and more economic design which will reduce total costs.

7.2.4 Specification

The project specification is an essential part of the design, and it is germane to what has to be paid for. The project specification should express clearly what the designer requires, be up to date and refer to current national and international standards. Conformance with well recognised specifications for fabrication and erection (eg based on BS 5400: Part 6) will reduce uncertainty and help to minimise cost; specifiers should avoid introducing personalised clauses demanding, say, extra fabrication tolerances, testing procedures, or architectural finishes as these will increase fabrication costs. Some projects will require special clauses to meet particular needs, but these should reflect recognised good practice and not over-anticipate problems. The SCI publication "Model Appendix 18/1" (Specification of Structural Steelwork for Bridges) contains a series of model clauses which may be inserted into a project specification and which is compatible with the Specification for Highway Works, BS 5400 Part 6, and associated standards. In the limit, any tendency towards "preferential engineering" adds to the cost and price of a steel bridge.

7.2.5 Programme

The project programme should reflect an informed view of achieving the client's objective consistent with allowing sufficient time to complete all the necessary tasks – administrative, intellectual, and practical, at site and elsewhere – within the logical constraints of the design and other project requirements. Within that programme, the steelwork contractor needs sufficient time to do all that he has to do – many activities are in his direct control, others such as supply of steel are not. For most bridge steelwork the time required to complete the work most economically can be reduced by special measures, or taking risks, but such measures come at a price. Therefore it is important not to compress the steelwork programme below the allowance of sufficient time for economy, without recognising the enhanced cost and risk to the project. This is discussed in more detail in section 7.3. Typical fabrication periods range from four weeks from receipt of steel for small simple structures through to many months for large complex structures: the necessary period depends on the capacity of the factory and its workload too.

Within the detail of the project programme features which tend to increase the site cost of the steelwork are

- time constraints on deliveries and hours of working
- phasing of erection requiring more than one visit to site
- possession work requiring multi-shift and night work

- timing of work such as welding and painting in unseasonable periods of the year, requiring extra measures and risks of excessive down time.

7.2.6 Conditions of Contract

The conditions of contract particular to a project and the related subcontract conditions, introduce elements of cost for the steelwork contractor which are reflected in his price. Comparatively aggressive terms and conditions will result in higher prices.

Factors which increase the cost of structural steelwork include the financing of materials and fabricated steelwork at the factory until it is paid for, and the risk provision for unreasonable damage clauses which are disproportionate to the size of the subcontract. The provision of interim payments for steel and steelwork should be included where it is required that work be done well in advance of erection dates. As with all other aspects of project requirements the application of the contract conditions to a project needs to be thought through to ensure that they are in the best interests of achieving a successful project even down to minor considerations such as times for approvals. Price is related to risk, and offloading risk on to the contractor or subcontractor increases the price to be paid for the work.

7.2.7 Commercial Factors

The price to be paid for steelwork will reflect not only the costs and risks inherent in the explicit requirements of the project documents, but also less tangible factors such as the relationships between the parties and market conditions.

As with any specialist work, the perceived degree of risk will depend upon the trust that each of the parties has with the others. When the parties (client, designer, main contractor and steelwork contractor) have worked together successfully in the past by keeping to contractual agreements such as payment terms and by maintaining good working relationships, greater certainty of cost and fewer post-contract claims can be expected. The prices tendered will reflect that.

Market conditions will affect the steelwork contractor's costs, for example in the price and availability of material or labour and plant in remote locations. The contractor's margins will reflect the state of his forward work load and the overall demand and supply balance. However, no steelwork contractor can afford to be influenced by the immediate situation when considering projects, which may become orders in the medium or long term.

7.3 The Fabrication Process

7.3.1 A Manufactured Product

In any project using fabricated steelwork it is surprising how few people outside the factory doors understand what goes on within them - even when their roles give them an active interest or part in the process.

Steelwork is a manufactured product with a key function in a civil engineering project on site: most of its added value accrues over many weeks before delivery to site where it is often erected in a few days. The fundamental differences between production in a factory and production of civil engineering works on site, and in particular in their cost structures, lead to misunderstandings and commonly to unintended commercial surprises. Mutual recognition and understanding of the differences help relationships, control of costs, and ensure better value for the client; and this is particularly so in managing any change of requirements, and dealing with problems.

Between receipt of the final design input and the delivery of complete steel members to site is a sequence of dependent activities - through planning, preparation of data and drawings, procurement of material, receipt and preparation of steel, assembly and welding, possibly trial erection, and protective treatment. The factory, which represents a large fixed overhead, is laid out with covered space, cranes, machinery and equipment to suit the steelwork contractor's product range with efficiency and economy - the facility to manufacture building structures is quite different from one for plate girders or for steel decks. Steel bridge members are large, heavy and bulky, so the factory layout is designed to lift, move and manipulate the steelwork economically and safely between production activities. This non-productive work and the occupation of floor space represent a substantial proportion of bridge fabrication costs. Unlike a site, the factory works on a number of projects in parallel to achieve profitable utilisation of the factory and its permanent workforce, and thereby to be able to offer steelwork at competitive prices and maintain the company's expertise.

The sequence of activities for bridgework is described more fully in the following paragraphs to dispel some of the mystery about what does happen in the factory.

7.3.2 Starting the Process

Before fabrication can begin, the work has to be planned and programmed, drawings and production data produced, material ordered and first steel delivered. The target is to provide precise data and all the appropriate material for the first components to the shop floor by the planned date; and then to maintain the flow of data and material to meet the programme without delay or disruption.

7.3.3 Planning

The steelwork contractor is committed to deliver and erect the bridgework to meet the overall project programme, given receipt of the requisite design information by agreed key dates. Fabrication is planned to complete the members in sequence to suit the agreed erection sequence - to minimise the critical path for each member and to avoid stockpiling of finished work. Delivery dates for members to site are

determined by an erection programme with sufficient duration to do the work safely and to specification within all site constraints. Within the factory, efficient use of the space, equipment, and the substantially fixed level of resource requires the programme to fit into the overall works programme to balance demand and avoid bottlenecks. Work may be planned for sub-letting for specialist operations, say bending or machining, or to deal with overload.

Specialist planning is done, to meet the programme, in preparing method statements for more complex activities, inspection and test plans, risk assessments for site work, erection method statements, and health and safety plans - all within a company specific quality management system.

Preparation of all this information, which is prerequisite to doing the job properly, depends on timely and sufficient accurate input from the other parties to the project, and timely response to submissions requiring approval.

Erection planning will include a measure of construction engineering, dependent on the scale and complexity of the bridgeworks, including structural analysis, temporary works design and independent checks. This in turn requires full information from the site and agreement between the parties on method, timing and responsibilities before it can be completed.

7.3.4 Drawings and Production Data

The design input has to be processed to schedule material for procurement, to generate work instructions for tradesmen or machines on the factory floor, and for construction engineering at site. With progressive automation of fabrication, the industry is moving towards making fabrication drawings obsolescent – the design data are converted directly into digital instructions for machines. Each steelwork contractor will format the data to suit his particular factory facility and such fabrication drawings as are made, are for his purposes in fabrication and erection of the bridgework.

To implement the design of the steelwork efficiently and in a timely manner, it is vital that the design input expresses the designer's intent clearly and completely at the outset and certainly before the commencement of CAD detailing or modelling: typically this information is required between four and six weeks before fabrication starts. Where members are required to be cambered the designer should provide the data on the design drawings, which can come from his computer model; it is not cost effective for the steelwork contractor to set up a new model and make his calculations on the critical path of his work - adding time, cost, and risk of delay.

7.3.5 Material Procurement

Steelwork contractors do not carry stocks of material, except a basic minimum for projects in progress, so material is bought specifically for each new project. For

most bridges, costs can be minimised by ordering plates and sections directly from the steel mills, in contrast to the UK market for building steelwork, which depends much more on steel stockholders. Some bridge materials, including most special grades such as S460 or WR steels and larger sizes of section, are not available from stockholders at any price. Time has to be allowed in any bridge procurement programme for supply from the mills with typical lead times of six to twelve weeks for plate and between six and sixteen weeks for larger sections and tubes. Full design information is not necessary to enable orders for steel to be placed but sufficient detail must be available to define all components in advance of rolling dates to minimise waste and costs.

For members fabricated from plate, most plate components including flanges, webs and stiffeners, are cut from plates of economic size and width. Hence steel listing for ordering includes a computerised nesting process to achieve best utilisation and minimise waste to no more than a few percent. To the same end, the designer should avoid mixing of grades where possible and rationalise the range of plate thicknesses and section sizes. Advice is given in Chapters 1 and 2 on plate sizes and the availability of steel grades.

7.3.6 Receipt of Material

As material is received at the factory it is marshalled for transfer into the preparation area in the programmed sequence. Usually as the steel is picked up it receives pre-fabrication cleaning by grit-blasting to remove all mill-scale, rust and dirt. This provides clean surfaces for marking and welding and reveals any superficial defects in the material, should there be any, before work starts.

7.3.7 Preparation

This term is used to cover the set of operations which converts the plain material into finished plate or section components ready for assembly and welding. The range of processes and equipment used depends on the requirement for each component: it includes marking, cutting, edge preparation, drilling, pressing and machining: sections may be processed through automated saw and drill lines for cutting and drilling.

7.3.8 Marking

The day of the large template loft with string line and plywood is long gone, to be replaced by desktop PC. Some steelwork contractors have automated the process, but it still has a major cost which can be minimised by keeping the structure design simple. For example, complex arrangements of shear studs are inevitably more expensive than simple arrangements which can utilise templates for marking and are easy to check – ensuring that there are no fouls with reinforcing bars at site.

7.3.9 Cutting

Components for box and plate girders will usually be cut from plate by plasma or oxy-propane equipment mounted on CNC machines. These closely controlled techniques are generally accurate and efficiency is dependent largely on the process. It is possible to increase cutting costs by adding complexity; for example, creating too many types of stiffener prevents multi-head profiling. As plates are cut up, each piece is marked for identification and material traceability.

Other components such as bracings should be detailed for simplicity with the aim of minimising the number of pieces to cut. Ends of bracings should be cut square rather than mitred and single members should be used in preference to back-to-back members.

7.3.10 Preparation of Edges

Unnecessary preparation of edges should be avoided. The hardness of flame cut edges can be controlled quite simply through qualified cutting procedures so that grinding of edges is not necessary. Fillet welds rather than penetration welds should be used where possible, for the same reason. The costly practice of grinding arrives to a prescribed radius, of 3mm say, to avoid edge defects in protective treatment is no longer necessary with the high solids chemical cure paint systems used today.

Machining of edges should not be specified unless proven to be absolutely essential to achieve the welded connection – for example in achieving partial penetration welds for deck stiffeners with high penetration without blowthrough.

7.3.11 Drilling

Usually all holes for site-bolted connections are drilled in the factory, and for welded members most holes are drilled in preparation before assembly using CNC machines. Drilling holes in large assembled members is more costly because less efficient portable machines have to be mounted on the member. For complex assemblies final holes may have to be drilled in trial assembly with the joint material to ensure a good match at site. Small components, particularly splice plates, are drilled in packs so simple detail and repetition contribute to cost reduction.

7.3.12 Pressing

Bridge steelwork contractors and specialist workshops are equipped with a variety of presses which may be used to form members from plate, or for remedial working of deformed components. Designers are advised to seek specialist advice before using cold formed details in design. The details need to suit the available equipment and the specification for the relevant material may need modifying. The introduction of plate bending adds an activity, which the steelwork contractor may have to sublet, so time and cost effects

need to be considered.

7.3.13 Assembly

The fabrication process is arranged so that work on each principal member is a continuous process with the minimum standing time. Thus the set of components for a member is prepared as a batch and moved on to the assembly area or machines without delay to be put together and welded, for such non-productive time has a cost.

The assembly of plate girders and box girders is described in some detail in Chapter 3. Methods vary between steelwork contractors for similar products: each one chooses the most efficient and economic way of using the factory's equipment and space – some with large capital investment and fewer manhours, some with modest facilities and much greater skilled manhours. The same volume of welding is undertaken, the same issues of accuracy and distortion have to be controlled.

Welding procedure and processes are described in detail in Chapter 6. There are two main factors that affect welding costs, the choice of process and the efficiency of application of that process. Higher deposition processes such as submerged arc welding (SAW) can reduce welding costs, but they are limited by gravity and are intolerant of damp steel or consumables, so they are not practical for most site welding. High deposition processes, mounted on automatic or semi-automatic machines are used whenever possible in shop assembly, normally utilising metal active gas (MAG) techniques which are most common in UK steelwork contractors. Manual metal arc welding (MMA), commonly called 'stick' welding, is far less efficient, but can be the only choice for complex joints and details – a choice which is imposed by the complexity of design and where details have not taken account of how welds can be made. Generally the route to minimum cost of welding in the UK is to maximise the use of automated equipment in the fabrication works and minimise welding on site.

Grinding of butt welds in members requires another operation on the critical path of fabrication which is hazardous, time consuming and relatively costly for the perceived benefit. The vibration effects of the tools are hazardous and so their use is now strictly regulated to protect the operator. Consideration should be given to the need to grind flush particularly for longitudinal butt welds, where welds can be completed with a neat profile, and especially on internal surfaces.

As described earlier the cost of lifting and turning large assemblies to facilitate welding, particularly of box girders, can be reduced by careful design of the connections of webs and flanges. Similarly, hazardous and high cost work in the interior of box girders is very dependent on the thought given to internal detail.

Some types of bridge require members to be machined after completion of assembly and welding, for example the members of an arch or at connections for suspension systems on major bridges. Steelwork contractors have limited capability for in house machining, so subletting to specialists at high cost or using portable machines with limited cutting capacity are options. Designers should seek to avoid machinery at this stage of production unless there is very good cause.

Trial erection has been discussed elsewhere, but it is worth mentioning in a discussion of cost as it has a major impact on the length of the fabrication programme: a member required in trial erection cannot be released for painting and delivery to site until the last member is fabricated and the trial assembly is checked and released. Generally the considerable cost of manhours, craneage, and space in the works is non-productive save for the assurance of minimising risk of delay at site. Given the accuracy of modern fabrication machinery and the variety of techniques available to the steelwork contractor to demonstrate that the fit will be achieved, trial erection is to be avoided.

As assembly of members progresses inspection, NDT and mechanical testing are carried out to minimise delay to release of the completed members.

7.3.14 Managing Change

Fabrication is a continuous programme of activities from receipt of first information to completion and delivery of the finished member. The specification and other contract requirements require reference at various stages to the designer, the Engineer, and other parties - they have a part to play in the process, and how they fulfil their roles bears on the steelwork contractor's performance.

Few projects reach their conclusion without the need for change, stemming from any of the parties and impacting on the others. The cost effects of change which impact on fabrication become more severe the later they occur in the fabrication programme: even apparently quite modest changes can have substantial time and cost consequences, for they not only put the project fabrication at risk, but they can disrupt work on other projects in the factory at the same time.

Experienced steelwork contractors make prudent assessments of the risks of delays in information, approvals and consents, and develop contingency plans to deal with problems. To the extent that technical factors are involved, it is important that designers and supervising engineers develop good working relationships and effective channels of communication with the steelwork contractors; mutual understanding can make a great difference to the cost of the project and its success.

7.4 Protective Treatment

Conventional practice requires the completed steel members to be blast cleaned, perhaps metal sprayed, and part painted before delivery to site; finish coats are applied after the bridge is built. The steelwork contractor carries out the first stage at the fabrication works, given the capital investment in proper blasting and painting facilities, or en route to the site at a sub-contractor's facility which incurs extra handling and transport costs. Very bulky bridge members take up considerable space in the facility so each one is blast-cleaned and painted as quickly as possible, whilst maintaining intercoat times, to maximise throughput of the plant.

Although protective treatment of bridge steelwork is largely outside the scope of this book, the way it is organised within the project programme - when, where and how - does affect the overall cost of the bridge. Commonly, project specifications will constrain the application of the protective treatment without regard to the construction of the bridge; and sometimes the work can thereby be more expensive and protection be impaired. It is well worth reviewing the application requirements for each project to ensure best value.

The primary function of protective treatment is just that - to protect the steel from corrosion for as long as can be achieved with the chosen technology: the appearance of the finished bridge is not unimportant, but it should take second place to protection in the specifier's mind. Performance of the treatment depends on four fundamental factors

- design to avoid vulnerable details,
- very effective surface preparation,
- selection of an appropriate system, and
- application of the system within the manufacturer's criteria

Of these, the surface preparation and the application require suitable ambient conditions, which are best achieved in an indoor and preferably controlled environment. Dust and dirt, high humidity, low temperature and poor access all aggravate the risks of premature failure and reduced life before first maintenance.

Site conditions generally militate against good application standards, and the processes can have severe environmental impact. For example:

- the essential ambient temperature and humidity criteria are very difficult to meet in wet or cold weather; so the winter months in the UK are virtually a close season for site painting;
- exclusion of dust and dirt from the process, and between coats on a civil construction site is challenging;

- access to erected bridgework for safe treatment has a high cost, as does shielding of the process and the environment;
- site welded joints require blast-cleaning which is a very dirty process and a threat to the site environment;
- painting bridges over live highways or rail track in possessions, and at night, puts quality at risk.

Thus it is beneficial to the performance of the finished system and value to minimise protective treatment at site, and to eliminate it if practicable. The example of the Foyle Bridge, where less than 1% of a 508m long box girder bridge was painted at site, may be difficult to emulate but the potential benefits are substantial – directly and indirectly too in simplifying work overall on site. The practice of fully painting girders, sometimes in complete braced pairs, is increasing: certainly there seems to be a good case for leaving just the connections to be painted at site, and applying finish coat on the few surfaces that impact on the overall appearance of the bridge.

Damage to painted surfaces in transit, and during erection and construction of deck slabs is a very real problem, but with properly planned and managed systems of work should not be a major issue. Even when it does occur, the remedial measures should cost far less than full painting on site. Risk of damage during construction is not just a consideration for the steelwork contractor, but also for the designer and for the main contractor in detailing and construction of the substructures and composite decks.

In brief, as with most aspects of the bridge, the application of the protective treatment needs to be thought through by the designer in designing and specifying the work as part of seeking best value for the client.

7.5 Erection

The painted fabricated steelwork is delivered to site in sequence to meet the planned erection method and programme. For major roadworks projects steel erection is phased to suit the construction of roadworks; generally for railway bridges it will be organised around the key track possession dates.

The discussion of erection in Chapter 1 illustrates the variety of methods used with today's plant and equipment. Each new bridge presents a unique erection problem. The solution has to match the determining factors for that bridge on that site; so notionally identical structures on two different sites could well require different erection methods with quite unrelated levels of cost. Erection costs are determined fundamentally by the method to be used; so to estimate the cost, the steelwork contractor works up a method and then calculates the requirements for time, resources, temporary works, and engineering.

The erection of the bridge is an opportunity for the bridge-builder to use his ingenuity and experience to contribute to the best value of the project: he will do that to help the steelwork contractor to produce the most competitive tender and successful job. Bridge layout, configuration and details can help or hinder efficient safe erection so in an ideal world the designer would anticipate the optimum erection method: a principal benefit of design and construct projects is that design for function and service can go hand-in-hand with design for construction.

As discussed in Chapter 1 the designer has to make assumptions about sequence to complete his analysis and design, and to satisfy himself that the bridge can be built in a safe and practicable manner to fulfil his CDM obligations. It is quite possible that the contractor, who is responsible for the method which is used, will propose a different method: this may require the designer to revisit the design, but any cost to the client in doing that should be measured against the benefits of the more competitive offer. Clearly the steelwork contractor has to satisfy himself and the designer that the proposed method is structurally viable and safe.

Whatever the method, the steelwork contractor will submit method statements, temporary works designs and, when required, independent check certificates for approvals. It is not uncommon for the vagaries of construction, particularly of major roadworks, to prevent final details and documentation of schemes to be complete until shortly before the work is to be done. Again, good channels for technical communication between the parties are essential for safe efficient operations.

7.6 Guidance on Cost

7.6.1 What is a useful measure of cost?

Some believe that they can use a simple measure such as 'rate per tonne' to evaluate schemes; perhaps that view is encouraged by such in the common methods of measurement and bills of quantities. This is not effective and can be misleading because only a small percentage of the overall cost of steelwork can be related simply to tonnage - in fabrication or erection. Even for the basic steel material cost there is not a simple 'rate per tonne', with many factors such as the grade, source, section size, plate length, plate width, test requirements and quantity all having a significant effect on the price of the material from the mills - and before such factors as wastage are taken into account. Many erection costs, say for temporary works or hire of a crane, are virtually independent of the tonnage. This in itself raises commercial difficulties in evaluating changes for bridge steelwork through a bill of quantities at contract stage.

Almost all of the cost of bridge steelwork is influenced directly by the detail of the design and the configuration of the structure on the site which are of

great variety. Therefore a designer needing realistic estimates would be well advised to discuss his options with appropriately experienced steelwork contractors, even if only at an early stage of design, to assess budget figures. Budget rates per square metre of finished bridge deck will give a far more accurate estimate of cost than any 'guessed' rate per tonne applied to a budget estimate of weight.

7.6.2 Cost per square metre

Cost per square metre of finished bridge deck will depend on structure type, span configuration, design loading, erection method, and protective treatment system, amongst other factors. A steelwork contractor with a comprehensive track record of carrying out the type of work involved should be able to provide a designer with a global range of budget rates. Advice may vary between steelwork contractors due to differing expertise and fabrication facilities; so choosing a steelwork contractor with relevant experience and capability for the type and size of bridge envisaged is important. Any guidance on cost for fabrication or erection must be treated with care.

7.6.3 Relative costs per tonne

For designers contemplating alternatives to plate girders where relevant, the following is a breakdown of costs per tonne relative to plate girders at a datum of 100:

Bridge Type	Universal Beam	Plate Girder	Box Girder
Steel Materials	45	30	30
Fabrication	30	40	60
Protective Treatment	15	15	25
Erection	15	15	25
Total	105	100	140

Clearly these figures are only indicative and considerable variations are to be anticipated for each particular bridge.

Universal beam bridges are uncommon now as they tend to be heavier than plate girder structures and offering no benefit on a rate per tonne basis, they are uncompetitive – except possibly for very small spans.

Box girders are inherently more expensive to fabricate, especially with greater recognition of the hazards of working in confined spaces and the measures necessary to deal with them. Protective treatment and erection costs for box girders can be reduced through the use of weather resistant steels and careful choice of site connections.

7.7 Achieving best value

The aim of this publication is to provide information and guidance to designers to achieve best value for their clients in the design and construction of steel bridges.

The emphasis in this chapter on cost should not be construed as advocating that the lowest cost design is the optimum, but rather to advise how money should be well spent in giving the client the bridge he wants.

The services of the technical advisory staff and the relevant publications of the BCSA, the SCI and Corus are commended to designers engaged in steel bridge design. The Steel Bridge Group Guidance Notes, published by the SCI, are recommended for their coverage of many design topics beyond the scope of this book.

The steelwork contractors specialising in bridgework would encourage designers to familiarise themselves with fabrication and erection, by visiting their works and construction sites. Designers are not expected to be experts in steel construction but it is surprising how much can be learnt from relatively short visits. There is nothing like walking over the first steel bridge you have designed.

There is much to be gained from involvement of appropriate steelwork contractors in the design stages of a project. It is self evident that the prospect of best value will be the greater if the design anticipates fabrication and erection processes effectively. Throughout the 1990's, the UK construction industry was charged with improving performance - to seek to deliver the product to clients through cooperation and teamwork. The universal experience of the steel bridge

contractors over many years is that through such an approach everybody wins, and best value has been achieved. Partnering with a steelwork contractor in the team at tender stage can lead to reduced costs, especially in design & build projects and value engineering, to minimise outturn costs and ensure quality. Maximum benefit will come from early involvement.

The number of UK bridge steelwork contractors is relatively small: they vary in size, product range, and experience. The independent Register of Qualified Steelwork Contractors for Bridgework includes all those with audited technical capability and commercial standing: it provides information on their size and range of capabilities. Further details of the Register are given in Chapter 9.

CHAPTER 8

CASE STUDIES

8.1 Introduction

This chapter describes eight recently constructed short to medium span steel highway and rail bridges. All utilise composite construction and the majority were procured under design and construct contracts with steel providing the most competitive solution. The highway bridges have been selected to demonstrate the use of simple and continuous spans, multiple girder cross sections and 'ladder' bridges. The rail bridge case studies, together with some of the road bridges, provide excellent examples of the use of steel construction to overcome severe site constraints.

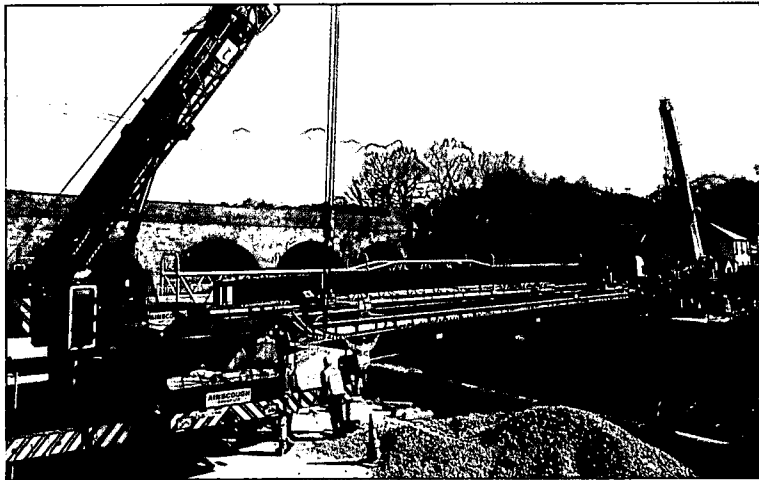

Tonna Road Bridge carries the B4434 over the River Neath, providing a key link from the A465 Trunk Road to villages in the Neath Valley. The load carrying capacity of the old riveted plate girder bridge was assessed as only suitable for vehicles up to 3 tonnes gross vehicle weight. Enforcement of this weight limit would have severely disrupted the operation of the Calor Gas Distribution Depot located on the northern side of the river and impacted on local bus services, businesses and residents. Council funding was secured to replace the 30m long, two span, single-lane bridge built in 1911. The new bridge provides a 7.3m wide carriageway with footways on both sides, spanning 35m over the River Neath. The steel and concrete composite deck consists of seven 1075 x 500 profiled welded plate girders, carrying a 175mm thick reinforced concrete deck slab. The depth of the beams was constrained by the vertical highway alignment, and the 1 in 100 year flood profile of the river. So 'compact' beams were required to support the deck, cambered to match the vertical curve of the highway. The mass concrete substructures were constructed directly behind the existing masonry abutments, supporting the superstructure on Freyssinet bearings.

To maintain vehicular access, the new bridge had to be constructed in two halves. In the first phase of the

8.2 Tonna Bridge Replacement

Client: Neath Port Talbot County Borough Council
Engineer: Director of Technical Services, Neath Port Talbot County Borough Council
Design: Director of Technical Services, Neath Port Talbot County Borough Council
Main Contractor: Balfour Beatty Construction
Steelwork Subcontractor: Rowecord Engineering Ltd
Completion date: December 2001

Approximate steelwork weight: 122 tonnes

project the existing bridge was kept in service during the construction of the downstream half of the bridge. The old bridge carried a multitude of statutory undertakers' services including a high pressure water main and gas and electricity services, so a great deal of work was required to transfer each of these mains onto the new bridge whilst keeping the road open.

The first half of the new bridge was opened to traffic in September 2001, allowing the demolition of the old bridge, the construction of the second half of the new bridge, and subsequent removal of the adjacent footbridge. The second phase included most of the roadworks construction and tie-ins, and was completed for the opening of the completed bridge on 10th December 2001. The footbridge was refurbished and recycled to reinstate a breach in the public footpath network, some five miles north of the bridge site.

The project was let under the I.C.E. Conditions of Contract (5th Edition), but managed as an informal partnering agreement. This allowed the design and construction teams to value engineer a number of options, including the use of permanent formwork, working around service diversions and designing out the need for a mid-span prop during deck construction.

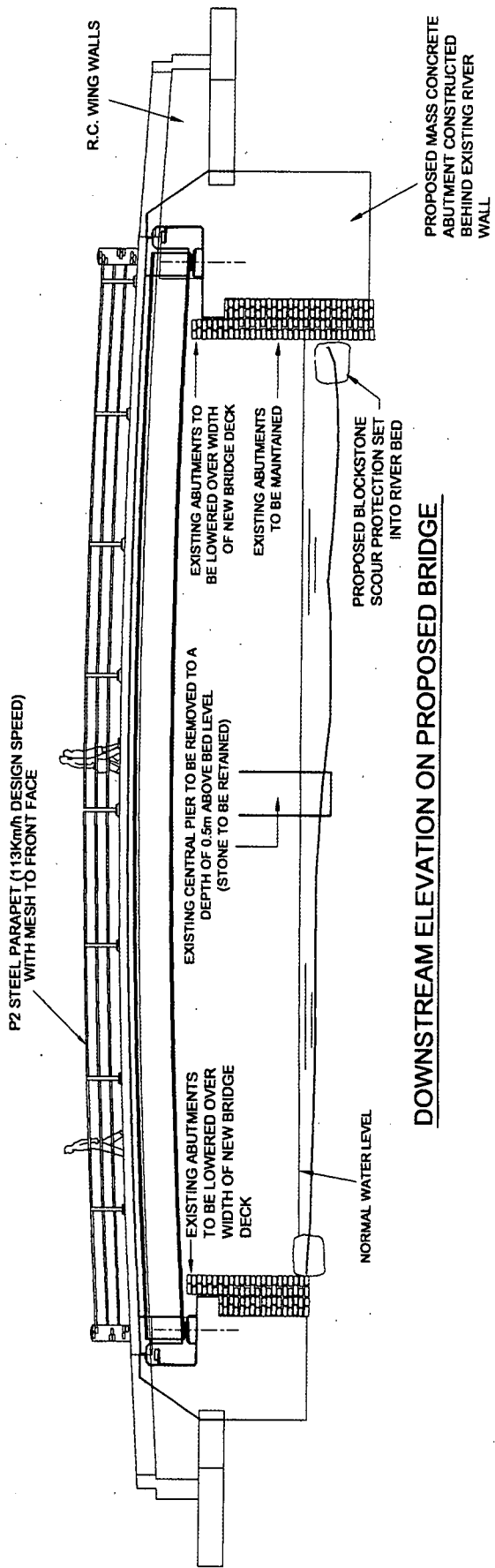

DOWNSTREAM ELEVATION ON PROPOSED BRIDGE

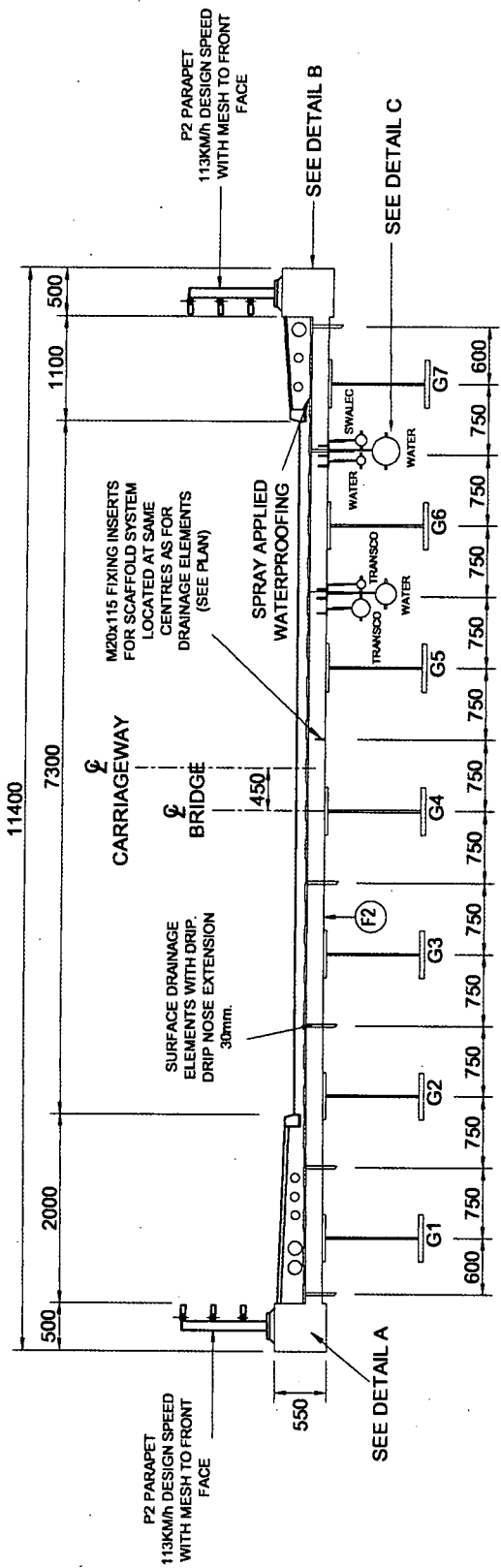

SECTION

CONSTRUCTION SEQUENCE

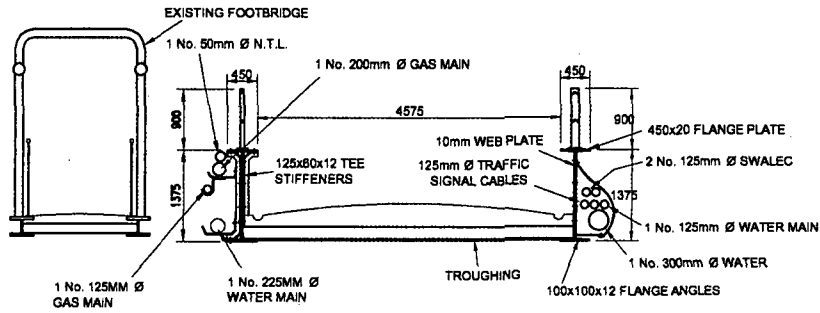

TRAFFIC MANAGEMENT PHASE 1
 SINGLE LANE TRAFFIC TO BE MAINTAINED ACROSS EXISTING BRIDGE 1 No & 2 No WATER MAINS TO BE DIVERTED TO UPSTREAM SIDE. TRAFFIC SIGNAL CABLES TO BE DISCONNECTED.

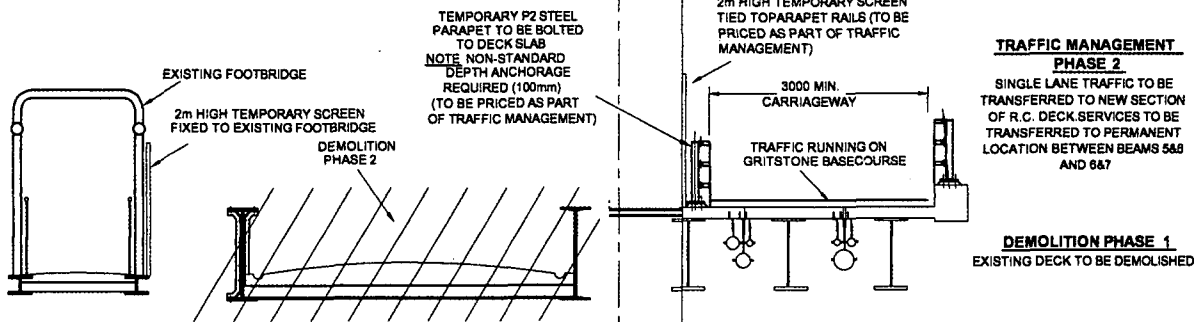
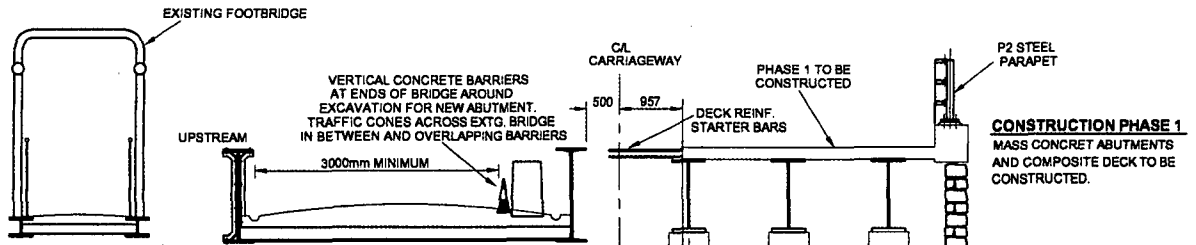

CONCRET BARRIERS TO BE USED AT ENDS OF BRIDGE DECK AROUND EXCAVATION FOR ABUTMENTS TO BE INCLUDED AS TRAFFIC MANAGEMENT ITEM FOR MEASUREMENT PURPOSES.

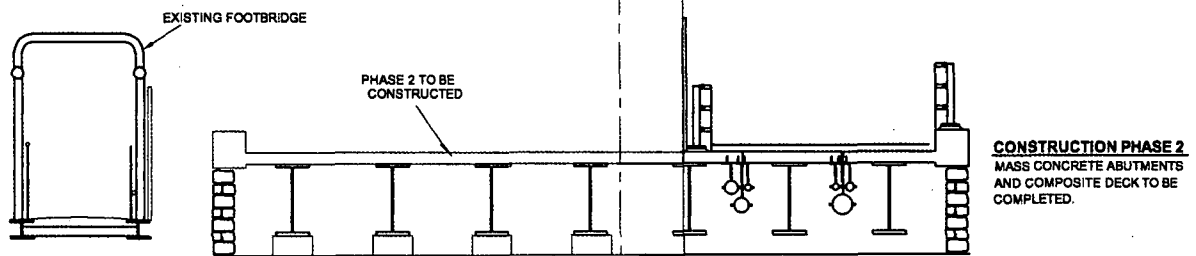

TRAFFIC MANAGEMENT PHASE 3
 STRUCTURE OPENED TO PEDESTRIANS, EXISTING FOOTBRIDGE TO BE REMOVED AND RELOCATED AT ANOTHER SITE. SINGLE LANE TRAFFIC TRANSFERRED TO UPSTREAM CARRIAGEWAY. WEARING COURSE AND FOOTWAY LAID ON DOWNSTREAM CARRIAGEWAY.

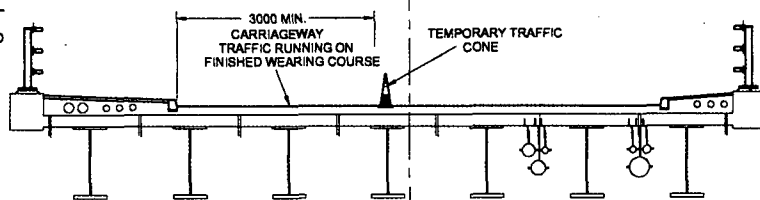

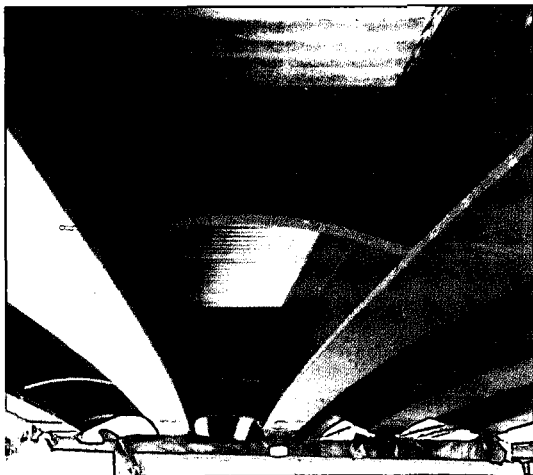

8.3 Road Bridge A34 Trunk Road – Newbury Bypass

Client: Neath Port Talbot County
Borough Council

Client: The Highways Agency

Engineer: Mott MacDonald

Design: Mott MacDonald

Main Contractor: Costain Civil Engineering

Steelwork

Subcontractor: Kvaerner Cleveland Bridge Ltd

Completion date: 1998

Approximate steelwork weight: 460 tonnes

This 11.3m wide Donnington Link Bridge carries the previous northbound carriageway of the A34 over the Newbury Bypass at a skew of 66 degrees. The curvature of the A34 at this point required significant widening of the central reserve and inside verge for visibility, affecting the positioning and size of the bridge supports. To minimise these increases single circular columns were selected for the intermediate supports resulting in a four span bridge with an overall length of 157m. The two centre spans are 40m in length and two end spans 33.5m.

A deck with twin steel box girders was selected to provide the torsional rigidity required by the single columns. Twin boxes were chosen as opposed to a wider single box to ease transport to site, and inverted "top hat" girders with an insitu concrete top slab selected to simplify fabrication. All site connections were detailed for bolting. The use of single column piers avoided the visual conflict that multi-column piers have on high skew bridges.

The girders were delivered to site singly in sections. They were lifted into position by crane on to intermediate temporary supports for splicing and connection at the permanent supports by solid diaphragms. Additional temporary supports were

provided under outer webs at the piers to provide stability until the deck slab had been cast and the boxes had achieved their torsional strength: these took the form of reinforced concrete columns supported on the pier bases using formwork for the pier of another bridge to cast them. The intermediate temporary supports were removed once the girders had been bolted together longitudinally, joined at the piers and abutments by the transverse diaphragms, and the permanent bearings grouted.

The box girders and the transverse diaphragms act compositely with the insitu deck slab, which was cast using permanent formwork within the boxes. GKN "Paraslim" formwork was used for the cantilevers.

Ease of maintenance was given a high priority in the detailing of the bridge. Access is available from chambers at the abutments along the whole length of the inside of the boxes, and through the diaphragms, with crossings provided between the girders at intermediate positions. Positive drainage is provided from the carriageway over the bridge and from the expansion joints should they leak. The girders are protected with a four-coat external paint system finished with a polyurethane gloss to provide a long maintenance-free life.



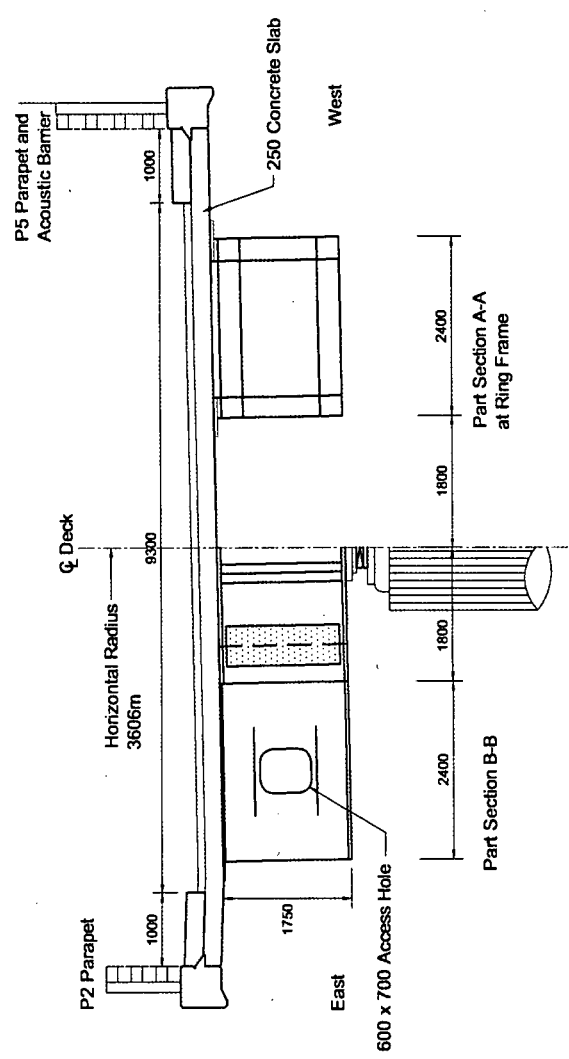
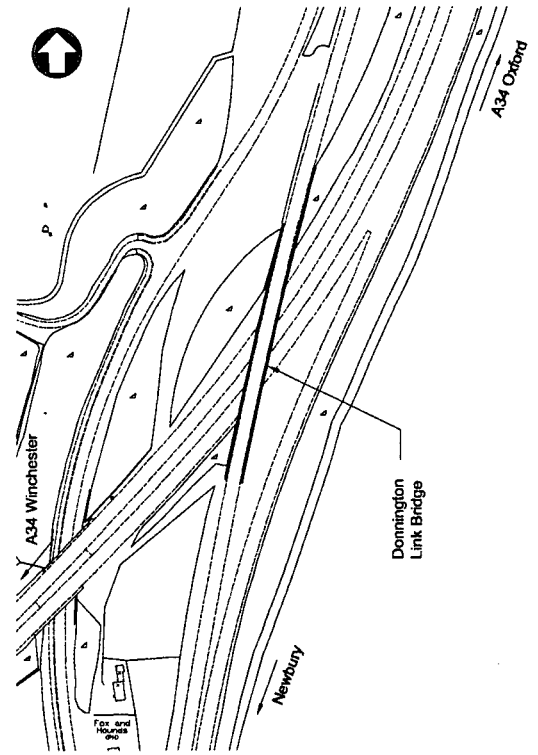
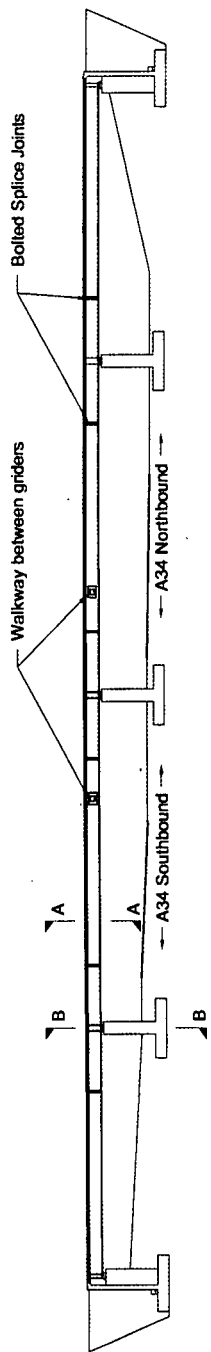
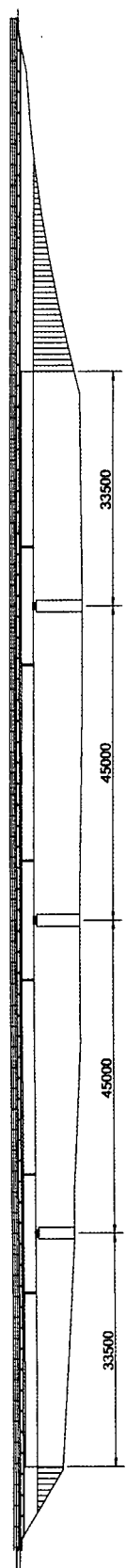

A34 NEWBURY BYPASS - DONNINGTON LINK

FIG. 16

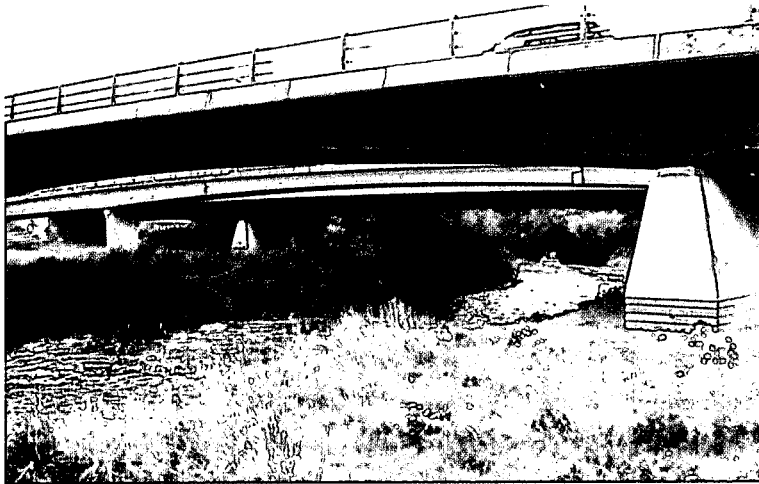

8.4 Westgate Bridges Deck Replacement

Client: Gloucestershire County Council

Engineer: Halcrow Group Ltd

Contractor: John Mowlem & Company plc

Steelwork

Subcontractor: Fairfield-Mabey Ltd

Completion date: June 2000

Approximate steelwork weight: 590 tonnes

The Westgate Bridges provide a strategic access to Gloucester City from the West. The original bridges were constructed in 1972 and comprised two identical 92m post tensioned concrete bridges with precast pre-tensioned concrete suspended spans. Each bridge carries one carriageway of the dual A417 over the Eastern Arm of the River Severn at Gloucester.

Deterioration of the prestressed concrete was so severe that a 3 tonne weight limit was imposed and prevented gridlock of the roads in Gloucester. Bridge deck replacement was compared with repair options including works to the halving joints and replacement of the concrete span with a lightweight structure. 'Whole Life Costing' techniques confirmed that repairs were not financially viable and the bridge deck would need to be replaced.

Replacement of the superstructure was governed entirely by the site constraints and sensitive traffic flows on roads and river. The site constraints included:

- extensive services throughout the site,
- site of archaeological interest,
- maintenance of waterway headroom,
- essential maintenance of peak hour traffic flows to avoid gridlock,
- poor ground conditions,
- works located within flood plain,
- vehicular and pedestrian access to be maintained through the site,
- residential and commercial properties adjacent to site, and
- existing footbridge located between road bridges.

The superstructure type was chosen for ease of construction and to minimise maintenance requirements over the River Severn. The chosen superstructure has two continuous three span overbridges with fabricated girders in weathering steel acting compositely with an in situ reinforced concrete deck slab.

Close co-operation between the Designer and Contractor produced an innovative method of construction using a bridge slide to maintain two lanes of traffic at peak hours in both directions throughout the works and prevent gridlock of Gloucester. Value engineering was encouraged throughout the project and a number of significant changes were made to the design. These included the retention of the existing pile caps and the use of polystyrene backfill behind the abutments.

To prevent gridlock and maintain two lanes of traffic the first new superstructure was constructed between the existing bridges. This with the existing South Bridge would carry in and outbound traffic enabling demolition and replacement of the North Bridge. Traffic would then use the two new superstructures during demolition of the South Bridge. During a weekend road closure the new South Bridge was slid into its final position. The bridge weighed approximately 2000 tonnes and took only four and a half hours to slide the 12m along PTFE stainless steel tracks into position. The bridge was re-opened to traffic some 45 hours after the road closure.

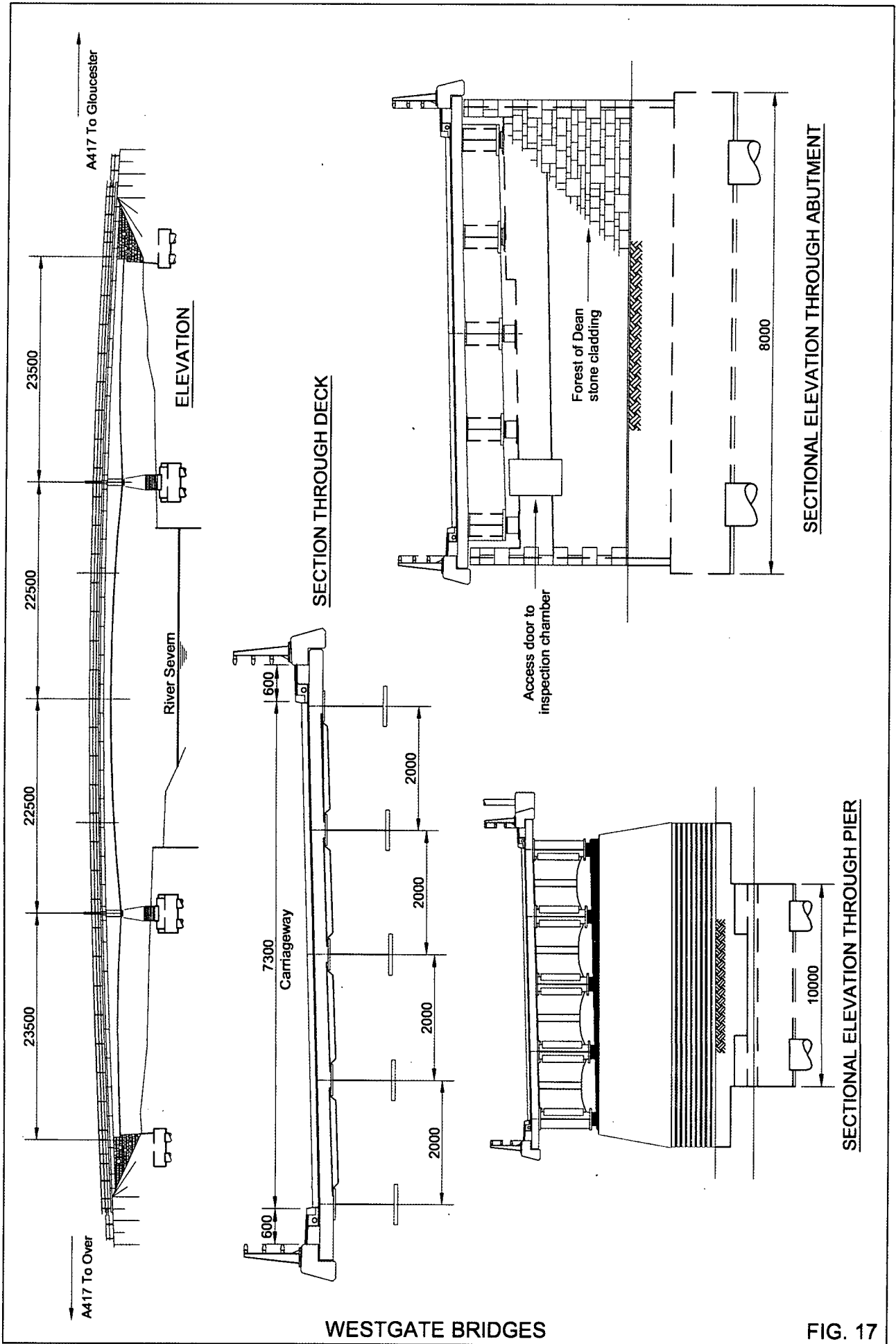

WESTGATE BRIDGES

FIG. 17

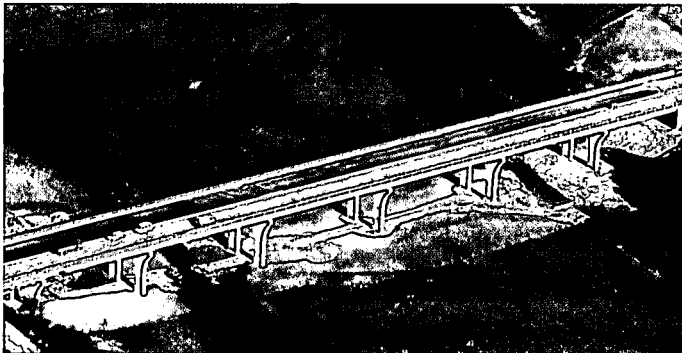

8.5 Churn Valley Viaduct

Client: RMS (Gloucester)

Designer: KBR (Brown & Root)

Main Contractor: Road Management Group – comprising Amec, Alfred McAlpine, Dragados and Brown & Root

Steelwork

Sub-contractor: Fairfield-Mabey Ltd

Completion date: 1998

Approximate steelwork weight: 890 tonnes

The A419/A417 forms a strategic link between the M4 and the M5 near Gloucester. In 1994, a contract to upgrade and manage the road was let as a DBFO contract to the Road Management Group consortium (RMG). Speed of construction was a key driver behind the design.

Churn Valley Viaduct is the major structure on the A417/A419 scheme. It comprises a 250m long, seven span continuous steel plate girder composite deck, crossing the River Churn and floodplain, the A435 and an access track. The project was approved by the Royal Fine Arts Commission and Joint Advisory Committee for the Cotswold Area of Outstanding Natural Beauty.

Each carriageway comprises two lanes with 1m hard strips giving an overall deck width of 22.5m. The spans were chosen to provide a similar aspect ratio between the span and the height above the valley floor. Each girder is constructed from separate pier and span sections with bolted splices at approximate points of contraflex. The eight plate girders are cranked at the splices to maintain a near 2.5m constant spacing around the curved horizontal profile. The steelwork top flanges were designed with a constant width to standardise the design of the EMJ permanent formwork, deck slab and girders. The bottom flange width and thickness were varied to provide efficiency in design.

Churn Valley Viaduct is at the bottom of a large sag curve for the road alignment, so the bridge drainage covers a significant catchment area with the low point approximately midway along the bridge. Bridge deck kerb drainage units along the inner channels feed into a collector pipe located within the central reserve. This is hidden beneath the deck within the girder depth for appearance.

Multiple fixed and guided bearings were incorporated to keep these elements within the standard range supplied by the manufacturer. These were designed to accommodate the thermal movements and flexural response of the structure.

Driven piled foundations were designed for economy in construction and programme efficiency; they also satisfy the Environment Agency requirements for the aquifer below bearing strata in the Churn Valley. The piles support flared leaf piers with two full height reinforced concrete abutments on each side of the valley. The substructure elements provide direct support to each of the main girders with sufficient space on the bearing shelf for flat jacks. Jacking points are provided beneath deep U-frame support bracing to keep the piers slender.

The design team included representatives from the construction partners to ensure the delivered product suited the particular skills of the Contractor. Steelwork member sizes and details were standardised with input from subcontractors to ensure efficiency and speed of construction issues were embodied within the design: the additional cost of material was insignificant compared to the savings in programme and easier construction.

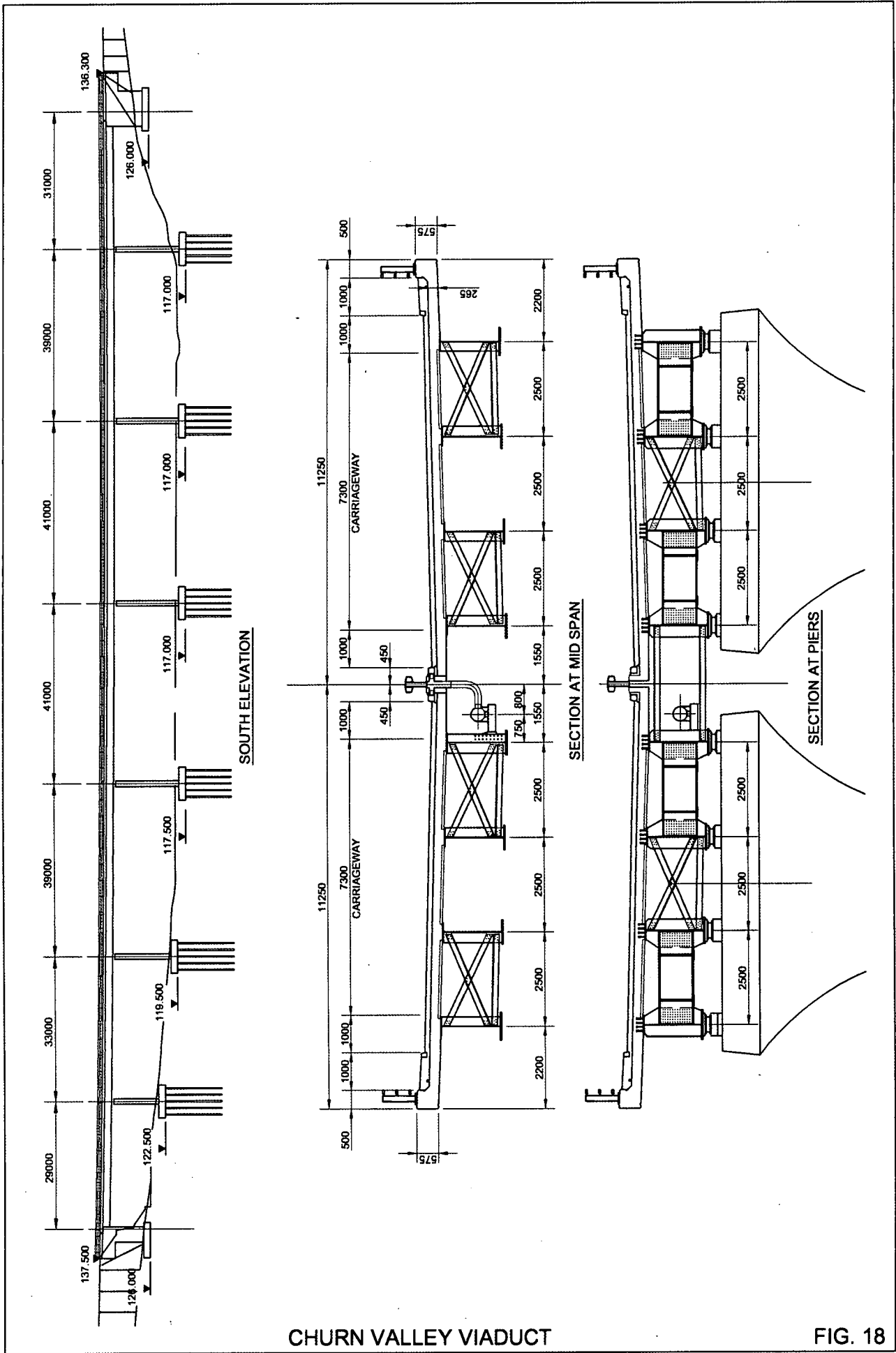

CHURN VALLEY VIADUCT

FIG. 18

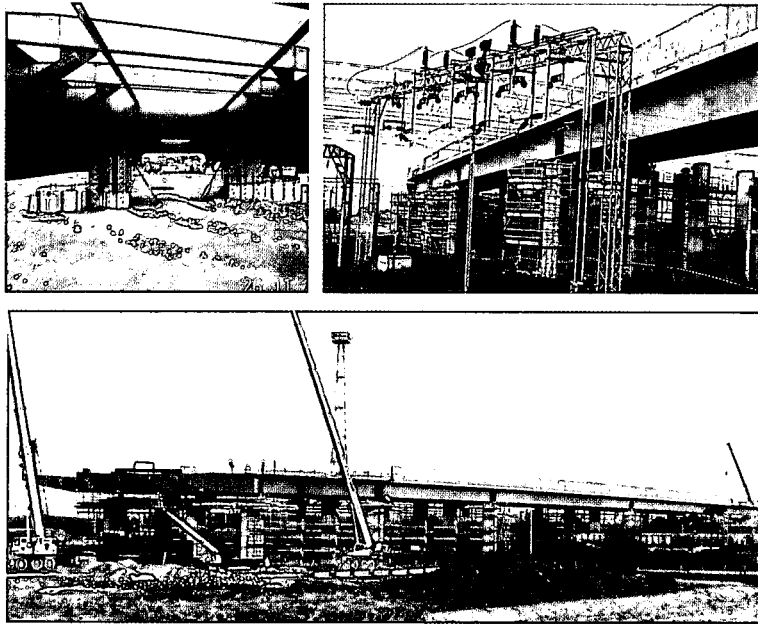

8.6 A500 Basford Hough Shavington Bypass, London to Crewe Railway Bridge

Client: Highways Agency
 Design: Babbie Group
 Main Contractor: John Mowlem & Company plc
 Steelwork
 Subcontractor: Fairfield-Mabey Ltd
 Completion date: 2002
 Approximate steelwork weight: 1270 tonnes

The bridge is located just south of Crewe and carries the A500 over the four tracks of the west coast main railway line and ten other tracks. All fourteen tracks are electrified with overhead catenaries supported from high gantries.

The bridge is 194m long, 22.6m wide with a skew of 23 degrees and consists of five continuous spans with a maximum length of 54.5m. Each half of the deck carries one carriageway and is supported on two main longitudinal weathering steel girders 2.5m deep, interconnected with skew transverse cross girders and bracing frames. The skew of the deck elements was dictated by the layout of the piers and for ease of launching. The deck slab of the bridge consists of insitu lightweight concrete on permanent ribbed grp formwork with precast concrete P6 parapets.

Each pier consists of a column under each bearing position, linked at low level by reinforced concrete walls. Pier size was dictated by the need to accommodate permanent bearings, temporary launch skates and jacks. Provision was also made for lateral guide rollers and a "fail safe" concrete upstand to prevent the girders falling sideways off the piers. The substructures are supported on 600mm diameter CFA piles to a maximum depth of 23m.

The deck was constructed in two halves on the partially constructed east approach embankment and launched longitudinally into position on the previously constructed substructure. This avoided the need for intricate staged erection between overhead lines requiring multiple possessions. The procedure is believed to be a world first for a composite bridge deck of this scale, in that the most of the concrete deck slab was cast prior to the launch, including precast concrete P6 parapets. The parapets and deck of the

leading and trailing spans were left off as they are not over railway lines. Each half of the bridge was launched separately, and both halves were completed in a 30 hour period during a 53 hour possession at Christmas 2001.

Temporary reinforced concrete foundations were constructed on the approach embankment to support the bridge before and during the launch. These were set to follow an extrapolation of the 10,000m radius vertical curve of the road over the railway. Temporary skates were located at each of the temporary foundations and permanent piers, and a winch system was constructed at the eastern end of the decks.

A steel launching nose with a tapered soffit was attached to the leading end of the deck to cater for cantilever deflections of up to 750mm. The soffit taper allowed the nose to land on the pier skates and guide the girders back to the correct level. During launching the bridges deflected in cantilever by up to 380mm at their maximum extent.

Fabrication of the deck steelwork began off-site in July 2001. Construction of the substructure began in August, and construction of the embankment, temporary supports, deck and winch system took place between the beginning of October and Christmas.

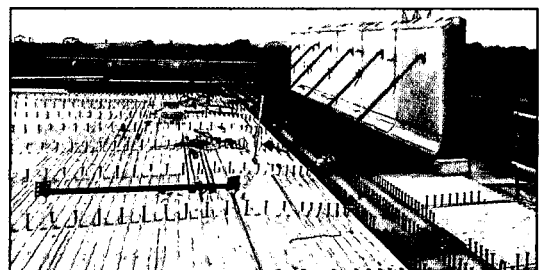

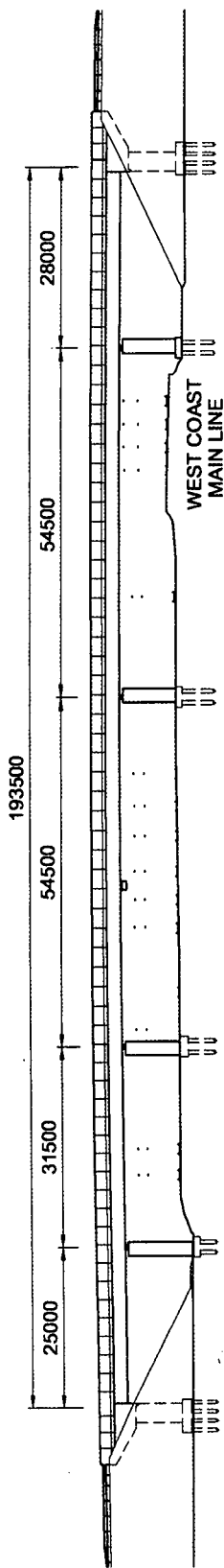

ELEVATION ON WEST BOUND CARRIAGEWAY

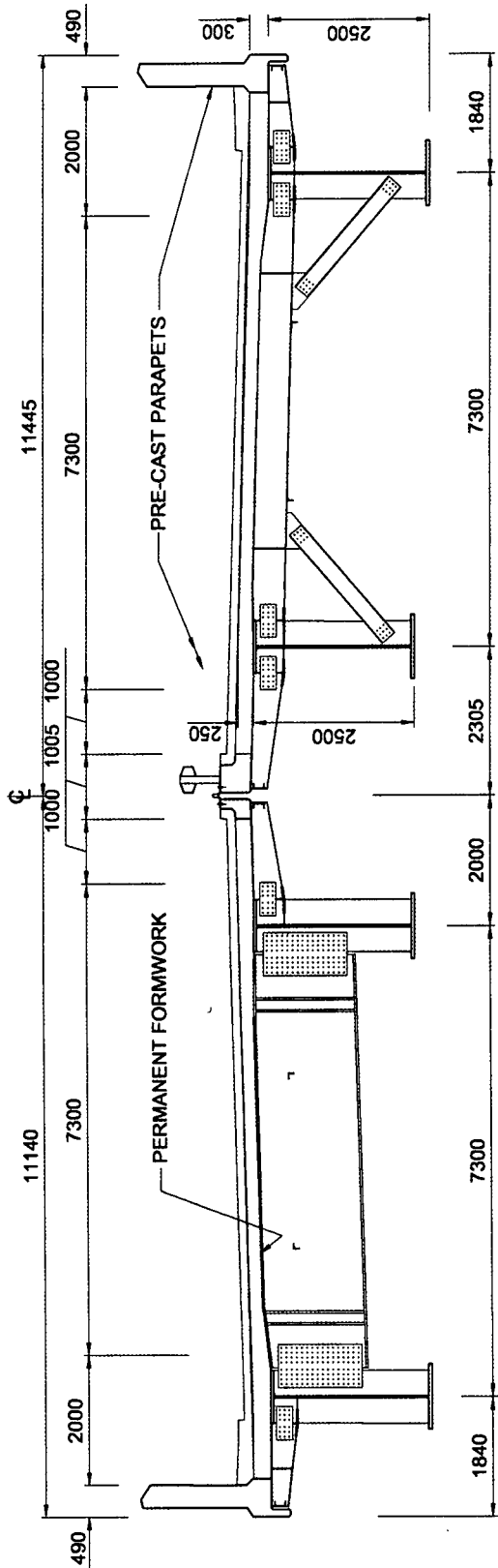

SECTION AT SUPPORTS

SECTION AT MIDSPAN

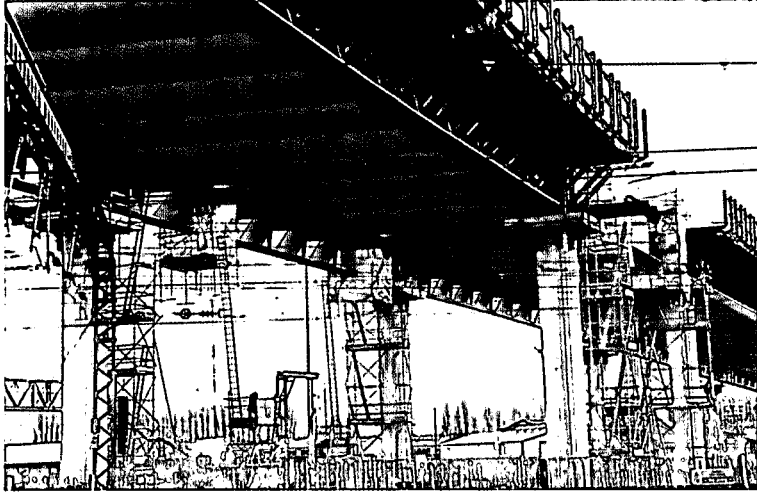

8.7 Doncaster North Bridge

Client: Doncaster Metropolitan
Borough Council

Viaduct designer: Robert Benaim & Associates

**Highway/abutment
designer:** Mott Macdonald

Main Contractor: AMEC

Steelwork

Subcontractor: Watson Steel Ltd

Completion date: 2001

Approximate steelwork weight: 2000 tonnes

The viaduct is the main structure on the Doncaster North Bridge project, a design and construct scheme carrying a new dual carriageway road across the river Don, the Sheffield and South Yorkshire Navigation, the East Coast Mainline (ECML) and a number of local rail lines and sidings. The viaduct has 15 spans and an overall length of 620m. The maximum span is 47.3m over the railways. The superstructure consists of a single continuous structure with two main steel girders of 2.45m depth and cross girders at 3.8m centres forming a ladder arrangement. Permanent formwork spans longitudinally between the cross girders to support the 225mm concrete deck slab. The main girders are curved in plan and use welded splices. Precast P6 parapets and P2 precast concrete copings with a steel parapet form the edge of the bridge.

Intermediate elliptical shaped piers are located square to the girders. Pot bearings are used throughout the structure. The abutment consists of a reinforced earth wall directly behind the first pier. Single large diameter bored pile foundations are used throughout, except for piers adjacent to the railway where multiple 600mm diameter pile foundations were used.

The steel design was submitted as an alternative to the concrete reference design to ease construction over the railway and optimise programme and cost requirements. The main span steelwork over the ECML was erected in one 150 tonne lift. A 60m ladder of main girders and cross beams was constructed on temporary supports adjacent to the railway and lifted in during an overnight possession of the railway, permanent formwork, edge cantilevers and concreting of the deck were completed in subsequent possessions. A similar technique was used for the construction of the nearby spans over the river Don.

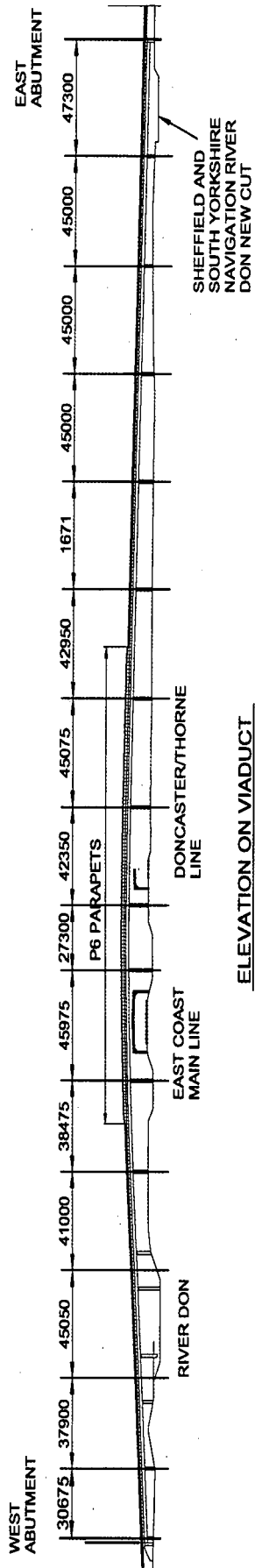

ELEVATION ON VIADUCT

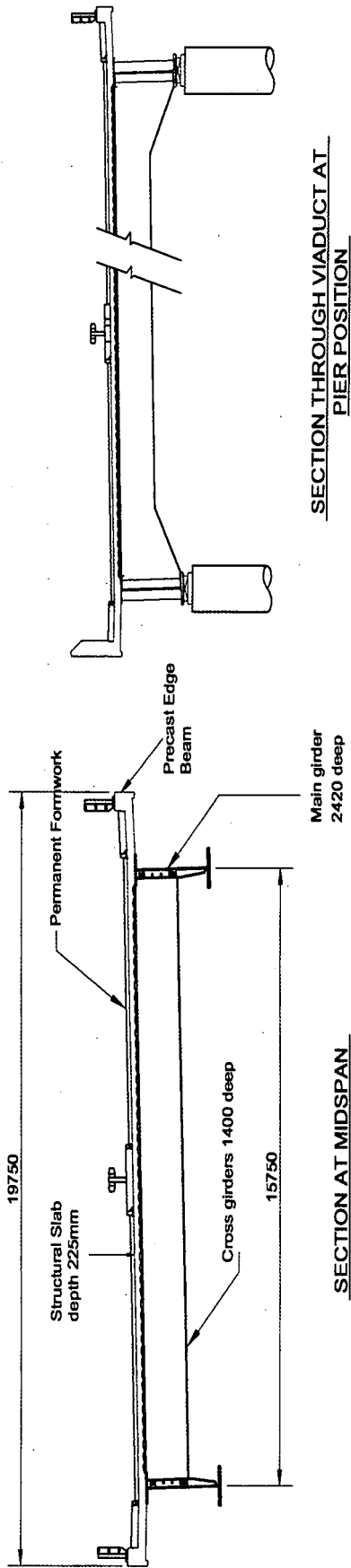

DONCASTER NORTH BRIDGE

FIG. 20

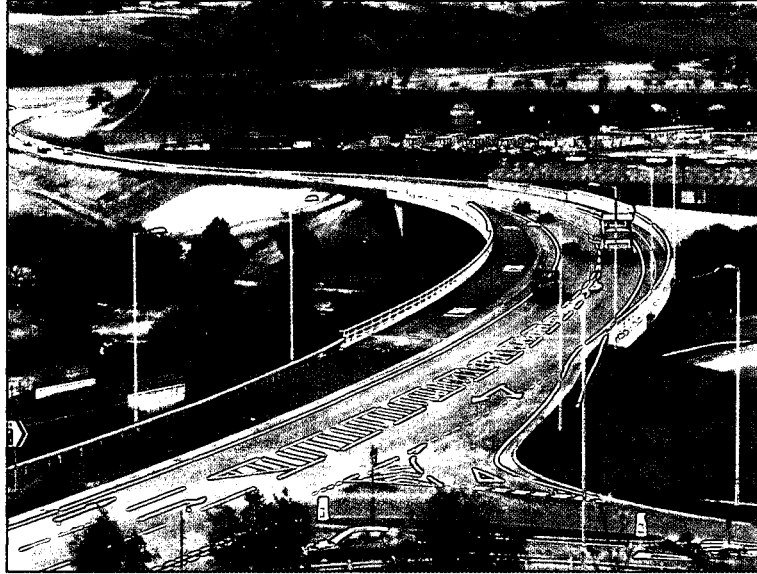

8.8 A69 Haltwhistle Bypass Railway Viaduct

Client: Road Link (A69) Ltd for Highways Agency
Design –
Bridge Deck: Cass Hayward & Partners
Design –
Substructure: Pell Frischmann
Main Contractor: A69 Haltwhistle Bypass Joint Venture

Steelwork
Subcontractor: Kvaerner Cleveland Bridge Ltd
Completion date: 1997
Approximate steelwork weight: 770 tonnes

This new viaduct carries the A69 Haltwhistle Bypass improvement over the Newcastle to Carlisle railway and Haltwhistle Burn in the north of England. The A69 was the first project under DBFO concession to be completed in the UK and the railway viaduct was the most prominent new structure on the route.

The bridge follows a tight 540m radius curve and supports a single 7.3m wide carriageway with 1m wide hard strips and a variable width extended verge on the south side to ensure sight lines are maintained. The bridge width varies as a consequence and intermediate support locations were constrained by the skewed alignment of the railway and river below. A wide "ladder" bridge provided the logical choice to accommodate these geometrical criteria using a pair of truly curved steel main plate girders, 3.2m deep, with cross girders at approximately 3.5m spacing between them. Concrete deck cantilevers 2.0m long were maintained throughout the length of the structure for aesthetic reasons and were designed to accommodate the loading specification for the P6 parapet required over the railway spans. Three intermediate piers comprising twin reinforced concrete columns within the 214m length provided support under each main girder leading to variable spans including a maximum span of 68 metres over the railway. All site joints were made using HSFG bolted connections and RSA knee braces provide restraint to bottom flanges in compression at and near to supports and adjacent to main girder splice positions. The longer span girders required two site splices within the length between piers and these were arranged to suit an erection sequence using cranes progressing from one abutment and phased installation over the railway during track possessions.

A special feature of the design was the use of part-depth precast concrete units for the deck slab cantilever construction encouraged by the restrictions of time available for working over the railway. The deck was cast in three phases, the first phase was for the complete slab width between the main girders using Omnia-style permanent formwork spanning between cross girders. The second phase involved the installation of precast edge units of two separate forms – as suited to the P2 and P6 parapet requirements – and incorporating a temporary over-deck restraint system which obviated any need to work below top flange level; separate units provided the wall element for the P6 parapets. The final phase involved placing reinforcement and concrete to achieve structural continuity of the deck and parapet concrete. The adoption of this method achieved significant programme benefits and helped to eliminate risks of delays from winter working in the exposed location.

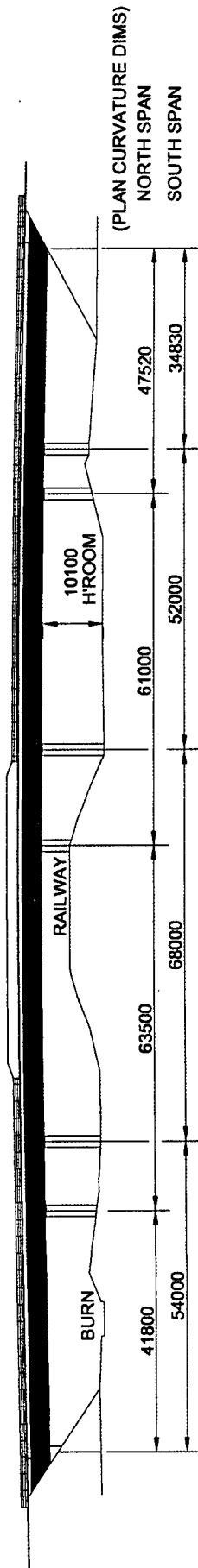

ELEVATION

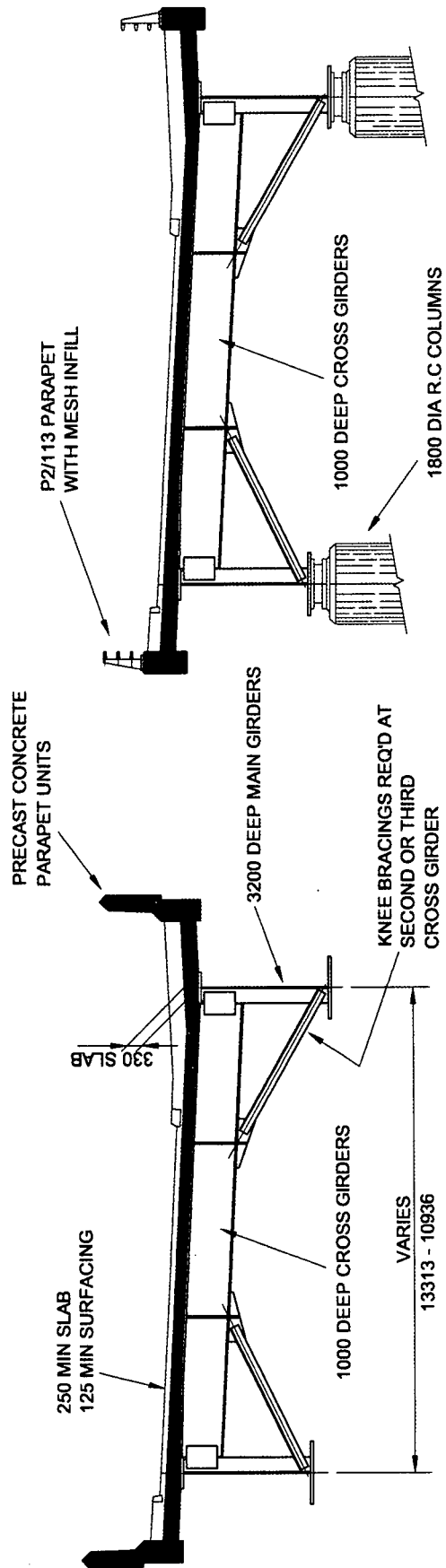

CROSS SECTION AT PIERS

CROSS SECTION AT SPAN

A69 HALTHWISTLE BYPASS RAILWAY VIADUCT

FIG. 21

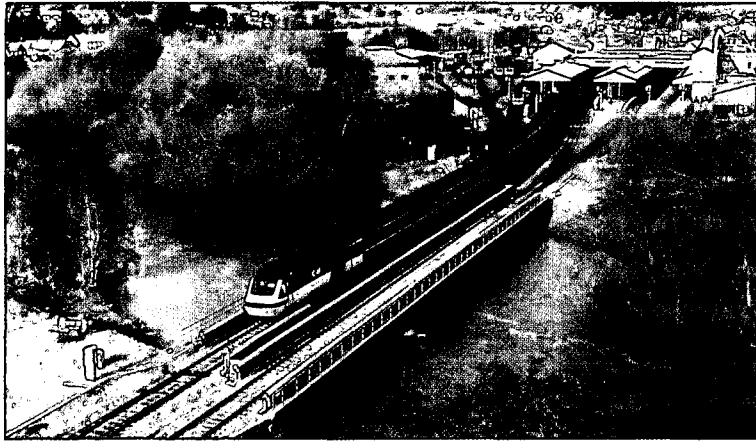

8.9 River Exe Viaduct

Client: Railtrack Great Western Zone
 Design: Cass Hayward & Partners
 Main Contractor: Hochtief Construction Ltd
 Steelwork
 Subcontractor: Butterley Engineering Ltd
 Completion date: October 1997
 Approximate steelwork weight: 500 tonnes

This strategic rail bridge over a flood-prone river had come to the end of its life. Adoption of lightweight continuous steel construction for its replacement made it possible to retain the existing sub-structures safely. Steel's advantages of flexibility, shallow depth and low weight were fully exploited to effect the replacement rapidly in two track possessions by rolling-in, including a controlled jacking-down procedure to redistribute the reactions onto the substructures. New steel crossheads used to transfer deck loading to the existing columns were also designed as rolling-in beams so minimising temporary works in the river and demonstrating the advantages of the design and construct method of implementation.

The two-track bridge has spans of 24m, 27.3m and 24m with severe skew and a plan taper towards one end. The original was built in 1846 by Brunel as a single track timber viaduct with a second track added in 1861 of iron construction. In 1896 this was replaced by a three girder arrangement of three lattice girders supported by wrought iron concrete filled columns in the river. By 1997 a replacement for this structure proved essential and this was required to carry ballasted tracks and to maintain the existing headroom over the river.

The two rail tracks are now carried by separate decks continuous over the three spans allowing each to be constructed alongside the existing structure prior to rolling-in during two track possessions. Each deck comprises two steel plate girders with a specially shallow composite floor to accommodate extra ballast depth without reducing existing headroom over the river. The design was arranged so that lateral clearance is provided from the existing centre girder whilst the new downline structure was rolled in. This enabled both tracks to be maintained in use at all times, except during the two possessions when one track was still available. At the piers the girders sit on steel trimmers on bearings which are located inboard of the main girders so that they would be clear of the existing column heads during construction. The

trimmers incorporate cantilever spreaders which support the deck whilst rolling-in and later in service act as jacking points for maintenance.

The new deck has been designed so that the total loads borne by the existing foundations are comparable with those existing previously despite the provision of extra ballast depth. However, the adoption of continuous spans with its technical advantages implied an increase of loads on the intermediate piers: this has been eliminated in design and construction by precambering the steelwork during manufacture by approximately 300mm. After steelwork preassembly, but before slab concreting and rolling-in the girder ends were raised by controlled jacking having the effect of transferring sufficient reaction from piers to abutments.

At each river pier the wrought iron columns have been retained and are now enveloped by a new steel crosshead located above river level which has enabled the existing substructure to remain intact. The crosshead consists of a pair of fabricated steel girders 1.2m deep with concrete infill which was prestressed by Macalloy bars so as to grip the existing columns. The steel girders also acted as runways for rolling-in the new superstructure and were specifically designed for these dual functions. The existing abutments have been retained but with new precast sill beams to distribute loads from the new deck.

During each of two 57 hour weekend possessions demolition of the existing bridge floors was carried out by mobile impact plant working on the deck into floating craft below. Mobile cranes removed the existing metalwork. The rolling-in carriages, incorporating jackdown facility as already mounted on the crossheads were used for controlled jacking of the steelwork at pre-assembly, had 76mm diameter steel balls running within pairs of bullhead rails. Controlled propulsion of each deck, complete with ballast and track weighing approximately 800 tonnes, was achieved with hydraulic rams.

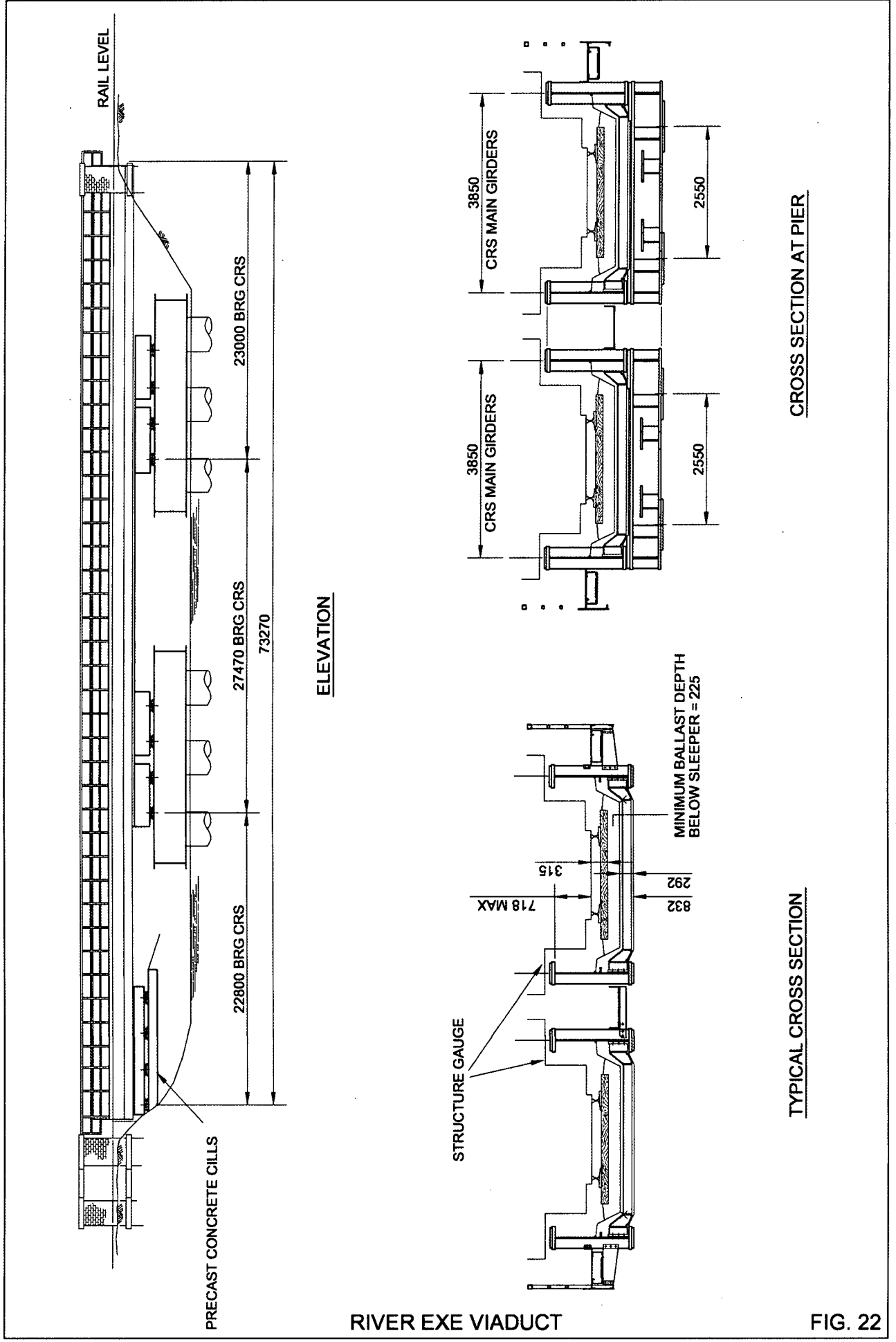

RIVER EXE VIADUCT

FIG. 22

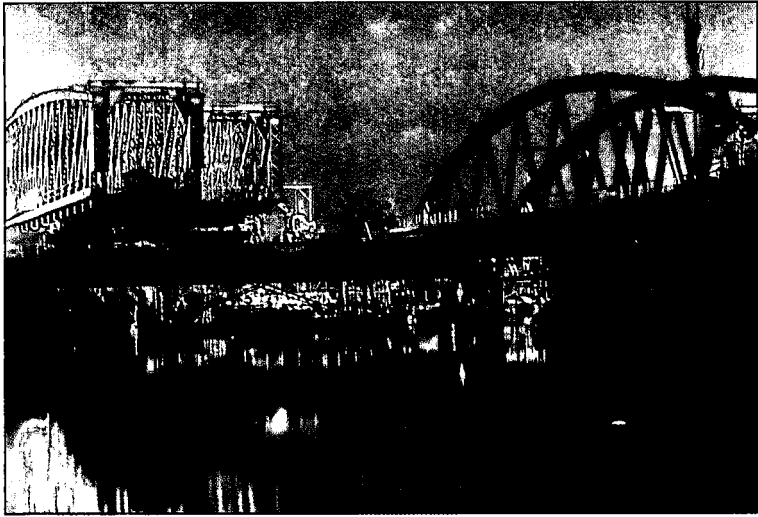

8.10 Newark Dyke Rail Bridge Reconstruction over the River Trent

Client: Railtrack London North East Zone

Design – Superstructure: Cass Hayward & Partners

Design – Substructure: Corus Rail

Main Contractor: Skanska UK Ltd

Steelwork Subcontractor: Cleveland Bridge UK Ltd

Completion date: August 2000

Approximate steelwork weight: 670 tonnes

The Newark Dyke rail bridge reconstruction demanded a high profile solution at a strategic river crossing on the East Coast Main Line. Railtrack demanded an aesthetically pleasing solution whilst specifying new high speed design criteria and demanding safety requirements so as not to disturb the live railway. Steel was chosen by the design and construction team as the ideal structural material on which to base their proposals to secure the contract. Steel was used for the primary feature of the new main span, for special substructures and the extensive temporary works, including piling, needed for launching and slide-in operations. Steel's high strength/weight ratio, shallow construction depth, flexibility, durability and robust qualities were essential ingredients in the success of this project.

Two previous bridges had carried the railway on a skewed alignment over the River Trent – the original wrought iron and cast iron trusses constructed in 1852 being replaced by the all steel Whipple Murphy trusses in 1890, one for each track, which survived until now. After a series of short-term strengthenings, Railtrack decided to replace the structure and, at the same time, take the opportunity to seek a solution that met their future aspirations for higher speed trains, by increase of the line speed from 100mph to 140mph. The existing double truss bridge involved reverse track curves and hence limited speeds at the site.

The 77m span bowstring half through bridge is carried on new outboard foundations to avoid uncertainties associated with re-use of the existing abutments. The necessarily heavier new superstructure, with its ballasted track and greater dynamic effects from higher speed trains, was considered likely to give long term safety risks if the existing abutments on timber piles were retained. The bridge itself is square spanning, unlike the original, so as to eliminate potential problems with track maintenance and dynamic behaviour. Main bowstring trusses are

diagonally braced to minimise deformations and are spaced at 11.25m centres to allow the tracks to be re-spaced for higher speed running. The top chord is of open 'H' steel plated section offering the maximum lateral inertia for stability whilst eliminating the need for overhead bracings between the trusses and is 1.5m wide and 1.0m deep. Flanges and web are up to 60mm plate thickness and the chord is straight between node points coinciding with a circular arc in elevation giving the best aesthetic appearance. Water run-off from the top chord is ensured by elimination of stiffening on the top surface of the web. Diagonals consist of fabricated 'I' sections measuring 500mm transverse to the bridge with flanges typically 325mm wide. Members of this form facilitate practicable and fatigue resistant welded end connections by elegantly shaped integral gussets to the chords and offer robustness against damage. Screwed rods, wire ropes, strand or hollow sections have been used in bowstring bridges, but were, in this case, rejected due to potential difficulties with compressive capability, durability, fatigue, creep or excessive maintenance of pinned connections. Spacing of node joints is generally 8.46m, but is decreased at the ends for aesthetic reasons and to facilitate rigid U-frame connection to the end three cross girders where the diagonals are of deeper section.

The bottom chord consists of a fabricated plate girder 1.5m deep with its top flange level with the top of the deck slab upstand robust kerb. Shear connectors are provided along the full length of the bottom chord to achieve composite behaviour. At the bridge ends the top and bottom chords converge to form a combined stiffened fabrication with a downstand to bearing level. The main bearings are of fabricated steelwork and eliminated the necessity for limited life low friction materials. Fixed end bearings are of linear rocker type with roller type bearings at the free end; these bearing types also assist in stability of the bowstring top chords.

The deck is of minimum depth to maintain headroom over the river and is supported by composite cross girders 550mm deep at 2.82m spacing, cranked at the ends to form rigid HSFG bolted end plate connections with the bowstring bottom chord. The slab is 250mm thick cast onto GRP permanent formwork and incorporates edge upstands containing the ballast and forming a robust kerb at least 400mm above rail level to meet Railtrack standards.

Two continuous longitudinal steel stringers at 4.0m spacing interconnect the cross girders and serve to distribute concentrated live loadings effectively between cross girders, forming virtually an isotropic floor which fully participates as part of the bowstring bottom chord. This floor configuration enables the calculated acceleration levels to be controlled to the specified limits as demanded by new criteria for dynamic response under higher speed trains.

The solution for the substructures completely eliminated risks involved in excavation beneath the live railway. During a railway possession at Christmas 1999 mined openings were formed through each of the existing abutments which otherwise remained intact to support the existing superstructures. New independent foundations were constructed outside the hazard zone of the railway to receive the ends of prefabricated steel box girder needle beams which were installed through each opening. The needle beam supports the permanent bearings and also facilitated installation of the superstructure by sliding-in on paths on its top surface fully prepared in advance.

Main bowstring girders manufactured and trial-assembled in Darlington were welded up to full length standing upright at site before launching out individually over the river immediately adjacent to the existing live bridge. Transverse slides enabled the girders to be positioned at the correct spacing to receive cross girders which were erected using a purpose-made steel gantry employing the permanent runway beams suspended beneath. Following completion of the deck slab and waterproofing the bridge was ready to be slid into place during the August 2000 Bank Holiday railway possession, which was successfully achieved along with re-alignment of the tracks and erection of new steel overhead electrification masts well within the 72 hours allocated.

The new bridge is the first to be completed in the UK which is designed to counteract the dynamic effects of high speed 140mph trains under European based criteria.

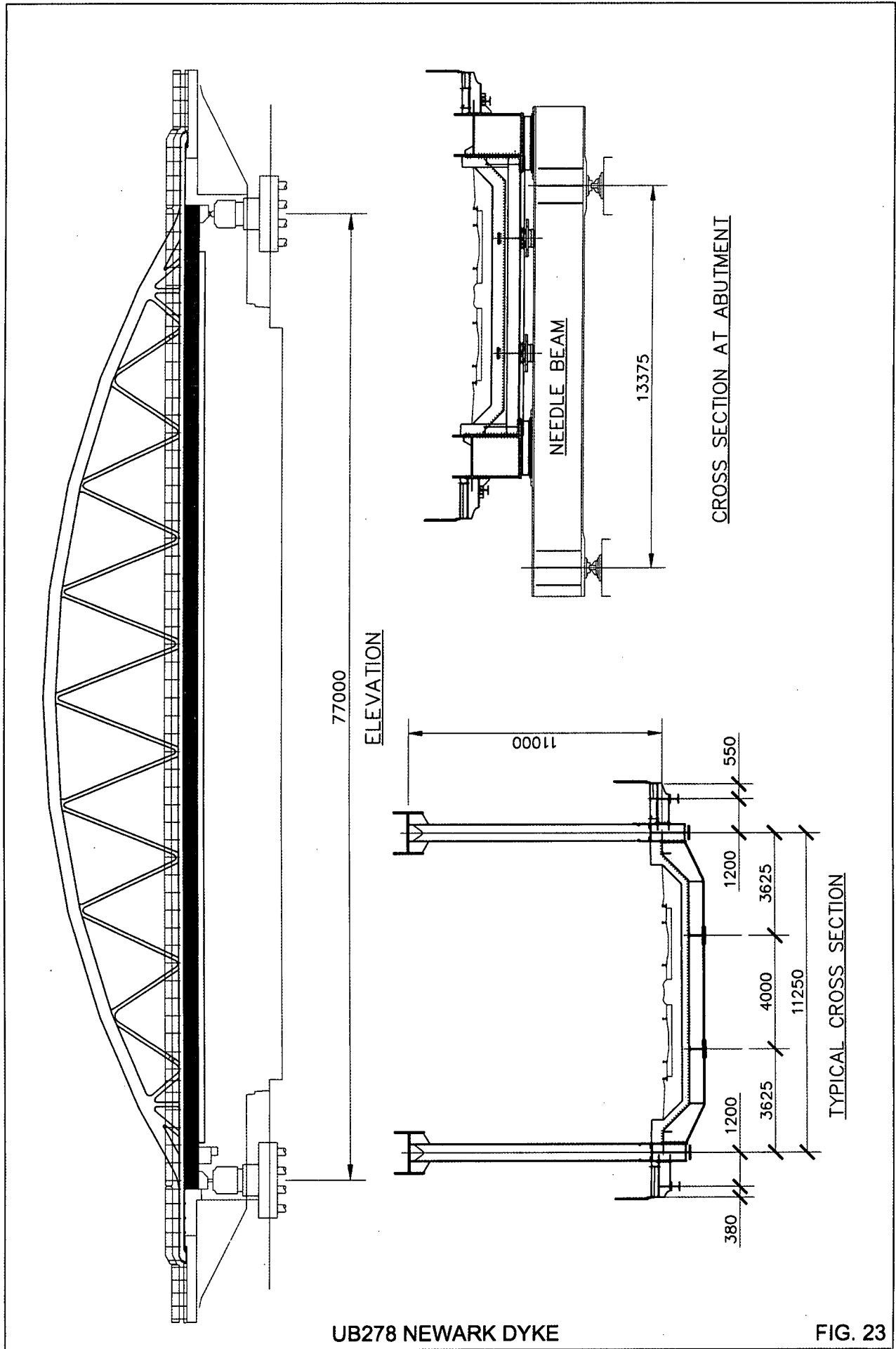

UB278 NEWARK DYKE

FIG. 23

CHAPTER 9

COMPETENCE IN STEEL CONSTRUCTION

9.1 Introduction

The objective of this book is to help designers of steel bridges to achieve optimum solutions for their clients, but it is appropriate in conclusion to reflect on how design solutions are to be constructed successfully. The client requires a robust supply chain for procurement of his project: each party has to be competent and have the resources to fulfil its role.

Successful construction is also safe construction and competence for the task is absolutely essential for a safe outcome as well as a technically and commercially successful project. Evolving UK health and safety legislation was rationalised by the Health & Safety Act in 1974 but it was the Construction (Design and Management) Regulations of 1994 which made explicit the indisputable requirement for competence in design and construction: the Regulations placed obligations on the parties down the supply chain to assess competence and satisfy themselves of the competence of parties before placing work with them. In brief, responsibility for ensuring safe practice cannot be escaped by subcontracting. How do Clients, or Designers or Principal Contractors, ensure that subcontracted work is done safely?

The problem of assessing competence in steel construction, let alone for bridgework, may often be aggravated because the Client, the Engineer and the Main Contractor are not expert in the intricacies of working with steel. This is a problem for the industry too, because this can increase the risk of a client accepting an unsustainably low price from an inexperienced steel firm obviating fair competition. How can this risk be reduced?

9.2 The Register of Qualified Steelwork Contractors

The government sponsored research into procurement in the construction industry included the issues of procuring competence and quality performance. This research, undertaken by the BCSA, led to the formation of the Register of Qualified Steelwork Contractors Scheme to provide procurement agencies with a reliable listing of steelwork contractors which identifies their capabilities for types of steel construction, and suggested maximum contract value.

A fundamental principle of the Register is that companies may apply to join it and are subject to independent expert audit before admission: the Register is administered by the Association but it is open to any capable steelwork contractor to join, member or non-member, British or foreign.

On receipt of an application to join the Register, the experienced professional auditors visit the company at

its premises to assess its capabilities in eleven categories of building steelwork and/or six sub-categories of bridge construction. The auditors also take up relevant project references before the application is accepted. Registered companies make annual returns and the auditors re-assess each company at the works triennially and when there are significant changes. Entry in the Bridgeworks section of the Register involves a more extensive audit with a wider range of acceptance criteria.

There are over 65 companies currently on the Register with several listed for Bridgeworks, including all the principal UK steel bridgework contractors (see www.steelconstruction.org).

9.3 Bridgeworks Scheme

All companies on the Register have to satisfy the auditor of their financial standing and resources: to be registered in the Bridgework Category, a company must have a minimum turnover in steelwork for bridges** of £1 million in the most recent year or alternatively per annum if averaged over the last three years.

The company must present references for completed supply and erect contracts that include at least six bridgework** contracts undertaken over the last five years, of which two must each exceed £100,000 contract value completed within the last three years.

The company's track record and the company's systems, existing facilities and employed personnel will be used to establish its capability.

- The track record will be based principally on the two £100,000 contracts. If necessary in addition other contract references of comparable complexity (but not necessarily of £100,000 value or as recent) can be used.
- The contracts can have been undertaken with sublet erection, but must have been either for bridges** exceeding 20m span, or for mechanically operated moving bridges. One contract must involve the application of multi-coat treatment, which may have been sublet.
- The end-user clients, who must be different for the two contracts, will be contacted to establish their satisfaction with the work on the contracts.
- The company must have manufactured in-house at least 75% of the steelwork for each of the two contracts. Both contracts must have required materials and workmanship to BS 5400-6**. One of the contracts must have required thick plate welding such as the butt welding of S355J2 plate in a thickness of at least 40mm.

- The company will need to demonstrate that it has erected a bridge** of at least 30m span over water, and a bridge** that involved the use of a railway possession.
- The company's quality system must be independently certified to meet the requirements of BS EN ISO 9001 with a scope of registration that includes steel bridges**.
- The company must have the ability undercover in its own works to lift a single piece of 20 tonnes using EOT cranes singly or in tandem. The company must be able to demonstrate that it has the ability to undertake trial assembly of large pieces post-fabrication and prior to despatch.
- The company must employ at least one suitably competent person with clearly designated tasks and responsibility in each of three key management disciplines: technical/design, welding and erection methods.
 - The technical/design manager should have appropriate specialised technical knowledge relevant to the assigned tasks, and at least five year's steel bridge construction engineering experience.

Note: In terms of knowledge, an individual with Chartered/Incorporated membership of one of the ICE, IStructE or IMechE would be appropriate.

- The manager of welding coordination should have appropriate specialised technical knowledge relevant to the assigned tasks, and at least five year's experience in the execution of steelwork.

Note: In terms of knowledge, a welding specialist with Specific knowledge to BS EN 719, or with the qualification of European Welding Technologist, or with individual Chartered/Incorporated membership of the Welding Institute would be appropriate.

- The manager in charge of erection methods should have a knowledge of the CDM and CHSW Regulations, and be able to produce a copy of the erection method statement that he/she has authored for used on a complex contract.

- The company must employ welders with suitable approvals.

Based on evidence from the company's resources and portfolio of experience, the Subcategories that can be awarded are as follows:

FG	Footbridges and Sign Gantries
PT	Plate girders [>900mm deep], trusswork [>20m long]
BA	Stiffened complex platework in decks, box girders, arch boxes
CM	Cable-stayed bridges, suspension bridges, other major structures [>100m]
MB	Moving bridges
RF	Bridge refurbishment
X	Unclassified

Companies wishing to be registered in the Bridgework Category but which do not possess suitably complete bridgework experience may be registered as unclassified companies. For acceptance in this sub-category such companies need to fulfil all the requirements set out above, but where the rules are marked ** they may use contracts of comparable complexity for steelwork other than bridgework. Unclassified companies cannot be awarded other sub-categories in the Bridgeworks Category. This enables companies with the relevant technical and managerial competence to enter the Bridgeworks Category and reflects the auditor's professional opinion of that competence.

9.4 Use of the Bridgeworks Register

The Bridgeworks Register provides an effective pre-qualification mechanism to match steelwork contractors to the needs of particular bridge tenders. Although the Register itself is not a quality assurance scheme, listing in the Bridgeworks Category verifies that the company's quality management systems are third party accredited by an appropriate body.

Particular projects may present requirements or challenges to prospective tenderers which go beyond the range of criteria of the Bridgework Category: that is for the procurement organisation to identify but it can be assured that a Registered Bridgework Contractor meets the essential basic requirements for bridgeworks. The use of a Registered company matched to the demands of the project is a prima facie defence to any allegation that insufficient care was taken in selecting a competent steelwork contractor.

The Highways Agency has given a lead to prospective bridge owners by requiring that only firms listed on the Register of Qualified Steelwork Contractors for the type and value of work to be undertaken will be employed for the fabrication and erection of bridgeworks. This places an obligation on tendering main contractors to anticipate this requirement in pricing their bids; and indeed, it assists them in fulfilling their duties under the C(D&M) Regulations.

CHAPTER 10

REFERENCES

10.1 Codes and Standards referred to in this edition

- BS 4-1:1993 Structural steel sections. Specification for hot-rolled sections
- BS 153: Specification for steel girder bridges.
- BS 153-1 & 2:1972 (withdrawn) Materials and workmanship. Weighing, shipping and erection
- BS 153-3A:1972 (withdrawn) Loads
- BS 153-3B & 4:1972 (withdrawn) Stresses. Design and construction
- BS 3692:2001 ISO metric precision hexagon bolts, screws and nuts. Specification
- BS 4190:2001 ISO metric black hexagon bolts, screws and nuts. Specification
- BS 4360:1990 (withdrawn) Specification for weldable structural steels
- BS 4395: Specification for high strength friction grip bolts and associated nuts and washers for structural engineering.
 - BS 4395-1:1969 General grade
 - BS 4395-2:1969 Higher grade bolts and nuts and general grade washers
- BS 4570:1985 Specification for fusion welding of steel castings.
- BS 4604: Specification for the use of high strength friction grip bolts in structural steelwork.
 - BS 4604-1:1970 Metric series. General grade
 - BS 4604-2:1970 Metric series. Higher grade (parallel shank)
- BS 4870 (withdrawn): Specification for approval testing of welding procedures.
 - BS 4870-1:1981 (withdrawn) Fusion welding of steel
 - BS 4870-4:1988 (withdrawn) Specification for automatic fusion welding of metallic materials, including welding operator approval
- BS 5135:1984 (withdrawn) Specification for arc welding of carbon and carbon manganese steels
- BS 5400: Steel, concrete and composite bridges.
- BS 5400-1:1988 General statement
- BS 5400-2:1978 (partially replaced) Specification for loads
- BS 5400-3:2000 Code of practice for design of steel bridges
- BS 5400-4:1990 Code of practice for design of concrete bridges
- BS 5400-5:1979 Code of practice for design of composite bridges
- BS 5400-6:1999 Specification for materials and workmanship, steel
- BS 5400-7:1978 Specification for materials and workmanship, concrete, reinforcement and prestressing tendons
- BS 5400-8:1978 Recommendations for materials and workmanship, concrete, reinforcement and prestressing tendons
- BS 5400-9.1:1983 Bridge bearings. Code of practice for design of bridge bearings
- BS 5400-9.2:1983 Bridge bearings. Specification for materials, manufacture and installation of bridge bearings
- BS 5400-10:1980 Code of practice for fatigue
- BS 5400-10C:1999 Charts for classification of details for fatigue
- BS 5996:1993 (withdrawn) Specification for acceptance levels for internal imperfections in steel plate, strip and wide flats, based on ultrasonic testing
- BS 7644: Direct tension indicators.
 - BS 7644-1:1993 Specification for compressible washers
 - BS 7644-2:1993 Specification for nut face and bolt face washers
- BS 7668:1994 Specification for weldable structural steels. Hot finished structural hollow sections in weather resistant steels
- BS EN 287: Approval testing of welders for fusion welding.
 - BS EN 287-1:1992 Steels
- BS EN 288: Specification and approval of welding procedures for metallic materials.
 - BS EN 288-1:1992 General rules for fusion welding
 - BS EN 288-2:1992 Welding procedures specification for arc welding
 - BS EN 288-3:1992 Welding procedure tests for the arc welding of steels
- BS EN 1011: Welding. Recommendations for welding of metallic materials.
 - BS EN 1011-1:1998 General guidance for arc welding

BS EN 1011-2:2001 Arc welding of ferritic steels

- BS EN 10025:1993 Hot rolled products of non-alloy structural steels. Technical delivery conditions
- BS EN 10045: Charpy impact test on metallic materials.

BS EN 10045-1:1990 Test method (V- and U-notches)

BS EN 10045-2:1993 Method for the verification of impact testing machines

- BS EN 10113: Hot-rolled products in weldable fine grain structural steels.

BS EN 10113-1:1993 General delivery conditions

BS EN 10113-2:1993 Delivery conditions for normalized/normalized rolled steels

BS EN 10113-3:1993 Delivery conditions for thermomechanical rolled steels

- BS EN 10137: Plates and wide flats made of high yield strength structural steels in the quenched and tempered or precipitation hardened conditions.

BS EN 10137-1:1996 General delivery conditions

BS EN 10137-2:1996 Delivery conditions for quenched and tempered steels

BS EN 10137-3:1996 Delivery conditions for precipitation hardened steels

- BS EN 10155:1993 Structural steels with improved atmospheric corrosion resistance. Technical delivery conditions
- BS EN 10160:1999 Ultrasonic testing of steel flat product of thickness equal or greater than 6 mm (reflection method)
- BS EN 10164:1993 Steel products with improved deformation properties perpendicular to the surface of the product. Technical delivery conditions
- BS EN 10210: Hot finished structural hollow sections of non-alloy and fine grain structural steels.

o BS EN 10210-1:1994 Technical delivery requirements

o BS EN 10210-2:1997 Tolerances, dimensions and sectional properties

- BS EN 10306:2002 Iron and steel. Ultrasonic testing of H beams with parallel flanges and IPE beams
- BS EN ISO 4063:2000 Welding and allied processes. Nomenclature of processes and reference numbers

10.2 Other documents, references, standards referred to in this edition

- Corus

Publications:

The Design of Steel Footbridges (10/2000)

Weathering Steel Bridges (01/2002)

Composite Steel Highway Bridges (02/2002)

Plate/Section Availability:

Plate Products: Range of Sizes

Structural Sections - To BS4: Part 1: 1993 and BS EN10056: 1999

- European Convention for Constructional Steelwork The Use of Weathering Steel in Bridges (Bridges in Steel no. 81 – 2001)

- Health and Safety Executive

Construction (Design and Management) (Amendment) Regulations 2000

- Highways Agency

Specification for Highways Works

Design Manual for Roads and Bridges

1.3 - BD13/90 - Design of Steel Bridges. Use of BS5400: Part 3: 1982

1.3 - BD24/92 - Design of Concrete Highway Bridges and Structures. Use of BS5400: Part 4: 1990

1.3 - BD16/82 - Design of Composite Bridges. Use of BS5400: Part 5: 1979

2.3 - BD20/92 - Bridge Bearings. Use of BS5400: Part 9: 1983

1.3 - BD9/81 – Implementation of BS5400: Part 10: 1980 – Code of Practice for Fatigue

2.3 - BD7/01 - Weathering Steel for Highway Structures

- Network Rail (Railtrack)

Railtrack Group Standards

- Steel Construction Institute / Steel Bridge Group.

Guidance Notes on Best Practice in Steel Bridge Construction:

GN 5.04 – Plate Bending

GN 7.03 – Verticality of webs at supports

Specification of Structural Steelwork for Bridges: A Model Appendix 18/1

10.3 Suggested further reading and sources of information

- CIRIA. Bridges – design for improved buildability (R155).
- Institution of Civil Engineers. Proceedings. Published papers (periodic) on the design and construction of steel bridges (see also section 10.X)
- Institution of Structural Engineers. Journal. Published papers (periodic) on the design and construction of steel bridges.
- New Steel Construction. Bi-monthly publication from BCSA and SCI, containing periodic articles on steel bridge construction and specific projects.
- Steel Construction Institute. Steel Designers' Manual – 5th Edition

- Steel Construction Institute / Steel Bridge Group. Guidance Notes on Best Practice in Steel Bridge Construction – 3rd issue. 2002.

The Steel Bridge group is a technical forum established to consider matters of high priority and interest to the steel bridge construction industry and to suggest strategies for improving the use of steel in bridgework. This publication presents a collection of separate Guidance Notes on a wide range of topics concerning the design and construction of steel bridges: it covers design, materials, contract documentation, fabrication, inspection and testing, erection and protective treatment. The representation of diverse interests in the Group means that the Guidance Notes can be considered to be guides to good, accepted practice.

- Steel Construction Institute. Series of publication relating to bridge design, including design guides and worked examples, commentaries on relevant Standards and Specification guidance.
- The Welding Institute. Published papers on welding aspects of the fabrication of steel bridges.

10.4 References used within the text of the first edition

- BS4: Part 1: 1980. Specification for hot rolled sections.
- BS153: Parts 3B and 4: 1972. Steel Girder Bridges.

Part 3B: Stresses Part 4: Design and construction.

- BS4360: 1979. Specification for weldable structural steels.
- BS5135: 1984. Process of arc welding of carbon and carbon manganese steels
- DD21: 1972. Quality grading of steel plate from 12mm to 150mm thick by means of ultrasonic testing.
- PD6493: 1980. Guidance on some methods for the derivation of acceptance levels for defects in fusion welded joints.
- American Iron and Steel Institute - Task group on weathering steel bridges. 1982.

Performances of weathering steel in highway bridges - A first phase report.

- BCSA. New developments in steel construction part 11 – bridges.
- BCSA. Structural steelwork – fabrication.
- Branco, FA and Green R. 1982. Construction bracing for composite box girder bridges. International conference on short and medium span bridges, Toronto.
- British Bridge Builders. 1981. Bridging the Humber. Compiled by G Wilkinson.
- Constrado. 1983. Weather resistant steel for bridgework.

- Constrado. 1984. Steel bridge design guide – composite UB simply supported span (by GFJ Nash).

- Blodgett OW. 1972. "Distortion How Metal Properties Affect It". Welding Engineer, February.

- Burdekin, Prof. FM. 1981. "To control distortion, keep it flat, keep it straight". Metal Construction, October.

- Freeman RA. 1977. Erection of Avonmouth Bridge. Acier: Stahl: Steel 5. 1977.

- Hansen, B. 1973. "Formulas for residual welding stresses and distortions". The Danish Welding Institute. Publication P73044.

- Hayward ACGH. 1984. Alternative designs of shorter span bridges. National Structural Steel Conference. New developments in steel construction. London.

- HMSO. 1973. Inquiry into the basis of design and method of erection of steel box girder bridges. Report of the Committee – Appendix 1 Interim design and workmanship rules (known as Merrison Rules or IDWR)

- Hunter IE & McKeown ME, 1984 "Foyle Bridge: Fabrication and Construction of the Main Spans". Proceedings ICE, vol 76, May.

- Hyatt KE. 1968 "Severn Bridge: Fabrication & Erection". Proceedings ICE vol 41, September.

- Kerensky OA and Dallard NJ. 1968. The four level interchange between M4 and M5 motorways at Almondsbury. Proceedings ICE vol 40 July. p295-321.

- Leggatt RH & White JD. "Predicted shrinkage & distortion in a welded plate". Proceedings of 1977 Conference on Residual Stresses in Welded Construction and Their Effects. TWI.

- Paton J, Fraser DD, Davidson JB. 1968. Special features of Hamilton bypass motorway (M74). Proceedings, ICE vol 41, October.

- Roberts Sir Gilbert, 1968 "Severn Bridge: Design and Construct Arrangements". Proceedings, ICE vol 41, September.

- Wex BP, Gillespie NM and Kinsella J, 1984 "Foyle Bridge: Design & Tender in a Design & Building Competition". Proceedings, ICE vol 76, May.

- White JD, Leggatt RH and Dwight JB. 1979. "Weld shrinkage prediction". Second International Conference on Offshore Structures. Paper 19, Imperial College, London.

10.5 Articles about early steel bridges

This list was provided by the Library of the Institution of Civil Engineers to whom reference can be made to examine or obtain copies of the articles given below:

- Baker, Sir B. Steel in railway structures. ICE Min Procs vol 85, 1886. pp140.

- Bernhard, C. Steel arched road bridge over the Neckar at Mannheim. ICE Min Procs vol 147, 1902. pp445-6; vol 150, 1902. p478.
- Bhvr, WH. The Ohio bridge of the Cincinnati and Conington Elevated Railway. ICE Min Procs vol 103, 1890. pp411-415.
- Bischoff, F. On the use of steel in bridge construction. ICE Min Procs vol 107, 1891. pp452-455.
- Brady, AB. Herbert River bridge, Gairloch, Queensland. ICE Min Procs vol 124, 1896. pp324-334.
- Bridge over the Mississippi at Memphis. ICE Min Procs vol 109, 1892. pp445-446.
- Burge, CO. The Hawkesbury bridge, New South Wales. ICE Min Procs vol 101, 1890. pp2-12.
- Clarke, TC. The design of iron bridges of very large span for railway traffic. ICE Min Procs vol 84, 1886. pp179-250, esp p192.
- Cooper, T. The use of steel for bridges. ASCE Transactions, vol 8. pp283-.
- Crofts, HA. New bridge, Portland, USA. ICE Min Procs vol 165, 1906. pp392.
- Crultwell, GEW and Hornfray, SG. Tower Bridge. ICE Min Procs vol 127, 1897. pp35-82.
- Dumas, A. Alexander III bridge over the Seine. ICE Min Procs vol 130, 1897. pp335-6.
- Frere, FH. Reconstruction of Midland Railway Bridge across the River Trent. ICE Min Procs vol 154, 1903. pp267-276.
- Goldsmith, AJ. Burnett and Kennedy Bridges, Bundaberg, Queensland. ICE Min Procs vol 153, 1903. pp267-279.
- Guadard, J. Correspondence on the erection of iron bridges. ICE Min Procs vol 157, 1904. pp248-253.
- Hackney, W. The manufacture of steel. ICE Min Procs vol 42, 1875 pp2-68
- Hallopeau, PFA. Employment of mild steel in railway bridges. ICE Min Procs vol 96, 1889. pp371-372.
- Hanson, CR. Malay States Railways. ICE Min Procs vol 150, 1902. pp330-333.
- Hobler, GA. Cairns Railway. ICE Min Procs vol 153, 1903. p28 + plate 5.
- Hobson, GA. Victoria Falls Bridge. ICE Min Procs vol 170, 1907. pp1-49.
- Jackson, CFV. Design and construction of steel bridge work with particulars of a recent example in Queensland. ICE Min Procs vol 142, 1900. pp253-271.
- Klette, H. Queen Carola Bridge, Dresden. ICE Min Procs vol 130, 1897. pp336-7.
- Krolm, R. Use of steel in bridge construction. ICE Min Procs vol 107, 1891. pp450-452.
- Krossen road bridge over the Oder. ICE Min Procs vol 170, 1907. pp409.
- Laurie, KA. Jubilee bridge over the River Hooghly. ICE Min Procs vol 158, 1904. pp374-379.
- Matheson, E. Steel for Structures. ICE Min Procs vol 69, 1882. pp1-78, esp pp63-64.
- Nansouty, M de. Road bridge over the Rhone at Lyons. ICE Min Procs vol 108, 1892. pp430-432.
- Nansouty, M de. The new bridge over the Rhone at Lyons. ICE Min Procs vol 106, 1891. pp360-2.
- New Westminster Bridge over the Fraser River, British Columbia. ICE Min Procs vol 164, 1906. pp447-448.
- Ridder, FW and Fox, FD. Great Central railway extension. ICE Min Procs vol 142, 1900. pp5-75.
- Roberts-Austen, Sir W. Use of cast steel in the Alexander III bridge. ICE Min Procs vol 150, 1902. pp164-66.
- Sharpe, W. On some methods of steel bridge erection. ICE Min Procs vol 150, 1902. pp352-360.
- Shaw, WR. Teesta bridge. ICE Min Procs vol 150, 1902. pp361-375.
- Smith, JT. On Bessemer steel rails. ICE Min Procs vol 42, 1875. pp69-75. Discussion esp pp95-97.
- Smith, M. Steel and iron railway bridges in Canada. ICE Min Procs vol 117, 1893. pp315-318.
- Taylor, WO., Damodar Coal Line Bridge. ICE Min Procs vol 160, 1904. pp315-325.
- Walton, FTG. Construction of the Dufferin Bridge over the Granges at Benares. ICE Min Procs vol 101, 1890. pp13-24 and discussion pp38-72.
- White, Sir WH. Victoria Jubilee bridge, Montreal. ICE Min Procs vol 160, 1905. pp82.
- Whited, W. Oakland Bridge. ICE Min Procs vol 170, 1907. pp408.