



Z

271

B15

**Cornell University Library**

BOUGHT WITH THE INCOME OF THE

**SAGE ENDOWMENT FUND**

THE GIFT OF

**Henry W. Sage**

1891

A. 359664

11 | VII | 16

9366

66 29 31

DATE DUE

W 22 1951

JUL 9 1951

Cornell University Library

Z271 .B15

Library bookbinding.



3 1924 031 036 266

olin

Handwritten scribbles and marks, possibly including the letters "M" and "N".

# LIBRARY BOOKBINDING



## Cornell University Library

The original of this book is in  
the Cornell University Library.

There are no known copyright restrictions in  
the United States on the use of the text.

# LIBRARY BOOKBINDING

BY ARTHUR L. BAILEY

*Librarian Wilmington (Delaware) Institute Free Library*



THE H. W. WILSON COMPANY  
WHITE PLAINS, N. Y., AND NEW YORK CITY  
1916

E.V.

et

271/10716

A.359664

Published May, 1916

Copyright, 1916

By THE H. W. WILSON COMPANY

1.25



## PREFACE

It has been the purpose of the writer in these chapters on library bookbinding to set forth as clearly as possible the best information relating to processes, materials, routine and various other lesser matters pertaining to bookbinding which must be taken into consideration by librarians, or by assistants in charge of binding departments. Although much of this information exists elsewhere in printed form, it is scattered through various books and articles. In some respects, therefore, this book is a gathering together of scattered material. It is hoped, however, that there is enough new material to make the book of interest to those who deal daily with binding problems, and that the book as a whole may help to solve some of the questions relating to binding in libraries both large and small.

Most books on binding and all books on library binding have devoted some space to paper, its composition, manufacture, finish and use. As the subject is so fully dealt with elsewhere it has not been included here. Those who are interested will find full information in the technical books on paper, in Mr. Dana's "Notes on book binding for libraries," and in Messrs. Coutts and Stephen's "Manual of library binding." There is also an excellent article on wood-

pulp paper in the *Scientific American* of October 4, 1913.

Nor has it seemed desirable to include chapters on commercial binding nor on historical bindings. Both of these subjects are treated adequately in Coutts and Stephen's "Manual." The present writer has limited his discussion to matters dealing directly with the binding of books for libraries.

In one or two cases the same subject has been treated in two different chapters because the subject matter belonged in both places, and in neither case would the discussion be complete without it.

A. L. B.

December 9, 1915.

## TABLE OF CONTENTS

Chapter	I.	Introduction .....	3
	II.	Selection of a binder .....	9
	III.	Processes .....	13
	IV.	Materials .....	51
	V.	Specifications .....	87
	VI.	Binding before purchase and re- forcing .....	103
	VII.	Cost .....	115
	VIII.	Preparing for the bindery.....	125
	IX.	Binding records and routine.....	149
	X.	Repairing, recasing, recovering, etc. ....	165
	XI.	Magazine binders .....	199
	XII.	Pamphlets .....	205
	XIII.	Bindery in the library building...	209
Appendix	A.	Specifications of the U. S. Bureau of Standards for book cloths...	217
	B.	Reading list on binding .....	221
	C.	List of technical terms.....	225
		Index .....	245



# LIBRARY BOOKBINDING



# LIBRARY BOOKBINDING

## CHAPTER I

### INTRODUCTION

An examination of the annual reports of libraries in the United States shows that from four to eight per cent of the total income is spent for binding; the amounts ranging from \$2,000 to over \$40,000 a year for this one item. It must be admitted that these are large sums and that a knowledge of binding materials and processes is necessary in order to spend this money wisely. In many libraries the appropriation for books includes binding and periodicals. It is evident, therefore, that every dollar saved on binding can be devoted to the purchase of books. And what librarian does not desire more money for new books?

In spite of the importance of the subject a great deal of ignorance has prevailed in years past, and far too many librarians of the present day fail to realize that here is one place where money can be easily wasted. Possibly one reason for the ignorance about binding is that, except in a minor degree, it does not directly affect the public, for librarians are quick to make changes which will increase the interest of the public in the library. Another reason is that experiments are necessary; and since it takes

time to draw conclusions from experiments, definite rules have not been formulated.

In fact, experiments are still being tried. But while in the past they were along the line of making books stronger, the experiments of the present are rather along the line of adapting different methods to different books, according to the paper on which they are printed, or according to the kind of use they will receive. It is reasonably safe to say that present methods of the best library binders make a book as strong as it is possible to make it. Progress no longer lies along the line of strength.

In order to administer a binding department wisely, the librarian or assistant in charge of binding must know materials, processes, and books; and especially must he know how books should be bound to meet the use they are to receive. For example, fiction that is very popular should be bound differently from fiction which must be kept on the shelves, but which is not popular; it is easily apparent that McCutcheon's "Graustark" should be bound differently from Henry James' "Golden bowl." Heavy reference books constantly consulted should be bound differently from reference books used only occasionally, while it may be wise to bind magazines differently from either. A librarian of a reference library will adopt methods differing from those which are used in public libraries. A good working knowledge of materials and processes can be easily obtained. The saving of expense comes in applying them to use.

A recent advertisement of a binder stated that



his books were rebound more times than the books of any other binder. This statement is a sad commentary on the serviceability of his books and calls to mind a practice of twenty years ago which is too prevalent even at the present time. At that time it was the recognized custom to bind as cheaply as possible books which circulated rapidly and wore out quickly. Those who favor this custom fail to realize that in the case of books which are constantly used the actual cost of binding does not depend on the initial cost per volume, but on the ratio of cost to circulation. This is a point first brought out by Mr. J. C. Dana in his "Notes on bookbinding for libraries," and one on which it is impossible to lay too much emphasis. A book which costs 35c. to bind and which circulates 35 times has cost one cent for each time it has been issued after rebinding; while a book which has cost 50c. to bind and has been issued 100 times (a fair average for a 50c. binding) costs one half cent for each time it has been issued. Obviously the 50c. binding is much cheaper. It is probable that the 35c. book must either be rebound at an additional expense of 35c. or else a new copy must be purchased at a cost of \$1, while the 50c. binding may carry the book to a point where it can be discarded absolutely. Certainly it should never be rebound again. It is important, therefore, that the librarian who does not know what his binding is costing per issue should keep statistics of circulation for a sufficient length of time to obtain general averages which will be fairly accurate.

While a very strong binding is necessary for

fiction and juvenile books in public libraries, it is probable that on many books of a serious character some of the strengthening processes which must be used on fiction and juveniles may be omitted. It should be noted that while this is true of public libraries, the reverse would probably be true in college and reference libraries where a much larger proportion of serious books should be bound as strongly as possible.

There are three general kinds of binding :

- (a) Commercial, or edition binding.
- (b) Artistic binding.
- (c) Library binding.

Commercial binding is that in which practically all books come from the publishers. For the most part it is the product of machinery from beginning to end, and the material used is generally poor. Apparently the sole object in view of most publishers is to turn out a book that will attract the eye. Strength is not an element for which they strive. From their point of view they cannot be severely blamed for making strength a secondary consideration. By far the largest part of their product is sold to individuals, and the strength of the binding is adequate for the amount of use that these books will receive. From the library point of view, however, publishers' bindings are entirely inadequate. One cannot expect, of course, that the publisher will put a popular novel into a binding strong enough to meet the demands of library use. On the other hand, one cannot blame librarians for being exasperated when heavy books of travel, history, or

biography part from their covers when they have been in the hands of less than ten readers.

The distinguishing characteristics of commercial binding, and at the same time its greatest weaknesses, are the machine sewing and the insecure way in which the book is fastened into the cover. Very little extra expense either in material, care, or workmanship, would make most books outside of fiction sufficiently strong to withstand all the wear that they will receive. Unfortunately the publishers fail to realize this, and books by the thousands come from the binderies covered on the back with the coarsest kind of super which does not even extend to the head or tail of the book. A stouter cloth, carefully applied, running the entire length of the back would cost very little more per volume, but would strengthen it materially.

While practically all commercial binding is lacking in strength, this is due almost wholly to trade conditions, for commercial binding can be made exceedingly strong. One has only to turn to the 1912 edition of the Century Dictionary or to the United States Catalog, which are practically machine bound throughout, to realize this fact. However, until librarians are united in their demands for stronger bindings, we can expect to see the present poor work turned out in as large quantities as ever.

There is another kind of binding which is, if possible, even more unsuitable for libraries. This is artistic binding which is done exclusively for individuals, beauty of appearance being the chief object in view. It differs from commercial binding in being

all hand work instead of machine work. Since hand work is used and the main object in view is beauty, it follows, of course, that such books are much stronger than those bound by publishers. But the strength of these books is in many cases not proof against the wear that they would receive in libraries. No special methods of sewing or strengthening the first and last sections are used. Practically all artistic books are bound in leather and frequently in full leather. Whenever the leather used is anything other than good morocco, it is an element of weakness rather than strength. In addition to these objections, artistic bindings are usually so expensive as to be beyond the reach of any library.

In library binding the main consideration is strength. Not only is beauty a secondary consideration, it is scarcely taken into consideration at all. For it must be confessed that library bindings are seldom attractive. No library can afford to pay for ornamentation of backs and sides of books. Library binding is all hand work. Although machine binding can be made exceedingly strong, machines cannot be used on library binding, because the books vary so much in size and lettering. The main reason why commercial binding can be done by machinery is because a large number of books are bound exactly alike. In library binding it seldom happens that more than two volumes, the same in size and lettering, are bound at the same time. Library binding also differs from other bindings in that the use the book is to receive is made the basis of selection of materials and methods.

## CHAPTER II

### SELECTION OF A BINDER

Since library binding differs widely from other kinds of binding, it follows naturally that it is best to have this work done by men who understand its special requirements. Unfortunately, there are comparatively few binders who make a specialty of this kind of work. Librarians of most of the smaller libraries are forced by local prejudice to give their work to the local binder or to the nearest outside binder in order to save the expense of transportation. If the work is sent to the local binder, it must be sent to one who is doing other kinds of binding and to whom the library work is, in a way, a minor consideration. He would object if the work were sent out of town, but the total amount of the library work is small compared with his other work. Such binders usually have one way for binding all books (except those which come under the head of blank-book work) and the library books go through the regular process of being sewed on twine and put into covers with no special reinforcements. The materials used are not the best and the workmanship is generally poor. Local binders, realizing that the funds are usually inadequate for the needs of the library, frequently do this work at a price which at first sight seems cheap. When, however, the poor

service which the bindings give is taken into consideration the price is really very high. Many of these binders have been in business for years; and although they may be good workmen and do honest work, they are very sure that they know more about binding than any librarian, and it is with difficulty that they can be prevailed upon to adopt suggestions.

It is only fair, of course, that a library which is supported either in whole or in part by public funds should, when possible, have its work done by residents of the town. For this reason, therefore, the librarian should learn in just what ways good library binding differs from other binding. All the good materials and processes, and all the various methods of strengthening a book should be studied carefully so that the binder can be told exactly how the work should be done. The binder will probably rebel, but perhaps he can be converted and the effort is worth while.

If the binder fails to grasp the ideas of the librarian, or refuses to carry them out, the work should be sent out of town to a good binder, for deference to local prejudice does not require that the efficiency of the library be impaired. When work is sent out of town the librarian is somewhat at a disadvantage, for no examination of the work can be made while the books are in process. That the binder chosen should do honest work goes without saying. The work of a dishonest or incompetent binder always shows in the poor service which the books give, but inasmuch as dishonest work is gen-

erally covered up, it takes time to discover it. Therefore, great care must be taken to select a good binder in the first place. Librarians who are in doubt should consult the librarians of large libraries, or apply to the Binding committee of the American Library Association for the names of reliable binders.

While librarians should be able to give suggestions to binders who are not accustomed to library binding, and failing that should exercise good judgment in selecting a binder at a distance, they should not expect the impossible. The writer has seen books sent to binders which were in such bad condition that no binder could bind them satisfactorily. Some librarians expect too much of a binder; others do not realize that they are not demanding all that they should receive.

Having selected a competent binder the librarian should not insist that unimportant details be done according to his own ideas. If the binder understands that he may have the work only so long as he follows the specifications faithfully, one may safely leave the details to him.

It should further be borne in mind that good binding is seldom obtained at low prices. A library book well bound requires good material, good workmanship and special reinforcements which take time. Since the largest part of the cost of a book is due to the labor spent on it, it follows that low prices can prevail only in those localities where the cost of labor is below the standard.

Since workmanship has as much to do with good

binding as specifications it is not wise to submit specifications to different binders for bids. It is better to ask binders to submit samples of their work with specifications of the way in which the books are bound. If, however, it seems wise to ask for bids, it is far from wise to choose the lowest bidder unless absolutely assured that the workmanship and material will be satisfactory.



## CHAPTER III

### PROCESSES

The processes of bookbinding have been so fully covered in the books of Messrs. Cockerell, Zaehnsdorf, Crane, and others, that the need of further material of a similar character is not readily apparent. The only excuse the writer has to offer for discussing the matter of processes at any length is that there seems to exist nowhere any description of the processes that are used in the best library binderies. Mr. Dana in his "Notes on bookbinding for libraries" touches only certain points of the processes here and there. Mr. Stephen in Coutts and Stephen's "Manual of library binding" has a chapter on hand bookbinding, but confines himself closely to the general processes that have been in vogue for years; the modifications used in library binding are not touched upon. In other words the works of Cockerell, Zaehnsdorf, Crane and others are too full, while descriptions in books devoted to library binding are not full enough.

It is the purpose of this chapter to cover somewhat in detail the main processes as they are carried out in the best library binderies. Explanations of the technical terms used will be found in the list of technical terms at the end of the book.

Without discussing the composition of paper it is necessary to state that the paper of a book has a very important effect upon its binding. Its thickness, tensile strength, firmness, toughness, strength after being sawed or perforated for sewing, and strength after folding, all have an effect on its durability. Especial emphasis must be laid upon strength after folding, for it must be remembered that it is through the fold that the book is sewed. If a crease or a fold in a piece of paper weakens that piece of paper, it will be impossible to make a strong book by sewing in the ordinary way. If a fold has very little effect upon the strength of the paper ordinary sewing may be satisfactory. The folding of paper in 95 per cent of fiction and juvenile books weakens it at the fold over 50 per cent. In a good piece of paper the fold weakens it not over 5 per cent.

The problem of paper is a modern one, due to the use of wood pulp and other short-fibred materials in paper manufacture. All binders complain bitterly of the impossibility of binding it properly. The librarian, however, should know the way in which it can be bound to give the maximum amount of service and should not allow a binder to blame the paper for faults which are due to his ignorance or to poor workmanship.

While the customs of library binders vary somewhat according to the prejudices of the different men, the following description covers the binding processes carried out at most binderies.

## I. TAKING APART

After the books have been checked with the statement of the librarian to see that the correct number has been received, each one is taken apart carefully and all old threads, glue, paste, etc., removed from the back. If the book is in a regular machine sewed publisher's cover it will be comparatively easy to remove old threads and glue from the back. If in an old hand sewed one, it may be a little more difficult.

The book is first removed from the cover. The first signature is then turned back and threads cut with a sharp knife. Generally this will loosen the signature so that it can be separated easily from the rest of the volume. If it is still held by glue and there is danger of injuring the back of the signature, a bone folder is used. If the book had a tight back and the leather, back-lining paper and glue form a very firm back not easily separated in the manner described, the glue may be softened with paste or warm water, with care necessary to prevent the dampness from penetrating the book.

## 2. COLLATION

The book should then be collated. The best library binders make themselves responsible for page collation but they do not bother to see that all plates, illustrations, maps, etc., which may be called for by the table of contents, are in proper place. In the case of periodicals they do not always discover the fact that certain parts, not included in the main

paging, are missing. Their collation is that of main paging only. Periodicals must, therefore, have title page, table of contents and index in their proper places. Books with two or more main pagings or many unpagged illustrations must be collated at the library. (See Preparing for the bindery, p. 132.)

### 3. KNOCKING DOWN

(a) Backs of signatures are then pounded down so that they may be as nearly as possible the same thickness as the front of the signatures. Care must be taken to have a clean hammer and to let it fall evenly on the paper. If the backs are not properly pounded down there is likely to be too much swell in the back of the book when it is finally sewed. In all the first processes of binding the question of undue swelling of the back must be taken into consideration.

(b) If the book must be overcast when it comes to be sewed, the back is not only pounded down at this stage, but it is also put under the knife and entirely cut off, leaving single leaves instead of folded sections. If it is not pounded it cannot be cut properly. The success of overcasting depends largely on the amount of margin at the back, so that care must be taken not to cut more than is absolutely necessary.

### 4. MENDING

Leaves are mended with thin tough paper. The librarian should not, however, expect binders to mend books which have a large number of torn leaves without making an extra charge.

## 5. GLUING

Books which are to be overcast and which have had the backs cut off are slightly glued to hold the leaves together. A sufficient number can then be taken off and handled as a section without coming apart.

## 6. FLY LEAVES GUARDED

Fly-leaves, made of kraft or manila paper running about 60 pounds to the ream, which have previously been guarded with cloth are added to the book. In guarding, a strip of cloth is pasted around the back of the folded fly-leaf covering about one quarter of an inch on each side. When the book is sewed the needle passes through the cloth as well as the paper. Different binders use different materials for guarding fly-leaves, end papers and signatures. It must, however, be a cloth of close weave, strong, and light in weight. The English cloth called jaconet, used by some binders, is probably as satisfactory as any.

This is one part of library binding which differs radically from the custom in ordinary hand work. Old-fashioned binders, unless properly instructed, will simply fold a piece of paper, and tip it on to the first and last signatures with paste, thus forming an element of weakness instead of strength. When the fly-leaves are guarded and properly sewed they become an integral part of the book and no tipping is necessary.

## 7. SECTIONS GUARDED

At this point it is also necessary to guard the first

and last signatures of books which are to be sewed in the regular way. Overcast books do not need such guards.

Guarding of first and last signatures is another of the distinctive features of library binding. In the case of books bound in the regular fashion the sewing invariably first gives way at the first and last signatures. Guarding with jaconet prevents the threads which lie in the middle of the signatures from pulling through the paper. This method is essential if it is supposed that the book will be much used. It is not essential for books which will be used only occasionally.

#### 8. ILLUSTRATIONS GUARDED

Illustrations are guarded with a thin, tough paper, not with cloth. The guard folds around an adjoining signature and is sewed through.

#### 9. SAWING

If the book is not to be overcast, it is screwed tightly into the backing-press and sawed to make the grooves in which the bands or twines are laid when the book is sewed. Grooves for three bands must be made for books eight inches high, four for twelve-inch books and five for fifteen-inch books. For fiction two bands are used. There must also be two additional grooves, much shallower than the others, about one half inch from the head and tail of the book for the kettlestitch.

After the grooves for kettlestitch have been sawed the two grooves for bands will divide the rest of the

back into three equal parts. For fine work it is necessary to measure the book carefully and mark with a pencil; but in most library work measurement by the eye alone is sufficient. In sawing, care must be taken not to saw too deeply, since too deep a cut allows the signature to play back and forth and is plainly visible inside.

There are some good library binders who overcast books in the modern way, and yet who sew on bands. Such binders will at this point saw all books. There are also some good library binders who use no bands when overcasting and who sew all other books on tapes. These binders omit sawing.

#### 10. END PAPERS ADDED

At this point it is best to add end papers. These are always guarded on the outside of the fold and sometimes on the inside. They should be made of good, strong paper somewhat heavier than that used for fly-leaves. Some binders have special papers made to order with a design which serves as a trade mark. End papers, in the same way as fly-leaves, are prepared with guards in quantity and simply need to be trimmed to the size of the book. They are not added at the same time as fly-leaves because they must not be sawed. If this is done the holes show through after the end paper is pasted down.

#### 11. SEWING

*Regular or Bench Sewing.* When the signatures are ready for sewing, twines (or "bands" as they are

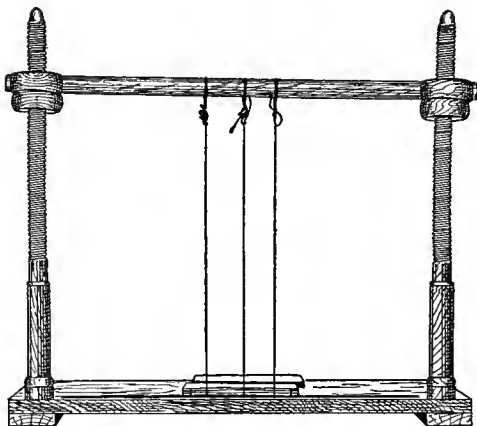

FIGURE 1.—Sewing bench showing bands adjusted.

commonly called) are stretched taut on the sewing bench and adjusted so that they will fit into the sawcuts in signatures. (Fig. 1.)

The book is placed back of the sewing bench with the fore-edge toward the sewer and with the first section on top. The first section (i. e. the end paper) to be sewed is then turned over, opened in the middle by the left hand, and placed on the sewing bench. The sewer, as she faces toward the right, with the right hand passes the needle from the outside through the sawcut for the kettlestitch, where it is taken by the left hand along the inside of the section and passed out on the near side of the first band, then in again on the far side of the first band, along the inside of the section to the second band, where the process is repeated; and so on, bringing the needle



out in the far kettlestitch. (Fig. 2.) The thread is pulled tight at each stitch and about two inches of thread is allowed to hang from the first kettlestitch. In some few cases it may be advisable to bring the

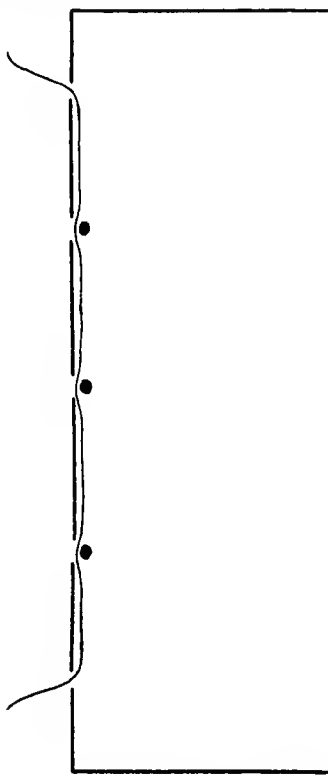

FIGURE 2.—Sewing on sunken cords. Based on illustration in Report of the Committee on Bookbinding. Edited for Society of Arts, London, 1905.

needle out on the far side of the band and in again on the near side, thus entirely encircling the band with the thread. The next section (i. e. the fly-leaves) is then laid on and the process repeated, except that the sewing proceeds from the far end to the near end. When the thread is brought out of the

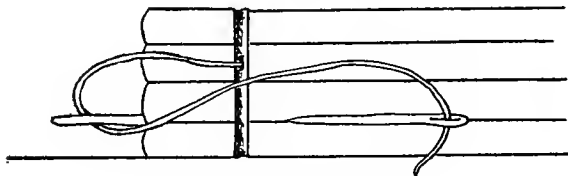

FIGURE 3.—Kettle stitch.

kettle stitch of the second section the end of the thread left projecting from the first section is securely tied to it, and the sewer proceeds with the third section. This will be the first signature of the book. On reaching the last sawcut at the far end in the third section the needle is put between the second and first sections carrying the thread down in such a way as to form a buttonhole stitch. (Fig. 3.)

All other signatures are sewed in the same way, the last section sewed being securely fastened to the others. It is possible to sew a number of books one after another without removing them from the sewing-bench. If the back swells unduly the sections can be pounded down with a piece of wood, care being taken not to drive them inward. The sewing should be neither too loose nor too tight. If too loose a firm, compact book cannot be made; if too tight the

threads may break in the process of backing. Bands are allowed to project about an inch on each side of the book.

Formerly it was the practice of some binders to sew in a way technically called "two-on." This simply means that the sewer when reaching the middle of the signature, passes the needle into the corresponding sawcut of the signature above and sews through to the other end. This always leaves an end of a signature unsewed. This way of sewing is permissible on books which have a large number of thin signatures, in order to prevent the thread from unduly swelling the back. It is never permissible on other books.

The foregoing account gives a very brief description of ordinary sewing. It is easily understood when once seen. Librarians who have charge of binding should keep the process thoroughly in mind for it is the most important single process in the making of a book. Such sewing will be used on a large number of books which have to be rebound, but a still larger number, practically all fiction and juvenile books, should be sewed in a different manner; that is, with some kind of an overcast stitch.

*Overcasting.* The modern overcasting stitch resembles in principle the old-fashioned whipstitching, but differs radically in actual performance. It is exceedingly strong, while the old-fashioned whipstitching is not. It has been objected that modern overcasting takes away much of the flexibility of a book and that books once sewed in this way can never

be rebound. It is true that an oversewed book is not as flexible as one sewed through the signatures, yet most of them are more flexible than one might suppose. It is also true that the book can never be rebound, but if the overcasting is properly done, the sewing will last until the book is discarded. It is for this reason that it is used on practically all fiction and juvenile books.

According to the old-fashioned method of whipstitching it was the custom to cut off the backs of signatures, glue them slightly, take a few leaves and sew them over and over making five or six stitches to a section, as shown in Figure 4. The next section was then sewed in the same way, but it was not joined in any way to the section beneath except by the kettlestitch and occasionally by a little paste. When sewed in this way the leaves inside of each arbitrary section would open only as far back as the

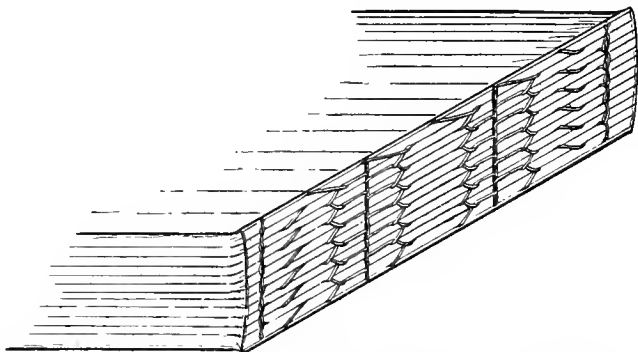

FIGURE 4.—Old-fashioned whipstitching. Each section is sewed separately.

threads of the stitches, while between the sections the book would open to the back of the section. If paste had been used the strain of opening tended to pull the leaves apart. If the book was subjected to hard wear the thread cut into the paper.

Today every progressive library binder has a special method of overcasting and each claims that his method is the best. Librarians, however, can see many points of resemblance between them, and few points of difference. In actual wearing qualities the sewing of one seems as good as that of another. When properly done the sewing prescribed by all of the methods is still in good condition when the books have to be withdrawn from circulation.

In overcasting, as in old-fashioned whipstitching, the sewer selects a certain number of sheets for sewing. Bands are placed on the sewing-bench as in regular sewing, though some binders claim that it is not necessary to sew either on bands or tapes. The sections are first perforated by a machine to facilitate the work of the sewer and to insure that all stitches shall be equidistant from the back of the book. So far as is known no machine for this purpose is on the market. It is certain, however, that the best binders have machines for this purpose. They have either designed their own machines or have adapted those made for other purposes. If the book is printed on thick, spongy paper it will increase flexibility if the paper is creased along the line of perforation.

It is difficult to give a description of modern

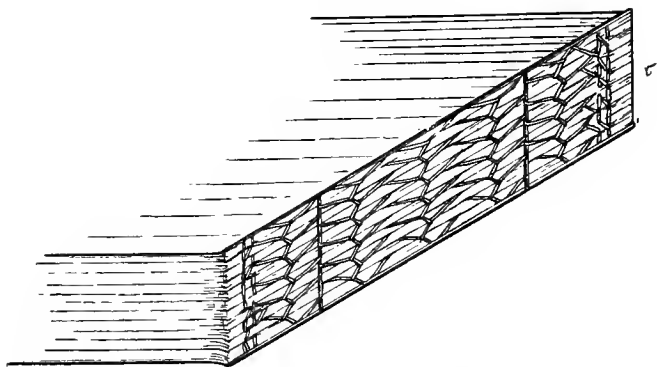

FIGURE 5.—One kind of modern overcast stitch. There are others equally good. Note that each stitch extends through two sections.

overcasting which can be easily understood by one unfamiliar with sewing processes. The reader will be helped by looking closely at Figure 5 while reading the following description, but one can understand it best by seeing it done or by tearing a book apart and examining the sewing.

The first section of the book is sewed over and over in the same way as in the old-fashioned method of whipstitching, except that a great many more stitches are taken. The second section, when placed on the first, is also sewed over and over but a certain number of stitches are also made which connect the second section with the first. In the same way the third section is sewed to the second and so on through the book, so that when the book is finally sewed it is tight and compact; its weakness lies in the paper itself, not in the sewing. Some binders add three

kettlestitches at the end of the book instead of one, believing that when all kettlestitches are placed in one saw-cut the swell at the head and tail of the book is too great.

Overcasting is the most expensive way of sewing a book, so that it is advantageous to binders to place as large a number of leaves as possible in a section.

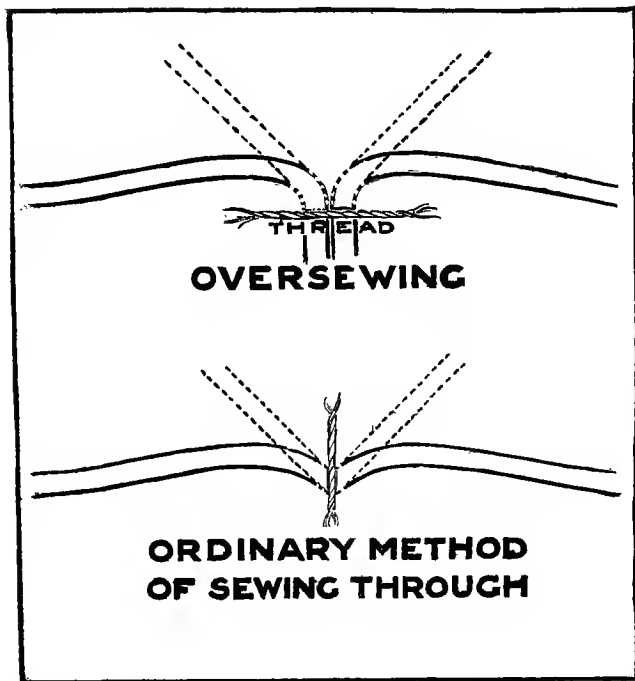

FIGURE 6.—From "About Public Library Books and Their Binding" by Cedric Chivers.

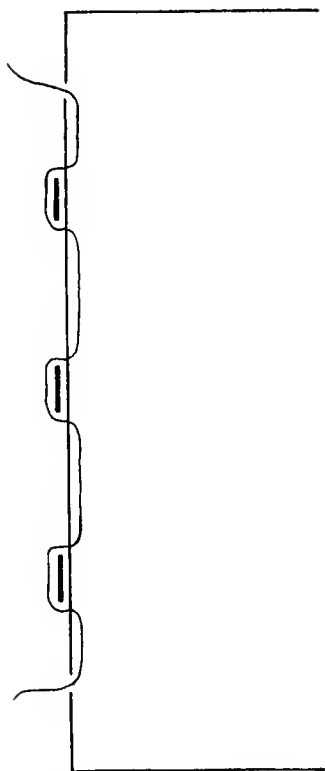

FIGURE 7.—Sewing on tapes. Sawcuts made only for kettle stitches. Based on illustration in Report of the Committee on Leather for Bookbinding. Edited for Society of Arts, London, 1905.

The more careful binders, however, regulate the number of leaves in a section according to the kind of paper in the book. A larger number of leaves can



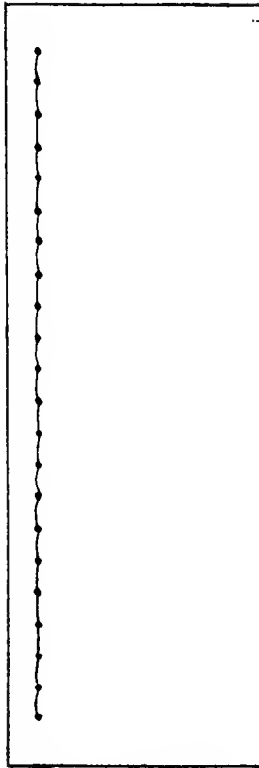

FIGURE 8.—Stitching.

be taken in books printed on thin paper than in those printed on thick, spongy or heavy papers.

In deciding how a book ought to be sewed one must consider: (*a*) The use the book is to receive. If it will not receive hard usage sew through the sig-

natures; otherwise overcast. (b) Paper on which the book is printed. Poor paper should be over-sewed. (Fig. 6.)

*Tapes.* When it does not seem necessary to overcast it may be advantageous to sew on tapes instead of bands. This method eliminates saw-cuts since the narrow tapes are simply laid against the back of the book and the needle passed around them, as indicated in Figure 7. Sewing on tapes makes a book much more flexible than it can be made any other way except by sewing on raised bands. Music should always be sewed in this way. Until recently it was supposed that tapes added strength, but it is certain that they do not if the book is properly bound in other respects. If used at all, tapes should be narrow. Wide ones take up a great deal of surface and when glue is applied this surface remains untouched, unless the sewer has sewed through them instead of around them.

*Stitching.* Stitching is the process of sewing loose leaves lengthwise on a sewing machine, after which the stitched sections are sewed in the regular way on bands. (Fig. 8.) The objection made to old-fashioned whipstitching, that between the sections the book opens all the way to the back while inside the section it opens only as far as the threads, is equally applicable to a stitched book. Any one who has read a book sewed in this way will remember how difficult it was to hold in the hands. Stitching makes a stronger book than the old-fashioned whipstitching but cannot compare in strength with the modern overcasting. In some few cases it may be used ad-

vantageously on the first and last signatures of a book, but its use on the entire book cannot be too strongly condemned.

It may be inferred by what has been said about sewing that it is a comparatively simple matter to sew books properly. It is right at this point, however, that the librarian and the binder who does not understand the requirements of library work will come into conflict. The binder will insist that all books must be sewed on bands. When the backs of sections are very badly worn he will agree to whipstitch, but will use the old method. The librarian will insist not only that nine-tenths of fiction and juvenile books must be overcast, but that a special kind of overcasting must be used. The binders who make a specialty of library work do all this as a matter of course. At least one binder tests the thickness, tensile strength and other qualities of the paper and sews each book in the way that experience has shown to be the best.

### FORWARDING

After the book is sewed it goes to the forwarder who has charge of the book during all processes which the book passes through between sewing and finishing. Forwarding includes trimming, gluing, rounding, backing, putting on back-lining, making the case (or lacing-in, see page 42), casing-in, pressing.

#### 12. FLY LEAVES PASTED

The end papers and fly-leaves which lie together are pasted together, making one thick fly-leaf. When

it is remembered that both end papers and fly-leaves are guarded with cloth, it will be seen that pasting the two together adds materially to the strength of the book.

### 13. BANDS FRAYED

The bands which project about an inch and a half on each side of the book are frayed out at the end and pasted to the end papers. The fraying is done so that they will paste down flat, and the pasting so that they will be out of the way during succeeding processes.

### 14. TRIMMING

The book is squared up by tapping on a flat surface, and trimmed at the head, fore-edge and tail. As little as possible must be trimmed, but binders find that if less than an eighth of an inch is cut the cutting machine does not work well. Trimming makes the edges even and what is more important in rebound books, removes much dirt.

### 15. SPRINKLING

At this point edges are sprinkled. This process is not essential either for strength or beauty, but it helps to keep the book from becoming soiled, or at least from showing dirt. It cannot be expected on cheap work. The process was formerly done by hand, using a brush and shaking the coloring matter on the book. It can now be done with a machine operated by hand which sprays the coloring matter on the book. Occasionally the top of the book is burished with an agate or blood stone.

Occasionally also it may be desirable to gild the top of a book which is being rebound. When this occurs it is not a process to which the librarian need give much attention, except to be sure that good gold is used.

#### 16. GLUING

The back of the book is then slightly glued. The glue must be very hot and quite thin, and must be thoroughly worked into the back. By placing books in a pile a number can be done at a time.

#### 17. ROUNDING

As soon as the glue has stiffened but before it is hard the book is rounded. This must be done by experts and is a process which must be seen to be understood. The book is placed on the table with the fore edge toward the workman who then hammers the part of the back lying uppermost in such a way as to force the upper part of the book toward the workman. The book is then turned over and the process repeated. After a few operations like this the back of the book becomes rounded and the fore edge concave.

#### 18. BACKING

The book is then placed in a backing press allowing about an eighth of an inch to project, and screwed very tight. With a backing hammer the rounding process is continued and the sides of the book forced down over the edge of the press to form a projection against which the edge of the board for the side rests, forming the joint. In hammering, the workman be-

gins at the proper distance from the center of the back so that he can force the backs of the other signatures over on each side toward the edge. (Fig. 9.)

This process is the most important one in forwarding, calling for skilled labor. If the hammer is not used in exactly the right way the backs of the

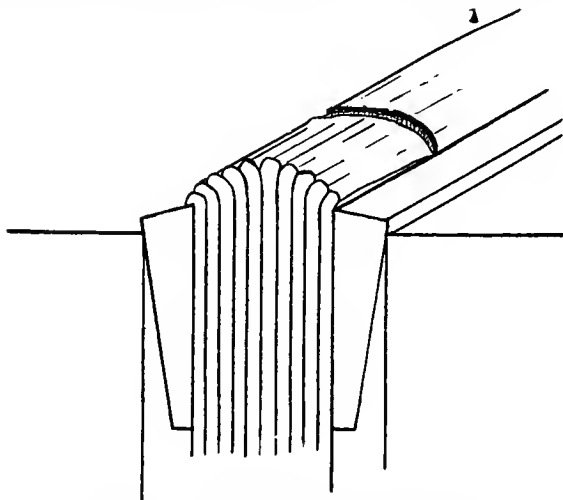

FIGURE 9.—A book rounded and backed.

signatures may be crushed in, the stitches broken, or the paper or bands cut. In any case the book is materially weakened. A good workman will make a sharp joint and round the book perfectly without injuring its strength in any way.

#### 19. BACK LINING

All books have a lining of one kind or another on the back. Machine-bound books are generally lined

with a coarse "super," as it is called in this country, or "mull" as it is called in England. Some library binders use a thin muslin, but the best material is canton flannel cut in strips wide enough to cover the back of the book and also to project about one inch on each side. The back of the book is glued, while the nap or fuzzy side of the canton flannel is pasted and then put on the back and well rubbed down. It is very important that both the glue and the paste be used. Experience has proved that when only one is used the canton flannel will come off, but when both are used, it becomes an integral part of the book.

The flannel which projects on the sides must be pasted to the end papers. When the paste and the glue have dried, the canton flannel shrinks tight to the back and adds materially to the strength of the book. After drying the flannel is trimmed at the head and tail close to the back.

If the book is a valuable one that will receive hard usage and therefore should be as strong as possible, the flesh side of a piece of split goat skin can be used for back-lining, covering the back from joint to joint. It will seldom be necessary, however, to employ this method.

Perhaps nothing better shows the difference between old methods of library binding and new than this one item of backlining. In the old methods the binders depended for strength largely upon the bands. In the new the bands are practically immaterial when the book is fastened into the cover.

## 20. REBACKING

At this point some binders reback to make a sharp joint, and to make the book open more easily. When the canton flannel dries it may pull the back somewhat out of shape. It is doubtful, however, if rebacking is always necessary.

## 21. BOARDS CUT

The book is then measured for boards which are cut to the proper size. In measuring it must be remembered that the boards must project an eighth of an inch on all edges (except the back) forming what is called the "squares." It will also make a difference in measuring if the book is to have a French joint. (See page 46.)

## 22. CLOTH CUT

If the book is to be bound in cloth, this is cut the proper size. If leather backs are to be used the covering material consists of two pieces of cloth and one of leather, all of which must be cut to the proper size.

## 23. LOOSE BACK

If the book is to be made a loose back, a piece of coarse paper is cut the size of the book from joint to joint and the length of the back. This is placed in the book.

## 24. MAKING THE CASE

(a) The cloth for a full cloth book is now glued all over on the inside. The boards are adjusted on the book ("setting the square," as the binders call it)



as they ought to be when the book is finally bound, and the book is placed on the right-hand side of the glued cloth, with the back toward the middle of the case, leaving enough cloth projecting on all sides to turn in. The other side of the case is then drawn up over the board on top and pressed down firmly enough so that when it is laid back again, the board which has been uppermost goes with it. The book itself is laid aside. The paper which is to prevent the glued cloth from sticking to the back of the book is then placed in the space between the two boards, and all edges of the cloth turned in on the boards. This forms the complete cover or case.

(*b*) If the book is to have a leather back, the boards are tipped lightly with paste to the end papers, allowing for the French joint. The leather is pasted and the book is then laid on the leather in the right position so that the rest of the leather can be pulled up over the back on the top board. The top cover is then laid back, the paper forming a loose back inserted, the leather turned in, and cloth sides put on and turned in.

#### 25. MAKING OF A FRENCH JOINT

The book is now set back in the cover just described and the space between the boards and the back is creased with a bone folder while the cloth or leather is damp. This forms the French joint.

#### 26. PASTING DOWN END PAPERS

End papers are then pasted down to the boards and the book, so far as strength is concerned, is fin-

ished. It will be remembered that the end papers were guarded with muslin, or jaconet, that the bands projected beyond the sides and were pasted to the end papers, and that the canton flannel also projected beyond the sides and was pasted to the end papers. Therefore, when the end paper is pasted to the board it carries with it first the canton flannel, then the bands and lastly the jaconet guard. This is as true of leather-backed books as of full cloth.

Strictly speaking, this makes what is technically known as a "cased" book, i. e., the case is made in one whole piece and the book fastened into it. Because leather bound books have always been considered stronger than others, and because they have always been laced-in to the boards (see page 42) before the leather has been put on, a prejudice against cased books has arisen. If the prejudice be directed against the usual commercial binding it is justified, but if directed against library books properly cased it is not justified.

## 27. PRESSING

At this stage the book is put under heavy pressure in the standing press until dry. A number of books are placed in the press at one time, separated by backing boards having metal projections which fit into the French joints. They should be left twelve hours at least, longer if necessary. After pressing, the book goes through a general cleaning process. In applying the glue or paste there are many chances of soiling the book. The great pressure which is applied

also squeezes out glue at the head and tail. This must all be cleaned off before the book goes to the finisher.

## FINISHING

### 28. GILDING

The gilding of a library book is a simple matter compared with that of books bound for individuals. Such books are usually meant to be artistic and their covers bear elaborate designs in gold, generally limited only by the size of the owner's pocketbook or by his taste.<sup>1</sup> In library binding gilding is confined to the furnishing of necessary information. Tooling of all kinds, with the possible exception of that which divides the back into panels, is unnecessary. A description of finishing processes is unnecessary here since they add nothing to the strength of a book. A description of the method of gilding call numbers will be found on page 194.

There are three different ways of lettering books bound in light colored cloths on which gold cannot be used: (a) In gold on leather labels pasted to the back. (b) In gold on panels which have been stained black. (c) In black ink directly on the back. The first two methods make more attractive-looking books but the process adds to the expense, and in the first case the labels have a tendency to peel off. The last method is the one generally used.

In this description of processes numerous details

<sup>1</sup> Finishing from the artistic point of view with an excellent description of tools, materials and processes will be found in Cockerell's "Binding and the care of books," Chapter 14.

have been omitted, because they would add little, if anything, to the librarian's ability to criticize properly the work being done by his binder.<sup>1</sup> In some respects the order here outlined may differ in different binderies, but the majority follow it closely.

The processes as outlined are those which should be used in library binding. There are, however, several additional points relating to binding processes with which it is well to be familiar.

### RAISED BANDS

In looking at many old books bound in the eighteenth or early part of the nineteenth century, or at books bound within recent years for individuals, one will find many that have the back divided by ridges. These are known as "raised bands." They are formed by sewing the book differently from either of the methods described up to this point.

According to this method the bands are not placed in grooves which sink them below the surface of the back, but are simply laid against the back. In sewing the thread may come out at the near side of the band and in at the far side, thus going around the band on the back of the book; or it may come out at the far side and in at the near side, thus entirely encircling the band. In either case the sewing is exceedingly strong. Since the bands are entirely on the surface, the leaves open all the way to the back of the signatures and greater flexibility can be obtained thereby. (Fig. 10.)

<sup>1</sup> For instructions to the binder about type, space, lettering, etc., see under Lettering, page 141.

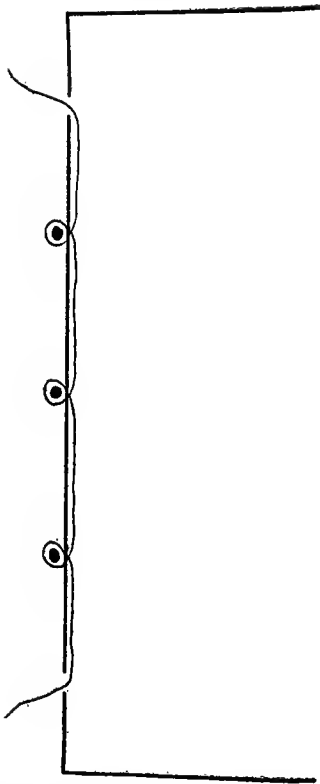

FIGURE 10.—Sewing on raised bands. No saw cuts except for kettle stitches. Based on illustration in Report of the Committee on Leather for Bookbinding. Edited for Society of Arts, London, 1905.

As it is much more difficult to sew and forward books with raised bands, they are not used in ordi-

nary library work. It may be advisable, however, to use them occasionally on a few large reference books such as dictionaries, where great flexibility combined with strength is essential. In fact the merits of binding in this way are not recognized as generally as they should be.

Many books look as if they were sewed on raised bands when in reality they are sewed in the ordinary way, with false raised bands pasted on the back. They add nothing to strength and have no place in library binding.

#### LACING-IN

Lacing-in is a method of attaching the bands to the book, which is in general use for all leather books bound by hand. This method requires that the boards which have been cut to the proper size be laid against the grooves formed in backing and marks be made about half an inch in from the back, opposite each band. At these points holes are punched through the board which is then turned over and other holes are punched about half an inch from the first ones. It is generally desirable to cut a groove in the board from the first holes to the edge of the board, for the bands to lie in, so that there will not be an unsightly protuberance when the book is bound. The bands which have been frayed out are then threaded through the first holes from the outside of the board inward and again through the second holes. They are drawn up tightly enough so that the board will fit close to the joint, but not enough to prevent it from lying flat.

The ends of the bands are spread out fan-wise, pasted, and hammered down smooth on the board. Before any back-lining has been put on, the boards are attached to the book simply by these bands. (Fig. 11.)

When bands are laced-in it is not customary to use anything stronger than paper for back lining;

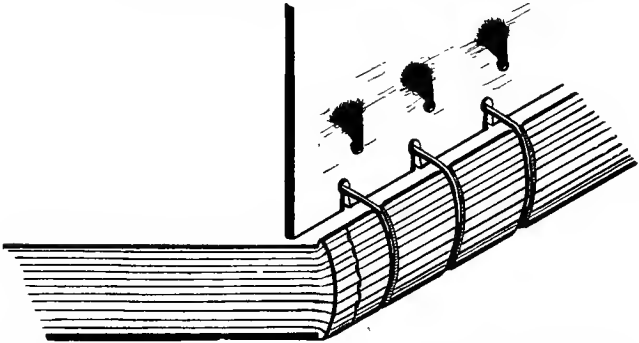

FIGURE 11.—Bands laced in, and ends frayed out. Based on illustration in Report of the Committee on Leather for Bookbinding. Edited for Society of Arts, London, 1905.

the strength of the book lies in the bands and the leather which covers the back. As long as the leather remains strong and the book does not receive hard usage this method is satisfactory. As soon, however, as the leather begins to disintegrate more strain is placed upon the bands. When the leather breaks completely the bands bear the entire burden at the joint, and eventually break. With the process as outlined in the preceding pages one need never fear that the book will come out of the cover, or that the sides

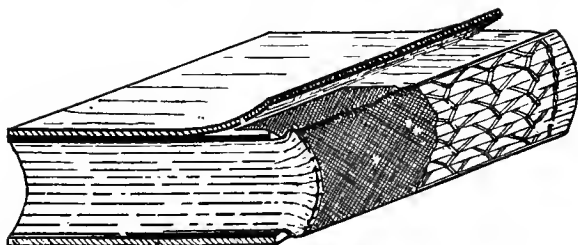

FIGURE 12.—Split boards. In actual work the backlining would cover the entire back.

will break at the joint. Even if the leather should break the cotton flannel will hold. The best library binders do no lacing-in at the present time.

#### SPLIT BOARDS

While the old method of lacing-in is not desirable in library binding, the method of using split boards makes a very strong book. Instead of making a case of cloth, or cloth and leather, the back lining and the bands (or tapes) are inserted in boards which have been split, or between two thin boards glued together with a space left unglued for this purpose. The covering material is put on after the book is in boards and the book is made tight backed. This is probably the strongest method of attaching a book to the boards. In fact it is stronger than is necessary for any except very heavy books which receive hard wear. (Fig. 12.)

#### TIGHT AND LOOSE BACKS

For years there has been a certain mild controversy regarding the relative merits of tight and loose



backs for leather bound books. Tight backs are those in which the material used for covering the book is pasted or glued to the back. Loose backs are those which, by means of folded paper or a piece of paper put in as described on page 37, are prevented from adhering to the back. When the book is opened the back springs out. (Fig. 13.)

The tight back book always forms a hinge at the place where the book is opened. Since the place of the hinge is constantly changing the back of the book after much use becomes concave instead of convex, and the appearance of the book is seriously marred. Also the constant creasing of the back tends to erase the gold lettering, so that it becomes indistinct. If labels are put on they speedily come off. It is customary to use tight backs on very heavy books, though there are cases where such books have been put in loose backs.

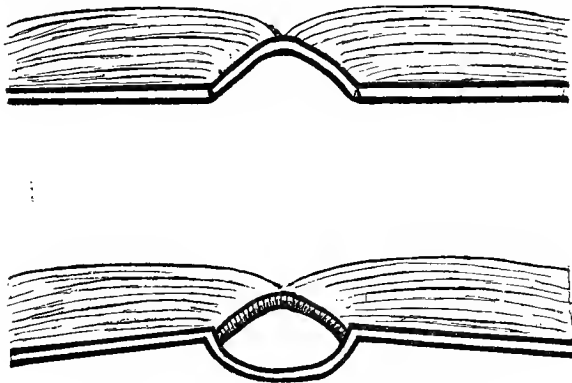

FIGURE 13.—Tight back and loose back.

The loose-back book always preserves its shape and good appearance, even when the paper on the inside may be so badly worn that the book should be withdrawn. The strain, however, always comes at the joint; therefore if poor leather is used it will quickly wear out at this point.

Each method has its advocates, but so far as the present writer can learn, there seems to be little to choose from the standpoint of strength. It might seem that the tight-back book would be the stronger, but as a matter of fact in actual wear loose-back books seem to hold their own with the others. In fact when the soft, spongy papers are used the loose backs are obviously stronger. It seems clear that there is little choice one way or the other, and the question must be decided by the personal preference of the librarian.

### JOINTS

In library binding French joints are now used in place of regular joints. Figure 14 shows plainly the difference between the two. In the regular joint it will be noticed that when the book is opened there is a sharp crease in one line from head to tail. In the French joint the strain is distributed over a much greater area. In regular joints the leather is sometimes pared at the joints to permit of easier opening of the book. In French joints the full thickness of the leather can be used. French joints are made by setting the boards away from the back about one-eighth of an inch. When the cover is put on it is

necessary to crease between the board and the back while the leather is still damp.

An excellent illustration showing the anatomy of a joint may be found on page 51 of Dana's "Notes on bookbinding for libraries," ed. 2.

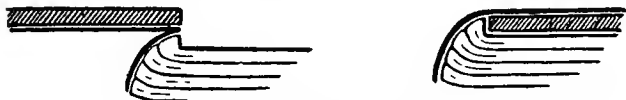

A Section of an Ordinary Joint with the board open shows that the creasing of the leather is concentrated on one line.

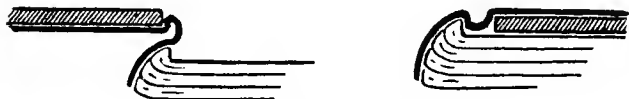

A Section of a "French Joint" shows how this creasing is distributed over a great surface, and so enables sufficient flexibility to be obtained with much thicker leather than can be used with an ordinary joint.

FIGURE 14.—French joint. From Report of the Committee on Leathers for Bookbinding. Edited for Society of Arts, London, 1905.

## CORNERS

Corners on library books should be rounded to prevent the board from breaking if the book falls and to prevent the cloth from wearing through at this point. Rounded corners are peculiar to library binding. As a rule they are not made by cutting off a corner of the board, but by turning in the cloth diagonally from the corner and then from the side and end. Sometimes both methods are adopted. If government specification cloth is used it is probable that "library corners" will not be necessary.

In some libraries pieces of leather or vellum are put on corners. Leather is put on in order to raise the bottom of the boards from the shelf, while vellum is used to make the corners hard and prevent them from breaking or showing signs of wear. While both serve the purpose for which they are intended, the process of putting them on adds materially to the expense, and in most cases this is not warranted by the increased use of the book.

### TRIMMING

Binders should be instructed to trim as little as possible. This is important for all books, but most of all for periodicals. In fiction and juvenile books it is important to have wide margins, because the text will remain legible for a longer period of time if protected by a margin from the contact of hands. Non-fiction books which are likely to remain in use for a longer period of years may need to be rebound and trimmed again. Therefore wide margins are essential to good wear as well as to good appearance.

It is customary to bind front covers of periodicals. Sometimes it is desirable to bind advertising pages, and it is necessary to do so when the publishers follow the pernicious practice of continuing regular articles on advertising pages. Covers and advertising pages are generally printed with much narrower margins than the body of the magazine and unless great care is taken in trimming parts of the printed matter will be cut off.

## HEADBANDS

Cotton headbands can be added during the forwarding but inasmuch as they are simply pasted on they add nothing to the strength and very little to the beauty of the book. When silk headbands are carefully sewed on they add both strength and beauty. An excellent description of the process of putting on headbands will be found in Cockerell's "Binding and the care of books," page 147.

## HOW TO RECOGNIZE A WELL BOUND BOOK

The ability to recognize a well bound book is necessary when comparing the work of different binders. A book should be bound in material suitable for the use which the book is to receive and in such a way as to give the maximum amount of service. It should also be as attractive in appearance as is compatible with these two requirements. In deciding whether a book is suitably bound for library use the following points should be kept in mind:

1. A volume must show evidence of neat and careful workmanship.
2. If the book is to be used constantly leather is essential; if occasionally only, leather is an element of weakness.
3. All books that receive hard usage should have end papers and fly-leaves guarded with cloth. If sewed regularly the first and last signatures also should be guarded.
4. Saw cuts should not be deep.
5. The book should be flexible and stay flat

wherever opened. (This is not always possible in the case of overcast books or books printed on stiff, brittle paper.)

6. When the book is lying flat the top should remain flat. When standing on end the sections should not separate slightly at the back.

7. The book should feel firm and compact to the hand.

8. When opened the volume should not make a crackling noise due to too much glue on the back.

9. The book should have a well rounded back and the cover should fit well at the joint. Flat backs are not desirable.

10. Margins should be wide and cut straight. Periodicals should not be trimmed so that printing on covers or advertisements is cut off.

11. The book should have French joints.

12. The cover should not separate easily from the book when pressure is applied.

13. Lettering on the back should be legible and put on straight.

14. On opening the book sections at the back should be perfectly smooth, showing that they have not been crushed in backing.

15. Guards for plates, maps, sections, etc., should be so applied as to leave the paper unwrinkled.

## CHAPTER IV

### MATERIALS

In a recent pamphlet issued by the Government Printing Office, containing a list of materials and articles used in the printing and binding of public documents, the number of items for binding alone reaches the surprising total of 171. Many of these are materials used in marbling, others indicate slight variations of color and weight in standard leathers and cloths. But exclusive of all these the number of materials called for is over forty.

It is not the writer's purpose to discuss all of these forty or more materials, but it seems necessary to mention that many materials other than those used in covering books (always some kind of cloth or leather) are used in binding. Furthermore, the strength of the book after it is bound will depend almost as much upon the materials used in its inner construction as upon those used in covering it. The inner materials, if not wisely selected as to quality or in reference to the kind of service which the book is to receive, may cause an otherwise excellently bound book to give poor service.

In general, however, a reference to binding materials means those which are used in covering books. It is the cover which renders a book attractive or

unattractive, and which contributes more than any other one item, except possibly sewing, to the long life of the book. We should therefore know the initial cost of different covering materials and the length of service which each material will give under different conditions. When they are not imitations we should be able to recognize the best-known materials, either on or off the books. An unscrupulous binder can easily take advantage of ignorance of these matters.

So far as the librarian is concerned only two classes of materials need be considered for the covers of books—leathers and book cloths. This does not indicate a restriction of choice, for when we consider that leather comes from a large number of animals, that there are a great many different kinds of cloth, that cloths and leathers can be obtained in a great variety of colors, there seems to be an embarrassment of riches. As a matter of fact most librarians confine themselves to four kinds of leather and four or five kinds of cloth, each in three or four different shades.

### LEATHER

The most expensive materials used in covering books and those which vary most in quality are leathers, the skins of animals which have been tanned and made flexible. The best bookbinding leathers are those which are flexible both in the skin and on books, and the surface of which is not easily damaged by friction. Owing to the many kinds of leathers and



their variation in quality, it is difficult to learn to know them well.

The skins of all sorts of animals have been used for covering books. Certain ones, not suitable for library binding, are still used for the purpose in various parts of the country, so that librarians need to become expert in their knowledge of which leathers may be employed and which ought to be rejected.

Variations in the same kinds of leathers are caused by:

(a) *Age.* Skins of animals which have not reached full growth should not be used for binding library books. Since they are immature, the fibres have not become tough, and they have not reached their maximum thickness. If the skins which the binder is using are exceptionally small, it is probable that the animals from which they were obtained were too young. On the other hand, the skins of very old animals should not be used, since the fibres of the skins have lost something of their flexibility and strength. They cannot be readily detected, but they are sure to give poor service. As an illustration of the effect which age has upon leather it will be sufficient to note the well-known fact that calf skin is useless for library purposes, while cow-hide within certain well-defined limits is exceedingly useful.

(b) *The sex of the animal.* It has been proved beyond question that the skin from the female of some animals, notably goats, does not wear as well as that from the male.

(c) *Country from which they come.* It is an

interesting fact that the skin of a sheep which comes from Persia is not the same kind of a skin as that of a sheep which is raised in the United States. In general, it may be said that skins from animals inhabiting warm countries are more likely to be serviceable than those from the same kind of animals inhabiting cold countries. In the cold countries more of the strength goes into the fur or hair which protects it, while in warm countries a greater amount of strength goes into the skin itself.

In addition to variations due to these causes there is likely to be a certain amount of variation in different parts of the same skin. That part of the skin which comes from the back of the animal is tougher than that which comes from the abdomen. The difference is very noticeable in the skins of some animals, less so in others.

*Decay of Leather.* Of late years there has been much dissatisfaction expressed over the decay of modern leathers. In many cases leathers 100 years old or more are in a fair state of preservation, while many leathers—perhaps we should say most leathers—30, 20 or even 10 years old, show signs of decay, and some have rotted away almost entirely. In no way is the decay of modern leathers shown more conclusively than in a long file of the sheep-bound set of the United States Public Documents. The earlier volumes, covering the 15th Congress up to the 36th, will in general be found to be in a good state of preservation. About the year 1860, however, marked deterioration appears. In some cases it

seems as if the backs had entirely disintegrated. While a sheep-bound set is the best example of the decay of modern leathers, many libraries have been greatly annoyed by the decay of other leathers which are supposed to be much stronger than sheepskin.

So great was the dissatisfaction with modern leathers that in the year 1900 the Society of Arts in London appointed a committee to investigate modern leathers and to ascertain the best methods for preparing leathers for binding. The report of this committee was published in 1905, and a general knowledge of its contents is necessary for those who wish to know why leathers decay and how they may be preserved. Another valuable work which should be carefully studied is entitled "Leathers for libraries," published by the Sound Leather Committee of the Library Association in England. In a chapter of this book J. Gordon Parker, Ph. D., Director of the London Leather Industries Research Laboratories, tells us that the chief causes of decay are as follows:

1. The introduction of tanning materials other than oak and sumac, stronger in tannin, and more rapid in their action. Many of these tanning materials are unstable, and the leather produced disintegrates on exposure to light and air.

Tanning is the process of changing hides, which are animal matter subject to decay, into material which is strong and flexible and which is not subject to decay. There are two groups of tanning materials. The one called the pyrogallol group, which includes sumac, gall nuts and oak bark, is commended by the Committee of the Society of Arts. The other is

called the catechol group and is strongly condemned. Among the materials belonging to the catechol group are hemlock bark and larch, used chiefly in this country, and turwar bark used largely in tanning East Indian goat and sheep skins.

The United States Government Printing Office proposals call for leathers tanned with a pyrogallol tannin, since it has been proved that such leathers prove most resistant to the evil effects of light, heat and gas. If a skin has been tanned with sumac, or sumac in combination with oak bark, it has received the best possible preparation for its life as a book-binding leather.

It is not possible, neither is it necessary, to have all leathers tanned with sumac. Those leathers which are intended to remain on the shelves for many decades, should be in this tannage. Those which will be discarded in a few years may be tanned in a less expensive manner. Even some of the quick, modern materials, which accomplish in a few hours what once would have taken weeks, are not too poor for leathers which are not to be kept indefinitely.

Even the expert cannot detect skins which have not been tanned and dyed properly, but leathers which last a short time may be suspected either of being improperly tanned or of having some kind of injurious acid in their composition.

2. The use of dried and cured skins of variable soundness imported from abroad. Goat, calf and sheep skins are imported into this country (England) from all over the world; some are simply dried in the sun, some salted, whilst others are cured with various ingredients.

3. The use of infusions of acids and other bleaching agents to produce bright and even shades of colour.

Skins tanned with sumac are light-colored and can be dyed any desired color. Most other tanning materials, however, make darker-colored skins, which can be dyed only with dark colors. It has been found possible to scour and bleach skins with sulphuric acid and to re-tan with sumac.

4. The use of sulphuric or other mineral acids for the purpose of developing the depth of colour during the process of dyeing.

Sulphuric acid is the cause of decay of over 90° of modern bookbinding leathers. Having once been used, it cannot be wholly removed without the use of other chemicals.

5. The shaving and splitting of skins for producing an even substance.

In splitting and shaving, the long, strongest fibres of the skin are torn or cut off, and the part which remains for binding purposes is the weakest part of the skin.

6. Printing and embossing grains upon leather, together with other methods of finishing now in common use.

There are various ways of bringing out the natural grain of leathers which are perfectly legitimate and which do no harm. The danger in graining comes when the grain is embossed by means of a plate, which is heated and pressed on the skin. No good leather should ever be embossed.

7. The stripping, scouring, souring and re-tanning of East India leathers (Persians).

Some imported skins are only partially tanned, and it is necessary to wash out the tannin with some kind of alkali, which also takes out much of the natural grease of the skin. They are then treated with sulphuric acid and re-tanned. They are always poor and are seldom sold as re-tanned skins.

8. The removal of the natural grease or nourishment of the skin.

The foregoing eight causes of decay are beyond our direct control. The leathers are manufactured and put on the market, and the binder has to use such as he is able to obtain. No matter how much the librarian may insist upon leathers free-from-acid, he is helpless if the binder cannot obtain them. All that he can do is to insist that leathers without acid must be used, if obtainable.

Although these causes of decay are beyond the librarian's control, there are several causes of decay quite within his power to avoid. They are the following, due to improper methods used in binding, or to physical conditions after the book is on the shelf:

1. Direct sunlight.
2. Gas fumes. This evil is hard to guard against if there are gas pipes in the building. There is sure to be more or less leakage, and even a small amount of gas in the air has a bad effect upon leather.
3. Tobacco smoke. This is not likely to be very

detrimental in libraries, since the rules generally forbid smoking.

4. Excessive dampness, which encourages mildew.

5. Extreme dry heat. A temperature much in excess of 70° Fahrenheit is likely to dry up the oil which gives flexibility to leather.

6. Undue wetting or stretching the leather in covering. Some binders soak the leathers and stretch them in placing them on the books. When the leathers dry they shrink, the fibres are strained and the life of the leather shortened.

7. Use of poor paste in binding. This frequently sets up a fermentation that is very harmful to leathers.

8. Dust, especially in conjunction with dampness, is very injurious to leather.

Doubtless there are other things which have a deleterious effect upon leathers in libraries; but if a library is well ventilated, if leather-covered books are not kept in cellars or basements that are very damp, or where direct sunlight can fall upon them, and if the binder uses good paste and proper care in covering the books, we may reasonably place the responsibility of undue decay of leathers upon the manufacturers.

The various reports quoted so far have dealt with qualities of leathers due to tanning, manufacture, method of binding and time in use. Natural or mechanical qualities of leathers have not been touched upon. Those who are interested in this phase

of the question should read the report of Mr. Cedric Chivers on "The relative value of leathers and other binding materials," made at the meeting of the American Library Association at Pasadena in 1911. Mr. Chivers employed Mr. Alfred Seymour Jones, in England, to make tests which would show the tearing and breaking strain of various leathers. These natural qualities of leathers are obviously important, but too much stress must not be laid upon them. It is possible that a leather naturally strong and tough when new would rapidly deteriorate with age. The records as presented in Mr. Chivers' report must be taken in conjunction with facts determined by the investigation of the Society of Arts. In the main, however, it will be found that leathers which best stood the tests of the Society of Arts also showed the greatest resistance to the tearing and breaking strains made by Mr. Chivers.

*Preservation of Leather.* Various attempts have been made both by librarians and others to discover some substance which would preserve leather effectually after the book is bound. Some of these attempts have been temporarily successful, but time alone will tell whether leathers are permanently preserved by the treatments used, or whether applications of the preservative must be frequently made. Owing to the fact that in law libraries practically all the books published previous to 1900 were bound in sheepskin, the lasting qualities of leathers is a question that affects law libraries more than any other. Dr. Wire, of the Worcester (Mass.) County Law Library, who has made a careful study of the



problem, advises the use of vaseline or some other similar by-product of petroleum well rubbed into the leather with the bare hand and allowed to dry in the air until the leather has absorbed it. Better results were obtained by allowing the volumes to dry in the summer by natural heat instead of artificial heat in the winter. For some books Dr. Wire makes use of a bookbinder's varnish after the softening product has thoroughly penetrated the leather. A full description of the processes may be obtained from Dr. Wire's pamphlet, "Leather preservation," published in 1911.

Some of the disadvantages of Dr. Wire's method are:

1. The necessity of rubbing in the preservative from three to five times, according to the condition of the leather at the time of first treatment.

2. The care necessary to prevent the material used from smearing tables, trucks, floor, shelves and clothing at time of application; also when books are back on the shelves the care required to keep from rubbing against them and the necessity of wiping them off when they are handed to readers.

3. The tendency of books to swell at the back when first treated in this way, demanding extra care lest, in an effort to pull out one book, a whole shelf-full fall to the floor.

4. The repetition of the process after ten years.

It is possible that these drawbacks will be sufficient to dissuade all except the most stout-hearted from using this method of preserving leather. Rebinding in cloth seems to be much more simple and, on the whole, not much more expensive.

The question of a preservative is discussed in the Report of the Society of Arts, from which the following quotation is taken:

Enquiries have frequently been made as to the use of preservative pastes upon old bindings. It has been mentioned that the seasonings of white of egg or blood albumen usually employed in finishing leather have some preservative effect, and no harm can arise from the application of very thin coatings of white of egg. The use of ammonia to thin or preserve the solution must be avoided, but the whites, after thorough beating, may be rendered antiseptic by the addition of a small quantity of camphor, thymol, or some essential oil. Vaseline has been employed as a dressing, and, if otherwise suitable, will no doubt have a preservative effect upon the leather. A very moderate use of the wax, soap, and turpentine preparations made as shoe pastes, is also likely to be beneficial, and no doubt a special preparation might be made on these lines which would be still more suitable. Parafin wax dissolved in benzine is also harmless, and the surface to which it has been applied takes a good polish with a flannel after drying. Professor Proctor has experimented with a finish introduced by the Berlin Aniline Company some years ago for coloured leathers, with apparently satisfactory results. The preparation is practically a very hard stearine soap with excess of stearic acid, and is made by boiling 8 parts of stearic acid with 1 part of caustic soda and 50 parts of water until thoroughly dissolved, and then adding 150 parts of cold water and stirring till the material sets to a jelly. It is applied very thinly with a sponge or rag, and after thorough drying is polished with a soft brush or flannel. The alkali present in the soap is useful in neutralising any mineral acids contained in the leather. In very acid leathers it has been noticed that the sodium sulphate so formed will sometimes appear upon the surface as a white film, but this is easily removed with a damp cloth, and the surface, after drying, repolished with flannel.

Old books which it is desirable to preserve as long as possible in their original bindings and books which will be used very little may be treated with some form of preservative. If the book is to be much used, it would better be rebound. Dr. Wire's experiments have been carried on exclusively with law books. Whether the same processes could be used on books bound in morocco or pigskin is something that has not yet been determined. Most leather-bound books break first at the joint. The sheep bindings in a law library would show signs of disintegration long before the leather reached the breaking point, whereas the librarian would first notice that morocco was decaying when the leather actually cracked. Once cracked, no amount of preservative would do any good.

#### KINDS OF LEATHER<sup>1</sup>

The leathers that have been used in binding books have come from all sorts of animals, but so far as the librarian is concerned the skins of four animals only need be taken into consideration—the sheep, the cow, the pig and the goat. In England some experiments have been made with sealskin, but it has not been used long enough to give any definite idea of its resistance to the encroachments of time.

#### SHEEPSKIN

Sheepskin is a soft, flexible leather with weak fibres, and with a surface easily abraded. It has been

<sup>1</sup> The prices of leathers given in the text are those which prevailed during the summer of 1915.

used for bindings practically ever since books were put into leathers; and, under the old methods of tanning and manufacturing, proved satisfactory. In many libraries it is possible to see leather books bound in sheep in the 17th century which are in a good state of preservation. Even the sheep of the beginning of the 19th century is frequently well preserved. Since 1860, however, the quality of sheep has greatly deteriorated. This is bad enough, but unfortunately sheep likes to masquerade under the name of morocco and other leathers of a better grade, so that its use is much more extensive than appears at first sight. In the process of imitation the grain of the leather imitated is stamped on the skin. When this is done it generally takes an expert to detect the fact that the leather is not what it pretends to be, and even experts are sometimes deceived after the leather is on a book.

The strongest sheepskins are made when tanned with oak bark. Sumac, which is such a valuable tanning material with other leathers, is here inferior to oak.

There are two kinds of sheepskin, the wool sheep which is known to all, and the hair sheep which is not found in the United States, and which in reality is a cross between a sheep and a goat. The hair sheep comes from India, China, South America and Africa, generally from mountainous districts. It has a much tougher fibre and is a better wearing skin than that of the wool sheep. Unfortunately most of these skins, which are all imported, are made into shoe

leather. When properly tanned they are very suitable for library binding, and their use for that purpose is increasing.

The wool sheepskin in its natural color has been used for many years for binding law books. It is seldom used for anything except government documents and law books, and for this reason is known as "law-sheep."

*Roan.* Roans, the term used for sheepskins after they are dyed, can be used advantageously on books which will be handled a great deal, and which in any event will not stay on the shelves indefinitely. Properly tanned and dyed, they make a satisfactory leather for a time, but their life under the best of conditions seldom exceeds ten or twelve years. While this is true of good roans, it unfortunately remains true that in the United States, at least, it is difficult to get roans that are properly tanned and dyed. Therefore, unless one is sure that the quality of the skin is the best, he should use no sheep under any conditions.

*Skiver.* Skiver is the outside of a sheepskin which has been split, the inner side being known as the flesher. It is a leather much used for commercial binding, but since the splitting process takes away a great part of the strength of the skin, leaving it not much stronger than strong paper, skiver is wholly unfitted for library use.

#### COWHIDE

Cowhide, sometimes known as American russia, is a leather which has increased enormously in use in

the last twenty-five years. It is a thick, coarse leather, rather unattractive in appearance, strong when new, but with age rapidly deteriorating in quality, even when no deleterious substance has been used in tanning or dyeing. It is a harder leather to work than roan, but the quality is much more uniform and it can be used advantageously for binding fiction and other books which will be much used. In its natural state (undyed) it can be used in place of law-sheep for law books, but has a tendency to become dark. It can be obtained in many colors. Since it is too thick a leather to be used in full thickness, practically all skins are split, and the amount of flesh left with the grain determines the weight of the leather. A greater or less amount is taken off according to the purpose for which the leather is intended. Book-binding cowhide costing 20c to 25c. a square foot is the lightest weight leather that has the right to be called cow.<sup>1</sup> The life of cowhide is from five to twelve years.

*Buffing.* Buffing is practically only the grain of cowskin from which almost all the flesh has been split. It is not suitable for library books, since it is very thin and begins to disintegrate in less than five years. After it is on the volume it is hard to detect, so that some library binders have been tempted to use it instead of cow. But as buffing is never sold as cow, the library binder has no excuse for keeping it in stock.

<sup>1</sup> This is the normal price of cow. The European war has had the disastrous effect of raising the price and lowering the quality. Until conditions become normal again all cowhide should be shunned.

## PIGSKIN

Pigskin is one of the strongest leathers, having a hard, resisting surface and a good, tough fibre. In the grain, the holes which were left when bristles were removed are plainly visible, giving the leather a distinctive appearance, which can be imitated successfully, but which is much less often imitated than the grain of morocco. If there be doubt of the genuineness of pig, soak a piece of the leather until it has absorbed a quantity of water, and then stretch it. If the grain pulls out, it is imitation; if genuine, the bristle holes still show plainly. Oak bark tanning is the best for this leather, and, since it is more nearly gristle (less fibrous) than other leathers, dyes and chemicals should not be used which will interfere with its quality of resisting friction. It should be used in its natural color whenever possible.

Pigskin frequently comes in skins which are too thick for the binder to work easily, or which are very uneven in thickness. In such cases the paring down of the skin is likely to injure its strength. Because of its thickness pig is generally supposed to be more suitable for large than for small books, but inasmuch as several binders have used it successfully for years on small books, it may be taken for granted that it can be used with good results on all books, large or small, which are to receive hard usage. It needs constant handling, and the absorption of a certain amount of oil from the hands to keep it pliable. Otherwise it dries rapidly and cracks along the joint.

This, however, is true of all leathers to a greater or less extent. Pig costs from 40c. to 45c. a square foot.

## GOAT

The leather which makes the strongest and most attractive binding comes from the skins of goats and is called morocco, because it originally came from that country. In the course of time goat skins from other countries were tanned with sumac (originally a distinguishing characteristic of a genuine morocco), but the same name was applied so that we now have the paradoxical terms, Turkey morocco, Levant morocco, etc. Moroccos have a beautiful grain, are flexible, soft and pliable to the hand, and resist hard wear; qualities which contribute to their great popularity.

Morocco varies greatly in quality as well as in appearance. Unfortunately the skins which are best in quality, considering the length of time they will wear, are not always those best in appearance. The skins of goats with long hair from the colder countries make beautiful bindings; but the skins of goats from the hot countries, such as the interior of Africa, having short hair, while not so attractive in appearance, are tougher and wear longer. In addition to the many grades of genuine morocco there are as many more imitations of it made from sheepskin, cowhide, etc. Only the expert can detect some of them in the skin, and even he may be deceived when the leather is on the back of the book.

In general it should be said that genuine morocco is the most expensive leather that a library can use,



and that it can be used to the greatest advantage only occasionally. It makes an excellent binding for large reference books which are constantly handled, for art books which must be attractively bound, and for some periodicals which are much used in reference work. It is not used nearly so much in libraries today as it was ten or fifteen years ago, and it is quite safe to say that it will be used less ten years from today than it is now.

*Levant morocco*, made from the skins of Angora goats, is the most expensive and most beautiful leather used in binding. It has a large, prominent grain, but is far too expensive for any library to use, especially when it must be conceded that in its wearing quality it does not equal that of some less expensive moroccos. Mr. Chivers' test showed that so far as tensile strength goes, this leather is very much weaker than many leathers much less expensive. When the skin has been subjected to pressure until the surface is smooth it is known as "crushed levant."

*Turkey morocco*, made of skins of goats from Turkey, is a very strong, durable leather which all libraries will find occasion to use from time to time. It is very easily imitated. Under exposure to atmospheric conditions existing in many libraries its life may not extend beyond thirty years. In one library at least, where conditions of light and heat were poor, the best Turkey morocco that the market afforded showed signs of disintegration within twelve years. Good Turkey morocco can be obtained for 35c. a square foot.

*Persian morocco*, which comes from the skin of a Persian sheep (not goat), is not particularly attractive in appearance and is very poor in quality. It is used extensively for commercial work, but is absolutely valueless for library binding.

*Niger morocco* is a goat skin which comes from the interior of Africa, generally by way of Tripoli, and is by no means a recent discovery, though we knew little about it five years ago. It is tanned by natives according to some method of vegetable tanning not completely known at this time. While in appearance it is not so attractive as some other moroccos, because of blemishes due to carelessness in handling and to the imperfect removal of some of the hairs, it has been proved by the tests made under the direction of Mr. Chivers to be stronger than all other moroccos; the inference is that it is more durable. Until recently it has been very hard to obtain in the United States.

*Bock morocco* is not a morocco but a split Persian sheep so poor in quality that it is mentioned only to be condemned.

#### CALFSKIN

Calfskin in all its various characters, such as divinity, kip, marbled, mottled, smooth, tree, or just plain calf is a very beautiful leather much used in the past for binding books for individuals. For this purpose it has, of late years, been crowded out by Levant morocco. It has a soft, smooth surface which disintegrates rapidly under the action of heat and gas

and has little strength even for temporary use. For the library it is useless.

#### RUSSIA LEATHER

This is a brownish-red leather made from the skins of different animals, tanned with willow bark and filled with a preparation of birch oil which gives it its peculiar odor. Neither in its genuine form nor in imitation is it a useful leather for libraries.

#### SEALSKIN

Although experiments have been made with it in some English libraries sealskin has never been much used in the United States for library binding. It is made from the skins of the hair seal, the supply coming from all parts of the North Atlantic Ocean. According to Mr. Douglas Cockerell and other binding experts in England, the skin is peculiarly suited for library use. It is reported to be a hard-wearing leather, tough and pliable, even in quality so that no part of the skin must be discarded because too thin or too weak, and possessing a beautiful grain. The price ranges from a point somewhat higher than that of the poorer moroccos to one somewhat lower than the higher prices. Unfortunately it can be easily imitated.

#### VELLUM

Probably no discussion of leather is complete without mentioning vellum, a binding material which does not resemble leather, but which nevertheless is made from calfskin or sometimes from goat skin. It

is prepared by the use of lime, and as far as the actual wear on flat surface is concerned, is perhaps better than any leather. It is, however, very susceptible to moisture, which makes it warp; and to light, which makes it hard and brittle. Since it is very hard, does not bend easily and is hard to work, its chief use is on the corners of books to protect them and make them less likely to break or rub. Large libraries have used it somewhat for this purpose, but the use is dying out.

In making a study of leathers it is well to obtain samples of all kinds, including those which are unsuitable for library use, and to examine them carefully, noting the appearance of the grain, thickness of skin, flexibility, and softness of surface. Perhaps more money can be wasted through ignorance of the comparative values of different kinds of leather which it is permissible to use in library binding, than in mismanagement of any other part of binding.

### CLOTH

Cloth is fully as important as leather in the economy of binding. Several years ago it was the custom to bind periodicals and other books which were used comparatively seldom in leather, while fiction, juvenile and other books which wore out quickly were bound in cloth. Recently the opposite course has been more favored. Books which receive unusually hard usage and are in the hands of readers constantly are bound in leather; while those which are used seldom, including periodicals, are bound in some

kind of cloth. Without doubt the change is a wise one. Even the best of leather disintegrates in time under the action of heat, gas, light, etc., and to-day many a volume bound in leather ten or fifteen years ago has parted from its sides, necessitating rebinding or recovering. Had it been bound in a good quality of cloth it would to-day be in good condition, and probably would remain in good condition for a hundred years. It requires considerable courage to change the binding of a good set of a standard periodical, such as the Atlantic or Harper's, from an attractive half morocco binding to an unattractive buckram. Unquestionably, if economy is an object, the change should be made, except possibly in the case of a library which uses these periodicals daily. Every librarian must decide each case for himself strictly according to the use the set is to receive, always bearing in mind the fact that leather disintegrates with time, whereas cloth does not unless exposed to excessive moisture.

No cloth which is suitable for library use is perfectly satisfactory because it has not the strength of good leather, cannot be used advantageously on very heavy books, soils easily and with use grows soft and flabby, especially along the joints. But on the other hand even those not suitable for libraries which are used by the publisher on cheap books are much better than poor grades of leathers, such as skiver, bock, buffing, etc.

The requisite qualities of a good cloth are:

- (a) Endurance when folded back and forth in

the same place, so that it may withstand the wear at the joint caused by opening the book.

(*b*) Smoothness, so that there will be a comparatively small amount of friction when withdrawing a book from between two others on the shelf.

(*c*) Ability to withstand constant rubbing back and forth on tables.

(*d*) Color that is fast when exposed to light; if possible it should be fast to water also, though this is less important.

(*e*) Color should be dyed in the piece, not pressed in by machinery.

Many cloths have some of these qualities but few have all of them. So far as is known to the writer only the grade of cloth described on page 77 has the last qualification.

Practically all cloth used in the United States is made of cotton. The best cloths are manufactured by The Holliston Mills, Norwood, Mass.; The Interlaken Mills, New York City; The Joseph Bancroft & Sons Company, Wilmington, Del., and by the Winterbottom Company and the Manchester Book Cloth Company in England. Since a number of grades are made in several different patterns and a great number of shades for each grade and each pattern, a variety of choice is permitted. As a matter of fact, however, most librarians select a good grade with a regular weave and confine themselves to a few standard shades, such as dark green, brown, red, dark blue, and tan.

Since the strength of the warp is much greater

than that of the weft, it is advisable when possible to cover books with the warp running across the cover. This, however, may entail some hardship on the binder for it may frequently happen that in order to cut his cover economically he must make the warp run lengthwise of the book. If a strong cloth is used the advantage is not great enough to be insisted upon.

Each of the American firms mentioned makes three distinct grades, all of which libraries may use. Each firm uses a different name for each grade. In other words, there are no general names which can be used for the corresponding grade in all makes. Therefore for the purposes of this chapter these cloths will be considered under the heads of Grades 1, 2 and 3, but it must be remembered that this is an arbitrary designation not known to the trade. Under each grade will be given the specific names used by the three manufacturers.

#### GRADE 1

Grade one of cloth, the cheapest that a librarian may use, is not made of the best quality of cotton thread and should never be used under any circumstances for full binding. It may be used on the sides of books bound in leather; if this be done the corners should be covered with vellum, for this cloth does not withstand hard usage and is likely to fray at the corners. It is a cloth commonly used by publishers, but should be used sparingly by the librarian. "Art vellum" made by the Interlaken Mills, "Aldine vellum"

made by the Holliston Mills, and "Linen finish" made by the Joseph Bancroft & Sons Company, come within this grade.

## GRADE 2

(a) Grade two is made of a better grade of cotton and with a closer weave than the preceding, but is not sufficiently strong to be used for full binding. It can be used more satisfactorily than the preceding on the sides of books bound in leather or duck. In common with all cloths, except the buckram made according to the government specifications (which will be discussed later), the different colors are not made, as one might suppose, by dyeing the cloth after it is woven, but by mixing the color with the sizing or starch which is used in finishing the cloth, and pressing it into the cloth by machinery. As a natural result the color rubs off with wear and the natural gray of the original cloth as first woven appears. "Art canvas" made by the Interlaken Mills, "Classic buckram" made by the Holliston Mills, and "Polished buckram," by the Joseph Bancroft & Sons Company come within this grade.

(b) *Buckram*. Under the name of buckram various grades of cloth are manufactured which resemble to a greater or less degree those mentioned under Grade 2 (a). Generally it is a coarsely woven cloth stiffened with glue or sizing, and the term originally indicated that the cloth was made of linen. At the present time linen buckram made in England can be obtained, but all that is manufactured in the United



States is made of cotton. Linen buckram costs much more than cotton and it is doubtful if it is any more serviceable. All of the three manufacturers mentioned make buckrams.

### GRADE 3

Prior to 1907 the Congressional set of government documents distributed to the depository libraries had been bound in sheepskin and the leather on the volumes had disintegrated so much as to make the set a hard one to care for. In 1907 the Congressional Printing Investigation Commission asked librarians of depository libraries to suggest, without considering cost, suitable binding materials for Government Documents. The number of replies received was 124, embodying suggestions as follows: full sheep, 11; half-russia, 78; cloth, 25; buckram, 70; linen duck, 20; canvas, 19. Some librarians expressed more than one preference, so that the total number of preferences was greater than the total of those replying. Most of those who favored sheep did so because of their desire for uniformity. Those who favored half-russia undoubtedly desired half American russia, or cowhide. 134 expressed preference for some form of cloth.

After receiving the replies from librarians the Printing Investigation Commission obtained samples of cloth from various cloth manufacturers in the United States and the Bureau of Standards made a series of chemical and physical tests to determine the durability of these cloths. Chemical tests were made

to discover whether the colors were fast when exposed to light. It is to be regretted perhaps that no tests were made to determine whether the cloths were fast to water and that this qualification was not included in the final specifications. Admitting, however, that a cloth which is fast to sun and water both is a valuable cloth for bookbinding, it is evident that the quality of fastness to water is not a vitally important one for cloth used in the United States. The total number of books injured by water is so small as to make insistence upon this quality entirely unnecessary. If books become so soiled that they need to be washed they should be bound in water-proof cloth.

Because many volumes of Government Documents are sent to Porto Rico and the Philippines where insects eat almost anything of an animal or vegetable character, the desirability of the cloth as an article of diet for insects, was also tested.

The physical tests indicated:

- a. Number of threads per inch of warp and weft.
- b. Absorption of moisture.
- c. Weight per yard.
- d. Tensile strength.
- e. Amount of stretch.
- f. Amount of friction developed by rubbing two pieces of cloth together.

This test was made because the friction developed in taking a book from between two others is an important matter when a shelf is full of books. If the friction is great the wear on the back of the book is correspondingly excessive.

*g.* Endurance when folded back and forth in the same place.

*h.* Endurance under extraordinary conditions of rubbing.

Some of these qualities, such as tensile strength, amount of stretch, etc., were comparatively unimportant, but the tests for all were severe and contributed much to our knowledge of the qualities which should enter into the composition of durable book cloths.

After a very careful consideration of the results of the tests and a thorough examination of the samples submitted, a committee of librarians and government officials unanimously chose three samples as the best of all those submitted by the manufacturers. Of these three samples the cloth numbered 666 was considered the most satisfactory.

Although these three samples were excellent, they all had one defect—the color was pressed in by machinery, not dyed in the piece. After various experiments had been made by the manufacturers this defect was remedied. The Government Printing Office then advertised for bids on cloths which would meet the Specifications drawn up by the Bureau of Standards (See Appendix A). Since that time all the Government documents which continue the old sheepbound set have been sent to depository libraries bound in cloth made according to these specifications.

This cloth is known sometimes as Government Specification Cloth, but is manufactured under the specific name of "Library buckram" by the Holliston Mills, "Art buckram" by the Interlaken Mills, and

“Legal buckram” by the Joseph Bancroft & Sons Company. The first two are made in pieces about 40 yards long and 38 inches wide, the Bancroft cloth in pieces 43 yards long and 43 inches wide. It must be admitted that this cloth is not quite so attractive in appearance as some of the old cloths which are not so durable. Some binders claim that it is hard to use. On the whole, however, it supplies a long felt want and is the strongest cloth made that is at all attractive in appearance.

### DUCK

Duck or canvas, a rough, heavy cloth much the same in quality as sail cloth, is the strongest cloth used in binding, but has some very decided drawbacks which militate against its use, except when the question of strength overshadows all others. It always makes an unattractive-looking volume—some of the more fastidious librarians rebel against its use; and it readily absorbs dirt and moisture, making it disagreeable to handle if the book has been much used. Duck having a double twisted thread in the weft is much more compact and absorbs dirt and moisture much less rapidly than other kinds. It should be used on the backs (never for full binding) of newspapers and such periodicals as are too heavy to put in library or legal buckram.

### IMPERIAL MOROCCO CLOTH

Imperial morocco cloth, manufactured by the Winterbottom Book Cloth Company in England, is made

of linen thread and finished with a grain to resemble leather. The kind most used in the United States resembles a straight-grained morocco. It is an excellent cloth in appearance, as well as in durability, but its cost is 50% greater than that of the Government Specification Cloth. It may be used on semi-popular books which will not receive a great amount of use, but which should be as attractive in appearance as possible.

#### WATER-PROOF CLOTHS

There are several cloths which are water-proof and therefore easily cleaned when the covers become soiled. The best of these are durabline, used exclusively by Cedric Chivers; rexine and pluvisin, used almost exclusively in England; keratol, made in Newark, New Jersey; and fabrikoid, made by the du Pont Powder Company, Wilmington, Delaware. All of these cloths are said to be acid, alkali and germ proof, do not absorb grease and can be washed with soap and water. They are strong, durable cloths, but they have at first a disagreeable odor, are hard to work and hard to letter in gold. In the application of paste to most waterproof cloths, either in the process of binding or in attaching labels to the back, it is first necessary to break down the surface of the cloth or the paste will not hold. This disadvantage no longer exists in the case of fabrikoid. Keratol and fabrikoid are made to imitate leather and are frankly sold as such. Probably the use of these cloths in libraries will always be comparatively small. Because

they can be easily cleaned they may be used on the sides of juvenile books, and in rare cases for full binding.

### GLUE

No very definite rules can be laid down as to what kind of glue should be used. The matter must be left largely in the hands of the binder, who must see that it is strong, yet flexible; not too poor in quality nor yet the most expensive kind which is generally used on furniture. This is too brittle for bookbinding use.

The best glue for bookbinding is made from skins and shows a dark wine color in the cake. Light colored glues are made chiefly from bones and are not usually so good. To prepare glue for use, soak small pieces in water over night and in the morning melt in the glue pot. It should never be boiled. A careful binder will see that utensils are kept clean and that glue is used in the proper thickness.

Flexible glue, which does not become too hard either before or after use, is made by mixing glycerine with good glue. It has no special advantages for use by binders, but can be used in the library itself for some of the repairs which assistants may have to make.

### PASTE

(For paste used in mending, see p. 167).

The best paste is that made in the ordinary way with flour and water. The paste should be fresh, for if it is not a certain fermentation takes place which is injurious to the book, especially to leather.

## BOARDS

Not the least important part of the make-up of a finished book are the boards forming the sides. There are practically four grades of boards which are known as strawboards; binders, cloth or millboards; semi-tar, and tar boards. The cheapest grade is the strawboard, for which there is no place in library work.

Mill or cloth boards, used for practically all library work, are generally made from waste papers of all kinds, though some may have an admixture of rags. Clay is also mixed with the waste paper pulp and the whole subjected to heavy pressure in the final stages of manufacture. They are made in two sizes, 20x30 and 23x29 inches, and are put up in 50-pound bundles, the number of sheets in the bundle indicating the thickness of the board. The thickest is a No. 12 which has 12 sheets in a 50-pound bundle. They may have as many as 70 sheets in a bundle, which makes a very thin board. A 20 or 25 board should be used for fiction and juvenile books and a 16 or 18 for heavier books such as magazines. Prices of good cloth boards run from \$40 to \$50 a ton.

Semi-tar boards, made from better grade stock than mill board, should have in their composition a certain amount of rags and hemp or naval cordage. They come in the same sizes and weights, costing about \$70 a ton.

Tar boards are the best boards obtainable. Made of naval cordage, they are very tough and hard to work. Many of them are allowed to season, in much

the same way as lumber seasons, in order to prevent warping. They are much too expensive for library use, sometimes costing as much as \$110 a ton.

The matter of boards is not one about which the librarian need exercise great watchfulness. Binders generally use a very good quality, though they sometimes use too thin a board on a heavy book, such as a newspaper or large folio. In such cases a board of suitable thickness can be made by pasting or gluing two or more together.

#### THREAD

At one time there was no question but that the best thread to be used in binding was linen. In the light of present knowledge it may be doubted if this is true under all circumstances. All commercially bound books, without exception, are sewed with cotton thread. Even such large books as the Century Dictionary, Webster's Dictionary and the United States Catalog of 1912 are sewed with cotton thread. Since it was unquestionably the aim of the publishers of all these books to issue them in the strongest possible bindings, it is reasonable to suppose that linen would have been used if it were really the best for the purpose. The main reason linen thread has been advised for so long is because its tensile strength is much greater than that of cotton. On the other hand, it is just as true that what we may call the fraying resistance of a cotton thread is greater than that of linen. Take two threads of the same size, one cotton and the other linen, make a loop of each thread with



one inside the other, saw back and forth, and the cotton will always cut the linen thread. Furthermore, linen thread deteriorates in quality unless very carefully stored. The publishers soon discovered these facts, and since tensile strength is not an important attribute in a thread that is being used in a book sewing-machine, they use a cotton thread with thoroughly satisfactory results.

In the case of library binding, however, the books are always sewed by hand and the sewer, as she draws the thread tight, is obliged to use some strength; for this reason tensile strength is an important attribute. Hayes' Irish linen thread is generally specified. The Barbour thread is referred to by Mr. Dana and by others, but the writer is not familiar with its use.

Other materials used in binding are gold leaf, paper for end papers, tape, headbands, cord and various concoctions used in finishing the books. Gold leaf should be 18 to 22 karat, and neither aluminum nor silver leaf should be used. Paper for end papers will vary somewhat with the size of the book, but should never be lighter in weight than a 60-pound manila. Large libraries may find it desirable to have an end paper specially made for their own use. Tapes should be linen and not over three-eighths of an inch wide. Cord for use in sewing in the regular way (not overcasting) is a soft twine which can be obtained from all dealers in bookbinding supplies. For all books less than twelve inches in height use four-ply cord; for larger books, five-ply.



## CHAPTER V

### SPECIFICATIONS

After the librarian has definitely decided upon the binder whom he wishes to employ he must, especially in dealing with binders who are not accustomed to library work, draw up specifications as to ways in which he wishes different classes of books bound. If he has employed a binder who thoroughly understands library binding, he may make use of the binder's knowledge in drawing up the specifications. Under certain circumstances it may be wise to enter into a contract with the binder, but ordinarily in the United States such a course will not be necessary. After the specifications have been prepared and a schedule of prices agreed upon, the librarian always has the right to refuse to pay for books not bound according to specifications. Therefore, a definite legal contract is not necessary. The librarian, except in the case of a few libraries which according to law must give their work to state officials, is always at liberty to take his custom from one binder and give it to another. Thus sufficient pressure is brought to bear on the binder.

Although the present chapter gives definite specifications for the binding of various classes of books, it is always wise to show a certain latitude in the use

of specifications. Local conditions, the papers used in bookmaking which seem to become poorer and poorer with each succeeding year, and the kind of a library which is to use the specifications—all these must be taken into consideration when specifications are drawn up. Moreover, the best specifications will accomplish little if they are not followed by the binder in a workmanlike manner, while good workmanship will sometimes make up for omission of important details in the specifications.

In the main, it will be found that the following specifications may be used as a guide, except possibly in the case of some reference and college libraries which do not issue books for home use. It has seemed best to place first general specifications which apply to all books, followed by additional specifications for each kind of books treated. The way in which these specifications are carried out is described in the chapter on Processes.

### GENERAL SPECIFICATIONS

1. The binder is responsible for all books consigned to his care and must replace or pay for all books lost or injured. When one considers the large number of volumes passing through a bindery, coming from many different libraries, the number of books for which the binder is unable to account is surprisingly small.

2. The librarian is the judge of whether the book is bound according to the specifications. Since he has submitted the specifications and the binder has

agreed to them he should be the sole judge of the result.

3. The binder will be allowed to depart from any specification if it is desirable in the interests of good binding. He must, however, prove that he is justified in so doing.

4. Books must be paid for according to a schedule of prices agreed upon by the binder and librarian.

5. The size should be determined by measuring at the back of the volume after it is bound. It might be wiser, perhaps, to measure the book before the boards are put on, so that binders would be sure to trim the book as little as possible. It is the universal custom, however, to pay according to the measure of the book with the boards on. This may possibly tempt the binder to increase the square of the book just enough to group it with the next larger size so that he can charge more for it.

6. All items not covered in the schedule of prices may be charged for at the regular rates of the binder for such work.

7. All books not oversewed are to be sewed all-along with Hayes' Irish linen thread, suiting the size of the thread to the requirements of the book; No. 25 for light, No. 20 for medium and No. 16 for heavy sections.

8. Cloth must be used for sides of all books bound in half-leather or half-duck. Never use marbled paper except occasionally on newspapers.

9. Unless otherwise specified, cloth which conforms to the specifications of the Bureau of Stand-

ards, or Imperial morocco cloth, must be used for full binding. For sides of leather bound books a somewhat cheaper grade may be used.

10. Duck should have a twisted, double thread in the weft.

11. Moroccos or pigskins must be guaranteed by the manufacturer to be free-from-acid.

12. Glue must be best quality of binders' or flexible glue, and must be used sparingly.

13. Poor materials of any kind must not be used.

14. In taking books apart, all old glue, paste, back-lining, paper, etc., should be carefully removed.

15. The binder should expect to do a certain amount of mending of torn pages and guarding of weak signatures, but should be allowed to charge extra when the amount is excessive.

16. The text of all books must be collated by binder and imperfect books returned to the library. (See under Processes, Collation, p. 15).

17. All illustrations of whatever character printed on single leaves must be guarded with thin, tough paper and the guard folded around the adjoining sections.

Some librarians and binders advocate the use of cloth guards but this seems hardly necessary. The cloth guards tend to swell the back of the book, especially if there be many plates, while the thin, tough paper is strong enough for ordinary books. Folded plates should never be sewed through the middle of the fold, but should be mounted on guards so that the plates will open out nearly flat when the book is

opened. Folded maps, or other folded plates which may be consulted often should, unless otherwise specified, be guarded with cloth which is as wide as the book, so that they may be thrown entirely outside the book and lie flat on a table.

18. Illustrations which are folded more than once, such as maps, should be carefully cut and mounted on thin cloth in such a way as to allow for the folding to come on the cloth alone, not on the paper.

19. Stitching (that is, sewing signatures lengthwise with a sewing-machine) or old-fashioned whip-stitching, is not permitted for any books; with the possible exception of newspapers.

20. In sewing three bands or tapes must be used for eight-inch books, four for twelve-inch, etc.

21. Tapes, or bands, and back-lining must project at least an inch and a quarter on each side of the book.

22. All books should be lined on the back with canton flannel as described in the chapter on Processes, except in a few cases where it may be advisable to use duck or a fletcher. This eliminates lacing-on of boards.

23. Adjoining leaves of fly leaves and end papers must always be pasted together.

24. Books must be trimmed as little as possible.

25. All books should have rounded corners.

26. All books must have French joints.

27. All books, unless otherwise specified, will be fastened finally into the covers by pasting down end

papers. Tight-back books will in addition have the back glued to the book.

28. Books should be loose-back unless otherwise specified.

29. Edges should be sprinkled unless the library specifies gilding on top. The color used may be varied to harmonize with the color of the book.

30. Books must be pressed until thoroughly dry.

31. Binders must keep a record of each book, whether periodical or not, which has a volume number.

This record, commonly known as a "rub" or "rub-off," shows the size of the book, kind of binding and exact lettering. Whenever other volumes of the same work or same periodical are received they will be bound according to this record, unless the librarian has specified a different material, or different lettering. In such a case the matter must be referred to the librarian before the book is bound. If a binder receives a book with a volume number and has no record of previous volumes, he should ask the librarian for a sample volume, unless it is obviously a book for which there could be no sample, such as the first volume of a periodical giving contemporary dates.

32. The binder is expected to paste in book-pockets and book-plates when furnished by the library but may charge extra for the work.

33. The best gold leaf must be used in lettering unless cover is light enough in color to take ink. Leather labels should never be used.



## FICTION AND JUVENILE BOOKS

It seems to be fairly well proven that all fiction and juvenile books should be bound in some kind of leather, preferably cowhide.<sup>1</sup> Objections to this are heard from time to time, but the objections come chiefly from the large steel towns where the sulphur in the air has a bad effect on leathers. In most communities leather will outwear cloth and in any event cloth becomes shabby, even when perfectly strong, much more quickly than leather. When the French joint is used the leather need not be pared and ordinarily will outwear the paper of the book.

Follow general specifications as outlined above, supplemented by the following:

1. Books should be bound in one-half cowhide (American russia). Roan may be used if the librarian is sure that it is good.

2. Fly-leaves should be made of white book paper, 70 pounds to the ream and guarded with jaconet.

It is apparent that when fly-leaves are guarded with cloth they are sewed as a separate section and not tipped on as is done in ordinary binding. Since practically all fiction and juvenile books are over-sewed, it will not be necessary to carry the guard around to the inner side of the fold.

3. End papers may be made of paper specially made for the binder, but it should be equal in strength to an 80-pound manila paper and should be guarded

<sup>1</sup> See footnote, page 66.

with jaconet on the outside of the fold in the same way as fly-leaves.

4. If book is not oversewed the first and last sections must be guarded with jaconet.

5. Nearly all books should be sewed with some modern method of overcasting.

It is probable that in every lot of books sent to the binder there will be some fiction and juvenile books which could be sewed in the regular way through the signatures either on bands or on tapes, but the number is so small that the binder finds it easier to sew all the books alike. In any event only those which have the backs of the sections unbroken the entire length and which, in addition, are seldom used, should be sewed in the regular way.

#### NON-FICTION

1. Books should be bound in full cloth.

2. Books in which the backs of sections are not injured, or which cannot be easily mended may be sewed regularly. The rest must be oversewed.

3. In all other respects the preceding specifications should be followed.

#### PERIODICALS

There is no place in a small library where good judgment will do more to make the library efficient at a minimum cost than in the binding of periodicals. The use of libraries for reference purposes is increasing and the use of periodicals is made easy by means of the periodical indexes. The enthusiastic librarian

who wishes to answer all questions will be tempted to bind more periodicals than are really needed, thus impairing the efficiency of the book fund. On the other hand, to some the cost of binding may seem so great that some useful periodicals will remain unbound. But it is not necessary to throw away unbound periodicals. If they are to be used only now and then in reference work, it is a good plan to wrap them in stout manila paper with stiff boards on the outside, letter carefully on the back and file away on the shelves in their regular places among other periodicals.

Supplement the general specifications by the following:

1. Fly-leaves should be made of white book paper, 80 pounds to the ream, guarded with jaconet on both sides.

2. End papers may be made of special papers used by the binder, but it is wise to have a 100-pound manila guarded with jaconet on the outside and also on the inside of the fold.

3. First and last sections must be guarded with jaconet.

4. Books 10 inches in height should be sewed regularly on four bands or on tapes one-quarter of an inch wide; larger volumes on five bands or tapes. Sew all-along, passing needle through center of tapes.

5. A millboard as heavy as the weight of the book will allow must be used.

6. (a) Books should be bound in full cloth made according to the specifications of the Bureau of Standards. As light colors, which may be lettered

in ink, show dirt very readily it seems better to use a dark color and letter in gold.

(b) In large reference or college libraries there are certain periodicals that receive constant use. It would be a mistake to bind such volumes in cloth, because no cloth will endure the wear that they receive. They should be bound in leather, preferably Turkey or Niger morocco. On no account should American russia be used.

7. If leather is used the sides should be covered with Bureau of Standards cloth.

#### NEWSPAPERS

Because newspapers are printed on wretched paper which it is freely admitted will disintegrate in a comparatively short time, the question when to bind and when to throw away is a hard one to decide. For the small library it is surely unwise to bind any except the local paper, which will be used from time to time for local history. In many cases it may be wiser simply to wrap the volumes to protect them from the light and file them chronologically. The librarian of the large library, however, no matter how disgusted he may be with the poor quality of paper used finds it necessary to bind a number of newspapers. When bound they will last twenty-five years or more, during which time they are sure to be used sufficiently to warrant binding.

Newspapers must be kept away from light, heat and moisture. If possible, keep in a dark closet until

ready for binding. Publishers of local papers ought to give a copy for binding.

1. Newspapers must be bound in one-half duck, best quality.

It is never under any circumstances wise to bind newspapers in leather. Duck, to be sure, gathers dirt easily, but it seems to be the only material sufficiently strong and long-lived for binding newspapers.

2. Fly-leaves and end papers should be made of extra heavy paper well guarded inside and outside the fold.

3. It is permissible to stitch sections lengthwise before sewing regularly on bands, but oversewing is preferable.

4. Boards of double thickness must be used. It is best, perhaps, to make the boards by gluing or pasting two boards of ordinary thickness together.

5. Corners should be covered with vellum tips.

6. Tight backs must be used.

7. Sides must be covered with paper.

This facilitates the handling of the volumes. If cloth sides are used on newspapers it increases enormously the labor in shelving them and even of using them on ordinary library tables. In libraries that can afford to shelve newspapers on patent shelving with rollers, cloth sides are preferable.

8. Libraries that can afford it should use a fibre-filling preservative on the edges. (See page 116 of the Bulletin of the American Library Association for 1912.)

## REFERENCE BOOKS

Reference books should be bound in the same way as fiction or juvenile books, except that morocco, instead of cowhide, should be used for books constantly handled. Books used only occasionally should be covered with cloth made according to the Specifications of the Bureau of Standards. Very heavy, thick volumes, such as dictionaries, should have all the strengthening devices and especially should have the bands and canton flannel on the back placed in split boards or between two boards glued together. It is impossible to bind such books too strongly. In rare cases it may be well to sew heavy books constantly used on raised bands, to have leather corners, and a strip of leather along the bottom of each board.

## LAW BOOKS

Some of the professions have conventional ways of binding professional books. In the law, for example, it was formerly customary to bind all law books in full sheep of the natural color. When sheep fell into disrepute, the law publishers began to substitute cloth similar in shade to the sheep generally used—a decided gain for law libraries.

Supplement the general specifications by the following:

1. End papers and fly-leaves must be guarded with jaconet, as described in specifications for fiction and juvenile books, page 93.
2. First and last sections must be guarded with jaconet.

• • 3. All maps and charts must be backed with muslin and not folded unless necessary.

4. (a) Bancroft Legal buckram (the lightest shade made), or Holliston Mills Library buckram No. 32, should be used for covering.

(b) Books used constantly should be bound in half Turkey morocco or Niger morocco.

### MUSIC

1. The most essential quality of a well-bound book of music is its ability to lie flat wherever opened. It is unwise therefore to use any kind of an overcast stitch in sewing. Regular sewing on tapes, instead of bands, must be used.

2. The square at the bottom of the book should be greater than at the top so that leaves will not catch on the music-rack when turned over.

3. Imperial morocco cloth should be used for covering. If hard usage is expected half cowhide, with sides of some kind of washable cloth, is preferable.

4. Part music for various instruments or solos with accompaniment must have one strong binding for the part which takes the most space, with pocket on the inside of the back cover to hold the other parts. If these are bulky compensating guards should be inserted in the back of the book.

### BOOKS OF ILLUSTRATIONS

Every library finds it necessary to bind a few books, such as Racinet's "Le costume historique,"

which have very little text and a great number of illustrations. It is evident that the illustrations in such books are most useful if kept in unbound form in portfolios, but when kept in such a way they are likely to be lost, torn, mutilated or misplaced.

1. Each plate should be guarded with thin, tough paper and the guards overcast.

This insures a good strong sewing; in addition the guard forms a hinge where it meets the plate and the plate will lie flat and can easily be examined when the book is opened.

2. Because of the artistic nature of such books, they should be bound in one-half morocco, taking extra care to see that acid-free leather is used.

3. Canton flannel and bands, or tapes, should be inserted between split boards. If the book is very heavy, it would be wise to line the back with duck or a fletcher rather than with canton flannel.

#### COMMERCIAL BINDING FOR REFERENCE BOOKS

While they are not a part of library binding, it may not be amiss to include specifications for commercial binding of heavy reference books, such as dictionaries, cyclopedias, etc. It is done with the hope that librarians will exert pressure upon the publishers to induce them to adopt these or other specifications which will produce equally good results.

1. Four tapes should be used in sewing; the tapes must extend on each side of the book at least two inches. The book should contain as many stitches as possible, using the best four-strand cotton thread.



The thickness of the thread will depend somewhat upon the number of pages in a signature. Books should be sewed "all along" with no splitting of signatures at head or tail.

2. First and last signatures should be reinforced inside and outside of the fold with a strip of strong, thin muslin which passes around the outside of the end papers. The English cloth called jaconet is the best for this purpose.

3. The second signature and the next to the last should be reinforced with muslin on the inside of the fold.

4. The end papers should also be lined on the inside.

5. Illustrations should be guarded with muslin which is folded around the next signature.

6. Books should be lined with a medium grade of canton flannel, with the fuzzy side to the back and extending from one-half inch from the head to within one-half inch of the tail of the book, lapping over at least two inches on the side.

7. The flannel, together with the tapes, should be inserted between split boards.

8. Over the canton flannel, but not extending over to the sides, there should be pasted a good quality of linen, rope or manila paper of sufficient thickness to make the book firm. In putting on this lining paper paste instead of glue must be used.

9. Volumes should have French joints.

10. The best quality millboard of suitable thickness with rounded corners should be used.

11. Leather should be made, if possible, according to the specifications of the London Society of Arts. Niger morocco is probably the best. Volumes should have leather corners as well as backs.

12. For cloth sides, Winterbottom's Imperial morocco cloth, Bancroft's Legal buckram, or Holliston's Library buckram should be used.

## CHAPTER VI

### BINDING BEFORE PURCHASE AND REINFORCING

One way of economizing in libraries is to buy books that have been bound in strong binding before they come to the library. It is not, however, a universal panacea which will reduce binding bills to a minimum. On the contrary, if not used with caution, this plan will result in the expenditure of large sums of money for which the library will never receive a return in actual wear of the books. Library binders who adopt this scheme buy books in the sheets from the publishers, put them into a strong binding and sell them directly to the library. Mr. Cedric Chivers of Bath, England, was the first to adopt this plan. Later he started a bindery in this country, and since then other binders have followed his practice. For the librarian there are several advantages in this method of buying books.

1. Books can be bound according to the library's special needs before they have received any wear, while the paper is fresh and clean. Books printed on very thick, spongy paper must be sewed very strongly and receive special reinforcements that are not necessary on paper which is more suitable for binding. If a good library binder buys the sheets from the pub-

lishers, he can test the paper to see what kind of treatment it should receive, and he can then bind it suitably for library wear. If the book is used in the original publishers' binding it deteriorates much more rapidly than when properly bound at the beginning.

2. The book can remain in circulation at the time when it is most needed. Formerly one of the greatest trials in public libraries was the necessity of withdrawing from the shelves practically all the copies of a popular novel in order to send them to the bindery where they remained from four to six weeks, the public meanwhile hurling anathemas at the librarian for not providing sufficient copies of the book. Not only were the books out of circulation when most needed, but much time was used in preparing them for the bindery, checking them up on return, putting on the library marks of ownership, making cards, marking pockets, etc., all of which added to the expense. Today, in the case of new novels which are sure to be popular, such troubles are unnecessary. Instead of buying the original publishers' binding, the wise librarian buys a sufficient number of copies bound from the sheets; if the binding is properly done, he need pay no more attention to them until they are worn out. He has done what he could to prevent the public from becoming dissatisfied, and he has saved the cost of the work required to send them to the bindery.

3. Not only has he served his public better and saved the time of assistants, but in most cases he has actually saved money on his binding bills. Let us

suppose that he pays \$1.50 for a book bound from the sheets; and suppose that he also buys a copy of the same book in the publisher's cover at a cost of \$1.22, which, after it has been issued twenty times, has to be bound at a cost of 50 cents, making a total cost of \$1.72. If they are issued the same number of times there is a clear saving of 22 cents in favor of the book bound from the sheets. As a matter of fact, however, statistics kept by the Wilmington Institute Free Library indicate that the first book will be issued 125 times before it is discarded, and the second 100 times—twenty before binding and eighty afterward. If this be true, it is clear that there is a further saving, provided that both have to be replaced when finally worn out.

While these advantages are well worth considering, the librarian should not necessarily get all his books in this form. It is a plan which is peculiarly advantageous in the case of fiction and those few other books which are in constant use. In the case of juvenile books one must be cautious. Juvenile books, particularly books for boys, become soiled so much more quickly than the adult books that they frequently have to be discarded because they are dirty rather than because they are worn out. If the books were bound before purchase the library may have lost money, because one can frequently buy a publisher's book and rebind it more cheaply than he can purchase the book bound from the sheets.

Most books in the classes should be purchased in the regular publisher's binding unless they are con-

stantly used. In other words, the use a book is to receive is the test of whether it should be bound from the sheets before purchase. Having decided that the use of a book warrants binding from the sheets, it is well to consider other facts.

1. It may not always be wise to bind from the sheets all the copies of a new book by a well-known author whose works are always popular and likely to continue so for years. If ten copies are approximately sufficient for use during the first year, it is safe to say that in most cases they will be too many for the needs of the library during the second and third years. If they are bound in leather before purchase they will not wear out and during the third and succeeding years a number of them may be dead-wood on the shelves. It is therefore wiser to buy a few copies in leather binding and the others either in a regular publishers' binding, or in some publisher's cover reinforced. When these volumes have come to the point where they need binding the period of greatest popularity may have passed and they may be withdrawn, thus saving the library the expense of binding.

2. When the book is finally worn out and must be withdrawn from circulation, the question always arises, must it be replaced with a new copy? The majority of fiction and juvenile books so replaced are books of wide popularity. Occasionally a book, such as Henry James' "Princess Casamassima," or W. D. Howells' "Modern instance," is replaced because the library must have it on the shelves, not

because it is popular. But ordinarily the popularity of a book is the determining factor in replacing worn-out copies. The decision to replace carries with it the decision to keep a book on the shelves indefinitely. Since the book has proved its worth and is to receive hard wear, the reasons which prevailed against buying it in a strong binding when it was new no longer exist. The strongest binding that can be obtained suited to the strength of the paper is none too strong.

Perhaps the most vehement objection to books bound from the sheets comes from those librarians who have a strong sense of aesthetic values and who claim that these books are not so attractive to the eyes as the regular books in their bright and gay publishers' covers. The objection is valid. It must be admitted that the leather-covered books have the appearance of strength and serviceability, but not of beauty. If a reader knows that he wishes a particular book, he will not be prevented from taking it because of its appearance, but if it is bound in leather and he knows nothing about it, he will very likely pass it over and select some book which has a bright, attractive cover. This is true even of adults, while of children it is doubly true. A large part of the popularity of that well-known book, "Fighting a fire," is due to the attractive cover which almost always excites the interest of boys who happen to see it.

Although the first cost of books bound from the sheets is always greater than that of books in the regular publishers' covers, it is hoped that the economy of buying them under certain conditions has

been made clear. There is, however, a cheaper way of buying some books which one would otherwise obtain in this form. Every year many copies of popular fiction and juvenile books find their way to the shelves of second-hand book dealers. Some of these copies show signs of wear, while some of them are in excellent condition. In any event it is always wise to submit a list of replacements to some large dealer in second-hand books; to buy such books as may be obtained from him (generally at considerably less than one-half the published price); and to send them at once to a good library binder for rebinding before placing upon the shelves of the library. In this way one should get from 25 per cent to  $33\frac{1}{3}$  per cent of fiction replacements in a substantial binding at a cost much less than the cost of a book in the original publishers' binding.

#### REINFORCED BOOKS

For those who wish strong bindings, but who wish them attractive also, reinforced bindings can be recommended. Reinforced books are those which have been strengthened either by the publishers in the regular course of manufacture, or by some binder who takes the book as it comes from the publisher, removes the cover, strengthens the book and puts it back into the same cover. A reinforced book generally appears in the attractive publisher's cover, and it always appears in some form of cloth, never in leather.

Owing to the small number of times which books in the original publishers' binding were issued, the



committee on binding of the American Library Association made an effort in 1906 to induce the publishers to issue a special edition for library use. As it was recognized that the publishers would not take kindly to elaborate specifications for stronger bindings, the improvements asked for were made as few in number as possible. They were the following:

1. Sewed on three tapes (very small books sewed on two tapes).
2. First and last signatures reinforced with muslin.
3. Cloth strip in joints pasted on fly leaf and sewed through.
4. Thin strong muslin over backs.

An attempt to demand hand-sewed books was abandoned when it was discovered that this stipulation added greatly to the cost of the binding without noticeably increasing its strength. The main strength of a book bound according to these specifications lay in the guarding of the first and last signatures.

The honor of issuing the first reinforced book for library use belongs to Charles Scribner's Sons Co., who in the summer of 1906 bound 1500 copies of F. Hopkinson Smith's "Tides of Barnegat." Their specifications, based on those submitted by the A. L. A. committee on binding, required that:

1. Signatures contain not more than sixteen pages;
2. First and last signatures be guarded with muslin before sewing;

3. First and last signatures be oversewed (actually they were run through a sewing machine);
4. Lining papers be guarded with strong drill and sewed through;
5. The book be sewed on two tapes;
6. Highest grade super be used for back-lining;
7. Books be glued to the back of the cover; making a tight back book;
8. Buckram be used for the covers instead of the regular publisher's cover.

The extra cost of the book was ten cents, and it was an excellent piece of work. In actual wear the books far exceeded the hopes of those who favored the plan, for they all went through the period of greatest popularity without being withdrawn from circulation. When they came to the point where they could no longer be circulated, most of them were discarded instead of being sent to the bindery.

The initial success of the plan induced other publishers to try the experiment. In 1908 one hundred and twenty different books could be obtained in reinforced bindings from seventeen publishers. Among these publishers were the firms of Century Company, Harper, Houghton, Little Brown & Company, McClurg, Putnam, Scribner's, Stokes, and Warne. Some of these books were well-bound, the publishers evidently making a conscientious effort to meet the demands of the committee; others were makeshifts not worth one-half the extra cost.

The success of "Tides of Barnegat" encouraged Charles Scribner's Sons to give the experiment further trial, and from time to time during a period of

several months this firm issued books bound in this way. In no case, however, was the initial success repeated. After the experiments had been tried by the different publishers for several months the obstacles to the plan, several of which had been foreseen, grew greater rather than less, and in the end the publishers gave up the plan of providing special editions of new fiction and juvenile books for library use.

The main obstacle to the successful culmination of the plan lay in the inability of librarians to order books before publication, and in the inability of publishers to make special editions after the book had been published. The success of "Tides of Barnegat" was due largely to the fact that the author and book were well known in advance of publication. Librarians knew at once that they wanted the book and the orders were filed promptly. In the case of nearly every other book which Scribner published in this way librarians could not decide until they had actually seen the book, or at least had seen reviews of it. Quite naturally they sent in few orders for the books. On the other hand Scribner did not care to bind a large number of books in special binding unless they had some assurance that the books would be sold; and they could not at any time afford to manufacture a very small number. It seemed impossible to bridge this gap which existed between the publisher and the librarian.

Other reasons which worked against the success of the plan were:

- (a) The apathy of the library world in general.

In spite of efforts made both by publishers and by those librarians specially interested; in spite of the proved success and economy of the best reinforced bindings, librarians in general paid little attention to them.

(*b*) The opposition of booksellers. This opposition was not violent at any time; but a special edition for one class of buyers inevitably entailed more labor upon jobbers and booksellers with no financial return, since there was no discount on the 10c. extra cost. It followed that orders from librarians for the special library editions were filled by some jobbers with regular editions; and the time required to exchange the copy of a regular edition for one of a special edition was generally sufficient to prevent the librarian from returning the books. Had it been possible to have one central bureau to bunch orders and to distribute them, greater success might have resulted.

While the effort to induce publishers to issue special library editions and to keep them in stock was a failure, there were nevertheless good results from the venture. While most of the commercial bindings are no better to-day than they were ten years ago, yet the publishers know that something better is needed for library use. Small books which are used by children and receive hard usage are as a rule much stronger bound than formerly, and will last as long as they are needed. As one direct result of the agitation, the well-known Everyman's set can now be obtained in a library binding. Certain large

reference books, such as Webster's and the Century dictionaries, U. S. Catalog, etc., have been put into the strongest possible binding. In these cases the publishers have tried to meet the demands of librarians.

When the publishers ceased to make special editions for libraries several library binders undertook to supply books in this form. Their method was to buy the books from the publishers, remove the covers, re sew the books in the most approved library style and replace the books in the publisher's covers. When this cover wears out the sewing is so good that it is only necessary to recover either with a regular leather-back binder's cover, or with a home-made cloth cover. By this method the librarian is assured of a book in the same cover as the regular edition, the necessity of sending orders in advance of publication is obviated, and the publishers, jobbers and booksellers do not have to keep a stock of a special edition. In practice the plan works well.

Librarians for years have been annoyed because certain books, such as the Brownie books, have given such poor service no matter how they were bound. In the original boards they went to pieces very quickly and the paper was of such a character that they were hard to rebind. The strong leather bindings bound from the sheets were too strong because the paper wore out long before the binding. In 1912 books of this character, through the initiative of Mr. H. R. Hunting in Springfield, Massachusetts, were sewed by the Samson-back method, a

strong machine sewing; they were then covered with cloth and the paper covers, so attractive to children, pasted on the outside. The cost of the books was much less than that of the leather-back binding and they were much more attractive. The Samson-back method of reinforcement therefore practically solved the problem of binding large thin books with wide margins at the back, precisely the books that had given librarians the most trouble.

## CHAPTER VII

### COST

Binding is a work of repair, not one of expansion, and consequently the amount spent for this purpose adds little to the resources of the library. The modern librarian does not begrudge money for salaries; heat, light and the general up-keep are items that cannot be reduced materially in most libraries. But money spent on binding reduces the funds available for new books. Therefore, a study of the many ways in which binding bills can be made smaller is well worth while.

Two elements, material and labor, enter into the cost of binding, labor of course forming the larger part. Since the cost of labor varies in different parts of the United States, it is impossible to give figures of cost applicable to all places. Furthermore, as the cost of both material and labor is increasing constantly any statement made at the present time might be wrong a year from now.

So far as figures of cost are concerned, it therefore seems best to discuss maximum and minimum figures. On this basis it is fair to assume that it will not be necessary at any time in the near future to pay more than fifty cents a book for fiction and juve-

nile books eight inches or less in height, bound in cowhide, government cloth, or the more expensive imperial morocco cloth. For this amount the librarian should get the best binding obtainable. As high a price as this is actually charged by a few binders only, some of whom are justified in so doing because they give full value for the money, or because the cost of their labor is high.

If less than thirty-five cents is paid for fiction and juvenile books eight inches high, it is probable that the binding is not serviceable and therefore not economical; but in rare cases bindings costing thirty cents a volume will give excellent service. When low prices are charged the librarian should be sure that, taking the ratio of cost to circulation into consideration, he is getting full value. In general, it may be said that he who gets fiction and juvenile books well bound for less than forty cents a volume is to be congratulated. Naturally, this statement does not apply to the large libraries which bind a large number of books every month, and can therefore obtain better rates than the smaller libraries.

For books bound in cowhide or cloth, the cost increases at the rate of from fifteen to twenty cents a volume for every two inches in height.

The price of the smallest volumes bound in morocco is considerably greater than of those bound in other materials, and the increase according to size is also somewhat greater. One dollar is the highest price paid within the knowledge of the writer for an eight-inch morocco book, and sixty cents the



lowest price. The difference in the value of the work about corresponds to the difference in price.

Periodicals bound in government cloth, or duck, may cost from fifty-five cents to eighty cents a volume ten inches or less in height, increasing fifteen cents to twenty cents a volume for every two inches in height.

Newspapers well bound should not cost less than \$2.00 a volume, nor over \$4.00. More variations will be found in the prices for newspapers than in any other kind of binding.

Most binders are paid a certain amount for books eight inches high or less, the prices differing according to the material used. The price in a few cases increases with each inch or fraction thereof in height to ten inches; in most cases the increase is for each two inches or fraction. For example, a book which measures eight and one quarter inches in height is charged for at the ten inch rate. One which measures ten and one quarter inches at the twelve inch rate. Sometimes an extra charge for books which are much thicker than usual is justified.

The following schedule covers practically all the different sizes and materials which the librarian must take into consideration. The prices given are those actually charged by a good library binder.

## REBINDING

ADULT AND JUVENILE AND MISCELLANEOUS BOOKS NOT  
EXCEEDING 2 INCHES IN THICKNESS

	8 in.	9 in.	10 in.	12 in.
Half Pigskin or Cowhide.....	45	55	65	85
Full Cloth (Library Buckram).....	40	50	60	80
Full Imperial Morocco Cloth.....	45	55	65	85
	14 in.	16 in.	Extra sizes per inch	
Half Pigskin or Cowhide.....	1.10	1.30	20 cents	
Full Cloth (Library Buckram)..	1.00	1.20	15 cents	
Full Imperial Morocco Cloth....	1.10	1.30	20 cents	

Books over 2 inches thick charged at rate of size above.

MAGAZINES, PERIODICALS, SHEET AND FOLIO MUSIC NOT  
EXCEEDING 4 INCHES IN THICKNESS

	8 in.	9 in.	10 in.	12 in.
Full Cloth (Lib. Buck.) or Full Duck	45	55	65	85
Full Imperial Morocco Cloth.....	50	60	70	95
Half Cowhide .....	50	65	85	1.10
Half Pigskin (English) .....	55	70	90	1.15
Half Pigskin (American) .....	50	65	85	1.10
Half Morocco .....	65	80	1.00	1.25
Half Duck (Waterproof sides) ....	45	55	65	85
	14 in.	16 in.	Extra sizes per inch	
Full Cloth Lib. Buck. or Full Duck	1.10	1.35	15 cents	
Full Imperial Morocco Cloth.....	1.20	1.45	20 cents	
Half Cowhide .....	1.30	1.60	20 cents	
Half Pigskin (English) .....	1.35	1.65	20 cents	
Half Pigskin (American) .....	1.30	1.60	20 cents	
Half Morocco .....	1.50	1.85	25 cents	
Half Duck (Waterproof sides) ...	1.10	1.35	15 cents	

Above prices include all lettering on books.

Books over 4 inches thick charged at rate of size larger.

Newspapers not over 30 inches, in half library buckram or half duck \$2.25, or in full duck, \$2.40.

Special prices for dictionaries, cyclopedias and other sizes not in above schedules.

## SUGGESTIONS FOR REDUCING COST

Following is a statement of plans for cutting down the cost of binding, a few of them being obviously makeshifts for the benefit of poor or very small libraries.

## BOOKS BOUND BEFORE PURCHASE

Under this head will be found (in Chapter 6) a full statement of reasons for buying books bound from the sheets.

## REPRINTS BOUND BEFORE PURCHASE

The cheap reprints of popular novels which cost less than one-half as much as the original edition, although attractive in appearance, are very poorly bound and if bought in original covers must be rebound within a short time after they are first placed on the shelves. Some librarians find that it pays to send orders for books which can be obtained in cheap reprints directly to their binders, who buy the books and rebind them in the regular half-leather binding which the library uses for its rebound fiction and juvenile. He bills the books to the library at the cost of the volume plus the cost of binding, the total in any event being considerably less than one dollar. Not over ninety cents should be paid and eighty-five cents is the general price for such books. In this way the library gets a book in a good, strong library binding for less than the cost of the original edition in publisher's cover. Furthermore all labor involved in sending the book to the bindery and receiving it again—no inconsiderable item—is eliminated.

## SECOND-HAND BOOKS

Akin to the foregoing plan is the practice which some libraries have of sending lists of replacements to dealers in second-hand books and having all books obtained in this way rebound at once before putting them into circulation. Moreover this arrangement eliminates the time and labor necessary to send a book to the bindery. Binderies in large cities can undertake to supply second-hand books, with advantages both to themselves and to the libraries employing them. The library is relieved from the necessity of searching for second-hand volumes, while the binder can well afford to do this service for a stated price per volume which will be reasonable from the library point of view, but which will allow the binder profit on all books which he can find at very cheap prices. When such a plan is adopted the binder should understand that the library wants neither the cheap books printed on wretched paper and having very small print, nor the very fine editions with colored illustrations.

## REINFORCEMENTS

A reinforced book is one which has been removed from the original publisher's cover, strengthened in various ways and put back into the same cover. (See chapter on this subject, page 108.) In its best form it means the complete resewing of the book with an overcast stitch. It is advisable to buy such books frequently, since they preserve the attractive publisher's cover and since they can also be recovered by

the library itself without resewing. Statistics kept by the Wilmington Institute Free Library show that such books when properly recovered give as good relative service as those which have been bound before purchase. The main advantage lies in the elimination of the time necessary to send them to the bindery and the greater length of service which they give at the height of their popularity.

#### RECOVERING AT THE LIBRARY

Many books which come to the binding department require rebinding in order to put them into the best condition, but the books will be used so little that rebinding would not pay. In the numerous cases in which the sewing is in good condition it will be possible to recover them at the library and letter them by hand. In cases where the sewing is poor it will be possible to re sew and recover. Such books are neither so strong nor so attractive as books which have been wholly rebound, but they can be recovered at an expenditure of less than fifteen cents a volume, as against forty to fifty cents a volume for binding, and are in sufficiently good condition to wear a long time, perhaps as long as the library needs them. (For description of the process of recovering see page 185.)

#### DISCARDING VALUELESS BOOKS

In the preceding case it has been taken for granted that the books in question add something to the resources of the library and that they must be kept. Books that have outlived their usefulness because they

have been superseded by later editions, or by other books more authoritative, in all except the largest libraries should be discarded. (For arguments in favor of this see Chapter 8, p. 131.)

#### LEATHER VS. CLOTH

Notwithstanding that he is repeating himself, the writer wishes to emphasize one point. It may almost be made a general rule, though like other rules, it will not work well at all times. Never bind a seldom used book in leather, or a much used one in cloth.

#### CHEAP EDITIONS

Money may be saved by replacing books which need rebinding with good editions cheaper than the cost of binding. (See (*f*), page 129.)

#### PROPER CARE

The life of the book in the library may be prolonged in several ways.

1. In opening the leaves of uncut books at the top the paper knife should be carried to the back of the book, using a dull knife that is thin, long and tapering.

2. Many books should be carefully opened before being placed on the shelves. This is done by resting the book on its back and dropping the covers on the table. Taking a few leaves at a time first at the front and then at the back, press them down carefully until the middle of the book is reached. If this be done

there is little chance that the back of the book will be broken if the book is suddenly opened.

3. Books should not be pressed tightly together on the shelves.

4. They should not be piled on other books resting on their fore-edge.

5. They should not be pulled from the shelves by the head bands.

6. They should be dusted frequently.

7. They should be kept upright on the shelves instead of half-fallen over.

8. In every way they should be handled as if they were books, not bricks.





## CHAPTER VIII

### PREPARING FOR THE BINDERY

To decide properly what books should be rebound and how they should be rebound is not a simple matter nor one which should be left to an inexperienced or uneducated assistant. In addition to a good working knowledge of materials and processes the assistant in charge of this work should have a general knowledge of books—paper, editions, prices, literary value, timeliness, etc.—and good judgment in deciding whether a book should be bound or whether it should be mended, recased, wrapped in paper, recovered, or thrown away. The binding, therefore, should be in the hands of an assistant who understands the demands of this department of library service, and for economy's sake as well as for the sake of efficiency it should not be shifted from one person to another.

Mr. Dana has shown in his "Notes on bookbinding for libraries" how essential it is that binding assistants should know books. Credit for much of what here appears in support of that viewpoint is due him and is herewith acknowledged.

In considering the binding of fiction and juvenile books the following are some of the questions which the binding assistant must ask and decide before determining whether a book is to go to the shelves in a new dress, or to the junk-man as waste paper:

(a) Is the book in such poor condition that it cannot be rebound or recased? If so, it must be discarded. While this decision is generally easy to make, it is sometimes made difficult by books which are in too good condition to throw away and in too poor condition to rebind. In such cases the decision must depend on the popularity of the book. If very popular, it may be wise to rebind it, for it must be remembered that good library binders can accomplish wonders with books that are in poor condition.

Sometimes the question arises whether the book is in poor enough condition to need rebinding. Perhaps it will survive a few more issues just as it stands. If the book is a trifle shaky in its covers, the decision should be to rebind. The binder can do a better job at this time than he can when the book becomes more worn, and the life of the book will be prolonged by prompt binding. If the assistant decides not to rebind it, the book will be issued only a few more times before it will have to be withdrawn from circulation and sent to the repair room again. The result is a greater loss of time with no actual gain in wear.

(b) Is the book much read? If it is an old one that is evidently popular, it is reasonable to suppose that it is the policy of the library to supply the demand for this book, and the book will be rebound as a matter of course. A decision about new books which are popular is harder to make because it is fair to ask:

(c) Is the demand falling off? It is here that

the assistant must show good judgment. It may be that the book can be rebound easily with profit, if there is a sufficient demand to keep all the copies in circulation. It may be that the book is waning in popularity and that other copies in the library are ample to supply present demands. If they are, the copy in hand should be canceled, since the cost of binding will then be saved. But the assistant should ascertain the condition of the remaining copies. Let us take the case of a novel which has been withdrawn from circulation because it needs rebinding. The assistant looks at the record of circulation on the book card or pocket and discovers that last year the book was issued four times a month, while now it is issued only twice a month. He finds also that there are four other copies. These four copies should be sufficient to meet present demands, and the book in hand may be withdrawn. But suppose that further investigation shows that two of the four copies are in very poor condition and cannot be rebound. If he withdraws the one in hand, only two good copies will remain, and perhaps these are not sufficient to supply the demand. On the other hand, it is possible that they are sufficient to supply the demand. In any event, the situation is one which requires a knowledge of the book itself, its popularity with the public, and general good judgment. The question may be summed up in this way :

1. It is cheaper to rebind a book than it is to discard it and later be obliged to buy a new copy.
2. It is cheaper to discard a book when it seems

assured that the book's popularity is over, than to bind it and have it remain for years unused.

(*d*) If the book is much used, is it a book that the library wishes to circulate? Every library has certain books on its shelves of which those in authority somewhat disapprove, but which are very popular and not poor enough to be done away with altogether. It is sometimes the policy to supply only partially the demand for such books; sometimes to discard them entirely when worn out. The good binding assistant will remember the titles of these books and use good judgment in dealing with them when they come into his hands.

(*e*) If the book is not much read, is it a standard work? For example, in the case of a work of Anthony Trollope the assistant discovers that it was issued only once during the last year and that it is the only copy in the library. If he does not "know books," he will be led to believe that the book has no value and will cancel it. In a large library an action of this sort would be unwise; in a small library the decision would depend upon the particular title. Most libraries keep a book of this particular class in order to supply the occasional demand for it. There are many books not written by men with the reputation of Anthony Trollope which, nevertheless, have intrinsic worth and have a small circle of admirers. They may not have great merit, but on no account should the library be without them. As examples of books of this kind we may take Mrs. Brush's "Colonel's opera cloak" and Theodore Winthrop's "John Brent."

(f) Can the book be replaced with a good reprint which will wear as long as a new binding and cost less? While there are not many cases in which this can be done, the assistant should watch for them. The most noteworthy reprints which will meet these requirements are the volumes in Everyman's Library. In the original Everyman's edition these were entirely unsuited for library use, but in 1910 they were all put into a strong library binding. In the cloth edition they sell for thirty-five cents a volume and can easily be issued from forty to fifty times before being discarded. This makes the cost for each issue as small as can be obtained by binding higher-priced editions.

The following case, which actually happened, illustrates the point, although the books are not fiction. Grote's "History of Greece," in twelve volumes, was in bad condition; several of the cloth backs were torn and the sewing of all the volumes was loose. It was decided to send the books to be rebound at a cost of \$5.40. Before doing so, the list of Everyman's Library was consulted and it was found that the work could be obtained in that form in twelve volumes at a cost of \$4.20, a clear saving of \$1.20, or over 20 per cent. The work was seldom used, yet it was necessary to have the set on the shelves; the Everyman's edition answered every purpose, and will undoubtedly last as long as the rebound set would have done. Unfortunately, owing to copyright provisions, comparatively few of the books which are constantly wearing out can be obtained in this edition.

(g) Is it an old edition, with poor paper and

poor type? A book of this sort should never be rebound but should be discarded and a new copy purchased even if the cost of a new copy be much greater than that of rebinding.

(*h*) If the book is the only copy in the library and is read not oftener than once in ten years, should it be kept because it is important historically? Good examples of this class of unused books are the works of Charles Brockden Brown. They are not interesting at the present time, but when first published were much read. Every student of American literature should read them, and they should be on the shelves of all except the small libraries. Here again good judgment is called for on the part of the assistant.

(*i*) Is the book used so seldom that it can be recased or recovered by the library? The process of recasing (described on page 184) can be used in the case of small-sized books which have covers showing little evidence of wear, and which do not receive hard usage. The process of recovering (described on page 185) can be used on leather-bound books which have cracked at the joints. In either case the sewing must be perfectly sound.

(*j*) Finally, let us suppose that we have asked all the foregoing questions and are still undecided what to do. There will be very few cases of the kind. Perhaps the best solution is to wrap the book in paper, letter it with author, title and call number, and transfer it from the fiction shelves to the regular literature shelves. It may stay there for years unused and yet be at hand when finally called for.

With books other than fiction and juvenile many of the same questions must be asked. In addition, however, it is sometimes necessary to ask the following:

(a) Are there later editions which are more valuable? This question will arise with frequency especially in the case of scientific, technical and reference books, and careful judgment must be exercised in making decisions. It often happens that a later edition of a technical book has little more value than the one which precedes it; frequently it entirely supersedes the earlier edition. In the one case the book can be rebound with profit, in the other it is best to discard it and buy the latest edition. Some libraries keep all the editions of a book for historical purposes; but most libraries, especially the smaller ones, will do better to discard older editions when they are superseded by later ones. Sometimes a book has no later edition, but its place has been entirely taken by the work of other authors. In such cases it should be remembered that an out-of-date technical book in the hands of an inexperienced person frequently causes more harm than good. It may cost more to buy a new book than to rebind an old one; yet this is exactly what should be done in every such case if the funds of the library permit.

(b) May not the library be better off without either the book or a substitute? In the past librarians have hesitated to discard any book which has once been placed on the shelves. They have believed that all printed matter has value and that a book

which belongs to the library is sacred and must on no account be destroyed. It is difficult to defend such an attitude. If we admit for the time being that the librarian never makes mistakes in acquiring books, still it is sure to happen that many books will outlive their usefulness, except as a part of the history or bibliography of the subject. Why should they be kept on the shelves when they are not used and ought not to be used? It cannot, of course, be admitted that the librarian makes no mistakes in acquiring books; every library in the country will show examples of poor selection. Why, after a mistake has been made, refuse to admit it? If the original purchase (or acceptance of a gift) was a mistake, to keep the book on the shelves simply perpetuates the mistake and adds to the expense of maintenance. It is no crime to discard a book. On the contrary, in many cases, it is the only sensible thing to do. In doubtful cases, however, the book should be kept.

#### ARRANGEMENT

If the final decision is to bind the book the next step is to arrange the book in the way in which it should be bound. The question of collation is one on which there has been a difference of opinion. Some librarians have claimed that it is best to collate books at the library in order to prevent imperfect books being bound, since it is always disappointing to discover, after a book has been bound, that it is incomplete. In the great majority of cases, how-



ever, collation is a waste of time, since good binders refuse to bind imperfect volumes. In the case of very valuable books, especially those with many plates, and even in the case of less valuable books which have many illustrations not paged-in, it may be best to collate at the library since it is obviously unfair to the binder to expect him to be responsible for anything except the main paging. Fiction or juvenile books may sometimes be bound when one or two pages are missing. Juvenile books, especially, often go to the bindery with missing pages. Many times these missing pages are not especially important and in these cases it seems more economical to bind the book than to buy a new copy. If the number of missing pages is not too great they may be typewritten from other copies. Books other than fiction or juvenile should seldom be bound in an imperfect condition.

Another exception to the rule of sending books uncollated is in the case of popular periodicals, such as Scribner's, Harper's, Century, etc., where the library has only one copy which it binds. Since periodicals frequently become torn and mutilated and must be replaced it will save delay in having the volumes bound, if the collation is done at the library.

But while collation is generally unnecessary, arrangement in proper order is essential. In dealing with periodicals this is not always an easy task. They should first be examined to see that all the numbers are in hand, and that there is a title-page and an index. It would seem as if there were little

chance to go astray in doing this, yet the vagaries of periodicals are innumerable and nothing must be taken for granted. If only five monthly numbers are found when there should be six to complete the volume, it is not best to conclude hastily that it is incomplete. Sometimes the cover indicates that two numbers are published in one. If it is not so indicated one must look at the paging. If the paging is consecutive, and there is a title-page and index, it is safe to assume that the volume is complete, even if a number is apparently missing.

The general rule for arranging periodicals is: Place title page at the beginning, followed by table of contents, text, and index at the end. Periodicals in English are generally easy to arrange, though even in this case one must know whether the periodical in hand is in the habit of publishing supplements which are paged separately, but which are called for by the table of contents. If such supplements are omitted the volume is incomplete. An example of a periodical of this class was the *Annals of the American Academy of Political and Social Science*, before it changed to its method of issuing each number as a separate volume. Many volumes of English periodicals such as *All the Year Round*, *Household Words*, etc., have been bound without the Christmas supplements, which those periodicals always issued. A few periodicals in English have two or more sets of pagings either in each number, or in some of the numbers and not in others. When the numbers are taken apart and the proper pagings grouped together, the table of contents will generally indicate how these

should be arranged. But if not, it is usually readily apparent which is the main paging and which the minor paging or pagings.

Though rarely found in periodicals printed in English, this exasperating condition of affairs frequently exists in foreign periodicals. The Germans are especially fond of printing several different parts in the same number. Frequently a long monograph will begin in the first number of a volume and extend through two or more volumes. When completed it may or may not have a special title-page and index of its own. Perhaps the table of contents of the last volume in which part of it has appeared will call for it as a supplement to that volume. Perhaps it does not. In any event the paging must be removed from the first and succeeding volumes until the monograph is finally complete. If it is not called for by any regular title-page or table of contents, it may be bound separately. Sometimes a periodical will appear in two or more parts each month, each part covering some phase of the larger subject indicated by the general title of the periodical. These parts will be paged separately and numbered differently but will have the same kind of cover, and care must be used to keep the proper parts together. Peculiarities and irregularities of this sort make periodicals veritable puzzles, some of which it may take months to solve.

In arranging periodicals, front covers having a different color from the text must be kept to facilitate use.

Advertisements as a rule should not be bound.

Since they are a part of the history of the times, it is desirable for a few of the largest libraries to bind the advertising pages of one or two numbers a year in each periodical. Other libraries should throw them away. It is not necessary to remove them entirely before sending the volumes to the bindery; tearing down two or three inches on pages which are to be discarded is sufficient indication to the binder that they are not to be bound.

Several magazines, such as McClure's and Everybody's, have, for several years, made a practice of leaving articles unfinished in the main paging and continuing them on advertising pages. This is an annoying practice since great care must be taken to see that all text matter is complete, even if it becomes necessary to bind all advertising pages.

Many periodicals, especially those of a scientific character, contain plates which are not paged-in. If these are scattered through the text they may be allowed to stay there, but if they are grouped together at the end of each number they should be placed together in proper order at the end of the complete volume.

The vagaries of periodical publishers are shown as much in the way in which they issue (or do not issue) title-pages and indexes as in any other way. The proper way, which is seldom done, is to issue both title-page and index in the last number of each volume. Some publishers issue them in the first number of the next volume; some at various times during the publication of the succeeding volume.

Some publish a title-page at the beginning of the first number of a volume and an index when the spirit moves. Some publish a title-page but no index or table of contents. Others publish a title-page and table of contents but do not send them unless requested to do so. Many publish neither title-page nor index, and perfectly reputable periodicals which have published these essential parts of a periodical for twenty years or more will suddenly cease publishing them. It is evident that title-pages and indexes are nuisances in preparing periodicals for the bindery.

The assistant in charge should keep a record showing (*a*) which publishers must be asked to send title-pages and indexes, and this should be done as soon as possible after the volumes are complete; (*b*) in which number of a periodical title-pages and indexes may be looked for if they come regularly; (*c*) which periodicals do not publish title-pages and indexes.

If lack of funds makes it impossible to bind periodicals and they must be wrapped in paper it is highly important that title-pages and indexes be included, since it may be impossible to obtain them when funds permit binding.

Changes in the size of periodicals are a cause of annoyance. The annoyance is not great when the change is from a large quarto to an octavo, for the cost of binding an octavo is considerably less than that of a quarto. Unfortunately, the present tendency is almost wholly the other way. Many periodicals, for years published in a comfortable octavo

size have been changed to a much larger size. This in itself is exasperating, but in addition the publishers apparently make no effort to change the size with the beginning of a new volume, so that part of a volume will be of one size and part of another. In such cases the troubles of the binding assistant may be readily imagined.

While it is highly important to bind only complete volumes of periodicals, it is occasionally permissible to bind volumes with guards for missing numbers which may be inserted later if they are obtained. This method makes it possible to put a volume into permanent form better suited for use than unbound numbers, and prevents further loss of numbers already in hand. It can be done only when the numbers are very thin, particularly in the case of newspapers.

Quite a number of periodicals have so few pages in each number that a complete volume makes a very thin book. In such cases it is best to bind two volumes in one at the cost of one.

Among other material which passes through the hands of a binding assistant are the annual reports of various organizations—religious, charitable, fraternal, governmental, etc. In large libraries these must be bound for permanent preservation. In small libraries the annual reports of all local organizations should be bound if funds permit, others wrapped in paper and lettered on the wrapper. Whether they are to be bound or wrapped in paper, they should be grouped by regular periods, preferably five or ten

reports in a volume, according to size, following the decades or half decades.

### INSTRUCTIONS TO THE BINDER

Having decided that the volume must be bound and having arranged it in its proper order, the next step is to indicate to the binder how it is to be bound and lettered. Various methods have been used to indicate style and lettering. Some libraries have an elaborate binding slip, giving on one side the different materials, colors, etc., and having the other divided into panels for lettering. A slip is made for each book and the binder follows it carefully. Some libraries arrange an arbitrary system with the binder making one letter or figure indicate much that otherwise would have to be written in full. For example, "C" under such an arrangement might mean "Bind in one-half red cowhide with green cloth sides." Some librarians give a general blanket order to bind all fiction in one way and all juvenile books in another.

For most books in English, except periodicals, lettering need not be indicated on a binding slip. All that is necessary is to underscore lightly on the title page the first letter of words which must be used. The call number may be put on a binding slip enclosed in the book, or in the case of fiction and juvenile books, it may be pencilled lightly on the title page, thus doing away altogether with the binding slip. If there is a chance for misunderstanding on the part of the

finisher, or if an author's real name must be used instead of a pseudonym which appears on the title page, a binding slip must be filled out giving exact lettering.

While exact lettering on a binding slip is not essential for ordinary books, it is necessary for periodicals, each set of which should be bound and lettered uniformly. This may be assured by making out a binding slip giving in full the title, dates covered, volume number and call number, if one is used. The slip goes to the bindery with the book, and when the volume is returned is filed so that when the next volume is to be bound the slip can be consulted and a new one written with the necessary changes in volume number and dates. The chief value of the slip is to show exactly how the previous volume has been bound, so that the following volumes can be made uniform if possible.

A carbon copy of binding slips for periodicals should be made, to be kept at the library for charging purposes.

When binding volumes which are a part of a set, other than a periodical, a slip must be made to be kept on file so that when another volume of the set comes to hand it will not be necessary to visit the shelves to see whether other volumes have been bound and how they have been bound.

In finishing periodicals the position of lettering and the size of type used may be kept uniform if the binder takes what is called a "rub" or "rub-off" of the book after it is lettered and keeps it on file at



the bindery. This can easily be made by laying a sheet of thin, but tough, paper over the back and rubbing it with shoemaker's heel-ball which will show white lettering on a black background. When the next volume comes to the bindery the "rub-off" shows exact height of boards, exact position of lettering and size of type.

A few libraries have had a dummy back made for each periodical showing color and kind of material in addition to other details. But the cost of a dummy is not slight and a new one must be made whenever any change in title or size occurs. Large college or reference libraries may need dummy backs for their numerous sets of foreign periodicals having various marks, such as umlauts, etc., over or under letters. When a library operates its own bindery it is possible to send the last bound volume as a sample. While this adds much to the routine, its main advantage is that it eliminates the possibility of mistakes due to defective dummy or indistinct "rub-off."

### LETTERING

It is necessary that binders understand exactly how books are to be lettered, what kind of type to use and the position on the back of the book which each item of information must have. There are differences of opinion as to the best ways of lettering, but it is essential that every librarian have uniformity in his own library, even if he disagrees with his fellow workers. In all lettering a bold, clear type should be

used, and all figures should be in Arabic, since it is plainer than Roman.

In most leather bindings the back is divided into five or six panels, making it possible to obtain uniformity by setting aside each panel for a definite purpose. If desired, another narrow panel may be made in which to stamp a mark of ownership. Paneling is a useful device in the case of books which are eight inches or more in height, but in the case of juvenile books and fiction it may be omitted entirely. As most of these books require simply author, title and call number, if one be used, the device of paneling adds to the labor in binding and serves no useful purpose in the library. It should be used on most other books bound in leather and on all periodicals bound in cloth or duck.

Which shall go at the top of the book, author or title? In favor of the title it can be claimed that all publishers letter the title first with the author second; and since in non-fiction the books in publishers' covers on the shelves will outnumber the rebound books, it is advisable to put the title first in order to have uniformity. On the other hand, it can be claimed that the arrangement under the class is by author, that most library assistants look for the author rather than the title, and that it is therefore advisable to put the most important item of information at the top in the position of greatest prominence. In the opinion of the writer this advantage outweighs any other.

It may be assumed, therefore, that the best arrangement is author, title, volume number if neces-

sary, and call number. In the case of fiction, juvenile books and all other books from which it seems desirable to omit panels, these items will be put on with sufficient space between to make them independent of each other. The bottom of the call number should be  $1\frac{1}{4}$  or  $1\frac{1}{2}$  inches from the tail of the book on all books in the library, except oversized books, which should have the call number at the top (Fig. 16). If panels are used, the author's name should be near the bottom of the first panel, the title in the second, volume number in the fourth and call number in the fifth (Fig. 15).

If two books are bound together, letter, author and title of the second book in the third panel (Fig. 17).

When a work is in more than one volume with separate titles for each volume, place the author's name in the first panel, general title in the second, volume in the third and the title of the particular volume in the fourth (Fig. 18).

If six panels are used, each item is dropped one panel.

In most cases the author's last name is sufficient, but occasionally it may be necessary to use initials to distinguish between authors having the same name. Use both surnames of joint authors (Fig. 19). For pseudonyms use the form adopted by the cataloging department. For example, if the catalog entry is under Clemens instead of Twain, letter Clemens on the book. Both real name and pseudonym may be put on the back, but it does not seem necessary. In

Beecher
Sermons
1
252 B 398

Fig. 15

914.5 qJ 23 James
Italian Hours

Fig. 16

Patton
Home And School Sewing
Rorer Hot Weather Dishes
641 R 694

Fig. 17

Bancroft
Works
30
Oregon 2
979.5 B 22

Fig. 18

Kipling Bailestier
Naulahka
K 575

Fig. 19

Plato
Dialogues
Jowett
1
888 P 69

Fig. 20

National Conference on City Planning
Proceedings
1
Chicago
352 N 23

Fig. 21

Nineteenth Century
Jan.-June 1894 35

Fig. 22

Nature
Nov. 1895 Apr. 1896 53

Fig. 23

National Municipal Review
1913 2

Fig. 24

Littel's Living Age
July-Sep. 1888 178
Series 5 63

Fig. 25

Independent
Apr.-June 1903 55 Part 2

Fig. 26

Punch
1882 82-83

Fig. 27

Griggs Use of the Margin 170-G87
--

Fig. 28

Harper's Magazine
Index 1-40

Fig. 29

Monist
1908 18
Index 1-17

Fig. 30

the case of the classics add the name of translator or editor in the panel under the title (Fig. 20).

When the names of foreign cities or countries must be placed in the author panel, use the English form. Names of government departments, bureaus, etc., should be inverted if necessary to bring the distinctive word first. For example, use Health bureau, not Bureau of health.

In lettering titles it is seldom desirable to omit the first part of the title in order to use words which are more distinctive, in other words, to use a binder's title. If it is necessary it should be done with care and discrimination. Ordinarily, give first words, omitting articles. Very long titles must be condensed, sometimes at the expense of clearness.

Proceedings of organizations which meet in different cities should have the name of the place of the meeting lettered in the third panel (Fig. 21).

On periodicals, the author panel is left vacant and the title of the periodical given in full in the second panel. Here it is never permissible to omit first words, except articles. Letter "American review of reviews," not "Review of reviews." In case of foreign periodicals it may be necessary to place a sub-title in the third panel when a periodical is issued in two or more parts and each part bound separately with a distinct title page. With this exception, leave the third panel vacant and letter date and volume number in the fourth panel. Place first the months covered by the volume, followed by the year (Figs. 22 and 23.)

Use the first three letters of each month, except June and July, which should be given in full. On foreign periodicals use the English abbreviations for months. If the volume covers the calendar year the months may be omitted (Fig. 24). In the same panel place the volume number beneath the year.

If the periodical has more than one series give dates and total volume number, placing underneath the series number and volume of series (Fig 25).

If the unbound volume of a periodical is too large to be bound in one book, bind it in two volumes and letter the exact months in each part, placing "Part 1" and "Part 2" underneath the volume number (Fig. 26).

If two volumes are bound in one give the inclusive volume numbers (Fig. 27).

In the case of periodicals having more than one series and which are indexed in Poole's index or the Readers' guide, the volume number given first should correspond with the one given in the indexes.

Thin volumes must be lettered lengthwise in the same order as outlined above. Always letter from head to tail. This facilitates reading on the shelves. since shelves are naturally read from left to right. In lettering lengthwise place the book number below the class number, if there is room, if not, after the class number with a hyphen between (Fig. 28).

Oversized books which must be shelved on their sides should also be lettered from head to tail.

If the book is an index complete in itself letter

the word "Index" in the fourth panel, followed by the inclusive volume numbers covered by the index (Fig. 29).

If a periodical index covering several volumes is included at the end of one of the volumes, place the word Index and the inclusive volume numbers underneath the dates and regular volume number (Fig. 30).

Other questions are sure to arise, but they can be solved satisfactorily if it be remembered that the essentials are definiteness and clearness.



## CHAPTER IX

### BINDING RECORDS AND ROUTINE

Binding records must be as simple as possible, but they should

1. Instruct the binder.
2. Show what books are in the bindery and when they were sent.
3. Show how previous volumes of a set have been bound.
4. Act as a check on books when returned.
5. Show the cost of binding.

Some librarians keep a record of all books bound, called a "binding book." To the writer the need of a permanent register of books bound is not apparent. It is much easier to keep in other ways a record of books actually in the bindery and after the books have been bound and returned to the library the value of having the fact recorded in any other place than on the accession book is negligible. In the case of popular books easily replaced we may even question the necessity of recording in the accession book the fact that a book has been bound. Any other permanent record seems useless.

1. When books are sent to the bindery the binder must be told:
  - a. In what material each book is to be bound.
  - b. How each book is to be lettered.

The best way to indicate lettering, etc., has been shown in the chapter "Preparing for the bindery." The designation of material and color can frequently be done by giving a blanket order if the books are of the same character. For example, if all the books are fiction it is perfectly feasible to send a written order, stating that they are all to be bound in half brown cowhide with red cloth sides, French joints, etc. If the shipment is a miscellaneous one of periodicals, reference books, fiction and juvenile books it may be necessary to state on the binding slips how each book is to be bound.

2. For public libraries the question of keeping a record of books that are in the bindery is a simple one. The use of book cards for charging purposes is practically universal. All that is necessary is to remove the book card from the book, stamp the name or first initial of the binder's name and the date after the last charging date (Z25Ap14), and file the cards just as they are filed at the loan desk. If a book cannot be found on the shelves or in circulation, it takes but a few seconds to discover whether or not it is in the bindery. When the book is returned the card is replaced in the book. This is the easiest way of keeping this record and shows at once how many times a book circulated in the publisher's covers before it needed to be bound.

For books which have no book cards, such as reference books and periodicals, it will be necessary to write a slip which can be filed as a record with the book cards. If a binding slip must be sent to the bindery, by using carbon paper both slips can be made

at the same time. The binder should be notified if books have not been returned; if unable to find them he must pay for them.

It is possible that some may think this method of keeping records unduly lax; that without a permanent record in book form many errors will creep in and that books will be lost. The answer to such a criticism is that in the Wilmington Institute Free Library it has worked for a period of ten years. During that time more than 25,000 volumes have been bound by five different binders, and the writer does not recall that a single volume has gone astray or that there have been any errors which would have been avoided if a record had been kept which required a careful invoicing of each volume sent to the bindery. When the books are shipped a statement is sent to the binder that so many volumes are in the shipment and it is his business to keep the books in this shipment together and return all at the same time. It is his responsibility, not that of the librarian.

3. Records showing how previous volumes of a set are bound should be kept as outlined under "Preparing for the bindery," page 140. The binding slip for the last volume of the periodical will show how it is bound. As an alternative to the carbon slip for periodicals it may be possible to keep a record of volumes in the bindery on the periodical checklist, if that be kept on sheets. A similar record should be kept for all books with volume numbers. For example, if volume 10 of Smith's works comes to the binding assistant a binding slip should be made out which records the material and color in which the

book is to be bound, together with exact lettering used. When returned from the bindery this slip should be filed and referred to when another volume of the same work needs to be bound. Unless this is done it will be necessary to go to the shelves to see whether other volumes have been bound. If only one volume has been bound and that is in the hands of a reader it will be necessary to wait until it is returned, all of which means loss of time. No book with a volume number should be sent to the bindery without consulting the file of binding slips. If there is no record that a previous volume has been bound it may be advisable for the assistant to go to the shelves to see if there are other volumes of the same set which need binding. It is little more work to send five volumes than to send one.

4. From what has been said it can readily be seen what sort of a check is placed upon the binder. Books sent to him are charged to him as if delivered to a borrower. If he does not return them he must pay for them. Let the method be elaborate or simple, this is all that it amounts to. It behooves the librarian, therefore, to make his charging as simple as is compatible with safety.

5. Records of cost may be kept in various ways, but the essential facts which it is best to record are:

- a.* Number of volumes rebound;
- b.* Number newly bound;
- c.* Number resewed or recased;
- d.* Number repaired at the library;
- e.* Total cost.

If desired, the cost of each of the foregoing items

may be kept. A large library will also need to keep a record of the binding for each branch, and possibly for each department in the main library.

In most cases it is not necessary for the binder to send a bill itemized by author and title.

It will be sufficient if he bill the books in some such way as this:

52 vols. Cowhide .....	8 in.	@ .45	\$23.40
16 vols. Buckram .....	10 in.	@ .65	10.40
6 vols. Imperial morocco cloth.....	8 in.	@ .50	3.00
2 vols. Morocco .....	8 in.	@ .70	1.40
			\$38.20

Books may more easily be checked with such a bill than with an itemized one. The information may then be drawn off on a sheet, allowing a column for each material and size, monthly and yearly statistics being easily compiled from these sheets. If it is the policy of the library to send an itemized invoice of books to be bound the binder should return the invoice with prices for each volume added.

In large libraries, such as the large college and reference libraries and public libraries with many branches, more elaborate binding records than those just outlined are necessary. College libraries, which do not as a rule have book cards, will find it necessary to make out a slip of one kind or another for charging purposes. In large library systems books should be sent directly from the branch to the binder and returned to the branch. A record should be sent to the head of the binding department at the main library, showing the number of volumes sent with the date, also the date when the books were returned to the

branch. Each branch should, of course, keep records in much the same way as a single small library, but the needs of statistics require further records at the main library.

It is probable that each large library will have to work out forms suitable for its own needs, but the following are suggested as feasible.

Volumes	
<u>½ Mor.</u>	
Lib. Buck.	
Cloth	
<u>½ Duck</u>	
<u>½ Pig</u>	
Light Brown	
Dark Brown	
Black	
Dark Blue	
Dark Green	
Red	

Binding slip. Size 6x4 in.

Material and color are indicated on the left by underlining. Author, title, volume number, etc., are written in proper panels.

## BLANKTON PUBLIC LIBRARY

Branch

Date

Following books are ready for binding:

- ..... vols. to be bound in ½ morocco.
- ..... vols. to be bound in library buckram.
- ..... vols. to be bound in ½ duck.
- ..... vols. as samples.
- ..... vols. to be repaired.
- ..... vols. for corrections.

.....  
Branch Librarian.

Size 5x3 in.

This slip is filled out by the branch librarian and sent to supervisor of binding, who decides who shall bind the books and sends the order to the binder.

## BLANKTON PUBLIC LIBRARY

Order No. 1002. .... 191

Messrs. ....

Please send to ..... Branch  
for the following books:

- ..... vols. to be rebound.
- ..... vols. samples.
- ..... vols. to be repaired.
- ..... vols. for corrections.

Bind according to specifications, following instructions for style on binder's slip in each book.

Please return books with bill to the Branch.

.....  
Supervisor.

Size 5x3 in.

When books are returned to the branch they are checked up with the bill. If there are no discrepancies the bill is sent to the binding supervisor.

Order No. 1002.	Sent .....	191
from .....	Branch	
to .....		
..... vols. to be rebound.		
..... vols. samples.		
..... vols. to be repaired.		
..... vols. for corrections.		
Returned .....	191	Amt. \$.....
Blankton Public Library.		

Size 5x3 in.

This slip, made out at the central library upon advice from branch librarian that books have been shipped, is filed numerically. When bill is received, the information is drawn off on a monthly sheet. A similar slip can be used to keep records for each branch separately.

The weekly or monthly statistics sheets ought to give in vertical columns the number of volumes and cost of each kind of binding and repair work used by the library. They will include one-half cowhide, one-half morocco, library buckram, one-half duck, reinforcing, recasing, lettering, etc. The first column at the left will have the names of different depart-



ments and branches. The last column on the right will give the total expenditure for each department and branch, and the footings of columns will give the cost of each kind of work. If necessary this sheet can also indicate number of volumes rebound and the number of volumes newly bound.

### BINDING ROUTINE

In preparing books for the bindery and keeping binding records a regular routine should be adopted which should be followed as closely as possible in order to avoid errors. Each library should adopt a routine suited to its needs, modifying when necessary the following suggestions.

#### BINDING ROUTINE FOR SMALL LIBRARY

1. Examine book, noticing condition, completeness, title pages, indexes, etc., and decide how book is to be bound.
2. Underline on title page the first letter of words which must be lettered on back. Pencil call number on reverse of title page.
3. If volume is a periodical or a volume in a set make out binding slip giving volume number and dates.
4. File book cards at loan desk.
5. Send books to bindery.
6. When books are returned check bill with books to see that no mistake has been made in charges.

7. Replace book cards in books.
8. File slips for periodicals.

#### BINDING ROUTINE FOR MEDIUM-SIZED LIBRARY

1. Examine books for binding noticing condition, completeness, plates, title pages, indexes, number and condition of copies, editions and various other points noted under "Preparing for the Bindery."

2. If the book is a periodical find title page and index. A special record ought to show when these are due and which periodicals do not publish them. Arrange exactly as the book is to be bound.

3. If the book is a periodical consult file showing how previous volumes have been bound and make out a binding slip with carbon copy, making such changes as are required by changes in title, date and volume number. The binding slip should be laid in the front of the book.

4. If the book is one of a set see if other volumes have been bound.

5. For books, not periodicals, indicate lettering by underlining on the title page the first letter of each word that is to go on the back.

6. Indicate color, material, volume number, call number, etc., on a binding slip which should be laid in front of the book. If the shipment is all fiction and no call number is used it will not be necessary to make out any slip of instruction. A blanket order may be made saying that all books are to be bound in a certain way.

7. When ready to send to the bindery, remove

book card or carbon copy of binding slip. Leave slips containing information for the binder in the book.

8. Pack books and send to the binder, notifying him of the date of shipment and the number of volumes sent as follows:

96 vols. to be rebound.

25 vols. of periodicals.

3 vols. to be recased.

4 vols. of corrections.

2 vols. of samples.

---

130

(It sometimes happens that a volume of a set is going to a binder who did not bind the previous volumes. In such a case the second binder has no "rubbing" and a sample volume or a "rubbing" must be sent.)

9. Stamp carbon slips, and book cards after the last charging date, with the name or initial of the binder and the date sent.

10. File book cards and carbon slips alphabetically by author, or first word of title in the case of periodicals.

11. When books are returned from the bindery see that bill is correct.

12. See that books are lettered correctly, returning such as are incorrect.

13. Remove book cards from the file and place in the books.

14. Letter book pockets or book plates with call

number and accession number, if this is the custom of the library.

15. Send periodicals and other books which have not been properly recorded to the order or accession department to follow regular routine for new books. Books that have been rebound may go directly to the shelves.

16. File binding slips for periodicals and destroy slips for previous volumes.

17. If it is the custom of the library to enter cost of binding in the accession book it will be necessary to put the accession number and cost on the binding slip. These slips may then be arranged numerically by accession number and the cost entered in the accession book.

#### ROUTINE FOR LARGE COLLEGE AND REFERENCE LIBRARIES

The routine just given is as simple as can be made without endangering the safety of books. It is not sufficiently accurate for the large libraries, especially the college libraries which bind a large number of periodicals belonging to many departments, each department being obliged to pay for its own binding. This requires complex records in the binding department. In order to eliminate as many mistakes as possible it will be necessary to have a binding card for each periodical and for sets. (See Fig. 31)

This card has a line for the title, a place for the description of the binding, and is ruled on both sides. On the right-hand side it is ruled in three columns—



effect on the binding card); and if separate, lay inside the volume.

4. If volume is part of a set examine binding records to see if other volumes have been bound. If no record is found in binding files look in catalog and order records to see if other volumes are already in the library, or have been recently bought and are not yet cataloged. If it is desirable to match exactly old sets bound elsewhere, make a "rub-off" for the binder and indicate the material and color. If the volume is one of a new set make decision in regard to style of binding and order a sample back.

5. If a periodical, get old card from "binding returned" file. In the case of new periodicals and books a card must be made, and the binder instructed to make a sample back for future use. Enter volume on card (one volume a line, unless several volumes are to be bound together).

6. Fill out binding slip (see page 154), indicating full lettering, proper spacing, style and material. Also make note on bottom of slip for such directions as "make sample back," "include all front covers," "no title page or index published," etc.

7. In the case of separate books it will be necessary to make out a card similar to the periodical binding card to be used in sending invoice of shipment to the binder.

8. Place binding slip in front of volume; tie up periodicals and lay aside with the volumes waiting to be shipped.

9. When shipment is ready to be sent, arrange cards:

a. By departments which are responsible for the cost of binding;

b. Alphabetically by author or title under departments.

10. Make typewritten list in triplicate (or more if necessary) of volumes for each department; one copy for filing, one for the binder and one to go to the order department with an estimate of the cost to serve as a charge against the proper department. If the departments against which charges must be made are many it may be simpler to list the books as they come, even if several departments are on one page, and to draw off from this the charges for the order department. Where departments are numerous and the record of each department is kept on a separate sheet there are a great number of sheets to handle, causing annoyance both in the binding department and in the bindery. Two lists may be sent to the binder so that he may add prices to one when the books are returned. This saves his time and also that of the binding assistant.

11. Stamp date on the binding card in the column marked "sent."

12. Stamp name of binder on binding card if the work is divided among different binders.

If all the work of the library goes to one binder this will not be necessary.

13. Ship the books.

14. File one copy of the list made out as noted in No. 10, send one copy to the binder, and add the estimated cost to the third list which is sent to the order department.

15. File cards in "binding sent" file.
16. When books are returned itemized bills are sent by the binder made out to each department.
17. Check books with the bills, arranging books in order of bills.
18. Take cards out of "binding sent" file in order of bills so that bills, books and cards are in the same order.
19. Compare lettering with slip to see if correct, lay aside such as are incorrect to be returned to the binder. Destroy slips.
20. See if charge is correct and enter on binding card in column marked "price." If there is a sample back, enter the cost and letters "S. B." above the line of the volume for which it is made.
21. Stamp date of bill on card in column marked "returned."
22. Stamp date of bill and cost in book on first recto after title page: "27 June 1914 Binding 75."
23. Send books to the cataloging department for cataloging, shelf-listing, etc.
24. Draw off on statistics sheet number of volumes and cost.
25. Send bills to the order department.
26. File cards for periodicals and all books with volume numbers in permanent file. Destroy cards for single books.



## CHAPTER X

### REPAIRING, RECASING, RECOVERING, ETC.

Practically all repairs to a book short of rebinding should be made in the library, since the work requires little space and no machinery, and the books may speedily be replaced on the shelves for general use. Large or medium sized libraries can well afford to hire one or more girls as menders, while the small library must utilize the spare time of regular assistants.

When books are sent to the binding department they should be sorted into the following groups:

Books to be (*a*) rebound, (*b*) recased, (*c*) recovered, (*d*) mended, (*e*) discarded; to have (*f*) new sides, (*g*) new labels, (*h*) new book cards or pockets.

When menders are employed all except those in the first group may be cared for in the library.

In sorting the books the question of whether to rebind or repair at the library must be decided for all books, except those in the discarded class and those which need new records (tags, pockets, book cards, etc.). The decision is not always an easy one to make. The kind of library in question, whether public, college, subscription, etc., will influence the decision, as well as the actual condition of the book.

A few general rules about mending may help in making decisions.

1. If the book has never been rebound and in all probability must go to the bindery in a few months' time, send to the bindery at once. Mending not only adds nothing to the life of this book, but may easily shorten it.

2. Mend books which have been rebound once but which it would not pay to rebind again. Judicious mending of such books may keep them in service for a long time, but there comes a day when the use gained does not pay for the time put upon them.

3. Mend books which have nearly outlived their usefulness or which are to be withdrawn absolutely when worn out. The question need be decided only when the book is fairly clean, for if very soiled it should be withdrawn at once.

4. Mend books which must be on the library shelves, but which are seldom used.

5. Mend books printed on heavily loaded papers which will not pay to rebind. There are, unfortunately, many of them.

6. Mending cannot be done if the sewing is completely broken, though it is sometimes possible to insert signatures which are loose.

7. Books with broken corners must be rebound.

8. Recase books which have sewing intact and covers in good condition, if they will be used comparatively seldom.

9. Recover books which have worn covers but firm sewing.

## MENDING MATERIALS

## ADHESIVES

*Paste.* Home-made pastes are cheapest. While there are various recipes for paste, either of the following will give satisfaction:

(1)

Wheat flour, 8 oz.

Powdered alum,  $\frac{1}{4}$  oz.Glycerine,  $1\frac{1}{2}$  oz.

Oil wintergreen, 1 dram.

Water,  $1\frac{1}{2}$  pts.

Dissolve the alum in water and mix gradually with the flour into a smooth, thin paste; cook in a double boiler until smooth and clear; take from the fire and add the glycerine and oil of wintergreen. This quantity will make about one quart. If after standing a day a watery fluid collects, stir it into the paste. Keep this paste covered.

(2)

 $\frac{1}{4}$  pound of flour (1 cup).

1 teaspoonful of alum, dissolved.

1 generous fourth teaspoonful of oil of clove.

4 cups of boiling water.

Mix the flour well with a little cold water, beating until perfectly smooth. Add the alum dissolved in a little cold water. Pour on two cups of the boiling water, strain through a wire sieve. Add the remainder of the boiling water and cook, stirring

constantly until partially clear. Add the oil of clove and put into a clean, covered earthen jar. The paste thickens as it cools. Take out small quantities for use. The materials for this paste cost less than 2 cents for a hundred books.

To all pastes it is best to add a spoonful of carbolic acid or formaldehyde to prevent spoiling. A small quantity of corrosive sublimate will make paste unattractive to bugs.

Although home-made pastes are cheapest, they are a bother to make and the saving of expense over commercial pastes is not worth while except in the very small library. Besides paste in bulk which can be obtained from the local binder there are many kinds of commercial paste. Some may be bought in powders; others, designed primarily for mounting photographs, in glass jars; still others in cans ready to use. The powders are cheap, keep indefinitely, but when needed must be mixed with water, and as a rule are not very satisfactory. Higgins' and other photo-mounting pastes are expensive and dry too quickly, but keep indefinitely. In the long run the most satisfactory pastes are those in tin cans with tight lids; these are ready to use, do not dry up and the preservative which they contain keeps them indefinitely. The Arabol Manufacturing Company, 100 William Street, New York, makes several varieties. Their "Sphinx" paste, which gives excellent satisfaction, can be bought in six one-gallon can lots at 75 cents a gallon, f. o. b., and in larger quantities at slightly reduced rates. Great care should

be used to avoid having the paste so thin that it makes the paper stretch.

Although paste is a necessity in every library, there is a tendency to use too much of it, and to use it when it is not necessary. Ordinarily it will injure the book less than other adhesives, but it should be used sparingly on books that must be rebound. When applied to the backs of loose signatures they become brittle; then when the book goes to the bindery a much larger amount must be cut from the back than would otherwise be the case.

If paste is to be applied to part of the paper only, the easiest way is to lay the paper on a board, place another piece of paper over it, leaving exposed the surface to which paste is to be applied. It can be spread more evenly with the finger, faster with a soft, long-handled brush. The larger libraries will find a pasting-machine a great time-saver. Book labels, book pockets, new end papers to freshen soiled books—anything which needs to have the entire surface covered—is pasted on the machine in one-tenth the time required by hand.

*Glue.* For ordinary mending, glue should never be used. (See Materials, p. 82.) Flexible glue, however, is a necessity for recasing and recovering books. It keeps indefinitely, can be used easily by those who acquire the knack of using it, and it sticks everlastingly.

*Mucilage.* Mucilage has no real place in a library. If paste is not the suitable material to use, substitute flexible glue, never mucilage.

## CLOTH

*Cheesecloth.* This well-known cloth is used when pressing down paper or book labels after they have been pasted and applied, and for quickly cleaning the hands of superfluous paste or glue. It should be cut in pieces of convenient size and not used many times before being discarded.

*Jaconet.* A thin, strong muslin will be needed for guarding sections and occasionally for forming joints. Jaconet is the best and may be obtained from a few library binders.

*Canton flannel.* A medium grade of this cloth is used for back-lining.

*Book cloth.* If recovering or re-siding is done the library must have a supply of book cloths in the shades preferred. For re-siding, any cloth in grade 1 (see page 75) is sufficiently good. For recovering cloths in the grade which meets the requirements of the Bureau of Standards are none too good. If much recovering is done it is best to buy the cloth by the piece.

*Crepeline.* This very thin cotton cloth, also called mousseline, through which print is easily read, is sometimes pasted over the entire surface of pages which receive very hard usage, and which would otherwise be literally thumbed to pieces long before the rest of the book.

*Specially prepared cloth.* The Gaylord Bros., of Syracuse, and the Multum in Parvo Binder Co., of Philadelphia, manufacture hinges made of cloth. While these are often useful they cannot be used under

any and all conditions, as one might be led to believe from the claims of the manufacturers.

## PAPERS

*Onion skin.* Onion skin is a very thin, tough paper, used for mending torn pages, illustrations, etc., where print must show through. While it may be obtained gummed on one side, very little is gained, for it is nearly as easy to paste the ungummed onion skin as to moisten the gummed. For tears which do not run into the text a thin; strong bond paper will be satisfactory.

*Kraft or manila paper.* A 30x40 60-pound kraft paper makes good end papers in recasing and recovering. A 70-pound manila paper may be used instead of kraft, if desired.

*Red rope manila.* This is a very strong, tough fibred cardboard which may sometimes be used as covers for books that it will scarcely pay to put into stouter covers. It may be obtained in several weights, the lighter weights being sufficiently strong for library use.

## THREAD

Even if no resewing is done, thread is necessary for making various repairs. The best are Hayes' linen thread No. 25, and Barbour's No. 40.

## AMMONIA

This is necessary for breaking down surfaces of highly glazed cloths so that labels will stick.

## SHELLAC

After labels or the backs of books have been lettered in white or black ink they should have a covering of shellac. A supply of the best white shellac may be obtained from the local paint dealer.

Occasional use is found for various other materials, such as powdered pumice stone, sponge rubber, India rubber erasers and art gum.

## TOOLS

### FOLDERS

Several binder's bone folders, costing fifteen cents each, should be kept in the binding department.

### KNIVES

A long knife, broad at the point, thin-bladed but dull, is needed for cutting paper after it is folded and for various other uses. A sharp, pointed knife is needed for removing books from the covers, or old labels from the back.

### SCISSORS

Long, thin-bladed, best quality.

### NEEDLES

Regular book-sewing needles.

### HAMMER

A broad-faced hammer may be required for beating down the backs of sections, or the entire book when it is difficult to replace it in its old cover.



## PRESS

Books wet with paste or glue must be pressed. An old-fashioned letter-press which screws down by hand will answer all purposes in a small library. As they are now out-of-date, second-hand ones can be purchased for a small sum. There are one or two inexpensive small presses which are not so heavy as the letter-press, but which hold a larger number of books and are fairly satisfactory. The most satisfactory press is a stationary one which holds a number of books and which will exert great pressure. On account of lack of space and the cost it is inadvisable to use this in a mending room, and makeshifts are generally necessary.

## PRESS-BOARD

A few press-boards with projections which will fit into the joints of books may be necessary. They may be obtained from any dealer in binders' supplies.

## SEWING BENCH

If any resewing is done a sewing bench is a necessity. Ordinarily books needing resewing should be sent to the bindery.

## GLUE-POT

A double-boiler glue-pot is a necessity if recovering or recasing is to be done. It should be kept clean.

## BRUSHES

A long-handled, small-sized brush with soft

bristles will be used for pasting, while glue will require a large, round brush such as is commonly used in binderies.

#### PASTING MACHINE

A good pasting machine will cost about ten dollars, but it is a great time saver. There are several on the market. In the Wilmington Library the "Universal" is used and gives satisfaction in all cases when a machine can be used.

#### CUTTING-BOARD

A small-sized cutting-board, such as is used by photographers, is useful in the mending room as well as in other parts of the library.

#### CLEANING

A part of the duty of the mending department is to remove such dirt or stains as can readily be removed without injury to the books.

#### PAGES

Various materials may be used for cleaning books which show soiled pages here and there, but which are in the main fairly clean. A red rubber or a sponge rubber is much better than an India rubber eraser. The latter should never be used unless the paper is excellent in quality. Bread crumbs rolled in a ball or powdered pumice stone put on with a dry cloth will often give good results. If the book is much soiled, or has mud stains, it may be advisable to use ivory soap and water with a few drops of ammonia, applied with a piece of cheesecloth well wrung out.

If the paper is of good quality it may be washed with Javelle water, a preparation used in French laundries. This may be made by the following recipe:

To one pound of chloride of lime add four and a half pints of water, and put in a jar with tight cover. In a separate vessel, dissolve 20 oz. of ordinary washing soda in four and a half pints of boiling water, and immediately pour it into the first mixture. When cold add enough water to make eleven pints in all. Strain through muslin, settle, and pour off the clear solution. After using it care must be taken to rinse the paper thoroughly with water, as it tends to rot paper.

In the cleaning of pages care should be taken not to erase any marks made by the cataloging or accession departments. Rubbing must be done slowly and the pages held flat to prevent tearing. Rub from the inside outward. All traces of pumice stone, rubber, etc., should be carefully removed. If water and soap have been used, it may be necessary to put a pressing tin under the leaf, placing blotting paper on each side.

Fox marks may be removed by immersing the leaves in a weak solution of chlorine water and then transferring to a hot bath of very weak hydrochloric acid.

To remove creases from leaves accidentally folded, place the leaves between moistened blotters enclosed between dry blotters and press. This can be repeated until the crease is entirely removed. Sometimes creases may be ironed out with a hot iron.

Ink stains can be removed by any one of the standard eradicators (oxalic acid followed by chloride of lime). Stains from pad ink used for dating stamps can be removed with benzine.

The edges of leaves on very soiled books may be sandpapered. In this case the book should be held very firm, if possible in a vise.

#### TO PREVENT MILDEW OR MOLD

Occasionally books are accidentally soaked with water. In many a fire more damage is done by water than by fire. In such cases it may be a waste of time and money to reclaim ordinary books which can easily be replaced. It is a different matter when it comes to rare books and especially to manuscripts which cannot be replaced. Mr. J. I. Wyer, Jr., director of the New York State Library, in his annual report for 1911 describes as follows the method used in that library after the disastrous fire of that year.

The first step was to remove all covers. Each volume was then taken apart leaf by leaf, and each sheet was laid between print paper for drying. After twenty-four hours every leaf was again handled and placed between heavy blotting paper; after twenty-four hours here, each leaf was again removed to a second blotting paper. At all of these stages pressure was applied to facilitate the drying and keep the documents from wrinkling. . . . When each leaf had thus passed through these three drying processes, those belonging to the same volume were collected and carefully tied up in boxes or separate packages to wait until all the manuscripts were thus treated. . . . When all were dried, the manuscripts were arranged in volumes. . . . The rarest pieces will in time be

mended, nearly all will be covered with crepeline, all will be mounted on fresh paper and carefully bound into new volumes.

## COVERS

Covers may be cleaned by the same materials as those used on pages, but the best method is to wash them with soap and water. For this reason the use of a washable cloth for covers, such as keratol, durabline, or fabrikoid, is an advantage. Miss Margaret Brown, in her pamphlet on mending, *Library handbook No. 6*, advises the use of a wash as follows: "Two parts good vinegar and one part water. Apply with a clean cloth and rub hard until dirt is removed, then place upright to dry. This should not be used on leather."

Grease spots may be removed from both leather and cloth by covering with a blotter and ironing with a hot iron. The same method will partially remove paint or varnish.

For a great variety of cleansing receipts see Coutts and Stephen's "Manual of library bookbinding," Chapter X.

Covers that have warped must be dampened and put under pressure.

Shellacing of covers has been advocated by some librarians, but it is doubtful if it pays. It may be used in the interests of cleanliness on books bound in light colored cloth and on books in towns where the atmosphere is very smoky. It is a process which takes some time since two coats of shellac must be applied, and it does not increase the wear of the cloth

to any great extent. As a regular part of preparing the book for use it takes more time and material than it is worth.

Sometimes a book becomes wonderfully rejuvenated simply by having its cover and edges cleaned and a new pocket pasted in the back.

### MENDING

It is very desirable that mending should not be done by inexperienced assistants, for an uninstructed beginner may do as much harm as good.

#### TORN PAGES

Torn pages may be mended in any one of the following ways :

1. If the tear does not affect the printing, cut a strip of thin, tough bond paper one-half inch wide, a little longer than the tear to be covered, put through pasting-machine and cover the tear, trimming the overhang even with the page.

2. If the page is torn into the text, and the book is not valuable commercially, use unglued onion skin about one-half inch wide and apply as above. If onion skin is not available a very thin, tough bond paper will do very well. Use a thin coating of paste, first putting a piece of white paper under the page to absorb extra paste.

3. If torn in the text and it is desirable to make as good a job as possible, use the following method :

Rub a very little paste on the torn edges, and place them together. Then take a rather large piece of ordinary tissue paper and rub it gently along the tear

so that the tissue paper will adhere to the torn edges. Put under the press; when dry the superfluous tissue paper should be torn off, taking care to pull always toward the tear and from both sides at the same time. The delicate fibre of the tissue paper acts as an adhesive in such a way that it is almost impossible to discern how the mending was done.

4. If the margin of the leaf of a valuable book is torn in several places, take two sheets of paper the size of the leaf, cut out from the middle of each a piece a little larger than the letter-press of the book; trim the torn leaf so that it remains somewhat larger than the space cut out of the blank leaves; place it between these two leaves and paste down, thus forming new margins.

Books that have torn leaves mended may be put into the press, but it is not strictly necessary. When very much of this mending is done pressing is impossible unless a standing press is at hand.

A few books such as Granger's Index and some of the Poole's Index volumes should have the first few pages entirely reinforced with cloth. The best cloth for this purpose is crepeline, through which the text can be easily read. When applying it put a thin layer of paste on the leaf and then put on the cloth. The book should then be pressed, first protecting adjoining pages with paper.

#### LOOSE LEAVES

Loose leaves may be inserted in several ways:

1. Lay a piece of white paper over the leaf, allowing one-eighth of an inch of back margin of

the leaf to project. Paste this exposed surface and attach it to the adjoining leaf in the book, pressing down firmly. This can be done only when adjoining leaves are firm.

2. Sometimes the leaf when inserted will extend beyond the fore edge of the book. Trimming of either back margin or fore edge is inadvisable. It is possible to turn over about one-eighth of an inch of back margin, using some kind of straight edge for this purpose. Apply paste to turned over part and press the fold well down into the book. This will give more freedom to the leaf than if one-eighth of an inch has been cut off and another eighth of an inch pasted.

3. Fold strips of thin bond paper cut with the grain, three-fourths of an inch in width, through the center. Paste the outside. Attach the loose leaf to one side and attach the other side to the adjoining leaf in the book. It will be necessary to work quickly because the paper strips when wet will cause a wrinkling of the leaf. This method can be used only if adjoining leaf is firm, but can never be employed with over-casting.

4. If necessary to use as little paste as possible, apply paste to a piece of common soft string by drawing it over a board covered with paste. Then draw the string through the book at the back. The leaf may then be inserted.

#### LOOSE SIGNATURES

Ordinarily when one signature becomes loose others speedily follow, and the book must be sent



to the bindery unless it is withdrawn absolutely. Sometimes, however, one section will become loose when the rest of the book is firm and solid, sometimes also the use a book will receive does not warrant binding. In such cases, if the book has a loose back, open the section in the middle and place it in its proper place in the book. Thread a darning-needle with Hayes' No. 25 thread (or Barbour No. 40), pass the needle through the hole at top of the section (the kettlestitch hole) in such a way as to bring it out at the top of the book between the book and the loose back. Draw thread through, allowing a few inches to remain inside the section. Drop needle through the loose back, insert it from the back through the kettlestitch hole at tail of the book. The thread can then be tied to the thread projecting at the upper kettlestitch hole. This is a makeshift, but may answer if the book is not to receive hard usage. If the back of the signature is badly worn, mend it by guarding with jaconet on the outside, or by pasting a strip of bond paper down through the center of the fold.

### *Tight Backs*

For tight backs cut a guard of firm, thin cloth, such as cambric or jaconet, about three-fourths of an inch wide and as long as the book. Sew the section to the middle of the guard, and paste the guard to the book, one-half to each of the adjoining leaves. Press this guard well back into the book. This can be done only when the adjoining pages are securely held.

### LOOSE JOINTS

It frequently happens that a book in the original publisher's cover becomes loose at the joint, because the super used as back-lining cannot stand the strain put upon it. Ordinarily, a book defective in this manner should be bound at once; but if it is deemed best to attempt mending it, a strip of jaconet should be cut  $1\frac{1}{4}$  inches wide and the length of the book. Paste one-half of this to the cover and the other to the adjoining fly-leaf, thus transferring the strain from the super to the fly-leaf. This method can also be used to mend a break in the middle of a book, but should never be used if the book must eventually be rebound.

Another method of mending a loose joint is to remove the book entirely from the cover, sew on new end papers guarded with muslin, and cover the back of the book with canton flannel which extends three-fourths of an inch on each side. When dry, paste the entire back of book and sides and put the book back into the cover, pasting down the new end paper. This is, in effect, recasing. (See page 184.)

Sometimes books which are loose at the joints and have loose signatures may be mended by applying paste with a long-handled paste brush to the backs of the signatures. This must never be done if it is possible that the book will need to be rebound later.

### FLY-LEAVES

To add new fly-leaves, cut paper suitable for this purpose the same length as the old fly-leaves and

one-half inch wider. Fold over this one-half inch, paste it on the outside and attach it to the old fly-leaf. If necessary, this may be used as a new end paper and pasted to the cover over the old end paper. If used as an end paper, the book should be pressed promptly to prevent it from warping.

#### REPAIR OF MAPS

All old or mutilated maps or charts must be flattened out by placing the maps between large millboards with heavy weights over them, before they can be inserted in books. Repairs may be made with onion skin paper or any other thin, tough paper, the same as is done with torn leaves in books. If the map is very old and valuable, it may be advisable to use paper which resembles in a way the texture and color of the map itself.

It is advisable to mount all maps on some kind of cloth. It is best to have this done by a regular binder, but it may be done in the library if there is sufficient room.

If the map is to go on rollers, a piece of cotton cloth is tacked to a large table, the top of the cloth pasted, and the map placed on top, back down, all wrinkles having been removed. Millboards or strawboards are then placed on the map and weights placed on top until it is dry. This may take some time, after which it may be tacked to the rollers.

If it is a folding map or chart, it may be necessary to cut the map into sections before mounting. When mounted there will be one-eighth of an inch

space between sections, so that the map itself will not be defaced through constant folding. The mounting of such maps is a difficult task and should be done only by an expert.

### RECASING BOOKS

1. Remove book from the cover; cut out old super from the back of the cover; thoroughly clean the back of the book of super and glue without injuring the backs of the signatures. Lift the lining-paper from the back and front boards of the cover and remove the old super. Scrape with a knife the glue which does not come off with the super. If the back of the book seems to be much thicker than the fore edge, pound down with a backing-hammer.

2. Cut strips of muslin (or canton flannel) a little shorter than the height of the book, wide enough to cover the back and to extend over the boards  $1\frac{1}{4}$  inches on each side.

3. Cut enough flexible glue to fill a double-boiler glue pot half full when dissolved. When the water comes to a boil the glue, which must be used hot to get good results, will generally be ready to use. If it is still too thick, add a little hot water to thin it.

4. Turn back the lining paper on front and back covers, spread the glue on the inside of the back of the cover and on the boards where the lining has been turned back.

5. Put the strip of muslin in the place just glued; then rub down the lining paper over the muslin.

6. Even up the book by tapping it on the table

so that no leaves will project at the top, bottom or front.

7. Holding the book firmly in the hand, glue the back.

8. Place the back on the muslin lining previously glued to the back of the cover, care being taken to see that the book is not put in upside down.

9. Fold over the cover and, taking the entire book firmly in the left hand, with the right hand push the book firmly back into the cover. This will prevent it from becoming concave.

10. Crease the joints with a bone folder and rub down the back.

11. When the book is dry, open it and, if necessary, paste new papers over the inside covers. This is necessary, because it is frequently impossible to turn back the lining and remove the old super without making an unsightly piece of work.

### RECOVERING

Rules for recovering can be used only when books do not need to be re sewed.

1. Remove cover from the main part of the book.

2. Remove with a dull knife the cloth from the outside and inside of the cover until the two boards are clean, being careful not to cut into the board itself. It is not worth while to remove old paper sides or end papers.

3. Remove superfluous glue, super, etc., from the back. If the book has been overcast, and small strips of leather have been placed over the back, paste the

ends of these strips of leather to the end papers. Such a book will also have end papers guarded which will remain as an integral part of the book.

4. If the book has not been overcast, it will be necessary to add end papers. This can be done by using two sheets which when folded once will be the size of the leaves of the book. One of these should be a 60-pound and the other an 80-pound manila paper, both guarded entirely around the fold with jaconet. Whipstitch the 60-pound fly-leaves to the first and last sections of the book, then whipstitch the 80-pound, being careful to pass the needle back through the first section. Paste one of the fly-leaves and one of the end papers together.

If the book has been oversewed, cut the end papers of 80-pound manila or 60-pound kraft paper the size of the book and paste on the entire surface of the fly leaves which are integral parts of the book. It will not be necessary to guard these new end papers.

5. Trim the new fly leaves and end papers the exact size of the book.

6. Mark the boards and book with corresponding numbers so as to identify them.

7. Place boards on the book to within one-eighth of an inch of the back and mark the distance from the back.

8. Measure exactly the distance across the back between marks just made on the end papers.

9. Select the proper cloth with which to cover the book. Place the boards on the cloth, allowing the width necessary for the back as measured in No. 8.

10. Mark around boards on cloth.
11. Cut cloth, allowing approximately an inch and a quarter all around outside edge of the boards.
12. Glue the entire surface of the cloth.
13. Place boards on markings previously made, pressing down firmly on the glued cloth.
14. Put stiff paper, previously cut to the proper size, on the glued cloth between the boards, to prevent the glue from sticking to the back of the book. This should not be done if the book must have a tight back.
15. Turn in the corners as follows: Take the exact corner of the cloth and turn it straight in over the corner of the board. Next turn in the end and then the side. Rub down well with a bone folder.
16. With bone folder, round the corners, and crease the joints at the back.
17. Put the case so formed into a press for a few minutes.
18. Cut a strip of thin, tough muslin or canton flannel one-half inch shorter than the height of the book and wide enough to extend an inch on each side of the book.
19. Glue the back of the book and put on the muslin or canton flannel.
20. Glue the entire surface of the completed case.
21. With the fore edge in the right hand, lay book in its proper place on the right-hand cover, draw up the left-hand cover and lay it on top. Open the book, rub down the end papers well with bone folder, and rub down the back; also crease the joints.
22. Put book in press over night.

23. Letter by hand either with black or white ink as the case demands.

### RE-SIDING

Many books which have been rebound with leather backs come to the binding department with the cloth sides badly frayed at the corners or edges. If the sewing is good and the book is clean, it is worth while to put on new sides.

1. Remove cloth sides and smooth off the inside of the board with a dull knife.
2. Cut two pieces of cloth a little larger than the sides.
3. Glue the inner surface of the cloth and place on the book, turning in the corners as described in 15 on page 187.
4. Put book in the press.
5. After book is dry, paste a single end paper over the inside of each cover.

### REINFORCING

In Chapter 6 will be found a discussion of the advisability of purchasing books bound from the sheets or in reinforced publisher's covers. While it is advisable on the whole to have reinforcing done by regular library binders, the work can be done in large libraries that have proper equipment and labor. The essential principles of reinforcing are the same in all libraries that practice it, though they may differ as to minor details. The following method has proved satisfactory.



1. Remove the book from its cover, which is laid aside for future use. If the call number is to be gilded it will be easier to do it before the cover is removed than after it is replaced.

2. Make end papers and fly-leaves of 60-pound kraft paper or 80-pound manila, guarded with jaconet on one side of the sheet. End papers should be guarded on the inside of the fold.

3. Oversew the fly-leaves to the first and last sections of the book, being careful that stitches are not over one-eighth of an inch deep.

4. Sew the end papers to the fly-leaves which have just been oversewed, and paste fly-leaves and end papers together.

5. Apply a thin coating of flexible glue to the back of the book and put over it a piece of thin canton flannel cut as long as the book and wide enough to extend an inch on each side. This should be well rubbed down.

6. Paste the canton flannel which projects on the side to the end papers.

7. Glue one side of the book and place it on the proper side of the cover. Glue the side remaining uppermost and draw the cover up over it.

8. Rub both sides and back until sure that the glue is well forced into them.

9. If desired, the book may be given a coat of white shellac and one of varnish, after which it should be wiped with a paraffine cloth.

## MAGAZINE OR PAMPHLET COVERING

1. Cut red rope manila cardboard the exact size of the two covers plus the width of the back.
2. Remove the cover of magazine or pamphlet, if possible keeping it in one piece.
3. Fit the red rope cover over the magazine, creasing carefully at the joints with a folder so that it will lie flat across the back as well as over the sides.
4. Glue the back of the magazine with flexible glue and press it firmly into the improvised cover. Rub down the back with a folder.
5. Thread a needle with stout linen thread and, using it double, at the middle of the book put the needle through from the inside to the outside. Leave about two inches of thread projecting on the inside.
6. Put the needle through from the outside about an inch from the head of the book. The needle must come through in the same section where the thread is projecting.
7. Carry the thread through to about the same distance from the tail of the book and again put the needle through from the inside to the outside.
8. Return the needle at the same place where the first stitch was taken and tie to the thread left projecting in such a way as to hold fast the long thread through the center.
9. Paste the paper cover previously removed on to the new cover.

This method can be used for all pamphlets one-

half inch or more thick; even for those two inches thick, provided that the use they will receive is slight. In the case of the thicker unbound books, it is necessary to sew them in two or three places.

### LABELING

Few libraries can afford to have all call numbers gilded. Therefore it is necessary either to letter directly on the book, or to put call numbers in ink on a white label which has first been placed on the book. Much objection exists to these gummed labels, because it is claimed that they come off very easily and the work soon has to be done over again. Undoubtedly this is true if the labels are not properly put on; but if care be taken, there is no reason why the white gummed labels should not last until it is necessary to rebind a book, when of course the call number will be gilded.

Two points must be remembered in applying labels.

1. They must be put on at an even distance from the bottom of the book. Perhaps nothing else will give a library such an unsightly appearance as uneven labels—some at the top, some in the middle and some at the bottom. The exact distance from the bottom of the book is not one of great importance, but the bottom of the label should not be less than  $1\frac{1}{4}$  inches from the bottom of the book, nor more than two inches. Whatever distance is adopted, it will be necessary to have a piece of cardboard which may be used as a measure when applying the label.

2. Labels must be fastened so securely that they will not come off. This seems sufficiently obvious, but as a matter of fact many assistants who do this work do not spend sufficient time to do it right.

The following directions should be followed:

a. If the book is new, it will be necessary to break down the glazed surface of the cloth or leather where the label is to be placed. To do this, use ammonia diluted somewhat with water. Use a brush about the width of the label and draw across the back of the book at the proper place. After having done ten or a dozen books, it is best to wipe off the ammonia with a piece of cheesecloth which brings with it the glaze.

b. Labels are not put on until books are dry. Use labels made of extra heavy paper, so that they will not turn dark when shellac is applied later. They may be moistened on a wet sponge or on some one of the numerous moisteners, or better still, they may be dipped quickly in hot water with a pair of tweezers. In using some labels it is not inadvisable to cover the gummed surface with a thin coating of paste. As soon as the label is pasted on the book straight and in proper alignment, it should be pressed firmly down with a piece of cheesecloth. This part of the operation should not be hurried and considerable pressure should be used until the label has firmly adhered.

c. When dry, letter with India ink and cover label with a very thin coating of white shellac. Later, when the first coating is thoroughly dry, cover with

a thicker coating of shellac. This should be done quickly and neatly. If the line of shellac is uneven the book has an unsightly appearance.

*d.* If books are thin, it is best to put labels on lengthwise. If very thin, put labels on front covers, near the back. If labels project over the back, trim with scissors.

If books have been used or have already had labels, the process is the same, except that no ammonia need be used.

Old labels which have been shellaced are hard to remove. The best way is to apply ammonia and water to the label, allowing it to soak in. When thoroughly moistened, remove with a dull knife. Removing dry labels by scraping with a knife injures the back of the book.

## LETTERING

### BY HAND

It is sometimes feasible to letter with ink on the back of a book instead of putting on a label which holds the lettering. If the surface be glazed, it can be broken down with diluted ammonia, or sometimes merely a damp cloth will be sufficient.

So far as possible, letter with black India ink. Carter's white ink is the best for lettering dark colored cloths. It is sometimes difficult for a novice to use white ink, but it can be handled satisfactorily if one uses a stub pen which is kept perfectly clean and is always wiped before being dipped in the ink. Shake

the bottle often and add water if ink is too thick. Gold ink should never be used.

When lettering is dry, apply shellac as described under Labeling.

#### WITH TYPE

Some of the larger libraries have found it economy to have a binder's printing outfit for lettering call numbers on all books, even when the library does not bind books. Such an outfit may be used of course for lettering author and title, but there will be little occasion to do this except in connection with a regular bindery. Call numbers, however, are so much more legible and permanent when put on with type that it should always be done whenever the number of accessions is sufficiently large to warrant the employment of some person to do the work. It does not, however, need experienced finishers and, if time permits, may be done by regular library assistants after some instruction and practice. It will be discovered, however, that lettering in gold on cloth is more difficult than on leather. For the benefit of those who wish to try it the following description is given.

*Tools.* The tools necessary are a pallet to hold the type; four fonts of brass type (lead, or type other than brass should never be used); long-bladed knife with straight edge for cutting gold leaf; cutting pad; gas burner similar to the burners on cook stoves; and

a frame with wooden screws in which to hold the book while it is being stamped.

*Materials.* The materials needed are the best American gold leaf, cotton batting, sweet oil, some specially prepared rubber for removing the excess gold leaf, and glaire.

The tools or materials which are used exclusively by binders can be obtained from any binders' supply house. Glaire is easily made as follows:

Take whites of three eggs; add three teaspoonfuls of vinegar and beat until it is a light froth. Let stand a few hours and strain through a piece of muslin into a bottle. If kept corked glaire will keep for some time.

*Process.* 1. Place on finishing bench, backs up, books on which call numbers are to be gilded.

2. With a small sponge, apply the glaire to the part of the back which is to receive the call number, taking care to draw the sponge evenly across the back, leaving a straight line. If the application of glaire makes that part of the book appear radically different from the rest of the back, the glaire may be applied to the entire back. It should not be allowed to run over on the sides. Allow the glaire to dry thoroughly.

3. With a long-bladed knife, transfer a sheet of gold leaf to the cutting pad which must be thoroughly protected by screens from all draughts. If the gold leaf does not lie unwrinkled on the cutting pad breathe on it lightly. With the knife, cut the leaf in

proper size for work to be done, being careful to make the cuts clean, not ragged.

4. Arrange type in the pallet, beginning at the right, and put type in the gas to heat.

5. Screw book, back up, firmly in the frame.

6. With cotton batting, apply sweet oil to the part to be stamped, being careful to cover thoroughly this surface with the oil. This is done to make the gold stick.

7. Apply a piece of cotton, slightly oiled, to the gold leaf which will instantly stick. It can then be transferred to the book, where the sweet oil will hold it securely.

8. Test the type for heat. A little practice will soon teach the novice when the type is hot enough. The object of heating the type is to make the gold combine with the glaire in such a way as to cause the gold to adhere. It is better to have the type too cold rather than too hot. If it is too cold, the gold will not stick and the work must be done over again; if too hot, it burns the leather or cloth and the damage is irremediable. For cloth work the type can be used hotter than for leather.

9. Apply type to the book, pressing down firmly. The pressure makes an indentation. If the materials are of the right quality, the work carefully done and the type of the right degree of heat, the gold will be firmly embedded.

10. With the specially prepared rubber remove the waste gold. When the rubber has absorbed all



the gold that it is capable of taking up, it may be sent to a dealer who will refine it and give credit for the gold which it contains. About one-third of the original cost of the gold should be obtained from the sale of the waste.

Whenever books are bound in light colored cloths on which gold does not readily show use a black ink specially made for this purpose. It is much easier to use than gold, since the ink is evenly spread on a smooth, hard surface and the type is used cold. No glaire is necessary.



## CHAPTER XI

### MAGAZINE BINDERS

One of the vexing questions which properly comes under the head of binding is that of magazine binders used on current periodicals in reading rooms. The binding of current numbers for circulation is described on page 190. It must be admitted that no binder on the market is perfectly satisfactory. Some hold the periodicals satisfactorily but are hard to adjust. Others are easy to adjust but the magazines slip out easily, or can with ease be surreptitiously removed. Some have keys which become lost or will not work; some are clumsy; and some have projections which scratch tables. All are hard to hold in the hands. On an average a new binder is put on the market each year with the assurance of the maker that all faults have been eliminated. A trial soon convinces the librarian that it is no better than others and that the perfect binder does not exist.

For the small library the problem is not an important one, since it is entirely feasible in such libraries to place current numbers without covers on reading room tables, or to cover them with tough paper. Mr. Dana advocates using most magazines without binders even in the reading room of a large library.

Possibly this may be done advantageously in some libraries, but it will depend upon the atmosphere of the city, the character of those who use the library and the ease with which assistants can keep all readers under observation. Librarians for the most part will continue to believe that a temporary binder of one kind or another is necessary for current periodicals in the general reading room.

Binders in the reading room serve two purposes. They protect the magazine and they help to remind readers that the magazines are public property. Some magazines—the *Scientific American*, for example—are very thin and may be easily folded and put into an inside pocket. A binder does not prevent theft, but its tendency is to reduce it.

The qualifications of a good binder are:

1. Ease of fastening, together with difficulty in removing magazines by the uninitiated.
2. Comparative ease of holding in the hand.
3. Durability of surface and of device used for fastening the magazine.
4. Preservation of the magazine without injury.
5. Firmness when finally fastened.

Even the best magazine binders are far from being perfect in any of these requirements, except in ease with which they are fastened.

There are many kinds of magazine binders. Mr. Dana, in the second edition of his "Notes on book-binding for libraries," mentions by name twelve different makes; and as many more, some of which are equally good, are known to the writer. But were

there twice as many it is probable that they would fall, as they do now, into five classes.

1. Spring back.
2. Eyelet and tape.
3. Sewed.
4. Rod.
5. Clamp which is screwed up tight.

The well known spring-back variety is, in principle, a semi-circular steel tube longer than the magazine to be held, to which board sides are attached. When the cover is closed the jaws of the steel are close together. In order to insert the magazine the covers are bent back toward each other. This opens wide the jaws and the magazine is slipped in. When the covers are released the steel tube is firmly fastened to the back of the magazine. This kind of binder is probably the easiest of all to adjust. It is, however, equally easy to remove, is clumsy and is harder to hold in the hand than others.

In the eyelet and tape class there are holes in the back of the cover. In fastening the magazine, tape or cord (generally a shoe string) is passed through the center of the magazine, laced into the eyelet and tied. The main objections to this kind of a binder are that it takes some time to fasten them and the magazine is generally loose in the binder when fastened.

Binders which require sewing have holes in the sides near the back. Instead, however, of passing the cord through the center of the magazine, holes corresponding to holes in the binder are punched directly

through the magazine at the back, one near the head, one near the tail and another in the middle. The binder is then sewed on through these holes. The chief merit of these binders is that they are inexpensive; but it takes longer to attach them than other binders and the magazine is injured by the holes which have been punched.

There are various kinds of binders which use steel rods or bars through the center of the magazine. Some use one rather heavy rod which is hinged at one end, and hooked or fastened into a slot at the other end when the magazine has been inserted. Some have two or more thin steel rods hinged or pivoted at one end and held by a pin or a lock at the other end. And one at least has steel bars not permanently attached, the ends of which are in the form of a semi-circle, which are dropped between rigid uprights and prevented from slipping off by caps screwed on the uprights.

The writer knows of only two binders which use a clamp which must be screwed tightly in order to hold the magazine firmly. The great merit of these binders is that they hold the magazine firmly, so that it can by no possibility be removed except by the assistant who has the key. They are, however, clumsy and unduly large at the back and it takes some time to fasten them to the magazine.

Taking into consideration all points of excellence it is probable that some form of rod binder is the best. Rod binders are not hard to apply; they require some effort to remove them—those which lock cannot be

removed without a key; they are firm when applied; and many of them do not injure the magazine. Nearly every librarian has his own personal preference among such binders.

Since binders receive very hard wear it is important that they should be made of good material. Those which are used for popular magazines should have cowhide backs and buckram or imitation leather (keratol or fabrikoid) sides. A full leather binding would help solve the question of dirt, but it is equally well and less expensively solved by using imitation leather on the side. In reading rooms frequented only by educated persons binders with flexible leather covers are desirable and are greatly enjoyed by readers. The cheaper grades of cloth, such as are used by the publishers, should never be used, as they soon wear through at the edges and corners. In many cases it is wise to use pigskin or morocco on the back, though if this is done, the cloth sides and the boards themselves may become disreputable before the back is worn. In nearly all binders the mechanism can be removed from the boards when they become shabby, and new covers attached. This will save some of the expense of a new binder. A clever mender can do such work so that it need not be sent to a regular library binder. The boards should not be made of mill boards, but of semi-tar or tar boards.





## CHAPTER XII

### PAMPHLETS

Fortunately it is not necessary to decide here the ever-vexing question "When is a pamphlet not a pamphlet?" From the binding viewpoint any printed matter of more than four pages which does not have a stiff cover is a pamphlet and it is within the province of the binding assistant to prepare it for the shelves.

Unbound material in libraries is of three kinds: periodicals; serial publications which are not periodicals such as annual reports, bulletins of societies or government bureaus, etc.; and separate pamphlets not numbered, of a monographic character. The binding of periodicals forms part of the regular routine and is discussed elsewhere in this book.

Annual reports and other publications of a serial character should be filed in pamphlet boxes on the regular shelves at the end of the bound set. When a sufficient number of reports have collected they may be bound in cloth by decades or half-decades, according to the thickness of the reports. In many libraries most of such publications need not be bound at all, but will answer every purpose if wrapped in paper and lettered by hand. Serials other than annual reports generally give some indication of which numbers

should be bound together, if bound at all. If there be no change of numbering or no completion of volume numbers to indicate a separation, they should be arbitrarily grouped in volumes of a convenient size, conforming if possible to one or more calendar years, and bound or wrapped in paper. If series are not to be kept together they should be treated as described in the following paragraphs.

Monographic works in unbound form range in size from those of a dozen pages to those of several hundred. Probably the best arrangement for a large part of this material is to assign a subject heading or a class number and keep in a vertical file alphabetically or by class number. With this the binding department has no concern, but there are always a number of pamphlets which have permanent value for the library and which should be treated in the same way as a book with stiff covers.

Undoubtedly the cheapest way to prepare pamphlets not over one-half inch thick for the shelves is to put them into Gaylord binders. These are made of board sides connected at the back by a strip of cloth and having on the inside gummed flaps which can be attached to the back of the pamphlet. There are thirty different sizes ranging from 5 by 7 inches to 12½ by 17 inches. They are made in two qualities, the photo-mount costing from \$3.15 to \$13.60 per hundred and press board costing from \$4.25 to \$17.60 a hundred.<sup>1</sup> If the pamphlet has a cover as well as a title page, the cover should be taken off and pasted to

<sup>1</sup> Prices increased 10 per cent April 10, 1916.

the outside of the front cover of the binder. In addition to moistening and attaching the gummed flaps, it will be found necessary in many cases either to wire through the back of the pamphlet with some kind of a stapling machine, or to sew through as described on page 190 for attaching red rope manila to circulating magazines.

When the pamphlet is firmly attached in the binder it should be lettered in white ink along the back. If the pamphlet is very thin it will be necessary to letter author, title and call number along the back edge of the front cover, close to the back. If the original cover has not been pasted on the outside it will also be necessary to letter author and title across the front cover.

Pamphlets which are too big to go into the binders can be bound in regular book form if their use will warrant the expense. If the use will be slight they can be made very serviceable by using the red rope manila as described on page 190.

Very large libraries keep all pamphlets permanently. Those which are not sufficiently important to treat as books are generally kept in classified order in temporary cases. When a sufficient number have been collected on any subject they may be bound together in volumes of proper size. So far as possible pamphlets of the same size should be bound together in cloth, but they may vary a little if they are level on top. The expense of binding in this way is, of course, much less than if each pamphlet had been put in a

binder. Smaller libraries may perhaps be well advised to bind in this way pamphlets having a local interest which must be kept permanently.

It is not necessary to discuss here the various kinds of temporary homes of pamphlets, such as manila folders, envelopes, wooden or pasteboard boxes, Ballard klips, etc. They all have their uses, and each librarian must work out whatever scheme seems best to him.

## CHAPTER XIII

### BINDERY IN THE LIBRARY BUILDING

How large an amount of binding must a library have before it becomes economical to establish a bindery in the library building? This question is frequently asked and is difficult to answer. In the first place, local conditions must be taken into consideration. Is there in the same city a library bindery which does satisfactory work at reasonable prices, or must work be sent a long distance away? Is there ample room in the building and is it easily adapted to binding purposes? Can a good foreman be employed? Is the local rate of wages so high as to make the cost of the binding in the library equal the cost in a good bindery outside the city? These are some of the questions which must be considered.

Some of the advantages in having a bindery in the building are as follows:

1. It is more convenient. When books are much needed they can be found and generally used, even if incompletely bound.

2. There is less chance of losing books. When books are sent to a binder who does the work of other libraries also there is always a chance of loss. The binder, of course, is responsible, but one would always rather have the book than the cash value.

3. There is no chance of damage to books in transit.

4. Repairs which are too difficult for the ordinary library mender to make can easily be done in the library bindery at slight cost.

5. The books need not as a rule spend so long a time in the bindery. If perchance the bindery becomes clogged with extra work the librarian can rush the books that are needed most. If such books are in another bindery, especially when that bindery is outside the city, it is difficult to get the books that are needed first.

6. There is a certain amount of competition which works to advantage if part of the books have to be bound outside. The outside binder knows that the librarian who operates a bindery in his own building knows something about the cost of binding, and he realizes that unless his prices are reasonable and his work good he need not expect to be favored.

7. The librarian can at all times inspect materials on hand and see the books in the process of binding. The bindery outside the building can sometimes substitute inferior materials without fear of detection for many months.

8. When the work reaches a certain amount it can be done at reduced cost in the library, since the ordinary profits of the bindery will accrue to the library.

9. It is much easier to make experiments with new materials or new processes. While the outside

binder does not care to get a small quantity of a new material, the library which owns its own bindery can do so easily.

10. A bindery in the library can do much work, such as the mounting of maps or photographs, gilding of call numbers and book-mending, which needs skilled workmen. Such work frequently remains undone, either because the regular library force has no time to do it or because it seems unwise to send it outside the library.

Such are some of the benefits, but only the larger libraries which bind many thousands of volumes can take advantage of them successfully from the financial standpoint. In order to be administered economically there must be sufficient work to keep several workmen busy. It probably is not wise to open a bindery when the annual expenditure for binding is less than \$4,000.

There are two ways in which a library bindery may be administered. Under the first plan the library buys all material and hires all the workmen, employing a foreman on salary to take charge. A schedule of prices which is lower than the prices paid to outside binders should be adopted, and the total value of binding in a year based on this schedule must equal the cost of material, wages and depreciation on the value of the plant. Under this plan the work may be unexcelled in quality, but there is no incentive to produce it in quantity. So long as the work turned out balances the outlay the employees, unless they are exceptionally conscientious, are satisfied. There is

also the added difficulty of finding a competent foreman. Any man who is able to manage a library bindery successfully is able to manage any bindery successfully and he will not be willing to work for the salary which the library can afford to pay. The librarian himself, harassed as he is with many problems, must of necessity leave such matters as the purchase of material and the hiring of workmen to the foreman in whom he must have implicit confidence. The librarian cannot assume the same attitude toward his bindery foreman that the proprietor of a regular bindery may assume. He is not skilled in the craft, does not know about materials, especially leathers, and cannot direct the work.

Under the second plan the library lets the work out by contract to some binder who agrees to do the work in the building. The contractor is under no expense for rent, heat and light, and in arranging prices this is taken into consideration. It is obvious that it is to the interest of the binder to turn out as large a number of books as possible. Since the librarian has safeguarded the library in the contract by specifying that all materials and work must meet with his approval, this plan is more advantageous to him than the former plan. The contract should allow for frequent revision of schedule.

Under the first plan the librarian will be obliged to buy all machinery, tools and materials, and to hire the workmen. Under the second plan he may have to buy the machinery and tools, but the purchase of



materials and the hiring of labor will be in the hands of the contractor.

A good binding plant will contain the articles in the following list. Those marked \* are necessary, even when the amount of work turned out is small:

- |                                       |                                   |
|---------------------------------------|-----------------------------------|
| * 1 sewing frame                      | 1 ruler                           |
| * 1 standing press                    | * 1 screw driver                  |
| * 4 dozen press-boards<br>(all sizes) | 1 lying press                     |
| * 1 glue pot                          | * 1 finishing press               |
| * 3 hammers                           | 1 steel square                    |
| * 1 board shears                      | * 1 pair pliers                   |
| * 1 lever paper cutter                | 2 straight-edges                  |
| 1 perforating machine                 | * 3 awls                          |
| 2 extra cutting knives                | * 1 iron divider                  |
| * 1 hammering-block with<br>plate     | * 1 oil can                       |
| 1 grindstone                          | * 1 paste bucket                  |
| * 1 paring stone                      | * 1 complete set of brass<br>type |
| * 1 oil stone                         | * 1 pallet                        |
| * 2 pairs of shears                   | * 1 gold cushion                  |
| * 2 paring knives                     | * 1 gold knife                    |
| * 8 bone folders                      | * 6 gilding rolls                 |
| * 4 brushes                           | * 1 imprint stamp                 |
| * 1 monkey wrench                     | * 1 single fillet                 |
| 1 sandstone                           | 1 two-line fillet                 |
| * 2 saws                              | * 1 finishing gas stove           |
| * 1 book-backing machine              | * 1 ten-drawer type cabinet       |
| * 2 dozen sewing needles              | 1 flat agate polisher             |
|                                       | 1 flat steel polisher             |

1 round agate polisher	* 1 finisher's bench
1 gas stove for heating	1 small table
glue	1 band nippers
* 1 forwarder's bench	1 creaser
* 1 sewing table	

The total cost of the plant will vary in various sections of the country, but it ought not to cost more than \$800. If second-hand cutting machines, benches, etc., can be obtained it is possible that the cost may be reduced to \$650 or less. The St. Louis Public Library recently equipped a bindery at a cost of \$587. During the first year, with a force of fifteen, it turned out work to the value of \$9,609.

## APPENDIXES



## APPENDIX A

# SPECIFICATIONS OF THE U. S. BUREAU OF STANDARDS FOR BOOK CLOTHS

### FABRIC

The fabric shall be made from first-quality staple cotton, uniformly woven and of a grade known as "firsts." The weave shall be two up and two down in the warp and one up and one down in the weft.

The gray cloth shall consist of from 33 to 36 threads per centimeter (85 to 90 per inch) in the warp, and 12 to 15 threads per centimeter (30 to 38 per inch) in the weft.

The surface shall be finished smooth and hard and show no tendency to stick when folded upon itself.

### THICKNESS, TENSILE STRENGTH AND WEIGHT

The thickness of the finished fabric shall not exceed 0.30 millimeter (0.012 inch) or be less than 0.20 millimeter (0.008 inch). The tensile strength of the gray cloth shall be not less than 18 kilograms per centimeter (100 pounds per inch) of width in the warp, and 9 kilograms per centimeter (50 pounds per inch) in the weft. The average value for the warp and weft in the finished fabric must show an increase over the average value for the warp and weft in the gray cloth of at least 10 per cent of the strength of the gray cloth.

The finished fabric, when dry, shall weigh not more than 250 grams per square meter (0.5 pound per yard), or less than 200 grams per square meter (0.4 pound per yard).

## ABSORPTION OF MOISTURE

At a normal relative humidity of 65 per cent it shall not absorb more than 5 per cent of moisture, or expand (an average of both directions) to exceed 0.45 per cent, and when subjected in a closed case to a saturated atmosphere for two hours at a temperature of 20° C. (68° F.) shall not absorb more than 10 per cent of moisture or expand (an average of both directions) to exceed 2 per cent. All increases to be computed on the basis of the dry weight and dimensions.

## FOLDING ENDURANCE

The folding endurance, as determined by the Schopper folder, shall be not less than 65,000 double folds for the warp and not less than 10,000 for the weft.

## COLOR

Before coating, the fabric must be dyed with a purely mineral or inorganic color (such as iron salts), so as to imitate the color of the finished cloth, but somewhat lighter in shade, so as to give the desired "linen" effect. All coal-tar, aniline, vegetable, or other organic dyes and lakes must be strictly excluded from both fabric and coating, even in traces; except where necessary to match color, lake may be used in red, blue, or brown. The following substances must be also excluded: Chrome yellow and other chromates, ultramarine, browns containing bituminous or other organic matter, compounds of lead and arsenic.

The color of the finished fabric should be slightly darker than the standard sample, which will be furnished on application, and it must not show the slightest change of color after exposure under prescribed conditions to direct sunlight, or to the action of ammonia gas, sulphuretted-hydrogen gas, sulphur-dioxide gas, or illuminating gas.

## RESISTANCE TO MOLD AND INSECTS

The finished fabric shall be immune to the growth of mold or the attack of insects.

## TESTS

Physical and chemical tests to verify the properties required by these specifications will be made according to the "Standard method for testing book cloths" as used by the Bureau of Standards, copies of which can be obtained on application.





## APPENDIX B

### READING LIST ON BINDING

- Adam, Paul. Practical bookbinding. 1903. Van Nostrand.  
\$1.25.  
A translation of a German work.
- American library association. Committee on bookbinding.  
Binding for libraries. 1915. A. L. A. Publishing Board.  
\$.15. (Library handbook No. 5. Second edition, revised.)  
Binding specifications which may be used by large as well as small  
libraries.
- Bailey, A. L. Bookbinding. 1911. A. L. A. Publishing  
Board. \$.10.  
Preprint of Manual of library economy, Chapter 26.
- Bindery talk. 1912-13. v. 1-2. All published.  
A periodical published by W. E. Reavis, Los Angeles, California,  
covering various phases of library binding.
- Bliss, H. E. Better bookbinding for libraries. Library  
Journal, 1905, 30:849-57.  
Brief article on methods and materials.
- Brown, J. D. Bookbinding and repairing. In *his* Manual  
of library economy, pp. 328-48.  
Valuable chiefly for its section on lettering.
- Brown, M. W. Mending and repair of books. A. L. A.  
Publishing Board. \$.15. (Library handbook No. 6.)
- Caldwell, M. R. Preparing for the binder. Public Li-  
braries, 1906, 11:302-3.
- Chivers, Cedric. Paper and binding of lending library  
books. American Library Association. Bulletin. 1909,  
3:231-59.  
Also published separately by Mr. Chivers. A record of experiments  
and tests of modern book papers.

Chivers, Cedric. Relative value of leathers and other binding materials. 1911. Published by the author.

A record of tests of leathers. Practically the same article will be found in the Bulletin of the American Library Association for 1911, p. 164.

Cockerell, Douglas. Bookbinding and the care of books. 1902. Appleton. \$1.25.

Best general book on binding processes, but does not cover all library requirements.

Coutts, H. T., and Stephen, G. A. Manual of library bookbinding. 1911. Libraco Limited. 7s. 6d. net.

A valuable book for all libraries. Gives the English point of view.

Crane, W. J. E. Bookbinding for amateurs. 1903. Scribner. \$.65.

Cundall, Joseph, ed. On bookbindings, ancient and modern. 1881. Bell, Lond. \$12.

Will be used mainly by those interested in the history and artistic side of bookbinding.

Dana, J. C. Notes on bookbinding for libraries. Ed. 2. 1910. Library Bureau. \$1.

The best single book for the librarian.

Drury, F. K. W. On protecting pamphlets. Library Journal, 1910, 35: 118-19.

Field, C. Book repairing. California News Notes, 2: 105-8.

Hasluck, P. N., ed. Bookbinding. 1903. McKay. \$.50.

Practical handbook. Does not cover strong binding for libraries.

Horne, H. P. Binding of books. 1894. Scribner. \$2.

For those interested in the artistic side of binding.

Hulme, E. W., and others. Leather for libraries. 1905. Library Supply Co., London. 2s. 6d. net.

Lowe, J. A. Permanent book marking. Library Journal. 1910, 35: 15-17.

Macleod, R. D. Preservation of books in libraries. Library World, 11: 256, 331, 368, 417.

Deals with general repairs, etc. The second part (p. 331) is especially valuable for the large number of cleaning recipes.

- Memoranda relative to binding publications for distribution to state and territorial libraries and depositories. 1908. U. S. Superintendent of Documents.  
An account of the tests of book cloths made by the Bureau of Standards.
- Philip, A. J. The business of bookbinding from the viewpoint of the binder, the publisher, the librarian and the general reader. 1912. S. Paul. 6s. net.  
In spite of the title the viewpoint is that of the librarian.
- Prideaux, S. T. Historical sketch of bookbindings. 1893. Lawrence, London. \$1.50 net.
- Sawyer, H. P. How to care for books in a library. 1912. Democrat Printing Co., Madison, Wis. \$.10.  
A good article on mending.
- Society of arts. Report of the Committee on leathers for bookbinding. 1905. Bell. 10s. 6d.
- Stephen, G. A. Commercial bookbinding. 1910. Stonhill, London. 2s. 6d.  
The best book on this subject.
- . Machine book-sewing. 1908. Aberdeen University Press.  
Reprinted from the Library association record, June 1908.
- . Notes on materials for library bookbinding. Library Assistant, 1905-7, 5:143-6, 162-4.
- Swezey, A. D. Binding records. Public Libraries, 1909, 14: 5-7.
- Worcester (Mass.) County law library. Leather preservation. 1911.
- . A small binding plant in the building. 1912.
- Zaehnsdorf, Joseph. Bookbinding. Macmillan. \$1.50.
- Zahn, Otto. On art binding. 1904. Toof & Co., Memphis. \$1.50.  
By a well known artistic bookbinder.



## APPENDIX C

### LIST OF TECHNICAL TERMS

In this list terms relating to paper, to materials described in the body of this work and to historical bindings, and terms seldom used have been omitted.

**Acid free leather.** Leather which is manufactured without using acid. As interpreted by some dealers, it means leather from which all acid has been removed.

**Aldine style.** Decorative design consisting of solid face ornaments without shading. First used by Aldus and other early Italian printers.

**All-along.** In hand-sewing when the thread passes from kettlestitch to kettlestitch in each signature it is sewed all-along.

**Antique.** See Blind-tooled.

**Arabesque.** Decorative design consisting of many interwoven lines and curves arranged in conventional patterns. Sometimes applied to a design consisting of interwoven plants, animals, birds, etc.

**Arming press.** See Blocking press.

**Asterisk.** This well known sign is sometimes used to indicate that the printed matter on which it appears is to take the place of pages previously printed.

**Awl.** See Bodkin.

**Azuré tools.** Tools with a series of horizontal lines parallel on their faces.

**Back lining.** Cloth or paper glued to the back of a book to help hold the signatures together.

**Backing.** Forcing over the folds on each side at the back to form grooves into which boards fit, forming the joint.

**Backing boards.** Used for backing or forming the joint. Made of hardwood sometimes faced with iron. Have a beveled edge, over which the paper is forced by hammering and are thicker at this edge than at the other, so that when placed one on each side of the book and all are placed in the lying press, the power of the press is brought to bear on the part of the book nearest the back.

**Backing hammer.** Has a broad, flat face and short handle. Used in rounding and backing.

**Backing machine.** Machine run by power used in edition work for backing books.

**Backing press.** A press having vertical steel plates brought together with a screw. When the book is placed in it with the back slightly projecting it can be backed in exactly the same way as if backing boards were used.

**Band-driver.** Used in forwarding to eliminate irregularities of raised bands.

**Band nipper.** Pincers used after leather has been put on over raised bands in order to straighten them.

**Banding.** Decorating by means of horizontal stripes.

**Bark skiver.** Tanned with oak bark.

**Bastard title.** See Half title.

**Beading.** Small twist or roll formed when winding the cotton or silk in head-banding.

**Beating.** Process of flattening and smoothing out the folded sheets to make the leaves lie closely together.

**Beating hammer.** Heavy, short-handled hammer used for beating books to make the leaves lie closely together.

**Beating stone.** Stone or iron bed on which books are beaten.

**Beveled boards.** Heavy boards with beveled edges, sometimes used for the sides of very heavy or large books.

**Binder.** 1. Case used for the temporary protection of pamphlets and periodicals. Can be detached and used on succeeding numbers. 2. One whose business it is to bind books.

**Binder's title.** Title lettered on the back of a book. Frequently differs from that on the title page.

**Binder's board.** See Boards.

**Binding slip.** Sheet of paper containing instructions to the binder inserted in each book sent to the bindery.

**Blanks.** Books with blank leaves of good paper used for keeping records which are more or less permanent. The binding of such books is a special trade.

**Bleed.** When books are trimmed so that part of the print is cut off they are said to bleed.

**Blind-tooled.** Books on which impressions have been made by tools without the use of gilt are blind-tooled. Sometimes called "Antique" tooling.

**Block.** The solid metal stamp used for impressing a design on a book cover.

**Blocking.** Stamping the design in gold or other material on book covers.

**Blocking press.** Used in stamping designs on cloth book covers or back. Known also as stamping press and arming press.

**Board papers.** The parts of end papers pasted to the boards.

**Board shears.** Heavy shears with a gauge, for cutting boards for the sides of books.

**Boards.** Boards for the sides of books are called cloth board, binder's board, mill board, tar board. They are called boards in the full size and also when cut for sides.

**Bodkin.** An awl used for punching holes in boards through which the bands are laced.

**Body.** Main part of the book, from Chapter I to the end of the text.

**Bolt.** The folded edge of signatures at the head, fore edge and tail of books.

**Book card, or Book slip.** Card kept in the book, used in charging the book when it is borrowed.

**Book label.** See Label.

**Book pocket.** A pocket made of paper, generally pasted on the last fly-leaf to hold the book card when the book is on the shelf, or to hold the reader's card when the book is borrowed.

**Bosses.** Metal ornaments fastened on the boards of books.

**Broken.** 1. Paper folded over. 2. The back of a book which has been cracked open from head to tail is broken.

**Broken up (or over).** Plates are broken up when they are folded over a short distance from the back before being placed in the book.

**Burnish.** The gloss produced by the application of a burnisher to the edges of a book.

**Burnisher.** Piece of agate or blood-stone set in handles and used to produce a gloss on the edges of books.

**Calendered paper.** Paper with a highly polished surface.

**Cancels.** Leaves containing errors which are to be replaced with corrected pages. The replacements are frequently marked with an asterisk.

**Canvas.** Same as duck. See page 80.

**Caps.** Coverings which protect the edges of books during the processes of covering and finishing.

**Case.** 1. A cover for a book made independently of the book, i. e. the boards are not laced in. 2. Cover made to fit over book already bound in order to protect it.

**Case bindings.** Books in which the boards and covering materials are made into a case and the book glued into it. Term generally applied to commercial work, which is practically all done by machinery.

**Casing-in.** The operation of putting a sewed and forwarded book into its case.

**Catchword.** In old books and in a few modern books the first word of a page is printed under the last line on the preceding page. This is called the catchword.



**Center tools.** Specially-cut tools for ornamenting the centers of panels.

**Circuit edges.** Projecting flexible covers turned over to protect the leaves of the book. Used almost wholly on Bibles and prayer books. Sometimes called divinity edges.

**Clasp.** A catch for fastening the covers of a book together.

**Clearing-out.** The process of removing the waste paper and paring away superfluous leather on the inside of the covers before pasting down end papers.

**Cloth boards.** 1. Boards covered with cloth. 2. Boards used for the sides are sometimes called cloth boards instead of mill boards.

**Collation.** An examination of a book to see if it is complete. May be done by signatures before book is bound. Must be done page by page in books which are to be rebound.

**Combs.** An instrument with wire teeth used in marbling.

**Compensating guards.** Short stubs bound in the back to equalize space taken up by thick folded plates.

**Creaser.** The tool used in marking on each side of raised bands. Generally made of steel.

**Cropped.** Term applied to books which have been trimmed too much.

**Crushed.** Term applied to leather, generally morocco, which has been pressed so that the surface, naturally grained, is made smooth.

**Cut edges.** See Edges cut.

**Cut flush.** In very cheap binding the book is trimmed after the cover is on and edges of boards are cut flush with the leaves.

**Cutter, or Cutting machine.** A machine used for trimming the edges of books. Sometimes called guillotine.

**Cutting boards.** Boards similar to backing boards, except that they are not beveled. Used in trimming.

**Cutting in boards.** See In boards.

**Cutting press.** The "lying press" turned over so that the runners are uppermost.

**Deckle edge.** The rough untrimmed edge of hand-made paper.

**Dentelle.** A form of book ornament which supposedly represents lace.

**Derome.** A style of ornament having dentelle border with small birds among the arabesques.

**Diaper.** A form of ornament consisting of a small pattern repeated in geometrical form.

**Divinity calf.** Dark brown calfskin blind-stamped and without gilding, formerly used in binding religious books.

**Divinity edges.** See Circuit edges.

**Die.** An engraved stamp used for stamping a design.

**Double.** See Doublure.

**Doubled.** A design is doubled when the finisher tries to make a second impression and the tool does not quite follow the lines of the first impression.

**Doublure.** The lined and decorated inside face of boards on fine bindings. When so lined the cover is said to be "double."

**Dummy.** 1. A book made up of blank leaves to show style of binding and grade of workmanship. 2. A piece of leather or cloth mounted on a board to show exact size and lettering of a periodical.

**Duodecimo.** Book printed on paper folded into twelve leaves. Generally written 12mo. Loosely applied to books from six to eight inches high.

**Dutch metal.** An imitation of gold leaf which soon tarnishes.

**Edges cut.** A book which has all edges trimmed smooth.

**Edges gilt.** All edges trimmed smooth and gilded.

**Edges opened.** A book which has the folds of leaves cut by hand with a paper knife, has its edges opened.

**Edges rolled.** The edges of the covers are marked with a roll.

**Edges trimmed.** Edges cut somewhat, but not enough to cut all the folds.

**Edges uncut.** Uncut edges have not been trimmed in any way, though they may have been opened with a paper knife.

**Edition de luxe.** Fine editions of books printed on large paper and handsomely bound. Many books so-called are in reality cheaply bound.

**Eighteenmo.** A book printed on paper folded into eighteen leaves. Not often found.

**Elephant folio.** See Folio.

**Embossing.** The process of producing raised designs by means of stamps. Used in imitating leathers.

**End papers.** Folded sheets at the beginning and end of books, half of which are pasted to the boards. Sometimes called lining papers.

**Eve style.** Decorative design consisting of geometrical figures joined by interlaced circles. The figures contain flowers and the space surrounding them contains scroll work and branches of laurel and palm.

**Extra binding.** Trade term for the best work.

**Fanfare style.** Leafy spirals interwoven with a delicate tracery over the cover.

**Fast.** Colors are fast to sunlight if they do not fade; to water if they do not wash off.

**Fillet.** 1. Plain lines stamped upon the back or cover of the book. 2. The tool with which the work is done.

**Filling.** See Weft.

**Finishing.** 1. All processes after the book leaves the hand of the forwarder are known as finishing processes. 2. The ornaments stamped on a book.

**Finishing press.** A small wooden press with wooden screws which holds a book with the back up.

**Finishing stove.** A small gas or electric stove used for heating finishing tools.

**Flexible.** A form of binding in which the book is sewed on raised bands, the thread being passed entirely around the bands.

**Flush cut.** See Cut flush.

**Fly leaves.** Blank leaves at the beginning and end of the book between end papers and the book itself.

**Folder.** 1. Small flat piece of bone used in folding sheets and in other binding processes. 3. Person engaged in folding sheets.

**Folding machines.** Power machine for folding sheets.

**Folio.** 1. A book printed on paper folded in two leaves—four pages. Loosely applied to books over fifteen inches high. Very large books are sometimes called elephant folios. 2. Consecutive page numbers of a book.

**Fore-edge.** The front edge of the leaves of a book.

**Font.** The complete number of letters, figures, etc., forming a set of type.

**Format.** Size and shape of a book.

**Forwarding.** 1. All processes between sewing and finishing. 2. The department which takes charge of books during these processes. Those who work in it are called forwarders.

**Foxed.** Books having leaves stained by dampness are said to be foxed.

**French guard.** The back edge of an illustration turned over and folded around the adjoining signature.

**French joint.** Joint formed by setting the boards a short distance away from the back. See page 46.

**French morocco.** A very inferior quality of levant morocco. Many skins so-called are sheep skins or cowhide.

**Frontispiece.** Illustration facing the title page.

**Full-bound.** Term applies to books entirely covered,

back and sides, with the same material, whether cloth or leather.

**Gascon style.** The distinguishing characteristic of this style of decoration is that dotted lines are used instead of lines which are continuous.

**Gathering.** Collecting the folded sheets, or signatures, in the order in which they are bound.

**Gaufre edges.** Edges which have had impressions made by finishing tools after the edges have been gilded.

**Gauge.** A tool used for obtaining the correct size of a volume in order to mark it on boards for squaring.

**Gilding press.** Same as the finishing press.

**Gilt edge.** See Edges gilt.

**Gilt tops.** Top edges gilded.

**Glaire.** A liquid made by beating whites of eggs. Used in lettering and gilding. See page 195.

**Goffered edges.** See Gaufre edges.

**Gold cushion.** Leather cushion on which the finisher cuts gold leaf.

**Gold knife.** A long straight knife used in cutting gold leaf.

**Gold leaf.** Gold beaten very thin, used for lettering and gilding.

**Gouge.** A finishing tool used to stamp the segment of a circle on a book.

**Grain.** The outer surface of a piece of leather from which the hair has been removed. Generally used with adjectives which indicate the appearance of the grain in question.

**Graining.** 1. Process of "bringing up" the natural grain of leather by artificial means. 2. Process of embossing leather to produce a fictitious grain.

**Grater.** Tool used for rubbing backs after they are paste-washed.

**Grolier.** An elaborate style of ornament consisting of scroll work with interwoven squares, circles and diamonds, parts of the design being studded with gold dots.

**Grooves.** Projections at the back against which boards rest to form the joint. Made by the backing hammer. Sometimes called joints.

**Guards.** 1. Narrow strips of paper bound in books to which plates or leaves are attached later. 2. Narrow strips of cloth or paper used to reinforce the folds of signatures, or pasted to single leaves and folded around adjoining signatures.

**Guides.** The grooves in which the plough moves on the face of the cutting press.

**Guillotine.** See Cutter, or Cutting machine.

**Half-bound.** Term indicating that leather is used on the back, with cloth or paper on the sides. If small pieces of leather are placed on the corners the book is still half-bound. If the corner pieces are large the book is three-quarters bound.

**Half-title.** Brief title on the leaf preceding the main title page. Also called Bastard title.

**Hand letters.** Single letters affixed to handles and used in lettering.

**Head.** The top of the back of the book.

**Headband.** A silk or cotton band attached to the head of the book to strengthen it, improve its appearance, and make the back even in thickness with the boards.

**Head cap.** Fold of leather over the headband.

**Heel-ball.** Shoemaker's preparation of wax used for taking rubbings of the backs of books.

**Holeing.** Piercing the boards with an awl so that bands can be laced-in.

**Hollow back.** See Loose back.

**Imperfections.** In commercial binderies, sheets rejected because imperfect.

**In boards.** 1. Term used when books are cut after boards have been attached. 2. Style of binding which has a very narrow cloth back and paper covered sides.

**In print.** Obtainable from the publishers.

**India-rubbered.** When the backs of books consisting of single leaves are covered with a solution of india

rubber instead of being sewed they are said to be India-rubbered. Not practicable for permanent bindings.

**Inlaid.** The cover of a book bound in leather in which leather of a different kind or color has been inlaid.

**In quires.** Unbound books in sheets.

**Inset.** A folded sheet laid inside of another.

**In sheets.** A book is said to be in sheets before it has been bound, whether the sheets are folded or not.

**Inside margin.** The border made by the turned-in leather on the inside face of the boards.

**Inside tins.** Sheets of tin sometimes placed in books which are to receive heavy pressure.

**Jansen style.** A style of decoration in which the book is absolutely plain on the outside except for lettering. The inside covers, however, may be elaborately decorated.

**Joints.** The part of the book which bends when the book is opened. See also Grooves; French joint.

**Kettlestitch.** The stitch made at the head and tail of the book fastening a signature at these points to the preceding signature.

**Keys.** Small metal objects which fasten the bands to the under side of the sewing bench.

**Kip calf.** Made from the skin of a heifer. Stronger than calfskin.

**Knocking-down iron.** Iron plate on which books are placed when it is necessary to hammer down the ends of laced-in bands to prevent them from showing.

**Label.** A piece of paper or leather affixed to the back of a book on which to letter information.

**Lacing-in.** Process of attaching the ends of bands to boards through holes made with an awl. See page 42.

**Large-paper edition.** Copies of a book printed on paper with wide margins.

**Laying press.** See Lying press.

**Law sheep.** Uncolored sheepskin. So-called because

at one time it was generally used on law books. See page 65.

**Lay cords.** The bands when stretched on the sewing bench ready for the signatures.

**Leatherette.** Imitation leather, generally made of cloth.

**Lettering block.** A dummy book made of wood on which leather labels that are to be lettered are placed for greater ease in gilding.

**Lettering box.** That part of the pallet in which type is screwed up before lettering.

**Limp leather.** Books bound in full leather without stiff boards are said to be bound in limp leather.

**Lining papers.** See End papers.

**Loose back.** Books are loose backed when the covering material is not glued to the back, but springs out when the book is opened. Called "hollow back" in England.

**Lying press.** The under side of the cutting press used in backing. Sometimes called laying press.

**Magazine binder.** See Binder.

**Maioli style.** Decoration formed of shields or medallions with scroll work running through them.

**Marbled calf.** Calfskin treated with acid so that it resembles marble.

**Marbling.** Process of staining the paper or the edges of books with colors irregularly combined, similar to the irregular colorings and markings in marble.

**Marker.** Piece of ribbon fastened to the headband and used as a book mark. Also called Register.

**Marking-up.** Marking the position of the cords on the back.

**Millboard.** See Boards.

**Millboard machine.** Used for cutting and squaring boards.

**Mitred.** Term indicating that lines in finishing meet-ing each other at right angles, continue but do not over-run each other.



**Mosaic binding.** A leather binding ornamented by designs made of inlaid pieces of leather or other material of different colors.

**Mottled calf.** Light brown calf treated with acid to give it a mottled appearance.

**Mull.** See Super.

**Octavo.** Book printed on paper folded into eight leaves. Usually written 8vo. Loosely used to indicate that the size of a book is between eight and ten inches in height.

**Off and on.** Term used in machine sewing, meaning that certain stitches in each signature are skipped.

**Off-set.** Marks made on opposite page because the printer's ink had not become thoroughly dry. In case of illustrations tissue paper is frequently inserted to prevent this. Also called set-off.

**Opened edges.** See Edges opened.

**Out of boards.** A book trimmed before the boards have been fastened to it.

**Out of print.** Not obtainable from the publishers.

**Overcasting.** Process of sewing single leaves over and over. Also called whipstitching. See page 23.

**Pallet.** A tool used in lettering having an adjustable box for holding type securely, with a handle attached.

**Panel.** 1. Space between raised bands, or between stamped lines on the back. 2. A square or rectangular space on the side of a book, whether sunken or enclosed by beveled edges or gilded lines.

**Papering-up.** Covering the leaves of a book, especially if it has gilded edges, to protect it during further processes.

**Parchment.** A material similar to vellum, but not so thick.

**Paring.** Process of thinning the edges of leather with a sharp knife, so that there will not be a rough edge when it is on the book. Sometimes called skiving.

**Pastewash.** Paste diluted with water.

**Pasting-down.** Operation of pasting end papers to the boards.

**Payne, Roger.** Style of decoration distinguished by gold-tooled corner pieces and by the grace and freedom of ornamentation.

**Pebble-grained.** Covering material grained in an irregular manner.

**Pegamoid.** An imitation leather made in England.

**Perforating machine.** A machine which punches holes in sections so that they can be more easily overcast.

**Petits fers.** Small hand tools used in finishing, as distinguished from the stamps or blocks used in a press.

**Pieced.** Any space on the cover of a book which has a piece of another material attached to it. Most often used to mean leather which is used as labels for titles; also called titled.

**Plate.** 1. Illustration printed from a plate. The term is often used incorrectly for wood cuts. 2. In library usage any full-page illustration not paged-in.

**Plough.** A tool used for trimming books.

**Pluvisin.** An imitation leather made in England.

**Pocket.** An envelope made of paper or cardboard generally attached to the inside of the back cover and used to hold loose maps or plates. See also Book pocket.

**Pointillé style.** A form of decoration in which the design is marked with small dots or points.

**Points.** Holes made in sheets during the process of printing which serve as guides in registering and folding.

**Polisher.** A steel tool used to give a gloss to leather after finishing.

**Portfolio.** A case made for holding loose plates or maps.

**Powder, Semé.** A form of decoration in which a small figure is repeated regularly.

**Preliminary matter.** Half title, title, table of contents and preface, and all other matter preceding the main part of the book.

**Press pin.** An iron bar used to turn the screws of standing presses.

**Presses.** For various kinds see Lying press; Cutting press; Finishing press; Blocking press.

**Pressing boards.** Wooden boards placed between books in the standing press. Brass strips which project over the edges of the board fit into the grooves of the joint.

**Pressing plates.** Japanned or nickeled plates, which, when placed next to leather bindings under heavy pressure give them a finish.

**Pulled.** A book taken from its cover and the signatures separated is said to be pulled.

**Puppy.** The specially prepared rubber used to remove superfluous gold leaf from a book is sometimes called the puppy.

**Quarto.** A book printed on paper folded into four leaves (eight pages). Generally written 4to. Loosely applied to books between ten and fifteen inches high.

**Quire.** Twenty-four sheets.

**Raised bands.** See Bands.

**Re-casing.** Replacing a book in its original cover, either with or without resewing.

**Recto.** Right hand page of an open book.

**Register.** 1. Ribbon attached to a book to be used as a book mark. 2. Term indicating that the print on the verso falls exactly over that on the recto.

**Rexine.** An imitation leather made in England.

**Roll.** Finishing tool with brass wheel having a design on the circumference. Used in decorating leather bound books.

**Rolled edges.** See Edges rolled.

**Rolling machine.** Used in publisher's binding to press the leaves firmly together.

**Roulette border.** Border design made with a roll.

**Rounding hammer.** Heavy hammer used in rounding.

**Roundlet.** Small circle in gold used in decorating books.

**Roxburgh binding.** Plain leather backed book, lettering near the top enclosed in gold lines, gilt top, and cloth or paper sides.

**Rub-off, or Rubbing.** A copy of the back of a book showing exact lettering. Made by placing a sheet of thin strong paper on the back and rubbing it with a piece of heel-ball until all lettering is fully outlined.

**Run-up.** The back of a book with a fillet from head to tail not mitred at the bands is said to be run-up.

**Running title.** Short title of a book or chapter appearing at the head of the page throughout the book or chapter.

**Saddle stitching.** A machine process which either sews or staples pamphlets of one signature.

**Sawing-in.** Sawing the back of a book to make grooves in which the bands will rest when the book is sewed.

**Section.** See Signature.

**Semé.** See Powder.

**Set-off.** See Off-set.

**Setting the headband.** Adjusting the leather so that it covers the headband with a kind of cap.

**Sewer.** The person who sews the signatures together on a sewing bench to form a book.

**Sewing bench.** A board about two feet long having at each end on the front edge an upright. These are connected by a bar which is adjustable in height and between which and the board are stretched the bands or tapes on which the book is sewed.

**Sextodecimo.** See Sixteenmo.

**Shears.** See Board shears.

**Sheets in.** See In sheets.

**Signature.** 1. The letter or figure on the first page of each folded sheet to ensure its proper place in the book when bound. 2. The folded sheet itself. Often called section.

**Sixteenmo.** A book printed on sheets folded into sixteen leaves. Generally written 16mo.

**Size.** A preparation used in gilding and finishing.

**Skiving.** See Paring.

**Slips.** The pieces of bands or tapes projecting beyond the book after it is sewed.

**Smooth calf.** Plain, undecorated calf.

**Split boards.** 1. Boards split at the edge to admit slips and backlining. 2. Boards made of two boards glued together, leaving a space for insertion of slips and backlining.

**Sprinkled calf.** Calf treated with acid so that it looks as if it had been sprinkled with dye.

**Sprinkled edges.** Edges which have been colored by shaking or spraying coloring matter on them.

**Squares.** The parts of the board projecting beyond the edges of the leaves of the book.

**Stabbing.** 1. Process of fastening together the signatures of a pamphlet with wire. 2. Piercing the boards for lacing-in.

**Stabbed.** A pamphlet is said to be stabbed when the signatures are held together by wire staples driven in vertically near the back and clinched on the other side.

**Stamping press.** See Blocking press.

**Stamps.** Blocks or dies used to impress designs upon leather.

**Standing press.** A large fixed press capable of holding many books.

**Start.** Sections which after cutting project beyond the others, are said to have started.

**Steamboating.** Cutting a number of books at the same time.

**Stitching.** Process of sewing signatures lengthwise with a sewing machine. *See also* Saddle stitching.

**Strawboard.** Very soft paper board easily broken or cut. Sometimes used in cheap work.

**Super.** A thin, coarsely woven cotton cloth used for backlining. Called mull in England.

**Tacky.** Glue that is still sticky but not wet is tacky.

**Tail.** The bottom of the back of the book.

**Tar board.** See Boards.

**Thirty-twomo.** A book printed on sheets folded into thirty-two leaves. Written 32mo.

**Three-quarters bound.** See Half-bound.

**Thrown out.** Folded maps or diagrams which are likely to be used a great deal can be mounted on cloth guards the width of the book. When opened they will be entirely outside the book and are said to be thrown out.

**Tight back.** A book on which the covering material is glued to the back. See page 44.

**Title.** Space between the bands upon which the title is lettered.

**Title skiver.** Very thin skiver used as labels on which to gild lettering.

**Titled.** See Pieced.

**Tooling.** The decoration of leather made by stamping designs in gold leaf upon it.

**Tools.** Brass stamps used in tooling.

**Top gilt.** Indicates that only the top edge of the book is gilded.

**Tree calf.** Imitation of the trunk and branches of a tree made with acid on the sides of a book bound in full calf.

**Trimmed.** 1. Books which have only the edges of projecting leaves, not the folds, cut off are said to be trimmed. 2. In library binding the term generally means that all edges have been trimmed even.

**Trindle.** A small tool used to take out the round of a book when it is being cut.

**Tub.** Stand supporting the lying press. Formerly a tub used to catch the paper cut from the edges.

**Turning up.** When books are cut in boards it is necessary to take the round out of the back. The process is assisted by the use of trindles and is called turning up.

**Twelvemo.** See Duodecimo.

**Twenty-fourmo.** A book having twenty-four leaves to a sheet.

**Two on.** See page 23.

**Tying up.** When leather covers are put on over raised bands it is necessary to tie them with twine so that the leather will stick to the sides of the bands.

**Uncut.** See Edges uncut.

**Unopened.** When the folds of signatures have not been cut the book is unopened.

**Varnish.** Bookbinder's varnish is used to give a gloss to leather. It is claimed that it acts as a preservative also.

**Verso.** Left hand page of an open book.

**Warp.** The threads running lengthwise in cloth.

**Waste papers.** The part of the end papers or fly leaves which in some kinds of work are removed when the end paper is pasted to the cover. The terms end papers, fly leaves and waste papers are used in different binderies with much the same meaning.

**Waterproof sheets.** Sheets of waterproof cardboard sometimes laid in or between books when pressing.

**Weft.** The threads running crosswise in cloth. Also called woof, and filling.

**Whipping, or whipstitching.** See Overcasting.

**Whole bound.** Term indicating that a book is bound in full leather. See also Full bound.

**Wire sewing.** Sewing the signatures of a book to cloth by means of wire staples driven through their centers.

**Wired.** Pamphlets held together by wire staples driven through and clinched near the back edge, are said to be wired.

**Witness.** The leaves of a book which show the original size of the sheet, although other sheets have been trimmed, are a witness to the fact that the book has not been cut down.

**Woof.** See Weft.





# INDEX

- Acid-free leather, 58, 90  
 Acids used in dyeing, effects, 57  
 Adhesives, 167  
 Advertisements, when to bind, 135  
 Age of animals, effect on leather,  
     53  
 Aldine vellum, 76  
 A. L. A. Committee on Binding, 11  
     — Specifications for reinforced  
     books, 109  
 American russia, 65  
 Ammonia, 171  
 Angora goatskin, 69  
 Arrangement for binding, 132  
 Art canvas, 76  
     — vellum, 76  
 Artistic binding, 7  
 Back-lining, 34  
 Backing, 33  
 Backs, loose, mending, 181  
     —, tight, mending, 181  
     —, tight and loose, 44  
 Bands, 19  
     — frayed, 32  
     —, number necessary, 18, 91  
     —, raised, 40  
 Barbour's thread, 85  
 Bench sewing, 19  
 Bibliography of binding, 221  
 Bids for binding, 11  
 Binder, instructions for, 139  
 Binders' boards, 83  
 Binders for magazines, 199  
     — ignorant of library binding, 9  
 Bindery in the library, 209  
     —, equipment, 213  
 Binding before purchase, 103  
     — records, 149  
     — routine, 157  
     — slip, use of, 139, 140  
 Boards, 83  
     — cut, 36  
 Bock, 70  
 Bone folders, 172  
 Bookbinding terms, 225  
 Books, discarding of, 131  
     —, opening of, 122  
     —, proper care, 122  
 Booksellers, oppose reinforced  
     books, 112  
 Brownie books, strong binding, 113  
 Brushes, 173  
 Buckram, 76  
 Buffing, 66  
 Bureau of Standards, Specifica-  
     tions for cloth, 217  
     —, tests of cloth, 78  
 Burnishing, 32  
 Calfskin, 70  
     — vs. cowhide, 53  
 Call number, location of, 143  
     — numbers gilded, 39  
 Canton flannel for lining, 35  
 Canvas, 80  
 Care of books, 122  
 Case, making of, 36  
 Cased books, 38  
 Catechol group, 56  
 Cheesecloth, 170  
 Chivers, Cedric, binding from  
     sheets, 103  
     —, tests of leather, 60  
     —, test of levant morocco, 69  
 Classic buckram, 76  
 Cleaning cover, 177  
     — pages, 174  
 Climate, effect on leather, 54  
 Cloth, 72  
     — boards, 83  
     —, cutting of, 36  
     — for sides, 89  
     —, government specifications, 79,  
     217  
     —, grades of, 75  
     — guards, 90  
     —, manufacturers of, 74  
     —, qualities of, 74  
     —, tests of, 78  
     — used in mending, 170  
     — vs. leather, 122  
 Collation, 15, 133  
 Commercial binding, 6  
     — binding, specifications, 100  
 Copying press, 173  
 Corners of vellum, 72  
     — rounded, 47  
 Cost of binding, 5, 11, 115  
     —, records of, 152  
     —, suggestions for reducing,  
     104, 119  
 Cotton vs. linen thread, 85  
 Covers, how cleaned, 177

- Covers of periodicals, when to bind, 135  
 Cowhide, 65  
 — for fiction and juvenile, 93  
 Creases, how removed, 175  
 Creasing for flexibility, 25  
 Crepeline, 170, 179  
 Crushed levant, 69  
 Cutting board, 174  
 Dampness, effect on leather, 59  
 Decay of leather, 54  
 Discarding books, 121, 131  
 Duck, 80, 90  
 — for newspapers, 97  
 Dummy backs, 141  
 Durabline, 81  
 Embossing leather, 57  
 End papers, 19  
 — papers and fly leaves pasted together, 31  
 — papers pasted down, 37  
 — papers, quality, 85  
 English buckram, 77  
 Everyman's library, library edition, 112, 129  
 Eyelet and tape binders, 201  
 Fabrikoid, 81, 82  
 Fibre-filling preservative, 97  
 Fiction, specifications, 93  
 Finishing, 39  
 Flesher for back-lining, 35  
 Flexible glue, 82  
 — sewing, 40  
 Fly leaves and end papers pasted together, 31  
 — leaves guarded, 17  
 — leaves tipped on, 17  
 — leaves, renewal, 183  
 Folded plates, guarded, 90  
 Folders, bone, 172  
 Forwarding, 31  
 Fox marks, how removed, 175  
 French joints, 37, 46, 91  
 Gall nuts for tanning, 55  
 Gas, effect on leather, 58  
 Gaylord binders, 206  
 Gilding, 39  
 — tops, 33  
 Glaire, 195  
 Glue, 82, 169  
 —, flexible, 82  
 — pot, 173  
 —, removed from back of books, 15  
 Gluing, 33  
 — for overcasting, 17  
 Goatskins, 68  
 Gold leaf, 85  
 Government cloth, 77  
 — cloth, specifications, 217  
 — documents, binding of, 54, 77  
 — documents, materials used in binding, 51  
 Graining leather, 57  
 Grease in leather, 58  
 — spots, how removed, 177  
 Guarding fly leaves, 17  
 — illustrations, 18  
 — signatures, 17  
 Hair sheep, 64  
 Hayes' thread, 85  
 Headhands, 49  
 Heat, effect on leather, 59  
 Hemlock bark, 56  
 Home binderies, 209  
 Huntting, H. R., Samson-back sewing, 113  
 Illustrations guarded, 18, 90  
 — mounted on cloth, 91  
 Imitation of morocco, 64, 68  
 Imperfect books, when to bind, 133  
 Imperial morocco cloth, 81, 90  
 Incomplete volumes, when to bind, 138  
 Index, where to place, 134  
 — volumes, lettering of, 147  
 Ink stains, how removed, 176  
 Instructions to binder, 139  
 Jaconet, 17, 170  
 Javelle water, 175  
 Joint authors, lettering, 143  
 Joints, 46  
 Juvenile books bound from sheets, 105  
 — books, specifications, 93  
 Keratol, 81, 82  
 Kettlestitch, 22  
 —, sawing for, 18  
 —, three for overcast books, 27  
 Knives, 172  
 Knocking down, 16  
 Kraft paper, 171  
 — paper for fly leaves, 17  
 Labeling, process, 191  
 Labels made of leather, 39  
 — on tight-back books, 45  
 —, removal of, 193  
 Labor, effects on cost of binding, 115  
 Lacing-in, 38, 42  
 Larch, for tanning, 56  
 Law books, specifications, 98  
 — sheep, 65  
 Leather, 52  
 —, causes of variation in, 53  
 — corners, 48  
 —, decay of, 54, 73  
 —, embossed, 57  
 — for back-lining, 35  
 —, imitation of, 82  
 —, kinds of, 63  
 — labels, 39  
 —, mechanical qualities, 60  
 —, preservation of, 60  
 — vs. cloth, 122

- Legal buckram, 80  
 Lettering, arrangement, 141  
   — by hand, 193  
   —, how indicated, 139  
   — in white ink, 193  
   —, joint authors, 143  
   —, oversized books, 147  
   —, pamphlets, 207  
   —, periodicals, 146  
   —, pseudonyms, 143  
   —, thin volumes, 147  
   —, two books in one, 143  
   — with type, 194  
 Levant morocco, 69  
 Library binderies, 209  
   — binderies, administration, 211  
   — binderies, cost of, 214  
 Library binding, 8  
 Library buckram, 80  
 Linen buckram, 77  
   — finish cloth, 76  
   — vs. cotton thread, 85  
 Loose back, 36, 44  
   — joints, how mended, 182  
   — leaves, inserting, 180  
   — signatures, inserting, 181  
 Machine-bound books, 6  
 Magazine binders, 199  
 Making the case, 36  
 Manila paper, 171  
   — paper for fly leaves, 17  
 Maps, repair of, 183  
 Materials, 51  
   — for lettering, 195  
   — for repairing, 167  
 Mending, 16, 178  
   — by binder, 90  
   — materials, 167  
   —, rules for, 166  
 Mildew, how prevented, 176  
 Mill-boards, 83  
 Morocco, 68  
   —, book, 70  
   —, imitation of, 64  
   —, Levant, 69  
   —, Niger, 70  
   —, Persian, 70  
   —, Turkey, 69  
 Mucilage, 169  
 Music, specifications for, 99  
 Newspapers, specifications, 96  
   —, wrapped in paper, 96  
 Niger morocco, 70  
 Non-fiction, specifications, 94  
 Oak bark, 55, 56  
   — bark for pigskin, 67  
   — bark for sheepskin, 64  
 Onion skin, 171  
 Overcast books, cut before sewing, 16  
 Overcasting, 23, 25  
   —, sawing for, 19  
 Oversized books, lettering, 147  
 Pages, cleaning of, 174  
   —, how mended, 178  
   — missing, 133  
 Pamphlets, binding, 205  
   —, binding single copies, 190  
   —, lettering, 207  
 Panels, 142  
   —, staining of, 39  
 Paper, effect of folding, 14  
   —, effect on binding, 14  
 Parker, J. Gordon, on causes of decay in leathers, 55  
 Paste, 83, 167  
   —, poor, effect on binding, 59  
 Pasting down, 37  
   — machine, 169, 174  
 Perforating machine, 25  
 Periodicals, arrangement of, 16, 134  
   —, binding single copies, 190  
   —, lettering, 146  
   —, specifications, 94  
   —, two volumes in one, 138  
   —, vagaries of, 134  
   —, when to bind incomplete, 138  
 Persian morocco, 70  
 Plates, folded, guarding, 90  
   —, unpagged, where to place, 136  
 Preparing for the bindery, 125  
 Press used in mending, 173  
 Pressing, 38  
 Pigskin, 67  
 Pluviusin, 81  
 Polished buckram, 76  
 Preservation of leather, 60  
 Prices, schedule of, 118  
 Printing Investigation Committee, 77  
 Processes, 13  
 Pseudonyms, lettering, 143  
 Publishers' binding, 6  
   — reinforced books, 109  
   — reinforced books, failure of, 111  
 Pyrogallol group, 55  
 Questions binding assistants must ask, 125  
 Raised bands, 40  
 Ratio of cost to circulation, 5  
 Reading list, 221  
 Rehacking, 36  
 Recasing instead of rebinding, 130  
   —, process, 184  
 Records for large libraries, 153  
   — of binding, 149  
   — of previous volumes, 140, 151  
 Recovering, 121  
   —, process, 185  
 Red rope manila, 171  
 Reference books, specifications, 98  
 Regular sewing, 19  
 Reinforced books, 108, 120

- Reinforced books, specifications, 109
- Reinforcing, process, 188
- Repairing, 165
- Reports, binding of, 138, 205
- Reprints, bound before purchase, 119
- , use instead of rebinding, 129
- Resewed commercial books, 113
- Re-siding, process, 188
- Retanning, 58
- Rexine, 81
- Roan, 65
- Rod binders, 202
- Rounding, 33
- Routine of binding, 157
- Royal Society of Arts, investigation of leather, 55
- Ruh or rub-off, 92, 140
- Russia leather, 71
- Samson-back sewing, 113
- Sawing, 18
- Scientific books, when to rebind, 131
- Scribner's, Charles, Sons Co., reinforced books, 109
- Sealskin, 63, 71
- Second-hand books, rebound before using, 108, 120
- Selection of binder, 9
- Semi-tar boards, 84
- Setting the square, 36
- Sewing, 19
- , affected by paper, 14
- , bench, 20
- , on tapes, 30
- , two-on, 23
- Sex of animals, effect on leather, 53
- Shaving of skins, 57
- Sheep-bound set of U. S. documents, 54
- Sheepskin, 63
- Sheets, binding from, 103
- Shellac, 172
- Shellacking of covers, 177
- Signatures, guarding of, 17-18
- Size, basis for prices, 89
- Skiver, 65
- Society of Arts, investigation of leather, 55
- , on preservation of leather, 62
- Sound Leather Committee of the Library Association, 55
- Specifications, 87
- , books of illustrations, 100
- , commercial binding, 100
- , fiction, 93
- , general, 88
- , juvenile, 93
- , law books, 98
- , music, 99
- , newspapers, 96
- , non-fiction, 94
- , periodicals, 94
- , reference books, 98
- , reinforced books, 109
- Split boards, 44
- , cowhide, 66
- , sheepskins, 65
- Splitting of skins, 57
- Spring-back binders, 201
- Sprinkling, 32
- Squares, 36
- Stained labels, 39
- Stitching, 91
- Strawboards, 83
- Sulphuric acid, 57, 58
- Sumac, 55, 56, 57
- , for sheepskin, 64
- Sunlight, effect on leather, 58
- Super, 35
- Supplements to periodicals, 134
- Taking apart, 15
- Tanning materials, 55
- Tapes, 86
- , sewing on, 30
- Tar boards, 84
- Technical books, when to rebind, 131
- , terms, 225
- Thread, 84, 171
- Tides of Barnegat, reinforced, 109
- Tight backs, 44
- , backs, mending, 181
- Title page, where to place, 134
- , pages, vagaries of, 136
- Tobacco smoke, effect on leather, 58
- Tooling, 39
- Tools for repairing, 172
- , used in lettering, 194
- , used in mending, 172
- Torn leaves, mending, 178
- Trimming, 32, 48
- Turkey morocco, 69
- Turwar hark, 56
- Two-on, sewing, 23
- Use determines kind of binding, 4
- Valueless hooks, discarding of, 121
- Vaseline for leathers, 61
- Vellum, 71
- , corners, 48
- Warp, strength of, 75
- Water-proof cloths, 81
- Wet, strength of, 75
- Well-bound book, how to recognize, 49
- Whipstitching, 24
- White ink, when used, 193
- Wire, Dr. G. E., on preservation of leather, 60
- Wool sheep, 64







