

A COMPREHENSIVE TREATISE ON INORGANIC AND
THEORETICAL CHEMISTRY

VOLUME V

B, Al, Ga, In, Tl, Sc, Ce and
Rare Earth Metals, C (Part I) .

BY THE SAME AUTHOR

A COMPREHENSIVE TREATISE ON INORGANIC AND THEORETICAL CHEMISTRY.
Royal 8vo.

- Vol. I. H, O. 63s. net.
Vol. II. F, Cl, Br, I, Li, Na, K, Rb, Cs. 63s. net.
Vol. III. Cu, Ag, Au, Ca, Sr, Ba. 63s. net.
Vol. IV. Ra and Ac Families, Be, Mg, Zn, Cd, Hg.
63s. net.
Vol. V. B, Al, Ga, In, Tl, Sc, Ce, and Rare Earth
Metals, C (Part I). 63s. net.
Vol. VI. C (Part II), Si, Silicates. 63s. net.
Vol. VII. Ti, Zr, Hf, Th, Ge, Sn, Pb, Inert Gases.
63s. net.
Vol. VIII. N, P. 63s. net.
Vol. IX. As, Sb, Bi, V, Cb, Ta. 63s. net.

INTRODUCTION TO MODERN INORGANIC
CHEMISTRY.

• With 232 Illustrations. Crown 8vo, 9s. net.

MODERN INORGANIC CHEMISTRY.

With 334 Illustrations. Crown 8vo, 12s. 6d. net.

HIGHER MATHEMATICS FOR STUDENTS OF
CHEMISTRY AND PHYSICS. With Special
Reference to Practical Work.

With 189 Diagrams. 8vo, 21s. net.

LONGMANS, GREEN AND CO. LTD.

LONDON, NEW YORK, TORONTO, CALCUTTA, BOMBAY, AND MADRAS.

A COMPREHENSIVE TREATISE
ON
INORGANIC AND THEORETICAL
CHEMISTRY

Joseph William BY
J. W. MELLOR, D.Sc.



VOLUME V

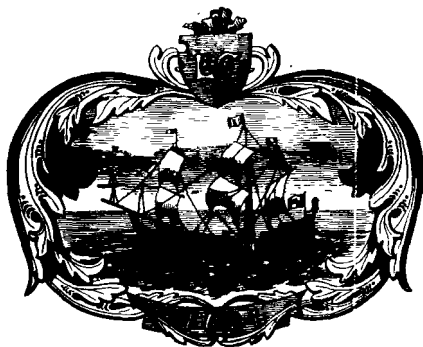

WITH 206 DIAGRAMS

NEW IMPRESSION

12273

LONGMANS, GREEN AND CO. LTD.

39 PATERNOSTER ROW, LONDON, E.C.4

NEW YORK, TORONTO

CALCUTTA, BOMBAY AND MADRAS

1929

540.3

M48 .

Vol. 5.

CONTENTS

CHAPTER XXXII

BORON

- § 1. The History of Boron (1); § 2. The Occurrence of Boron (3); § 3. Boron (7); § 4. The Borides (23); § 5. The Hydrides of Boron or Hydroborons (33); § 6. Boron Oxides (39); § 7. Boron Trioxide, Boric Oxide, or Boric Anhydride (41); § 8. The Boric Acids (47); § 9. The Alkali and Ammonium Borates (65); § 10. The Borates of Copper, Silver, and Gold (84); § 11. The Borates of the Alkaline Earths (85); § 12. The Borates of Beryllium, Magnesium, Zinc, Cadmium, and Mercury (95); § 13. The Borates of Aluminium, Thallium, and the Elements of the Rare Earths (102); § 14. The Borates of Tin, Lead, and Zirconium (105); § 15. The Borates of Arsenic and Chromium Families (107); § 16. The Borates of Manganese and of the Iron and Platinum Families (111); § 17. Perboric Acids and the Perborates (115); § 18. Boron Fluoride (121); § 19. Hydrofluoboric and Borato-fluoric Acids (123); § 20. The Fluoborates (125); § 21. Boron Trichloride (129); § 22. Boron Tribromide (134); § 23. Boron Tri-iodide (135); § 24. Boratochlorides, Boratobromides, and Boratoiodides (137); § 25. Boron Sulphides (142); § 26. Boron Sulphates (146); § 27. Boron Phosphates (147).

CHAPTER XXXIII

ALUMINIUM

- § 1. The History of Aluminium (148); § 2. The Occurrence of Aluminium (153); § 3. The Preparation and Production of Aluminium (160); § 4. The Physical Properties of Aluminium (173); § 5. The Chemical Properties of Aluminium (202); § 6. The Atomic Weight and Valency of Aluminium (227); § 7. Alloys and Intermetallic Compounds of Aluminium (229); § 8. The Occurrence of Aluminium Oxides (247); § 9. Aluminium Oxides (253); § 10. The Properties of Aluminium Oxide (263); § 11. Aluminium Hydroxides, and Peroxides (273); § 12. The Aluminates (284); § 13. Aluminium Fluoride (300); § 14. The Fluocaluminates (303); § 15. Aluminium Chloride (311); § 16. Aluminium Bromide (324); § 17. Aluminium Iodide (327); § 18. Aluminium Sulphides (329); § 19. Aluminium Sulphates (332); § 20. The Complex Salts of Aluminium Sulphate (340); § 21. Aluminium Carbonates (358); § 22. The Aluminium Nitrates (359); § 23. The Aluminium Phosphates (362).

CHAPTER XXXIV

GALLIUM

- § 1. History of Gallium (373); § 2. The Occurrence of Gallium (374); § 3. The Extraction of Gallium (375); § 4. The Physical Properties of Gallium (377); § 5. The Chemical Properties of Gallium (380); § 6. Gallium Oxides and Hydroxides (382); § 7. Gallium Halides (383); § 8. Gallium Sulphides, Sulphates, and Nitrates (384).

CHAPTER XXXV

INDIUM

- § 1. The History and Occurrence of Indium (387); § 2. The Extraction of Indium (388); § 3. The Physical Properties of Indium (390); § 4. The Chemical Properties of Indium (393); § 5. The Oxides of Indium (397); § 6. Indium Halides (399); § 7. Indium Sulphides (403); § 8. Indium Sulphates (404); § 9. Indium Carbonate, Nitrate, and Phosphate (405).

CHAPTER XXXVI

THALLIUM

- § 1. The History and Occurrence of Thallium (406); § 2. The Extraction of Thallium (408); § 3. The Physical Properties of Thallium (410); § 4. The Chemical Properties of Thallium (419); § 5. The Alloys of Thallium (425); § 6. Thallium Oxides (430); § 7. Thallium Fluorides (436); § 8. Thallium Chlorides (438); § 9. The Thallium Bromides (450); § 10. Thallium Iodides (458); § 11. Thallium Sulphides (462); § 12. Thallium Sulphates (465); § 13. Thallium Carbonates (471); § 14. Thallium Nitrates (472); § 15. Thallium Phosphates (477).

CHAPTER XXXVII

SCANDIUM

- § 1. The History and Occurrence of Scandium (480); § 2. The Extraction of Scandium (482); § 3. The Properties of Scandium (485); § 4. Scandium Oxide and Hydroxide (488); § 5. Scandium Halides (488); § 6. Scandium Sulphide and Sulphate (491); § 7. Scandium Carbonate, Nitrate, and Phosphate (492).

CHAPTER XXXVIII

THE RARE EARTHS

- § 1. The Rare Earths (494); § 2. The History of the Rare Earths (496); § 3. The Occurrence of the Rare Earths (507); § 4. Fractional Precipitation, and Fractional Crystallization (538); § 5. The General Separation of the Rare Earth Group into Chemical Individuals (543); § 6. The Processes Employed in Resolving the Rare Earths into their Component Earths (556); § 7. The Occurrence and Isolation of the Cerium Family of Rare Earths (586); § 8. The Preparation of the Metals of the Cerium Family (589); § 9. The Physical Properties of the Cerium Family of Metals (591); § 10. The Chemical Properties of the Cerium Family of Metals (601); § 11. The Valency of the Rare Earth Metals, and their Position in the Periodic System (612); § 12. The Atomic Weights of the Cerium Family of Metals (621); § 13. The Oxides of the Cerium Family of Earths (625); § 14. The Halides of the Cerium Metals (637); § 15. The Sulphides of the Cerium Metals (648); § 16. The Sulphates of the Cerium Metals (650); § 17. The Carbonates of the Cerium Metals (664); § 18. The Nitrates of the Cerium Metals (668); § 19. The Phosphates of the Cerium Metals (675); § 20. Yttrium (676); § 21. The Terbium Family of Rare Earths (686); § 22. The Compounds of the Terbium Earth Metals (692); § 23. The Erbium Family of Rare Earths (696); § 24. Compounds of the Erbium Earth Metals (702); § 25. The Ytterbium Family of Earths (705).

CHAPTER XXXIX

CARBON

- § 1. The History of Carbon (700); § 2. The Occurrence of Carbon (715); § 3. The Different Forms of Carbon—Allotropy (718); § 4. The Action of Heat on the Diamond and Graphite (724); § 5. The Synthesis and Genesis of Diamonds (730); § 6. The Genesis of Graphite (738); § 7. The Preparation of Amorphous Carbon (744); § 8. The Physical Properties of the Different Forms of Carbon (755); § 9. The Adsorption of Gases, etc., by Carbon (789); § 10. The Action of Oxygen and Water on Carbon (811); § 11. The Chemical Properties of Carbon (821); § 12. The Constitution, Valency, and Atomic Weight of Carbon (837); § 13. The Carbides—The Alkali Carbides (844); § 14. The Carbides of the Copper Family of Elements (850); § 15. The Carbides of the Alkaline Earths (856); § 16. The Carbides of the Magnesium-Zinc Family (866); § 17. The Carbides of Aluminium and the Rare Earth Metals (870); § 18. The Carbides of the Silicon and Tin Families of Elements (875); § 19. Carbides of the Nitrogen, Vanadium, and Chromium Families of Elements (887); § 20. The Carbides of Manganese, and of the Iron and Platinum Family of Elements (892); § 21. The Carbon Oxides and Suboxides (904); § 22. The History of Carbon Monoxide (907); § 23. The Occurrence and Preparation of Carbon Monoxide (909); § 24. The Physical Properties of Carbon Monoxide (915); § 25. The Solubility of Carbon Monoxide (923); § 26. The Chemical Properties of Carbon Monoxide (926); § 27. The Metal Carbonyls (950); § 28. The Carbonyl Halides (962); § 29. Carbonyl Sulphide (971).

INDEX 979

ABBREVIATIONS

aq.	= aqueous
atm.	= atmospheric or atmosphere(s)
at. vol.	= atomic volume(s)
at. wt.	= atomic weight(s)
T° or °K	= absolute degrees of temperature
b.p.	= boiling point(s)
°	= centigrade degrees of temperature
coeff.	= coefficient
conc.	= concentrated or concentration
dil.	= dilute
eq.	= equivalent(s)
f.p.	= freezing point(s)
m.p.	= melting point(s)
mol(s)	= $\begin{cases} \text{gram-molecule(s)} \\ \text{gram-molecular} \end{cases}$
mol(s)	= $\begin{cases} \text{molecule(s)} \\ \text{molecular} \end{cases}$
mol. ht.	= molecular heat(s)
mol. vol.	= molecular volume(s)
mol. wt.	= molecular weight(s)
press.	= pressure(s)
sat.	= saturated
soln.	= solution(s)
sp. gr.	= specific gravity (gravities)
sp. ht.	= specific heat(s)
sp. vol.	= specific volume(s)
temp.	= temperature(s)
vap.	= vapour

In the **cross references** the first number in clarendon type is the number of the volume; the second number refers to the chapter; and the succeeding number refers to the "§," section. Thus 5, 38, 24 refers to § 24, chapter 38, volume 5.

The oxides, hydrides, halides, sulphides, sulphates, carbonates, nitrates, and phosphates are considered with the basic elements; the other compounds are taken in connection with the acidic element. The double or complex salts in connection with a given element include those associated with elements previously discussed. The carbides, silicides, titanides, phosphides, arsenides, etc., are considered in connection with carbon, silicon, titanium, etc. The intermetallic compounds of a given element include those associated with elements previously considered.

The use of **triangular diagrams** for representing the properties of three-component systems was suggested by G. G. Stokes (*Proc. Roy. Soc.*, 49, 174, 1891). The method was immediately taken up in many directions and it has proved of great value. With practice it becomes as useful for representing the properties of ternary mixtures as squared paper is for binary mixtures. The principle of triangular diagrams is based on the fact that in an equilateral triangle the sum of the perpendicular distances of any point from the three sides is a constant. Given any three substances *A*, *B*, and *C*, the composition of any possible combination of these can be represented by a point in or on the triangle. The apices of the

ABBREVIATIONS

triangle represent the single components *A*, *B*, and *C*, the sides of the triangle represent binary mixtures of *A* and *B*, *B* and *C*, or *C* and *A*; and points within the triangle ternary mixtures. The compositions of the mixtures can be represented in percentages, or referred to unity, etc. In Fig. 1, pure *A* will be represented by a point at the apex marked *A*. If 100 be

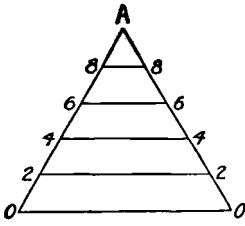

FIG. 1.

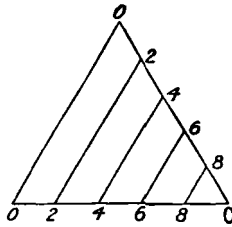

FIG. 2.

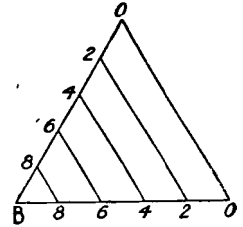

FIG. 3.

standard of reference, the point *A* represents 100 per cent. of *A* and nothing else; mixtures containing 80 per cent. of *A* are represented by a point on the line 88, 60 per cent. of *A* by a point on the line 66, etc. Similarly with *B* and *C*—Figs. 3 and 2 respectively. Combining Figs. 1, 2, and 3 into one diagram by superposition, and Fig. 4 results. Any point in the

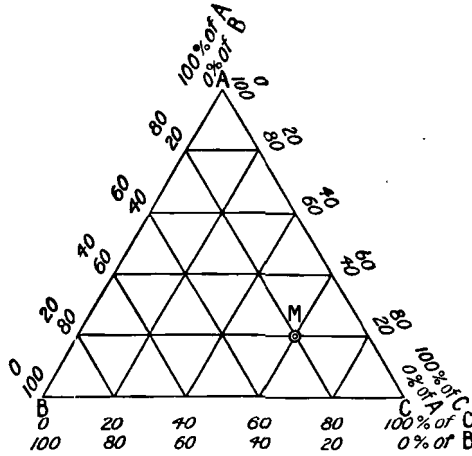

FIG. 4.—Standard Reference. Triangle.

diagram, Fig. 4, thus represents a ternary mixture. For instance, the point *M* represents a mixture containing 20 per cent. of *A*, 20 per cent. of *B*, and 60 per cent. of *C*.

CHAPTER XXXII

BORON

1. The History of Boron

UNDER the name *tincal* or *tincar*, the salt *borax* was exported to Europe from Central Asia, through Constantinople and Venice. It is not known when the trade began, but it must have been before G. Agricola,¹ since borax was much used in his time—1556. According to J. G. Wallerius, the Arabian Avicenna first described *tincar*. From G. Agricola's descriptions it is evident that his "*chrysocolla* which the Moors call *borras*" was the same salt as that now called borax. F. Hoefler says that the word *borax* is derived from an Arabian or Persian word *borak*, meaning white. The Arabians—e.g. Avicenna, Almas'adi, Madoyas, Alhabib, Dschabir Ibn Hajjan, Ibn Hauqual, etc.—some of the Greek alchemical writers—e.g. Joannis in his *De arte sacra*—as well as the chemists of the Middle Ages—e.g. A. Libavius, A. A. Barba, etc.—seem to have included several different salts—nitrum, natron, and borax—under the term *bauracon*, *borach*, *baurak*, or *baurach*; and when it was found that *baurach* is quite different from nitre, the term was reserved in Europe for the one particular salt "which first came from Tibet and India," and the word was soon modified into the present-day term borax. The term *baurax* is used by Raymund Lully, and *baurach* by Roger Bacon. G. Agricola was wrong in many of his statements about borax. He said that the *chrysocolla*—*chrysos*, gold; *colla*, solder—of the ancients was borax.

A spurious work attributed to Aristotle, but thought by J. Ruska, and E. O. von Lippmann to have been written in the ninth century, refers to the use of *nitron* as a flux, and for soldering. F. Freise reported the discovery at Delos of a crucible used for gold melting, which appeared to have once contained molten borax. The presence of boriferous minerals in Asia Minor also indicates the possibility that borax may have been known in the East. In the first century of our era, Pliny referred several times to *chrysocolla*, which he confused with gold solder, a copper ore, and a green pigment. G. Agricola seems to have based an opinion on Pliny's statement that *chrysocolla*—used as a solder for gold and silver—was made from verdigris, nitrum, and urine; and he argued that since borax is used in soldering gold, the two substances must be the same. G. Agricola said:

Native *nitrum* is found in the earth or on the surface. . . . It is from this variety that the Venetians make *chrysocolla*, which I call *borax*. . . . The second variety of artificial *nitrum* is made at the present day from the native *nitrum*, called by the Arabs *tincar*, but I call it usually by the Greek name *chrysocolla*; it is really the Arabic borax. This *nitrum* does not decrepitate nor fly out of the fire; however, the native variety swells up from within.

G. E. Stahl emphasized that the Venetians did not make borax, but rather purified crude *tincal*. This confusion in the meaning of the word prevailed up to the seventeenth century. Paul de Canotanto, who lived in the middle of the fifteenth century, referred to the different kinds of borax, and stated that one variety was used in fusing, and in soldering the metals. Some extraordinary guesses were made near the beginning of the eighteenth century as to the nature of borax. J. Zwelfer regarded it as a natural fixed alkali; G. Homberg, as a *sel urineux mineral*; and J. J. Becher, as a compound of the universal acid with a vitrifiable earth. The

confusion was partly the result of observations on the impure tincal which gave on distillation or combustion empyreumatic and ammoniacal products derived from organic impurities which were not recognized as accidental and foreign to the salt but were considered to be inherent constituents of borax.

From the behaviour of borax towards alkalies and acids N. Lemery, in 1703, inferred that it contained a *sel salé*. G. E. Stahl (1702), and H. Boerhaave (1732) classed borax among the mineral acids. In 1702, G. Homberg heated borax with ferrous sulphate, and obtained a product, boric acid, which, on account of its medicinal properties, was designated *sal sedativum*, and it came to be called *le sel sédatif de Homberg*, although G. Homberg himself gave *sal sedativum*—*sedative salt*—many names—e.g. he called it *sel volatil narcotique de vitriol*, *sel volatil de borax*, *fleurs de vitriol philosophique*, *sel blanc des alchimistes*, and *fleurs de Diane*, for he regarded it as a compound of ferrous sulphate. L. Lemery (1728) showed that *sal sedativum* could be obtained by treating borax with acids in place of ferrous sulphate, and C. J. Geoffroy (1732) decomposed borax with sulphuric acid, and obtained (i) *le sel sédatif* in the form of white crystals, and (ii) Glauber's salt. J. F. Henkel had previously obtained an analogous result in 1722. C. J. Geoffroy added :

Je pouvais donc conclure que le sel de la soude a beaucoup d'analogie avec le borax, puisqu'ils ont tous les deux une terre semblable à la terre du sel marin (soude), mais qu'il manque au sel de soude pour être parfaitement semblable au borax, la terre vitrifiable qui est dans ce dernier (boric acid).

J. H. Pott discovered the more salient properties of *sal sedativum*, but he did not advance our knowledge of the constitution of borax very far; he called it "a neutral salt composed of vitriol and borax." He found that the salt imparts a green colour to the flame of burning alcohol. This coloration led many later chemists to assume wrongly that copper is an essential constituent of borax. In 1747-8, T. Baron published two memoirs describing his *Expériences pour servir à l'analyse du borax*, and he there clearly described the nature of borax. He said that *sal sedativum* is always the same whatever be the acid employed to derive it from borax; that borax can be reproduced by mixing *sal sedativum* with a sodium salt; and that two other kinds of borax can be made by substituting a salt of potassium or ammonium in place of sodium. He showed that *sal sedativum* is not volatile, but that it does sublime when heated with water vapour. He regarded *sal sedativum* as a new substance, and showed that, at an elevated temp., it can drive the acid from potassium nitrate or from sodium chloride. In 1775, U. F. Hofer discovered *sal sedativum Hombergii* in the waters of the Tuscan lagoons of Monte Rotondo and Castelnuovo, and found that when treated with mineral alkali, it formed borax; this gave him the idea of manufacturing borax from the waters.

In the light of present knowledge, T. Baron's conclusions seem a satisfactory proof that borax is "a compound of *sal sedativum* and the alkali of common salt," but his contemporaries were still puzzled, for, in 1761, L. C. Cadet raised some ill-founded objections to T. Baron's views, and stated his belief that borax contains copper, arsenic, and a vitrifiable earth; L. C. Bourdelin (1753) assumed that it contained a vitriolic acid; G. V. M. Fabroni, that it is a modification of muriatic acid; B. G. Sage, that phosphoric acid is present; and L. F. F. von Crell (1799), that it contains carbon. T. Bergman was clear enough as to the acid nature of *sal sedativum*. He said :

The substance commonly called sedative salt is more nearly allied to acids than to any other class of bodies. It reddens litmus; and saturates alkalies and soluble earths. It also dissolves various metals, and has other properties which show its acid nature; and it seems better entitled to the name borax acid than to that of sedative salt.

With the introduction of anti-phlogistic chemistry, the nature of borax became clear; *sal sedativum* was recognised as an acid, and called *boric or boracic acid*. In August, 1807, H. Davy electrolyzed moist boric acid and obtained a dark-coloured combustible mass at the negative pole, and the following year he obtained a similar

product by heating potassium with boric acid in a gold tube. Towards the end of 1808, he examined the properties of the dark product, and concluded "from all analogy, there is strong reason to consider the boracic basis as metallic in its nature, and I venture to propose for it the name of *boracium*." J. L. Gay Lussac and L. J. Thénard decomposed boric acid with potassium on the 21st of June, 1808. They said :

Nous désignerons par le suite ce radical sous le nom de *bore*, qui est tiré de celui du borax, et nous désignerons l'acide boracique sous celui d'acide borique pour nous conformer aux principes des nomenclateurs. Ainsi nous aurons les trois expressions, *bore*, *borique*, *borate*, entièrement analogues aux trois autres, *carbone*, *carbonique*, *carbonate*.

A few years later, 1812, H. Davy also stated that boracium is more analogous to carbon than to any other substance, and hence proposed "*boron* as a more unexceptional name." In 1824, J. J. Berzelius demonstrated the proportion of oxygen present in boric acid. F. Fittica thought that he had transformed boron into silica, but C. Counciler showed that the alleged transformation was due to a mal-observation.

REFERENCES.

¹ E. O. von Lippmann, *Entstehung und Ausbreitung der Alchemie*, Berlin, 1919; G. Agricola, *De natura fossilium*, Basileæ, 206, 1506; *De re metallica*, Basileæ, 1556; T. Bergman, *De attractionibus electivis*, Upsala, 1775; London, 1785; H. Kopp, *Geschichte der Chemie*, Braunschweig, 3, 339, 1845; Pliny, *Historiæ naturalis*, 33, 26, c. 77; 35, 23, c. 77; F. Freise, *Geschichte der Bergbau und Hütten Technik*, Berlin, 104, 1908; A. Libavius, *Alchemia*, Francofurti, 1595; J. Ruska, *Das Steinbuch des Aristotlus*, Heidelberg, 45, 1912; Paul de Canotanto, MS. No. 7150; *Theoria ultra estimationem peroptima ad cognitionem totius alkimiæ veritatis*, in the Bibliothèque royale at Paris—vide F. Hofer, *Histoire de la chimie*, Paris, 1, 443, 1842; N. Lemery, *Hist. Acad.*, 49, 1703; T. Baron, *Mém. Math. Phys.*, 1, 295, 447, 1748; 2, 412, 1752; Raymond Lully, *Testamentum*, Colonia Agrippinæ, 1566; Roger Bacon, *Speculum alchemiæ*, Norumburgæ, 1541; A. A. Barba, *El arte de los metales*, Lima, 1817; G. E. Stahl, *Specimen e Bechersiano*, Franckfurth, 1702; *Ausführliche Betrachtung und zulanglicher Beweis von den Salzen das desselben aus einer arten Erde mit Wasser innig verbunden bestehen*, Halle, 1723; A. Baumé, *Chymie expérimentale et raisonnée*, Paris, 1773; J. H. Pott, *Observationum et animadversionum chymicarum*, Berolini, 1741; G. V. M. Fabroni in A. F. de Fourcroy's *Système des connaissances chimiques*, Paris, 2, 128, 1801; L. F. F. von Crell, *Crell's Ann.*, ii, 320, 378, 1799; *Ann. Chim. Phys.*, (1), 35, 202, 1800; C. J. Geoffroy, *Mém. Acad.*, 393, 1732; L. C. Cadet, *ib.*, 365, 1766; L. C. Bourdelin, *ib.*, 201, 1753; 397, 1755; L. Lemery, *ib.*, 273, 1728; 282, 1729; G. Homberg, *ib.*, 33, 1702; J. J. Becher, *Physicæ subterranea*, Leipzig, 1869, *Suppl.* 1674; H. Boerhaave, *Elementa chemiæ*, Lugduni Batavorum, 1732; J. F. Henkel, *Flora saturniana*, Leipzig, 1722; U. F. Hofer, *Sopra il sale sedativo della Toscana*, Firenze, 1778; *Mém. Soc. Firenze*, 1, 1775; J. J. Berzelius, *Pogg. Ann.*, 2, 113, 1824; H. Davy, *Phil. Trans.*, 98, 1, 333, 1808; 99, 32, 1809; *Elements of Chemical Philosophy*, London, 232, 1812; J. I. Gay Lussac and L. J. Thénard, *Recherches physico-chimiques*, Paris, 1, 276, 1811; *Nouv. Bull. Soc. Philomath.*, 10, 1808; *Ann. Chim. Phys.*, (1), 68, 169, 1808; *Mém. Soc. Arcueil*, 2, 311, 1809; J. Zwelfer, *Pharmacopœia regia*, Vienna, 1652; F. Fittica, *Chem. Ztg.*, 25, 191, 978, 1901; C. Counciler, *ib.*, 25, 977, 1029, 1901; J. G. Wallerius, *De systematibus mineralogiciis*, Holmiæ, 13, 1768; B. G. Sage, *Mémoires de chimie*, Paris, 1773.

§ 2. The Occurrence of Boron

Boron does not occur abundantly on the earth, but small quantities are widely distributed. F. W. Clarke and H. S. Washington estimate that the ten-mile crust, the hydrosphere, and the atmosphere of the earth contain 0.001 per cent. of boron. This element occurs in the form of boric acid and borates, and is an essential constituent of many silicate minerals—e.g. tourmaline and datolite. H. A. Rowland¹ says that boron is not revealed in the spectrum of the sun. J. Smithson, and H. Jay have discussed the occurrence of boric acid in nature; and C. F. Rammelsberg, the general distribution of the borates. The native borates, borosilicates, borosulphate, chloroborates, and borophosphates are :

Sassolite, or *sassolin*, boric acid, H_2BO_3 ; *larderellite*, $(NH_4)_2B_3O_{13} \cdot 4H_2O$; *borax*, or *tincal*, $Na_2B_4O_7 \cdot 10H_2O$; *borocalcite*, or *berchilite*, $CaB_4O_7 \cdot 4H_2O$; *pandermite*, or *pricéite*,

$\text{Ca}_2\text{B}_4\text{O}_{11}\cdot 3\text{H}_2\text{O}$; *colemanite*, $\text{Ca}_2\text{B}_4\text{O}_{11}\cdot 5\text{H}_2\text{O}$; *boronatrocalcite*, or *ulexite*, $\text{NaCaB}_5\text{O}_{10}\cdot 6\text{H}_2\text{O}$; *cryptomorphite*, $\text{H}_2\text{Na}_2\text{Ca}_4(\text{B}_4\text{O}_7)_2\cdot 22\text{H}_2\text{O}$; *franklandite*, $\text{CaNa}_2\text{B}_4\text{O}_{11}\cdot 7\text{H}_2\text{O}$; *ascharite*, $3\text{Mg}_2\text{B}_2\text{O}_7\cdot 2\text{H}_2\text{O}$; *pinnoite*, $\text{MgB}_2\text{O}_4\cdot 3\text{H}_2\text{O}$; *boromagnesite*, or *szabelyite*, $4\text{BO}_2(\text{Mg}\cdot\text{OH})\cdot \text{Mg}(\text{OH})_2$; *pinnoite*, $\text{MgB}_2\text{O}_4\cdot 3\text{H}_2\text{O}$; *kaliborite*, or *heintzite*, $\text{K}_2\text{Mg}_2\text{B}_2\text{O}_7\cdot 14\text{H}_2\text{O}$ or $\text{K}_2\text{H}_2\text{Mg}_2\text{B}_{11}\text{O}_{30}\cdot 6\text{H}_2\text{O}$; *hydroboracite*, $\text{CaMgB}_6\text{O}_{11}\cdot 6\text{H}_2\text{O}$; *boracite*, $\text{Mg}_2\text{B}_6\text{O}_{10}\text{Cl}_2$; *sulphoborite*, $4\text{MgHBO}_3\cdot 2\text{MgSO}_4\cdot 7\text{H}_2\text{O}$; *lüneburgite*, $\text{MgB}_2\text{O}_4\cdot 2\text{MgHPO}_4\cdot 7\text{H}_2\text{O}$; *hambergite*, $(\text{Be}\cdot\text{OH})\text{BeBO}_3$; *jeremejewite*, AlO_2BO_3 ; *rhodizite*, $\text{K}(\text{AlO})_2(\text{BO}_3)_2$; *pinakolite*, $(\text{Mg}, \text{Mn})_2\text{O}(\text{BO}_3)\text{MnO}_2$; *sussexite*, $(\text{Mn}, \text{Mg}, \text{Zn})\text{BO}_2\text{OH}$; *lagonite*, $\text{Fe}(\text{BO}_3)_2\cdot 1\frac{1}{2}\text{H}_2\text{O}$; *ludwigite*, $\text{Mg}_2\text{O}(\text{BO}_2)(\text{FeO}_2)$; *datolite*, $\text{Ca}(\text{B}\cdot\text{OH})\text{SiO}_4$; *howlite*, $\text{CaH}_2(\text{BO}_3)_2\cdot \text{CaH}_2\text{SiO}_4$; *bakerite*, $8\text{CaO}\cdot 5\text{B}_2\text{O}_7\cdot 6\text{SiO}_2$; *homilite*, $\text{Fe}\{\text{Ca}(\text{BO})\text{SiO}_4\}_2$; *tourmaline*, or *schörl*, $(\text{SiO})_3(\text{AlO}\cdot\text{BO})\{(\text{AlO})_2(\text{Mg}, \text{Fe}, \text{Na}_2, \text{Li}_2, \text{H}_2)\}_3$.

E. Filhol found traces of borates in felspar from the Pyrenees, and in pegmatite from Aveyron; E. Bechi, in Italian limestones, travertine, basalt, sandstone, etc.; E. T. Wherry and W. H. Chapin, in vesuvianite; L. Dieulafait, and C. Nöllner, in Chilian nitrate deposits; J. B. J. D. Boussingault, in the crater of some volcanoes; E. Filhol, and F. P. Venable and J. S. Callison in commercial caustic alkalies; and T. Egleston, in the iron ores of Lake Superior. A. Lacroix and A. de Gramont spectroscopically examined the aluminosilicate minerals for traces of boron.

According to L. Dieulafait, G. Forchhammer, and C. Nöllner, borates are contained in sea-water, and in the ashes of marine plants. J. A. Veatch found boric acid in the water collected over a submarine ridge along the coast of California, and he suggested that it had a volcanic origin from submerged sources. The existence of borates in sea-water is exemplified by the borates of the Stassfurt deposits described by H. E. Boeke, and W. Biltz and E. Marcus. The Stassfurt borates—boracite, pinnoite, ascharite, heintzite, hydroboracite, sulphoborite, lüneburgite, etc.—are essentially magnesian, in contrast with the Chilian and Californian deposits where calcium borates are dominant. In 1775, U. F. Hoefler reported *sal sedativum* (boric acid) in the waters of Monte Rotondo. Free boric acid also occurs in the crater of an extinct volcano in the Lipari Islands, and in the crater of Stromboli. Volcanic ejecta containing boric acid have been reported in Nova Scotia, and in Nevada, California. The *soffioni* or fumaroles of Pomerance, Massa Marittima, Castelnuovo di Val di Cecina, and Montieri, all in Tuscany, are an important source of boric acid; jets of steam carrying boric acid emerge from the ground, and sassolite, larderellite, bechilite, and lagonite are deposited by the lagoons in which the vapours are condensed. The salts have been analyzed by C. Schmidt, and C. M. Kurtz. The average foreign matter in the Tuscan lagoon waters, in grams per litre, is: Total solids, 9.96; boric acid, 7.14; ammonium sulphate, 0.87. There is some relation between the ammonium salts and the boric acid. A. Lacroix likewise found ammonium chloride and boric acid in Vesuvian fumaroles; A. Bergeat, in the volcanic products of Vulcano (Lipari Islands); G. F. Becker, and H. G. Hanks, in Borax Lake (Lake County, Cal.); in the water of the Devil's Inkpnt (Yellowstone Park); and by E. Cortese, in the hot springs of Chaguarama Valley (Venezuela). This led to the hypothesis—R. Warrington, H. St. C. Deville and F. Wöhler, O. Popp, E. Bechi, etc.—that the boric acid is derived from the action of steam on boron nitride. The latter, however, has not yet been observed as a mineral species; and similar remarks apply to J. B. A. Dumas' hypothesis, adopted by A. Payen, that the boric acid is the result of the action of steam on boron sulphide, a reaction devised to account for the presence of hydrogen sulphide in the gases. P. A. Bolley suggested that the boric acid is a product of the action of ammonium chloride on borax; E. Bechi, the action of steam and carbon dioxide, at 300°, on boriferous serpentine; and E. Perrone, and R. Nasini, by the action of steam on tourmaline. The subject has also been discussed by G. d'Achiardi, H. St. C. Deville and F. Leblanc, F. Fouqué and H. Gorceix, and H. Coquand. The borates of Esmeralda County, Nevada, and of Inyo and San Bernardino Counties, in Death Valley, in the basin of the Amargosa River, etc.—e.g. Searles' Borax Lake—are represented by the predominant calcium salts, ulexite and colemanite, as well as by some borax.²

W. D. Dennis has described the borax deposits of Lake Alvord in Harney County, Oregon. Arid regions containing sodium nitrate occur near the borate deposits of South California and ulexite occurs near the nitre deposits of Tarapaca and Atacama (South America).³ The calcium salt is the predominant borate in the deposits near Iquique, the Cordilleras of Coquimbo, and the Taltal district; and R. T. Chamberlin has noted that the borax lake of Ascotan derives its borates from the leachings from adjacent volcanoes. J. J. Kyle described the deposits in Salta and Catamarca; H. Buttgenbach, the Salinas Grandes, Province of Jujuy, Argentine; F. Reichert, the Argentine borates; and A. Jockamowitz, the Salinas Lagoon, Arequipa, Peru. W. S. Vernadsky and S. P. Popoff described the borax deposits near the Sea of Azov, Kerch peninsula. H. von Schlagintweit described the great borax deposits of Puga Valley, Ladak, Tibet. He said that the borax is a deposit from hot springs at a temp. between 54° and 58°, and situated over 15,000 feet above sea-level. The saline mass is said to contain free boric acid and sulphur, and a little salt, ammonium chloride, magnesium sulphate, and alum, but no ulexite. The Nova Scotia deposits, described by H. How, are supposed to be marine, but the total absence of magnesium is not in accord therewith, for, as F. W. Clarke has shown, marine deposits usually contain magnesium borates; lake-bed deposits contain calcium borates with nitrates near by, while borates from volcanic waters and fumaroles yield some ammonium compounds.

Small quantities of borates have been reported to occur in many mineral waters and springs—e.g. in Aachen, by R. Wildenstein⁴; at Wiesbaden, Schlangenbad, Krankenheil, and Weilbach (Nassau), by C. R. Fresenius, and G. C. Wittstein; at Schinznach and Bex (Switzerland), by S. Baup, and L. Dieulafait; at Vichy, etc., by H. Fonzes-Diacon and M. Fabre, where the amount increased with the temp. of the spring; at Salzmatt, by A. Béchamp, and L. R. Lecanu; at Sulzbach, by C. Oppermann; at Rhodisfort, by H. Göttl; at Kissingen, by J. von Liebig; at Orb, by F. Rummel; at Soden (Spessart), by F. Moldenhauer; at Olette, by J. Bouis; at Bagnères-de-Luchon, Barèges, Cauterets, Bonnes, and Labanère in the Pyrenees, by E. Filhol; at Courset, Hauterive, St. Yorre, Vaise, and Vichy by J. Bouquet; at Plombières, by O. Henry and M. Lhéritier; in most mineral waters of Central France, by F. Parmentier; at Montecatini (Tuscany), by L. Dieulafait; in North Africa, by L. Dieulafait; at White Island (New Zealand), by C. du Ponteil; in the mud volcanos of the Colorado District, San Diego County, as well as in the waters of several mineral springs in Tehama County, California, by J. A. Veatch; and in Rohat, by A. Carnot.

E. Hotter,⁵ H. Agulhon, and H. Jay have discussed the occurrence of boric acid in the vegetable kingdom, and in various kinds of fruit; and A. H. Smith, in food stuffs. G. Baumert, P. Soltsien, J. Dugast, M. Bertainchaud and E. Gauvry, M. Ripper, S. Weinwurm, A. Gassend, F. Schaffer, and E. Azzarello found boric acid normally present in wines; J. Brand, in hops, and hence also in beer; G. C. Wittstein and F. Apoiger, in the seeds of the *maasa picta*; E. O. von Lippmann, beet root; C. A. Crampton, water melon; E. Bechi, the beeches of Tuscany; A. Gassend, pepper; P. Kulisch, apples; E. Deltour, in almonds, molasses, chicory, acorns, mountain-ash berries, white wines, Bordeaux wines, and fruit syrups; apples, pears, currants, raspberries, and cherries. According to A. H. Smith, dates showed the largest proportion of boric acid, and prunes came next. The percentage amounts were: dates, 0.0299; dried peaches, 0.0065; dried apricots, 0.00216; prunes, 0.00792; figs, 0.0039; and raisins, 0.0049. Boric acid has also been found in parsnips, carrots, ranunculaceæ, radishes, angelica, and peonies; E. O. von Lippmann, and A. Hebebrand also reported boric acid in various fruit juices—lemons, oranges, etc. A. Gassend said boric acid is never found in tea, or saffron; but E. Deltour found it in fern leaves, tomatoes, ergot, potatoes, tobacco, straw, pepper, beer, vinegar, milk, vines, corn, coffee, and grass. E. Eckenroth, E. G. Clayton, E. Deltour, and A. Gassend said that boric acid is not a normal constituent of milk. E. Deltour found no boric acid in the bones of fowls, or in egg-shells.

K. Fischer found boric acid in many varieties of parchment. A. H. Smith found 0.00049 per cent. of boric acid in sausages; the salt in which the meat was cured contained 0.00045–0.00077 per cent. of boric acid. He added that these results show that in some of our common fruits, probably in meat, and certainly in common salt, there are minute though measurable quantities of boric acid occurring naturally. However, it does not seem probable that these amounts of boric acid could injure the persons eating the foods. G. Bertrand and H. Agulhon examined about thirty species of animals, and concluded that boron exists normally in very small proportions, 1 part in 100,000,000 parts of living matter. It is most abundant in animals of marine origin. It was detected in the hair, horns, bones, liver, and muscles.

REFERENCES.

- ¹ J. Smithson, *Gilbert's Ann.*, **43**, 331, 1813; H. Jay, *Compt. Rend.*, **121**, 986, 1895; A. Lacroix, *ib.*, **147**, 161, 1908; E. Filhol, *ib.*, **36**, 229, 1863; L. Dieulafait, *ib.*, **98**, 1545, 1884; **93**, 224, 1881; **94**, 1352, 1882; *Ann. Chim. Phys.*, (5), **12**, 318, 1877; (5), **25**, 145, 1882; J. B. J. D. Bous-singault, *Arch. Sciences Genève*, (1), **26**, 184, 1854; *Compt. Rend.*, **38**, 765, 1854; H. St. C. Deville and F. Leblanc, **45**, 750, 1857; **47**, 317, 1858; F. Fouqué and H. Gorceix, *ib.*, **69**, 946, 1869; J. Smithson, *Phil. Trans.*, **101**, 171, 1811; C. F. Rammelsberg, *Neues Jahrb. Min.*, ii, 158, 1884; T. Egleston, *Trans. Amer. Inst. Min. Eng.*, **5**, 131, 1876; E. Bechi, *Gazz. Chim. Ital.*, **10**, 40, 1880; *Bull. Soc. Ind. Min.*, **3**, 329, 1858; *Atti Accad. Lincei*, (3), **2**, 514, 1878; C. Nöllner, *Journ. prakt. Chem.*, (1), **102**, 463, 1867; *Zeit. Chem.*, (2), **2**, 89, 1866; F. P. Venable and J. S. Callison, *Journ. Amer. Chem. Soc.*, **4**, 196, 1890; E. T. Wherry and W. H. Chapin, *ib.*, **30**, 1684, 1908; J. A. Veatch, *Proc. California Acad. Science*, **2**, **7**, 1359; *Journ. Franklin Inst.*, **69**, 113, 1860; *Phil. Mag.*, (4), **19**, 323, 1860; G. Forchhammer, *Phil. Trans.*, **155**, 203, 1865; H. E. Boeke, *Centr. Min.*, **531**, 1910; W. Blitz and E. Marcus, *Zeit. anorg. Chem.*, **72**, 302, 1911; U. F. Hoefler, *Sopra il sale sedativo della Tuscano*, Firenze, 1778; C. Schmidt, *Liebig's Ann.*, **98**, 273, 1856; **102**, 190, 1857; H. St. C. Deville and F. Wöhler, *ib.*, **105**, 71, 1858; P. Bolley, *ib.*, **68**, 125, 1848; C. M. Kurtz, *Dingler's Journ.*, **212**, 493, 1874; O. Popp, *Liebig's Ann. Suppl.*, **8**, 5, 1870; R. Warrington, *Chem. Gaz.*, **12**, 419, 1854; A. Payen, *Ann. Chim. Phys.*, (3), **1**, 247, 1841; J. B. A. Dumas, *ib.*, (2), **34**, 136, 1826; E. Perrone, *Carte idrographica d'Italia*, **31**, 355, 1904; R. Nasini, *Gazz. Chim. Ital.*, **38**, ii, 598, 1908; *Atti Accad. Lincei*, (5), **17**, ii, 43, 1908; G. d'Achiardi, *ib.*, (5), **17**, ii, 238, 1908; *Atti Soc. Toscana*, **3**, **2**, 1878; **23**, 8, 1907; H. Coquand, *Bull. Soc. Géol.*, (2), **6**, 91, 1849; A. Bergault, *Zeit. prakt. Geol.*, **7**, 45, 1899; G. F. Becker, *Mon. U.S. Geol. Sur.*, **13**, 264, 1888; H. G. Hanks, *Ann. Rep. State Mineralogist, California*, **3**, 1, 1883; *Amer. Journ. Science*, (3), **37**, 63, 1889; E. Cortese, *Eng. Min. Journ.*, **78**, 741, 1904; F. W. Clarke, *The Data of Geochemistry*, Washington, 237, 1920; F. W. Clarke and H. S. Washington, *Proc. Nat. Acad. Sciences*, **8**, 108, 1922; J. H. L. Vogt, *Zeit. prakt. Geol.*, **6**, 225, 314, 377, 413, 1898; **7**, 10, 274, 1899; H. A. Rowland, *Amer. Journ. Science*, (3), **41**, 243, 1891; J. L. Smith, *ib.*, (2), **16**, 293, 1853; A. Lacroix and A. de Gramont, *Bull. Soc. Min.*, **44**, 67, 1921.
- ² H. G. Hanks, *Amer. Journ. Science*, (3), **37**, 63, 1889; *Ann. Rep. California State Min.*, **3**, 1, 1883; G. E. Bailey, *The Saline Deposits of California*, Sacramento, 1902; C. R. Keyes, *Bull. Amer. Inst. Min. Eng.*, 867, 1909; M. R. Campbell, *Bull. U.S. Geol. Sur.*, **200**, 1902; **213**, 1903; H. S. Gale and W. T. Schaller, *ib.*, **580**, 1914; F. A. Gooch and J. E. Whitfield, *ib.*, **47**, 1888; H. de Groot, *Ann. Rep. California State Min. Bur.*, **10**, 535, 1890; W. H. Storms, *ib.*, **11**, 345, 1893; S. L. Penfield, *Amer. Journ. Science*, (4), **9**, 425, 1900; J. H. Pratt, *ib.*, (4), **2**, 123, 1896; (4), **3**, 75, 1897; S. L. Penfield and G. S. Jamieson, *ib.*, (3), **20**, 217, 1905; W. B. Giles, *Min. Mag.*, **13**, 353, 1903; W. D. Dennis, *Eng. Min. Journ.*, **73**, 581, 1902; A. B. de Schulten, *Bull. Soc. Min.*, **19**, 164, 1896; *Compt. Rend.*, **143**, 403, 1906; A. Campbell, *Chem. News*, **21**, 90, 1870; A. Robottom, *ib.*, **32**, 286, 1875; E. L. Fleming, *ib.*, **63**, 74, 1891; C. N. Hake, *Journ. Soc. Chem. Ind.*, **8**, 854, 1889.
- ³ A. A. Hayes, *Amer. Journ. Science*, (1), **47**, 215, 1844; H. How, *ib.*, (2), **32**, 9, 1861; *Phil. Mag.*, (4), **35**, 31, 1868; (4), **41**, 270, 1871; F. W. Clarke, *The Data of Geochemistry*, Washington, 247, 1921; H. von Schlagintweit, *Sitzber. Akad. München*, **8**, 518, 1878; D. Forbes, *Journ. Geol. Soc.*, **17**, 7, 1861; *Phil. Mag.*, (4), **25**, 113, 1863; L. Darapsky, *Das Departement Taital*, Berlin, 1900; R. T. Chamberlin, *Journ. Geol.*, **20**, 763, 1912; J. J. Kyle, *Ann. Soc. Cient. Argentina*, **10**, 169, 1880; H. Buttgenbach, *Ann. Soc. Géol. Belg.*, **28**, 99, 1901; *Zeit. Kryst.*, **37**, 175, 1903; F. Reichert, *Chem. Ztg.*, **30**, 150, 1906; *Los yacimientos de boratos*, Buenos Aires, 1907; W. S. Vernadsky and S. P. Popoff, *Zeit. prakt. Geol.*, **79**, 1902; A. Jockamowitz, *Bol. Cuerpo Ing. Minas Peru*, 49, 1907.
- ⁴ L. Dieulafait, *Compt. Rend.*, **95**, 999, 1882; **96**, 452, 100, 1014, 1240, 1885; J. Bouis, *ib.*, **36**, 229, 1853; A. Béchamp, *ib.*, **36**, 495, 1853; F. Parmentier, *ib.*, **113**, 41, 1891; H. Fonzes-Diacon and M. Fabre, *ib.*, **158**, 1541, 1914; J. Bouquet, *ib.*, **39**, 326, 961, 1854; *Ann. Chim. Phys.*, (3), **42**, 278, 1854; R. Wildenstein, *Journ. prakt. Chem.*, (1), **55**, 165, 1852; C. R. Fresenius, *ib.*, (1), **55**, 163, 1852; (1), **58**, 156, 1853; (1), **70**, 1, 1857; *Zeit. anal. Chem.*, **25**, 204, 1886; S. Baup, *Journ. Pharm. Chim.*, (3), **23**, 43, 1863; O. Henry and M. Lhéritier, *ib.*, (3), **28**, 333, 408, 1855;

L. R. Lecanu, *ib.*, (3), 24, 22, 1853; *Compt. Rend.*, 86, 580, 1853; G. C. Wittstein and F. Apoiger, *Liebig's Ann.*, 103, 362, 1857; G. C. Wittstein, *Viertelj. prakt. Pharm.*, 2, 42, 1853; F. Rummel, *ib.*, 5, 544, 1856; H. Göttl, *ib.*, 4, 192, 1855; 5, 161, 1856; *Arch. Pharm.*, (2), 84, 179, 1855; C. Oppermann, *Neues Jahrb. Min.*, 184, 1854; C. du Ponteil, *Liebig's Ann.*, 96, 193, 1855; J. von Leibig, *ib.*, 98, 145, 1856; F. Moldenhauer, *ib.*, 97, 353, 1856; J. A. Veatch *Proc. California Acad. Science*, 2, 7, 1859; *Phil. Mag.*, (4), 18, 323, 1860; A. Carnot, *Ber.*, 12, 2150, 1879; E. Hotter, *Landw. Versuchsstat.*, 37, 437, 1890; *Zeit. Nahr. Hyg. Waar.*, 9, 1, 1895; K. Fischer, *Zeit. Unters. Nahr. Genuss.*, 8, 417, 1904; A. Hebebrand, *ib.*, 5, 1044, 1902; H. Agulhon, *Recherches sur la présence et le rôle du bore chez les végétaux*, Laval, 1910; G. Baumert, *Ber.*, 21, 3290, 1888; *Pharm. Ztg.*, 33, 708, 1888; P. Soltsien, *ib.*, 33, 312, 1888; E. Eckenroth, *ib.*, 34, 122, 1889; M. Bertainchaud and E. Gauvry, *Ann. Chim. Pure App.*, 15, 179, 1910; M. Ripper, *Weinbau Weinhandel*, 6, 331, 1888; A. H. Smith, *Ohio Journ. Science*, 17, 66, 1916; S. Weiwurm, *Zeit. Nach. Hyg. Waar.*, 8, 186, 1889; A. Gassend, *Boll. Chim. Pharm.*, 5, 61, 1891; E. Azzarello, *Gazz. Chim. Ital.*, 36, ii, 575, 1906; F. Schaffer, *Schweiz. Wochs. Pharm.*, 50, 478, 1902; E. G. Clayton, *Analyst*, 24, 141, 1899; J. Brand, *Zeit. Ges. Brauw.*, 15, 426, 1892; G. C. Wittstein and F. Apoiger, *Liebig's Ann.*, 103, 362, 1857; J. Dugast, *Compt. Rend.*, 150, 838, 1910; H. Jay, *ib.*, 121, 896, 1895; G. Bertrand and H. Agulhon, *ib.*, 155, 248, 1912; 156, 732, 1913; E. O. von Lippmann, *Ber.*, 21, 3492, 1888; *Chem. Ztg.*, 26, 465, 1902; C. A. Crampton, *ib.*, 22, 1072, 1889; E. Bechi, *Bull. Soc. Chim.*, (3), 3, 122, 1890; P. Kulisch, *Zeit. angew. Chem.*, 6, 473, 1893; E. Filhol, *Compt. Rend.*, 86, 229, 1863; E. Deltour, *Rev. Internat. Falsific.*, 6, 157, 1893.

§ 3. Boron

In 1808, J. L. Gay Lussac and L. J. Thénard¹ prepared impure boron by fusing boric acid, mixing the powdered vitreous product with potassium, and heating the mixture to redness in a tube of iron, copper, platinum, or glass. The product was boiled with dil. hydrochloric acid; washed with water; and dried at a gentle heat. According to J. J. Berzelius, if the glassy boric acid is not thoroughly freed from water, the reaction will be attended by detonation or spurting. The product is amorphous or colloidal, and as the potassium salt is removed by washing, the boron remains suspended in the water in so fine a state of subdivision that it runs through the filter paper, and, continued Berzelius, "it even dissolves in the water to which it imparts a slight yellow colour." The presence of salts or acids prevents the comminution of the boron in the water, and he therefore recommended washing the product with a soln. of ammonium chloride, and removing the latter with alcohol. B. Reinitzer, and R. Lorenz also showed that some solid boron hydride is formed in the process; and H. Moissan added that if the operation is conducted in metal tubes—copper, iron, gold, or platinum—the metal is attacked and the product is correspondingly contaminated. H. Davy, and R. D. Thomson employed a similar process. In place of potassium as a reducing agent F. Wöhler and H. St. C. Deville used sodium in the presence of sodium chloride. H. Moissan analyzed the products obtained (i) by J. L. Gay Lussac and L. J. Thénard's process as well as (ii) by F. Wöhler and H. St. C. Deville's process and heated in vacuo; (iii) the same after washing in boiling hydrochloric acid; and (iv) after a prolonged treatment with water:

	B	H ₂ BO ₃	K	Cu	Fe	Na	BH	H	H ₂ O
(i) . . .	44·10	17·80	14·4	12·5	5·80	—	—	—	4·9 = 99·50
(ii) . . .	69·50	15·65	—	—	4·61	6·63	5·84	0·44	— = 102·67
(iii) . . .	71·97	13·50	—	—	5·04	3·89	5·28	—	— = 99·68
(iv) . . .	32·38	42·52	—	—	7·51	10·34	2·26	4·10	— = 99·11

This shows that the products by these processes are very impure. According to N. A. Orloff, a sample of commercial boron contained glassy granules of boric oxide, a little iron, and 9·07 per cent. of water corresponding with 20·83 per cent. of boric acid.

J. J. Berzelius reduced potassium borofluoride with potassium. F. Wöhler and H. St. C. Deville, and A. Geuther used magnesium; according to H. Moissan, the product contains:

B	H ₂ BO ₃	K	Fe	BN
51·15	23 07	6·00	3·06	8·75 = 92·03

J. W. Döbereiner claimed to have reduced calcined borax with carbon, but neither L. Gmelin, nor A. Pleischl were able to confirm this result; L. Gattermann, C. Winkler, F. Jones, T. L. Phipson, and H. C. C. Maisch reduced calcined borax or boric acid with magnesium; F. Wöhler and H. St. C. Deville, L. Franck, K. A. Kühne, O. Hönigschmid, F. E. Weston and H. R. Ellis, and H. Goldschmidt used aluminium as reducing agent; H. Moissan reduced boric oxide, or boron bromide or nitride with calcium, but A. Stock and W. Holle found the product is calcium boride not boron. A. C. Vournasos reduced the oxide with sodium formate; and G. Dragendorff reduced calcined borax with red phosphorus. H. N. Warren reduced a mixture of boric oxide and magnesium sodium chloride with sodium.

According to H. Moissan, when boric anhydride is heated with the theoretical quantity or an excess of magnesium, reduction takes place with formation of magnesium borides. The author finds that if the boric anhydride is in considerable excess different results are obtained. There are two magnesium borides, one unstable and decomposed by water with liberation of hydrogen and boron hydride, the other stable and not affected by water, hydrochloric acid, or nitric acid. To prepare amorphous boron, H. Moissan recommended the following process:

Seventy grms. of finely powdered magnesium, free from iron and silicon, were intimately mixed with 210 grms. of recently fused boric anhydride. The mixture was heated to bright redness in a clay crucible, and in a few minutes an energetic reaction took place. The central part of the product was boiled with water and hydrochloric acid until the magnesium borate was removed, then treated for a long time with successive quantities of pure boiling hydrochloric acid, washed with water, and with alcoholic potash, again washed with water, boiled for several hours with hydrofluoric acid, washed with water, and dried in a vacuum. The product is a very light maroon powder which does not alter when exposed to air; it contains 94 to 95 per cent. of boron, 2.3 to 3.75 per cent. of magnesium, and 1.2 to 1.6 per cent. of insoluble matter. If this product is fused with 50 times its weight of boric anhydride, and the product treated in the same way as the original product, a maroon powder is obtained containing only traces of magnesium. One product contained boron, 98.30; magnesium, 0.37; insoluble, 1.18 = 99.85. If the boron is required perfectly free from nitride, reduction must be effected in a crucible brasqued with a mixture of finely powdered titanic oxide and carbon; the product contains from 92.6 to 99.2 per cent. of boron. Boric anhydride may also be reduced by magnesium in porcelain dishes in an atmosphere of hydrogen, and a very pure product is obtained, but the yield is small.

A. Stock and W. Holle say that the product obtained by reducing boric acid with magnesium is always impure—86 per cent. of boron, and 8 per cent. of magnesium. G. Constant and V. Raisin made boron by the electrolysis of fused boric oxide made conductive by the addition of sodium chloride, alkali borate, etc. E. Podszus prepared boron by the reduction of boron trichloride by electrically heated iron wire. Reduction progresses at 800° and the temp. was raised to 1400°. The porous mass can be welded into a compact mass, and drawn into wire. The reduction of boron trichloride with sodium gave only a black powder which does not weld into a compact mass.

F. Ageno and E. Barzetti obtained a colloidal solution of boron by heating a mixture of boric anhydride with 25 per cent. of magnesium powder to redness; washing the cold powdered mass with warm dil. hydrochloric acid; boiling the product with conc. hydrochloric acid, and washing by decantation with water. A reddish-brown sol is formed which shows Tyndall's effect, and may be preserved some months. The colloid is negatively electrified; and it is precipitated by electrolytes. H. Kuzel has studied the peptization of colloidal boron.

J. J. Berzelius scrubbed gaseous boron fluoride in a tube containing crystallized boric acid, and in another tube containing lead dioxide to free it from silicon fluoride and sulphur dioxide. The boron fluoride was then reduced by passing it over heated potassium, which is first covered with a black crust and then burns with a red flame producing a mixture of boron and potassium fluoride. The latter is removed by washing. The boron thus prepared contained 0.4 per cent. of silicon. S. G. Rawson employed a similar reaction. J. B. A. Dumas claimed to have reduced

hydrated boron chloride with hydrogen at a red heat; A. Besson and L. Fournier exposed a mixture of boron chloride and hydrogen to the silent electrical discharge; and H. Gustavson, distilled boron chloride over sodium at 150°. E. Weintraub reduced a mixture of the vapour of boron trichloride with hydrogen in a high-tension electric arc, between copper poles beneath the liquid or in the gas. The reaction was studied by J. N. Pring and W. Fielding, and by A. Besson and L. Fournier. F. Meyer and R. Zappner prepared it from boron bromide, which was boiled in a small bulb directly attached to a large bulb holding the electrodes, and this bulb was attached to a reflux condenser which returned the unattacked bromide to the vaporization flask. The tension of the current was 100,000 volts, and equilibrium was established in about five hours. A. H. Warth reduced boron trichloride with hydrogen in the presence of a glowing tungsten filament at 1300°–1850°, and obtained a deposit of boron of a high degree of purity.

B. Springfeldt obtained boron by heating the nitride, BN, to 1500° or 2000°; and A. C. Vournasos reduced the nitride by heating it with sodium formate, when amorphous boron, ammonia, and boron hydride are formed. A. Besson stated that in preparing boron iodide by the action of hydrogen iodide on H. St. C. Deville and F. Wöhler's amorphous boron, only a small portion is attacked, and he postulates that this represents a more *active variety of boron* than the remainder; but H. Moissan stated that this active boron is probably a mixture of iron and sodium borides.

H. Davy prepared impure boron by the electrolysis of moist boric acid. W. Hampe electrolyzed fused borax, and found that the sodium produced at the cathode immediately reduces the boric acid, forming boron. A carbon crucible was used with a platinum rod as anode, and a pencil of retort carbon as cathode. The product more or less crystalline is contaminated with carbon. H. Moissan, however, found that when a current of 35 amps. is passed through boric anhydride mixed with 20 per cent. of borax, and heated to 1200°, boron is liberated, but it immediately recombines with oxygen, with vivid incandescence. G. Gore, A. Stähler and J. J. Elbert, and A. Z. Hartmann have made some observations on this subject. E. Weintraub, and P. C. Ray showed that the amorphous boron prepared by H. Moissan's process contains several per cent. of oxygen; so also does the product obtained by the electrolysis of fused borax. As much as 16 per cent. oxygen has been reported. E. Weintraub also showed that in the magnesium reduction process, boron is easily obtained free from magnesium if a higher temp. be employed for the reduction than was the case in H. Moissan's experiments. P. C. Ray purified boron by heating to redness the amorphous powder with an excess of sodium or magnesium in a stream of hydrogen. In the former case magnesium boride is formed and decomposed. The product is extracted successively with water, hydrochloric acid, and warm 40 per cent. nitric acid. According to E. Weintraub, magnesium boride, nitride, and the product contaminated with oxide all decomposed when heated in vacuo, the change is appreciable at 1200°, and is rapid at 1500°. This dissociation enables the amorphous and less pure varieties of boron to be readily purified. E. Weintraub placed the powder in a water-cooled copper cup, which formed one electrode of an arc, the other electrode was of copper. The heating is conducted in vacuo or in hydrogen; and E. Tiede and E. Birnbräuer heated the impure boron by focussing the cathode rays on the powder. E. Weintraub also purified boron by compressing the powder into a rod *D*, Fig. 1, mounted in a

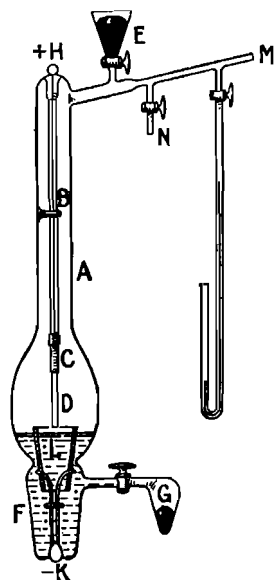

FIG. 1.—E. Weintraub's Mercury Arc Furnace.

carbon holder, *C*, to which a lead *B* is attached. This arrangement is placed inside a glass vessel *A*. The apparatus is filled with hydrogen *via M*, or evacuated *via N*. Mercury is introduced *via E* until the end of *D* is just covered; hydrogen is admitted to 2·5–15 cms. press., and the electrodes *H* and *K* connected to the source of current. Mercury is run into *G* until the end of *D* is just clear of mercury in the lower part of *F*. An arc is formed between the boron and the mercury in *F*. The end of *D* melts and falls off, and as the rod *D* shortens more mercury is run from *E* to maintain the arc. The bottomless alundum cup *L* serves to prevent the arc straying to the glass.

F. Wöhler and H. St. C. Deville reported the existence of black and yellowish forms of crystalline boron which they designated respectively *bore graphitoidé*, and *bore adamantin*. They prepared the crystals in long prismatic needles by melting together boric anhydride and aluminium in a graphite crucible; and by packing a fireclay crucible with amorphous boron, and inserting an aluminium rod in a hole bored in the powder. The crucible is then covered with its lid, and packed inside a larger crucible with powdered carbon. The whole is heated white hot. The boron dissolves in the molten aluminium, and crystalline boron separates out as the metal cools. F. Wöhler and H. St. C. Deville recognized that the crystals always contain carbon and aluminium, but they regarded the presence of these elements as accidental impurities. W. Hampe, and A. Joly have shown that these elements are essential constituents of crystalline boron. W. Hampe said the composition is $B_{48}C_2Al_3$. H. Biltz obtained $C_2Al_3B_{44}$ for the yellowish crystals. He separated them from the black crystals by flotation in a mixture of methylene iodide and benzene. A. Joly stated that among the products of the reduction of boric anhydride by aluminium in the presence of carbon, there are (i) golden-yellow hexagonal plates of aluminium boride, AlB_2 , described by F. Wöhler and H. St. C. Deville and at one time thought to be graphitoidal boron; (ii) black plates of aluminium boride, AlB_2 , described by W. Hampe; (iii) yellow quadratic crystals of adamantine lustre containing carbon and aluminium; and (iv) hard black crystals of a boron carbide, or more probably of several carbides, formed by the alteration of the preceding compounds at a high temp., in the presence of carbon and an excess of boric anhydride. The British Thomson-Houston Co. used the aluminium reduction process for preparing boron for the treatment of copper. K. A. Kühne prepared crystalline boron by heating boric acid with aluminium turnings and sulphur, and treating the cold mass with water. The aluminium sulphide is decomposed, while the crystalline boron remains intact. H. Biltz found the crystals to be aluminium boride, AlB_2 .

The physical properties of boron.—Most of our knowledge of the physical properties of boron has been obtained from very impure samples. J. L. Gay Lussac and L. J. Thénard's² product was a dark greenish-brown or olive-green powder, without smell or taste. H. Moissan's amorphous boron is pale brown, greyish-brown, or a bright maroon-coloured powder which stains the fingers, and can be readily compressed into a cake. The powder is without any recognizable crystalline form. E. Weintraub's fused boron resembled black diamonds; it takes a good polish; and it has a conchoidal fracture with no recognizable microcrystalline form. F. Meyer and R. Zappner's boron was a fine deep black powder. J. L. Gay Lussac and L. J. Thénard's product sank rapidly when placed in conc. sulphuric acid. H. Moissan, and A. Wigand gave 2·45, A. H. Warth, 2·3, and E. Weintraub, 2·34 for the **specific gravity**; E. Donath and J. Mayrhofer gave 0·373 for the sp. vol. J. L. Gay Lussac and L. J. Thénard said that boron does not scratch glass; actually, its **hardness** is rather less than that of the diamond, but it rubs off readily on the carborundum wheel. J. R. Rydberg placed its hardness as 9·5 on his scale. A. H. Warth said that boron is harder than sapphire; and is brittle. The **compressibility**, according to T. W. Richards, is $0·3 \times 10^{-6}$ per atm. at 20°.

C. M. Despretz said that amorphous boron readily melts between the poles of a battery of 600 Bunsen's cells, and that the **melting point** is lower than that of silicon, and that its **volatility** is greater than that element, but J. L. Gay Lussac and

L. J. Thénard could neither melt nor volatilize amorphous boron at the strongest white heat available. E. Tiede and E. Birnbräuer melted boron in vacuo in a cathode ray furnace at 2200°. W. Guertler and M. Pirani gave 2400° for the m.p. of boron. W. R. Mott gave 2500° for an approximation to the m.p., and 2300° for the **boiling point**. F. Wöhler and H. St. C. Deville said that boron is slightly volatile at the m.p. of nickel, and that its colour changes by heating it to a very high temp. H. Moissan said that amorphous boron shrinks slightly, and increases in density when heated to 1500° in an atm. of hydrogen; and that when placed in the electric arc, amorphous boron becomes red, and is surrounded by *une grande auréole verte*, but it shows no signs of fusion, and at the conclusion of the experiment, the ends of the carbon electrode have much boron carbide. E. Weintraub, however, showed that boron can be readily fused at atm. press. or in vacuo. E. Tiede and E. Birnbräuer gave 2200° for the m.p., and E. Weintraub, 2800°. Boron begins to vaporize below its m.p.; and the vap. press. is appreciable at 1200°. H. Kopp gave 0.254 for the **specific heat** of boron; these numbers show that boron does not obey Dulong and Petit's rule as was observed by H. V. Regnault. H. Moissan and H. Gautier found the sp. ht. over 0°, and F. Koref below 0°, with the following results:

	-191° to -78°	-76° to 0°	0° to 100°	100° to 192.3°	192° to 234°
Sp. ht.	0.0707	0.1677	0.3066	0.3776	0.3443
At. ht.	0.778	1.838	3.372	4.153	4.766

The sp. ht. rises with temp., and by extrapolation, H. Moissan and H. Gautier infer that the at. ht. will be about 6.4 at 400°. A. Wigand, G. Schmidt, E. van Aubel, and F. Michaux have also discussed the question—*vide* Fig. 7, l. 13, 12. According to L. Troost and P. Hautefeuille, the **heat of combination** of boron with oxygen is 14.42 Cals. per gram, or 158.6 Cals. per eq.; M. Berthelot gave $(B, \frac{1}{2}O_3) = \frac{1}{2}B_2O_3 + 156.3$ Cals. Some idea of its affinity for some other elements may be gathered from the heats of formation with $\frac{1}{3}B$, with

	F	O	Cl	B	S
Cals.	78.3	45.4	31.1	14.4	13.8

J. H. Gladstone gave 4.0 for the **refraction equivalent** of boron, and 0.364 for the specific refraction. A. Schrauf has made observations on this subject. A. Ghira said that the at. refraction of combined boron is nearly independent of the elements with which it was united. As previously indicated, about the middle of the eighteenth century, J. H. Pott said that *le sel sédatif* communicates a green colour to the flame of alcohol, and that the colour is the same though a little feebler than that produced by cupric sulphate. The **spectrum** of the alcohol, Bunsen's or hydrogen flame coloured by boron compounds,

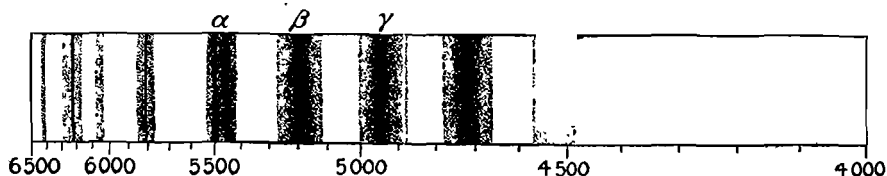

FIG. 2.—Spectrum of Boric Acid.

was observed by J. F. W. Herschel, W. A. Miller, R. T. Simmler, R. Böttger, A. Mitscherlich, C. Horner, L. de Boishaudran, W. Weith, J. M. Eder and E. Valenta, A. Hagenbach and H. Konen, A. de Gramont, M. W. Iles, L. Dieulafait, G. Salet, O. Vogel, etc. The flame spectrum of boric acid shows many bands, the most prominent of which are in the yellow and green; they are essentially different from the similar coloured bands produced by barium compounds. The spectrum is shown in Fig. 2; there are three feeble orange-yellow bands, 6598, 6211, and 6032; a yellow band, 5808; an intense yellow band with sharp lines—5481 and 5440, α , Fig. 2—a feeble green band with lines 5193, β , Fig. 2, and 4912, γ , Fig. 2; and

finally, a feeble blue band, 4722 and 4530. The flame spectrum is not easy to produce, it requires a large excess of boric acid, and the slit of the spectrum rather more open than usual. The three bands, α , β , and γ , with the green line 5481, and the weaker line 5440, are useful in the spectroscopic recognition of boric acid. The spectrum of boron fluoride is similar. The same bands are observed in the arc spectra of boron, boric oxide, and the spark spectrum of soln. of boric acid in hydrochloric acid; they are attributed to boron oxide; they do not occur in the spark spectrum of boron itself. According to W. Jevons, boron trichloride or methyl borate in the after-glow of nitrogen shows another series of bands which have definite heads and digrade towards the red; these bands also occur in the arc spectrum of boron and its oxide, and are attributed to boron nitride even though they do not occur in the spark spectrum of boron in nitrogen. The spectrum of boron fluoride in Geissler's tube was investigated by J. Plücker, G. Ciamician, etc. The band spectrum was studied by R. Thalén, L. Troost and P. Hautefeuille, C. P. Smyth, L. de Boisbaudran, G. Salet, F. Jones, A. Hagenbach, G. Kühne, H. Gilbert, H. Gilm, V. Merz and W. Weith, M. Bidaud, M. A. Catalan, H. Auerbach, etc. H. Rose showed that the presence of tartaric or phosphoric acid hinders the development of the green flame. The spark spectrum was investigated by W. N. Hartley, J. M. Eder and E. Valenta, F. Exner and E. Haschek, A. Hagenbach and H. Konen, etc. W. N. Hartley observed the three lines 3450.3, 2497.0, and 2496.3 when borax is volatilized in the electric arc. The spark spectrum obtained with electrodes of adamantine boron furnished J. M. Eder and E. Valenta 14 lines in the ultra-violet, namely, 3957.9, 3941.7, 3829.3, 3824.5, 3246.9, 2689.0, 2686.2, 2388.5, 2267.0, 2266.4, 2088.8, 2088.4, 2066.2, 2046.6, when the lines due to foreign metals are eliminated. The arc spectrum was studied by H. Kayser and C. Runge, H. A. Rowland and co-workers, F. Exner and E. Haschek, A. Hagenbach and H. Konen, etc. The effect of press. was studied by W. J. Humphreys. R. A. Millikan measured the extreme ultra-violet spectrum of boron. The wave-length of the K-radiation of boron has been measured by O. W. Richardson and C. B. Bazzoni, A. L. Hughes, and J. Holtzmark. The latter found $\lambda=83.6$. F. K. Richtmyer found a discontinuity in the X-ray spectrum of boron in the region of very short wave-lengths, and considered it as evidence of the presence of characteristic J-radiations. J. Holtzmark measured the characteristic X-rays of boron. J. C. McLennan and M. L. Clark gave 23.45 for the critical voltage of the L-series of X-rays from boron for $\lambda=525.8 \times 10^{-8}$ cms., and 42.2 volts for $\lambda=292.2 \times 10^{-8}$ cms. E. Rutherford and J. Chadwick obtained evidence of the emission of long-range particles, detected by scintillations on a zinc sulphide screen—probably hydrogen—when α -rays pass through boron.

J. L. Gay Lussac and L. J. Thénard said that the electrical conductivity of boron is nil. H. Moissan found that electrical conductivity of the pressed powder is very low, being but 0.125×10^{-6} rec. ohms per cm. cube when that of mercury is 1.063×10^4 at 0° ; and its electrical resistance, 807 megohms. A. H. Warth gave 9×10^5 ohms per cm. calc. for the sp. resistance at 26° , and this falls considerably with rise of temp. E. Weintraub found fused boron, when cold, is a very poor conductor, for its sp. resistance is 10^{12} times that of copper at ordinary temp. In this respect, boron resembles carbon; but unlike carbon, boron has an abnormally high negative temp. coeff. of its resistance. Metals usually have a positive temp. coeff., and the metalloids a negative temp. coeff. The sp. conductivity of boron at 0° is nearly 0.5×10^{-6} or 0.6×10^{-6} mho per cm. cube, and it doubles in value for every 17° . The curve is shown in Fig. 3. The observed data are:

	0°	27°	100°	170°	320°	520°	600°
Ohms	9×10^6	775×10^3	66×10^3	7.7×10^3	180	7	4

Above 1000° , the resistance is but a fractional part of an ohm. The effect of traces of impurities in the boron is to raise the conductivity many-fold. Thus, one per cent. of carbon makes the remarkable character of the conductivity of boron disappear;

and its conductivity becomes comparable with that of carbon or silicon. With metals, the resistance, not the conductivity, increases if impurities are present. The negative temp. coeff. of impure boron becomes numerically less and less as the temp. increases; so that all the curves seem to converge at about 1000° . The behaviour of fused boron is more like that of a spark gap or arc than that of a solid

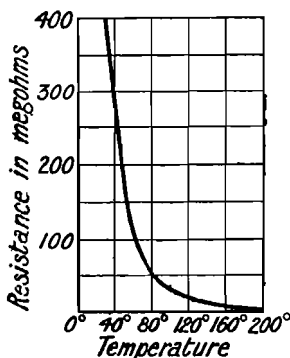

FIG. 3.—The Electrical Resistance of Boron.

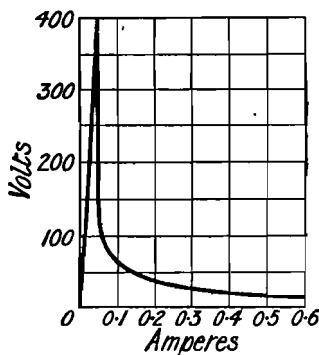

FIG. 4.—Volt-Ampere Curve of Boron in Air.

conductor, for there exists a break-down voltage in the case of boron as in the case of an air-gap. Below the break-down voltage, only a very small current flows through a boron conductor, but once the current is started, boron becomes a relatively good conductor. Fig. 4, for example, shows the volt-ampere curve of boron in air. At 400 volts, the breakdown occurs when only 0.004 amp. is passing; after that the current rises, and the voltage drops rapidly. H. N. Warren used boron as the positive pole in a galvanic element. F. Zantedeschi said that boron is diamagnetic. K. Honda gave for the **magnetic susceptibility** at 18° , -0.71×10^6 mass units, and at 1100° , -0.80×10^6 units.

The fact that crystallized boron has not been prepared, and that the so-called graphitoidal and adamantine forms crystalline boron are not really boron, but rather compounds—aluminium borides, and aluminium borocarbides—or solid soln. does not render nugatory the published data respecting the properties of crystalline boron, but it renders it necessary to transpose the descriptions from the sections dealing with boron to those dealing with the corresponding compounds.

F. Wöhler and H. St. C. Deville proved that *graphitoidal boron* is aluminium boride, AlB_2 (*q.v.*), and they also argued that the small proportion of carbon always associated with *adamantine boron* must be present as diamond-carbon because the crystals are transparent, and thus the larger the proportion of carbon the greater the transparency. As previously indicated, W. Hampe represented the composition by $Al_3B_{10}C_2$, and H. Biltz by $Al_3B_{10}C_3$, and, added the latter, it is not possible to say whether these crystals are a definite chemical compound—an *aluminium borocarbide*—or a saturated solid soln. The crystals are colourless or they vary in colour from a honey-yellow to a brownish-yellow, a hyacinth-red, a dark reddish-brown approaching black in transmitted light, and in reflected light they are dark brown to grey. L. Gattermann said that the crystals are six-sided plates; and F. Wöhler and H. St. C. Deville obtained eight-sided prisms with octahedral ends. A. Sella, and G. Sartorius agree that the crystals are bipyramids belonging to the tetragonal system, the axial ratios were given respectively as $a : c = 1 : 0.5762$ and $1 : 0.5756$. F. Wöhler and H. St. C. Deville gave 2.68 for the sp. gr.; A. Wigand, 2.49; and H. Biltz, 2.590 ± 0.006 at $18^{\circ}/4^{\circ}$. F. Wöhler and H. St. C. Deville found the crystals to be so very hard that they readily scratch ruby and corundum, and even the diamond; and they stated that the crystals do not change when heated to the m.p. of iridium, and that in air they burn superficially at the same temp. as the diamond, forming a crust of boron oxide; H. V. Regnault found 0.260 for the sp. ht.; H. Kopp gave 0.230; A. Wigand, 0.165 at 21° ; W. G. Mixer and E. S. Dana, 0.2518; and H. F. Weber

	$-39^{\circ}6'$	$26^{\circ}6'$	$27^{\circ}6'$	$125^{\circ}8'$	$233^{\circ}2'$
Sp. ht.	0.1915	0.2382	0.2737	0.3069	0.3663

According to F. Wöhler and H. St. C. Deville, the crystals are doubly refracting. Adamantine boron is not attacked by acids, but aqua regia acts slowly; it is attacked by fused potassium hydrosulphate at red heat, forming sulphur dioxide; fused phosphoric acid forms boric oxide and a flame coloured by phosphorus; fused potassium nitrate has no action; fused sodium hydroxide or sodium carbonate forms a little sodium borate at a red heat, but a boiling aq. soln. of the former has no action. A. Ditte found that boric acid and iodine are formed when hydrogen iodide acts on adamantine boron at a red heat. M. Berthelot allowed chlorine to act on white-hot adamantine boron, and found that a part of the carbon is removed and deposited as graphite crystals a little distance away from the seat of the reaction; it was accordingly assumed that a compound with chlorine is formed and decomposed during the reaction.

The chemical properties of boron.—Most of our knowledge of the chemical properties of amorphous boron is a result of H. Moissan's ³ *Études sur le bore amorphe*. The samples here used were shown by E. Weintraub to contain 4–5 per cent. of oxygen. Summaries have been made by E. Davies, W. Müller-Erbach, F. Tiemann, etc. According to H. Moissan, amorphous boron unites with the metalloids more readily than with the metals, and it has a strong affinity for oxygen, sulphur, fluorine, and chlorine. It is a more energetic reducing agent than carbon and silicon because it decomposes the oxides of these elements at a red heat. Its general chemical properties resemble those of carbon more closely than those of silicon. Indeed, boron resembles no other element so much as it does carbon. According to F. Wöhler and H. St. C. Deville, strongly calcined amorphous boron is less readily attacked by chemical agents than that which has not been calcined.

According to H. Davy, H. V. Regnault, and F. Wöhler and H. St. C. Deville, boron is not influenced when heated to redness in **hydrogen**, and H. Moissan found the sp. gr. was not affected by heating boron to 1500° in hydrogen. H. B. Baker and H. B. Dixon found boron retains occluded hydrogen very tenaciously. J. L. Gay Lussac and L. J. Thénard said that amorphous boron does not oxidize in **air** at ordinary temp. B. Reinitzer found that very finely divided amorphous boron becomes covered with microscopic crystals of boric acid after 8–10 days' exposure to moist air. J. L. Gay Lussac and L. J. Thénard state that the oxidation of boron in air begins at about 300°; it then burns in air with a reddish glow, and, added J. J. Berzelius, a green flame; scintillating parts are produced, some boric oxide sublimes, and a dark residue mixed with vitreous boric oxide remains. H. Davy regarded the dark residue as *boron suboxide*, for he said that it contains less oxygen than is present in boric anhydride; J. J. Berzelius said that it is only boron changed physically by the high temp. of combustion; and it is probable that it contains a nitride. E. Weintraub showed that the brown amorphous boron prepared by the reduction of boric oxide or borax always contains oxygen, and he suggested that it is boron suboxide; more probably it is a solid soln. of boric oxide in boron. H. V. Regnault said amorphous boron oxidizes in air at 100°; F. Meyer and B. Zappner's product oxidizes on exposure to air; and F. Wöhler and H. St. C. Deville noted that the light flocculent boron burns in air when the temp. is slightly raised. H. Moissan said that the reports of the low temp. of the inflammation of boron are based on observations with samples contaminated with sodium boride; and he added that the purified product inflames in air when heated to 700°, and it burns with a brilliant green flame of low actinic power. The combustion is soon stopped by the formation of a layer of boric anhydride on the surface of the boron. E. Weintraub found that fused boron can be heated strongly in air without undergoing any perceptible oxidation. H. Moissan's boron behaves similarly in **oxygen** to what it does in air, but it ignites at a lower temp., and burns with a dazzling light. H. B. Baker and H. B. Dixon found the dryness of the oxygen has a marked influence on the results.

J. J. Berzelius said that the freshly prepared uncalcined amorphous boron is soluble in **water** to which it imparts a greenish-yellow colour, and that the boron is precipitated from its aq. soln. by acids and salts; the residue left on evaporating the liquid in a glass dish forms a yellowish film which is only partially taken up

when treated with water. J. J. Berzelius was obviously dealing with a colloidal soln. G. Dragendorff thought that he had prepared hydrated boron by the reducing action of phosphorus on borax. J. L. Gay Lussac and L. J. Thénard said that amorphous boron does not decompose water at 100°; but F. Wöhler and H. St. C. Deville, and H. Moissan found that steam reacts with boron at a red heat, forming boric acid and hydrogen. Once the reaction is started it proceeds with great energy, forming boric acid and hydrogen. F. Ageno and E. Barzetti said that **hydrogen peroxide** is decomposed by a colloidal soln. of boron, and that boric acid is simultaneously formed.

According to H. Moissan, **fluorine** attacks boron at ordinary temp., the mass becomes incandescent, and boron trifluoride is formed. W. Müller-Erbach studied the affinity of the halogens for boron. Boron takes fire in **chlorine** at 410°, forming boron chloride; H. Davy's impure boron ignited at ordinary temp. in chlorine. H. Moissan further observed that in **bromine** vapour, inflammation occurs at 700°, and boron bromide is formed. Bromine water attacks boron very slowly at ordinary temp., but the reaction is faster in the presence of potassium bromide. Boron is not attacked by **iodine** at ordinary temp., the reaction begins at about 1250°; iodine in the presence of water acts slowly on boron at ordinary temp. The hydrogen halides react with greater difficulty on boron; H. Moissan found that **hydrogen fluoride** is not attacked below dull redness; and F. Wöhler and H. St. C. Deville, and H. Moissan found that **hydrogen chloride** attacks boron at a bright red heat—in both cases hydrogen and the boron halide are formed. The former added that if the reaction occurs in a glass tube, some silicon chloride is formed by the joint action of boron and hydrogen chloride on glass. Boron is not attacked by **hydrochloric acid**, sat. at 0°. H. Davy's impure boron was attacked by the boiling acid. H. Moissan found that **hydrogen iodide** does not attack boron at 1300°, but at a more elevated temp. boron iodide is formed. According to H. Moissan, boron reacts energetically with many metal fluorides, forming boron fluoride, the **fluorides of the alkalis and alkaline earths** are decomposed at a bright red heat; **zinc fluoride** is decomposed at a dull red heat; the reaction by simple contact with **lead and silver fluorides** proceeds with explosive violence. The reaction with the chlorides is not so energetic; the **chlorides of the alkalis, alkaline earths, zinc, and lead** are not attacked at a red heat, but **mercurous chloride** is reduced to mercury at 700°. F. Wöhler and H. St. C. Deville found that lead chloride, **mercuric chloride**, and **silver chloride** are reduced to the metal and boron chloride. H. Moissan found that boron reduces a soln. of **ferric chloride** to ferrous chloride, and soln. of **palladium and platinum chlorides** are reduced at ordinary temp.; J. J. Berzelius and H. Moissan stated that a soln. of **auric chloride** is reduced by boron to aurous chloride. The last named also found that boron does not reduce **lead, zinc, cadmium, and copper iodides** at a red heat, but **tin and bismuth iodides** are readily reduced. According to H. Moissan, **chloric acid** is reduced by boron to chlorous acid; and, according to A. Ditte and H. Moissan, **iodic acid** attacks boron below 40°, forming boric acid and iodine, at the same time, the mixture becomes incandescent; while the last named also found that iodine is precipitated from a cold aq. soln. of iodic acid. Fused **potassium chlorate** reacts vigorously with boron; each portion of boron which is projected on the fused mass produces *une lumière éblouissante*.

H. Davy's impure boron dissolved slightly in molten **sulphur**. According to H. Moissan, boron unites with sulphur in the vicinity of 600°, and the mass becomes incandescent—boron sulphide is formed; it behaves similarly with **selenium** at a more elevated temp., but it does not unite with melted **tellurium**. F. Wöhler and H. St. C. Deville found that boron sulphide is formed when boron is heated with **hydrogen sulphide**. At a dull red heat, boron reduces **sulphur dioxide** to sulphur. J. L. Gay Lussac and L. J. Thénard, and H. Davy said that boron readily decomposes hot conc. **sulphuric acid**; but is not attacked by the cold acid. H. Moissan found that the reaction begins at 250°, and sulphur dioxide is formed. F. Wöhler and H. St. C. Deville said that when boron is heated with **lead sulphide**, boron

sulphide and lead are produced. J. L. Gay Lussac and L. J. Thénard found that boron at a red heat reduces **sulphites** and **sulphates**, forming sulphur and the metal borate. The **sulphates of the alkalis and alkaline earths** were found by H. Moissan to be reduced to sulphides by boron at a red heat.

H. Moissan and G. Charpy found that **carbon** does not combine directly with boron, although a boron carbide is formed when boron is heated in the electric arc in an atm. of hydrogen. J. N. Pring and W. Fielding found that above 2000°, boron changes carbon catalytically into graphite. At 1200°, boron reduces **carbon monoxide** to carbon. According to R. Lorenz, **carbon dioxide** is likewise reduced by heated boron. H. Moissan heated boron to redness in the vapour of purified dried **carbon disulphide**, and obtained carbon and boron sulphide. According to P. C. Chabrié, **carbon tetrachloride** forms much boron chloride at 200°–250°: $4B + 3CCl_4 = 3C + 4BCl_3$; **chloroethene**, C_2Cl_4 , acts less readily, and **hexachlorobenzene**, C_6Cl_6 , not at all; **dibromoethane**, $C_2H_4Br_2$; and **tribromhydrin** likewise form much boron bromide in a sealed tube at 250°. J. L. Gay Lussac and L. J. Thénard found that when **carbonates** are heated with boron, carbon and the corresponding borate are formed. H. Moissan also found **sodium carbonate** is rapidly decomposed by boron at a dull red heat; **potassium carbonate** at a higher temp.; and **barium and calcium carbonates** not at all. H. Davy observed no reaction with **acetic acid**. He also found that **silicon** does not unite directly with boron; and that **silica** is reduced to silicon when the mixture is heated in a forge. A. Duboin and A. Gautier said that an intimate mixture of boron and silicon behaves like carbon in the presence of alumina. According to L. Troost and P. Hautefeuille, when boron is heated with silicon dioxide, silicon and boric oxide are formed. Similar results were obtained with **zirconium dioxide**, and **titanium dioxide**.

F. Wöhler and H. St. C. Deville, and H. Moissan stated that boron unites with **nitrogen** at 1230°. The last named found that boron is without action on **nitrogen peroxide**. F. Wöhler and H. St. C. Deville found that amorphous boron burns when heated in an atm. of **nitric oxide**, forming boron nitride and boric oxide. F. Wöhler said the action starts at a red heat. H. Davy noted that boron burns in **nitrous oxide**, forming boric oxide—H. St. C. Deville and F. Wöhler showed that some boron nitride is produced as well. The last named also found that when boron is heated in a stream of **ammonia**, boron nitride is formed. J. L. Gay Lussac and L. J. Thénard stated that feebly warmed **nitric acid** is decomposed by boron, furnishing boric acid, nitric oxide, and nitrogen; they also stated that **nitrates** and **nitrites** are vigorously decomposed by boron. H. Moissan also found nitric acid reacts energetically with boron, and that with the conc. acid the reaction is so vigorous as to raise the mass to incandescence; F. Meyer and R. Zappner's boron is a fine powder which reacts violently with dil. nitric acid, and inflames on contact with the conc. acid. On the contrary, E. Weintraub's fused boron is scarcely attacked when gently warmed with 40 per cent. nitric acid, under conditions where amorphous boron is readily attacked. Notwithstanding its great affinity for oxygen, boron may be immersed in fused **potassium nitrate** up to about 400°, without any reaction taking place, but as soon as the potassium nitrate begins to decompose an energetic reaction occurs; a mixture of boron, sulphur, and nitre deflagrates at a dull red heat. Molten **potassium nitrite** is violently decomposed by boron. H. Moissan found that a soln. of **silver nitrite** is reduced by boron, forming crystalline silver. H. Davy's impure boron was slightly attacked by molten **phosphorus**, but H. Moissan found that boron does not unite directly with phosphorus, **arsenic**, or **antimony** at 750°; **phosphorus pentoxide** at 800° is reduced to phosphorus; **arsenious acid** and **arsenic acid** are reduced to arsenic at 800°; and the **arsenites** and **arsenates** are reduced at a dull red heat; **antimonious oxide** is also readily reduced when heated with boron. The **chromates** are likewise reduced at dull redness, and a cold soln. of **potassium permanganate** is decolorized by boron.

According to H. Moissan, the **alkali metals** have no action on boron, and they can be distilled from boron without combination; **magnesium**, on the contrary,

gives a boride at a dull red heat; **iron** and **aluminium** form borides only at a high temp.; while **silver** and **platinum** readily combine with boron. H. Moissan and G. Charpy found that when reduced iron is melted with boron in an atm. of hydrogen, about 10 per cent. of the latter is dissolved. The **ferroboron** so produced can be alloyed with steel, and the tensile strength of the steel is increased without perceptibly affecting the hardness. H. Davy observed no reaction when boron is heated with **mercury**, and A. B. du Jassonneix that at the temp. of an electric furnace, boron is insoluble in **copper**, **tin**, and silver. E. Weintraub also found boron does not alloy with copper at a red heat, and P. C. Ray observed a similar result with **magnesium**.

H. Davy's impure boron was attacked by fused and aq. soln. of the fixed alkalis. According to J. J. Berzelius, when boron is heated with **potassium hydroxide**, potassium borate and hydrogen are formed; H. Moissan observed a similar action with the molten hydroxide, and he found that the metallic oxides are reduced more readily by boron than by carbon. For example, when a mixture of **cupric oxide** and boron is warmed in a glass tube, the action is violent and the glass is melted; **stannous oxide**, **lead oxide**, and **bismuth oxide** are readily reduced; a mixture of boron and **lead dioxide** detonates violently when triturated in a mortar. At a red heat, the **alkaline earth oxides** are not affected; but **ferric and cobalt oxides** are reduced. H. Giebelhausen found that amorphous boron dissolves in **calcium fluoride** and the boron crystallizes out on cooling; with **cadmium fluoride**, boron fluoride and cadmium are formed.

The volatility of boron prevents its use in making filaments for electric lamps. E. Weintraub recommends it strongly for purifying copper; he said that if 0.03-0.1 per cent. be added to molten copper before it is cast, the metal is deoxidized and purified to a remarkable extent. He added that it is cheaper to use the amorphous powder than fused boron. The product was called *boronized copper*, although it is virtually free from boron. The term, therefore, refers to a mode of treatment rather than to its chemical composition. Similar remarks apply to the *bronze silicieux* which F. Gautier found to contain no silicon. According to L. Guillet, H. Moissan and G. Charpy, and G. Hannesen, a little boron increases the breaking stress of steel.

Reactions of analytical interest.—When a moderately conc. soln. of borax is treated with one of **silver nitrate**, a white precipitate of metaborate, AgBO_2 , is formed, soluble in ammonia or nitric acid; when the silver metaborate is warmed, brown silver oxide is formed; with cold dil. soln., silver oxide is precipitated. Fairly conc. soln. of borax with **barium chloride** give a white precipitate of barium metaborate, $\text{Ba}(\text{BO}_2)_2$, soluble in an excess of barium chloride, and in soln. of ammonium salts and acids. A soln. of **calcium chloride** or of **lead chloride** behaves like that of barium chloride; and a soln. of **mercuric chloride** gives a red precipitate. The latter reaction is sometimes styled G. Tammann's reaction⁴ for free borates.

A hot very conc. soln. of an alkali borate may give a precipitate of boric acid when treated with **hydrochloric acid**; again, **sulphuric acid** exerts no visible action on a soln. of borax, but most borates are decomposed by this acid liberating boric acid. A soln. of boric acid dissolves in **alcohol**, and the alcohol burns with a green flame—*flame test*. Similarly, if a borate be decomposed by an acid, and the mass be mixed with alcohol, the latter burns with a green flame. The test is conveniently made on a watch glass. Methyl alcohol gives better results than ethyl alcohol. It is possible to detect 0.001 per cent. of boric oxide in a soln. by this test. If copper or barium be present the test is not satisfactory—the former must then be removed by hydrogen sulphide, and the latter by sulphuric acid. According to M. W. Iles,⁵ the test is best conducted by heating the borate moistened with sulphuric acid on a platinum foil until all the acid is expelled. It is then moistened with glycerol, and the latter ignited. A flame tinged green is produced if boric oxide be present; and 0.001 per cent. of boric acid can be detected by this reaction. According to E. Turner, if a powdered borate be mixed with a few drops of water, and

approximately three times its weight of Turner's flux—a mixture of powdered calcium or potassium fluoride with 4–5 times its weight of potassium hydrosulphate—and the paste exposed on a loop of platinum wire in the blowpipe (or Bunsen's) flame, boron fluoride is volatilized and it imparts a greenish tinge to the flame. The reaction will detect 0·01 grm. of boric acid in a silicate.

If a borate be just acidified with dil. hydrochloric acid, and a strip of turmeric paper be half immersed in the soln., no apparent change occurs; but if the paper be dried on a watch-glass at 100°, the half which has been dipped in the boric acid shows a peculiar brownish-red coloration—**turmeric test**. If but a small trace of boric oxide be present, the stain may be pink. The colour remains when the stain is dipped in boric acid again, or in dil. sulphuric or hydrochloric acid. The brown stain produced by alkalis changes into yellow under these conditions. If too little acid be used, there may be no coloration; if too much, the colour may be brown. If the boric acid stain be touched with a soln. of potassium hydroxide, the paper becomes bluish-black or bluish-grey, according as much or little boric acid be present. A little hydrochloric acid will restore the red colour. As little as 0·0001 grm. of boric acid can be detected by the (pink) colour produced in this manner. The presence of oxidizing agents like chlorates, chromates, iodides, etc., interferes with the test by destroying the turmeric. Nitric acid is an exception. Conc. hydrochloric acid may give a dark brown stain under the conditions of the test; ferric chloride, molybdenum, and zirconium salts give a brownish-red stain which is not coloured bluish-black with potash soln.

Still smaller amounts of boric acid can be detected if needed by placing the soln. under investigation in a small dish and evaporating it to dryness in a desiccator in vacuo at a low temp. If a few drops of an alcoholic extract of a few turmeric papers be mixed in a porcelain dish with the borate, the soln. acidified with acetic acid, and evaporated to dryness on a water-bath, a reddish-brown residue will be obtained if as little as 0·0002 grm. of B_2O_3 be present, while 0·00002 grm. will produce a perceptible coloration.

Boric acid reacts feebly acid towards **litmus**; and the alkali salts react alkaline; the colour of **methyl orange** or of **p-nitrophenol** is not affected by boric acid; a soln. of boric acid neutralized with alkali hydroxide, with **phenolphthalein** as indicator, again gives an acid reaction if glycerol or mannite be added to the soln. If an aq. soln. of boric acid be titrated with a standard soln. of sodium hydroxide, the pink colour of phenolphthalein is developed before all the boric acid is neutralized; but if the soln. contains sufficient glycerol or mannitol, the boric acid all reacts with the sodium hydroxide: $NaOH + H_3BO_3 = 2H_2O + NaBO_2$, before the pink coloration appears. A volumetric process is based on this reaction. If a standard soln. of hydrochloric acid be added to a soln. of borax with methyl orange or better, *p*-nitrophenol, as indicator, the soln. reacts acid only when all the sodium is neutralized by hydrochloric acid: $Na_2B_4O_7 + 5H_2O + 2HCl = 2NaCl + 4H_3BO_3$. The liberated boric acid can then be titrated with standard alkali with phenolphthalein as indicator.

If a borate be distilled with sulphuric acid and methyl alcohol, a volatile methyl borate, boiling at 65°, distils over; with ethyl alcohol a volatile ethyl borate, boiling at 120°, is obtained. The alkyl borate can be saponified with alkali hydroxide, and the boric acid determined by volumetric methods, *vide supra*, or weighed as potassium fluoborate.

Determination of the atomic weight of boron.—The accurate determination of the at. wt. of boron has presented many difficulties because of the small number of compounds which are suited to accurate measurements. J. L. Gay Lussac and L. J. Thénard⁶ said that when oxidized with nitric acid boron takes up about one-third of its weight of oxygen; this would make the at. wt. 48—oxygen, 16; H. Davy found that when one part of boron is burnt in oxygen, it takes up 1·8 parts of oxygen. This would make the at. wt. 13·3. The samples of boron employed were very impure. T. Thomson discussed the at. wt. of boron in 1824. In J. J. Berzelius's

list of 1815, a number corresponding with 11·15, if oxygen be 16, was given; and in 1818, he gave 11·15. At first, J. J. Berzelius wrote the formula of boron oxide, B_2O_3 , and he later changed this to BO_2 (with oxygen=8), thus making the at. wt. of boron approximately 22—some wrote the formula BO_2 . V. Kletzensky in 1865 wrote the formula BO_6 (with oxygen 8), and gave 44 for the at. wt. The at. wt. of boron=11, is in harmony with values deduced by Avogadro's rule from the volatile compounds of boron.

In its compounds with the electronegative elements boron is trivalent, and highest known oxide is the trioxide (B_2O_3) $_n$; no halide is known higher than BF_3 or BCl_3 ; and in the boron alkyls, $B(CH_3)_3$ and $B(C_2H_5)_3$, boron is undoubtedly trivalent. It has been argued that if three represents the maximum valency of boron, the boron alkyls and halides would probably be chemically inert like the hydrocarbons, and carbon tetrachloride; on the contrary, the boron halides and alkyls are very reactive, and readily unite additively with ammonia, potassium hydroxide, etc., forming compounds like $B(CH_3)_3.NH_3$, $B(CH_3)_3.KOH$, BF_3 , $BCl_3.NOCl$, $BCl_3.HCy$, $BCl_3.C_2H_5Cy$, $BCl_3.CyCl$, etc., in which it is supposed the boron is quinquevalent. It is also said to behave as a quinquevalent element in ammonio-boron trimethyl, and in the boronium compounds of J. Schumacher—e.g. acetylacetonoboronium chloride, which he represents by the formula

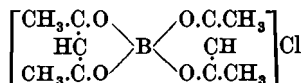

$H_3N : B(CH_3)_3$ and in boric ethopentaethylate, $(C_2H_5O)_3B : B(C_2H_5)(OC_2H_5)_4$, as shown by E. Frankland in 1876; in monophenyl boron chloride, $C_6H_5BCl_4$, as shown by A. Michaelis and P. Becker; in the pyrocatecholboric acid, $(C_6H_4O_2)_2''BH$, of J. Boeseken, and P. H. Hermans; in sodium ethyl borate, $Na.B(OC_2H_5)_4$, or $NaO.B(OC_2H_5)_3.C_2H_5$, in boron pentasulphide, B_2S_5 , prepared by H. Moissan; in M. Travers and P. C. Ray's borohydrates; and in boron oxytrichloride, $BOCl_3$, reported by C. Counciler, but shown by R. Lorenz to be more probably $B_8O_{11}Cl_2$. The existence of neither $BOCl_3$ nor of B_2S_5 has been confirmed. J. Boeseken regarded the existence of the quinquevalent boron compounds as lending support to the octet theory of valency; and to be explained on the same lines as that of the ammonium compounds, but whereas the nitrogen atom has to lose an electron in order to become quinquevalent, thereby becoming an electropositive ion, the boron atom has to gain an electron, forming an electronegative ion. In boron fluoride, BF_3 , the outer electron shell of the boron atom contains six electrons, shared in pairs with the fluorine atom. When combining with another mol. of hydrogen fluoride, the boron atom completes its octet by sharing with the new fluorine atom one of the electrons of the latter and a hydrogen electron. By taking the hydrogen electron, however, it forms the negative ion, BF_4^- , and the positive ion, H^+ . It follows that when boron is functioning as a quinquevalent atom four of its valencies are non-polar and the fifth polar, as in the case of nitrogen. Boron functions as a quadrivalent element when a normal boron compound such as BF_3 combines with a mol. containing two available electrons in the outer shell of one of its atoms, for instance, ammonia. Thus the stable compound, $BF_3.NH_3$, can be formulated as in Fig. 5, in which the boron atom appears truly quadrivalent, as does the nitrogen. A. Stock and co-workers stated that the evidence for the quinquevalency of boron is feeble and indecisive, and that the maximum valency of boron is four. He added that G. Bodländer and R. Abegg's rule that the sum of the maximum positive and negative valencies of all elements is 8, does not apply in the case of boron.

The at. wt. 11 is almost in harmony with the position of boron at the head of the third group of the periodic table, assigned to it by D. I. Mendeléeff. P. Georgievic

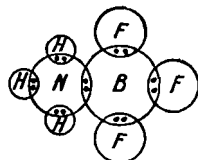

FIG. 5.—Electronic Structure of $BF_3.NH_3$.

argued that the right position of boron in the periodic table is in the aluminium group because (i) its oxide acts like aluminium oxide as a feeble base and as a feeble acid; (ii) the alkyl compounds of the two elements are similar; and (iii) the isomorphism of euclase and datolite. A. Étard placed it at the head of the vanadium group very near to phosphorus: N, P, As, Sb, Bi, . . . B, V, Nb, Ta, . . . The abnormal sp. ht. of boron made the at. wt. 11 not fit well with Dulong and Petit's rule. N. Delaunay made some observations on the at. wt. of boron with other elements.

Preliminary experiments were made by J. J. Berzelius with boric acid; and by A. Arfvedson with borax. These are so discordant with later values that they are usually omitted from calculations. Some years later, in 1822, J. J. Berzelius made determination based on three concordant measurements of the per cent. of water in borax, and from the ratio, $\text{Na}_2\text{B}_4\text{O}_7 \cdot 10\text{H}_2\text{O} : 10\text{H}_2\text{O}$, he calculated 11.08; from the same ratio, A. Laurent (1849) calculated 11.85; V. Dobrovolsky (1896), 10.87; J. L. H. Abrahall (1892), 10.70; W. Ramsay and E. Aston (1893), 10.94; and F. P. Armitage (1898), 10.99. There are special sources of error connected with the use of borax due to (i) the difficulty in ensuring complete dehydration by ignition, but, said V. Dobrovolsky, this readily can be ensured if small quantities are employed; (ii) the possibility of volatilizing both soda and boric acid during the ignition as shown by N. Leonard; (iii) the difficulty in avoiding the inclusion of some mother liquid during the crystallization of borax; and (iv) the difficulty in accurately weighing the crystals owing to efflorescence if the vap. press. of the hydrated salt is greater than that of the humidity in the atm., and to the surface condensation moisture when the humidity of the atm. is greater than the vap. press. of the crystals. R. Fresenius also wrote on this subject. The risks are illustrated by J. L. H. Abrahall who found that crystallized borax contained 47.286 per cent. of moisture, and W. Ramsay and E. Aston, 47.168 per cent.

In 1824, J. J. Berzelius transformed borax into sodium sulphate by igniting it with sulphuric and hydrofluoric acids, and, from the ratio $\text{Na}_2\text{B}_4\text{O}_7 \cdot 10\text{H}_2\text{O} : \text{Na}_2\text{SO}_4$ he calculated the at. wt. 11.0. W. Ramsay and E. Aston distilled dehydrated borax with hydrochloric acid and methyl alcohol, and from the ratios $\text{Na}_2\text{B}_4\text{O}_7 : 2\text{NaCl}$ calculated the at. wt. 10.96 and 10.97. They also converted the sodium chloride into silver chloride, and from the ratios $\text{Na}_2\text{B}_4\text{O}_7 : 2\text{NaCl} : 2\text{AgCl}$ calculated the at. wt. 11.05. E. Rimbach titrated a soln. of borax with hydrochloric acid with methyl orange as indicator, and from the ratio $\text{Na}_2\text{B}_4\text{O}_7 \cdot 10\text{H}_2\text{O} : 2\text{HCl}$ calculated the at. wt. 11.01; F. P. Armitage titrated a soln. of fused borax with sulphuric acid, and from the ratio $\text{Na}_2\text{B}_4\text{O}_7 : \text{H}_2\text{SO}_4$ obtained the at. wt. 10.94. G. P. Baxter and A. F. Scott determined the ratios $\text{BCl}_3 : 3\text{Ag}$ and $\text{BBr}_3 : 3\text{Ag}$, and obtained 10.83 ± 0.01 for the at. wt. of boron; O. Hönigschmid and L. Birckenbach obtained from the ratios $\text{BCl}_3 : 3\text{Ag}$, and $\text{BCl}_3 : 3\text{AgCl}$, 10.82.

In 1859, J. B. A. Dumas communicated the results of experiments by F. Wöhler and H. St. C. Deville on the composition of the boron halides in which the ratio $\text{BCl}_3 : 3\text{AgCl}$ give numbers corresponding with 10.62 to 11.06, and the ratio $\text{BBr}_3 : 3\text{AgBr}$, 10.96 for the at. wt. of boron; for the latter ratio, H. Gautier (1890) obtained 11.02 and 11.03, and for the ratio $\text{BCl}_3 : 3\text{AgCl}$, 10.95. J. L. H. Abrahall obtained for the ratio $\text{BBr}_3 : 3\text{Ag}$, 10.82 and 10.90. It is very difficult to prepare the boron halides quite free from hydrogen halides. H. Gautier converted boron sulphide into the sulphate, and from the ratio $\text{B}_2\text{S}_3 : 3\text{BaSO}_4$ obtained the at. wt. 11.04; H. Gautier also burnt boron carbide, and from the ratio $\text{B}_6\text{C} : \text{CO}_2$ calculated the at. wt. 11.00. A. Stock and E. Kuss measured the hydrogen evolved in the reaction $\text{B}_2\text{H}_6 + 6\text{H}_2\text{O} = 2\text{H}_3\text{BO}_3 + 6\text{H}_2$, and from the results calculated for the at. wt. of boron 10.8055 ($\text{H}=1.0077$). F. H. Loring calculated 10.77.

In 1898, T. W. Richards gave 10.95 as the best representative value for the at. wt. of boron; and in 1910, F. W. Clarke calculated the general mean to be 10.9805 ± 0.0013 , but added: "the uncertainties are so great that the final mean may be allowed to stand until better evidence as to the true at. wt. of boron is obtained." B. Brauner also wrote in 1905: "We know little more about the at.

wt. of boron than was known in 1824, that is that the at. wt. is 11.0; but we cannot say with any assurance whether the true at. wt. is greater or less than this value." The International Committee on Atomic Weights gave 11.0 for the best representative value of this constant.

The **atomic number** of boron is 5. F. W. Aston⁷ found that boron has two **isotopes** of at. wt. respectively 10 and 11, and that the evidence is against the presence of a third isotope. F. H. Loring has discussed this subject. H. V. A. Briscoe and P. L. Robinson, in some preliminary observations on the ratio $\text{BCl}_3 : 3\text{Ag}$, found for Tuscany and Asia Minor minerals the at. wt. 10.82, and for a United States mineral, 10.84 ($\text{Ag}=107.880$, $\text{Cl}=35.460$). E. Rutherford and J. Chadwick, and G. Kirsch and H. Pettersson found that long-range particles were liberated from boron when bombarded by α -rays. These were assumed to be hydrogen nuclei, resulting from the **decomposition of boron atoms**. The distribution of momentum in terms of the initial velocity of the α -particles has been measured, and it is estimated that there is a 42 per cent. gain in energy as a result of the assumed disintegration of the boron. N. V. Sidgwick discussed the **electronic structure** of the atoms.

REFERENCES.

- ¹ J. L. Gay Lussac and L. J. Thénard, *Recherches physico-chimiques*, Paris, 1. 276, 1811; *Bull. Soc. Philomath.*, (2), 1. 10, 1808; *Ann. Chim. Phys.*, (1), 68. 169, 1808; *Mém. Soc. Arceuil*, 2. 311, 1809; J. J. Berzelius, *Pogg. Ann.*, 2. 113, 1824; 34. 560, 1835; H. Davy, *Phil. Trans.*, 98. 1, 333, 1808; 99. 75, 1809; R. D. Thomson, *Phil. Mag.*, (2), 10. 419, 1831; F. Wöhler and H. St. C. Deville, *Compt. Rend.*, 43. 1088, 1856; 44. 342, 1857; 45. 888, 1857; 64. 19, 1867; A. C. Vournasos, *ib.*, 150. 464, 922, 1910; *Ann. Chim. Phys.*, (3), 52. 63, 1858; *Liebig's Ann.*, 101. 113, 347, 1857; 105. 67, 1858; 141. 268, 1867; W. Hampe, *ib.*, 183. 75, 1876; *Chem. Ztg.*, 12. 841, 1888; R. Lorenz, *Liebig's Ann.*, 247. 226, 1888; K. A. Kühne, *German Pat.*, D.R.P.P. 147871, 1902; 179403, 1904; B. Springfeldt (The British Thomson-Houston Co.), *Elektrochem. Zeit.*, 15. 8, 1908; H. Moissan, *Compt. Rend.*, 114. 319, 392, 617, 622, 1892; 116. 1087, 1893; 117. 423, 1893; *Bull. Soc. Chim.*, (3), 11. 955, 1894; *Ann. Chim. Phys.*, (7), 6. 296, 438, 1895; (7), 9. 133, 1896; (7), 18. 289, 1899; J. B. A. Dumas, *ib.*, (2), 31. 376, 1826; F. Ageno and E. Barzetti, *Atti Accad. Lincei*, (5), 19. i, 331, 1910; B. Reinitzer, *Sitzber. Akad. Wien*, 82. 736, 1880; *Monatsh.*, 1. 792, 1880; N. A. Orloff, *Chem. Ztg.*, 25. 465, 1901; L. Franck, *ib.*, 22. 236, 1898; G. Dragendorff, *Chem. Centrbl.*, (2), 8. 865, 1861; A. Geuther, *Jena Zeit.*, 2. 209, 1865; C. Winkler, *Ber.*, 23. 772, 1890; L. Gattermann, *ib.*, 22. 195, 1889; A. Stock and W. Holle, *ib.*, 41. 2099, 1908; H. Biltz, *ib.*, 41. 2634, 1908; 43. 297, 1910; A. Joly, *Compt. Rend.*, 97. 456, 1883; A. Besson and L. Fournier, *ib.*, 150. 872, 1910; A. Besson, *ib.*, 114. 771, 1892; H. Goldschmidt, *Elektrochem. Zeit.*, 4. 494, 1898; T. L. Phipson, *Proc. Roy. Soc.*, 13. 217, 1864; F. Jones, *Journ. Chem. Soc.*, 35. 41, 1879; A. Z. Hartmann, *Ueber die Elektrolyse geschmolzener Borate*, München, 1913; A. Stock and W. Holle, *Ber.*, 41. 2095, 1908; F. E. Weston and H. R. Ellis, *Trans. Faraday Soc.*, 3. 170, 1908; A. Stähler and J. J. Elbert, *Ber.*, 46. 2060, 1913; F. Meyer and R. Zappner, *ib.*, 54. B, 550, 1921; O. Hönigschmid, *Monatsh.*, 28. 1107, 1907; G. Constant and V. Raisiu, *Brit. Pat. Nos.* 162252, 162655, 1921; E. Podszus, *Zeit. anorg. Chem.*, 99. 123, 1917; A. Zschille-Hartmann, *Silikat. Zeit.*, 2. 113, 1914; J. N. Pring and W. Fielding, *Journ. Chem. Soc.*, 95. 1497, 1910; R. C. Ray, *ib.*, 105. 2162, 1914; E. Tiede and E. Birnbrauer, *Zeit. anorg. Chem.*, 87. 129, 1914; E. Tiede, *Ber.*, 46. 2229, 1913; F. Meyer and R. Zappner, *ib.*, 54. B, 550, 1921; E. Weintraub, *Trans. Amer. Electrochem. Soc.*, 16. 165, 1909; *Journ. Ind. Eng. Chem.*, 3. 299, 1911; 5. 106, 1913; *U.S. Pat. Nos.* 997879, 997880, 997881, 997882, 1911; 1019394, 1019569, 1912; *Brit. Pat. Nos.* 21667, 22334, 25978, 1906; 1197, 1907; 25033, 1910; 7103, 1911; S. G. Rawson, *Chem. News*, 58. 283, 1888; G. Gore, *ib.*, 50. 113, 1884; H. N. Warren, *ib.*, 74. 64, 1896; H. Kuzel, *German Pat.*, D.R.P. 186980, 1906; H. Gustavson, *Zeit. Chem.*, (2), 6. 421, 1870; H. C. C. Maisch, *Zur Kenntnis des Bors*, Göttingen, 1887; L. Gmelin, *Schweigger's Journ.*, 15. 245, 1824; J. W. Döbereiner, *ib.*, 16. 116, 1816; A. Pleischl, *ib.*, 25. 438, 1819; A. H. Warth, *Bull. Maryland Acad.*, 3. 3, 1923; British Thomson-Houston Co., *Brit. Pat. No.* 193894, 1921.

- ² F. Wöhler and H. St. C. Deville, *Compt. Rend.*, 43. 1088, 1856; 44. 342, 1857; 45. 888, 1857; 64. 19, 1867; H. Moissan, *ib.*, 114. 319, 392, 617, 622, 1892; 116. 1087, 1893; 117. 423, 1893; *Bull. Soc. Chim.*, (3), 11. 955, 1894; *Ann. Chim. Phys.*, (7), 6. 296, 428, 1895; (7), 9. 133, 1896; (7), 18. 289, 1899; J. I. Gay Lussac and L. J. Thénard, *Recherches physico-chimiques*, Paris, 1. 276, 1811; *Bull. Soc. Philomath.*, (2), 1. 10, 1808; *Ann. Chim. Phys.*, (1), 68. 169, 1808; *Mém. Soc. Arceuil*, 2. 311, 1809; A. Wigand, *Ann. Physik*, (4), 22. 64, 99, 1906; E. Donath and J. Mayrhofer, *Ber.*, 16. 1588, 1883; J. R. Rydberg, *Zeit. phys. Chem.*, 33. 353, 1900; F. Zantedeschi, *Giom. Fis. Chim. Ital.*, 222, 1852; H. Kopp, *Liebig's Ann. Suppl.*, 3. 1, 289, 1865; *Liebig's Ann.*, 126. 362, 1863; W. Hampe, *ib.*, 183. 75, 1876; W. G. Mixer and E. S. Dana, *ib.*, 169. 388, 1873; H. Moissan and H. Gautier, *Ann. Chim. Phys.*, (7), 7. 568, 1896; *Compt. Rend.*, 116. 924, 1893; L. Troost and P. Hautefeuille, *ib.*, 70. 185, 1870; *Bull. Soc. Chim.*, (2), 13.

213, 1870; M. Berthelot, *ib.*, (2), 12. 4, 1869; *Ann. Chim. Phys.*, (5), 15. 185, 1878; (5), 16. 442, 1879; H. V. Regnault, *ib.*, (3), 63. 5, 1861; G. Schmidt, *Sitzber. Akad. Wien*, 52. 407, 1865; A. Schrauf, *Pogg. Ann.*, 126. 177, 1865; 127. 175, 344, 1866; J. H. Gladstone, *Proc. Roy. Soc.*, 18. 49, 1870; T. W. Richards, *Journ. Amer. Chem. Soc.*, 37. 1646, 1915; C. M. Despretz, *Compt. Rend.*, 29. 545, 1849; A. Ditte, *ib.*, 70. 621, 1870; L. Troost and P. Hautefeuille, *ib.*, 73. 620, 1871; L. de Boisbaudran, *ib.*, 76. 833, 1873; *Spectres lumineux*, Paris, 1874; G. Salet, *Traité de spectroscopie*, Paris, 1888; *Ann. Chim. Phys.*, (4), 28. 5, 1873; L. Dieulafoy, *ib.*, (5), 12. 318, 1877; *Compt. Rend.*, 85. 605, 1877; A. de Gramont, *ib.*, 145. 1279, 1907; 146. 1260, 1908; M. Bidaud, *ib.*, 76. 489, 1873; 86. 387, 1878; J. C. McLennan and M. L. Clark, *Proc. Roy. Soc.*, 102. A, 389, 1922; K. Honda, *Ann. Physik*, (4), 32. 1027, 1910; F. Koref, *ib.*, (4), 86. 49, 1911; H. F. Weber, *Program. Jahresfeier Akad. Hohenheim*, 56. 1, 1874; *Pogg. Ann.*, 154. 367, 553, 1875; *Phil. Mag.*, (4), 49. 161, 276, 1875; W. A. Miller, *ib.*, (3), 27. 81, 1845; H. A. Rowland, *ib.*, (5), 86. 49, 1893; *Astron. Astrophys.*, 12. 321, 1893; H. A. Rowland and R. R. Tatnall, *Astrophys. Journ.*, 1. 14, 1895; W. J. Humphreys, *ib.*, 6. 232, 1897; H. Rose, *Pogg. Ann.*, 102. 545, 1857; J. F. W. Herschel, *Trans. Roy. Soc. Edin.*, 9. 445, 1832; J. Plücker, *Pogg. Ann.*, 104. 113, 1858; R. T. Simmler, *ib.*, 115. 242, 425, 1862; A. Mitscherlich, *ib.*, 121. 459, 1864; F. Meyer and R. Zappner, *Ber.*, 54. B, 550, 1921; R. Böttger, *Journ. prakt. Chem.*, (1), 65. 392, 1862; V. Merz, *ib.*, (1), 99. 179, 1866; H. Biltz, *Ber.*, 41. 2634, 1908; 43. 397, 1910; L. Gattermann, *ib.*, 22. 195, 1889; H. Gilm, *ib.*, 11. 712, 1878; V. Merz and W. Weith, *ib.*, 6. 1518, 1873; R. Thalén, *Upsala Univ. Årskr.*, (3), 6. 9, 1866; C. P. Smyth, *Astron. Obs. Edin.*, 13. 85, 1871; C. Horner, *Chem. News*, 29. 66, 1874; M. W. Iles, *ib.*, 35. 204, 1877; W. Weith, *Chem. Centrbl.*, (3), 7. 164, 1876; R. Capron, *Photographed Spectra*, London, 1877; G. Ciamician, *Sitzber. Akad. Wien*, 82. 425, 1880; F. Exner and E. Haschek, *ib.*, 106. 494, 1897; *Tablette der Funkenlinien*, Wien, 1902; *Tablette der Bogenlinien*, Wien, 1904; A. Hugenbach, *Wöllner's Festschrift*, 128, 1905; A. Hagenbach and H. Konen, *Atlas der Emissionsspektren*, Jena, 1905; H. Gilbert, *Zeit. angew. Chem.*, 6. 531, 1893; A. Sella, *Mem. Accad. Torino*, (2), 17. 364, 493, 1858; G. Sartorius, *Abhand. Ges. Wiss. Göttingen*, 7. 297, 1857; *Ueber der Krystallformen des Bors*, Göttingen, 1857; A. Ghira, *Gazz. Chim. Ital.*, 23. 451, 1893; H. N. Warren, *Chem. News*, 74. 64, 1996; E. Tiede and E. Birnbrauer, *Zeit. anorg. Chem.*, 87. 129, 1914; E. Weintraub, *Journ. Ind. Eng. Chem.*, 3. 299, 1911; 5. 106, 1913; W. R. Mott, *Trans. Amer. Electrochem. Soc.*, 34. 555, 1918; R. A. Millikan, *Proc. Nat. Acad. Science*, 7. 289, 1921; R. A. Millikan and I. S. Bowen, *Phys. Rev.*, (2), 23. 1, 1924; W. Guertler and M. Pirani, *Zeit. Metallkunde*, 11. 1, 1919; A. L. Hughes, *Phil. Mag.*, (6), 43. 145, 1922; O. W. Richardson and C. B. Bazzoni, *ib.*, (6), 42. 1015, 1921; J. K. Richtmyer, *Phys. Rev.*, (2), 17. 433, 1921; J. Holtsmark, *Phys. Zeit.*, 23. 252, 1922; 24. 225, 1923; E. Rutherford and J. Chadwick, *Nature*, 107. 41, 1921; J. M. Eder and E. Valenta, *Denkschr. Akad. Wien*, 60. 307, 467, 1893; O. Vogel, *Zeit. anorg. Chem.*, 5. 42, 1894; F. Jones, *Journ. Chem. Soc.*, 39. 213, 1881; W. N. Hartley, *ib.*, 43. 390, 1883; *Proc. Roy. Soc.*, 35. 301, 1883; W. Jevons, *ib.*, 91. A, 120, 1915; H. Kayser and C. Runge, *Wied. Ann.*, 48. 126, 1893; G. Kühne, *Ueber das Bandenspectrum des Bor*, Bonn, 1906; *Zeit. wiss. Phot.*, 4. 172, 1906; H. Auerbach, *ib.*, 7. 30, 41, 1909; *Spectroscopische Untersuchungen über das Verhalten der Metallsalze in Flammen von verschiedener Temperatur*, Berlin, 1907; J. H. Pott, *Observationum et animadversionum chymicarum*, Berolini, 1741; M. A. Catalan, *Anal. Soc. Espan. Fis. Quim.*, 15. 432, 438, 1917; A. H. Warth, *Bull. Maryland Acad.*, 3. 3, 1923; F. Michaud, *Compt. Rend.*, 171. 241, 1920; E. van Aubel, *Bull. Acad. Belg.*, 7. 165, 1921.

^b F. Wöhler, *Liebig's Ann.*, 105. 259, 1858; F. Wöhler and H. St. C. Deville, *Compt. Rend.*, 43. 1088, 1856; 44. 342, 1857; 45. 888, 1857; 64. 19, 1867; H. Moissan, *ib.*, 114. 319, 392, 617, 622, 1892; 116. 1087, 1893; 117. 423, 1893; *Bull. Soc. Chim.*, (3), 11. 955, 1894; *Ann. Chim. Phys.*, (7), 6. 296, 428, 1895; (7), -9. 133, 1896; (7), 18. 289, 1899; J. L. Gay Lussac and L. J. Thénard, *Recherches physico-chimiques*, Paris, 1. 276, 1811; *Bull. Soc. Philomath.*, (2), 1. 10, 1808; *Ann. Chim. Phys.*, (1), 68. 169, 1808; *Mém. Soc. Arceuil*, 2. 311, 1809; E. Davies, *Pharm. Journ.*, (3), 11. 451, 1880; W. Müller-Erbach, *Liebig's Ann.*, 218. 113, 1883; 221. 125, 1883; R. Lorenz, *ib.*, 247. 226, 1888; F. Tiemann in A. W. Hoffmann, *Bericht über die Einwirkung der chemischen Industrie*, Braunschweig, 1. 322, 1875; H. V. Regnault, *Ann. Chim. Phys.*, (3), 62. 5, 1861; *Phil. Mag.*, (4), 23. 103, 1862; H. B. Baker and H. B. Dixon, *Proc. Roy. Soc.*, 45. 1, 1889; J. J. Berzelius, *Schweigger's Journ.*, 23. 160, 1818; *Pogg. Ann.*, 2. 113, 1824; F. Ageno and E. Barzetti, *Atti Accad. Lincei*, (5), 19. i, 381, 1910; G. Dragendorff, *Chem. Centr.*, (2), 6. 865, 1861; A. Ditte, *Compt. Rend.*, 70. 621, 1870; A. Duboin and A. Gautier, *ib.*, 129. 217, 1899; L. Troost and P. Hautefeuille, *ib.*, 75. 1819, 1872; P. C. Chabrie, *Bull. Soc. Chim.*, (3), 7. 18, 1892; H. Moissan and G. Charpy, *ib.*, (3), 13. 953, 1895; *Compt. Rend.*, 120. 130, 1895; J. N. Pring and W. Fielding, *Journ. Chem. Soc.*, 95. 1497, 1909; A. B. du Jassonneix, *Ann. Chim. Phys.*, (8), 17. 145, 1909; H. Giebelhausen, *Zeit. anorg. Chem.*, 91. 251, 1915; B. Reinitzer, *Sitzber. Akad. Wien*, 32. 736, 1880; *Monatsh.*, 1. 798, 1880; E. Weintraub, *Trans. Amer. Electrochem. Soc.*, 16. 165, 1909; *Journ. Ind. Eng. Chem.*, 2. 477, 1910; 3. 299, 1913; 5. 106, 1913; P. C. Ray, *Journ. Chem. Soc.*, 105. 2162, 1914; L. Guillet, *Compt. Rend.*, 144. 1049, 1907; H. Moissan and G. Charpy, *ib.*, 120. 130, 1895; G. Hannesen, *Zeit. anorg. Chem.*, 89. 257, 1914; F. Meyer and R. Zappner, *Ber.*, 54. B, 550, 1921; H. Davy, *Phil. Trans.*, 98. 1, 333, 1808; 99. 75, 1809; F. Gautier, *Journ. Iron Steel Inst.*, 86. ii, 243, 1889.

^a G. Tammann, *Journ. prakt. Chem.*, (2), 45. 435, 1892.

^b M. W. Iles, *Amer. Chemist*, 6. 361, 1876; E. Turner, *Edin. Phil. Journ.*, 14. 124, 1826; J. W. Mellor, *A Treatise on Quantitative Inorganic Analysis*, London, 1. 576, 1913.

⁶ V. Kletzinsky, *Mitteilungen aus dem Gebiete der reinen und angewandten Chemie*, Wien, 1865; V. Dobrovolsky, *Contributions to the Chemistry of Boron and its Compounds*, Kieff, 1869; R. Lorenz, *Liebig's Ann.*, 247, 226, 1888; E. Frankland, *Proc. Roy. Soc.*, 25, 165, 1876; *Compt. Rend.*, 127, 798, 1898; A. Étard, *ib.*, 91, 637, 1880; H. Moissan, *ib.*, 115, 271, 1892; H. Copaux, *ib.*, 127, 719, 1898; N. Delauney, *Chem. News*, 97, 99, 1908; *Compt. Rend.*, 145, 1279, 1907; A. Laurent, *ib.*, 29, 7, 1849; G. D. Hinrichs, *ib.*, 130, 1712, 1900; *Monit. Scient.*, (4), 21, 733, 1907; T. Thomson, *Ann. Phil.*, 7, 245, 1824; A. Michaelis and P. Becker, *Ber.*, 13, 58, 1880; P. Georgievio, *Journ. prakt. Chem.*, (2), 38, 118, 1888; A. Arfvedson, *Schweigger's Journ.*, 38, 8, 1823; J. J. Berzelius, *ib.*, 23, 160, 1818; *Pogg. Ann.*, 2, 126, 1824; 8, 19, 1826; *Afhandl. Fysik*, 4, 1, 1815; R. Fresenius, *Zeit. anal. Chem.*, 3, 262, 1864; J. B. A. Dumas, *Ann. Chim. Phys.*, (3), 55, 181, 1859; J. L. Gay Lussac and L. J. Thénard, *ib.*, (1), 68, 169, 1808; F. Wöhler and H. St. C. Deville, *ib.*, (3), 52, 84, 1858; H. Gautier, *ib.*, (7), 18, 352, 1899; *Compt. Rend.*, 129, 678, 1899; W. Ramsay and E. Aston, *Journ. Chem. Soc.*, 63, 207, 1893; J. L. H. Abrahall, *ib.*, 61, 650, 1892; F. P. Armitage, *Proc. Chem. Soc.*, 14, 22, 1898; *Chem. News*, 77, 78, 1898; N. Leonard, *ib.*, 77, 104, 1898; O. Hönigschmid and L. Birckenbach, *Ann. Soc. Espan. Fis. Quim.*, 20, 167, 1922; *Ber.*, 56, B, 1467, 1923; J. Boeseken, *Rec. Trav. Chim. Pays-Bas*, 37, 184, 1918; *Proc. Acad. Amsterdam*, 26, 97, 1923; P. H. Hermans, *ib.*, 26, 32, 1923; H. Davy, *Phil. Trans.*, 98, 82, 1808; E. Rimbach, *Ber.*, 26, 164, 1903; F. W. Clarke, *A Recalculation of the Atomic Weights*, Washington, 255, 1910; *Phil. Mag.*, (5), 12, 101, 1881; *Amer. Chem. Journ.*, 3, 263, 1881; T. W. Richards, *ib.*, 20, 543, 1898; B. Brauner in R. Abegg, *Handbuch der anorganischen Chemie*, Leipzig, 3, 1, 5, 1906; C. Counciler, *Journ. prakt. Chem.*, (2), 18, 371, 1878; M. W. Travers and P. C. Ray, *Proc. Roy. Soc.*, 87, A, 163, 1912; A. Stock, E. Kuss, and O. Priess, *Ber.*, 47, 3115, 1914; A. Stock and E. Kuss, *ib.*, 56, B, 314, 1923; *Zeit. anorg. Chem.*, 128, 49, 1923; F. H. Loring, *Chem. News*, 125, 239, 1922; J. Schumacher, *Ueber Boronitium und Titanonitiumsalze*, Zurich, 1906; G. P. Baxter and A. F. Scott, *Science*, (2), 54, 524, 1921; *Proc. Amer. Acad.*, 59, 21, 1923.

⁷ F. W. Aston, *Nature*, 109, 468, 1920; *Phil. Mag.*, (6), 40, 628, 1920; G. P. Baxter and A. F. Scott, *Science*, (2), 54, 524, 1921; A. D. Monroe, *Journ. Chem. Soc.*, 121, 986, 1922; E. Rutherford and J. Chadwick, *Phil. Mag.*, (6), 42, 809, 1921; (6), 44, 417, 1922; F. H. Loring, *Chem. News*, 125, 239, 1922; N. V. Sidgwick, *Journ. Soc. Chem. Ind.—Chem. Ind.*, 42, 1203, 1923; G. Kirsch and H. Petersson, *Phil. Mag.*, (6), 47, 500, 1924; H. V. A. Briscoe and P. L. Robinson (private communication).

§ 4. The Borides

H. Davy¹ stated that potassium united with boron to form a grey mass of **potassium boride** which was decomposed by water into potassium hydroxide, and boron hydride; but J. L. Gay Lussac and L. J. Thénard said that only a mixture is formed in this way. H. Moissan found that the alkali metals can be distilled from boron without reaction, but by reducing boric oxide with metallic sodium he found a little **sodium boride** is formed.

H. Gieselhausen² said that amorphous boron is not dissolved and is hardly wetted by molten copper. H. N. Warren electrolyzed a molten borate with a molten copper cathode, and obtained what he regarded as a copper boride; E. H. and A. H. Cowles used a mixture of boric acid and copper as an electrically heated resistance, and they found a little boron raised the tenacity of copper without affecting its resistance. R. S. Marsden claimed to have prepared a **copper boride**, Cu_3B_2 , by heating for 3–4 hrs., to a temp. above the m.p. of copper, a mixture of the two elements in a porcelain crucible placed in a graphite crucible and packed with carbon. The reddish-yellow metallic mass was cleaned from the boron nitride. The product had the colour of iron pyrites; it is hard enough to scratch bronze but not steel or glass; it is malleable but brittle; and its sp. gr. is 8.116, that of copper being 8.921. Analysis agreed with Cu_3C_2 , or $\text{Cu} : \text{B} : \text{Cu} : \text{B} : \text{Cu}$. K. Nischk described the preparation of alloys of copper and boron; on the contrary, A. B. du Jassonneix found that boron is insoluble in copper at the temp. of the electric furnace; S. A. Tucker and H. R. Moody also failed to make a copper boride, and they added, "there does not seem to be any affinity between boron and the members of the copper group."

H. Gieselhausen said that amorphous boron is not dissolved, and hardly wetted by molten silver. Similar results were obtained by A. B. du Jassonneix with silver and boron as he obtained with copper and boron. Boron was found by H. Moissan³

to precipitate metallic silver from a soln. of silver nitrate ; and the brown precipitate obtained by P. Sabatier by passing gaseous boron hydride into a soln. of silver nitrate was found by C. Winkler to be metallic silver. H. N. Warren claimed to have made an alloy of silver with 3 per cent. of boron as **silver boride** by heating potassium borofluoride with sodium and silver in a blast flame ; and a 6 per cent. alloy by heating a mixture of boron oxide, silver, and magnesium in an iron crucible lined with carbon. The yellow regulus dissolved with difficulty in nitric acid, and was little attacked by hydrogen sulphide.

According to H. C. Geelmuyden, when a mixture of boric oxide and calcium carbide is heated for 5 mins. in an electric furnace, **calcium boride**, CaB_6 , is formed. E. Wedekind obtained a theoretical yield by heating in an iron tube under press. a mixture of 30 grms. of calcium metaborate with 50 grms. of calcium, and extracting the product first with dil. acetic acid, then with dil. hydrochloric acid, and finally with hot water. Barium borate and calcium treated in a similar manner gave a product which always contained some calcium. W. Muthmann and L. Weiss made calcium boride by heating a mixture of calcium and calcium borate at 1400° . E. Jüngst and R. Mewes made calcium boride and **barium boride**, BaB_6 , by heating the chloride or fluoride with an excess of boron in the electric furnace, and H. Moissan and P. Williams made both these borides as well as **strontium boride**, SrB_6 , by heating an intimate mixture of the alkaline earth borate, say, borate (1000 grms.), sugar charcoal (200 grms.), and aluminium (630 grms.) in a carbon crucible in an electric furnace for 7 mins. The powdered crystalline product was washed with dil. hydrochloric acid, and the residue boiled with the conc. acid, washed with water, and then with ether and toluene. The product was treated in turn with hydrofluoric acid, water, and ether until the latter was no longer coloured. The resulting boride was contaminated with a little graphite and boron carbide. A. Stock and W. Holle found the product of the action of calcium on boric oxide is calcium boride, not boron as supposed by H. Moissan. All three borides are black crystalline powders consisting of rectangular or cubic crystals which are transparent in thin layers and have a yellowish- or reddish-brown colour. H. Moissan gave for the sp. gr. of calcium boride, 2.33, strontium boride 3.28, and barium boride 4.36, all at 15° ; E. Wedekind gave 2.11 at 18° for the sp. gr. of calcium boride. The crystals scratch the ruby but not the diamond. The borides all melt in the electric furnace. E. Wedekind found that calcium boride is a conductor of electricity, and if an arc be struck between two electrodes made by compressing powdered calcium boride, the masses sinter leaving a product which cuts glass. When heated in air, calcium boride is superficially oxidized. H. Moissan found that hydrogen has no action on the boride at a red heat ; fluorine reacts in the cold with incandescence ; chlorine reacts at a red heat, forming chlorides of the constituent elements ; bromine and iodine act more slowly ; bromine water, or a mixture of potassium chlorate and hydrochloric acid, acts slowly ; the red-hot boride burns when heated to redness ; water at ordinary temp. has no action nor does it act under press. at 250° , but above this temp. a skin of boric acid and calcium hydroxide is formed ; the hydrogen halides attack the boride slowly at a red heat ; the corresponding acids have no action ; sulphur acts at a bright red heat ; dil. sulphuric acid has no action, while the conc. acid furnishes sulphur dioxide ; nitrogen at 1000° has no action ; ammonia does not act at the softening temp. of glass ; dil. and conc. nitric acid act vigorously ; oxidizing agents like lead oxide or potassium nitrate act energetically at a red heat ; and similar remarks apply to potassium carbonate, hydroxide, and hydrosulphate.

P. Lebeau⁴ claimed to have made a crystalline mass of **beryllium boride** or possibly **beryllium borocarbide**, $\text{Be}_3\text{B}_3\text{C}_2$, of sp. gr. 2.4, by melting beryllia with boron in a carbon crucible. The product was not attacked by hydrofluoric, hydrochloric, sulphuric, or nitric acid ; it was not attacked by oxygen at 20° , but there was a slight action at 800° ; and chlorine attacked it with incandescence at 450° . T. L. Phipson,⁵ and H. Moissan claimed to have made a mass containing magnesium

boride by reducing boric oxide with magnesium; the dark green mass was decomposed by water. A. Geuther made **magnesium boride**, Mg_3B_2 , by heating sodium fluoborate with magnesium; E. Jüngst and R. Mewes heated magnesium chloride in an electric furnace with an excess of boron and obtained a grey mass of the boride; F. Jones and R. L. Taylor represented the reaction between magnesium and boric oxide by $6Mg + B_2O_3 = Mg_3B_2 + 3MgO$, and the reaction between boric chloride and magnesium by $6Mg + 2BCl_3 = Mg_3B_2 + 3MgCl_2$. The product obtained by the last-named process is black and deliquescent owing to its being contaminated with some magnesium chloride. This product has much impurity; when treated with conc. hydrochloric acid, spontaneously inflammable gas is obtained, presumably derived from the presence of magnesium silicide as an impurity. A. Stock and C. Massenez made magnesium boride by heating to redness an intimate mixture of powdered boron trioxide with three times its weight of magnesium powder in a thin-walled iron crucible. The yield is reduced if the temp. is too high; if a clay or porcelain crucible be used, the product is contaminated with silicon; and a nickel crucible is more attacked by the fused mass than an iron crucible. The fusion is best conducted in an atm. free from oxygen and nitrogen. The boride is but slowly attacked by water with the formation of traces of boron hydride; it is slowly attacked by acetic acid, and rapidly attacked by a sulphuric or hydrochloric acid, forming a mixture of boron hydride gases contaminated with traces of carbon dioxide and silicon hydride; a brown residue remains undissolved, and the soln. contains derivatives of the lower boron oxides. M. W. Travers and P. C. Ray showed that probably *magnesium diboride*, MgB_2 , or Mg_2B_4 , also exists.

H. St. C. Deville⁶ made an alloy of aluminium with boron by melting the metal with borax, boric acid, or potassium fluoborate. H. N. Warren also introduced aluminium into a fused mixture of fluorspar and boric acid. In both cases the white alloy was brittle. T. S. Hunt made aluminium boride by the electrolysis of boron with fused alumina and powdered carbon. F. Wöhler and H. St. C. Deville showed that the so-called *graphitförmige Bors* is really **aluminium diboride**, AlB_2 , or Al_2B_4 , and they made it by heating a mixture of boron and aluminium, or of boric oxide and aluminium for a short time at not too high a temp.; by passing boron chloride over heated aluminium; or by melting a mixture of potassium fluoborate (8 parts), potassium and sodium chlorides (16 parts), and aluminium (5 parts) at the m.p. of silver. The excess of aluminium was removed by treatment with hydrochloric acid; sodium hydroxide; and hydrofluoric acid. F. E. Weston and H. R. Ellis reduced boron trioxide with aluminium powder by the thermite reaction, and boiled the product with hydrochloric or hydrofluoric acid, or fused it with borax and extracted it with water. A residue containing aluminium boride and alumina remained. F. Wöhler and H. St. C. Deville said the crystals of aluminium boride were six-sided plates, and W. Sartorius von Waltershausen made some observations on them. The former regarded them as identical with the monoclinic crystals measured by W. H. Miller, but it is not clear what crystals the latter really did measure. W. Hampe said that the crystals of the diboride appear as copper-red plates, and he showed that the crystalline boron prepared by F. Wöhler and H. St. C. Deville is really a mixture of **aluminium dodecaboride**, AlB_{12} , or Al_2B_{24} , and aluminium borocarbide—*q.v.* W. Hampe made it by fusing aluminium with boric oxide; by fusing aluminium with boric oxide and cryolite or fluorspar; and by passing boron fluoride over heated aluminium. The first process gave the best results, the most important condition for the success being the absence of carbon; the temp. of melting iron maintained for 2 to 3 hrs. was sufficient to produce the crystals, but the yield was larger at higher temp. According to H. Biltz, the black crystals, being specifically lighter, can be separated from those of aluminium borocarbide by flotation in a mixture of methylene iodide and benzene. A. Joly also prepared crystals of the dodecaboride, and H. Biltz made it by heating a mixture of boric oxide (250 grms.), sulphur (250 grms.), and aluminium (600 grms.). The cold product was decomposed by water, the resulting aluminium hydroxide

removed by levigation, and the globules of aluminium picked out. The mass was digested successively with conc. hydrofluoric acid, hydrofluoric acid and dil. hydrochloric acid, for many days. W. Hampe stated that the crystals are black or in very thin laminae dark red, and yield a brownish-red powder; they belong to the monoclinic system; H. Biltz gave $a : b : c = 0.7130 : 1 : 0.7139$ for the axial ratios; W. Hampe said that the sp. gr. at 17.2° is 2.5345 ; H. Biltz found 2.455 ± 0.005 at $18\frac{1}{4}^\circ$. The hardness is greater than that of corundum, and smaller than that of the diamond. According to W. Hampe, the crystals become steel-blue when heated in air, and do not change when heated in oxygen at the temp. at which the diamond easily burns; they are not attacked by hydrochloric acid; scarcely attacked by an aq. soln. of potassium hydroxide; scarcely attacked by boiling conc. sulphuric acid; gradually dissolved completely by hot conc. nitric acid—with the production of some aluminium hydroxide; oxidized with incandescence by molten potassium hydroxide, or lead chromate; not attacked by molten potassium nitrate; and slowly dissolved by molten potassium pyrosulphate. This boride forms a fusible alloy with platinum. H. Giebelhausen found that amorphous boron is not dissolved, and hardly wetted by molten thallium and no *thallium boride* has been made.

H. Moissan⁷ noticed that when boron is vaporized in the electric arc, the tips of the electrodes have black masses formed by the union of carbon and boron to form **boron carbide** or **carbon boride**, and he stated that when the two elements are heated in the electric furnace, two borides are formed—one **carbon hexaboride**, CB_6 , is stable, and the other product is alone attacked by a mixture of potassium chlorate and nitric acid. The hexaboride was found by A. Joly among the products obtained in the preparation of adamantine boron—*q.v.* H. Moissan gave three methods of preparation: (i) by passing an arc between carbon electrodes which are bound together with a mixture of boric oxide and aluminium silicate—the product was found to be contaminated with silicon carbide; (ii) by heating amorphous boron with carbon to about 3000° , either by placing the mixture directly in the arc, or by exposing it to the radiant heat of the arc in a small covered carbon crucible; and (iii) by dissolving boron and carbon in certain metals—silver or copper—in the electric furnace, and dissolving out the metal with nitric acid. H. Gautier also employed the last-named process, which is considered to be the most suitable for the purpose. S. A. Tucker and H. J. W. Bliss introduced powdered boric oxide into an arc furnace in which a layer of petroleum coke at the bottom of a carbon crucible formed one pole, and the other pole consisted of a graphite rod hung vertically. J. N. Pring and W. Fielding fitted a strip of carbon in water-cooled brass tubes filled with graphite and pieces coppered and soldered to the brass tubes. This arrangement was fitted in a large glass globe through which a mixture of boron chloride and hydrogen was allowed to circulate, when the carbon strip was at 1500° , a deposit of free boron was formed; at 1750° , boron carbide commenced to form; at 2150° , large crystalline masses of the carbide were formed; and at 2200° , the boron carbide was dispersed (not volatilized) and deposited on the water-cooled brass tubes. According to E. Podszus, at about 2000° boron nitride is converted by carbon, carbon monoxide, or hydrogen and carbon disulphide into boron carbide. J. M. Logan made the carbide by heating mixtures of boric oxide and carbon in an electric furnace; and C. E. Parsons, a mixture of borax and carbon. K. Nischk studied the formation of carbon boride, and the affinity of carbon for boron.

Carbon hexaboride is a black crystalline substance with a metallic lustre. H. Moissan gave 2.51 for the sp. gr., S. A. Tucker gave 2.7, and A. Joly, 2.542 at 17° . S. A. Tucker said that the compound is harder than silicon carbide, and H. Moissan also noted its extreme hardness. Hence, it was recommended by H. Moissan for cutting diamonds; and by S. A. Tucker for drills in rock boring; for cutting rocks and glass; grinding wheels, in wire-drawing, etc. J. N. Pring and W. Fielding gave 2350° for the m.p., and added that it does not undergo any appreciable decomposition or volatilization below 2800° . W. R. Mott said that boron carbide boils above the b.p. of carbon. S. A. Tucker and H. J. W. Bliss add that it

conducts electricity, and it has been utilized for electrodes by F. Bölling, in the construction of electric furnaces by K. G. Acheson, and for making lamp filaments by C. R. Böhm. According to H. Moissan, carbon hexaboride gives no carbon dioxide when heated in oxygen to 500° , and it burns slowly at 1000° , but more readily than the diamond, forming carbon dioxide and a black mass containing boric oxide. A. Joly found that when heated in chlorine, a residue of carbon mixed with a little aluminium and ferric chlorides is produced, and H. Moissan said that chlorine acts at 1000° without incandescence, producing boron chloride and black porous carbon. Under similar conditions, bromine and iodine have no action. Boron carbide was found by H. Moissan, and S. A. Tucker and H. J. W. Bliss, not to be attacked by any acid—indeed, the former said that boiling conc. hydrofluoric acid and nitric acid, alone or mixed, have no action, and when heated with fuming nitric acid for 4 hrs. in a sealed tube, there is but little action, and likewise also with a mixture of iodic and chromic acid; S. A. Tucker and H. J. W. Bliss found that a mixture of hot nitric acid and potassium chlorate, and boiling sulphuric acid have no action. H. Moissan, and S. A. Tucker and H. J. W. Bliss found that boron carbide is decomposed by molten potassium hydroxide with the evolution of carbon monoxide; it is also decomposed by a fused mixture of potassium and sodium carbonates.

O. Mühlhäuser claimed to have made *carbon monoboride*, CB, or C_2B_2 , by heating a mixture of boric oxide and carbon in an electric furnace. The graphite-like mass was heated in a platinum crucible for $5\frac{1}{2}$ hrs., powdered, boiled with hydrochloric acid, filtered, washed, again boiled with hydrochloric acid, and finally with a mixture of this acid and hydrofluoric acid. The black powder could scarcely be distinguished from graphite; e.g. it blackened the fingers like graphite, etc. Its analysis was represented by $B\equiv C-C\equiv B$. It behaves like H. Moissan's hexaboride towards reagents—e.g. at a higher temp. it becomes soft and melts; it burns with difficulty in oxygen; it is insoluble in nearly all the solvents; it is decomposed by fusion with alkali hydroxides or carbonates; and it is oxidized by heating it with lead chromate. Hence, added S. A. Tucker and H. J. W. Bliss, "O. Mühlhäuser actually obtained a mixture of carbide and graphite, owing to the difficulty of separating the latter; and he failed to obtain any large masses of the product because of the very high temp. necessary."

H. Moissan and A. Stock⁸ heated one part of boron and five parts of crystalline silicon for about a minute in a vessel of refractory clay by means of an alternating current of 600 amps. and 45 volts. The cooled mass was treated with a mixture of nitric and hydrofluoric acids in order to remove excess of silicon, and the crystalline portion of the residue after heating with moist potassium hydroxide was extracted with dilute nitric acid and hot water and dried at 130° . The product consisted of a mixture of two borides, SiB_3 and SiB_6 , containing about 80–90 per cent. of the latter. The hexaboride is readily oxidized by boiling nitric acid, whereas the triboride is only slowly attacked by this reagent; the latter compound, on the other hand, is decomposed by fused potassium hydroxide, whilst the former remains unchanged. **Silicon triboride**, SiB_3 , forms black, rhombic plates which, when very thin, appear yellowish-brown by transmitted light; its density is 2.52. The **silicon hexaboride**, SiB_6 , is always obtained in thick, black, opaque crystals with somewhat irregular faces; its density is 2.47. These silicon borides, like the boride and silicide of carbon, are very hard, being intermediate between the diamond and ruby in the scale of hardness; they are soluble in fused silicon and conduct electricity. When gently heated, they are decomposed by fluorine and are attacked at higher temp. by chlorine and bromine, but not by iodine or nitrogen. They become superficially oxidized by heating in air or oxygen. They are not affected by the haloid acids, but are slowly decomposed by boiling conc. sulphuric acid, and rapidly dissolved by fused potassium carbonate or by a mixture of this compound with potassium nitrate; the latter salt alone has no action on them. O. P. Watts did not succeed in making definite borides by the action of boron on silicon at a high temp.

H. Moissan obtained a diamond-hard **titanium boride** by heating the two constituents in an electric furnace. S. A. Tucker and H. R. Moody prepared

zirconium boride, Zr_3B_4 , by heating a mixture of 15 grms. of zirconium with 2.2 grms. of boron, for 5 mins. in a carbon crucible with the aid of a current of 200 amps. and 65 volts. The product was a button, blackish on the outside, brittle, and of a steel-grey colour on fracture. Under the microscope, it proved to be an agglomeration of brilliant, tabular, translucent to transparent crystals, many of these being colourless. It had a sp. gr. 3.7 and a hardness 8. It was slowly attacked by hot conc. acids and aqua regia. Boiling liquid bromine attacked it feebly. E. Wedekind obtained what he regarded as *zirconium borocarbide*, by reducing zirconia with boron in an electric furnace; black crystals separate from molten copper.

A. B. du Jassonneix⁹ found no signs of the formation of a *tin boride* when the two elements are heated in an electric furnace; and H. Giebelhausen found that amorphous boron is not dissolved and is hardly wetted by molten lead or tin. No *lead boride* has been reported. E. Wedekind and K. Fetzner obtained a micro-crystalline mass by heating an intimate mixture of thoria and boron in a magnesia crucible at a high temp. According to A. B. du Jassonneix, if a mixture of thorium oxide and boron is heated for three minutes in a carbon boat in an electric furnace, with a current of 500 amps. and 100 volts, the mixture assumes a metallic appearance, and fusion occurs only after some minutes with a current of 700 amps. The hard bronze-yellow or red product contains masses of needles, and is slightly carbonized only in the vicinity of the boat. When treated with hydrochloric acid, a gas containing hydrogen and hydrocarbons is evolved; it burns with a green flame; and leaves a residue containing the tetraboride or a mixture of tetra- and hexa-borides. The product containing not more than 10–12 per cent. of boron furnishes a yellow metallic powder of **thorium tetraboride**, ThB_4 , consisting of fragments of prismatic crystals and having a sp. gr. 7.5 at 15°. It is dissolved by cold conc. hydrochloric acid, by cold nitric acid with the formation of boric acid, or by hot sulphuric acid. Below a red heat, it is attacked by hydrogen chloride, by chlorine, or by sulphur with formation of boron and thorium sulphides, and it burns when slightly heated in contact with fluorine. The bronze-yellow to red product, containing over 12 per cent. of boron, contains a mixture of the borides from which the tetraboride is removed by extraction with conc. hydrochloric acid; the remaining **thorium hexaboride**, ThB_6 , is an amorphous, reddish-violet, metallic substance which has a sp. gr. 6.4 at 15°, is not dissolved by conc. hydrochloric, hydrofluoric, or sulphuric acid, or by aq. alkali hydroxides, but dissolves easily in hot nitric acid and burns when slightly heated in fluorine. It is attacked by chlorine and oxygen below a red heat, by hydrogen chloride at a red heat, and forms boron and thorium sulphides when heated in sulphur vapour.

Boron reacts with nitrogen, forming boron nitride (*q.v.*); and with phosphorus forming boron phosphide (*q.v.*), but borides of the arsenic family have not been made. S. A. Tucker and H. R. Moody failed to make a *bismuth boride*. H. Giebelhausen found that boron is not dissolved and is hardly wetted by molten bismuth. H. Moissan first prepared crystalline chromic boride by heating the two elements in a carbon crucible in an electric furnace. O. P. Watts also made some impure chromium borides by heating a mixture of potassium dichromate, borax, calcium carbide, fluorspar, and aluminium in an electric arc furnace. S. A. Tucker and H. R. Moody obtained **chromium monoboride**—probably CrB —by heating a mixture of 10 grms. of chromium and 2.1 grms. of boron for 6 mins. in an electric furnace—175 amps., 60 volts. A product with the same composition was made by A. B. du Jassonneix by heating a mixture of chromium sesquioxide and boron and treating the product containing 16 per cent. of boron with hydrogen chloride or chlorine; and by E. Wedekind and K. Fetzner, by heating amorphous boron with chrome thermite mixture in a fire-clay crucible. S. A. Tucker and H. R. Moody's product was green and crystalline with a sp. gr. 5; E. Wedekind and K. Fetzner's product was silvery-white and crystalline, of sp. gr. 5.4 at 17°; and A. B. du Jassonneix' product had a sp. gr. 6.1 at 15°. This boride is hard; melts with difficulty;

conducts the electric current; and is feebly ferromagnetic. It does not change when heated in air, or in oxygen at a red heat. A. B. du Jassonneix found that it reacts with cold fluorine with incandescence; sulphur converts it into sulphide; when heated with nitrogen there is only a superficial action, forming a greyish-black substance which gives ammonia when fused with potassium hydroxide; and cold hydrofluoric, hydrochloric, and sulphuric acids react. E. Wedekind and K. Fetzer said that the dil. acids have no action, and that hydrofluoric acid, a mixture of hydrofluoric and nitric acids, and a mixture of nitric and hydrochloric acids act very slowly; hot conc. sulphuric acid is reduced to sulphur dioxide; and molten potassium hydroxide, nitrate, or chlorate acts feebly, but it is decomposed vigorously by sodium dioxide, forming chromate and borate. A. B. du Jassonneix found that **chromium dinitride**, Cr_3B_2 , can be isolated from an alloy containing 11.6 per cent. of boron by the action of hydrogen chloride below a red heat, it has a sp. gr. 6.7 at 15° , burns in fluorine when gently heated, and is attacked with incandescence by chlorine below a red heat; the action of bromine is less vigorous, whilst iodine vapour has only a superficial action at a red heat. When heated in air or oxygen, it becomes covered with a vitreous layer of the borate; it is converted into a mixture of boron and chromium sulphides together with unchanged boron by the action of boiling sulphur; it is completely soluble in conc. or dil. hydrofluoric, hydrochloric, or sulphuric acid, and is oxidized with incandescence by fused alkali hydroxides or carbonates; it is not acted on by nitric acid or alkali soln., or by nitrogen at a white heat.

According to S. A. Tucker and H. R. Moody,¹⁰ **molybdenum boride**, Mo_3B_4 , is obtained by heating a mixture of the two constituent elements in an electric furnace for 20 mins. The crystalline mass has a sp. gr. 7.105; and hardness 9. It melts at a very high temp., and is not easily attacked by acids. O. P. Watts also made a soln. of molybdenum boride in a large excess of molybdenum, by heating in an electric arc furnace a mixture of molybdenite, boron oxide, and aluminium powder. H. Moissan prepared a **tungsten boride** which scratched glass by heating the two elements in an electric arc furnace, and S. A. Tucker and H. R. Moody obtained tungsten boride, probably WB_2 , by fusing a mixture of the two elements in an electric arc furnace. The silvery product contained octahedral crystals of sp. gr. 9.6, and hardness 8. It was slowly attacked by conc. acids, and vigorously by aqua regia.

L. Troost and P. Hautefeuille¹¹ prepared small violet-grey crystals of **manganese boride**, MnB_2 , by heating manganese carbide with boric oxide in a carbon crucible: $\text{Mn}_3\text{C} + 3\text{B}_2\text{O}_3 + 8\text{C} = 3\text{MnB}_2 + 9\text{CO}$. C. Matignon and R. Trannoy obtained needle-like crystals by firing according to the thermite process an intimate mixture of manganese and boric oxides, and finely powdered aluminium in a crucible lined with magnesia; and O. P. Watts obtained a mixture of the two manganese borides by a similar process. A. B. du Jassonneix said that the product always contains aluminium from which it is purified by heating it in a stream of chlorine, and washing out the chlorine successively with ice-cold water, alcohol, and ether. The sp. gr. of the greyish-black or greyish-violet crystals, according to A. B. du Jassonneix, is 6.9, and that of boride, according to E. Wedekind, is 6.04 at 19° . The last-named found this boride melts when heated on a platinum foil, and there is some oxidation. According to L. Troost and P. Hautefeuille, the heat of formation is 2.487 Cals. per gram. E. Wedekind found that the powder compressed into a block does not conduct electricity, but it is strongly magnetic, and possesses considerable permanent magnetism. According to L. Troost and P. Hautefeuille, and E. Wedekind, this manganese boride is decomposed by water at 100° ; and in the absence of water it is very stable; L. Troost and P. Hautefeuille said that the boride dissolves readily in acids with the evolution of hydrogen, while E. Wedekind said that conc. hydrochloric acid dissolves it only when heated, and that aqua regia attacks it slowly, otherwise, dil. acids, including acetic acid, dissolve the boride easily. L. Troost and P. Hautefeuille said that

hydrogen chloride attacks the boride slowly at a red heat; and that alkaline soln. dissolve it slowly below 100° . Mercuric chloride quickly converts it into manganese chloride, boric acid, and hydrochloric acid; and mercury cyanide attacks it in the presence of water. A second compound, **manganese monoboride**, MnB , was prepared by A. B. du Jassonneix by reducing manganese oxide with an excess of boron in an electric furnace, and removing the accompanying products by treatment of the powdered material at a dark red heat with chlorine, following by washing first with water, and then with alcohol. E. Wedekind made it by a similar process; and O. P. Watts, by firing a mixture of aluminium, boric oxide, and manganese dioxide according to the thermite process. A. B. du Jassonneix said that the crystalline powder has a sp. gr. of 6.2 at 15° . E. Wedekind found that it is strongly magnetic, and possesses considerable permanent magnetism. According to A. B. du Jassonneix, this boride burns in fluorine at the ordinary temp., is attacked by chlorine or bromine at a red heat, whilst the action of iodine at a high temp. is only superficial; it forms a fusible borate when heated in oxygen, is not attacked by nitrogen; it slowly decomposes, cold water forming magnetic hydroxide and boric acid; dissolves in dil. hydrochloric acid, and is attacked by hydrogen chloride or hydrogen fluoride, nitric or sulphuric acid; by the action of ammonia at 1000° , a compound is obtained which contains nitrogen, is not attacked by acids, and yields manganates and borates with evolution of ammonia on fusion with alkali carbonates. E. Wedekind found that warm conc. sulphuric acid is reduced to sulphur dioxide, and that conc. nitric acid attacks it at ordinary temp. with the evolution of red fumes.

H. Moissan¹² prepared **iron monoboride**, FeB , by the action of the vapour of boron chloride in reduced iron at a dull red heat, or by the direct union of iron and boron at 1200° in an atm. of hydrogen. If the temp. is too high, boron carbide will be formed. The product is heated with hydrochloric acid, and the residue washed successively with water, alcohol, and ether. C. Matignon and R. Trannoy prepared a mass of tough prismatic needles of iron boride by heating a mixture of ferric oxide, boric oxide, and aluminium in an electric furnace. According to H. Moissan, iron boride forms brilliant yellowish-grey crystals, sp. gr. 7.15 at 18° . Iron boride does not alter in dry air or oxygen, but in moist air it becomes covered with an ochreous layer. When heated in oxygen, it takes fire, and then burns brilliantly without further extraneous heat. In all cases, amorphous iron boride is much more readily attacked than the crystalline compound, and since the action of oxygen on the boride is greatly accelerated by the presence of moisture and carbonic anhydride, the incandescence sometimes observed during the drying of impure amorphous boron may be attributed to the presence of amorphous iron boride. It is attacked by chlorine at a red heat, with incandescence, and even more readily by bromine, with the formation of a double iron boron bromide, but iodine and hydrogen iodide have no action even at 1100° . Dil. hydrochloric acid has no action, but the hot conc. acid attacks the boride slowly. Hydrofluoric acid also attacks it slowly, whether hot or cold. The boride is attacked by sulphur and phosphorus at high temp. Potassium nitrate and potassium chlorate are without action at their m.p., but at higher temp. attack the boride with incandescence. Fused alkali carbonates and hydroxides decomposed it rapidly and completely. Conc. or dil. sulphuric has no action in the cold, but the boiling conc. acid converts it into ferrous sulphate with evolution of sulphurous anhydride. Very dil. nitric acid dissolves the boride only when hot, but the conc. acid attacks it with violence. When grey cast iron containing about 3.2 per cent. of carbon is strongly heated in a porcelain boat brasqued with boron and contained in a porcelain tube through which a current of hydrogen is passed, the boron displaces the carbon, which is reduced to 0.36-0.14 per cent., whilst at the same time the quantity of slag present in the iron is considerably reduced because the boron combines readily with the impurities. The residual iron contains 8 to 9 per cent. of boron. Similar effects are observed with white cast iron, the carbon in one case being reduced from 3.85 to 0.24 per cent., and the slag from 0.36 to 0.06 per cent. When cast iron containing 10 per cent. of boron is

added to 10 times its weight of grey cast iron fused in a forge, there is still a notable displacement of carbon, and the metal has a lamellar structure, is very hard, and resembles white cast iron in appearance.

A. B. du Jassonneix prepared two other borides by heating mixtures of iron, reduced by hydrogen, and boron in a stream of hydrogen in a porcelain tube; the one, **iron hemiboride**, Fe_2B , forms steel-grey prisms of sp. gr. 7.37 at 18° . It is oxidized by dry air at a dull red heat, but is readily attacked by moist air at ordinary temp. It is dissolved by cold conc. nitric acid, and by hot dil. nitric acid, or hot hydrochloric or sulphuric acid. The other, **iron diboride**, FeB_2 , contaminated with 2 per cent. of carbon boride, resembles cast iron, but is slightly yellow, and hard enough to scratch quartz. Its sp. gr. is 5.0 at 18° ; it is oxidized by moist air; and dissolved by hot conc. hydrochloric or nitric acid, leaving the carbon boride as a residue.

The thermal diagram of the binary system iron and boron has been investigated by G. Hannesen, and N. Tschischewsky and A. Herdt, for mixtures with up to about 12 per cent. of boron. The former found the solubility of boron in iron to be greater than did the latter. Both agree that a compound **iron pentahemiboride**, Fe_2B_5 , is formed which, according to G. Hannesen, melts at 1360° , and, according to N. Tschischewsky and A. Herdt, at 1325° . For the saturated mixed crystals, Fig. 6, the former obtained 0.25 per cent. of boron, the latter 0.08 per cent. The former gives 1165° for the eutectic, E, with 4 per cent. of boron, the latter give 1130° with 0.3 per cent. of boron. According to the former, the mixed crystals have a maximum boron content, P, of 0.8 per cent., the latter gave 3.5 per cent.; G, represents mixed crystals of iron boride with α -iron containing 0.25 per cent. of boron, according to the former, and 0.08 per cent. of boron, according to the latter. The former gave 720° for the decomposition temp., the latter gave 760° . The former gave 1400° for the transformation temp. of δ -iron into γ -iron, the latter gave 1320° . G. Hannesen alone gave a special curve for the transformation of γ -iron mixed crystals into β -iron mixed crystals. There is also evidence of the hemiboride. N. Parravano and C. Mazzetti prepared a boride by heating iron to 900° in an atm. of boron trichloride. H. W. Gillet and E. Mack studied the effect of boron on steel.

H. Giebelhausen found that boron readily dissolves in molten nickel. H. Moissan prepared **nickel boride**, NiB , and **cobalt boride**, CoB , by heating their constituents in crucibles, brasqued with boron, in an electric furnace with a current of 300 amps. and 50 volts, or in a reverberatory furnace fed with gas carbon. The product is treated with dil. nitric acid, and the borides are obtained in brilliant prisms which are often several mm. long, are magnetic, and about as hard as quartz. The sp. gr. of the nickel compound is 7.39 at 18° , and of the cobalt compound 7.25. They are attacked by chlorine at a dull red heat, by bromine at a higher temp., and by iodine at the softening temp. of glass. They are not affected by dry air or oxygen, but alter rapidly in moist air, especially in presence of carbonic anhydride. Fused alkali chlorates, nitrates, hydroxides, or carbonates dissolve and decompose them; water vapour at a dull red heat converts them into oxides and boric acid, and acids, conc. or dil., attack them with varying degrees of readiness. The nickel and cobalt borides are analogous to the iron borides previously described, and may likewise be used for introducing boron into a metal such as iron. A. B. du Jassonneix

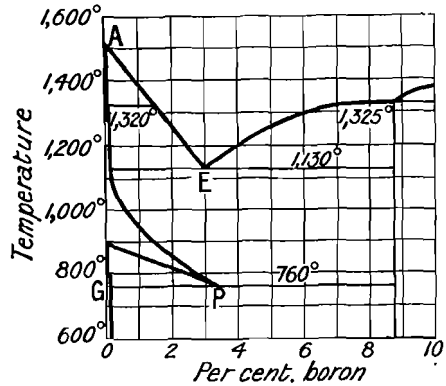

Fig. 6.—Freezing-point Curve of Mixtures of Iron and Boron.

prepared **cobalt hemiboride**, Co_2B , and **nickel hemiboride**, Ni_2B , as well as **cobalt diboride**, CoB_2 , and **nickel diboride**, NiB_2 , by methods similar to those employed with the corresponding iron compounds. A. Stock and E. Kuss obtained nickel hemiboride by the action of di- and tetra-boron hydrides on a soln. of a nickel salt. According to A. B. du Jassonneix, the product from cobalt and boron, containing about 5 per cent. of the latter, consists of an agglomeration of small, elongated, prismatic crystals; it is only very slowly attacked by hot hydrochloric acid, leaving a residue which is still less easily attacked. This consists of the boride Co_2B in the form of small, brilliant, steel-grey needles, with a sp. gr. 7.9 at 20° , which are violently attacked by nitric acid and slowly oxidized by moist air. The nickel mass, containing 5 per cent. of boron, has a microcrystalline structure, and is very slowly attacked by hot hydrochloric acid, but leaves no residue, and the compound Ni_2B is isolated by dissolving the excess of nickel electrolytically in nickel chloride soln. The boride forms small, very slender, yellow, acicular crystals, with a sp. gr. 8.0 at 20° , which are violently attacked by nitric acid and are slightly oxidized by long exposure to moist air. Borides of cobalt and nickel, containing more than 20 per cent. of boron, are more easily prepared in the electric furnace. N. Parravano and C. Mazzetti prepared a nickel boride by heating nickel to 900° in an atm. of boron trichloride,

H. Giebelhausen studied the f.p. curve of mixture of nickel with up to 20 per cent. of boron, Fig. 7. The curve has maxima at 1225° and 1160° , corresponding with the

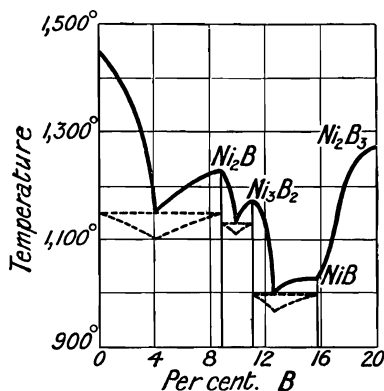

Fig. 7.—Freezing-point Curve of Mixtures of Nickel with up to 20 per cent. of Boron.

compounds Ni_2B and Ni_3B_2 respectively, the latter of which undergoes a transformation at 1050° . A compound, NiB , is indicated at about 1020° without giving a maximum. The curve then rises rapidly, suggesting a maximum at the composition Ni_2B_3 . Only the last of these compounds forms solid soln. and only the alloys containing free nickel are magnetic. The compound Ni_2B is slightly harder than quartz, whilst the compounds richer in boron are somewhat harder, but are scratched by topaz. The borides, FeB_2 , CoB_2 , and NiB_2 , represent the superior limit of the combination of boron with the respective elements.

H. V. C. Descotils¹³ fused platinum along with carbon and boric acid, and obtained what may have been a boride or a borocarbide. According to H. Moissan, when finely divided boric acid and potassium are heated in a platinum crucible, a considerable amount of platinum is taken up. F. Wöhler and H. St. C. Deville obtained a silvery-white **platinum boride** by heating platinum with boron. Cubic crystals of sp. gr. 17.32 have been found in the fused mass. The colour of the boride resembles platinum, and it can be readily ground to powder. The boride is very slowly soluble in aqua regia, and boric acid separates from the soln. Analyses by C. A. Martius agree with the formula Pt_2B_3 . J. G. Rose reported the presence of platinum in borax, but E. G. Bryant showed that the borax was contaminated with an impurity.

REFERENCES.

- ¹ H. Davy, *Phil. Trans.*, **98**, 1, 333, 1808; **99**, 75, 1809; J. L. Gay Lussac and L. J. Thénard, *Ann. Chim. Phys.*, (1), **68**, 169, 1808; H. Moissan, *Compt. Rend.*, **114**, 319, 1892.
- ² H. Giebelhausen, *Zeit. anorg. Chem.*, **91**, 251, 1915; H. N. Warren, *Chem. News*, **64**, 302, 1891; R. S. Marsden, *Journ. Chem. Soc.*, **37**, 672, 1880; E. H. and A. H. Cowles, *Amer. Journ. Science*, (3), **30**, 310, 1885; A. B. du Jassonneix, *Ann. Chim. Phys.*, (8), **17**, 145, 1909; S. A. Tucker and H. R. Moody, *Journ. Chem. Soc.*, **81**, 14, 1902; K. Nischk, *Zeit. Elektrochem.*, **29**, 373, 1923.

⁵ H. Moissan, *Bull. Soc. Chim.*, (3) 17. 1019, 1897; *Compt. Rend.*, 114. 617, 1892; H. Moissan and P. Williams, *ib.*, 125. 629, 1897; P. Sabatier, *ib.*, 112. 865, 1891; H. C. Geelmuysen, *ib.*, 130. 1026, 1900; C. Winkler, *Ber.*, 23. 780, 1890; A. Stock and W. Holle, *ib.*, 41. 2099, 1908; E. Wedekind, *ib.*, 46. 1885, 1913; H. N. Warren, *Chem. News*, 61. 231, 1890; 62. 231, 1890; H. Gieselhausen, *Zeit. anorg. Chem.*, 91. 251, 1915; E. Jungst and R. Mewes, *German Pat.*, D.R.P. 157615, 1902; W. Muthmann and L. Weiss, *Liebig's Ann.*, 355. 137, 1907.

⁶ P. Lebeau, *Compt. Rend.*, 123. 818, 1896.

⁷ T. L. Phipson, *Proc. Roy. Soc.*, 13. 217, 1864; H. Moissan, *Compt. Rend.*, 114. 392, 1892; A. Geuther, *Jena Zeit.*, 2. 209, 1865; M. W. Travers and P. C. Ray, *Proc. Roy. Soc.*, 87. A, 163, 1912; F. Jones, *Journ. Chem. Soc.*, 35. 42, 1879; F. Jones and R. L. Taylor, *ib.*, 39. 213, 1881; E. Jungst and R. Mewes, *German Pat.*, D.R.P. 157615, 1902; A. Stock and C. Massenez, *Ber.*, 45. 3539, 1912.

⁸ T. S. Hunt, *Chem. News*, 53. 64, 1886; H. N. Warren, *ib.*, 62. 51, 1890; H. St. C. Deville, *Ann. Chim. Phys.*, (3), 43. 11, 1855; F. Wöhler and H. St. C. Deville, *ib.*, (3), 52. 67, 1857; *Liebig's Ann.*, 141. 268, 1867; W. Hampe, *ib.*, 183. 75, 1876; H. Biltz, *Ber.*, 41. 2634, 1908; 42. 297, 1910; A. Joly, *Compt. Rend.*, 97. 456, 1883; W. Sartorius von Waltershausen, *Abhand. Ges. Wiss. Göttingen*, 7. 297, 1857; *Ueber des Krystallformen des Bors*, Göttingen, 1857; W. H. Miller, *Proc. Roy. Soc.*, 15. 12, 1866; H. Gieselhausen, *Zeit. anorg. Chem.*, 91. 251, 1915; F. E. Weston and H. R. Ellis, *Trans. Faraday Soc.*, 3. 170, 1907.

⁹ H. Moissan, *Le four électrique*, Paris, 1897; London, 272, 1904; *Bull. Soc. Chim.*, (3), 11. 993, 1894; *Compt. Rend.*, 117. 423, 1893; 118. 556, 1894; H. Gautier, *ib.*, 129. 595, 1899; A. Joly, *ib.*, 97. 456, 1883; S. A. Tucker and H. J. W. Bliss, *Journ. Amer. Chem. Soc.*, 28. 605, 1906; S. A. Tucker, *Brit. Pat. No. 22434*, 1907; *French Pat. No. 383182*, 1907; *U.S. Pat. No. 869114*, 1907; E. G. Acheson, *ib.*, 718891, 718892, 1903; O. Mühlhäuser, *Zeit. anorg. Chem.*, 5. 92, 1893; J. N. Pring and W. Fielding, *Journ. Chem. Soc.*, 95. 1497, 1909; F. Bölling, *German Pat.*, D.R.P.P. 173066, 188008, 1904; 183134, 183138, 1905; E. Podszus, *ib.*, 327509, 1916; W. R. Mott, *Trans. Amer. Electrochem. Soc.*, 34. 255, 1918; J. M. Logan, *Trans. Roy. Soc. Canada*, 15. iii, 58, 1921; K. Nischk, *Zeit. Elektrochem.*, 29. 373, 1923; C. R. Böhm, *Chem. Ztg.*, 31. 985, 1014, 1037, 1049, 1907; C. E. Parsons, *U.S. Pat. No. 1473510*, 1923.

¹⁰ H. Moissan and A. Stock, *Compt. Rend.*, 131. 139, 1900; H. Moissan, *ib.*, 120. 290, 1895; O. P. Watts, *An Investigation of the Borides and Silicides*, Madison, 1906; S. A. Tucker and H. R. Moody, *Journ. Chem. Soc.*, 81. 14, 1902; E. Wedekind, *Ber.*, 35. 3929, 1902.

¹¹ A. B. du Jassonneix, *Compt. Rend.*, 141. 191, 1905; 143. 897, 1149, 1906; *Bull. Soc. Chim.*, (4), 1. 250, 1907; S. A. Tucker and H. R. Moody, *Journ. Chem. Soc.*, 81. 14, 1902; H. Moissan, *Compt. Rend.*, 119. 185, 1894; O. P. Watts, *An Investigation of the Borides and the Silicides*, Madison, 1906; H. Gieselhausen, *Zeit. anorg. Chem.*, 91. 251, 1915; E. Wedekind and K. Fetzer, *Chem. Ztg.*, 29. 1032, 1905.

¹² S. A. Tucker and H. R. Moody, *Journ. Chem. Soc.*, 81. 14, 1902; A. B. du Jassonneix, *Compt. Rend.*, 143. 169, 1906; H. Moissan, *ib.*, 123. 13, 1896; O. P. Watts, *An Investigation of the Borides and the Silicides*, Madison, 1906.

¹³ L. Troost and P. Hautefeuille, *Ann. Chim. Phys.*, (5), 9. 65, 1875; *Compt. Rend.*, 81. 1263, 1875; C. Matignon and R. Trannoy, *ib.*, 141. 190, 1905; A. B. du Jassonneix, *ib.*, 139. 1209, 1904; *Bull. Soc. Chim.*, (3), 35. 102, 1906; E. Wedekind, *Zeit. Elektrochem.*, 11. 850, 1905; *Ber.*, 38. 1228, 1905; O. P. Watts, *An Investigation of the Borides and Silicides*, Madison, 1906.

¹⁴ H. Moissan, *Ann. Chim. Phys.*, (7), 9. 273, 1896; *Compt. Rend.*, 119. 1172, 1894; 120. 173, 1893; 122. 424, 1896; C. Matignon and R. Trannoy, *ib.*, 141. 190, 1905; A. B. du Jassonneix, *ib.*, 145. 121, 240, 1907; *Ann. Chim. Phys.*, (8), 17. 145, 1909; A. Stock and E. Kuss, *Ber.*, 47. 810, 1913; N. Parravano and C. Mazzetti, *Atti Accad. Lincei*, (5), 31. ii, 424, 1922; H. Gieselhausen, *Zeit. anorg. Chem.*, 91. 251, 1915; R. Ruer and F. Goerens, *Ferrum*, 14. 175, 1917; G. Hannesen, *Zeit. anorg. Chem.*, 89. 257, 1914; R. Vogel and G. Tammann, *ib.*, 123. 225, 1922; N. Tschischewsky and A. Herdt, *Iron Age*, 98. 396, 1916; *Journ. Russ. Met. Soc.*, 1. 533, 1915; H. W. Gillet and E. L. Mack, *Trans. Amer. Electrochem. Soc.*, 43. 231, 1923.

¹⁵ C. A. Martius, *Liebig's Ann.*, 109. 79, 1859; *Journ. prakt. Chem.*, (1), 77. 125, 1859; H. V. C. Descotils, *Ann. Chim. Phys.*, (1), 67. 88, 1808; E. G. Bryant, *Chem. News*, 98. 210, 1908; J. G. Rose, *ib.*, 98. 104, 1908; F. Wöhler and H. St. C. Deville, *Compt. Rend.*, 43. 1086, 1856; H. Moissan, *ib.*, 114. 320, 1892; *Ann. Chim. Phys.*, (7), 6. 296, 1895; A. B. du Jassonneix, *ib.*, (8), 17. 145, 1909.

§ 5. The Hydrides of Boron or Hydroborons

There is no evidence of the direct union of hydrogen and boron, even at 1500°, although the union can be effected by indirect means, and quite a number of boron hydrides have been prepared. In 1810, H. Davy¹ noticed that when the mass obtained in the preparation of boron by the reduction of boric oxide with potassium, is treated with water or dil. hydrochloric acid, a gas is obtained which is mainly hydrogen, but it has a disagreeable odour, and burns with a blue flame tinged with

green. He accordingly assumed that the hydrogen obtained in this way is mixed with a small quantity of a compound of hydrogen and boron. F. Wöhler and H. St. C. Deville (1858), and H. Moissan (1893) tried in vain to prepare a boron hydride by the action of dil. hydrochloric acid on aluminium boride, and by the direct union of the elements; and G. Gustavson (1870) likewise failed to make a boride of hydrogen by the action of sodium amalgam on boron trichloride at 150°, although silicon hydride can be obtained by the analogous reaction. V. C. Vournasos also obtained boruretted hydrogen by heating boric oxide with sodium and sodium formate, or with sodium formate alone. H. B. Baker and H. B. Dixon observed that boron occludes hydrogen with great tenacity.

In spite of F. Wöhler and H. St. C. Deville's failure, F. Jones (1878), and F. Jones and R. L. Taylor (1881) obtained hydrogen mixed with appreciable quantities of what was presumably boron hydride by treating magnesium boride with dil. hydrochloric acid. The results were confirmed by P. Sabatier (1891), who showed that although F. Jones and R. L. Taylor's gas contained but small traces of boron hydride, yet the amount sufficed to impart to the gas a disagreeable smell; to make the hydrogen burn with a green flame; to make the gas give a brown precipitate, soluble in nitric acid, when bubbled through a soln. of silver nitrate; to give a ring of boron when passed through a red-hot tube so that the issuing gas was free from boron; and to attack mercury, forming a brown solid. The supposed boron hydride is decomposed by treatment with potash lye, forming ordinary hydrogen with a slight increase in volume; it is also decomposed by a stream of electric sparks; by a soln. of potassium permanganate, etc. C. Winkler also obtained a similar gaseous product.

W. Ramsay and H. S. Hatfield (1901) found that F. Jones' gas could be dried by potassium hydroxide or phosphorus pentoxide, and be frozen to a white crystalline solid by cooling with liquid air. After removing the gases from the solid in vacuo, the crystals were warmed; they melted and vaporized, giving a gas with a foetid odour and density 19.36, and which burnt in air with a green flame. The gas was decomposed by electric sparks, and the products gave analytical numbers in agreement with the formula B_3H_3 , and it was called **triborene**. Further attempts to make the gas gave another one which, unlike the first, decomposed when treated with sulphuric acid, and with potassium hydroxide. The density was 18.1, and W. Ramsay and H. S. Hatfield therefore concluded that there are two isomers with the formula B_3H_3 . This has been explained by assuming that there are four different gaseous triborenes, namely, saturated and unsaturated triborene, and saturated and unsaturated **cycloborene** with trivalent boron:

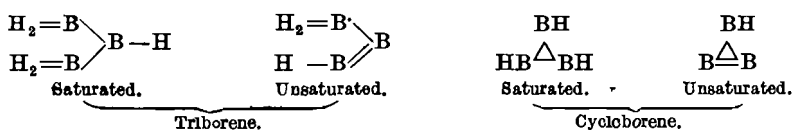

W. Ramsay and H. S. Hatfield found that, in the preparation of triborene, B_3H_3 , the exit gases consisted of a mixture of hydrogen and boron trihydride. The latter was stated to be a colourless gas with an unpleasant and characteristic odour, and which, when inhaled, produced sickness and headache. It dissolves in water, and the soln. does not change on standing; it burns with a bright green flame, forming boron trioxide; and it is decomposed into its constituents at a red heat, or by electric sparks. It gives a black precipitate with silver nitrate which contains boron and silver, and which is decomposed by hot water with the evolution of boron hydride. When boron hydride is passed into ammonia, it acquires a foetid odour, and burns with a yellow-green flame; and the characteristic smell of boron hydride reappears if the ammoniacal soln. is acidified; it unites with ammonia, furnishing a product which can be frozen to a white crystalline solid. The gas was not obtained pure, but when burnt with hot copper oxide, the analytical data correspond very nearly with **boron trihydride, BH_3** .

A. Stock and his co-workers have not been able to establish the existence of any of these compounds; although qualitative evidence makes the existence of one or more gaseous boron hydrides B_mH_n highly probable. In truth, a mixture of gaseous boron hydrides can be prepared under these conditions; but they add that the agreement of the analytical figures of W. Ramsay and H. S. Hatfield with the formula B_3H_3 appears rather as a chance coincidence.

There is also evidence of the existence of solid boron hydrides; for example, B. Reinitzer (1880) obtained a solid hydride by washing with hot water the mass obtained by fusing boric oxide with potassium under a layer of sodium chloride; C. Winkler (1889), L. Gattermann, and W. Ramsay, and H. S. Hatfield found a solid hydride, which the two former believe to be B_3H , in the residue obtained by treating magnesium boride with boiling hydrochloric acid; H. Moissan (1893) obtained a solid hydride in the preparation of F. Wöhler and H. St. C. Deville's amorphous boron by treating the crude mass with distilled water instead of with hydrochloric acid; and R. Lorenz also found that boron prepared by reducing boric acid with sodium or potassium is invariably accompanied by a solid hydride. Formulæ like B_3H ; $B_{3.3}H$, etc., have been assigned to these products, but the evidence is far from satisfactory.

A. Stock and co-workers have studied the product of the action of acids on magnesium boride very closely. They obtained ten boron hydrides. Those corresponding with the series BH_4 are called *boranes*; thus, monoborane or simply borane is BH_4 ; diborane, B_2H_6 ; etc. The corresponding univalent radicle BH_3 is called monoboryl; the radicle BO , boroil; and for the OH derivatives of the boranes the termination *ol* is used. Thus, B_2H_5OH would be *diboranol*. They found that the best yield of boron hydrides is obtained if magnesium boride be dropped, in small portions at a time, into sulphuric or hydrochloric acid not too dil.—say, two, four, or eight times normal—between 40° and 50° . The isolation of the various hydrides is complicated by the presence of silicon hydrides, and this could not well be avoided since it was not found possible to make magnesium entirely free from silicon. The gaseous products are washed with water, dried by calcium chloride and phosphorus pentoxide, and condensed as far as possible by liquid air. The crude condensate is then fractionally condensed or distilled.

The apparatus is illustrated in Fig. 8. The 4*N*-HCl is placed in a flask *A*, fitted (i) with a condenser *F* and exit tube *H*; (ii) a mercury safety valve *G*; and (iii) a coil *I* of lead tubing fed with water from the condenser. The neck of the flask *B* is fitted with a glass cylinder containing powdered boride to be gradually added to the acid in the flask *A*. The powder is continually agitated by the rotation of a metal tube fitted with lugs *ee* as shown in the diagram. The tube is joined to a rod which passes through the mercury seal *C* and is slowly rotated by the pulley *P* connected with a motor. A slow current of hydrogen passes through the tube and side-neck *D*, down the metal tube through an opening *k*, and into the flask *A*.

The powder falls through the opening *m* at a rate which can be regulated by the speed of rotation of the central rod. The flow of gas can thus be regulated by the agitator. The gas is partially freed from water vapour (i) by the condenser *F*; then passes (ii) through the small wash-bottle containing water so that the bubbles can be counted; thence through (iii) a U-tube one half of which contains calcium chloride and the other half phosphorus pentoxide. The gas then passes through (iv) a U-tube receiver fitted with stopcocks, and cooled by liquid air; 100 grms. of boride give about 70 litres of gas, from which about 95 c.c. of the hydride B_3H_{10} , and 0.02 grm. of the hydride B_2H_{12} can be obtained.

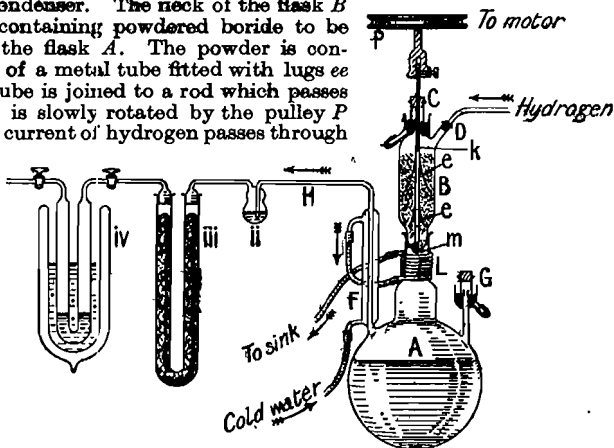

FIG. 8 — Stock's Apparatus for Preparing Boron Hydrides.

The gas then passes through (iv) a U-tube receiver fitted with stopcocks, and cooled by liquid air; 100 grms. of boride give about 70 litres of gas, from which about 95 c.c. of the hydride B_3H_{10} , and 0.02 grm. of the hydride B_2H_{12} can be obtained.

The condensed liquid readily decomposes, and it explodes when exposed to the air. The receiver is therefore fitted with another system of U-tubes, mercury gauge, and special tubes for receiving the particular fractions to be collected. The crude gas is passed through a tube cooled by liquid ammonia (between -45° and -35°) whereby white crystals of the solid $B_{10}H_{14}$ are collected; then through a large U-tube cooled by a mixture of acetone and solid carbon dioxide (between -82° and -75°) in which a little of the hydride B_4H_{10} , some silicon hydride, and much of the hydride B_5H_{12} , is condensed; and finally the main bulk of the gas is condensed with liquid air. The liquid can be freed from silicon hydride, carbon dioxide, phosphine, and hydrogen sulphide by reducing the press. to a few millimetres while the temp. is kept at about -80° . The liquid is then warmed to about 20° under a press. below 3 mm. when the more volatile hydride, B_4H_{10} , comes off. This hydride is removed by distilling the residue at -40° under a press. of about 1.5 mm., and the temp. is raised to 0° under a press. of 9 to 10 mm. The residue furnishes the decahydride B_5H_{12} when distilled, while the press. falls to 5 mm.

No diborane, B_2H_6 , was found in the crude gas; and the production of monoborane, BH_3 , or triborane, B_3H_8 , could not be established. As just indicated, **tetraboron decahydride**, B_4H_{10} , or **borobutane**, is isolated from the products of the action of an acid on magnesium boride. It is a colourless liquid gas with a disagreeable smell. A few bubbles of the gas affect the respiration, and produce a headache. The compound is rather unstable and begins to decompose at the room temp. in a few hours, forming other boron hydrides. The vap. press. of the liquid at 6° is 580 mm.; at 10° , 630 mm.; at 15° , 710 mm.; at 16° , 740 mm.; and it boils between 16° and 17° (760 mm.). The solid melts at about -112° . This compound is rapidly decomposed when heated at 100° , forming three solid hydrides, and at a higher temp. it is resolved into its elements $B_4H_{10} = 4B + 5H_2$. Even at ordinary temp. the purified gas decomposes fairly quickly into hydrogen, diborane, and less volatile hydrides. It inflames spontaneously when exposed to air or oxygen. Vapour density determinations and analyses of the gas agree with the formula B_4H_{10} . This is also consistent with the products of the action of the gas on alkali-lye, or on water or dil. hydrochloric acid. This reaction can be symbolized: $B_4H_{10} + 12H_2O = 4B(OH)_3 + 11H_2$. Conc. nitric acid causes explosion, potassium permanganate soln. is rapidly reduced; and gaseous ammonia gives a brown solid insoluble in water and possibly **diamminoborobutane**, $B_4H_{10} \cdot 2NH_3$. Assuming that boron is quadrivalent, the constitution of this compound can be represented $BH_3 \cdot BH_2 \cdot BH_2 \cdot BH_3$ —thus recalling the hydrocarbon butane, C_4H_{10} , or $CH_3 \cdot CH_2 \cdot CH_2 \cdot CH_3$.

Small quantities of **pentaboron enneahydride**, B_5H_9 , are present in the higher boiling fractions of the crude condensate, but its isolation from this source is extremely difficult, and it is more readily obtained from the products of the decomposition of tetraborane at 100° . It is a colourless, mobile, not highly refractive liquid with an extremely unpleasant odour; it is the noxious component of the crude boron hydrides. It is slowly decomposed by water, but otherwise fairly stable. A. Stock and co-workers also isolated **hexaboron decahydride**, B_6H_{10} , from the crude condensate, as a colourless, moderately highly refractive liquid which is less mobile and not so unpleasant in odour as the other boron hydrides. It decomposes slowly when preserved in daylight at the atm. temp., giving small quantities of hydrogen and diborane and mainly a yellow crystalline solid, possibly **hexacosiboron hexatriacontihydride**, $B_{26}H_{36}$.

The action of dil. acid on magnesium boride, as indicated above, furnishes a gas whose analysis and vapour density agree with the formula for **hexaboron dodecahydride**, B_6H_{12} , or **borohexylene**, but the data are not sufficiently accurate to decide definitely the exact amount of hydrogen. This hydride is a colourless highly refracting liquid with an unpleasant odour, and is spontaneously inflammable in air. The vap. press. of the liquid at -40° is about 1 mm.; at 0° , 10 mm.; at 10° , 15 mm.; and at 24° , 25 mm. The liquid boils at about 100° (760 mm.). Hexaboron hydride readily decomposes, it becomes yellow in a short time, and finally deposits a solid. It is more resistant towards water and moisture than the tetraboron hydride. In contact with alkali-lye, hexaboron hydride gives off hydrogen,

the tetraboron hydride does not. Assuming that boron is quadrivalent, the constitution of this compound can be represented $\text{BH}_3 \cdot \text{BH}_2 \cdot \text{BH} : \text{BH} \cdot \text{BH}_2 \cdot \text{BH}_3$.

When gaseous tetraboron decahydride is allowed to stand, it increases in volume and forms gaseous, liquid, and solid products of decomposition. The gaseous products are hydrogen and **diboron hexahydride**, B_2H_6 , or **borothane**, or **diborane**. A convenient method of making this hydride is to heat the tetraboron hydride for about four hours at 100° . The decomposition products are condensed by cooling in liquid air, and the fraction, pumped from the condensate and cooled between -125° and -115° in a bath of alcohol and liquid air, is the hydride in question. Diboron hexahydride is a colourless gas having a repulsive smell with a taint of the tetraboron hydride and hydrogen sulphide. The vap. press. of the liquid at -130° is 40 mm. ; at 100° , 400 mm. ; and it boils between -87° and -88° (760 mm.). The solid melts at -169° . When heated with a naked flame it forms a colourless and yellow solid boron hydride, but unlike B_4H_{10} , it forms no liquid products. The yellow solid sublimes in vacuo, and the same solid is formed by heating the tetraboron hydride, B_4H_{10} , and it probably has the composition $\text{B}_{10}\text{H}_{14}$. Analyses of the gas and vapour density determinations agree with the formula B_2H_6 ; and this is confirmed by the products of its explosion with oxygen: $\text{B}_2\text{H}_6 + 3\text{O}_2 = \text{B}_2\text{O}_3 + 3\text{H}_2\text{O}$; and the action of water: $\text{B}_2\text{H}_6 + 6\text{H}_2\text{O} = 2\text{H}_3\text{BO}_3 + 6\text{H}_2$. Assuming that boron is quadrivalent this compound may be constituted $\text{H}_3\text{B} \cdot \text{BH}_3$, thus resembling the hydrocarbon ethane, C_2H_6 , or $\text{CH}_3 \cdot \text{CH}_3$. The diboron hydride is more stable than the tetraboron hydride. It does not fire spontaneously in air unless contaminated with other boron hydrides. It reacts with alkali-lye like the tetraboron hydride. The diboron hydride is soluble in carbon disulphide, and the soln. decolorizes bromine, forming hydrogen bromide. It does not react with dry hydrogen chloride, but it forms crystalline products with ammonia. Diboron hexahydride explodes in contact with chlorine at ordinary temp. ; bromine reacts slowly in light, and the action is complete at 100° . The hydrogen is replaced by the halogen. An excess of halogen gives the simple trihalides BCl_3 and BBr_3 , and not B_2Cl_6 and B_2Br_6 . When diboron hydride was treated with about one-third of the theoretical quantity of bromine required for complete substitution, the intermediate products BHBBr_2 , BH_2Br , $\text{B}_2\text{H}_2\text{Br}_4$, B_2HBr_5 , $\text{B}_2\text{H}_4\text{Br}_2$ were not observed, but $\text{B}_2\text{H}_5\text{Br}$ and BBr_3 were obtained. Probably small quantities of other intermediate products were formed, but soon rearranged themselves to form $\text{B}_2\text{H}_5\text{Br}$ and BBr_3 as shown by the increase in the vapour density of the mixture at ordinary temp.—indeed, $\text{B}_2\text{H}_5\text{Br}$ itself decomposes into B_2H_6 and BBr_3 in a short time. The instability of these haloid substitution products is significant ; and A. Stock (1914) uses the fact that these boron hydrides, and their haloid substitution products appear to be sat. as an argument in favour of the assumption that the maximum negative valency of boron is four. **Diboron monobromohydride**, $\text{B}_2\text{H}_5\text{Br}$, is a colourless fuming gas with an irritating odour. The vap. press. of the liquid at -80° is 3 mm. ; at -40° , 53 mm. ; at -10° , 255 mm. ; and it boils at about 10° (760 mm.). It burns with a pale green flame. The monobromide reacts with water as symbolized: $\text{B}_2\text{H}_5\text{Br} + 3\text{H}_2\text{O} = \text{B}_2\text{O}_3 + \text{HBr} + 5\text{H}_2$. Like the hydrides B_2H_6 , it also reacts with alkali-lye, forming hypoborates, but it does not react appreciably with sodium. The analogous **diboron monochlorohydride**, $\text{B}_2\text{H}_5\text{Cl}$, is more volatile and less stable than the bromo-derivative ; it is a spontaneously inflammable gas.

A mixture of three solid hydrides is formed by heating B_2H_6 for 48 hrs. at 115° to 120° , or the tetraboron hydride at 100° for 4 or 5 hrs. A longer heating at a higher temp. lessens the yield. One of the three hydrides, **decaboron tetradecahydride**, $\text{B}_{10}\text{H}_{14}$, is volatile, the other two are non-volatile ; and of the latter, one is colourless, the other yellow ; the yellow non-volatile solid is insoluble in carbon disulphide, and it can therefore be separated from the colourless non-volatile solid which is soluble. This yellow non-volatile solid is insoluble in water, and probably contains about 4 atoms of hydrogen to 5 of boron— B_5H_4 . When heated it gives a number of boron hydrides poor in hydrogen, which have not been

further studied. The colourless non-volatile hydride is soluble in carbon disulphide, stable in water, and forms a yellow soln. with soda-lye. It probably contains 12 atoms of boron in the mol. It decomposes when heated, forming a liquid hydride.

The mol. wt. of the volatile solid in benzene soln. agrees with the formula $B_{10}H_{14}$. Decaboron tetradecahydride is a colourless solid with a penetrating odour. When heated in vacuo it forms long colourless needle-like crystals, of sp. gr. 0.94, which melt sharply to a clear liquid at 99.5° . It is soluble in carbon disulphide, alcohol, ether, and benzene, but is not attacked by water, for it floats in a molten condition on boiling water at 100° . Dil. soda-lye dissolves the solid hydride, forming a solid soln. It is reduced by potassium permanganate, and is slightly attacked by nitric acid. The fused mass begins to decompose at 200° , forming yellow products. The vap. does not decompose to any appreciable extent in a short time at 400° , but at 600° it decomposes into its elements boron and hydrogen. Bromine and chlorine react sluggishly with the solid decaboron hydride, $B_{10}H_{14}$, not additively, for the hydrogen is replaced by the halogen. When the solid hydride is allowed to stand in contact with an excess of bromine for about six months, the product, on evaporation, furnishes a residue with a composition ranging between $B_{10}H_{12}Br_2$ and $B_{10}H_{11}Br_3$, and the separated individuals were isolated by fractional crystallization from a mixture of benzene and light petroleum. The alkaline soln. of these bromo-derivatives, when acidified, yields tetraboron decahydride, B_4H_{10} . Both the acidic and alkaline soln. reduced potassium permanganate; the former gradually evolves tetraboron and other hydrides which have not been identified.

The di- and tetraboron hydrides, B_2H_6 and B_4H_{10} , dissolve in sodium hydroxide, forming soln. which contain hypoborates, and which gradually decompose, forming borates. A. Stock and E. Kuss (1914) conclude that the first stage of the reaction is in accord with the equation: $B_4H_{10} + 4NaOH = H_2 + 4NaOBH_3$; and the second stage $B_4H_{10} + 4NaOH + 4H_2O = 4NaBO_2 + 11H_2$. The last-named reaction occurs rapidly when the soln. is warmed. Potassium hypoborate, $KOBH_3$, was obtained in octahedral, colourless, deliquescent crystals by treating a soln. of potassium hydroxide with an excess of tetraboron hydride at 0° . In the presence of moisture, the hypoborates decompose at room temp. in accord with the equation: $2KOBH_3 + 2H_2O = 2KBO_2 + 5H_2$. The hypoborates are strong reducing agents, stronger indeed than hypophosphites and give precipitates with most salts, but insoluble hypoborates have not yet been prepared. With copper salts, copper hydride is formed, and with nickel salts an insoluble black nickel boride, Ni_2B . Potassium hypoborate dissolves in alcohol with partial decomposition. At 500° , it partially decomposes into potassium, hydrogen, water, etc.: $10KOBH_3 = 2K_3B_5O_3 + 4K + 4H_2O + 11H_2$. The resulting $K_3B_5O_3$ is hygroscopic. The aq. soln. has an alkaline reaction; slowly decolorizes potassium permanganate; and gives a yellowish-brown coloration to warm nitric acid. With sulphuric acid, it gives hydrogen and boron hydrides. The aq. soln. obtained by treating magnesium boride with water has properties similar to that of a soln. of $K_3B_5O_3$. Sodium hypoborate resembles the potassium salt; magnesium hypoborate could not be isolated from soln. The failure to obtain a boron hydride with a single boron atom, analogous with the boron trihalides, and with the boron alkyls, $B(CH_3)_3$, etc., is significant. Triphenylmethyl, $C(C_6H_5)_3$, has been reported, but no carbon trihydride CH_3 is known, hence, the fact that $B(CH_3)_3$ is known does not definitely prove that BH_3 can likewise exist. The failure may be due to our ignorance of the right conditions for its preparation, or because BH_3 is so very unstable that if it were momentarily formed, it would immediately polymerize to B_2H_6 , just as E. Frankland (1862) found that boron ethyl above 149° has a vapour density in agreement with the formula $B(C_2H_5)_2$, but below 101.6° , there are signs of a polymerization to $B_2(C_2H_5)_6$.

A. Stock emphasized the peculiarities shown by the boron hydrides in furnishing formulæ which are not explained by simple and constant valencies; the great affinity of boron for oxygen which is shown by the ready decomposition of the hydrides by water; the inclination of the molecules to polymerize to form hydrides.

of high mol. wt., and non-volatile oxides and nitrides; and the instability of compounds containing positive and negative radicles—e.g. the compound B_2H_5Cl decomposes into a hydride and a chloride. A. Stock considered that in B_2H_6 , B_4H_{10} , B_6H_{12} , $B_{10}H_{14}$ the boron is quadrivalent. M. L. Maurice assumed that the double-bonded atoms of boron have a greater tendency to form and maintain complexes than carbon atoms, and that the residual affinity of this double-bond is strong enough to hold hydrogen atoms, but is incapable of holding larger atomic nuclei. He then proposed a structural formula for B_2H_6 analogous to ethylene; one for B_4H_{10} analogous to butylene; one for B_6H_{12} analogous to benzene; and one for $B_{10}H_{14}$ analogous to naphthalene.

REFERENCES.

¹ H. Davy, *Phil. Trans.*, **99**, 85, 1809; F. Wöhler and H. St. C. Deville, *Ann. Chim. Phys.*, (3), **52**, 88, 1858; G. Gustavson, *Zeit. Chem. Phys. Math.*, (2), **6**, 522, 1870; F. Jones, *Chem. News*, **38**, 262, 1878; *Journ. Chem. Soc.*, **35**, 41, 1879; F. Jones and R. L. Taylor, *ib.*, **39**, 213, 1881; W. Ramsay and H. S. Hatfield, *Proc. Chem. Soc.*, **17**, 152, 1901; R. Lorenz, *Liébig's Ann.*, **247**, 246, 1888; P. Sabatier, *Compt. Rend.*, **112**, 865, 1891; V. C. Vournasos, *ib.*, **150**, 464, 922, 1910; H. Moissan and P. Williams, *ib.*, **125**, 629, 1897; H. Moissan, *ib.*, **117**, 423, 1893; *Ann. Chim. Phys.*, (7), **6**, 296, 1895; B. Reinitzer, *Monatsh.*, **1**, 792, 1880; *Sitzber. Akad. Wien*, **82**, 736, 1881; H. B. Baker and H. B. Dixon, *Proc. Roy. Soc.*, **45**, 1, 1888; M. L. Huggins, *Journ. Phys. Chem.*, **26**, 833, 1922; L. Gattermann, *Ber.*, **22**, 195, 1889; C. Winkler, *ib.*, **23**, 772, 1890; A. Stock and C. Massenez, *ib.*, **45**, 3539, 1912; A. Stock and K. Frederici, *ib.*, **46**, 1959, 1913; A. Stock, K. Frederici, and O. Friess, *ib.*, **46**, 3353, 1913; A. Stock and K. Kuss, *ib.*, **47**, 810, 1913; **50**, B, 789, 1923; A. Stock, E. Kuss, and O. Friess, *ib.*, **47**, 3115, 1914; A. Stock, *ib.*, **39**, 108, 1917; **54**, A, 142, 1921; *Zeit. angew. Chem.*, **35**, 341, 1922.

§ 6. Boron Oxides

The behaviour of boron towards oxygen has already been discussed. C. Winkler¹ believed that only one oxide is formed, namely, boron trioxide, B_2O_3 . The evidence in favour of the existence of a boron suboxide, previously discussed, is not satisfactory. A. Stock and E. Kuss prepared a class of salts which they call *hypoborates*—vide boron hydrides. M. W. Travers and co-workers believe that they have established the independent existence of a tetraboron trioxide, B_4O_3 ; of acidic diboron dioxide, B_2O_2 ; and of tetraboron pentoxide, B_4O_5 ; in addition to the ordinary boric oxide, B_2O_3 , but the products they obtained were very impure.

Boron dioxide, B_2O_2 , has not been isolated in a pure state. It was prepared by decomposing crude magnesium boride with cold water and the soln. evaporated to dryness in vacuo and heating. The residue is a mixture of dioxide with the magnesium salt magnesium borite, $MgO \cdot 2\frac{1}{2}B_2O_2$, or MgB_4O_5 . Boron dioxide is obtained free from magnesium borite, but contaminated with about 5 per cent. of a lower oxide, $B_4O_3 \cdot 2H_2O$, by treating the aq. soln. of magnesium boride with ammonia, and evaporating the filtered soln. The product is soluble in water, and the aq. soln. is oxidized to boric oxide, by evaporating it in air, or by heating it with nitric acid, but is not oxidized by iodine. The lowering of the f.p. of aq. soln. corresponds with the formula B_2O_2 . The oxide seems to combine with water to form an acid, which dissolves freshly precipitated magnesium hydroxide to form magnesium borite. Attempts to make ammonium borite were not satisfactory.

As already indicated, an impure dihydrated tetraboron trioxide, $B_4O_3 \cdot 2H_2O$, has been obtained from the product of the action of water on magnesium boride; it is soluble in nitric acid with the formation of boric acid. When dried at 100° , analyses correspond with the formula just indicated. When magnesium diboro-hexahydroxide, $Mg_3B_2(OH)_6$, is treated with conc. ammonia for several days in an atm. of hydrogen, filtered, evaporated to dryness in vacuo, and heated, a pale brown tetraboron pentoxide, B_4O_5 , is formed.

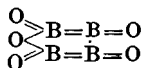

It does not fuse at the softening temp. of Jena glass. If allowed to stand in contact with water in vacuo, a yellow soln. is obtained, which oxidizes rapidly in air, forming a flocculent yellow residue containing tetraboron trioxide : $3B_4O_5 + 2H_2O = B_4O_3 \cdot 2H_2O + 4B_2O_3$.

M. W. Travers and co-workers showed that when crude magnesium boride is treated with water **magnesium diborohexahydroxide**, $Mg_3B_2(OH)_6$, is formed : $Mg_3B_2 + 6H_2O = 3H_2 + Mg_3B_2(OH)_6$, which remains as a white insoluble powder. It appears to be a derivative of $H_3B_2(OH)_6$, and, by analogy with the carbohydrates, is regarded as one member of a series of **borohydrates**. When treated with conc. ammonia in an atm. of hydrogen, it is assumed that the soluble product of the reaction is a diammonium derivative of $BH_2(OH)_2 \cdot BH(OH) \cdot BH(OH) \cdot BH_2(OH)_2$; and that when this product is acidified it loses four atoms of hydrogen, and forms $BH(OH)_2 \cdot B(OH) \cdot B(OH) \cdot BH(OH)_2$, which loses more hydrogen when treated with iodine, forming two mols of hydrogen iodine and $B(OH)_2 \cdot B(OH) \cdot B(OH) \cdot B(OH)_2$. When the ammoniacal soln. is evaporated in vacuo, and heated, tetraboron pentoxide is formed : $BH_2(OH)_2 \cdot BH(OH) \cdot BH(OH) \cdot BH_2(OH)_2 = 5H_2 + H_2O + B_4O_5$.

The soln. obtained by the action of water on magnesium boride is yellow because it contains colloidal boron; it decomposes slowly at ordinary temp. with the evolution of hydrogen, and the decomposition is accelerated if platinum black be present; it precipitates silver and mercury from their salts; it precipitates amorphous boron or copper hydride from copper salts; and when acidified, it gives off hydrogen with brisk effervescence and the liquid so obtained decolorizes iodine. The soln. is supposed to contain a very small proportion of borohydrates or allied compounds which are produced by unknown side reactions in the action of water on magnesium boride.

M. W. Travers and co-workers assume that the soln. contains two compounds with quinquivalent boron, and with the formulæ $H_5B_2O_2$ and $H_5B_2O_3Mg$; and that the latter is a magnesium derivative of $H_5B_2O_3$. The graphic formulæ are based on the assumption that the evolution of hydrogen is due to the elimination of pairs of hydrogen atoms attached directly to atoms of boron :



When treated with acids, these compounds furnish respectively

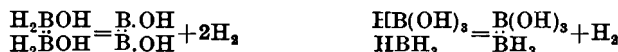

The compound $HO \cdot B \cdot B \cdot OH$ has a structure analogous with that of hyponitrous acid. The two products are oxidized by iodine to boron dioxide, B_2O_2 :



When the soln. obtained by the action of water on magnesium boride is treated with ammonia, magnesium hydroxide is precipitated. When the **magnesium borohydrate**, $MgH_6B_2O_3$, or possibly $MgH_4B_2O_2 \cdot H_2O$, is treated with ammonia, the new product, when acidified, gives twice as much hydrogen as before. It is assumed that intramolecular change occurs as an intermediate stage of the reaction :

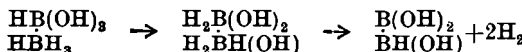

The product is oxidized by iodine to boron dioxide, B_2O_2 ; *i.e.* $O : B : B : O$, or

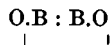

P. C. Ray isolated **potassium borohydrate**, $(KO)_2B_2H_4$, from the soln. obtained

by the action of water on magnesium boride. It is also formed when magnesium boride is treated with a dil. soln. of potassium hydroxide. Conductivity determinations show that it is the salt of a dibasic acid. The action of iodine on acidified soln. is represented: $H_4B_2(OK)_2 + 2H_2SO_4 = 2KHSO_4 + 2H_2 + B_2(OH)_2$; and $B_2(OH)_2 + I_2 = B_2O_2 + 2HI$. The constitution of the salt is represented by

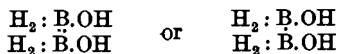

according as boron is quinque- or quadri-valent. The salt is fairly stable in the absence of moisture and carbon dioxide; it is a powerful reducing agent; and is highly soluble in water. The salt loses four atoms of hydrogen when treated with an acid, forming **diboron dihydroxide**, $HO.B : B.OH$.

REFERENCES.

¹ C. Winkler, *Ber.*, 23, 790, 1890; A. Stock and E. Kuss, *ib.*, 47, 810, 1914; M. W. Travers, N. M. Gupta, and P. C. Ray, *Some Compounds of Boron, Oxygen, and Hydrogen*, London, 1916; *Journ. Indian Inst. Science*, 1, 1, 1914; M. W. Travers and P. C. Ray, *ib.*, 1, 1914; *Proc. Roy. Soc.*, 87, A, 163, 1912; P. C. Ray, *Journ. Chem. Soc.*, 105, 2162, 1914; 121, 1088, 1922.

§ 7. Boron Trioxide, Boric Oxide, or Boric Anhydride

Boric oxide is formed when H. Moissan's boron is heated in air or oxygen, or in nitric oxide; the same oxide is formed in the combustion of boron hydride; and when boron is employed as a reducing agent with the dioxides of carbon, silicon, titanium, or zirconium. H. Henstock discussed its electronic structure.

The usual method of making boron trioxide is to melt boric acid in a platinum or Hessian crucible until all is tranquil, showing that the water has been expelled. The molten mass is poured on to a cold slab. The resulting boron trioxide, called *vitreous or glassy boric acid*, is preserved in well-stoppered bottles. A. Atterberg¹ and others have also described its preparation by heating the hydrate. According to P. G. Robiquet, the product still retains 0.225 per cent. of water, which he said can be removed only by ignition with cupric oxide. R. Lorenz also made observations on the rapidity with which water is absorbed by boric oxide. If one portion of the clear glass is rapidly powdered in a hot mortar, and the powder is immediately heated in a small dried test-tube, it melts with bubbles under conditions where a piece not powdered melts without bubbling. This does not necessarily prove, as R. Lorenz supposes, that water is so rapidly imbibed by the powder, but rather, in melting, a skin is formed over the surface of the powder before the air entangled in the powder has escaped. R. Lorenz added that the fused oxide is so strongly hygroscopic that it can take up 1.9 per cent. of water during one minute's trituration in a hot mortar.

Boric oxide so formed is a colourless, transparent glass which is hard and brittle. H. Davy² said that it has no smell, and that it has a slightly bitter, not an acid taste. The **specific gravity** of boric oxide was given by A. Royer and J. B. A. Dumas as 1.83 at 4° in vacuo; G. Quincke gave 1.83 at 0° and 1.75 at 1300°; P. A. Favre and C. A. Valson gave 1.825 at 216°; A. Ditte gave 1.8766 at 0°; 1.8476 at 12°; and 1.6988 at 80°; P. P. Bedson and W. C. Williams gave 1.848 at 14.4°, and 1.853 at 15.8°. K. Arndt and A. Gessler found the sp. gr. at 900° to be 1.520; at 1000°, 1.508; and at 1100°, 1.495. V. de Luynes said the **hardness** of the glass is great; it scratches glass and is scarcely affected by quartz. K. Arndt found the **viscosity** of boric oxide to be 118.0 at 900° and 40.0 at 1100° (water at 20° = 0.01). G. Quincke stated that its **surface tension** in air at 1700° is 847 dynes per cm., and its **specific cohesion** is $a^2 = 9.865$ sq. mm.

According to A. Ditte, the coeff. of **thermal expansion** is 0.001308 between

12° and 80°. G. Quincke gave 1300° for the **melting point**, and T. Carnelley gave 577° approximately. The truth is that the glass has no m.p.; it is a congealed liquid which has never solidified, but has become as viscid that it appears even harder than many crystalline compounds—*vide* l. 9, 6. The hardness of the glass can be readily augmented by quick cooling; and if the molten glass be poured on a cold metal plate, the lower face contracts faster than the upper face, which is more slowly cooled. In consequence, the plate is bent and it finally shivers into fragments. According to J. B. A. Dumas, when the molten oxide is cooled in a platinum crucible it cracks spontaneously and glows along the cracks with a light which is visible even in daylight. C. L. Bloxam said that boric oxide is slightly volatile at a bright red heat; F. Wöhler and H. St. C. Deville, that it volatilizes at the m.p. of nickel, or, according to J. J. Ebelmen, at the highest temp. of a porcelain oven; and H. Moissan found that it readily volatilizes in the electric furnace. W. R. Mott gave 1500° for the **boiling point** of boric oxide at 760 mm. H. von Wartenberg and O. Bosse found that at 1501° and 138 mm. boric oxide did not boil, and that the molten mass had the viscosity of olive oil; they could not measure the **vapour pressure** of boric oxide at 1536°–1546°. The **specific heat** was found by H. V. Regnault to be 0.2574 between 16° and 98°. M. Berthelot gave for the **heat of formation**, $B + \frac{1}{2}O_3 = \frac{1}{2}B_2O_3 + 156,300$ cals., and L. Troost and P. Hautefeuille gave 317.2 Cals. for the mol. heat of formation. The former also gave for the **heat of hydration**, $B_2O_3 + 3H_2O + 400H_2O$ at 13.5° = -9.62 Cals. P. A. Favre and C. A. Valsen gave 122.731 Cals. per eq. of B_2O_3 .

According to V. de Luynes, molten boric oxide acts strongly on polarized light, P. P. Bedson and W. C. Williams found that a prism of boric acid with the *D*-line had an **index of refraction** 1.46303 and sp. gr. 1.848 at 14.4°; and another at 15.8° had an index of refraction 1.46427 and sp. gr. 1.853. The index of refraction of soln. of sp. gr. 1.0111 at 20° with 1.93 per cent. of B_2O_3 was 1.0096 at 20° with a 1.68 per cent. soln. According to E. Tiede and co-workers, if boric acid is dehydrated either in the air or in a vacuum over phosphoric oxide, either slowly at 300° or quickly at red heat, it exhibits a **phosphorescence**, the intensity of which reaches a maximum with a certain, minute proportion of water still present, but disappears as full dehydration is attained. The exceptionally bright light emitted does not continue for long, and may be excited by an arc or mercury lamp, but not by cathode X-rays, radium rays, or by heat. E. Tiede and P. Wulff found that the phosphorescence of partly dehydrated boric acid originates from traces of organic compounds, and is removable, not by recrystallization, ignition in a stream of oxygen, boiling with nitric acid, or fusion with potassium nitrate, but by boiling with fuming nitric acid for twenty-four hours, subsequently recrystallizing three times from water specially purified, and finally igniting the upper portion of the filtered mass (which had not been in contact with filter-paper) in a platinum crucible. Phosphorescence would not be induced in such a product by any means other than by introduction of organic impurities. For this purpose, even those present in ordinary distilled water suffice. It is presumed that the phosphorescence emanates from definite organic derivatives of boric acid. Boric acid phosphorescent compounds were studied by R. Tomaschek. E. H. Nichols and D. T. Wilber found boric oxide showed a dim flame **luminescence**.

According to H. Davy, moist boric acid conducts electricity; but, according to M. Faraday, the acid, fused in the oxy-hydrogen blowpipe, "gained no conducting powers sufficient to affect the galvanometer, and it underwent no apparent voltaic decomposition"; A. Connell also confirmed this observation. M. Lapschin and M. Tichanewitsch also found that molten boric oxide did not conduct a current at 950 volts; and W. Hampe, and L. Bleekrode also classed boric oxide acid as a bad conductor. H. Moissan said that the presence of 20 per cent. of borax makes the acid a conductor. G. Meslin found that boric oxide is diamagnetic.

E. Davy, and J. L. Gay Lussac and L. J. Thénard made rough analyses of boric oxide. J. J. Berzelius' analyses were originally interpreted on the

assumption that the at. wt. of boron corresponded with the oxide BO_6 (oxygen 8), later, the at. wt. was halved, and J. J. Berzelius, A. Payen, and E. Soubeiran wrote the formula BO_3 ; when the at. wt. of oxygen was doubled, this became B_2O_3 . The tribasicity of ordinary boric acid, orthoboric acid, has been established by the formation of the esters trimethylborate, $\text{B}(\text{OCH}_3)_3$, and triethylborate, $\text{B}(\text{OC}_2\text{H}_5)_3$, by J. J. Ebelmen and M. Bouquet; of methyl difluoroborate, $\text{BF}_2(\text{OCH}_3)$, and ethoxy difluoroborate, $\text{BF}_2(\text{OC}_2\text{H}_5)$ by V. Gasselin; and of a number of metal borates by J. J. Ebelmen, L. Ouvrard, etc. M. Prokofieff also emphasized the analogy between the formula of boric acid and of the methyl esters. O. Hehner supposed boric acid to be constituted $\text{H}_4\text{B}_4\text{O}_8 \cdot \text{H}_2\text{O}$. E. Beckmann found the mol. wt. of boric oxide in boiling sulphuric acid to correspond with the value calculated for B_2O_3 .

According to J. E. Myers, when boron trioxide is placed in water, even if it be in a finely ground condition, it does not dissolve immediately. After the trioxide has been in contact with water for a minute or two, a reaction takes place quite suddenly, and is marked by a notable change in the vol. of the solid. The solid produced dissolves fairly quickly in water. The phenomenon is best observed by exposing the substance to a moist atm. when there is a gradual and easily observed change from the hard glassy material to a light powdery substance. The boron trioxide is hydrated to metaboric acid, HBO_2 , and orthoboric acid, H_3BO_3 . J. E. Myers studied the velocity of hydration of boron trioxide, and found the reaction occurs in at least two stages, the first yielding metaboric acid and on further hydration orthoboric acid. The hydration to metaboric acid is a unimolecular reaction and much faster than the further reaction. The dehydration of orthoboric acid at 100° is a unimolecular reaction resulting in the formation of metaboric acid. At a higher temp. the reaction becomes more complicated, probably on account of the formation of mol. complexes of metaboric acid. According to A. Ditte, during the dissolution of boric oxide in water, so much heat is evolved that the temp. can be raised to the b.p., and P. A. Favre and C. A. Valson found that the dissolution is attended by a contraction of 16.2 c.c. per eq. B_2O_3 . The aq. soln. colours litmus a faint red, and in the presence of mineral acids, turmeric paper becomes reddish-brown; if the dried paper is dipped in a dil. soln. of potassium hydroxide, K. Kraut showed that a blue colour is developed. According to L. Kahlenberg and O. Schreiner, boric oxide, B_2O_3 , immediately forms boric acid, H_3BO_3 , when dissolved in water, but O. Hehner thinks that the behaviour of the aq. soln. towards turmeric shows that it dissolves as B_2O_3 and not as H_3BO_3 , because the aq. soln. colours turmeric paper a pale rose colour, but the colour becomes intense if a trace of mineral acid is present, and turmeric paper sat. with a soln. of boric acid becomes red on exposure to air.

Boric oxide was found by H. Moissan³ to react at ordinary temp. with **fluorine** very energetically and with *une vive incandescence de brillantes étincelles*, forming boron fluoride and oxygen. L. Gmelin found that while **bromine** and **chlorine** do not act on heated boric oxide, if the latter be mixed with carbon, the corresponding boron halide and carbon monoxide are formed. J. Inglis obtained an analogous result with **iodine**. J. J. Berzelius found that **hydrofluoric acid** converts boric oxide into the fluoride; G. Gore also obtained a similar result with liquid **hydrogen fluoride**, but not with liquid **hydrogen chloride**. J. Nickless studied the action of **hydrogen bromide** and of hydrogen chloride on an alcohol soln. of boric oxide. According to H. St. C. Deville and H. Caron, when boric oxide is heated with **metal fluorides**, boron fluoride and crystals of the oxide are formed. When boric oxide mixed with silica-free **calcium fluoride**, with or without sulphuric acid, is heated to whiteness, J. L. Gay Lussac and L. J. Thénard observed the formation of boron fluoride and calcium borate. The reaction has also been studied by J. Davy, G. Ferrari, and S. G. Rawson. L. Ouvrard studied the action of the oxides of calcium, strontium, barium, magnesium, zinc, cadmium, manganese, and nickel on a mixture of boron oxide and **potassium hydrofluoride**. J. L. Gay Lussac and L. J. Thénard said that **chlorides** do not decompose boric oxide at a white heat,

but H. le Chatelier obtained *calcium chloroborate*, $3\text{CaO} \cdot \text{B}_2\text{O}_3 \cdot \text{CaCl}_2$, by adding calcium oxide and boric oxide to molten **calcium chloride**; and L. Ouvrard made observations on this subject. A. J. Balard found that boric oxide does not decompose **potassium bromide** at a red heat, but if moisture be present, hydrogen bromide and potassium borate are formed. L. Ouvrard made needle-like crystals of *calcium bromoborate*, $3\text{CaO} \cdot 5\text{B}_2\text{O}_3 \cdot \text{CaBr}_2$, by melting boric oxide with **calcium bromide**. H. Schulze found boric oxide to be without action on **potassium iodide**, but if air be present, C. F. Schönbein found that the iodide is decomposed at its m.p. L. Ouvrard did not succeed in making *calcium iodoborate* analogous with the corresponding chloro- and bromo-salts, by melting boric oxide with **calcium iodide**.

According to J. F. A. Götting, when a mixture of **sulphur** with boric oxide burns, the flame is tinted green. According to L. Gmelin, and E. Frémy, **carbon disulphide** attacks a heated mixture of boric oxide and carbon, forming carbon monoxide and boron sulphide. H. Prinz found that **sulphur monochloride**, S_2Cl_2 , is without action on boric oxide. R. F. d'Arcy observed no signs of a reaction with **sulphur trioxide**, but A. Pictet and G. Karl said that two compounds are formed, $\text{B}_2\text{O}_3 \cdot \text{SO}_3$ and $\text{B}_2\text{O}_3 \cdot 2\text{SO}_3$. According to L. Gmelin, H. Schiff, and G. Merz, boric oxide dissolves copiously in **sulphuric acid**, especially at an elevated temp., and furnishes a viscid mass from which water precipitates boric oxide. J. J. Berzelius found that selenium dioxide is expelled from **selenites** when they are heated with boric oxide.

When boric oxide is heated in a stream of **ammonia**, L. Möser and W. Eidmann found that boron nitride, BN, is formed: $\text{B}_2\text{O}_3 + 2\text{NH}_3 = 2\text{BN} + 3\text{H}_2\text{O}$; likewise also, according to H. Rose, with a mixture of boric oxide and **ammonium chloride**. L. Gmelin found that red-hot barium borate is not attacked by the vapour of **phosphorus**. G. Gustavson found that no action occurs when boric oxide is heated for two weeks at 200° with **phosphorus trichloride**; while boron oxychloride and boron trichloride are formed with **phosphorus pentachloride**; and the double chloride, $\text{POCl}_3 \cdot \text{BCl}_3$, is formed if **phosphoryl chloride**, POCl_3 , is used; with **phosphorus pentabromide**, boron tribromide is formed with difficulty; while **phosphorus tetraiodide**, P_2I_4 , and **phosphorus triiodide**, PI_3 , have no action.

According to L. Gmelin, **carbon** at a white heat has no action on boric oxide. E. Tiede and E. Birnbräuer found that a carbide is formed which sublimes in threads. The reduction occurs at 2400° . H. Quantin found a mixture of **carbon monoxide** and chlorine does not attack boron oxide; and H. Quantin, E. Demarçay, P. Camboulives, and L. Meyer and R. Wilkins found **carbon tetrachloride** has no action. W. H. Balmain showed that when calcined with **potassium cyanide**, boric oxide is converted into the nitride; and M. Darmstadt obtained a similar product with **urea**. The affinity of boric oxide or boric acid for the bases is but little greater than that of carbonic oxide, or carbonic acid; but when heated, L. Gmelin showed that it expels all acids more volatile than itself; thus, N. Tate showed that it expels the acid from **carbonates**, **nitrates**, and in part from the sulphates. The gas is expelled from the **carbonates** when they are heated with boric oxide, and the product behaves as a mixture of boric and metal oxides, as shown by C. H. Burgess and A. Holt, L. Ouvrard, etc. H. Schiff found that when boric oxide is warmed with absolute **alcohol**, some passes into soln., forming in a sealed tube at 120° , boric acid, H_3BO_3 , and triethylborate, $\text{B}(\text{OC}_2\text{H}_5)_3$, a reaction previously studied by J. J. Ebelmen and M. Bouquet. V. C. Vournasos reduced boric oxide to boron by heating it with **sodium formate**. P. Schützenberger found that boiling **acetic anhydride** dissolves a large proportion of boric oxide; the reaction was also studied by A. Pictet and A. Geleznoff. A. Wohl and C. Neuberg, and G. Lockeman and O. Liesche investigated the action of boric oxide on **glycerol**.

J. L. Gay Lussac and L. J. Thénard found that a heated mixture of **potassium** and boric oxide decomposes with incandescence; **sodium** acts similarly without incandescence. A. Stock and W. Holle found that reduction likewise occurs with **calcium**, but calcium boride, CaB_2 , is formed. As indicated in connection with the preparation

of boron, boric oxide is readily reduced when heated with **magnesium**. The reaction with powdered **aluminium** conducted by the thermite process was found by F. E. Weston and H. R. Ellis to furnish a product difficult to isolate, and it is not suited for the preparation of boron. J. S. C. Wells found that **platinum** is appreciably attacked at high temp. by fused boric oxide. C. L. Bloxam reported that when **sodium hydroxide** or **barium hydroxide** is melted with a mol of boric oxide, three mols of water are expelled: $B_2O_3 + 6NaOH = 2Na_3BO_3 + 3H_2O$; and with **potassium hydroxide**, two mols are driven off: $B_2O_3 + 4KOH = K_2B_2O_5 + 2H_2O$. W. Guertler studied the solubility of the **metal oxides** in fused boric oxide; he divided them into groups: I. The oxides of the five alkali metals, thallium, and silver dissolve in all proportions, and the soln., on cooling, furnish clear glasses if the proportion of boric oxide is high, and crystalline masses if the proportion of metal oxide is high. II. The oxides of copper (ous), lead, bismuth, antimony, arsenic, titanium, molybdenum, tungsten, and vanadium furnish, at 1400° , clear glasses which on cooling separate into an emulsion of two liquids, which on further cooling solidify. III. The oxides of the metals of the three alkaline earths, magnesium, zinc, cadmium, manganese, iron (ous), cobalt, nickel, cerium, lanthanum, neodymium, praseodymium, samarium, and gadolinium, are not mutually soluble in all proportions at 1400° , but give a mixture of two liquids. Several of these are said to form borates—e.g. W. Guertler said that cerium forms $Ce_2O_3 \cdot B_2O_3$, but this H. Holm denied. C. H. Burgess and A. Holt found that calcium, strontium, barium, zinc, cadmium, magnesium, manganese, lead, and bismuth oxides are insoluble in small quantities, but, on gradually increasing the amount, dissolve to clear glasses; with a further addition of oxide, the mass again becomes opaque except in the cases of lead and bismuth, which yield pale yellow, very fusible glasses. The oxide of mercury appears to be soluble, and those of antimony and arsenic slightly so. The oxides of aluminium, beryllium, zirconium, tin, cerium, thorium, columbium, and silicon are all quite insoluble. The oxides which colour the borax bead, namely, those of chromium, copper, molybdenum, uranium, iron, nickel, and cobalt, are all insoluble in the fused anhydride, manganese in this respect behaving exceptionally. The last series of oxides can, however, be dissolved in boric anhydride containing lithium, potassium, caesium, rubidium, and thallium, and the clear glasses obtained with large amounts of the coloured oxides are similar to the borax beads, although the colours are sometimes modified. W. G. Mixter said that boric oxide unites with **sodium dioxide** to form sodium orthoborate. L. Wöhler and W. Becker found that when boric oxide is heated with **ammonium dichromate**, Guignet's green, $Cr_4O_3(OH)_6$, is obtained free from boric oxide; with **potassium dichromate** and an excess of boric oxide, the product has the composition $Cr_4O_3(B_4O_7)_3$. K. Arndt and A. Gessler found the sp. gr. and eq. conductivity at 900° of various fused mixtures of boric acid and **sodium metaphosphate**, $NaPO_3$, to be:

Per cent. $NaPO_3$. . . 100	50	25	10	5	1	0.5
Sp. gr. at 900°	. . . 2.144	2.115	1.820	1.655	1.585	1.552	1.522
Conductivity	. . . 49.5	16.4	—	—	1.55	—	0.67

K. Arndt also measured the viscosities. The solvent action of boric oxide has been utilized in opening up **silicates** for analysis.⁴

REFERENCES.

- ¹ P. G. Robiquet, *Ann. Chim. Phys.*, (2), 17, 216, 1821; R. Lorenz, *Liebig's Ann.*, 247, 250, 1888; A. Atterberg, *Öfvers. Ver. Akad. Förh.*, 6, 1874; *Bull. Soc. Chim.*, (2), 22, 350, 1874.
- ² A. Royer and J. B. A. Dumas, *Ann. Pharm. Chim.*, 92, 408, 1821; P. A. Favre and C. A. Valson, *Compt. Rend.*, 77, 579, 1872; L. Ouvrard, *ib.*, 130, 172, 335, 1900; H. Moissan, *ib.*, 114, 392, 1892; G. Meslin, *ib.*, 140, 782, 1905; A. Ditte, *ib.*, 85, 1069, 1877; *Ann. Chim. Phys.*, (5), 13, 67, 1878; *Chem. News*, 36, 387, 1877; G. Quincke, *Pogg. Ann.*, 134, 356, 1868; 135, 621, 1868; E. Davy, *New Edin. Journ.*, 6, 131, 1828; V. de Luynes, *L'Instil.*, 141, 1872; C. L. Bloxam, *Journ. Chem. Soc.*, 12, 177, 1859; T. Carnelley, *ib.*, 33, 278, 1878; J. E. Myers, *ib.*, 111, 172, 1917; J. J. Ebelmen, *Ann. Chim. Phys.*, (3), 22, 211, 1848; *ib.*, (3), 33, 50, 1851;

J. J. Ebelmen and M. Bouquet, *ib.*, (3), 17. 54, 1846; V. Gasselin, *ib.*, (7), 3. 17, 1894; J. B. A. Dumas, *ib.*, (2), 32. 335, 1826; H. Lescaeur, *ib.*, (6), 19. 45, 1890; H. V. Regnault, *ib.*, (3), 1. 129, 1841; F. Wöhler and H. St. C. Deville, *ib.*, (3), 52. 63, 1858; L. Troost and P. Hautefeuille, *ib.*, (5), 9. 70, 1876; M. Berthelot, *ib.*, (5), 15. 185, 1878; (5), 16. 442, 1879; *Compt. Rend.*, 37. 573, 1878; M. Lapschin and M. Tichanowitsch, *Bull. Acad. St. Petersburg*, 4. 81, 1861; W. Hampe, *Chem. Ztg.*, 12. 841, 1888; L. Bleekrode, *Weid. Ann.*, 3. 161, 1878; *Phil. Mag.*, (5), 5. 375, 430, 1878; P. P. Bedson and W. C. Williams, *Ber.*, 14. 2554, 1881; H. Schiff, *Liebig's Ann. Suppl.*, 5. 154, 1867; E. Beckmann, *Zeit. phys. Chem.*, 53. 129, 1905; L. Kahlenberg and O. Schreiner, *ib.*, 20. 547, 1896; E. L. Nichols and D. T. Wilber, *Phys. Rev.*, (2), 17. 707, 1921; A. Connell, *New Edin. Phil. Journ.*, 19. 159, 1835; K. Kräut, *Zeit. anal. Chem.*, 4. 168, 1865; O. Hehner, *Analyst*, 15. 141, 1891; J. L. Gay Lussac and L. J. Thénard, *Ann. Chim. Phys.*, (1), 68. 169, 1808; *Recherches physico-chimiques*, Paris, 1. 276, 1811; E. Tiede, *Ber.*, 53. B, 2214, 1921; E. Tiede and A. Ragos, *ib.*, 56. B, 655, 1923; E. Tiede and F. Büscher, *ib.*, 53. B, 2210, 1921; E. Tiede and P. Wulff, *ib.*, 55. B, 588, 1922; W. R. Mott, *Trans. Amer. Electrochem. Soc.*, 34. 255, 1918; H. Davy, *Phil. Trans.*, 93. 1, 1808; 99. 75, 1809; M. Faraday, *ib.*, 123. 507, 1833; R. Tomasechek, *Ann. Physik*, (4), 67. 612, 1922; E. Soubeiran, *Journ. Pharm. Chim.*, 11. 29, 558, 1824; A. Payen, *Journ. Chim. Méd.*, (1), 4. 159, 1828; K. Arndt and A. Gessler, *Zeit. Elektrochem.*, 13. 809, 1907; 14. 666, 1908; K. Arndt, *ib.*, 13. 578, 1907; *Zeit. Chem. Apparatenkunde*, 3. 474, 1908; H. von Wartenberg and O. Besse, *ib.*, 28. 384, 1922; M. Prokofieff, *Bull. Soc. Chim.*, (2), 41. 389, 1884; H. Henstock, *Chem. News*, 127. 18, 1923.

* H. Moissan, *Le fluor et ses composés*, Paris, 128, 1900; L. Gmelin, *Schweigger's Journ.*, 15. 245, 1815; J. Inglis, *Phil. Mag.*, (3), 7. 441, 1835; (3), 8. 12, 191, 1836; W. H. Balmain, *ib.*, (3), 21. 170, 1842; (3), 22. 467, 1843; (3), 23. 71, 1843; (3), 24. 191, 1844; G. Gore, *ib.*, (4), 29. 541, 1865; *Journ. Chem. Soc.*, 22. 368, 1869; C. L. Bloxam, *ib.*, 14. 143, 1862; N. Tate, *ib.*, 12. 160, 1860; R. F. d'Arcy, *ib.*, 55. 155, 1889; *Chem. News*, 59. 58, 1889; S. G. Rawson, *ib.*, 53. 283, 1888; J. J. Berzelius, *Pogg. Ann.*, 1. 169, 1824; 2. 111, 1824; 4. 1, 117, 1825; C. F. Schönbein, *ib.*, 78. 513, 1849; H. Rose, *ib.*, 80. 262, 1850; *Sitzber. Acad. Berlin*, 201, 1850; J. L. Gay Lussac and L. J. Thénard, *Recherches physico-chimiques*, Paris, 2. 94, 1811; *Ann. Chim. Phys.*, (1), 69. 204, 1809; J. J. Ebelmen and M. Bouquet, *ib.*, (3), 17. 54, 1846; E. Frémy, *ib.*, (3), 36. 312, 1863; H. le Chatelier, *Compt. Rend.*, 99. 276, 1884; E. Demarçay, *ib.*, 104. 111, 1887; P. Camboulives, *ib.*, 150. 175, 1910; L. Ouvrard, *ib.*, 130. 172, 335, 1901; 132. 257, 1901; 141. 351, 1022, 1905; H. St. C. Deville and H. Caron, *ib.*, 46. 764, 1858; H. Quantin, *ib.*, 104. 223, 1887; V. C. Vournasos, *ib.*, 150. 464, 922, 1910; A. J. Balard, *Ann. Chim. Phys.*, (2), 82. 337, 1826; H. Schulze, *Journ. prakt. Chem.*, (2), 21. 407, 1890; J. F. A. Götting, *Almanach Scheidekunstler*, 1. 88, 1780; H. Schiff, *Liebig's Ann. Suppl.*, 5. 165, 1867; H. Schiff and E. Bechi, *Compt. Rend.*, 61. 697, 1865; *Bull. Soc. Chim.*, (2), 5. 372, 1866; M. Prokofieff, (2), 41. 389, 1884; J. Nicklès, *ib.*, (2), 4. 189, 1865; P. Schützenberger, *ib.*, 53. 538, 1861; G. Merz, *Journ. prakt. Chem.*, (1), 99. 179, 1866; G. Lockemann and O. Liesche, *ib.*, (2), 71. 474, 1905; H. Prinz, *Liebig's Ann.*, 223. 355, 1884; M. Darmstadt, *ib.*, 151. 255, 1869; J. Davy, *Phil. Trans.*, 102. 252, 1812; G. Ferrari, *Journ. Pharm. Chim.*, 19. 48, 1833; O. Hehner, *Analyst*, 16. 141, 1891; L. Möser and W. Eidmann, *Ber.*, 35. 536, 1902; A. Pictet and A. Geleznoff, *ib.*, 38. 2219, 1903; L. Meyer and R. Wilkins, *ib.*, 20. 681, 1887; A. Stock and W. Holle, *ib.*, 41. 2099, 1908; A. Wohl and C. Neuberg, *ib.*, 32. 1352, 1899; G. Gustavson, *Zeit. Chem.*, 13. 521, 1870; C. H. Burgess and A. Holt, *Proc. Chem. Soc.*, 19. 221, 1903; *Trans. Cer. Soc.*, 5. 163, 1906; F. E. Weston and H. R. Ellis, *Elektrochem. Zeit.*, 16. 44, 101, 1909; K. Zulkowsky, *Chem. Ind.*, 23. 108, 1900; W. G. Mixer, *Amer. Journ. Science*, (4), 23. 125, 1908; W. Guertler, *Ueber wasserfrei Borate und über Entglasung*, Leipzig, 1904; *Zeit. anorg. Chem.*, 40. 225, 377, 1904; E. Tiede and R. Birnbräuer, *ib.*, 87. 129, 1914; M. G. Levi and S. Castellani, *Gazz. Chim. Ital.*, 40. i, 138, 1910; J. S. C. Wells, *School Mines Quart.*, 12. 295, 1891; *Chem. News*, 64. 294, 1911; L. Wöhler and W. Becker, *Zeit. angew. Chem.*, 21. 1600, 1908; A. Pictet and G. Karl, *Arch. Sciences Genève*, (4), 26. 437, 1908; *Bull. Soc. Chim.*, (4), 3. 1114, 1908; K. Arndt, *Zeit. Elektrochem.*, 13. 578, 1907; K. Arndt and A. Gessler, *ib.*, 13. 809, 1907; 14. 666, 1908; H. Holm, *Beiträge zur Kenntniss des Cers*, München, 1902.

* H. Davy, *Phil. Trans.*, 85. 231, 1805; P. Jannasch, *Ber.*, 28. 2822, 1896; P. Jannasch and O. Heidenreich, *Zeit. anorg. Chem.*, 12. 208, 219, 1896; P. Jannasch and H. A. Weber, *Ber.*, 32. 1670, 1899; K. Pfeil, *Ueber die Aufschliessung der Silikate und anderer schwererzsetzbar Mineralien mit Borsäureanhydrid*, Heidelberg, 1901; H. A. Weber, *Ueber die Aufschliessung der Silikate durch Borsäureanhydrid*, Heidelberg, 1900; E. Rupp and F. Lehman, *Chem. Ztg.*, 85. 565, 1911; C. Rammelsberg, *Zeit. deut. geol. Ges.*, 24. 69, 1872; W. Suida, *Tschermak's Mitt.*, (1), 5. 176, 1876; *Zeit. anal. Chem.*, 17. 212, 1878.

§ 8. The Boric Acids

As previously cited, T. Bergman, in his *De attractionibus electivis* (Upsala, 1775), clearly recognized the acid nature of "borax acid" and compared its affinity with that of other acids. Theoretically, boric anhydride should furnish the acids represented by :

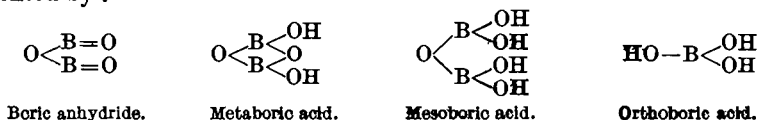

Meta- and ortho-boric acids have been obtained, but not mesoboric acid, and the researches of J. J. Ebelmen and M. Bouquet¹ show that the first two acids are definite compounds. According to A. Holt, no clear evidence can be found for the existence of any acid containing less water than metaboric acid. Only orthoboric acid can exist in soln., under which conditions it is present in simple mols. Metaboric acid cannot be regarded as an equimolecular mixture of orthoboric acid and boric anhydride. Fused mixtures of orthoboric acid and boric anhydride, in which the mol. ratio of the latter to the former compound exceeds 4 : 1, can exist in a vitreous metastable and a crystalline form. Salts of the meta- and ortho-acids, the meta- and ortho-borates, are known, and also a number of salts with a higher proportion of acid. H. Rose said that the acid salts may be regarded either as mol. compounds of boric acid and the borates, or, better, as condensed acids formed by the removal of water from two or more mols of orthoboric acid, for boron, like carbon, exhibits a tendency to form complex mols. These condensation products form the so-called *polyboric acids* and polyborates—*e.g.* diborates, triborates, tetraborates, etc. Excepting, possibly, tetraboric acid, the polyboric acids have not been isolated although their salts are known. H. le Chatelier assumed that there are four types of borates, derivatives of the acids H_3BO_3 , $\text{H}_6\text{B}_4\text{O}_9$, $\text{H}_4\text{B}_2\text{O}_5$, and HBO_2 . R. Benedikt classed the different borates as salts of polyboric acids indicated in Table I.

TABLE I.—POLYBORIC ACIDS AND POLYBORATES.

Acid.	Formula.	Origin.	Reported salts.
Orthoboric	H_3BO_3	—	Mg
Metaboric	$\text{H}_2\text{B}_3\text{O}_6$	$2\text{H}_3\text{BO}_3 - 2\text{H}_2\text{O}$	Li, K, Na, Ba, and Mg
Dihydrodiboric	$\text{H}_4\text{B}_2\text{O}_5$	$2\text{H}_3\text{BO}_3 - \text{H}_2\text{O}$	Na
Hexahydro-tetraboric	$\text{H}_6\text{B}_4\text{O}_9$	$4\text{H}_3\text{BO}_3 - 3\text{H}_2\text{O}$	Na
Dihydro-tetraboric	$\text{H}_2\text{B}_4\text{O}_7$	$4\text{H}_3\text{BO}_3 - 5\text{H}_2\text{O}$	Borax, etc.
Hexahydro-hexaboric	$\text{H}_6\text{B}_6\text{O}_{12}$	$6\text{H}_3\text{BO}_3 - 6\text{H}_2\text{O}$	None
Dihydro-hexaboric	$\text{H}_2\text{B}_6\text{O}_{10}$	$6\text{H}_3\text{BO}_3 - 8\text{H}_2\text{O}$	Li, K, and Mg
Hexahydro-octoboric	$\text{H}_6\text{B}_8\text{O}_{15}$	$8\text{H}_3\text{BO}_3 - 9\text{H}_2\text{O}$	Na and Mg
Dihydro-octoboric	$\text{H}_2\text{B}_8\text{O}_{13}$	$8\text{H}_3\text{BO}_3 - 11\text{H}_2\text{O}$	NH ₄ and Na
Dihydro-decaboric	$\text{H}_2\text{B}_{10}\text{O}_{16}$	$10\text{H}_3\text{BO}_3 - 14\text{H}_2\text{O}$	Li, Na, and K
Dihydro-dodecaboric	$\text{H}_2\text{B}_{12}\text{O}_{18}$	$12\text{H}_3\text{BO}_3 - 17\text{H}_2\text{O}$	K, Na, Ba, Sr, Mg, and Al

J. J. Berzelius prepared what was once called *pyroboric acid*, $\text{H}_6\text{B}_4\text{O}_9$, or $2\text{B}_2\text{O}_3 \cdot 3\text{H}_2\text{O}$, which may be regarded as **tetraboric acid**, by heating orthoboric acid to 100°, until half the contained water is lost. G. Merz doubted the individuality of the product. The sodium salt of this acid, sodium tetraborate, $\text{Na}_6\text{B}_4\text{O}_9$, was made by A. Arfvedson by melting borax with sodium carbonate whereby two mols of carbon dioxide are driven off per mol of borax; $\text{Na}_2\text{B}_4\text{O}_7 + 2\text{Na}_2\text{CO}_3 = 2\text{CO}_2 + \text{Na}_6\text{B}_4\text{O}_9$. L. Kahlenberg and O. Schreiner reported **dihydro-tetraboric acid**, $\text{H}_2\text{B}_4\text{O}_7$, or $2\text{B}_2\text{O}_3 \cdot \text{H}_2\text{O}$, to be formed by heating orthoboric acid to 140°; or, according to J. J. Ebelmen and M. Bouquet, to 160° in a stream of dry air; or, according to A. Atterberg, to 100° for a week. R. Nasini and J. Ageno said that this acid is

produced when orthoboric acid is heated between 138° and 140°. The brittle glassy mass forms orthoboric acid when treated with water. It can also be regarded as the second anhydride of tetraboric acid, $H_2B_4O_9$. *Dehydrated borax*, $Na_2B_4O_7$, is then regarded the sodium salt of this acid, and can be called sodium metatetraborate.

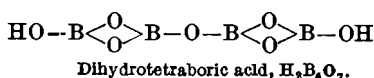
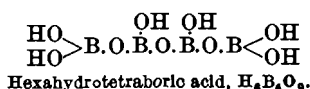

C. Zulkowsky represented the structure of dihydrotetraboric acid by the graphic formula just indicated. G. T. Gerlach said 100 grms. of water dissolve 2.69 grms. of $H_2B_4O_7$ at 15°, and the soln. has a sp. gr. 1.015. G. Merz reported the hydrate $8B_2O_3 \cdot H_2O$, or *dihydrohexadecaboric acid*, $H_2B_{16}O_{25}$, to be formed by heating orthoboric acid to 270°; and A. Atterberg the hydrate, $3B_2O_3 \cdot H_2O$, or *dihydrohexaboric acid*, $H_2B_6O_{10}$, by heating orthoboric acid for a week to 140°. There is, however, nothing to indicate that these two products are chemical individuals.

The first anhydride of orthoboric acid, **metaboric acid**, $B_2O_3 \cdot H_2O$, or HBO_2 , or $(HO)BO$, was obtained by G. Merz,² F. G. Schaffgotsch, C. L. Bloxam, H. Lescœur, and L. Kahlenberg and O. Schreiner, by the expulsion of a mol of water from one of orthoboric acid at 100°; A. Atterberg worked at 80°; and R. Nasini and J. Ageno, between 107° and 108°. P. Tschijewsky said that if boric acid be volatilized in a current of steam at 100°, crystals of metaboric acid appear where the steam condenses. O. Hehner said that at 100°, orthoboric acid does not lose two-thirds of its water, but vaporizes itself as such. According to H. Lescœur, the vap. press. of orthoboric acid becomes insensibly small when metaboric acid is formed. Metaboric acid is stable above 100°, and at 200° it forms a viscid mass which has a perceptible vap. press. too small for measurement. J. Thomsen gave for the heat of neutralization ($H_2B_2O_4 \text{ aq.}, 2NaOH \text{ aq.}$) = 20.01 Cals.; and L. Kahlenberg and O. Schreiner found the heat of soln. in water to be positive, that of orthoboric acid is negative. H. Menzel gave for the ionization constant, $HBO_2 \rightleftharpoons H^+ + BO_2^-$, $5.7 \times 10^{-10} [HBO_2] = [H^+][BO_2^-]$. The transport number of the BO_2^- -ions in 0.05N-soln. was found by R. Abegg and A. J. Cox, J. Walker and W. Cormack, and H. S. Shelton to be nearly the same as for acetate ions. L. Kahlenberg and O. Schreiner found that water immediately converts metaboric acid into orthoboric acid. R. Nasini and J. Ageno found the mol. wt. in glacial acetic acid to be 38.3, when the value calculated for HBO_2 is 44; P. Walden stated that in aq. soln. the electrical conductivities of borax and of sodium metaborate are similar, and hence suggested that metaboric acid is dibasic, $H_2B_2O_4$, but P. T. Muller said that the abnormal conductivity is due to hydrolysis, and that the formula of the metaborates is MBO_2 . C. Zulkowsky, however, used the graphic formula :

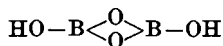

P. Tschijewsky believed that **mesoboric acid**, $H_2B_2O_5$, or $HBO_2 \cdot H_3BO_3$, or $B_2O_3 \cdot 2H_2O$, is formed as a compound which is volatile with steam, and which appears in crystals when molten boric acid is cooled.

The discovery of boric acid by G. Homberg³ in 1702, and the occurrence of boric acid in the waters of the lagoons of Tuscany has already been discussed. G. Homberg's preparation was first called *sal sedativum*, and it was some time before it was recognized to be **orthoboric acid**, H_3BO_3 . This acid is generally understood when the term *boric acid* or *boracic acid* is employed. This acid is formed by the action of water, steam, or alkali-lye on boron sulphide, or boron nitride; and, as already indicated, hypotheses as to the origin of boric acid in the fumaroles of Tuscany have been based upon these reactions. The boron halides are also hydrolyzed by water into boric acid and the corresponding haloid acid—*vide infra*. F. Landolph showed that boron hydrofluoride, $BF_3 \cdot HF$, is decomposed by atm. moisture with great

rapidity. F. Jones and R. L. Taylor found boron hydride is oxidized to this acid by a soln. of potassium permanganate. J. L. Gay Lussac and L. J. Thénard, and H. Moissan showed that nitric acid converts boron into boric acid; and B. Reinitzer found that when finely divided, well-washed boron is left between filter paper in moist air for 8–10 days, it becomes covered with microscopic crystals of boric acid. R. Lorenz also demonstrated the extraordinary avidity of boric oxide for water whereby it is converted into boric acid.

The preparation of orthoboric acid.—The sources of commercial boric acid are the naturally occurring acid in the soffioni of Tuscany; native borax or tincal; boronatocalcite, or Chilian borate of lime; pandermite from Asia Minor (*Turkish boracite*) and Stassfurtite, *i.e.* boracite.

(1) *From borax.*—Boric acid was formerly obtained by sublimation from a mixture of 16 parts of borax, 5 of sulphuric acid, and 2 of water, heated in a retort; the powdered residue was frequently moistened with water and again ignited. The yield was small. It is more conveniently made by treating a soln. of one part of borax in four parts of boiling water with one-third the quantity of sulphuric acid; on cooling the soln., boric acid crystallizes out, and a further quantity can be obtained by evaporating and cooling the soln. This is virtually G. Homberg's original process for *sal sedativum*. W. Meissner⁴ evaporated the mixtures of sulphuric acid and boric acid to dryness, and extracted the boric acid with hot alcohol. H. W. F. Wackenroder preferred hydrochloric acid to sulphuric acid because the latter adheres more tenaciously to the separated boric acid; and E. Reichardt decomposed the soln. of borax with an excess of hydrochloric acid, evaporated the mixture to dryness at 100°, and extracted the sodium chloride with the smallest possible amount of water.

(2) *From the Tuscany fumaroles.*—Up to the end of the eighteenth century, boric acid was obtained industrially almost exclusively from borax. In 1775, U. F. Hoefer,⁵ and P. Mascagni discovered boric acid in the waters of the Tuscany lagoons of Monte Rotondo and Castelnuovo; and shortly afterwards it was found in the solid state by P. Mascagni, at Sasso—hence D. L. G. Karsten's name *sassolin*, which was afterwards changed to *sassolite*. U. F. Hoefer discussed the possibility of the extraction and utilization of the boric acid. The boric acid fumaroles and lagoons of Tuscany appear at the distance like clouds of vapour rising from the rugged mountains. They cover an area of about 30 sq. miles. In the vicinity, jets of boiling water seem to burst explosively from the earth, and voluminous clouds of steam rush into the atmosphere. The ground is hot, and is covered with crystalline sulphur and other minerals; the atm. smells of sulphurous oxide. The temp. of the water may be as high as 105°. The place was formerly regarded by the peasants as the veritable entrance to Hell, a superstition no doubt derived from ancient times, for the neighbouring volcano still bears the name Mons Cerberi or Monte Cerboli. A photograph of a boric acid lagoon at Volterra is shown in Fig. 9.

To recover the boric acid, it is merely necessary to evaporate the condensed vapours from the fumaroles. In 1807 G. Gazzeri's analyses led him to conclude that the quantity of boric acid contained in the waters was too small to promise successful extraction on a large scale. Undeterred by this, attempts were made at Monte Rotondo, in 1815, to extract the acid on an industrial scale by the evaporation of the liquor, but the cost of fuel (charcoal) required for the evaporation was prohibitive; about 1828 F. de Larderel happily conceived the idea of applying the heat from the soffioni to evaporate their own waters instead of wasting itself in the air. There are establishments at Castelnuovo, Monte Rotondo, Serrazzano, Lustignano, Larderello, Monte Cerboli, San Federigo, Sasso, and Lago, each operating 10 to 40 lagoons. The process of extraction is comparatively simple.⁶

Native steam issues from numerous blow-holes or soffioni in the ground in the neighbourhood of Larderello (Monte Cerboli district); it contains up to one-tenth per cent. of boric acid. The vents are lined with about 8-inch pipes extending into the earth from a few feet to over 300 ft. Some of the blow-holes are artificial, for they have been produced by boring

and thus resemble artesian wells. The temp. of the issuing steam varies from 98° to 140° . Circular basins, about 30 ft. diameter, are built about the soffioni so as to include two or three vents, as shown diagrammatically in Fig. 10. A series of such basins, $A_1, A_2, \dots, A_7, A_8$, Fig. 10, are built at different levels on the side of a hill so as to form a kind of terrace of



FIG. 9.—Boric Acid Lagoon at Volterra.

artificial lagoons. The uppermost one is filled with water from the mountain streams. The hot vapours bubble through the water producing a turbulent fountain several feet in height. The hot vapours give up their boric acid and raise the temp. of the water. In about 24 hours, the impregnated water is run into the next lagoon where a second impregnation occurs.

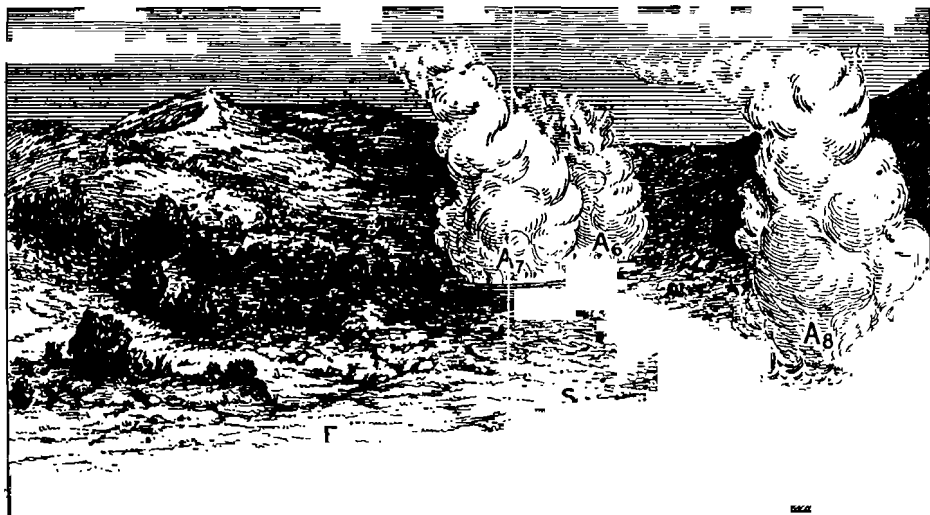

FIG. 10.—The Extraction of Boric Acid from the Soffioni in Tuscany.

In another 24 hours the liquid passes on to the third lagoon, and so on until it has reached the last of the series. The water will then have gathered about 2 per cent. of boric acid. If impregnation is allowed to proceed further, boric acid will be carried off with the escaping steam. The soln. is then allowed to settle in a rectangular settling-tank, *S*, Fig. 10, where

fine mud containing more or less boric acid is deposited. This mud is used by country people for treating the skin diseases of cattle. The water from the settling-tank is allowed to run down a series of corrugated lead lined evaporating troughs, *E*—6 ft. wide, 150 ft. long, and 8 ins. deep—heated by vapours from the soffioni. The liquid enters at one end and runs over the corrugations, where it is rapidly evaporated. If the temp. rises much above 50°, there is a loss of boric acid with the vapour. Any further evaporation, if needed, is conducted in leaden pans. When conc. to the point of crystallization—about sp. gr. 1.116 at 15°—the liquid is transferred to wooden crystallizing vats—10 × 30 sq. ft.—and allowed to cool. The mother liquor is returned to the evaporation pans. The crystals of boric acid are removed by wooden scoops, drained in baskets, and dried on a floor heated by native steam. The boric acid is shipped in casks containing about 1000 lbs. each.

According to O. L. Erdmann,⁷ the Tuscan boric acid so prepared contains 3.18 per cent. of ammonia; and, according to G. C. Wittstein's analysis of a specimen in 1840,

H ₃ BO ₃	(NH ₄) ₂ SO ₄	NH ₄ Cl	MgSO ₄	CaSO ₄	Na ₂ SO ₄	K ₂ SO ₄	Fe ₂ (SO ₄) ₃	Al ₂ (SO ₄) ₃
76.494	8.508	0.298	2.632	1.018	0.917	0.369	0.365	0.320

together with a combination of boric and sulphuric acids 1.322; silica, 1.200; combined water, 6.447; and traces of manganese sulphate and organic matter. The data may have been accurate to the first decimal. Another analysis by A. Scheuer (1892) is:

B ₂ O ₃	H ₂ O	NH ₃	K ₂ O	CaO	MgO	Fe ₂ O ₃ + Al ₂ O ₃	Cl	H ₂ SO ₄
46.47	42.03	1.23	0.72	0.40	0.83	0.28	0.66	7.04

This is equivalent to 82.31 per cent. of boric acid. The Tuscan acid is refined by dissolving it in water heated by blowing in steam, and adding freshly ignited charcoal. The filtered soln. furnishes colourless crystals. M. Clouet purified the acid by heating it with nitric acid or sodium nitrate. Boric acid can also be still further purified by converting it into borax, purifying that by recrystallization, and subsequently converting the borax into boric acid again by adding hydrochloric acid to the hot soln. The resulting crystals of boric acid can be purified by crystallization from water.

The mother liquor remaining after the extraction of crude boric acid is called *salaccio*; it contains ammonium, magnesium, and sodium sulphates in addition to boric acid. U. Sborgi recovers the boric acid by boiling the *salaccio* with sodium carbonate, ammonia, and carbon dioxide, and concentrating for the crystallization of borax. The mother liquor is used as a source of sodium sulphate in the Dresel process for borax.

Boric acid is converted into borax by adding the necessary quantity of sodium carbonate to the aq. soln., and crystallizing. In the E. Dresel and J. Lenhoff's process⁸ for making borax from boric acid and sodium chloride or sulphate, a soln. of boric acid and the alkali salt is subjected to the action of ammonia: $4\text{H}_3\text{BO}_3 + 2\text{NH}_3 + 2\text{NaCl} = \text{Na}_2\text{B}_4\text{O}_7 + 2\text{NH}_4\text{Cl} + 5\text{H}_2\text{O}$, a reaction which recalls the Solvay process for sodium carbonate. The reaction has been investigated by U. Sborgi and C. Franco at different temp. There are two invariant points in the system, and it is in the neighbourhood of one of these, corresponding to a solid phase composed of ammonium borate, borax, and ammonium chloride, that the best conditions for the practical working of the process are found. At 10° C. these conditions are obtained with an initial mixture in the proportions, NaCl 393 grms., H₃BO₃ 654 grms., NH₃ 89.95 grms., H₂O 1206 grms. The quantity of crystallized borax precipitated is 941 grms., and the mother liquor contains 282.3 grms. NH₄Cl, 35.35 grms. Na₂B₄O₇, and 84.36 grms. NaCl per 1000 grms. of water. The yield of precipitated borax is eq. to a recovery of 73.3 per cent. of the sodium and 93.4 per cent. of the boric acid in the initial mixture.

(3) *From the calcium and magnesium borates.*—Boric acid is obtained from pandermite and other calcium borates by suspending the powdered mineral in water and adding sulphuric acid. A current of steam is blown into the liquid, so that the boric acid dissolves and the calcium sulphate is converted into a compact form which

is readily separated. The temp. is not allowed to rise over 80° or some boric acid will be lost in the vapour. The filtered liquid is cooled and allowed to crystallize. The crystals are purified if necessary by re-crystallization. F. Gutzkow⁹ used a similar process with boronatrocalcite, and further discussed by G. Lunge, J. B. Hobson, F. Filsinger, and G. Krause. Hydrochloric acid can be used instead of sulphuric acid. P. Marquart and H. Schulz patented the use of carbon dioxide, the gas from lime kilns, etc., under press. for converting powdered boronatrocalcite suspended in water into calcium and sodium carbonates and boric acid; sulphur dioxide, or sodium hydrosulphite was also substituted for carbon dioxide. These processes have been discussed by J. Winkler. A. Schuster and M. Wilhelmy proposed hydrofluoric acid; R. Rickmann and E. Rappe, silicon tetrafluoride, sodium fluosilicate, or hydrofluosilicic acid: $2\text{CaB}_4\text{O}_7 + \text{SiF}_4 = 4\text{B}_2\text{O}_3 + 2\text{CaF}_2 + \text{SiO}_2$; M. Chenal and M. Douilhet, ammonium chloride; and C. C. Moore, chlorine: $3\text{Ca}_2\text{B}_4\text{O}_8 + 6\text{Cl}_2 + 18\text{H}_2\text{O} = 12\text{H}_3\text{BO}_3 + 5\text{CaCl}_2 + \text{Ca}(\text{ClO}_3)_2$. A. Partheil and J. Rose proposed extracting the boric acid from residues with ether, acetic ether, or chloroform. E. Becchi described methods for extracting boric acid from serpentine and related rocks.

The physical properties of orthoboric acid.—Boric acid crystallizes from hot aq. soln. in lustrous, colourless, flexible, six-sided plates which feel greasy to the touch. According to W. H. Miller,¹⁰ the crystals are of larger size when they separate from a soln. containing sulphuric acid, etc., than from water alone as solvent. The crystals are triclinic pinacoids with the axial ratios and angles, according to K. Haushofer, $a:b:c=1.7329:1:0.9228$, and $\alpha=92^{\circ}30'$; $\beta=104^{\circ}25'$; and $\gamma=89^{\circ}49'$. Measurements have also been made by W. H. Miller, A. des Cloizeaux, G. d'Achiardi, and A. Kennigott. The hardness on Mohs' scale is 3. The specific gravity of the crystal, according to R. Kirwan, is 1.479; F. Stolba gave 1.4347 at 15° ; P. A. Favre and C. A. Valson, 1.493 at 20° ; and, according to A. Ditte:

Sp. gr.	0°	12°	14°	60°	80°
	1.5463	1.5172	1.5128	1.4165	1.3828

The value calculated from B_2O_3 and solid water is 1.3003. According to P. A. Favre and C. A. Valson, the contraction during the crystallization of an eq. of boric acid is 9.3 c.c. E. F. Anthon gave 1.014 for the sp. gr. of a sat. aq. soln. at 8° ; F. Stolba, 1.0248 for a soln. sat. at 15° ; and P. A. Favre and C. A. Valson, 1.0106 for a N-soln. at 20.2° , and the contraction on soln. is 6.9 c.c. O. Bock gave for the sp. gr. of aq. soln. at $18^{\circ}/4^{\circ}$:

Per cent. H_3BO_3	0.78	1.92	2.88	3.61
Sp. gr.	1.0029	1.0073	1.0109	1.0131

L. W. Ohlms measured the diffusion of boric acid in aq. soln. from 18° to 20° , and found the coeff. k to be:

Conc. of soln.	1.5N	N	0.5N	0.1N	0.05N
Coefficient	0.813	0.816	0.826	0.876	0.954

F. Auerbach found the elastic modulus of crystals of boric acid to be 2030 kgms. per sq. mm. For the elastic number—the ratio of the transverse contraction to the longitudinal extension—R. Straubel gave 0.28, and F. Auerbach, and R. Straubel gave 79.3 kgms. per sq. mm. for the torsion modulus of the crystals of boric acid.

According to A. Ditte, the coeff. of thermal expansion of crystalline boric acid is 0.0015429 between 12° and 60° . H. V. Regnault gave 0.3535 for the specific heat; and T. Carnelley, 184° – 186° for the melting point; it will, however, be obvious that this number does not apply to orthoboric acid. Not all are agreed as to the action of heat on boric acid. J. A. Rose observed no loss in weight when boric acid is dried in vacuo over conc. sulphuric acid. E. Löwenstein also observed no loss at 25° , when the acid is confined over 97 per cent. sulphuric acid. H. Lescœur found that boric acid formed by the hydration of boric oxide lost at ordinary temp. over

sulphuric acid, 0.35 per cent. the first day, 0.08 per cent. the second day, and 0.00 per cent. the third day.

F. G. Schaffgotsch said that it is converted to metaboric acid, HBO_2 . G. Merz said that no water is lost by heating it to a temp. of 70° , and that two-thirds is lost at 100° , and that it forms dihydrotetraboric acid, $\text{H}_2\text{B}_4\text{O}_7$, at 160° . At a higher temp., the acid froths up, losing its water, and forming a fused viscid mass of anhydride (*q.v.*), which on cooling congeals to a transparent but fissured glass. The formation of different hydrates has already been discussed. At a red heat, boric acid loses all its water and this is attended by much bubbling. H. Lescœur said that the acid is stable up to 100° , but at that temp. it has an appreciable vap. press. and slowly loses weight. In 1702 G. Homberg distilled ferrous sulphate with borax and found the distillate contained what is now known to be boric acid. G. Merz, F. G. Schaffgotsch, J. A. Rose, R. Bunsen, and H. Lescœur noted that the loss of the water of crystallization is attended by the vaporization of some boric oxide, and P. Tschijewsky found that a gram of the acid containing :

Grms. water of crystallization lost	:	:	:	0.7808	0.7543	0.2783
Volatilized B_2O_3 per grm. of water	:	:	:	0.1405	0.1358	0.1032

O. Hohner said that at 100° it vaporizes as H_3BO_3 , G. Watson as HBO_2 . P. Tschijewsky believes that the cause of the **volatility** is the formation of a volatile compound with water, just as the high volatility of boric oxide in the presence of methyl or ethyl alcohol is due to the formation of the corresponding esters. F. G. Schaffgotsch found much boric acid is lost during the evaporation of aq. soln. L. de Koningh said that this only applies with conc. soln., and that dil. soln. may be evaporated to half their vol. without appreciable loss—a rapid volatilization of the acid occurs as the soln. approaches dryness. P. Tschijewsky found that the loss is not proportional to the conc. of the soln. The evaporation on a water-bath of a soln. of *g* grms. of boric acid in 20 grms. of water was attended by the loss of *l* grms. of B_2O_3 per 20 grms. of water :

<i>g</i>	:	:	1.1296	1.0305	0.9547	0.8874	0.8197	0.0382	0.0201	0.0098
<i>l</i>	:	:	0.0991	0.0758	0.0673	0.0577	0.0485	0.0181	0.0103	0.0066

F. W. Skirrow distilled sat. soln. of boric acid in contact with the solid phase but did not obtain a distillate of constant composition with unsat. soln.; the conc. of the vapour increases slowly with increasing conc. of the liquid, showing that the acid is not in the same mol. state in the soln. and vapour phases. He believed that in the soln. there is a condition of equilibrium: $2\text{H}_3\text{BO}_3 \rightleftharpoons 2\text{H}_2\text{O} + \text{H}_2\text{B}_2\text{O}_4$, and also $4\text{H}_3\text{BO}_3 \rightleftharpoons 5\text{H}_2\text{O} + \text{H}_2\text{B}_4\text{O}_7$; and the state of equilibrium between the acid in soln. and in vapour is $\text{H}_3\text{BO}_{3\text{soln.}} \rightleftharpoons \text{H}_3\text{BO}_{3\text{vapour}}$. The constancy of the "constants" calculated on these assumptions is not altogether satisfactory. J. A. Rose observed an 8.62 per cent. loss of boric acid during the evaporation of ethereal soln. All the boric acid can be volatilized from soln. containing enough methyl or ethyl alcohol.

The **dissociation pressure** at 20° was found by H. Lescœur to be 2 mm., and the **vapour pressure** of boric acid at different temp. to be :

Vap. press.	:	:	20°	43.5°	66°	79°	100°	128°
	:	:	2	5	16	30	60	242 mm.

He further found at 20° for the vap. press., *p* mm., of a mol of boric oxide, B_2O_3 , with *n* mols of H_2O :

<i>n</i>	:	0.01	0.3	0.65	0.98	1.00	1.63	25.0	2.92	2.69
<i>p</i>	:	1.4	2.4	2.2	3.4	7.1	7.2	8.5	9.6	14.5

and at 5° :

<i>n</i>	:	:	:	3.00	3.05	3.20	3.74	3.81
<i>p</i>	:	:	:	1.8	5.8	5.9	6.0	5.95

He inferred that a hydrate higher than H_3BO_3 probably exists at a low temp., but it is not stable at 15° ; the vap. press. at 5° is 5.8 mm.; at 10° , 6.8 mm.; and at 15° , 12.1 mm. E. Löwenstein made some observations on this subject. G. Tammann gave 10.2, 26.3, and 56.1 mm. for the **lowering of the vapour pressure** of aq. soln. with respectively 5.25, 13.11, and 27.36 grms. of boric acid per 100 grms. of water, at 100° , and F. W. Skirrow found the vap. press, p mm., of aq. soln. with g grms. of H_3BO_3 per litre at 92.8° :

g	.	.	.	21.7	23.0	42.8	67.5	80.7	143	152	172
p	.	.	.	579.5	580	578	572	570	566	564	561

The **raising of the boiling point** of aq. soln. of boric acid has been measured by E. Beckmann, W. Landsberger, and L. Kahlenberg, and only varied from 0.49° to 0.51° with soln. containing 2.35 and 36.41 grms. H_3BO_3 per 100 grms. of water. R. Nasini and J. Ageno also found the raising of the b.p. of aq. soln. by boric acid to be in accord with the mol. wt. $H_3BO_3=62$. S. Arrhenius, and L. Kahlenberg and O. Schreiner measured the **lowering of the freezing point** of aq. soln.; the former obtained 1.02 for the constant of association, and the latter found distinct evidence of association as is evident on comparing the first and last of the following:

Conc. of H_3BO_3	.	.	.	0.25	0.167	0.126	mols per litre.
Depression of f.p.	.	.	.	0.483°	0.327°	0.247°	"
Calculated conc. H_3BO_3	.	.	.	0.27	0.177	0.133	"

The **partition coefficient** of boric acid between amyl alcohol and water was measured by C. J. J. Fox, P. Müller and F. Auerbach, and found to be nearly constant 3.35 at 25° for soln. of different conc. P. Müller gave 3.37 at 15° ; 3.34 at 25° ; and 3.31 at 35° . These results indicated that there is no change in the mol. state of boric acid in soln. of different conc. The partition coeff. of boric acid in aq. soln. of sodium chloride and amyl alcohol was measured by P. Müller and R. Abegg; between an aq. soln. of potassium fluoride, and amyl alcohol by C. J. J. Fox; between water, and mixtures of amyl alcohol and carbon disulphide by W. Herz and A. Kurzer; between water and ether, by J. A. Rose; and between amyl alcohol and glycerol, by W. Herz and M. Levy.

According to M. Berthelot,¹¹ the **heat of formation** of crystalline boric acid is $(B_2O_3, 3H_2O_{liquid})=16.8$ Cals.; or $(B_2O_3, 3H_2O_{solid})=12.6$ Cals. A. Ditte found that an eq. of boric acid absorbs 3.187 Cals. in order to make a sat. aq. soln., and if more water is added, only 0.241 Cal. is absorbed. J. Thomsen gave $(H_3BO_3, aq.)=-5.4$ Cals.; and M. Berthelot gave 4.8 Cals. for the **heat of solution** of a mol. of boric acid in 800 mols. of water. This agrees with a large positive temp. coeff. for the solubility. J. Thomsen also found the **heat of neutralization** of one eq. of sodium hydroxide with n eq. of boric acid:

n	.	.	$\frac{1}{2}$	$\frac{2}{3}$	1	$1\frac{1}{2}$	$1\frac{2}{3}$	2	4	6
Cals.	.	.	1.940	6.820	10.010	10.305	10.700	11.100	12.800	13.600

The heat effect which occurs after eq. amounts of acid and alkali have been mixed shows that polyborates are probably formed exothermally. M. Berthelot found that an eq. of boric acid in 4 litres of water with $\frac{1}{2}$ eq. Na_2O per litre= 11.56 Cals.; with 1 eq. $Na_2O=19.82$ Cals.; and with $1\frac{1}{2}$ eq. $Na_2O=19.65$ Cals. M. Berthelot gave for the heat of neutralization of an eq. of boric acid (70 grms. B_2O_3 in four litres) with one eq. of NH_3 in 2 litres, 8.93 Cals.; with 2 eq. NH_3 , 11.55 Cals.; and with 3 eq. NH_3 , 12.60 Cals. H. Lunden gave for the heat of neutralization of boric acid with ammonia, 11440—36.89 cals., at θ° . H. von Steinwehr gave for the **heat of dissociation**, -3.85 Cals. at 18.2 ; -4.04 Cals. at 16.4 ; and -4.14 Cals. at 13.6 ; H. Lunden gave -3.17 Cals. for the heat of dissociation at 15° , and -3.08 Cals. at 25° . J. Thomsen, P. Georgievic, J. Shields, and W. Ostwald found the **avidity** of boric acid for sodium hydroxide to be very small compared with those of other acids.

According to A. des Cloizeaux,¹² the **double refraction** of crystals of boric acid

is strongly negative; and the dispersion is inappreciable; J. Chaudier found that **elliptical polarization** is produced when 0.3 gm. of boric acid is mixed with 50 c.c. of carbon disulphide, benzene, pseudocumene, turpentine, ether, carbon tetrachloride, chloroform, or petroleum. G. Meslin also studied the polarization of aq. soln. of boric acid. B. Wagner found the **index of refraction** of soln. containing 1, 2, 3, and 4 grms. of boric acid in 100 c.c. of soln. to be respectively 1.33396, 1.33464, 1.33532, and 1.33600 at 17.5° for the *D*-line. P. P. Bedson and W. C. Williams found the index of refraction of isotropic fused boric oxide to be 1.4694 for the H_{α} -line; 1.4637 for the Na-line; and 1.4623 for the H_{β} -line. J. H. Gladstone and W. Hibbert found that with the H_{α} -line, solid boric acid has the **molecular refraction** 15.20, and in sat. sol., 14.77. S. Procopiu studied the effect of boric acid on the birefringence of benzene, etc. For the **phosphorescence** of boric acid, *vide* boron trioxide.

E. Bourgoïn¹³ said that an aq. soln. of boric acid is not decomposed by a current, but A. Bartoli and G. Papasogli found that a perceptible decomposition occurs with a current from 6-8 Bunsen's cells. O. Bock found the specific **electrical conductivity** of the soln. at 18° to be:

Per cent. H_2BO_3	0.776	1.92	2.88	3.612
Conductivity	0.022	0.11	0.21	0.31
Temp. coeff.	0.0231	0.0143	0.0119	0.0075

J. Kendall and J. C. Andrews measured the conductivity of boric acid in aq. soln. of hydrochloric and nitric acids. A. B. Bryan measured the conductivity of flames charged with boric acid. J. Walker and W. Cormack gave for the mol. conductivity, μ , the **degree of ionization**, α , and the **ionization constant** of dil. soln. with a mol of the acid in v litres at 18°:

v	11.1	22.2	33.3	44.4
μ	0.0450	0.0636	0.0783	0.0891
Degree ionization, α	1.37×10^{-5}	1.94×10^{-5}	2.39×10^{-5}	2.72×10^{-5}
Ionization constant, K	1.7×10^{-6}	1.69×10^{-6}	1.71×10^{-6}	1.66×10^{-6}

H. Lunden calculated the eq. conductivity of boric acid, assuming the ionization proceeds $H_3BO_3 \rightleftharpoons H^+ + H_2BO_3'$, at θ° , to be $\lambda_{\infty} = 18.5 + 0.6471\theta + 0.00328\theta^2$. E. O. Mandala, and H. Menzel have also studied this subject. A. Hantzsch and A. Barth gave 2.3×10^{-9} for the ionization constant of boric acid which thus falls between those of hydrosulphuric and hydrocyanic acids:

	$H(HCO_2)$	$H_2S_{aq.}$	H_2BO_3	Hcy	C_6H_5OH	H(OH)
K	3.04×10^{-7}	0.91×10^{-10}	2.3×10^{-9}	1.3×10^{-6}	1.3×10^{-10}	1.2×10^{-14}

G. A. Abbott and W. C. Bray also found the ionization constant $H_3BO_3 \rightleftharpoons H^+ + H_2BO_3'$, 1.7×10^{-9} at 18°; S. Arrhenius corrected this value to 1.06×10^{-9} ; H. Menzel gave 5.7×10^{-10} at 18°, and J. Lundberg obtained 6.4×10^{-10} by making an allowance for hydrolysis. Boric acid thus behaves as a weak monobasic acid. The conc. of the H^+ -ion exceeds 1×10^{-5} , and S. P. L. Sørensen found 6.55×10^{-5} , and C. L. A. Schmidt and C. P. Finger, 4.7×10^{-5} . S. Arrhenius emphasized the small change in the electrical conductivity of soln. of boric acid with dilution. The splitting of the first of the three H^+ -ions of boric acid evidently takes place with difficulty; and the tertiary salts of boric acid are not formed in aq. soln., for the acid is also considerably hydrolyzed. For soln. of boric acid F. Auerbach, W. M. Clark and H. A. Lubs, E. B. R. Prideaux and co-workers, S. Palitzsch, S. P. L. Sørensen, and C. L. A. Schmidt and C. P. Finger found that the ionization constant is increased by decreasing the conc. of the soln., and for very dil. soln. is not far from $k = 1.7 \times 10^{-9}$; and that the addition of a neutral salt increases the value of k . J. Walker calculated the **degree of hydrolysis** to be 0.84 per cent. with 0.1*N*-soln. of borax, to be 0.3 per cent., and J. Shields found 0.5 per cent. J. Lundberg calculated the OH^- -conc. of borate soln. from the velocity of saponification of esters and found the hydrolysis constant $K = [OH^-][HBO_2]/[BO_2^-]$ to be 1.9×10^{-5} at 18°; H. Menzel gave 1.12×10^{-5} at 18°. G. Magnanini found for

four litres of soln. containing 1, 0.5, and 0.1 mols of mannite, $C_6H_8(OH)_8$, and one mol of boric acid the mol. conductivity, 100μ , falls from 120 to 65.0 to 16.4; and with four litres of a soln. containing a mol of mannite and 1, 0.5, and 0.1 mols of boric acid, the mol. conductivity, 100μ , falls from 118 to 93.5 to 43.4. He infers that the conductivity is approximately proportional to the conc. of the mannitol, and to the cube root of the conc. of the boric acid; and this agrees with the mass law on the assumption that three mols of mannitol and one mol of boric acid form a complex ion. He also studied the action of glycerol and erythritol. H. Lunden found for the **transport number** of the ion H_2BO_3' is 29.0 at 15°; 36.8 at 25°; and 49.7 at 40°. C. L. A. Schmidt and C. P. Finger studied the potential difference of the **hydrogen electrode** in a soln. of boric acid.

G. Gore¹⁴ found that a copper plate at 100° is electropositive towards a cold plate in a soln. of boric acid. G. Meslin found the **magnetic susceptibility** of boric acid to be -0.60×10^{-6} mass units.

The solubility of orthoboric acid.—The solubility of boric acid in water has been measured by R. Brandes and E. Firnhaber,¹⁵ and by A. Ditte. The latter represented the amount, S , in grams of boric acid dissolved in a litre of water at θ° , by $S = 19.4 + 0.63636\theta + 0.016608\theta^2 - 0.00001604\theta^3$, but his results are undoubtedly too low. R. Nasini and J. Ageno gave for the percentage solubility:

	0°	10°	20°	40°	60°	80°	100°	120°
H_3BO_3 . . .	2.59	3.45	4.8	8.02	12.90	19.11	28.7	52.4

They gave -0.76° for the eutectic temp. with a soln. containing 2.27 per. cent. of boric acid; F. Guthrie gave -0.7° for the eutectic temp. W. Herz and F. Auerbach also obtained some isolated data for the solubility of boric acid in water; and W. Herz and M. Knoch found the normality of aq. soln. sat. at 13°, 20°, and 25° to be respectively 0.620, 0.7915, and 0.8999.

R. Aegg, C. J. J. Fox, and W. Herz found that water at 26° dissolves 0.80 mol of boric acid, and with 3.21 and 2.80*N*-soln. of *hydrofluoric acid*, 0.75 and 0.96 mol of boric acid are dissolved, so that the solubility of boric acid is depressed by hydrofluoric acid. W. Herz represented the solubility of boric acid in terms of normal soln. at 26°. Without acid, the soln. of boric acid is 0.907*N*- H_3BO_3 , and with *hydrochloric acid*:

<i>N</i> -HCl . . .	0.130	0.260	0.390	1.30	2.16	6.0	7.08	9.51
<i>N</i> - H_3BO_3 . . .	0.895	0.870	0.842	0.646	0.542	0.338	0.327	0.338

showing that the solubility decreases with increasing proportions of acid and finally attains a constant value with about 5*N*-HCl. J. Kendall and J. C. Andrews also measured the solubility of boric acid in hydrochloric acid. A. Ditte said that boric acid is more easily soluble in dil. hydrochloric acid than in water; and all three agree that there is no sign of a combination of the two acids. W. Herz's results with *sulphuric acid* are, at 26°:

<i>N</i> - H_2SO_4				0.548	2.74	5.48	8.75
<i>N</i> - H_3BO_3				0.746	0.518	0.312	0.092

L. Gmelin, H. Schiff, and G. Merz found that with conc. sulphuric acid, a colourless viscid mass is produced from which water precipitates boric acid—*vide* boron sulphate. With *nitric acid*, W. Herz found at 26°:

<i>N</i> - HNO_3	0.241	1.206	1.607	2.411	5.96	7.38
<i>N</i> - H_3BO_3	0.818	0.676	0.593	0.567	0.268	0.238

showing a steady fall in the solubility as the conc. of the nitric acid increases. With 0.570*N*-, 2.85*N*-, and 5.70*N*- *acetic acid*, W. Herz found sat. soln. contained respectively 0.887*N*-, 0.538*N*-, and 0.268*N*-boric acid, at 26°. P. Schützenberger described a compound of acetic and boric acids. According to A. Holt, orthoboric acid is readily soluble in hot glacial acetic acid, from which it separates out unchanged on cooling. The pyro-acid and boric anhydride are insoluble, whilst metaboric

acid dissolves to a very slight extent, the soln. depositing the ortho-acid on cooling. M. P. Dukelsky studied the ternary system, $H_3BO_3-H_2O-(CH_3CO)_2O$. W. Herz found the solubility of boric acid and *oxalic acid* at 25° in grams per 100 c.c. of sat. soln. to be:

$H_2C_2O_4$	2.26	5.36	12.39	11.27	10.84	10.77	10.63
H_3BO_3	6.17	6.70	7.44	3.45	0.97	0.55	0
Solid phase	Boric acid.			Oxalic acid.			

W. Herz also gave with *tartaric acid* at 25° (grams per 100 c.c. of sat. soln.):

	<i>d</i> -tartaric acid.			<i>l</i> -tartaric acid.		
$H_2C_4O_6$	0	11.25	45.00	9.45	18.90	37
H_3BO_3	5.59	6.20	7.48	6.11	6.48	7.23

showing that the solubility increases with increasing proportions of acid. G. Magnanini, A. F. W. Duve, G. Baudran, and H. Grossmann and L. Wieneke observed the formation of complexes with tartaric acid. W. Herz gave for soln. with 2.321, 18.77, 36.33 molar per cent. of *lactic acid* at 25°, respectively 6.64, 11.53, and 12.90 grms. of boric acid per 100 c.c. of sat. soln. at 25°, and G. Magnanini observed the formation of complexes with these two acids. P. Müller and R. Abegg also measured the solubility of boric acid in lactic acid. A compound of boric acid with *benzoic acid* was described by A. Michaelis and E. Richter; with *citric acid*, by A. Scheibe; and with *salicylic acid* by E. Jahns.

P. Bogdan measured the solubility of boric acid in aq. soln. of *sodium chloride* and *potassium chloride* at 25°, and W. Herz, in aq. soln. of *lithium chloride* and *rubidium chloride* at 25°. The results interpolated by A. Seidell, so as to show the number of grams *g* of the chloride per 100 c.c. of sat. soln., with the number of grams of boric acid dissolved per 100 c.c. of sat. soln., at 25°, when the solubility in water alone ($g=0$) is 5.59 are:

<i>g</i>	2	4	6	8	10	15	20	30
HCl	4.92	4.36	3.88	3.50	3.15	—	—	—
LiCl	5.20	4.85	4.45	4.07	3.75	3.00	—	—
NaCl	5.40	5.30	5.20	5.15	5.10	5.07	—	—
KCl	5.67	5.75	5.85	5.90	6.00	6.25	6.50	—
RbCl	5.60	5.62	5.67	5.72	5.77	5.90	6.10	6.55

P. Bogdan also measured the solubility of boric acid in soln. of *potassium and sodium nitrates*, and in *potassium and sodium sulphates*, and, expressing the results as above, found 5.75 with water alone, $g=0$:

<i>g</i>	10	20	40	60	80
NaCl	5.75	5.74	5.72	5.72	5.71
KCl	5.80	5.86	5.98	6.12	6.29
$NaNO_3$	5.78	5.81	5.87	5.95	6.02
KNO_3	5.81	5.88	6.04	6.20	6.37
Na_2SO_4	5.88	6.00	6.33	6.70	7.10
K_2SO_4	5.92	6.10	6.50	6.92	7.40

P. Bogdan added that the raising of the solubility is the more marked the weaker the acid of the added salt, and is probably to be ascribed to chemical action. F. Aurbach gave for the solubility of boric acid in soln. of *borax*, in mols per litre at 25°:

Na	0	0.05	0.075	0.10	0.15	0.20
Excess acid over B: Na	0.885	1.075	1.155	1.25	1.37	1.51
Excess acid over 2B: Na	0.885	1.025	1.08	1.15	1.22	1.31
Total conc. B	0.885	1.125	1.23	1.35	1.52	1.71
Combined B	0	0.240	0.345	0.465	0.635	0.825
Ratio Na to combined B	—	4.8	4.6	4.65	4.2	4.1
B in polyborates	—	0.236	0.340	0.458	0.624	0.811

Borax thus augments the solubility of boric acid. M. Puaux obtained soln. containing boric acid eq. to a hexaborate, by adding a little calcined *magnesium oxide* to the boiling soln., and then more boric acid. The magnesia keeps the soln. alkaline, and this enables more boric acid to dissolve. For a 10 per cent. soln. of boric acid—sp. gr. 1.044—1.4 grms. of magnesia are needed; and for a 20 per cent. soln.—sp. gr. 1.088—3.5 grms. of magnesia are required. T. W. B. Welsh and H. J. Broderson found 100 grms. of anhydrous *hydrazine* dissolved 55 grms. of boric acid at room temp. P. Bogdan found that at 25° soln. containing 0, 20, 60 grms. of *urea* per 100 grms. of water dissolved respectively 5.75, 5.93, and 6.31 grms. of boric acid per 100 grms. of water.

P. Müller and R. Abegg measured the solubilities of boric acid in aq. soln. of *methyl, ethyl, propyl, iso-butyl, and iso-amyl alcohols*. Expressing the amount of alcohol in per cent. by weight, and the amount of boric acid in grams per 100 c.c. of sat. soln., at 25°, they obtained:

CH ₃ OH . . .	19	41.5	50	58	66	100
H ₃ BO ₃ . . .	5.55	6.27	6.81	7.20	8.10	17.99
C ₂ H ₅ OH . . .	20.2	42.3	76.3	91.1	95	100
H ₃ BO ₃ . . .	5.14	4.96	4.34	5.54	6.85	9.47
C ₃ H ₇ OH . . .	50.83	79.41	95.5	100	—	—
H ₃ BO ₃ . . .	3.99	2.83	3.58	5.96	—	—
C ₄ H ₉ OH . . .	0.70	2.18	71.4	77.1	85.6	100
H ₃ BO ₃ . . .	5.48	5.32	2.00	2.15	2.61	4.30
C ₅ H ₁₁ OH . . .	0.448	0.525	67.26	75.54	83.40	100
H ₃ BO ₃ . . .	5.48	5.46	1.60	1.69	1.98	3.54

The results are plotted in Fig. 11. The sp. gr. of the soln. were also measured. A. Seidell has also measured the solubilities of soln. in ethyl alcohol at 10° and 25°; and P. Bogdan, the solubility in propyl alcohol. The diminishing solvent power of alcohol for boric acid as the amount of water increases is attributed to the breaking down of a compound with alcohol and boric acid; and the variation in the different alcohols is taken to indicate that the affinity of boric acid for alcohol with increasing carbon content, decreases more rapidly than the affinity of boric acid for water. The limited miscibility of the higher alcohols in water accounts for the dotted lines in the curves.

D. Hooper measured the solubility of boric acid expressed in grams per 100 grms. of *glycerol* of sp. gr. 1.260 at 15.5°, and found:

	0°	10°	20°	40°	60°	80°	109°
H ₃ BO ₃ . . .	20	24	28	38	50	61	72

FIG. 11.—Solubility of Boric Acid in Mixtures of Alcohol and Water at 25°.

W. Herz and M. Knoch found that at 25° 100 grms. of a solvent containing *n* per cent. of *glycerol*, dissolved the following percentage amounts of boric acid:

Glycerol soln., <i>n</i> . . .	0	7.15	31.55	40.95	48.7	69.2	100
H ₃ BO ₃	5.60	5.38	5.29	5.41	5.64	7.32	19.02

P. Müller and R. Abegg, and A. M. Ossendowsky also measured the solubility of boric acid in *glycerol*. P. Müller and R. Abegg measured the solubility of boric acid in soln. of *dulcitol* and of *mannitol* and gave for soln. containing 0.065, 0.130, and 0.260 molar per cent. of *dulcitol*, C₆H₈(OH)₆, the respective solubilities 5.50,

5.63, and 5.81 grms. of boric acid per 100 c.c. of sat. soln. at 25°. Expressing the results in grams per 100 c.c. of sat. soln., F. Ageno and E. Valla found for *mannitol*, $C_6H_8(OH)_6$, at 25°:

Mannitol . . .	0	1.82	9.11	14.57	32.43	27.97	24.65	19.58
H_3BO_3 . . .	5.50	5.90	6.64	7.27	9.43	7.71	4.92	0
Solid phase . . .		H_3BO_3				$C_6H_8(OH)_6$		

G. Magnanini's observations are discussed in connection with the electrical conductivity of aq. soln. of mannitol and boric acid.

H. Schiff, and H. Rose said dried *ether* dissolves only traces of boric acid, and J. A. Rose showed that the solubility increases with increasing proportions of water. Thus, 100 grms. of dried ether dissolve 0.00775 grm. of boric acid, and 100 grms. of ether sat. with water dissolve 0.2391 grm. He also measured the partition coeff. as indicated above, and found for $H_2O : (C_2H_5)_2O = 1 : 45.37$ at 27°, $1 : 44.62$ at 17°. D. H. Wester and A. Bruins found 100 grms. of *dichloroethylene*, at 15°, dissolved 0.006 grm. of boric acid; and 100 grms. of *trichloroethylene*, 0.016 grm. P. Bogdan measured the solubility of boric acid in *acetone* at 20°, and W. Herz and M. Knoch, at 20°. The latter give, per 100 c.c. of solvent:

Acetone . . .	0	20	40	60	80	100
H_3BO_3 . . .	4.91	5.07	5.13	4.74	3.41	0.50

J. Timmermans found that with a 64 per cent. soln. of *phenol* the molar conc. rose from 1.291 to 1.62. H. Rose found boric acid dissolves in many *essential oils*.

The relation of boric acid to indicators.—According to M. Faraday,¹⁶ and M. Desfosses, *turmeric* paper dipped in a soln. of boric acid is quickly coloured brownish-red, and when the paper is dried, the effect resembles that produced by a weak alkali. The original colour is restored by washing the paper. The mineral acids and oxalic acid produce a bright red with the browned paper, and alkalis turn the brown paper into various shades of yellowish-red, purple, and blue. If the browned paper be heated, the turmeric yellow is almost restored. The effect produced by aq. ammonia or hydrochloric acid on the browned paper is lost by volatilization. Boric acid in all states of dilution reddens turmeric paper, but with very dil. soln., it requires a few minutes to produce the effect. Soln. once made acid, redden litmus and turmeric, however much they be diluted, so that the acidified soln. does not become alkaline when diluted. A cold sat. soln. of boric acid colours blue *litmus* wine-red, and, according to F. J. Malaguti, the colour becomes bright when the soln. is heated. D. Klein showed that a soln. of boric acid which is so diluted that it does not react to litmus, develops a strong acid reaction if glycerol, erythritol, mannitol, or galactose is added; blue litmus, he added, is reddened by boric acid in the presence of mannitol if but 0.00005th of boric acid is present. These carbohydrates accentuate the acidity of boric acid. Quercitol does not show the reaction. The reaction has also been discussed by J. A. Rose, R. T. Thomson, etc. F. A. Flückiger and R. T. Thomson noted that *phenolphthalein*, reddened by the addition of an alkali, is decolorized by boric acid. In the titration of borax with 0.5*N*-hydrochloric acid, and *p*-nitrophenol as indicator, the soln. reacts acid only when all the soda has been neutralized; *p*-nitrophenol is indifferent to boric acid. The boric acid can then be titrated in the same liquid with the same standard alkali by using phenolphthalein as indicator, in the presence of glycerol or mannitol. J. L. Gay Lussac used litmus as indicator in titrating boric acid; F. Parmentier, and A. Joly, *helianthin*; R. Engel, *Porrier's soluble blue*; A. Guyard, *hæmatoxylin*; V. de Luynes, *orceine*; C. Schwarz, *congo red*; R. T. Thomson, *lacmoid*; L. Barthe, tincture of *rose leaves*; L. Robin, tincture of *mimosa blossoms*; H. N. Morse and W. M. Burton, and A. Joly, *tropæolin*; R. T. Thomson, and A. Joly, *methyl orange*; R. T. Thomson, *phenolacetolin*.

When two electrodes of the same metal are placed in two soln. in electrical contact containing the ion of the metal in different conc., C_1 and C_2 respectively,

the difference of potential, E , is given fairly closely by $E=0.000198T/(\log_{10} C_1/C_2)/n$, when n is the valency of the ions of the metal in soln., and T is the absolute temp. The principle can be employed to determine, say C_2 , the conc. of the H^+ -ion in soln., for, at 18° , with the normal hydrogen electrode $C_1=1$, and $n=1$, the measurement of E enables C_2 to be calculated from $E=0.058 \log_{10} (1/C_2)$. W. Böttger¹⁷ first used this principle for the electrometric titration of acids and bases. According to J. Stieglitz, indicators can be regarded as acids and bases which take part in the equilibrium of the system in virtue of the H^+ -ions or OH^- -ions, for, even if the colour changes are directly dependent on tautomeric structural changes, the change of colour is a function of the H^+ -ions, and, as A. A. Noyes has emphasized, if the ionization constant of the indicator be known, the conc. of the H^+ -ion at which the colour change occurs can be computed. H. Friedenthal, W. Salessky, B. Fels, S. P. L. Sørensen, E. Salm, etc., have determined the conc. of the H^+ -ion at which the colour change occurs, and the following is a selection from the results of the last named :

Representing the conc. of the H^+ -ion in terms of the nearest power of 10, *cochineal* is yellow for 10^{-4} , yellowish-pink for 10^{-5} , and lilac for 10^{-6} ; *Congo red* is blue for 10^{-3} ; violet for 10^{-4} ; reddish-violet for 10^{-5} ; orange for 10^{-6} ; and orange-red for 10^{-7} ; *helianthin* is yellow with 10^{-13} , and lilac with 10^{-11} ; *litmus* is red for 10^{-5} ; reddish-violet for 10^{-6} ; and yellow for 10^{-7} ; and blue for 10^{-8} ; *methyl red* is red for 10^{-3} ; pinkish-yellow for 10^{-5} ; and yellow for 10^{-6} ; *methyl orange* is rose-red for 10^{-1} ; orange for 10^{-4} ; pinkish-yellow for 10^{-5} ; and yellow for 10^{-6} ; *p-nitrophenol* is colourless for 10^{-5} ; light green for 10^{-6} ; and yellow for 10^{-7} ; *phenacetolin* is yellow for 10^{-4} ; brownish-red for 10^{-5} ; rose-red for 10^{-6} ; violet-red for 10^{-11} ; and colourless for 10^{-12} ; *phenolphthalein* is colourless for 10^{-8} ; and red for 10^{-9} ; while *tropæolin OO* is cherry-red for 10^{-1} ; flesh-colour for 10^{-2} ; and yellow for 10^{-3} .

In Fig. 12, the e.m.f. expressed in terms of the computed conc. of the H^+ -ion is plotted during the addition of standard alkali to a soln. of boric acid and of hydrochloric acid.

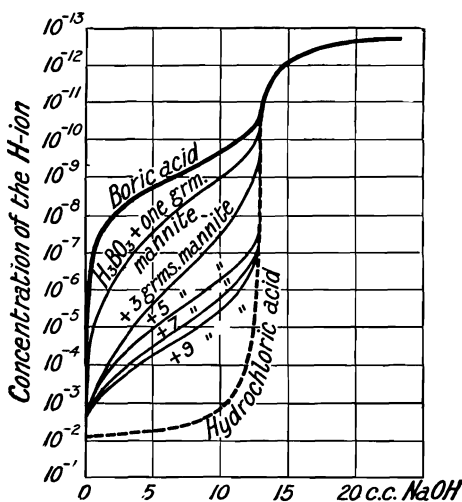

FIG. 12.—Electrometric Titration of Hydrochloric Acid, and of Boric Acid (with and without Mannite) by Standard Sodium Hydroxide.

The greater jump in the range with hydrochloric acid than with boric acid shows that in the former case a slight addition of alkali suffices to change the conc. of the H^+ -ion through a range from 10^{-2} to 10^{-10} , whereas with boric acid alone, the range is very narrow on each side of 10^{-11} . Otherwise expressed, in titrating hydrochloric acid with alkali, the acidity of the soln., i.e. the conc. of the H^+ -ion changes through a range great enough to include the colour changes characteristic of most indicators, but with the titration of hydrochloric acid with methyl orange as indicator a very slight addition of alkali at the end-point is sufficient to change the acidity, that is, the conc. of the H^+ -ion through a range great enough to include all the colour changes of the indicator in question. With boric acid, however, the rapid change in acidity at about 10^{-9} , throws out methyl orange changing between 10^{-4}

and 10^{-5} , long before the eq. amount of base has been added; nor does phenolphthalein changing at 10^{-8} give a satisfactory end-point. An indicator changing colour near the middle of the jump in the curve will in general give the sharpest end-point. The conc. of the H^+ -ion at which an indicator changes colour may be different from E. Salm's value, but if 1, 3, 5, 7, 9 grms. of mannitol be

progressively added, there is a proportionate increase in the H⁺-ion conc. of the soln., until the strength of the boric acid becomes great enough to permit its titration with phenolphthalein. An indicator changing at 10⁻¹¹ would permit the titration of boric acid without the addition of mannitol. The subject has also been studied by E. Rimbach and P. Ley, and R. Dubrisay.

Some chemical properties of boric acid.—H. Schiff and R. Sestini¹⁸ found that **iodine** has no action on boric acid. The action of **hydrochloric acid** is indicated in dealing with the solubility; similar remarks apply to aq. soln. of the **alkali chlorides**. H. Baubigny and P. Rivals found boric acid decomposed hot soln. of chlorides, or **bromides** provided the soln. is sat. If **hydrogen bromide** be passed into an alcoholic soln. of boric acid, J. Nicklès found that boron bromide and a complex of that salt with alcohol are formed. R. Höpke investigated the influence of boric acid on the reaction between **iodic acid** and sulphur dioxide. H. N. Warren found that if boric acid be added to molten sodium chloride, a layer of fused borax appears under the molten sodium chloride; and M. G. Levi and S. Castellani proposed the reaction for converting boric acid into borax. G. Ubaldini found that iodine separated when an **alkali iodide** is triturated with boric acid provided air has free access or the soln. be hot. H. Baubigny and P. Rivals also observed that boric acid decomposes a cold soln. of **potassium iodide** with the separation of hydrogen iodide, but P. Georgievic said that boric acid does not liberate iodine from a mixture of potassium iodide with potassium iodate, or nitrite.

The action of **sulphuric acid**, and of **potassium and sodium sulphates**, has been discussed in connection with the solubility of boric acid; and the action of sulphuric acid, and **sulphur trioxide**, is treated in connection with boron sulphate. Boric acid is so weak an acid that it is readily expelled from many of its combinations, and partially so even by hydrosulphuric and carbonic acid. A boiling conc. soln. decomposes soluble **sulphides**, as well as manganese sulphide. In a dry way, at high temp., boric acid will decompose the salts of all more volatile acids. H. Schulze studied the action of boric acid on colloidal **antimony sulphide**. A. Étard found boric acid has no action on a soln. of **ammonium magnesium sulphate**, (NH₄)₂SO₄.MgSO₄.6H₂O, but if some **hydrogen peroxide** be present a white precipitate is formed. The action of various organic compounds on boric acid has been discussed in connection with the solubility of boric acid. D. Klein studied the action of **polyhydric alcohols** on boric acid. E. Tiede and E. Birnbräuer said that boron oxide forms a carbide when it is heated with **carbon**. As indicated above, **carbonic acid** will displace boric acid from the borates, but a boiling conc. soln. will decompose the **carbonates**. F. Ageno studied the partition of sodium oxide between boric and carbonic acids. When *a* is the total conc. of the sodium oxide, *x* that required by the combined carbonic acid, *C* the total conc. of the carbonic acid, then, with soln. sat. with boric acid—0.90 mol per litre, then $K = 0.90x / (a - x)(C - x)$; but *K*, at 25°, varies from 2.37 to 0.827 as the conc. of the sodium oxide is increased. The deviations from constancy are said to be due to variations in the solubility of carbon dioxide in the presence of borates and hydrocarbonates; and to the formation of polyborates with increasing conc. of the sodium oxide. P. Georgievic found boric acid has no visible action on soln. of the **alkali carbonates or bicarbonates**, but, added C. Jehn, effervescence occurs if glycerol, honey, or one of the polyhydric alcohols be present; neither quercitol nor glycogen has any action. L. Reed found that by mixing boric acid and **calcium carbonate** (1:20) with water to form a slip, a hard cement-like mass is obtained in a few days—the setting is retarded by mercuric iodide, lead chromate, and ultramarine. F. de Lalande and M. Prud'homme showed that a mixture of boric oxide and **sodium chloride** is decomposed in a stream of dry air or oxygen at a red heat with the evolution of chlorine.

The effect of boric acid on the setting of hemihydrated **calcium sulphate** is treated in connection with plaster of Paris. H. Rose found if an aq. soln. of boric acid and **ammonium chloride** is evaporated to dryness, and the mixture calcined with the exclusion of air, some boron nitride is formed; **ammonium nitrate** furnishes

no nitride under similar conditions. The effect of **potassium and sodium nitrates** is discussed in connection with the solubility of boric acid. It has been suggested that boric acid can be used in the preparation of nitric acid from Chili saltpetre, and so obtain borax as a by-product. F. Auerbach found that a complicated condition of equilibrium occurs with a mixture of boric and **arsenious acids** competing for sodium oxide insufficient for complete neutralization. Both acids form complex compounds.

G. F. Jaubert found **sodium dioxide** converts boric acid into a perborate (*q.v.*). A. Étard prepared **barium diborate**, $BaB_2O_5 \cdot 3H_2O$, by the action of **barium dioxide** on boric acid. By the action of boric acid on a mixture of **calcium oxide** and boric oxide, C. Bigot and J. Schreiter obtained what they regarded as **dicalcium diborate**, $Ca_2B_2O_5$, from which he made the **tetrasodium diborate** by treating with sodium sulphate. L. de Koningh ignited a dried mixture of boric acid and an excess of **ammonium zincate**, and obtained zinc oxide free from boric oxide. T. Bergman in his arguments in favour of regarding *sal sedativum* as an acid stated: "The acid of borax attacks **metals** with difficulty." C. Tissier, and H. Rose found **calcium hydroxide** dissolves in a boiling conc. soln. of boric acid; **calcium and barium carbonates** do not dissolve; hydrated **magnesium carbonate** dissolves quickly; the anhydrous carbonate does not dissolve; and calcined **magnesium oxide** slowly; **ferrous hydroxide** dissolves, and if air be present, ferric hydroxide is precipitated; **manganous hydroxide** dissolves and remains in soln. on exposure to air; and **zinc oxide, aluminium hydroxide or oxide** and **ferric oxide** dissolve in the soln. P. Georgievic found that the brownish-red colour of **ferric chloride** in acetate soln., or the violet colour of ferric chloride in phenol soln. is discharged by boric acid. M. Berthelot said that boric acid converts **potassium chromate** to the dichromate, but P. Sabatier found very little action. When boric acid is heated with **ammonium fluosilicate**, F. Stolba found ammonium borofluoride is formed. L. Kahlenberg and W. J. Trautman did not succeed in reducing boric oxide by **silicon**. The tendency of boric oxide or acid to form complexes is well illustrated by its compounds with inorganic acids as well as by the corresponding salts: *e.g.*, borophosphates, borarsenites, borotungstates, boromolybdates, and borovanadates—*q.v.*

REFERENCES.

- ¹ A. Holt, *Mem. Manchester Lit. Phil. Soc.*, 55, 10, 1911; C. Zulkowsky, *Chem. Ind.*, 23, 108, 1900; G. T. Gerlach, *Zeit. anal. Chem.*, 28, 473, 1889; J. J. Berzelius, *Schweigger's Journ.*, 23, 161, 1818; G. Merz, *Journ. prakt. Chem.*, (1), 99, 179, 1865; A. Atterberg, *Bull. Soc. Chim.*, (2), 22, 350, 1874; J. J. Ebelmen and M. Bouquet, *Ann. Chim. Phys.*, (3), 17, 63, 1846; L. Kahlenberg and O. Schreiner, *Zeit. phys. Chem.*, 20, 547, 1869; F. W. Skirrow, *ib.*, 37, 84, 1901; R. Nasini and J. Ageno, *ib.*, 69, 485, 1909; H. le Chatelier, *Compt. Rend.*, 113, 1034, 1891; A. Arvedson, *Kongl. Vet. Acad. Handl.*, 87, 1824; *Phil. Mag.*, (1), 62, 355, 1823; R. Benedikt, *Ber.*, 7, 700, 1874; J. E. Myers, *Journ. Chem. Soc.*, 111, 172, 1917; H. Rose, *Pogg. Ann.*, 19, 158, 1830; 86, 465, 561, 1852; 87, 1, 1852; *Sitzber. Akad. Berlin*, 462, 536, 1852; *Liebig's Ann.*, 84, 216, 1852.
- ² G. Merz, *Journ. prakt. Chem.*, (1), 99, 179, 1866; F. G. Schaffgotsch, *Pogg. Ann.*, 107, 427, 1859; J. Thomsen, *ib.*, 143, 354, 497, 1871; C. L. Bloxam, *Journ. Chem. Soc.*, 12, 177, 1860; J. Walker and W. Cormack, *ib.*, 77, 5, 1900; H. Löscœur, *Ann. Chim. Phys.*, (6), 19, 42, 1890; L. Kahlenberg and O. Schreiner, *Zeit. phys. Chem.*, 20, 547, 1869; R. Nasini and J. Ageno, *ib.*, 69, 485, 1909; H. Menzel, *ib.*, 105, 402, 1923; F. W. Skirrow, *ib.*, 37, 84, 1901; P. Walden, *ib.*, 1, 529, 1887; H. S. Shelton, *ib.*, 43, 494, 1903; R. Abegg and A. J. Cox, *ib.*, 46, 1, 1903; *Zeit. Electrochem.*, 9, 892, 1903; P. T. Müller, *Bull. Soc. Chim.*, (3), 15, 756, 1896; A. Atterberg, *ib.*, (2), 22, 350, 1874; C. Zulkowsky, *Chem. Ind.*, 23, 108, 1900; P. Tschijewsky, *Arch. Sciences Genève*, (3), 12, 146, 1884; O. Hohner, *Analyst*, 16, 141, 1891.
- ³ F. Landolph, *Compt. Rend.*, 86, 803, 1878; J. L. Gay Lussac and L. J. Thénard, *Recherches physico-chimiques*, Paris, 1, 276, 1811; *Ann. Chim. Phys.*, (1), 68, 169, 1808; H. Moissan, *ib.*, (7), 6, 296, 1895; B. Reinitzer, *Sitzber. Akad. Wien.*, 82, 736, 1880; *Monatsh.*, 1, 798, 1880; R. Lorenz, *Liebig's Ann.*, 247, 232, 1888; F. Jones and R. L. Taylor, *Journ. Chem. Soc.*, 39, 216, 1881; G. Homberg, *Mém. Acad.*, 33, 1702.
- ⁴ H. W. F. Waackenroder, *Arch. Pharm.*, (1), 21, 313, 1840; W. Meissner, *Trommsdorff's Journ. Pharm.*, 1, 460, 1817; E. Reichardt, *Zeit. Pharm.*, 10, 17, 1858.
- ⁵ U. F. Hofer, *Sopra il sale sedativo della Toscana*, Firenze, 1778; *Mem. Soc. Firenze*, 1, 1775; G. Gazzeri, *Ann. Mus. Firenze*, 2, 125, 1810; P. Mascagni, *Mem. Soc. Ital. Modena*, 8, 487, 1794; D. L. G. Karsten, *Mineralogische Tabellen*, Berlin, 40, 75, 1800.

⁶ J. Bowring, *New Edin. Phil. Journ.*, 28. 85, 1839; C. le Neve Foster, *Pharm. Journ.*, (3), 5. 343, 1874; H. Durval, *Ann. Chim. Phys.*, (3), 46. 363, 1856; A. Payen, *ib.*, (3), 1. 247, 1841; D. Casanti, *Nuovo Cimento*, (1), 3. 111, 1856; J. Henkel, *Arch. Pharm.*, (2), 187. 57, 1869; W. P. Jerris, *Chem. News*, 2. 21. 1860; C. M. Kurtz, *Dingler's Journ.*, 212. 493, 1874; *Monit. Scient.*, (3), 6. 1236, 1876; W. P. Mason, *Journ. Amer. Chem. Soc.*, 16. 538, 1894; E. Capella, *Rev. Chim. Pure App.*, 6. 188, 1903; M. Thomson, *Repert. Pharm.*, 68. 382, 1839.

⁷ O. L. Erdmann, *Journ. prakt. Chem.*, (1), 18. 72, 1838; G. C. Wittstein, *Repert. Pharm.*, 72. 145, 1840; A. Scheuer, *Zeit. angew. Chem.*, 5. 241, 1892; H. Vohl, *Dingler's Journ.*, 182. 173, 1866; M. Clouet, *ib.*, 142. 395, 1856; J. Gilbert, *ib.*, 259. 383, 1886; C. Schmidt, *Liebigs Ann.*, 99. 273, 1856; A. Péchiney-Rangot, *Journ. Pharm. Chim.*, (3), 28. 358, 1855; (3), 29. 16, 1856; U. Sborgi, *Giorn. Chim. Ind. App.*, 3. 293, 1921.

⁸ E. Dresel and J. Lenhoff, *Brit. Pat. No. 14905*, 1894; U. Sborgi and C. Franoo, *Gazz. Chim. Ital.*, 51. ii, 1, 1921.

⁹ J. Winkler, *Journ. Amer. Chem. Soc.*, 29. 1366, 1907; A. Payen, *Journ. Chim. Méd.*, 4. 153, 1828; F. Gutzkow, *Proc. California Acad.*, 68, 1874; A. Scheuer, *Zeit. angew. Chem.*, 5. 241, 1892; P. Marquart and H. Schulz, *ib.*, 8. 386, 1895; *German Pat.*, D.R.P.P. 71310, 72012, 1892; 81886, 1894; A. Schuster and M. Wilhelm, *ib.*, 94050, 1897; R. Rickmann and E. Rappe, *ib.*, 96196, 1897; A. Partheil and J. Rose, *ib.*, 136181, 1901; Schott and Gen., *ib.*, 375308, 1921; M. Chenal and M. Douilhet, *ib.*, 110421, 1899; *French Pat. No. 292630*, 1899; C. C. Moore, *Brit. Pat. No. 20384*, 1899; F. Filsinger, *Chem. Ztg.*, 3. 46, 1879; G. Lunge, *Dingler's Journ.*, 181. 370, 1866; E. Becchi, *Pogg. Ann.*, 57. 604, 1842; J. B. Hobson, *U.S.A. Pat. No. 289836*, 1883; G. Krause, *Die Industrie von Stassfurt und Leopoldshall und die dortigen Bergwerke*, Cöthen, 1876; *Ueber Vorkommen und Verwendung des Stassfurter, Cöthen*, 1876.

¹⁰ K. Haushofer, *Zeit. Kryst.*, 9. 77, 1884; G. d'Aohiardi, *Ann. Univ. Tosc. Pisa*, 23. 1, 1900; W. H. Miller, *Trans. Cambridge Phil. Soc.*, 2. 365, 1830; A. des Cloizeaux, *Manuel de minéralogie*, Paris, 2. 1, 1874; A. Kenngott, *Sitzber. Akad. Wien*, 12. 26, 1854; F. Stolba, *Journ. prakt. Chem.*, 90. 457, 1863; G. Merz, *ib.*, (1), 99. 179, 1896; E. F. Anthon, *ib.*, (1), 14. 125, 1838; P. A. Favre and C. A. Valsou, *Comp. Rend.*, 77. 577, 1873; A. Ditte, *ib.*, 85. 1069, 1877; *Ann. Chim. Phys.*, (5), 13. 67, 1878; H. V. Regnault, *ib.*, (3), 1. 129, 1841; H. Leconte, *ib.*, (6), 19. 43, 1890; *Compt. Rend.*, 103. 1260, 1886; R. Kirwan, *Physisch-chemische Schriften*, Berlin, 1783; O. Book, *Wied. Ann.*, 30. 631, 1887; T. Carnelley, *Journ. Chem. Soc.*, 33. 275, 1878; E. F. Anthon, *Journ. prakt. Chem.*, (1), 2. 337, 1836; F. G. Schaffgotsch, *Pogg. Ann.*, 107. 427, 1859; P. Tschijewsky, *Arch. Sciences, Genève*, (3), 12. 120, 1884; *Bull. Soc. Chim.*, (2), 42. 324, 1884; J. A. Rose, *Beiträge zur Kenntnis der Borsäure und über eine direkte gewichtsanalytische Bestimmung derselben*, Bonn a. Rh., 1902; R. Bunsen, *Liebigs Ann.*, 111. 257, 1859; O. Hohner, *Analyst*, 16. 141, 1891; G. Watson, *Chem. News*, 68. 199, 1893; L. de Koningh, *Journ. Amer. Chem. Soc.*, 19. 385, 1897; F. W. Skirrow, *Zeit. phys. Chem.*, 37. 84, 1901; E. Beckmann, *ib.*, 6. 227, 1891; 8. 227, 1891; 21. 254, 1896; 40. 153, 1902; S. Arrhenius, *ib.*, 2. 495, 1888; R. Nasini and J. Ageno, *ib.*, 69. 482, 1909; P. Müller and R. Abegg, *ib.*, 57. 514, 1906; L. Kahlenberg and O. Schreiner, *ib.*, 20. 547, 1896; L. Kahlenberg, *Journ. Phys. Chem.*, 5. 378, 1901; G. Tammann, *Mém. Acad. St. Petersburg*, (7), 35. 9, 1887; W. Landsberger, *Zeit. anorg. Chem.*, 17. 434, 450, 1898; C. J. J. Fox, *ib.*, 35. 129, 1903; F. Auerbach, *ib.*, 37. 363, 1903; *Ann. Physik*, (4), 3. 116, 1900; E. Löwenstein, *ib.*, 63. 69, 1909; *Ueber Hydrate, deren Dampfspannung sich kontinuierlich mit der Zusammensetzung ändert*, Hamburg, 1909; L. W. Ohlms, *Finske Kemistsamfundets Meddelanden*, 30. 69, 1921; P. Müller, *Borsäure, Amylalkohol und Wasser*, Breslau, 1906; G. Homberg, *Mém. Acad.*, 33, 1702; W. Herz and A. Kurzer, *Zeit. Elektrochem.*, 16. 240, 869, 1910; W. Herz and M. Levy, *Jahresber. Schles. Ges.*, 1, 1906; R. Straubel, *Wied. Ann.*, 63. 369, 1899.

¹¹ M. Berthelot, *Compt. Rend.*, 73. 864, 1871; 87. 573, 1878; P. A. Favre and C. A. Valsou, *ib.*, 77. 577, 1873; A. Ditte, *ib.*, 85. 1069, 1877; *Ann. Chim. Phys.*, (5), 13. 67, 1878; J. Thomsen, *Pogg. Ann.*, 189. 193, 1870; 140. 505, 1870; 143. 354, 497, 1871; H. von Steinwehr, *Zeit. phys. Chem.*, 38. 198, 1901; H. Lunden, *Journ. Chim. Phys.*, 5. 574, 1907; J. Shields, *Chem. News*, 67. 285, 1893; P. Georgievic, *Journ. prakt. Chem.*, (2), 38. 118, 1888; W. Ostwald, *Lehrbuch der allgemeinen Chemie*, Leipzig, 2. ii, 178, 1902.

¹² A. des Cloizeaux, *Manuel de minéralogie*, Paris, 2. 1, 1874; J. Chaudier, *Compt. Rend.*, 142. 201, 1906; G. Meslin, *ib.*, 148. 1095, 1909; B. Wagner, *Tabellen zum Eintauchrefraktometer*, Sondershausen, 1907; J. H. Gladstone and W. Hibbert, *Journ. Chem. Soc.*, 67. 831, 1895; P. P. Bedson and W. C. Williams, *Ber.*, 14. 2553, 1881; S. Procopiu, *Compt. Rend.*, 172. 1172, 1921.

¹³ E. Bourgoin, *Compt. Rend.*, 67. 94, 1868; *Ann. Chim. Phys.*, (4), 15. 47, 1868; *Bull. Soc. Chim.*, (2), 10. 206, 1868; A. Bartoli and G. Pappasogli, *Gazz. Chim. Ital.*, 13. 35, 1883; E. O. Mandala, *ib.*, 40. i, 102, 1910; C. Luckow, *Zeit. anal. Chem.*, 19. 1, 1880; *Chem. News*, 41. 213, 1880; O. Book, *Wied. Ann.*, 30. 631, 1887; G. Magnanini, *Atti Acad. Lincei Rend.*, (4), 6. 457, 1890; *Gazz. Chim. Ital.*, 20. 448, 1890; S. Arrhenius, *Recherches sur la conductibilité galvanique des électrolytes*, Stockholm, 1884; *Medd. Vet. Nobelinst.*, 2. 42, 1913; J. Walker and W. Cormack, *Journ. Chem. Soc.*, 77. 5, 1900; J. Walker, *Zeit. phys. Chem.*, 32. 137, 1900; H. Menzel, *ib.*, 100. 276, 1922; J. Lundberg, *ib.*, 69. 442, 1909; H. S. Shelton, *ib.*, 43. 494, 1903; J. Shields, *ib.*, 12. 167, 1893; R. Abegg and A. J. Cox, *ib.*, 46. 1, 1903; *Zeit. Elektrochem.*, 9. 892, 1903; C. L. A. Schmidt and C. P. Finger, *Journ. Phys. Chem.*, 12. 406, 1908; A. B. Bryan, *Phys. Rev.*, (2), 18. 275, 1921; A. Hantzsch and A. Barth, *Ber.*, 35. 216, 1902; G. A. Abbott and W. C. Bray, *Journ. Amer. Chem. Soc.*, 31. 729, 1909; W. Guertler, *Zeit. anorg. Chem.*, 40.

337, 1904; H. Lunden, *Journ. Chim. Phys.*, **5**, 574, 1907; S. P. L. Sørensen, *Biochem. Zeit.*, **21**, 131, 1909; **22**, 352, 1910; J. Kendall and J. C. Andrews, *Journ. Amer. Chem. Soc.*, **43**, 1545, 1921; E. B. R. Prideaux, *Trans. Faraday Soc.*, **15**, 76, 1915; E. B. R. Prideaux and A. T. Ward, *Journ. Chem. Soc.*, **125**, 69, 1924; S. Palitzsch, *Biochem. Zeit.*, **70**, 333, 1915; F. Auerbach, *Zeit. anorg. Chem.*, **37**, 352, 1904; W. M. Clark and H. A. Lubs, *Journ. Biol. Chem.*, **25**, 479, 1916.

¹⁴ G. Gore, *Proc. Roy. Soc.*, **19**, 324, 1871; G. Meslin, *Ann. Chim. Phys.*, (8), **7**, 145, 1906.

¹⁵ R. Brandes and E. Firnhaber, *Brandes' Archiv*, **7**, 151, 1824; A. Ditte, *Ann. Chim. Phys.*, (5), **13**, 67, 1878; G. Baudran, *ib.*, (7), **19**, 536, 1900; H. Schiff, *Liebig's Ann. Suppl.*, **5**, 154, 1867; F. Guthrie, *Phil. Mag.*, (5), **6**, 35, 1878; R. Nasini and J. Ageno, *Zeit. phys. Chem.*, **69**, 485, 1909; P. Müller and R. Abegg, *ib.*, **57**, 526, 1907; H. Grossmann and L. Wieneke, *ib.*, **54**, 385, 1906; J. Timmermans, *ib.*, **58**, 129, 1907; W. Herz and M. Levy, *Jahresber. Schles. Ges.*, **1**, 1906; W. Herz, *Zeit. anorg. Chem.*, **33**, 355, 1903; **34**, 205, 1903; **65**, 341, 1910; **66**, 93, 358, 1910; **67**, 365, 1910; **68**, 69, 165, 1910; **71**, 206, 1911; **72**, 106, 1911; **73**, 274, 1912; W. Herz and M. Knoch, *ib.*, **41**, 319, 1904; F. Auerbach, *ib.*, **37**, 353, 1903; M. P. Dukelsky, *ib.*, **62**, 114, 1909; R. Abegg, C. J. J. Fox, and W. Herz, *ib.*, **35**, 129, 1903; M. Puaux, *Journ. Pharm. Chim.*, (5), **25**, 111, 1892; H. Rose, *Pogg. Ann.*, **80**, 262, 1850; P. Bogdan, *Ann. Scient. Univ. Jassy*, **2**, 95, 1903; L. Gmelin, *Schweigger's Journ.*, **15**, 245, 1815; G. Merz, *Journ. prakt. Chem.*, (1), **99**, 179, 1866; P. Schützenberger, *Compt. Rend.*, **53**, 538, 1861; A. Michaelis and E. Richter, *Liebig's Ann.*, **315**, 19, 1901; A. Scheibe, *Russ. Pharm. Journ.*, **18**, 257, 289, 321, 1879; **19**, 514, 1880; G. Magnanini, *Gazz. Chim. Ital.*, **20**, 453, 1890; *Atti Accad. Lincei Rend.*, (4), **6**, 260, 411, 1890; A. F. W. Duve, *Viertelj. prakt. Pharm.*, **13**, 321, 1869; E. Jahns, *Arch. Pharm.*, (3), **12**, 212, 1878; A. Seidell, *Trans. Amer. Electrochem. Soc.*, **13**, 319, 1908; *Solubilities of Inorganic and Organic Substances*, New York, 153, 1920; D. Hooper, *Pharm. Journ.*, (3), **13**, 253, 1882; A. M. Ossendowsky, *ib.*, (3), **79**, 575, 1907; *Journ. Pharm. Chim.*, (6), **26**, 162, 1907; F. Ageno and E. Valla, *Atti Ist. Veneto*, (8), **14**, ii, 331, 1912; *Gazz. Chim. Ital.*, **43**, ii, 168, 1913; T. W. B. Welsh and H. J. Broderson, *Journ. Amer. Chem. Soc.*, **37**, 816, 1915; D. H. Wester and A. Bruins, *Pharm. Weekb.*, **51**, 1443, 1914; A. Holt, *Mem. Manchester Lit. Phil. Soc.*, **55**, 10, 1911; P. Müller, *Borsäure Amylalkohol und Wasser*, Breslau, 1905; J. A. Rose, *Beiträge zur Kenntnis der Borsäure und über eine direkte gewichts analytische Bestimmung derselben*, Bonn a. Rh., 1902; J. Kendall and J. C. Andrews, *Journ. Amer. Chem. Soc.*, **43**, 1545, 1921.

¹⁶ F. J. Malaguti, *Ann. Chim. Phys.*, (3), **37**, 206, 1853; V. de Luynes, *ib.*, (4), **6**, 184, 1865; M. Desfosses, *ib.*, (2), **16**, 75, 1821; R. Engel, *ib.*, (6), **8**, 564, 1886; *Compt. Rend.*, **102**, 214, 262, 1886; *Chem. News*, **53**, 87, 1886; R. T. Thomson, *ib.*, **47**, 123, 135, 1883; *Journ. Soc. Chem. Ind.*, **6**, 195, 1887; **12**, 433, 1893; A. Guyard, *Bull. Soc. Chim.*, (2), **40**, 422, 1883; D. Klein, *ib.*, (2), **29**, 195, 1878; *Compt. Rend.*, **86**, 826, 1878; F. Parmentier, *ib.*, **113**, 41, 1891; A. Joly, *ib.*, **100**, 103, 1885; L. Robin, *ib.*, **138**, 1046, 1904; *Ann. Chim. Anal. App.*, **9**, 336, 1904; *Ber. Internat. Congress App. Chem.*, **8**, i, 429, 1912; H. N. Morse and W. M. Burton, *Amer. Chem. Journ.*, **10**, 154, 1888; L. Barthé, *Journ. Pharm. Chim.*, (5), **29**, 163, 1894; C. Schwarz, *Pharm. Ztg.*, **37**, 562, 1887; J. A. Rose, *Beiträge zur Kenntnis der Borsäure und über eine direkte gewichtsanalytische Bestimmung derselben*, Bonn a. Rh., 1902; F. A. Flückiger, *Arch. Pharm.*, (2), **22**, 605, 1884; M. Faraday, *Quart. Journ. Science*, **6**, 152, 1819; **11**, 403, 1821; **13**, 315, 1822.

¹⁷ W. Böttger, *Zeit. phys. Chem.*, **24**, 253, 1897; E. Rimbach and P. Ley, *ib.*, **100**, 393, 1922; E. Salm, *ib.*, **57**, 471, 1907; J. H. Hildebrand, *Journ. Amer. Chem. Soc.*, **35**, 847, 1913; A. A. Noyes, *ib.*, **32**, 815, 1910; J. Stieglitz, *ib.*, **25**, 1112, 1903; C. L. A. Schmidt and C. P. Finger, *Journ. Phys. Chem.*, **12**, 413, 1908; H. Friedenthal, *Zeit. Elektrochem.*, **10**, 113, 1904; W. Salesky, *ib.*, **10**, 204, 1904; B. Fels, *ib.*, **10**, 208, 1904; S. P. L. Sørensen, *Compt. Rend. Lab. Carlsberg*, **8**, 1, 1909; E. B. R. Prideaux, *The Theory and Use of Indicators*, London, 277, 1917; *Trans. Faraday Soc.*, **11**, 76, 1915; A. Thiel, *Der Stand der Indikatoren Frage*, Stuttgart, 1911; N. Bjerrum, *Die Theorie der alkalimetrischen und azulimetrischen Titrierungen*, Stuttgart, 1914; R. Dubrisay, *Compt. Rend.*, **172**, 1658, 1921; **175**, 762, 1922; L. Kahlenberg and W. J. Trautman, *Trans. Amer. Electrochem. Soc.*, **39**, 377, 1923.

¹⁸ M. G. Levi and S. Castellani, *Gazz. Chim. Ital.*, **40**, i, 138, 1910; R. Höpke, *Ueber die Bestimmung der Säureaffinitäten mittels der Reaktion zwischen Jodsäure und schwefliger Säure*, Berlin, 1888; H. Schiff and R. Sestini, *Gazz. Chim. Ital.*, **15**, 156, 1885; *Liebig's Ann.*, **228**, 72, 1885; J. Nicklès, *Compt. Rend.*, **60**, 800, 1865; A. Étard, *ib.*, **91**, 931, 1880; H. Baubigny and P. Rivals, *ib.*, **137**, 650, 1903; D. Klein, *ib.*, **99**, 144, 1884; P. Sabatier, *ib.*, **103**, 138, 1886; *Bull. Soc. Chim.*, (2), **46**, 294, 1886; M. Berthelot, *ib.*, (2), **43**, 530, 1885; *Ann. Chim. Phys.*, (6), **6**, 506, 1885; *Compt. Rend.*, **100**, 207, 1885; G. F. Jaubert, *ib.*, **139**, 796, 1904; C. Tissier, *ib.*, **39**, 192, 1858; T. Bergman, *De attractionibus electivis*, Upsala, 1775; London, 1785; C. Bigot and J. Schreiter, *Brit. Pat. No.* 19382, 1891; F. Argento, *Atti Accad. Lincei*, (5), **21**, i, 121, 1912; F. Auerbach, *Zeit. anorg. Chem.*, **37**, 353, 1903; E. Tiede and E. Birnbräuer, *ib.*, **87**, 129, 1914; H. N. Warren, *Chem. News*, **62**, 181, 1890; L. Reed, *ib.*, **51**, 63, 1855; G. Ubaldini, *Nuovo Cimento*, (1), **9**, 186, 1859; P. Georgievic, *Journ. prakt. Chem.*, (2), **38**, 118, 1888; H. Schulze, *ib.*, (2), **27**, 320, 1883; C. Jehn, *Arch. Pharm.*, (3), **25**, 250, 1887; (3), **26**, 495, 1888; H. Rose, *Pogg. Ann.*, **80**, 262, 1850; **91**, 452, 1854; *Sitzber. Akad. Berlin*, **201**, 1850; **51**, 1854; L. de Koningh, *Journ. Amer. Chem. Soc.*, **19**, 385, 1897; F. Stolba, *Zeit. anal. Chem.*, **9**, 95, 1870; F. de Lalande and M. Prud'homme, *Bull. Soc. Chim.*, (2), **17**, 290, 1872.

9. The Alkali and Ammonium Borates

A. C. Reischle¹ prepared **lithium orthodihydroborate**, $\text{LiH}_2\text{BO}_3 \cdot 7\text{H}_2\text{O}$, by mixing aq. soln. of boric acid, and of lithium oxide made by igniting the nitrate in hydrogen, and evaporating to crystallization in a vacuum. It forms thin, hexagonal tables, which are described in detail in the paper, together with the method of analysis. The water of crystallization is lost at 110° , the remainder at 160° . H. le Chatelier prepared triclinic plates of anhydrous **lithium metaborates or diborate**, $\text{Li}_2\text{O} \cdot \text{B}_2\text{O}_3$, or LiBO_2 , by melting boric oxide with the calculated quantity of lithium carbonate; and A. C. Reischle by adding an alcoholic soln. of boric acid to a soln. of lithium metal in absolute alcohol. The white crystals obtained by the latter process contain alcohol of crystallization which is not removed in vacuo, but is expelled by gentle heat. H. S. van Klooster gave 843° for the m.p. of lithium metaborate. G. Tammann found that the heat of soln. of the metaborate glass in *N*-HCl is 259 cal. per gram, and of the crystals, 203 cal. per gram. Hence the heat of crystallization is 56 cal. per gram.

C. L. Bloxam found that at a bright red heat, a mol of boric acid expels 2.5 mols of carbon dioxide from 3 to 5 mols of lithium carbonate. G. Ribaud studied the f.p. curves of the binary system $\text{Li}_2\text{O} - \text{B}_2\text{O}_3$ and found a maximum corresponding with **lithium metaborate**, LiBO_2 , fusing at 840° , and one corresponding with **lithium tetraborate**, $\text{Li}_2\text{O} \cdot 2\text{B}_2\text{O}_3$, fusing at 900° . By applying the phase rule to the lithium borates in aq. soln., M. Dukelsky studied the ternary system: $\text{Li}_2\text{O} - \text{B}_2\text{O}_3 - \text{H}_2\text{O}$, at 30° . The region of stability of the solid phase $\text{LiOH} \cdot \text{H}_2\text{O}$ is represented in Fig. 13 by the area $ab\text{LiOH} \cdot \text{H}_2\text{O}$; the phase $\text{Li}_2\text{O} \cdot \text{B}_2\text{O}_3 \cdot 16\text{H}_2\text{O}$ by the area bcM ; the region of stability of the phase $\text{Li}_2\text{O} \cdot 2\text{B}_2\text{O}_3 \cdot n\text{H}_2\text{O}$ was not clearly established; the phase $\text{Li}_2\text{O} \cdot \text{B}_2\text{O}_3 \cdot 10\text{H}_2\text{O}$, by the area deP ; and of boric acid, $\text{B}(\text{OH})_3$, by the area feB .

H. le Chatelier prepared **octo-hydrated lithium metaborate**, $\text{Li}_2\text{O} \cdot \text{B}_2\text{O}_3 \cdot 16\text{H}_2\text{O}$, or $\text{LiBO}_2 \cdot 8\text{H}_2\text{O}$, by crystallization of a soln. of the cake obtained by melting 2 mols of lithium hydroxide with one of boric oxide, or by crystallization

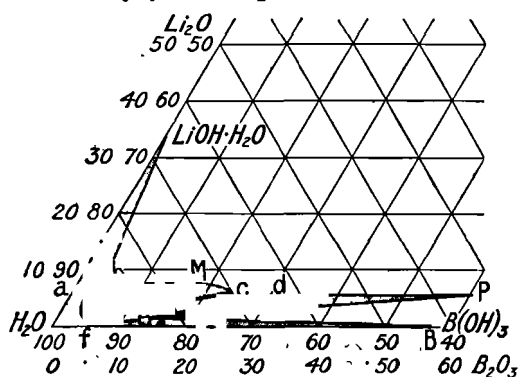

Fig. 13.—Equilibrium in the Ternary System, $\text{Li}_2\text{O} - \text{B}_2\text{O}_3 - \text{H}_2\text{O}$, at 30° .

in vacuo of an aq. soln. of lithium hydroxide free from carbon dioxide and 1 to 3 mols of boric acid. The region of stability is shown in Fig. 13. The trigonal crystals were found by P. Termier to have the axial ratio $a : c = 1 : 0.944$, and $\alpha = 81^\circ 0'$; and the sp. gr. 1.38; H. le Chatelier found the sp. gr. to be 1.397 at 14.7° , and the m.p. 47° . The crystals slowly effloresce in air; and, according to A. C. Reischle, they lose 7 mols of water at 114° , and the remaining mol at 160° . The heat of formation is $\text{B}_2\text{O}_{3\text{soln}} + 2\text{LiOH}_{\text{soln}} = 18.6$ Cals.; the heat of hydration is 43.4 Cals.; the heat of soln., -28.4 Cals. The crystals have a positive double refraction. A. Rosenheim and W. Reglin found that the solubility coeff. is positive, and the depression of the f.p. of soln. is normal. They gave for the solubility of the salt (grams per 100 grms. of soln.) 0.89 at 0° ; 3.42 at 25.6° ; 9.42 at 38.8° ; and 14.7 at 44.8° ; while H. le Chatelier gave 0.70 at 0° ; 1.91 at 15° ; 3.7 at 27.5° ; 5.28 at 31.5° ; 9.1 at 37.5° ; 14.3 at 43° ; and 20.0 at 45° . The last number is considered to be too high. F. M. Jäger found for the anhydrous salt the surface tension in ergs per sq. cm., 261.8 at 879.2° , and 192.4 at 1520° . The salt melts 845° . G. Ribaud gave 840° for the m.p. F. M. Jäger found the salt begins to give off vapour at about 1200° ,

and that the vapour is alkaline. The volatilization of lithium oxide is fairly rapid at 1300°.

In 1818, J. A. Arfvedson² boiled an aq. soln. of boric acid with an excess of lithium carbonate, and when the evolution of carbon dioxide had ceased, he filtered the clear liquid from the excess of carbonate, and obtained on evaporation a syrupy liquid which when rubbed up with alcohol a number of times, furnished a white crystalline powder. C. G. Gmelin obtained this salt in the form of a transparent green mass; and M. Dukelsky could obtain only a colloidal form from aq. soln. F. Filsinger's analysis agrees with **pentahydrated lithium tetraborate**, $\text{Li}_2\text{O} \cdot 2\text{B}_2\text{O}_3 \cdot 5\text{H}_2\text{O}$, or $\text{Li}_2\text{B}_4\text{O}_7 \cdot 5\text{H}_2\text{O}$. M. Dukelsky's study showed that such a borate is formed in aq. soln., but he did not establish its composition, nor locate the course of the curve between *c* and *d*, Fig. 13. J. A. Arfvedson's crystals were said to have an alkaline taste and reaction; and to be soluble in water. F. Filsinger said that two-fifths of the water are lost at 200°; to swell up and lose their water of crystallization when heated, and ultimately to fuse to a transparent glass. F. Filsinger obtained what he regarded as **hexahydrated lithium hexaborate**, $\text{LiB}_3\text{O}_5 \cdot 3\text{H}_2\text{O}$, or $\text{Li}_2\text{O} \cdot 3\text{B}_2\text{O}_3 \cdot 6\text{H}_2\text{O}$, by crystallization from a soln. prepared like the tetraborate, and mixed with an eq. amount of boric acid. The salt was found to behave like the preceding salt when heated; to be readily soluble in water, and insoluble in alcohol and ether. M. Dukelsky did not find the salt in his exploration at 30°, but he obtained **decahydrated lithium decaborate**, $\text{LiB}_5\text{O}_8 \cdot 5\text{H}_2\text{O}$, or $\text{Li}_2\text{O} \cdot 5\text{B}_2\text{O}_3 \cdot 10\text{H}_2\text{O}$, stable in the region *deP*, Fig. 13. H. le Chatelier obtained insoluble prismatic crystals of what he regarded as **lithium octoborate**, $\text{Li}_2\text{O} \cdot 4\text{B}_2\text{O}_3 \cdot (n\text{H}_2\text{O})$, or $\text{Li}_2\text{B}_8\text{O}_{13} \cdot (n\text{H}_2\text{O})$, by extracting with water the cold cake obtained by the fusion of a mol of lithium carbonate, with six mols of boric oxide. M. Dukelsky did not find this salt in his study of the stable phases in aq. soln. at 30°. A. C. Reischle suggested that some of these borates are mixtures with carbonate. J. A. Arfvedson, C. L. Bloxam, E. Mallard, and H. Rose measured the amount of gas expelled from sodium carbonate when fused with a mol of boric acid, from which it appears that at a dull red heat, a mol of boric oxide drives off a mol of carbon dioxide from 1.2 to 3.1 mols of sodium carbonate; and at a bright red heat, 1.5 to 2.3 mols of carbon dioxide from 1.5 to 5.6 mols of sodium carbonate. C. L. Bloxam also measured the amount of water expelled when sodium hydroxide is fused with boric acid, and found that a mol of boric oxide can displace 3 mols of water from the fused hydroxide. The results have been cited as evidence of the formation of the **basic sodium borates**: $3\text{Na}_2\text{O} \cdot 2\text{B}_2\text{O}_3$ was given by J. A. Arfvedson, and H. Rose; $5\text{Na}_2\text{O} \cdot 3\text{B}_2\text{O}_3$, by C. L. Bloxam; and $3\text{Na}_2\text{O} \cdot \text{B}_2\text{O}_3$, by C. L. Bloxam and E. Mallard.

I. F. Ponomareff studied the binary system with borax and boric oxide, and obtained evidence of the formation of sodium hexaborate, $\text{Na}_2\text{O} \cdot 3\text{B}_2\text{O}_3$, or $\text{Na}_2\text{B}_6\text{O}_{10}$, m.p. 694°; and of sodium octoborate, $\text{Na}_2\text{O} \cdot 4\text{B}_2\text{O}_3$, or $\text{Na}_2\text{B}_8\text{O}_{13}$, m.p. 783°. These salts form mixed crystals with each other and with boric oxide. M. Dukelsky studied the eq. conditions in the ternary system: $\text{Na}_2\text{O} - \text{B}_2\text{O}_3 - \text{H}_2\text{O}$, at 30°, and his results are summarized in Fig. 15. The line *ab* represents the solid phase $\text{NaOH} \cdot \text{H}_2\text{O}$ in eq. with the soln.; the line *bc*, with the metastable phase corresponding with *cm*, represents the solid phase $\text{Na}_2\text{O} \cdot \text{B}_2\text{O}_3 \cdot 4\text{H}_2\text{O}$; the line *cd*, the phase $\text{Na}_2\text{O} \cdot \text{B}_2\text{O}_3 \cdot 8\text{H}_2\text{O}$; the line *de*, the phase $\text{Na}_2\text{O} \cdot 2\text{B}_2\text{O}_3 \cdot 10\text{H}_2\text{O}$; the line *ef*, the phase $\text{Na}_2\text{O} \cdot 5\text{B}_2\text{O}_3 \cdot 10\text{H}_2\text{O}$; and the line *fg*, the phase $\text{B}(\text{OH})_3$.

U. Sborgi and F. Mecacci also investigated the same ternary system at 60°, and obtained in addition, the solid phases **monohydrated tetrasodium diborate**, $2\text{Na}_2\text{O} \cdot \text{B}_2\text{O}_3 \cdot \text{H}_2\text{O}$, or $\text{Na}_4\text{B}_2\text{O}_5 \cdot \text{H}_2\text{O}$, corresponding with the region *bMc*, Fig. 14; $\text{Na}_2\text{O} \cdot \text{B}_2\text{O}_3 \cdot \text{H}_2\text{O}$, with the region *cOd* and extending as an unstable phase along the dotted curve *dm*; the pentahydrate $\text{Na}_2\text{O} \cdot 2\text{B}_2\text{O}_3 \cdot 5\text{H}_2\text{O}$ also appears in the region *ePf*; the phases corresponding with those observed by M. Dukelsky at 30°, are $\text{Na}_2\text{O} \cdot \text{B}_2\text{O}_3 \cdot 4\text{H}_2\text{O} - dDe$; $\text{Na}_2\text{O} \cdot 5\text{B}_2\text{O}_3 \cdot 10\text{H}_2\text{O} - fOg$; $\text{NaOH} \cdot \text{H}_2\text{O} - Nab$; and $\text{B}(\text{OH})_3 - gBh$. The phases $\text{Na}_2\text{O} \cdot \text{B}_2\text{O}_3 \cdot 8\text{H}_2\text{O}$ and $\text{Na}_2\text{O} \cdot 2\text{B}_2\text{O}_3 \cdot 10\text{H}_2\text{O}$ do not appear at 60°.

J. J. Berzelius, and G. M. Wunder made anhydrous **sodium metaborate or diborate**, $\text{Na}_2\text{O} \cdot \text{B}_2\text{O}_3$, or NaBO_2 , by heating a mixture of equi-molar parts of sodium carbonate and borax. According to A. Stromeyer, by mixing alcoholic soln. of sodium hydroxide and boric acid, crystals of borax and a viscid liquid are produced; the latter furnishes crystals of anhydrous sodium borate after standing some time. M. Aschkenasy prepared the metaborate by adding powdered crystalline borax to a conc. soln. of sodium hydroxide and drying the solid in vacuo at a moderate temp. S. Motylewsky found the drop-weight of the molten salt to be 229, when that of water at 0° is 100 mgrms. F. M. Jäger, and R. Lorenz and W. Herz gave

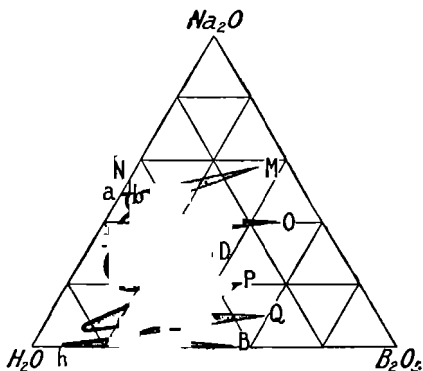

FIG. 14.—Ternary System, $\text{Na}_2\text{O}-\text{B}_2\text{O}_3-\text{H}_2\text{O}$, at 60°

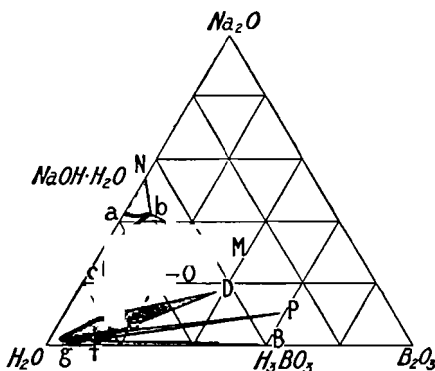

FIG. 15.—Equilibrium Conditions in the Ternary System, $\text{Na}_2\text{O}-\text{B}_2\text{O}_3-\text{H}_2\text{O}$, at 30° .

112.3 for the surface tension of sodium metaborate in ergs per sq. cm. at its b.p., and 201.1 at its m.p. H. S. van Klooster, and F. M. Jäger gave 966° for the m.p. of sodium metaborate. The latter found vaporization begins at 1230° , and is rapid at 1350° . R. Benedikt prepared crystals of **tetrahydrated sodium diborate**, $\text{NaBO}_2 \cdot 2\text{H}_2\text{O}$, or $\text{Na}_2\text{O} \cdot \text{B}_2\text{O}_3 \cdot 4\text{H}_2\text{O}$, by fusing a mol of the metaborate with two mols of sodium hydroxide, and allowing the aq. soln. to crystallize. M. Dukelsky showed the zone of stability of this salt to be bcM , Fig. 15; R. Benedikt prepared this salt by melting the higher hydrate in its water of crystallization, and drying the needle-like crystals in vacuo; and also by evaporating a soln. of borax with an excess of sodium hydroxide to a syrupy liquid, and allowing the product to crystallize. A. Rosenheim and F. Leyser confirmed M. Dukelsky's work as to the existence of the three salts, $\text{Na}_2\text{O} : \text{B}_2\text{O}_3 : \text{H}_2\text{O} = 1 : 1 : 8$; $1 : 2 : 10$; and $1 : 5 : 10$. A. Atterberg claimed to have made prismatic crystals of the two hydrates, $\text{Na}_2\text{O} \cdot \text{B}_2\text{O}_3 \cdot 4.5\text{H}_2\text{O}$ and $\text{Na}_2\text{O} \cdot \text{B}_2\text{O}_3 \cdot 5.5\text{H}_2\text{O}$, but there is no evidence that these products are not partially dehydrated octohydrates, or imperfectly dried tetrahydrates. Similar remarks also apply to J. J. Berzelius' hexahydrate, $\text{Na}_2\text{O} \cdot \text{B}_2\text{O}_3 \cdot 6\text{H}_2\text{O}$, which he claimed to have made as a confused mass of crystals, by melting the octohydrate in its own water of crystallization, and cooling the product to 0° . E. Bechi found a salt of a similar composition as an incrustation at the boric acid lagoons of Tuscany. According to J. J. Berzelius, an aq. soln. of the metaborate in hot water yields when slowly cooled in a covered vessel, large oblique rhombic prisms of **octohydrated sodium diborate**, $\text{Na}_2\text{O} \cdot \text{B}_2\text{O}_3 \cdot 8\text{H}_2\text{O}$, or $\text{NaBO}_2 \cdot 4\text{H}_2\text{O}$. H. Hahn believed the crystals to be monoclinic; R. Benedikt, triclinic. C. F. Rammelsberg also made some observations on these crystals. M. Dukelsky represented the region of stability of this hydrate at 30° by the area cdO , Fig. 15. R. Benedikt also made crystals of the same salt by concentrating a boiling soln. of equi-molar proportions of sodium hydroxide and borax to a thin syrup, and leaving it to crystallize over conc. sulphuric acid. According to J. J. Berzelius, the crystals melt at 57° in their water of crystallization and on cooling, crystals of a lower hydrate are formed; when heated to

a still higher temp., the salt tumefies, forming a frothy mass, and at a still higher temp. R. Benedikt obtained a clear glass. The dehydrated salt rapidly absorbs carbon dioxide from the air, and is gradually converted into a mixture of borax and sodium carbonate. The same change occurs when the soln. is exposed to air, but when re-boiled the carbon dioxide is gradually expelled. H. S. van Klooster found that with lithium metaborate, melting at 843°, and about 42 molar per cent. of sodium metaborate, melting at 966°, there is a eutectic at 648°. H. V. Regnault found the sp. ht. to be 0.2571 between 17° and 97°. J. Thomsen's observations on the neutralization of boric acid with sodium hydroxide (*vide boric acid*) show that the heat developed is proportional to the quantity of alkali until the ratio Na : B = 1 : 1 is attained, the heat developed then becomes small possibly owing to hydrolysis. L. Kahlenberg and O. Schreiner's and H. S. Shelton's measurements of the electrical conductivity and f.p. of soln. of sodium metaborate show that polyborates are probably formed. P. Walden measured the electrical conductivity, λ , of a soln. containing a mol of sodium metaborate in *v* litres of water at 25°, and obtained

v
λ
		32	64	128	256	512	1024		
		73.3	77.8	81.4	84.3	86.9	89.1		

and from the difference $\lambda_{1024} - \lambda_{32}$ he showed that metaboric acid is dibasic, although hydrolysis interferes with the application of Ostwald's rule. Aq. soln. of sodium metaborate react feebly alkaline, owing to hydrolysis—*vide infra*. L. Kahlenberg also said that the soln. contains but few hydroxyl-ions. E. Polenske obtained crystals of sodium metaborate with alcohol of crystallization, $\text{Na}_2\text{O} \cdot \text{B}_2\text{O}_3 \cdot 5\text{CH}_3\text{OH}$, in the residue obtained by distilling borax with methyl alcohol.

The mineral *tinkal* or *tincal* or crude *borax* was described by G. Agricola, and by J. G. Wallerius. It was originally brought to Europe from a salt lake in Tibet, where it occurs in the deposits from several lakes, and at Pugatal (Rupschn), there is a deposit about a metre thick containing sulphur, borax, sodium chloride, ammonium chloride, and magnesium and aluminium sulphates. The Thibetan deposits have been described by R. Saunders, and H. von Schlagintweit. The former described the extraction of tincal from the borax lake of Thibet. This lake is 20 miles in circumference, and is fed by springs and not by rivers and streams. It is frozen over for the greater part of the year. The tincal is deposited in the bed of the lake, and collected in the summer months from the shallowed depths and near the bank. Rock salt is also found in the deeper parts, but not in the shallows and borders. The cavities made by digging out the tincal soon fill up again. The following is from H. Vohl's analysis of tincal from Tibet:

H_2BO_3	Na_2O	K_2O	CaO	MgO	SiO_2	H_2O	Cl	H_2SO_4	Sand, etc.
36.89	16.48	0.013	0.24	0.19	0.05	44.64	0.17	0.22	0.78

In addition, alumina, 0.0013, and ferric oxide, 0.0068 per cent., with traces of manganese oxide, and carbon dioxide are found. The salt was originally purified in Holland, and France, and at Venice—hence the name *borax veneta*. Ordinary borax is **decahydrated sodium tetraborate**, $\text{Na}_2\text{B}_4\text{O}_7 \cdot 10\text{H}_2\text{O}$, or $\text{Na}_2\text{O} \cdot 2\text{B}_2\text{O}_3 \cdot 10\text{H}_2\text{O}$; and it is also called *sodium biborate* or *diborate*. Borax also occurs at Viquintzoa and Escapa in Peru; in the Sirdian steppe, Persia (H. Winklehner); at Halberstadt in Transylvania (J. D. Dana); in the Sambhar Lake, India; Kertsch and Taman (Russia) (W. S. Vernadsky and S. P. Popoff); and in Ceylon (J. R. Blum); near the soffioni of Tuscany (E. Bechi), but G. d'Achiardi found only traces of sodium in Bechi's samples at Pisa, at Chambly, and St. Ours in East Canada; in Borax Lake, in California, etc. The crude borax can be purified from earthy and fatty matters, sodium chloride, sodium sulphate, calcium borate, etc., by digestion with water, filtration, and crystallization. R. von Wagner removed the fatty matters by washing with a 5 per cent. soln. of sodium or calcium hydroxide; and M. Clouet, by calcination with 10 per cent. of sodium nitrate. A. Payen, G. Lunge, P. J. Robiquet and R. L. Marchand, and E. Durand have also described processes for purifying borax.

Before 1870, European borax was made by mixing a soln. of boric acid with the proper proportions of sodium carbonate, sodium hydroxide, or sulphide as described by F. Witting, F. Jean, A. Payen, or O. Köhnke. The range of stability of the salt at 30° is shown in Fig. 15, and at 60°, in Fig. 14. Borax crystallizes best when about an excess of 5 parts of soda crystals per 100 parts of borax is present—if the excess be too great, metaborate, $\text{NaBO}_2 \cdot 4\text{H}_2\text{O}$, will be formed. If the hot liquid be too conc., octahedral borax, $\text{Na}_2\text{B}_4\text{O}_7 \cdot 10\text{H}_2\text{O}$, will be formed. The best crystals are produced by very slowly cooling the hot soln. of the correct sp. gr. in large vats. Finely powdered borax is produced from the detritus of borax crystals, or by agitating the crystallizing liquid in small vats. Other processes have been suggested for converting boric acid into borax. For example, G. Lunge proposed fusing the boric acid with soda ash, digesting the product with water, and crystallizing the soln. The ammonium sulphate in Tuscany can be recovered as ammonium carbonate. H. N. Warren, and N. Tate suggested fusing the boric acid with sodium chloride—hydrogen chloride is a by-product. Heating the boric acid with sodium sulphate has also been tried.

The crude borax from the tincal beds, or salt marshes—*e.g.* Saline Valley, Inyo Co., Cal.—contains sand, sodium sulphate, carbonate, or chloride, admixed with 10–90 per cent. of borax. The process of purification is simple. It has been discussed by E. L. Fleming, C. N. Hake, etc. The surface to a depth of 18 ins. is mixed with boiling water in large iron pans. The clear liquor is run from the sediment into iron vats when the borax crystallizes out first; the mother liquor is conc. and again allowed to crystallize, after which it is allowed to run to waste. The borax in the waters of Searle's Lake, San Bernardino, Cal., is extracted by G. P. Burnham's process of fractional crystallization at different conc. and temp. so that the salts are separately deposited in different ponds. According to L. W. Chapman :

In Burnham's process several ponds are provided and the potash is made by running the brine into shallow ponds during the summer days, then into deep ponds at night in order to retain the heat. By continuing the process, the evaporation is maintained until the brine becomes sat. with KCl. At this point, the brine is circulated between two shallow ponds, and, on cooling at night, the potassium chloride crystallizes out in one pond, and during the day further evaporation of the sodium chloride crystallizes out in the other. Borax is made by running the brine into shallow ponds at night during the winter to cool, sodium sulphate and sodium carbonate being deposited. When the brine is coolest, in the early morning, it is run into deep ponds, where the temp. is maintained for several days, the borax gradually crystallizing out.

Borax is derived from colemanite of Death Valley and at Lang, near Los Angeles; from pandermite of Asia Minor; and from boronatrocalcite, ulexite, tiza, or cotton balls of Peru and Chili—Province of Atacama, and Ascotan, Maricunga, and Copiapó. The process for the extraction of borax from boronatrocalcite, and colemanite has been described by F. Witting, A. Kelly and R. B. R. Walker, F. M. Dupont, A. Campbell, L. Darapsky, A. Robottom, N. Gräger, etc. The manufacture involves four operations: (i) Boiling the ore with a soln. of sodium carbonate; (ii) lixiviating the filter-press mud to remove entrained borax; (iii) crystallizing the liquor; and (iv) working up the mother liquor from the crystallizing vats.

There are many modifications in detail in the different processes of extraction. In general, the crushed ore is powdered, and sifted. It is then transferred from the storage bins to the decomposing vats, where it is mixed with the mother liquid from the crystallizing vats and water. The right proportions of sodium carbonate and hydrocarbonate are added, and steam is introduced. After boiling for some time, the liquor is pumped through filter presses, and the clear liquor is run to the crystallizing vats with or without an intermediate settling vat. The mud from the filter presses is cleaned out. The crystallizing vats are filled with vertical iron rods hanging from bars. The rods are suspended in the liquor about 8 ins. apart. In about 8 days, the liquor is syphoned off, and the crystals are washed, broken from the rods and sides of the tank, dried, and granulated or powdered.

With pandermite, the powdered mineral, with the liquor, and sodium carbonate is boiled over-night in closed vessels at about 60 lbs. pressure; pandermite is also

decomposed by heating it with a soln. of sodium carbonate in autoclaves. The calcium borate furnishes a soluble basic sodium borate which is afterwards mixed with enough boric acid to produce borax.

C. Bigot and J. Schreiter converted the natural calcium borate into sodium tetraborate by mixing it with lime, and decomposing the product with sodium sulphate; E. Dressel and J. Lennhof mixed the calcium borate with sodium chloride and ammonium borate, and digested the mass under press. with ammonia at 12°, when the sodium borate is precipitated; or they digested the mineral with ammonium tetraborate, sodium chloride and sulphate. U. Sborgi and C. Franco have studied the conditions which favour the right side of the system $(\text{NH}_4)_2\text{B}_4\text{O}_7 + 2\text{NaCl} \rightleftharpoons \text{Na}_2\text{B}_4\text{O}_7 + 2\text{NH}_4\text{Cl}$. C. Masson and C. Tilière proposed digesting the mineral with a soln. of ammonium hydrocarbonate or sulphate at 60° in an autoclave at 2 atm. press. A. A. Kelly and B. D. Jones calcined the ore with alkali and treated the mixture with water and carbon dioxide at atm. or an increased press. The alkali borate was crystallized by concentrating the aq. soln. K. Harding and B. D. Jones treated the boron mineral—colemanite, boracite, ulexite, etc.—with nitre cake and sulphuric acid. R. Rickmann and E. Rappe treated the calcium borate with sodium hydrofluosilicate, $3\text{CaB}_2\text{O}_7 + \text{Na}_2\text{SiF}_6 + 4\text{H}_2\text{O} = 3\text{CaF}_2 + \text{Si}(\text{OH})_4 + \text{Na}_2\text{H}_4\text{B}_4\text{O}_{21}$. A. Schuster and M. Wilhelmly treated boronatrocalcite with fluorine, hydrofluoric acid, or a fluoride: $\text{Na}_2\text{Ca}_2\text{B}_2\text{O}_{11} + 4\text{HF} = 2\text{CaF}_2 + \text{Na}_2\text{B}_4\text{O}_7 + 2\text{B}_2\text{O}_3 + 2\text{H}_2\text{O}$; and they also proposed fusing the native borate with sodium hypophosphate: $3\text{CaB}_2\text{O}_7 + 2\text{Na}_3\text{PO}_4 = \text{Ca}_3(\text{PO}_4)_2 + 3\text{Na}_2\text{B}_4\text{O}_7$.

E. Schweizer³ stated that if a soln. of borax be evaporated on a water-bath at 90°, an amorphous mass with 26.6 per cent. of water corresponding with *tetrahydrated sodium tetraborate*, $\text{Na}_2\text{B}_4\text{O}_7 \cdot 4\text{H}_2\text{O}$, is formed. There is no particular reason for assuming that this partially dehydrated product is a chemical individual. The observations and analyses of J. J. Berzelius, A. Stromeyer, C. F. Rammelsberg, J. J. Ebelmen, J. Tünnermann, J. C. G. de Marignac, H. Rose, P. Bolley, T. J. Hera-path, A. Laurent, and C. Tissier show that if borax soln. be crystallized below 60°–62°, *decahydrated sodium tetraborate*, $\text{Na}_2\text{B}_4\text{O}_7 \cdot 10\text{H}_2\text{O}$, is formed, but if over that temp., *pentahydrated sodium tetraborate*, $\text{Na}_2\text{B}_4\text{O}_7 \cdot 5\text{H}_2\text{O}$, appears. J. Ponomarev measured the m.p. of fused mixtures of borax and boron trioxide and found evidence of the formation of *sodium hexaborate*, $\text{Na}_2\text{B}_6\text{O}_{10}$, m.p. 694°, and of *sodium octoborate*, $\text{Na}_2\text{B}_8\text{O}_{13}$, m.p. 783°. There is a continuous series of solid soln. ranging from $\text{Na}_2\text{B}_4\text{O}_7$ to $\text{Na}_2\text{B}_8\text{O}_{13}$. E. Soubeiran and F. A. Pellerin first reported crystals of the pentahydrate; its range of stability at 60° is shown in Fig. 14. According to D. Gernez, if a supersaturated soln. of borax be allowed to evaporate spontaneously at ordinary or at elevated temp., the pentahydrate is formed. The supersat. soln. can be made by dissolving three parts of the ordinary decahydrate in 4 parts of warm water, and cooling the mixture rapidly in a flask with the contents protected from the dust; or a dil. soln. can be evaporated in vacuo, but in the latter case, care must be taken that undissolved particles of the decahydrate are not present. A. Payen recommended dissolving in water at 100° enough borax to form a soln. of sp. gr. 1.246; on cooling, the pentahydrate begins to separate at 79°, and continues to 56°, below this temp. the ordinary decahydrate is formed; on the other hand, a soln. of sp. gr. 1.17 gives nothing but the ordinary decahydrate. T. W. Richards and J. B. Churchill found that the transition temp. could not be located very precisely. E. Soubeiran, and F. A. Pellerin stated that if the soln. of the pentahydrate be boiled for some time it appears to yield more pentahydrate, even when cooled below 56°; but D. Gernez doubted this statement. C. Tomlinson found the under-cooled soln. can be preserved at –17.8°. D. W. Horn and E. M. van Wagener showed that while the decahydrate and the metastable pentahydrate can be obtained side by side below 62°, only the pentahydrate crystallizes from soln. above this temp.

The unsaturated character of boric acid as a derivative of tervalent boron leads to the formation of stronger, polyboric acids which, according to J. Böeseken, must be derivatives of quinquevalent boron; and he writes the formula of borax:

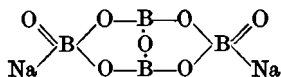

but the direct union of sodium to boron in borax is not probable. Anhydrous borax

forms a clear brittle glass—*borax glass*; but, according to C. H. Burgess and A. Holt, if borax glass be kept some hours at a temp. at which a viscid syrup is formed, small colourless needle-like crystals are formed. The crystals of borax were described by C. F. Naumann in 1829, and by A. Lévy in 1837. The crystals of the decahydrate are monoclinic prisms, with axial ratios, according to C. F. Rammelsberg, $a : b : c = 1.0995 : 1 : 0.5629$, and $\beta = 106^\circ 35'$. Measurements were also made by H. Hahn, H. de Sénarmont, and by M. S. Miguel and M. de J. Naranjo y Vega. A. Payen said that the crystals of the pentahydrate are octahedral, and hence the salt is often called *octahedral borax*, but this is a misnomer, since the crystals were shown by A. Arzruni to be hexagonal rhombohedrons belonging to the trigonal system, with the axial ratio $a : c = 1 : 1.87$, and $\alpha = 72^\circ 2'$. G. Brügelmann reported mixed crystals with sodium chlorate and borax containing 89.19 per cent. NaClO_3 , 4.7 per cent. $\text{Na}_2\text{B}_4\text{O}_7$, and 6.11 per cent. of water, but O. Lehmann showed that the two salts crystallize from the mixed soln. side by side. H. Baumbauer studied the analogies between the crystal forms of borax and diopside, and the **corrosion figures**; M. Kuhara investigated the **percussion figures** of borax. The **specific gravity** of anhydrous borax was stated by E. Filhol to be 2.367; by P. A. Favre and C. A. Valson, 2.371 at 20° ; by P. P. Bedson and W. C. Williams, 2.368 at 16° , and 2.373 at 18.5° ; G. Quincke gave 2.5 for the sp. gr. of borax glass; A. Payen gave 1.815 for the sp. gr. of the pentahydrate, and for the decahydrate, 1.74; R. Boyle gave 1.714; R. Kirwan obtained a similar result for the decahydrate; while R. Watson gave 1.757; J. H. Hassenfratz, 1.723; L. Playfair and J. P. Joule, 1.730 at 3.9° ; E. Filhol, 1.692; H. J. Buignet, 1.692; F. Stolba, 1.7156 at 17° ; P. A. Favre and C. A. Valson, 1.711 at 20° ; W. C. Smith, 1.736; and J. Dewar, 1.694 at 17° , and 1.728 at -188° . The sp. gr. of aq. soln. with 2.08, 2.44, and 3.65 per cent. of $\text{Na}_2\text{B}_4\text{O}_7$ were found by P. P. Bedson and W. C. Williams to be respectively 1.0185, 1.0211, and 1.0331 at 20° ; F. Forster found for 1.34 and 2.65 per cent. soln., 1.0105 and 1.0247 respectively at 25° . G. T. Gerlach gave for the soln. at 15° :

Per cent. decahydrate	0.5288	1.0576	1.5864	2.1152	2.6439	3.1727
Sp. gr.	1.0049	1.0099	1.0149	1.0199	1.0249	1.0299

F. Stolba found a soln. sat. at 17° had a sp. gr. 1.0208, and H. G. Greenish and F. A. U. Smith 1.020 at 16.5° . Measurements were also made by F. Fouqué, and by A. Michel and L. Krafft. The **hardness** of the decahydrate is 2.0–2.5 on Mohs' scale, and A. Payen said that the pentahydrate is harder than the decahydrate. G. Quincke gave for the **surface tension** of fused borax at 1000° , 211.9 dynes per cm., and for the **specific cohesion**, $a^2 = 17.28$ per sq. mm.

Borax glass becomes opaque on exposure to air, owing to the absorption of moisture; indeed, H. V. Blücher found that after powdered borax glass had been exposed for a few months to air, it was completely converted into the decahydrate; but C. H. Burgess and A. Holt found that the needle-like crystals of anhydrous borax are non-hygroscopic.

The decahydrate effloresces superficially in dry air, and becomes opaque; the crystals of the pentahydrate were found by A. Payen to absorb water and become opaque; while D. Gernez found that they remain transparent even in air sat. with moisture, if dust is excluded, but in ordinary atm. air, they become white and some decahydrate is formed. The decahydrate decrepitates when heated, but, according to A. Payen, the pentahydrate does not. A. Atterberg found that when the decahydrate is heated to 80° , it loses four-fifths of its water, and at 100° more water is continuously given off, and all is lost at 200° ; the pentahydrate was found by D. Gernez to lose part of its water at 57° . When the decahydrate is heated, it tumefies, swelling up to a spongy mass called *borax usta*, or *calcined borax*; at a higher temp. this runs together, forming a clear colourless glass—*borax glass*. V. Meyer and W. Riddle said that the **melting point** of borax glass is 878° ; T. Carnelley, 561° ; J. Ponomarey, 730° ; and A. L. Day and co-workers, 741° . The glass, of course, has not a true m.p., it gradually softens on a rising temp.;

C. H. Burgess and A. Holt found the crystals of the anhydrous salt melt at a higher temp. than the glass.

Borax is lost by **volatilization** during calcination; the proportion lost depends on the magnitude of the exposed surface, and the duration of the heating; thus S. Walbott found, by heating 0.6532 grm. of borax glass in a crucible over a gas-blowpipe flame:

Time	.	.	.	5	12	22	29	39	44	46 mins.
Loss	.	.	.	0.8	1.0	2.0	2.5	3.3	4.1	4.2 per cent.

and E. Cramer found at about 1200°:

Time	3	26	48	60 hrs.
Loss	1.47	7.88	22.40	48.98 per cent.

T. H. Norton and D. M. Roth said that in the hottest part of a Bunsen's flame, sodium chloride volatilizes 16.54 times as fast as borax. H. Lescœur measured the **vapour pressure** of the hydrates of sodium tetraborate, and obtained indications of the formation of a di-, penta-, and a deca-hydrate. E. Löwenstein made some remarks on this subject. E. Jänecke also claimed to have formed **dihydrated sodium tetraborate**, $\text{Na}_2\text{B}_4\text{O}_7 \cdot 2\text{H}_2\text{O}$, by compressing the pentahydrate which melts under the operation.

According to G. Tammann, the lowering of the vap. press. of aq. soln. of 5.78, 19.07, and 50.22 grms. of borax, $\text{Na}_2\text{B}_4\text{O}_7$, per 100 grms. of water are respectively 13.5, 32.4, and 63.2 mm. G. T. Gerlach measured the **boiling point** of soln. containing g grms. of $\text{Na}_2\text{B}_4\text{O}_7$ grms. of water, and found:

g	.	.	.	8.64	17.2	26.5	37.5	48.5	61.2	90.8	112.3
B.p.	.	.	.	100.5°	101°	101.5°	102°	102.5°	103°	104.0°	104.6°

The soln. boiling at 103° is sat., those boiling at a higher temp. are supersaturated. T. Griffiths placed the b.p. of a sat. soln. at 105°. L. Kahlenberg and O. Schreiner, and H. S. Shelton measured the lowering of the **freezing point** of aq. soln. of borax, and found with 0.0125, 0.0250, 0.0500, and 0.1000 mol of borax per litre, a mol. depression respectively of 10.6°, 9.7°, 8.3°, and 7.2°. The high values in the more dil. soln. are taken to show that the mol dissociates as symbolized by: $\text{Na}_2\text{B}_4\text{O}_7 + \text{H}_2\text{O} = 2\text{Na}^+ + 2\text{BO}_2^- + 2\text{HBO}_2$.

H. V. Regnault gave 0.2382 for the **specific heat** of borax glass between 16° and 98°, and H. Kopp, 0.229 between 17° and 47°; the latter also gave 0.385 for the sp. ht. of the decahydrate between 19° and 50°. M. Berthelot gave 74.81 Cals. for the **heat of formation** of the anhydrous salt from its elements; W. G. Mixer gave for $3\text{Na}_2\text{O} + \text{B}_2\text{O}_3 = 2\text{Na}_3\text{BO}_3 + 104.2$ Cals. P. A. Favre and C. A. Valson found 10.2 Cals. for **heat of solution** of the anhydrous salt; and -23.9 Cals. for the decahydrate; J. Thomsen found -25.9 Cals. for the heat of soln. of a mol of the decahydrate in 1600 mols of water. Hence, the **heat of hydration** is 34.1 Cals.

The **refractive index** of isotropic borax glass was found by P. P. Bedson and W. C. Williams to be 1.5216 for the H_α -line; 1.5147 for the Na-line; and 1.5139 for the H_β -line. H. Dufet gave for crystals of the decahydrate:

		F-line	Tl-line	Na-line	C-line	Li-line
α	.	1.4517	1.4491	1.4467	1.4445	1.4441
β	.	1.4750	1.4719	1.4694	1.4669	1.4665
γ	.	1.4778	1.4778	1.4724	1.4699	1.4695

Measurements have also been made by D. Brewster, A. des Cloizeaux, F. Kohlrausch, and G. Tschermak. The crystals of the pentahydrate have a positive **double refraction**, that of the decahydrate is negative. According to H. de Sénarmont, the decahydrate shows a well-defined *dispersion croisée*. J. H. Gladstone and W. Hibbert found the **molecular refraction** of fused borax to be 42.80 for the A-line, and 42.83 in sat. soln. F. Forster gave 0.1663 for the specific refraction. A. Schrauf studied the absorption of vibrations in different directions in the crystals of borax.

H. Murschhauser found that the specific rotation of soln. of glucose and borax decreased as the conc. of the soln. increased.

C. Doelter found the crystals to be fairly transparent to **X-rays**, being about the same as corundum, and less than boric acid. A sample of borax from Mono Lake was found by C. Baskerville to phosphoresce in **ultra-violet light**—probably the effect of certain impurities because no other sample showed any phosphorescence. W. W. Coblenz found the **ultra-red transmission spectrum** of borax glass gave bands at 1.9μ , 3μ , 3.7μ , and 4.8μ ; and in the reflection spectrum wide maxima at 7.5μ and 10μ . According to E. Tiede and co-workers, when boric acid is mixed with certain organic substances, particularly aromatic and heterocyclic substances, and partly dehydrated by melting, it is found on cooling that the mixtures are strongly phosphorescent. These substances after illumination by ultra-violet light emit a phosphorescent glow of a colour which varies with the organic substance and in the best cases persists for two to three minutes after the exciting light is removed.

According to P. Burkhard,⁴ molten borax conducts electricity, and during electrolysis, oxygen is given off at the anode, and at the cathode, a gas which burns with a yellow flame is given off; if a platinum cathode is used, platinum boride is formed. A. Z. Hartmann also studied the electrolysis of molten borates. P. Walden found the eq. **electrical conductivity**, λ , and H. C. Jones the mol. conductivity, μ , of an aq. soln. of borax with a mol of the salt in v litres of water, at 0° to 65° to be

v	16	32	128	512	1024	2048	4096
μ_{0°	57.99	64.36	72.87	78.04	79.20	83.45	85.50
μ_{25°	113.54	125.49	141.72	152.00	153.40	161.23	163.99
μ_{55°	231.3	256.2	281.6	316.7	—	359.3	—

The calculated percentage **degrees of ionization**, α , are :

v	16	32	128	512	1024	2048	4096
α_{0°	67.8	75.3	85.3	91.3	92.7	97.6	100.0
α_{25°	69.2	76.5	86.4	92.7	93.5	98.3	100.0

The assumptions on which the calculations are based are wholly inadequate on account of hydrolytic and other disturbing reactions. H. C. Jones also calculated the temp. coeff. of the conductivity for soln. of different conc. L. Kahlenberg and O. Schreiner, A. A. Noyes and W. R. Whitney, and H. S. Shelton found that with soln. made up from borax; or from the corresponding amounts of sodium metaborate and boric acid; or from sodium hydroxide and boric acid, both the lowering of the f.p. and the conductivity determinations agree that the borax is probably ionized in dil. aq. soln.: $\text{Na}_2\text{B}_4\text{O}_7 + \text{H}_2\text{O} = 2\text{Na}^+ + 2\text{BO}_2^- + 2\text{HBO}_2$. The univalency of the borate-ions in soln. was tested by P. Walden's application of Ostwald's rule for the mol. conductivity of soln. of the sodium salt: $\mu_{1024} - \mu_{32} = 13.5$; this value is greater than that required for univalent ions; but the discrepancy was attributed to disturbances due to hydrolysis. F. Auerbach showed that with conc. soln. complexes are formed. P. Müller and R. Abegg calculated that at 25° , a soln. of borax with the conc. expressed in mols per litre :

Conc. of Na ⁺ -ion	0.050	0.090	0.206
Conc. of free boric acid	0.043	0.058	0.066
Conc. of boric acid in polyborates	0.007	0.041	0.140

The work of A. Atterberg, M. Dukelsky, etc., has shown that a polyborate of the type $\text{Na}_2\text{O} \cdot 5\text{B}_2\text{O}_3 \cdot 10\text{H}_2\text{O}$ is formed in conc. soln. Besides the equilibrium between the different borate ions in aq. soln., the salt is hydrolyzed. As shown by C. Herzog, the dissociations of the salt in aq. soln. into acid and base is evidenced by soln. colouring red litmus blue, and turning turmeric brown. As shown by H. Rose, J. Shields, L. C. Barreswil, W. Henneberg, J. Bottomley, P. Georgievic, etc., the hydrolysis explains the action which the feeblest of acids and the halogens exercise on soln. of borax. J. Walker estimated that a $0.1N\text{-NaBO}_2$ soln. was 0.84 per cent. hydrolyzed, and J. Shields, that a $0.1N\text{-Na}_2\text{B}_4\text{O}_7$ soln. is

between 0.3 and 0.5 per cent. H. Menzel found the degree of hydrolysis of M molar soln. to be :

M	0.4	0.2	0.1	0.04	0.02	0.01
Per cent. hydrolysis	0.50	0.57	0.76	1.22	1.70	2.30

He also studied the equilibrium conditions in the reaction $2\text{Na}_2\text{CO}_3 + \text{Na}_2\text{B}_4\text{O}_7 + \text{H}_2\text{O} \rightleftharpoons 2\text{NaHCO}_3 + 4\text{NaBO}_2$. R. Abegg and A. J. Cox have computed the solubility product of the soln. A. Schrauf studied the **magnetic axes** of the crystals. G. Meslin found borax to be diamagnetic.

In measuring the **solubility** of borax, G. J. Mulder⁵ found 100 parts of water at 0° dissolve 1.4 and at 100°, 55.3 parts of anhydrous borax. Y. Osaka found 100 grms. of water at 25° dissolve 3.33 grms. of $\text{Na}_2\text{B}_4\text{O}_7$. Measurements were also made between 0° and 100° by A. B. Poggiale. D. W. Horn and E. M. van Wegener found that the solubility, S , with soln. crystallized from supersaturation, expressed in grams per 100 grms. of $\text{Na}_2\text{B}_4\text{O}_7$, is :

S	0.5	10	30	50	60	62	65	70	80	100
	1.3	1.6	3.9	10.5	19.4	22	24	24.4	31.4	52.3

Solid phases

$\text{Na}_2\text{B}_4\text{O}_7 \cdot 10\text{H}_2\text{O}$

$\text{Na}_2\text{B}_4\text{O}_7 \cdot 5\text{H}_2\text{O}$

The results are graphed in Fig. 16. The transition temp., $\text{Na}_2\text{B}_4\text{O}_7 \cdot 10\text{H}_2\text{O} \rightleftharpoons \text{Na}_2\text{B}_4\text{O}_7 \cdot 5\text{H}_2\text{O} + 5\text{H}_2\text{O}$, is very nearly 62°, O , Fig. 16. J. H. van't Hoff and

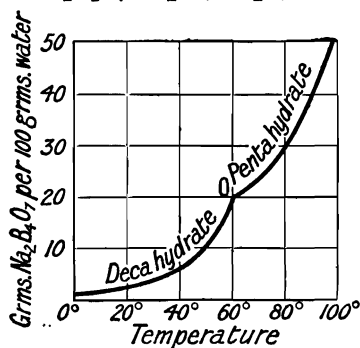

FIG. 16.—Solubility Curve of Borax in Water.

W. C. Blasdale said that in the presence of sodium chloride the transition temp. can be reduced to 35.5°. H. Lescœur is of the opinion that at 125°, the pentahydrate passes into **dihydrated sodium tetraborate**, $\text{Na}_2\text{B}_4\text{O}_7 \cdot 2\text{H}_2\text{O}$. A. Rosenheim and F. Leyser gave 0.14 mol per litre for the solubility of sodium diborate at 0°. M. Dukelsky studied the ternary system $\text{Na}_2\text{O} - \text{B}_2\text{O}_3 - \text{H}_2\text{O}$, at 30°; and U. Sborgi and F. Mecacci, the same system at 60°. J. H. van't Hoff and W. C. Blasdale found that in aq. soln. a mixture of sodium chloride and potassium borate forms potassium chloride and sodium borate at 25° and 83°. Table II shows the composition of soln.—mols of salt per 1000 mols of water sat. with borax and sodium chloride,

and the salts indicated.

TABLE II.—COMPOSITION OF SATURATED SOLUTIONS OF BORAX AND SOME OTHER SALTS.

Soln. sat. with borax sodium chloride, and	Na_2Cl_2	K_2Cl_2	Na_2SO_4	$\text{Na}_2\text{B}_4\text{O}_7$	Na_2Cl_2	K_2Cl_2	Na_2SO_4	$\text{Na}_2\text{B}_4\text{O}_7$
	54	—	—	1.01	50.5	—	—	8.9
KCl	45.4	19.6	—	1.39	33.1	39.5	—	19.1
Na_2SO_4	49.7	—	12.5	1.07	52.0	—	8.8	10.1
NaCl, glaserite	44.8	18.4	4.5	1.46	29.1	40.5	4.6	19.7
Na_2SO_4 , glaserite	43.5	9.2	14.6	1.18	30.7	20.9	10.9	13.5

According to D. S. Wester and A. Bruins, 100 grms. of *trichloroethylene* dissolve 0.011 gm. of sodium tetraborate at 15°. A. Stromeyer found that borax is virtually insoluble in absolute *alcohol*, but readily dissolves in an alcoholic soln. of *sodium acetate*, while, according to the U.S. Pharmacopœia, 100 grms. of alcohol, sp. gr. 0.941, dissolve 2.48 grms. of sodium borate at 15.5°; A. Vogel found that 100 parts of *glycerol* of sp. gr. 1.225 dissolve 6.7 parts of borax; and, according to the U.S. Pharmacopœia, (1907), 100 grms. of glycerol dissolve 60.3 grms. at 15.5°, and 100 grms. at 80°.

L. F. Kebler showed that glycerol and other polyhydric alcohols decompose a soln. of borax into sodium metaborate and boric acid. Molten borax glass dissolves many **metallic oxides**, which impart characteristic colours in oxidizing and reducing atm. Hence the use of borax in qualitative blowpipe analysis; and as a flux in soldering. H. Rose found that ferric oxide crystallizes from the soln. as magnetic oxide of iron; and titanite oxide, as rutile. G. Wunder also found that the oxides of the alkaline earths furnish characteristic crystals. J. J. Berzelius, A. Knop, and C. H. Burgess and A. Holt have studied this subject.

According to M. Faraday, a soln. of borax first reddens turmeric paper because of the excess of alkali; but as the colouring matter becomes altered by the presence of boric acid, the tint becomes dirty blue, and the paper then behaves towards acids and alkalies just as if it had been cooled by boric acid—*q.v.* An aq. soln. of borax is decomposed by **chlorine** into sodium hypochlorite; and when evaporated with **hydrochloric acid** on a water-bath it is all decomposed into sodium chloride and boric acid. J. L. Gay Lussac,⁶ and A. Laurent found that when an aq. soln. of borax coloured blue with litmus, is titrated with **sulphuric acid**, the blue colour changes to claret-red, and finally red when all the sodium has been converted to sulphate. H. Rose said that when a soln. of borax which has been made feebly acid is diluted with hot water, it again reacts alkaline—J. Joulin did not confirm this statement. According to E. Schweizer, when an aq. soln. of borax is sat. with **hydrogen sulphide**, sodium sulphide and free boric acid are formed. No borax is precipitated when the soln. is treated with alcohol; and when shaken with ether, two layers appear—the lower layer contains sodium sulphide, the upper layer boric acid; similarly, an aq. soln. of borax absorbs **carbon dioxide** until all the sodium is converted into carbonate, when the soln. reacts acid; alcohol does not precipitate borax from this soln., but when evaporated, the carbon dioxide is expelled, and borax remains. According to E. D. Clarke, a mixture of borax glass and **carbon** boils in the oxy-hydrogen flame giving off a white smoke, and forming a substance which becomes white on exposure to air. H. Murschhauser studied the effect of borax on the mutarotation of sugar. Gelatinous **silicic acid** does not act on a soln. of borax, but **organic acids** displace the boric acid. C. J. B. Karsten stated that when borax is triturated with **ammonium chloride**, ammonia is produced. According to G. Dragendorff, when a mixture of **phosphorus** and powdered borax glass is heated to redness, a dark brown glass is formed from which boron separates when agitated with water. C. Winkler found that when a mixture of borax and **magnesium** powder is heated in the absence of air, sodium, sodium metaborate, magnesium oxide, and magnesium boride are produced. A. Laurent stated that when **iron** is heated with borax glass a combustible gas is given off. T. Bergman added that when a soln. of borax is dropped into metallic salt soln., freed as much as possible from acid, sparingly soluble borates are precipitated from soln. of mercury, lead, copper, iron, tin, nickel, cobalt, and zinc; but soln. of gold, platinum, bismuth, and manganese remained undisturbed. W. Ackermann prepared what he called *boric acid water-glass* by gently warming a mixture of boric acid and borax in the proportions of 1 : 3. The product is supposed to be analogous to ordinary water-glass, and to be a colloidal soln. of boric acid in borax. The aq. soln. is rather less stable than ordinary water-glass, for it tends to solidify, and crystallize on standing, especially if shaken. It is said to have several advantages over borax as a flux in soldering.

Some uses of borax.—Borax and boric acid have an extraordinary number of applications in different industries.⁷ They are used as constituents in making enamels for iron, and other metals; in the manufacture of pottery glazes; in making glass, artificial gems and strass; and in the manufacture of pigments for glass painting. Borax is used in making Guignet's green. It is employed in the tannery, and in the currying shops for dissolving dirt and blood from skins and thus ensuring a more rapid liming. It is used for cutting oils and fats used in stuffing leather and in bleaching and mordanting leather. It is used in the laundry in washing and starching; it helps to give linen a high gloss. Many commercial starches contain borax; and borax is also used in making some soaps. Borax is used as a wood preservative against dry rot, and on account of its antiseptic qualities it is

introduced in cosmetics, mouth-washes, tooth-powders, and salves. It is used as a constituent of powders for killing insects, etc. It is employed as a preservation for meats, fish, and other food-stuffs. A varnish for stuffing hats is made from borax and shellac. A mixture of casein and borax is a substitute for gum and it is moisture-proof. The paper mills use borax in making a kind of parchment, and borax is used in making sizes and coatings for glazed papers and playing cards. Borax is used as a stiffening agent for the wicks of stearin candles; and it is also used in calico-printing. On account of the solvent action of fused borax on metal oxides, it is used for keeping a clear surface in the welding and brazing of metals. It is also used as a flux in many other operations; and in blowpipe analysis. Borax is employed in making manganese borate to be used as a drying agent for oils.

In addition to the tetraborates, represented by borax, other still more acid borates have been reported. According to L. Barthé,⁸ when a boiling soln. of equal parts of borax and boric acid is cooled, the first crop of crystals has the composition: $2\text{Na}_2\text{O}\cdot 3\text{B}_2\text{O}_3$; the second crop, $\text{Na}_2\text{O}\cdot 2\text{B}_2\text{O}_3$; and the third crop, $2\text{Na}_2\text{O}\cdot 5\text{B}_2\text{O}_3$. These products are in all probability mixtures. L. Spiegel found that soln. of borax containing an excess of boric acid deposit crystals of **sodium hexaborate**, $\text{Na}_2\text{O}\cdot 3\text{B}_2\text{O}_3\cdot n\text{H}_2\text{O}$, and he found a sample of commercial borax which he assumed to contain this salt because of its high B_2O_3 content. I. F. Ponomarey also examined the hexaborate. H. le Chatelier reported the formation of **sodium octoborate**, $\text{Na}_2\text{O}\cdot 4\text{B}_2\text{O}_3\cdot n\text{H}_2\text{O}$, apparently analogous with the corresponding lithium salt. P. A. Bolley prepared what he regarded as the decahydrate by boiling a soln. of two eq. of borax with one eq. of ammonium chloride. If the soln. is moderately dil., ammonia gas is evolved, and when the evolution of gas has ceased, the filtered soln. furnishes milk-white or transparent crystals. I. F. Ponomarey also examined the octoborate. Analyses by A. Laurent, and P. A. Bolley agree with the formula $\text{Na}_2\text{O}\cdot 4\text{B}_2\text{O}_3\cdot 10\text{H}_2\text{O}$. The crystals lose water when heated, but do not swell up so much as borax; 100 parts of water dissolve 17–20 parts of the salt. The soln. is neutral to litmus.

The aq. soln. precipitates boric acid when treated with dil. acids, and it gives precipitates with those salts which gave precipitates with soln. of borax; although the products sometimes differ in colour and solubility both lose boric acid when washed with water. A. Atterberg believed that P. A. Bolley's salt is a mixture of tetra- and deca-borates.

A. Atterberg found that a soln. of a mol. of sodium hydroxide with 5 mols of boric oxide deposits small prismatic crystals of **decahydrated sodium decaborate**, $\text{Na}_2\text{O}\cdot 5\text{B}_2\text{O}_3\cdot 10\text{H}_2\text{O}$ —also called *sodium pentaborate*. The first crop of crystals contains a little boric acid; and the last crop a little borax. M. Dukelsky prepared this salt and showed the conditions of stability at 30° —*vide* Fig. 15. Judging from U. Sborgi and F. Mecacci's study at 60° , the salt does not appear to be stable at 60° in aq. soln. M. Dukelsky, and A. Rosenheim and F. Leyser, as indicated above, also prepared decahydrated sodium decaborate, $\text{Na}_2\text{O}\cdot 5\text{B}_2\text{O}_3\cdot 10\text{H}_2\text{O}$. The solubility at 0° is 10.3 mols per litre. A. A. Kelly and B. D. Jones prepared the decaborate by passing sulphur dioxide into a mixture of 100 parts boronatrocalcite and 400 parts of water: $\text{Na}_2\text{O}\cdot 2\text{CaO}\cdot 5\text{B}_2\text{O}_3 + 3\text{SO}_2 = 2\text{CaSO}_3 + \text{Na}_2\text{SO}_3 + 5\text{B}_2\text{O}_5$. The calculated amount of boronatrocalcite is added, and the mixture boiled: $\text{Na}_2\text{O}\cdot 2\text{CaO}\cdot 5\text{B}_2\text{O}_3 + 2(\text{Na}_2\text{SO}_3 + 5\text{B}_2\text{O}_3) = 2\text{CaSO}_3 + 3(\text{Na}_2\text{O}\cdot 5\text{B}_2\text{O}_3)$. The borate may be recovered by crystallization. W. Voss obtained the decaborate by treating boronatrocalcite with sufficient sulphuric and boric acids to form the required salt. A. Atterberg found the crystals rapidly lose 6 mols of water at 80° , and slowly two mols more; at 200° , one mol of water is still retained, but at higher temp. all the water is expelled with intumescence. A. Atterberg believes this salt is the same as that prepared by A. Laurent, to which the formula $5\text{Na}_2\text{O}\cdot 24\text{B}_2\text{O}_3\cdot 55\text{H}_2\text{O}$ was assigned.

J. Tünnermann reported hydrated **sodium dodecaborate**, $\text{Na}_2\text{O}\cdot 6\text{B}_2\text{O}_3\cdot n\text{H}_2\text{O}$ —water 30 per cent.—to be formed in tabular crystals by adding boric acid to an aq. soln. of borax until the soln. no longer reddens turmeric, and evaporating and cooling. The salt tastes like nitre, and is neutral to vegetable colours; it swells up when heated, and melts to a clear glass. A. Laurent stated that if 2 mols of sulphuric acid are added to 3 mols of borax, the mixture does not redden litmus because the dodecaborate is formed, but with another mol of sulphuric acid the soln. reddens litmus because boric acid is liberated, and with another

drop of sulphuric acid, the litmus is coloured bright red from the excess of the last-named acid. A. A. Noyes and W. R. Whitney infer the formation of complex borates as high as the dodecaborate because the heat of neutralization of sodium hydroxide with boric acid steadily increases up to this proportion.

J. A. Arfvedson,⁹ H. Rose, C. L. Bloxam, and N. Tate measured the amount of carbon dioxide expelled when boric acid is fused with potassium carbonate, from which it appears that at a dark red heat a mol of B_2O_3 drives out one mol of carbon dioxide from an excess of the carbonate, and at a bright red heat, 1.08–1.26 mol of carbon dioxide. C. L. Bloxam found that when boric acid is boiled with an aq. soln. of the carbonate three mols of B_2O_3 decompose one mol of potassium carbonate. C. L. Bloxam measured the water evolved when boric oxide is fused with potassium hydroxide, and found: $B_2O_3 + 4KOH = 2K_2O \cdot B_2O_3 + 2H_2O$. There is no other evidence of the formation of a basic carbonate. M. Dukelsky studied the ternary system, $K_2O \cdot B_2O_3 \cdot H_2O$, at 30° , and his results are shown graphically in Fig. 17. The area *Kab* refers to the solid phase $KOH \cdot 2H_2O$; *bMc*, to the phase $K_2O \cdot B_2O_3 \cdot 2\frac{1}{2}H_2O$; *cDd*, to the solid phase $K_2O \cdot 2B_2O_3 \cdot 4H_2O$; *dPe*, to the solid phase $K_2O \cdot 5B_2O_3 \cdot 8H_2O$; and *eBf*, to solid boric acid, $B(OH)_3$.

As already indicated, J. A. Arfvedson, H. Rose, etc., found that a mol. of boric oxide will displace approximately a mol. of carbon dioxide from an excess of potassium carbonate at a red heat; and this was taken to show that **potassium metaborate or diborate**, $K_2O \cdot B_2O_3$, or KBO_2 ,

is formed; and J. J. Berzelius fused eq. proportions of carbonate and boric oxide or acid at a white heat. J. Schabus also prepared monoclinic plates of this salt with axial ratios $a : b : c = 2.7440 : 1 : 2.6760$, and $\beta = 93^\circ 54'$. J. J. Berzelius added that the salt dissolves in water with difficulty, and does not crystallize from the soln.; it has a caustic alkaline taste and absorbs carbon dioxide from the air, forming a mixture of potassium carbonate and the tetraborate $K_2O \cdot 2B_2O_3$. A. Atterberg prepared what he regarded as a trihydrate, $K_2O \cdot B_2O_3 \cdot 3H_2O$, by dissolving the anhydrous compound in water, and evaporating it over sulphuric acid with an excess of potassium hydroxide. The microscopic crystals lose their water when heated, without changing their form, and the residue melts at a white heat, being much less fusible than the more acid salt. S. Motylewsky found the drop-weight of the molten salt to be 155 when that of water at 0° is 100 mgrms. H. S. van Klooster, and F. M. Jäger gave 947° for the m.p. of potassium metaborate. The surface tension at 992° is 123.5 ergs per sq. cm., and at 1142° , 96.6 ergs per sq. cm. A. Atterberg found that the salt volatilizes rapidly at a white heat. The fused salt forms needle-like crystals on cooling. It absorbs much gas while being melted, and this is rejected on cooling, thus causing some decrepitation. The salt deliquesces in air, absorbing carbon dioxide as well as water. It would appear that this salt is probably the same as the hemipentahydrate, $K_2O \cdot B_2O_3 \cdot 2\frac{1}{2}H_2O$, of M. Dukelsky, the zone of stability of which in aq. soln. at 30° is indicated by the area *bcM*, Fig. 17. A. Rosenheim and F. Leyser gave the solubility of the diborate as 0.9 mol per litre at 0° .

A. Atterberg obtained the **tetrahydrated potassium tetraborate**, $K_2O \cdot 2B_2O_3 \cdot 4H_2O$, monoclinic prisms which, when heated, lost their water with intumescence, and finally fused to a clear glass, which H. J. Buignet found to have a sp. gr. 1.74. M. Dukelsky showed that the zone of stability of the tetrahydrate in aq. soln. is represented by the area *cDd*, Fig. 17. A Laurent made a pentahydrate, $K_2O \cdot 2B_2O_3 \cdot 5H_2O$, in

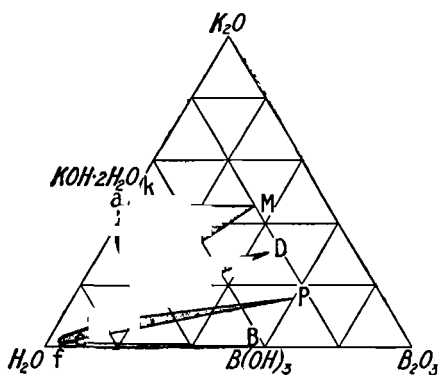

FIG. 17.—Equilibrium in the Ternary System, $K_2O-B_2O_3-H_2O$, at 30° .

hexagonal prisms by crystallization during the cooling of a boiling soln. of potassium carbonate mixed with an excess of boric acid, and made alkaline with potassium hydroxide. The first crop of crystals contain the octohydrated hexaborate, but afterwards the tetraborate alone appears. The salt dissolves readily in hot and cold water; it tastes slightly alkaline, reddens turmeric; tumefies when heated; and finally fuses to a clear glass. A. Atterberg reported a hemihenadecahydrate, $K_2O \cdot 2B_2O_3 \cdot 5\frac{1}{2}H_2O$, to be formed in hexagonal prisms by evaporating at ordinary temp. the aq. soln. of a fused mixture of eq. proportions of the component salts. A. Laurent, and A. Atterberg also reported monoclinic prisms of the hexahydrate, $K_2O \cdot 2B_2O_3 \cdot 6H_2O$, which lost 2 mols at 75° ; 2 mols more at 100° ; and which retained one mol of water at 200° . M. Dukelsky obtained no evidence of any other than the tetrahydrate at 30° , so that the penta- to the hexa-hydrates were possibly the tetrahydrate with entrained water. A. Rosenheim and F. Leyser made **potassium pentaborate** with a solubility of 0.07 mol per litre at 0° .

H. Schiff observed that the aq. soln. of the tetraborate absorbs much iodine to form a colourless soln. Potassium iodide and iodate are formed in accord with the equation $9K_2B_4O_7 + 3I_2 = 6K_2B_6O_{10} + 5KI + KIO_3$; as well as hydrated **potassium hexaborate**, $K_2O \cdot 3B_2O_3 \cdot nH_2O$. W. Reissig prepared what he regarded as the pentahydrate, $K_2O \cdot B_2O_3 \cdot 5H_2O$, by cooling to 6° a boiling soln. of a mol of potassium carbonate with 2 mols of boric oxide. The rhombic prisms so obtained have the axial ratios $a : b : c = 0.5285 : 1 : 0.9206$; and are stable in air. A. Laurent obtained what he regarded as the octohydrated hexaborate, $K_2O \cdot 3B_2O_3 \cdot 8H_2O$, during the preparation of the tetraborate. The rhombic prisms have the axial ratios $a : b : c = 0.77 : 1 : 0.70$; they are stable in air; and readily melt with intumescence. A. Atterberg believes that A. Laurent's salt is really the decaborate. M. Dukelsky observed no signs of formation of a hexaborate in aq. soln. at 30° . H. le Chatelier prepared what he regarded as **potassium octaborate**, $K_2O \cdot 4B_2O_3$, by a process analogous to that he employed for the lithium salt.

C. F. Rammelsberg obtained crystals of **octohydrated potassium decaborate**, $K_2O \cdot 5B_2O_3 \cdot 8H_2O$, from a boiling aq. soln. of potassium hydroxide sat. with boric acid. A. Laurent gave the formula $5K_2O \cdot 24B_2O_3 \cdot 55H_2O$. J. Böeseken represented the salt KB_5O_8 by the graphic formula $K-B \equiv (OBO)_4$, with one boron atom quinquevalent. A. Laurent found that the rhombic crystals had the axial ratios $a : b : c = 0.9709 : 1 : 0.8054$. V. von Lang also measured the crystals which have a positive double refraction. M. Dukelsky found the region of stability of the crystals in aq. soln. at 30° to be represented by *dPe*, Fig. 17. According to A. Atterberg, the crystals rapidly lose 6 mols of water at 100° , and still more water is lost slowly; at 200° , one mol of water is still retained; at a red heat, the salt forms a clear glass. When treated with hydrofluoric acid, potassium borofluoride is formed. A. Laurent stated that rhombic prisms of *decahydrated potassium dodecaborate*, $K_2O \cdot 6B_2O_3 \cdot 10H_2O$, crystallize from neutral soln. of potassium hydroxide and boric acid. He said that the crystals are permanent in air; turn reddened litmus slightly blue; dissolve sparingly in cold water and copiously in hot water. A. Atterberg tried to make this salt from soln. containing 3, 4, 5, and 6 mols of boric oxide to one mol of K_2O , but obtained in every case, octohydrated potassium decaborate; nor did M. Dukelsky obtain any evidence of a dodecaborate in aq. soln. at 30° .

A. C. Reischle¹⁰ prepared anhydrous **rubidium tetraborate**, $Rb_2B_4O_7$, by precipitating an alcoholic soln. of rubidium oxide with a similar soln. of boric acid. The free crystalline precipitate contains alcohol of crystallization. W. Reissig, and A. C. Reischle prepared the **hexahydrated rubidium tetraborate**, $Rb_2B_4O_7 \cdot 6H_2O$, by dissolving 2 mols of boric acid and one mol of rubidium carbonate in boiling water; rhombic six-sided plates separate during the cooling of the soln.; and they are stable in air. A. C. Reischle obtained **caesium hexaborate**, $Cs_2B_6O_{10}$, or $Cs_2O \cdot 3B_2O_3$, by mixing alcoholic soln. of caesium oxide, and boric acid. The crystals separate slowly from the soln. A. Rosenheim and F. Leyser made **rubidium pentaborate**.

According to H. S. van Klooster, the f.p. curve of mixtures of lithium and sodium

metaborates, Fig. 18, gives no indication of the formation of a compound, but there is a eutectic at 650° with 52 per cent. of lithium metaborate. The miscibility of the crystals is very limited, for **lithium metaborate** dissolves 2 per cent. of sodium metaborate, and the latter 3 per cent. of the lithium salt. Mixtures of sodium and potassium metaborates give a f.p. curve, Fig. 19, showing a continuous series of mixed crystals, and having a flat minimum with 50 per cent. of sodium metaborate. There is evidence of a decomposition of the mixed crystals between 522° and 553° with mixtures with 40 to 60 per cent. of sodium metaborate. The f.p. curve, Fig. 20, of mixtures of potassium metaborate and metaphosphate possesses two eutectics at 681° and 770° respectively, the former corresponding with 90 per cent. and the latter with 30 per cent. of potassium metaphosphate. The portion of the curve between the eutectics rises to a very flat maximum, extending between 50 and 60 per cent. of potassium metaphosphate. The eutectic arrest is only noticeable in the neighbourhood of the eutectics, so that it cannot be used to determine the position of the maximum. The composition agrees with **potassium metaphosphato-metaborate**, $KPO_3 \cdot KBO_2$. Fusions of this composition give neutral soln., whereas with higher and lower percentages of potassium metaphosphate they are respectively acid and alkaline. The presence of the compound $KPO_3 \cdot KBO_2$ is also indicated by the microscopic examination of thin sections. Fusions containing between 65 and 85 per cent. potassium metaphosphate would not crystallize, but they solidified to a

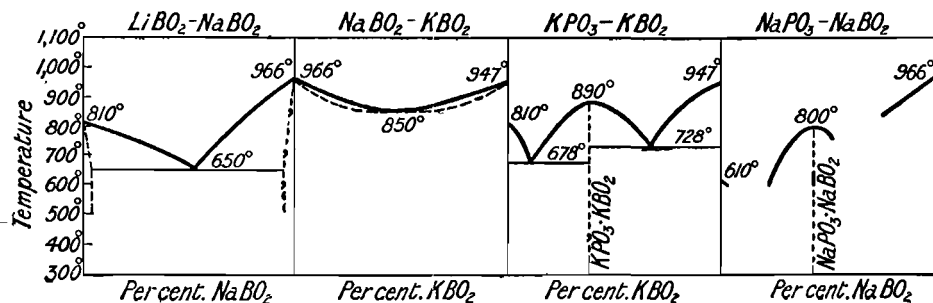

FIGS. 18-21.—Freezing-point Curves of Binary Mixtures.

viscous mass. The f.p. curve of mixtures of sodium metaphosphate and sodium metaborate, Fig. 21, could be followed only with mixtures containing between 0 and 30 per cent. and between 50 and 80 per cent. of sodium metaphosphate, the other mixtures solidifying to vitreous masses. The curve between 50 and 80 per cent. of sodium metaphosphate shows a flat maximum which is probably due to the existence of **sodium metaphosphatometaborate**, $NaPO_3 \cdot NaBO_2$, further evidence in support of the existence of which is given by chemical and optical investigations similar to those described for the potassium compounds. Conductivity measurements showed that this compound also exists in soln. to some extent.

Eleven **ammonium borates** have been described; but U. Sborgi¹¹ could find only three in his study of the ternary system $(NH_4)_2O-B_2O_3-H_2O$, at 30° . He found the 1:4:6 compound at 60° , and the 1:2:4 and the 1:5:8 compounds at 45° . His results at 30° are shown graphically in Fig. 22, the region *bMc* corresponding with the solid phase

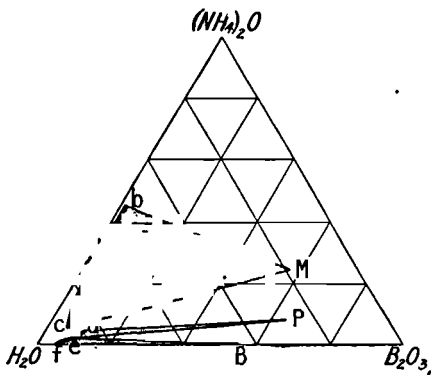

FIG. 22.—Equilibrium in the Ternary System, $(NH_4)_2O-B_2O_3-H_2O$, at 30° .

$(\text{NH}_4)_2\text{O} \cdot \text{B}_2\text{O}_3 \cdot 2\frac{1}{2}\text{H}_2\text{O}$; the region *dPe* with the solid phase $(\text{NH}_4)_2\text{O} \cdot 0.5\text{B}_2\text{O}_3 \cdot 8\text{H}_2\text{O}$; and the region *eBf* with boric acid, $\text{B}(\text{OH})_3$.

J. J. Berzelius reported a basic salt *dihydrated tetra-ammonium diborate*, $2(\text{NH}_4)_2\text{O} \cdot \text{B}_2\text{O}_3 \cdot 2\text{H}_2\text{O}$, or $(\text{NH}_4)_4\text{B}_2\text{O}_5 \cdot 2\text{H}_2\text{O}$, but there are doubts about the accuracy of the analysis. J. A. Arfvedson dissolved ammonium tetraborate in hot conc. aq. ammonia, and allowed the soln. to cool in a covered vessel, when crystals of the composition: $3(\text{NH}_4)_2\text{O} \cdot 4\text{B}_2\text{O}_3 \cdot 3\text{H}_2\text{O}$, *ammonium octotriborate*, separated out; he also found that 100 parts of crystalline boric acid absorbed 21 parts of ammonia, producing what was thought to be the *enneahydrate*, $3(\text{NH}_4)_2\text{O} \cdot 4\text{B}_2\text{O}_3 \cdot 9\text{H}_2\text{O}$.

L. Gmelin slowly cooled a soln. of a "moderate" proportion of boric acid in hot aq. ammonia, and obtained tetragonal crystals. Analyses by L. Gmelin, E. Soubeiran, A. Laurent, and C. F. Rammelsberg correspond with **tetrahydrated ammonium tetraborate**, $(\text{NH}_4)_2\text{O} \cdot 0.2\text{B}_2\text{O}_3 \cdot 4\text{H}_2\text{O}$, or $(\text{NH}_4)\text{H}(\text{BO}_2)_2 \cdot 1\frac{1}{2}\text{H}_2\text{O}$. A. Atterberg's analysis agrees with the assumption that this salt is a pentahydrated tetraborate, $(\text{NH}_4)_2\text{O} \cdot 0.2\text{B}_2\text{O}_3 \cdot 5\text{H}_2\text{O}$, and he considered this to be one of the only two ammonium borates whose existence has been established. This salt may have been U. Sborgi's hemipentahydrate, $(\text{NH}_4)_2\text{O} \cdot 0.2\text{B}_2\text{O}_3 \cdot 2\frac{1}{2}\text{H}_2\text{O}$, with some entrained water. If so, the region of stability is fairly large, corresponding with *bcM*, Fig. 22. C. F. Rammelsberg found the axial ratios of the tetragonal crystals to be $a : c = 1 : 0.8283$. W. H. Miller described crystals of ammonium borate, but it is not clear what particular salt he measured. G. d'Achiardi also studied these crystals. L. Gmelin said that the crystals effloresce in air, lose ammonia, and form the octoborate; that 100 parts of cold water dissolve 8.3 parts of the salt, and that the soln. has an alkaline reaction, and evolves ammonia when heated. According to P. A. Favre and C. A. Valson, the sp. gr. of the *N*-soln. of this salt is 1.0678, and the volume increase per litre, attending the soln. of one eq. of the salt, is 10.2 c.c. According to M. Faraday, a neutral or slightly alkaline soln. of ammonium borate soon colours turmeric paper the red tint characteristic of boric acid, and the red tint is effected by ammonia, etc., as with the coloration produced by boric acid itself—*q.v.*

J. A. Arfvedson obtained a salt whose analysis corresponded with $2(\text{NH}_4)_2\text{O} \cdot 0.5\text{B}_2\text{O}_3 \cdot 5\text{H}_2\text{O}$, but C. F. Rammelsberg believed this is probably a less pure form of the tetraborate. A. Schleisner reported *heptahydrated ammonium hexaborate*, $(\text{NH}_4)_2\text{O} \cdot 3\text{B}_2\text{O}_3 \cdot 7\text{H}_2\text{O}$, to be formed by adding the calculated quantity of ammonia to a hot aq. soln. of boric acid. He added that the salt is formed only above 30° , and that it is very soluble in water. It is used for preparing hard and washable figures of plaster of Paris.

A. Atterberg mixed a hot soln. of boric acid with aq. ammonia in the proportion $\text{NH}_3 : \text{H}_3\text{BO}_3 = 1 : 3.5$, and obtained rhombic double pyramids of **octohydrated ammonium decaborate**, $(\text{NH}_4)_2\text{O} \cdot 0.5\text{B}_2\text{O}_3 \cdot 8\text{H}_2\text{O}$, analogous to the corresponding potassium salt. The area *dPe* in U. Sborgi's diagram, Fig. 22, shows the range of stability of the salt at 30° . J. Schabus, and V. von Lang also measured the crystals, which have a positive double refraction. L. Gmelin obtained colourless, transparent, six-sided pyramids by saturating a hot conc. aq. soln. of ammonia with boric acid, and slowly cooling the mixture; he supposed the product to be *hexahydrated ammonium octoborate*, $(\text{NH}_4)_2\text{O} \cdot 4\text{B}_2\text{O}_3 \cdot 6\text{H}_2\text{O}$, but it is probably a less pure form of the decaborate. C. F. Rammelsberg found the crystals to be rhombic bipyramids with axial ratios $a : b : c = 0.9827 : 1 : 0.8201$. L. Gmelin said the crystals appear tasteless at first, but they afterwards excite a burning bitter taste. The salt is permanent in air, but when heated, it swells up and fuses, leaving behind glassy boric oxide which A. Laurent said still retains some ammonia very tenaciously. According to L. Gmelin, 100 parts of cold water dissolve nearly 12.5 parts of the salt, and the soln. gives off ammonia when boiled; the aq. soln. has an alkaline reaction. By treating the soln. with vanadium pentoxide, A. Ditte obtained ammonium trivanadate. The salt has also been studied by C. F. Wenzel, J. M. F. de Lassone, E. Soubeiran, and J. A. Arfvedson.

Analyses of the mineral *larderellite* occurring at the Tuscan lagoons, by the discoverer E. Bechi, and by J. A. Rose, correspond with *tetrahydrated ammonium*

octoborate, $(\text{NH}_4)_2\text{O} \cdot 4\text{B}_2\text{O}_3 \cdot 4\text{H}_2\text{O}$, or $(\text{NH}_4)_2\text{B}_8\text{O}_{13} \cdot 4\text{H}_2\text{O}$. The crystalline form of the rhombic plates has not been established. Larderellite is soluble in hot water, and, according to E. Bechi, the soln. deposits crystals of *enneahydrated ammonium dodecaborate*, $(\text{NH}_4)_2\text{O} \cdot 6\text{B}_2\text{O}_3 \cdot 9\text{H}_2\text{O}$.

A. Dschawachoff¹² prepared rhombic crystals of **decahydrated hydrazine hexahydro-dodecaborate**, $(\text{N}_2\text{H}_4)_2(\text{H}_2\text{B}_4\text{O}_7)_3 \cdot 10\text{H}_2\text{O}$, by adding boric acid to a 50 per cent. soln. of the base, and concentrating the soln. first on the water-bath, and then in a desiccator. The crystals readily effloresce, and when kept over sulphuric acid, pass into the pentahydrate, $(\text{N}_2\text{H}_4)_2(\text{H}_2\text{B}_4\text{O}_7)_3 \cdot 5\text{H}_2\text{O}$, and at 100° they form the anhydrous salt, $(\text{N}_2\text{H}_4)_2(\text{H}_2\text{B}_4\text{O}_7)_3$. When heated to 250°–260°, they formed $(\text{N}_2\text{H}_4)_2(\text{B}_2\text{O}_3)_6$. Above 260°, the salt decomposes into boric acid and anhydrous hydrazine, N_2H_4 .

REFERENCES.

- ¹ H. le Chatelier, *Bull. Soc. Enc.*, **97**, 2520, 1899; *Compt. Rend.*, **124**, 1091, 1897; *Bull. Soc. Chim.*, (3), **21**, 35, 1898; F. Filsinger, *Arch. Pharm.*, **208**, 211, 1876; M. Dukelsky, *Zeit. anorg. Chem.*, **54**, 45, 1907; F. M. Jäger, *ib.*, **101**, 1, 1917; R. Lorenz and W. Herz, *ib.*, **117**, 103, 1921; A. C. Reischle, *ib.*, **4**, 166, 1893; *Untersuchungen über neue Alkaliborate und über die quantitative Bestimmung der Borsäure*, München, 1892; J. A. Arfvedson, *Ann. Chim. Phys.*, (2), **7**, 197, 284, 1818; (2), **10**, 82, 1819; P. Termier, *Bull. Soc. Min.*, **20**, 257, 1897; C. L. Bloxam, *Journ. Chem. Soc.*, **12**, 177, 1859; L. Grenet, *Compt. Rend.*, **123**, 891, 1896; C. G. Gmelin, *Gilbert's Ann.*, **62**, 399, 1819; **64**, 371, 1820; *Schweigger's Journ.*, **30**, 173, 1820; G. Ribaud, *Courbes de fusion des borates de lithium*, Paris, 1909; A. Rosenheim and W. Reglin, *Zeit. anorg. Chem.*, **120**, 103, 1921; H. S. van Klooster, *ib.*, **69**, 122, 1910; G. Tammann, *Kristallisieren und Schmelzen*, Leipzig, 56, 1903.
- ² J. A. Arfvedson, *Ann. Chim. Phys.*, (2), **7**, 197, 284, 1818; (2), **10**, 82, 1819; H. V. Regnault, *ib.*, (3), **1**, 167, 1841; L. F. Ponomareff, *Journ. Russ. Phys. Chem. Soc.*, **49**, 229, 1917; C. L. Bloxam, *Journ. Chem. Soc.*, **12**, 177, 1859; **14**, 143, 1861; N. Tate, *ib.*, **12**, 160, 1859; H. Rose, *Pogg. Ann.*, **80**, 269, 1850; E. Mallard, *Compt. Rend.*, **75**, 472, 1872; M. Dukelsky, *Zeit. anorg. Chem.*, **50**, 38, 1906; A. Stromeyer, *Liebig's Ann.*, **100**, 93, 1856; G. M. Wunder, *Program. Gewerbeschule Chemnitz*, 3, 1870; *Journ. prakt. Chem.*, (2), **1**, 459, 1870; A. Atterberg, *Öfvers. Vet. Akad. Förh.*, **6**, 1874; *Bull. Soc. Chim.*, (2), **22**, 350, 1874; R. Benedikt, *Ber.*, **7**, 700, 1874; L. Kahlenberg and O. Schreiner, *Zeit. phys. Chem.*, **20**, 547, 1896; H. S. Shelton, *ib.*, **43**, 494, 1903; P. Walden, *ib.*, **1**, 529, 1887; J. Walker, *ib.*, **32**, 137, 1900; T. W. Richards and J. B. Churchill, *ib.*, **28**, 313, 1899; E. Polenske, *Arbeit. Kais. Ges. Amt.*, **17**, 564, 1900; U. Sborgi and F. Mecacci, *Atti Accad. Lincei*, (5), **24**, i, 443, 1915; (5), **25**, ii, 327, 386, 455, 1916; E. Bechi, *Amer. Journ. Science*, (2), **17**, 129, 1854; (2), **19**, 120, 1855; C. F. Rammelsberg, *Pogg. Ann.*, **49**, 460, 1840; H. Hahn, *Arch. Pharm.*, (2), **99**, 146, 1859; J. A. Phillips, *Quart. Journ. Science*, **6**, 14, 1869; *Chem. News*, **21**, 83, 1870; A. Campbell, *ib.*, **21**, 90, 1870; N. Gräger, *Neues Jahrb. Pharm.*, **31**, 297, 1869; *Chem. News*, **20**, 120, 1869; A. Robotom, *ib.*, **54**, 245, 1886; H. N. Warren, *ib.*, **62**, 181, 1890; E. L. Fleming, *ib.*, **63**, 74, 1891; J. J. Berzelius, *Pogg. Ann.*, **2**, 113, 1824; **33**, 98, 1834; **34**, 566, 1835; *Liebig's Ann.*, **28**, 3, 1838; *Schweigger's Journ.*, **23**, 160, 1818; F. Jean, *Bull. Soc. Chim.*, (2), **10**, 336, 1868; F. M. Jäger, *Zeit. anorg. Chem.*, **101**, 1, 1917; R. Lorenz and W. Herz, *ib.*, **117**, 103, 1921; **120**, 340, 1922; R. von Wagner, *Handbuch der chemischen Technologie*, Leipzig, 294, 1873; H. Vohl, *Chem. News*, **23**, 214, 1871; *Dingler's Journ.*, **199**, 498, 1871; M. Clouet, *ib.*, **142**, 395, 1856; G. Lunge, *ib.*, **181**, 370, 1866; E. Durand, *ib.*, **227**, 561, 1878; *Bull. Soc. Enc.*, (3), **4**, 444, 1877; C. Bigot and J. Schreiter, *Brit. Pat. No.* 19382, 1891; E. Dresel and J. Lennhof, *ib.*, 14905, 1894; C. Masson and C. Tillière, *ib.*, 10361, 1897; *German Pat.*, *D.R.P.P.* 71310, 72012, 81836, 95642, 1898; 98680, 1899; R. Rickmann and E. Rappe, *ib.*, 96196, 98759, 1898; A. Schuster and M. Wilhelm, *ib.*, 94050, 1897; A. Kelly and R. B. R. Walker, *Brit. Pat. No.* 175201, 1921; Schott and Co., *ib.*, 153007, 1921; A. Rosenheim and F. Leyser, *Zeit. anorg. Chem.*, **119**, 1, 1921; F. M. Dupont, *Journ. Ind. Eng. Chem.*, **2**, 500, 1910; F. Witting, *Zeit. angew. Chem.*, **1**, 483, 1888; A. Scheuer, *ib.*, **5**, 241, 1892; C. N. Hake, *Journ. Soc. Chem. Ind.*, **8**, 854, 1889; L. Darapsky, *Chem. Ztg.*, **11**, 675, 1887; H. S. van Klooster, *Zeit. anorg. Chem.*, **69**, 122, 131, 1911; Ö. Köhnke, *Arch. Pharm.*, (2), **39**, 279, 1844; A. Payen, *Précis de chimie industrielle*, Paris, 222, 1849; *Ann. Chim. Phys.*, (3), **2**, 322, 1841; J. G. Wallerius, *Mineralogia*, Stockholm, 1747; G. Agricola, *De natura fossilium*, Basileæ, 1556; *De re metallica*, Basileæ, 1556; R. Saunders, *Phil. Trans.*, **79**, 79, 1789; *Rec. Geol. Sur. India*, **24**, 68, 1891; W. S. Vernadsky and S. P. Popoff, *Zeit. prakt. Geol.*, **10**, 79, 1902; G. d'Achiardi, *Acido borico e borati dei soffioni e lagoni boriferi della Toscana*, Pisa, 1900; H. Winklehner, *Oester. Zeit. Berg. Hütt.*, **47**, 627, 1899; J. R. Blum, *Lithurgik*, Stuttgart, 370, 1840; P. J. Robiquet and R. J. Marchand, *Journ. Pharm. Chim.*, (1), **4**, 96, 1818; *Ann. Chim. Phys.*, (2), **8**, 359, 1818; J. D. Dana, *A System of Mineralogy*, New York, 597, 1868; G. P. Burnham, *U.S. Pat. Nos.* 1286932, 1918; 1317954, 1321282, 1919; 1328314, 1920; 1424447, 1922; L. W. Chapman, *Met. Chem. Ind.*, **24**, 683, 1921; A. A. Kelly and B. D. Jones, *Brit. Pat. No.* 158992, 1919; M. Aschkensay, *German Pat.*, *D.R.P.P.* 337058, 337322, 1920; F. Filsinger,

Arch. Pharm., (2), 8, 211, 1876; S. Motylewsky, *Zeit. anorg. Chem.*, 38, 410, 1904; J. Thomsen, *Pogg. Ann.*, 139, 193, 1870; 140, 505, 1870; 143, 354, 497, 1871; U. Sborgi and C. Franco, *Gazz. Chim. Ital.*, 51, ii, 1, 1921; H. von Schlagintweit, *Sitzber. Akad. München*, 505, 1878.

³ E. Schweizer, *Mitt. nat. Ges. Zürich*, 1, 1850; *Liebig's Ann.*, 76, 267, 1850; G. Brügelmann, *Ber.*, 17, 2359, 1884; O. Lehmann, *ib.*, 17, 2831, 1884; J. Ponomarey, *Zeit. anorg. Chem.*, 89, 383, 1814; E. Soubeiran and F. A. Pellerin, *Journ. Pharm. Chim.*, (2), 14, 170, 1828; H. J. Buignet, (3), 40, 161, 337, 1860; D. Fernez, *Compt. Rend.*, 78, 68, 1874; P. A. Favre and C. A. Valson, *ib.*, 77, 579, 1873; C. Tissier, *ib.*, 89, 192, 1854; 45, 411, 1857; A. Payen, *Journ. Chim. Méd.*, (1), 3, 594, 1827; *Quart. Journ. Science*, 25, 483, 1823; T. Griffiths, *ib.*, 18, 90, 1825; C. F. Rammelsberg, *Handbuch der krystallographischen Chemie*, Berlin, 171, 1855; *Pogg. Ann.*, 49, 445, 1840; H. Rose, *ib.*, 80, 269, 1850; 86, 561, 1852; 87, 1, 470, 1852; 88, 299, 482, 1853; 89, 473, 1853; 91, 452, 1854; A. Arzruni, *ib.*, 158, 250, 1876; G. Quincke, *ib.*, 135, 642, 1868; H. de Sénarmont, *Ann. Chim. Phys.*, (4), 41, 336, 1854; E. Filhol, *ib.*, (3), 21, 415, 1847; J. H. Hassenfratz, *ib.*, (1), 28, 3, 1798; H. V. Regnault, *ib.*, (3), 1, 167, 1841; H. Lescœur, *ib.*, (7), 9, 543, 1896; A. Michel and L. Krafft, *ib.*, (4), 41, 482, 1854; M. Berthelot, *ib.*, (4), 29, 470, 1873; J. J. Ebelman, *ib.*, (3), 16, 129, 1846; (3), 17, 54, 1846; (3), 33, 34, 1851; A. Laurent, *ib.*, (2), 67, 215, 1838; *Compt. Rend.*, *Trav. Chim.*, 6, 33, 1850; U. Sborgi and C. Franco, *Gazz. Chim. Ital.*, 51, ii, 1, 1921; E. Jänecke, *Zeit. phys. Chem.*, 90, 265, 1915; P. Bolley, *Liebig's Ann.*, 68, 122, 1848; A. Stromeyer, *ib.*, 100, 87, 1856; H. Kopp, *Liebig's Ann. Suppl.*, 3, 1, 1864; T. J. Herapath, *Phil. Mag.*, (3), 34, 375, 1849; D. W. Horn and E. M. van Wagener, *Amer. Chem. Journ.*, 30, 344, 1903; C. H. Burgess and A. Holt, *Proc. Roy. Soc.*, 74, 285, 1904; G. Tammann, *Mém. Acad. St. Petersburg*, (7), 35, 1, 1887; *Wied. Ann.*, 24, 530, 1885; R. Kirwan, *Physisch-chemische Schriften*, Berlin, 1783; D. Brewster, *Treatise on New Philosophical Instruments*, Edinburgh, 1813; *Quart. Journ. Science*, 22, 356, 1827; W. W. Coblentz, *Investigations of Infra-red Spectra*, Washington, 3, 62, 1906; 4, 86, 1906; L. Kahlenberg and O. Schreiner, *Zeit. phys. Chem.*, 20, 547, 1896; H. S. Shelton, *ib.*, 43, 494, 1903; W. G. Mixer, *Amer. Journ. Science*, (4), 26, 125, 1908; T. Carnelley, *Journ. Chem. Soc.*, 33, 273, 1878; J. H. Gladstone and W. Hibbert, *ib.*, 67, 831, 1895; J. Thomsen, *Thermochemische Untersuchungen*, Leipzig, 3, 199, 1893; H. Dufet, *Bull. Soc. Min.*, 11, 123, 191, 1888; F. Kohlrausch, *Wied. Ann.*, 4, 28, 1878; K. Harding and B. D. Jones, *Brit. Pat. No. 175795*, 1920; A. Rosenheim and F. Leyser, *Zeit. anorg. Chem.*, 119, 1, 1921; E. Löwenstein, *ib.*, 63, 69, 1909; J. Bösenken, *Proc. Acad. Amsterdam*, 26, 97, 1923; R. Boyle, *Hydrostatic Balance*, London, 1690; A. Payen, *Journ. Chim. Méd.*, 4, 153, 1828; E. Tiede, P. Wulff, and A. Ragoss, *Phys. Zeit.*, 22, 563, 1921; A. des Cloizeaux, *Mém. Acad.*, 18, 511, 1868; *Manuel de minéralogie*, Paris, 1874; G. Teschemak, *Sitzber. Akad. Wien*, 67, 641, 1868; H. G. Greenish, and F. A. U. Smith, *Pharm. Journ.*, 66, 774, 806, 1901; H. V. Blücher, *Pogg. Ann.*, 50, 541, 1840; C. F. Naumann, *Lehrbuch der Krystallographie*, Leipzig, 1829; A. Lévy, *Description d'une collection de minéraux*, London, 1837; C. Doelter, *Neues Jahrb. Min.*, ii, 92, 1896; C. Baskerville, *Chem. News*, 95, 255, 1906; A. Schrauf, *Sitzber. Akad. Wien*, 39, 905, 1860; M. S. Miguel and M. de J. Naranjo y Vega, *Pub. Sec. Cienc. Nat. Univ. Barcelona*, 21, 1918; H. Hahn, *Arch. Pharm.*, (2), 99, 146, 1859; P. P. Bedson and W. C. Williams, *Ber.*, 14, 2553, 1881; V. Meyer and W. Riddle, *ib.*, 26, 2443, 1893; A. L. Day and R. B. Sosman, *Zeit. anorg. Chem.*, 72, 1, 1911; A. L. Day and E. T. Allen, *Zeit. phys. Chem.*, 54, 1, 1905; L. Playfair and J. P. Joule, *Mem. Chem. Soc.*, 2, 401, 1845; F. Stolba, *Journ. prakt. Chem.*, (1), 97, 603, 1866; W. C. Smith, *Amer. Journ. Pharm.*, 53, 148, 1881; R. Watson, *Phil. Trans.*, 60, 325, 1770; J. Dewar, *Chem. News*, 85, 289, 1902; C. Tomlinson, *ib.*, 18, 2, 1868; G. T. Gerlach, *Zeit. anal. Chem.*, 28, 473, 1889; J. C. G. de Marignac, *ib.*, 1, 405, 1862; H. Baumbauer, *Pogg. Ann.*, 153, 75, 1874; F. Forster, *Mitt. Nat. Bern*, 1, 1878; D. Forbes, *Phil. Mag.*, (4), 25, 113, 1863; J. Tünnermann, *Kastner's Arch.*, 20, 1, 1830; A. Atterberg, *Efvers. Vet. Akad. Förh.*, 6, 1874; *Bull. Soc. Chim.*, (2), 22, 350, 1874; E. Cramer, *Tomind. Ztg.*, 16, 155, 1892; S. Walcott, *Journ. Amer. Chem. Soc.*, 16, 268, 1894; T. H. Norton and D. M. Roth, *ib.*, 19, 155, 1897; E. Bechi, *Amer. Journ. Science*, (2), 17, 129, 1854; F. Fouqué, *Ann. Obs. Paris*, 9, 172, 1868; M. Kuhara, *Mem. Coll. Eng. Kyoto Univ.*, 2, 53, 1918; H. Murschhauser, *Biochem. Zeit.*, 138, 6, 1923; J. J. Berzelius, *Pogg. Ann.*, 34, 566, 1835; T. W. Richards and J. B. Churchill, *Zeit. phys. Chem.*, 28, 314, 1899; W. A. Kuhnert, *U.S. Pat. No.* 1474433, 1923.

⁴ P. Burckhard, *Jena Zeit.*, 5, 393, 1870; *Zeit. Chem.*, (2), 6, 212, 1870; P. Walden, *Zeit. phys. Chem.*, 1, 529, 1887; L. Kahlenberg and O. Schreiner, *ib.*, 20, 547, 1896; A. A. Noyes and W. R. Whitney, *ib.*, 15, 694, 1894; P. Müller and R. Abegg, *ib.*, 57, 513, 1907; H. S. Shelton, *ib.*, 43, 494, 1903; *Proc. Chem. Soc.*, 18, 169, 1902; P. Müller, *Börsäure, Amylalkohol, und Wasser—Ein Beitrag zur chemischen Theorie der Lösungen*, Breslau, 1905; C. Herzog, *Arch. Pharm.*, 86, 17, 1843; H. Rose, *Journ. prakt. Chem.*, (1), 57, 126, 1852; P. Georgievic, *ib.*, (2), 37, 118, 1888; J. Shields, *Phil. Mag.*, (5), 35, 365, 1893; *Zeit. phys. Chem.*, 12, 176, 1893; J. Walker, *ib.*, 32, 137, 1900; J. Walker and W. Cormack, *Journ. Chem. Soc.*, 77, 5, 1900; L. C. Barreswil, *Journ. Pharm. Chim.*, (3), 7, 462, 1845; W. Henneberg, *Chem. Centrbl.*, (1), 21, 309, 1850; J. Bottomley, *Chem. News*, 31, 76, 1875; R. Abegg and A. J. Cox, *Zeit. phys. Chem.*, 46, 1, 1903; *Zeit. Elektrochem.*, 9, 892, 1903; G. Meslin, *Compt. Rend.*, 140, 782, 1905; H. C. Jones, *The Electrical Conductivity, Dissociation, and Temperature Coefficients of Conductivity of Aqueous Solutions of a Number of Salts and Organic Acids*, Washington, 19, 1912; A. Z. Hartmann, *Ueber die Elektrolyse geschmolzener Borate*, München, 1913; A. Schrauf, *Sitzber. Akad. Wien*, 39, 905, 1860; F. Auerbach, *Zeit. anorg. Chem.*, 37, 353, 1904; A. Atterberg, *ib.*, 48, 367, 1906; M. Dukelsky, *ib.*, 50, 38, 1906; H. Menzel, *Zeit. phys. Chem.*, 100, 276, 1922.

⁴ G. J. Mulder, *Scheikund. Verhandl.*, 144, 1864; Y. Osaka, *Mem. Coll. Science Kyoto*, 1, 93, 265, 290, 1908; D. W. Horn and E. M. van Wegener, *Amer. Chem. Journ.*, 30, 347, 1903; A. B. Poggiale, *Ann. Chim. Phys.*, (3), 8, 467, 1843; H. Lescœur, *ib.*, (7), 9, 543, 1896; J. H. van't Hoff and W. C. Blasdale, *Sitzber. Akad. Berlin*, 1086, 1905; T. Bergman, *De attractionibus electivis*, Upsala, 1775; London, 1785; U. Sborgi and F. Mecacci, *Atti Accad. Lincei*, (5), 24, i, 443, 1915; (5), 25, ii, 327, 386, 455, 1916; M. Dukelsky, *Zeit. anorg. Chem.*, 50, 42, 1906; L. F. Kebler, *Journ. Franklin Inst.*, 134, 236, 1892; D. S. Wester and A. Bruins, *Pharm. Weekb.*, 51, 1443, 1914; A. Kopp, *Liebig's Ann. Suppl.*, 3, 289, 1864; H. Rose, *Sitzber. Akad. Berlin*, 129, 450, 1867; G. Wunder, *Program. Gewerbeschule Chennitz*, 13, 1870; *Journ. prakt. Chem.*, (2), 1, 459, 1870; H. Kopp, *Liebig's Ann.*, 157, 363, 1871; 159, 36, 1871; C. H. Burgess and A. Holt, *Chem. News*, 38, 269, 1903; J. J. Berzelius, *The Use of the Blowpipe in Chemical Analysis*, London, 1822; A. Stromeyer, *Liebig's Ann.*, 100, 87, 1856; A. Vogel, *Neues Repert. Pharm.*, 16, 554, 1867; M. Faraday, *Quart. Journ. Science*, 11, 403, 1821; A. Rosenheim and F. Leyser, *Zeit. anorg. Chem.*, 119, 1, 1921.

⁶ E. Schweizer, *Liebig's Ann.*, 76, 267, 1850; J. L. Gay Lussac, *Ann. Chim. Phys.*, (2), 49, 323, 1832; A. Laurent, *ib.*, (2), 67, 218, 1838; *Compt. Rend. Trav. Chim.*, 6, 33, 1850; J. Joulin, *Bull. Soc. Chim.*, (2), 19, 344, 1873; H. Rose, *Journ. prakt. Chem.*, (1), 57, 126, 1852; C. Winkler, *Ber.*, 23, 775, 1890; H. Murschhauser, *Biochem. Zeit.*, 138, 6, 1923; E. D. Clarke, *Journ. Roy. Inst.*, 2, 104, 1816; G. Dragendorff, *Chem. Centrbl.*, 6, 872, 1861; C. J. B. Karsten, *Philosophie der Chemie*, Berlin, 69, 1843; W. Ackermann, *Chem. Ztg.*, 39, 225, 1915; T. Bergman, *De attractionibus electivis*, Upsala, 1775; London, 1784.

⁷ F. M. Dupont, *Journ. Ind. Eng. Chem.*, 2, 500, 1910; A. Scheuer, *Zeit. angew. Chem.*, 5, 241, 1892.

⁸ A. Atterberg, *Öfvers. Vet. Akad. Förh.*, 6, 1874; *Bull. Soc. Chim.*, (2), 22, 350, 1874; H. le Chatelier, *ib.*, (3), 21, 35, 1899; L. Spiegel, *Chem. Ztg.*, 28, 750, 1904; P. A. Bolley, *Liebig's Ann.*, 68, 122, 1847; A. Laurent, *Compt. Rend. Trav. Chim.*, 6, 33, 1850; *Ann. Chim. Phys.*, (2), 67, 218, 1838; A. A. Kelly and B. D. Jones, *Brit. Pat. No.* 180110, 1921; W. Voss, *U.S. Pat. No.* 1444989, 1923; J. Tünnermann, *Kastner's Arch.*, 20, 8, 1830; A. A. Noyes and W. R. Whitney, *Zeit. phys. Chem.*, 15, 694, 1894; L. Barthé, *Journ. Pharm. Chim.*, (6), 1, 303, 1895; U. Sborgi and F. Mecacci, *Atti Accad. Lincei*, (5), 24, i, 443, 1915; (5), 25, ii, 327, 386, 455, 1916; M. Dukelsky, *Zeit. anorg. Chem.*, 50, 42, 1906; A. Rosenheim and F. Leyser, *ib.*, 119, 1, 1921; I. F. Ponomarev, *Journ. Russ. Phys. Chem. Soc.*, 49, 229, 1917.

⁹ J. A. Arfvedson, *Ann. Chim. Phys.*, (2), 7, 197, 284, 1818; (2), 10, 82, 1819; A. Laurent, *ib.*, (2), 67, 215, 1838; *Compt. Rend. Trav. Chim.*, 6, 33, 1850; C. L. Bloxam, *Journ. Chem. Soc.*, 12, 177, 1859; 14, 143, 1861; N. Tate, *ib.*, 12, 160, 1859; H. Rose, *Pogg. Ann.*, 80, 269, 1850; J. J. Berzelius, *ib.*, 34, 566, 1835; C. F. Rammelsberg, *ib.*, 95, 199, 1855; A. Atterberg, *Öfvers. Vet. Akad. Förh.*, 6, 1874; *Bull. Soc. Chim.*, (2), 22, 350, 1874; *Zeit. anorg. Chem.*, 48, 367, 1906; M. Dukelsky, *ib.*, 50, 38, 1906; H. J. Buignet, *Journ. Pharm. Chim.*, (3), 40, 161, 337, 1860; H. Schiff, *Liebig's Ann. Suppl.*, 5, 175, 1867; W. Reissig, *Liebig's Ann.*, 127, 37, 1863; H. le Chatelier, *Bull. Soc. Chim.*, (3), 21, 35, 1899; J. Schabus, *Bestimmung der Krystallgestalten in chemischen Laboratorien erzeugter Produkte*, Wien, 92, 1855; A. Rosenheim and F. Leyser, *Zeit. anorg. Chem.*, 119, 1, 1921; H. S. van Klooster, *ib.*, 69, 122, 1910; F. M. Jäger, *ib.*, 101, 1, 1917; J. Böseken, *Proc. Acad. Amsterdam*, 26, 97, 1923; V. von Lang, *Sitzber. Akad. Wien*, 45, 113, 1862; S. Motylewsky, *Zeit. anorg. Chem.*, 38, 410, 1904.

¹⁰ A. C. Reischle, *Zeit. anorg. Chem.*, 4, 173, 1893; W. Reissig, *Liebig's Ann.*, 127, 37, 1863; A. Rosenheim and F. Leyser, *Zeit. anorg. Chem.*, 119, 1, 1921; H. S. van Klooster, *ib.*, 69, 122, 135, 1910.

¹¹ U. Sborgi, *Atti Accad. Lincei*, (5), 21, ii, 855, 1912; (5), 22, i, 90, 1913; U. Sborgi and L. Ferri, *ib.*, (5), 31, i, 324, 1922; *Mem. Accad. Lincei*, (5), 13, 570, 1922; G. d'Aochiardi, *ib.*, (5), 9, ii, 342, 1909; C. F. Rammelsberg, *Pogg. Ann.*, 90, 20, 1853; 95, 199, 1855; J. J. Berzelius, *ib.*, 2, 126, 1824; J. A. Arfvedson, *ib.*, 2, 130, 1824; *Vet. Akad. Handl. Stockholm*, 5, 444, 1822; *Schweigger's Journ.*, 8, 7, 1813; L. Gmelin, *ib.*, 15, 258, 1815; P. A. Favre and C. A. Valson, *Compt. Rend.*, 77, 802, 1873; A. Ditte, *ib.*, 102, 1105, 1886; A. Schleisner, *German Pat.*, D.R.P. 65271, 1891; E. Bechi, *Amer. Journ. Science*, (2), 17, 129, 1854; (2), 19, 120, 1855; J. A. Rose, *Beiträge zur Kenntnis der Borsäure und über eine direkt gewichtsanalytische Bestimmung derselben*, Bonn a Rh., 1902; A. Laurent, *Compt. Rend. Trav. Chim.*, 6, 33, 1850; *Ann. Chim. Phys.*, (2), 67, 215, 1838; E. Soubeiran, *Journ. Pharm. Chim.*, (2), 11, 29, 558, 1825; W. H. Miller, *Trans. Cambridge Phil. Soc.*, 3, 365, 1830; A. Atterberg, *Bull. Soc. Chim.*, (2), 22, 351, 1874; *Öfvers. Vet. Akad. Förh.*, 6, 1874; *Zeit. anorg. Chem.*, 48, 371, 1906; C. F. Wenzel, *Lehre von der Verwandtschaft der Körper*, Dresden, 355, 1777; J. M. F. de Lassone, *Crell's Chem. Journ.*, 5, 83, 1780; H. Hahn, *Arch. Pharm.*, 127, 33, 1862; V. von Lang, *Sitzber. Akad. Wien*, 45, 113, 1862; J. Schabus, *Bestimmung der Krystallgestalten in chemischen Laboratorien erzeugter Produkte*, Wien, 92, 1855; M. Faraday, *Quart. Journ. Science*, 11, 403, 1821.

¹² A. Deschawachoff, *Journ. Russ. Phys. Chem. Soc.*, 34, 227, 1902.

§ 10. The Borates of Copper, Silver, and Gold

W. Hermann¹ found that a mixture of copper oxide and borax melts with difficulty and furnishes a blue glass. H. Hecht studied the effect of boric oxide on the colour of alkali silicate glasses coloured with cupric oxide. P. A. Bolley discussed the uses of the copper borates as pigments for painting. M. G. Levi and S. Castellani observed no signs of the formation of copper borates in the electrolysis of a soln. of boric acid in the cathode compartment, and of a soln. of a cupric salt in the anode compartment.

A. Rosenheim and F. Leyser made **cupric pentaborate**; and obtained the complex **hydrated tetrasodium tetracupric octodecaborate**, $2\text{Na}_2\text{O}\cdot 4\text{CuO}\cdot 9\text{B}_2\text{O}_3\cdot 38\text{H}_2\text{O}$, that is, $\text{Na}_4[\text{Cu}_4(\text{B}_4\text{O}_7)_6]\cdot 50\text{H}_2\text{O}$. According to W. Guertler, brownish crystals, with a greenish surface shimmer, **cuprous tetraborate**, $\text{Cu}_3\text{B}_4\text{O}_9$, or $3\text{Cu}_2\text{O}\cdot 2\text{B}_2\text{O}_3$, are produced when cupric diborate, $\text{Cu}(\text{BO}_2)_2$, is heated until gas is developed, and washed with boiling water; when a mixture of three mols of cupric nitrate and two mols of boric oxide is heated until reduction is complete; and when cuprous hydroxide is evaporated with 3 to 5 eq. of boric acid, and heated; the homogeneous liquid cools to a reddish-yellow mass which is rapidly decomposed by water. F. P. le Roux said that when a fused glass $\text{Cu}_2\text{O}\cdot 2\text{B}_2\text{O}_3$ is rapidly cooled the colour is citron-yellow, if slowly cooled, orange; and if $\text{Cu}_2\text{O}\cdot 2\text{B}_2\text{O}_3$ is slowly cooled, it has an orange colour.

J. Tünnermann found borax precipitated a pale green cupric borate from a soln. of cupric sulphate; and different results are obtained according as the borax or cupric salt is in excess. The greater the proportion of the latter, the more basic the precipitate. The composition also depends on the conc. and temp. of the mixed soln. As a result quite a number of hydrated cupric borates have been reported, but there is nothing to show that any of them is a chemical individual.

According to H. Rose, cold conc. soln. of cupric sulphate and borax give a precipitate of $33\text{CuO}\cdot 20\text{B}_2\text{O}_3\cdot 33\text{H}_2\text{O}$, which when washed with cold water furnishes *dihydrated cupric diborate*, $\text{CuO}\cdot \text{B}_2\text{O}_3\cdot 2\text{H}_2\text{O}$; and with hot conc. soln., the monohydrate is formed. A. Laurent obtained a similar hydrate, $2\text{CuO}\cdot \text{B}_2\text{O}_3\cdot 1\frac{1}{4}\text{H}_2\text{O}$, by drying at 100° , the precipitate obtained by adding borax to a hot soln. of cupric sulphate. Expressing the mol. ratio $\text{CuO} : \text{B}_2\text{O}_3 : \text{H}_2\text{O}$, H. Rose obtained the salt 11 : 1 : 9 by washing the precipitate obtained by adding borax to a hot dil. soln. of cupric sulphate; by a long continued boiling with water, hydrated cupric oxide is finally obtained. E. Pasternack warmed a cold soln. of two parts of cupric sulphate and one of borax; the filtrate from the basic sulphate was dropped into an excess of a hot soln. of borax, and, on cooling, the compound 5 : 1 : 12 deposited. H. Rose obtained 4 : 1 : 3, by washing the 2 : 1 : 1 product with cold water. By washing the precipitate obtained by mixing equi-molar parts of cupric sulphate and borax in cold conc. soln., H. Rose obtained 9 : 5 : 9 which by washing with cold water gave 3 : 1 : 3; if hot soln. are employed, the precipitate is 11 : 5 : 11, and after washing with hot water, 11 : 4 : 11. H. Rose also obtained 5 : 2 : 5, by washing the precipitate obtained by mixing cold dil. soln. of cupric sulphate and borax.

W. Guertler evaporated a soln. of a mol of cupric nitrate with 2 mols of boric acid and fused the product in a platinum crucible at a temp. not exceeding 950° , the blue needle-like crystals have the composition of **cupric di- or metaborate**, $\text{CuO}\cdot \text{B}_2\text{O}_3$, or $\text{Cu}(\text{BO}_2)_2$; he also obtained the same product by melting cupric oxide with a large excess of boric oxide, and slowly cooling the product; and A. Ditte, by the action of water on cupric tetraborate, CuB_4O_7 . This product can also be obtained as a dark green glass. The blue doubly refracting needles have a sp. gr. $3\cdot 859 \pm 0\cdot 003$, and the hardness of corundum. When heated to $875^\circ \pm 10^\circ$, oxygen is given off, and the weight becomes constant when 5·32 per cent. in weight has been expelled. H. Moissan found fluorine attacks copper borate vigorously at ordinary temp. and the mass becomes incandescent. Cold dil. mineral acids have no action; neither does dil. hydrofluoric acid attack the compound; conc. hydrofluoric acid has a slow solvent action. Sodium hydroxide and alkali sulphides

have no action; molten potassium hydrosulphate and molten alkali carbonates act slowly.

A. Ditte prepared crystals of **cupric tetraborate**, $\text{Cu}_2\text{B}_4\text{O}_7$, by evaporating a soln. of cupric oxide or carbonate in one of boric acid sat. at 40° . E. Pasternack prepared hexahydrated **cupric tetramminotetraborate**, $\text{Cu}_2\text{B}_4\text{O}_7 \cdot 4\text{NH}_3 \cdot 6\text{H}_2\text{O}$, by adding alcohol to an ammoniacal soln. of equi-molar parts of borax and cupric acetate, or by warming a soln. of a mol of cupric acetate and 2 mols of boric oxide in aq. ammonia, and filtering hot. On cooling, dark blue crystals are obtained which can be crystallized from aq. ammonia. They effloresce in air, smell of ammonia, and are decomposed when boiled with water, with the separation of cupric tetraborate.

J. Donau² found silver dissolves in fused borax, staining it yellow. J. Tünnermann noted the formation of a white precipitate when borax is added to soln. of silver nitrate. According to H. Rose, equi-molar and *N*-soln. of sodium borate and silver nitrate in the cold give a dirty yellow precipitate which when pressed contains $11\text{Ag}_2\text{O} \cdot 10\text{B}_2\text{O}_3 \cdot 10\text{H}_2\text{O}$; and after washing with cold water, and drying contains $6\text{Ag}_2\text{O} \cdot \text{B}_2\text{O}_3$. Cold conc. soln. of 2 mols of silver nitrate and one mol of borax give a precipitate containing $3\text{Ag}_2\text{O} \cdot 4\text{B}_2\text{O}_3$, and after washing, $4\text{Ag}_2\text{O} \cdot 5\text{B}_2\text{O}_3$. Boiling conc. soln. of the two salts precipitate silver oxide only; whilst very dil. soln. give the same precipitate. L. Joulin also found that an excess of borax precipitates **silver metaborate**, AgBO_2 , from a conc. soln. of silver nitrate, but if the latter is in excess, or if the soln. be dil., silver oxide is precipitated. H. Rose found that potassium borate behaves like sodium borate; a conc. soln. of ammonium borate precipitates silver borate from a soln. of silver nitrate; with dil. soln. silver oxide alone is precipitated. As L. Vanino showed, the silver tetraborate first precipitated is more or less hydrolyzed according to the conc. of the soln. A. Laurent said that potassium hexaborate gave a white precipitate with soln. of silver nitrate. E. C. Franklin found silver borate is insoluble in liquid ammonia; and H. Hamers, that it is insoluble in ethyl acetate. R. Abegg and A. J. Cox found a litre of aq. soln. at 25° contains about 9.05 grms. of AgBO_2 ; and they also studied the hydrolyses of silver borate by water. *Gold borate* has not been prepared.

REFERENCES.

¹ H. Hecht, *Tonind. Ztg.*, **19**, 453, 471, 1895; M. G. Levi and S. Castellani, *Atti Accad. Lincei*, (5), **17**, ii, 613, 1908; W. Hermann, *Zeit. anorg. Chem.*, **60**, 378, 1908; W. Guertler, *ib.*, **38**, 458, 1904; **40**, 232, 1904; *Ueber wasserfreie Borate und über Entglasung*, Leipzig, 33, 1904; F. P. le Roux, *Compt. Rend.*, **64**, 126, 1867; J. Tünnermann, *Kastner's Arch.*, **20**, 18, 1830; H. Rose, *Pogg. Ann.*, **87**, 587, 1852; P. A. Bolley, *Dingler's Journ.*, **105**, 158, 1847; **106**, 157, 1847; **108**, 144, 1848; H. Moissan, *Ann. Chim. Phys.*, (6), **24**, 266, 1891; A. Ditte, *ib.*, (5), **40**, 248, 1883; *Compt. Rend.*, **96**, 1663, 1883; E. Pasternack, *Liebig's Ann.*, **151**, 227, 1869; A. Laurent, *Compt. Rend. Trav. Chim.*, **6**, 33, 1850; A. Rosenheim and F. Löyser, *Zeit. anorg. Chem.*, **119**, 1, 1921.

² J. Donau, *Monatsh.*, **25**, 913, 1914; H. Rose, *Pogg. Ann.*, **19**, 148, 1830; **88**, 482, 1853; R. Abegg and A. J. Cox, *Zeit. phys. Chem.*, **46**, 1, 1904; L. Joulin, *Ann. Chim. phys.*, (4), **30**, 272, 1873; A. Laurent, *Compt. Rend. Trav. Chim.*, **6**, 33, 1850; J. Tünnermann, *Kastner's Arch.*, **20**, 28, 1830; E. C. Franklin and C. A. Kraus, *Ann. Chem. Journ.*, **21**, 1, 1899; H. Hamers, *Verhalten der Halogenverbindungen des Quecksilber in reinem und in bei 18° mit Wasser gesättigten Aethylacetat*, Giessen, 1910; L. Vanino, *Zeit. anal. Chem.*, **54**, 408, 1915.

§ 11. The Borates of the Alkaline Earths

T. Bergman¹ prepared calcium, barium, and magnesium borates. He said:

Depurated borax may be decomposed by boiling with lime; the acid forsakes the caustic fossil alkali to seize the lime, and produces a salt scarcely soluble. The same thing takes place within ponderous earth, and magnesia.

A. Ditte said that a boiling aq. soln. of borax does not decompose calcium carbonate, and C. Tissier, that calcium hydroxide but not calcium carbonate is soluble in a

boiling aq. soln. of boric acid, that barium carbonate is not soluble in aq. soln. of boric acid; and that if a soluble calcium salt be boiled with an excess of an aq. soln. of boric acid, no precipitate occurs if enough borax be added to make the sodium of the borax eq. to the calcium of the calcium salt. J. H. van't Hoff studied the paragenesis of the calcium borates in natural salt deposits. For the formation of borate minerals, *vide* the occurrence of boron. A. Laurent studied the precipitates obtained by double decomposition of barium salts and borax; judging from the analysis, the products appear to be mixtures. L. B. Guyton de Morveau obtained a transparent glass by melting two parts of borax with one of barium oxide; and N. Tate melted barium sulphate with boric oxide at a high temp., but succeeded in

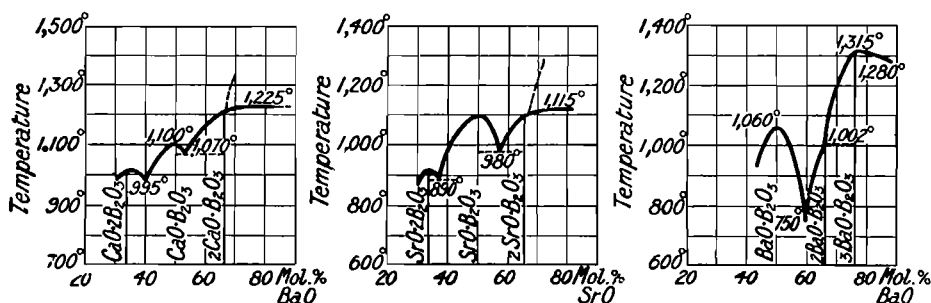

FIGS. 23-25.—Freezing-point Curves of Binary Mixtures of Boric Oxide with Calcium, Strontium, or Barium Oxide.

displacing only a part of the sulphuric acid. Two layers were formed, a soln. of a little barium sulphate in boric acid above and a soln. of a little boric acid in barium sulphate below. Similar results were obtained with barium chloride and boric acid. W. Guertler partially explored the f.p. curves of fused mixtures of boric oxide with the alkaline earths, and obtained the results shown graphically in Figs. 23, 24, and 25. The calcium curve has maxima corresponding with $\text{CaO} \cdot 2\text{B}_2\text{O}_3$; $\text{CaO} \cdot \text{B}_2\text{O}_3$; and $2\text{CaO} \cdot \text{B}_2\text{O}_3$; the strontium-curve likewise with $\text{SrO} \cdot 2\text{B}_2\text{O}_3$; $\text{SrO} \cdot \text{B}_2\text{O}_3$; and $2\text{SrO} \cdot \text{B}_2\text{O}_3$. The curves were not continued to the left because of the non-crystallization of the glasses; and to the right, because the fusion temp. was outside the range of the apparatus employed. J. J. Berzelius noted that

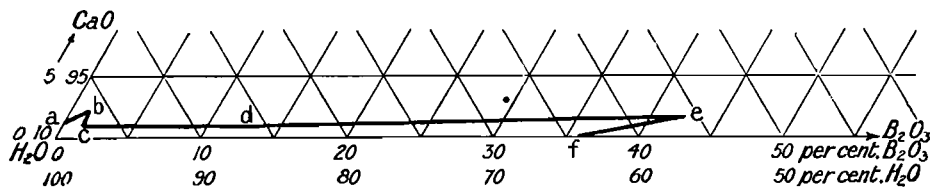

FIG. 26.—Solubility Curves in the Ternary System, $\text{BaO}-\text{B}_2\text{O}_3-\text{H}_2\text{O}$, at 30° .

small proportions of barium oxide give transparent glasses when melted with boric acid, but crystalline masses are formed with higher proportions of baryta. There is nothing to show that calcium and strontium would not form orthoborates analogous to the barium compound; or that barium would not form a salt analogous to the calcium and strontium tetraborates. U. Sborgi has studied the ternary systems, $\text{CaO}-\text{B}_2\text{O}_3-\text{H}_2\text{O}$, and $\text{BaO}-\text{B}_2\text{O}_3-\text{H}_2\text{O}$, at 30° ; the results with the lime system are represented graphically in Fig. 26, which shows but a portion of the triangular diagram, where *ab* denotes the solubility curve of calcium hydroxide; *bc*, of $\text{CaO} \cdot \text{B}_2\text{O}_3 \cdot 6\text{H}_2\text{O}$; *cd*, of $2\text{CaO} \cdot 3\text{B}_2\text{O}_3 \cdot 9\text{H}_2\text{O}$; *de*, of $\text{CaO} \cdot 3\text{B}_2\text{O}_3 \cdot 12\text{H}_2\text{O}$; and *ef*, of boric acid, $\text{B}(\text{OH})_3$. Similarly, with the baryta system, he obtained as solid phases barium hydroxide $\text{BaO} \cdot \text{H}_2\text{O}$ with the solubility

curve *ab*, Fig. 27; $\text{BaO} \cdot \text{B}_2\text{O}_3 \cdot 4\text{H}_2\text{O}$, *bc*; $2\text{BaO} \cdot 3\text{B}_2\text{O}_3 \cdot 6\text{H}_2\text{O}$, *cd*; $\text{BaO} \cdot 3\text{B}_2\text{O}_3 \cdot 7\text{H}_2\text{O}$, *de*; and boric acid, $\text{B}(\text{OH})_3$, *ef*.

L. Ouvrard claimed to have made transparent prismatic crystals of **calcium orthoborate**, $3\text{CaO} \cdot \text{B}_2\text{O}_3$, or $\text{Ca}_3(\text{BO}_3)_2$, by melting at a red heat the eq. quantities of boric oxide and calcium oxide or carbonate with a flux of calcium chloride, or bromide or of potassium hydrofluoride free from potassium chloride. The cold mass was digested with cold water and then with dil. acetic acid. The crystals become opaque when boiled with water; and they are very soluble in dil. acids. The corresponding **strontium orthoborate**, $3\text{SrO} \cdot \text{B}_2\text{O}_3$, or $\text{Sr}_3(\text{BO}_3)_2$, was prepared in a similar manner, and it was found to be less readily attacked by water than with the calcium salt; similar remarks apply to **barium orthoborate**, $3\text{BaO} \cdot \text{B}_2\text{O}_3$, or $\text{Ba}_3(\text{BO}_3)_2$. The last-named compound was also prepared by W. Guertler, and found to melt at about 1315° (Fig. 25).

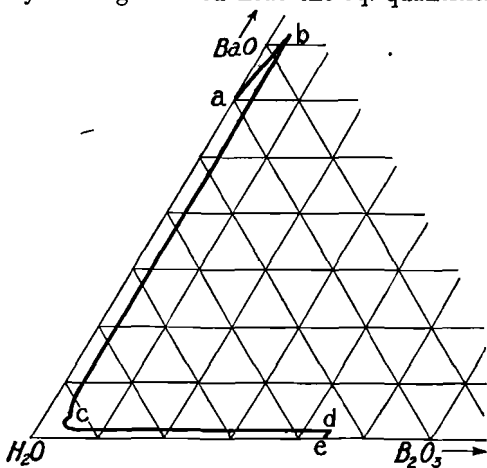

FIG. 27.—Solubility Curves in the Ternary System, $\text{CaO}-\text{B}_2\text{O}_3-\text{H}_2\text{O}$, at 30° .

L. Ouvrard melted a mol of boric oxide, 0.5 mol of calcium oxide, and 2 mols of calcium chloride in the presence of 50 per cent. of sodium or potassium chloride, and extracted the cold mass with water; 2 mols each of calcium oxide and bromide, and one of boric oxide gave similar results. Transparent, doubly refracting tabular crystals were obtained of **dicalcium diborate**, $2\text{CaO} \cdot \text{B}_2\text{O}_3$, or $\text{Ca}_2\text{B}_2\text{O}_5$, very resistant towards cold water, but soluble in dil. acids. H. S. Roberts gave 1304° for the m.p. L. Ouvrard prepared **distrontium diborate**, $2\text{SrO} \cdot \text{B}_2\text{O}_3$, or $\text{Sr}_2\text{B}_2\text{O}_5$, and **dibarium diborate**, $\text{Ba}_2\text{B}_2\text{O}_5$, in a similar manner. The prismatic crystals of the strontium compound are readily soluble in dil. acids, and form the tetrahydrated metaborate when treated with water. W. Guertler prepared these three salts—Figs. 23 to 25—and found them to melt with decomposition respectively at 1225° , 1115° , and 1002° . A. Ditte claimed to have made tabular and columnar crystals of **tristrontium tetraborate**, $3\text{SrO} \cdot 2\text{B}_2\text{O}_3$, by heating equi-molar parts of strontia and boric oxide in a carbon crucible to bright redness. The molten portion crystallized on cooling. The chemical individuality of the product has not been confirmed.

A. Ditte reported **calcium metaborate or diborate**, $\text{CaO} \cdot \text{B}_2\text{O}_3$, or $\text{Ca}(\text{BO}_2)_2$, to be formed by fusing the precipitate obtained by adding borax to a soluble calcium salt, with a mixture of potassium and sodium chlorides and less than 25 per cent. of calcium chloride; and H. le Chatelier also prepared the crystals by melting together equi-molar proportions of the components. The crystals were washed with water and dil. acetic acid. As L. Vanino showed, the tetraborate first precipitated is hydrolyzed, thus $\text{CaB}_4\text{O}_7 + 3\text{H}_2\text{O} \rightleftharpoons \text{Ca}(\text{BO}_2)_2 + 2\text{H}_3\text{BO}_3$; or even $\text{CaB}_4\text{O}_7 + 7\text{H}_2\text{O} \rightleftharpoons \text{Ca}(\text{OH})_2 + 4\text{H}_3\text{BO}_3$ crystals form transparent needles, prisms, or plates, which, according to E. Mallard, belong to the rhombic system, and have axial ratios $a : b : c = 0.539 : 1 : 0.372$. The double refraction is negative, and the indices of refraction for Na-light are $\mu_\alpha = 1.540$; $\mu_\beta = 1.656$; and $\mu_\gamma = 1.682$. A. Ditte found that the crystals are insoluble in water, in aq. soln. of the alkali chlorides, or in boiling conc. acetic acid; but they are soluble in hot or cold soln. of ammonia salts—especially the nitrate; and readily soluble at 50° in dil. mineral acids. W. Guertler prepared the same compound melting at 1100° (Fig. 23). L. Ouvrard prepared **strontium metaborate or diborate**, $\text{SrO} \cdot \text{B}_2\text{O}_3$, and found that water converted it into the dihydrate. W. Guertler's preparation melted at about 1100° (Fig. 24). L. Ouvrard

made **barium metaborate or diborate**, $\text{BaO} \cdot \text{B}_2\text{O}_3$, in a similar manner to the strontium compound; R. Benedikt made it by melting sodium metaborate with an eq. amount of barium chloride, and extracting the mass with water; and W. Guertler made it by fusing together the components. The acicular crystals melt at 1060° (Fig. 25). G. Tammann found the heats of soln. of calcium and strontium metaborates in $N\text{-HCl}$, to be respectively 161 and 141 cal. per gram for the crystals, and 211 and 175 cal. per gram for the glasses; hence, the heats of crystallization are respectively 50 and 34 cal. per gram. The sp. hts. of the crystals were respectively 0.222cand and 0.176 , and of the glasses 0.218 and 0.175 .

A. Ditte mixed the precipitate, obtained by adding borax to a soln. of a calcium salt and washing, with an excess of a soln. of calcium hydroxide; crystals are gradually formed which he regarded as heptahydrated calcium diborate, but which J. H. van't Hoff and W. Meyerhoffer showed to be **hexahydrated calcium diborate**, $\text{Ca}(\text{BO}_2)_2 \cdot 6\text{H}_2\text{O}$. W. Meyerhoffer made the same salt by the action of boric acid on calcium chloride in an aq. soln. of potassium hydroxide. The conditions of stability at 30° were worked out by U. Sborgi, Fig. 27. When a soln. of calcium hydroxide is gradually added to an eq. quantity of a soln. of boric acid at $60^\circ\text{--}70^\circ$, an amorphous precipitate is formed approximating to $\text{CaO} \cdot \text{B}_2\text{O}_3 \cdot 4\text{H}_2\text{O}$; but after shaking the mixture for several days, the precipitate becomes crystalline and has the composition $\text{CaO} \cdot \text{B}_2\text{O}_3 \cdot 6\text{H}_2\text{O}$. Two-thirds of the water is lost at 105° , and the remainder at a red heat; and it is hence inferred that 4 mols. of water are associated differently from the remaining two; and this idea is expressed by regarding the salt as **tetrahydrated calcium tetrahydroxyorthoborate**, $\text{Ca}[\text{O} \cdot \text{B}(\text{OH})_2]_2 \cdot 4\text{H}_2\text{O}$. According to A. Ditte, the crystals are six-sided prisms, or hexagonal plates. They are rapidly dehydrated at 80° , at 10° a litre of water dissolves 2 grms. of the salt, and the soln. has an alkaline reaction. The salt is not decomposed by atm. carbon dioxide. According to J. H. van't Hoff, U. Behn, and W. Meyerhoffer, when the hexahydrate is heated with water below 50° , long rectangular crystals are formed of an unstable **tetrahydrated α -calcium diborate**, $\text{Ca}(\text{BO}_2)_2 \cdot 4\text{H}_2\text{O}$, which has a transition temp. at 24° when it passes into the hexahydrate. When the α -salt is heated it contracts and passes into a stable β -form, namely, **tetrahydrated β -calcium diborate**. This change is greatly accelerated if sodium chloride be present in the soln.—with a 10 per cent. soln. of sodium chloride it occurs at 40° . The crystals of the hexahydrate were also found to become opaque when warmed, and to pass by reversible transformation at 45.5° into an unstable **dihydrated calcium diborate**, $\text{Ca}(\text{BO}_2)_2 \cdot 2\text{H}_2\text{O}$. H. Rose obtained this salt by treating equi-molar parts of cold soln. of sodium metaborate and calcium chloride; pressing the precipitate, and drying at 100° —the analysis agreed with $11\text{CaO} \cdot 10\text{B}_2\text{O}_3 \cdot 18\text{H}_2\text{O}$. At 200° , the salt still retained a mol of water, and not all was expelled at 300° . The salt absorbs carbon dioxide when it is being washed, and the product is then poorer in water. The precipitates which H. Rose obtained under similar conditions with barium chloride were regarded as **barium borocarbonate**, $3(\text{BaO} \cdot \text{B}_2\text{O}_3 \cdot \text{H}_2\text{O})\text{CO}_2$, or $\text{BaO} \cdot \text{B}_2\text{O}_3 \cdot \text{CO}_2 \cdot 7\text{H}_2\text{O}$.

A. Ditte prepared **pentahydrated strontium diborate**, $\text{Sr}(\text{BO}_2)_2 \cdot 5\text{H}_2\text{O}$, by a process similar to the one he employed for his heptahydrated calcium diborate. A litre of water at 10° dissolves 2.3 grms. of the prismatic crystals without decomposition. L. Ouvrard obtained **tetrahydrated strontium diborate**, $\text{Sr}(\text{BO}_2)_2 \cdot 4\text{H}_2\text{O}$, by the action of water on his $2\text{SrO} \cdot \text{B}_2\text{O}_3$; and prismatic crystals of **dihydrated strontium diborate**, $\text{Sr}(\text{BO}_2)_2 \cdot 2\text{H}_2\text{O}$, by the action of cold water on his $\text{SrO} \cdot \text{B}_2\text{O}_3$. The crystals become matt on exposure to air, and, according to E. Mallard, they belong to the rhombic system, and have a sp. gr. of 3.34. J. J. Berzelius prepared a hydrated barium diborate, $\text{BaO} \cdot \text{B}_2\text{O}_3 \cdot n\text{H}_2\text{O}$, by adding potassium diborate to a soln. of barium chloride. H. N. Morse with W. M. Burton and D. W. Horn found that when the precipitate obtained with an alcoholic soln. of boric acid is treated with baryta water, it has a constant composition $\text{BaO} : \text{B}_2\text{O}_3 = 1 : 1$, and can be used for the gravimetric determination of boric acid in the presence of carbonates; L. C. Jones showed that the process is not accurate in aq. soln. A. Ditte prepared **penta-**

hydrated barium diborate, $\text{Ba}(\text{BO}_2)_2 \cdot 5\text{H}_2\text{O}$, by the process he employed for the strontium salt; the crystals lose their water when heated and fuse to a transparent glass at a red heat. L. Ouvrard obtained **tetrahydrated barium diborate**, $\text{Ba}(\text{BO}_2)_2 \cdot 4\text{H}_2\text{O}$, by a process similar to that which he employed for the strontium salt. A. Atterberg also prepared the same salt by mixing warm soln. of two mols of barium hydroxide and one mol of boric acid, and allowing the mixture to stand for some time. The voluminous precipitate furnishes prismatic crystals which do not melt in their own water of crystallization. The dehydrated salt melts at a white heat, and cools to a mass of needle-like crystals. U. Sborgi explored the region of stability of the tetrahydrate at 30° , Fig. 26. By using an excess of barium hydroxide in a boiling soln., A. Atterberg obtained crystals of **dihydrated barium diborate**, $\text{Ba}(\text{BO}_2)_2 \cdot 2\text{H}_2\text{O}$; L. Ouvrard obtained the dihydrate by a similar process to that used for the strontium salt. A. Laurent dropped a soln. of the octoborate $\text{Na}_2\text{O} \cdot 4\text{B}_2\text{O}_3$ into a warm soln. of barium nitrate, and obtained what he regarded as **decahydrated barium diborate**, $\text{BaO} \cdot \text{B}_2\text{O}_3 \cdot 10\text{H}_2\text{O}$.

G. vom Rath applied the term *pandermite* to a hydrated calcium borate which occurs in a field covering about 20 sq. miles near the port of Panderna, on the Black Sea side of Asia Minor; the field embraces the villages of Sultan, Thair, Yildiz, and Omerly. It is situated in a basin surrounded by volcanic hills and the presence of hot mineral springs in various parts testifies to the volcanic influences at work in the formation of this mineral. Pandermite exists in closely packed snow-white nodules of irregular shape and size, in an enormous bed of grey-coloured gypsum, covered with several feet of clay. The chemical composition approaches that of colemanite, but the latter exfoliates and decrepitates when heated, while pandermite sinters together and fuses to a transparent mass. The general appearance of pandermite recalls that of fine-grained marble. Analyses and reports have been made by K. Kraut, G. Linck, A. Kenngott, M. Schlüter, A. Scheuer, J. E. Whitfield, F. Pisani, G. vom Rath, etc. The range is B_2O_3 , 40.90 to 48.63 per cent.; CaO , 27.22 to 32.16 per cent.; water, 18.06 to 19.40 per cent.; and in addition, a sample contained:

MgO	CaCO ₃	NaCl	MgCl ₂	Fe ₂ O ₃	H ₂ SO ₄	SiO ₂
0.24	6.82	0.44	0.09	0.60	2.11	2.47 per cent.

Pandermite is sold on a basis of 44 per cent. B_2O_3 —sometimes as *Turkish boracite*. E. S. Dana, J. E. Whitfield, and E. S. Larsen considered pandermite to belong to the same mineral species as *princeite*, which occurs, associated with serpentine, in compact nodules and in chalky powder consisting of minute rhombic crystals near Chetko in Oregon. The analyses of B. Silliman, and A. W. Chase correspond with $3\text{CaO} \cdot 4\text{B}_2\text{O}_3 \cdot 6\text{H}_2\text{O}$; and this in turn is not very different from the *cryptomorphite* of H. How, except that the latter contains some soda. C. F. Rammelsberg represented the composition of pandermite by $\text{Ca}_3\text{B}_8\text{O}_{15} \cdot 5\text{H}_2\text{O}$, or $3\text{CaO} \cdot 4\text{B}_2\text{O}_3 \cdot 5\text{H}_2\text{O}$; G. vom Rath, $2\text{CaO} \cdot 3\text{B}_2\text{O}_3 \cdot 3\text{H}_2\text{O}$; B. Silliman, H. Gilbert, G. Linck, and W. Meyerhoffer and J. H. van't Hoff, $\text{Ca}_3\text{B}_{20}\text{O}_{38} \cdot n\text{H}_2\text{O}$, where the ratio $\text{CaO} : \text{B}_2\text{O}_3 = 4 : 5$. The best representative formula is enneahydrated **tetracalcium decaborate**, $4\text{CaO} \cdot 5\text{B}_2\text{O}_3 \cdot 9\text{H}_2\text{O}$. According to J. H. van't Hoff, pandermite is synthesized by boiling boronatrocalcite with a sat. soln. of sodium and potassium chlorides—the temp. approximates 110° . When the product is allowed to stand a few days with its own mother liquid, well-developed crystals are produced. G. Linck found that the crystals of pandermite belong to the monoclinic system with $a : b : c = 0.555 : 1 : -$, and β about 70° . The optical axial angle $2V_a$ is about 35° ; and the cleavage parallel to (001) is good, while that parallel to (110) is not so good. The index of refraction is 1.592. E. S. Larsen gave $\alpha = 1.582$, $\beta = 1.592$, and γ less than 1.606. G. Linck gave 2.433 for the sp. gr.

H. Rose prepared what he regarded as *heptahydrated strontium decaborate*, $3\text{SrO} \cdot 5\text{B}_2\text{O}_3 \cdot 7\text{H}_2\text{O}$, by mixing equimolar soln. of borax and strontium chloride in the cold—if the soln. be heated, less boric oxide is present in the product. The pressed

precipitate dried at 100° retains 7 mols of water, 3 of which are lost at 200°. A. Ditte prepared long silky needles of anhydrous **dicalcium hexaborate**, or *calcium sesquiborate*, $2\text{CaO} \cdot 3\text{B}_2\text{O}_3$, or $\text{Ca}_2\text{B}_6\text{O}_{11}$, by fusing calcium oxide with a small excess of boric oxide in the presence of 50 per cent. of a mixture of sodium and potassium chlorides; and also by melting some calcium borates with alkali chlorides. He also made six-sided prisms of **dibarium hexaborate**, or *barium sesquiborate*, $2\text{BaO} \cdot 3\text{B}_2\text{O}_3$, or $\text{Ba}_2\text{B}_6\text{O}_{11}$, in a similar way. The salt is easily soluble in warm dil. acids. The mineral *colemanite* approaches **pentahydrated dicalcium hexaborate**, $2\text{CaO} \cdot 3\text{B}_2\text{O}_3 \cdot 5\text{H}_2\text{O}$, or $\text{Ca}_2\text{B}_6\text{O}_{11} \cdot 5\text{H}_2\text{O}$, in composition. It was named after W. T. Coleman, one of the founders of the Californian borax industry. The chief sources of supply are the mines in Death Valley, California, and at Lang, near Los Angeles. The mineral has the appearance of calcspar, and is sometimes called *borspar*; its colour varies from white to yellowish-white, or grey; its hardness is $3\frac{1}{2}$ to 5, and although it pulverizes easily, the sharp edges of the crystals rapidly wear the pulverizing plant. The ore as mined runs 30 to 35 per cent. B_2O_3 . A selected sample from Lang, according to F. M. Dupont, had the analysis:

B_2O_3	CaO	Al_2O_3	Fe_2O_3	MgO	CO_2	SiO_2	H_2O
31.10	23.74	1.27	1.32	2.36	5.14	13.97	16.10

Analyses have also been made by J. T. Evans, and J. E. Whitfield. According to J. H. van't Hoff, the naturally occurring calcium borates lie between the di- and hexaborates, and borates containing $\text{CaO} : \text{B}_2\text{O}_3$ in the same ratio as in colemanite, are obtained by adding boric acid to the diborates, or removing boric acid from the higher borates. For example, colemanite is synthesized in a crystalline form by heating to 70° a mixture of 140 c.c. of water with 50 grms. of sodium chloride and 4 grms. of boronatrocalcite, together with 0.4 gm. of boric acid to avoid the production of pandermite. H. Rose made a hydrated borate by adding an excess of calcium chloride to a soln. of borax; after washing it contained $\text{CaO} : \text{B}_2\text{O}_3$ in the ratio 2 : 3, and when dried at 100° retained $3\frac{1}{2}$ to 5 mols of water; and at 300°, $1\frac{1}{2}$ mols. The sp. gr. of colemanite so prepared is 2.43. J. T. Evans found 2.428, and G. vom Rath gave 2.417 for the sp. gr. of native borate; G. vom Rath found the monoclinic prisms of the mineral have the axial ratio $a : b : c = 0.7769 : 1 : 0.5416$, and $\beta = 110^\circ 17'$; A. W. Jackson gave $0.7748 : 1 : 0.5410$, and $\beta = 69^\circ 50' 45''$; and A. S. Eakle, $0.7768 : 1 : 0.5430$, and $\beta = 110^\circ 7'$. W. W. Coblenz found colemanite to be unusually opaque to ultra-red radiations, and it is almost opaque beyond 3μ . This opacity is characteristic of the borates. The water bands at 1.5μ , 2μ , and 3μ are almost obliterated. The reflecting power is very low. There are maxima at 7.3μ , (7.6μ), 9.4μ , 10.6μ , and 11.2μ . A. S. Eakle described a borate from Lang, Los Angeles, which agrees with colemanite from Death Valley, Inyo, and Calico district, San Bernardino, in its general chemical and physical properties, but "in its optical properties it is somewhat different so that the name *neocolemanite* is proposed to distinguish it as a variety from colemanite." A. Hutchinson, however, showed that the two minerals have the same optical and crystallographic properties if the neocolemanite crystals be rotated through 180° about the normal to the cleavage plane (001). The double refraction is positive; and the indices of refraction, according to A. Mülheims, are:

	B-line	C-line	D-line	E-line	F-line
α	1.58230	1.58345	1.58626	1.58952	1.59214
β	1.58807	1.58922	1.59202	1.59531	1.59810
γ	1.60978	1.61100	1.61398	1.61762	1.62044

According to W. Meyerhoffer and J. H. van't Hoff, when hexahydrated calcium diborate, $\text{Ca}(\text{BO}_2)_2 \cdot 6\text{H}_2\text{O}$, is heated at 100° with a 3 per cent. soln. of boric acid, it is converted into **heptahydrated dicalcium hexaborate**, $\text{Ca}_2\text{B}_6\text{O}_{11} \cdot 7\text{H}_2\text{O}$, which forms long rectangular crystals possibly identical with the hexahydrate reported by K. Kraut in 1862 as being obtained by the action of water on boronatrocalcite. It is distinguished from colemanite in the proportion of water it contains, and,

regarded as a mineral, it is called *meyerhofferite*. W. T. Schaller found small transparent colourless crystals of *meyerhofferite* in the colemanite deposit of Death Valley (Cal.). The triclinic crystals had the axial ratios $a : b : c = 0.7923 : 1 : 0.7750$, and $\alpha = 89^\circ 32'$, $\beta = 78^\circ 19'$, $\gamma = 86^\circ 52'$; the sp. gr. was 2.120; the hardness 2; and refractive indices $\alpha = 1.500$, $\beta = 1.535$, $\gamma = 1.560$. The mineral fuses without decrepitation, but with intumescence, forming an opaque white enamel. A. Atterberg also made **heptahydrated dibarium hexaborate**, $\text{Ba}_2\text{B}_6\text{O}_{11} \cdot 7\text{H}_2\text{O}$, as an amorphous precipitate by adding boric acid to an excess of an aq. soln. of barium hydroxide. It loses 4 mols of water at 100° , and the remainder on further heating; it melts at a red heat without swelling. W. Meyerhoffer and J. H. van't Hoff also made **enneahydrated calcium hexaborate**, $\text{Ca}_2\text{B}_6\text{O}_{11} \cdot 9\text{H}_2\text{O}$, by heating hydrated calcium diborate with the requisite amount of an aq. soln. of boric acid; or by the action of water on octohydrated calcium hexaborate, $\text{Ca}_3\text{B}_6\text{O}_{11} \cdot 8\text{H}_2\text{O}$, at ordinary temp. It forms crystals resembling augite. The mineral *inyoite* is **tridecahydrated calcium hexaborate**, $\text{CaB}_6\text{O}_{10} \cdot 13\text{H}_2\text{O}$. Crystals found by W. T. Schaller in the colemanite deposit of Death Valley (Inyo Co., Cal.); and by E. Poitevin and H. U. Ellsworth in the Whitehead gypsum quarry, Hellsborough (New Brunswick, Canada). The monoclinic crystals of *inyoite* have the axial ratios $a : b : c = 0.94 : 1 : 0.67$, and $\beta = 62^\circ 30'$; the sp. gr. is 1.875; hardness 2; and refractive indices $\alpha = 1.495$, $\beta = 1.51$, and $\gamma = 1.520$. *Inyoite* decrepitates and fuses with intumescence before the blowpipe flame.

H. Rose prepared **enneahydrated tricalcium decaborate**, $\text{Ca}_3\text{B}_{10}\text{O}_{18} \cdot 9\text{H}_2\text{O}$, or $3\text{CaO} \cdot 5\text{B}_2\text{O}_3 \cdot 9\text{H}_2\text{O}$, by precipitation from a cold soln. of calcium chloride with borax in equi-molar proportions. The exact proportions of water in H. Rose's product was not definitely determined, but J. H. van't Hoff also made needle-like crystals of the enneahydrate by heating boronatrocalcite with a soln. of borax, when $2\text{CaO} \cdot 3\text{B}_2\text{O}_3 \cdot 7\text{H}_2\text{O}$ is formed at an intermediate stage of the reaction. H. Rose also made **heptahydrated tristrontium decaborate**, $\text{Sr}_3\text{B}_{10}\text{O}_{18} \cdot 7\text{H}_2\text{O}$. If precipitated from a hot soln., the product contains a smaller proportion of boric oxide. H. Rose made **hexahydrated tribarium decaborate**, $3\text{BaO} \cdot 5\text{B}_2\text{O}_3 \cdot 6\text{H}_2\text{O}$. H. Rose found the strontium salt retains 3 mols of water at 200° , J. J. Berzelius said that 100 parts of cold water dissolve one part of the barium salt; and on cooling the hot soln. a white powder is deposited; carbon dioxide precipitates barium carbonate from the soln. According to R. H. Brett, and H. W. F. Wackenroder the salt dissolves readily in cold aq. soln. of ammonium chloride or nitrate; and, according to H. Rose, in a soln. of barium chloride. L. C. Jones found barium borate is decomposed by carbon dioxide in aq. or alcoholic soln.

A. Ditte prepared crystalline plates of anhydrous **calcium tetraborate**, CaB_4O_7 , or $\text{CaO} \cdot 2\text{B}_2\text{O}_3$, by melting calcium oxide with an excess of boric acid and a mixture of sodium and potassium chlorides. B. Blount and W. Guertler (Fig. 23) made this compound by fusing the constituents together, and they added that it is decomposed by water. A. Ditte and H. le Chatelier also made fine needles of anhydrous **strontium tetraborate**, $\text{SrO} \cdot 2\text{B}_2\text{O}_3$, by boiling strontium carbonate with boric acid; by precipitating a soln. of strontium nitrate with borax; and by the method used for the calcium salt. W. Guertler found that if strontia is melted with an excess of boric oxide, two layers are formed; the upper layer contains but little strontia, but when the lower glassy layer is heated some days it forms crystals of this salt from which the excess of boric acid is removed by water—*vide* Fig. 24. A. Ditte made anhydrous **barium tetraborate**, BaB_4O_7 , by a process similar to that employed for the strontium salt. All these borates are soluble in dil. nitric acid. J. J. Berzelius noted that when calcium chloride is added to a warm soln. of borax, the precipitate redissolves (on cooling), but if an excess of borax be used, the precipitate is permanent. A. Ditte prepared pentahydrated calcium tetraborate, $\text{CaB}_4\text{O}_7 \cdot 5\text{H}_2\text{O}$, by adding lime water to an aq. soln. of boric acid sat. at 40° and warming the filtered soln. to 70° ; the precipitate which is formed redissolves as the soln. cools; but if most of the hot mother liquid be poured off, and the

precipitate and the mother liquid be allowed to stand for some months, needle-like crystals of this salt are formed. They are decomposed by much water into the diborate. The bechilite of E. Bechi, and the hayesine of D. Forbes were considered to be tetrahydrates, but J. H. van't Hoff could not make them artificially. J. Tünnermann believed the air-dried precipitate produced by adding borax to a soln. of calcium nitrate is a monohydrate, $\text{CaO} \cdot 2\text{B}_2\text{O}_3 \cdot \text{H}_2\text{O}$; L. R. Lecanu obtained what he regarded as a tetrahydrate, $\text{CaO} \cdot 2\text{B}_2\text{O}_3 \cdot 4\text{H}_2\text{O}$, by the action of boiling water on boronatrocalcite; O. Popp obtained what he regarded as the octohydrate, $\text{CaO} \cdot 2\text{B}_2\text{O}_3 \cdot 8\text{H}_2\text{O}$, by drying in air the product obtained by heating an aq. soln. of boric acid with calcium carbonate. E. Bechi found crusts of tetrahydrated calcium tetraborate are deposited from the Tuscan springs, and, when regarded as a mineral, the salt is called *bechilite*; and the *hayesine* of D. Forbes, deposited from the hot springs of Banos del Toro, Cordilleras (Coquimbo), is possibly the same. The *borocalcite* found by A. A. Hayes at Iquique (Peru) was said to be a hexahydrate, $\text{CaO} \cdot 2\text{B}_2\text{O}_3 \cdot 6\text{H}_2\text{O}$. J. H. van't Hoff said that all attempts to prepare *borocalcite*, $\text{CaO} \cdot 2\text{B}_2\text{O}_3 \cdot 4\text{H}_2\text{O}$, from natural sources have been unsuccessful; various specimens from collections have been shown to be boronatrocalcite, pandermite, etc. Experiments to prepare it have also been without the desired result. An aq. soln. of lime and boric acid, kept at 40° for three weeks, deposits a substance of the approximate composition demanded by the formula; it is really, however, a mixture of calcium hexaborate, $\text{CaO} \cdot 3\text{B}_2\text{O}_3 \cdot 4\text{H}_2\text{O}$, and dicalcium hexaborate, $2\text{CaO} \cdot 3\text{B}_2\text{O}_3 \cdot 9\text{H}_2\text{O}$. At 83° , however, this soln. deposits, after two months, colemanite; this is the best method of obtaining artificial colemanite. Borocalcite, if capable of existence, is therefore very difficult to prepare. J. H. van't Hoff also studied the limits of formation of colemanite, pandermite, boronatrocalcite, and the tetrahydrate, $\text{NaCaB}_5\text{O}_9 \cdot 4\text{H}_2\text{O}$, and represented his results graphically in conjunction with those of sylvine, borax, calcium chloride, etc. The rule that the difficulty of forming artificial minerals increases from the chlorides to the sulphates and to the borates is given a quantitative significance, in which the idea of "mean valence" is introduced. "Mean valence" is a quotient of two totals; the values for Na, K, Cl are 1; Ca, Mg, SO_4 , 2; B_2O_3 , 6, and H_2O , 4, in the numerator, those in the denominator being Na, K, Cl, Ca, Mg, SO_4 , 1; B_2O_3 , 2; and H_2O ; thus for ascharite, MgHBO_3 or $2\text{MgO} \cdot \text{B}_2\text{O}_3 \cdot \text{H}_2\text{O} = (4+6+4)/(2+2+3) = 2$. A. Laurent and A. Ditte obtained **tetrahydrated strontium tetraborate**, $\text{SrO} \cdot 2\text{B}_2\text{O}_3 \cdot 4\text{H}_2\text{O}$, by double decomposition between aq. soln. of borax and strontium chloride. R. H. Brett said that the precipitate is soluble in soln. of ammonium salts, and that 100 parts of water dissolve 0.77 part of the salt. It is thought that the product obtained by J. J. Berzelius, and C. G. Gmelin, and J. Tünnermann by the action of an excess of borax on a soln. of barium chloride is hydrated barium tetraborate salt. According to I. W. Kölreuter, it behaves like barium carbonate towards alkali sulphates.

According to A. Ditte, if calcspar be boiled with a sat. soln. of boric acid, **tetrahydrated calcium hexaborate**, $\text{CaO} \cdot 3\text{B}_2\text{O}_3 \cdot 4\text{H}_2\text{O}$, or $\text{CaB}_6\text{O}_{10} \cdot 4\text{H}_2\text{O}$, is formed as a crystalline crust which loses all its water at 200° , and melts to a glassy mass at 400° . W. Meyerhoffer and J. H. van't Hoff found that the **dodecahydrated calcium hexaborate**, $\text{CaB}_6\text{O}_{10} \cdot 12\text{H}_2\text{O}$, is formed by shaking the above hexahydrate with boric acid in cold aq. soln.; the conversion is complete in about twenty-four hours. This hydrate is unstable and changes at the ordinary temp. into the **octohydrated calcium hexaborate**, $\text{CaB}_6\text{O}_{10} \cdot 8\text{H}_2\text{O}$, which forms doubly refracting leaflets and slowly undergoes degradation to A. Ditte's tetrahydrate. A. Ditte made **strontium hexaborate**, $\text{SrO} \cdot 3\text{B}_2\text{O}_3$, by the action of borax on an excess of strontium oxide. According to A. Atterberg, if an aq. soln. of baryta-water be dropped into an excess of an aq. soln. of boric acid, a precipitate nearly corresponding with *hexahydrated barium hexaborate*, $\text{BaO} \cdot 3\text{B}_2\text{O}_3 \cdot 6\text{H}_2\text{O}$, is formed, but since the composition varies a little, the product is thought to be a mixture.

A. Laurent boiled milk of lime with an excess of boric acid, and obtained a white precipitate whose analysis corresponded with **enneahydrated calcium octoborate**,

$\text{CaO} \cdot 4\text{B}_2\text{O}_3 \cdot 9\text{H}_2\text{O}$; and A. Ditte obtained **dodecahydrated calcium octoborate**, $\text{CaO} \cdot 4\text{B}_2\text{O}_3 \cdot 12\text{H}_2\text{O}$, by treating a soln. of boric acid, sat. at 40° , with milk of lime, and evaporating the filtered soln. slowly at ordinary temp. The product decomposes at 70° into water, boric acid, and a little tetraborate which in turn decomposes into the diborate. A. Ditte also prepared **heptahydrated strontium octoborate**, $\text{SrO} \cdot 4\text{B}_2\text{O}_3 \cdot 7\text{H}_2\text{O}$, **dodecahydrated strontium octoborate**, $\text{SrO} \cdot 4\text{B}_2\text{O}_3 \cdot 12\text{H}_2\text{O}$; and also **dodecahydrated barium octoborate**, $\text{BaO} \cdot 4\text{B}_2\text{O}_3 \cdot 12\text{H}_2\text{O}$. A. Laurent assumed that he made *barium, strontium, and calcium dodecaborates* as precipitates by adding ammonium or an alkali dodecaborate to a soln. of the corresponding salt.

J. J. Berzelius found calcium oxide dissolves in fused borax, forming a clear glass, which on cooling furnishes a crystalline mass if a large proportion of lime is present; if otherwise, a glass is formed. The mineral *boronatrocalthite* is a sodium calcium borate also called *ulexite* after G. L. Ulex,² who first gave a correct analysis. It occurs in the dry plains of the provinces of Tarapaca, Atacama, Ascotan, Maricunga, and Copiapó in Chile and Peru, as in white roundish masses mixed with aluminium, magnesium, calcium, and sodium sulphates, sodium chlorides, etc. These masses are locally called *tiza*, *cotton-balls*, *tincalcite*, or *borax-lime*. It also occurs in the desert regions in zones or layers alternating with strata of salty earth, and also on the West African coast; in Nova Scotia; etc. Analyses have been published by G. L. Ulex, C. F. Rammelsberg, A. Dick, K. Kraut, F. W. Helbig, G. Lunge, M. Kletzinsky, T. L. Phipson, A. Salvétat, H. How, T. L. Walker, etc. These analyses range from 34.71 to 49.5 per cent. of boric oxide; 12.69 to 15.9, calcium oxide; 5.42 to 11.95, sodium oxide; 0.5 to 1.0, potassium oxide; 25.80 to 37.40, water; 0.81 to 2.65, sodium chloride; magnesia up to about 0.5; sulphate up to about 1.5 per cent.; and earthy matters and sand up to about 5 per cent. F. M. Dupont gives the following analysis of a sample from Ascotan, and J. E. Whitfield of a sample from Rhodes' Marsh, Esmeralda County, Nevada:

	B_2O_3	H_2O	Na_2O	CaO	MgO	SiO_2	Cl	SO_3
Ascotan	38.04	19.86	15.91	12.34	0.37	4.95	9.64	0.84
Rhodes' Marsh	43.20	29.46	10.20	14.52	—	0.04	2.38	0.28

and in sample A, 0.24 per cent. of ferric oxide and alumina, and in sample B, 0.44 per cent. of K_2O . The difficulties in the determination of boric oxide left the composition of the mineral for some time in doubt; and it was thought that the contained soda might be present as an impurity. A. Raimondi stated that all Peruvian calcium borates contain some soda. Different formulæ have been assigned to the mineral; K. Kraut gave $(\text{Na}_2\text{O} \cdot 2\text{B}_2\text{O}_3)(\text{CaO} \cdot 3\text{B}_2\text{O}_3) \cdot 15\text{H}_2\text{O}$, or $\text{Na}_2\text{CaB}_{10}\text{O}_{17} \cdot 15\text{H}_2\text{O}$; C. F. Rammelsberg, $(\text{Na}_4\text{B}_6\text{O}_{11})(\text{Ca}_2\text{B}_6\text{O}_{11})_2 \cdot 28\text{H}_2\text{O}$; J. E. Whitfield gave $\text{NaCaB}_5\text{O}_9 \cdot 6\text{H}_2\text{O}$; and L. Darapsky, and H. Gilbert, $\text{NaCaB}_5\text{O}_9 \cdot 8\text{H}_2\text{O}$, i.e. $\text{Na}_2\text{O} \cdot 2\text{CaO} \cdot 5\text{B}_2\text{O}_3 \cdot 16\text{H}_2\text{O}$. The analyses of artificial boronatrocalthite agree with the last-named formula, **hexadecahydrated sodium dicalcium decaborate**.

T. L. Walker measured the loss which occurs when the ulexite is heated for 24 hrs. at different temp. up to 355° ; he found that the first 12 mols of water are given off very readily and in proportion to the rise of temp., except the fifth mol, which appears to be more firmly held; the last four mols are held more closely and are slowly driven off. Of these, the last is held most firmly, and is given off between 355° and red heat. The dehydration curve is illustrated in Fig. 28.

H. How's *cryptomorphite* occurring in minute plates, has an analysis corresponding with $\text{Na}_2\text{O} \cdot 3\text{CaO} \cdot 9\text{B}_2\text{O}_3 \cdot 12\text{H}_2\text{O}$; it is said to lose much of its water when

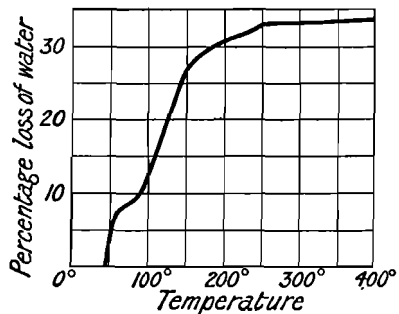

FIG. 28.—Dehydration Curve of Ulexite, $\text{Na}_2\text{O} \cdot 2\text{CaO} \cdot 5\text{B}_2\text{O}_3 \cdot 16\text{H}_2\text{O}$.

exposed to air. It is probably a mixture. J. E. Reynolds obtained a massive white mineral with a fine fibrous structure, of hardness 1, and sp. gr. 1.65, from Tarapaca, Peru. Analyses agreed with the formula $2\text{Na}_2\text{O} \cdot 2\text{CaO} \cdot 6\text{B}_2\text{O}_3 \cdot 15\text{H}_2\text{O}$, or $\text{Na}_2\text{CaB}_5\text{O}_{11} \cdot 7\frac{1}{2}\text{H}_2\text{O}$, and it was named *franklandite*. J. H. van't Hoff said that the analytical data correspond with an impure boronatrocalcite, and his attempts to obtain the product artificially were unsuccessful; when a mixture of boronatrocalcite and borax is heated to 60° , pentahydrated sodium tetraborate appears at 60° , and at 63° , the boronatrocalcite loses water with the formation of **octohydrated sodium dicalcium decaborate**, $\text{Na}_2\text{O} \cdot 2\text{CaO} \cdot 5\text{B}_2\text{O}_3 \cdot 8\text{H}_2\text{O}$, or $\text{NaCaB}_5\text{O}_9 \cdot 4\text{H}_2\text{O}$. Consequently, the formation of coemanite from boronatrocalcite at about 65° according to the equation: $2\text{NaCaB}_5\text{O}_9 \cdot 8\text{H}_2\text{O} = \text{Na}_2\text{B}_4\text{O}_7 \cdot 5\text{H}_2\text{O} + \text{Ca}_2\text{B}_6\text{O}_{11} \cdot 5\text{H}_2\text{O} + 6\text{H}_2\text{O}$, is possible only when superheating of the boronatrocalcite takes place. This implies that the upper temp. limit for the existence of boronatrocalcite is lower than that previously recorded, and dilatometer experiments indicate that this limit is below 60° . In presence of sodium chloride, borax, potassium chloride and glaserite, decomposition of boronatrocalcite was found to take place at 51° .

A. B. de Schulten prepared boronatrocalcite by the action of an excess of a cold sat. soln. of borax on calcium chloride; the amorphous precipitate is transformed in 5–30 days into a mass of fine crystals. J. H. van't Hoff made it by mixing 110 grms. of hexahydrated calcium diborate, 40 grms. of boric acid, 100 grms. of borax, 450 grms. of calcium chloride, and $2\frac{1}{2}$ litres of water. The mixture is seeded with boronatrocalcite, and in a few days, the crystals are filtered off; washed successively with water, 75 per cent. alcohol, and ordinary alcohol; and then dried. W. Foshag and others assume that boronatrocalcite is formed in nature by the action of soln. of boric acid and sodium salts on marble; J. H. van't Hoff studied the paragenesis of the sodium calcium borates in the formation of salt deposits.

Although boronatrocalcite occurs in microscopically fine crystals—needles and plates—of snow-white colour, exact crystallographic data are not available. H. Buttgenbach has made some measurements. A. des Cloizeaux examined the corrosion figures. H. How gave 1.65 for the sp. gr. of the mineral; and A. B. de Schulten, 1.955 at 15° for the artificial compound. The compound loses its water of crystallization when heated; and melts at a red heat. H. Buttgenbach said that the crystals have a positive double refraction, while those of borocalcite are sometimes negative. Cold water extracts some soda from the mineral, but even boiling water (1 : 40) does not remove the soda completely, and L. R. Lecanu, and J. H. van't Hoff obtained crystals of tetrahydrated calcium tetraborate, $\text{CaO} \cdot 2\text{B}_2\text{O}_3 \cdot 4\text{H}_2\text{O}$, from the hot aq. soln., while K. Kraut obtained $2\text{CaO} \cdot 3\text{B}_2\text{O}_3 \cdot 6\text{H}_2\text{O}$. According to J. H. van't Hoff, the transformation of boronatrocalcite into the tetrahydrate—pandermite—proceeds much faster in porcelain than in glass vessels. With a boiling soln. of ammonium chloride, boronatrocalcite gives off ammonia.

REFERENCES.

- ¹ T. Bergman, *De attractionibus electivis*, Upsala, 1775; London, 1785; A. Ditte, *Ann. Chim. Phys.*, (5), **30**, 248, 1883; *Compt. Rend.*, **77**, 783, 1873; **80**, 490, 561, 1875; **96**, 1663, 1883; C. Tissier, *ib.*, **89**, 192, 1854; L. Ouvrard, *ib.*, **132**, 258, 282, 1901; **141**, 353, 1023, 1905; **142**, 282, 1906; H. le Chatelier, *ib.*, **113**, 1036, 1891; H. Rose, *Pogg. Ann.*, **86**, 561, 1852; **87**, 1, 1852; E. Mallard, *Bull. Soc. Min.*, **15**, 15, 1892; L. B. Guyton de Morveau, *Polyt. Journ.*, **8**, 298, 1796; K. Kraut, *Arch. Pharm.*, (2), **112**, 33, 1862; *Ber.*, **86**, 167, 1897; *Zeit. anal. Chem.*, **88**, 165, 1897; C. F. Rammelsberg, *Neues Jahrb. Min.*, **ii**, 158, 1884; W. Guertler, *Zeit. anorg. Chem.*, **40**, 343, 1904; *Ueber wasserfreie Borate und über Entglasung*, Leipzig, 1904; R. Benedikt, *Ber.*, **7**, 703, 1874; L. Vanino, *Zeit. anal. Chem.*, **54**, 408, 1915; E. S. Larsen, *Amer. Min.*, **1**, 2, 1917; A. Kenngott, *Neues Jahrb. Min.*, **ii**, 141, 1885; G. Linck, *Centr. Min.*, **193**, 1923; W. T. Schaller, *Bull. U.S. Geol. Sur.*, **610**, 35, 1916; E. Poitevin and H. U. Ellsworth, *Bull. Canada Geol. Sur.*, **32**, 1921; N. Tate, *Journ. Chem. Soc.*, **12**, 160, 1859; J. E. Whitfield, *Bull. U.S. Geol. Sur.*, **55**, 1889; J. H. van't Hoff, *Sitzber. Akad. Berlin*, **568**, 690, 1906; **562**, 1907; J. H. van't Hoff and U. Behn, *ib.*, **653**, 1906; W. Meyerhoffer and J. H. van't Hoff, *Liebigs Ann.*, **351**, 101, 1906; O. Popp, *Liebigs Ann. Suppl.*, **8**, 10, 1872; B. Blount, *Chem. News*, **54**, 208, 1886; L. R. Lecanu, *Journ. Pharm. Chim.*, (3), **24**, 22, 1853; J. Tünnermann, *Kastner's*

Arch., 20. 50, 1830; A. Laurent, *Compt. Rend. Trav. Chim.*, 6. 33, 1850; H. N. Morse and W. M. Burton, *Amer. Chem. Journ.*, 10. 154, 1888; H. N. Morse and D. W. Horn, *ib.*, 24. 105, 1900; L. C. Jones, *Zeit. anorg. Chem.*, 32. 164, 1902; *Amer. Journ. Science*, (4), 5. 442, 1898; H. S. Washington, *ib.*, (3), 34. 281, 1887; B. Silliman, *ib.*, (3), 6. 128, 1873; A. W. Chase, *ib.*, (3), 5. 287, 1873; H. How, *ib.*, (2), 32. 9, 1861; A. W. Jackson, *ib.*, (3), 23. 447, 1884; (3), 29. 341, 1885; *Bull. California Acad. Science*, 2. 2, 1885; 4. 358, 1886; A. S. Eakle, *Bull. Dept. Geol. Univ. California*, 3. 31, 1902; 6. 179, 1911; A. Scheuer, *Zeit. angew. Chem.*, 5. 241, 1892; F. Pisani, *Travé élémentaire de minéralogie*, Paris, 215, 1875; G. vom Rath, *Ber. niederrh. Ges. Bonn*, 191, 1877; *Neues Jahrb. Min.*, i, 77, 1385; E. S. Dana, *A System of Mineralogy*, New York, 3. 97, 1882; E. S. Larsen, *Amer. Min.*, 2. 1, 1917; F. M. Dupont, *Journ. Ind. Eng. Chem.*, 2. 500, 1910; J. T. Evans, *Proc. California Acad. Science*, 1, 1886; H. Gilbert, *Zeit. angew. Chem.*, 6. 523, 1893; A. Mühlheims, *Zeit. Kryst.*, 14. 202, 1888; F. Hiortdahl, *Zeit. Kryst.*, 10. 25, 1885; C. Bodewig and G. vom Rath, *ib.*, 10. 179, 1885; A. Arzruni, *ib.*, 10. 272, 1885; R. H. Brett, *Phil. Mag.*, (3), 10. 95, 1837; G. Tammann, *Kristallisieren und Schmelzen*, Leipzig, 56, 1903; W. W. Coblenz, *Investigations of Infra-red Spectra*, Washington, 3. 25, 1906; 4. 85, 1906; M. Schlüter, *Kali*, 16. 190, 1922; H. W. F. Wackenroder, *Liebig's Ann.*, 41. 315, 1842; L. W. Kölsreuter, *Mag. Pharm.*, 8. 181, 1824; C. G. Gmelin, *Gilbert's Ann.*, 62. 399, 1819; 64. 371, 1820; *Schweigger's Journ.*, 30. 173, 1820; A. Hutchinson, *Min. Mag.*, 16. 239, 1912; U. Sborgi, *Atti Accad. Lincei*, (5), 22. i, 636, 715, 798, 1913; (5), 23. i, 530, 717, 854, 1914; A. Atterberg, *Öfvers. Vet. Akad. Förh.*, 6, 1874; *Bull. Soc. Chim.*, (2), 22. 351, 1874; J. J. Berzelius, *Pogg. Ann.*, 34. 561, 1835; A. A. Hayes, *Amer. Journ. Science*, (1), 46. 337, 1844; (1), 47. 215, 1844; (2), 18. 95, 1854; E. Bechi, *ib.*, (2), 17. 129, 1854; D. Forbes, *Phil. Mag.*, (4), 25. 113, 1863; H. S. Roberts, *Phys. Rev.*, (2), 23. 386, 1924.

^a C. F. Rammelsberg, *Pogg. Ann.*, 97. 301, 1856; *Handbuch der Mineralchemie*, Leipzig, 988, 1860; F. M. Dupont, *Journ. Ind. Eng. Chem.*, 2. 500, 1910; G. L. Ulex, *Liebig's Ann.*, 70. 49, 1849; G. Lunge, *ib.*, 138. 51, 1866; K. Krut, *ib.*, 189. 252, 1866; *Arch. Pharm.*, (2), 112. 25, 1862; A. Dick, *Phil. Mag.*, (4), 6. 50, 1853; M. Kletzinaky, *Journ. Chim. Méd.*, 6. 518, 1860; T. L. Hipson, *Compt. Rend.*, 52. 407, 1861; A. Salvétat, *ib.*, 52. 536, 1861; A. B. de Schulten, *ib.*, 132. 1576, 1901; H. How, *Amer. Journ. Science*, (2), 24. 230, 1857; (2), 32. 9, 1861; A. A. Hayes, *ib.*, (2), 18. 95, 1854; B. Silliman, *ib.*, 6. 130, 1848; H. Buttgenbach, *Mém. Soc. Geol. Belgique*, 28. 99, 1901; A. des Cloizeaux, *Manuel de minéralogie*, Paris, 2. 10, 1874; L. R. Lecanu, *Journ. Pharm. Chim.*, (3), 24. 22, 1853; J. H. van't Hoff, *Sitzber. Akad. Berlin*, 566, 689, 1906; A. Raimondi, *Minéraux de Perou*, Paris, 252, 1878; W. Foshag, *Amer. Min.*, 3. 35, 1918; L. Darapsky, *Chem. Zig.*, 11. 676, 1887; H. Gilbert, *Zeit. angew. Chem.*, 6. 532, 1893; H. Winklehner, *Oester. Berg. Hüt.*, 47. 627, 1899; B. Simmerbach, *Jahrb. Nassau Ver. Naturkunde*, 71. 67, 1918; F. W. Helbig, *Dingler's Journ.*, 147. 319, 1858; J. H. van't Hoff, *Sitzber. Akad. Wien*, 567, 689, 1906; 301, 365, 1907; J. E. Reynolds, *Phil. Mag.*, (5), 3. 284, 1877; J. E. Whitfield, *Bull. U.S. Geol. Sur.*, 55. 56, 1889; T. L. Walker, *Univ. Toronto Stud. Geol.*, 12. 54, 1922.

§ 12. The Borates of Beryllium, Magnesium, Zinc, Cadmium, and Mercury

W. Guertler¹ found beryllium oxide is but sparingly soluble in fused boric oxide. G. Krüss and H. Moraht found that freshly precipitated beryllium hydroxide does not act on boric acid, and barium borate gives no beryllium borate on treatment with beryllium sulphate, but simply the hydroxide. The borate may, however, be obtained by precipitating beryllium chloride soln. with borax soln. or by neutralizing the same with sodium carbonate in presence of a large excess of boric acid. It is a white precipitate, resembling beryllium hydroxide, and has the composition of a basic salt, namely, *pentaberyllium diborate*, $5\text{BeO} \cdot \text{B}_2\text{O}_3$, which B. Bleyer and L. Paczuský believe is a solid soln. of boric acid in beryllium hydroxide. They found that the ratio of distribution of boric acid between water and beryllium hydroxide is independent of the conc. of the boric acid at 20° and at 100°, showing that no definite compounds can be formed by the action of aq. soln. of boric acid and beryllium hydroxide, and that the boric acid removed by the hydroxide forms a solid soln. The conc. of the solid soln. formed when aq. soln. of beryllium sulphate and borax are mixed, varies considerably with the conc., and with the relative proportions of the reacting substances. Precipitates containing the largest proportions of boric acid are obtained when the beryllium salt reacts with an eq. quantity of sodium borate in a soln. of the highest possible conc. The addition of sodium or ammonium sulphate to the soln. has no appreciable influence on the composition of the precipitate.

The greyish-white mineral *hambergite* is possibly a solid soln., although it is

usually regarded as a basic borate in which two of the three hydrogen atoms of boric acid are displaced by beryllium, and the other, by the monad radicle $\text{Be}(\text{OH})$, forming **beryllium hydroxyorthoborate**, $\text{BeOH}\cdot\text{BeBO}_3$. It was first found by W. C. Brögger near Hegerøen, in Norway; A. Lacroix found it near Imalo, in Madagascar; R. C. Burton found crystals at Cashmir in India; and H. Bäckström at Jacobsberg. According to W. C. Brögger, the crystals are rhombic with axial ratios $a : b : c = 0.79876 : 1 : 0.72669$; and they have also been studied by V. Goldschmidt and co-workers, by A. Lacroix, W. J. Sokoloff, and R. C. Burton. Hambergite is soluble in hydrofluoric acid. H. Haga and F. M. Jäger obtained X-radiograms corresponding approximately with the rhombic holohedral symmetry. The sp. gr. is 2.347; the hardness 7.5; the crystals do not melt in the blowpipe; the double refraction is strongly positive, and the indices of refraction are:

		Li-line	Na-line	Tl-line
α	•	1.5542	1.5595	1.5693
β	•	1.5891	1.5908	1.5928
γ	•	1.6294	1.6311	1.6331

M. Puaux assumed that magnesium polyborates are formed in order to account for the augmented solubility of boric acid in water containing a little magnesia. C. Tissier found hydrated magnesium carbonate is soluble in a boiling soln. of boric acid, but the anhydrous salt is insoluble, and calcined magnesia dissolves slowly; O. Popp said magnesite is decomposed by a soln. of boric acid in brisk ebullition; and magnesia alba forms a sparingly soluble basic salt. J. C. G. de Marignac evaporated to dryness a soln. of boric acid and aq. ammonia mixed with enough ammonium magnesium chloride to give the ratio $\text{H}_3\text{BO}_3 : \text{MgO} = 1 : 2$ by weight. After these mixtures had been heated to redness, and washed with water, the boric acid is fixed as magnesium borate, mixed with the excess of magnesia. G. C. Wittstein found cold aq. soln. of magnesium salts are not precipitated by soln. of borax, and, as shown by F. Wöhler, the precipitate formed when the soln. is heated redissolves on cooling. Similar results obtain with a cold sat. soln. of borax and an aq. soln. of potassium carbonate and magnesium chloride. O. Popp said that the borates of ammonia, the alkalis, and of calcium form magnesium borate when heated with a magnesium salt.

J. J. Ebelmen melted magnesium oxide with an excess of boric oxide, and found that the glassy mass loses boric oxide in the pottery oven, and forms on cooling a radiating mass of crystals of **magnesium orthoborate**, $3\text{MgO}\cdot\text{B}_2\text{O}_3$, or $\text{Mg}_3(\text{BO}_3)_2$. W. Guertler obtained similar crystals. H. le Chatelier melted a mol of boric oxide with 2.5 mols of magnesia, and floated off the crystals with methylene iodide. L. Ouvrard melted at a red heat equi-molar proportions of boric oxide and potassium fluoride along with a slight excess of magnesium oxide. The cold powdered mass was extracted with boiling water and dil. acetic acid. K. A. Hofmann and K. Höschele made crystals of the orthoborate by fusing magnesium chloride with boric oxide. The fine needle-like crystals of magnesium orthoborate, according to E. Mallard, belong to the rhombic system, and have axial ratios $a : b : c = 0.6412 : 1 : 0.5494$. J. J. Ebelmen gave 2.987 for the sp. gr. L. Ouvrard said that boiling water does not attack the crystals, that dil. acetic acid attacks them slowly, and that dil. mineral acids attack them easily. According to F. Wöhler, **enneahydrated magnesium orthoborate**, $\text{Mg}_3(\text{BO}_3)_2\cdot 9\text{H}_2\text{O}$, is produced by precipitation from a boiling soln. of magnesium sulphate with a soln. of borax, and washing the precipitate with cold water. He also obtained a similar precipitate by boiling a soln. of sodium magnesium borate, and C. F. Rammelsberg added that the boiling must be continued for a long time, and the liquid filtered hot; the precipitate has to be washed with cold water because hot water would withdraw a portion of the acid; it is then dried over sulphuric acid. The fresh precipitate is gelatinous, the dried precipitate is white and gritty. It is slightly soluble in cold water; the soln. has an alkaline reaction, becomes turbid when boiled, and on evaporation leaves a

transparent varnish. By a protracted boiling with water, boric acid is withdrawn from the salt.

G. Tammann found the heat of soln. of **magnesium metaborate**, $\text{Mg}(\text{BO}_2)_2$, glass in $N\text{-HCl}$ to be 719 cal. per gram, and of the crystals, 59 cal. per gram. Hence the heat of crystallization is 120 cal. per gram. The sp. ht. of both crystals and glass was 0.247.

The mineral *szaibelyite* or *boromagnesite* was found by K. F. Peters in needle-like crystals and grains in the limestone at Werksthal (Hungary) and at Vasko (Krassosozoreny). The analyses of A. Stromeyer, and F. Sommaruga agree with the formula $3(5\text{MgO} \cdot 2\text{B}_2\text{O}_3) \cdot 8(\text{or } 4)\text{H}_2\text{O}$; it is usually represented by the formula $\text{Mg}_5\text{B}_4\text{O}_{11} \cdot 1\frac{1}{2}\text{H}_2\text{O}$. The sp. gr. of the needles is 2.7, and that of the grains, 3.0; the hardness is 3-4. Szaibelyite melts to a white slag in the blowpipe flame; it is optically negative; and the index of refraction $\omega=1.65$, and $\epsilon=1.59$. F. Slavik gave 1.575-1.600 for the refractive index. It is insoluble in hydrochloric acid. The mineral *paternoite* was found in the salt-deposits at Mount Sambuco, Calasibetta, Sicily. Its composition corresponds with $\text{MgO} \cdot 4\text{B}_2\text{O}_3 \cdot 4\text{H}_2\text{O}$, or $\text{H}_3\text{MgB}_2\text{O}_7$, and it contains admixed carnallite and blöedite. It is white and granular, and is made up of minute rhombic laminae; it is slightly deliquescent; mean refractive index 1.475; it is partially soluble in water with an alkaline reaction; and is readily soluble in dil. acids.

According to W. Guertler, when magnesia is heated with an excess of boric oxide, the fused magma separates into two layers, and on cooling, the lower layer forms a mass resembling marble. It is not homogeneous because different parts have a different sp. gr. If it be treated with water, small crystals of **dimagnesium diborate**, $2\text{MgO} \cdot \text{B}_2\text{O}_3$, or $\text{Mg}_2\text{B}_2\text{O}_5$, are formed, and the excess of boric oxide is washed away. The crystals are doubly refracting; they do not dissolve in water, but do so in a dil. soln. of sodium carbonate. The monohydrate, $2\text{MgO} \cdot \text{B}_2\text{O}_3 \cdot \text{H}_2\text{O}$, occurs in nature as the mineral *ascharite* discovered by W. Feit in nodules of rock salt and kainite from Schmidtmannshall. C. Ochsenius did not find ascharite, but, according to J. H. van't Hoff, H. Precht obtained it at Neu-Stassfurt along with kainite and leonite. W. Feit supposed that its formula was $3\text{Mg}_2\text{B}_2\text{O}_5 \cdot 2\text{H}_2\text{O}$, but J. H. van't Hoff showed that it contained rather more water. P. Groth represented it as the normal salt of diboric acid: $\text{Mg}=\text{O}_2=\text{B}-\text{O}-\text{B}=\text{O}_2=\text{Mg}$; but J. H. van't Hoff regarded it as *magnesium hydroxyorthoborate*, $\text{Mg}=\text{O}_2=\text{B}-\text{OH}$. J. H. van't Hoff obtained it from a soln. of boracite at 83° , or by heating to 150° pinnoite with an aq. soln. of sodium chloride for 8 days. The needle-like crystals are sparingly soluble in $\frac{1}{10}N$ -hydrochloric acid. W. Feit first gave 1.85 for the sp. gr. of ascharite, but afterwards changed it to 2.45. H. E. Boeke gave 2.65, dried at 90° , and J. H. van't Hoff gave 2.70. H. E. Boeke gave 1.54 for the mean refractive index of the doubly refracting crystals of ascharite. The rhombic mineral *camsellite* from Douglas Lake, British Columbia, has the same composition, $2\text{MgO} \cdot \text{B}_2\text{O}_3 \cdot \text{H}_2\text{O}$, when allowance is made for the impurities. H. V. Ellsworth and E. Poitevin gave for the refractive indices $\alpha=1.575$, and $\gamma=1.649$. About 2.95 per cent. of the water is lost at 550° .

W. Heintz claimed to have made salts corresponding with $5\text{MgO} \cdot 4\text{B}_2\text{O}_3$, and with $7\text{MgO} \cdot 4\text{B}_2\text{O}_3$, by careful levigation from the products obtained in their process for the preparation of boracite—*vide infra*. A. Ditte claimed to have made flat needles of *trimagnesium tetraborate*, $3\text{MgO} \cdot 2\text{B}_2\text{O}_3$, by melting a mol of magnesia with 2 mols of boric oxide, heating the product with a mixture of sodium and potassium chloride, and washing out the salt. It is soluble in sulphuric or nitric acid. A. Ditte also made needle-like crystals of *magnesium diborate*, $\text{MgO} \cdot \text{B}_2\text{O}_3$, by heating the preceding borate with sodium and potassium chlorides; but neither H. le Chatelier nor W. Guertler could prepare this salt, or the preceding one.

The mineral *pinnoite*, **trihydrated magnesium diborate**, $\text{Mg}(\text{BO}_2)_2 \cdot 3\text{H}_2\text{O}$, as yellowish coloured crystals, was found by H. Staute in the upper layers of the kainite zone of the Stassfurt salt deposits. L. Löwe and E. Erdmann supposed it to be a transformation product of boracite. Analyses by H. Staute, and J. H. van't Hoff and G. Bruni agree with the formula just indicated. The latter prepared it by mixing 100 grms. of borax dissolved in 450 grms. of water, with 53 grms. of hexahydrated magnesium chloride in 50 grms. of water, and warming on a water-bath.

A further 70 grms. of the last-named salt in 60 grms. of water were added and the soln. conc. by evaporation. It was then seeded with pinnoite, and left in a closed vessel on a water-bath at 100°. After 5 days bunches of needle-like tetragonal bipyramids were formed, with axial ratios $a : c = 1 : 0.7609$. The crystals were studied by O. Lüdecke and H. E. Boeke. H. Staute gave 2.27 for the sp. gr.; O. Lüdecke, 2.37; and H. E. Boeke, 2.292. The hardness is 3-4. H. E. Boeke gave $\omega = 1.565$ and $\epsilon = 1.575$ for the indices of refraction. The salt readily dissolves in warm mineral acids; when boiled with water, an alkaline liquid and a flocculent precipitate are formed. The latter redissolves as the soln. cools. When the filtrate is evaporated some boric acid appears. J. H. van't Hoff has studied the paragenesis of pinnoite with löweite, langbeinite, tachhydrite, and sylvite.

J. J. Ebelmen fused together magnesium and boric acid and obtained in addition to the orthoborate, prismatic crystals of **magnesium tetraborate**, $Mg_3B_4O_{10}$, which E. Mallard found to belong to the triclinic system, and to have the axial ratios and angles $a : b : c = 1.795 : 1 : a = 91^\circ 47'$, $\beta = 123^\circ 46'$, and $\gamma = 77^\circ 12'$.

A. Ditte prepared what he regarded as *tetrahydrated magnesium diborate*, $Mg(BO_2)_2 \cdot 4H_2O$, by heating to over 70° a mixture of magnesia alba and a soln. of boric acid sat. at 30°-40°; the hot filtrate was then heated to a rather higher temp. The precipitate redissolves on cooling the soln., but if most of the hot mother liquor be decanted, the precipitate forms colourless prismatic crystals on standing a few hours at 3°. F. Wöhler prepared **octohydrated magnesium diborate**, $Mg(BO_2)_2 \cdot 8H_2O$, by heating an aq. soln. of magnesium sulphate and borax till it becomes turbid. The precipitate redissolves on cooling, and if kept for some months below 0°, tufts of long, slender, transparent needles are formed. H. Rose said that if equi-molar parts are used, the precipitate does not have a constant composition. A. Laurent made the octohydrate by the action of magnesium nitrate on a boiling soln. of borax; and J. H. van't Hoff from a warm soln. of 53 grms. of hexahydrated magnesium chloride and 100 grms. of borax in water. O. Popp also made the same salt by the action of a boiling soln. of boric acid sat. with magnesia. According to F. Wöhler, the crystals become milk-white and lose their water of crystallization when heated; they are not soluble in cold or hot water, but they are readily soluble in hydrochloric acid. Boric acid crystallizes from the soln. in warm hydrochloric acid, and ammonia precipitates the salt in fine needles.

A. Ditte reported the formation of *trimagnesium octoborate*, $3MgO \cdot 4B_2O_3$, by heating magnesia with a large excess of boric oxide to a white-heat in a carbon crucible. The needle-like crystals are soluble in hot dil. mineral acids, but not in acetic acid. Neither H. le Chatelier nor W. Guertler could confirm A. Ditte's result. A. Ditte also claimed to have made crystals of the hexahydrate, $3MgO \cdot 4B_2O_3 \cdot 6H_2O$, by keeping for 4 or 5 weeks mixed cold conc. soln. of borax and magnesium nitrate. H. le Chatelier claimed to have made *dimagnesium hexaborate*, $2MgO \cdot 3B_2O_3$, by melting a mol of boric oxide with 2.5 mols of magnesia. The excess of boric oxide was removed by boiling water. If an excess of magnesia is used the orthoborate is formed and it can be separated by methylene iodide. W. Guertler could not confirm the existence of H. le Chatelier's product.

F. Wöhler claimed to have made *octohydrated magnesium hexaborate*, $MgO \cdot 3B_2O_3 \cdot 8H_2O$, but J. H. van't Hoff and G. Bruni showed that the salt is probably **heptahydrated magnesium hexaborate**, $MgB_6O_{10} \cdot 7H_2O$. F. Wöhler boiled an excess of a soln. of boric acid with magnesium hydroxide or magnesia alba, and evaporated the filtered soln. to the point of crystallization; J. H. van't Hoff and G. Bruni saturated a hot soln. of one part of boric acid in ten parts of water with magnesia or magnesium carbonate, and slowly conc. the filtered soln. by evaporating at 60° to 70°. F. Wöhler said that when the salt is heated, it loses water and boric oxide, and leaves a fused spongy mass. C. F. Rammelsberg found 100 parts of water dissolve 1.33 parts of the salt. F. Wöhler found that the aq. soln. has an alkaline reaction, and gives up boric acid to boiling water, leaving a residue of magnesium hydroxide. The aq. soln. does not become turbid when boiled, and only conc. soln. give a precipitate with aq. ammonia.

A. Laurent boiled magnesium carbonate with an excess of a soln. of boric acid, and after separating the crystals of boric acid from the filtered soln., obtained crystals of what he regarded as *trihydrated magnesium octoborate*, $\text{MgO} \cdot 4\text{B}_2\text{O}_3 \cdot 3\text{H}_2\text{O}$; and A. Ditte obtained small crystals of the salt by heating an excess of magnesia alba to 70° with a soln. of boric acid sat. at 30° – 40° , and evaporating the filtered soln. A. Laurent obtained no precipitate by adding potassium dodecaborate to a soln. of a magnesium salt, but C. F. Rammelsberg claimed to have obtained *octodecahydrated magnesium dodecaborate*, $\text{MgO} \cdot 6\text{B}_2\text{O}_3 \cdot 18\text{H}_2\text{O}$, during the preparation of the hexaborate by F. Wöhler's process.

L. B. Guyton de Morveau² obtained an opaque glass by fusing one part of magnesia with three parts of borax; and J. J. Berzelius stated that magnesia behaves like calcium oxide towards fused borax. According to L. Gmelin, the spontaneous evaporation of a mixed soln. of borax with an excess of magnesium sulphate furnishes crystals containing boric acid and magnesium and sodium sulphates which he first regarded as forming a quadruple salt, but later showed to be a mixture. F. Wöhler found that the evaporation of a soln. of magnesia in one of borax furnishes small crystals of what he thought to be sodium magnesium borate; and he obtained **sodium magnesium decaborate**, $\text{Na}_2\text{O} \cdot 2\text{MgO} \cdot 5\text{B}_2\text{O}_3 \cdot 30\text{H}_2\text{O}$, by allowing a cold aq. soln. of magnesium sulphate and borax to stand for some months—fine needles of octohydrated magnesium diborate first appear, and afterwards large crystals of the double salt. C. F. Rammelsberg found that with two mols of borax to one or two mols of magnesium sulphate borax first crystallizes, and then the double salt. The crystals belong to the monoclinic system, and, according to C. F. Rammelsberg, have the axial ratios $a : b : c = 1.1761 : 1 : 11206$, and $\beta = 112^\circ 26'$, and effloresce slightly in air. They swell up and lose water when heated. The ignited mass redissolves slowly in cold water excepting a small residue of magnesium orthoborate. If a crystal be placed in hot water, it becomes opaque, and if reduced to powder, the interior consists of a viscid mass. The salt is about as soluble in water as borax, and the soln. is not precipitated by ammonia. When the aq. soln. is heated, it becomes turbid, depositing magnesium orthoborate, which redissolves as the soln. cools. The salt is readily decomposed by water.

C. F. Rammelsberg found that an aq. soln. of a mol of potassium borate and two mols of magnesium chloride furnishes crystals of potassium chloride, and a syrupy mother liquid which solidifies to a crystalline mass. The mineral *kaliborite* was reported by W. Feit in the Stassfurt salts, along with pinnoite and kainite; according to J. H. van't Hoff, it has the composition **enneahydrated potassium magnesium henadecaborate**, $\text{KMg}_2\text{B}_{11}\text{O}_{19} \cdot 9\text{H}_2\text{O}$, or $\text{K}_2\text{O} \cdot 4\text{MgO} \cdot 11\text{B}_2\text{O}_3 \cdot 18\text{H}_2\text{O}$; analyses were also made by W. Feit, L. Milch, and O. Lüdecke. J. H. van't Hoff suggested that the mineral was formed from pinnoite in contact with a sat. soln. of kainite, and he has worked out the conditions under which it is formed, as well as several methods of preparation. The simplest method is founded on the observation that kaliborite in water at 100° is only slowly converted into pinnoite, and that the presence of boric acid almost entirely prevents the change. The acid borate of magnesium, $\text{MgO} \cdot 3\text{B}_2\text{O}_3 \cdot 7\text{H}_2\text{O}$, was prepared by adding magnesium hydroxide to 30 grms. of boric acid dissolved in water, and the soln. was conc. to 75 c.c. To this was added another soln. containing 3.6 grms. of potassium hydroxide and 10 grms. of boric acid in 30 c.c. of water. If the mixture was kept at 100° and stirred to prevent the formation of crust, about 13 grms. of kaliborite were obtained. L. Milch found the crystals to belong to the monoclinic system, and to have axial ratios $a : b : c = 1.2937 : 1 : 1.7539$, and $\beta = 99^\circ 48'$. The double refraction is positive. W. Feit found that the mineral has a sp. gr. 2.05 at 20° ; O. Lüdecke, 2.109–2.129 at 10° ; and L. Milch, 2.127; J. H. van't Hoff found the artificial crystals have a sp. gr. 2.081 at 25° . The mineral was found by W. Feit to fuse with difficulty; to be sparingly soluble in water, forming an alkaline soln.; and to be very soluble in mineral acids. J. H. van't Hoff and L. Lichtenstein prepared rhombic crystals of a compound, $2\text{K}_2\text{O} \cdot 2\text{MgO} \cdot 11\text{B}_2\text{O}_3 \cdot 20\text{H}_2\text{O}$, analogous to kaliborite by the action of a sat. soln. of potassium chloride and boric acid on pinnoite at 40° . The double borate *heintzite*, $\text{K}_2\text{Mg}_4\text{B}_{22}\text{O}_{38} \cdot 14\text{H}_2\text{O}$, is also said to occur in the Stassfurt deposits.

The mineral *hydroboracite*, **hexahydrated calcium magnesium hexaborate**, $\text{CaMgB}_6\text{O}_{11}\cdot 6\text{H}_2\text{O}$, was found by G. Hess in some Caucasian minerals. It occurs in foliated and fibrous masses resembling gypsum, but is rather more fusible. It is slightly soluble in water, forming a soln. with an alkaline reaction. It is also soluble in nitric and hydrochloric acids.

According to W. Guertler,³ zinc oxide dissolves in molten boric oxide, forming two layers; the upper layer, mainly boric oxide, readily dissolves in water with the formation of a little flocculent zinc oxide, while the lower layer is **glassy**, even if very slowly cooled. Its composition corresponds with **zinc di- or metaborate**, $\text{Zn}(\text{BO}_2)_2$. Crystals are obtained when the proportion of zinc oxide is raised to that corresponding with **zinc tetraborate**, $3\text{ZnO}\cdot 2\text{B}_2\text{O}_3$, or **zinc sesquiborate**, a compound described by H. le Chatelier and J. J. Ebelmen. The crystals, according to E. Mallard, are isomorphous with those of magnesium and manganese; and they belong to the triclinic system. By melting equi-molar proportions of boric oxide, zinc oxide, and potassium hydrofluoride, L. Ouvrard obtained prismatic crystals of **zinc orthoborate**, $3\text{ZnO}\cdot \text{B}_2\text{O}_3$, or $\text{Zn}_3(\text{BO}_3)_2$. This compound is decomposed by water and is readily dissolved by dil. acids.

F. Borchers found that boric acid does not react with zinc oxide or hydroxide to form zinc borate, although some zinc does pass into soln. Boric acid and zinc carbonate react readily. Borax does not give a precipitate when added to a soln. of sodium zinc oxide. J. Tünnermann, and T. C. N. Broeksmit obtained a white insoluble zinc borate by mixing aq. soln. of borax and zinc sulphate. The product is used in pharmacy (S. Kraus), and in making a cement for glass (R. Luther and W. Ostwald). H. Rose said that the precipitate obtained in the cold, and washed with cold water, contained principally $9\text{ZnO}\cdot 4\text{B}_2\text{O}_3\cdot 9\text{H}_2\text{O}$. E. Holdermann added, with constant stirring, a soln. of 443.6 grms. of borax in 309 grms. of 15 per cent. sodium hydroxide to a soln. of 500 grms. of heptahydrated zinc sulphate in 5-10 litres of water. The precipitate was washed by suction, and dried. Its composition corresponded with $3\text{ZnO}\cdot 4\text{B}_2\text{O}_3\cdot \text{H}_2\text{O}$, or **monohydrated zinc octoborate**, $\text{Zn}_3\text{B}_8\text{O}_{15}\cdot \text{H}_2\text{O}$. A. Ditte prepared crystals of **decahydrated zinc octoborate**, $\text{ZnO}\cdot 4\text{B}_2\text{O}_3\cdot 10\text{H}_2\text{O}$, or $\text{ZnB}_8\text{O}_{13}\cdot 10\text{H}_2\text{O}$, by digesting at 30° zinc carbonate with a sat. soln. of boric acid, and slowly cooling. A. Rosenheim and F. Leyser could not make complex salts of **zinc pentaborate**, although a soluble salt was formed. A. Ditte also prepared prismatic crystals of **tetrahydrated zinc tetraborate**, $\text{ZnO}\cdot 2\text{B}_2\text{O}_3\cdot 4\text{H}_2\text{O}$, or $\text{ZnB}_4\text{O}_7\cdot 4\text{H}_2\text{O}$, by heating a soln. of the preceding salt to about 50° , and leaving the precipitate for some time in contact with the greater part of the mother liquid when it gradually crystallizes; and by boiling zinc hydrocarbonate with a sat. soln. of boric acid—the precipitate gradually crystallizes in the course of a few days. The product is soluble in water with decomposition and liberation of boric acid; if repeatedly washed with water, zinc oxide remains as a residue.

F. Borchers found that the precipitate obtained by adding borax to a soln. of a zinc salt is very variable, owing to hydrolytic changes. The equilibrium condition is assumed to be $[\text{B}_2\text{O}_7]''[\text{H}_2\text{O}']^3[\text{Zn}'] = K[\text{H}_3\text{BO}_3]^2[\text{Zn}(\text{BO}_2)_2]$. The largest yield is obtained by adding a conc. soln. of a zinc salt to a slight excess of a sat. soln. of borax. Supersaturated soln. or solid borax give higher results. An excess of the zinc salt diminishes the yield by forming complex zinc salts; neutral salts also diminish the yield; magnesium chloride, for instance, prevents precipitation completely. If the hydrolysis of the borax is checked by adding boric acid, the whole of the borax and even part of the boric acid may be precipitated by the zinc salt. The precipitation is rendered more complete if a small proportion of sodium hydroxide is present. E. Büscher said that if a soln. of 20 parts of borax and 60 parts of zinc sulphate be mixed at 50° - 60° , the white precipitate of basic sulphate is free from borate; but if a soln. of zinc sulphate be poured into an excess of a hot soln. of borax, the white voluminous precipitate of zinc borate is free from sulphates. By dissolving the precipitate in ammonia, and mixing the liquid with a soln. of boric acid in aq. ammonia, and adding alcohol, E. Büscher obtained rhombic prisms of

hexahydrated zinc tetramino-tetraborate, $4\text{ZnO} \cdot 2\text{B}_2\text{O}_3 \cdot 4\text{NH}_3 \cdot 6\text{H}_2\text{O}$; the same compound was obtained by evaporating a soln. of 20 parts of basic zinc carbonate in acetic acid, saturating the liquid with ammonia, and adding 38 parts of boric acid dissolved in aq. ammonia. The crystals separate when alcohol is added. The crystals decompose in air, but may be preserved under ammoniacal alcohol. They are soluble in aq. ammonia, and acids.

F. Stromeyer prepared a cadmium borate, with 27.9 per cent. of boric oxide, by mixing soln. of borax and cadmium sulphate. The white powder is sparingly soluble in water. According to H. Rose, the precipitate produced in the cold contains rather more boric oxide than with hot soln., and in the latter case, the pressed, but not washed, precipitate has the composition $3\text{CdO} \cdot 2\text{B}_2\text{O}_3 \cdot 3\text{H}_2\text{O}$. W. Guertler obtained similar results with cadmium oxide and fused boric oxide, as when zinc oxide was used, and he thus prepared **cadmium di- or meta-borate**, $\text{Cd}(\text{BO}_2)_2$, or $\text{CdO} \cdot \text{B}_2\text{O}_3$, melting at $875^\circ \pm 5^\circ$. He believed that this salt can be obtained in two different modifications by annealing the glass at $830^\circ\text{--}870^\circ$ or at $670^\circ\text{--}690^\circ$. L. Ouvrard obtained prismatic crystals of **cadmium orthoborate**, $3\text{CdO} \cdot \text{B}_2\text{O}_3$, or $\text{Cd}_3(\text{BO}_3)_2$, by the method used for the corresponding zinc salt. A. Rosenheim and F. Leyser made cadmium pentaborate as in the case of the zinc salt.

J. Tünnermann⁴ believed that the precipitates he obtained by mixing soln. of mercurous and mercuric salts were respectively *mercurous and mercuric borates*, but A. Gossmann showed that neither compound is formed. A hot soln. of boric acid dissolves no mercurous oxide, does not give a precipitate with soln. of mercurous nitrate, and if evaporated with mercurous nitrate may be extracted from the dry residue with alcohol; borax gives a precipitate of basic nitrate, free from borates when added to a soln. of mercurous nitrate. Products free from borates are also obtained, according to H. Rose, by rubbing together mercurous nitrate and borax, and also, according to E. F. Anthon, by adding a soln. of borax previously neutralized with boric acid to a soln. of mercurous nitrate. Mercuric salts behave similarly, A soln. of ammonium borate acts on mercury salts like aq. ammonia. M. G. Levi and S. Castellani obtained no sign of a mercury borate by the electrolysis of a soln. of boric acid in the cathode cell and a soln. of a mercury salt in the anode cell.

REFERENCES.

- ¹ J. J. Ebelmen, *Ann. Chim. Phys.*, (3), 33. 34, 1851; H. le Chatelier, *Compt. Rend.*, 113. 1034, 1891; L. Ouvrard, *ib.*, 132. 257, 1901; C. Tissier, *ib.*, 39. 192, 1854; 45. 411, 1857; A. Ditte, *ib.*, 96. 1663, 1883; 77. 893, 1873; *Ann. Chim. Phys.*, (5), 30. 254, 1883; E. Mallard, *ib.*, 105. 1260, 1887; *Ann. Mines*, (8), 12. 427, 460, 1887; F. Wöhler, *Pogg. Ann.*, 28. 525, 1833; H. Rose, *ib.*, 87. 13, 1852; C. F. Rammelsberg, *ib.*, 49. 445, 1840; W. Heintz, *ib.*, 110. 613, 1860; W. Guertler, *Ueber wasserfreie Borate und über Entglasung*, Leipzig, 28, 1904; *Zeit. anorg. Chem.*, 40. 236, 1904; A. Stromeyer, *Liebig's Ann.*, 126. 315, 1862; F. Sommaruga, *Sitzber. Akad. Wien*, 48. 548, 1862; K. F. Peters, *ib.*, 44. 143, 1861; J. H. van't Hoff, *Sitzber. Akad. Berlin*, 1008, 1901; 658, 1907; J. H. van't Hoff and G. Bruni, *ib.*, 805, 1902; M. Piaux, *Journ. Pharm. Chim.*, (5), 25. 111, 1892; O. Popp, *Liebig's Ann. Suppl.*, 8. 11, 1872; J. C. G. de Marignac, *Zeit. anal. Chem.*, 1. 405, 1862; G. C. Wittstein, *Arch. Pharm.*, (3), 6. 40, 1875; W. Feit, *Chem. Ztg.*, 25. 327, 1891; G. Tammann, *Kristallisieren und Schmelzen*, Leipzig, 56, 1903; F. Slavik, *Rozpravy Ceska Akad.*, 26. 60, 1917; *Bull. Acad. Bohême*, 22. 32, 1918; C. Ochsenius, *Zeit. prakt. Geol.*, 11. 335, 1903; L. Löwe, *ib.*, 11. 355, 1903; P. Groth, *Tabellarische Uebersicht der Mineralien*, Braunschweig, 80, 1898; H. E. Boeke, *Centr. Min.*, 534, 1910; H. Staute, *Ber.*, 17. 1584, 1884; E. Erdmann, *Kalibergbau Deutschlands*, Berlin, 15, 1907; O. Lüdeke, *Zeit. Naturwiss. Halle*, 58. 645, 1885; A. Laurent, *Compt. Rend. Trav. Chim.*, 6. 33, 1850; F. Millosevich, *Rend. Accad. Lincei*, (5), 29. 286, 1920; H. V. Ellsworth and E. Poitevin, *Trans. Roy. Soc. Canada*, (3), 15. 1, 1921; G. Krüss and H. Morath, *Ber.*, 23. 735, 1890; *Liebig's Ann.*, 40. 225, 1904; B. Bleyer and L. Paczuský, *Koll. Zeit.*, 14. 295, 1914; W. C. Brögger, *Zeit. Kryst.*, 16. 65, 1890; A. Lacroix, *Bull. Soc. Min.*, 32. 320, 1909; 33. 37, 1910; 35. 76, 1912; W. J. Sokoloff, *Ann. St. Petersburg Inst. Mines*, 2. 394, 1910; V. Goldschmidt and F. C. Müller, *Zeit. Kryst.*, 48. 473, 1910; J. Drugman and V. Goldschmidt, *ib.*, 50. 596, 1912; H. Haga and F. M. Jäger, *Proc. Acad. Amsterdam*, 17. 430, 1914; R. C. Burton, *Rec. Geol. Sur. India*, 43. 168, 1913; K. A. Hofmann and K. Höschele, *Ber.*, 47. 238, 1914.

² L. B. Guyton de Morveau, *École Polyt. Journ.*, 3. 298, 1796; J. J. Berzelius, *The Use of the Blowpipe in Chemical Analysis*, London, 1822; F. Wöhler, *Pogg. Ann.*, 28. 526, 1833; C. F. Rammelsberg, *ib.*, 49. 451, 1840; G. Hess, *ib.*, 31. 49, 1834; L. Gmelin, *Schweigger's Journ.*,

15. 261, 1815; W. Feit, *Chem. Ztg.*, **13**, 1188, 1889; J. H. van't Hoff, *Sitzber. Akad. Berlin*, 1008, 1902; J. H. van't Hoff and L. Lichtenstein, *ib.*, 936, 1904; O. Lüdecke, *Zeit. Kryst.*, **18**, 481, 1891; L. Milch, *ib.*, **18**, 478, 1891.

² J. Tünnermann, *Kastner's Arch.*, **20**, 13, 1830; S. Kraus, *Pharm. Post*, **26**, 465, 474, 1893; F. Stromeyer, *Schweigger's Journ.*, **22**, 362, 1818; W. Ostwald and R. Luther, *Hand- und Hilfsbuch zur Ausführung physico-chemischer Messungen*, Leipzig, 145, 1910; E. Mallard, *Compt. Rend.*, **105**, 1260, 1887; H. le Chatelier, *ib.*, **113**, 1034, 1891; L. Ouyard, *ib.*, **130**, 172, 335, 1900; A. Ditte, *Ann. Chim. Phys.*, (5), **30**, 256, 1883; J. J. Ebelmen, *ib.*, (3), **33**, 34, 1851; E. Büscher, *Liebig's Ann.*, **151**, 234, 1869; E. Holdermann, *Arch. Pharm.*, (3), **42**, 567, 1904; C. F. Wenzel, *Lehre von der Verwandtschaft der Körper*, Dresden, 491, 1777; H. Rose, *Pogg. Ann.*, **88**, 299, 1852; F. Borchers, *Zeit. anorg. Chem.*, **68**, 269, 1910; A. Rosenheim and F. Leyser, *ib.*, **119**, 1, 1921; T. C. N. Broeksmit, *Pharm. Weekbl.*, **59**, 265, 1922; W. Guertler, *ib.*, **40**, 343, 1904; *Ueber wasserfreie Borate und über Eniglasung*, Leipzig, 37, 1904.

⁴ J. Tünnermann, *Kastner's Arch.*, **20**, 23, 1830; M. G. Levi and S. Castellani, *Atti Accad. Lincei*, (5), ii, **17**, 613, 1908; H. Rose, *Pogg. Ann.*, **51**, 117, 1840; E. F. Anthon, *Repert. Pharm.*, **63**, 22, 1833; A. Gossmann, *ib.*, **61**, 131, 1833.

§ 13. The Borates of Aluminium, Thallium, and the Elements of the Rare Earths

The evidence for the existence of definite **aluminium borates** is very unsatisfactory. Alumina was found by W. Guertler¹ not to be particularly soluble in molten boric oxide; and, according to J. J. Ebelmen, alumina mixed with boric oxide is not altered when heated in a pottery oven, but with borax the alumina is changed to corundum. E. Mallard represented J. J. Ebelmen's product by the formula $3\text{Al}_2\text{O}_3 \cdot \text{B}_2\text{O}_3$, or $(\text{AlO})_3\text{BO}_3$, and found the rhombic crystals had the axial ratios $a : b : c = 0.974 : 1 : 0.679$. L. Troost and P. Hautefeuille found that alumina is volatilized when heated in the vapour of boron trichloride. E. Frémy and F. Feil found that an aluminium borate is formed when boric oxide is heated with aluminium fluoride; F. Wöhler and H. St. C. Deville showed that aluminium borate is formed along with the boride when boric oxide is heated with aluminium; the borate is decomposed by water.

C. Tissier showed that alumina does not dissolve in an aq. soln. of boric acid; and A. Ditte found that aluminium hydroxide does not dissolve, but takes up boric acid, forming $\text{Al}_2\text{O}_3 \cdot \text{B}_2\text{O}_3$ when the product is dried. C. Tissier found a precipitate is produced when a soln. of an aluminium salt is treated with a soln. of boric acid which has been neutralized with borax. According to H. Rose, when borax or sodium metaborate is added to a cold aq. soln. of potash alum, a precipitate containing some absorbed soda is produced; this is removed by washing with water, and the product dried at 100° had composition varying between $2\text{Al}_2\text{O}_3 \cdot \text{B}_2\text{O}_3 \cdot 5\text{H}_2\text{O}$ and $3\text{Al}_2\text{O}_3 \cdot 2\text{B}_2\text{O}_3 \cdot 8\text{H}_2\text{O}$. There is nothing here to show that a definite aluminium borate is formed, and F. Jean and E. Reichardt, A. Ditte, and J. Martenson found that the precipitate obtained by adding borax to a soln. of aluminium salt is completely hydrolyzed to aluminium hydroxide when thoroughly washed.

P. W. Jeremejeff² obtained from Nertschinsk, Siberia, masses of crystals of a basic aluminium borate to which A. Damour ascribed the formula $(\text{Al}_2\text{O}_3 \cdot \text{Fe}_2\text{O}_3) \cdot \text{B}_2\text{O}_3$, based on the analysis: B_2O_3 , 40.19; Al_2O_3 , 55.03; Fe_2O_3 , 4.08; K_2O , 0.70. P. Groth ascribed to it the generalized formula $\text{AlO} \cdot \text{BO}_2$. The outer portions of these masses are hexagonal crystals, called *jeremejeffite*, with axial ratio $a : c = 1 : 0.68351$, and the interior consists of rhombic crystals, called *eichwaldite*, with axial ratios $a : b : c = 0.5523 : 1 : 0.5434$. The sp. gr. is 3.28, the hardness 6.5; and the index of refraction 1.64. The optical properties of jeremejeffite are anomalous, and were examined by P. W. Jeremejeff, C. Klein, and R. Brauns.

The mineral *rhodizite*—from $\rho\delta\iota\zeta\epsilon\upsilon$, in allusion to its colouring a flame red—is likewise a basic aluminium potassium borate. It was obtained by G. Rose³ in minute white crystals on red tourmalines from Sarapulsk, and Schaitansk near Keitharinenburg; A. Lacroix found crystals at Bity, Antandrokomby, and Munjaka in Madagascar; and L. Duparc, at Ampakita in Madagascar. The first

of the following analyses, by A. Damour, refers to a sample from the Urals; the second, by F. Pisani, to a sample from Antandrokomby; and the third, by A. Lacroix, to a sample from Bity:

B ₂ O ₃	Al ₂ O ₃	BeO	K ₂ O	Na ₂ O	Li ₂ O	SiO ₂	Loss on ignition.	Water.
33.93	41.40	—	12.00	1.62	—	—	2.96	95.40
40.60	30.50	10.10	5.90	3.30	7.30	1.36	0.45	99.51
41.69	30.70	10.36	6.05	3.38	7.36	—	0.46	100.00

The first one also had 0.74, CaO; 0.82, MgO; 1.93, FeO. A. Damour represented his results by R₂O.2Al₂O₃.3B₂O₃; F. Pisani, by 4(Li, K, Na, H)₂O.4BeO.3Al₂O₃.6B₂O₃; and P. Groth gives the generalized formula, **potassium aluminoborate**, (AlO)₂K(BO₂)₃. The crystals belong to the cubic system. The sp. gr. is 3.415; the hardness is 8, for the mineral scratches topaz. The index of refraction, according to L. Duparc, is 1.6895 for the Li-light, 1.6935 for the Na-light, and 1.6965 for the Tl-light. E. Bertrand, C. Klein, R. Brauns, and J. Beckenkamp have studied the anomalous double refraction. The crystals fuse to an opaque glass when heated in the blow-pipe flame; they dissolve in fused borax, or microcosmic salt; and they dissolve with difficulty in hydrochloric acid.

C. H. Burgess and A. Holt,⁴ and W. Guertler found thallium oxide or carbonate dissolved in fused boric acid, forming a clear glass, or a crystalline solid. M. Hebbeling obtained no precipitate on adding a soln. of borax to a conc. soln. of thallous salts; but W. Crookes found that boric acid and thallous carbonate, or borax and thallous sulphate, give a white granular precipitate insoluble in cold dil. sulphuric acid, and soluble in boiling water. H. Buchtala prepared **thallous tetraborate**, Tl₂B₄O₇.2H₂O, by crystallization from an aq. soln. of a mol of thallous carbonate and 1 to 4 mols of boric acid; it is also formed by fusing a mol of thallous carbonate with 6 mols of boric acid, extracting the cold mass with water, and allowing the soln. to crystallize. The tetraborate is here accompanied by more **thallous hexaborate**, Tl₂B₆O₁₀.3H₂O. If more boric acid is used, say 8 mols, a mixture of the hexaborate and **thallous decaborate**, Tl₂B₁₀O₁₆.8H₂O, is formed. **Thallous octoborate**, Tl₂B₈O₁₃.4H₂O, and **thallous dodecaborate**, Tl₂B₁₂O₁₉.7H₂O, are formed when a mol of thallous carbonate is dissolved in an excess, say 10 mols, of an aq. soln. of boric acid. The dodecaborate also forms twinned monoclinic crystals of a pentahydrate with axial ratios, according to R. Scharizer, $a : b : c = 1.583 : 1 : 1.955$, and $\beta = 94^\circ 25'$. A. Rosenheim and F. Leyser made **thallous pentaborate**. **Thallous metaborate** is formed by evaporation from an aq. soln. of the perborate. The colourless wedge-shaped crystals have the composition TlBO₂. $\frac{1}{2}$ H₂O; they become dark red on exposure to air. G. Canneri and R. Morelli found that the fusion curve, Fig. 29, of mixtures of thallous oxide and boric oxide has three maxima corresponding with thallous metaborate, TlBO₂, m.p. 472°; thallous pyroborate, Tl₄B₂O₅, of m.p. 434°; and normal thallous borate, Tl₃BO₃, of m.p. 370° with decomposition.

The metaborates of the rare earths have been discussed by W. Guertler,⁵ A. E. Nordenskjöld, O. Holm, etc. According to N. J. Berlin, boric acid gives with neutral and acid salts of ytterbium a white precipitate of **ytterbium borate**, which readily attracts carbon dioxide from the atm. J. J. Berzelius found that boric acid precipitates white flocculent thorium borate when added to a soln. of a salt of that element; the precipitate is insoluble in an excess of boric acid. G. Karl treated an aq. soln. of thorium nitrate with a hot soln. of borax until a permanent precipitate was formed; this was washed and dried at 400°–500°. The composition

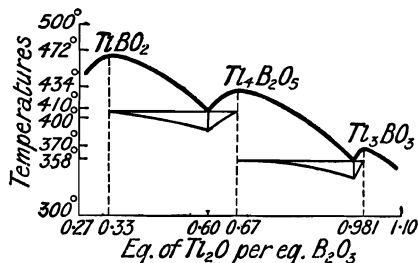

FIG. 29.—Fusion Curves of Mixtures of Thallous and Boric Oxides.

of the amorphous white mass corresponded with **thorium orthoborate**, $\text{Th}_3(\text{BO}_3)_4$. It is decomposed by water. W. Guertler could not make a thorium borate by fusing thoria with boric oxide on account of the very sparing solubility of the thoria. A. E. Nordenskjöld reported the formation of a basic **lanthanum borate**, $2\text{La}_2\text{O}_3 \cdot \text{B}_2\text{O}_3$, by fusing borax with lanthanum oxide in a pottery oven; but experiments to prepare *didymium borate* in a similar way were not satisfactory. W. Guertler obtained **lanthanum metaborate**, $\text{La}(\text{BO}_2)_3$, by crystallization from slowly cooled soln. of lanthanum oxalate in boric oxide. The upper layer is mainly boric oxide. W. Guertler found that when boric oxide is fused with cerium oxalate, in a stream of carbon dioxide, two layers are formed; the upper greyish-brown layer is a soln. of cerium oxide in boric oxide, and the lower dark brown layer, when allowed to devitrify, furnishes **cerium metaborate**, $\text{Ce}_2\text{O}_3 \cdot 3\text{B}_2\text{O}_3$, or $\text{Ce}(\text{BO}_2)_3$; **neodymium metaborate**, $\text{Nd}(\text{BO}_2)_3$; **praseodymium metaborate**, $\text{Pr}(\text{BO}_2)_3$; and **gadolinium metaborate**, $\text{Gd}(\text{BO}_2)_3$, are produced in a similar way. P. T. Cleve said that samarium dissolves in molten borax, forming a topaz-like glass from which, when saturated, microscopic micaceous scales separate. When the powdered glass is treated with dil. hydrochloric acid, **samarium metaborate**, $\text{Sm}(\text{BO}_2)_3$, remains. The borate is soluble in hydrochloric acid, particularly when heated, so that the isolation of the crystals requires care. The sp. gr. is 6.048 at 16.4°. W. Guertler found erbia and yttria to be insoluble or only very sparingly soluble in boric oxide. According to W. Crookes, scandium hydroxide suffers virtually no change when triturated with a soln. of boric acid, but a slight combination occurs when the mixture is boiled. A mixture of boric oxide and scandia forms a clear liquid when fused at a bright red heat; and after lixiviation of the cold mass, a white microcrystalline powder remains. Analyses correspond with **scandium orthoborate**, ScBO_3 .

REFERENCES.

- ¹ W. Guertler, *Ueber wasserfreie Borate und über Entglasung*, Leipzig, 1904; *Zeit. anorg. Chem.*, **40**, 225, 1904; J. J. Ebelmen, *Compt. Rend.*, **32**, 331, 1851; *Ann. Chim. Phys.*, (3), **33**, 62, 1851; F. Wöhler and H. St. C. Deville, *ib.*, (3), **52**, 63, 1858; *Liebig's Ann.*, **101**, 113, 1857; *Compt. Rend.*, **43**, 1088, 1856; E. Mallard, *ib.*, **105**, 1260, 1887; *Ann. Mines*, (8), **12**, 427, 460, 1887; L. Troost and P. Hautefeuille, *Compt. Rend.*, **75**, 1819, 1872; E. Frémy and F. Feil, *ib.*, **85**, 1029, 1878; C. Tissier, *ib.*, **39**, 192, 1854; **44**, 411, 1857; A. Ditte, *ib.*, **96**, 1663, 1883; *Ann. Chim. Phys.*, (5), **30**, 259, 1883; H. Rose, *Pogg. Ann.*, **91**, 452, 1854; F. Jean and E. Reichardt, *Arch. Pharm.*, (3), **5**, 125, 1874; J. Martenson, *Zeit. österr. Apoth. Ver.*, **34**, 80, 1896.
- ² P. W. Jeremejeff, *Proc. Russ. Min. Soc.*, **5**, 415, 1870; C. Klein, *Sitzber. Akad. Berlin*, 703, 1890; *Neues Jahrb. Min.*, **i**, 84, 1891; R. Brauns, *Die optischen Anomalien der Krystalle*, Leipzig, 353, 1891; A. Damour, *Bull. Soc. Min.*, **6**, 20, 1883; P. Groth, *Tabellarische Uebersicht der Mineralien*, Braunschweig, 1898.
- ³ G. Rose, *Pogg. Ann.*, **33**, 253, 1834; **39**, 321, 1836; P. Ries and G. Rose, *ib.*, **59**, 353, 1843; P. Kalugiu, *Proc. Russ. Min. Soc.*, **24**, 253, 1888; A. Lacroix, *Compt. Rend.*, **149**, 896, 1909; *Bull. Soc. Min.*, **33**, 37, 1910; **35**, 76, 1912; L. Duparc, *ib.*, **34**, 239, 1911; A. Damour, *ib.*, **5**, 98, 1882; F. Pisani, *ib.*, **33**, 37, 1910; E. Bertrand, *ib.*, **5**, 31, 72, 1882; P. Groth, *Tabellarische Uebersicht der Mineralien*, Braunschweig, 1898; R. Brauns, *Die optischen Anomalien der Krystalle*, Leipzig, 353, 1891; C. Klein, *Sitzber. Akad. Berlin*, 703, 1890; *Neues Jahrb. Min.*, **i**, 65, 1891; J. Beckenkamp, *Die Anomalien der Krystalle*, Mülhausen, 1889; *Liefaden der Kristallographie*, Berlin, 427, 1919.
- ⁴ C. H. Burgess and A. Holt, *Proc. Chem. Soc.*, **19**, 221, 1903; W. Guertler, *Zeit. anorg. Chem.*, **40**, 225, 1904; *Ueber wasserfreie Borate und über Entglasung*, Leipzig, 1904; M. Heberling, *Liebig's Ann.*, **134**, 11, 1865; G. Canneri and R. Morelli, *Atti Accad. Lincei*, (5), **31**, i, 109, 1922; W. Crookes, *On Thallium*, London, 1863; *Proc. Roy. Soc.*, **12**, 150, 1862; *Journ. Chem. Soc.*, **17**, 112, 1864; H. Buchtala, *Journ. prakt. Chem.*, (2), **88**, 771, 1913; R. Scharizer, *Zeit. Kryst.*, **54**, 232, 1914; A. Rosenheim and F. Leyser, *Zeit. anorg. Chem.*, **119**, 1, 1921.
- ⁵ J. J. Berzelius, *Pogg. Ann.*, **16**, 385, 1829; N. J. Berlin, *ib.*, **43**, 108, 1838; A. E. Nordenskjöld, *ib.*, **114**, 618, 1861; G. Karl, *Zeit. anorg. Chem.*, **68**, 57, 1910; W. Guertler, *ib.*, **40**, 232, 1904; *Ueber wasserfreie Borate und über Entglasung*, Leipzig, 1904; W. Crookes, *Phil. Trans.*, **210**, A, 359, 1910; P. T. Cleve, *Chem. News*, **53**, 30, 45, 67, 80, 91, 100, 1886; O. Holm, *Beiträge zur Kenntnis des Cers*, München, 1902.

§ 14. The Borates of Tin, Lead, and Zirconium

C. F. Wenzel¹ found that a soln. of stannous chloride gives a white precipitate when treated with borax. According to M. Kaatz, the precipitate is a mixture of stannous hydroxide and boric acid, and it is not obtained in soln. feebly acidified with hydrochloric acid; and the boric acid is removed from the assumed stannous borate by washing twice with water. A. C. Campbell boiled stannous chloride with hydrochloric acid and tin to ensure that all was converted into stannous salt; he then added sodium carbonate until a permanent precipitate commenced to form; the mixture was then treated with enough borax to convert all the tin into *stannous borate*. The precipitate was found to remain unaltered after 12 hrs.' exposure to air, and he therefore recommended it to be used in the preparation of standard soln. of stannous salts. W. Guertler found that in his attempts to make stannous borate, the product decomposed into tin, stannic oxide, and boric oxide. C. H. Burgess and A. Holt, and W. Guertler found stannic oxide to be insoluble in molten boric oxide. The rare mineral *nordenskiöldine* was found in rhombohedral crystals by W. C. Brögger in the pegmatite veins of the Island of Gross-Arø south of Christiania, Norway. An amphibole from Ruscula, Lake Onega, was named *nordenskiöldite* by Kennigott. The colour of W. C. Brögger's mineral is yellow, its sp. gr. is 4.20, and its hardness, $5\frac{1}{2}$ to 6. Its analysis corresponds with **calcium stannic borate**, $\text{CaSn}(\text{BO}_3)_2$, or less probably $\text{Ca}(\text{BO}_2)_2\text{SnO}_4$. The stannate formula is preferred by P. Groth, but W. C. Brögger said that the crystalline form is against that assumption. The trigonal crystals were found by W. C. Brögger to have the axial ratio $a:c=1:0.8221$, and $\alpha=102^\circ 58'$. L. Ouvrard synthesized the mineral by heating a mixture of calcium tetraborate and stannic oxide in a stream of hydrochloric acid; or by passing the vapour of stannic chloride over the red-hot borate. The colour of the mineral is yellow. L. Ouvrard's preparation forms colourless transparent hexagonal plates. The sp. gr. of the mineral is 4.20, that of L. Ouvrard's preparation is 4.8 at 15° . The hardness of the mineral is 5.5-6.0. L. Ouvrard made the corresponding **strontium stannic borate**, and **barium stannic borate**.

M. Faraday² found that a fused mixture of 112 parts of lead oxide and 24 of boric acid forms a soft yellow glass of sp. gr. 6.4, which softens on immersion in boiling oil, and is blackened by hydrogen sulphide; if 72 parts of boric acid are used, the glass is colourless, as hard as flint glass, and possesses a high refracting power. According to W. Guertler, mixtures of boric oxide and lead oxide melt, forming clear glasses, which, on cooling, may furnish emulsions. The phenomenon is analogous with that observed with mixtures of say phenol and water (1. 10, 3—Fig. 11); and the temp. at which an emulsion of lead and boric oxides is produced is shown in Fig. 30. Mixtures containing between 0.0008 and 0.0725 eq. of $(\text{PbO})_3$ per eq. of B_2O_3 alone show this turbidity during cooling, and the two legs *ac* and *bc* are solubility curves respectively of lead oxide in boric oxide and of boric oxide in lead oxide. At temp. exceeding *c*, clear glasses are produced and the two oxides are mutually soluble in all proportions. Mixtures with more than 0.0725 $(\text{PbO})_3 \cdot \text{B}_2\text{O}_3$ furnish clear glasses on cooling. The glasses are either colourless or tinged faintly yellow;

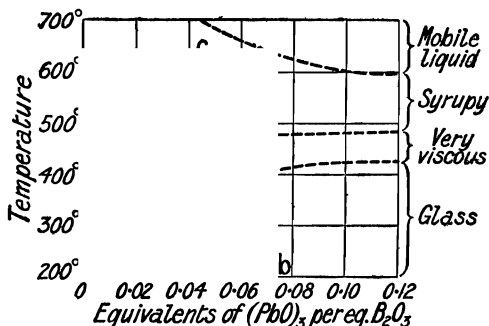

FIG. 30.—Solubility Curve of Lead Oxide in Boric Oxide.

they are insoluble in water; and are decomposed by hydrogen sulphide. There is here no sign of the formation of definite lead borates. A few lead borates have been reported as precipitates formed by double decomposition, but so long as chemical analyses alone are available there will be doubts as to the chemical individuality of the observed products.

According to J. Tünnermann, if an excess of borax be added to lead nitrate, at ordinary temp. or boiling, a white precipitate is obtained containing $\text{PbO} \cdot 1.3\text{B}_2\text{O}_3$; while if the borax soln. be mixed with enough boric acid to give it an acid reaction, a white precipitate is formed containing $\text{PbO} \cdot 2.6\text{B}_2\text{O}_3$. G. Rose reported that hydrated lead metaborate, $\text{Pb}(\text{BO}_2)_2 \cdot \text{H}_2\text{O}$, is formed as a white precipitate when a soln. of borax and a neutral soln. of lead nitrate are mixed in the presence of aq. ammonia. H. V. Thompson obtained the same compound. The white powder is insoluble in water and in alcohol, but soluble in nitric or acetic acid without decomposition. The salt is decomposed by sulphuric or hydrochloric acid; and by the alkalis. Lead metaborate melts to a colourless transparent glass. Water is given off at about 120° , but the anhydrous salt is obtained at about 250° . S. Motylewsky found the drop-weight of fused lead metaborate to be 185 mgrms. when that of water at 0° is 100; and the drop-weight of the molten borate to be 185 mgrms. when water at $0^\circ = 100$. H. Becquerel gave for the index of refraction 1.780; and he found the molten borate exhibited magnetic rotation of the plane of polarized light. J. Rosenthal found the compressed powder did not conduct electricity at 340° , but it does so as the glass softens—*vide* glasses. T. W. B. Welsh and H. J. Broderson found that lead metaborate is soluble in dried hydrazine, and that the soln. conducts electricity badly, forming a black deposit on the cathode.

A number of basic lead borates are produced by mixing soln. of sodium borate and lead nitrate. The basicity depends on the temp., on the conc. of the soln., and on the amount of washing employed. H. Rose thus reported the salts $\text{PbO} : \text{B}_2\text{O}_3 : \text{H}_2\text{O} = 2 : 1 : 2$; $4 : 3 : 5$; $9 : 3 : 8$; and $6 : 5 : 6$. These represent different stages in the hydrolysis of lead borate, and they are probably mixtures and not compounds. Some polyborates have also been reported. E. Soubeiran obtained tetrahydrated diplumbic hexaborate, $2\text{PbO} \cdot 3\text{B}_2\text{O}_3 \cdot 4\text{H}_2\text{O}$, by precipitation from a boiling soln. of an excess of borax mixed with lead nitrate; the white powder lost half of its combined water between 180° and 200° . H. V. Thompson working with cold soln. obtained only $\text{Pb}(\text{BO}_2)_2 \cdot \text{H}_2\text{O}$. T. J. Herapath said that the compound fuses to a colourless glass, and he claimed to have prepared tetrahydrated lead tetraborate, $\text{PbO} \cdot 2\text{B}_2\text{O}_3 \cdot 4\text{H}_2\text{O}$, by boiling either of the preceding salts with an excess of soln. of boric acid. He added that 3 mols of water are lost at about 220° . H. V. Thompson could not find any definite compound to be formed by T. J. Herapath's process. H. le Chatelier also claimed to have made anhydrous lead hexaborate, $\text{PbO} \cdot 3\text{B}_2\text{O}_3$, by fusing together lead carbonate and boric acid, and treating the cold product with water to remove the excess of boric oxide. H. V. Thompson verified this result. According to L. Kahlenberg and W. J. Trautman, lead borate gives a black slag when heated with silicon.

W. Guertler³ found that silica and zirconia are insoluble or only very sparingly soluble in molten boric oxide; and there is no evidence of the formation of a *silicon borate* or of a *zirconium borate*. F. P. Venable and T. Clark found that zirconia does not dissolve in molten borax. A white precipitate, possibly a *basic zirconium borate*, insoluble in water, is produced when borax is added to a soln. of a zirconium salt. Cerium and thorium borates have been discussed in connection with the rare earth borates.

REFERENCES.

- ¹ C. F. Wenzel, *Lehre von der Verwandtschaft der Körper*, Dresden, 1777; A. C. Campbell, *Journ. anal. Chem.*, 2, 207, 1888; C. H. Burgess and A. Holt, *Proc. Chem. Soc.*, 19, 221, 1903; W. Guertler, *Zeit. anorg. Chem.*, 40, 225, 1904; *Ueber wasserfreie Borate und über Entglasung*,

Leipzig, 1904; W. C. Brögger, *Zeit. Kryst.*, **16**, 62, 1890; L. Ouvrard, *Compt. Rend.*, **143**, 315, 1906; M. Kaatz, in L. Gmelin, *Handbuch der anorganischen Chemie*, Heidelberg, **4**, i, 991, 1911; C. A. Kennigott, *Sitzber. Akad. Wien*, **12**, 297, 1854; P. Groth, *Tabellarische Uebersicht der Mineralien*, Braunschweig, 1898.

² W. Guertler, *Zeit. anorg. Chem.*, **40**, 225, 1904; *Ueber wasserfreie Borate und über Entglasung*, Leipzig, **18**, 1904; H. Rose, *Pogg. Ann.*, **87**, 470, 1852; G. Rose, *ib.*, **29**, 445, 1833; E. Soubeiran, *Journ. Pharm. Chim.*, (2), **21**, 31, 1835; H. le Chatelier, *Bull. Soc. Chim.*, (3), **21**, 35, 1899; T. J. Herapath, *Phil. Mag.*, (3), **34**, 375, 1849; H. V. Thompson, *Trans. Cer. Soc.*, **18**, 511, 1919; M. Faraday, *Phil. Trans.*, **120**, 1, 1830; J. Tünnermann, *Kastner's Arch.*, **20**, 8, 1830; A. D. Holdcroft, *Trans. Cer. Soc.*, **9**, 37, 1911; H. Becquerel, *Ann. Chim. Phys.*, (5), **12**, 5, 1873; J. Rosenthal, *Wied. Ann.*, **43**, 720, 1891; T. W. B. Welsh and H. J. Broderston, *Journ. Amer. Chem. Soc.*, **37**, 819, 1915; S. Motylewsky, *Zeit. anorg. Chem.*, **38**, 410, 1904; L. Kahlenberg and W. J. Trautman, *Trans. Amer. Electrochem. Soc.*, **39**, 377, 1921.

³ F. P. Venable and T. Clark, *Journ. Amer. Chem. Soc.*, **18**, 434, 1896; W. Guertler, *Zeit. anorg. Chem.*, **40**, 225, 1904; *Ueber wasserfreie Borate und über Entglasung*, Leipzig, 1904.

§ 15. The Borates of the Arsenic and Chromium Families

According to W. Guertler,¹ the oxides of arsenic, antimony, bismuth, tungsten, vanadium, molybdenum, and uranium dissolve in fused boric oxide more or less sparingly, and on cooling, the oxide may separate from the melted mass, forming an emulsion. H. Rose noted that bismuth oxide readily dissolves in molten borax, forming a glass which with a little bismuth oxide is yellow when hot, and colourless when cold; with more bismuth oxide, orange-red when hot and yellow and opaque when cold. L. Vanino and F. Hartl found that when a borate is added to a soln. of bismuth nitrate and mannite, a white precipitate of **dihydrated bismuth orthoborate**, $\text{BiBO}_3 \cdot 2\text{H}_2\text{O}$, is formed. According to J. J. Berzelius, bismuth borate is sparingly soluble in water; according to L. Vanino and F. Hartl, it is stable towards potassium hydroxide, and potassium iodide, and is immediately decomposed by hydrogen sulphide.

According to J. J. Berzelius, a soln. of vanadyl sulphate gives with borax a greyish-white precipitate of **vanadyl borate** insoluble in water and soluble in a soln. of boric acid, forming a blue soln. which becomes green on exposure to air, and is decomposed by hydrogen sulphide. A. Guyard melted together vanadic and boric acids, and obtained a pale green glass of **vanadium borate** soluble in water, from which solvent it can be crystallized; but the aq. soln. is unstable, and some hydrolysis occurs.

Molten borax was found by H. Rose, M. Landecker, and L. Weiss to dissolve *columbic oxide*, forming a clear glass which is colourless in both the oxidizing and reducing flame. A. G. Ekeberg, and L. Weiss and M. Landecker found *tantalic oxide* dissolved in fused borax, forming a colourless glass very sparingly soluble in water.

According to A. Moberg,² sodium metaborate or tetraborate gives a pale blue *chromous borate* when added to a soln. of chromous chloride. The precipitate is soluble in free acids, but not in an excess of the precipitant. N. J. Berlin obtained a blue precipitate by adding borax to a soln. of a chromic salt, the precipitate is soluble in an excess of the precipitant. M. Heberling found that borax gives a greyish-green *chromic borate*, $7\text{Cr}_2\text{O}_3 \cdot 4\text{B}_2\text{O}_3$, when added to a soln. of a chromic salt; if the soln. of chromic salt and borax is mixed with ammonia, and the excess of ammonia is expelled by boiling, the precipitate contains less boric oxide, the smaller the excess of borax in the soln. C. Tissier mixed a chromic salt soln. with a large excess of boric acid, and added as much borax to the boiling soln. as was necessary to neutralize the acid of the chromic salt; he found that chromic oxide was precipitated. A. A. Hayes found that ammonium hydrodiborate, $(\text{NH}_4)\text{H}(\text{BO}_2)_2$, gave a pale green precipitate with an aq. soln. of chromic chloride; and A. Laurent found potassium hexaborate gives a green precipitate. A. Rosenheim and F. Leyser made a complex **chromium pentaborate**.

J. J. Berzelius³ obtained a dark grey precipitate of *molybdous borate* on adding

a soln. of borax to a molybdous salt soln. The precipitate is black when dried; it is insoluble in water, but sparingly soluble in a soln. of boric acid. A reddish-yellow precipitate of *molybdic borate* is produced when ammonium borate is added to a soln. of molybdic chloride; molybdic hydroxide dissolves in a soln. of boric acid, producing a yellow soln. which, on evaporation, solidifies to a jelly and deposits the normal borate. J. J. Berzelius also showed that a boiling aq. soln. of boric acid dissolves molybdic acid, and when the latter is in excess, produces a viscid liquid. The soln. becomes turbid when cooled, and when the clear filtered liquid is evaporated, colourless crystals are deposited—thought to be *boromolybdic acid*. These crystals are decomposed by alcohol into molybdic and boric acids. C. W. Scheele found that fused borax dissolves tungstic oxide, forming a clear glass, which when overloaded with tungsten becomes brown or white.

Although boric acid has a marked tendency to form complex salts, it forms well-defined heteropolyacids only with tungstic oxide, the so-called **borotungstates**. J. D. Klein⁴ made a borododecatungstic acid, $B_2O_3 \cdot 12WO_3 \cdot nH_2O$, by the method employed by J. C. G. de Marignac for hydrosilicododecatungstic acid. D. Klein also reported borotungstic acids of the composition $B_2O_3 \cdot 14WO_3 \cdot nH_2O$ and $B_2O_3 \cdot 9WO_3 \cdot 24H_2O$, which he called respectively *acide borotungstique* and *acide tungstoborique*. H. Copaux considered that both these acids are mixtures of respectively $(6H_2O \cdot B_2O_3 \cdot 28WO_3) \cdot 56H_2O$, and $(5H_2O \cdot B_2O_3 \cdot 24WO_3) \cdot 61H_2O$. D. Klein made the former by treating the sodium salt with mercurous nitrate, decomposing the product with hydrochloric acid and removing the mercury with hydrogen sulphide; and the latter was made in a similar manner from the sodium salt, or by the action of dil. sulphuric acid on the barium salt. H. Copaux made what he regarded as $6H_2O \cdot B_2O_3 \cdot 28WO_3 \cdot 56H_2O$, or $H_6B_2W_{28}O_{93} \cdot 56H_2O$, by mixing soln. of sodium tungstate and boric acid in boiling water; decomposing the product with a mineral acid; and extracting the complex acid with ether. The small hexagonal prisms have the axial ratio $a:c=1:0.993$; and on exposure to air they become yellow. A soln. of boiling water soon decomposes the acid with the separation of tungstic acid. A. Rosenheim showed that the analyses agreed with the assumption that the acid is enneabasic **hydroborododecatungstic acid**, $H_9[B(W_2O_7)_6] \cdot 22H_2O$, and this was confirmed by A. Rosenheim and J. Jänicke.

A. Rosenheim and J. Jänicke prepared the acid $H_9[B(W_2O_7)_6] \cdot 28H_2O$ by dissolving 100 grms. of sodium tungstate and 150 grms. of boric acid in 400–500 c.c. of boiling water, and boiling the soln. until a sample treated with hydrochloric acid gave no precipitation of tungstic oxide. The cold soln. was separated from the boric acid and sodium borate by suction; mixed with 70 grms. of boric acid; and conc. over the naked flame. The cold soln. was again separated from the crystals by suction, and washed with 33 per cent. sulphuric acid. The liquor was then shaken with 2 to 3 times its vol. of 33 per cent. sulphuric acid and ether. The oily liquor is dissolved in cold water, and the soln. allowed to stand in vacuo over conc. sulphuric acid. A good yield of crystals is thus obtained.

According to A. Rosenheim and J. Jänicke, the *octocosihydrate*, $H_9[B(W_2O_7)_6] \cdot 28H_2O$, begins to melt at 45° , and at 51° it forms a clear liquid. Soln. of this acid in dil. nitric acid give only the octocosihydrate, and the soln. rapidly decomposes with the separation of tungstic acid; but soln. in conc. nitric acid of sp. gr. 1.4, furnish a white crust of microscopic crystals of a *decahydrate*, $H_9[B(W_2O_7)_6] \cdot 10H_2O$.

H. Copaux also obtained the acid $5H_2O \cdot B_2O_3 \cdot 24WO_3 \cdot 61H_2O$ by treating the soln. used in the preparation of the preceding mother-liquid acid with barium carbonate, and decomposing the barium salt with dil. sulphuric acid. The tetragonal octahedra have the axial ratio $a:c=1:1.010$; and they are isomorphous with silicotungstic acid. They are stable in dry air, but decompose in moist air. H. Copaux said the acid is pentabasic; A. Rosenheim, enneabasic, $H_9[B(W_2O_7)_6] \cdot 22H_2O$, and the latter hypothesis was confirmed by A. Rosenheim and J. Jänicke. H. Copaux considered these acids to be different hydrates of one acid, but both acids are obtained from the same soln., and the octocosihydrate is not converted into the decosihydrate by heat; A. Rosenheim inferred that it is more likely that the

docosi- and the octocosi-hydrates are isomeric forms. The one is called **isohydroborododecatungstic acid**, $H_9[B(W_2O_7)_6] \cdot 22H_2O$, and other hydroborododecatungstic acid, $H_6[B(W_2O_7)_6] \cdot 28H_2O$; their composition can be represented by co-ordination formulæ :

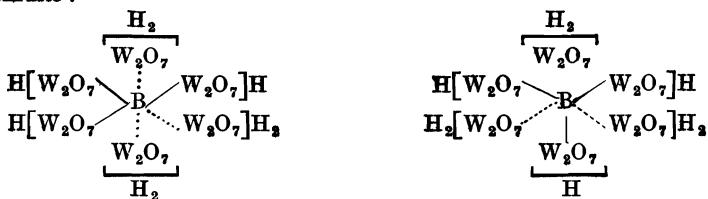

For W. and D. Asch's hexite theory of the constitution of the borododecatungstic acids, *vide* silicotungstic acids.

D. Klein prepared an ammonium borotungstate to which he assigned the formula $2(NH_4)_2O \cdot 9WO_3 \cdot B_2O_3 \cdot 19H_2O$ by the action of ammonium sulphate on the barium salt; and H. Copaux, one of the composition $5(NH_4)_2O \cdot 24H_2O \cdot B_2O_3 \cdot 52H_2O$ by the action of dil. aq. ammonia on the free acid, and evaporating the soln. in air. The observations of A. Rosenheim and co-workers indicate that the salt is **ammonium isotetrahydroborododecatungstate**, $(NH_4)_5H_4[B(W_2O_7)_6] \cdot nH_2O$. The tetragonal crystals have the axial ratio $a : c = 1 : 1.016$; and they are isomorphous with the free acid. The crystals are stable in dry air, but deliquescent in moist air.

H. Copaux made a lithium salt by a process analogous to that employed for the ammonium salt, and from the observations of A. Rosenheim, it is probably **lithium isotetrahydroborododecatungstate**, $Li_5H_4[B(W_2O_7)_6] \cdot nH_2O$. It forms triclinic crystals with axial ratios $a : b : c = 1.629 : 1 : 0.748$, and $\alpha = 98^\circ 4'$, $\beta = 102^\circ 2'$, and $\gamma = 86^\circ 10'$. The crystals are stable in dry air, but deliquescent in moist air. D. Klein reported three sodium borotungstates with $Na_2O : WO_3 : B_2O_3 : H_2O = 2 : 14 : 1 : 29$; $1 : 9 : 1 : 23$; and $2 : 9 : 1 : 12$. K. Ebenhusen also obtained the $2 : 14 : 1 : 29$ salt. According to H. Copaux, the $5 : 24 : 1 : 35$ salt can be obtained by a similar process to that employed for the ammonium salt, and from A. Rosenheim's observations, it would appear to be **sodium isotetrahydroborododecatungstate**, $Na_5H_4[B(W_2O_7)_6] \cdot 15 \cdot 5H_2O$. It forms monoclinic crystals stable in air, and with the axial ratios $a : b : c = 0.461 : 1 : 0.569$, and $\beta = 97^\circ 17'$. According to A. Rosenheim and H. Schwer, **sodium tetrahydroborododecatungstate**, $Na_5H_4[B(W_2O_7)_6] \cdot 27H_2O$, is obtained by treating a soln. of the acid with the calculated amount of sodium carbonate, and evaporating the liquid on a water-bath and then over conc. sulphuric acid. The crystals are isomorphous with those of sodium metatungstate. The loss in water at different temp. is:

Molar loss	110°	120°	140°	160°	300°
	27	27	27	28	29

showing that two of the 29 mols of water are constitutional. The eq. conductivity at 25° when an eq. of the acid is contained in v litres of water is :

v	32	64	128	156	512	1024
λ	183.9	196.0	203.2	213.6	225.2	235.2

and $\lambda_{1024} - \lambda_{32} = 51.3$ corresponding with a pentabasic salt; but the neutralization curve obtained with progressive additions of 0.1N-NaOH, to $\frac{1}{8}N-Na_5H_4[B(W_2O_7)_6] \cdot 27H_2O$, and sp. conductivities in reciprocal ohms :

C.c. $\frac{1}{10}N$ -NaOH	0	1	2	2.8	3	4	5	6	7	8
Rec. ohms	3.054	2.506	1.96	1.684	1.654	1.89	2.02	2.22	2.48	2.62

has a minimum corresponding with at least two more replaceable atoms of hydrogen. The guanidinium salt, $(CN_3H_6)_6H_3[B(W_2O_7)_6]$, is hexabasic; but enneabasic salts have not been obtained with certainty. D. Klein reported potassium salts

with $K_2O : WO_3 : B_2O_3 : H_2O = 3 : 14 : 1 : 23$; $2 : 12 : 1 : 18$; $4 : 12 : 1 : 21$; and $2 : 9 : 1 : 13$; and K. Ebenhasen, $5 : 25 : 1 : 34$. H. Copaux reported **potassium trihydroborododecatungstate**, $K_6H_3[B(W_2O_7)_6] \cdot 21H_2O$, according to A. Rosenheim's formulation. The white hexagonal microscopic prisms were obtained by crystallization from a soln. containing a mol. of the acid and less than 6 mols of potassium carbonate. The salt is completely decomposed by boiling alkali-lye. He also made **potassium isotetrahydroborododecatungstate**, $K_5H_4[B(W_2O_7)_6] \cdot 18H_2O$, according to A. Rosenheim's interpretation. Hexagonal prisms were obtained by an analogous process to that employed for the ammonium salt. The hexagonal prisms have the axial ratio $a : c = 1 : 0.652$; the crystals are optically negative, and have the rotatory power $\alpha_D = 14^\circ$. The crystals lose a mol. of water on exposure to air. D. Klein reported a *silver borotungstate* with $3Ag_2O \cdot 14WO_3 \cdot B_2O_3 \cdot 7H_2O$. A. Rosenheim and H. Schwer made **silver isotetrahydroborododecatungstate**, $Ag_5H_4[B(W_2O_7)_6] \cdot 7H_2O$, as a white crystalline precipitate by adding an aq. soln. of the sodium salt to one of silver nitrate. The existence of the normal salt $Ag_5[B(W_2O_7)_6]$ was not proved.

D. Klein reported a calcium borotungstate, $2CaO \cdot 9WO_3 \cdot B_2O_3 \cdot 15H_2O$, and H. Copaux reported **calcium isotetrahydroborododecatungstate**, $Ca_5\{H_4[B(W_2O_7)_6]\}_2 \cdot 44H_2O$, according to A. Rosenheim's hypothesis. The salt is made by saturating the free acid with an excess of calcium carbonate, and evaporating the liquid. The triclinic crystals have the axial ratios $a : b : c = 1.357 : 1 : 1.524$, and $\alpha = 82^\circ 20'$, $\beta = 101^\circ 42'$, and $\gamma = 94^\circ 44'$. D. Klein made a *strontium salt*, and a *sodium barium salt*; K. Ebenhusen also reported a barium salt. H. Copaux made tetragonal crystals of **barium isotetrahydroborododecatungstate**, $Ba_5\{H_4[B(W_2O_7)_6]\}_2 \cdot 54H_2O$, according to A. Rosenheim's interpretation. The axial ratio is $a : c = 1 : 1.077$; another salt reported with $6BaO \cdot 24WO_3 \cdot B_2O_3 \cdot 58H_2O$ probably contained admixed barium tungstate.

D. Klein reported *magnesium borotungstate*, and H. Copaux obtained doubly refracting crystals of **magnesium isotetrahydroborododecatungstate**, $Mg_5\{H_4[B(W_2O_7)_6]\}_2 \cdot 42H_2O$, according to A. Rosenheim's views. The soln. crystallizes badly at ordinary temp. but better at 40° . D. Klein reported a *zinc borotungstate* in rhombic needles, and the sat. aq. soln. has a sp. gr. 3.15 ; and K. Ebenhusen gave for the ratio $ZnO : WO_3 : B_2O_3 = 2 : 9 : 1$. D. Klein likewise reported *cadmium borotungstate*, $2CdO \cdot 9WO_3 \cdot B_2O_3 \cdot 18$ (or 19) H_2O , to be formed by treating the barium salt with cadmium sulphate. According to G. Linck, six of the 18 mols of water are combined. The crystals are dimorphous; the rhombic form has the axial ratios $a : b : c = 1.3321 : 1 : 1.1383$; and the triclinic form, $a : b : c = 0.6261 : 1 : 0.4398$, and $\alpha = 1.14^\circ 56'$, $\beta = 92^\circ 42'$, and $\gamma = 94^\circ 57'$. Eight parts of water dissolve more than 100 parts of the salt at 17° , and the sp. gr. of the sat. soln. at $15.6^\circ/4$ is 3.2887 ; and at $16.2^\circ/4$, 3.2868 ,—it is the so-called *Klein's solution* used in the separation of minerals. The optical properties of the soln. were studied by G. W. A. Kahlbaum and co-workers. The index of refraction at 20° is 1.5781 for the H_α -line; 1.5836 for the D-line; and 1.5980 for the H_β -line. The dispersion is therefore $\mu_{H_\beta} - \mu_D = 0.0144$. The crystals are pleochroic and effloresce readily. At 100° only traces of water are expelled; at 150° , 12 mols are given off; and the remainder at a red heat. H. Copaux made **cadmium isotetrahydroborododecatungstate**, $Cd_5\{H_4[B(W_2O_7)_6]\}_2 \cdot 51H_2O$, according to A. Rosenheim's theory. The triclinic crystals are stable in air. D. Klein reported *mercurous borododecatungstate* to be formed as a yellowish-white precipitate when the potassium salt is treated with mercurous nitrate; he also reported *mercuric borotungstate*. H. Copaux made **mercurous borododecatungstate**, formulated $Hg_9[B(W_2O_7)_6] \cdot 12.5H_2O$, by treating sodium borotungstate with mercurous nitrate; the precipitate is washed with water containing mercurous nitrate, and dried in air. The same salt was made by A. Rosenheim and H. Schwer.

D. Klein reported *aluminium borotungstate*, $2Al_2O_3 \cdot 9WO_3 \cdot B_2O_3 \cdot 65H_2O$; *didymium borotungstate* in rose-red octahedra; *cerium borotungstate* of indefinite composition; *thallium borotungstate*, $2Tl_2O \cdot 9WO_3 \cdot B_2O_3 \cdot 5H_2O$ *chromium borotungstate*,

$2\text{Cr}_2\text{O}_3 \cdot 9\text{WO}_3 \cdot \text{B}_2\text{O}_3 \cdot 74\text{H}_2\text{O}$; uranium borotungstate, $3\text{UO}_3 \cdot 9\text{WO}_3 \cdot \text{B}_2\text{O}_3 \cdot 30\text{H}_2\text{O}$; manganese borotungstate, $2\text{MnO} \cdot 9\text{WO}_3 \cdot \text{B}_2\text{O}_3 \cdot 17\text{H}_2\text{O}$; antimonious borotungstate, and antimonic borotungstate by dissolving antimonious or antimonic acid in a boiling soln. of borotungstate acid; and vanadium borotungstate, $3\text{V}_2\text{O}_5 \cdot (\text{B}_2\text{O}_3 \cdot 9\text{WO}_3)_2 \cdot 30\text{H}_2\text{O}$; D. Klein made lead borotungstate, $2\text{PbO} \cdot 9\text{WO}_3 \cdot \text{B}_2\text{O}_3 \cdot 12\text{H}_2\text{O}$, in two forms: one, in rhombic crystals, by treating the acid with lead carbonate; and another, by evaporation *spontanée* of a mixed soln. of sodium borotungstate, and lead nitrate. These salts are decomposed by water. He made ferric borotungstate, and ferrous borotungstate of undetermined composition; and he also obtained cobalt borotungstate, $2\text{CoO} \cdot 9\text{WO}_3 \cdot \text{B}_2\text{O}_3 \cdot 18\text{H}_2\text{O}$, in monoclinic crystals isomorphous with the nickel salt—it has 5 mols of constitutional water. At 19° , the conc. aq. soln. has a sp. gr. 3.36 to 3.37. At 16.2° , 100 parts of water dissolve 306.8 parts of the salt dried at 100° ; 299.7 parts at 19.6° , and 286 parts at 21.8° . G. W. A. Kahlbaum and co-workers give for the index of refraction at 20° , $\mu = 1.6109$ for the He_β -line, and 1.5981 for the Na-line. D. Klein obtained nickel borotungstate, $2\text{NiO} \cdot 9\text{WO}_3 \cdot \text{B}_2\text{O}_3 \cdot 18\text{H}_2\text{O}$, in green crystals which melt at 80° , forming a liquid of sp. gr. 3.6; a per cent. soln. has a sp. gr. 3.34. A soln. with 261.6 parts of salt in 100 parts of water has a maximum sp. gr. The sp. gr. of a sat. soln. at $15.75^\circ/4^\circ$ is 2.2959; and at $15.90^\circ/4^\circ$, 2.2956. G. W. A. Kahlbaum and co-workers gave for the index of refraction at 20° , $\mu = 1.4946$ for the orange He -line; 1.5037 for the bluish-green He -line; 1.5046 for the blue He -line; and 1.5047 for the He_β -line. These preparations want repeating.

According to C. F. Rammelsberg,⁵ the dark green precipitate which borax forms with uranium tetrachloride soln. is almost wholly uranous hydroxide; J. B. Richter obtained a pale yellow *uranyl borate* by treating a uranyl salt soln. with borax. It is sparingly soluble in water.

REFERENCES.

¹ M. Landecker, *Untersuchungen über die quantitative Bestimmung der Erdsäuren*, München, 1909; L. Weiss and M. Landecker, *Zeit. anorg. Chem.*, **64**, 83, 1909; H. Rose, *Pogg. Ann.*, **63**, 307, 693, 1844; **69**, 118, 1846; A. G. Ekeberg, *Scherer's Journ.*, **9**, 597, 1802; *Crell's Ann.*, **i**, 1, 1803; W. Guertler, *Zeit. anorg. Chem.*, **40**, 225, 1904; *Ueber wasserfreie Borate und über Entglasung*, Leipzig, 1904; J. J. Berzelius, *Schweigger's Journ.*, **22**, 51, 1818; *Pogg. Ann.*, **4**, 153, 1825; **6**, 331, 369, 1826; **7**, 261, 1826; L. Vanino and F. Hartl, *Journ. prakt. Chem.*, (2), **74**, 151, 1906; A. Guyard, *Bull. Soc. Chim.*, (2), **25**, 564, 1876.

² A. Moberg, *Journ. prakt. Chem.*, (1), **44**, 332, 1848; A. A. Hayes, *Amer. Journ. Science*, (1), **14**, 136, 1828; (1), **20**, 409, 1831; M. Heberling, *Chem. Centr.*, (3), **1**, 122, 1870; C. Tissier, *Compt. Rend.*, **45**, 411, 1857; N. J. Berlin, *Pogg. Ann.*, **43**, 108, 1838; A. Laurent, *Compt. Rend. Trav. Chim.*, **6**, 33, 1850; A. Rosenheim and F. Leyser, *Zeit. anorg. Chem.*, **119**, 1, 1921.

³ J. J. Berzelius, *Schweigger's Journ.*, **22**, 51, 1818; *Pogg. Ann.*, **4**, 153, 1825; **6**, 331, 369, 1826; **7**, 261, 1826; F. Mauro, *Bull. Soc. Chim.*, (2), **33**, 564, 1880; C. W. Scheele, *De principis lapidis ponderosi*, Upsala, 1781.

⁴ H. Copaux, *Compt. Rend.*, **147**, 973, 1908; *Ann. Chim. Phys.*, (8), **17**, 217, 1909; *Bull. Soc. Chim.*, (4), **13**, 324, 1913; *Zeit. anorg. Chem.*, **70**, 297, 1911; A. Rosenheim, *ib.*, **70**, 423, 1911; A. Rosenheim and J. Jänicke, *ib.*, **77**, 239, 1912; **101**, 235, 1917; A. Rosenheim and H. Schwer, *ib.*, **89**, 224, 1914; E. Mauro, *Gazz. Chim. Ital.*, **11**, 214, 1881; *Ber.*, **14**, 1379, 1881; *Bull. Soc. Chim.*, (2), **33**, 564, 1880; D. Klein, *ib.*, (2), **33**, 466, 1880; (2), **34**, 23, 1880; (2), **35**, 12, 1881; (2), **36**, 17, 547, 1881; (2), **37**, 202, 1882; *Sur les acides borotungstiques*, Paris, 1883; *Bull. Soc. Min.*, **4**, 151, 1881; *Ann. Chim. Phys.*, (5), **23**, 350, 1883; *Compt. Rend.*, **91**, 415, 474, 495, 1070, 1880; **93**, 318, 492, 1881; E. Brauer, *Ueber die Beständigkeit der Anionen der Heteropolysäuren*, Berlin, 1918; K. Ebenhusen, *Ueber Borwolframate*, Bern, 1905; G. W. A. Kahlbaum, K. Roth, and P. Siedler, *Zeit. anorg. Chem.*, **29**, 229, 1902; G. Linck, *Zeit. Kryst.*, **12**, 442, 1886; J. C. G. de Marignac, *Ann. Chim. Phys.*, (4), **3**, 55, 1864; W. and D. Asch, *Die Silicate in chemischer und technischer Beziehung*, Berlin, 95, 1911; London, 97, 1913.

⁵ C. F. Rammelsberg, *Pogg. Ann.*, **55**, 318, 1842; **56**, 125, 1842; **59**, 1, 1843; J. B. Richter, *Ueber die neueren Gegenstände der Chymie*, Breslau, **1**, 1, 1791; **9**, 36, 1800; *Gehlen's Ann.*, **4**, 402, 1804.

§ 16. The Borates of Manganese and of the Iron and Platinum Families

According to J. J. Berzelius,¹ borax gives a white precipitate with salts of manganese, and the precipitate is soluble in an aq. soln. of magnesium sulphate; the presence of a magnesium salt prevents the precipitation. Water decomposes the precipitate rapidly, forming manganic oxide. F. Borchers observed similar results with manganous salts as those indicated in connection with zinc salts. L. Joulin found

Manganese borate is used in the preparation of drying oils, and oil varnishes.² Large proportions of calcium sulphate as impurity have been reported.

C. W. Scheele³ noted that fused borax dissolves manganese oxide, forming a colourless clear glass which becomes opaque on cooling. A. Rosenheim and F. Leyser made complex **manganese pentaborate**. Manganese carbonate was found by W. Guertler to dissolve rapidly in the fused acid with the evolution of carbon dioxide. The molten soln. separates into two layers; the upper colourless layer is mainly boric oxide, the lower layer is dark brown. The powdered mass after extraction with water furnishes crystals of **manganese tetraborate**, $\text{MnO} \cdot 2\text{B}_2\text{O}_3$, or MnB_4O_7 , and the compound shows some analogies with the corresponding strontium and calcium borates. H. Endemann and J. W. Paisley obtained **pentahydrated manganese tetraborate**, $\text{MnB}_4\text{O}_7 \cdot 5\text{H}_2\text{O}$, by triturating an acid manganese borate with a little water and the calculated proportions of boric acid, and drying the product in air; it was also obtained by adding sodium hydroxide to a soln. of borax so as to furnish 4 mols of NaBO_2 , and mixing the product with 2 mols of manganese chloride. The precipitate was washed and the right amount of a soln. of boric acid added to convert the precipitate into MnB_4O_7 , and the product was dried in air. If dried just below 120° , **trihydrated manganese tetraborate**, $\text{MnB}_4\text{O}_7 \cdot 3\text{H}_2\text{O}$, is formed. This product when mixed with water hardens like plaster of Paris. It loses all its water at a red heat, and loses a little boric oxide as shown by its becoming superficially brown.

L. Ouvrard prepared **manganese orthoborate**, $\text{Mn}_3(\text{BO}_3)_2$, or $3\text{MnO} \cdot \text{B}_2\text{O}_3$, by heating manganese sulphate or chloride with equi-molar proportions of potassium hydrofluoride and boric oxide. The needle-like crystals are pale brown and, according to E. Mallard, the rhombic crystals have the axial ratios $a:b:c = 0.6511:1:0.5311$. J. J. Ebelmen obtained the same compound, and he also reported **manganese sesquiborate**, $3\text{MnO} \cdot 2\text{B}_2\text{O}_3$, which E. Mallard said forms rhombic crystals with axial ratios $a:b:c = 1.8873:1:2.012$; but W. Guertler thinks that this product is more probably dimanganese diborate, $2\text{MnO} \cdot \text{B}_2\text{O}_3$. W. Guertler also prepared **manganese di- or metaborate**, $\text{Mn}(\text{BO}_2)_2$, or $\text{MnO} \cdot \text{B}_2\text{O}_3$, by fusing together eq. quantities of the components. W. N. Hartley and H. Ramage made this borate by heating manganese tetrahydro-orthoborate to incipient fusion. G. J. Brush described a mineral *sussexite*, found in the zinc mine at Sussex, New Jersey. G. J. Brush's and S. L. Penfield's analyses correspond with $(\text{Mn}, \text{Mg}, \text{Zn})\text{H} \cdot \text{BO}_3$, or $[(\text{Mn}, \text{Mg}, \text{Zn})\text{OH}]\text{BO}_2$.

B_2O_3	MnO	MgO	ZnO	H_2O
32.60	39.09	16.47	3.24	9.06

The mineral occurs in fibrous masses coloured white or yellow; the sp. gr. is 3.42; and the hardness 3. It is soluble in hydrochloric acid. The mineral *pinakioïte* was found by G. Flink in the manganese mine at Langbanshyttan, Sweden, and named after *πινάκιον*, a small board, and *λίθος*, stone. Analyses by G. Flink, and H. Bäckström correspond with $(\text{MgO})_3 \cdot \text{B}_2\text{O}_3 \cdot \text{MnO} \cdot \text{Mn}_2\text{O}_3$; W. C. Brögger assigns to it the formula $\text{Mg}_2\text{O} \cdot \text{MnO} \cdot \text{BO}_3$, or $\text{Mg}_2\text{O} \cdot \text{MnO}_2 \cdot \text{BO}_2$.

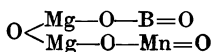

The rhombic plates have the axial ratios $a:b:c = 0.83385:1:0.58807$; the sp. gr. is 3.881; and the hardness 6. The mineral is dark brown, almost black. It is almost opaque in the direction of the *c*-axis; dark reddish-brown in the direction of the *b*-axis; and reddish-yellow in the direction of the *a*-axis. Dil. acids have very little action. It is soluble in conc. hydrochloric acid.

J. Percy⁴ fused mixtures corresponding with $\text{FeO} : \text{B}_2\text{O}_3$, $3\text{FeO} : \text{B}_2\text{O}_3$, $3\text{FeO} : 2\text{B}_2\text{O}_3$, and $6\text{FeO} : \text{B}_2\text{O}_3$, and obtained brownish-black vitreous products, but no evidence of the formation of definite borates. C. W. Scheele prepared a pale yellow powder of **ferrous borate** by double decomposition with borax and a

ferrous salt soln.; J. Tünnermann likewise obtained a green product. It was fusible before the blowpipe, and hydrolyzed by water. W. Guertler could not make ferrous borate by fusing ferrous oxide with boric acid, oxidation always occurred even when the fusion took place in a stream of hydrogen. The product separates on cooling into two layers. The upper black layer is a soln. of iron oxide in boric oxide; the lower layer contained crystals of $2\text{FeO} \cdot 2\text{Fe}_2\text{O}_3 \cdot 3\text{B}_2\text{O}_3$. J. Percy heated mixtures corresponding with $\text{Fe}_2\text{O}_3 \cdot \text{B}_2\text{O}_3$ and $\text{Fe}_2\text{O}_3 : 3\text{B}_2\text{O}_3$, and obtained vitreous products but no evidence of combination; part at least of the ferric oxide was reduced to a lower oxide. H. Rose obtained a voluminous yellow insoluble precipitate of **ferric borate** by the action of borax on a soln. of a ferric salt. The colour darkens when it is heated. G. Rousseau and H. Allaire prepared cubic crystals of **ferrous chloroborate**, $6\text{FeO} \cdot 8\text{B}_2\text{O}_3 \cdot \text{FeCl}_2$, by passing the vapour of ferrous chloride over iron wire and calcium borate in a stream of carbon dioxide at 330° .

The dark green mineral *ludwigite* is a magnesium ferric borate; specimens from Morawitz were described by G. Tschermak, A. Veszely, J. E. Whitfield, and V. von Zepharovich; W. T. Schaller described a sample from Philipsbury, Montana. The last-named represented its composition by $\text{FeO} \cdot \text{Fe}_2\text{O}_3 \cdot 3\text{MgO} \cdot \text{B}_2\text{O}_3$; J. J. Ebelmen synthesized a related product of sp. gr. 3.85 by melting together 26 grms. of ferric oxide, 20 grms. of magnesia, and 25 grms. of boric oxide. It is possible that a magnesium ferrimagnesium borate, $\text{MgO} \cdot \text{Fe}_2\text{O}_3 \cdot 3\text{MgO} \cdot \text{B}_2\text{O}_3$, and a ferrous ferrimagnesium borate, $\text{FeO} \cdot \text{Fe}_2\text{O}_3 \cdot 3\text{MgO} \cdot \text{B}_2\text{O}_3$, are in isomorphous admixture. The idealized compound is also regarded as a **magnesium boratoferrite**, $\text{Mg}_2\text{O} \cdot \text{FeO}_2 \cdot \text{BO}_2$. The rhombic crystals have the axial ratios $a : b : c = 0.988 : 1 : -$. E. Mallard also measured the prism angles. A. F. Renard made observations on the crystals. The sp. gr. is 3.907–4.016; and the hardness is 2. G. Tschermak found that ludwigite melts to a black magnetic slag. Cold dil. hydrochloric acid slowly dissolves the fine powder while the warm acid acts rapidly; sulphuric acid also dissolves the mineral slowly, forming a green soln., and, according to F. Berwerth, ludwigite is converted into limonite. A. S. Bakle also found black prismatic crystals of a mineral at Riverside, California, and they called it *vonsenite*. Its structure and optical properties differ from ludwigite. Its composition approximates to $3(\text{Fe}, \text{Mg})\text{O} \cdot \text{B}_2\text{O}_3 + \text{FeO} \cdot \text{Fe}_2\text{O}_3$. The mineral is either rhombic or monoclinic with the axial ratios $a : b : c = 0.7558 : 1 : -$ —the sp. gr. is 4.21, and the hardness 5. It is quite soluble in hydrochloric or sulphuric acid.

W. Guertler⁵ melted a mol of cobalt with 3 mols of boric oxide, and obtained a glass which separated into two layers; the upper blue layer was mainly boric oxide; the lower layer furnished violet acicular crystals which could be isolated by washing out the boric oxide. The composition corresponded with **cobalt diborate**, $2\text{CoO} \cdot \text{B}_2\text{O}_3$, or $\text{Co}_2\text{B}_2\text{O}_5$. L. Ouvrard also made a compound with the same composition by treating cobalt chloride with a mixture of equi-molar proportions of boric oxide and potassium hydrofluoride. The violet prismatic crystals were isolated by washing with water. E. Mallard assumed the existence of $3\text{CoO} \cdot 2\text{B}_2\text{O}_3$, isomorphous with the corresponding magnesium compound; and when the latter was shown to be $2\text{MgO} \cdot \text{B}_2\text{O}_3$, the former was taken to be best represented by $2\text{CoO} \cdot \text{B}_2\text{O}_3$. L. Ouvrard also made rose-violet crystals of **cobalt orthoborate**, $3\text{CoO} \cdot \text{B}_2\text{O}_3$, or $\text{Co}_3(\text{BO}_3)_2$, by using less boric oxide than was employed for the preceding. E. Mallard said that the rhombic crystals have the axial ratio $a : b = 0.641$. A. Rosenheim and F. Leyser made complex **cobalt pentaborate**. A. Ditte made **decahydrated cobalt tetraborate**, $\text{CoO} \cdot 2\text{B}_2\text{O}_3 \cdot 10\text{H}_2\text{O}$, by mixing a cold soln. of borax with one of a cobalt salt; and **dodecahydrated cobalt octoborate**, $\text{CoO} \cdot 4\text{B}_2\text{O}_3 \cdot 12\text{H}_2\text{O}$, in rose-red crystals; by evaporating a sat. soln. of cobalt carbonate in boric acid. H. Rose reported a rose-coloured amorphous **tetrahydrated tricobalt tetraborate**, $3\text{CoO} \cdot 2\text{B}_2\text{O}_3 \cdot 4\text{H}_2\text{O}$, to be formed when a soln. of borax is added to one of a cobalt salt. J. J. Ebelmen, and E. Mallard studied the **cobalt magnesium borate**, $2\text{B}_2\text{O}_3(\text{CoO} \cdot \text{MgO})_3$, which is obtained in triclinic crystals from a molten mixture of the components. J. J. Ebelmen's $2(\text{CoO} \cdot \text{MgO}) \cdot \text{B}_2\text{O}_3$ is assumed by E. Mallard

to be isomorphous with $2\text{CoO}\cdot\text{B}_2\text{O}_3$ and $2\text{MgO}\cdot\text{B}_2\text{O}_3$. R. Tupputi obtained a pale apple-green powder by adding borax to a soln. of a nickel salt; the precipitate is insoluble in water but soluble in the three mineral acids. J. J. Berzelius said that the product fused to a hyacinth-coloured glass. According to W. Guertler, nickel oxide behaves like cobalt oxide towards fused boric oxide, and he obtained crystals of **dinickel diborate**, $2\text{NiO}\cdot\text{B}_2\text{O}_3$. L. Ouvrard obtained green crystals of **nickel orthoborate**, $3\text{NiO}\cdot\text{B}_2\text{O}_3$, or $\text{Ni}_3(\text{BO}_3)_2$; of **hexahydrated nickel tetraborate**, $\text{NiO}\cdot 2\text{B}_2\text{O}_3\cdot 6\text{H}_2\text{O}$; and of **decahydrated nickel octoborate**, $\text{NiO}\cdot 4\text{B}_2\text{O}_3\cdot 10\text{H}_2\text{O}$, analogous to the cobalt borates.

Soln. of rhodium salts give a precipitate—probably *rhodium borate*—with sodium borate.

REFERENCES.

¹ W. Guertler, *Zeit. anorg. Chem.*, **40**, 225, 1904; *Ueber wassfreie Borate und über Entglasung*, Leipzig, 1904; G. J. Brush, *Amer. Journ. Science*, (2), **46**, 240, 1869; S. L. Penfield, (3), **36**, 317, 1888; G. Flink, *Zeit. Kryst.*, **18**, 361, 1891; W. C. Brögger, *ib.*, **18**, 377, 1891; H. Bäckström, *Geol. Fören. Förl.*, **17**, 257, 1895; E. Mallard, *Compt. Rend.*, **105**, 1263, 1887; C. Tissier, *ib.*, **39**, 192, 1854; **45**, 411, 1857; H. Endemann and J. W. Paisley, *Zeit. angew. Chem.*, **16**, 175, 1903; W. N. Hartley and H. Ramage, *Journ. Chem. Soc.*, **63**, 129, 1893; A. Laurent, *Compt. Rend. Trav. Chim.*, **6**, 33, 1850; J. J. Berzelius, *The Use of the Blowpipe in Chemical Analysis*, London, 1822; C. W. Scheele, *De magnesia nigra*, Upsala, 1774; F. Borchers, *Zeit. anorg. Chem.*, **68**, 269, 1910; J. J. Ebelmen, *Ann. Chim. Phys.*, (3), **33**, 34, 1851; L. Joulin, *ib.*, (4), **30**, 272, 1875; L. Ouvrard, *Compt. Rend.*, **130**, 172, 335, 1900; J. L. Smith, *Amer. Chem. Journ.*, **4**, 279, 1882; W. Thomas, *ib.*, **4**, 358, 1882.

² Anon., *Kunst und Gewerbeblatt*, 314, 1856; I. Hoffmann, *Dingler's Journ.*, **145**, 450, 1857; R. Kayser, *ib.*, **256**, 424, 1885.

³ W. Guertler, *Zeit. anorg. Chem.*, **40**, 225, 1904; *Ueber wasserfreie Borate und über Entglasung*, Leipzig, 1904; G. J. Brush, *Amer. Journ. Science*, (2), **46**, 140, 240, 1869; S. L. Penfield, *ib.*, (3), **36**, 317, 1888; G. Flink, *Zeit. Kryst.*, **18**, 361, 1891; W. C. Brögger, *ib.*, **18**, 377, 1891; H. Bäckström, *Geol. Fören. Förl.*, **17**, 257, 1895; E. Mallard, *Compt. Rend.*, **105**, 1263, 1887; C. Tissier, *ib.*, **39**, 192, 1854; **45**, 411, 1857; H. Endemann and J. W. Paisley, *Zeit. angew. Chem.*, **16**, 175, 1903; W. N. Hartley and H. Ramage, *Journ. Chem. Soc.*, **63**, 129, 1893; A. Laurent, *Compt. Rend. Trav. Chim.*, **6**, 33, 1850; J. J. Berzelius, *The Use of the Blowpipe in Chemical Analysis*, London, 1822; C. W. Scheele, *De magnesia nigra*, Upsala, 1774; F. Borchers, *Zeit. anorg. Chem.*, **68**, 269, 1910; A. Rosenheim and F. Leyser, *Zeit. anorg. Chem.*, **119**, 1, 1921; J. J. Ebelmen, *Ann. Chim. Phys.*, (3), **33**, 34, 1851; L. Joulin, *ib.*, (4), **30**, 272, 1873; L. Ouvrard, *Compt. Rend.*, **130**, 172, 335, 1900; J. L. Smith, *Amer. Chem. Journ.*, **4**, 279, 1882; W. Thomas, *ib.*, **4**, 358, 1882.

⁴ C. W. Scheele, *Crell's Ann.*, ii, 387, 1785; J. Percy, *Metallurgy of Iron and Steel*, London, 1, 101, 1864; J. Tünnermann, *Kastner's Arch.*, **20**, 21, 1830; H. Rose, *Pogg. Ann.*, **89**, 473, 1853; E. Bechi, *Amer. Journ. Science*, (2), **17**, 129, 1854; (2), **19**, 119, 1855; W. Guertler, *Zeit. anorg. Chem.*, **40**, 232, 1904; *Ueber wasserfreie Borate und über Entglasung*, Leipzig, 1904; E. Mallard, *Ann. Mines*, (8), **12**, 427, 1887; A. F. Renard, *Bull. Acad. Belg.*, **9**, 547, 1885; F. Berwerth, *Tschermak's Mitt.*, 247, 1874; G. Tschermak, *ib.*, 59, 1874; A. Veszely, *ib.*, 65, 1874; V. von Zepharovich, *Jahresb. Ver. Lotos Prag*, 27, 1877; W. T. Schaller, *Zeit. Kryst.*, **48**, 548, 1911; J. E. Whitfield, *Amer. Journ. Science*, (3), **34**, 281, 1887; J. J. Ebelmen, *Ann. Chim. Phys.*, (3), **33**, 34, 1851; G. Rousseau and H. Allaire, *Compt. Rend.*, **116**, 1195, 1893; A. S. Eakle, *Amer. Min.*, **5**, 141, 1920.

⁵ W. Guertler, *Zeit. anorg. Chem.*, **40**, 232, 1904; *Ueber wasserfreie Borate und über Entglasung*, Leipzig, 1904; L. Ouvrard, *Compt. Rend.*, **130**, 335, 1900; A. Rosenheim and F. Leyser, *Zeit. anorg. Chem.*, **119**, 1, 1921; A. Ditte, *Ann. Chim. Phys.*, (5), **30**, 257, 1883; J. J. Ebelmen, *ib.*, (3), **33**, 34, 1851; H. Rose, *Pogg. Ann.*, **88**, 299, 1853; E. Mallard, *Compt. Rend.*, **105**, 1260, 1887; *Ann. Mines*, (8), **12**, 427, 1887; J. J. Berzelius, *Schweigger's Journ.*, **32**, 156, 1821; R. Tupputi, *Ann. Chim. Phys.*, (1), **78**, 133, 1811; (1), **79**, 153, 1811.

§ 17. Perboric Acids and the Perborates

The existence of perborates was demonstrated by A. Étard¹ in 1880; by mixing a sat. soln. of boric acid and hydrated barium peroxide, he obtained a product which possessed oxidizing properties, liberating chlorine from hydrochloric acid, and giving oxygen with dil. acids. In 1898, S. M. Tanatar produced sodium perborate by the action of hydrogen dioxide on a soln. of sodium orthoborate. P. G. Melikoff

and L. Pissarjewsky in 1898 prepared the potassium and sodium salts. *Perboric acid* itself has not been made. L. Pissarjewsky said that at 25° aq. soln. of boric acid and hydrogen peroxide do not combine, but in ethereal soln. and an excess of hydrogen peroxide, the partition coeff. of boric acid increases a little corresponding with the formation of free perboric acid in the ethereal soln. As a typical perborate, consider ordinary **sodium perborate**, $\text{NaBO}_3 \cdot 4\text{H}_2\text{O}$. P. G. Melfkoff and L. Pissarjewsky made it by treating a sat. soln. of borax containing an eq. amount of sodium hydroxide with double the amount of hydrogen peroxide required for the production of the perborate. After some time, crystals of the salt separate: $\text{Na}_2\text{B}_4\text{O}_7 + 2\text{NaOH} + 4\text{H}_2\text{O}_2 = 5\text{H}_2\text{O} + 4\text{NaBO}_3$.

According to F. H. Fuhrmann, the introduction of catalytic metallic compounds in the liquid is avoided by using wooden vats and stirrers, and all metal pipes, taps, etc., are well tinned. The product is best separated from the mother liquid centrifugally; and the salt is dried by passing it through an apparatus where it meets a current of air which may be heated to 50°.

The two modern methods used in the manufacture of sodium perborate are: (i) the interaction of sodium dioxide and sodium metaborate; and (ii) electrolytic methods. Hinkel et Cie. suggest the auto-oxidation of aq. soln. of borax and lime by means of aluminium amalgam in a current of oxygen. J. Bruhat and H. Dubois obtained it by adding alcohol to a soln. of sodium orthoborate with twice the calculated quantity of hydrogen peroxide. O. T. Christensen cooled a soln. of 62 grms. of boric acid in 500 c.c. of water, and added 87 grms. of sodium peroxide in small portions at a time so that the temp. did not rise over 30°. Next day, 45 grms. of crystals of the perborate separated out. G. F. Jaubert added enough mineral acid to a soln. of perborate to neutralize about half the contained alkali, and crystallized the soln.

S. M. Tanatar stated that perborates are produced at the anode during the electrolysis of conc. soln. of sodium orthoborate, but E. J. Constam and J. C. Bennett did not confirm this. J. Bruhat and H. Dubois, however, confirmed S. M. Tanatar's observation, and E. A. Pouzenc patented a process for making sodium perborate by electrolysis. The mechanism of the electrolysis has not been established. S. M. Tanatar assumed that the borate is oxidized by the hydrogen peroxide formed at the anode. The hydrogen peroxide would be produced by the discharge of OH' -ions contained in the soln. of sodium orthoborate. E. J. Constam and J. C. Bennett objected that the soln. of hydrogen peroxide under such conditions is too dil. for the conversion of borates to perborates. The latter objection does not allow for a possible local conc. of the hydrogen peroxide at the anode sufficient for the purpose. E. H. Reisenfeld and B. Reinhold could not obtain hydrogen peroxide by electrolysis of soln. of sodium hydroxide, but they did obtain it in the presence of potassium hydroxide. The Fredrikstad elektrokemiske Fabrik claims that in the preparation of perborates by the usual electrolytic process, a large percentage of electrical energy and borax is wasted, only highly purified borax can be used, and it is difficult to maintain a constant and continuous production. The last-named disadvantages are overcome by adding sodium cyanide to the borax soln. This prevents the decomposition of the perborate formed in the soln. When the soln. is sat., sodium peroxide is added, and the perborate then crystallizes out. The Deutsche Gold- und Silberscheideanstalt add fluorides or perchlorates to increase the anode potential. The subject has been investigated by T. Valeur, and P. C. Alsgaard. K. Arndt's electrolytic process is as follows:

A soln. of 40 grms. of borax and 120 grms. of anhydrous sodium carbonate is electrolyzed between a platinum gauze anode and a cathode made of tin tubing bent in a zigzag form round the anode. A current of water is circulated through the cathode, whereby the temp. is kept below 18°. A current of 20 amps. at 6 volts is used with an anode 8×6 cms. After an hour the current is stopped and the soln. cooled, when about 20 grms. of sodium perborate separate out in small crystals. These are washed with a little ice-cold water and dried. A somewhat better yield can be obtained if 0.1 gm. of sodium chromate and 1 drop of turkey-red oil are added to the soln. For the preparation of soln. of sodium perborate for bleaching

purposes, it is recommended that the anode should be smeared with vaseline. In these circumstances, a yield of 27 grms. per litre can be very efficiently obtained.

Sodium perborate forms transparent monoclinic prisms of the *tetrahydrate*, and, according to J. Bruhat and H. Dubois, if the tetrahydrate be dried, it furnishes the *monohydrate*, and in vacuo, over phosphorus pentoxide, the anhydrous salt is formed. F. Förster prefers to regard the tetrahydrate as a salt, $\text{NaBO}_2 \cdot \text{H}_2\text{O}_2 \cdot 3\text{H}_2\text{O}$, than as $\text{NaBO}_3 \cdot 4\text{H}_2\text{O}$. When the salt, after dehydration at $50^\circ\text{--}55^\circ$, is further heated at 120° in a vacuum, it loses water, and the residue, which evolves oxygen on treating with water, consists chiefly of $(\text{NaBO}_2)_2\text{O}_2$ with some NaBO_2 , H_2O and metaborate. This compound, $(\text{NaBO}_2)_2\text{O}_2$, has properties which differ from those of NaBO_3 , and this tends to imply the existence of a substitution product of hydrogen peroxide of the composition $\text{ONa} \cdot \text{B} < \overset{\text{O}}{\underset{\text{O}}{\text{O}}}$, analogous to persulphates and percarbonates. This is confirmed by the fact that sodium perborate has been electrolytically prepared. Sodium perborate, obtained by the action of hydrogen peroxide on the metaborate, behaves as the salt of an acid of greater strength than boric acid. The salt is stable in air; and G. F. Jaubert stated that the salt is not affected by atm. carbon dioxide, whereas, S. M. Tanatar found it is rapidly decomposed by that gas. The solubility of the salt in water has been measured by P. G. Melikoff and L. Pissarjewsky, S. M. Tanatar, and G. F. Jaubert and G. Lion. The latter found that 100 c.c. of water at 15° dissolve 2.55 grms. of the tetrahydrated salt at 21° , 2.69 grms.; at 26° , 2.85 grms.; and at 32° , 3.78 grms. J. Bruhat and H. Dubois found that the solubility is increased in the presence of boric tartaric or citric acid, or of glycerol, while G. F. Jaubert and G. Lion found that the solubility is increased in the presence of small proportions of magnesium and ammonium sulphates. G. F. Jaubert noticed that the temp. is lowered when the salt is dissolved in water, and S. M. Tanatar gave -11.564 Cals. for the heat of soln. in water at 16.1° ; and -8.950 Cals. for the heat of soln. in $\frac{1}{2}N$ -sulphuric acid at 17.29° ; so that the heat of decomposition of the dissolved salt by sulphuric acid is 2.614 Cals.

The aq. soln. has an alkaline reaction, and it is stable at ordinary temp. L. Pissarjewsky measured the distribution coeff. of hydrogen peroxide between aq. and ethereal soln. of borates, and found the relative conc. of the borates in the ether phase increased in conformity with the assumption that the soln. contains perborates. He further showed that at least 60 per cent. of the peroxide oxygen in an aq. soln. of sodium perborate, at 25° , is hydrogen peroxide; and at this temp. he inferred that sodium perborate does not exist in aq. soln., but hydrolyzes: $\text{NaO}_2\text{BO} + \text{H}_2\text{O} = \text{NaO}_2\text{H} + \text{HBO}_2$; and in accord with the experiments of H. T. Calvert, he assumed that the sodium hydroperoxide thus formed hydrolyzes into hydrogen peroxide and sodium hydroxide. The latter unites with the boric acid so that the aq. soln. contains sodium borate, boric acid, sodium hydroperoxide, hydrogen peroxide, sodium hydroxide, and traces of sodium perborate. At lower temp., sodium perborate is formed, $\text{NaO}_2\text{H} + \text{HO} \cdot \text{BO} = \text{H}_2\text{O} + \text{NaO}_2\text{BO}$, in increasing proportions the lower the temp., so that at 0° only sodium perborate is present. This is in agreement with the measurements of E. J. Constanam and J. C. Bennett on the electrical conductivity of aq. soln. of sodium perborate. The conductivity at a dilution $v=32$ is 30.7, and for $v=1024$, 40.1, so that, according to Ostwald's rule, the acid is monobasic, and the formula of the sodium salt is NaBO_3 , and not $\text{Na}_2\text{B}_2\text{O}_6$. H. Menzel measured the effect of hydrogen dioxide on the f.p. and electrical conductivity of soln. of orthoboric acid, and on soln. of alkali metaborate, and borax. He also measured the partition coeff. of hydrogen dioxide between anyl alcohol and aq. soln. of potassium metaborate. For the equilibrium $(\text{BO}_2 \cdot \text{H}_2\text{O}_2)' \rightleftharpoons \text{BO}_2' + \text{H}_2\text{O}$, where $[(\text{BO}_2 \cdot \text{H}_2\text{O}_2)']K = [\text{BO}_2'][\text{H}_2\text{O}_2]$, he found $K=0.024$ at 0° , and 0.033 at 18° ; for $\text{HBO}_2 + \text{H}_2\text{O}_2 \rightleftharpoons (\text{HBO}_2 \cdot \text{H}_2\text{O}_2) \rightleftharpoons \text{H}^+ + (\text{BO}_2 \cdot \text{H}_2\text{O}_2)'$, he found $[\text{HBO}_2][\text{H}_2\text{O}_2]K = [\text{H}^+][(\text{BO}_2 \cdot \text{H}_2\text{O}_2)']$, $K=2 \times 10^{-8}$ at 18° ; and for $\text{HBO}_2 \rightleftharpoons \text{H}^+ + \text{BO}_2'$, $[\text{HBO}_2]K = [\text{H}^+][\text{BO}_2']$, $K=5.7 \times 10^{-10}$. In conc. soln. of metaborates and borax to which hydrogen dioxide has been added, there is a great reduction of alkalinity and affinity due to the

formation of complex acids, a fact which explains the evolution of carbon dioxide from mixtures of borax and hydrocarbonate on the addition of hydrogen dioxide.

The hydrolysis of the perborate in aq. soln. is in agreement with the constitution HO.O.B : O , and the reaction : $\text{O : BO.OH} + 2\text{H}_2\text{O} = \text{B(OH)}_3 + \text{HO.OH}$. E. Bosshard and H. K. Zwicky do not agree with this. They found that when a soln. of an alkali perborate is gently distilled under press. at $50^\circ\text{--}60^\circ$, or in a stream of dry air free from carbon dioxide, no hydrogen peroxide is found in the distillate ; water is lost, and the percentage of active oxygen in the residue increases. They infer that in perborates the active oxygen cannot be represented as hydrogen peroxide of crystallization, and that sodium perborate has the constitution

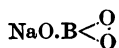

This view is supported by the fact that a stable potassium hyperborate, $\text{KBO}_4 \cdot \text{H}_2\text{O}$, is known which evolves only traces of oxygen when dissolved in water. When dried over phosphorus pentoxide in vacuo, $4\text{KBO}_4 \cdot \text{H}_2\text{O}$ is produced so that the hyperborate cannot be formulated $\text{KBO}_3 \cdot \text{H}_2\text{O}_2$, but is rather a derivative of potassium hyperoxide and perboric acid, and it may be represented

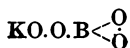

This compound is stable, but if its constitution were KO.O.OBO , analogies indicate that it would be unstable.

According to P. G. Melikoff and L. Pissarjewsky, the aq. soln. of sodium perborate begins to decompose at 40° giving off oxygen. U. Sborgi and G. Nocentini found that the decomposition of sodium perborate in aq. soln. at different temp. does not obey any simple law, although it corresponds approximately with a unimolecular reaction, the values of the equilibrium constant lying on a regular curve which passes through a maximum. The velocity of the reaction is influenced in one direction or the other by the decomposition products of the perborate and by a number of other substances. E. Bosshard and H. K. Zwicky found the velocity of decomposition of aq. soln. under the catalytic influence of colloidal platinum is smaller than that of a soln. of hydrogen peroxide under similar conditions ; and with dil. sulphuric acid it forms hydrogen peroxide ; G. F. Jaubert found that if the powdered salt be added to 50 per cent. sulphuric acid, boric acid is precipitated and a soln. of hydrogen peroxide is formed. According to O. T. Christensen, with conc. sulphuric acid, ozonized oxygen is evolved ; the soln. possesses oxidizing properties, it liberates chlorine from hydrochloric acid ; it oxidizes ammonium sulphide with the evolution of much heat. The soln. gives off oxygen when treated with solid or soln. of iodine, or with bromine water ; it gives a precipitate with mercurous nitrate soluble in excess, and when the soln. is warmed mercury is precipitated ; mercuric chloride gives a reddish-yellow or brown precipitate containing free mercury ; mercuric oxide is reduced ; auric chloride furnishes brown gold ; platinum tetrachloride does not react at ordinary temp. ; palladium tetrachloride gives oxygen ; cupric sulphate gives a yellowish-green precipitate which is soon decomposed ; neutral lead acetate gives a yellowish-white precipitate, and basic lead acetate a dark brown precipitate ; lead dioxide gives oxygen ; manganous salts form manganese dioxide with the evolution of oxygen ; cobalt nitrate gives a precipitate which soon decomposes with the evolution of oxygen ; chromic acid and ether, or chromates with an acid, give the perchromate reaction ; it converts ferrous to ferric salts ; morphine hydrochloride gives a colourless acicular precipitate which soon dissolves with the evolution of oxygen ; and quinine sulphate and strychnine nitrate also give white precipitates. Thus, as J. Bruhat and H. Dubois have shown, the aq. soln. has properties characteristic of soln. of hydrogen peroxide. According to A. Monnier, a dil. soln. of titanous chloride gives a reddish tinge with perborates ; and no coloration or precipitation with a 0.5 per cent. alcoholic soln. of benzidine. Perborates with a

soln. of chrome alum give a greenish-yellow precipitate, which when shaken with a little ether and dil. sulphuric acid, furnishes a blue ether extract. This distinguishes perborates from percarbonates and hydrogen dioxide. Both perborates and percarbonates impart a blue coloration to a soln. of potassium dichromate acidified with sulphuric acid.

The active oxygen in perborates is determined by titrating the acid soln. with potassium permanganate soln. E. K. Farrar, E. Rupp and J. Mielck, A. Skrabal and J. P. Vacek, and W. Lenz and E. Richter have discussed this problem. J. M. Mathews emphasized that the bleaching is due to the hydrogen peroxide which is formed when the salt is dissolved in water; and while sodium perborate furnishes about 10.4 per cent. of active oxygen, sodium peroxide gives twice as much. The cost of bleaching with the former is expensive, out of all proportion when compared with the latter. The advantage with sodium perborate is that the bleaching soln. can be used with hot soln. Indeed, hot water is required for the complete decomposition. The particular advantage of the perborates over hydrogen peroxide is due to the fact that they can be employed in various scouring mixtures to be used by the laundry in hot soln. For example, the perborates of sodium and magnesium are used industrially for bleaching purposes. Not only is sodium perborate used as a bleaching agent in the textile industries; and as a detergent in place of sodium peroxide, but it also enters into the composition of deodorants, germicides, decolorizing agents, antiseptics, dentifrices, and various pharmaceutical preparations. Well-crystallized sodium perborate preserves its strength and is now manufactured on a commercial scale, and it may replace hydrogen and sodium peroxides in the various industries. It has the advantage over hydrogen peroxide of being highly stable, and being a solid it is more easily and economically transported. Sodium perborate can be incorporated with soaps and washing powders to furnish a combined washing and bleaching agent; such preparations are *persil*—a mixture of soap, soda ash, sodium silicate, and perborate; *clarax*—a mixture of borax, sodium phosphate, and perborate; *ozonite*—a mixture like persil with different proportions of the same constituents; and *perborin* products. *Perborin-M* is a mixture of soap, perborate, and alkali. Perborin is a trade-name for sodium perborate.

O. T. Christensen prepared potassium perborate by a process similar to that employed for the sodium salts, but the constitution was not very clear; it may be $2\text{KBO}_3 \cdot \text{KBO}_4 \cdot 5\text{H}_2\text{O}$, or $3\text{KBO}_3 \cdot \text{H}_2\text{O}_2 \cdot 4\text{H}_2\text{O}$. C. F. von Girsewald and A. Wolokitin obtained **hemihydrated potassium perborate**, $2\text{KBO}_3 \cdot \text{H}_2\text{O}$, by adding 100 c.c. of a cold 95 per cent. soln. of potassium metaborate to 1020 c.c. of a cold 3 per cent. soln. of hydrogen peroxide. The filtered liquid was treated with 900 c.c. of methyl alcohol. The microcrystalline powder was washed with ice-cold water. The salt is stable when dry, but an aq. soln. at 50° loses its active oxygen in an hour, and more slowly at lower temp. 100 parts of water dissolve 1.25 parts of the salt at 0° , and 2.5 parts at 15° . The white powder is stable at ordinary temp., and it has a composition and properties corresponding with **potassium perborate hemiperhydrate**, $2\text{KBO}_3 \cdot \text{H}_2\text{O}_2$. When rapidly heated, it deflagrates at 150° – 160° , but if heated slowly, the active oxygen is quantitatively evolved. O. T. Christensen prepared **rubidium perborate**, $\text{RbBO}_3 \cdot \text{H}_2\text{O}$, by warming 20 grms. of rubidium hydroxide with 40 c.c. of water and 12 grms. of boric acid, and treating the cold soln. with 110 c.c. of 6 per cent. hydrogen peroxide, and then with an equal vol. of 96 per cent. alcohol. The oily precipitate was then allowed to crystallize. The properties of the salt resembled those of sodium perborate. He also made **caesium perborate**, $\text{CsBO}_3 \cdot \text{H}_2\text{O}$, in a similar manner. P. G. Melikoff and L. Pissarjewsky prepared **hemihydrated ammonium perborate**, $2(\text{NH}_4)_2\text{BO}_3 \cdot \text{H}_2\text{O}$, by dissolving boric acid in 2.5 per cent. hydrogen peroxide, adding aq. ammonia, and then alcohol, when colourless isotropic crystals of the trihydrate are deposited. When kept 24 hrs. over conc. sulphuric acid, the hemihydrate is formed; and, according to E. J. Constam and J. C. Bennett, the salt is completely dehydrated over phosphorus pentoxide. S. M. Tanatar has described a monohydrate.

P. G. Melikoff and L. Pissarjewsky prepared **cupric perborate**, $\text{Cu}(\text{BO}_3)_2$, by adding a sat. soln. of sodium perborate at 0° to a cupric salt. The salt is readily decomposed by water. If silver nitrate be treated with sodium perborate a white curdy precipitate of an impure **silver perborate** is formed. A. Étard prepared **barium perborate** by the action of a soln. of barium peroxide on boric acid. The white amorphous precipitate was stated to be insoluble in water, and to lose a mol of water at 100° , and not to be decomposed by water. The product is hygroscopic, but not deliquescent; it gives off oxygen with acids, and with conc. hydrochloric acid at 40° , chlorine is evolved. J. Bruhat and H. Dubois noted that soluble perborates give a white precipitate when added to a barium salt soln. According to P. G. Melikoff and L. Pissarjewsky the white flocculent precipitate has the composition $\text{Ba}(\text{BO}_3)_2 \cdot 7\text{H}_2\text{O}$. The corresponding **strontium perborate** and **calcium perborate** were prepared in a similar manner. The calcium salt is said to be sparingly soluble in water and to be decomposed by water more quickly than the barium salt. H. Byk obtained a 90 per cent. yield of calcium perborate by treating a soln. of 11 parts of crystallized calcium chloride in 10 parts of water with 15.4 parts of sodium perborate at 50° - 60° .

A. Étard, and J. Bruhat and H. Dubois prepared **magnesium perborate**, but the composition was not constant presumably because of hydrolysis. The Deutsche Gold- and Silberscheide Anstalt prepared a white amorphous magnesium perborate by the action of sodium peroxide and boric acid on a magnesium salt. When dry the salt is stable, but with water there is formed an aq. soln. of an acid perborate, and a precipitate of a basic perborate. The corresponding **zinc perborate** was similarly prepared. H. Buchtala prepared **thallous perborate**, $\text{Tl}_2\text{B}_2\text{O}_7$, as a white powder by adding 30 per cent. of hydrogen peroxide to an aq. soln. of one of the thallous borates. The aq. soln. decomposes on evaporation, forming thallous metaborate. The salt exhibits the usual reactions of a per-salt, and explodes when heated rapidly. The graphic formula is written :

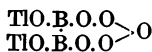

Unstable **nickel perborate**, and **cobalt perborate** were obtained by P. G. Melikoff and L. Pissarjewsky. By the action of a soln. of a perborate on uranium dioxide, J. Bruhat and H. Dubois prepared a yellow, stable, **uranyl perborate**, $(\text{UO})\text{BO}_3$.

G. F. Jaubert claimed to have made **sodium pertetaborate**, $\text{Na}_2\text{B}_4\text{O}_8 \cdot 10\text{H}_2\text{O}$, or *perborax* by crystallization from a soln. of 248 grms. of boric acid, and 78 grms. of sodium peroxide in 2 litres of cold water. The salt decomposed into hydrogen peroxide when dissolved in water, and the soln. has an alkaline reaction. The first crop of crystals is richer in active oxygen than those separating later, and the last fraction contains no active oxygen at all; and ordinary sodium perborate crystallizes out if the aq. soln. is mixed with hydrochloric acid eq. to half the sodium in the perborate. 100 grms. of water at 11° , 22° , and 32° dissolve respectively 4.2, 7.1, and 13.8 grms. of salt. J. Bruhat and H. Dubois prepared what they regarded as **potassium perdifborate**, $\text{KB}_2\text{O}_5 \cdot 2\text{H}_2\text{O}$, by adding alcohol to a soln. of potassium diborate in hydrogen peroxide. The crystals lose a mol of water in vacuo over phosphorus pentoxide.

P. G. Melikoff and L. Pissarjewsky obtained indications of the formation of **sodium hyperborate**, $\text{NaO} \cdot \text{BO}_3$, or NaBO_4 , but the salt was not isolated. E. Bosshard and H. K. Zwicky prepared **potassium hyperborate**, $\text{KBO}_4 \cdot \text{H}_2\text{O}$, which evolves only traces of oxygen when dissolved in water—*vide supra*. G. I. Petrenko prepared an **ammonium hyperborate**, $\text{NH}_4\text{BO}_3 \cdot \text{NH}_4\text{BO}_4 \cdot 2\text{H}_2\text{O}$, by the action of hydrogen peroxide on ammonium perborate, and precipitation with alcohol at a low temp. A monohydrate was also prepared.

REFERENCES.

- ¹ A. Étard, *Compt. Rend.*, **91**. 931, 1880; G. F. Jaubert, *ib.*, **139**. 796, 1904; J. Bruhat and H. Dubois, *ib.*, **140**. 506, 1905; P. G. Melikoff and L. Pissarjewsky, *Ber.*, **30**. 3144, 1897; **31**. 678, 953, 1898; **32**. 341, 1899; E. H. Riesenfeld and B. Reinhold, *ib.*, **42**. 2977, 1909; C. F. von Girssewald and A. Wolotkin, *ib.*, **42**. 865, 1909; P. G. Melikoff and S. Lordkipanidzé, *ib.*, **32**. 3349, 3510, 1899; *Journ. Russ. Phys. Chem. Soc.*, **32**. 77, 1900; G. I. Petrenko, *ib.*, **34**. 37, 1902; G. F. Jaubert and G. Lion, *Rev. Gén. Chem. Pure App.*, (7), **8**. 163, 1905; O. T. Christensen, *Danke Vid. Selsk. Forh.*, 397, 1904; L. Pissarjewsky, *Zeit. anorg. Chem.*, **32**. 341, 1902; *Zeit. phys. Chem.*, **48**. 170, 1903; H. Menzel, *ib.*, **199**. 276, 1922; **105**. 402, 1923; H. T. Calvert, *ib.*, **38**. 513, 1901; S. M. Tanatar, *ib.*, **28**. 132, 1898; **29**. 162, 1899; *Zeit. anorg. Chem.*, **28**. 343, 1901; E. J. Constan and J. C. Bennett, *ib.*, **25**. 265, 1900; **26**. 451, 1901 E. K. Farrar, *Journ. Soc. Dyers*, **26**. 81, 1910; E. Rupp and J. Mielck, *Arch. Pharm.*, **245**. 5, 1907; W. Lenz and E. Richter, *Zeit. anal. Chem.*, **50**. 537, 1911; F. H. Fuhrmann, *Chem. Ztg.*, **35**. 1022, 1911; J. M. Mathews, *Journ. Ind. Eng. Chem.*, **3**. 191, 1911; O. Liebknecht, *U.S. Pat. No.* 1281983, 1918; C. F. von Girssewald, *German Pat.*, *D.R.P.P.* 204279, 1911; 227907, 229675, 1911; Deutsche Gold- und Silberscheideanstalt, *ib.*, 165278, 165279, 1904; 193722, 218569, 1911; 350986, 1919; Konsortium für elektrochemische Industrie, *ib.*, 237608, 1911; H. Byk, *ib.*, 236881, 238104, 238338, 243368, 248683, 249325, 250331, 1911; F. Bergius, *ib.*, 243948, 232001, 243368, 1911; M. Stolle and M. Kopke, *ib.*, 199753, 1907; A. Brauer, *ib.*, 218760, 1910; 237096, 1911; A. Holste, *ib.*, 231960, 1911; I. Wertheim, *ib.*, 215001, 1911; Saccharin Fabrik, *ib.*, 257808, 1911; H. Giessler and H. Bauer, *ib.*, 149335, 1904; Hinkel et Cie., *ib.*, 283894, 1915; G. F. Jaubert, *ib.*, 193559, 207580, 1911; F. Bräunlich, *ib.*, 248893, 1911; M. Elb, *ib.*, 216311, 1911; 223449, 235462, 237814, 244783, 1911; L. Elkan, *ib.*, 224850, 1911; 226250, 230175, 235619, 245702, 1911; L. Sarason, *ib.*, 185331, 1910; 219378, 226090, 1911; *Brit. Pat. No.* 10066, 1910; A. Monnier, *Ann. Chim. Anal.*, **21**. 237, 1916; Chemische Werke-Kirchoff und Neirath, *French Pat. No.* 390154, 1910; E. A. Pouzenc, *ib.*, 411258, 1910; E. Bosshard and H. K. Zwicky, *Zeit. angew. Chem.*, **23**. 1153, 1910; **25**. 942, 1912; F. Förster, *ib.*, **34**. 354, 1921; H. K. Zwicky, *Ueber Perborate und ihre technische Verwendung*, Zürich, 1911; L. Blumer, *German Pat.*, *D.R.P.* 49641, 1908; C. F. von Girssewald, *Anorganische Peroxyde und Persalze*, Braunschweig, **54**, 1914; T. S. Price, *Percarids and their Salts*, London, 59, 1912; Fredrikstad elektrokemiske Fabriken, *Chem. Age*, **4**. 695, 1921; *U.S. Pat. No.* 1375596, 1921; T. Valeur, *Tids. Kemi Farm. Christiania*, **17**, 18, 1916; U. Sborgi and G. Nocentini, *Gazz. Chim. Ital.*, **51**. i, 289, 1921; K. Arndt, *Zeit. Elektrochem.*, **22**. 63, 1916; M. le Blanc and R. Zellmann, *ib.*, **29**. 179, 192, 1923; K. Arndt and E. Hantge, *ib.*, **28**. 263, 1922; *Chem. Trade Journ.*, **72**. 70, 1923; **73**. 65, 1923; A. Skrabal and J. P. Vacek, *Oester. Chem. Ztg.*, **13**. 27, 1910; A. Stephan, *Apoth. Ztg.*, **27**. 726, 1912; H. Buchta, *Journ. prakt. Chem.*, (2), **88**. 771, 1913; A. Klages and F. Sommer, *U.S. Pat. No.* 996773, 1911; P. C. Alsgaard, *Journ. Phys. Chem.*, **26**. 137, 1922; *Trans. Amer. Electrochem. Soc.*, **40**. 139, 1921.

§ 18. Boron Fluoride

J. L. Gay Lussac and L. J. Thénard¹ heated a mixture of vitreous boric oxide with twice its weight of fluorspar free from silica to whiteness in an inclined iron tube, and obtained *le gas fluoborique*, boron trifluoride, BF₃. J. Davy obtained the same gas by heating in a glass flask a mixture of 12 parts of sulphuric acid, one of vitreous boric oxide, and two of fluorspar; G. Ferrari, and S. G. Rawson used a similar process for these three constituents. According to J. J. Berzelius, the gas obtained by this method contains a large quantity of silicon fluoride, derived from the silica in the fluorspar and in the glass. The gas can be freed but imperfectly from the silicon fluorides by scrubbing with vitreous boric oxide. H. Schiff, and F. Stolba made the gas by heating a mixture of potassium fluoborate, KBF₄, with 15–20 per cent. of fused and pulverized boron trioxide and conc. sulphuric acid. O. Ruff recommended heating a mixture of equal parts of boron trioxide and cryolite free from silica, with conc. sulphuric acid.

H. Moissan found that boron trifluoride is formed when fluorine is treated with an excess of boron; by the action of phosphorus trifluoride on boron; by the action of silver fluoride on cold boron iodide; and when fluorine acts on boron chloride; A. Étard, by the action of hydrofluoric acid on barium perborate; L. Ouvrard, by heating potassium hydrofluoride, KHF₂, and boric oxide with metallic oxides; and L. Möser and W. Eidmann, by heating boron nitride with sodium fluoride and sulphuric acid; ammonium sulphate and boron fluoride are formed. H. Giebelhausen

found that amorphous boron reacts with fused cadmium fluoride, forming cadmium and boron trifluoride. E. Berger made boron trifluoride from a mixture of lead fluoride, calcium boride, and alkali nitrate.

Boron trifluoride is a colourless gas, with a pungent, suffocating odour. It is stable and non-combustible and a non-supporter of combustion. In moist air it gives dense white fumes. Its **vapour density**, determined by J. Davy, T. Thomson, and J. B. A. Dumas—2·3124–2·3709—corresponds with the formula BF_3 . M. Faraday found that the gas is not liquefied when cooled by the ordinary carbon dioxide bath, but that it forms a limpid, colourless, clear liquid, as mobile as hot ether, when cooled by carbon dioxide under an air pump. He found the approximate **vapour pressures** of the liquid are :

Vap. press.	−52°2'	−54°4'	−57°8'	−63°3'	−73°3'
	11·54	10·00	9·23	7·50	4·61 atm.

According to H. Moissan, boron trifluoride solidifies to a white mass at -160° , and when the gas is purified from hydrogen fluoride by scrubbing with sodium fluoride, its **boiling point** is -101° , and its **melting point** -127° . R. W. Millar calculated the **specific heat**, C_p , to be 11·70 at 273°K. , and 10·00 at 189°K. H. Hammerl and M. Berthelot gave 234·8 Cals. for the **heat of formation** of fused BF_3 from amorphous boron.

M. Berthelot found that the gas is not changed by the silent electric discharge, and H. Moissan found that the vol. of the gas remains constant after the passage of electric sparks, and that the walls of the glass containing vessel are not attacked. J. M. Seguin found that the sparking boron trifluoride furnishes a spectrum showing a blue line due to fluorine; he also found that a mixture of **hydrogen** and boron trifluoride is decomposed by electric sparks. J. Davy found that **water** at ordinary temp. absorbs about 700 times its vol. of boron trifluoride to form a syrupy liquid. According to J. I. Gay Lussac and L. J. Thénard, water absorbs about the same vol. of boron trifluoride as of hydrogen chloride; the absorption is rapid, and is attended by the evolution of heat. According to H. Hammerl, the soln. of a mol of the gas in water develops 24·51 Cals. A. Basaroff said that water at 0° and 762 mm. press. absorbs 1057 times its vol. of the gas. J. Davy found that **sulphuric acid** absorbs about 50 vols. of the gas. Boron trifluoride should be collected over mercury. According to J. Davy, equal vols. of **ammonia** and boron trifluoride unite to form a white solid which in a closed vessel can be sublimed unchanged. It is probably **boron monammino-trifluoride**, $\text{B}(\text{NH}_3)\text{F}_3$. W. G. Mixter made it by passing boron trifluoride into dried ammonia, and he gave 23 for the vapour density at $19\cdot4^\circ$, 754·8 mm. press. and 23·1, at $24\cdot6^\circ$ and 765·9 mm. press.—theoretical value for a mixture of equal vols. of the component gases is 21·3. He also noticed that the vapour attacks glass. J. Davy found that it is decomposed by a trace of moisture into ammonium oxyfluoborate, and boric acid, and when dissolved in water J. J. Berzelius and J. Davy noted the formation of oxyfluoborate. J. Davy also found that one vol. of boron trifluoride unites with two and with three vols. of ammonia, producing in the former case **boron diammino-trifluoride**, $\text{B}(\text{NH}_3)_2\text{F}_3$, and in the latter case **boron triammino-trifluoride**, $\text{B}(\text{NH}_3)_3\text{F}_3$. In conformity with the so-called amines of the other boron halides, these products may prove to be mixtures of ammonium fluoride and boronamide. According to A. Besson, boron trifluoride does not unite with **phosphine** at ordinary temp., but combination begins at -30° and at -50° a white solid is obtained, which becomes yellow as the temp. rises, with evolution of 2 vols. of boron fluoride and 1 vol. of hydrogen phosphide, the latter being mixed with some free hydrogen, whilst some solid hydrogen phosphide is formed. The white solid is a **boron hemiphosphinofluoride**, $\text{PH}_3\cdot 2\text{BF}_3$, and is decomposed by water with the evolution of hydrogen and hydrogen phosphide. A. F. O. Germann and M. Cleaveland studied the f.p. of binary mixtures of boron trifluoride with methyl ether, and methyl chloride. They found a compound $\text{BF}_3\cdot(\text{CH}_3)_2\text{O}$ is formed.

According to J. L. Gay Lussac and L. J. Thénard, when **potassium** or **sodium** is heated with boron trifluoride, the metal is covered with a black crust, and burns with a reddish flame; water extracts potassium fluoride or fluoborate from the cold residue, and boron remains, $3K + 4BF_3 = 3KBF_4 + B$, or $3K + 2BF_3 = KBF_4 + 2KF + B$. S. G. Rawson also studied the reaction with potassium. L. J. Thénard found that **iron** is without action on boron trifluoride at a red heat. J. Davy found **calcium oxide** rapidly absorbs boron trifluoride especially if warmed, forming a fusible mass which gives off the original gas when treated with sulphuric acid: $4CaO + 8BF_3 = Ca(BO_2)_2 + 3Ca(BF_4)_2$. A. Baudrimont found that when passed over **red lead** a yellowish-brown gas is produced which smells of chlorine and burnt sugar; decolorizes indigo; does not attack glass; but unites with gold.

REFERENCES.

- ¹ J. L. Gay Lussac and L. J. Thénard, *Recherches physico-chimiques*, Paris, 2, 38, 1811; *Ann. Chim. Phys.*, (1), 69, 204, 1808; H. Moissan, *ib.*, (6), 24, 244, 1891; (8), 8, 84, 1906; *Le fluor et ses composés*, Paris, 18, 1900; *Compt. Rend.*, 99, 655, 1884; 112, 17, 1891; 139, 711, 1904; A. Besson, *ib.*, 110, 80, 1890; E. Berger, *ib.*, 170, 1492, 1920; M. Berthelot, *ib.*, 82, 1360, 1876; *Thermochimie*, Paris, 2, 149, 1897; *Bull. Soc. Chim.*, (2), 26, 101, 1876; V. Gasselin, *ib.*, (3), 7, 209, 1892; (3), 9, 401, 483, 1893; A. Basaroff, *ib.*, (2), 22, 8, 1874; *Compt. Rend.*, 78, 1698, 1874; 79, 483, 1874; A. Étard, *ib.*, 91, 931, 1880; L. Ouvrard, *ib.*, 130, 172, 1900; J. M. Seguin, *ib.*, 54, 933, 1862; H. Hammerl, *ib.*, 90, 312, 1880; F. Landolph, *ib.*, 85, 39, 1877; 86, 539, 601, 671, 1463, 1879; 89, 173, 1879; *Ber.*, 10, 1312, 1877; 12, 1583, 1879; L. Möser and W. Eidmann, *ib.*, 35, 538, 1902; C. Counciler, *ib.*, 12, 1967, 1879; S. Rideal, *ib.*, 22, 993, 1889; J. Davy, *Phil. Trans.*, 102, 365, 1812; M. Faraday, *ib.*, 135, 155, 1845; J. J. Berzelius, *Pogg. Ann.*, 1, 1, 169, 1824; 2, 113, 1824; 4, 1, 117, 1824; *Ann. Phil.*, (2), 8, 330, 350, 1824; (2), 9, 124, 1825; (2), 10, 116, 1825; *Acad. Handl. Stockholm*, 284, 1823; 46, 278, 1824; J. von Liebig and F. Wöhler, *ib.*, 24, 171, 1832; H. Schiff, *Liebig's Ann. Suppl.*, 5, 172, 1867; R. W. Millar, *Journ. Amer. Chem. Soc.*, 45, 874, 1923; H. Giebelhausen, *Zeit. anorg. Chem.*, 91, 251, 1915; F. Kuhlmann, *Liebig's Ann.*, 39, 319, 1841; G. Ferrari, *Journ. Pharm.*, 19, 48, 1833; S. G. Rawson, *Chem. News*, 58, 283, 1888; F. Stolba, *Chem. Centr.*, (3), 3, 395, 1872; W. G. Mixer, *Amer. Chem. Journ.*, 2, 153, 1881; O. Ruff, *Die Chemie des Fluors*, Berlin, 25, 1920; T. Thomson, *Ann. Phil.*, 1, 177, 1813; A. Baudrimont, *Compt. Rend.*, 2, 421, 1836; A. F. O. Germann and M. Cleaveland, *Science*, (2), 53, 582, 1922; J. B. A. Dumas, *Traité de chimie appliquée aux arts*, Paris, 1, 332, 1828.

§ 19. Hydrofluoboric and Boratofluoric Acids

According to J. L. Lussac and L. J. Thénard,¹ when boron trifluoride is passed into a sufficiently large proportion of cold water, the absorption is rapid, and a colourless fuming syrupy liquid is produced. The boron fluoride is best passed through a tube dipping under mercury which is covered with water, for if the end of the tube dips directly into water, the rapid absorption of the gas would cause the liquid to regurgitate into the generating apparatus. J. Davy showed that water at ordinary temp. absorbs 700 vols. of this gas. The soln. then has a sp. gr. 1.770; it gives off unchanged about one-fifth of the absorbed boron fluoride; and, after that, the b. p. rises much above 100°. The boric acid simultaneously formed in the reaction: $4BF_3 + 3H_2O = 3HBF_4 + B(OH)_3$, is said to separate as metaboric acid. When the reaction occurs in the presence of an excess of water, H. Hammerl gives 98.04 Cals. for the thermal value. J. J. Berzelius obtained a similar liquid by dissolving boric acid in cold conc. hydrofluoric acid, concentrating the soln. over a water-bath, boiling until it evolves white fumes, and allowing the product to remain over conc. sulphuric acid. The liquid thus obtained has a sp. gr. 1.586. F. C. Mathers and co-workers made an alcoholic soln. of fluoboric acid by adding about 35 grms. of boric acid, free from sodium, to 100 grms. of 48 per cent. hydrofluoric acid—the boric acid was added until a test portion gave no precipitate with lead nitrate. The cold soln. is mixed with an equal volume of alcohol. The liquid can be preserved in wax, rubber, lead, or paraffin bottles, and used as precipitant for sodium in the presence of potassium and magnesium.

According to J. J. Berzelius, the composition of the liquid obtained by the action of hydrofluoric acid on boric acid is in agreement with $H_2B_2O_4 \cdot 6HF$, and it is decomposed by an excess of water with the precipitation of boric acid and the formation of an aq. soln. of hydroborofluoric acid, $FH \cdot BF_3$. J. J. Berzelius regarded the acid liquor as a definite compound which may be called **boratofluoric acid**; he stated that the aq. soln. of the acid distils unchanged; and that when neutralized with an alkali, it forms a series of **boratofluorides**, $M_2B_2O_4 \cdot 6MF \cdot H_2O$. These statements and assumptions are probably wrong. The evidence for the individuality of boratofluoric acid is not satisfactory; for when distilled, the different fractions differ in sp. gr. and in composition; the re-crystallization of the salts gives first the alkali fluoride and then a mixture of alkali fluoride and alkali metaborate; and the acid liquid with the silver nitrate gives a mixed precipitate of silver metaborate and oxide. A. Basaroff accordingly stated that the liquid is a mixture of metaboric, hydrofluoboric, and hydrofluoric acids.

R. Abegg, C. J. J. Fox, and W. Herz studied the reactions between boric acid and hydrofluoric acid, and between boric acid and potassium fluoride, but came to no definite conclusions. They measured the partition coeff. of boric acid between water and amyl alcohol, and between a soln. of potassium fluoride and amyl alcohol; the f.p. of soln. of boric acid and hydrofluoric acid and potassium fluoride; the electrical conductivity of mixtures of soln. of boric and hydrofluoric acids; and they made some titration experiments on the mixed acids. The conductivity of conc. hydrofluoric acid increased by the addition of boric acid, but with dil. soln. the conductivity is diminished. This means that boric acid combines with several mols of hydrofluoric acid, to form a complex acid which is highly ionized in conc. soln. The measurements are not independent of time, showing that the instantaneous reaction between the two acids, or between soln. of boric acid and potassium fluoride, is followed by another slower change.

J. Thomsen measured the heat, Q Cals., evolved on mixing boric acid, B_2O_3 aq., with n mols of hydrofluoric acid, and found for $(B_2O_3 \text{ aq.} \cdot nHF \text{ aq.}) = Q$ Cals.

nHF	:	:	:	2	4	6	8	12
Q	:	:	:	9.132	18.600	27.468	29.479	29.136

which shows that some kind of exothermal reaction occurs between the hydro-

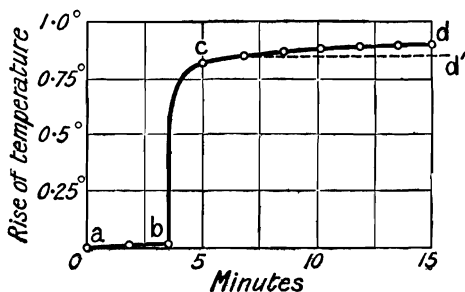

FIG. 31.—Thermal Changes on mixing Boric Oxide or Boric Acid with Hydrofluoric Acid.

fluoboric acid and the excess of hydrofluoric acid. O. Mulert represented the thermal changes which occur on mixing boric oxide or boric acid with hydrofluoric acid by Fig. 31. There is a preliminary period ab where very little change occurs; the temp. then suddenly rises, bc , and instead of remaining constant, cd' , the temp. continues to rise cd . The **heat of solution** of a mol of glassy boric acid in 3.65 per cent. hydrofluoric acid is given as 29.64 Cals.

In addition to J. J. Berzelius' acid, $H_2B_2O_4 \cdot 6HF$, another acid, $HBO_3 \cdot 3HF$, or $H_4BF_3O_3$, is said to be formed by the action of boron trifluoride on alcohol. Its sp. gr. was stated to be 1.1574, and its b.p. 92° at 3 cms. press. V. Gasselín said that the alleged acid is a mixture of the products of the hydrolysis of boron trifluoride, $2BF_3 + 3H_2O = 2HF + HBF_4 + H_3BO_3$. F. H. Landolph also reported $H_4B_2O_7 \cdot 3HF$ to be formed as a clear yellow liquid, b.p. 160° , when boron trifluoride acts on amylene. The acid is said to fume in air, and to be decomposed by water. These results have not been confirmed.

J. J. Berzelius prepared crystals of what he regarded as **sodium boratofluoride**, $(NaO)_2 \cdot BF \cdot 2NaF \cdot 4H_2O$, or F.B. $(ONa)_2 \cdot 2NaF \cdot 4H_2O$, by evaporating a soln. of a mol of sodium metaborate and 3 mols of sodium fluoride in boiling water. A. Basaroff stated that the product is really a mixture not a chemical individual—*vide supra*. J. J. Berzelius also reported two other sodium boratofluorides, one, $Na_2O \cdot 2B_2O_3 \cdot 12NaF \cdot 22H_2O$, obtained from

a mol of borax and 6 mols of sodium fluoride; and the other, $(\text{NaO})(\text{HO})\text{BF}\cdot 2\text{NaF}$, obtained from a cooling soln. of a mol of boric acid and 3 mols of sodium fluoride in boiling water. J. J. Berzelius also made **potassium boratofluoride** in a similar manner to that which he employed in making the sodium salts. A. Basaroff believed these products to be only mixtures. H. Schiff prepared two potassium boratofluorides whose composition can be represented by $\text{B}_4(\text{OK})_2\text{OF}_2$, and $\text{B}(\text{OK})_2\text{F}$; or



The former was made by fusing 7 parts of boron trioxide with 12 parts of potassium chloride, and extracting the matter soluble in alcohol from the cold cake; the latter was made by fusing the former in the calculated quantity of potassium carbonate. Both compounds dissolve in a small portion of water without decomposition, but with more water they are decomposed. J. J. Berzelius made **ammonium boratofluoride**, $2\text{NH}_4\text{F}\cdot\text{B}_2\text{O}_3\cdot 6\text{HF}$, i.e. $2\text{NH}_4\text{BF}_4\cdot 3\text{H}_2\text{O}$, by heating a mol of boric oxide with eight mols of ammonium fluoride: $\text{B}_2\text{O}_3 + 8\text{NH}_4\text{F} = 2\text{NH}_4\text{F}\cdot\text{B}_2\text{O}_3\cdot 6\text{HF} + 6\text{NH}_3$. G. I. Petrenko also made an ammonium boratofluoride, $(\text{NH}_4)\text{HB}_2\text{F}_2\text{O}_3$, or $(\text{NH}_4\text{O})\text{FB}\cdot\text{O}\cdot\text{BF}(\text{OH})$, by the action of hydrogen peroxide on a mixture of ammonium metaborate and fluoperborate. F. H. Landolph prepared what he regarded as **ethylene oxyfluoride**, $\text{C}_2\text{H}_4\cdot\text{HFBO}_2$, by the action of boric fluoride on ethylene in sunlight at $25^\circ\text{--}30^\circ$. The clear mobile fuming liquid has a sp. gr. 1.0478 at 23° ; b.p. $124^\circ\text{--}125^\circ$; burns with a green flame; and is decomposed by water, forming boric acid and a volatile boron compound, b.p. $10^\circ\text{--}15^\circ$, supposed to be an ethyl fluoride.

The liquid prepared by dissolving boron trifluoride in water until the soln. has an acid reaction is said to contain **hydrofluoboric acid**, HBF_4 , which furnishes a series of well-defined salts, the **fluoborates**, also called *borofluorides*. M. Berthelot estimated the heat of formation of hydrofluoboric acid, HBF_4 , to be $(\text{B}, 4\text{F}, \text{H})\text{aq.} = 307.6$ Cals. The ions of hydrofluoboric acid are H^+ and BF_4^- ; a little of the latter possibly dissociates $\text{BF}_4^- \rightleftharpoons \text{BF}_3 + \text{F}^-$; and the boron trifluoride is partly hydrolyzed to hydrofluoric and boric acids, $\text{BF}_3 + 3\text{H}_2\text{O} = \text{B}(\text{OH})_3 + 3\text{HF}$. A dil. soln. of hydrofluoboric acid does not attack glass, but a conc. soln. does. The acid is poisonous. I. Homeyer said that a 0.1–0.5 per cent. soln. of the acid or of its salts retards fermentation. F. Stolba also noted the feeble antiseptic qualities of the ammonium salt, *q.v.*

F. H. Landolph claimed to have made a more complex acid **hydrohexafluoboric acid**, H_3BF_6 , or $\text{BF}_3\cdot 3\text{HF}$, as a heavy transparent liquid during the action of boron trifluoride on anethol. The acid is said to be easily isolated, to distil at about 130° , without exhibiting a constant b.p.; and to have a vapour density 4.72—calculated 4.42. It rapidly decomposes when exposed to moist air, forming boric and hydrofluoric acids. This result has not been confirmed.

REFERENCES.

- ¹ J. L. Gay Lussac and L. J. Thénard, *Ann. Chim. Phys.*, (1), **69**, 204, 1809; F. Stolba, *Chem. Centrbl.*, (3), **3**, 395, 1872; J. J. Berzelius, *Pogg. Ann.*, **58**, 503, 1843; **59**, 644, 1843; H. Hammerl, *Compt. Rend.*, **90**, 312, 1880; A. Basaroff, *ib.*, **78**, 1698, 1874; **79**, 483, 1874; *Bull. Soc. Chim.*, (2), **22**, 8, 1874; *Ber.*, **7**, 1121, 1874; F. Landolph, *ib.*, **12**, 1583, 1879; J. Thomsen, *Thermochemische Untersuchungen*, Leipzig, **2**, 421, 1882; O. Mulert, *Zeit. anorg. Chem.*, **75**, 232, 1912; J. C. G. de Marignac, *Zeit. anal. Chem.*, **1**, 410, 1862; I. Homeyer, *Pharm. Ztg.*, **34**, 761, 1889; R. Abegg, C. J. J. Fox, and W. Herz, *Zeit. anorg. Chem.*, **35**, 129, 1903; H. Schiff and R. Sestini, *Liebig's Ann.*, **228**, 83, 1885; H. Schiff, *Liebig's Ann. Suppl.*, **5**, 175, 228, 1867; J. Davy, *New Edin. Phil. Journ.*, **17**, 246, 1812; *Phil. Trans.*, **102**, 365, 1812; V. Gasselin, *Bull. Soc. Chim.*, (3), **7**, 754, 1892; F. C. Mathers, C. O. Stewart, H. V. Housemann, and I. E. Lee, *Journ. Amer. Chem. Soc.*, **37**, 1515, 1915; M. Berthelot, *Thermochimie*, Paris, **2**, 149, 1897; G. Leuchs, *Monit. Scient.*, (3), **16**, 1390, 1886; F. Kuhlmann, *Liebig's Ann.*, **39**, 319, 1841; G. I. Petrenko, *Journ. Russ. Phys. Chem. Soc.*, **34**, 37, 1902.

§ 20. The Fluoborates

It is generally stated that J. J. Berzelius¹ discovered hydrofluoboric acid and the fluoborates in 1824, but, as a matter of fact, J. L. Gay Lussac and L. J. Thénard prepared a series of compounds by the action of a soln. of boron trifluoride in water

on les diverses bases salifiables ; and their term *le gaz fluoborique* for boron trifluoride was probably based on the recognition of this fact. They called the soln. of the gas in water *l'acid fluoborique*, and noted its solvent action on zinc. They added :

Il est probable qu'il existe des fluoborates de barite, de strontiane, de chaux, de potasse, de soude, de magnésie, de glucine, d'alumine, d'yttria, de zirconie et de silice, et des fluo-borates métalliques ; et que tous ces sels sont autant de sels triples. On parviendroit probablement à faire tous ces sels, en fondant ensemble des fluates et des borates de la même base ; et il est aussi très probable qu'en traitant les fluo-borates par de l'acide sulfurique concentré, on obtiendrait facilement de l'acide fluo-borique.

J. J. Berzelius prepared the salts of hydrofluoboric acid, HBF_4 , by the action of boron trifluoride on the metal fluoride ; by dissolving the metal oxide, hydroxide or carbonate in a soln. of hydrofluoboric acid ; by the action of hydrofluoboric acid on metal fluorides ; by the joint action of a metal fluoride and hydrofluoric acid on boric acid ; and by the action of a metal hydrofluoride on boric acid. As pointed out by W. C. Zeise, the last process presents the curious phenomenon of a mixture of two acid liquids producing an alkaline soln. ; $\text{H}_3\text{BO}_3 + 2\text{NaHF}_2 = \text{NaBF}_4 + \text{NaOH} + 2\text{H}_2\text{O}$. Gebrüder Siemens made the alkali fluoborates by mixing boric acid and the alkali chloride into a thin paste with water, and adding hydrofluoric acid. The fluoborates are usually crystalline ; readily soluble in water ; lose boron trifluoride and form fluorides when calcined ; and, when distilled with sulphuric acid, they yield gaseous boron trifluoride, liquid hydrofluoboric and hydrofluoric acids, and a residual metal sulphate. Most of our knowledge of the fluoborates is still in the state left by J. J. Berzelius' memoir : *Untersuchungen über die Flussspathsäure und deren merkwürdigsten Verbindungen*.

J. J. Berzelius made **lithium fluoborate**, possibly $\text{LiF} \cdot \text{BF}_3$ or LiBF_4 : by treating barium fluoborate with lithium sulphate, and crystallizing the clear liquid by slow evaporation at 40° . The prismatic crystals deliquesce in air ; and taste like the sodium salt. The aq. soln. furnishes rhombic crystals. He also found sodium fluoride unites with hydrofluoboric acid, and the soln., when slowly cooled, furnishes "transparent, rectangular, four-sided prisms, often shortened and approaching the cubical form," presumably **sodium fluoborate**, NaBF_4 , since they contain no water of crystallization. F. Stolba also made this salt. S. Motylewsky found the drop-weight of the molten salt to be 119 when that of water is 100 mgrms. at 0° . According to J. J. Berzelius, sodium fluoborate has a bitter acid taste, and it reddens litmus. The salt is slowly decomposed by heat : $\text{NaBF}_4 = \text{NaF} + \text{BF}_3$, and it fuses below a red heat. It is more soluble in water than sodium hydrofluoride, but is only sparingly soluble in alcohol. F. C. Mathers and co-workers use an alcoholic soln. of hydrofluoboric acid for precipitating sodium fluoborate in the presence of potassium and magnesium salts. J. O. Perrine observed no ultra-violet fluorescence with this salt.

J. J. Berzelius made **potassium fluoborate**, KBF_4 , as a gelatinous precipitate by mixing hydrofluoboric acid with a soln. of a potassium salt. When washed and dried, it forms a gritty white powder. He also made the salt by dissolving a mol each of potassium hydrocarbonate and boric acid in an excess of hydrofluoric acid, and evaporating the soln. for crystallization. C. Montemartini used a somewhat similar process but with potassium carbonate. F. Stolba heated boric acid with potassium silicofluoride, and added potassium carbonate to the mixture ; he also warmed a mixture of 156 grms. of powdered fluorspar, 62 grms. of boric acid, 420 c.c. of hydrofluoric acid, for 2-3 hrs. in a flask with a reflux condenser, then diluted the mixture with half its vol. of water, and mixed the filtrate with a warm sat. soln. of potassium chloride or nitrate. The crystalline precipitate was washed with water, pressed, and recrystallized from a hot soln. of ammonia.

According to J. J. Berzelius, the salt has a feeble somewhat bitter taste, and is not at all acid to litmus. It crystallizes from its aq. soln. in "small shining, anhydrous, six-sided prisms with dihedral summits." According to C. Montemartini, the salt is dimorphous for the gritty powder indicated above, contains minute octahedra and

dodecahedra belonging to the cubic system, and the crystals obtained by evaporating an aq. soln. of the salt belong to the rhombic system, and have axial ratios $a : b : c = 2.7898 : 1 : 1.2830$. According to F. Zambonini, and T. V. Barker, potassium fluoborate and perchlorate are isomorphous. The former found a slight miscibility of up to 0.4 per cent. of potassium permanganate with the fluoborate. F. Stolba gave 2.498–2.524 for the sp. gr. at 20°. S. Motylewsky found the drop-weight of the molten salt is 103 when that of water at 0° is 100 mgrms. According to J. J. Berzelius, the undried crystals decrepitate when heated and give off some water and hydrofluoboric acid; according to F. Stolba, the wet crystals colour Bunsen's flame green, green and violet, and finally violet. J. J. Berzelius found that the dry salt is decomposed by heat into boron trifluoride, potassium fluoride, etc., as indicated above; a high temp. is required for decomposition. When heated rapidly, the salt fuses just below a red-heat—say, 500°. J. J. Berzelius found 100 parts of cold water dissolve 1.42 parts of the salt, while F. Stolba said 100 parts of water at 20° dissolve 0.448 part of the salt, and at 100°, 6.27 parts. The aq. soln. is at first neutral to litmus, but on standing, or on dilution, or heating, it becomes acid without attacking glass; F. Stolba said that in aq. soln. the salt is decomposed into potassium fluoride, hydrofluoboric acid, and hydroxyfluoboric acid, and that these components re-form potassium fluoborate when the soln. is evaporated. According to J. J. Berzelius, the salt is not decomposed by aq. soln. of ammonia, or of sodium or potassium hydroxide, or carbonate, and it is no more soluble in these soln. than it is in water. H. Rose found the salt to be more soluble in a soln. of ammonium chloride than it is in water, and A. Stromeyer said that it is not soluble in a 20 per cent. soln. of potassium acetate. H. Rose said that the salt is not soluble in cold alcohol, but, added J. J. Berzelius, it is a little soluble in hot alcohol and crystals are deposited when the soln. cools. When fused with alkali carbonates, A. Stromeyer, and J. C. G. de Marignac found that the fluoborate is decomposed into alkali fluoride and borate; and F. Stolba based a volumetric process for the determination of soda on this reaction. J. J. Berzelius found that the salt is decomposed by sulphuric acid; and F. Stolba by hydrofluosilicic acid, and by a mixture of silicic and hydrochloric acids.

F. Godeffroy prepared **rubidium fluoborate**, $RbBF_4$, and **cæsium fluoborate**, $CsBF_4$, in a similar manner to the preceding salt. F. Zambonini made the rubidium salt by adding rubidium carbonate to a soln. of boric acid in 35 per cent. hydrofluoric acid. The gelatinous mass, when washed and dried, forms a crystalline powder. Good crystals are obtained by the slow evaporation of the mother liquid from the gelatinous mass. F. Zambonini found that the rubidium salt is isomorphous with the rhombic form of the potassium salt, and that it has the axial ratios $a : b : c = 0.8067 : 1 : 1.2948$; the sp. gr. of the rubidium salt is 2.820. F. Godeffroy found that 100 c.c. of water at 20° and 100° dissolve respectively 0.55 and 1.0 parts of the rubidium salt, and 0.92 and 0.04 part of the cæsium salt.

J. J. Berzelius obtained **ammonium fluoborate**, NH_4BF_4 , by evaporating a soln. of his preparation of the oxyfluoborate. The product is sublimed to free it from boric acid. F. Stolba obtained the salt by sublimation from a mixture of boric acid and ammonium fluosilicate, and also by adding aq. ammonia to a sat. soln. of boric acid in hydrofluoric acid until the solution is alkaline; the liquid was then boiled, filtered, and cooled. The product was purified by crystallization from its aq. soln. a number of times. The salt tastes like ammonium chloride. The sublimate is white and pulverulent, but that deposited on the hotter parts may be fused and transparent. The crystals obtained from the aq. soln., said J. J. Berzelius, form "small six-sided prisms with dihedral summits." F. Stolba gave 1.851 for the sp. gr. at 17.5°. According to F. Stolba, the salt volatilizes from a platinum dish without leaving a residue; and it colours Bunsen's flame green, but the soln. in aq. alcohol burns with flame which is not green. In 1808, J. L. Gay Lussac and L. J. Thénard before J. J. Berzelius prepared ammonium fluoborate, and noted that it could sublime. F. Stolba found that 100 parts of water at 16° and 100° dissolve respectively 25 and

95–98 parts of the salt. J. J. Berzelius said that the salt also dissolves freely in alcohol. The aq. soln. reddens litmus, and, added F. Stolba, the soln. is feebly acid when freshly prepared; and turmeric paper, dipped in the soln. and moistened with hydrochloric acid, gives a boron stain when dried. The aq. soln. does not attack glass, and behaves like the soln. of the potassium salt. The salt is not changed by recrystallization from aq. ammonia.

By mixing soln. of cupric sulphate and barium fluoborate, and evaporating the filtrate, J. J. Berzelius obtained pale blue deliquescent needles, presumably of **cupric fluoborate**, $\text{Cu}(\text{BF}_4)_2$. He also prepared **calcium fluoborate**, presumably $\text{Ca}(\text{BF}_4)_2 \cdot n\text{H}_2\text{O}$, as a gelatinous precipitate by dissolving calcium fluoride in hydrofluoboric acid; he also made it by spontaneously evaporating an acid soln. of calcium carbonate in the same acid. The salt tastes acid, and reddens litmus. Water, especially hot water, decomposes the salt, dissolving out an acidic salt, and leaving behind a basic salt containing an excess of calcium fluoride. J. J. Berzelius prepared **dihydrated barium fluoborate**, $\text{Ba}(\text{BF}_4)_2 \cdot 2\text{H}_2\text{O}$, by adding barium carbonate to an aq. soln. of hydrofluoric acid so long as it is dissolved; if too much barium carbonate is added, barium fluoride is formed and boric acid set free. On evaporation, any excess of boric acid crystallizes out first, and from the syrupy soln., barium fluoborate separates in "long rectangular four-sided prisms and needles, often with step-like depressions." The salt tastes like other barium salts, but not acid, although it reddens litmus. The salt loses its water of crystallization at 40° , and effloresces on the surface. When heated the salt first loses hydrofluoboric acid, then boron trifluoride, and leaves barium fluoride as a residue. The salt deliquesces in a moist atm., and is readily soluble in water. Alcohol decomposes it into an acid salt which dissolves, and a pulverulent basic salt which remains undissolved.

J. J. Berzelius prepared **magnesium fluoborate**, $\text{Mg}(\text{BF}_4)_2$, in large prisms with a bitter taste, and readily soluble in water; and **zinc fluoborate**, $\text{Zn}(\text{BF}_4)_2$, by dissolving zinc in an aq. soln. of hydrofluoboric acid until no more hydrogen was evolved. The soln. on evaporation furnishes a syrupy liquid which solidifies to a white deliquescent mass. J. L. Gay Lussac and L. J. Thénard also dissolved zinc in hydrofluoboric acid 16 years earlier than J. J. Berzelius. The last-named prepared **hydrated aluminium fluoborate**, possibly, $\text{Al}(\text{BF}_4)_3 \cdot n\text{H}_2\text{O}$, or $\text{AlF}_3 \cdot 3\text{BF}_3 \cdot n\text{H}_2\text{O}$, by the slow evaporation of a soln. of aluminium hydroxide in hydrofluoboric acid. The product is soluble only in acidulated water. When soln. of aluminium chloride and sodium fluoborate are mixed, a basic compound separates, and the liquid contains free acid which retains a portion of the precipitate in soln. The product fuses at a red heat giving off water, and hydrofluoboric acid, and leaving aluminium borate as a residue. In a similar manner, J. J. Berzelius also made what was regarded as **yttrium fluoborate**, which if Y be the symbol for the mixture then thought to be yttrium, could be symbolized $\text{Y}(\text{BF}_4)_3 \cdot n\text{H}_2\text{O}$; he said that the salt is soluble only in water containing an excess of acid, and the soln. on evaporation furnishes crystals of the salt. He also prepared **cobalt fluoborate**, $\text{Co}(\text{BF}_4)_2$, as a white powder; and **lead fluoborate**, $\text{Pb}(\text{BF}_4)_2$. The last-named salt is made by adding lead carbonate, in small portions at a time, to hydrofluoboric acid, until a precipitate is formed. When the soln. is evaporated to a syrup, and cooled, it deposits long needles, but if slowly evaporated, "four-sided prisms or tables" are obtained. The taste at first appears sweet and astringent, but this is followed by a sensation of sourness. F. Fischer and K. Thiele obtained the salt in acicular crystals, but could not free the salt from the mother liquid on account of its extreme tendency to deliquesce. It is hydrolyzed by water to a soluble acid salt, and an insoluble basic salt. J. J. Berzelius added that if the salt is boiled for a long time with water or alcohol, this compound is resolved into an acid salt which dissolves, and a basic salt which remains undissolved as a white powder. An easily fusible basic compound was also said to be formed by heating lead with lead oxide. A. Miolati and G. Rossi made **cobaltic hexamminofluoborate**, or *luteocobaltic fluoborate*, $[\text{Co}(\text{NH}_3)_6]_3\text{F}_3 \cdot 3\text{BF}_3 \cdot \text{HF}$, by adding a soln. of luteocobaltic carbonate to

a soln. of boric acid in hydrofluoric acid. It can be recrystallized from dil. hydrofluoric acid; and it is stable at 110°–120°.

A series of complex **fluoperborates** has been obtained by G. I. Petrenko,² and P. G. Melikoff and S. Lordkipanidzé by the action of hydrogen peroxide on fluoborates, but *fluoperboric acid* has not been prepared. P. G. Melikoff and S. Lordkipanidzé obtained **potassium fluoperborate**, $K_4B_4F_4O_{11} \cdot H_2O$, by treating an aq. soln. of potassium fluoborate, $2KF \cdot B_2O_3$, with a slightly alkaline soln. of hydrogen peroxide, separates on the addition of alcohol as a viscous mass which becomes crystalline on stirring; the substance is redissolved in water and the process repeated, the salt being finally obtained in rhombic prisms. The following constitution, $OK \cdot BF \cdot O \cdot O \cdot BF \cdot O \cdot OK : OK \cdot O \cdot BF \cdot O \cdot O \cdot BF \cdot O \cdot OK \cdot H_2O$, is assigned to the compound. The aq. soln. has an alkaline reaction and slowly evolves oxygen at the ordinary temp., this decomposition being accelerated by warming; the silver salt is produced as a yellow precipitate by adding silver nitrate to the soln.; it is unstable, and blackens owing to the separation of metallic silver, oxygen being simultaneously evolved. The dry potassium salt is moderately stable; dil. sulphuric acid liberates hydrogen peroxide, whilst the conc. acid evolves ozonized oxygen. This salt may also be obtained by the action of hydrogen peroxide on potassium oxyfluoborate, $BF(OK)_2$. P. G. Melikoff and co-worker also precipitated the fluoborate, $K_2B_2F_2O_6 \cdot H_2O$, or $O_2(BF \cdot O \cdot OK)_2 \cdot H_2O$, by adding alcohol to the hydrogen peroxide soln. G. I. Petrenko also prepared the same salt. P. G. Melikoff and S. Lordkipanidzé, and G. I. Petrenko obtained **ammonium fluoperborate**, $(NH_4)_2B_2F_2O_6 \cdot 3H_2O$, by adding hydrogen peroxide, ammonia, and alcohol to a soln. of boric acid and ammonium fluoride. The white crystalline powder is moderately stable. The aq. soln. decomposes slowly at ordinary temp., and rapidly on warming. Ammonium peroxide acts as a base towards perboric acid; and the two unite, forming a salt-like compound.

REFERENCES.

- ¹ J. J. Berzelius, *Stockholm Acad. Handl.*, 284, 1823; 46, 278, 1824; *Ann. Phil.*, (2), 8, 330, 450, 1824; (2), 9, 124, 1825; (2), 10, 116, 1825; *Pogg. Ann.*, 1, 1, 169, 1824; 2, 113, 1824; 4, 1, 117, 1824; H. Rose, *ib.*, 80, 276, 1850; W. C. Zeise, *Schweigger's Journ.*, 32, 306, 1821; J. C. G. de Marignac, *Zeit. anal. Chem.*, 1, 405, 1862; F. C. Mathers, C. O. Stewart, H. V. Housemann, and I. E. Lee, *Journ. Amer. Chem. Soc.*, 37, 1515, 1915; F. Stolba, *Zeit. anal. Chem.*, 9, 95, 1870; *Chem. Tech. Centr. Anz.*, 7, 459, 1889; *Chem. Centr.*, (3), 3, 395, 1872; (3), 6, 403, 1875; (3), 7, 703, 1876; F. Godeffrey, *Ber.*, 9, 1363, 1876; A. Stromeyer, *Liebig's Ann.*, 100, 82, 1856; C. Montemartini, *Gazz. Chim. Ital.*, 24, i, 478, 1894; *Atti Accad. Lincei*, (5), 3, i, 339, 1894; A. Miolati and G. Rossi, *ib.*, (5), 5, ii, 183, 223, 1896; F. Zambonini, *ib.*, (5), 31, ii, 67, 1922; *Zeit. Kryst.*, 41, 57, 1905; T. V. Barker, *Journ. Chem. Soc.*, 101, 2484, 1912; Gebrüder Siemens, *German Pat.*, D.R.P. 279011, 1915; J. L. Gay Lussac and L. J. Thénard, *Recherches physico-chimiques*, Paris, 2, 43, 1811; *Ann. Chim. Phys.*, (1), 69, 204, 1808; F. Fischer and K. Thiele, *Zeit. anorg. Chem.*, 67, 304, 1910; S. Motylewsky, *ib.*, 38, 410, 1904; J. O. Perrine, *Phys. Rev.*, (2), 22, 48, 1923.

² G. I. Petrenko, *Journ. Russ. Phys. Chem. Soc.*, 34, 37, 1902; P. G. Melikoff and S. Lordkipanidzé, *ib.*, 32, 77, 1900; *Ber.*, 32, 3349, 3510, 1899.

§ 21. Boron Trichloride

J. Davy¹ observed that boron burns in chlorine gas, but he did not investigate the products of the combustion; J. J. Berzelius showed that **boron trichloride**, BCl_3 , is formed when amorphous boron is warmed in chlorine gas. Dry amorphous boron ignites spontaneously in the gas, but boron which has been preheated has a higher temp. of ignition. H. Moissan gave 410° for the temp. of ignition. J. J. Berzelius' analyses were confirmed by G. Oddo and M. Tealdi, and by F. Wöhler and H. St. C. Deville. The last-named investigators first liquefied the gas. L. Gattermann recommended heating amorphous boron to dull redness in a stream of dried

hydrogen in order to get rid of moisture; the hydrogen is then replaced by chlorine. The temp. should be so regulated that the glass is attacked as little as possible. The condensing apparatus must be well cooled with a freezing mixture since boron trichloride boils at a comparatively low temp., 13° . A. Stock and O. Priess condensed the crude chloride at -80° . It is shaken with mercury, or powdered silver to remove free chlorine; and it is redistilled in a fractionating column to get rid of hydrogen chloride and silicon chloride. The latter is produced by the joint action of boron and chlorine on the glass. A. Stock and O. Priess recommended distillation in a high vacuum from a bath at 78° . The early fractions, condensed by liquid air, contained hydrogen chloride, which influenced the vap. press. at 0° far more than the m.p., whilst the silicon chloride collected in the end fractions. A. Stock and E. Kuss discussed the purification of boron trichloride for at. wt. determinations. Modifications of this process have been described by F. Wöhler and H. St. C. Deville, H. Schnitzler, E. Podszus, H. Gautier, C. M. Despretz, and H. C. C. Maisch. Boron trichloride was made by F. Wöhler and H. St. C. Deville by the action of hydrogen chloride on boron, but a high temp. is required and much silicon chloride is formed. They also made boron trichloride by heating boron with silver, mercury or lead chloride. P. C. Chabré made boron trichloride by the action of carbon tetrachloride on boron at 200° – 250° ; $3\text{CCl}_4 + 4\text{B} = 4\text{BCl}_3 + 3\text{C}$. C. Mazzetti and F. de Carli obtained almost quantitative yields by passing dry chlorine through a porcelain tube containing ferro-boron at 500° —*vide* silicon tetrachloride.

J. B. A. Dumas made boron trichloride by the action of chlorine on an intimate mixture of carbon and boric oxide at a high temp.: $\text{B}_2\text{O}_3 + 3\text{Cl}_2 + 3\text{C} = 3\text{CO} + 2\text{BCl}_3$. G. Gustavson obtained boron trichloride by heating in a sealed tube a mixture of boric oxide with an excess of phosphorus pentachloride for 3–4 days at 150° : $6\text{PCl}_5 + 5\text{B}_2\text{O}_3 = 10\text{BCl}_3 + 3\text{P}_2\text{O}_5$; no phosphoryl chloride is formed: he also found that if phosphorus trichlorodibromide be employed in place of phosphorus pentachloride, boron trichloride and free bromine are formed—virtually no boron tribromide is produced. H. Moissan found that boron trichloride is produced when boron sulphide, B_2S_3 , is treated with chlorine, or with hydrogen chloride at 400° . H. Moissan and P. Williams obtained boron trichloride by treating calcium boride with chlorine. J. Tarible noted the formation of boron trichloride when arsenic trichloride acts on boron tribromide; and C. Counciler, when boron oxytrichloride is heated: $3\text{BOCl}_3 = \text{B}_2\text{O}_3 + 3\text{Cl}_2 + \text{BCl}_3$. Boron chloro-hydrides have been described in connection with boron hydride.

Boron trichloride is a colourless gas which can be condensed to a colourless mobile liquid. Both gas and liquid form dense clouds in air. F. Wöhler and H. St. C. Deville gave 1.35 for the **specific gravity** of the liquid at 17.5° ; A. Ghira gave 1.43386 at $0^{\circ}/4^{\circ}$, and the latter gave 81.94 for the mol. vol. F. Wöhler gave 17° for the **boiling point** of the liquid; H. V. Regnault gave 18.23° at 760 mm.; P. Walden, 18.2° – 18.8° at 767 mm.; and A. Stock and O. Priess, 13° at 764 mm. The last value is probably the best representative one. A. Stock and O. Priess' value for the **vapour density** of the gas is 58.43 ($\text{H}_2=2$); and F. Wöhler and H. St. C. Deville's value 3.97–4.065. The **vapour pressure** of the liquid was measured by H. V. Regnault, T. Tate, and A. Stock and O. Priess. The last-named gave for the vap. press., p , in mm. of mercury:

	-80°	-60°	-40°	-20°	-10°	0°	5°	10°	12.4°
p	4	18	67	197	314	477	579	695	753

The extrapolated value for the b.p. at 760 mm. is 12.5° . H. V. Regnault gave for p mm.,

	-20°	-10°	0°	10°	20°	30°	40°	60°	80°
p	159.46	250.54	381.32	562.94	807.50	1127.50	1535.25	2658.52	4248.28

H. V. Regnault represented his measurements at θ° by the formula $\log p = 4.8159298 - 2.7690345\theta + 0.0120096\theta^2$. when $\log a = \bar{1}.9965575$, and $\log b = \bar{1}.9770709$, and $t = \theta + 27$; below 0° the last term may be omitted. C. Antoine

represented the vap. press. of boron trichloride by $\log p = 0.9290(7.1268 - 1000/t)$, where $t = \theta^\circ + 130^\circ$. A. Stock and O. Priess gave -107° for the **melting point**. The **heat of formation** from amorphous boron, as given by M. Berthelot, is 89.1 Cals. for the gas, and 93.4 for the liquid. This makes the mol. **heat of vaporization** 4.3 Cals. L. Troost and P. Hautefeuille gave 104 Cals. for the heat of formation of the gas, and for the **heat of solution** of the gas in 100 times its weight of water, 7.2 Cals. per gram, or 79.2 Cals. per eq. According to P. Walden, the **electrical conductivity** of the liquid is virtually nil, and it shows no tendency to ionize binary salts and strong acids at 0° .

By subjecting a mixture of boron trichloride and **hydrogen** at ordinary temp. to the silent electric discharge, H. V. A. Briscoe found that a pale yellow transparent substance is produced with a smaller atomic ratio than $B : Cl = 1 : 3$ —possibly *boron subchloride*. It is rapidly decomposed by water with the evolution of hydrogen and the formation of a soln. with reducing properties. According to C. A. A. Michaelis and P. Becker, if a mixture of boron trichloride and **oxygen** is exposed to the silent electric discharge in an ozone tube, very little boric oxide is formed, but if the mixture be sparked, a vigorous action occurs: $4BCl_3 + 3O_2 = 2B_2O_3 + 6Cl_2$; **ozone** does not attack the gas. C. A. A. Michaelis and P. Becker did not detect any signs of the formation of an oxychloride in their study of the action of oxygen and of ozone on boron trichloride. Gaseous and liquid boron trichloride react with **water**, forming hydrochloric and boric acids. The reaction has been studied by F. Wöhler and H. St. C. Deville, and J. von Liebig. J. B. A. Dumas said that if a small proportion of water be used a solid hydrate is formed, and this, when heated in a stream of hydrogen, furnishes hydrochloric and boric acids. According to H. Moissan, when **fluorine** is passed into boron trichloride, each bubble of fluorine forms boron trifluoride. Boron trichloride reacts with **hydrogen iodide** at a high temp., forming boron iodide. A. Stock and Q. Priess say that **chlorine** has no perceptible action on boron trichloride even at -80° . G. Gustavson said that **sulphur** does not act on the gas at 250° . According to A. Stock and O. Poppenberg, **hydrogen sulphide** forms boron sulphide at a red heat. G. Gustavson found that when a mixture of boron trichloride with **sulphur trioxide** is heated in a sealed tube at 150° , a reaction, probably $2BCl_3 + 3SO_3 = 3SO_2Cl_2 + B_2O_3$ occurs. H. Moissan found that **sulphur tetrachloride**, SCl_4 , gives a liquid double chloride which freezes at -33° .

W. Jevons found that with the so-called active form of **nitrogen**, boron trichloride forms a white amorphous solid containing both nitrogen and boron, the reaction is accompanied by a pale bluish-green glow quite different from the green colour of the flame tinted with boric acid. According to J. J. Berzelius, one vol. of boron trichloride unites with $1\frac{1}{2}$ vol. of **ammonia** producing a white substance, **boron sesquiamminochloride**, $2BCl_3 \cdot 3NH_3$. C. A. Martius prepared this compound by passing dry ammonia into cooled liquid boron trichloride. The compound does not fume in air; it is rather less volatile than ammonium chloride, and sublimes undecomposed. It is decomposed by water, forming hydrochloric acid, and ammonium chloride and borate. When mixed with ammonia, and passed through a hot tube, it forms spontaneously inflammable boron nitride. A. Besson stated that ammonia displaces the hydrogen phosphide from boron phosphinochloride at 8° , and yields **boron hemiennamminochloride**, $2BCl_3 \cdot 9NH_3$, which alters but slowly when exposed to air, and does not lose ammonia below 50° , but is immediately decomposed by water with the production of a slightly alkaline soln. According to A. Joannis, the variable results obtained by the action of ammonia on boron trichloride are due to the complexity of the reaction; additive compounds are not formed, but rather mixtures of ammonium chloride. Thus, with **boron hexamminochloride**, $BCl_3 \cdot 6NH_3 = B(NH_2)_3 + 3NH_4Cl$; and $2B(NH_2)_3 = B_2(NH)_3 + 3NH_3$. The ammonium chloride can be washed out with liquid ammonia—*vide* silicon hexamino-tetrachloride and zirconium octammino-tetraiodide. A. Joannis added that when a current of hydrogen carrying the vapour of boron chloride is passed through

liquid ammonia at -70° to -50° , and the temp. raised to volatilize the excess of ammonia, a mol of boron chloride fixes 15 mols of ammonia, and when the temp. is raised to 0° , 9 mols of ammonia are expelled, and the vap. press. is the same as that of $\text{NH}_4\text{Cl}\cdot 3\text{NH}_3$. During this reaction no nitrogen or hydrogen is evolved, and from the increase in weight, and the action of water, whereby boric acid is formed, it is inferred that three amido-groups united to boron are produced from the three ammonia groups, so that the reaction at -23° is $\text{BCl}_3 + 15\text{NH}_3 = \text{B}(\text{NH}_2)_3 + 3(\text{NH}_4\text{Cl}\cdot 3\text{NH}_3)$; and at 0° , $\text{BCl}_3 + 6\text{NH}_3 = 3\text{NH}_4\text{Cl} + \text{B}(\text{NH}_2)_3$. The *boramide*, $\text{B}(\text{NH}_2)_3$, cannot be separated completely from the ammonium chloride, although the latter is more soluble in liquid ammonia. When the boramide is heated to 440° , it loses 1.5 mols of ammonia and is slowly converted into *borimide*, $\text{B}_2(\text{NH})_3$, by a reaction: $2\text{B}(\text{NH}_2)_3 = 3\text{NH}_3 + \text{B}_2(\text{NH})_3$. This reaction begins at ordinary temp. Borimide can be readily separated from ammonium chloride by washing out the latter with liquid ammonia. A. Stock and M. Blix prepared white pulverulent *borimide trihydrochloride*, $\text{B}_2(\text{NH})_3\cdot 3\text{HCl}$, by allowing borimide to react with hydrogen chloride. It is decomposed by water, and is insoluble in the usual organic solvents.

Boron trichloride has a marked tendency to form complexes. According to A. Geuther, when boron trichloride is treated with *nitrogen tetroxide* an energetic action takes place, a solid substance being deposited in the liquid, while yellow crystals condense on the sides of the flask. When distilled after standing two days, volatile yellow crystals condense in the receiver, and the brownish-red vapour of these crystals fume on coming in contact with the air. A liquid which appears to be a soln. of the crystals in boron trichloride also passes over. The crystals have a composition corresponding with *boron nitrosylchloride*, $\text{BCl}_3\cdot \text{NOCl}$. The reaction is probably $16\text{BCl}_3 + 6\text{N}_2\text{O}_4 = 2\text{B}_2\text{O}_3 + 12(\text{BCl}_3\cdot \text{NOCl}) + 3\text{O}_2$. The compound forms rhombic octahedrons or prisms which dissolve in water with a hissing sound, boric acid, nitric acid, and chlorine being produced. At 23° – 24° the crystals melt, forming two layers of fluid, the upper of which appears to consist of boron trichloride containing a small portion of the original substance, while the lower probably consists of the fused substance together with a small portion of nitrosyl chloride. On cooling, the two layers reunite with rarer or less rapidity, according to circumstances, reproducing the original substance.

A. Besson found that phosphine combines with boron chloride with development of heat, and yields white *boron phosphinochloride*, $\text{BCl}_3\cdot \text{PH}_3$, which alters rapidly when exposed to air, and is immediately decomposed by water with liberation of hydrogen phosphide. It begins to dissociate at 20° under the ordinary press., and if the products of dissociation be slowly cooled, the compound is obtained in bulky, colourless, highly refractive crystals. G. Gustavson said that when boron trichloride is heated with *phosphorus pentoxide* in a sealed tube, a crystalline complex, *boron phosphoryl chloride*, $\text{POCl}_3\cdot \text{BCl}_3$, is formed; $\text{P}_2\text{O}_5 + 2\text{BCl}_3 = \text{PBO}_4 + \text{POCl}_3\cdot \text{BCl}_3$; and that with *phosphoryl chloride* a similar product is obtained, but G. Oddo and M. Tealdi denied the formation of a crystalline compound under these conditions.

H. Schiff noted that boron trichloride reacts with *alcohol*, forming ethyl borate, and C. Counciler studied its action on different alcohols. G. Gustavson said that boron trichloride readily reacts with organic compounds containing OH- or NH_2 -groups. S. Rideal studied its action on *aniline*; C. A. Martius, with *hydrogen cyanide*, and with *cyanogen chloride*; G. Gustavson, with *carbon tetrabromide*; and with *potassium cyanide*; A. Gautier, with *ethyl cyanide*. E. Frankland found boron trichloride converts *zinc ethyl* into *boron ethyl*, $\text{B}(\text{C}_2\text{H}_5)_3$. C. A. A. Michaelis and P. Becker, F. J. Schumacher, W. Dilthey, and A. Rosenheim and co-workers made boro-organic compounds. Boron trichloride reacts so energetically with *fat* that A. Stock and O. Priess devised a special valve to avoid the use of greased taps.

A and B, Fig. 32, are solid glass floats, resting by three feet on the enlargement in the tubes, and ground at the top to fit into the ground constriction. C and D connect the other pieces of apparatus. The bulb E contains clean mercury. When A and B have fallen,

C communicates with *D*. By raising the mercury in *F*, the floats are forced into constrictions, to make, with a thin film of mercury, a gas-tight seal. The floats are made to fall again by evacuating *E* and opening the tap *G*.

According to G. Gustavson, boron trichloride can be distilled from **sodium** without alteration, but at 150° , some boron is formed; A. C. Vournasos found the boron halides are reduced with difficulty by **potassium**. **Sodium amalgam** is covered with a film of boron after being in contact with boron trifluoride for a day; **zinc** dust does not react at 200° , but **magnesium** was found by F. Jones and R. L. Taylor to furnish magnesium boride: $6\text{Mg} + 2\text{BCl}_3 = 3\text{MgCl}_2 + \text{Mg}_3\text{B}_2$, and **iron** reduced in hydrogen was also found by H. Moissan to form iron boride. N. Parravano and C. Mazzetti found both **nickel** and iron form borides when heated in an atm. of boron trichloride. A. Stock and O. Priess said that boron trichloride does not attack hot **mercury**. L. Troost and P. Hautefeuille found that boron trichloride reacts with **silica** at a high temp., forming boric oxide and silicon tetrachloride; and that **titanic oxide**, TiO_2 , and **zirconia**, ZrO_2 , act in an analogous manner. They also found that with **alumina**, aluminium chloride and aluminium borate are formed; and that **porcelain** is attacked at a bright red heat, forming aluminium and silicon chlorides, aluminium borate, etc. G. Gustavson stated that when eq. quantities of boron trichloride and **boric oxide** are heated in a sealed tube at 150° , **boron oxymonochloride**, BOCl , is formed, but R. Lorenz tried to confirm this and found that the product is a mixture of boron chloride and oxide, $2\text{BCl}_3 + 7\text{B}_2\text{O}_3$. C. Councler claimed to have obtained **boron oxytrichloride**, BOCl_3 , as a by-product in the preparation of boron trichloride; he described it as a yellowish-green liquid which decomposes on heating into boron trichloride, chlorine, and boric oxide; and with water it forms chlorine, and boric and hydrochloric acids. In R. Lorenz's attempt to make this compound by passing chlorine over a mixture of boric oxide and charcoal, he obtained a liquid mixture of boron trichloride and benzene hexachloride. The oxychloride remains as a white fibrous mass when the liquid is distilled; it had a composition $\text{B}_8\text{O}_{11}\text{Cl}_2$, or $11\text{B}_2\text{O}_3 + 2\text{BCl}_3 = 3\text{B}_8\text{O}_{11}\text{Cl}_2$; and not BOCl_3 as stated by C. Councler.

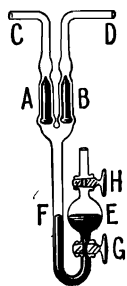

FIG. 32.—Valve to replace the Greased Tap.

REFERENCES.

- ¹ J. Davy, *Phil. Trans.*, **99**, 75, 1809; J. J. Berzelius, *Pogg. Ann.*, **2**, 147, 1824; H. C. C. Maisch, *Zur Kenntniss des Bors*, Göttingen, 1889; F. J. Schumacher, *Ueber Boronitium und Titanonitiumsalze*, Zürich, 1906; P. C. Chabrié, *Bull. Soc. Chim.*, (3), **7**, 18, 1892; L. Troost and P. Hautefeuille, *ib.*, (2), **13**, 213, 1870; *Ann. Chim. Phys.*, (5), **7**, 452, 476, 1876; *Compt. Rend.*, **70**, 185, 1870; **75**, 1819, 1876; H. Moissan, *ib.*, **112**, 717, 1891; **114**, 319, 617, 1892; **115**, 203, 319, 1892; *Ann. Chim. Phys.*, (7), **6**, 296, 1895; H. Gautier, *ib.*, (7), **18**, 352, 1899; *Compt. Rend.*, **129**, 678, 1899; A. Gautier, *ib.*, **63**, 920, 1866; J. Tarible, *ib.*, **132**, 204, 1901; C. Antoine, *ib.*, **107**, 778, 836, 1888; A. Joannis, *ib.*, **135**, 1106, 1902; A. Besson, *ib.*, **110**, 517, 1890; H. Moissan and P. Williams, *ib.*, **125**, 629, 1897; F. Wöhler and H. St. C. Deville, *ib.*, **45**, 888, 1857; *Ann. Chim. Phys.*, (3), **52**, 84, 1858; J. B. A. Dumas, *ib.*, (2), **31**, 346, 1826; (2), **33**, 376, 1826; M. Berthelot, *ib.*, (5), **15**, 185, 1878; (5), **16**, 442, 1879; *Thermochimie*, Paris, **2**, 148, 1897; G. Gustavson, *Ann. Chim. Phys.*, (5), **2**, 200, 1874; *Zeit. Chem.*, (2), **6**, 521, 1870; (2), **7**, 417, 1871; *Ber.*, **6**, 9, 1873; C. A. A. Michaelis and P. Becker, *ib.*, **13**, 58, 1880; **14**, 914, 1881; **15**, 180, 1882; A. Rosenheim, W. Löwenstamm, and L. Singer, *ib.*, **36**, 1839, 1903; L. Gattermann, *ib.*, **22**, 195, 1889; S. Rideal, *ib.*, **22**, 992, 1889; A. Stock and M. Blix, *ib.*, **34**, 3040, 1901; A. Stock and O. Priess, *ib.*, **47**, 3109, 1914; A. Stock and O. Poppenberg, *ib.*, **34**, 399, 1901; C. Councler, *ib.*, **10**, 1665, 1877; **11**, 1108, 1878; *Journ. prakt. Chem.*, (2), **18**, 399, 1878; A. Geuther, *ib.*, (2), **8**, 357, 1873; *Jena Zeit.*, **7**, 375, 1873; C. A. Martius, *Liebig's Ann.*, **109**, 81, 1859; W. Dilthey, *ib.*, **344**, 300, 1906; H. Schnitzler, *Dingler's Journ.*, **211**, 485, 1874; H. V. Regnault, *Mém. Acad.*, (2), **26**, 479, 658, 1862; P. Walden, *Zeit. anorg. Chem.*, **25**, 221, 1900; A. C. Vournasos, *ib.*, **81**, 364, 1913; C. Mazzetti and F. de Carli, *Atti Accad. Lincei*, (5), **31**, ii, 119, 1922; N. Parravano and C. Mazzetti, *ib.*, (5), **31**, ii, 424, 1922; E. Podszus, *Zweit. anorg. Chem.*, **99**, 123, 1917; A. Stock and E. Kuss, *Ber.*, **56**, B, 1463, 1923; T. Tate, *Phil. Mag.*, (4), **26**, 502, 1863; *Arch. Sciences Genève*, (2), **19**, 140, 1864; F. Jones and R. L. Taylor, *Journ. Chem. Soc.*, **39**, 314, 1881; A. Ghira, *Zeit. phys. Chem.*, **12**, 768, 1894; *Gazz. Ital.*, **23**, i, 452, 1893; G. Oddo and M. Tealdi, *ib.*, **33**, ii, 431, 1903; H. Schiff, *Liebig's Ann. Suppl.*,

5. 154, 1867; E. Frankland, *Proc. Roy. Soc.*, **25**, 165, 1877; W. Jevons, *ib.*, **91**, A, 120, 1915; J. von Liebig, *Schweigger's Journ.*, **46** 117, 1826; H. V. A. Briscoe, in H. F. V. Little, *Aluminium and its Congeners*, London, **23**, 1917; R. Lorenz, *Liebig's Ann.*, **247**, 241, 1888; C. M. Despretz, *Ann. Chim. Phys.*, (2), **36**, 426, 1827; *Quart. Journ. Science*, **1**, 234, 1827.

§ 22. Boron Tribromide

A. B. Poggiale¹ first obtained **boron tribromide**, BBr_3 , by the action of bromine vapour on an intimate mixture of carbon and boric oxide at a red heat. He did not condense his product to a liquid. F. Wöhler and H. St. C. Deville made the tribromide by passing bromine over boron at a dull red heat. Before passing the bromine, the apparatus is dried by passing a stream of dried hydrogen over the heated boron. H. Gautier, J. L. H. Abrahall, H. Moissan, A. von Bartal, and A. Stock and E. Kuss employed a similar process. The crude boron tribromide condenses in a well-cooled receiver as a yellow liquid. The product is purified by shaking it with mercury, and it is rectified at atm. press. by fractionation with a distillation column. A. Stock and E. Kuss also discussed the purification of the bromide for at. wt. determinations. F. Meyer and R. Zappner purified the bromide by distillation under reduced press. P. C. Chabrie noted that a little boron bromide is formed when a mixture of amorphous boron with ethylene dibromide, or tribromohydrine, is heated in a sealed tube. H. Moissan noted the formation of boron tribromide when boron sulphide is heated with bromine; and G. Gustavson, when a mixture of boric oxide and phosphorus pentabromide is heated in a sealed tube at 140° . A. Stock and E. Kuss described the preparation of the tribromide of a high degree of purity. The boron bromo-hydrides have been described in connection with the boron hydrides.

Boron tribromide is a colourless fuming liquid. F. Wöhler and H. St. C. Deville gave 2.69 for the sp. gr., and A. Ghira gave 2.94985 at $0^\circ/4^\circ$, and T. Ewan and P. J. Hartog gave 2.6175 at 16.5° ; and for the mol. vol., A. Ghira gave 94.72 at 0° . F. Wöhler and H. St. C. Deville found the vap. density to be 8.78, the normal value is 8.772 (air unity); A. B. Poggiale found 8.46. F. Wöhler and H. St. C. Deville, and H. Gautier found the b.p. to be 90.5° ; A. von Bartal, 90.6° ; and A. Stock and E. Kuss, 90.1° at 740 mm. The last-named found the mol. wt., from the f.p. of benzene soln., to be 252; and the vap. press., p in mm. of mercury to be:

	-50°	-30°	-10°	0°	10°	30°	50°	70°	90°
p	0.7	3	10.5	19	32	85	193	390	730

They also gave -46° for the m.p. of boron tribromide; H. Gautier gave -44° . M. Berthelot gave for the heat of formation (B , 3Br_{gas}) = 543 Cals. and (B , $3\text{Br}_{\text{liquid}}$) = 43.2 Cals. for liquid boron tribromide.

H. Gautier said that **water** reacts with boron tribromide with explosive violence. F. Wöhler and H. St. C. Deville merely mentioned the existence of boron oxybromide; A. Besson, that **hydrogen iodide** replaces one or two atoms of bromine by iodine; A. Stock and O. Poppenberg found that **hydrogen sulphide** converts it into boron sulphide; and G. Gustavson, that with **sulphur trioxide** in a sealed tube at 120° , the compound $\text{B}_2\text{O}_3 \cdot \text{SO}_3$ is formed. According to A. Besson, ammonia gas combines directly with boron bromide with great development of heat and partial conversion into boron nitride. In order to obtain a definite compound, rise of temp. must be avoided. If dry ammonia, cooled to 0° , be passed into a soln. of boron bromide in dry carbon tetrachloride, cooled to 0° , a white, solid substance separates, and at the end of the reaction the solvent is expelled by means of a current of dry air at 50° – 60° . The product is amorphous, and corresponds with **boron tetrammino-tribromide**, $\text{BBr}_3 \cdot 4\text{NH}_3$. At 10° it absorbs more ammonia, but the excess is expelled in a current of dry air. When heated in dry oxygen, decomposition begins at about 150° , without sublimation, the products being boron nitride and ammonium bromide.

The compound is also decomposed by water and alkalis. A. Stock treated boron arsenotribromide, $\text{BBr}_3 \cdot \text{AsH}_3$, with ammonia at -25° , and obtained a liquid which gives off the excess of ammonia when warmed and forms a white solid corresponding with **boron enneaminotribromide**, $\text{BBr}_3 \cdot 9\text{NH}_3$. A. Joannis considered that the products of the action of ammonia on boron tribromide are ammonium bromide and boramide—*vide* boron trichloride. A. Stock noted that with **phosphine**, $\text{BBr}_3 \cdot \text{PH}_3$, is formed; with **phosphorus trichloride**, $2\text{BBr}_3 \cdot \text{PCl}_3$; with **phosphorus pentachloride**, $2\text{BBr}_3 \cdot \text{PCl}_5$; with **phosphoryl chloride**, $\text{BBr}_3 \cdot \text{POCl}_3$; with **phosphorus tribromide**, $\text{BBr}_3 \cdot \text{PBr}_3$; with **phosphorus pentabromide**, $\text{BBr}_3 \cdot \text{PBr}_5$; with **phosphorus iodides**, $2\text{BBr}_3 \cdot \text{P}_2\text{I}_4$; and with **arsine**, $\text{BBr}_3 \cdot \text{AsH}_3$ is formed. J. Tarible found that **arsenic trichloride** reacts; $\text{AsCl}_3 + \text{BBr}_3 = \text{AsBr}_3 + \text{BCl}_3$; **antimony trichloride** reacts in an analogous manner; while **arsenic tribromide**, **arsenic tri- and penta-iodides**, **antimony tribromide**, and **antimony tri-iodide** are readily dissolved by boron tribromide. G. Gustavson found that when a mixture of boron tribromide and **carbon tetrachloride** is heated in a sealed tube at 150° – 200° , about 10 per cent. of the boron forms the trichloride; and A. Besson found that **carbonyl chloride** is converted into the chlorobromide and bromide under similar conditions. S. Rideal, C. A. A. Michaelis, etc., have studied the action of boron bromide on **organic compounds**.

REFERENCES.

¹ A. B. Poggiale, *Compt. Rend.*, **22**, 124, 1846; F. Wöhler and H. St. C. Deville, *ib.*, **45**, 888, 1857; *Ann. Chim. Phys.*, (3), **52**, 89, 1858; H. Moissan, *ib.*, (7), **6**, 296, 1895; *Compt. Rend.*, **114**, 617, 1892; **115**, 203, 1892; A. Besson, *ib.*, **112**, 1002, 1891; **113**, 78, 1891; **114**, 542, 1892; **120**, 190, 1895; A. Joannis, *ib.*, **135**, 1106, 1902; **139**, 364, 1904; J. Nicklès, *ib.*, **60**, 800, 1865; J. Tarible, *ib.*, **116**, 1521, 1893; **132**, 204, 1901; H. Gautier, *ib.*, **129**, 678, 1899; *Ann. Chim. Phys.*, (7), **18**, 352, 1899; M. Berthelot, *ib.*, (5), **15**, 185, 1878; (5), **16**, 442, 1879; *Thermochimie*, Paris, **2**, 149, 1897; G. Gustavson, *Ann. Chim. Phys.*, (5), **2**, 200, 1874; *Zeit. Chem.*, (2), **6**, 521, 1870; *Ber.*, **3**, 326, 1870; **6**, 10, 1873; A. Stock, *ib.*, **34**, 949, 1901; S. Rideal, *ib.*, **22**, 992, 1889; A. Stock and E. Kuss, *ib.*, **47**, 3113, 1914; **56**, B, 1463, 1923; A. Stock and O. Poppenberg, *ib.*, **34**, 399, 1901; C. A. A. Michaelis, *Liebig's Ann.*, **315**, 19, 1901; A. von Bartsch, *ib.*, **345**, 339, 1906; P. C. Chabrie, *Bull. Soc. Chim.*, (3), **7**, 18, 1892; A. Ghira, *Zeit. phys. Chem.*, **12**, 768, 1894; J. L. H. Abrahall, *Journ. Chem. Soc.*, **61**, 650, 1892; T. Ewan and P. J. Hartog, *ib.*, **61**, 650, 1892; F. Meyer and R. Zappner, *Ber.*, **54**, B, 550, 1921; A. Stock and E. Kuss, *Zeit. anorg. Chem.*, **56**, B, 1463, 1923.

§ 23. Boron Triiodide

J. Inglis¹ obtained a small quantity of a yellow sublimate by passing iodine vapour over an intimate mixture of carbon and boric oxide at a red heat; the product was thought to be an impure boron iodide; but F. Wöhler and H. St. C. Deville were not able to make boron iodide by the direct union of the elements nor by heating a mixture of boron with silver iodide. H. Moissan first established the existence of **boron triiodide**, BI_3 , which he obtained in 1891 by heating a mixture of the vapours of boron trichloride and hydrogen iodide; by the action of iodine vapour on the amorphous boron of F. Wöhler and H. St. C. Deville, at 700° – 800° ; and by the action of hydrogen iodide on red-hot amorphous boron. The last-named process is considered to be the best. The boron is first heated to about 200° in a stream of dried hydrogen. It is then heated in a Bohemian glass tube, almost to the m.p. of the glass. A stream of hydrogen iodide, dried by passage over calcium iodide, is passed through the tube. The boron triiodide sublimes in large lamellæ which have a purple-red colour owing to the presence of a little free iodine; the crude product is purified by dissolving it in carbon disulphide, shaking it with mercury to remove free iodine, and recovering the iodide by evaporating the soln. It is considered remarkable that the amorphous boron of H. Moissan is not satisfactory, while the less pure preparation by F. Wöhler and H. St. C. Deville's process is satisfactory. A. Besson said that only a small portion of the boron is attacked, and that

this portion must be a more active variety than the remainder of the boron, but H. Moissan said that the more active variety is probably a mixture of iron and sodium borides. A. Besson also obtained a mixture of boron dibromiodide, and bromodiiodide, with boron triiodide, by passing a mixture of the vapours of hydrogen iodide and boron tribromide through a glass tube heated to 300°–400°. After shaking the mercury, the three constituents can be separated by repeated fractional distillation, **boron dibromiodide**, BBr_2I , boils at 125°; **boron bromodiiodide**, BBrI_2 , at 180°; and boron triiodide at 210°. The yields are poor. The two bromiodides are colourless liquids. Light alone has no action on them, but moist air and light decompose both compounds as in the case of boron triiodide. Both compounds are decomposed by water with violence.

Boron triiodide forms colourless crystals. According to H. Moissan, the compound melts at 43°, and readily crystallizes on cooling; the sp. gr. at 50° approximates to 3·3; the liquid boils undecomposed at 210°. Boron triiodide is not changed by an electric current of 50 volts. The crystals are very hygroscopic, and readily decompose on exposure to air, or to light, and iodine is liberated. A. Besson said that light alone does not appear to have any action, and he thinks that the moisture first decomposes the iodide into boric and hydriodic acids, and that the latter is decomposed by air and light into iodine and water. H. Moissan found that boron triiodide is not altered when heated to redness in a stream of **hydrogen**. When the vapour is heated to redness in a glass tube, it burns when brought in contact with the **air**, and iodine is then set free; a similar result is obtained by heating the iodide in **oxygen**. Boron triiodide is immediately decomposed by **water** into a mixture of boric and hydriodic acids without the separation of iodine. It is rapidly attacked by melted sulphur; at 400°, boron trisulphide is formed; a soln. of **sulphur** and boron triiodide in carbon disulphide at ordinary temp. forms boron pentasulphide.

According to A. Besson, **ammonia** unites with boron triiodide with the development of much heat. When a current of ammonia cooled to 0° is passed into a soln. of boron triiodide in carbon tetrachloride, cooled to 0°, white amorphous **boron pentamminotriiodide**, $\text{BI}_3 \cdot 5\text{NH}_3$, separates. This becomes brown when exposed to light; a little iodide is also decomposed when the salt is heated in a current of hydrogen, iodine being liberated; and it is decomposed by water. In a current of dry ammonia, the pentamine absorbs the gas rapidly, and yields a liquid approximately of the composition of **boron pentadecamminotriiodide**, $\text{BI}_3 \cdot 15\text{NH}_3$; but even at 0° this compound is unstable, and in a current of dry air it gradually loses ammonia, and is reconverted into the original compound. According to A. Joannis, it is probable that additive compounds are not formed by the action of ammonia on boron triiodide, but rather a mixture of ammonium iodide and boramide—*vide* boron chloride. Boron triiodide reacts with warm **phosphorus** (ordinary or red) with incandescence; but H. Moissan found that with soln. of the two substances in carbon disulphide, in a closed vessel, **boron phosphoiodide**, BPI_2 , is formed; he also found that boron triiodide dissolves in liquid **phosphorus trichloride** or in liquid **arsenic trichloride**. A. Besson said that boron triiodide forms a crystalline compound with **phosphine**. H. Moissan found boron triiodide reacts vigorously with **phosphoryl chloride**. Boron triiodide is readily soluble in **carbon disulphide**, in **carbon tetrachloride**, and in **benzene**. Absolute **alcohol** reacts thus: $6\text{C}_2\text{H}_5\text{OH} + 2\text{BI}_3 = 2\text{H}_3\text{BO}_3 + 6\text{C}_2\text{H}_5\text{I}$; **ether** reacts: $3(\text{C}_2\text{H}_5)_2\text{C} + \text{BI}_3 = 3\text{C}_2\text{H}_5\text{I} + \text{B}(\text{OC}_2\text{H}_5)_3$. Most ethers, carbohydrates, and ammonium-bases react vigorously with boron triiodide.

According to H. Moissan, boron triiodide can be distilled unchanged from **sodium**, but at a red heat there is a reaction; **magnesium** acts at 500° with incandescence; **silicon** is not attacked at a dull red heat; **aluminium**, and **silver** do not react with boron triiodide at 500°; but **silver fluoride** reacts in the cold forming silver iodide and boron trifluoride.

REFERENCES.

¹ J. Inglis, *Phil. Mag.*, (3), 7. 441, 1835; (3), 8. 12, 191, 1836; F. Wöhler and H. St. C. Deville, *Ann. Chim. Phys.*, (3), 52. 84, 1858; H. Moissan, *Compt. Rend.*, 112. 717, 1891; 113. 624, 1891; 114. 622, 1892; A. Besson, *ib.*, 112. 1001, 1891; 114. 542, 1892; A. Joannis, *ib.*, 135. 1106, 1902.

§ 24. Boratochlorides, Boratobromides, and Boratiodides

The mineral **boracite** is comparatively rare; it was described by G. S. O. Lasius¹ in 1787 as a *cubical quartz*; in 1788, J. F. Westrumb found that it contained boric acid, magnesium, and calcium, and hence called it *Lüneberg sedative spar*; A. G. Werner named it *borazite*. L. N. Vauquelin called it *borate magnésio-calcaire*. An analysis by C. H. Pfaff in 1813 corresponded with the formula MgB_2O_4 , but it was not until 1858 that H. Rose, and W. Heintz demonstrated that magnesium chloride is an essential and not an accidental constituent. It occurs in crystals embedded in anhydrite, gypsum, or rock salt, at Kalkberg and Schildberg (Lüneberg, Hanover); Seegeberg (Kiel, Holstein); Douglasshall (Westeregeln), Leopoldshall (Stassfurt), Solvayshall (Bernburg); Luneville (La Meurthe, France); and, as shown by M. R. Campbell, among the borates of Nevada and Oregon (United States). A massive variety was called *stassfurtite* by G. Rose; it occurs in the carnallite and kainite zone of the Stassfurt salt deposits, and it may resemble fine-grained marble, or granular limestone, or it may be more or less earthy and tinted variously green, yellow, or red by impurities. The occurrence of stassfurtite has been studied by J. Nöggerath, E. Reichardt, F. Bischof, H. E. Boeke, C. J. B. Karsten, etc. Analyses of boracite crystals have been made by F. Stromeyer, J. A. Arfvedson, C. F. Rammelsberg, H. Rose, L. Potyka, W. Heintz, etc.; and analyses of stassfurtite have been made by C. J. B. Karsten, W. Heintz, C. F. Chandler, H. Ludwig, L. Potyka, H. Precht and B. Wittjen, etc. The results are best represented by the formula: $Mg_7B_{16}O_{30}Cl_2$, or $6MgO \cdot 8B_2O_3 \cdot MgCl_2$, **magnesium hexadecaboratodichloride**. F. Bischof uses $(3MgO \cdot 4B_2O_3)_2MgCl_2$ for boracite, and $(3MgO \cdot 4BO_3)(3FeO \cdot 4B_2O_3)MgCl_2$ for iron boracite. P. Groth regards boracite as a salt of diboric acid in which the two chlorine atoms are united directly to boron, and not to magnesium, $Cl.B : O_2 : B.O.Mg(O.B : O_2 : B.OMg)_6O.B : O_2 : B.Cl$. The analyses range from 58.90 to 69.77 per cent. of boric oxide; 24.93 to 33.0 per cent. of magnesia; and 9.97 to 11.75 per cent. of magnesium chloride. The ferric oxide ranges up to 1.6 per cent., and a variety with about half the magnesia replaced by ferrous oxide was called *iron boracite*, or rather *Eisenstassfurtit*, by A. Huyssen. The water in the analyses of crystals of boracite ranges up to about 2 per cent., but in the massive stassfurtite up to 11.27 per cent. has been reported. C. F. Chandler said that stassfurtite retains no water if dried at 100°. The mineral is slightly desiccant on exposure, and this led to the view discussed by F. Bischof, and A. Steinbeck that there is a hydrated boracite; the plumose interior of some crystals of boracite was called *parasite*, by G. H. O. Volger, and is probably a result of this action. L. Potyka observed the conversion of boracite to stassfurtite by the slow absorption of water.

Boracite was synthesized by L. Bourgeois, and W. Heintz by slowly cooling a molten mixture of magnesia and boric acid with a great excess of sodium and magnesium chlorides. The product is washed first with water and then with cold conc. hydrochloric acid until the prismatic crystals of magnesium borate have been removed. The product is washed and dried. A. de Gramont heated a mixture of one part of borax with two parts of magnesium chloride with a little water for 2 or 3 days in a tube at 275°–280°. G. Rousseau and H. Allaire obtained boracite by the action of the vapour of magnesium chloride on boronatrocalcite.

The crystals of boracite have attracted much attention. At first sight they appear to belong to the cubic system and to have polar ditesseral symmetry. The

ordinary form is that of a cube with an octahedron and dodecahedron; but usually, the faces of one tetrahedron are large, and those of the other small; and one is bright, and the other dull. The crystals have been studied by B. Schultze, C. Klein, H. Bücking, H. Baumhauer, O. Mügge, F. Rinne, A. Karnojitzky, etc. C. Oehsenius observed pseudomorphs of boracite after quartz. The cubic form of boracite crystals naturally suggests that the crystals will be singly refracting and optically isotropic. On the contrary, boracite exhibits an anomalous double refraction, for it is strongly doubly refracting, and exhibits brilliant polarization colours. This is not characteristic of cubic crystals. D. Brewster first established the birefringency of boracite. Between crossed nicols, the mineral sometimes appears to have a fibrous or lamellar structure. A thin slice cut parallel to one of the cube faces shows a division into four fields along the diagonals of the face, and each field exhibits an optic axis characteristic of biaxial crystals; there are also twin laminations. J. B. Biot attributed the phenomenon to the separation of the crystal into a system of plates; F. C. Naumann, G. H. O. Volger, H. Marbach, F. Klocke, and F. E. von Reusch to the existence of strains produced when boracite originally crystallized at a high temp. as a cubic mineral, and developed stresses and strains during the contraction on cooling. P. Groth pointed out that boracite is found enclosed in gypsum, a hydrated mineral which could not be formed at a high temp. except under a great press. The internal strain hypothesis is not likely in view of the fact that each portion of the crystal has a definite refraction, birefringence, and axial angle, showing that the various portions differ only in their orientation. The crystal of boracite, indeed, consists of definite individuals united by twinning on planes parallel to the dodecahedron faces of the cubic crystal. E. Mallard's hypothesis is generally accepted:

Imagine a rhombic dodecahedron to be constructed of twelve pyramids, each having a dodecahedron face for base, and its apex at the centre of the crystals. Each of these will then be one of the twelve rhombic or monoclinic individuals which form the crystal of boracite; the axial plane of each crystal will be parallel to the longer diagonal of the rhombic face, and a bisectrix perpendicular to the face; the true axial angle being about 90° , one optic axis will be perpendicular to each cube face. The interpenetrating constituent crystals meet in irregular boundaries.

E. Mallard showed that the rhombic constituents of the boracite crystals have the axial ratios $a:b:c=0.70715:1:1$. H. Baumhauer, O. B. Böggild, C. Klein, J. Beckenkamp and W. Agafonoff have also studied the twinning of boracite crystals. H. Baumhauer found the corrosion figures with a mixture of hydrochloric and sulphuric acids are in harmony with E. Mallard's hypothesis.

When a section of a crystal of boracite is heated, the birefringence of the different portions changes, as is demonstrated by the change in the interference tints; the boundaries move and often take up different positions when the section is allowed to cool. E. Mallard further showed that at 265° , all these optical differences abruptly disappear, and the crystal becomes isotropic, and is dark between crossed nicols; on cooling, the optical anomalies, complex structure, and twin lamination reappear. This shows that boracite is dimorphous, and that above 265° the crystal is isotropic and cubic; and below that temp. it is biaxial, probably rhombic. W. Schwarz gives 265.2° for the enantiotropic transition temp. F. Rinne found a greyish-green boracite with 7.9 per cent. of ferrous oxide, changed to a deep bluish-green when heated, but the green colour was restored on cooling. The transition temp. was raised 20° by the contained iron. According to R. Brauns, the doubly-refracting boracite found in salt deposits first crystallized in the cubic form below its transition temp., 265° . O. Mügge assumed that there must have been a local rise of temp. during crystallization, but R. Brauns believed that the metastable crystalline form usually separates first—*e.g.* sulphur, potassium nitrate, and mercuric iodide—and with boracite the metastable cubic form was first produced.

C. J. B. Karsten gave 2.75 for the sp. gr. of boracite; F. Bischof, 2.667; E. Reichardt, 2.38–2.458; C. F. Rammelsberg, 2.955; H. Ludwig, 2.507; C. F. Chandler,

2.994; and F. von Kobell, 2.91 before and after calcination. A. de Gramont gave 2.89 for the sp. gr. of the artificial crystals, and B. Schultze, 2.90-2.92. Boracite is harder than felspar; the hardness is 7 on Mohs' scale. W. Meyerhoffer found an increase in vol. with rise of temp. up to 255°, and from 265°-267° a decrease in vol. J. J. Berzelius found that boracite melts before the blowpipe, forming a clear glass which cools to an opaque glass with needle-like crystals; and G. Rose added that stassfurtite behaves similarly, but is rather more fusible. E. Mallard and H. le Châtelier observed a slow increase in the sp. ht. with rise of temp. up to 252°, and a rapid rise between 252° and 277°, and after that a small decrease. The mean sp. ht. of rhombic boracite, according to W. Schwarz, is 0.246, and of cubic boracite, 0.265. K. Kröker found the sp. ht. of hexahedral and of dodecahedral boracite to be:

	-32°	50°	100°	200°	270°	300°
Hexahedral .	0.1607	0.2124	0.2398	0.2901	0.2650	0.3757
Dodecahedral .	—	0.2157	0.2398	0.2901	0.2532	0.4781

The results in the former case are represented by $0.1809614 + 0.0006313844 - 0.0000004284\theta^2$; and in the latter case by $0.1809647 + 0.0006313844\theta - 0.0000004284\theta^2$. D. Brewster found the index of refraction to be 1.701. E. Mallard gave for the mean index of refraction for white light, $\alpha = 1.6622$; $\beta = 1.6670$; and $\gamma = 1.6730$. E. Marbach measured the effect of temp. and found for light $\lambda = 5016$, 1.6776 at 290°, and 1.6796 at 502°; and for $\lambda = 5873$, 1.6714 at 290° and 1.6741 at 502°. P. Gaubert measured the effect of press. on the double refraction of the crystals. R. J. Haiiy found in 1791 that when a cube of boracite is heated, it becomes positively electrified on four of its corners, and negatively on the remaining four corners. Hence if a mixture of red-lead and sulphur be blown or sieved upon the crystal, four of the corners negatively electrified will be coloured by the red-lead as the crystal cools, and the other four corners will be coloured by the sulphur. The subject has been further studied by F. Köhler, W. Hankel, P. T. Ries and G. Rose, E. Marbach, C. Friedel and J. Curie, A. Kundt, and W. C. Röntgen. K. Mack showed that the pyroelectrical behaviour disappears at 265°, and is mainly developed along certain lines which traverse the surface of the crystal, and that these are the lines of contact of the twelve sub-individuals whose existence is indicated by the optical properties of the crystal. J. and P. Curie found that piezoelectrical properties are developed in crystals of boracite such that cooling and compression develop the same electrification at the same corners of the crystal. Theoretical explanations of the optical behaviour of the crystals based on the arrangement of the structural units in the space lattice have been investigated by E. Mallard, and J. Beckenkamp. H. Haga and F. M. Jäger found that the X-radiograms of boracite above and below the transition point are identical within the limits of experimental error.

A. Kenngott found that powdered boracite, both before and after calcination, is very sparingly soluble in water, to which it imparts an alkaline reaction. W. Heintz, H. Ludwig, and H. Rose showed that the contained chloride cannot be removed from boracite by washing. J. H. van't Hoff has investigated the paragenesis of boracite. K. Kraut found that boracite is slowly soluble in acids; and F. Bischof made a similar observation with respect to stassfurtite. K. Kraut also found that when boiled with a soln. of ammonium chloride, an amount of ammonia is evolved eq. to the contained magnesium oxide.

G. Rousseau and H. Allaire prepared a series of boratochlorides, isomorphous with boracite, by the action of the vapours of metallic chlorides on native calcium borate or boronatrocalcite. The products contained 0.8 to 1.2 per cent. of calcium as impurity. The results with borax in place of the calcium borate were unsatisfactory. W. Heintz's and A. de Gramont's methods for boracite also gave negative results except in the case of zinc. The oxychloroborates are not obtained by the action of the vapours of the metallic chlorides on boracite. If calcium borate or boronatrocalcite be freed from sodium, it does not yield

oxychloroborates, showing that the sodium borate is probably converted into the chloride, which then acts as an *agent minéralisateur*. H. Allaire considered that the best way of preparing boracite consists in passing hydrogen chloride over the amorphous borate at a dull red heat. The product is well crystallized. All the chloroborates crystallize in cubes, tetrahedra, and dodecahedra, and they have the pseudo-cubic symmetry and optical characters of natural boracite. The general formula is $6MO.8B_2O_3.MCl_2$, where M stands for an atom of the bivalent element. *Zinc-boracite*, or **zinc hexadecaboratodichloride**, is obtained by the action of the vapour of zinc chloride on borax at a dull red heat; by adding boric acid and a little borax to a fused mixture of zinc and sodium chlorides; and by the wet processes used by W. Heintz, and A. de Gramont for boracite. The salt forms colourless tetrahedra and dodecahedra, of sp. gr. 3.48; and they are very stable. Colourless crystals—chiefly cubes with some tetrahedra and dodecahedra—of *cadmium-boracite*, or **cadmium hexadecaboratodichloride**, were obtained by passing dry chlorine over an intimate mixture of boronatrocalcite and the finely divided metal at a red heat. T. J. Herapath obtained **lead boratodichloride**, $PbCl_2.Pb(BO_2)_2.H_2O$, by mixing conc. soln. of borax, and lead chloride, washing the product with warm water, and drying it over sulphuric acid. The microscopic needles lose water at 200° ; and are hydrolyzed by hot water. Yellow tetrahedra and dodecahedra of *nickel-boracite*, or **nickel hexadecaboratodichloride**, were obtained in a similar way. The corresponding *cobalt-boracite*, or **cobalt hexadecaboratodichloride**, forms tetrahedra and cubes which are violet by reflected and green by transmitted light. White cubes of *manganese-boracite*, or **manganese hexadecaboratodichloride**, were formed by the action of chlorine on a mixture of boronatrocalcite and manganese carbide, the product being purified by treatment with conc. hydrochloric acid, and any carbon being separated by means of bromoform and methylene iodide. The case of iron presents special difficulties, because ferrous chloride is not volatile at a sufficiently low temp. Good results are, however, obtained by passing the vapour of ferric chloride over an intimate mixture of calcium borate with a large excess of small pieces of wrought-iron or of steel wire, the mixture being heated at about 330° . Ferrous chloride is formed, and immediately reacts with the borate. The excess of ferrous chloride is dissolved by means of water, and the unattacked iron is easily separated. The *ferrous-boracite*, or **ferrous hexadecaboratodichloride**, so produced forms greyish transparent crystals; it dissolves slowly in nitric acid, and is rapidly decomposed by fused alkali carbonate. T. J. Herapath made fine acicular crystals of monohydrated **lead diboratodichloride**, $PbCl_2.Pb(BO_2)_2.H_2O$, by the action of a conc. soln. of borax on one of lead chloride. The crystals are not appreciably affected by cold water, but they are decomposed by hot water and by nitric acid.

G. Rousseau and H. Allaire prepared a series of **boratobromides** or **bromoboracites** analogous to the boratochlorides, and by similar methods—by the action of bromine on a mixture of metal and boronatrocalcite. W. Heintz's method for boracite is applicable for zinc and magnesium bromoborates. The cubes, tetrahedra, and dodecahedra seem to have the pseudo-cubic symmetry characters of boracite; they have the same general formula, $6MO.8B_2O_3.MBr_2$. Colourless crystals of **magnesium hexadecaboratodibromide** are formed by the action of the vapour of magnesium bromide on calcium borate heated to redness in an atm. of carbon dioxide; **zinc, cadmium, and manganese hexadecaboratodibromides** form white crystals; **ferrous hexadecaboratodibromide** forms greyish-white cubes and octahedra, and is obtained by passing bromine over an intimate mixture of boronatrocalcite with iron wire heated to redness. The crystals are larger the higher the temp., and are mixed with black prisms of ferric borate which can be removed by treatment with cold, conc. hydrochloric acid. Iron boratobromide dissolves slowly in warm nitric acid. The corresponding **cobalt hexadecaboratodibromide** is green by transmitted light, and violet by reflected light; while **nickel hexadecaboratodibromide** is yellow.

H. Allaire prepared a number of **boratiodides**, or **iodoboracites**, by fusing mol.

proportions of the iodides of sodium and of the metal chosen with boric acid and a small quantity of borax, in a steel crucible on to which is fitted a cover furnished with a small iron exit-tube; this is necessary in order to prevent aq. vapour from the furnace coming into contact with the contents of the crucible. They are analogous with natural boracite in composition and crystalline habit. The general formula is $6MO.8B_2O_3.MI_2$. **Magnesium hexadecaboratodiiodide** is obtained only with difficulty by passing the vapour of magnesium iodide over heated magnesium borate; it is also formed, but in an impure state, by the action of iodine on a mixture of magnesium and its borate heated in an atm. of hydrogen; it forms colourless cubes and tetrahedra. The **zinc hexadecaboratodiiodide** is, however, readily prepared by passing a stream of carbon dioxide laden with iodine vapour over a heated mixture of zinc and zinc borate; the **cadmium hexadecaboratodiiodide** and **manganese and iron hexadecaboratodiiodides** are prepared similarly, and closely resemble the zinc derivative, but the **nickel hexadecaboratodiiodide** is yellow, and the **cobalt hexadecaboratodiiodide**, violet in colour.

H. le Chatelier,² and L. Ouvrard prepared a series of boratochlorides and boratobromides of the alkaline earths by fusing together different proportions of boric oxide and the calcium halide in varying proportions with or without lime. He was unable to make the corresponding boratiodides. When mixtures of a mol of boric oxide and two mols of calcium iodide are fused with varying proportions of lime, crystals of calcium borate are produced with $CaO:B_2O_3$ in the molar ratios 1:1, 2:1, and 3:1. A. Ditte was also unable to make iodo-apatites by means of the iodides of the alkaline earths owing to their ready decomposition; he had better success with the double iodides of the alkalis and alkaline earths.

According to H. le Chatelier, when a mixture of boric and calcium oxides in any proportion is projected into fused calcium chloride, the mass becomes incandescent, a clear soln. is formed which then becomes turbid owing to the separation of triclinic crystals of **calcium orthoboratodichloride**, $Ca_3(BO_3)_2.CaCl_2$. This compound was also made by L. Ouvrard: it is slowly decomposed by alcohol, and rapidly by water and moist air. L. Ouvrard melted a mixture of 0.5 mol of calcium oxide, one mol of boric oxide, and 5 mols of calcium chloride; and obtained arborescent masses of granular crystals of **calcium trimetaboratodichloride**, $3CaO.3B_2O_3.CaCl_2$, or $3Ca(BO_2)_2.CaCl_2$. The same compound is obtained by fusing one part of boric oxide with 8 parts of calcium chloride. The salt is feebly active towards polarized light, and is rendered opaque by water. Lamellæ of calcium borate, $Ca_2B_2O_5$, active towards polarized light, are formed at the same time. L. Ouvrard prepared needles or prisms of **calcium decaboratodichloride**, $3CaO.5B_2O_3.CaCl_2$, showing a feeble longitudinal extinction. The salt is scarcely affected by water or dil. acetic acid, but dissolves in dil. mineral acids. When a mixture of boric oxide and strontium chloride, with or without the addition of not more than one mol of strontia per mol of boric oxide, is fused, long needles of **strontium decaboratodichloride**, $3SrO.5B_2O_3.SrCl_2$, are formed. If the proportion of strontia be increased borates are formed. The crystals show longitudinal extinction, and are unaltered by water or cold dil. acetic acid. L. Ouvrard prepared **barium decaboratodichloride**, $3BaO.5B_2O_3.BaCl_2$, in an analogous manner; he also obtained **calcium decaboratodibromide**, $3CaO.5B_2O_3.CaBr_2$, by fusing a mixture of boric anhydride (1 mol) with calcium bromide (2 mols), with or without the addition of lime (not more than 0.5 mol); it forms needles or prisms showing longitudinal extinction, almost insoluble in dil. acetic acid, but soluble in mineral acids; when the quantity of lime is increased to 1 mol., **calcium trimetaboratodibromide**, $3CaO.3B_2O_3.CaBr_2$, is formed as transparent octahedra or arborescent, crystalline masses, feebly active towards polarized light, very sparingly soluble in water, but readily so in dil. acetic acid; if, however, the proportion of lime be increased to 2 mols or 3 mols, crystals of calcium borate, $2CaO.B_2O_3$, or $3CaO.B_2O_3$, are respectively obtained. L. Ouvrard likewise prepared **strontium decaboratodibromide**, $3SrO.5B_2O_3.SrBr_2$; and **barium decaboratodibromide**, $3BaO.5B_2O_3.BaBr_2$.

REFERENCES.

- ¹ G. S. O. Lasius, *Crell's Ann.*, ii, 333, 1787; J. F. Westrumb, *Kleine physikalische-chemische Abhandlungen*, Leipzig, 3, 167, 1789; A. G. Werner, *Berg. Journ.*, 393, 1789; 234, 1790; G. H. O. Volger, *Versuch einer Monographie des Borazite*, Lüneburg, 1855; *Pogg. Ann.*, 92, 77, 1854; G. Rose, *ib.*, 97, 632, 1856; *Zeit. deut. geol. Ges.*, 8, 156, 1857; W. Heintz, *Sitzber. Akad. Berlin*, 466, 1860; *Zeit. Nat. Ver. Halle*, 11, 265, 1858; 13, 1, 1859; 16, 121, 1860; *Journ. prakt. Chem.*, (1), 76, 243, 1858; (1), 77, 338, 1859; *Pogg. Ann.*, 110, 613, 1860; P. T. Ries and G. Rose, *ib.*, 59, 376, 1843; F. E. von Reusch, *ib.*, 147, 307, 1872; C. F. Rammelsberg, *ib.*, 49, 445, 1840; H. Rose, *ib.*, 80, 282, 1850; L. Potyka, *ib.*, 107, 433, 1859; A. Steinbeck, *Zeit. Ges. Nat. Halle*, 25, 397, 1865; *Pogg. Ann.*, 125, 68, 1865; C. J. B. Karsten, *ib.*, 70, 557, 1847; *Sitzber. Akad. Berlin*, 337, 1847; F. Stromeyer, *Gilbert's Ann.*, 48, 215, 1814; F. Köhler, *Pogg. Ann.*, 17, 150, 1829; W. Hankel, *ib.*, 50, 471, 1840; 61, 282, 1844; *Abhand. Ges. Wiss. Leipzig*, 4, 151, 1859; J. A. Arfvedson, *Ver. Akad. Handl. Stockholm*, 92, 1822; H. Rose, *Journ. prakt. Chem.*, (1), 76, 244, 1858; H. Ludwig, *Arch. Pharm.*, (2), 96, 129, 1858; (2), 97, 150, 1859; (2), 98, 129, 1859; K. Kraut, *ib.*, (2), 111, 101, 1862; A. Huyssens, *Neues Jahrb. Min.*, 329, 1865; A. Kennigott, *ib.*, 436, 1867; E. Reichardt, *ib.*, 333, 1866; B. Schultze, *ib.*, 844, 1871; C. Klein, *ib.*, ii, 209, 1880; i, 239, 1881; i, 235, 1884; *Nachr. Gott.*, 469, 1844; O. Mügge, *Centr. Min.*, 504, 1921; *Neues Jahrb. Min.*, i, 251, 1889; F. Klocke, *ib.*, i, 53, 1880; E. Geinitz, *ib.*, 484, 1876; F. Rinne, *ib.*, ii, 108, 1900; C. Ochsensius, *ib.*, i, 271, 1889; H. E. Boeke, *Centr. Min.*, 535, 1910; H. Bücking, *Centr. Akad. Berlin*, 533, 1895; *Zeit. Kryst.*, 15, 573, 1889; H. Baumhauer, *Die Resultate der Aetzmethode in der kristallographische Forschung*, Leipzig, 1894; *Zeit. Kryst.*, 3, 332, 1879; J. Beckenkamp, *ib.*, 14, 379, 1888; 34, 569, 1901; 44, 583, 1908; P. Groth, *ib.*, 9, 405, 1885; O. B. Böggild, *ib.*, 50, 417, 1912; K. Mack, *ib.*, 8, 503, 1884; M. R. Campbell, *Bull. U.S. Geol. Sur.*, 22, 1902; A. Karnojitzky, *Proc. Russ. Min. Soc.*, 33, 1895; H. Haga and F. M. Jäger, *Proc. Acad. Amsterdam*, 22, 725, 1914; J. H. van't Hoff, *Zur Bildung der ozeanischen Salzablagerungen*, Braunschweig, 2, 63, 1909; W. Meyerhoffer, *Zeit. phys. Chem.*, 29, 661, 1899; R. J. Haiüy, *Mem. Inst.*, 1, 49, 1791; A. Kundt, *Wied. Ann.*, 20, 592, 1883; W. C. Röntgen, *ib.*, 19, 513, 1883; J. J. Berzelius, *The Use of the Blowpipe in Chemical Analysis*, London, 1822; L. Bourgeois, *Reproduction artificielle des minéraux*, Paris, 155, 1884; H. Marbach, *Pogg. Ann.*, 94, 412, 1855; E. Marbach, *Beitrag zur Kenntnis der optischen Verhältnisse von Flussspat, Steinsalz, Stylovin, Kalkspat, Aragonit und Borazit*, Weida i. Th., 1913; J. B. Biot, *Mémoire sur la polarisation lamellaire*, Paris, 1841; R. Brauns, *Die optischen Anomalien der Krystalle*, Leipzig, 1891; *Centr. Min.*, 225, 1921; D. Brewster, *Edin. Phil. Journ.*, 5, 217, 1821; F. C. Naumann, *Die Gesetze der Doppelbrechung des Lichts in comprimierten unkrystallinischen Körpern*, Berlin, 1843; W. Agafonoff, *Russ. Assoc. Science*, 8, 15, 1890; F. von Kobell, *Sitzber. Akad. München*, 1, 1878; W. Schwarz, *Beiträge zur Kenntnis der Umwandlungen polymorpher Körper*, Göttingen, 1892; C. H. Pfaff, *Schweigger's Journ.*, 8, 131, 1813; J. Nöggerath, *Niederrh. Ges. Nat.*, 1, 1864; D. Brewster, *Treatise on New Philosophical Instruments*, Edinburgh, 1913; *Quart. Journ. Science*, 22, 355, 1827; F. Bischof, *Die Steinsalzwerke bei Stassfurt*, Halle, 1864; C. F. Chandler, *Miscellaneous Chemical Researches*, Göttingen, 1857; L. N. Vauquelin, *Bull. Soc. Philom.*, 1, 92, 1802; *Nicholson's Journ.*, 2, 120, 1802; H. Precht and B. Wittgen, *Ber.*, 14, 2134, 1881; K. Kröker, *Gött. Nachr.*, 122, 1892; E. Mallard, *Bull. Soc. Min.*, 2, 214, 1882; 6, 129, 1883; *Ann. Mines*, (7), 10, 60, 1876; (8), 12, 427, 460, 1887; *Compt. Rend.*, 105, 1260, 1887; E. Mallard and H. le Chatelier, *Bull. Soc. Min.*, 6, 122, 1884; P. Gaubert, *ib.*, 25, 154, 1902; A. de Gramont, *ib.*, 13, 245, 1890; *Compt. Rend.*, 111, 43, 1890; G. Rousseau and H. Allaire, *ib.*, 116, 1195, 1445, 1894, 1893; 118, 1255, 1894; 119, 71, 1894; H. Allaire, *ib.*, 127, 555, 1898; J. and P. Curie, *ib.*, 91, 294, 383, 1880; *Bull. Soc. Min.*, 3, 40, 1880; C. Friedel and J. Curie, *ib.*, 6, 191, 1883; *Compt. Rend.*, 97, 61, 1883; P. Groth, *Tabellarische Uebersicht der Mineralien*, Braunschweig, 1898; T. J. Herapath, *Phil. Mag.*, (3), 34, 375, 1849.
- ² L. Ouvrard, *Compt. Rend.*, 141, 351, 1023, 1905; 142, 281, 1906; A. Ditte, *ib.*, 96, 1226, 1883; H. le Chatelier, *ib.*, 99, 276, 1884.

§ 25. Boron Sulphides

J. J. Berzelius,¹ observed that boron burns when heated to redness in sulphuric acid vapour, forming a white deposit on the sides, and a grey deposit on the bottom of the containing vessel. The white powder is boron trisulphide, B_2S_3 , and the grey deposit is a mixture of this and uncombined boron. If the boron be merely heated until it takes fire, and no further application of heat is made, the sulphide which is formed contains an excess of sulphur. When sulphur and boron are melted together, the excess of sulphur can be distilled from the olive-green mixture. H. Moissan pointed out that at 610° , when the combustion is very vigorous, the boron sulphide coats the boron protecting it from further action so that the transformation is incomplete. This was also emphasized by G. Gustavson.

F. Wöhler and H. St. C. Deville, P. Sabatier, and H. Gautier, heated the boron in a stream of hydrogen sulphide. N. D. Costeanu placed the boron in a small boat in a porcelain tube fitted in a tube furnace, Fig. 33. Each end of the porcelain tube is cemented to a wider glass tube; glass plates, *G*, *H*, are cemented to the free ends of the glass tubes so that the inner tube is visible from end to end. The ends of the porcelain tube are cooled by coils of lead tubing, *A*, *B*, through which cold water flows. One glass tube has a side tube through which the thoroughly dried mixture of hydrogen and hydrogen sulphide can be passed. The other end is fitted with glass bulbs, *C*, *D*, *E*, and with a calcium chloride tower, *F*. The apparatus is first dried and cleansed from air by a stream of dry hydrogen; the temp. then raised to 1500°, and the mixture of hydrogen sulphide and hydrogen introduced. The speed of the current of gas should be sufficient to allow some crystals of the sulphide to deposit near *A*, and a white powder collects in the bulbs *C*, *D*, and *E*. If too much hydrogen sulphide be used, the tube will be obstructed by the decom-

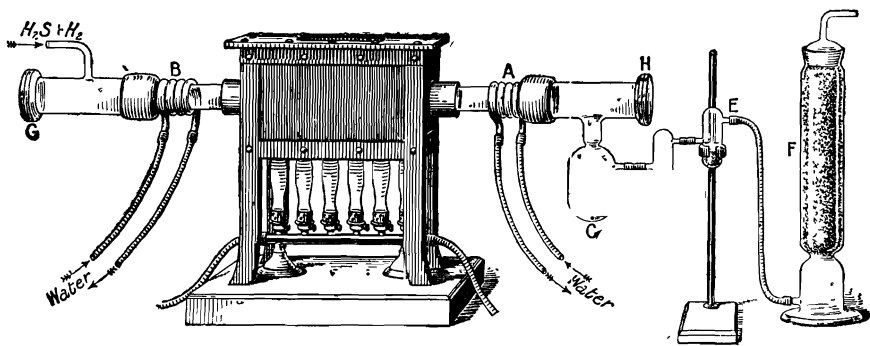

FIG. 33.—The Preparation of Boron Trisulphide.

position of impure sulphide; consequently the hydrogen sulphide must be largely diluted with hydrogen.

H. Moissan passed the vapour of dried carbon disulphide over boron at a bright red heat, and found that carbon is deposited in the tube while the boron sulphide volatilized. J. Hoffmann suggested a cheap method of preparing boron sulphide by passing hydrogen sulphide over commercial manganese or iron boride at 630°–640°, and washing away the excess of sulphur with carbon disulphide. The ferroboron is more rapidly decomposed and gives a better yield than the mangano-boron. In both cases, only a portion of the contained boron is converted into sulphide. F. Wöhler and H. St. C. Deville made the sulphide by melting boron with lead sulphide: $3\text{PbS} + 2\text{B} = \text{B}_2\text{S}_3 + 3\text{Pb}$, and H. Moissan found that the sulphides of zinc, arsenic, or antimony acted in an analogous manner at a red heat. E. Frémy, and M. Skoblikoff passed carbon disulphide over boric oxide or a borate mixed with carbon and heated to a high temp.; H. Moissan passed a stream of hydrogen sulphide over amorphous boron heated on a gradually rising temp. to 400° so as to expel the excess of sulphur; and A. Stock and O. Poppenberg obtained boron sulphide by passing a mixture of hydrogen and boron chloride through a tube at a dull red heat; and also by heating sulphometaboric acid, HBS_2 , to 300°.

Boron sulphide as a white microcrystalline powder; when sublimed it furnishes white needle-like crystals which, according to E. Frémy, have a sulphurous smell, and affect the eyes. H. Moissan said that the sp. gr. is 1.55; and the m.p., 310°. The molten sulphide solidifies to a glassy mass which, when exposed to air, is more stable than the ordinary form. Boron sulphide volatilizes when heated in a stream of inert gas; P. Sabatier detected volatilization in hydrogen at 300°. The heat of formation, determined by P. Sabatier, is $(2\text{B}, 3\text{S}) = 82.6$ Cals.; A. Stock and O. Poppenberg gave $2\text{BCl}_3 + 3\text{H}_2\text{S} = 6\text{HCl} + \text{B}_2\text{S}_3 - 31.1$ Cals.; and $2\text{BBr}_3 + 3\text{H}_2\text{S}$

$=6\text{HBr} + \text{B}_2\text{S}_3 + 10.9 \text{ Cals.}$ P. Sabatier gave for the heat of decomposition in water $\text{B}_2\text{S}_3 + 6\text{H}_2\text{O}_{\text{liquid}} = 2\text{H}_3\text{BO}_{3\text{soln.}} + 3\text{H}_2\text{S}_{\text{soln.}} + 57.8 \text{ Cals.}$

E. Frémy noted that a little sulphur is given off when boron sulphide is heated in **hydrogen**. P. Sabatier said that boron sulphide is dissociated in hydrogen at temp. exceeding 300° , forming hydrogen sulphide and boron subsulphide, B_4S . There is some doubt about this because H. Moissan said that, at a red heat, boron trisulphide is not affected by this gas. H. Moissan found that boron sulphide burns with a green flame when heated in **oxygen**, and boric oxide is formed. Boron sulphide absorbs moisture from the air with extreme rapidity, but the glassy form is less speedily affected by moist air. J. J. Berzelius, P. Sabatier, and H. Moissan have emphasized how violently boron sulphide reacts with **water**, forming hydrogen sulphide and boric acid. When the grey sulphide is treated with water, J. J. Berzelius noted that non-sulphurized boron collects as a sediment, while the sulphide with an excess of sulphur deposits milk of sulphur. J. Hoffmann showed that the glassy sulphide is also vigorously attacked by water. According to H. Moissan, boron trisulphide inflames in **chlorine** in the cold, forming boron trichloride and sulphur tetrachloride; if warmed a little, it also reacts with **bromine**, forming boron tribromide and sulphur tetrabromide; but it does not react with melted **iodine**; P. Sabatier said that at a dull red heat boron triiodide is formed. According to H. Moissan, **hydrogen chloride** transforms boron trisulphide at 400° into boron trichloride and hydrogen sulphide; **hydrogen iodide** has no action under these conditions, **sulphur** dissolves in boron trisulphide and some pentasulphide is formed—*vide infra*; boron sulphide forms a complex with **sulphur chloride**; at a red heat, it is not affected by **nitrogen**.

According to H. Moissan, dry **ammonia** is rapidly absorbed with the development of heat, and a yellow powder is formed which becomes white when the temp. is raised, and which with potassium hydroxide gives off ammonia. A. Stock and M. Blix said that if ammonia be liquefied over sulphometaboric acid, HBS_2 , and shaken for some hours, a deep yellow soln. is formed; if the ammonia be evaporated at 0° a yellow liquid remains, which at ordinary temp. gives off ammonia and hydrogen sulphide, forming a solid, possibly **boron hexamminotrisulphide**, $\text{B}_2(\text{NH}_3)_6\text{S}_3$ —perhaps identical with H. Moissan's yellow powder. At 104° , it decomposes, thus $\text{B}_2\text{S}_3.6\text{NH}_3 = 3\text{NH}_4\text{SH} + \text{B}_2(\text{NH})_3$. The reaction with water is not particularly violent, and a yellow soln. is formed. A. Joannis said that the product of the action of ammonia on boron trisulphide is probably a mixture of ammonium hydro-sulphide and boramide—*vide boron trichloride*—but A. Stock and M. Blix say that this cannot be the case because it does not lose ammonium sulphide by volatilization at ordinary temp.; it dissolves completely in liquid ammonia, and does not leave a residue of the insoluble borimide.

H. Moissan said that boron trisulphide burns in **nitrogen peroxide**, forming boric oxide and sulphur; it does not react with **phosphorus** at a red heat; it unites with **phosphorus and arsenic chlorides**, forming double chlorides; it is very soluble in phosphorus trichloride, and the soln. deposits fine needle-like crystals—its solubility in phosphorus trichloride is augmented in the presence of sulphur chloride, and the soln. also yields separations such as occur when sulphur chloride is absent. Boron trisulphide does not react with **carbon** or **silicon** at a red heat. N. D. Costeau said that **carbon dioxide** commences to act on boron sulphide at about 300° , the reaction is faster at higher temp.; sulphur, carbon monoxide, and boric oxide are formed: $\text{B}_2\text{S}_3 + 3\text{CO}_2 = 3\text{CO} + 3\text{S} + \text{B}_2\text{O}_3$. H. Moissan said that boron sulphide decomposes **alcohol** and **ether**; and **organic compounds** generally react with boron trisulphide giving off hydrogen sulphide. It is, however, insoluble in most of the recognized solvents. The metals **potassium, sodium, magnesium, and aluminium** decompose boron sulphide, forming the metal sulphide, and may be the metal boride; but **copper, silver, zinc, mercury, and iron** do not react.

P. Sabatier found that if boron trisulphide be heated to 300° at one end of a sealed tube, while the other end is cooled by water, boron trisulphide first forms a sublimate

of long needles, and behind this appear drops of a colourless liquid which, when cooled for some hours, forms white masses which he considers to be **boron hydro-sulphide**, $B(SH)_3$, or $3H_2S \cdot B_2S_3$. A. Stock and O. Poppenberg passed a current of dried hydrogen sulphide into a carbon disulphide or benzene soln. of boron tribromide. The evolution of hydrogen bromide begins at once, but the later stages of the reaction are so slow that it requires about 6 days in order to ensure the complete expulsion of all the bromine as hydrogen bromide. A. Stock and M. Blix suppose the reaction occurs in two stages: (i) A quick reaction between the boron bromide and hydrogen sulphide, forming boron sulphobromide; and (ii) a slow decomposition of the sulphobromide by the hydrogen sulphide. On evaporation of the remaining liquid, long, white, needle-like crystals are obtained. Analyses and mol. wt. determinations in benzene soln. agree with **sulphometaboric acid**, $B_2S_3 \cdot H_2S$, or $BS(HS)$, or HBS_2 . The compound was also made by J. Hoffmann. It begins to melt in a sealed tube at 120° , and is quite fluid at 135° – 140° ; it freezes to a white crystalline mass on cooling. The compound is sparingly soluble in carbon disulphide at -20° , but at ordinary temp., 100 parts of benzene or of carbon disulphide dissolve 20 parts of the compound. Sulphometaboric acid smells of hydrogen sulphide, and it slowly loses the last-named gas at ordinary temp. and press., the action is faster in vacuo over sulphuric acid, and faster still if heat be applied—boron trisulphide remains. Water vigorously decomposes the compound into hydrogen sulphide and boric acid; hydrogen sulphide is also evolved when in contact with alcohol and ether—a compound appears to be also formed in the last-named reaction.

A. Stock and M. Blix prepared double compounds of boron sulphide with boron chloride and bromide, by dissolving sulphometaboric acid in an excess of the boron halide, and evaporating to dryness in vacuo. Analyses agree with **boron sulphochloride**, $B_2S_3 \cdot BCl_3$, or $BSCl$, and with **boron sulphobromide**, $B_2S_3 \cdot BBr_3$, or $BSBr$. These compounds are decomposed into their components by heat; and when boiled with carbon disulphide the boron halide is given off.

According to H. Moissan, **boron pentasulphide**, B_2S_5 , is obtained by heating boron iodide (20 grms.) with sulphur (rather less than one eq.) in carbon disulphide soln. for 24 hrs. at 60° . The precipitated product is washed with carbon disulphide to remove the iodine. The pentasulphide appears to form a sparingly soluble additive compound with iodine; it cannot therefore be washed quite free from iodine. Boron pentasulphide is a white crystalline powder of sp. gr. 1.85, and m.p. 390° ; it is hydrolyzed by water into boric acid, hydrogen sulphide, and sulphur, and resembles the trisulphide in its behaviour with alcohol, the excess of sulphur separating in the free state. It dissociates into the trisulphide and sulphur when heated to its m.p. in a vacuum, and is decomposed in a similar manner when heated with mercury or silver, a sulphide of the metal being formed. It is converted by aq. potassium hydroxide into potassium borate and polysulphide, and is acted on by chlorine at a low temp. with the formation of an unstable crystalline substance. If the individuality of boron pentasulphide be established, it would indicate that boron can function as a quinquivalent element.

REFERENCES.

- ¹ J. J. Berzelius, *Pogg. Ann.*, **2**, 113, 1819; L. Gmelin, *Schweigger's Journ.*, **15**, 245, 1815; H. Davy, *Phil. Trans.*, **99**, 75, 1809; H. Moissan, *Compt. Rend.*, **114**, 617, 1892; **115**, 203, 271, 1892; P. Sabatier, *ib.*, **112**, 862, 1891; *Bull. Soc. Chim.*, (3), **6**, 215, 1891; E. Frémy, *Ann. Chim. Phys.*, (3), **38**, 312, 1853; *Compt. Rend.*, **35**, 27, 1852; **36**, 178, 1853; *Chem. Gaz.*, **11**, 261, 1853; M. Skoblikoff, *ib.*, **12**, 289, 1854; *Bull. Acad. St. Petersburg*, **12**, 319, 1854; G. Gustavson, *Ber.*, **6**, 10, 1873; *Zeit. Chem.*, (2), **7**, 418, 1871; C. Schultz-Sellac, *ib.*, (2), **7**, 315, 1871; *Ber.*, **4**, 15, 1872; J. Hoffmann, *Zeit. angew. Chem.*, **19**, 1363, 1906; *Zeit. anorg. Chem.*, **59**, 127, 1908; **66**, 364, 1910; F. Wöhler and H. St. C. Deville, *Ann. Chim. Phys.*, (3), **52**, 90, 1858; H. Gautier, *ib.*, (7), **13**, 352, 1899; *Compt. Rend.*, **129**, 595, 1899; A. Joannis, *ib.*, **135**, 1106, 1902; N. D. Costeau, *ib.*, **157**, 934, 1913; *Ann. Chim. Phys.*, (10), **2**, 189, 1914; *Étude de l'action du gaz carbonique sur les sulfures minéraux*, Paris, 1914; A. Stock and M. Blix, *Ber.*, **34**, 3039, 1901; **36**, 319, 1903; A. Stock and O. Poppenberg, *ib.*, **34**, 399, 1901.

§ 26. Boron Sulphates

According to G. Gustavson,¹ boron chloride or bromide reacts with sulphur trioxide in a sealed tube at 120°: $2\text{BCl}_3 + 4\text{SO}_3 = 3\text{SO}_2\text{Cl}_2 + \text{B}_2\text{O}_3\cdot\text{SO}_3$. The white product was not analyzed; it reacts with water, forming boric and sulphuric acids, and when heated in a platinum dish, sulphur trioxide is evolved, and boric oxide remains. The compound has the composition $\text{B}_2\text{O}_3\cdot\text{SO}_3$, and it may be regarded as **boryl sulphate**, $\text{O}:\text{B.O.B}:\text{SO}_4$, or $\text{SO}_2(\text{OBO})_2$. Neither R. F. d'Arcy nor A. Pictet and G. Karl could obtain a compound of sulphur and boron trioxide by heating a mixture of the two in open vessels; but the latter obtained boryl sulphate by heating a mixture of boron and sulphur trioxides in a sealed tube at 115°–120°. By working at 230°, **boryl disulphate**, $\text{B}_2\text{O}_3\cdot 2\text{SO}_3$, or $\text{BO.O.SO}_2\text{O.SO}_2\text{O.BO}$, is formed, and mixtures of the two are obtained at intermediate temp. Both compounds are colourless, amorphous, bulky, brittle, hygroscopic substances, which have no definite m.p., do not fume in moist air, but dissociate when heated, leaving eventually residues of boron trioxide. They dissolve in water, yielding soln. of boric and sulphuric acids. Boryl disulphate reacts with alcohol to form alkyl borates and alkyl-sulphuric acids.

H. Bauer and J. Gyiketta prepared what appeared to be boryl sulphates, $\text{M}'(\text{BO})\text{SO}_4$, under the trade name *borol*, by gradually adding an eq. of boric acid to an eq. of a fused metal hydrosulphate—e.g. KHSO_4 , or NaHSO_4 —and heating the mixture to 500°; or by similarly heating a mixture of sulphuric acid, a borate, and a metal sulphate:

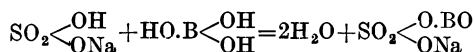

Sodium borylsulphate, $\text{Na}(\text{BO})\text{SO}_4$, is soluble in water, and the soln. has an acid reaction. The salt contains less boron than boric acid, but has greater antiseptic properties than the eq. boron; and it has been recommended as a depilatory for hides and skins.

According to H. Davy,² boron dissolves in hot sulphuric acid with a slight effervescence, forming a black liquid, which gives a black precipitate with potash-lye. The product has not been further studied. L. Gmelin found boric oxide or acid readily dissolves in sulphuric acid, especially if heated, forming a viscid coloured mass from which boric acid separates on standing. H. Schiff found that it precipitates boric acid or boric oxide. V. Merz stated that a substance with the composition $5\text{B}_2\text{O}_3\cdot 2\text{SO}_3\cdot 2\text{H}_2\text{O}$, or $5\text{B}_2\text{O}_3\cdot 2\text{H}_2\text{SO}_4$, is produced by melting equal parts by weight of boric acid and conc. sulphuric acid, and then warming the product to 250°–280° so as to volatilize the excess of sulphuric acid. A transparent glass is formed on cooling. If heated to 350°–400°, the product is not decomposed, but in some cases nearly all the sulphuric acid was driven off by this treatment. The glass becomes white and opaque on exposure to the air, and moisture is at the same time absorbed. Neither R. F. d'Arcy nor C. Schultz-Sellac could obtain V. Merz's product, for sulphur trioxide was continuously evolved on a rising temp., and the composition of the product is never constant. C. Schultz-Sellac stated that if the soln. of boric acid in sulphuric acid be treated with sulphur trioxide, or if boric oxide be dissolved in fuming sulphuric acid, crystals separate from the liquid. The composition is stated to be $\text{B}_2\text{O}_3\cdot 3\text{SO}_3\cdot \text{H}_2\text{O}$, but since sulphur trioxide is evolved when the product is melted, C. Schultz-Sellac said that the compound is not to be regarded as *boron sulphate*, $\text{B}_2(\text{SO}_4)_3\cdot \text{H}_2\text{O}$, but is rather a *boryl sulphate*, $\text{H}(\text{BO})\text{SO}_4\cdot \frac{1}{2}\text{SO}_3$. R. F. d'Arcy failed to obtain this compound, but he found that a violent reaction ensues when finely powdered boric acid is added to a large quantity of sulphur trioxide, and the whole mass liquefies. The product was heated to 100° until sulphur trioxide ceased to be evolved, and on cooling, a solid separated which when dried on porous tiles over sulphuric acid had a composition $\text{B}_2\text{O}_3\cdot 6\text{SO}_3\cdot 3\text{H}_2\text{O}$, or $\text{H}_3\text{BO}_3\cdot 3\text{SO}_3$, or $\text{B}(\text{HSO}_4)_3$, **boron hydrosulphate**. It is a white solid with a m.p. 215°; it dissolves readily in fuming sulphuric acid, and is very hygroscopic.

The mineral *sulphoborite* occurs in the Stassfurt salt beds, and was obtained along with anhydrite as a residue in the soln. of the carnallite of Westeregeln. K. Thaddéeff's analysis³ corresponds with $2\text{MgSO}_4 \cdot 2\text{Mg}_2\text{B}_2\text{O}_5 \cdot 9\text{H}_2\text{O}$, or $2\text{MgSO}_4 \cdot 4\text{MgHBO}_3 \cdot 7\text{H}_2\text{O}$, **hydrated magnesium sulphatoborate**. It forms colourless crystals, may be with a reddish tint, belonging to the rhombic system with axial ratios, according to H. Bücking, $a : b : c = 0.6196 : 1 : 0.8100$. The sp. gr. is 2.44, and the hardness over 4. The double refraction is negative, and H. Bücking's values for the indices of refraction with sodium light are $\alpha = 1.5272$; $\beta = 1.5362$; and $\gamma = 1.5443$.

REFERENCES.

- ¹ G. Gustavson, *Ber.*, 6, 10, 1873; H. Bauer and J. Gyiketta, *German Pat.*, D.R.P. 57964, 1890; *Brit. Pat. No.* 19637, 1891; A. Pictet and G. Karl, *Arch. Sciences Genève*, (4), 26, 437, 1908; *Bull. Soc. Chim.*, (4), 3, 1114, 1908; R. F. d'Arcy, *Journ. Chem. Soc.*, 55, 155, 1889.
² H. Davy, *Phil. Trans.*, 99, 75, 1809; L. Gmelin, *Schweigger's Journ.*, 15, 245, 1815; H. Schiff, *Liebig's Ann. Suppl.*, 5, 165, 1867; V. Merz, *Journ. prakt. Chem.*, (1), 99, 179, 1866; R. F. d'Arcy, *Journ. Chem. Soc.*, 55, 155, 1889; *Chem. News*, 59, 58, 1889; C. Schultz-Sellac, *Zeit. Chem.*, (2), 7, 315, 1871; *Ber.*, 4, 15, 1871.
³ H. Bücking, *Sitzber. Akad. Berlin*, 967, 1893; K. Thaddéeff, *Zeit. Kryst.*, 28, 264, 1897.

§ 27. Boron Phosphates

A. Vogel¹ prepared **boron phosphate**, BPO_4 , by the action of a boiling soln. of phosphoric acid on boric acid. The turbid liquid was evaporated to dryness, and the excess of phosphoric acid was removed by washing with hot water. G. Meyer heated the mass to redness before leaching with water, otherwise the product filters with great difficulty. G. Gustavson prepared the same compound by heating boric oxide with phosphoryl chloride, $\text{B}_2\text{O}_3 + 2\text{POCl}_3 = \text{BPO}_4 + \text{BCl}_3 \cdot \text{POCl}_3$, or boron trichloride with phosphorus pentoxide, $2\text{BCl}_3 + \text{P}_2\text{O}_5 = \text{BPO}_4 + \text{BCl}_3 \cdot \text{POCl}_3$, in a sealed tube; the residue should be calcined. Boron phosphate is a white powder which cannot be fused in the blowpipe flame. It is not decomposed by boiling water, or by conc. acids, but it is soluble in a boiling soln. of alkali hydroxide. J. Prescher said that the attack with a boiling dil. soln. of alkali hydroxide is very slow. According to G. Meyer, boron phosphate is decomposed by fused alkali hydroxides or carbonates, or by fused sodium chloride. J. Prescher represents the reaction with fused sodium hydroxide: $\text{BPO}_4 + 3\text{NaOH} = \text{NaBO}_2 + \text{Na}_2\text{HPO}_4 + \text{H}_2\text{O}$. When heated with sodium, A. Vogel obtained sodium phosphide and a black mass, probably boron phosphide. According to G. Meyer, compounds in which boron plays the rôle of base, are usually chemically inert; and J. Prescher emphasized the rôle this insoluble compound plays in the analysis of mixtures of phosphates and borates.

M. Prinvault² melted equi-molar parts of boric acid and sodium pyrophosphate, and obtained a white mass with the composition $2\text{Na}_2\text{O} \cdot \text{B}_2\text{O}_3 \cdot \text{P}_2\text{O}_5$, corresponding with **sodium borylphosphate**, $\text{Na}_2(\text{BO})\text{PO}_4$. It is decomposed by water or alcohol, forming normal sodium phosphate. The corresponding **potassium borylphosphate**, $\text{K}_2(\text{BO})\text{PO}_4$, was also prepared.

C. Nöller³ applied the term *lünebergite* to a **magnesium boratophosphate**, $3\text{MgO} \cdot \text{P}_2\text{O}_5 \cdot \text{B}_2\text{O}_3 \cdot 8\text{H}_2\text{O}$, or $\text{Mg}(\text{BO})_2 \cdot 2\text{MgHPO}_4 \cdot 7\text{H}_2\text{O}$, found in the gypsum beds of Lüneberg, Hannover. It also contains 0.7 per cent. of fluorine. The sp. gr. is said to be 2.061. It loses no water at 100° , and is soluble in nitric and hydrochloric acids. W. Biltz and E. Marcus' analysis corresponds with $\text{Mg}_3(\text{PO}_4)_2 \cdot 1.75\text{H}_3\text{BO}_3 \cdot 6\text{H}_2\text{O}$. Dehydration curves show that six mols of water are lost at 200° , and the remainder is slowly evolved at 600° . Free boric acid is not present, but microscopic examination does not determine whether the boric acid and magnesium phosphate are in solid soln.

REFERENCES.

- ¹ A. Vogel, *Zeit. Chem.*, (2), 6, 125, 1870; G. Gustavson, *ib.*, (2), 7, 417, 1871; G. Meyer, *Ber.*, 22, 2919, 1889; J. Prescher, *Arch. Pharm.*, 242, 194, 1904.
² M. Prinvault, *Compt. Rend.*, 74, 1249, 1872.
³ C. Nöller, *Sitzber. Akad. München*, 291, 1870; W. Biltz and E. Marcus, *Zeit. anorg. Chem.*, 77, 124, 1912.

CHAPTER XXXIII

ALUMINIUM

§ 1. The History of Aluminium

SUBSTANCES with a styptic or astringent taste seem to have been designated *στυπτηρία*, by the Greeks, and *alumen*, by the Romans. Herodotus,¹ circa 500 B.C., relates that Amasis, King of Egypt, contributed a thousand talents of *στυπτηρία* to the people of Delphos as a subscription to enable them to rebuild their temple which had been destroyed by fire; and Dioscorides, near the beginning of our era, mentioned a number of places from which the mineral *στυπτηρία* could be obtained; and he indicated several varieties, some of which were used in dyeing and in medicine. Aulus Gellius narrates that in the war between the Mithridates and the Romans, 87 B.C., General Archelaus made a wooden turret fireproof by smearing it over with *alumen*, so that all Sylla's attempts to set it in flames proved abortive. The use of *alumen* for fireproofing wood is mentioned later by H. J. Wecker, and by A. Marcellinus. Pliny also said that a white variety of *alumen* was used for dyeing bright colours, and a dark variety for dark colours; and that *alumen* is coloured black by the juice of the pomegranate. This may be regarded as showing that iron was probably present in *alumen*. Such information as the scholars have gleaned from the ancient writers agrees with the assumption that the different varieties of *alumen* were more or less impure mixtures of aluminium and ferrous sulphates. The derivation of *alumen* is unknown; some obtain it from *ἀλμη*; others from *ἀλειμμα*; Isidorus' suggestion that *alumen vocatur a lumine, quod lumen coloribus præstat tingendis*—*alumen* is so-called from *lumen* because it gives brilliancy to dyes—is improbable.

Pliny said that in his time Egyptian alum was accounted best; and, according to J. P. de Tournefort, and M. G. A. F. Choiseul-Gouffier, the island of Milo was celebrated on account of its *alumen*. According to Strabo, and Diodorus Siculus, the islands of Lipari and Stromboli contained so much *alumen* that the Romans derived a considerable revenue from the export duty. It is not known when the salt now called *alum* was discovered, but it was no doubt obtained from the East. This alum was regarded as a species of the ancient *alumen*, and since the new alum was better fitted for general use, the name was soon restricted to it alone. In his *De investigatione magisterii*, the, presumably, twelfth-century Geber spoke of an *alumen glaciale* obtained from Rocca, the son of Serapion, who lived after Rhazes; Geber was acquainted only with the impure *στυπτηρία* of Dioscorides, and J. Beckmann, therefore, inferred that the purer form of alum was not known before the thirteenth century. The Italians first procured their alum from the Levant, and when these countries were captured by the Turks, the Christians were compelled to purchase alum from their enemy. From F. B. Pegolotti, a writer of the fourteenth century, it appears as if the Italians at that time knew only the Turkish alum.

The Italians learned how the salt was manufactured at Rocca di Soria, but the location of this place is not clear. C. Niebuhr suggests that it is probably Edessa in Mesopotamia. Edessa was also called Roha, Raha, Ruha, Orfa, and Roccha. The new alum was at first called *rocca*, a term which the French altered to *alun de roche*, the English into *roche alum* or *rock alum*, and the Germans—e.g. M. B. Valentinus—*Rotzalun*. As V. Biringuccio has remarked, the origin of the

term *rocca* is not known. J. C. Scaliger refers it to a Greek term, because the salt was extracted from a rock *alumen rupeum*; M. Mercatus said that alum acquired the name *rocca* from the alum rocks near Tolfa; while G. W. von Leibniz said that *alumen rocca* was the kind first obtained from Rocca di Soria, and the name was afterwards given to every good species of alum, just as the purer varieties of alum to-day are called *Roman alums*.

P. Bellon has given a description of the alum-works about Constantinople in the fifteenth century; and he said that in commerce, the alum was called *alumen Lesbium* or *alumen di Metelin*. Another alum-works flourished in the fifteenth century near Phocæa Nova, *i.e.* Foya Nova near Smyrna. F. B. Pegolotti has given a description of the Eastern alum-works of the fourteenth century. According to A. Baumé, M. Ducus referred to alum from Smyrna, and the mode of manufacture was described as follows:

In Phocis, which lies close to Ionia, there is a mountain abundant in aluminous mineral. The stones found on the top of this mountain are first calcined in the fire, and then reduced to powder by being thrown into water. The water, mixed with that powder, is put into a kettle; and a little more water being added to it, and the whole having been made to boil, the powder is lixiviated, and the thick part which falls to the bottom in a cake is preserved; what is hard and earthy is thrown away as of no use. The cake is afterwards suffered to dissolve in vessels for four days; at the end of which the alum is found in crystals round their edges, and the bottoms of them also are covered with pieces and fragments of like nature. The remaining liquor, which at the end of four days does not harden, is poured into a kettle, more water and more powder are added to it, and being boiled as before, it is put into proper vessels, and the alum obtained in this manner is preserved as an article necessary for dyers.

J. J. Pontanus, P. Bizaro, A. Giustiniano, and D. Bottone state that alum was first manufactured in Europe by Bartholomew Perdix or Pernix in the island of Ischia about 1460. The earlier date, 1284, given by G. Targioni-Tozzetti, is wrong. An alum-works, north-west of Tolfa near Civita Vecchia, was founded by John di Castro between 1460-70. Pope Pius II. said: *alumen de Tolpha primum fossum est in Italia*; and he has given a minute history of the discovery; he also reported that a statue was erected with the inscription "John di Castro, the Inventor of Alum." It has been stated that the evergreen prickly shrub *Ilex aquifolium* induced John di Castro to search for alum since he considered this plant an indication of the presence of alum; but, as P. S. Boccone and G. Targioni-Tozzetti have pointed out, the plant does not always grow on alum soils, and it grows on soils where there is "not the slightest trace of alum." The Church derived a great revenue from the alum here made. A number of other Italian alum-works are mentioned by A. Baccius, V. Biringuccio, etc.; they worked in competition with the Tolfa factory, owned by the Church, but finally had to close. According to N. R. Ferosini, religion was employed as a medium to extend the trade, for a papal bull was issued by the pontiff at Rome forbidding the people to purchase alum elsewhere; even threats of excommunication were made against transgressors. A. Cesalpinus has described the manufacture of alum at the alum-works of Pope Pius II. at Tolfa. F. Bussi said that over 800 persons were employed, and he added that the alum was made in the following manner:

The stones were first calcined in a furnace; a large quantity of water was then thrown over them, and when they were dissolved, the water was boiled in great leaden cauldrons; after which it was poured into wooden vessels, where, evaporating by degrees, the result was alum of the most perfect kind.

According to V. Biringuccio, an alum-works was erected at Almacaron near Carthagenia in Spain. Spanish alum-works have been described by D. G. Bowles, and J. Dillon. J. Beckmann says that alum was made at Oberkaufungen (Hesse) in 1554; at Commotau (Bohemia) in 1558; and at Langenau (Glatz) in 1563. G. Agricola also mentions several other German works. According to G. Jars, an alum-works was erected at Andrarum (Sweden) in 1630. According to A. Anderson, the first alum-works in England was erected at Gisborough (Yorkshire) in

1608. T. Pennant said that T. Chaloner suspected the presence of alum because the trees in the district were tinged an unusual colour. The alum-works at Whitby and the vicinity have been abandoned in recent years. The original process was described by W. Simpson in his *Hydrological essayes, with a brief account of the allom works at Whitby* (London, 1670).

The *alumen* of the ancients was not the same as the ordinary *alum* of to-day; probably the former was aluminium sulphate contaminated with iron sulphate, while alum is a double salt containing potassium sulphate or an eq. sulphate. *Alumen* was classed with the vitriols—ferrous and cupric sulphates—so that in the thirteenth century alum and vitriol were regarded—by Geber, Albertus Magnus, and the alchemists—as related substances. In the sixteenth century, Paracelsus, in his *De generibus salis*, stated that alum differs from the vitriols because it takes its *corpus* from an intermixture of earths, whereas vitriol takes its *corpus* from the intermixture of metallic *corpora*—whatever that may mean! In 1684, M. Etmüller² discovered that alum is obtained by acting on clay with sulphuric acid; G. E. Stahl, 1702, and J. Juncker, 1730, believed that the unknown base of alum is a *terra calcaria* because it has the nature of lime or chalk; H. Boerhaave adopted the same view. Twenty years later, F. Hoffmann stated his opinion that the base of alum is a true, distinct earth. This view was accepted by C. J. Geoffroy in 1728; by J. Hellot in 1739; and by J. H. Pott in 1746. The last-named chemist called the base *thonichte Erde*, or *terre argilleuse*. In 1754, A. S. Marggraf showed that the earth is a definite substance *sui generis* quite different from lime, that it is contained in all natural clays, from which it can be extracted by sulphuric acid, leaving behind silica so that the purest white clay contains only silica and the earthy base of alum.

Many chemists supposed that alum earth was a variety of silica. Thus, C. W. Pörner, and A. Baumé regarded the earth of alum to be silica; common clay, to be siliceous earth; and alum, to be the same earth supersaturated with sulphuric acid. The subject was also discussed by G. L. L. de Buffon, G. K. C. Storr, J. K. F. Meyer, and J. C. Wiegleb. C. W. Scheele, however, showed that in establishing his conclusion, A. Baumé fused the silica with potassium hydroxide in a fireclay crucible, and the alum was derived from the clay of the crucible.

The presence of an alkali, as well as sulphuric acid and the earthy base, is necessary for the production of alum.

The early philosophers, R. Boyle, and N. Grew, seem to have adopted the opinion that metals could be produced from common earthy substances. J. J. Becher, and G. E. Stahl first indicated the relations of the metals to earthy substances. The term *argil* or *argil pur* was then applied to the earthy base of alum; but L. B. Guyton de Morveau argued that since alum is a *sel alumineux* the proper name for the base is *alumine*; the use of terms like *argille* and *terre argilleux* is confusing and should not be continued. The term *alumine* was thereafter employed in France, and this was anglicized to *alumina* in England, while in Germany the earth of alum is still called *Thonerde*.

Having discovered the acid and one of the bases in alum, it remained to find the second base. G. Agricola, and A. Libavius stated that the soln. from the alum-rock does not crystallize readily unless an alkali is present; and each stated that the general practice was to add decomposed urine to the soln. to facilitate crystallization, so that the alum made by G. Agricola, A. Libavius, J. Kunckel, and F. Hoffmann must have contained ammonia alum. Later, the urine was replaced by potash. Both T. Bergman and C. W. Scheele regarded the presence of potash in alum as an impurity. A. S. Marggraf and G. von Engeström showed that alum contains two bases, and this was further emphasized by A. L. Lavoisier, and A. F. de Fourcroy. L. N. Vauquelin, and J. A. C. Chaptal established by analysis that potash is an essential constituent of ordinary alum, and that that base can be replaced by ammonia; they also showed that alum can be made from alumite without adding potash because the alkali base is already present in the mineral.

In 1758, P. J. Macquer stated his belief that the earth of alum is more or less

distinctly related with the metal earths; and soon afterwards, T. Baron showed that the base of alum has some analogies with the metal earths, and has no properties in common with any other known earths. He then tried all known methods of reducing the earth to a metal, but failed. He concluded:

If I had been fortunate enough to reduce the base of alum to a metal, no other argument would be needed, and that which to-day is conjectured would be a demonstrated fact. I am far from regarding the problem as an impossibility. I think it not too venturesome to predict that a day will come when the metallic nature of the base of alum will be incontrovertably proved.

In 1782, A. L. Lavoisier said that it is highly probable that alumina is the oxide of a metal whose affinity for oxygen is so strong that it cannot be overcome either by carbon or by any other known reducing agent; and, with prophetic sagacity, he added: *Il seroit possible à la rigueur que toutes les substances auxquelles nous donnons le nom de terres, ne fussent que des oxides métalliques, irréductibles par les moyens que nous employons.* M. de Ruprecht and M. Tondi claimed to have obtained a metal from alumina by heating to a high temp. for 3 hrs., an intimate mixture of alumina and charcoal dust packed in a fireclay crucible, and filled up with charcoal and covered with a layer of bone ash. A. M. Savaresi, and M. H. Klapproth showed that the alleged metal base of alumina was really iron phosphide. There is a report in some encyclopædias that in the time of Tiberius (41 B.C. to 37 A.D.) a metal was made from clay. It was said that the metal had the appearance of, but was lighter than silver, and that it could be wrought like iron. This statement is probably founded on a misinterpretation of Pliny's ³ words—*vide* history of silica.

H. Davy ⁴ tried to isolate the metal by electrolyzing a mixture of alumina and mercuric oxide, but without result; he then passed the current through a fused mixture of alumina and potassium hydroxide, and obtained a metallic deposit which was decomposed by water giving a soln. which contained alumina. The deposit was apparently a mixture of alkali metal and aluminium, but he was unable to isolate the latter; similarly with the action of potassium on alumina. By fusing iron in an electric arc in contact with alumina, he showed that the iron is alloyed with aluminium. He obtained a similar alloy by heating a mixture of alumina, potassium, and iron filings. H. Davy added: "Had I been fortunate enough to isolate the metal after which I sought, I would have given it the name *aluminium*;" but later on, influenced by the argument that the metal should be named after the oxide, so that the stem word should be *alumin*, he used the term *aluminium*—later writers have adopted the more euphonious *aluminium*.

B. Silliman fused alumina on charcoal before the oxy-hydrogen blowpipe flame, and noted small metallic globules darting and rolling from under the fused mass, and burning with a bright light. The globules were presumably aluminium, which burnt instantly so that no globules of metal could be obtained. In 1824, H. C. Oersted reported that he had isolated aluminium by the action of potassium amalgam on aluminium chloride; and distilling the mercury from the product. It has been questioned if aluminium, or an alloy of potassium and aluminium, was obtained. I. Fogh, however, claims that by this process H. C. Oersted did prepare aluminium for the first time, and said that it is a metal with the colour and lustre of tin; and exhibited a sample of the metal in April, 1825, before the Danish Scientific Society. In 1809, J. J. Berzelius wrote to H. Davy that he had reduced alumina by heating it with carbon and iron, but since no reference is made to aluminium prepared by this process in J. J. Berzelius' later writings, it is assumed that he must have found that he had been mistaken. J. J. Berzelius tried to get aluminium by the action of potassium on cryolite, but later knowledge showed that he used an excess of potassium, and so obtained an alloy which decomposed in water; had he used an excess of fluoride, he would have obtained the metal. In 1827, F. Wöhler obtained the metal as a grey powder by the action of potassium on the chloride; and H. St. C. Deville obtained the metal by reducing the chloride

with sodium. He also tried reducing aluminium compounds with carbon; and, almost simultaneously with R. Bunsen, he isolated the metal by electrolysis.

The cost of H. St. C. Deville's early experiments was met by a grant from the French Academy of Sciences. In 1855, a large bar of aluminium was exhibited at the Palais de l'Industrie, docketed with the sensational name *l'argent de l'argile*. In 1854, a medal of aluminium was struck and presented to Napoleon III. The Emperor hoped to apply such a light metal to the armour and helmets of the French cuirassiers, and he authorized experiments to be made on a large scale at his expense. Large-scale experiments were made at Javel with the assistance of C. and A. Tissier, who were subsequently reproached by H. St. C. Deville with having acted in bad faith in claiming patents and with starting a works at Rouen in which Deville's sodium processes were to be applied. H. St. C. Deville had a plant for producing aluminium erected at Glacière, and this was subsequently removed to Nanterre. Other plants were installed at a number of general chemical works. Between 1859-65, a works used Deville's process at Battersea (London), and between 1860-74, a works used the same process at Washington (Newcastle-on-Tyne). Several improvements were made in Deville's process by J. Webster, H. Y. Castner, etc.

The first pencils of aluminium made by H. St. C. Deville were obtained by electrolysis, but the use of a battery as the source of the current was far too costly to permit its industrial exploitation. Consequently, H. St. C. Deville confined himself to the use of the alkali metals. Meanwhile, great advances had been made in dynamo-electric machinery. This gave an impetus to the electrolytic processes of R. Bunsen, and H. St. C. Deville. Thus, R. Grätzel in 1883, and E. C. Kleiner in 1886, devised industrial electrolytic processes, but these were not very successful until C. M. Hall, and P. V. L. Héroult had developed their method based on the electrolysis of soln. of alumina in molten cryolite—*vide infra*. In illustration of the rise of the aluminium industry, the price fell from 1000 francs per kgrm. in the spring of 1856 when the metal was a chemical curiosity, to 300 francs per kgrm. in August, 1856, to 130 francs per kilo in 1862. In 1895, the price was 1s. 5d. per lb. The lowest price in 1913 was £81 per ton, and the highest, £85 per ton; during the war the price in 1917 rose to £225 per ton; and in 1919, the average price was £150 per ton. J. W. Richards' estimate of the World's production of aluminium in metric tons from 1913-19 is shown in Table I.

TABLE I.—THE WORLD'S PRODUCTION OF ALUMINIUM (IN METRIC TONS).

Year.	Austria.	Canada.	France.	Germany.	Great Britain.	Italy.	Norway.	Switzerland.	United States.	Total.
1913	5,000	5,916	15,000	800	10,000	874	2,500	10,000	29,500	79,590
1914	4,000	6,820	12,000	800	8,000	937	2,500	10,000	40,500	84,957
1915	2,500	8,490	7,500	2,000	6,000	904	3,500	12,500	45,000	88,394
1916	5,000	8,800	20,000	8,000	4,000	1,126	6,000	15,000	63,000	130,626
1917	5,000	11,800	20,000	15,000	6,000	1,740	8,000	15,000	90,700	173,240
1918	8,000	15,000	20,000	25,000	14,000	1,715	7,500	15,000	102,000	208,215
1919	5,000	15,000	15,000	15,000	10,000	4,000	4,000	15,000	90,000	173,000

REFERENCES.

¹ Herodotus, 2. 180, c. 408 B.C.; Dioscorides, *Περὶ ἕλης ἱατρικῆς*, 5. 114, c. 50 A.D.; Pliny, *Historia naturalis*, 34. 128, c. 77 A.D.; Isidorus, *Originum*, 16. 2, c. 620 A.D.; Aulus Gellius, *Noctes Atticæ*, 15. 1, c. 150 A.D.; Diodorus Siculus, *Bibliotheca historica*, 100. 1, c. 8 B.C.; Strabo, *Geographia*, 6. 1, c. 20 A.D.; U. Aldrovandus, *Museum metallicum*, Lugduni Batavorum, 334, 1636; H. J. Wecker, *De secretis*, Basilæ, 445, 1604; A. Marcellinus, *Historia*, Lugduni Batavorum, 12, 1591; C. Niebuhr, *Reisebeschreibung nach Arabien und andern umliegenden Ländern*, Copenhagen, 2. 408, 1774; Johannes Serapionis Arabis, *De simplicibus medicinis opus*, J. J. Pontanus in J. G. Grævius, *Thesaurus antiquitatum et historiarum Italiae*, Lugduni Batavorum, 9. iii, 88, 1725; P. Bizaro, *Senatus populique genuensis rerum domi forisque gestarum historiae atque annales*, Antverpiæ, 302, 1579; A. Giustiniano, *Annali della repubblica di Genoa*, Genoa, 5. 214, 1537; M. G. A. F. Choiseul-Gouffier, *Voyage pittoresque de la Grèce*, Paris, 1. 12, 1782;

D. Bottone, *Pyrologia topographica*, Neapoli, 1692; Pii Secundi Pontificis Max., *Commentarii rerum memorabilium quae temporibus suis contigerunt*, Francofurti, 185, 1614; F. Bussi, *Historia della città de Viterbo*, Roma, 262, 1742; P. S. Boccone, *Museo di Fisica*, Venetia, 152, 1697; G. Targioni-Tozzetti, *Relazione di alcuni viaggi fatte in diverse parti della Toscana*, Firenze, 7, 234, 1779; A. Bacci, *De thermis*, Venetiis, 293, 1571; J. Serapion, *De simplicium medicamentorum historia*, Venetiis, 1552; J. Beckmann, *Beiträge zur Geschichte der Erfindungen*, Leipzig, 2, 62, 1788; London, 1, 180, 1846; G. Vossius, *Etymologicum linguae Latinae*, Amstelodami, 779, 1662; A. Cesalpinus, *De metallicis*, Noribergæ, 1602; G. Agricola, *De ortu et causis subterraneorum*, Basilie, 47, 1558; V. Biringuccio, *Pirotechnica*, Venetia, 31, 1559; N. R. Fermosini, *Tractatus criminalium*, Lugduni Batavorum, 2, 63, 1670; A. Anderson, *History of Commerce*, London, 1764; T. Pennant, *Tour in Scotland*, Chester, 1769; G. Jars, *Voyages métallurgiques*, Lyon, 3, 297, 1781; M. Mercatus, *Metallotheca*, Romæ, 54, 1719; G. W. von Leibniz, *Protogæa*, Göttingæ, 47, 1749; M. B. Valentinus, *Historia simplicium*, Francofurti, 1716; M. Ducus, *Historia Byzantina*, Venetia, 71, 1729; F. B. Pegolotti, *Della decima e di varie altre gravezza imposte dal comune di Firenze*, Lisbona, 1765; D. G. Bowles, *Introduction a la historia natural a la geografia fisica de Espagna*, Madrid, 1775; J. Dillion, *Travels through Spain*, London, 220, 1780; J. P. de Tournefort, *Relation d'un voyage du Levant*, Paris, 1717; J. C. Scaliger, *Exotericarum exercitationum*, Francofurti, 325, 1612; P. Bellon, *Les observations de plusieurs singularités et choses mémorables trouvées en Grèce, Asie, Egypte, Arabie et autres pays estranges*, Paris, 1553; A. Baumé, *Chymie expérimentale et raisonnée*, Paris, 1, 458, 1773.

² G. Agricola, *De re metallica*, Basilie, 1546; H. Boerhaave, *Elementis chemiæ*, Lugduni Batavorum, 1732; M. Etmüller, *Chemia rationalis ac experimentalis curiosa*, Leiden, 1684; G. E. Stahl, *Ausführliche Betrachtung und zulänglicher Beweiß von der Saltzen das dieselben aus einer arten Erde mit Wasser innig verbanden bestehen*, Halle, 1723; *Specimen Becherianum*, Franckfurth, 1702; *Fundamenta chymicæ*, Norimbergæ, 9, 1723; F. Hoffmann, *Observationum physico-chymicarum selectiorum*, Halæ, 1722; T. de Saussure, *Journ. Phys.*, 52, 290, 1801; C. J. Geoffroy, *Mém. Acad.*, 193, 1724; 114, 1727; 69, 1744; J. H. Pott, *Lithogognosia*, Potsdam, 1746; Berlin, 1754; A. S. Marggraf, *Mém. Acad. Berlin*, 41, 1754; P. J. Macquer, *Mém. Acad.*, 155, 1758; T. Baron, *ib.*, 274, 1760; A. L. Lavoisier, *ib.*, 92, 1777; T. de Saussure, *ib.*, 52, 290, 1801; J. Hellot, *ib.*, 62, 1739; M. H. Klaproth, *Ann. Chim. Phys.*, (1), 8, 275, 1791; L. B. Guyton de Morveau, *Encyclopédie méthodique*, Paris, 1786; M. de Ruprecht and M. Tondi, *Ann. Chim. Phys.*, (1), 8, 1, 1791; A. M. Savaresi, *ib.*, (1), 10, 254, 1791; L. N. Vauquelin, *Journ. Mines*, 5, 429, 1797; 16, 49, 1804; *Nicholson's Journ.*, 1, 318, 1797; *Bull. Soc. Enc.*, (1), 2, 149, 1804; *Ann. Chim. Phys.*, (1), 50, 159, 1804; *Mém. L'Inst.*, 7, 66, 1806; J. A. C. Chaptal, *Ann. Chim. Phys.*, (1), 22, 280, 1797; C. W. Pörner, *Chymische Versuche und Bemerkungen zum Nutzen der Farbekunst*, Leipzig, 1772-3; A. Baumé, *Mémoire sur les argilles*, Paris, 1770; C. W. Scheele, *Acta Acad. Sweden.*, 37, 36, 1776; T. Bergman, *De confectione aluminis*, Upsala, 1767; *Sciographi regni mineralis*, London, 1783; J. K. F. Meyer, *Schriften Ber. Ges. Natur Freunde*, 6, 368, 1785; J. C. Wiegand, *Crell's Ann.*, i, 21, 246, 392, 529, 1785; G. K. C. Storr, *ib.*, i, 5, 1784; G. L. L. de Buffon, *Epoques de la nature*, Paris, 1778; G. von Engeström, *Akad. Handl. Stockholm*, 35, 273, 1774; P. Zellner, *Schweigger's Journ.*, 18, 344, 1816; A. Libavius, *Alchemia*, Francofurti, 1595; J. Kunkel, *Vollständiges laboratorium chymicum*, Berlin, 1716; A. F. de Foureroy, *Éléments d'histoire naturelle et de chimie*, Paris, 1793; J. J. Becher, *Physica subterranea*, Lipsiæ, 61, 1690; R. Boyle, *Collected Works*, London, 1, 564, 1772; N. Grew, *Anatomy of Plants*, London, 242, 1682; J. Juncker, *Conspectus chemiæ theoretico-practicae*, Halæ Magdeburgica, 1730; A. M. Sieffert, *Neues Hamburg. Mag.*, 163, 1772.

³ Pliny, *Historiæ naturalis*, 36, 66, c. A. D. 77; J. T. Kemp, *Chem. News*, 86, 171, 1902; J. L. Howe, *ib.*, 86, 293, 1902.

⁴ H. Davy, *Phil. Trans.*, 98, 333, 1808; 100, 16, 1810; 102, 1, 1812; J. J. Berzelius, cited by H. Davy, *l.c.*; H. C. Oersted, *Øfvers. Danske Vid. Selsk. Förh.*, 15, 1825; *Ferussæ Bull. Math.*, 275, 1826; *Naturvidenskabelige Skrifter*, Kjöbenhavn, 1920; I. Fogh, *Danske Vid. Selsk.*, 3, 14, 1921; B. Silliman, *Mem. Connecticut Acad. Arts Sciences*, 1, 329, 1812; H. St. C. Deville, *Compt. Rend.*, 38, 279, 1854; 39, 321, 535, 901, 1854; *Ann. Chim. Phys.*, (3), 43, 5, 1855; (3), 46, 415, 1856; *L'aluminium, ses propriétés, sa fabrication, et ses applications*, Paris, 1859; A. Chenot, *Compt. Rend.*, 38, 415, 1854; J. Webster, *Brit. Pat. No. 18721*, 1881; H. Y. Castner, *ib.*, 1989, 18062, 1889; R. Grätzler, *German Pat.*, D.R.P. 26972, 1883; E. C. Kleiner, *ib.*, 42022, 1886; C. M. Hall, *U.S. Pat. No. 400664*, 400665, 400667, 400766, 1889; P. V. L. Héroult, *French Pat. N^o. 175711*, 1886; C. and A. Tissier, *Guide pratique de la recherche, de l'extraction, et de la fabrication de l'aluminium et des métaux alcalins*, Paris, 1858; R. Bunsen, *Pogg. Ann.*, 92, 648, 1854; J. W. Richards, *Aluminium*, Philadelphia, 1896; F. Wöhler, *Liebig's Ann.*, 99, 255, 1856.

§ 2. The Occurrence of Aluminium

Aluminium does not occur on the earth's surface in the metallic state. M. Stocker¹ was wrong in stating that aluminium occurs in shining scales in the formations near St. Austell (Cornwall). The combinations of aluminium with oxygen,

fluorine, silicon, etc., are lavishly distributed; they form large mountainous masses; they are the bases of clays and soils. Attempts have been made by F. W. Clarke to calculate the average composition of the earth's lithosphere, from data furnished by A. Harker, A. Knopf, H. S. Washington, etc. Alumina comes second in the list showing the relative abundance of the oxides; silica comes first, and ferrous oxide third.

	Igneous rocks.	Shales.	Sandstones.	Limestones.	Weighted average.
SiO ₂	59·83	58·10	78·33	5·19	59·77
Al ₂ O ₃	15·02	15·40	4·77	0·81	14·89
Fe ₂ O ₃	2·62	4·02	1·07	0·54	2·69
FeO.	3·43	2·45	0·30	—	3·39

Aluminium is more abundant than any other metal; it comprises nearly 8 per cent. of the earth's crust. Aluminium is nearly twice as abundant as iron. The average elemental composition of known terrestrial matter—including the lithosphere and hydrosphere—starting from the most abundant, is:

	Lithosphere (95 per cent.).	Hydrosphere (7 per cent.).	Average, including atmosphere.
Oxygen	47·33	85·79	50·02
Silicon	27·74	—	25·80
Aluminium	7·85	—	7·30
Iron	4·50	—	4·18

Other estimates have been made by J. H. L. Vogt, J. F. Kemp, etc. Expressing these data in terms of the percentage numbers of atoms in the half-mile crust, ocean, and atmosphere, we have:

O	H	Si	Al	Na	Mg	Ca	Fe
53·81	16·30	15·87	4·68	1·72	1·61	1·40	1·29

H. A. Rowland² found the relative order of the intensity of the spectral lines of the elements in the sun is K, Fe, H, Na, Ni, Mg, Co, Si, Al, Ti, Cr, . . . The subject has been discussed by J. N. Lockyer, and A. Cornu. The fortuitous occurrence of aluminium in old bronzes has been examined by E. Nauck, L. C. Marquart, and J. J. Nöggerath.

The most important aluminiferous minerals, from the point of view of the extraction of the metal, are bauxite, and cryolite. Native alums usually occur in out-of-the-way places, and the deposits are comparatively small. Some of the aluminiferous minerals have so fine a lustre and colour that they are included in the lists of precious stones—*e.g.* the ruby, sapphire, turquoise, topaz, garnet, etc.

The aluminium minerals include the **oxides**: *corundum*, Al₂O₃, with the varieties *ruby* and *sapphire*. The **hydroxides**: *gibbsite* or *hydrargillite*, Al(OH)₃; *bauxite*, Al₂(OH)₄O; *diaspore*, Al₂(OH)₂O₂; *völknerite*, approximating Al(OH)₃·3Mg(OH)₂·3H₂O; and *namaqualite*, approximating Al(OH)₃·2Cu(OH)₂·2H₂O. The **aluminates**: *spinel*, or *magnesia spinel*, or *spinel ruby*, Mg(AlO₂)₂; *hercynite* or *iron spinel*, Fe(AlO₂)₂; *pleonaste* or *magnesia iron spinel* (Mg, Fe)(AlO₂)₂; *chrome spinel* or *picotite*, (Mg, Fe)(Al, Fe, Cr)₂O₄; *zinc spinel* or *gahnite*, Zn(AlO₂)₂; *dyskuite*, (Zn, Mn)(Al, Fe)₂O₄; *chrysoberyl*, and *alexandrite*, Be(AlO₂)₂. The **halide salts**: *fluellite*, AlF₃·H₂O; *cryolite*, 3NaF·AlF₃; *chiolite*, 5NaF·3AlF₃; *parchnolite*, and *thomsonolite*, AlF₃·NaF·CaF₂·H₂O; *gearksvilleite*, Al(F, OH)₃·CaF₂·H₂O; *prosopite*, 2Al(F, OH)₃·Ca(F, OH)₂; and *ralstonite*, 3Al(F, OH)₃·(Na₂, Mg)F₂·2H₂O. The **sulphates**: *alum*, (NH₄, K, Na)Al(SO₄)₂·12H₂O; *kalinite*, KAl(SO₄)₂·12H₂O; *tschermigite*, NH₄Al(SO₄)₂·12H₂O; *mendozite* is an impure soda-alum, ideally NaAl(SO₄)₂·12H₂O; *pickeringite*, or *magnesia-alum*, MgAl₂(SO₄)₄·22H₂O; *picroalumogen*, Mg₂Al₂(SO₄)₅·22H₂O; *apjohnite*, manganese-alum, MnAl₂(SO₄)₄·22H₂O; *boşjemanite* is a mixture of *magnesia alum* and *manganese sulphate*; *diétrichite* is a mixture of *manganese-zinc alum*; *halotrichite*, FeAl(SO₄)₃·12H₂O; *keramohalite*, or *alunogen*, Al₂SO₄·18H₂O; *aluminite*, (AlO)₂SO₄·9H₂O; *aluman*, Al(AlO)(SO₄)₂; *alunite*, K(H₂AlO₂)₃(SO₄)₂·3H₂O; *zinc aluminite*, (AlOH)SO₄·Zn₃(AlO₂)₂·8H₂O; *cyprusite*, (FeO)₇Al(SO₄)₃·7H₂O; *felsöbanyite*, Al₂(SO₄)(OH)₄·2Al(OH)₃·5H₂O; *paraluminite*, Al₂(SO₄)(OH)₄·2Al(OH)₃·10H₂O; *sonomaité*, 3MgSO₄·Al₂(SO₄)₃·33H₂O; *dumreicherite*, 4MgSO₄·Al₂(SO₄)₃·36H₂O; *plagiocitrite*, (Al, Fe)₂(Fe, Mg, Ni, Co)(K, Na)(OH)₆·21H₂O; *clinophäite*, (Al, Fe)₂(Fe, Mg, Ni, Co)(K, Na)₈(OH)₆(SO₄)₅·5H₂O; *voltaité*, (Al, Fe)₄(Fe, Mg)(K, Na)₂(OH)₂(SO₄)₁₀·14H₂O; *étringite*, Al₂Ca₆(OH)₁₂(SO₄)₃·24H₂O; *lettsonite*, or *cyanotrichite*, Cu₂Al₂(OH)₄(SO₄)₃·Cu₃(AlO₂)₂·5Cu(OH)₂·13H₂O; and *wodwardite*, Cu₂Al₂(OH)₄(SO₄)₃·Cu₆(AlO₂)₂·18H₂O. The **carbonates**: *dawsonite*,

NaAl(OH)₂CO₃; and *mellitite*, Al₂C₁₂O₁₂.18H₂O. The phosphates: *minervite*, AlPO₄.7H₂O; *amblygonite*, or *montebasite*, LiAl(F,OH)PO₄; *angelite*, Al₂(OH)₃PO₄; *trolleite*, Al₄(OH)₃(PO₄)₃; *lazulite*, (Mg, Fe, Ca)(AlOH)₂(PO₄)₂; *cirrolite*, Ca₂Al₂(OH)₃(PO₄)₃; *tavistockite*, Ca₃Al₂(OH)₆(PO₄)₂; *berlinite*, AlPO₄.4H₂O; *variscite*, or *callaite*, AlPO₄.2H₂O; *barrandite*, (Fe, Al)PO₄.2H₂O; *callainite*, AlPO₄.2½H₂O; *zephyrovichite*, AlPO₄.3H₂O; *gibbsite*, AlPO₄.4H₂O; *wavellite*, (AlOH)₃PO₄.4½H₂O; *kalaite* or *turquoise*, Al₂(OH)₃PO₄.H₂O, or Al₂(OH)₄HPO₄; *peganite*, Al₂(OH)₃PO₄.1½H₂O; *fischerite*, Al₂(OH)₃PO₄.2½H₂O; *evansite*, Al₃(OH)₆PO₄.6H₂O; *eosphorite*, MnAl(OH)₂PO₄.2H₂O; *childrenite*, FeAl(OH)₂PO₄.H₂O, or (Fe'', Mn, Ca)Al(OH)₂PO₄.H₂O; *henwoodite*, Al₄CuH₁₀(PO₄)₈.6H₂O; *chalcociderite*, Cu(Fe'', Al)₂(Fe''O)₄(PO₄)₈.8H₂O; *goyazite*, Al₁₀Ca₃P₂O₂₃.9H₂O; *hitchcockite*, Al₄PbP₂O₁₂.9H₂O; and *svanbergite*, (AlO)₆(CaOH)Na₃(PO₄)₂(SO₄)₂.3H₂O. The arsenates: *durangite*, Na(AlF)AsO₄; *synadelphite*, Mn₅Al₂(OH)₁₀(AsO₄)₂; *hæmatolite*, or *diadelphite*, Mn₄Al(OH)₈AsO₄; *liskeardite*, (Al, Fe)AsO₄.8H₂O; and *liroconite*, or *linsene rz*, Cu₈Al₄(OH)₁₆(AsO₄)₅.20H₂O. The borates: *jeremejeffite*, AlBO₃ or (AlO)BO₂; and *rhodizite*, KAl₂B₃O₈, or K(AlO)₂(BO₂)₃. The silicates or aluminosilicates include *felspars*, *micas*, *clays*, *sillimanite*, *cyanite*, *garnet*, etc.—*vide* the silicates.

Many natural waters contain alumina, and particularly those in volcanic districts. Thus, C. du Ponteil³ found 0.3546 per cent. of aluminium sulphate, Al₂(SO₄)₃, in the clear, yellow, very acid water of a hot-lake on White Island (Bay of Plenty, N.Z.); W. Skey, and J. S. Maclaurin have also analyzed the water from the same locality. S. de Luca found 0.335 grm. of alumina per litre in the solfatara waters of Pozzaoli. J. B. J. D. Boussingault reported 1.66 parts per 1000 in the water of the thermal spring at Paramo de Ruiz (New Granada). W. B. Markownikoff reported 13.27 per cent. of aluminium sulphate in the salt deposited on the shores of Lake Djouvan-Tubé (Akmolink Province, Russia). J. K. Crook reported on the aluminiferous spring water of the United States:

This substance is found in springs in the form of the oxide, or alumina, and of the sulphate. It occurs in variable quantities, ranging from a mere trace to sixty or eighty grains per gallon, as seen in some of the Virginia alum springs. The sulphate is almost always present in the sulphuretted chalybeate waters, and, as stated above, in the acid springs. The internal use of alum waters is generally governed by these associated ingredients. Some of the alum springs have acquired a considerable reputation in scrofulous diseases and in chronic diarrhoea and dysentery. The iron-alum waters are beneficial in passive hemorrhages and in exhausting night-sweats. Locally their astringent action calls them into service in much the same class of cases as are benefited by the acid waters. They have produced valuable results in conjunctivitis, stomatitis, chronic vaginitis, and other relaxed or inflammatory states of those portions of the mucous surfaces accessible to local treatment. They have also been found to act as a useful auxiliary in the treatment of ulcerated surfaces, abrasions, etc. In large quantities alum waters have a laxative influence, but they are seldom used in virtue of this action.

A. C. Peale's report of the composition of the mineral waters of the United States shows the presence of up to 226.41 grains of alumina per gallon; this quantity was reported in the water of the Iowa Acid Spring. C. F. Langworthy and P. T. Austen have compiled reports of nearly 500 determinations of alumina in natural waters in different parts of the world.

A small proportion of aluminium is found in the ashes of numerous plants, but, so far as is known, this element is not essential for plant growth, and G. Cugini⁴ considers that it may be regarded as an accidental constituent. Most soils contain traces of aluminium phosphate, and, according to J. Lewitsky, aluminium phosphate is slightly soluble in soil soln., and hence alumina is carried into the plant sap and distributed to the different parts. L. Ricciardi concluded that the assimilation of alumina by the plant does not depend on the percentage of alumina in the soil, and that, generally speaking, alumina is most abundant in the trunk and branches, less so in the husks and seeds, and least of all in the leaves. W. Knop said that the lycopodiaceæ secrete organic acids, and contain oxalic acid which dissolves alumina and ferric oxide. D. D. Jackson found that alumina is precipitated from natural waters by the *crenotherix* (bacteria), and that about one-third of the dried organism consists of alumina. It is not known how the alumina is combined in the plant. H. Yoshida thought that in the lacquer tree (*rhus vernicefera*) alumina is present

as an aluminium arabate. H. G. Smith found a deposit of a basic aluminium succinate, $\text{Al}_2(\text{C}_4\text{H}_4\text{O}_4)_3 \cdot \text{Al}_2\text{O}_3$, in the centre of a silky oak tree (*orites excelsa*) from Queensland; and he suggested that the alumina was present in the sap as aluminium malate. L. N. Vauquelin has stated that he found aluminium acetate in the sap of the birch. He considered the deposit represented a natural effort to get rid of a surplus of alumina not needed by the tree. In the analyses by J. C. Bell, the alumina in the plant ash was reported as aluminium phosphate. O. L. Erdmann assumed that the alumina is free in the ashes of woods and seeds. H. Coupin found that the presence of one part of aluminium sulphate in 50,000 parts of distilled water is toxic to the roots of wheat, for the plant is injured but not killed. M. Wypfel found aluminium chloride to have a toxic effect on seedlings of corn, bean, pea, cucurbit, sunflower, beet, and onion, when the plants are watered daily with a 0.5 or 1.0 per cent. soln. A. Chassevent and C. Richet found that the order of toxicity of metal salts on the lactic ferment is: Mg, Li, Ca, Sr, Ba, Al, Mn, Fe, Pb, Zn, Ca, Cd, Pt, Hg, Ni, Au, Co. Lists of the occurrence of alumina in plants have been given by C. F. Langworthy and P. T. Austen, by F. Czapek, and by G. Stoklasa.

A. W. Blythe⁵ is of the opinion that cleaned *wheat* contains no alumina, and that particles of clay and sand from the mill-stones find their way into the flour so that no second-class flour in commerce is free from a small percentage of alumina. J. C. Bell reported up to 0.017 per cent. of aluminium phosphate in the ash of wheat; up to 0.0204 per cent. of aluminium phosphate in the ash of *flour*; and up to 0.011 per cent. of aluminium phosphate in *bread* free from alum. A. H. Allen said that aluminium is a normal constituent of wheat in amount corresponding with "8 grains in a 4-lb. loaf of bread." A. Dupré, M. D. Penney, G. L. Teller, J. A. Wanklyn and W. J. Cooper, G. Wellborn, W. C. Young, C. Counciler, T. J. Herapath, and H. Yoshida have reported on the aluminium content of flour. A. Béchamp⁶ found alumina in *yeast*; C. H. Lawall, C. G. Wheeler, J. Lerner, H. Watts, and G. E. Colby, in *hops*; W. Baer, in *rape* and *rape-seed*; E. H. S. Bailey, in *corn-cobs*; J. T. Way and G. H. Ogston, and C. Counciler, in *rye*; F. W. Dafert, in *panic grasses* (*panicum*); T. J. Herapath, in *oats*; J. Stoklasa, H. Yoshida, J. Lerner, in *barley*; F. Vielguth, in *straw* (*galium mollugo*); and H. Yoshida, in *millet*, *rice*, and *buckwheat*; and F. Aopger, and O. Habermann, in *maesa picta*. J. C. Bell⁷ found from 0.05 to 3.850 per cent. of aluminium phosphate in the ash of pure *grape juice*; and from 0.377 to 3.956 per cent. in the ash of fermented and unfermented *wines*. L. Gabba said that wines do not contain aluminium in excess of 0.01 per cent. R. Kayser added that the presence of 0.3-0.4 grain of alumina per litre in wine cannot safely be taken as a proof that alum has been added because it takes into soln. during its course of manufacture some alumina. This is especially the case when the wine has been cleared with china clay, as some wines dissolve small amounts of the china clay, and hence contain alumina in the form of a soluble salt. L. l'Hote, M. Minas, J. Moritz, L. Ricciardi, E. Demarçay, W. Hadelich, F. Guerrieri, G. F. Walz, E. Rotondi, F. Sestini, etc., have reported on this subject. The occurrence of aluminium in *club mosses* (*lycopodiaceae*) has been reported by A. Aderholdt,⁸ A. H. Church, C. Counciler, W. Knop, A. Langer, W. F. Salm-Horstmar, H. Ritthausen, G. Solms-Laubach, and W. Pfeffer; in *cryptogams*—mosses, ferns, equisetum, etc.—by A. H. Church, G. Mariani, and A. Mayer. L. P. Brown,⁹ A. K. Dambergis, F. M. Brandt, and J. R. McD. Irby and J. A. Cabell, and A. P. Smith found alumina in *tobacco*; W. Athenstead, J. H. M. Clinch, and P. Schridl, in *tea*; P. S. Clarkson, in *cocoa*; and H. Ludwig, in *coffee*. Aluminium has been reported in *sumach* by F. P. Dunnington,¹⁰ and H. W. Harper; in *sassafras*, by F. P. Dunnington; and F. J. Malaguti and J. Durocher reported analyses of the ash of 115 wild plants. F. P. Dunnington found alumina in *brown sedge*, *wire-grass*, *blue thistle*, *potato-weed*, *purslane*, *ragweed*, *mullein*, *dock*, and *stick-weed*. Alumina was found in *anatto* (*bixa*) by A. E. Ebert, and A. H. Hassall; in *sarsaparilla*, by A. B. Griffiths, and H. Ludwig; in *cardamon*, by A. B. Griffiths, and H. B. Yardley; in *chine* and *rhatany*, by A. B. Griffiths; in *red pepper*, by B. von Bitto; in *peppermint*, by H. Trimble and H. J. Schuchard; in *cinnamon*, by M. Schäzler; in *kouso* (*brazer*), by E. Harms; in *lac* (*rhus vernicefera*), by H. Yoshida; in *plantain*, by E. Harms, and J. F. Strawinski; in *chickweed*, by E. Harms; in *spurge*, by G. C. Wittstein; in *ophelia*, by H. Höhn; in *rupture-wort* (*herniaria*), by G. C. Wittstein; in *millingtonia*, by H. Hollandt; in *dog-bane*, by A. Jessler; in *lichens*, by W. Knop, C. H. Weigelt, and G. C. Wittstein; in *Spanish moss*, by S. de Luca; in *mosses* (*fontinalis*), by R. Strohecker, and G. C. Wittstein; in *sea-weeds*, by E. Mitscherlich, J. Percival, and F. Sestini; in *algae*, by K. Petter; in *ferns*, by C. Struckmann; in *buttercups*, by G. Ruge¹¹; in *dandelions*, by C. H. Lawall, L. E. Sayre, and M. Winternitz; in the *poppy*, by C. J. H. Warden; in the *golden seal*, by R. Gaze; in the *primrose*, by G. C. Wittstein; in the *heather*, by G. C. Wittstein, and E. Wolff; in the *shepherd's purse*, by F. Daubrawa; in the *geranium*, by C. H. Lawall; in the *rhododendron*, by T. de Saussure; in the *pink* (*dianthus*), by R. Andreaesch; in

the *hyacinth*, by A. Tschirch; in the *sunflower*, by G. C. Wittstein; in the *rose (rosa)*, by R. Andreaesch; in the *star anise*, by C. E. Schlegel; in the *cuckoo-pint*, by C. Rode; in the *Virginian creeper*, by G. C. Wittstein; in the *colchicum* or *autumn crocus*, by C. Reithner; in the *bryony*, by C. F. Heller; in the *thrift* or *sea-pink*, by A. Völcker; in the *boletus*, by K. Fritsch; in *poke-weed (phytolacca)*, by G. B. Frankforter; in *ivy*, by H. Block; in *poison ivy*, by J. Khittel; in *aralia*, by W. R. Munroe; in *hemlock*, by E. S. Bastin and H. Trimble; in *water hemlock*, by R. Glenk; in *wormwood*, by C. Eylerts; in *gastrolobium bilobum*, by H. Fraas; in *Petalostigma quadriloculare*, by C. Falco; in *symplococæ*, by E. Kratzmann; in *jute*, by E. J. Bevan and C. F. Cross; in *hemp*, by A. Bobierre; in *flax*, by R. J. Kane; in *eel-grass (zostera)*, by E. Baudrimont; in *alfalfa*, by M. Berthelot and G. André, and P. von Gasparin; in *Bermuda grass, convolvulus, lupine, and linden*, by M. Berthelot and G. André; in *peas*, by T. Broméis; in *red clover* and *blood-root*, by C. H. Lawall; in *yams*, by T. J. Herapath; in *potato*, by C. Counciler; in *beet*, by C. Eylerts; in the *banana*, by A. Hébert; in *horse-bean* and *eddoes* or *taro*, by T. J. Herapath; in *tayuya (trianosperma)*, by D. Parodi; *stereo caulon vesuvianum*, by M. Coppola; in *fruit-juices*, by R. Kayser;¹² in *raspberry*, by C. F. Bergstrand; in *apple*, by C. A. Browne; in *cider*, by R. E. Doolittle and W. H. Hess; in *plum*, by W. Tod; in *pomegranate*, by E. Speiss; in *sloe* or *black thorn*, by E. Schreiner; in *cherry*, by W. Keim; in *fig*, by G. C. Wittstein; *blue-berries*, by R. Kayser; in *rhubarb*, by R. Brandes;¹³ in *prickly chaff (achyanthes)*, by C. J. H. Warden; in *prickly-pear*, by W. W. Light, and L. Ricciardi; in *orange*, by O. Huischke, and L. Ricciardi; in *hydrangea*, by C. H. Lawall, and C. S. Bondurant; in *colls-foot*, by C. S. Bondurant; in *thapsia*, by M. Yvon; in *antherosperma*, by N. Zeyer; in *soya-bean*, by H. Yoshida; in *bread-fruit*, by L. Ricciardi; in *almond*, by L. Ricciardi; in *chestnuts*, by E. Dieterich; in *horse-chestnut*, by E. Staffel; in *paw-paw*, by T. Peckolt; in *guarana*, by T. Peckolt, and C. H. Lawall; in *pareira*, by F. A. Ringer and E. Brooke; in *truffles*, by A. Chatin,¹⁴ and A. Pizzi; in *edible fungus*, by P. Nettlefold; in *boletus*, by J. Wolff; in *morell*, by A. Pizzi; in *sycamore*, by C. Counciler;¹⁵ in *lilac*, by C. Counciler, and G. C. Wittstein; in *beech*, by C. Counciler, and G. C. Wittstein; in *gentian*, by C. Counciler; in *bloody-eye*, by C. Counciler; in *holly*, by C. Reithner; in *adder's tongue*, by C. Counciler; in *mistletoe*, by C. Counciler; in *coniferæ*, by E. S. Bastin and H. Trimble, C. Karmrodt, H. Krutzsch, and R. Weber and E. Ebermayer; in *Scotch pine*, by C. Counciler, E. Demarçay, C. Karmrodt, K. Kresling and G. C. Wittstein; in *white pine*, by R. Weber and E. Ebermayer; in *Scotch fir*, by E. Demarçay, and C. Karmrodt; in *silver fir*, E. Demarçay; in *eucalyptus*, by W. Smith; in *oak*, by E. Demarçay; in *prickly ash*, and in *elm*, by C. H. Lawall; in *silky oak*, by J. H. Maiden and H. G. Smith; in *birch*, by W. A. E. Witting, and G. C. Wittstein; in *poplar*, by E. Demarçay; in *plane-tree*, by G. M. Tucker and B. Tollens; in *hornbean*, by E. Demarçay; in *myrtle*, by J. W. England; in *honeysuckle*, by J. B. Enz; in *elder*, by L. Huber, and G. C. Wittstein; in *larch*, by C. Karmrodt; in *laurel*, by H. Matusou; in *willow*, by E. Reichardt; in *cane sugar*, by J. W. MacDonald,¹⁶ A. Payen, and W. Wallace; in *beet sugar*, by J. W. MacDonald; in *honey*, by G. von Bunge; in *corn cockle*, by T. Crawford; in *cockle-burr (xanthium)*, by R. Godefroy; in *ergot*, by J. C. Hermann, G. Ramdohr, and S. von Thielau; in *morphine*, by L. F. Kebler; in *opium*, by C. J. H. Warden; in *cinchonine*, by D. Hooper, G. Lindenmayer, and C. H. Lawall; in *belladonna*, by F. Muck, and C. H. Lawall; in *china*, by E. Reichardt; in *aconite*, by D. von Wasowicz, and C. H. Lawall; and in *legen*, by H. Wefers-Bettink. C. H. Lawall found alumina in *calumba, castanea, chimaphila, calceaya, digitalis, frangula, gelsemium, glycyrruza, hydrastis, hyoscyamus, jalap, kola-nut, piscidia erythrina, choke-cherry, cascara, ruta herba, sabadilla, and hellebore.*

E. Staffel¹⁷ found alumina in veal and in beef; R. Theile, in egg albumen; M. Thezard, in the tibia of an adult mummy from an Egyptian tomb. T. M. Rotch reported 0·37 per cent. of ferric oxide and alumina in the ash of woman's milk, and 0·44 per cent. in the ash of cow's milk. E. Dieterich found 1·398 per cent. of alumina in the ash of cochineal, and C. Liebermann assumed that carmine is an "aluminium-calcium-protein compound of the colouring matter." A. Heyl found alumina in sponge; J. Mayrhöfer, and A. Müntz, in leather; W. McMurtie, 19·88 per cent. of alumina in the excrement of the common bat; R. Schütze, in the mantle of the *phallusia mamillaris*; and G. Walter, in the outer covering of the *protopteris annexens*.

REFERENCES.

- ¹ F. W. Clarke, *Chem. News*, 61. 31, 1890; *The Data of Geochemistry*, Washington, 22, 1920; A. Harker, *Geol. Mag.*, (4), 6. 220, 1899; *Tertiary Igneous Rocks of the Isle of Skye*, London, 416, 1904; H. S. Washington, *Prof. Paper U.S. Geol. Sur.*, 14, 1903; A. Knopf, *Journ. Geol.*, 24. 620, 1916; M. Stocker, *Compt. Rend.*, 41. 412, 1855; F. W. Clarke and G. Steiger, *Journ. Washington Acad.*, 4. 57, 1914; F. W. Clarke and H. S. Washington, *Proc. Nat. Acad. Sciences*, 8. 108, 1922; J. H. L. Vogt, *Zeit. prakt. Geol.*, 6. 225, 314, 377, 413, 1898; 7. 10 274, 1899; J. F. Kemp, *Econ. Geol.*, 1. 207, 1905.

² H. A. Rowland, *Amer. Journ. Science*, (3), **41**, 243, 1891; J. N. Lockyer, *Phil. Trans.*, **163**, 253, 639, 1873; A. Cornu, *Compt. Rend.*, **86**, 101, 983, 1878; E. Nauck, L. C. Marquart, and J. J. Nöggerath, *Rheinl. Westphal. Corresp.*, **15**, 46, 1858.

³ C. du Ponteil, *Liebig's Ann.*, **96**, 193, 1855; *Journ. prakt. Chem.*, (1), **67**, 249, 1855; W. Skey, *Trans. N.Z. Inst.*, **10**, 423, 1877; J. S. Maclaurin, *Proc. Chem. Soc.*, **27**, 10, 1911; S. de Luca, *Compt. Rend.*, **70**, 408, 1870; J. B. J. D. Boussingault, *ib.*, **24**, 397, 1847; *Ann. Chim. Phys.*, (3), **20**, 199, 1847; J. K. Crook, *The Mineral Waters of the United States and their Therapeutic Uses*, Philadelphia, 1899; W. B. Markownikoff, *Journ. Russ. Phys. Chem. Soc.*, **32**, 307, 1900; A. C. Peale, *Bull. U.S. Geol. Sur.*, **32**, 1886; C. F. Langworthy and P. T. Austen, *The Occurrence of Aluminium in Vegetable Products, Animal Products, and Natural Waters*, New York, **51**, 1904; F. Parmentier, *Compt. Rend.*, **115**, 125, 1892; A. L. Lavoisier, *Mém. Acad.*, **92**, 1777.

⁴ G. Cugini, *Nuovo Giorn. Bot. Ital.*, **8**, 77, 261, 1876; *Pharm. Journ.*, (3), **7**, 616, 1878; H. Coupin, *Compt. Rend.*, **132**, 645, 1901; A. Chassevent and C. Richet, *ib.*, **117**, 673, 1893; H. Snyder, *The Chemistry of Plant and Animal Life*, Easton, Pa., **168**, 1903; G. Stoklasa, *Ann. Agron.*, **23**, 588, 1897; *Ueber die Verbreitung des Aluminiums in der Natur*, Jena, 1922; M. B. Thomas, *Proc. Indiana Acad.*, **239**, 1893; M. Wypfel, *Jahresb. Niederöster. Landes Waldhofen*, **23**, 22, 1892; O. Loew, *The Physiological Role of Mineral Nutrients*, Washington, 1899; J. Lewitsky, *Just's Bot. Jahresb.*, **2**, ii, 866, 1874; F. Sestini, *Gazz. Chim. Ital.*, **15**, 107, 1885; L. Ricciardi, *ib.*, **19**, 150, 1889; H. Yoshida, *Journ. Chem. Soc.*, **51**, 748, 1887; H. G. Smith, *Chem. News*, **88**, 135, 1903; J. C. Bell, *Analyst*, **4**, 126, 1879; **6**, 197, 1887; J. H. Marden and H. G. Smith, *Proc. Roy. Soc. N.S.W.*, **29**, 325, 1895; L. N. Vauquelin, *Trommsdorff's Journ.*, **7**, 219, 1800; W. Knop, *Der Kreislauf des Stoffes*, Leipzig, **1**, 263, 1868; D. D. Jackson, *Journ. Soc. Chem. Ind.*, **21**, 681, 1902; O. L. Erdmann, *Journ. prakt. Chem.*, (1), **40**, 254, 1847; F. Czapek, *Biochemie der Pflanzen*, Jena, **2**, 855, 1905; C. F. Langworthy and P. T. Austen, *The Occurrence of Aluminium in Vegetable Products, Animal Products, and Natural Waters*, New York, 1904.

⁵ A. H. Allen, *Analyst*, **13**, 41, 1888; J. C. Bell, *ib.*, **4**, 126, 1879; A. Dupré, *ib.*, **4**, 1, 1879; W. C. Young, *ib.*, **2**, 13, 1877; **12**, 29, 145, 1887; **13**, 5, 1888; **15**, 83, 1890; C. Counciler, *Bot. Centr.*, **40**, 97, 129, 1889; T. J. Herapath, *Journ. Roy. Agric. Soc.*, **11**, 93, 1850; A. W. Blythe, *Foods: Composition and Analysis*, London, **177**, 1888; M. D. Penney, *Chem. News*, **39**, 80, 1879; G. L. Teller, *Bull. Arkansas Station*, **42**, 75, 1896; J. A. Wanklyn and W. J. Cooper, *Bread Analysis*; London, **22**, 1886; G. Wellborn, *Pharm. Journ.*, (3), **9**, 181, 1878; H. Yoshida, *Journ. Chem. Soc.*, **51**, 748, 1887.

⁶ A. Béchamp, *Compt. Rend.*, **73**, 337, 1871; W. Baer, *Arch. Pharm.*, (2), **66**, 285, 1851; E. H. S. Bailey, *Trans. Kansas Acad.*, **11**, 49, 1888; G. E. Colby, *Rep. California Station*, **ii**, 252, 1901; C. Counciler, *Bot. Centr.*, **40**, 97, 129, 1889; F. W. Dafert, *Ann. Inst. Agron. Estado Sao Paulo et Campenia*, 1893; J. Lermer, *Dingler's Journ.*, **179**, 71, 1866; *Wittstein's Viertel. Jahr.*, **13**, 182, 1865; J. Stoklasa, *Ann. Agron.*, **23**, 588, 1897; F. Vielguth, *Vierteljahr. prakt. Pharm.*, **5**, 187, 1856; F. Apoiger, *ib.*, **6**, 481, 1857; H. Watts, *Phil. Mag.*, (3), **32**, 54, 1847; J. T. Way and G. H. Ogston, *Journ. Roy. Agric. Soc.*, **11**, 497, 1850; T. J. Herapath, *ib.*, **11**, 93, 1850; O. Habermann, *Ueber die Bestandtheile des Samens von Maesa Picta*, Erlangen, 1894; C. G. Wheeler, *Journ. prakt. Chem.*, (1), **94**, 385, 1865; H. Yoshida, *Journ. Chem. Soc.*, **51**, 748, 1887; C. H. Lawall, *Amer. Journ. Pharm.*, **69**, 137, 1897.

⁷ J. C. Bell, *Analyst*, **6**, 197, 1881; L. Gabba, *Trattato di analisi chimica*, Milano, **2**, 514, 1880; R. Kayser, *Repert. Anal. Chem.*, **2**, 242, 1882; L. P'Hote, *Compt. Rend.*, **104**, 853, 1887; E. Demarçay, *ib.*, **130**, 91, 1900; M. Minas, *Zur Frage über Einfluss pasteurisierter Traubensäfte auf den allgemeinen Stickstoffumsatz, das Körpergewicht und die Darmfäulnis beim gesunden Menschen bei gemischter Kost*, Dorpat, 1900; J. Moritz, *Ann. Oecnologie*, **4**, 153, 1874; L. Ricciardi, *Gazz. Chim. Ital.*, **19**, 150, 1889; E. Rotondi, *Rel. lav. Esequite. lab. Chim. Staz. Asti*, **111**, 1878; F. Sestini, *Studi Ric. Ist. Lab. Chim. Agrar. Pisa*, **6**, 97, 1887; F. Guerrieri, *Staz. Sper. Agr. Ital.*, **34**, 338, 1901; W. Hadelich, *Chem. Centr.*, (3), **12**, 101, 1881; G. F. Walz, *Jahrb. prakt. Pharm.*, **15**, 65, 1847.

⁸ A. Aderholdt, *Liebig's Ann.*, **82**, 111, 1852; A. H. Church, *Chem. News*, **30**, 137, 1874; *Journ. Botany*, (2), **4**, 169, 1875; *Proc. Roy. Soc.*, **44**, 121, 1888; C. Counciler, *Landw. Vers. Stat.*, **29**, 241, 1883; W. Knop, *Der Kreislauf des Stoffes*, Leipzig, **1**, 263, 1868; A. Langer, *Arch. Pharm.*, (3), **27**, 289, 1889; *Ueber Bestandtheile der Lycopodiumsporen*, Erlangen, 1889; G. Mariani, *Studi Ric. Ist. Lab. Chim. Agrar. Piser*, **7**, 69, 1888; A. Mayer, *Lehrbuch der Agriculturchemie*, Heidelberg, **280**, 1886; H. Ritthausen, *Journ. prakt. Chem.*, (1), **53**, 413, 1851; (1), **58**, 133, 1853; G. Solms-Laubach, *Liebig's Ann.*, **100**, 297, 1856; W. Pfeffer, *Pflanzen-physiologie*, Leipzig, **1**, 432, 1897; W. F. Salm-Horstmar, *Journ. prakt. Chem.*, (1), **40**, 302, 1847.

⁹ J. R. McD. Irby and J. A. Cabell, *Chem. News*, **30**, 117, 1874; A. P. Smith, *ib.*, **28**, 261, 324, 1873; L. P. Brown, *Amer. Chem. Journ.*, **11**, 37, 1889; A. K. Dambergis, *Oester. Chem. Ztg.*, **1**, 479, 1898; F. M. Brandt, *Wittstein's Vierteljahr.*, **13**, 322, 1864; W. Athenstedt, *Ber. deut. bot. Ges.*, **3**, 57, 1885; J. H. M. Clinch, *Amer. Journ. Pharm.*, **56**, 131, 1884; P. S. Clarkson, *ib.*, **59**, 277, 1887; H. Ludwig, *Arch. Pharm.*, (3), **1**, 482, 1872; P. Schridl, *ib.*, (3), **3**, 375, 1873.

¹⁰ F. P. Dunnington, *Journ. Amer. Chem. Soc.*, **2**, 24, 1880; A. E. Ebert, *Vierteljahr. prakt. Pharm.*, **17**, 438, 1868; H. Hollandt, *ib.*, **10**, 321, 1861; A. Jessler, *ib.*, **17**, 266, 1868; B. von Bitto, *Landw. Vers. Stat.*, **42**, 369, 1893; **46**, 327, 1895; W. Knop, *ib.*, **7**, 436, 1865; A. B. Griffiths, *Compt. Rend.*, **131**, 422, 1900; E. Harms, *Arch. Pharm.*, (2), **88**, 165, 1856; (2), **93**, 158, 1858; H. Höhn, *ib.*, (2), **139**, 213, 1869; H. Ludwig, *ib.*, (2), **52**, 61, 1847; R. Strohecker, *ib.*, (2), **145**, 131, 1871; H. W. Harper, *Amer. Journ. Pharm.*, **53**, 209, 1881; H. B. Yardley, *Chem.*

News, 79. 122, 1899; J. F. Strawinski, *ib.*, 70. 189, 1894; H. Trimble and H. J. Schuchard, *ib.*, 57. 21, 1885; A. H. Hassall, *Food: its Adulterations and the Methods for their Detection*, London, 617, 1861; S. de Luca, *Compt. Rend.*, 51. 176, 1860; F. J. Malaguti and J. Durocher, *Ann. Chim. Phys.*, (3), 54. 257, 1858; E. Mitscherlich, *Sitzber. Akad. Berlin*, 430, 1847; J. Percival, *Agricultural Botany*, New York, 167, 1900; K. Petter, *Vierteljahr. prakt. Pharm.* 11. 545, 1862; M. Schätzler, *ib.*, 11. 426, 1862; F. Sestini, *Gazz. Chim. Ital.*, 4. 182, 1874; C. Struckmann, *Liebig's Ann.*, 97. 143, 1856; C. H. Weigelt, *Journ. prakt. Chem.*, (1), 106. 193, 1869; G. C. Wittstein, *Arch. Pharm.*, (2), 111. 14, 1862; (3), 8. 341, 1875; H. Yoshida, *Journ. Chem. Soc.*, 43. 472, 1883; 51. 748, 1887.

¹¹ R. Andreasch, *Journ. prakt. Chem.*, (2), 18. 204, 1878; T. Bromeis, *ib.*, (1), 48. 447, 1849; *Ann. Landw.*, 14. 207, 1849; E. S. Bastin and H. Trimble, *Amer. Journ. Pharm.*, 69. 90, 1897; E. Wolf, *Aschenanalysen*, Berlin, 128, 1871; E. Baudrimont, *Journ. Pharm.*, (3), 42. 388, 1862; E. J. Bevan and C. F. Cross, *Chem. News.*, 42. 77, 91, 1880; C. J. H. Warden, *ib.*, 39. 27, 1879; B. von Bitto, *Landw. Vers. Stat.*, 42. 369, 1893; 46. 327, 1895; A. Tschirch, *Gartenztg.*, 34, 1883; H. Block, *Arch. Pharm.*, 226. 953, 1888; K. Fritsch, *ib.*, (3), 27. 193, 1889; G. C. Wittstein, *Liebig's Ann.*, 108. 203, 1858; M. Berthelot and G. André, *Compt. Rend.*, 120. 288, 1895; *Ann. Chim. Phys.*, (7), 5. 429, 1895; A. Bobierre, *Journ. Agric. Prat.*, 2. 199, 1876; P. von Gasparin, *ib.*, 2. 410, 1875; C. Counciler, *Bot. Centrbl.*, 40. 97, 129, 1889; F. Daubrawa, *Vierteljahr. prakt. Pharm.*, 3. 337, 1854; C. Falco, *ib.*, 15. 509, 1866; H. Fraas, *ib.*, 15. 338, 1866; J. Khittel, *ib.*, 7. 348, 1858; C. Reithner, *ib.*, 4. 481, 1855; C. Rode, *ib.*, 9. 530, 1860; M. Winternitz, *ib.*, 4. 542, 1855; C. Eylerts, *ib.*, 9. 529, 1860; *Arch. Pharm.*, (2), 109. 105, 1862; G. C. Wittstein, *ib.*, (3), 8. 229, 1876; G. B. Frankforter, *Amer. Journ. Pharm.*, 69. 134, 1897; R. Glenk, *ib.*, 63. 328. 1891; C. F. Heller, *ib.*, 59. 68, 1887; C. H. Lawall, *ib.*, 69. 137, 1897; R. Gaze, *Apoth. Zig.*, 15. 9, 1900; G. Ruge, *ib.*, 6. 208, 1891; A. Hébert, *Bull. Soc. Chim.*, (3), 13. 927, 1896; T. J. Herapath, *Journ. Roy. Agric. Soc.*, 11. 93, 1850; R. J. Kane, *Phil. Mag.*, (3), 31. 36, 105, 1847; W. R. Munroe, *Amer. Journ. Pharm.*, 70. 489, 1898; L. E. Sayre, *ib.*, 69. 643, 1897; C. E. Schlegel, *ib.*, 57. 426, 1885; D. Parodi, *Pharm. Journ.*, (3), 10. 667, 1880; T. de Saussure, *Recherches chimiques sur la végétation*, Paris, 1804; A. Völcker, *B.A. Rep.*, 43, 1850; G. C. Wittstein, *Repert. Pharm.*, (2), 46. 329, 1847; *Vierteljahr. prakt. Pharm.*, 4. 525, 1855; M. Coppola, *Gazz. Chim. Ital.*, 10. 9, 1880; E. Kratzmann, *Pharm. Post*, 47. 101, 109, 1914.

¹² C. F. Bergstrand, *Öfver. Svenska Akad. Förh.*, 27, 1875; C. A. Browne, *Journ. Amer. Chem. Soc.*, 23. 869, 1901; R. E. Doolittle and W. H. Hess, *ib.*, 22. 218, 1900; R. Kayser, *Repert. Anal. Chem.*, 3. 182, 289, 1883; W. Keim, *Zeit. anal. Chem.*, 30. 401, 1891; W. W. Light, *Amer. Journ. Pharm.*, 56. 3, 1884; O. Huischke, *Vierteljahr. prakt. Pharm.*, 17. 284, 1868; E. Schreiner, *ib.*, 5. 207, 1856; L. Ricciardi, *Gazz. Chim. Ital.*, 19. 150, 1889; E. Speiss, *Wittstein's Viertelj.*, 9. 392, 1860; W. Tod, *Arch. Pharm.*, (2), 78. 136, 1864; C. J. H. Warden, *Chem. News*, 64. 161, 1891; G. C. Wittstein, *Vierteljahr. prakt. Pharm.*, 13. 364, 1865.

¹³ C. S. Bondurant, *Amer. Journ. Pharm.*, 59. 122, 1887; F. A. Ringer and E. Brooke, *ib.*, 64. 255, 1892; C. H. Lawall, *ib.*, 69. 137, 1897; R. Brandes, *Arch. Pharm.*, (2), 75. 269, 1853; E. Staffel, *ib.*, (2), 64. 129, 1850; E. Dieterich, *Vierteljahr. prakt. Pharm.*, 15. 196, 1866; N. Zeyer, *ib.*, 10. 504, 1861; T. Peckolt, *Pharm. Journ.*, (3), 10. 343, 383, 1879; *Sitzber. Akad. Wien*, 54. 462, 1866; L. Ricciardi, *Gazz. Chim. Ital.*, 19. 150, 1889; H. Yoshida, *Journ. Chem. Soc.*, 51. 748, 1887; M. Yvon, *Journ. Pharm. Chim.*, (4), 25. 588, 1877; C. J. H. Warden, *Chem. News*, 64. 161, 1891; W. W. Light, *Amer. Journ. Pharm.*, 56. 3, 1884; O. Huischke, *Vierteljahr. prakt. Pharm.*, 17. 284, 1868.

¹⁴ A. Chatin, *Compt. Rend.*, 110. 376, 1890; P. Nettlefold, *Chem. News*, 55. 191, 1887; A. Pizzi, *Staz. Sper. Agr. Ital.*, 16. 737, 1888; 17. 1, 167, 1889; J. Wolff, *Vierteljahr. prakt. Pharm.*, 3. 1, 1853.

¹⁵ H. Krutzsch, *Tharander forstl. Jahrb.*, 6. 88, 1850; C. Counciler, *Bot. Centrbl.*, 40. 97, 129, 1889; E. Demarcay, *Compt. Rend.*, 130. 91, 1900; J. B. Enz, *Vierteljahr. prakt. Pharm.*, 5. 196, 1856; C. Reithner, *ib.*, 4. 382, 1855; G. C. Wittstein, *ib.*, 3. 10, 1854; 16. 81, 1867; *Arch. Pharm.*, (2), 111. 14, 1862; (3), 7. 394, 1875; J. W. England, *Amer. Journ. Pharm.*, 55. 246, 1883; E. S. Bastin and H. Trimble, *ib.*, 69. 90, 1897; H. Matusou, *ib.*, 69. 341, 1897; C. H. Lawall, *ib.*, 69. 137, 1897; L. Huber, *ib.*, (3), 7. 394, 1875; K. Kresling, *ib.*, (3), 229. 389, 1891; E. Reichardt, *ib.*, (2), 73. 257, 1853; C. Karmrodt, *Zeit. Landw. Ver. Rheinpruss.*, 427, 1864; J. H. Maiden and H. G. Smith, *Proc. Roy. Soc. N.S.W.*, 29. 325, 1895; H. G. Smith, *Chem. News*, 88. 135, 1903; W. Smith, *Journ. Chem. Soc.*, 37. 415, 1880; G. M. Tucker and B. Tollens, *Ber.*, 32. 2575, 1899; R. Weber and E. Ebermayer, *Lehre der Waldstreu*, Berlin, 1876; W. A. E. Witting, *Mordamer Monatsb. Nat. Heilkunde*, 1. 165, 1205, 1850.

¹⁶ G. von Bunge, *Zeit. Biol.*, 41. 155, 1901; R. Godeffroy, *Arch. Pharm.*, (3), 10. 297, 1877; G. Ramdohr, *ib.*, (2), 91. 129, 1857; T. Crawford, *Vierteljahr. prakt. Pharm.*, 6. 361, 1857; J. C. Hermann, *ib.*, 19. 481, 1869; S. von Thielau, *ib.*, 4. 537, 1855; G. Lindenmayer, *ib.*, 17. 290, 1868; F. Muck, *ib.*, 5. 544, 1856; D. Hooper, *Pharm. Journ.*, (3), 17. 545, 1887; D. von Wasowicz, *ib.*, (3), 10. 301, 341, 463, 1879; A. Payen, *Compt. Rend.*, 28. 613, 1849; E. Reichardt, *Chemische Bestandtheile der Chinارينden*, Braunschweig, 1855; W. Wallace, *Analyst*, 3. 243, 1878; H. Wefers-Bettink *Rec. Trav. Chim. Pays-Bas*, 2. 126, 1883; C. H. Lawall, *Amer. Journ. Pharm.*, 69. 137, 1897; L. F. Kebler, *ib.*, 67. 398, 1895; J. W. MacDonald, *Chem. News*, 37. 127, 1878; C. J. H. Warden, *ib.*, 38. 146, 1878.

¹⁷ T. M. Rotch, *Pediatrica*, Philadelphia, 175, 1896; E. Dieterich, *Vierteljahr. prakt. Pharm.* 16. 56, 1867; A. Heyl, *Liebig's Ann.*, 62. 87, 1847; J. Mayrhöfer, *Versml. Ver. Bayr. ang.*

Chem., 9. 27, 1890; R. Schütze, *Mitt. Pharm. Inst. Erlangen*, 280, 1889; W. McMurtie, *Amer. Chemist*, 4. 339, 1873; A. Müntz, *Ann. Chim. Phys.*, (4), 20. 309, 1870; *Compt. Rend.*, 69. 1309, 1869; M. Thezard, *ib.*, 120. 1126, 1895; R. Theile, *Jenaische Zeit. Med.*, 3. 147, 1868; G. Walter, *Zeit. physiol. Chem.*, 13. 464, 1889; E. Staffel, *Arch. Pharm.*, (2), 64. 148, 1850; C. Liebermann, *Ber.*, 31. 2709, 1898.

§ 3. The Preparation and Production of Aluminium

A very large number of processes¹ have been devised for the production of aluminium, but few have attained any industrial importance. Some have been worked for a time on a large scale, but have succumbed in the competition against cheaper and more economical processes. Some schemes could have been proposed only by those possessing an inadequate knowledge of chemistry. The only successful process is the electrolysis of a soln. of alumina in a bath of molten fluoride. The different methods which have been proposed have usually been the subject of a patent; nevertheless, nearly all have proved to be either chemically impossible or commercially impracticable. Consequently, the literature of aluminium production is largely a series of sign-posts indicating: No Thoroughfare. The different proposals may be classified: I. Chemical methods involving reduction with (a) an alkali metal, (b) by some metal other than the alkali metals, and (c) by some other reducing agent. II. Electrothermal processes in which the current plays the part of heating agent. III. Electrolytic processes including (a) the electrolysis of aq. soln. of aluminium salts, or (b) the electrolysis of molten aluminium compounds. IV. Combination of the electrothermal and electrolytic processes in which the heat required for maintaining the charge in a state of fusion is derived from the current itself within the electrolytic cell. This idea was filed as a patent by C. S. Bradley in 1883, which was granted in 1891.

The production of aluminium by chemical processes.—In 1824, H. C. Oersted² reduced aluminium chloride with a conc. *potassium amalgam*, and distilled the mercury from the resulting amalgam in *vacuo*. F. Wöhler failed to verify H. C. Oersted's results, but obtained aluminium in the form of a grey powder by warming a mixture of potassium and aluminium chlorides contained in a porcelain crucible. J. von Liebig passed the vapour of aluminium chloride over *potassium*, and this plan was later employed by F. Wöhler. H. St. C. Deville reduced aluminium chloride with *sodium*, and he found that the reaction is facilitated by the presence of cryolite which serves as a flux, forming a slag light enough to allow the aluminium to collect below. The industrial success of the process depended on the cheap production of large quantities of sodium; the production of purified alumina; and the conversion of the aluminium oxide into chloride.

In H. St. C. Deville's process, a mixture of 220 lbs. of aluminium chloride, 100 lbs. of cryolite, and 77 lbs. of sodium was charged into a reverberatory furnace, with a well, and a sloping hearth, and at a dull red-heat. The temp. was regularly increased for about 3 hrs. The slag was first tapped, then the aluminium, and finally a mixture of sodium chloride and cryolite containing beads of aluminium was tapped last. In 1872, A. Wurtz estimated the costs of materials, fuel, wages, and other expenses to be 70·25–80·00 francs per kilogram of aluminium.

H. Rose obtained aluminium by heating in a crucible a mixture of 5 parts of cryolite, 5 parts of potassium chloride, and 2 parts of sodium. A similar process involving the reduction of cryolite by sodium was described by A. Dick, C. Brunner, M. Herzog, L. Grabau, W. F. Gerhard, J. B. Thompson and W. White, M. Ichon, W. Weldon, J. Webster, A. Stevart, M. Rousseau and P. Morin, B. Kosmann, W. Anderson, etc.

A. Dick lined a platinum crucible with magnesia, and introduced alternate layers of cryolite and sodium, finishing with a thick layer of cryolite. The crucible was closed with a tight-fitting lid, and heated in the blowpipe flame. There resulted some globules of

aluminium. Iron, porcelain, and fireclay crucibles were not satisfactory; in the first case, the aluminium "seemed to alloy with the sides of the crucibles, which thereby acquired a colour like zinc"; in the other cases, the fluorides attacked the crucibles vigorously.

M. A. Brogowsky passed the vapour of sodium over the molten cryolite. H. Rose's process was employed for a time by C. and A. Tissier at Amfreville. N. V. Castner improved the method of making sodium, and used sodium aluminium chloride mixed with cryolite. The process was employed near Birmingham about 1899. C. Netto reduced artificial cryolite by sodium by H. Rose's old process, and it was used for a time by The Alliance Aluminium Co., at Wallsend-on-Tyne. L. Grabau reduced aluminium fluoride with sodium: $2\text{AlF}_3 + 3\text{Na} = \text{Al} + \text{AlF}_3 \cdot 3\text{NaF}$, and recovered the fluoride by treatment with aluminium sulphate: $\text{Al}_2(\text{SO}_4)_3 + 2\text{Na}_3\text{AlF}_6 = 4\text{AlF}_3 + 3\text{Na}_2\text{SO}_4$. A. Feldmann heated a mixture of strontium aluminium fluoride with sodium: $\text{Al}_2\text{F}_6 \cdot 3\text{SrF}_2 + 6\text{Na} = 2\text{Al} + 3\text{SrF}_2 + 6\text{NaF}$. The strontium fluoride is insoluble in water so that the other materials can be washed away, and the strontium fluoride used for making more double fluoride. H. St. C. Deville tried to produce the sodium and aluminium in one operation by passing the vapour from a heated mixture of lime, carbon, and soda into heated aluminium chloride; W. Frishmuth likewise allowed the vapours of aluminium sodium chloride and of sodium to react in a suitable receptacle. H. D. Gadsden, E. Foote, H. Niewerth, and L. Henne used modifications of the process.

From their study of the direct reduction of alumina by *carbon*, R. S. Hutton and J. E. Petavel³ inferred (1) that metallic aluminium can be produced by a purely thermal reaction; (2) that the lowest temp. at which this reaction can take place coincides with the m.p. of alumina; (3) that the metal is first produced in the form of vapour. Under ordinary circumstances, however, the metal vapour immediately interacts with the carbon monoxide, and to collect the pure metal it is therefore necessary (1) to dilute and remove the carbon monoxide, (2) to limit the vaporization of the metal by working under high gaseous press. In this way it has been possible to prepare and collect 40–50 grms. of aluminium. P. Askenasy and N. Lebedeff found that a mixture of alumina and wood charcoal heated in an arc furnace at first gives off large quantities of carbon monoxide followed by brilliant flames of burning aluminium vapour. If the heating be stopped as soon as these appear, the product consists of fused alumina mixed with aluminium carbide and aluminium. In the carbon tube resistance furnace, where the highest temp. reached is not much above the m.p. of alumina, both carbide and metal were formed. It is thought that aluminium carbide is first formed, $2\text{Al}_2\text{O}_3 + 9\text{C} = \text{Al}_4\text{C}_3 + 6\text{CO}$, and that this reacts with alumina, or dissociates at a higher temp. yielding aluminium which is probably dissolved by the carbide, otherwise it would distil away; on cooling, the aluminium separates from the soln., and is found side by side with the carbide in the cold product. L. Burgess heated a mixture of bauxite and carbonaceous matter in the electric arc. According to the purity of the material and the proportion of carbon, the product may be aluminium, the carbide, or mixture of either with other carbides or metals.

W. F. Gerhard claimed to have obtained aluminium by heating aluminium fluoride or cryolite to redness in a stream of *hydrogen*. A. Schneller and A. Astfalck claimed to have obtained aluminium by heating the oxide, fluoride, or chloride to the temp. of the electric arc in a stream of hydrogen; and H. N. Warren passed hydrogen over alumina in a tube of lime heated by the oxyhydrogen blowpipe flame. L. P. B. E. Cumenge reduced aluminium sulphide with hydrogen. A. L. Fleury heated an intimate mixture of alumina and carbon—tar, resin, petroleum—to redness in an atm. of a *hydrocarbon* gas under a press. of 20–30 lbs. per sq. in. H. Bessemer proposed reducing a mixture of alumina and carbon by burning gases under 3–4 atm. press. T. L. Willson heated a mixture of alumina and tar in an electric furnace. J. S. Howard, F. G. Bates, and F. P. Pendleton heated a mixture of alumina, carbon, and sodium chloride; E. Meyer heated a mixture of alkali aluminate and carbon, sawdust, or carbohydrate. Various modifications of the process

for reducing aluminium sulphide with hydrocarbons or carbon have been suggested by D. A. Peniakoff, H. F. D. Schwahn, D. G. Reillon and co-workers, G. A. Faurie, W. Rübel, etc. D. G. Reillon, S. C. Montagne, and O. L. B. L. Bourgerel, and T. Petitjean reduced aluminium sulphide, or sodium aluminium sulphide, with hydrocarbon gases. N. Lebedeff fluxed alumina with fluorspar or cryolite, and exposed the molten mass to hydrogen or hydrocarbon gas. J. W. Richards' experiments in this direction were fruitless. In 1854, M. Chapelle claimed to have obtained globules of metal from an intimate mixture of natural clay, sodium chloride, and carbon contained in a fireclay crucible heated in a reverberatory furnace with coke as fuel. J. W. Richards has suggested that M. Chapelle's metallic globules were siliceous iron reduced from the iron oxide in the clay. W. Hempel expressed his doubts whether alumina can be reduced by carbon in a purely thermal reaction. H. Moissan, and W. Borchers noted the formation of aluminium carbide and aluminium at high temp., and the former assumed that it is the vapour of alumina which is reduced by carbon. E. Tiede and E. Birnbräuer give 1800° for the reduction temp. of alumina by carbon. O. Knöfler and H. Ledderboge made a mixture of alumina and carbon into rods which were used as electrodes for an electric arc in vacuo or in an atm. of an indifferent gas. J. M. A. Gérard-Léscuyer used a somewhat similar process. E. Duvivier reduced disthene between carbon electrodes in the electric arc furnace. G. W. Reiner stated that the mass obtained by heating a mixture of soda or potash alum with carbon contains an alloy of aluminium and the alkali metal, and that the latter can be removed by dil. nitric acid. W. A. Baldwin heated a mixture of bauxite, carbon, and sodium chloride, and then melted the resulting sodium-aluminium alloy with sodium chloride to separate the aluminium. N. Lebedeff reduced the sulphide with carbon. O. M. Thowless obtained aluminium by heating a mixture of aluminium chloride, chalk, coal, soda, and cryolite in a closed vessel; S. Pearson, J. Liddon, and J. H. Pratt likewise heated a mixture of cryolite, bauxite or clay, calcium chloride or carbonate, and coke or anthracite. R. E. Green heated a mixture of aluminium fluoride or cryolite with carbon and a silicate, contained in a carbon crucible in an atm. of coal gas: $\text{AlF}_3 \cdot 3\text{NaF} + \text{SiO}_2 + 2\text{H}_2 = \text{Al} + \text{Na} + \text{Na}_2\text{SiF}_6 + 2\text{H}_2\text{O}$. S. Pearson, A. W. Turner, and W. Andrews claimed to have made aluminium by heating aluminium silicate with calcium fluoride, and an alkali carbonate or hydroxide. D. G. Reillon, S. C. Montagne, and O. L. B. L. Bougerel heated a mixture of clay and carbon in an atm. of a hydrocarbon and *carbon disulphide*. G. A. Faurie heated a mixture of sulphur, clay, and carbon to redness; carbon disulphide is first formed, and finally aluminium. J. Morris claimed to have obtained aluminium by heating an intimate mixture of alumina and charcoal in an atm. of carbon dioxide. S. A. Tucker and H. R. Moody reduced alumina with *calcium carbide* in an electric furnace: $\text{CaC}_2 + \text{Al}_2\text{O}_3 = 2\text{Al} + 2\text{CO} + \text{CaO}$; and H. S. Blackmore, and P. R. Hershman, with *aluminium carbide*, $\text{Al}_2\text{O}_3 + \text{Al}_4\text{C}_3 = 6\text{Al} + 3\text{CO}$. E. Straub described a process involving the reduction of alumina with aluminium carbide.

F. C. Knowles proposed to reduce a mixture of alumina and aluminium chloride with *potassium or sodium cyanide*; I. L. Bell tried a similar process but obtained no metal. L. F. Corbelli heated a mixture of aluminium sulphate with sodium chloride and *potassium ferrocyanide* in a crucible to a white heat. H. St. C. Deville obtained no satisfaction with this process, and the button of metal probably consisted chiefly of iron.

L. P. B. E. Cumenge⁴ heated aluminium sulphide with alumina or aluminium sulphate in a non-oxidizing atm. The proportions employed are such as to produce only aluminium and sulphur dioxide: $\text{Al}_2\text{S}_3 + 2\text{Al}_2\text{O}_3 = 6\text{Al} + 3\text{SO}_2$; and $\text{Al}_2\text{S}_3 + \text{Al}_2(\text{SO}_4)_3 = 4\text{Al} + 6\text{SO}_2$. It is also claimed that aluminium sulphate can be used with other metal sulphides to produce alloys: $\text{Al}_2(\text{SO}_4)_3 + 3\text{FeS} = 6\text{SO}_2 + 2\text{Al}_3\text{Fe}$. J. Malovich applied his process for barium to aluminium. G. Gin described a process in which a molten mixture of aluminium and sodium sulphides formed by melting together aluminium fluoride and sodium sulphide: $6\text{Na}_2\text{S} + 4\text{AlF}_3$

$=2(\text{AlF}_3 \cdot 3\text{NaF}) + 3\text{Na}_2\text{S} \cdot \text{Al}_2\text{S}_3$, was electrolyzed. In the first stage of the reaction $3\text{Na}_2\text{S} \cdot \text{Al}_2\text{S}_3 = 3\text{Na}_2\text{S} + 3\text{S} + 2\text{Al}$, and the liberated sodium sulphide attacks the double fluoride, forming more double sulphide; finally, $3\text{Na}_2\text{S} + 2(\text{AlF}_3 \cdot 3\text{NaF}) = 12\text{NaF} + 3\text{S} + 2\text{Al}$. T. Petitjean, and M. Herzog suggested reducing aluminium sulphide with iron or hydrocarbons. F. Lauterborn said that aluminium sulphide is reduced by iron at a red heat. W. A. Baldwin, G. Bamberg, G. H. Billings, L. Q. Brin, F. C. Calvert and R. Johnson, A. Chenot, E. Cleaver, J. H. H. Corbin, L. P. B. E. Cumenge, M. Faraday and J. Stodart, M. Grüner and M. Lan, C. T. Holbrook, A. Ledebur, M. Lohage, A. Mann, H. Niewerth, P. Ostberg, S. Pearson and J. H. Pratt, F. G. Reichel, C. E. Schafhäütl, J. A. Stephan and R. Southerton, W. P. Thompson, etc., have dealt with the production of iron-aluminium alloys.

L. P. Devaucelle made an alloy of zinc or copper by heating aluminium sulphide with an excess of one of these metals. A. Mann reduced aluminium sulphide with zinc, iron, or copper: $2\text{AlCl}_3 + \text{Al}_2\text{S}_3 + 3\text{CaCl}_2 + 6\text{Cu} = 6\text{CuCl}_2 + 3\text{CaS} + 4\text{Al}$. E. L. Benzon, P. Bolley, L. Q. Brin, F. C. Calvert and R. Johnson, L. P. B. E. Cumenge, G. A. Faurie, W. Hampe, K. List, F. G. Reichel, etc., have studied the reduction of aluminium compounds with copper, and the production of aluminium-copper alloys. N. N. Beketoff could not reduce the vapour of aluminium chloride by the vapour of zinc, although silicon chloride is readily reduced. H. St. C. Deville said that a mixture of zinc and sodium aluminium chloride detonated at a white heat. M. Dullo found the reduction by zinc presents no difficulty, although it is less easy than with sodium, and N. Basset stated that "all the metalloids and metals which form, by decomposition, more fusible or more soluble chlorides than aluminium chloride may reduce it or even sodium aluminium chloride. Thus, arsenic, bismuth, copper, zinc, antimony, mercury, or even tin, or an amalgam of zinc, tin, or antimony may be employed to reduce the single or double chloride." F. Flavitzky found that zinc is quantitatively displaced by aluminium from zinc chloride. The reaction is probably reversible. The process has been discussed by H. Wedding. Processes for reducing aluminium salts by zinc have been devised by F. J. Seymour, L. P. Devaucelle, L. P. B. E. Cumenge, F. Lauterborn, A. Mann, J. Clark, G. Bamberg, S. van Oldruitenborgh, R. de Montgelas, etc. A. J. Rogers said that the molten cryolite is reduced by an alloy of sodium with lead or tin more easily than by sodium alone; and A. E. Wilde obtained aluminium by heating an intimate mixture of lead or lead sulphide and dried alum. The Aluminium Product Co. reduced aluminium chloride with tin. W. Weldon claimed to produce aluminium by heating the chloride or sulphide with manganese or spiegeleisen—and adding a little sodium to promote the reaction. W. H. Greene and W. H. Wahl noted the converse reaction, for manganese is obtained by the action of aluminium on a soln. of manganese oxide in molten cryolite. N. N. Beketoff said that magnesium reduces molten cryolite; C. Winkler obtained what he regarded as a suboxide, AlO , by the action of powdered magnesium on heated alumina in an atm. of hydrogen. R. Grätzel reduced alkali aluminium fluoride by metallic magnesium or magnesium vapour, and R. de Montgelas reduced aluminium chloride with magnesium. B. Kosmann reduced cryolite with magnesium, or in the presence of magnesium chloride undergoing electrolysis. F. Lauterborn heated a mixture of antimony, sodium carbonate, and aluminium sulphate in a coke furnace. In the first stage of the reaction: $2\text{Sb}_2\text{S}_3 + 6\text{Na}_2\text{CO}_3 + 3\text{C} = 6\text{Na}_2\text{S} + 9\text{CO}_2 + 4\text{Sb}$; and in the second stage: $2\text{Al}_2(\text{SO}_4)_3 + 6\text{Na}_2\text{S} + 4\text{Sb} + 12\text{C} = 4\text{Na}_3\text{SbS}_3 + 12\text{CO} + 4\text{Al}$. F. Fischer added that these extraordinary formulæ have little or no basis in chemical science; they are false. J. W. Richards obtained negative results. L. Grabau was not very successful in an attempt to reduce aluminium salts with phosphorus, although he did get an aluminium-phosphorus alloy. M. Wanner suggested reducing molten aluminium fluoride with the extraordinary reagent silicon sulphide.

The electro-deposition of aluminium from aqueous solutions of its salts.—Z. Roussin⁶ said that magnesium does not precipitate metallic aluminium from soln. of its salts, but J. W. Richards added that aluminium is so precipitated but instantly

oxidized by the water; thus S. Kern found that aluminium hydroxide appears when magnesium is immersed in aq. soln. of aluminium salts. F. Wöhler could get no aluminium by the electrolysis of a soln. of cryolite in an aq. soln. of sodium hydroxide; nor did H. St. C. Deville obtain any metal by the electrolysis of aq. soln. of aluminium salts. On the other hand, F. S. Thomas and W. E. Tilley electrolyzed a soln. of freshly precipitated alumina or alum in a soln. of potassium cyanide, and claimed to have deposited aluminium; and L. F. Corbelli said that he deposited aluminium by electrolyzing a mixed soln. of alum or aluminium sulphate and calcium or sodium chloride; G. Gore said that he electro-deposited aluminium on copper from a warm dil. soln. of aluminium hydroxide in hydrochloric acid; from a sat., aq. soln. of potash alum; from a conc. soln. of aluminium acetate; and from a cold, filtered soln. of pipeclay in hydrochloric acid. A. Bertrand electro-deposited aluminium on a copper plate from a soln. of ammonium aluminium chloride; T. Ball used a soln. of potassium aluminium chloride; and patents have been obtained by J. Braun, L. and A. Brin, H. C. Bull, C. A. Burghardt and W. J. Twining, S. Coulson, R. A. Falk and A. Schaag, M. G. Farmer, W. Frishmuth, W. F. Gerhard and J. Smith, A. F. B. Gomess, A. H. Harris, J. S. Haurd, J. A. Jeançon, J. Marino, R. de Montgela, G. Nahnsen and J. Pfeleger, G. von Overbeck and H. Niewerth, M. Rietz and M. Herold, A. J. Rogers, L. Senet, A. Walker, H. N. Warren, S. Wohle, etc. Several of these processes have been challenged by F. Wöhler, and H. St. C. Deville. J. Nicklès said that in some cases the precipitated metal is not aluminium; F. Fischer showed that J. Braun mistook a deposit of cupric sulphide for aluminium. G. Gore, also, in his later work, makes allusion to his 1854 process. S. Mierzinsky claimed that in 1883, the electro-deposition of aluminium from aq. soln. had not been accomplished; and W. Hampe, A. Watt, C. Winkler, and J. T. Sprague have recorded their failure to deposit aluminium electrolytically in the wet way. W. A. Plotnikoff found that aluminium is deposited on the carbon cathode when a soln. of aluminium bromide in ethyl bromide is electrolyzed; H. E. Patten confirmed this result, using platinum as well as aluminium electrodes.

The electro-deposition of aluminium from molten aluminium salts.—In 1808, H. Davy⁶ applied his method of decomposing the alkali hydroxides to alumina, but, owing to the weakness of the available current, he obtained no aluminium; in 1810, however, he did succeed in producing an alloy of aluminium and iron by fusing iron to whiteness in the arc in contact with alumina. He thus showed that alumina can be decomposed in the electric arc, and its metal alloyed with iron. R. Bunsen first obtained aluminium by the electrolysis of fused sodium aluminium chloride, contained in a partitioned, porcelain crucible using carbon electrodes, and similar to the apparatus which he employed for magnesium. At low temp., the aluminium was obtained as a grey powder, but by working at a higher temp., with sodium chloride also present, beads of the metal were obtained. H. St. C. Deville decomposed fused sodium aluminium chloride by electrolysis about the same time as R. Bunsen. He used the apparatus illustrated by Fig. 1. A porcelain crucible, *D*, is fitted inside a fireclay crucible *E*. The fireclay cover *B* has apertures to admit a strip of platinum *K* to serve as cathode; and a porous cell *C* containing a carbon anode *A*. The porcelain crucible and porous cell are filled to the same level with fused sodium aluminium chloride, and the current is passed. Aluminium deposits on the cathode. H. St. C. Deville used a similar bath for

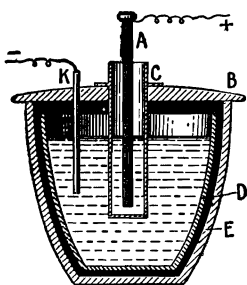

FIG. 1.—H. St. C. Deville's Cell for the Electrolysis of Sodium Aluminium Chloride.

plating metals, particularly copper. He said:

A bath of double chloride, which has been entirely purified from foreign metallic matter by the action of the battery itself, is used. When aluminium is being deposited at the negative pole, the first portions of metal obtained are always brittle, the impurities in the bath being

removed in the first metal thrown down; so, when the metal deposited appears pure, the piece of copper to be plated is attached to this pole and a bar of pure aluminium to the positive pole. However, a compact mixture of carbon and alumina can be used instead of the aluminium anode, which acts similarly to it and keeps the composition of the bath constant. The temp. ought to be kept a little lower than the fusing point of aluminium. The deposit takes place readily and is very adherent, but it is difficult to prevent it being impregnated with double chloride, which attacks it the moment the piece is washed. The washing ought to be done in a large quantity of water. Cryolite might equally as well be used for this operation, but its fusibility should be increased by mixing with it a little double chloride of aluminium and sodium and some potassium chloride.

H. le Chatelier patented a very similar process, using a mixture of alumina and carbon for the anode, as recommended by H. St. C. Deville. M. G. Farmer used the containing vessel with walls electrically conducting so as to serve as cathode. J. P. Kagensbusch electrolyzed a fused mixture of clay with fluxes and zinc or like metal so as to obtain an alloy of aluminium. H. M. A. Berthaut electrolyzed a fused mixture of equal parts of cryolite and sodium chloride. A. Feldmann obtained better results by adding a little calcium oxide to the electrolyte. The electrolysis of molten cryolite has been studied by E. C. Kleinert, A. J. Rogers, A. Zdziarsky, I. Omholt, J. W. Richards, M. Gauduin, J. Garneri, C. A. Faure, etc. W. Diehl showed that in the presence of alkali chloride, chlorine is evolved at the anode, and the spent electrolyte can be reconverted into a double aluminium fluoride by adding alum: $7\text{NaF} + 2\text{KAl}(\text{SO}_4)_2 = \text{NaF} \cdot 2\text{AlF}_3 + \text{K}_2\text{SO}_4 + 3\text{Na}_2\text{SO}_4$. A. Minet electrolyzed a mixture of sodium chloride with 37.5 per cent. of cryolite fused internally. The bath was replenished from time to time by the addition of aluminium fluoride. The method has been discussed by W. Borchers; and the electrolysis of a fused mixture of cryolite and alkali chloride by W. Hampe, and O. Schmidt. Modifications of the process have been described by L. Grabau, M. J. Berg, L. Lossier, R. Grätzel, H. de Grouilliers, F. J. Tone, F. Haber and R. Geipert, M. Sprenger, F. A. Gooch and L. Waldo, J. L. E. Daniel, etc. A. Feldmann used double fluorides of aluminium and the alkaline earths, magnesium, or zinc in place of alkali aluminium fluoride.

A. H. Bucherer,⁷ electrolyzed the product obtained by melting a sulphide or polysulphide of the alkalis or alkaline earths with alumina or aluminium hydroxide; and M. M. Jännigen electrolyzed the double sulphide obtained by passing carbon disulphide over a molten mixture of alumina and alkali carbonate. A. Winkler electrolyzed fused aluminium phosphate or borate. A. Julien proposed to electrolyze a soln. of alumina in fused sodium chloride, fluorspar, alkali silicate, sodium borate, or boric acid; and M. Blasi, a bath of a soln. of alumina in fused baryta.

The electro-deposition of aluminium from a solution of alumina in fused cryolite.—In 1886, P. L. V. Héroult⁸ obtained aluminium by the electrolysis of a soln. of alumina in fused cryolite contained in a crucible heated from without. Attempts to manufacture aluminium by the electrolysis of a bath of the fused halide, externally heated have not been successful. It is difficult to procure a suitable containing vessel to resist the corrosive action. If the crucibles contain silica, then the deposited metal is contaminated with silicon derived from the silica dissolved from the containing vessel. Compressed coke crucibles are too porous; metal vessels do not stand against the corrosive action. This difficulty was overcome by generating the necessary heat for fusing the electrolyte within the containing vessel. The same year, C. M. Hall likewise proposed to electrolyze a soln. of alumina in fused cryolite. For the purposes of the American patent, C. M. Hall was able to cite Feb. 23, 1886, as the date of the invention and putting into practice, while P. L. V. Héroult cited April 23, 1886, as the date of his French invention. As a result, C. M. Hall received the American patent on April 2, 1889. He claimed:

Dissolving alumina in a fused bath composed of the fluorides of aluminium and a metal more electropositive than aluminium, and then passing an electric current through the fused mass. Dissolving alumina in a fused bath composed of the fluorides of aluminium and sodium and then passing an electric current, by means of a carbonaceous anode, through the fused mass.

The losses in fluorine are made good by additions of aluminium fluoride; and fresh alumina is added to the bath, to make up for that which has been reduced to aluminium. The later forms of the two processes are the same in principle. In both processes, the current not only performs the work of electrolysis, but also melts the electrolyte, and continually makes good the losses of heat due to radiation and conduction. There are modifications in the composition of the bath, and in the

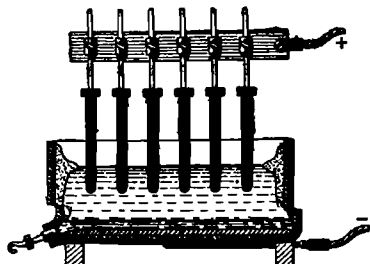

FIG. 2.—Cell for the Electrolysis of a Solution of Alumina in Fused Cryolite (Diagrammatic).

form of the cells, in different works. Furnaces have been devised by L. Grabau, B. Neumann and H. Olsen, M. Schindler, E. C. Kleinert, L. Lossier, R. J. Henderson, etc., and the subject has been discussed by J. W. Richards, M. Kuss, B. Kosmann, R. J. Henderson, W. Borchers, A. Lodin, etc. In general, the baths are made of wrought-iron, and the walls are coated with solid electrolyte which protects the iron from corrosion by the melted electrolyte. Some baths have a carbon lining but it is then difficult to prevent the molten electrolyte working its way through the capillary pores. The bottom of the bath is covered with carbon plates, Fig. 2, which serve as cathode until they are covered with aluminium, when the metal itself acts as cathode.

The leads of the anode are screwed on an insulated support so that they can be lowered as they are burnt by the anodic oxygen, and as the resistance of the bath varies. Air circulates about the bath so that a crust of electrolyte freezes on the surface inside. A tapping hole allows the aluminium to be run into moulds from time to time. Water-cooled cathodes have been tried; but the objection is the attack of the metal by the electrolyte, thus introducing impurities into the bath. The carbon anodes are costly, since almost three-fourths as much carbon is consumed by anodic oxygen as aluminium is produced—approximately $\text{Al}_2\text{O}_3 + 3\text{C} = 3\text{CO} + 2\text{Al}$. The anodes are also burnt by atm. oxygen. The anodes must contain very little impurities other than alumina, or the bath, and subsequently the aluminium, will be contaminated. The manufacture of the anodes has been described by W. Clacher; and the best form of anode has been investigated by F. Bock.

G. H. Bailey and R. Seligman have shown that the consumption of carbon, in practice, is much less than is represented by $\text{Al}_2\text{O}_3 + 3\text{C} = 3\text{CO} + 2\text{Al}$, assumed by J. W. Richards, F. Haber, etc., to represent the main reaction. According to G. H. Bailey, the composition of the anode gases corresponds more nearly with $2\text{Al}_2\text{O}_3 + 3\text{C} = 4\text{Al} + 3\text{CO}_2$. With normal anode consumption, the temp. of the bath being 945° , R. Seligman found the anode gases to contain CO_2 , 45.6; CO , 43.6; O_2 , 0.8; and N_2 , 10 per cent. The nitrogen present does not account for the presence of carbon dioxide as burnt carbon monoxide. It is therefore assumed that the alumina itself is electrolyzed so that the aluminium is liberated at the cathode and oxygen at the anode, and the oxygen then unites with carbon to form carbon monoxide and carbon dioxide. Some of the carbon monoxide burns to carbon dioxide in contact with air. The composition of the anode gases is therefore dependent upon temp., current density, physical character of anode, rapidity with which the gases are removed from contact with the anode, etc. A. Minet suggested that the aluminium liberated at the cathode is really produced by the decomposition of the aluminium fluoride, and that the fluorine liberated at the anode attacks the alumina, reforming fluoride and liberating oxygen: $\text{Al}_2\text{O}_3 + \text{F} = \text{Al}_2\text{F} + \text{O}_2$ —but this hypothesis has been abandoned.

Alumina alone melts at so high a temp. that a solvent must be obtained. Cryolite melts a little below 1000° . The fusibility of the cryolite is lowered by the addition of other fluorides—aluminium fluoride, or calcium fluoride. F. Haber says that the temp. of the bath should be kept as low as practicable, fluctuating between 900° and

1000°, but never exceeding 1065°; J. W. Richards gave 900°–950° for the bath temp. The effect of fluorspar on the m.p. of cryolite as found by P. Pascal and A. Jouniaux is shown in Fig. 3; there is a eutectic at 905° containing 25.4 per cent. of fluorspar. Mixed crystals are formed with 20.5 and 50 per cent. of fluorspar. The effect of calcium fluoride on the m.p. of cryolite has been determined by P. P. Fedotieff and W. Ijinsky, and by N. A. Puschin and A. Baskoff, Fig. 6. P. Pascal and A. Jouniaux found that alumina lowers the m.p. of cryolite from 977° to the eutectic at 904°

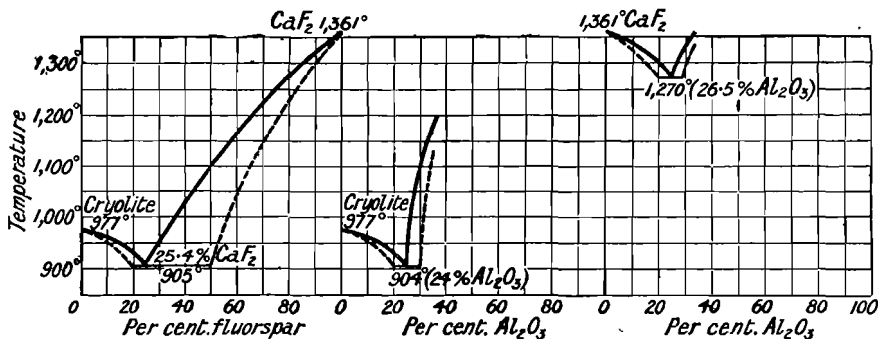

FIG. 3.—Melting Points of Mixtures of Cryolite and Fluorspar. FIG. 4.—Melting Points of Mixtures of Alumina and Cryolite. FIG. 5.—Melting Points of Mixtures of Alumina and Fluorspar.

with 24 per cent. of alumina—Fig. 4. Mixed crystals occur with 20 and 29 per cent. of alumina. R. Lorenz and co-workers place the eutectic at 937°–938° with 32–33 molar per cent. of alumina; and M. Moldenhauer, at 880° with 20 per cent. alumina. Similarly, P. Pascal and A. Jouniaux state that alumina lowers the m.p. of fluorspar from 1361° to the eutectic at 1270° with 26.5 per cent. of alumina—Fig. 5. Mixed crystals with 20 and 28.5 per cent. of alumina are formed. P. Pascal and A. Jouni-

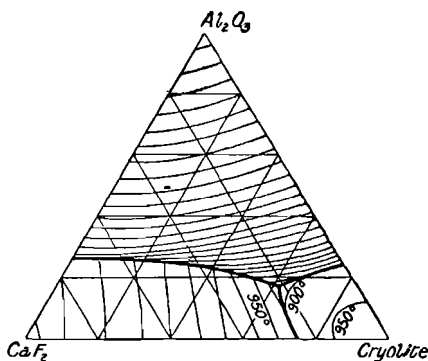

FIG. 6.—Liquidus of the Ternary System: Cryolite, Fluorspar, Alumina.

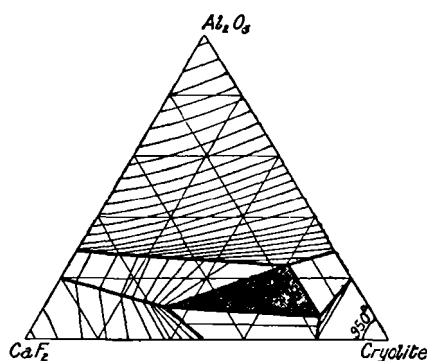

FIG. 7.—Solidus of the Ternary System: Cryolite, Fluorspar, Alumina.

aux studied the m.p. of the ternary system containing cryolite, alumina, and fluorspar. The liquidus system is shown in Fig. 6, and the solidus system in Fig. 7; the contour lines are drawn for each 50° difference of temp. The eutectic in Fig. 6 at 868° has 59.3, 23.0, and 17.7 per cent. respectively of cryolite, fluorspar, and alumina. The mixed crystals composing the ternary eutectic in Fig. 7 contain the percentage amounts cryolite, fluorspar, alumina as 77 : 16 : 7; 60 : 15 : 25; and 34 : 54 : 12.

J. W. Richards found the sp. gr. of solid and liquid commercial aluminium to be 2.66, and 2.54; of commercial cryolite, 2.92 and 2.08; of commercial cryolite sat. with alumina, 2.90 and 2.35; of commercial cryolite with aluminium fluoride $3\text{NaF}\cdot\text{AlF}_3 + 2\text{AlF}_3$, 2.96 and 1.97; and of the same mixture sat. with alumina, 2.98 and 2.14. The sp. gr. of cryolite at ordinary temp. is greater than that of aluminium, so that if this condition were maintained at the temp. of the bath, the metal would float on the molten flux. At the temp. of electrolysis, however, the sp. gr. of the metal is the greater, and it accordingly collects at the bottom of the cell. P. Pascal and A. Jouniaux's data are:

	658°	682°	740°	802°	868°	925°	1000°
Sp. gr. Al	2.46	2.45	2.43	2.41	2.39	2.37	2.35

Molten cryolite has a point of maximum density at 995°, when the sp. gr. is 2.22. Thus,

	972°	978°	995°	1003°	1032°	1061°	1083°
Sp. gr. cryolite	2.185	2.203	2.220	2.209	2.189	2.154	2.102

The sp. gr. of cryolite is decreased by the addition of silica, and increased by the addition of fluorspar; the sp. gr. of ternary mixtures of cryolite, fluorspar, and alumina are shown graphically in Fig. 8. K. Arndt and W. Kalass have investigated the conductivity of soln. of alumina in molten cryolite.

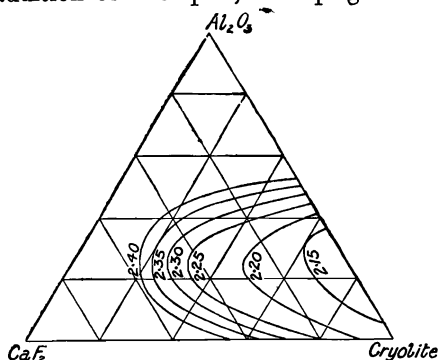

FIG. 8.—Specific Gravities of Ternary Mixtures of Cryolite, Fluorspar, and Alumina at 950°

J. W. Richards said that the sp. resistance of the electrolyte is 3 ohms per c.c., and estimated the decomposition voltages of the constituents of the bath to be approximately 4.7 volts for sodium fluoride, 4.0 volts for aluminium fluoride, and 2.2 volts for alumina. Assuming that these values are correct, alumina will decompose first. If high current densities be used, sodium will be liberated, and fluorine may be liberated at the anode if the proportion of alumina in the bath be very low, or

the current density be high. There are so many difficulties in preventing the baths from clogging, becoming discoloured, and ceasing to operate properly that the production of aluminium by electrolysis on a laboratory scale is difficult. One difficulty is due to polarization at the anode owing to the formation of a film of gas, which reduces the current so much that the bath freezes. If a higher voltage be used, the bath is heated locally, and the aluminium is oxidized. This is prevented to some extent by using an anode with a large surface area. The production of aluminium on a small scale has been studied by F. Haber and R. Geipert, M. de K. Thompson, B. Neumann and H. Olsen, N. A. Puschin, E. Dischler and M. Maksimenko, H. K. Richardson, etc. The current consumed by the cell is approximately 10,000 amps. at 5.5 volts, and the current density at the cathode is 100 amps. per sq. dm., and about 500 amps. per sq. dm. at the anode. For the plant examined by F. Haber the current efficiency was 71 per cent.; the voltage, 5.5; the current, 7520 amps.; the yield of metal, 43.1 kgms. per 24 hrs.; and the energy consumption 23,000 kilowatt hours per ton. The chief losses are due to the formation of a metal fog which diffuses from cathode to anode, resulting in a regeneration of alumina at the anode; there are also losses due to short circuiting between anode and cathode.

Electro-thermal processes for aluminium alloys.—The brothers E. H. and

A. H. Cowles⁹ showed that if alumina be heated with carbon and a metal oxide, an alloy of aluminium with the metal is obtained—*e.g.* cupro-aluminium. Several modifications of the furnace were proposed. The mixture is heated by passing a current through the mixture *A*, Fig. 9, to be heated *viâ* carbon electrodes *C, C*. The reaction is thermic not electrolytic, for, said B. Kosmann, the electric current is utilized by its conversion into heat by the resistance offered; pure electrolysis is either absent, or occurs to so small an extent as to be inappreciable. W. Borchers has described a number of these resistance furnaces. That shown in Fig. 10 has two



FIG. 9.—A. H. and E. H. Cowles' Resistance Furnace.

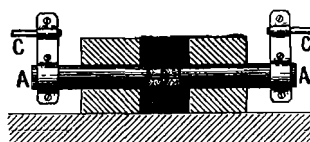

FIG. 10.—W. Borchers' Resistance Furnace

carbon rods *A, A* fitted with a thin carbon pencil *B* between them. This lies in the axis of a paper cartridge filled with the mixture to be heated—say clay, carbon, and copper oxide. This is covered over with coarse carbon powder. The circuit *CC* is closed, and in a few minutes a copper aluminium alloy is formed. E. Viel made ferro-aluminium alloys by a somewhat similar process. J. H. J. Dagger, W. P. Thompson, C. F. Mabery, and T. S. Hunt have described E. H. and A. H. Cowles' processes for making aluminium alloys.

The impurities in commercial aluminium.—A. Salvétat¹⁰ analyzed Deville's aluminium in 1856, and found that it contained copper, iron, silicon, and traces of lead as impurities. J. W. Mallet found traces of sodium and titanium. O. L. Erdmann found zinc to be present. In 1868, C. F. Rammelsberg reported 0·7 per cent. of silicon and 4·6-7·5 per cent. of iron in a sample of commercial aluminium; and in 1876, W. Hampe found 0·4 to 1·0 per cent. of silicon, 1·3 to 1·4 per cent. of iron, 0·2 per cent. of lead, 0·1 to 0·4 per cent. of copper. Analyses of the metal prepared by the sodium process have also been given by C. H. Hirzel, C. Karmarsch, etc. H. Moissan found that electrolytic aluminium contained iron and silicon, 0·1 per cent. of carbon, and some nitrogen. Numerous analyses of modern aluminium have been published, since it is the fashion to give the analysis of the material used in description of the physical and chemical properties of the metal. First-grade aluminium contains 99 per cent. or more aluminium, and the second-grade metal 98 to 99 per cent. aluminium. The chief impurities are iron and silicon. Thus G. H. Bailey quotes analyses of 18 samples with 95·48 to 99·65 per cent. aluminium; 0·029 to 3·22 per cent. of iron; and 0·17 to 0·64 per cent. of silicon. Two of the samples had 0·09 to 0·116 per cent. of sodium; and four samples 0·30 to 3·70 per cent. of copper. R. Seligman and P. Williams quotes five samples with 0·14 to 1·3 per cent. of iron; 0·13 to 1·4 per cent. of silicon; and in one sample there was 0·3 per cent. of copper. R. L. y Gamboa, and C. Boulanger and J. Bardet found gallium in specimens of aluminium and of bauxite. J. Czochralsky found traces of aluminium oxide, and carbide in the commercial metal. Virtually no sodium, aluminium sulphide or phosphide was present.

The purification of aluminium.—H. St. C. Deville found that ferruginous aluminium can be partially purified by a kind of liquation. To free the metal from sodium and slag, the molten metal was kept fused in contact with air for a long time and the surface film was skimmed off. Fusion under potassium polysulphide partially removes some lead, copper, and iron. He obtained the best results by fusing the metal with nitre in a cast-iron crucible well oxidized itself by nitre on the inside. W. Diehl claimed to remove iron by fusion with sulphur; P. É. Placet used potassium dichromate and permanganate; and U. J. J. le Verrier said that he reduced the silicon in a sample of aluminium from 0·81 to 0·57 per cent. by fusing the metal

under a layer of alkali fluoride. A. G. Betts, and The Pittsburg Reduction Co. tried electrolytic methods of purification. H. St. C. Deville, and C. and A. Tissier cleaned the surface of aluminium by washing it first with an aq. soln. of potassium hydroxide, and then with nitric acid—*vide* etching aluminium. J. W. Mallet in his *Revision of the atomic weight of aluminium* (1880) started with commercial aluminium containing 96.89 per cent. of aluminium, 1.84 per cent. of iron, and 1.27 per cent. of silicon. This was treated with liquid bromine, and the resulting aluminium bromide purified by fractional distillation repeated until the product was perfectly colourless, and dissolved in water without leaving any perceptible impurity. The bromide was reduced by treating it in a crucible made of a mixture of alumina and sodium aluminate. On analysis, the metal gave no weighable impurities. E. Strasser treated the molten metal with the vapour from nitric acid. F. and W. Mylius purified aluminium by fractional freezing of the molten metal; the first portions to crystallize are the purest.

O. Ohmann¹¹ prepared *aluminium wool*. J. Billitzer, F. Ehrenhaft, T. Svedberg, and D. Zavrjeff made **colloidal aluminium**. The last-named failed with G. Bredig's process (2. 23, 10), but he succeeded by placing two electrodes of aluminium 0.1 mm. apart in a vessel of water, and passing a current from an induction coil fed by 15–20 amps. at 120 volts, and having a spark 20 cms. long—the coil was in circuit with a large condenser. The colloidal soln. could be kept nearly a month without flocculation. C. H. Hall studied the electrical precipitation of finely divided aluminium.

REFERENCES.

¹ J. W. Richards, *Aluminium: its History, Occurrence, Properties, Metallurgy and Applications, including its Alloys*, Philadelphia, 1896; A. Minet, *L'aluminium—fabrication, emploi, alliages*, Paris, 1893; C. Grard, *Aluminium and its Alloys*, London, 1921; *L'aluminium—alliages, emplois récents*, Paris, 1897; *The Production of Aluminium and its Industrial Use*, New York, 1905; *Die Gewinnung des Aluminiums*, Halle, 1902; S. Mierzinsky, *Die Fabrikation des Aluminiums und des Alkalimetalle*, Wien, 1885; P. Moissonier, *L'aluminium, ses propriétés, ses applications*, Paris, 1903; F. Winteler, *Die Aluminium-Industrie*, Braunschweig, 1903; W. Borchers, *Zeit. Elektrochem.*, **3**, 189, 213, 239, 260, 1892; **8**, 453, 1897; *Elektrometallurgie. Die Gewinnung der Metalle unter Vermittelung des elektrischen Stromes*, Leipzig, 1903; London, 1904; A. Lejeal, *L'aluminium*, Paris, 1894; C. Schnabel, *Handbuch der Metallhüttenkunde*, Berlin, 2. 821, 1904; London, 2. 798, 1907; J. Escard, *L'aluminium dans l'industrie*, Paris, 1918; C. S. Bradley, *U.S. Pat. No. 464933*, 1891; L. Guillet, *Rev. Mét.*, **18**, 459, 1921; J. T. Pattison, *The Manufacture of Aluminium*, London, 1918; G. Mortimer, *Aluminium: its Manufacture, Manipulation, and Marketing*, London, 1919; A. Lodin, *Ann. Mines*, (8), **16**, 559, 1889; B. Kosmann, *Stahl Eisen*, **9**, 16, 106, 1889; **10**, 517, 695, 1890; J. H. J. Dagger, *Journ. Soc. Chem. Ind.*, **10**, 432, 1891; **11**, 124, 1892; *Chem. News*, **60**, 211, 225, 241, 1889; D. Wahl, *ib.*, **60**, 292, 1889; G. Gin, *ib.*, **88**, 62, 1903; P. P. Bedson, *ib.*, **60**, 199, 1889; H. N. Warren, *ib.*, **62**, 51, 1890; H. E. Roscoe, *ib.*, **59**, 283, 1889; *Journ. Soc. Chim. Ind.*, **8**, 463, 1889; R. W. Wallace, *ib.*, **17**, 308, 1898; A. E. Hunt, *ib.*, **11**, 124, 1892; J. W. Richards, *Journ. Franklin Inst.*, **141**, 357, 1897; C. Winkler, *Chem. Ztg.*, **16**, 349, 1892; J. Klauudy, *Öster. Zeit. Berg. Hütt.*, **39**, 221, 1891; A. H. Bucherer, *Zeit. angew. Chem.*, **6**, 515, 1893; C. Dreyfuss, *Bull. Soc. Chim.*, (3), **9**, 481, 1893.

² H. C. Oersted, *Øfvers. Danske Vid. Selsk. Förrh.*, **15**, 1825; *Ferussac Bull. Math.*, **275**, 1826; F. Wöhler, *Pogg. Ann.*, **11**, 146, 1827; *Liebig's Ann.*, **53**, 422, 1845; **99**, 255, 1856; J. von Liebig, *ib.*, **17**, 43, 1836; H. St. C. Deville, *Compt. Rend.*, **38**, 279, 1854; **39**, 321, 535, 901, 1854; **41**, 1053, 1855; **44**, 19, 1857; *Ann. Chim. Phys.*, (3), **43**, 5, 1855; (3), **46**, 415, 1856; *L'aluminium, ses propriétés, sa fabrication, et ses applications*, Paris, 1859; C. and A. Tissier, *Guide pratique de la recherche, de l'extraction, et de la fabrication de l'aluminium et des métaux alcalins*, Paris, 1858; A. Wurtz, *Berichte über die Entwicklung der chemischen Industrie*, Braunschweig, **1**, 657, 1875; H. Rose, *Pogg. Ann.*, **96**, 152, 1855; C. Brunner, *ib.*, **98**, 488, 1856; A. Dick, *Phil. Mag.*, (4), **10**, 364, 1855; M. Rousseau and P. Morin, *Le Technologiste*, **18**, 406, 1857; W. Weldon, *Journ. Soc. Chem. Ind.*, **2**, 369, 1883; B. Kosmann, *Stahl Eisen*, **9**, 16, 1889; M. Ichon, *Ann. Mines*, (8), **16**, 534, 1889; *Notice sur un nouveau procédé de fabrication de l'aluminium*, Angers, 1890; M. Herzog, *Ind. Blatt.*, **22**, 339, 1885; A. Stévant, *Rev. Univ. Mines*, **14**, 61, 1863; *Dingler's Journ.*, **171**, 51, 1863; C. Netto, *ib.*, **269**, 398, 1888; *Brit. Pat. No. 4228*, 17532, 1887; **359**, 1889; H. Niewerth, *ib.*, 5756, 1883; A. Feldmann, *ib.*, 12575, 1887; W. F. Gerhard, *ib.*, 2247 1858; J. Webster, *ib.*, 18721, 1881; J. B. Thompson and W. White, *ib.*, 8427, 1887; H. V. Cästner, *ib.*, 1989, 18062, 1889; E. Meyer, *ib.*, 1785, 1891; J. S. Howard, F. G. Bates, and F. P. Pendleton,

ib., 1909, 1879; W. A. Baldwin, *ib.*, 7198, 1887; 2584, 13474, 1888; E. Foote, *ib.*, 4930, 1893; L. Grabau, *ib.*, 9486, 1886; *Zeit. angew. Chem.*, 1. 708, 1888; 2. 149, 1889; The Alliance Aluminium Co., *German Pat.*, D.R.P. 50723, 1889; L. Henne, *ib.*, 32644, 1884; H. D. Gadsden, *ib.*, 27571, 1883; M. A. Brogowsky, *ib.*, 59240, 1890; W. Anderson, *Journ. Roy. Soc. Arts*, 37. 378, 1889; W. Frishmuth, *U.S. Pat. No.* 308152, 1884.

³ A. Schneller and A. Astfalck, *Brit. Pat. No.* 13486, 1890; W. F. Gerhard, *ib.*, 2920, 1856; L. Burgess, *ib.*, 182609, 1921; D. G. Reillon, S. C. Montagne, and O. L. B. L. Bourgerel, *ib.*, 4576, 1887; L. F. Corbelli, *ib.*, 142, 1858; R. E. Green, *ib.*, 5914, 9358, 1889; L. P. B. E. Cumenge, *ib.*, 461, 1858; H. S. Blackmore, *ib.*, 11933, 1901; S. Pearson, J. Liddon, and J. H. Pratt, *ib.*, 5316, 1888; H. Bessemer, *ib.*, 12033, 1889; T. L. Willson, *ib.*, 21696, 1893; W. A. Baldwin, *ib.*, 7198, 1887; 2584, 13474, 1888; E. Meyer, *ib.*, 1785, 1891; J. S. Howard, F. G. Bates, and F. P. Pendleton, *ib.*, 1909, 1879; J. Morris, *ib.*, 1058, 1882; F. C. Knowles, *ib.*, 1742, 1857; S. Pearson, A. W. Turner, and W. Andrews, *ib.*, 12332, 1887; O. M. Thowless, *ib.*, 14407, 1886; *U.S. Pat. No.* 370220, 1887; E. Straub, *ib.*, 721638, 1903; N. Lebedeff, *ib.*, 2241, 1892; *German Pat.*, D.R.P. 57768, 1889; O. Knöfler and H. Ledderboge, *ib.*, 49329, 1889; J. M. A. Gérard-Léscuyer, *ib.*, 48040, 1889; D. A. Peniakoff, *ib.*, 83638, 1894; H. F. D. Schwahn, *ib.*, 160286, 1903; W. Rübel, *ib.*, 140231, 1902; H. N. Warren, *Chem. News*, 70. 102, 1894; A. L. Fleury, *ib.*, 19. 332, 1869; J. W. Richards, *Aluminium*, Philadelphia, 409, 1896; T. Petitjean, *London Journ. Arts*, (4), 7. 282, 1858; M. Chapelle, *Compt. Rend.*, 33. 358, 1854; E. Duvivier, *ib.*, 33. 1066, 1854; G. A. Faurie, *ib.*, 105. 494, 1887; H. Moissan, *ib.*, 119. 15, 935, 1894; *Bull. Soc. Chim.*, (3), 13. 803, 1895; I. L. Bell, *Chemical Phenomena in Iron Smelting*, London, 230, 1872; G. W. Reiner, *Wagner's Jahresh.*, 5. 4, 1859; S. A. Tucker and H. R. Moody, *Journ. Soc. Chem. Ind.*, 20. 970, 1901; R. S. Hutton and J. E. Petavel, *Proc. Roy. Soc.*, 79. A, 153, 1907; *Phil. Trans.*, 207. A, 421, 1907; P. Askenasy and N. Lebedeff, *Zeit. Elektrochem.*, 16. 559, 1910; W. Hempel, *Chem. Ztg.*, 12. 391, 1888; W. Borchers, *Elektrometallurgie*, Leipzig, 104, 1896; E. Tiede and E. Birnbräuer, *Zeit. anorg. Chem.*, 87. 129, 1914; P. R. Hershman, *U.S. Pat. No.* 1220843, 1917; H. St. C. Deville, *Ann. Chim. Phys.*, (3), 43. 6, 1855; (3) 46. 415, 1856; *L'aluminium, ses propriétés, sa fabrication, et ses applications*, Paris, 1859.

⁴ L. P. B. E. Cumenge, *Brit. Pat. No.* 461, 1858; A. E. Wilde, *ib.*, 4539, 1876; H. Niewerth, *ib.*, 5756, 1883; W. P. Thompson, *ib.*, 2101, 1879; E. Cleaver, *ib.*, 1276, 1887; L. Q. Brin, *ib.*, 3547, 3548, 3549, 1888; W. A. Baldwin, *ib.*, 2584, 1888; G. Bamberg, *ib.*, 7666, 1889; S. Pearson and J. H. Pratt, *ib.*, 18048, 1889; A. Mann, *ib.*, 9313, 1887; E. L. Benzon, *ib.*, 2753, 1858; F. J. Seymour, *ib.*, 6460, 1888; G. Bamberg, *ib.*, 7666, 7667, 1889; *U.S. Pat. No.* 291631, 1884; 337996, 1886; *Brit. Pat. No.* 6460, 1888; F. J. Seymour and W. H. Brown, *ib.*, 1639, 1884; R. de Montgela, *ib.*, 10605, 10606, 1886; J. Clark, *ib.*, 10594, 15946, 1886; 12648, 1889; W. Weldon, *ib.*, 97, 1883; R. Grätzel, *ib.*, 14325, 1885; L. Grabau, *ib.*, 5798, 1883; J. A. Stephan and R. Southerton, *ib.*, 10266, 1888; M. Herzog, *Ind. Blatt.*, 22. 239, 1885; F. G. Reichel, *Journ. prakt. Chem.*, (2), 11. 55, 1875; C. E. Schafhäütl, *ib.*, (1), 67. 257, 1866; F. C. Calvert and R. Johnson, *Phil. Mag.*, (4), 10. 240, 1885; A. Chenot, *Compt. Rend.*, 38. 415, 1854; G. A. Faurie, *ib.*, 105. 949, 1887; *Brit. Pat. No.* 10043, 1887; M. Faraday and J. Stodart, *Quart. Journ. Science*, 9. 319, 1820; A. Ledebur, *Handbuch der Eisenhüttenkunde* Leipzig, 265, 1894; M. Grüner and M. Lan, *Berg. Hütt. Ztg.*, 21. 254, 1862; M. Lohage, *ib.*, 20. 160, 1861; J. H. H. Corbin, *Amer. Journ. Science*, (2), 48. 348, 1869; G. H. Billings, *Trans. Amer. Inst. Min. Eng.*, 5. 452, 1877; P. Ostberg, *Eng. Min. Journ.*, 41. 354, 1886; C. T. Holbrook, *Iron Age*, 47. 1127, 1891; M. Evrard, *Ann. Gén. Civ.*, 6. 189, 1867; P. Bolley, *Schweiz. Polyt. Zeit.*, 5. 16, 1850; K. List, *Program. Prov. Gewerkschule Hagen*, 6, 1860; *Wagner's Jahresh.*, 11. 23, 1865; F. Fischer, *ib.*, 31. 102, 1885; W. Hampe, *Chem. Ztg.*, 12. 391, 1888; N. N. Beketoff, *Bull. Soc. Chim.*, (1), 1. 22, 1859; *Zeit. Chem.*, (2), 1. 376, 1865; M. Dullo, *ib.*, (2), 5. 472, 1870; N. Basset, *French Pat. No.* 61656, 1864; *Génie Ind.*, 28. 22, 1864; *Dingler's Journ.*, 173. 359, 1864; H. Wedding, *ib.*, 177. 327, 1865; *Journ. Pharm. Chim.*, (4), 3. 155, 1866; H. St. C. Deville, *Ann. Chim. Phys.*, (3), 43. 27, 1855; F. Flavitzyk, *Ber.*, 6. 195, 1873; C. Winkler, *ib.*, 23. 772, 1890; F. Lauterborn, *Dingler's Journ.*, 256. 227, 1886; *Eisen Ztg.*, 150, 1885; *German Pat.*, D.R.P. 39915, 1886; S. van Oldruitenborgh, *ib.*, 67807, 1890; J. Malovich, *ib.*, 159632, 161428, 1902; L. P. Devaucelle, *ib.*, 54132, 1889; G. Gin, *ib.*, 148627, 1902; A. J. Rogers, *Journ. Franklin Inst.*, 99. 466, 1889; W. H. Greene and W. H. Wahl, *ib.*, 135. 218, 1893; J. W. Richards, *Aluminium*, Philadelphia, 437, 1896; The Aluminium Product Co., *U.S. Pat. No.* 378136, 1888; M. Wanner, *ib.*, 410508, 1889; B. Kosmann, *Stahl Eisen*, 9. 16, 106, 1889; J. Petitjean, *Dingler's Journ.*, 148. 371, 1858.

⁵ F. Wöhler, *Liebig's Ann.*, 99. 255, 1856; H. St. C. Deville, *Ann. Chim. Phys.*, (3), 43. 5, 1855; *Chemist*, (2), 13. 12, 1854; G. Gore, *Phil. Mag.*, (4), 7. 227, 1854; *The Art of Electro-metallurgy*, London, 1884; A. Bertrand, *Compt. Rend.*, 83. 854, 1876; J. Nicklès, *ib.*, 57. 740, 1863; *Chem. News*, 24. 227, 1871; H. N. Warren, *ib.*, 73. 122, 1896; T. Ball, *ib.*, 5. 153, 1866; J. B. Thompson, *ib.*, 24. 194, 1871; S. Kern, *ib.*, 33. 236, 1876; Z. Roussin, *ib.*, 14. 27, 1862; *Journ. Pharm. Chim.*, (4), 3. 413, 1866; J. W. Richards, *Aluminium*, Philadelphia, 437, 1896; F. Fischer, *Zeit. Ver. deut. Ing.*, 28. 554, 1884; L. Senet, *Lum. Elect.*, 17. 91, 1885; H. E. Patten, *Journ. Phys. Chem.*, 8. 548, 1905; A. H. Harris, *Journ. Soc. Chem. Ind.*, 14. 166, 1895; J. A. Jeançon, *U.S. Pat. No.* 140924, 1872; 436895, 1890; J. S. Haurd, *ib.*, 228900, 1880; M. G. Farmer, *ib.*, 315266, 1885; W. Frishmuth, *ib.*, 308152, 1884; J. T. Sprague, *Electricity*, London, 423, 1892; C. Winkler, *Deut. Ind. Ztg.*, 192, 1872; S. Mierzinsky, *Die Fabrication des Aluminiums und des Alkalimetalle*, Wien, 1885; W. Hampe, *Chem. Ztg.*, 11. 935,

1887; A. Watt, *Elect. Rev.*, **21**, 4, 29, 52, 75, 99, 131, 1887; W. A. Plotnikoff, *Journ. Russ. Phys. Chem. Soc.*, **34**, 466, 1902; J. Braun, *German Pat., D.R.P.* 28760, 1883; R. A. Falk and A. Schaag, *ib.*, 48078, 1888; M. Rietz and M. Herold, *ib.*, 58136, 1890; G. Nahnsen and J. Pfleger, *ib.*, 46753, 1888; A. Walker, *ib.*, 40626, 1887; G. von Overbeck and H. Niewerth, *Brit. Pat. No.* 5756, 1883; S. Wohle, *ib.*, 9253, 1890; C. A. Burghardt and W. J. Twining, *ib.*, 2602, 9389, 12856, 1887; F. S. Thomas and W. E. Tilley, *ib.*, 2756, 1855; A. F. B. Gomess, *ib.*, 7205, 1894; R. de Montgelas, *ib.*, 10607, 1886; 1751, 1887; A. J. Rogers, *ib.*, 6431, 1895; H. C. Bull, *ib.*, 10199, 1887; W. F. Gerhard and J. Smith, *ib.*, 16653, 1884; S. Coulson, *ib.*, 2074, 1857; J. Marino, *ib.*, 14445, 1888; L. and A. Brin, *ib.*, 3547, 3548, 3549, 8747, 1888; 15508, 1889; L. F. Corbelli, *ib.*, 507, 1858.

⁶ R. Bunsen, *Pogg. Ann.*, **92**, 648, 1854; H. Davy, *Phil. Trans.*, **98**, 333, 1808; **100**, 16, 1810; H. St. C. Deville, *Ann. Chim. Phys.*, (3), **43**, 5, 1854; H. M. A. Berthaut, *Brit. Pat. No.* 3579, 1879; H. le Chatelier, *ib.*, 1214, 1861; J. Garneri, *ib.*, 715, 1872; J. P. Kagensbusch, *ib.*, 4825, 1882; A. Zdziarsky, *ib.*, 3090, 1884; A. Minet, *ib.*, 10057, 1887; *Die Gewinnung des Aluminiums*, Halle, 48, 63, 1902; *Compt. Rend.*, **110**, 342, 1890; **111**, 603, 1890; **112**, 231, 1215, 1891; *Zeit. Elektrochem.*, **3**, 169, 1897; F. Haber and R. Geipert, *ib.*, **8**, 1, 26, 1902; A. Feldmann, *German Pat., D.R.P.* 49915, 1887; 50370, 1888; E. C. Kleinert, *ib.*, 42022, 1886; L. Grabau, *ib.*, 62851, 1891; I. Omholt, *ib.*, 34728, 1885; R. Grätzel, *ib.*, 26962, 1883; F. J. Tone, *ib.*, 174476, 1883; M. J. Berg, *ib.*, 56913, 1890; M. Sprenger, *ib.*, 39554, 1886; L. Lossier, *ib.*, 31089, 1884; F. A. Gooch and L. Waldo, 20615, 20616, 1894; J. L. E. Daniel, *ib.*, 4169, 1889; W. Diehl, *ib.*, 59447, 1890; *Zeit. angew. Chem.*, **3**, 365, 1890; B. Waeser, *Chem. Ztg.*, **46**, 928, 1922; E. C. Kleinert, *Eng. Min. Journ.*, **43**, 256, 1887; A. J. Rogers, *Chem. News*, **60**, 228, 237, 1889; J. W. Richards, *Journ. Franklin Inst.*, **138**, 51, 1894; H. de Grouilliers, *ib.*, **280**, 379, 1886; M. Gauduin, *Monit. Scient.*, (2), **6**, 62, 1869; M. G. Farmer, *U.S. Pat. No.* 315266, 1885; C. A. Faure, *ib.*, 385345, 1888; *Compt. Rend.*, **107**, 339, 1888; W. Borchers, *Elektrometallurgie*, Leipzig, 137, 1902; W. Hampe, *Chem. Ztg.*, **12**, 391, 1888; **13**, 1, 29, 49, 1889; O. Schmidt, *ib.*, **12**, 457, 1888.

⁷ M. Blasi, *Brit. Pat. No.* 180326, 1922; A. H. Bucherer, *German Pat., D.R.P.* 63995, 1892; A. Winkler, *ib.*, 45824, 1888; Aluminium Industrie A.G., *ib.*, 68909, 1890; A. Julien, *Monit. Scient.*, (4), **10**, 146, 1897; *French Pat. No.* 25040, 1897; M. M. Jännigen, *ib.*, 80944, 1894; G. Gin, *ib.*, 148627, 1902.

⁸ P. L. V. Héroult, *French Pat. No.* 175711, 1886; *Brit. Pat. No.* 7426, 16853, 1887; C. M. Hall, *U.S. Pat. No.* 400664, 400665, 400666, 400667, 400766, 1889; M. Schindler, *ib.*, 573041, 1896; C. S. Bradley, *ib.*, 464933, 1891; L. Grabau, *German Pat., D.R.P.* 62851, 1891; L. Lossier, *ib.*, 31089, 1884; E. C. Kleinert, *ib.*, 42022, 1886; *Brit. Pat. No.* 15322, 1886; W. Borchers, *Elektrometallurgie*, Leipzig, 1903; J. W. Richards, *Aluminium*, Philadelphia, 372, 1896; *Electrochem. Ind.*, **1**, 158, 1903; *Zeit. Elektrochem.*, **1**, 367, 1895; W. Clacher, *Elect. Rev.*, **108**, 99, 1911; *Mét. Chem. Eng.*, **9**, 137, 1911; M. de K. Thompson, *ib.*, **7**, 19, 1909; B. Neumann and H. Olsen, *ib.*, **8**, 185, 1910; *Zeit. Elektrochem.*, **16**, 230, 1910; F. Haber, *ib.*, **8**, 607, 1902; R. Seaver, *Brit. Pat. No.* 8531, 1886; R. J. Henderson, *ib.*, 7426, 1887; A. Lodin, *Ann. Mines*, (8), **16**, 559, 1889; A. Minet, *Die Gewinnung des Aluminiums*, Halle, 68, 1902; *Compt. Rend.*, **110**, 342, 1890; **111**, 603, 1890; **112**, 231, 1215, 1891; *Zeit. Elektrochem.*, **3**, 169, 1897; M. Kuss, *Ann. Mines*, (8), **16**, 545, 1889; B. Kosmann, *Stahl Eisen*, **9**, 16, 1889; F. Bock, *Zeit. angew. Chem.*, **22**, 1309, 1909; N. A. Puschin, E. Dischler, and M. Maksimenko, *Journ. Russ. Phys. Chem. Soc.*, **46**, 1347, 1914; H. K. Richardson, *Trans. Amer. Electrochem. Soc.*, **19**, 159, 1911; F. R. Pyne, *ib.*, **10**, 63, 1906; P. Pascal and A. Jouriaux, *Rev. Mét.*, **11**, 106, 1914; *Bull. Soc. Chim.*, (4), **13**, 439, 1913; (4), **15**, 312, 1914; R. Lorenz, A. Jabs, and W. Eitel, *Zeit. anorg. Chem.*, **83**, 39, 1913; P. P. Fedotieff and W. Ijinsky, *ib.*, **80**, 113, 1913; N. A. Puschin and A. Baskoff, *ib.*, **81**, 347, 1913; M. Moldenhauer, *Mét.*, **6**, 14, 1909; G. H. Bailey, *Journ. Inst. Metals*, **15**, 303, 1916; R. Seligman, *ib.*, **17**, 141, 1917; K. Arndt and W. Kalass, *Zeit. Elektrochem.*, **30**, 12, 1924.

⁹ E. H. and A. H. Cowles, *U.S. Pat. No.* 319795, 424659, 1884; *Brit. Pat. No.* 9781, 1885; *German Pat., D.R.P.* 33672, 35579, 1885; 36601, 36602, 1886; E. H. and A. H. Cowles and C. F. Mabery, *Amer. Journ. Science*, (3), **30**, 308, 1885; *Proc. Amer. Assoc.*, **34**, 136, 1885; *Amer. Chem. Journ.*, **9**, 11, 1887; E. Viel, *French Pat. No.* 355539, 359042, 380087, 1907; W. P. Thompson, *Journ. Soc. Chem. Ind.*, **5**, 205, 1886; J. H. J. Dagger, *B.A. Rep.*, 538, 1889; B. Kosmann, *Stahl Eisen*, **9**, 16, 106, 1889; W. Borchers, *Zeit. angew. Chem.*, **5**, 133, 1892; *Elektrometallurgie*, Leipzig, 1903; T. S. Hunt, *Chem. News*, **53**, 64, 1886.

¹⁰ R. Seligman and P. Williams, *Journ. Soc. Chem. Ind.*, **35**, 665, 1916; G. H. Bailey, *Journ. Inst. Metals*, **9**, 79, 1913; H. St. C. Deville, *Ann. Chim. Phys.*, (3), **43**, 5, 1854; A. Salvétat, *ib.*, (3), **46**, 265, 1856; H. Moissan, *ib.*, (7), **9**, 337, 1896; *Bull. Soc. Chim.*, (3), **11**, 1021, 1894; *Compt. Rend.*, **119**, 12, 1894; **121**, 794, 1895; C. and A. Tissier, *ib.*, **40**, 1202, 1855; R. L. y Gamboa, *Anal. Fis. Quim.*, **21**, 280, 1923; C. Boulanger and J. Bardet, *Compt. Rend.*, **157**, 718, 1913; C. H. Hirzel, *Zeit. Pharm.*, **10**, 145, 177, 1858; O. L. Erdmann, *Journ. prakt. Chem.*, (1), **67**, 194, 1856; J. C. Poggendorff, *Pogg. Ann.*, **97**, 643, 1856; J. W. Mallet, *B.A. Rep.*, **53**, 1857; *Phil. Trans.*, **171**, 1022, 1880; *Chem. News*, **46**, 178, 1882; U. J. J. le Verrier, *Compt. Rend.*, **119**, 13, 1894; C. Karmarsch, *Mitt. Hannover Gewerb.*, **70**, 1859; C. F. Rammelsberg, *Ber.*, **1**, 222, 1868; W. Hampe, *Liebig's Ann.*, **183**, 75, 1876; W. Diehl, *German Pat., D.R.P.* 59406, 1890; P. E. Placet, *ib.*, 96233, 1896; E. Strasser, *ib.*, 356529, 1921; A. G. Betts, *ib.*, 186182, 1906; The Pittsburg Reduction Co., *Brit. Pat. No.* 8153, 1901; W. P. Thompson, *Journ. Soc. Chem. Ind.*, **5**, 206, 1886;

F. and W. Mylius, *Zeit. anorg. Chem.*, **114**, 27, 1920; J. Czochralsky, *Zeit. Metallkunde*, **15**, 273, 1923.

¹¹ J. Billitzer, *Ber.*, **35**, 1933, 1902; T. Svedberg, *ib.*, **38**, 3618, 1905; F. Ehrenhaft, *Anz. Akad. Wien*, **39**, 241, 1902; D. Zavriff, *Zeit. phys. Chem.*, **87**, 507, 1913; O. Ohmann, *Ber.*, **45**, 2973, 1912; C. H. Hali, *Journ. Amer. Chem. Soc.*, **44**, 1246, 1922.

§ 4. The Physical Properties of Aluminium

F. Wöhler,¹ and J. W. Mallet likened the colour of compact aluminium to that of tin. C. Karmarsch said that the colour of commercial aluminium resembles that of platinum and comes between that of zinc and of tin; and H. St. C. Deville, that the colour has rather a bluer tinge than silver. J. W. Richards says that aluminium has a blue tinge after it has been worked or polished. The blue is also more pronounced the greater the amount of impurity the metal contains. A specimen with 10 per cent. of silicon and 5 per cent. of iron was almost as blue as lead. The metal prepared by F. Wöhler's process appears as a dull grey powder which acquires a metallic lustre when rubbed with a burnishing tool. M. Faraday obtained films of aluminium by deflagrating the metal by the Leyden battery and catching the vapour on glass plates. In reflected light the film is white and metallic; in transmitted light it is dark brown, bluish-brown, and occasionally, in the thinner parts, orange. A. W. Wright heated aluminium foil in an evacuated tube, by means of an electric discharge, and obtained a mirror of sublimed metal which appeared brown in transmitted light; J. A. Fleming likewise obtained a blue film. Very thin aluminium-leaf is violet-blue in transmitted light. According to H. Moissan, the vapour of aluminium is greyish-blue; and, according to W. L. Dudley, greenish-blue. According to J. W. Richards, purified aluminium has no odour, but the metal with over one per cent. of silicon exhales the odour of silicon hydride, and similar to that which proceeds from cast-iron. The smell of second-grade aluminium is best detected immediately after a brisk rubbing; purified metal has no taste, but the impure metal seems to taste like cast-iron.

No allotropic form of aluminium has been observed. Aluminium, said J. W. Mallet, has a crystalline fracture, and that of the cast ingot being slightly fibrous. Mechanical work makes the fracture more fibrous; and, added C. Karmarsch, the fracture is more fine-grained the more the metal has been mechanically worked. In conformity with R. Hooke's seventeenth century observations of the crystalline characters of the metals, aluminium cast from the liquid state is an aggregate of *allotriomorphic* (ἀλλότροπος, strange; μορφή, form) crystals since the shape of each crystal is determined by the crowding of the neighbouring crystals; no *idomorphic* (ἴδιος, characteristic) crystals, which have developed their characteristic form without being disturbed by other crystals, have been obtained. H. St. C. Deville said:

Aluminium often presents a crystalline appearance when it has been cooled slowly. When it is not pure, the little crystals which form are needles, and cross each other in all directions. When it is almost pure it still crystallizes from fusion, but with difficulty, and one may observe on the surface of the ingots hexagons which appear regularly parallel along lines which centre in the middle of the polygon. It is an error to conclude from this observation that the metal crystallizes in the rhombohedral system. It is evident that a crystal of the regular system may present a hexagonal section; while, on the other hand, in preparing aluminium by the battery at a low temp., I have observed complete octahedrons which were impossible of measurement, it is true, but their angles appeared equal. When a large mass of molten aluminium is slowly cooled, and the fluid interior poured out, distinct octahedrons may be observed. Surface depressions are found in an ingot of commercial aluminium where the metal has solidified last. There are numerous dendrites in these depressions, and these pass gradually into the normal granular structure. On the sides and base of the ingot where it has cooled in contact with the mould, leaf-like dendrites stand up above the surface; they represent the first points of solidification. W. Campbell showed that the structure is best examined by casting the metal on a smooth cold surface—

Figs. 11 and 12 ($\times 30$), by W. Campbell. The dendritic structure shown in Fig. 12 was obtained by casting the metal on a surface of stone. The dendrites are composed of two axes at right angles to one another, and as a rule only one quadrant of the dendrite reached perfect development. S. Kryropoulos found different parts of a piece of aluminium to exhibit differences in electric potential with respect to a soln. of potassium ferrocyanide.

The dendritic forms of aluminium crystals led H. Behrens, and F. Rinne to assume that the crystals are similar to those of iron, being octahedral and belonging to the cubic system. H. St. C. Deville also stated that regular octahedral crystals are formed when the metal was prepared by the electrolytic process. **X-radiograms** by A. W. Hull, W. L. Bragg, F. Kirchner, H. Bohlin, F. Rinne, E. A. Owen, and G. D. Preston, F. Körber, K. Becker and F. Ebert, W. H. Bragg, N. Uspensky and S. Konohejewsky, and P. Scherrer show that the unit structure

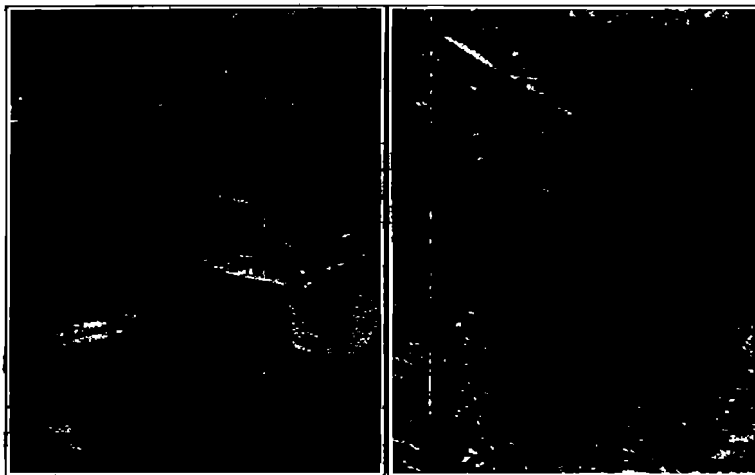

FIGS. 11 and 12.—Crystals showing on the Surfaces of Cast Aluminium.

of the aluminium crystal is that of a face-centred cube of side 4.04 to 4.05 Å. with an atom of aluminium at each corner, and one at each face of the cube. The closest approach of the atoms is 2.35 Å. S. Nishikawa and G. Asahara, H. Mark and K. Weissenberg, and M. Ettisch and co-workers studied the effect of rolling and annealing on the X-radiogram of aluminium. H. C. H. Carpenter and C. F. Elam also prepared crystals of aluminium with a face-centred cube lattice. According to W. L. Bragg, the radius of the atomic spheres is 1.35 Å. K. F. Slotte gave 6.6×10^{-9} cms. for the edge of the mol. cube of solid and liquid aluminium. C. Davisson and C. H. Kunsman made observations on the structure of the atom. C. J. Smithells found the fracture of single crystals to be of the wedge type.

Commercial aluminium has not the high degree of purity of commercial copper, and may contain about 99.2 per cent. of aluminium; the impurities are mainly iron and silicon. While the structure near the surface of an ingot is dendritic, the internal structure is allotriomorphic, and the one type of structure passes more or less abruptly into the other. According to R. J. Anderson,² the grains of aluminium, with any copper present in solid soln., and iron as iron aluminide, FeAl_3 , segregate at the grain boundaries, and the silicon, when free, appears to be inter- and intra-granular. Both F. J. Brislee and R. J. Anderson believe that aluminium loses its crystalline structure when cold worked, and becomes amorphous. The former said:

Microscopic examination of polished and etched specimens taken at various stages of cold-working shows that the crystalline structure disappears at a very early stage of the working,

and unless the metal is annealed, it will become fatigued, developing a species of *Forcier-krankheit*. Aluminium which has been subjected to excessive cold-working shows an entire absence of structure, and has the appearance of the metal which has flowed and passed into a vitreous amorphous state. . . . No modification of the customary methods of polishing and etching revealed elongated crystal boundaries such as are visible in other worked metals.

Au contraire, H. C. H. Carpenter and C. F. Elam followed the gradual elongation of the crystals from the cast ingot during the process of rolling; the metal finally appears to be a mass of parallel fibres running in the direction of the rolling. "The crystals in the cold-rolled sheet are so flattened out as to resemble the leaves of a book." A section cut transversely to the direction of rolling "would cut these leaf-like crystals in such an irregular manner that the structure revealed on etching would be very difficult to interpret." The idea that the cold-worked metal is amorphous is mainly due to difficulties in etching the metal. A. G. C. Gwyer, and W. Rosenhain do not believe that the metal becomes amorphous when severely deformed; although the latter thinks that the distorted grains in the highly deformed metal may not be accurately described as crystals, and that there must be a large proportion of disarranged—amorphous—matter.

J. W. Mallet said that highly purified aluminium is less hardened by working metal which is less pure. When aluminium is strained slip-bands are formed, but, according to R. J. Anderson, no twinning has been so far observed as the result of direct mechanical strain. The slip-bands are produced by a sliding or slipping within the crystals, and they make themselves evident as fine straight or curved lines on the faces of individual crystals subjected to a stress exceeding the elastic limit. Fig. 13 ($\times 1000$) shows the slip-bands in 97 per cent. aluminium developed by the deformation of the polished metal etched with sodium hydroxide. Two sets of bands are developed within individual grains, and they cross one another at an angle approximately 65° . Slip-bands are to be distinguished from the so-called Neumann-bands which are out-crops of mechanically twinned lamellæ formed by deformation.

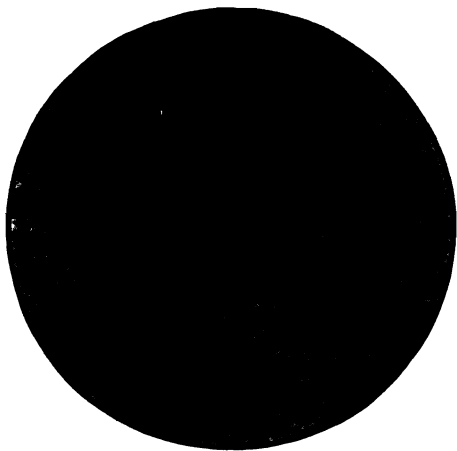

FIG. 13.—Slip-bands in Aluminium (Etch: NaOH; $\times 1000$).

The preparation of aluminium for microscopic examination has been described by D. Hanson and S. L. Archbutt, O. F. Hudson, R. J. Anderson, etc. Sodium or potassium hydroxide—in 0.10 to 20 per cent. soln.—is a common etching liquid; H. C. H. Carpenter and C. A. Edwards used 10 per cent. sodium hydroxide. The tarnished surfaces, due to carbonaceous matter, sometimes obtained are then cleaned with 60 per cent. nitric acid, or with chromic acid as recommended by W. Rosenhain and S. L. Archbutt. H. C. H. Carpenter and C. F. Elam preferred an alcoholic soln. of sodium hydroxide diluted with water until a stream of bubbles rises from all over the surface; followed by a 1–2 per cent. soln. of hydrofluoric acid. F. J. Brislee recommended hydrofluoric acid—in 10 to 15 per cent. soln.—the darkening of the surface is cleared by a few seconds' immersion in conc. nitric acid. Hydrofluoric acid tends to develop a pitted surface.

The hot-working of aluminium leaves the metal in a more or less strained condition since the finishing temp. is not usually high enough to effect the self-annealing of the metal. In the manufacture of sheet-aluminium, the metal is first worked hot, and finally rolled to gauge when cold. Z. Jeffries and R. S. Archer gave 150° as the lowest temp. at which the recrystallization of the cold-worked metal has been

observed. H. C. H. Carpenter and C. F. Elam found that the recrystallization of the cold-worked metal is excessively slow at 200° , and very rapid in the neighbourhood of 600° . Recrystallization is very incomplete after eighteen months' heating at 200° , and the new crystals are confined to the surface of the metal sheet. There is a gradual blurring of the original boundaries of the flattened crystals. In the early stages of recrystallization between 250° and 300° , new crystals appear at the old boundaries; these crystals appear white, the old un-reoriented crystals appear tarnished. An hour's heating at 600° produced large polyhedral crystals which were approximately equiaxial although there was a slight tendency for them to be slightly elongated in the direction of rolling. The elongation of the new crystals in the direction of the rolling is more pronounced in the metal annealed, say at 250° - 300° , than it is in the metal annealed at 450° - 600° . G. Tammann found that the size of the crystals decreases as the temp. is raised, reaching a minimum between 300° and 500° , and after that the size increases with temp. Fig. 14 ($\times 50$), by



Fig. 14.—Allotropic Crystals of Annealed Aluminium (Etch: HF; magnification $\times 50$).

R. J. Anderson, shows the appearance of an etched surface of aluminium annealed by four hours' exposure at 595° .

As a result of the work of C. Chappell on iron, of C. H. Mathewson and A. Phillips on α -brass, and of H. C. H. Carpenter and C. F. Elam on aluminium, and an alloy of tin with 1.5 per cent. of antimony, it is concluded that the recrystallization of strained metals does not take place as a result of the general disintegration of the distorted crystals. H. C. H. Carpenter and C. F. Elam inferred:

(1) Neither crystal growth nor recrystallization will take place unless the metal has been subjected to plastic deformation in the absence of a change of phase, and unless the metal has been heated to a certain minimum temp. for a certain minimum time.

(2) The effect of work depends on the amount of deformation and results in the production of twins, or slip-bands, or both followed; (i) neither by growth nor recrystallization on heating; (ii) by crystal growth on heating; nor (iii) by recrystallization and growth on heating.

(3) The degree of deformation which will produce these effects depends on the temp. The higher the temp. the less the required deformation. The effects produced by deformation are limited in extent, and depend on the amount of deformation, the annealing temp., and the period of heating.

(4) Recrystallization begins in crystal boundaries of old distorted crystals or in twin

boundaries. It starts from a few points and gradually spreads indiscriminately through the mass growing into the crystals in contact with the boundaries. The new crystals may exhibit twinned forms. No preference for growth in crystal boundaries or in twinning planes could be detected.

(5) Recrystallization is always followed by the growth of reoriented crystals into one another. Crystals can both grow and be grown into at the same time. A large crystal does not necessarily invade a small one with which it is in contact. A large crystal can grow at the expense of a small one, and conversely. Growth always occurs by boundary migration, not by coalescence. Neither similarity nor diversity of orientation affects the growth of one crystal into another. The size of the crystals when equilibrium is attained may vary within wide limits.

A. Sauveur, W. E. Ruder, C. Chappell, Z. Jeffries, and D. Hanson showed that if a metal be locally deformed and then heated, the largest crystals are produced at some distance from the point where the stress is most severe. R. Seligman and P. Williams, and G. Tammann and Q. A. Mansuri made some observations on the growth of the crystals. H. C. H. Carpenter and C. F. Elam found that if the metal be locally deformed the largest crystals are always formed at the minimum stress requisite to produce growth; and the lower the temp. of heating, the greater the stress required to produce the largest crystals obtainable at that temp. It was suggested that the mechanical deformation supplies the energy for crystal growth, and that heat permits only those changes to take place which deformation has rendered possible; consequently the more the crystals are strained the greater the energy they possess. They found that as deformation increases the size of the crystals diminishes, because growth starts from more instead of fewer centres. Heating aluminium of 99.6 per cent. purity to 550° for six hours, then subjecting it to a load of 2.4 tons per sq. in., and annealing the metal by raising its temp. from 450° to 550° at the rate of 15°-20° per day, and finally heating for one hour at 600°, sometimes gave pieces containing only one crystal. E. von Gomperz discussed this subject. E. Rasso and L. Velde represented the relations between the average grain-size of the allotriomorphic crystals of aluminium expressed in mm., the annealing temp., and the amount of cold-work expressed as a percentage reduction in the height of cm. cubes under compression, by means of a three dimensional diagram, Fig. 15. E. Wetzel also studied this question. E. C. Bain and Z. Jeffries investigated by X-radiographic examination whether deformation is accompanied by a rotation of crystal fragments or by the production of new orientations, and came to the latter conclusion.

M. Ettisch and co-workers say that the crystallites in soft wires are arranged irregularly, and those in hard-drawn wires regularly. E. von Gomperz made wires of single crystals of aluminium. The alleged deterioration of aluminium after repeated melting was shown by W. Rosenhain and J. D. Grogan to be due to the progressive contamination of the aluminium by other materials. K. Bornemann and F. Sauerwald found that the application of press. did not increase the grain-size during the annealing.

The **specific gravity** of aluminium is very small in comparison with that of ordinary metals, being nearly one-third that of iron; wt. for wt., therefore, aluminium occupies three times the vol. of iron, or vol. for vol., iron is nearly three times as heavy as aluminium. J. W. Mallet³ gave 2.583 for the sp. gr. of the highly purified metal at 4°. The less pure metal usually has a higher sp. gr., but the

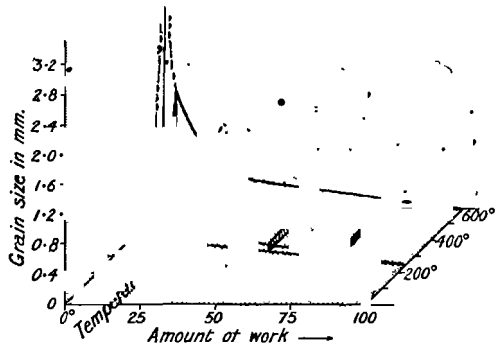

FIG. 15.—Effect of Work and Temperature on the Grain-size of Aluminium.

increase is not proportional to the amounts of impurity present. According to J. W. Richards :

Composition	{ Al	.	.	.	97·60	95·93	94·16	78·00
	{ Si	.	.	.	0·60	2·01	4·36	16·00
	{ Fe	.	.	.	1·80	2·06	1·48	4·00
Sp. gr. calculated	2·61	2·61	2·59	2·66
Sp. gr. observed	2·735	2·800	2·754	2·85

The calculated sp. gr. is always less than the observed, showing that a contraction occurs on alloying. Silicon has a smaller sp. gr. than aluminium. Assuming the total volume of impure aluminium is equal to that of the pure metal, it follows that the aluminium can be alloyed with several per cent. of iron and silicon and yet decrease in volume. According to F. Wöhler, the sp. gr. of cast aluminium is 2·50, and that of the hammered metal is 2·67; H. St. C. Deville gave respectively 2·56 and 2·66 for the cast and rolled metal; C. Karmarsch, 2·730–2·769 for commercial cast aluminium, 2·77 for thick sheet, and 2·798 for thin sheet. W. H. Barlow gave 2·688 for aluminium bars; E. Madelung and R. Fuchs, 2·7080; H. Buff, 2·664–2·667 for aluminium wire between 6° and 9°; and C. H. Hirzel gave 2·75 at 4·5° for the hammered metal. All this shows that the mechanical working of aluminium increases its sp. gr. J. D. Edwards and T. A. Moormann found that excessive cold work lowers the sp. gr.; thus, the sp. gr. of a sample of 99·5 per cent. aluminium drawn into wire, of No. 10 gauge, was 2·703 before annealing, and 2·7063 after annealing. G. W. A. Kahlbaum and E. Sturm found 2·713 for the sp. gr. of commercial aluminium; 2·703 for the metal, free from silicon, annealed at 470°, and 2·699 for the same metal cold-worked—all the data in vacuo at 20°/4°. F. C. A. H. Lantsberry gave 2·6995 for the cold-worked metal and 2·7030 for the annealed metal. For aluminium with 0·25 per cent. each of iron and silicon, F. J. Brislee found the sp. gr. of the cast metal to be 2·7080 at 14°–19°/4°; for hard drawn rod, 2·7052 at 22°/4°; and for the re-melted metal, 2·6821 at 16°/4°, the decrease may have been due to the adsorption of gases, say nitrogen. T. M. Lowry and R. G. Parker found the sp. gr. of filings of purified aluminium is rather less than that of the metal *en masse*, falling from 2·7040 to 2·7027. They showed further that although the complete annealing of worked aluminium is accompanied by a contraction, there is a slight expansion in volume in the earlier stages of the process of annealing at 100°. H. St. C. Deville said that heating the rolled metal to 100° had very little influence, for the sp. gr. was lowered from 2·67 to 2·66. J. W. Richards stated that heating a sample almost to its m.p., and then suddenly chilling it with water lowered its sp. gr. from 2·73 to 2·69. Annealing restores the sp. gr. of the worked metal to its original value; thus, J. D. Edwards and T. A. Moormann found the sp. gr. (in vacuo) of cast aluminium (99·75 per cent. Al) at 20° to be 2·703; and 2·703 when rolled and annealed. T. M. Lowry found the sp. gr. of aluminium is decreased by annealing at 100°. The best representative value for the sp. gr. of annealed aluminium is 2·703, and for the cold-worked metal 2·700. E. Heyn and E. Wetzel found that quenched aluminium suffers no perceptible change in vol. on standing. K. Bornemann and F. Sauerwald measured the sp. vol. of aluminium and its copper alloys. P. Pascal and J. Jouniaux gave 2·41 for the sp. gr. of aluminium at the m.p. in an atm. of an inert gas, 2·36 at 800°, and 2·29 at 1000°. J. D. Edwards and T. A. Moormann measured the sp. gr. (in vacuo) of aluminium up to 1100°, *A* with 99·55 per cent. Al; *B* with 99·4 per cent. Al; and *C* with 98·25 per cent. Al, and found:

		20°	100°	400°	659°	659°	700°	900°	1100°
Sp. gr.	{ <i>A</i>	2·703	2·69	2·62	2·55	2·382	2·371	2·316	2·262
	{ <i>B</i>	2·706	—	—	—	2·384	2·373	2·318	2·264
	{ <i>C</i>	2·727	—	—	—	2·405	2·394	2·339	2·285
		Solid				Liquid			

The sp. gr. of 99·75 per cent. aluminium, when molten at θ° , is $D=2\cdot382$

—0.000272(θ —658°). The sp. gr. of 99.75 per cent. aluminium at different temp. is plotted in Fig. 16.

There is a vol. change of 6.6 per cent. in passing from liquid to solid at the f.p. J. W. Richards gave 2.66 for the sp. gr. of commercial aluminium at ordinary temp., and 2.54 when melted. It is this solidification shrinkage which is responsible for the pipe formed in an ingot during freezing. H. Endo found a 6.26 per cent. change in vol. on melting. M. Täpler found 2.70 for the sp. gr. at 20°, and at the m.p. 2.426; this corresponds with a 4.8 per cent. expansion on melting; otherwise expressed, a gram of metal expands 0.019 c.c. J. H. Chamberlain observed an expansion during the freezing of aluminium; and a contraction when the metal is melted. This he attributed to the presence of gaseous impurities. H. A. Wilson found the **ratio of mass to weight** is the same for bismuth and aluminium to within one part per million.

H. St. C. Deville said that the **hardness** of cast aluminium is about the same as that of cast silver; and C. Karmarsch found silver wire will scratch cast aluminium.

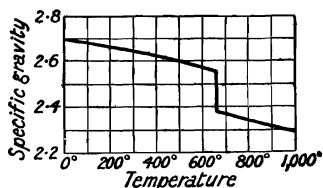

FIG. 16.—Specific Gravity of Aluminium at Different Temperatures.

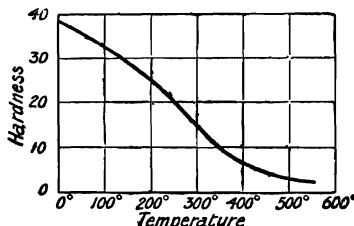

FIG. 17.—The Variation of the Hardness of Aluminium with Temperature.

J. W. Mallet found that highly purified aluminium is softer than the less pure metal, and is between 2.0 and 2.5 on Mohs' scale; it cannot therefore be scratched with the finger-nail, and it is not so soft as tin. The 99 per cent. metal, said J. W. Richards, can be readily cut with a knife, but the 95 per cent. metal is cut with difficulty. Aluminium becomes surface hardened by cold working, so that cold drawing or rolling makes aluminium nearly as hard as brass. Assuming the hardness of copper is 100, J. W. Richards gives 47 for the hardness of cast aluminium, and 62 for that of the rolled metal—the hardness of cast brass is 71, rolled brass 86. The hardness of aluminium on J. R. Rydberg's scale is 2.9 when that of copper is 3.0, and that of silver 2.7; and on F. Auerbach's scale of absolute values, the hardness of aluminium is 52 when that of silver is 91. S. Bottone gave 0.0821 for the hardness of aluminium, 0.1360 for copper, and 0.0990 for silver. The effect of temp. has been examined by P. Ludwik, and A. Kürth; the former found the viscosity hardness to vary with temp. as illustrated in Fig. 17. J. Okubo found the scleroscopic hardness of aluminium to be 3.75 when that of lead is 1.35. He also measured the **coefficient of restitution** on impact. The Brinell hardness of cast aluminium varies from 23 to 28; according to P. D. Merica, the scleroscopic hardness of annealed and cast aluminium varies from 4 to 6; the hardness of cold-rolled sheets varies from 13 to 15. R. J. Anderson measured the scleroscopic hardness of a number of sheets of hard aluminium, and found:

Thickness in mm.	0.2291 (3)	0.1215 (8)	0.1037 (10)	0.0841 (12)	0.0650 (14)	0.0169 (26)
Hardness	5.0	12.5	14.0	15.0	15.0	15.0

where the numbers in brackets refer to the sheet gauge. The effect of annealing is illustrated by selecting the results with sheet of 10-gauge. After 120 mins. heating to 200°, the hardness was 10.2; after 30 mins. at 350°, the hardness was 5.0; and

	300°			400°				600°
Time in mins	10	30	60	5	10	30	60	10
Hardness	10.0	7.0	5.0	10.6	5.0	4.8	4.5	4.0

M. Hanriot found that the Brinell's hardness of aluminium was raised from 14.6 to 19.0 after the metal had been compressed at 10,000 kgrms. per sq. mm. H. J. Coe gave for Brinell's hardness of cast aluminium,²³ for extended and drawn aluminium, 26-29; and for the metal annealed at 550°, 17.5-24.0. H. O'Neill measured the hardness of single crystals of aluminium. Z. Jeffries detected no change in the microstructure after the metal had been subjected to compression.

As shown by D. Saito and K. Hayashi,⁴ the fluidity of molten aluminium is large. K. Honda and S. Konno found the **viscosity** of the rolled metal at 20° to be 0.723×10^8 to 0.822×10^8 ; and for the metal annealed at 400°, 1.25×10^8 at 20°. K. Iokibe and S. Sakai found the viscosity of annealed aluminium to be 25.50×10^9 at 15°. S. W. Smith found the **surface tension** of molten aluminium between 700° and 820° to be 520 dynes per cm., and the **capillary constant** $a^2 = 45.09$ per sq. mm. I. Traube gave 119,300 megabars or 10^6 dynes per sq. cm. for the **internal pressure** of solid aluminium; and T. W. Richards, 126,000 megabars. J. H. Hildebrand and co-workers calculated relative values for the internal press. of the metals; and C. E. Guye and co-workers measured the effect of temp. on the viscosity. W. J. Humphreys studied the **diffusion** of aluminium in mercury; R. J. Anderson, of copper in molten aluminium, and G. Sirovich and A. Cartoceti, and O. Bauer and E. Piowowsky, of aluminium in solid copper. A. Masson gave 5104.5 metres per second for the **velocity of sound** in aluminium. J. W. Mallet found that the highly purified metal is not sonorous, but the less purified is highly sonorous. H. St. C. Deville reported: "A very curious property which aluminium shows is its excessive **sonorousness**, so that a bar of it suspended by a thin wire and struck, sounds like a crystal bell. The sonorousness is the more pronounced the purer the metal. A bell cast with the metal gave a sharp sound of considerable intensity, but which was not prolonged, and it seemed as if the clapper or support hindered the sound, which was thus far from agreeable." A. Springer said with respect to the use of aluminium for sounding boards:

Aluminium differs from all other metals in the absence of the comparatively continuous and uniform higher partial tones which give in other metals the tone-colour called metallic; and further, that it possesses an elasticity capable of sympathetic vibration uniformly through a wide range of tone-pitch, which renders it in this respect superior to wood.

The **malleability** of aluminium is high. It can be forged and rolled as readily as silver and gold, and as F. Wöhler, H. St. C. Deville, and M. Degousse⁵ showed, it can be beaten out into thin leaf. J. W. Richards said that commercial aluminium leaf is 0.000638 mm. in thickness, and compares favourably with ordinary silver-leaf. J. W. Mallet said that highly purified aluminium is more malleable than the less pure metal. In rolling, the more impurity in the metal the less readily can it be worked, and the quicker does it become hard. According to J. W. Richards, more than 1 per cent. of iron makes aluminium less and less malleable until with 6 per cent. of iron the metal is brittle; on the other hand, up to nearly 10 per cent. of silicon can be present without rendering the metal unfit for rolling. Aluminium is most malleable between 100° and 150°, and, according to C. Fabian, the metal is best worked in that range of temp., for it can be worked some time at that temp. before hardening. If rolled cold, it requires more frequent annealing. Annealed aluminium is one of the softest and most pliable of metals, yet, as H. St. C. Deville stated, by hammering it becomes as hard and elastic as iron; and, according to A. R. von Burg, by cold working it can be given the stiffness and temper of brass. Aluminium leaf is rubbed to powder and sold as a metallic dust for decorative purposes. C. Margot found that melted aluminium poured on glass sticks very tenaciously on cooling. J. Czochralsky studied the effect of occluded gases on the mechanical properties of aluminium.

Gold, silver, platinum, iron, and copper are said to be the only metals whose **ductility** is greater than that of aluminium. H. St. C. Deville noted that aluminium can be drawn into fine wire. The metal quickly hardens at the drawing plate, and

requires frequent annealing. The larger sizes of wire can be drawn warm, and they then require less annealing. Aluminium can be punched and stamped in dies. The elongation in the tensile strength test can be regarded as a measure of the ductility—Figs. 14 to 17. P. D. Merica gave for the ductility of soft annealed aluminium sheets of different thickness, by Erichsen's test :

Thickness	0.0126	0.0201	0.0319	0.0508	0.0808	0.1018 mm.
Ductility	5.5-7.5	7.0-8.0	7.5-9.0	9.0-10.5	10.5-12.0	11.0-12.5

W. H. Barlow found the ductility of cold-worked aluminium to be relatively small—2.5 per cent. According to H. St. C. Deville, aluminium can be filed without choking the file, but C. Karmarsch showed that the converse is true. W. C. Heraeus said that aluminium may be welded.

Cast aluminium has not a high **elasticity**, and in this respect it resembles cast silver; when worked, however, it becomes more rigid and elastic. If the hardened metal be re-heated to about 600°, and slowly or quickly cooled, it becomes almost as soft and pliable as lead. If re-worked, the metal again becomes stiff and elastic. According to W. Voigt, the **modulus of elasticity** or **Young's modulus** of longitudinal elasticity of cast aluminium is 6750 kgrms. per sq. mm. G. Angenheister gave 6716 kgrms. per sq. mm. for the annealed, and 7074 kgrms. per sq. mm. for the hardened metal. For the cold-worked metal, K. F. Slotte gave 7200; G. S. Meyer, 7462; and N. Katzenelsohn, 7540 kgrms. per sq. mm. F. J. Brislee found for Young's modulus of 99.3 per cent. aluminium in bars 9.84×10^6 lbs. per sq. in.; in wires, 9.79×10^6 lbs. per sq. in.—the average is 9.8×10^6 lbs. per sq. in. W. Sutherland gives 680×10^{-6} grms. per sq. cm. as the best representative value at 15° with the extremes 602×10^{-6} and 753×10^{-6} grms. per sq. cm., and he represents the value of Young's modulus at θ° by $E_0(1-0.823\theta)/T_m$, where T_m represents the m.p. of the metal; and E_0 , the value of Young's modulus at absolute zero. H. L. Dodge found with annealed wire of 99.29 per cent. aluminium and silicon 0.24 per cent., iron 0.44 per cent., and copper 0.03 per cent., the effect of temp. on Young's modulus, $E' = E \times 10^{-11}$ dynes per sq. cm., and the temp. coeff., $\alpha = 10^{-11} dE/dT$, to be:

	20°	40°	60°	80°	100°	120°	140°	160°	180°
E'	7.50	7.40	7.27	7.10	6.90	6.66	6.38	6.06	5.72
α	0.0046	0.0057	0.0072	0.0090	0.0112	0.0135	0.0155	0.0165	0.0170

With hard wire the results were rather lower, but there was a partial annealing at the higher temp. The temp. coeff. of the hard wire was almost constant. H. L. Dodge concluded that annealing does not materially affect the value of Young's modulus, but it does affect the rate of change, increasing the temp. coeff. for low temp. and decreasing it for higher values. C. Schäfer found the elastic modulus increased 21.32 per cent. per 100° in falling from 20° to -186°. According to J. Pionchon, just before the m.p., *i.e.* between 580° and 625°, aluminium acquires a granular structure, becoming very friable and falling to powder on the slightest press.; and A. Granger found that when aluminium is heated to a temp. of about 600°, its tenacity and hardness become greatly modified, the metal assumes a grained structure, and can be easily broken. On heating to a still higher temp., the metal can be cut with a knife or even crushed in a mortar. According to J. W. Richards, the presence of 2 to 5 per cent. of copper, nickel, silver, or titanium raises the elasticity without noticeably affecting its sp. gr., or impairing its malleability. W. Rübel found that from 4 to 7 per cent. of phosphorus raised the elasticity, sp. gr., and tenacity of aluminium. K. A. Schreiber examined the influence of different elements on the properties of aluminium.

For the **torsion modulus**, rigidity, or shear modulus of aluminium, C. Schäfer gave 2329, N. Katzenelsohn 3350, and F. Horton 2605 kgrms. per sq. mm.; for cast aluminium, W. Voigt gave 2580 kgrms. per sq. mm., and for the cold-worked metal, H. Tomlinson gave 2673 kgrms. per sq. mm. For the absolute values between 0° and 20°, W. Thomson gave 2410 kgrms. per sq. mm., and H. Tomlinson 2470-2400 kgrms. per sq. mm. W. Sutherland gave 0.932-0.943 for the ratio of the rigidity

at 100° to that at 0°, and 0.803 for the ratio at 200° and 0°. At 15°, W. Sutherland takes the best representative value as 2500 kgrms. per sq. mm., and for the rigidity, N , at θ° , $N/N_0 = 1 - (\theta/T_m)^2$, where T_m denotes the absolute m.p., and N_0 the rigidity at absolute zero. C. Schäfer represents the percentage decrease with temp. on cooling as 30.2. K. R. Koch and C. Dannecker found for the influence of temp. on the torsion modulus (lbs. per sq. in.):

Torsion modulus $\times 10^{-6}$.	20°	100°	200°	300°	400°	450°	500°
	3.87	3.73	3.45	3.10	2.63	2.03	0.68

W. H. Barlow⁶ found that a rolled bar of aluminium had a **tensile strength** of 26,800 lbs. per sq. in., and an elongation before breaking of 2.5 per cent. He added that the tenacity is almost equal to that of steel if the comparison be made by weight. C. Karmarsch, P. Ludwik, F. Haber and R. Geipert, A. G. C. Gwyer, E. A. Hunt and co-workers, H. J. Coe, H. L. Dodge, and many others have measured this constant. P. D. Merica gives for softened or *normalized aluminium*, i.e. aluminium which has been mechanically worked by rolling, drawing, or forging, and then annealed at 400°, the average tensile strength 12,500–15,000 lbs. per sq. in., or 8.78–10.54 kgrms. per sq. mm.; with the yield point 8000–9000 lbs. per sq. in., or 5.52–6.32 kgrms. per sq. mm. and an elongation in 2 ins. of 10.40 per cent., and a reduction in area of 20–30 per cent. He also gives the results indicated in Table II

TABLE II.—TENSILE PROPERTIES OF ALUMINIUM.

Form of metal.	Tensile strength lbs. per sq. in.	Yield point lbs. per sq. in.	Percentage elongation in 2 ins.	Percentage reduction in area.
Sand cast	11,000–13,000	8,500	15–25	—
Chill cast	12,000–14,000	9,000	15–25	—
Sheet: Annealed	12,000–15,000	8,000–9,000	12–35	20–30
Semi-hard	18,000–22,000	9,000–12,000	5–12	20–30
Hard	22,000–25,000	12,000–25,000	1–7	20–30
12-gauge	25,000	—	7	—
16-gauge	28,000	—	5	—
20-gauge	30,000	—	3	—
Bars, hard	28,000–35,000	14,000–23,000	—	30–40
Wire: Hard	25,000–55,000	16,000–33,000	—	40–60
40-mil	31,000	—	—	—
80-mil	28,000	—	—	—
120-mil	25,000	—	—	—
200-mil	22,000	—	—	—

for different forms of the metal. E. Wilson and J. Gavey found that the *duration of stress* or the time occupied in applying the tensile stress, has a marked influence on the result. Thus, with hard-drawn aluminium wires with a breaking load of 325 lbs. and a tensile strength of 25.3×10^3 lbs. per sq. in. under ordinary conditions, by varying the time of the application of the breaking load, they obtained:

Time of application, secs.	0.5	5	118	525
Breaking load	300	280	240	220
Tensile strength	23.3	21.8	18.7	17.1

and the wire was not broken, but still stretching at the end of 1900 hrs. Hence, about two-thirds the nominal breaking load caused rupture when applied continuously for about three weeks. H. Shoji found that the relation between the time t and the torsion angle α can be represented by $\alpha = ct/t^\alpha$, or $\alpha = a - b \log t$ when a , b , and c are constants. K. L. Meissner discussed this subject.

When aluminium has been strained beyond the elastic limit, it suffers plastic deformation with any increase of stress—*vide* copper. A. Morley and G. A. Tomlinson showed that the metal recovers from this overstrained state if allowed to rest for about 14 days; the recovery is accelerated by raising the temp., but the recovery

with the warmed metal is not so complete as the slower recovery at the lower temp. The rate of recovery from overstrain is not affected by the transverse or longitudinal vibrations produced by hammering. A. Elmendorf measured the effect of *alternating stresses* on the tenacity of aluminium which normally had a tensile strength of 15,000 lbs. per sq. in. If S denotes the fibre stress, and n the number of reversals required for rupture, then $S=48,000n^{-0.113}$. Hence, a million reversals are required for rupture with a fibre stress of 10,000 lbs. per sq. in., and ten million reversals for rupture with a fibre stress of 7800 lbs. per sq. in.

According to P. D. Merica, the *cold-working* of aluminium increases the tensile strength, and decreases the elongation or ductility. Representing the amount of cold-work in terms of the reciprocal ratio of the thickness of the sheet tested divided by the thickness of the original sheet, the percentage elongation in 2 ins. and the tensile strength in lbs. per sq. in. $\times 10^{-3}$ are shown in Fig. 18. H. C. H. Carpenter and L. Taverner examined the *rate of annealing* or softening of cold-rolled aluminium sheets by annealing at different temp., and for different periods of time. The impurities in the metal were silicon 0.75, iron 0.34, and copper 0.03 per cent. Selections from the results are shown in Figs. 19 and 20. The general conclusions

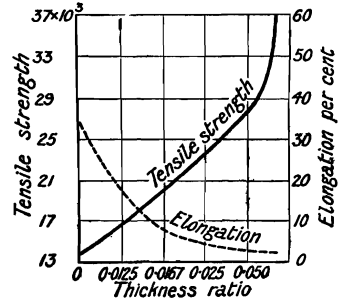
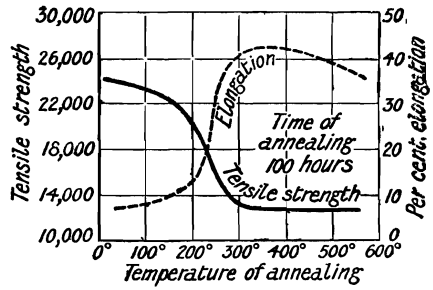
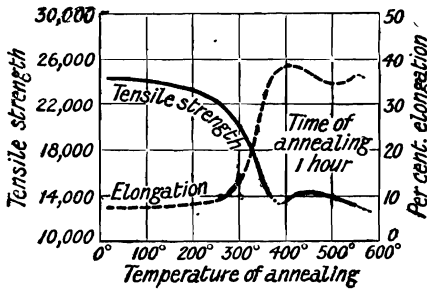

FIG. 18.—Effect of Cold-working on the Tensile Properties of Aluminium.



FIGS. 19 and 20.—The Annealing of Cold-worked Aluminium.

were: (1) The hardness caused by mechanical work is lost very rapidly upon annealing at from 300° to 500° C. The same final tensile strength of about 12,700 lbs. per sq. in. is obtained in all cases. (2) The softening is most marked within the first portion of the annealing period. (3) No hardening by annealing was noticed as in the case of copper and brass. (4) Below 300°, the decrease in hardness is very slow, but occurs within the temp. range of 100° to 200° with no increase of ductility.

A. G. C. Gwyer showed that the tensile strength and elongation increase rapidly as the *grain-size* decreases, Fig. 21, but with a grain-size finer than from 200–300 grains per sq. mm., the tensile strength and elongation are almost indifferent to the size of grain. The effect of *temperature* on the tensile properties of aluminium has been studied by P. Breuil, R. Baumann, H. le Chatelier, and G. D. Bengough. The results by the last-named with 99.56 per cent. aluminium are shown in Table III

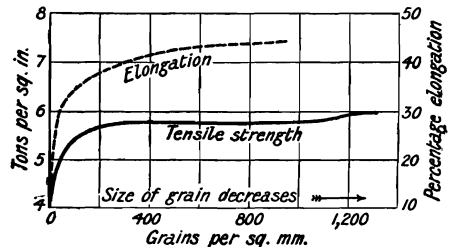

FIG. 21.—Effect of Grain-size on the Tensile Properties of Aluminium.

TABLE III.—THE EFFECT OF TEMPERATURE ON THE TENSILE PROPERTIES OF ALUMINIUM.

Temperature of test.	Tensile strength in lbs. per sq. in.	Percentage elongation in 2 ins.	Percentage reduction in area.
20°	19,200	12	75
200°	14,100	15	78
275°	11,110	17.2	79
330°	7,600	20.3	88
375°	3,800	25	88
396°	2,150	56	90
450°	—	65	96
520°	900	88.5	To finest possible point.
565°	540	70.3	
610°	660	75.0	
625°	420	39.0	92

and Fig. 22. There is a well-marked change in direction in the stress-temp. curve at about 395°, and at a rather lower temp. with the strain-temp. curve. The metal

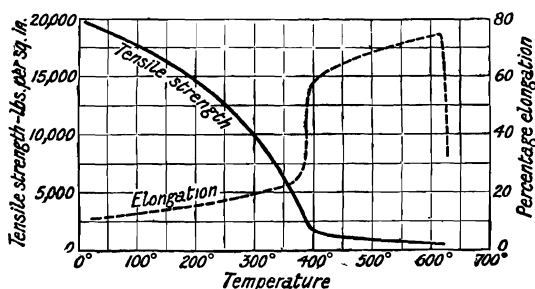

FIG. 22.—Effect of Temperature on the Tensile Properties of Aluminium.

becomes plastic just over 600°. G. Pisati and co-workers represented the tensile strength of aluminium at θ° between 0° and 100° by $50.8 - 0.0458\theta - 0.000372\theta^2$ kgms. per sq. mm., and between 100° and 200° by $54.7 - 0.12\theta$. Poisson's ratio, that is, the ratio of the transverse contraction to the longitudinal extension under a tensile stress, is 0.359 according to C. Schäfer, and 0.363 according to P. Cardani. The value

of Poisson's ratio was found by N. Katzenelsohn to increase 15.7 per cent. between 0° and 100° . The effect of various metals—copper, zinc, tin, and iron—on the mechanical properties of aluminium has been studied by M. Wählert. T. W. Richards⁷ and co-workers found the average compressibility, *i.e.* the fractional change in vol. caused by one megabar press. between 100 and 500 megabars press., to be 1.47×10^{-6} per megabar or 13.13×10^{-8} per at. vol. per megabar. E. Madelung and R. Fuchs gave 1.36×10^{-6} megabars per sq. cm. P. W. Bridgman's value is 1.21×10^{-6} at 20° up to 6500 atm. press.; J. W. Buchanan's 1.67×10^{-6} at 9° and 256 atm.; S. Lussana gave for press. up to 2000 atm.:

	14.7°	27°	71°	103°	126°
Compressibility coeff.	0.88×10^{-6}	0.96×10^{-6}	1.03×10^{-6}	1.10×10^{-6}	1.18×10^{-6}

and E. Grüneisen gave for press. between 10 and 150 atm. 1.32×10^{-6} at -191° ; 1.48×10^{-6} at 15° ; and 1.80×10^{-6} at 125° . L. H. Adams and co-workers gave 1.39×10^{-6} per megabar for the compressibility of aluminium; and they represented the change in vol., δv per c.c., produced when the press. changes from p_0 to p , by $\delta v = -1.2 \times 10^{-4} + 1.325 \times 10^{-6}(p - p_0)$. According to P. W. Bridgman, if v denote vol. at θ° at atm. press., and the change in vol., δv , by application of a press. p kgms. per sq. cm. is $\delta v/v \times 10^7$ at 30° is $-13.40p + 3.5 \times 10^{-5}p^2$ for hard drawn rod; for annealed drawn rod at 30° , $-13.34p + 3.5 \times 10^{-5}p^2$, and at 75° , $-13.91p + 3.5 \times 10^{-5}p^2$; and for the cast metal at 30° , $-13.43p + 5.0 \times 10^{-5}p^2$, and at 75° , $-13.76p + 5.1 \times 10^{-5}p^2$. P. D. Merica gives 6,000–25,000 lbs. per sq. in. for the elastic limit of aluminium under press., and 16,000–100,000 lbs. per sq. in. for the ultimate strength; A. Elmen-dorf found 67,000 lbs. per sq. in. for the ultimate strength of cast aluminium. P. W. Bridgman found that the linear change, δl , in the length l when the press.

is p kgrms. per sq. cm. is $\delta l/l=0\cdot0000003910p-0\cdot0000056$. C. J. Burton and W. Marshall observed a rise of $0\cdot181^\circ$ on compressing aluminium at 388 atm. press., this corresponds to a rise of $0\cdot00047^\circ$ per atm. H. J. Coe found the maximum load giving critical plasticity to be 5·16 tons per sq. in. for cast aluminium; 7·00 to 7·40 tons per sq. in. for extruded and drawn metal; and 6·41 to 6·50 tons per sq. in. for the metal annealed at $5\cdot50^\circ$. E. H. Dix studied the **impact** test on aluminium.

According to H. Fizeau,⁸ the coeff. of **thermal expansion**, α , of aluminium is $0\cdot00002313$ at 40° , and $0\cdot00002336$ between 0° and 100° ; P. Glatzel gave $\alpha=0\cdot00002354$; and F. C. Calvert and R. Johnson, $\alpha=0\cdot00002218$ between 0° and 100° . H. L. Dodge found $\alpha=0\cdot000025$ for wires with 99·29–99·39 per cent. of aluminium, 0·32–0·44 per cent. of iron, 0·22–0·24 per cent. of silicon, and 0·03–0·07 per cent. of copper, hard or soft. H. le Chatelier found $0\cdot0000246$ at 63° , and $0\cdot0000315$ at 600° ; and F. Henning found $0\cdot00002444$ between 16° and 250° , and $0\cdot00002717$ between 16° and 500° ; and $0\cdot00001835$ between 16° and -191° . F. J. Brislee showed that the thermal expansion is determined by the *history of the metal*, for if l denotes the length at θ° when l_0 is the length at 0° , $l=l_0(1+0\cdot00002432\theta)$ for hard-drawn aluminium, and $l=l_0(1+0\cdot00002454\theta)$ for annealed aluminium between 0° and 100° . Hence, the coeff. of expansion, $\alpha=0\cdot0_42454$, for annealed aluminium is slightly higher than $\alpha=0\cdot0_42432$, for hard-drawn aluminium. W. Dittenberger gave for the expansion, δl , of aluminium in mm. per metre, between 0° and 610° , $\delta l=0\cdot023536\theta+0\cdot00007071\theta^2$; and K. Scheel between -78° and 500° , $\delta l=0\cdot0229\theta+0\cdot00009\theta^2$. The last-named found the linear expansion, δl , of aluminium between 0° and θ° , in mm. per metre:

	-78°	0°	100°	200°	300°	400°	500°
δl	1·73	0	2·38	4·94	7·68	10·60	13·70

J. Disch made some observations at low temp. W. H. Souder and P. Hidnert found for the coeff. of linear expansion, α :

	$20^\circ-100^\circ$	$100^\circ-200^\circ$	$200^\circ-300^\circ$	$300^\circ-400^\circ$	$400^\circ-500^\circ$	$500^\circ-600^\circ$
α	0·00002375	0·00002575	0·00002715	0·00003000	0·00003260	0·00003605

or $l=l_0\{1+(21\cdot90\theta+0\cdot0120\theta^2)10^{-6}\}$. They gave between 20° and 300° , $\alpha=0\cdot0_4256$; between 300° and 600° , $\alpha=0\cdot0_43290$; and between 20° and 600° , $\alpha=0\cdot0_4294$. W. Voigt found for the effect of *temperature*, $\alpha \times 10^6=23\cdot06+0\cdot61(\theta-30)$ for 97·53 per cent. aluminium containing 1·33 per cent. of iron, 1·01 of silicon, and 0·17 of carbon. E. Grüneisen, and S. Lussana measured the effect of temp. and *pressure* on the coeff. of expansion, the former found for atm. press. $\alpha \times 10^6$ is 68·49 between 17° and 100° , and 54·66 between 17° and 190° ; the corresponding values for 1000 kgrms. per sq. cm. press. are 65·51 and 55·35 respectively. For atm. press. S. Lussana found $\alpha \times 10^6=67\cdot11$ between 27° and 71° , and 68·25 between 27° and 126° ; at 1000 atm. 64·71 and 65·88 respectively, and at 2000 atm. press., 62·58 and 63·55 respectively. For the proportional change of the thermal expansion, α , with press., p , P. W. Bridgman gave $-da/adp=1\cdot02 \times 10^{-5}$ for cast aluminium, and $1\cdot76 \times 10^{-5}$ for the drawn and annealed metal.

Gold, silver, and copper are the only metals with a higher **thermal conductivity** than aluminium. F. C. Calvert and R. Johnson⁹ found that if the conductivity of silver be 100, that of aluminium is 66·5. L. Lorenz found the thermal conductivity of aluminium to be 0·3445 cal. per cm. per sec. per degree at 0° , and 0·3619 cal. at 100° , so that if the conductivity of copper be 100, that of aluminium is 47·7 at 0° , and 50·0 at 100° . A. C. Mitchell's value, 0·6188 at 18° , is too high. W. Jäger and H. Diesselhorst obtained 0·4803 at 18° and 0·4923 at 100° with aluminium wire containing 0·5 per cent. of iron, and 0·4 per cent. of copper. The temp. coeff. is $+0\cdot29$ per cent. According to C. H. Lees, the variation of the conductivity with temp. has a minimum about -125° .

	18°	0°	-50°	-100°	-125°	-150°	-160°	-170°
Conductivity	0·504	0·502	0·496	0·492	0·491	0·508	0·514	0·524

R. Schott measured the low temp. conductivity of aluminium. S. Konno found that the thermal conductivity of aluminium decreases with rise of temp. up to the m.p.; there is then an abrupt decrease. According to J. W. Richards, the thermal conductivity of annealed aluminium, 38.87 (silver, 100), is rather greater than that of the unannealed metal, 37.96 (silver, 100).

The **specific heat** of aluminium is higher than that of the common metals. This might be anticipated from its low at. wt. and Dulong and Petit's rule. Many values have been given for the sp. ht. of aluminium. H. V. Regnault¹⁰ found 0.2056 between 25° and 97°, but his metal contained only 88.35 per cent. of aluminium. H. St. C. Deville said that H. V. Regnault asked for a sample in order to determine its sp. ht., but in spite of the warning that the available sample was very impure, H. V. Regnault persisted, and H. St. C. Deville added:

It is a pity that I gave such impure material to serve for determinations of such splendid precision, and I was persuaded to do so only by the entreaties of M. Regnault, who could not wait until I had prepared him better material.

Possibly, H. V. Regnault had not recognized so clearly as H. St. C. Deville the importance of working with purified materials. In another determination with 97 per cent. aluminium, he obtained 0.2122 between 14° and 97°. H. Kopp used a sample with 2 per cent. of iron and obtained 0.2070 between 20° and 52°. J. W. Mallet found the sp. ht. of highly purified aluminium to be 0.2253. The *temperature coefficient* of the sp. ht. is higher than that of the common metals. H. Tomlinson represented his results for the mean sp. ht. from 0° to θ° with commercial aluminium by $0.2070 + 0.000115\theta$; A. Niccari, by $0.2116 + 0.00009507\theta$ from 0° to 300°; J. W. Richards, by $0.2220 + 0.00005\theta$ from 0° to θ° up to 600°, and $0.2220 + 0.0001\theta$ at θ° . W. Bontscheff represented his results at θ° between -75° and 500° by $0.20890 + 0.00016186\theta - 0.0_6294246\theta^2 + 0.0_6461182\theta^3$, and his observations show that the sp. ht. of aluminium increases with rise of temp., and that the rate of increase decreases to a minimum between 200° and 300°, and thereafter increases. W. A. Tilden measured the mean sp. ht. of aluminium for ranges of temp. between -182° to 435°; and E. H. and E. Griffiths, between -114.3° and 97.6°. Other observations have been made by C. C. Trowbridge, R. Laemmel, H. C. Schmitz, P. Nordmeyer, E. Grüneisen, H. Schimpf, U. Behn, T. W. Richards and F. G. Jackson, J. A. Harker and H. C. Greenwood, W. Louguinine, and F. Glaser. W. Nernst and co-workers made some observations at temp. down to -253.9°, and P. Schübel up to 601°. The following is a selection from these results for C_p :

	-253.9°	-184.7°	-114.3°	-81.5°	0.1°	97.6°	303°	500°	601
Sp. ht.	0.066	0.0967	0.1709	0.1867	0.2096	0.2248	0.2293	0.2363	0.2447

The first value is due to W. Nernst and F. Schwerns, the second to W. Nernst and F. A. Lindemann, those above 97.6° are by P. Schübel, and the remainder by E. H. and E. Griffiths. The last-named also estimated values of the **atomic heats**, C_p and C_v , over the range -240.6° to 107°, or 32.4° K. to 380° K.

°K.	32.4°	50°	100°	160°	200°	250°	300°	340°	380°
C_p	0.25	0.91	3.08	4.64	5.14	5.54	5.81	5.98	6.13
C_v	—	—	3.05	4.56	5.03	5.37	5.57	5.69	5.79

The variation in the at. ht. at low temp. was found by W. Nernst and F. Schwerns to be in agreement with P. Debye's formula, $C_p = 8.4T^3$. F. J. Brislee showed that the results of many sp. ht. determinations are more or less fortuitous because the sp. ht. is determined by the thermal history of the metal; for example, the sp. ht. of annealed 99.6 per cent. aluminium is 0.2240 ± 0.0004 between 20° and 200°, and 0.2354 ± 0.00033 between 20° and 300°, while the sp. ht. of fresh hard-drawn wire is 0.2220 in the range 10° to 100°, and the value decreased after 10 days at 100° to 0.2150.

J. Pionchon found that with 99.1 per cent. aluminium the **thermal capacity**, or the amount of heat, Q , required to raise a gram of the metal from 0° to θ° is

$Q=0.393\theta-291.86\theta/(1517.8+\theta)$ up to 580° ; and for the liquid, from 630° to 800° , $Q=0.308\theta-46.9$. The sp. ht. thus rises slowly but with increasing rapidity from 0.201 at 0° to 0.2894 at 550° . The sp. ht. of the molten metal at 650° is 0.308. J. W. Richards represented the amount of heat in 99.93 per cent. aluminium at θ° up to 600° by $Q=0.2220\theta+0.00005\theta^2$; and he estimates the sp. ht. of the solid at the m.p. to be 0.285; J. Pionchon's value is 0.308. U. J. J. le Verrier reported that the sp. ht. of commercial aluminium is constant, 0.22 between 0° and 300° ; constant, 0.30, between 300° and 530° ; between 530° and 560° , there is an absorption of about 10 cal.; and between 540° and 600° , the sp. ht. is again constant 0.46. No other observer has been able to verify U. J. J. le Verrier's remarkable statements. It is, however, to be noted that at about 600° aluminium begins to soften, and some latent heat is absorbed before the true m.p. P. N. Laschtschenko found that with aluminium containing 0.31 per cent. of silicon, and 0.63 per cent. of iron, but no copper or lead, the curve connecting the temp. with the amount of heat required to raise the temp. of 1 gm. of metal from any given temp., is continuous up to 580° , and is slightly convex towards the temp. axis, Fig. 23; between 580° and 590° there is a marked change in the direction of the curve corresponding with the pasty condition of the metal; and at 650° - 670° , there is a sudden increase in the amount of heat, owing to the fusion of the metal. The high sp. ht. of aluminium, coupled with a large heat of fusion, causes the metal to melt very slowly even in a hot fire; and conversely on cooling. R. Ariano studied the heating and cooling curves of the metal. J. W. Richards showed that the amounts of heat required to raise a gram of a number of metals to the m.p. and then to melt them, are:

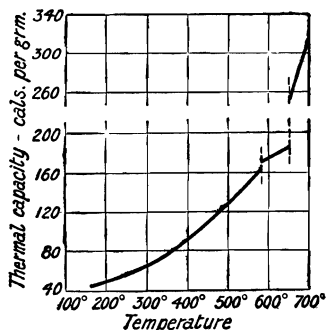

FIG. 23.—Thermal Capacity of Aluminium at Different Temperatures.

	Al	Fe	Cu	Pt	Ag	Au
Thermal capacity .	258.3	250.0	162.0	102.4	85.0	58.0 calcs.

G. N. Lewis and co-workers, and E. D. Eastman gave 6.82 for the **entropy** of aluminium at 25° and atm. press. W. M. Latimer discussed the entropy changes in the metal electrons.

Aluminium fuses at a relatively low temp.; H. St. C. Deville¹¹ said that the **melting point** lies above that of zinc, and below that of silver, but is nearer to that of zinc than to that of silver. R. Pictet gave 600° for the m.p.; F. Heeren, and T. Carnelley, 700° for aluminium with 4–5 per cent. of iron; P. H. van der Weyde, 850° . H. Rose said that pure aluminium is more fusible than the impure metal, but J. W. Mallet said that the converse is true, and H. le Chatelier has shown that a very small proportion of iron or silicon lowers the m.p.—*e.g.* aluminium with 0.75 per cent. and 1.50 per cent. of silicon melts at 619° ; but a large proportion of these impurities acts in the opposite direction. Outside the early difficulties in measuring what are now known as pyrometric temperatures, there are difficulties, as P. Rohland showed, arising from the presence of impurities, and from the masking of the true m.p. by the prior pasty condition; and, as C. Matignon, and W. von Bolton showed, a protective film of oxide may be formed which permits aluminium wire to be heated above its m.p. without losing its shape. C. T. Heycock and F. H. Neville gave 654.54° ; S. W. Holman, R. R. Lawrence, and L. Barr, 660° ; H. L. Callendar, 654.5° ; W. R. Mott, 657.3° ; H. Gautier, 660° ; L. Holborn and A. L. Day, 657.3° ; A. L. Day and R. B. Sosman, 657° ; C. W. Waidner and G. K. Burgess, 658° ; A. L. Day, R. B. Sosman, and E. T. Allen, $658.0^\circ \pm 0.6^\circ$; G. K. Burgess, $658^\circ \pm 1$. The best representative value is 658.7° as given by L. I. Dana and P. D. Foote;

W. Guertler and M. Pirani gave 658°; and F. Wüst and co-workers, 657°. W. Spring reported that aluminium powder flows to a solid mass at ordinary temp. under a press. of 38 tons per sq. in. If the liquid phase can escape, the m.p. of all metals are lowered by press. J. Johnston calculated that the press. necessary to melt aluminium at 27° is 5100 atm. R. C. Smith observed signs of sintering with aluminium filings at 200°.

H. St. C. Deville said that aluminium is non-volatile; it loses no weight when violently heated in a carbon crucible in a forge furnace. The volatilization of aluminium was noted with the introduction of electric furnaces. H. Moissan volatilized the metal in such a furnace, and he noted that if the vapour above the crucible be condensed on a copper tube through which cold water is passing, small spherules of the metal are obtained. H. C. Greenwood said that the **boiling point** of the metal at atm. press. is about 1800°; W. R. Mott also gave 1800°; and H. von Wartenberg, below 2200°. W. G. Duffield estimated the rate of evolution of molecules from the boiling liquid. J. W. Richards estimated the **vapour pressure** of solid aluminium at 0° to be 1.0×10^{-43} mm., and at the m.p., 5.25×10^{-7} mm., or $\log p = -14.190/T + 8.98$; and the vap. press. of the liquid at T° K. is $\log p = -15650/T + 8.4$. The latent **heat of fusion** of aluminium is very near that of ice. J. Pionchon found 78.9 cal. per gram, and P. N. Laschtschenko, 71 cal. per gram. F. Wüst and co-workers gave 93.96 cal. per gram. J. W. Richards estimated the latent **heat of vaporization** to be 2107–2305 cal. per kgrm. R. Pohl and P. Pringsheim made mirrors of aluminium by condensing the vapour on a quartz plate.

The **refractive index**, μ ; the **index of absorption**, k , such that the amplitude of a wave after travelling one wave-length, λ , measured in the metal, is reduced in the ratio 1 : $e^{-2\pi k}$, or for a distance S in the ratio 1 : $e^{-2\pi Sk/\lambda}$; and the percentage **reflecting power**, R , of aluminium have been measured by G. Quincke.¹² The values headed with an asterisk are by P. Drude :

λ	.	.	.	431	486	527	589	589*	630*	656 μ
μ	.	.	.	0.78	0.93	1.10	1.28	1.44	1.62	1.48
k	.	.	.	2.85	3.15	3.39	3.66	5.23	6.44	3.92
R	.	.	.	72.3	72.8	72.4	72.5	72.7	72.4	72.6

W. W. Coblentz also gave for the percentage reflecting power :

λ	.	.	.	1.0	2.0	4.0	7.0	10.0	12.0
R	.	.	.	71	82	92	96	98	98

J. Schumann and L. Mach studied the reflection of light of wave-length 1850–2800 on alloys of magnesium and aluminium; I. C. Gardner found aluminium reflects very poorly in the Schumann region. E. O. Hulbert also made observations on this subject. M. Faraday found that a film of aluminium in **polarized light** depolarized the ray, and brought in a red image which was reduced to a minimum by the rotation of the analyzer and then converted to a blue. S. Procopiu studied the optical effects of aluminium powder suspended in toluene. J. H. Gladstone gave 9.7 for the atomic **refraction equivalent** of aluminium with the H_α -line. W. J. Pope gave 14.61 for the at. refraction with the D -line.

According to W. H. Bragg,¹³ the stopping power of aluminium for the α -rays is 1.45 (air unity). H. R. von Traubenberg gave 40.6×10^{-4} cms. for the range of the α -rays from radium-C in aluminium. E. Rutherford and J. Chadwick obtained evidence of the emission of long-range particles—possibly hydrogen—when α -rays pass through aluminium. J. A. Crowther gave 5.26 for the ratio of the coeff. of absorption of β -rays and the density of the metal; and W. J. Russell and F. Soddy gave 0.111 per cm. for the coeff. of absorption of the γ -rays from radium; 0.130 per cm. for the uranium rays; 0.092 per cm. for thorium rays; and 0.119 for the mesothorium rays. J. Neukirchen gave 0.0872 ± 0.0011 for the scattering coeff. of aluminium for the γ -rays from radium-C. R. Whiddington, K. W. F. Kohlrausch, F. K. Richtmyer, W. Duane and K. C. Mazumder, P. A. Ross, C. G. Barkla and C. A. Sadler,

C. W. Hewlett, A. R. and W. Duane, E. H. Kurth, and H. G. J. Moseley studied the action of **X-rays** on aluminium, and the excitation of these rays by aluminium. The X-ray spectrum has been studied by E. H. Kurth, H. Kulenkampff, H. Bohlin, A. H. Compton, F. Horton and co-workers, etc. The *K*-series was measured by E. Hjalmar, and H. Fricke, who found, in Angström units, or 10^{-8} cm. units, $\alpha_2\alpha'$ and $\alpha_1\alpha=8\cdot31940$; $\alpha_3=8\cdot26460$; $\alpha_4=8\cdot25300$; $\alpha_5=8\cdot20580$; $\alpha_6=8\cdot18920$; $\beta'=8\cdot025$; $\beta_1\beta=7\cdot94054$; W. Duane and K. C. Mazumder, E. Rutherford, M. Ishino, S. J. Allen and L. M. Alexander, and A. W. Hull and M. Rice, measured the absorption of X-rays. J. A. Becker studied the effect of a magnetic field on the absorption of X-rays; R. Whiddington, the velocity of the electrons liberated by the action of X-rays; and F. K. Richtmyer, the absorption of X-rays by aluminium. The last-named found $\mu/D=5\cdot32$, and $\mu=1\cdot37$; C. W. Hewlett, $\mu/D=5\cdot17$, and $\mu=2\cdot30$; and C. E. Taylor, $\mu/D=5\cdot15$, and $\mu=2\cdot29$. F. K. Richtmyer found a discontinuity in the X-ray spectrum for very short wave-lengths, and inferred the existence of characteristic J-radiations. J. C. McLennan and M. L. Clark gave 123·3 for the critical voltage for the L-series of X-rays from aluminium. G. Scheerer sought a relation between the at. number, and the number of electrons emitted by metals exposed to the X-rays.

V. C. Gyllensköld, J. Stark and G. von Wendt, H. Smith, and E. Beckmann and H. Linder studied the effect of the **canal rays**. E. A. Bichat found that the **n-rays** are not absorbed by aluminium. In the electrolysis of soln. of sulphuric acid, hydrochloric acid, alkali hydroxides and chlorides, alum, etc., with an alternating current, and aluminium electrodes, a **luminescence** appears at the electrodes. With a current density of 0·06 amp. per sq. cm., the light is sufficient to enable print to be read. The light increases with increasing current density, but is diminished with a rising temp. With a direct current, the anode alone is luminescent. The phenomenon has been studied by F. Braun, W. von Bolton, H. N. Morse, E. Kielhauser, F. Eichberg and L. Kalier, W. Mitkewitsch, E. Kutsinikoff, and T. Tommasina. The **photoelectric effect** has been studied by W. Ramsay and J. F. Spencer, B. Aulenkamp, K. Herrmann, R. A. Millikan and G. Winchester, O. W. Richardson and K. T. Compton, A. L. Hughes, G. Reboul, T. C. Sutton, A. E. Hennings and W. Kadesch, J. R. Nielsen, R. Pohl and P. Pringsheim, and by O. von Baeyer and co-workers. W. Fresse found the photoelectric sensitiveness to be greatly reduced after treatment with water or alcohol. R. Hamer found the limiting frequency of the photoelectric effect to be $\lambda=3596 \pm 100$. M. Hake found that colloidal particles of aluminium may become negatively charged by exposure to ultra-violet light; with aluminium *en masse* the charge is positive. L. Clémandot studied the **phosphorescence** of alumina. A. Nodon showed that an aluminium plate is opaque to ultra-violet solar radiations under conditions where a lead plate is permeable.

Aluminium compounds do not impart any colour to the non-luminous gas flame. W. N. Hartley and H. Ramage¹⁴ have studied the spectrum produced by the oxygen-hydrogen flame. A. Masson first made some observations on the **spark spectrum** of aluminium. More accurate observations on the spark spectrum have been made by G. Kirchhoff, J. M. Eder, R. Grünter, R. Capron, W. A. Miller, R. Thalén, J. N. Lockyer, L. de Boisbaudran, A. S. King, J. Parry and A. E. Tucker, R. Seeliger and D. Thaer, G. D. Schallenberger, W. Spottiswoode, J. Dewar, W. N. Hartley, E. Fues, B. Hasselberg, F. McClean, J. M. Eder, E. Valenta, E. Demarçay, F. Exner, E. Haschek, G. A. Hemsalech, T. Tommasina, H. Konen, J. H. Pollok, A. G. G. Leonard, S. R. Milner, F. Paschen, etc. The most important lines in the visible spectrum are the yellowish-green lines at 572·3 and 569·6, the green line at 505·7, and the blue line at 466·2, Fig. 24. Many other lines are indicated in the Tables of wave-lengths. F. Brasack has stated that the presence of 0·00004 mgrm. of aluminium can be detected by the spark spectrum. The subject has also been studied by A. de Gramont. R. Bunsen thought that aluminium chloride gives no characteristic lines either in the flame or when sparked. An intense electric sparking is needed to detect

small quantities. The **arc spectrum** of aluminium has been investigated by H. Kayser and C. Runge, W. Huppers, C. Ramsaur and F. Wolf, S. Procopiu, R. Grünter, L. Arons, O. H. Basquin, H. Crew and J. Spence, R. Seeliger and D. Thaer, J. C. McLennan and co-workers, etc. In the arc spectrum there is a number of character-

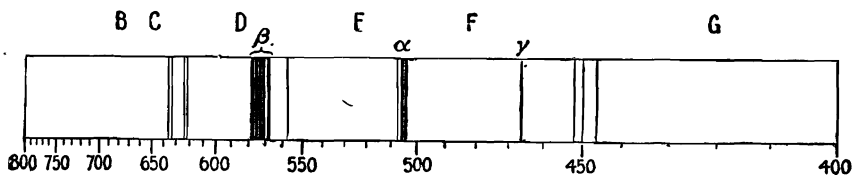

FIG. 24.—Spark Spectral Lines of Aluminium.

istic bands which, as M. Guichard and P. R. Jourdain showed, disappear if the arc be surrounded by hydrogen. The **band spectrum** has been studied by A. de Gramont, R. Thalén, L. de Boisbaudran, A. J. Angström, C. Ciamician, G. A. Hemsalech, G. Berndt, J. Lauwartz, and H. Morris-Airey. L. C. Glaser found the structure of the band spectra of beryllium and aluminium to be similar. The bands in the **ultra-violet spectrum** are extremely characteristic, and they have been investigated by G. G. Stokes, W. H. Fulweiler and J. Barnes, A. Hörnli, R. A. Millikan, J. L. Schön, A. Cornu, G. D. Liveing, J. Dewar, H. Deslandres, J. S. Ames, C. Runge, J. M. Eder, V. Schumann, and G. Berndt. The arc or spark discharge of aluminium under water gives an almost continuous spectrum, and W. Kasperowicz used it as a source of ultra-violet rays. The **ultra-red reflection spectrum** has been investigated by H. Becquerel, F. M. Walters, W. W. Coblenz, and F. Paschen. The percentage reflecting power of sheet aluminium for different wave-lengths is:

λ	1.06	3.06	5.24	8.02	10.49	12.03 μ
Reflecting power	73.8	88.3	93.8	96.9	96.9	97.3 per cent.

The **enhanced lines** have been studied by J. N. Lockyer, and J. Steinhausen; the **reversed spectrum**, by A. Cornu, G. D. Liveing, and J. Dewar; the causes of the *variability of the spectrum*, by A. S. King; the *influence of the medium*, by H. Finger; the *effect of temperature*, by A. Wüllner; the *effect of pressure*, by A. Wüllner, and W. J. Humphreys; V. C. Gyllensköld, and J. Stark and R. Künzer, the **canal ray spectrum**; and the **Zeeman effect**, by H. M. Reese.

The **absorption spectrum** of aluminium vapour has been investigated by J. N. Lockyer and W. C. Roberts-Austen, W. Grotrian, and J. C. McLennan and

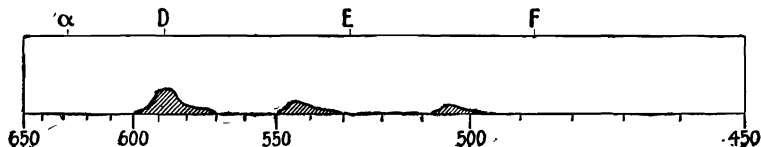

FIG. 25.—Absorption Spectrum of Alkanna and Aluminium Chloride.

co-workers; and of aluminium compounds in soln., by H. W. Vogel. The salt soln. of this element are colourless. H. W. Vogel showed that the absorption spectra of compounds of aluminium with some colouring agents is the best mode of applying the spectroscope to the detection of aluminium; a soln. of hæmatoxyline was found to be very suitable for the purpose; and J. Formanek said that tincture of alkanna is better. If a little aluminium salt be added to a soln. of alkanna when the reaction is completed, there is a prominent band at 585.7 and auxiliary bands at 542.5 and 504.8, as shown in Fig. 25.

The **series spectra** of aluminium have been studied by A. Cornu, E. Fues,

F. Paschen, G. D. Shallenberger, and H. Kayser and C. Runge. The last-named represented the two subordinate series of pairs of lines by the formulæ :

FIRST SERIES.

$$10^8\lambda^{-1} = 48308.2 - 156662m^{-2} - 2505331m^{-4}$$

$$10^8\lambda^{-1} = 48420.2 - 156662m^{-2} - 2505331m^{-4}$$

SECOND SERIES.

$$10^8\lambda^{-1} = 48244.5 - 127527m^{-2} - 687819m^{-4}$$

$$10^8\lambda^{-1} = 48356.5 - 127527m^{-2} - 687819m^{-4}$$

The relations of these subordinate pairs of lines with gallium, indium, and thallium are illustrated by Fig. 25. The spectroscopic method of C. Runge and J. Precht for estimating the at. wt. by plotting logarithms of at. wt. with logarithms of the distances of two lines—doublet separation—of the series spectra of related elements, and finding what at. wt. for a particular member of the family of elements lies on a straight line, was shown by W. M. Watts to agree with the aluminium family of elements. The method is illustrated by Fig. 26. L. C. Glaser discussed the relationship between the spectra of beryllium and of aluminium. F. L. Mohler and A. E. Ruark found the **resonance potential** of aluminium vapour to be 0.014 for $2p_2-2p_1$; 3.129 for $2p_2-2s$; and 4.004 for $2p_2-3d_{1,2}$; and for the **ionization potentials**, $2p_2=5.960$; and $2p_1=5.946$. J. E. P. Wagstaff gave $\gamma=7.5 \times 10^{12}$ for the **vibration frequency**. J. M. Eder studied the **actinic value** of the light from burning aluminium.

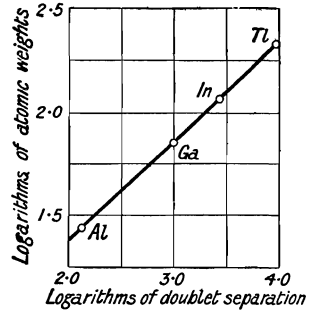

FIG. 26.—Relationship between the Spectral Lines and the Atomic Weights of Al, Ga, In, Tl.

C. Davison and C. H. Kunsman¹⁵ studied the **scattering of electrons** by aluminium. O. Edelmann found that for low voltages a layer of aluminium powder 8 mm. thick is practically a non-conductor; at 360 volts and upwards it conducts; and for the high voltages of frictional electricity, it may be regarded as a good conductor. R. D. Kleeman and W. Fredrickson found that if an electric current be passed through water in which aluminium and carbon are immersed, the aluminium acquires a negative charge.

A. T. Thomson, Lord Kelvin (W. Thomson), and H. St. C. Deville early noted that the **electrical conductivity** of aluminium is high. If the conductivity of copper

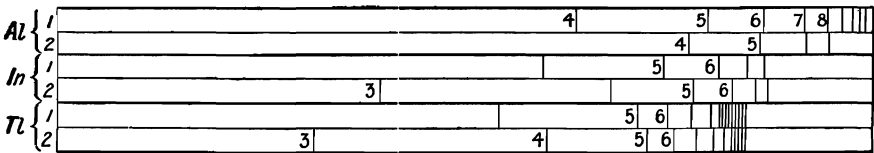

FIG. 27.—Series Spectra of Aluminium, Indium, and Thallium.

be 100, J. C. Poggendorff said that the conductivity of aluminium is 51.3; and if that of silver be 100, A. Matthiessen said that the conductivity of aluminium is 33.76. Measurements were also made by H. Buff, M. Weber, G. K. McGee, L. Lorenz, A. Emo, L. Weiler, A. Stein, J. B. C. Kershaw, A. Arndtsen, W. Jäger and H. Dieselhorst, A. Schulze, etc. The earlier determinations are mainly of historical interest. The deviations in the determinations by different observers are largely due to (i) Variations in the purity of the metal used. Only in 1889 was metal of 99 per cent. purity in commerce. (ii) References to copper or silver as standards require a knowledge of the degree of purity, and the history of these metals. Errors also arise from the lack of accurate standards of resistance as well as imperfect methods of measurement. The general result shows that the electrical conductivity of aluminium is 60.3 per cent. of that of annealed copper. A. Sturm found the conductivity at 0° to be 35.6×10^4 rec. ohms. Working with highly purified aluminium,

G. Niccolai found that the conductivity of aluminium, over a wide range of *temperature*, in reciprocal ohms, when that of mercury at 0° is 1.063×10^4 , is

	-189°	-100°	0°	100°	400°
Conductivity .	156×10^4	65.2×10^4	38.2×10^4	25.9×10^4	12.5×10^4

J. Dewar and J. A. Fleming gave for 99 per cent. commercial aluminium :

	-183°	-78°	0°	92.2°	191.5°
Conductivity .	178.6×10^4	58.7×10^4	39.0×10^4	28.3×10^4	21.6×10^4

J. W. Richards and J. A. Thomson found that annealed aluminium wire has a conductivity very nearly one per cent. greater than unannealed wire. E. F. Northrup measured the **electrical resistance** of 99.67 per cent. aluminium containing 0.16 per cent. silicon, 0.15 per cent. iron, and 0.02 per cent. of copper; and annealed by heating to redness, and cooling in air; and found 2.75 microhms per c.c. at 20°, and this increased linearly with temp. to 3.66 microhms at 100°. A. Somerville gave for the temp. coeff. of the resistance of aluminium wire between 18° and 100°, 0.0038; and at 25°, 0.00334; at 50°, 0.00337; at 100°, 0.00340; at 500°, 0.00350; and at 600°, 0.0060; L. Holborn gave 0.00445 between 0° and 100°. L. Cailletet and E. Bouty gave 0.00388 between -91° and 28°; J. Dewar and J. A. Fleming, 0.00390 between -100° and 0°; and 0.00423 between 0° and 100°. R. Benoit gave $R=R_0(1+0.003876\theta+0.0_51320\theta^2)$. For temp. in the vicinity of atm., the best representative value is 0.0039. J. W. Richards and J. A. Thomson found the best representative values of the resistances of hard and soft aluminium to be 2684 and 2659 per c.c. in C.G.S. units at 0°. W. Broniewsky gave $R=40.1 \times 10^2(1+0.00425\theta)$ for the resistance of hard aluminium at θ° between 0° and 100°; and $R=38.5 \times 10^2(1+0.00410\theta)$ for that of the soft metal. H. Tsutsumi found for the ratio of the conductivity of aluminium in the liquid and in the solid states at its m.p. to be 1.64.

P. W. Bridgman measured the effect of *pressure*, expressed in kgrms. per sq. cm., on the electrical resistance of 99.47 per cent. aluminium containing 0.23 per cent. of iron, 0.24 per cent. of silicon, and 0.06 per cent. of copper. The wire was annealed at 120°. The initial resistance was 18.7 ohms at 0°, and the temp. coeff. 0.00434.

		0°	25°	50°	75°	100°
R	.	1.0000	1.1077	1.2159	1.3245	1.4337
Press. coeff. {	0 kgrm.	-0.0 ₅ 416	-0.0 ₅ 410	-0.0 ₅ 405	-0.0 ₅ 401	-0.0 ₅ 397
	12,000 kgrms.	-0.0 ₅ 347	-0.0 ₅ 349	-0.0 ₅ 351	-0.0 ₅ 354	-0.0 ₅ 356
	(average)	-0.0 ₅ 3815	-0.0 ₅ 3794	-0.0 ₅ 3781	-0.0 ₅ 3772	-0.0 ₅ 3766

The mean press. coeff. is -0.0₅416 at 0°. W. E. Williams obtained 0.0₅37. W. Fraenkel and E. Scheuer studied the effect of ageing on the properties of aluminium alloys. L. Guillet found the electrical resistance of commercial aluminium to be 2.8 micro-ohms per cm. cube, and with less pure metal, the resistance increases. Mechanical treatment increased the resistance slightly; and in tempering, the more rapid the quenching the higher the resistance. A. T. Waterman applied the electronic theory of conduction to aluminium.

Many reports¹⁶ have been made on the uses of aluminium based on its relatively high electrical conductivity. A. L. Williams found that, unlike copper, aluminium does not fuse with mica to form a conducting mixture. O. Jaamaa and Y. E. G. Leinberg measured the resistance of powdered aluminium mixed with marble.

The electrode potential of aluminium has proved very difficult to measure accurately. In alkaline soln. commercial aluminium precipitates zinc, but not in neutral or acid soln.; amalgamated aluminium, however, does precipitate zinc from neutral soln., it vigorously decomposes water, rapidly oxidizes in air, and generally exhibits characters which place it in the electrochemical series directly after magnesium and the metals of the alkaline earths. This is taken to mean that commercial aluminium is in a passive state, otherwise expressed, it is more noble, and less active

than the amalgamated metal. In attempting to measure the electrode potential, B. Neumann¹⁷ obtained the best results with plates of aluminium cleaned with alkali-lye, and then rubbed while hot with mercury. No amalgam is formed, but the mercury mechanically held by the plates helps depolarization. With the cells $\text{Al} | \text{Al}_2(\text{SO}_4)_3$, $\text{Al} | \text{AlCl}_3$, and $\text{Al} | \text{Al}(\text{NO}_3)_3$ against KCl-Hg he found that the electrode potential of aluminium against the normal sulphate is +1.040 volts, the normal chloride +1.015 volts, and the normal nitrate +0.0775 volt. C. R. A. Wright and C. Thompson made some observations with aluminium against copper in a soln. of the sulphate; aluminium against cadmium in soln. of the chloride and bromide; and aluminium against zinc in soln. of the sulphate, chloride, and bromide. As a result, N. T. M. Wilshire provisionally set up the **electrochemical series** of electrolytic potentials:

K	Na	Ba	Sr	Ca	Mg	Al	Mn	Zn . . .
+3.20	+2.82	+2.82	+2.77	+2.56	+2.54-1.49	+1.276	+1.075	+0.770 . . .

R. Müller and F. Hölzl studied the potential of aluminium and amalgamated aluminium in soln. of aluminium chloride, potassium chloride, hydrochloric acid, and sodium hydroxide. In 6.8*N*-HCl, aluminium is more electropositive than the amalgam. The anomalous behaviour under some conditions is attributed to a coating of oxide. F. H. Jeffrey studied the electrolyses of soln. of sodium nitrite, and of potassium oxalate with aluminium electrodes. F. Streintz and F. Fiala studied the polarity of the aluminium cell. N. R. Dhar measured the difference of potential of aluminium against soln. of potassium chloride, and found -0.03 volt for the potential against water. C. M. van Deventer and H. van Lummel found that experiments on amalgamated aluminium also agree with this position for aluminium to the left of zinc. The inactivity of ordinary aluminium in a zinc | acid | aluminium cell is caused by a coating of aluminium oxide which with amalgamated aluminium is much less stable. The fact that this coating is a leaking insulator explains the abnormal electrical behaviour of ordinary aluminium. F. Streintz placed the elements in the order Mg, Zn, Al, Cd, Fe, Sn, Bi, Co, Sb, Cu, Ni, Hg, Pt, and Au. C. F. Burgess and C. Hambüchen found the potentials in volts of aluminium electrodes indicated in Table IV against a normal calomel electrode. They also tried mixtures of ammonium chloride with ammonium fluorides and with potassium fluoride. They infer that of these combinations aluminium fluoride is the best salt to use in connection with aluminium for battery purposes.

TABLE IV.—POTENTIALS OF ALUMINIUM ELECTRODES IN AQUEOUS SOLUTIONS (VOLTS)

Solutions.	Time in hours.					
	0.0	0.5	5.0	21.6	77.9	99.9
N-KCl . . .	0.370	0.226	0.226	0.220	0.232	0.250
AlCl_3 (comm.) dil.	0.382	0.220	0.220	0.211	0.220	0.220
AlCl_3 (pure) dil.	0.361	0.205	0.211	0.199	0.214	0.217
N-HCl . . .	0.406	-0.062	0.211	0.250	0.232	0.232
N- H_2SO_4 . . .	0.400	0.139	0.151	0.169	0.130	0.130
N- HNO_3 . . .	0.220	0.040	0.040	-0.023	-0.032	-0.017
N-NaOH . . .	1.120	0.964	0.889	0.790	0.925	1.090
0.1 <i>N</i> -NaOH . . .	1.147	0.913	0.826	0.220	0.820	0.874
N-HF . . .	0.430	0.397	0.238	0.229	0.370	0.289
N- NH_4Cl . . .	0.367	0.274	0.580	0.235	0.250	0.310
N- NH_4F . . .	0.925	0.595	0.556	0.217	0.400	0.454
N-KF . . .	0.010	-0.053	-0.023	-0.068	-0.026	-0.053
0.1 <i>N</i> -KF . . .	0.223	0.445	0.652	-0.026	0.100	0.040

According to E. Heyn, hardened aluminium is electropositive to the soft or annealed metal by about 0.03 volt in ordinary tap-water. H. Buff tried aluminium

in Bunsen's cell; J. Regnauld, in the cell $\text{Zn} | \text{ZnSO}_4, \text{Al}_2(\text{SO}_4)_3 | \text{Al}$; F. Streintz studied the cells $\text{Zn} | \text{Zn}(\text{NO}_3)_2, \text{Al}(\text{NO}_3)_3 | \text{Al}$, and $\text{Zn} | \text{ZnCl}_2, \text{AlCl}_3 | \text{Al}$. F. Exner measured the potential difference with aluminium and soln. of the halogens, and the halide acids. F. Wöhler studied the cell $\text{Al} | \text{conc. HNO}_3, \text{dil. NaOH} | \text{Al}$, and $\text{Al} | \text{conc. HNO}_3, \text{dil. HCl} | \text{Al}$; and V. Kistjakowsky measured the electrode potential of the cell $\text{Al} | N\text{-Al ions } N\text{-H ions} | \text{H}_2$ on platinum. F. Wöhler and H. Buff studied aluminium anodes in a soln. of sodium, ammonium, ferrous, or manganous chloride; the hydrogen is contaminated with spontaneously inflammable silicon hydride. V. Neyreneuf obtained a similar result on both aluminium electrodes by using an alternating current for the electrolysis. W. Beetz investigated the aluminium anode in dil. sulphuric acid $\text{Zn} | \text{ZnSO}_4, \text{H}_2\text{SO}_4 | \text{Al}$; and A. Coehn, in soln. of aluminium sulphate. H. T. Barnes and co-workers studied the behaviour of aluminium electrodes in water containing dissolved air, oxygen or hydrogen peroxide, and the abnormally high e.m.f. was connected with the presence of free oxygen in the water. The combination $\text{Mg} | \text{Al}_2(\text{SO}_4)_3 | \text{Al}$ gave a considerable current which rose to about 2 volts if hydrogen peroxide was added.

H. Buff, and C. Wheatstone noted that aluminium as anode in nitric acid or other oxidizing soln. becomes **passive** and electronegative. According to E. Newberry, aluminium in alkali-lye becomes passive with a current density of 600 milliampères per sq. cm., giving an anodic overvoltage of 0.95 volt. When the current density is reduced to 400 milliampères per sq. cm. the overvoltage falls to 0.01 volt. Below this, the metal dissolves slowly. It cannot be passivated in sulphuric acid. A very thin, brass-coloured film forms on the surface of the passive metal and prevents the current density from rising above 600 milliampères per sq. cm. with an applied electromotive force of 8.2 volts. The **polarization** of the aluminium electrode has been studied by H. Buff, who attributed it to the formation of a layer of silicon owing to the use of impure aluminium; and W. Beetz, to a layer of suboxide. P. G. Tait, and E. Pirani measured the e.m.f. of the polarization. The attention of E. Ducretet, C. Pollak, L. Graetz, P. Askenasy, F. Kohlrausch, A. Overbeck, A. M. Scott, F. Streintz, A. Naccari, P. Straneo, A. Isenburg, K. E. Guthe, G. C. Schmidt, and A. Bartorelli has also been attracted to this subject. When an aluminium anode is used in passing a current through an aq. soln. and the press. does not exceed 20 volts, the current falls almost to zero, probably owing to the formation of a layer of aluminium hydroxide. A. Smits and co-workers explain the strong positive character of the metal by assuming that primarily the metal surface becomes poor in ions and electrons, *i.e.* the metal at its surface passes into a metalloidal state and then has a low electrical conductivity. The oxygen separation and subsequent oxide formation are then secondary phenomena. They say that the commercial metal is not coated with a film of oxide, and that anodically polarized aluminium has no primary oxide layer. A. Günther-Schulze claims that this is opposed to known facts. R. Müller and F. Hölzl have investigated this subject. U. Sborgi and P. Marchetti studied the anodic behaviour of aluminium in a sat. soln. of lithium chloride in acetone. If a gradually increasing e.m.f. be used, F. Fischer showed that when the voltage attains a certain critical value, the coating on the anode is suddenly pulverized, and the current suddenly increases to 50 times its initial value. The critical voltage depends on the temp. and nature of the electrolyte; if a hollow anode be cooled internally the non-conducting layer will withstand 220 volts, when under ordinary circumstances 20 volts suffice to break it down. E. Lecher found that when the film is formed, the wire is heated, the film is a poor thermal conductor, and its temp. is raised until the soln. in the vicinity of the anode boils. K. Norden analyzed the film obtained when dil. sulphuric acid is the electrolyte and found 69.8 per cent. of alumina, 13.2 per cent. of sulphur trioxide, 14.8 per cent. of water, a few small particles of aluminium, and 2.2 per cent. of silica. The silica is probably derived from the oxidation of the silicon in the aluminium. A mixture of a basic sulphate and aluminium hydroxide, $\text{Al}_2\text{O}(\text{SO}_4)_2 \cdot \text{H}_2\text{O} + 10\text{Al}(\text{OH})_3$, with 9.25 per cent. of aluminium would have the same composition as the analysis.

W. W. Taylor and J. K. H. Inglis found that if a dil. sulphuric acid cell, in which the resistant film has been formed, be treated with potassium chloride, bromide, nitrate, chlorate, or thiocyanate, there is a ready passage of the current; potassium acetate does not act. They assume that the film of aluminium hydroxide which is formed is impermeable to Al^{+++} -ions and SO_4^{--} -ions. They measured the rates of diffusion of these salts in aluminium hydroxide films, and also the effect of these salts on the rate of soln. of the hydroxide in sulphuric acid. Potassium bromide has very little influence on the solubility. A. Heydweiller gave 40 for the **speed of migration** of aluminium ions, and W. Ostwald gave 392 Cals. per valence for the **heat of ionization** of aluminium.

A. Günther-Schulze found that with two uniform aluminium electrodes the electrolysis of a soln. of sodium metaphosphate by an alternating current of 50 cycles furnishes oxygen and hydrogen as though each phase were present alone. No appreciable depolarization of the products of one phase is brought about by those of the next phase. R. D. Kleeman and W. Fredrickson studied the electric charge assumed by an aluminium wire immersed in a liquid. If a cell be constructed with a platinum and an aluminium electrode, with a sulphate, phosphate, or oleate as electrolyte, then during electrolysis with an alternating current, the current only passes in one direction when the aluminium is the cathode. The polarization when aluminium is the anode prevents the current passing. Hence, it is possible to utilize the phenomenon in obtaining a direct from an alternating current. The **aluminium rectifier**, or the **electrolytic valve action** of aluminium has been studied by S. B. Charters, A. Günther-Schulze and co-workers, G. E. Bairstow and R. Mercer, E. Wilson, A. Smits, etc. For the luminescence of the anode during electrolysis with an aluminium anode, *vide supra*. F. Fischer and O. Hähnel, and V. Kohlschütter and co-workers examined the disintegration of aluminium electrodes in the vacuum tube containing different gases. S. Kyropoulos studied the electrodeposition of copper, silver, chromium, and nickel on aluminium.

The values of the **thermoelectric force**, E , of the *aluminium-platinum* couple, determined by W. Jäger and H. Diesselhorst,¹⁸ J. Dewar and J. A. Fleming, K. Noll, W. H. Steele, and E. Wagner, range from +0.37 to +0.41 millivolt per 100°. E. F. Northrup represented the e.m.f. of the *aluminium-copper* couple by $E \times 10^6 = 4.51 - 0.0122\theta^2 + 0.0000433\theta^3$ volts. For the *aluminium-silver* couple, W. M. Latimer found at 100°, dE/dT to be 3.7 microvolts per degree; at 200°, 4.4; at 300°, 5.0; at 400°, 5.9; at 500°, 7.5; and at 600°, 10.1 microvolts per degree. P. G. Tait obtained -0.68 for the *aluminium-lead* couple at 20°, and -0.56 microvolt at 50°; and $dE/d\theta = 0.0039\theta - 0.76$, so that the neutral point is 195°. P. W. Bridgman represents the results with purified and annealed aluminium for the Al-Pb couple: $E \times 10^6 = -0.416\theta + 0.048\theta^2 - 0.041\theta^3$ volts, and with commercial aluminium, $E \times 10^6 = -0.378\theta - 0.045\theta^2 + 0.0594\theta^3$ volts; for the **Peltier effect**, P , respectively with these two couples, $P \times 10^6 = (-0.416 + 0.00016\theta - 0.043\theta^2)(\theta + 273)$ volts, and $P \times 10^6 = (-0.378 - 0.0001\theta + 0.04282\theta^2)(\theta + 273)$ volts; and for the **Thomson effect**, σ , respectively $\sigma \times 10^6 = (0.00016 - 0.046\theta)(\theta + 273)$ volts per degree, and $\sigma \times 10^6 = (-0.0001 + 0.04564\theta)(\theta + 273)$ volts per degree. The differences in the numerical constants are not large. The effects of press. on the thermoelectric force of a couple composed of one branch of uncompressed metal and the other branch of the same metal compressed to the press. indicated in kgrms. per sq. cm.:

	10°	20°	40°	60°	80°	100°	
Press.	2,000 kgrms. .	-0.031	-0.054	-0.073	-0.058	-0.002	+0.101
	4,000 kgrms. .	-0.048	-0.081	-0.104	-0.080	+0.066	+0.294
	8,000 kgrms. .	-0.070	-0.089	-0.046	+0.146	+0.478	+0.929
	12,000 kgrms. .	-0.069	-0.068	+0.130	+0.543	+1.151	+1.962

The cold junctions were kept at 0°. The metal was specially purified. The e.m.f. is given in volts $\times 10^6$. The reversals of sign are not considered to be due to the assumption of two modifications in varying proportions. The curves,

Fig. 28, are all concave upwards. E. Wagner measured the effect of pressures up to 300 kgrms. per sq. cm. and at one temp. interval; and G. Borelius and F. Gunneson, the effect of temp. The Peltier effect $\times 10^6$ in joules per coulomb, with a similar couple made of compressed and uncompressed wires :

	0°	20°	40°	60°	80°	100°
Press. { 2,000 kgrms. .	-0.98	-0.53	-0.03	+0.60	+1.41	+2.50
4,000 kgrms. -	-1.48	-0.76	+0.12	+1.37	+3.10	+5.37
8,000 kgrms. .	-2.43	+0.29	+1.94	+4.40	+6.94	+9.41
12,000 kgrms. .	-2.86	+1.03	+0.468	+8.52	+12.42	+16.90

There is no sign of a maximum or a minimum, and the curvature is slight. The Thomson heat effect in joules $\times 10^8$ per coulomb per degree :

	0°	20°	40°	60°	80°	100°
Press. { 2,000 kgrms. .	+2.4	+2.6	+2.8	+3.0	+4.2	+5.6
4,000 kgrms. .	3.7	4.2	5.2	6.9	9.0	11.7
8,000 kgrms. .	10.8	11.1	11.3	11.2	10.6	9.8
12,000 kgrms. .	20.9	18.8	16.9	16.1	17.0	19.8

The effect is throughout positive; it increases regularly with press. at the lower temp., but at the higher temp. there is a crossing of the curves. The results

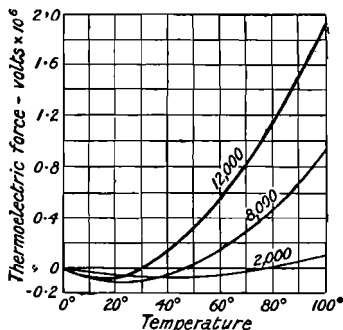

Fig. 28.—Thermo-electric Force of a Couple composed of Compressed and Uncompressed Aluminium.

The relation between the Thomson effect and thermal conductivity with increasing impurity.

H. St. C. Deville,¹⁹ J. C. Poggendorff, and P. Riess both stated that aluminium is very feebly magnetic, but they tested metal prepared by the sodium process which, as J. W. Richards said, almost invariably contains iron. The last-named stated that no signs of polarity could be observed with aluminium containing 0.05 per cent. of iron, the polarity was feeble with metal containing 1.5 per cent. of iron, and decided when two per cent. of iron was present. Aluminium prepared by the electrolytic process has so small a proportion of iron that it can be used for parts of electrical instruments where non-magnetic qualities are required. Aluminium is very feebly paramagnetic. At ordinary temp., J. Königsberger gave $+1.8 \times 10^{-6}$ vol. units for the **magnetic susceptibility**. L. Lombardi gave $+1.7 \times 10^{-6}$ and A. P. Wills, $+1.9 \times 10^{-6}$ vol. units, while K. Honda gave $+0.65 \times 10^{-6}$ mass units at 18°, and $+0.50 \times 10^{-6}$ mass units at 1000° when the metal was liquid. T. Ishiwara found that the magnetic susceptibility is constant up to the m.p., and it then decreases by about 2 per cent. and again remains constant. F. Unwin studied the **Hall effect** with aluminium.

REFERENCES.

- ¹ F. Wöhler, *Pogg. Ann.*, **11**, 146, 1827; *Liebig's Ann.*, **53**, 422, 1845; J. W. Mallet, *Chem. News*, **46**, 178, 1882; M. Faraday, *Phil. Trans.*, **147**, 145, 1857; *Phil. Mag.*, (4), **14**, 512, 1857; C. Karmarsch, *Mitt. Hannover Gewerbever.*, **343**, 1855; H. St. C. Deville, *Compt. Rend.*, **38**, 279, 1854; **39**, 321, 535, 901, 1854; **41**, 1063, 1855; **44**, 19, 1857; *Ann. Chim. Phys.*, (3), **43**, 5, 1855; (3), **46**, 415, 1856; *L'aluminium, ses propriétés, sa fabrication, et ses applications*, Paris, 1859; H. C. H. Carpenter and C. F. Elam, *Proc. Roy. Soc.*, **100**, 350, 1921; S. Kalischer, *Ber.*, **15**, 702, 1882; W. Campbell, *Met.*, **4**, 833, 1907; *Journ. Franklin Inst.*, **154**, 131, 1902; S. Kyropoulos, *Zeit. anorg. Chem.*, **114**, 157, 1920; H. Moissan, *Compt. Rend.*, **116**, 1429, 1893; *Bull. Soc. Chim.*, (3), **11**, 825, 1894; A. W. Wright, *Amer. Journ. Science*, (3), **13**, 49, 1877; (3), **14**, 169, 1877; W. L. Dudley, *Amer. Chem. Journ.*, **14**, 185, 1892; *Chem. News*, **66**, 163, 1892; J. A. Fleming, *Electrician*, **24**, 393, 1890; *Proc. Roy. Inst.*, **13**, 34, 1890; P. Scherrer, *Phys. Zeit.*, **17**, 277, 1916; A. W. Hull, *Phys. Rev.*, (2), **9**, 564, 1917; (2), **10**, 661, 1917; (2), **17**, 571, 1921; A. W. Hull and W. P. Davey, *ib.*, (2), **17**, 579, 1921; F. Kirchner, *Ann. Physik*, (4), **69**, 59, 1922; F. Rinne, *Centr. Min.*, **161**, 1919; H. Mark and K. Weissenberg, *Zeit. Physik*, **14**, 328, 1923; **16**, 314, 1923; F. Körber, *Zeit. Elektrochem.*, **29**, 295, 1923; K. Becker and F. Ebert, *Zeit. Physik*, **16**, 165, 1923; S. Nishikawa and G. Asahara, *ib.*, (2), **15**, 38, 1920; H. Behrens, *Das Mikroskopische Gefüge der Metalle und Legierungen*, Hamburg, 49, 1894; F. Rinne, *Neues Jahrb. Min.*, **ii**, 236, 1894; R. Hooke, *Micrographia*, London, 1665; M. Ettisch, M. Polyani, and K. Weissenberg, *Zeit. phys. Chem.*, **99**, 332, 1921; W. L. Bragg, *Phil. Mag.*, (6), **40**, 169, 1920; *Proc. Phys. Soc.*, **33**, 222, 1921; K. F. Slotte, *Acta Soc. Fennica*, **40**, 3, 1910; J. W. Richards, *Aluminium*, Philadelphia, 59, 1896; C. Davison and C. H. Kunsman, *Phys. Rev.*, (2), **19**, 534, 1922; E. A. Owen and G. D. Preston, *Proc. Phys. Soc.*, **35**, 101, 1923; H. Bohlin, *Ann. Physik*, (4), **61**, 421, 1921; N. Uspensky and S. Konohejewsky, *Zeit. Physik*, **16**, 215, 1923; M. Polanyi, *ib.*, **17**, 47, 1923; C. J. Smithells, *Nature*, **111**, 601, 1923.
- ² R. J. Anderson, *Iron Age*, **101**, 950, 1918; **102**, 148, 1918; *Journ. Inst. Metals*, **19**, 221, 1918; *Met. Chem. Engg.*, **18**, 172, 523, 1918; *Metal Ind.*, **16**, 223, 1919; *Journ. Franklin Inst.*, **187**, 1, 1919; (I am indebted to Mr. R. J. Anderson for Figs. 13-14); G. Tamman, *Nachr. Gott.*, **321**, 1919; W. Campbell, *ib.*, **154**, 131, 1902; *Met.*, **4**, 833, 1907; (I am indebted to Mr. Campbell for Figs. 11-12); W. Rosenhain and J. D. Grogan, *Metal Ind.*, **21**, 343, 1922; E. Wetzel, *Mitt. Inst. Metallforsch.*, **1**, 24, 1922; E. A. Owen and G. D. Preston, *Proc. Phys. Soc.*, **35**, 101, 1923; F. J. Brislée, *Trans. Faraday Soc.*, **9**, 171, 1913; **12**, 62, 1917; D. Hanson and S. L. Archbutt, *Journ. Inst. Metals*, **21**, 291, 1919; H. C. H. Carpenter and L. Taverner, *ib.*, **18**, 115, 1917; H. C. H. Carpenter and C. F. Elam, *Proc. Roy. Soc.*, **100**, 329, 1921; *Journ. Inst. Metals*, **24**, 83, 1920; **25**, 259, 1921; A. G. C. Gwyer, *ib.*, **25**, 281, 1921; W. Rosenhain, *ib.*, **25**, 284, 1921; O. F. Hudson, *ib.*, **13**, 193, 1915; Z. Jeffries, *ib.*, **20**, 109, 1918; D. Hanson, *ib.*, **20**, 141, 1918; R. Seligman and P. Williams, *ib.*, **20**, 162, 1918; E. von Gomperz, *Zeit. Physik*, **8**, 184, 1922; M. Hulot, *Compt. Rend.*, **64**, 1097, 1867; C. Chappell, *Journ. Iron Steel Inst.*, **89**, 460, 1914; C. H. Mathewson and A. Phillips, *Trans. Amer. Inst. Min. Eng.*, **54**, 1, 1916; M. Ettisch, M. Polyani, and K. Weissenberg, *Zeit. phys. Chem.*, **99**, 332, 1921; H. C. H. Carpenter and C. A. Edwards, *Rep. Alloys Research Committee Inst. Mech. Eng.*, **8**, 57, 1907; W. Rosenhain and S. L. Archbutt, *ib.*, **10**, 319, 1912; J. W. Mallet, *Chem. News*, **46**, 178, 1882; E. C. Bain and Z. Jeffries, *Chem. Met. Eng.*, **25**, 775, 1921; Z. Jeffries and R. S. Archer, *ib.*, **26**, 343, 1922; E. Rassow and L. Velde, *Zeit. Metallkunde*, **13**, 557, 1921; E. Rassow, *ib.*, **18**, 358, 1921; E. von Gomperz, *ib.*, **14**, 434, 1922; A. Sauveur, *Proc. Internat. Assoc. Testing Materials*, **2**, 6, 1912; W. E. Ruder, *Trans. Amer. Inst. Min. Eng.*, **47**, 569, 1913; C. Chappell, *Journ. Iron Steel Inst.*, **89**, 460, 1914; K. Bornemann and F. Sauerwald, *Zeit. Metallkunde*, **14**, 145, 1922; J. W. Richards, *Aluminium*, Philadelphia, 1896; *Journ. Franklin Inst.*, **138**, 51, 1894; G. Tamman and Q. A. Mansuri, *Zeit. anorg. Chem.*, **126**, 119, 1923; W. H. Bragg, *Proc. Phys. Soc.*, **33**, 222, 1921.
- ³ F. Madelung and R. Fuchs, *Ann. Physik*, (4), **65**, 293, 1921; F. Wöhler, *Liebig's Ann.*, **45**, 422, 1845; H. Buff, *ib.*, **102**, 276, 1857; T. M. Lowry and R. G. Parker, *Journ. Chem. Soc.*, **107**, 1005, 1915; W. H. Barlow, *B.A. Rep.*, **668**, 1882; R. J. Anderson, *Met. Chem. Engg.*, **18**, 523, 1918; C. H. Hirzel, *Zeit. Pharm.*, **10**, 145, 177, 1858; T. M. Lowry, *Journ. Inst. Metals*, **19**, 259, 1919; C. Karmarsch, *Mitt. Gewerbever. Hannover*, **345**, 1855; M. Täpler, *Wied. Ann.*, **53**, 343, 1894; J. W. Mallet, *Chem. News*, **46**, 178, 1882; S. Bottone, **27**, 215, 1873; J. W. Richards, *Aluminium*, Philadelphia, **62**, 1896; *Journ. Franklin Inst.*, **138**, 51, 1894; H. St. C. Deville, *Ann. Chim. Phys.*, (3), **43**, 11, 1855; J. Okubo, *Science Rep. Tohoku Univ.*, **11**, 455, 1922; H. A. Wilson, *Phys. Rev.*, (2), **20**, 75, 1922; E. Heyn and E. Wetzel, *Mitt. Inst. Metallforsch.*, **1**, 19, 1922; J. D. Edwards and T. A. Moormann, *Metal Ind.*, **18**, 261, 1921; *Chem. Met. Engg.*, **24**, 61, 1921; P. D. Merica, *ib.*, **19**, 135, 200, 329, 587, 625, 729, 780, 1918; K. Bornemann and F. Sauerwald, *Zeit. Metallkunde*, **14**, 145, 1922; F. J. Brislée, *Chem. News*, **105**, 3, 1912; *Trans. Faraday Soc.*, **7**, 221, 1911; **9**, 162, 1913; R. Seligman, *ib.*, **7**, 277, 1911; Z. Jeffries, *ib.*, **18**, 243, 1917; P. Pascal and J. Jouniaux, *Compt. Rend.*, **158**, 414, 1914; M. Hanriot, **155**, 971, 1502, 1912; P. Ludwik, *Zeit. phys. Chem.*, **91**, 232, 1916; *Zeit. Ver. deut. Ing.*, **59**, 657, 1915; A. Kürth, *ib.*, **53**, 85, 210, 1909; F. C. A. H. Lantsberry, *Proc. Birmingham Met. Soc.*, **5**, 101, 1913; G. W. A. Kahlbaum and E. Sturm, *Zeit. anorg. Chem.*, **46**, 217, 1905; J. R. Rydberg, *Zeit. phys. Chem.*, **33**, 353, 1900; F. Auerbach, *Wied. Ann.*, **43**, 61, 1891; **45**, 262, 1892; **53**, 1000, 1894; **58**, 357, 1896; J. W. Mallet, *Chem. News*, **46**, 178, 1882; J. H. Chamberlain, *Journ. Inst.*

Metals, 10, 193, 1913; H. O'Niell, *ib.*, 30, 299, 1923; H. Endo, *ib.*, 30, 121, 1923; H. J. Coe, *ib.*, 30, 309, 1923; *Metal Ind.*, 23, 245, 1923.

⁴ K. Honda and S. Konno, *Phil. Mag.*, (6), 42, 115, 1921; *Science Rep. Tohoku Univ.*, 11, 435, 1922; W. J. Humphreys, *Journ. Chem. Soc.*, 69, 1679, 1896; R. J. Anderson, *Met. Chem. Engg.*, 23, 575, 1920; *Met. Ind.*, 13, 25, 1921; S. W. Smith, *Journ. Inst. Metals*, 12, 168, 1914; 17, 65, 1917; I. Traube, *Ber. deut. phys. Ges.*, 41, 231, 1909; *Zeit. anorg. Chem.*, 34, 413, 1903; J. W. Mallet, *Chem. News*, 46, 178, 1882; A. Masson, *Cosmos*, 10, 423, 1858; *Pogg. Ann.*, 103, 272, 1858; A. Springer, *Trans. Amer. Assoc. Science*, 40, 182, 1891; H. St. C. Deville, *Ann. Chim. Phys.*, (3), 43, 11, 1855; K. Iokibe and S. Sakai, *Phil. Mag.*, (6), 42, 397, 1921; C. E. Guye and S. Mintz, *Arch. Sciences Genève*, (4), 26, 136, 263, 1908; C. E. Guye and V. Fredericks, *ib.*, (4), 29, 49, 157, 261, 1910; C. E. Guye and H. Schapper, *ib.*, (4), 39, 133, 1910; G. Sirovich and A. Cartoceti, *Gazz. Chim. Ital.*, 52, ii, 245, 1922; J. H. Hildebrand, T. R. Hogness, and N. W. Taylor, *Journ. Amer. Chem. Soc.*, 45, 2828, 1923; T. W. Richards, *ib.*, 46, 1419, 1924; D. Saito and K. Hayashi, *Mem. Coll. Eng. Kyoto Univ.*, 2, 83, 1919; O. Bauer and E. Piwowarsky, *Metall. Erz.*, 20, 416, 1923.

⁵ J. W. Mallet, *Chem. News*, 46, 178, 1882; F. Wöhler, *Liebig's Ann.*, 45, 422, 1845; H. St. C. Deville, *Ann. Chim. Phys.*, (3), 43, 11, 1855; M. Degousse, *Répert. Chim. App.*, 435, 488, 1859; J. W. Richards, *Aluminium*, Philadelphia, 75, 1896; C. Karmarsch, *Mitt. Gewerbever. Hannover*, 343, 1855; A. R. von Burg, *Dingler's Journ.*, 151, 286, 1859; A. Granger, *Bull. Soc. Chim.*, (2), 27, 789, 1902; C. Margot, *Arch. Sciences Genève*, (3), 33, 161, 1895; A. Morley and G. A. Tomlinson, *Phil. Mag.*, (6), 11, 380, 1906; W. Sutherland, *ib.*, (5), 32, 31, 215, 524, 1891; W. Rübel, *German Pat.*, D.R.P. 131517, 1901; J. Pionchon, *Compt. Rend.*, 115, 162, 1892; W. C. Heraeus, *Chem. Zig.*, 25, 69, 1901; G. Angenheister, *Ann. Physik.*, (4), 11, 188, 1903; K. R. Koch and C. Dannecker, *ib.*, (4), 47, 197, 1915; C. Schäfer, *ib.*, (4), 5, 220, 1901; *Zeit. Physik*, 17, 152, 1923; W. Voigt, *Wied. Ann.*, 48, 674, 1893; 49, 395, 1893; G. S. Meyer, *ib.*, 59, 668, 1896; K. F. Slotte, *Acta Soc. Fenn.*, 26, 5, 1899; 29, 3, 1900; K. A. Schreiber, *Metal Ind.*, 21, 362, 1922; N. Katzenelsohn, *Ueber den Einfluss der Temperatur auf die Elasticität der Metalle*, Berlin, 1887; F. J. Brislac, *Trans. Faraday Soc.*, 9, 155, 1913; H. Tomlinson, *Phil. Trans.*, 174, 1, 1883; *Proc. Roy. Soc.*, 33, 488, 1885; 40, 343, 1886; 42, 362, 1887; 43, 88, 1887; F. Horton, *ib.*, 73, 334, 1904; 74, 401, 1905; *Phil. Trans.*, 204, A, 1, 1905; Lord Kelvin (W. Thomson), *Encyc. Brit.*, 7, 796, 1877; W. H. Barlow, *B.A. Rep.*, 668, 1882; C. Fabian, *Dingler's Journ.*, 154, 437, 1859; H. L. Dodge, *Phys. Rev.*, (2), 6, 312, 1915; J. Czochralsky, *Zeit. Metallkunde*, 14, 277, 1922; T. D. Merica, *Met. Chem. Engg.*, 19, 135, 200, 329, 587, 625, 729, 780, 1918.

⁶ W. Barlow, *B.A. Rep.*, 668, 1882; C. Karmarsch, *Dingler's Journ.*, 172, 55, 1864; E. A. Hunt, J. W. Langley, and C. M. Hall, *Trans. Amer. Inst. Min. Eng.*, 13, 528, 1890; *Eng. Min. Journ.*, 49, 234, 314, 334, 1890; P. D. Merica, *Chem. Met. Engg.*, 19, 135, 200, 329, 587, 625, 729, 780, 1918; P. Breuil, *La Genie Civil*, 54, 7, 25, 1908; R. Baumann, *Zeit. Ver. deut. Ing.*, 55, 2016, 1911; A. Elmendorf, *Amer. Mach.*, 41, 811, 1914; G. Pisati and G. Saporita-Ricca, *Nuovo Cimento*, (3), 1, 35, 1877; G. Pisati and S. Scichilone, *Rend. Accad. Lincei*, (3), 1, 188, 1877; H. le Chatelier, *Compt. Rend.*, 109, 24, 58, 1889; H. L. Dodge, *Phys. Rev.*, (2), 6, 312, 1915; M. Wählert, *Metall. Erz.*, 18, 298, 1921; P. Ludwik, *Zeit. Ver. deut. Ing.*, 59, 657, 1915; E. Wilson and J. Gavey, *Journ. Inst. Elect. Eng.*, 31, 154, 1902; H. C. H. Carpenter and L. Taverner, *Journ. Inst. Metals*, 13, 115, 1917; A. G. C. Gwyer, *Journ. Birmingham Met. Soc.*, 8, 33, 1920; *Journ. Inst. Metals*, 25, 281, 1921; G. D. Bengough, *ib.*, 7, 123, 1912; P. Cardani, *Phys. Zeit.*, 4, 449, 1903; C. Schäfer, *Ann. Physik*, (4), 5, 220, 1901; F. Haber and R. Geipert, *Zeit. Electrochem.*, 8, 1, 26, 607, 1902; O. Bauer, *Zeit. Metallkunde*, 14, 263, 1922; K. L. Meissner, *ib.*, 14, 434, 1922; C. J. Smithells, *Nature*, 111, 601, 1923; N. Katzenelsohn, *Ueber den Einfluss der Temperatur auf die Elasticität der Metalle*, Berlin, 1887; A. Morley and G. A. Tomlinson, *Phil. Mag.*, (6), 11, 380, 1906; H. Shoji, *Bull. Japan Inst. Phys. Chem. Research*, 2, 334, 1923; Anon., *Metal Ind.*, 23, 411, 1923; H. J. Coe, *ib.*, 23, 245, 1923; *Journ. Inst. Metals*, 30, 309, 1923.

⁷ T. W. Richards, *Journ. Amer. Chem. Soc.*, 37, 470, 1643, 1915; T. W. Richards, F. N. Brink, and F. Bonnet, *ib.*, 31, 154, 1909; L. H. Adams, E. D. Williamson, and J. Johnston, *ib.*, 41, 12, 1919; P. D. Merica, *Chem. Met. Engg.*, 19, 135, 200, 329, 587, 625, 729, 780, 1918; A. Elmendorf, *Amer. Mach.*, 41, 811, 1914; P. W. Bridgman, *Proc. Amer. Acad.*, 44, 255, 1909; 58, 165, 1922; J. W. Buchanan, *Proc. Roy. Soc.*, 73, 296, 1904; C. J. Burton and W. Marshall, *ib.*, 50, 130, 1891; E. Grüneisen, *Ann. Physik*, (4), 25, 849, 1908; (4), 33, 1239, 1910; E. Madelung and R. Fuchs, *ib.*, (4), 65, 293, 1921; S. Lussana, *Nuovo Cimento*, (5), 7, 364, 1904; (5), 19, 187, 1910; E. H. Dix, *Mining Met.*, 160, 31, 1920; H. J. Coe, *Metal Ind.*, 23, 245, 1923; *Journ. Inst. Metals*, 30, 309, 1923.

⁸ H. Fizeau, *Compt. Rend.*, 68, 1125, 1869; H. le Chatelier, *ib.*, 108, 1096, 1889; 128, 1096, 1889; 128, 1444, 1899; K. Scheel, *Zeit. Instr.*, 39, 187, 1919; *Zeit. Physik*, 5, 167, 1921; J. Disch, *ib.*, 5, 173, 1921; W. Dittenberger, *Zeit. Ver. deut. Ing.*, 46, 1532, 1902; F. J. Brislac, *Trans. Faraday Soc.*, 7, 221, 1911; *Chem. News*, 105, 3, 1912; H. L. Dodge, *Phys. Rev.*, (2), 6, 312, 1915; F. Henning, *Ann. Physik*, (4), 22, 631, 1907; E. Grüneisen, *ib.*, (4), 33, 33, 65, 1910; P. Glatzel, *Pogg. Ann.*, 160, 497, 1877; W. Voigt, *Wied. Ann.*, 49, 702, 1893; S. Lussana, *Nuovo Cimento*, (5), 19, 187, 1910; F. C. Calvert and R. Johnson, *Phil. Mag.*, (4), 10, 240, 1855; *Phil. Trans.*, 148, 349, 1858; 149, 831, 1859; *Compt. Rend.*, 47, 1069, 1858; W. H. Souder and P. Hidnert, *Thermal Expansion of Nickel, Monel Metal, Stellite, Stainless Steel, and Aluminium*, Washington, 1922; P. W. Bridgman, *Proc. Amer. Acad.*, 58, 166, 1923.

⁹ S. Konno, *Science Rep. Tohoku Univ.*, 9, 169, 1919; *Phil. Mag.*, (6), 40, 542, 1920; F. C. Calvert and R. Johnson, *ib.*, (4), 10, 240, 1855; *Phil. Trans.*, 148, 349, 1858; 149, 831, 1859; *Compt.*

Rend., 47. 1069, 1858; L. Lorenz, *Wied. Ann.*, 13. 422, 1881; J. W. Richards, *Aluminium*, Philadelphia, 82, 1896; W. Jäger and H. Diesselhorst, *Abhand. Phys. Tech. Reichsanst.*, 8. 269, 1900; C. H. Lees, *Phil. Trans.*, 203. 381, 1908; A. C. Mitchell, *Proc. Roy. Soc. Edin.*, 33. 535, 1887; R. Schott, *Ber. deut. phys. Ges.*, 18. 27, 1916; H. L. Dodge, *Phys. Rev.*, (2), 6. 312, 1915.

¹⁰ H. V. Regnault, *Ann. Chim. Phys.*, (3), 46. 266, 1856; W. Louguinine, *ib.*, (5), 27. 398, 1882; H. St. C. Deville, *L'aluminium*, Paris, 1859; E. H. and E. Griffiths, *Phil. Trans.*, 213. A, 119, 1913; W. A. Tilden, *ib.*, 194. A, 233, 1900; 201. A, 37, 1903; *Journ. Chem. Soc.*, 87. 551, 1905; *Proc. Roy. Soc.*, 71. 220, 1903; H. C. Schmitz, *ib.*, 72. 177, 1903; H. Tomlinson, *ib.*, 38. 494, 1885; J. Pionchon, *Compt. Rend.*, 115. 162, 1892; U. J. J. le Verrier, *ib.*, 114. 907, 1892; C. C. Trowbridge, *Science*, 8. 6, 1898; U. Behn, *Ann. Physik*, (4), 1. 257, 1900; *Wied. Ann.*, 66. 237, 1898; L. Lorenz, *ib.*, 13. 422, 1881; P. Schübel, *Zeit. anorg. Chem.*, 87. 81, 1914; W. Nernst and F. Schwerns, *Sitzber. Akad. Berlin*, 355, 1914; R. Laemmle, *Ann. Physik*, (4), 10. 551, 1905; E. Grüneisen, *ib.*, (4), 33. 65, 1910; W. Bontscheff, *Die Abhängigkeit der spezifischen Wärme des festen Aluminiums von der Temperatur*, Zürich, 1899; P. N. Laschtschenko, *Journ. Russ. Phys. Chem. Soc.*, 46. 311, 1914; W. Nernst and F. A. Lindemann, *Zeit. Elektrochem.*, 17. 817, 1911; A. Niccari, *Atti Accad. Torino*, 23. 107, 1887; W. Jäger and H. Diesselhorst, *Abhand. Phys. Tech. Reichsanst.*, 3. 393, 1900; R. Ariano, *Gazz. Chim. Ital.*, 52. i, 246, 1922; J. W. Mallet, *Chem. News*, 46. 178, 1882; J. W. Richards, *ib.*, 65. 97, 1892; 68. 58, 1893; 69. 82, 1893; *Aluminium*, Philadelphia, 81, 1896; *Journ. Franklin Inst.*, 133. 121, 1892; 156. 116, 178, 1893; F. J. Brislce, *Trans. Faraday Soc.*, 12. 57, 1916; F. Glaser, *Met.*, 1. 103, 121, 1904; H. Kopp, *Liebig's Ann., Suppl.*, 3. 289, 1865; *Phil. Trans.*, 155. 71, 1865; J. A. Harker and H. C. Greenwood, *Rep. Nat. Phys. Lab.*, 54, 1911; P. Nordmeyer, *Ber. deut. phys. Ges.*, 6. 202, 1908; T. W. Richards and F. G. Jackson, *Zeit. phys. Chem.*, 70. 414, 1910; H. Schimpf, *ib.*, 71. 259, 1910; P. Debye, *Ann. Physik*, (4), 39. 752, 1913—*vide* 1. 13, 12 and 16, Fig. 11; G. N. Lewis and G. E. Gibson, *Journ. Amer. Chem. Soc.*, 39. 2554, 1917; G. N. Lewis, G. E. Gibson, and W. M. Latimer, *ib.*, 44. 1008, 1922; W. N. Latimer, *ib.*, 44. 2136, 1922; E. D. Eastman, *ib.*, 45. 80, 1923.

¹¹ H. St. C. Deville, *Ann. Chim. Phys.*, (3), 43. 11, 1855; *L'aluminium*, Paris, 1859; J. W. Mallet, *Chem. News*, 46. 178, 1882; F. Heeren, *Mitt. Gewerbever. Hannover*, 340, 1855; R. Pictet, *Compt. Rend.*, 88. 1317, 1879; H. Gautier, *ib.*, 128. 109, 1896; J. Pionchon, *ib.*, 115. 162, 1892; H. Moissan, *ib.*, 116. 1429, 1893; *Bull. Soc. Chim.*, (3), 11. 825, 1894; C. T. Heycock and F. H. Neville, *Journ. Chem. Soc.*, 67. 160, 1895; S. W. Holman, R. R. Lawrence, and L. Barr, *Phil. Mag.*, (5), 42. 37, 1896; H. L. Callendar, *ib.*, (5), 48. 519, 1899; H. Rose, *Pogg. Ann.*, 56. 152, 1855; P. Rohland, *Tech. Mitt. Bayr. Gewerbever. Nürnberg*, 301, 1906; L. Holborn and A. L. Day, *Ann. Physik*, (4), 2. 505, 1900; A. L. Day and R. B. Sosman, *Amer. Journ. Science*, (4), 29. 93, 1910; W. R. Mott, *Trans. Amer. Electrochem. Soc.*, 34. 555, 1918; R. C. Smith, *Journ. Chem. Soc.*, 123. 2088, 1923; W. G. Duffield, *Phil. Mag.*, (6), 45. 1104, 1923; C. W. Waidner and G. K. Burgess, *Bull. Bur. Standards*, 6. 111, 149, 1910; P. H. van der Weyde, *Trans. Amer. Inst.*, 557, 1861; T. Carnelley, *Ber.*, 12. 441, 1879; *Melting and Boiling Point Tables*, London, 1. 2, 1885; W. Spring, *Bull. Acad. Belg.*, 28. 23, 1894; C. Matignon, *Bull. Soc. Chim.*, (4), 5. 91, 1909; *Monit. Scienc.*, (4), 14. 357, 1900; W. von Bolton, *Zeit. Elektrochem.*, 4. 768, 1908; A. L. Day, R. B. Sosman, and E. T. Allen, *Amer. Journ. Science*, (4), 29. 93, 1910; G. K. Burgess, *Journ. Washington Acad.*, 1. 16, 1911; *Chem. News*, 104. 165, 1911; H. C. Greenwood, *Proc. Roy. Soc.*, 82. A, 396, 1909; 83. A, 483, 1910; H. von Wartenberg, *Zeit. anorg. Chem.*, 56. 320, 1908; P. N. Laschtschenko, *Journ. Russ. Phys. Chem. Soc.*, 45. 311, 1914; J. W. Richards, *Journ. Franklin Inst.*, 187. 581, 1919; L. I. Dana and P. D. Foote, *Trans. Faraday Soc.*, 15. 186, 1920; W. Guertler and M. Pirani, *Zeit. Metallkunde*, 11. 1, 1919; F. Wüst, A. Meuthen, and R. Durrer, *Ver. deut. Ing. Forschung.*, 204, 1918; H. le Chatelier, *Bull. Soc. Enc. Nat. Ind.*, 94. 569, 1895; *Compt. Rend.*, 120. 835, 1050, 1895; J. Johnston, *Journ. Amer. Chem. Soc.*, 34. 788, 1912; R. Pohl and P. Pringsheim, *Ber. deut. phys. Ges.*, 14. 506, 546, 1912.

¹² G. Quincke, *Pogg. Ann. Jubelb.*, 336, 1874; P. Drude, *Wied. Ann.*, 39. 481, 1890; J. Schumann and L. Mach, *Sitzber. Akad. Wien*, 108. 154, 1899; I. C. Gardner, *Astrophys. Journ.*, 45. 1, 1917; E. O. Hulbert, *ib.*, 42. 205, 1915; W. W. Coblenz, *Bull. Bur. Stand.*, 2. 457, 1906; 7. 197, 1911; 9. 281, 1913; J. H. Gladstone, *Proc. Roy. Soc.*, 18. 49, 1870; 60. 140, 1897; *Phil. Trans.*, 159. 13, 1869; M. Faraday, *ib.*, 147. 145, 1857; W. J. Pope, *Journ. Chem. Soc.*, 69. 1530, 1896; S. Procopiu, *Compt. Rend.*, 174. 1170, 1922.

¹³ E. Rutherford and J. Chadwick, *Nature*, 107. 41, 1921; H. R. von Traubenberg, *Zeit. Physik*, 2. 268, 1920; W. H. Bragg, *Phil. Mag.*, (6), 11. 617, 1906; J. Crowther, *ib.*, (6), 12. 379, 1906; C. G. Barkla and C. A. Sadler, *ib.*, (6), 17. 739, 1909; H. G. J. Moseley, *ib.*, (6), 27. 703, 1914; O. W. Richardson and K. T. Compton, *ib.*, (6), 24. 576, 1912; W. Ramsay and J. F. Spencer, *ib.*, (6), 12. 397, 1906; R. A. Millikan and G. Winchester, *ib.*, (6), 14. 188, 1907; J. A. Becker, *Phys. Rev.*, (2), 20. 115, 134, 1922; R. Hamer, *ib.*, (2), 20. 198, 1922; K. Herrmann, *Beiträge zum Hallwacheffekt*, Berlin, 1908; O. von Baeyer and A. Gehrts, *Verh. deut. phys. Ges.*, 12. 870, 1910; O. von Baeyer and A. Tool, *ib.*, 13. 569, 1911; J. C. McLennan and M. L. Clark, *Proc. Roy. Soc.*, 102. A, 398, 1922; A. L. Hughes, *Proc. Cambridge Phil. Soc.*, 16. 167, 1911; V. C. Gyllensköld, *Ark. Mat. Astron. Fysik*, 4. 33, 1908; F. Braun, *Wied. Ann.*, 65. 361, 1898; J. Stark and G. von Wendt, *Ann. Physik*, (4), 38. 669, 690, 1912; E. Fues, *ib.*, (4), 63. 1, 1920; R. Seeliger and D. Thaur, *ib.*, (4), 85. 423, 1921; H. Smith, *Phil. Mag.*, (6), 25. 461, 1913; R. Whiddington, *ib.*, (6), 44. 1116, 1922; G. Scheerer, *ib.*, (6), 44. 793, 1922; E. Beckmann and H. Linder, *Zeit. phys. Chem.*, 82. 641, 1913; T. Tommasina, *Compt. Rend.*, 129. 957, 1899; W. Frese, *Zeit.*

wiss. Phot., **21**, 37, 1921; L. Clémandot, *Compt. Rend.*, **92**, 1107, 1881; S. Procopiu, *ib.*, **174**, 1170, 1922; A. Nodon, *ib.*, **174**, 1061, 1922; H. Bohlin, *Ann. Physik*, (4), **61**, 421, 1921; H. Kulenkampff, *ib.*, (4), **69**, 548, 1922; H. Kulenkampff and E. Wagner, *Phys. Zeit.*, **23**, 503, 1923; W. von Bolton, *Zeit. Elektrochem.*, **9**, 913, 1903; H. N. Morse, *Astrophys. Journ.*, **19**, 167, 1904; E. Kielhauser, *Sitzber. Akad. Wien*, **115**, 1335, 1906; F. Eichberg and L. Kalier, *ib.*, **108**, 212, 1899; W. Mitkewitsch, *Russ. Journ. Elect.*, **17**, 33, 1901; E. Kutsnikoff, *ib.*, **16**, 83, 1900; W. Duane and K. C. Mazumder, *Proc. Nat. Acad. Science*, **8**, 45, 1922; J. Neukirchen, *Zeit. Physik*, **6**, 106, 1921; C. W. Hewlett, *Phys. Rev.*, (2), **17**, 285, 1921; C. E. Taylor, *ib.*, (2), **20**, 709, 1922; W. Duane and K. C. Mazumder, *ib.*, (2), **19**, 536, 1922; A. R. and W. Duane, *ib.*, (2), **20**, 86, 1922; W. J. Russell and F. Soddy, *ib.*, (6), **21**, 130, 1911; E. A. Bichat, *Compt. Rend.*, **138**, 1316, 1904; F. K. Richtmyer, *Phys. Rev.*, (2), **17**, 264, 433, 1921; (2), **18**, 13, 1921; (2), **20**, 87, 1922; E. H. Kurth, *ib.*, (2), **17**, 528, 1921; (2), **17**, 264, 433, 1920; (2), **18**, 99, 473, 1921; K. W. F. Kohlräusch, *Sitzber. Akad. Wien*, **126**, 683, 1917; J. A. Becker, *Phys. Rev.*, (2), **20**, 115, 1923; (2), **22**, 320, 1923; A. E. Hennings and W. H. Kadesch, *ib.*, (2), **8**, 209, 1916; T. S. Sutton, *Phil. Mag.*, (6), **47**, 679, 1915; A. H. Compton, *ib.*, (6), **46**, 897, 1923; F. Horton, U. Andrewes, and A. C. Davies, *ib.*, (6), **46**, 721, 1923; P. A. Ross, *Phys. Rev.*, (2), **22**, 524, 1923; J. R. Nielsen, *ib.*, (2), **22**, 525, 1923; M. Hake, *Zeit. Physik*, **15**, 110, 1923; G. Reoubol, *Compt. Rend.*, **158**, 477, 1914; R. Pohl and P. Pringsheim, *Ber. deut. phys. Ges.*, **14**, 506, 546, 1912; B. Aulenkamp, *Zeit. Physik*, **18**, 70, 1923; H. Fricke, *Phys. Rev.*, (2), **16**, 202, 1920; E. Hjalmar, *Zeit. Physik*, **1**, 439, 1920; *Phil. Mag.*, (6), **41**, 675, 1921; E. Rutherford, *ib.*, (6), **34**, 153, 1917; M. Ishino, *ib.*, (6), **33**, 129, 1917; S. J. Allen and L. M. Alexander, *Phys. Rev.*, (2), **9**, 198, 1917; A. W. Hull and M. Rice, *ib.*, (2), **8**, 326, 1916.

¹⁴ A. Masson, *Ann. Chim. Phys.*, (3), **45**, 385, 1385; H. Deslandres, *ib.*, (6), **15**, 5, 1888; J. Formanek, *Die Qualitative Spektralanalyse*, Berlin, 140, 1905; G. Kirchhoff, *Sitzber. Akad. Berlin*, **63**, 1861; **227**, 1863; G. D. Schallenger, *Phys. Rev.*, (2), **19**, 398, 1922; G. G. Stokes, *Phil. Trans.*, **152**, 599, 1962; S. R. Milner, *ib.*, **209**, 71, 1908; W. A. Miller, *ib.*, **152**, 861, 1862; J. N. Lockyer, *Proc. Roy. Soc.*, **65**, 451, 1899; *Phil. Trans.*, **163**, 253, 639, 1873; W. N. Hartley, *Trans. Roy. Soc. Dublin*, (2), **1**, 231, 1883; (2), **9**, 85, 1908; *Journ. Chem. Soc.*, **41**, 84, 1882; *Phil. Trans.*, **185**, A, 161, 1894; *Proc. Roy. Soc.*, **54**, 5, 1893; *Phil. Trans.*, **175**, 49, 325, 1884; W. N. Hartley and W. E. Adeney, *ib.*, **175**, 63, 1884; A. Schuster and G. A. Hemsalech, *ib.*, **193**, A, 189, 1899; W. N. Hartley and H. Ramage, *Trans. Roy. Soc. Dublin*, (2), **7**, 399, 1901; J. H. Pollok and A. G. G. Leonard, *Proc. Roy. Soc. Dublin*, **11**, 217, 1907; H. Pollok, *ib.*, **13**, 202, 1912; J. N. Lockyer and W. C. Roberts-Austen, *Proc. Roy. Soc.*, **23**, 344, 1875; G. D. Liveing and J. Dewar, *ib.*, **28**, 367, 1879; **32**, 402, 1881; *Phil. Trans.*, **174**, 187, 1883; W. Spottiswoode, *Proc. Roy. Soc.*, **30**, 173, 1880; J. Dewar, *ib.*, **30**, 170, 1880; *Proc. Roy. Inst.*, **9**, 204, 1882; G. D. Liveing, *ib.*, **10**, 245, 1883; W. N. Hartley and H. W. Moss, *Proc. Roy. Soc.*, **79**, A, 242, 1907; **87**, A, 38, 1912; R. Bunsen, *Zeit. anal. Chem.*, **15**, 92, 1876; F. M. Walters, *Scient. Paper Bur. Standards*, **17**, 161, 1921; R. Thalén, *Nova Acta Soc. Upsala*, (3), **6**, 9, 1868; *Om spectralanalys*, Upsala, 1866; A. Willner, *Poqg. Ann.*, **135**, 497, 1871; *Arch. Sciences Genève*, (2), **40**, 305, 1871; R. A. Millikan, *Proc. Nat. Acad. Sciences*, **7**, 289, 1921; R. A. Millikan and I. S. Bowen, *Phys. Rev.*, (2), **23**, **1**, 1924; L. de Boisbaudran, *ib.*, **76**, 833, 1873; *Spectres lumineux*, Paris, 1874; A. J. Angström and R. Thalén, *Nova Acta Soc. Upsala*, (3), **9**, 34, 1875; R. Capron, *Photographed Spectra*, London, 1877; J. Parry and A. E. Tucker, *Engg.*, **27**, 127, 429, 1879; **28**, 141, 1879; H. W. Vogel, *Ber.*, **8**, 1533, 1875; **9**, 1641, 1876; **10**, 157, 1877; F. von Lepel, *ib.*, **9**, 1845, 1876; C. Ciamician, *Sitzber. Akad. Wien*, **82**, 425, 1880; F. Exner and E. Haschek, *ib.*, **106**, 54, 1897; J. M. Eder, *ib.*, **112**, 249, 1903; *Denks. Akad. Wien*, **60**, 1, 1903; J. M. Eder and E. Valenta, *ib.*, **68**, 531, 1899; V. Schumann, *Anz. Akad. Wien*, **24**, 1895; *Chem. News*, **71**, 118, 1895; J. L. Schön, *Wied. Ann.*, **9**, 483, 1880; H. Kayser and C. Runge, *ib.*, **48**, 126, 1393; C. Runge, *ib.*, **55**, 44, 1895; A. Cornu, *Journ. Phys.*, (1), **10**, 425, 1881; (2), **5**, 93, 1886; *Compt. Rend.*, **73**, 332, 1871; **100**, 1181, 1885; M. Guichard and P. R. Jourdain, *ib.*, **155**, 160, 1912; H. Becquerel, *ib.*, **97**, 71, 1883; **99**, 374, 1884; S. Procopiu, *ib.*, **176**, 385, 1923; A. de Gramont, *ib.*, **126**, 1513, 1898; **127**, 866, 1898; **144**, 1101, 1907; **151**, 308, 1910; **157**, 1364, 1913; **170**, 31, 1920; **159**, 5, 1914; L. and E. Bloch, *ib.*, **158**, 1416, 1914; *Bull. Soc. Min.*, **21**, 94, 1898; *Bull. Soc. Chim.*, (3), **17**, 774, 1897; *Analyse spectrale directe des minéraux*, Paris, 1895; H. Geisler, *Zur anomalen Dispersion des Lichtes in Metalldämpfen*, Bonn, 1909; *Zeit. wiss. Phot.*, **7**, 89, 1909; R. Grünter, *ib.*, **13**, **1**, 1913; J. M. Eder, *ib.*, **13**, **20**, 1913; **14**, 137, 1914; W. Huppers, *ib.*, **13**, **46**, 1913; H. Finger, *ib.*, **7**, 329, 1909; *Ein Beitrag zur Kenntniss des Einflusses des Mediums auf die Linien in Funkenspectren*, Münster, 1909; J. S. Ames, *Phil. Mag.*, (5), **30**, 33, 1890; G. A. Hemsalech, *ib.*, (5), **44**, 289, 1897; *Journ. Phys.*, (3), **8**, 652, 1899; *Ann. Physik*, (4), **2**, 331, 1900; L. C. Glaser, *ib.*, (4), **68**, 73, 1922; L. Arons, *ib.*, (4), **1**, 700, 1900; G. Berndt, *ib.*, (4), **4**, 788, 1901; H. Koenig, *ib.*, (4), **9**, 742, 1902; F. Paschen, *ib.*, (4), **29**, 625, 1909; J. Stark, R. Künzer, G. Wendt, and H. Kirschbaum, *ib.*, (4), **42**, 241, 1913; J. Stark, R. Künzer, and G. Wendt, *Sitzber. Akad. Berlin*, **430**, 1913; J. Stark and R. Künzer, *Ann. Physik*, (4), **45**, 29, 1914; J. C. McLennan, J. F. T. Young, and H. J. C. Iretton, *Trans. Roy. Soc. Canada*, **13**, **7**, 1919; B. Hasselberg, *Astrophys. Journ.*, **11**, 793, 1892; W. J. Humphreys, *ib.*, **6**, 169, 1897; **26**, 18, 1907; H. M. Reese, *ib.*, **12**, 120, 1900; O. H. Basquin, *ib.*, **14**, **1**, 1901; A. S. King, *ib.*, **19**, 225, 1904; **21**, 236, 1905; *Ann. Physik*, (4), **16**, 360, 1905; C. Ramsauer and F. Wolf, *ib.*, (4), **66**, 273, 1921; W. W. Coblentz, *Investigations of Infra-red Spectra*, Washington, **4**, 97, 1906; H. Crew and J. Spence, *Astrophys. Journ.*, **22**, 199, 1905; C. Runge and J. Precht, *Phys. Zeit.*, **4**, 285, 1903; *Phil. Mag.*, (6), **5**, 476, 1903; W. M. Watts,

ib., (6), 8. 279, 1906; W. Kasperowicz, *Zeit. Elektrochem.*, 27. 24, 1920; F. McClean, *Month. Notices Astron. Soc.*, 52. 22, 1891; E. Demargay, *Spectres Electriques*, Paris, 1895; W. H. Fulweiler and J. Barnes, *Journ. Franklin Inst.*, 194. 83, 1922; A. Hörnli, *Jahrb. Rad. Elektron.*, 18. 297, 1921; W. Grotrian, *Zeit. Physik*, 12. 218, 1912; E. Fues, ib., 18. 211, 1913; H. A. Rowland, *Preliminary Table of Solar Spectrum Wave-lengths*, Chicago, 1898; T. Tommasina, *Nuovo Cimento*, (4), 11. 47, 1900; F. Exner and E. Haschek, *Tabellen der Funkenlinien*, Wien, 1902; *Tabellen der Bogenspectra*, Wien, 1904; *Die Spektren der Elemente bei normalen Druck*, Wien, 1911; J. Lauwartz, *Ueber Messungen und Gesetzmäßigkeiten in Bandenspectrum der Thonerde*, Bonn, 1903; *Zeit. wiss. Phot.*, 1. 160, 1903; J. Steinhausen, ib., 3. 45, 1905; *Ueber "enhanced lines"*, Bonn, 1904; L. Pucciantini, *Mem. Soc. Spettro. Ital.*, 33. 133, 1904; H. Morris-Adirey, *Mem. Manchester Lit. Phil. Soc.*, 49. 3, 1904; A. Hagenbach and H. Konen, *Atlas der Emissionspectra*, Jena, 1905; W. W. Coblentz, *Phys. Rev.*, (1), 22. 1, 1906; *Phys. Zeit.*, 9. 60, 1908; V. C. Gylensköld, *Ark. Mat. Astron. Fysik*, 4. 33, 1908; H. Kayser, *Handbuch der Spectroscopie*, Leipzig, 5. 94, 1910; J. C. McLennan, J. F. T. Young, and H. J. C. Ireton, *Proc. Roy. Soc.*, 98. 95, 1920; J. E. P. Wagstaff, *Phil. Mag.*, (6), 47. 66, 1924; R. Seeliger and D. Thær, *Ann. Physik*, (4), 85. 423, 1921; F. Brassack, *Abhand. Nat. Ges. Halle*, 9. 1, 1864; F. L. Mohler and A. E. Ruark, *Journ. Amer. Opt. Soc.*, 7. 819, 1923; G. D. Shallenberger, *Phys. Rev.*, (2), 19. 398, 1922; F. Paschen, *Ann. Physik*, (4), 71. 142, 537, 1923.

¹⁶ Lord Kelvin (W. Thomson), *B. A. Rep.*, 20, 1855; A. T. Thomson, *Elements of Materia Medica and Therapeutics*, London, 1. 139, 1832; *Phil. Mag.*, (3), 7. 441, 1835; J. Dewar and J. A. Fleming, ib., (5), 36. 271, 1893; W. E. Williams, ib., (6), 13. 635, 1907; H. St. C. Deville, *Ann. Chim. Phys.*, (3), 43. 11, 1855; W. Froniewsky, ib., (8), 25. 5, 1912; J. C. Poggendorff, *Pogg. Ann.*, 97. 643, 1856; A. Matthiessen, ib., 103. 428, 1858; A. Matthiessen and M. von Bose, ib., 115. 353, 1862; A. Arrdtzen, ib., 104. 1, 1858; H. Buff, *Liebig's Ann.*, 102. 273, 1857; G. K. McGee, *Trans. Amer. Inst. Min. Eng.*, 18. 528, 1890; C. Davison and C. H. Kunsman, *Phys. Rev.*, (2), 19. 534, 1922; A. Schulze, *Zeit. Metallkunde*, 15. 155, 1923; R. Benoit, *Compt. Rend.*, 76. 342, 1873; L. Caillaet and E. Bouty, ib., 100. 1188, 1885; L. Weiler, *Zentr. Ztg. Opt. Mech.*, 6. 28, 1885; J. W. Richards and J. A. Thomson, *Chem. News*, 75. 217, 1897; *Journ. Franklin Inst.*, 143. 195, 1897; L. Holborn, *Ann. Physik*, (4), 59. 14, 1919; *Zeit. Physik*, 8. 58, 1922; G. Nicolai, *Atti Accad. Lincei*, (5), 16. 757, 1907; W. Fraenkel and E. Scheuer, *Zeit. Metallkunde*, 12. 427, 1920; L. Lorenz, *Wied. Ann.*, 13. 422, 582, 1881; A. Stein, *Phys. Zeit.*, 13. 287, 1912; J. B. C. Kershaw, *Journ. Inst. Elect. Eng.*, 30. 348, 1901; O. Edelmann, *Chem. Ztg.*, 30. 925, 951, 1906; E. F. Northrup, *Elect. World*, 82. 598, 1898; *Met. Chem. Engg.*, 15. 193, 1917; W. Jäger and H. Diesselhorst, *Abhand. Phys. Tech. Reichsanst.*, 3. 269, 1900; A. Somerville, *Phys. Rev.*, (1), 31. 261, 1910; (1), 33. 77, 1911; P. W. Bridgman, *Proc. Amer. Acad.*, 52. 573, 1917; 58. 151, 1923; *Phys. Rev.*, (2), 9. 269, 1917; (2), 17. 161, 1921; A. Emo, *Atti Ist. Veneto*, (6), 2. 1163, 1884; A. Sturm, *Der spezifische elektrische Widerstand und dessen Temperaturkoeffizient bei Aluminium-Zink-Legierungen von verschiedenem Mischungsverhältnis*, Rostock, 1904; M. Weber, *Beziehungen zwischen der elektrischen Leitfähigkeit und ihrem Temperaturcoefficienten bei Strukturänderungen, untersucht an einigen Aluminium Legierungen*, Berlin, 1891; H. Tsutsumi, *Science Rep. Tohoku Univ.*, 7. 93, 1918; L. Guillet, *Compt. Rend.*, 177. 963, 1923; A. T. Waterman, *Phys. Rev.*, (2), 22. 259, 1923; R. D. Kleeman and W. Fredrickson, ib., (2), 22. 134, 1923.

¹⁶ D. Wyssling, *Bull. Soc. Suisse Electriciens*, 7. 121, 1916; E. V. Pannell, *Canadian Elect. News*, 15. 46, 1913; H. M. Hobart, *Elect. Times*, 37. 356, 1910; A. E. Hunt, *Eng.*, 86. 81, 1898; F. Krull, *Zeit. angew. Chem.*, 17. 1058, 1904; H. W. Stillwell, *Zeit. Ver. deut. Ing.*, 47. 1826, 1903; V. del Burno, *Atti Assoc. Electro. Ital.*, 13. 261, 1909; J. B. C. Kershaw, *Elect. Rev.*, 43. 470, 1903; E. Guillaume, *Eclair. Elect.*, 22. 321, 1900; F. A. C. Perrine and F. G. Baum, *Trans. Amer. Inst. Elect. Eng.*, 17. 345, 1900; A. L. Williams, *Phil. Mag.*, (6), 40. 281, 1920; O. Jaamaa and Y. E. G. Leinberg, *Soc. Scient. Fenn. Comment.*, 1. 21, 1922.

¹⁷ B. Neuman, *Zeit. phys. Chem.*, 13. 196, 1893; N. T. M. Wilmore, ib., 85. 291, 1900; J. Regnaud, *Ann. Chim. Phys.*, (3), 44. 453, 1855; *Compt. Rend.*, 43. 47, 1856; C. Pollak, ib., 124. 1443, 1897; V. Kistiakowsky, *Zeit. phys. Chem.*, 70. 206, 1910; C. R. A. Wright and C. Thompson, *Phil. Mag.*, (5), 17. 288, 1884; (5), 19. 1, 1885; W. W. Taylor and J. K. H. Inglis, ib., (6), 5. 301, 1903; C. Wheatstone, ib., (4), 10. 143, 1855; P. G. Tait, ib., (4), 38. 243, 1869; *Proc. Roy. Soc. Edin.*, 69. 579, 1868; C. F. Burgess and C. Hambüchen, *Electrochem. Ind.*, 1. 165, 1903; C. M. van Deventer and H. van Lummel, *Chem. Weekb.*, 4. 771, 1907; 5. 359, 1908; J. J. van Laar, ib., 5. 124, 1908; E. Wilson, *Proc. Roy. Soc.*, 63. 329, 1898; H. Buff, *Liebig's Ann.*, 102. 265, 1857; H. Buff and F. Wöhler, ib., 103. 218, 1857; L. Malavasi, *Atti Accad. Modena*, 18. 3, 1878; *Vertheilung des elektrischen Potentials in den Säulen*, Modena, 1882; F. Wöhler, *Nachr. Gott.*, 441, 1880; E. Lecher, *Sitzber. Akad. Wien*, 107. 739, 1898; F. Streintz and F. Fiala, *Phys. Zeit.*, 22. 141, 1921; F. Streintz, ib., 77. 21, 1878; *Phys. Zeit.*, 21. 477, 1920; *Wied. Ann.*, 34. 751, 1888; A. Overbeck, ib., 19. 625, 1883; A. M. Scott, ib., 87. 388, 1892; L. Graetz, ib., 62. 323, 1897; *Zeit. Elektrochem.*, 4. 67, 1897; P. Askenasy, ib., 4. 70, 1897; K. Norden, ib., 4. 159, 188, 1899; A. Isenburg, ib., 9. 278, 1903; A. Günther-Schulze, ib., 20. 307, 592, 1914; 27. 293, 579, 1921; *Phys. Zeit.*, 22. 146, 1921; *Zeit. Elektrochem.*, 28. 126, 545, 1922; *Zeit. Physik*, 9. 197, 225, 1922; F. Fischer, ib., 9. 507, 1903; *Zeit. phys. Chem.*, 48. 177, 1904; *Zeit. anorg. Chem.*, 43. 341, 1905; A. Günther-Schulze and P. Alberti, *Phys. Zeit.*, 23. 188, 1922; R. D. Kleeman and W. Fredrickson, *Phys. Rev.*, (2), 19. 409, 1923; E. Ducretet, *Journ. Phys.*, (1), 4. 84, 1875; V. Neyreneuf, ib., (2), 8. 250, 1888; A. Naccari, *Atti Accad. Torino*, 86. 790, 1901; P. Straneo, *L'ellettrica*, 20. 627, 1901; A. Bartorelli, *Phys. Zeit.*, 2. 469, 1901; K. E. Guthe, *Phys. Rev.*, (1), 15. 327, 1902;

S. B. Charters, *Journ. Phys. Chem.*, **9**, 110, 1905; G. E. Bairstow, *Trans. Faraday Soc.*, **8**, 232, 1912; G. E. Bairstow and R. Mercer, *ib.*, **7**, 1, 1911; S. Kyropoulos, *Zeit. anorg. Chem.*, **119**, 299, 1921; R. Müller and F. Hölzl, *ib.*, **121**, 103, 1921; R. Müller, E. Heyn and O. Bauer, *Mitt. Materialprüfungsamtes*, **29**, 2, 1911; H. T. Barnes and H. M. Tory, *Trans. Amer. Electrochem. Soc.*, **3**, 95, 1903; H. T. Barnes and G. H. Cole, *ib.*, **12**, 54, 1907; H. T. Barnes and G. W. Sheerer, *Journ. Phys. Chem.*, **12**, 155, 468, 1908; A. Smits, *Zeit. Elektrochem.*, **27**, 523, 1921; **28**, 543, 1922; *Ann. Physik*, (4), **65**, 223, 1921; *Versl. Acad. Amsterdam*, **28**, 930, 1920; A. Smits and A. H. W. Aten, *ib.*, **22**, 1138, 1914; A. Smits and C. J. de Gruyter, *Proc. Amsterdam Acad.*, **24**, 86, 1921; A. Smits, *ib.*, **22**, 876, 1920; F. H. Jeffrey, *Trans. Faraday Soc.*, **19**, 52, 1923; A. G. Ramsay, *Journ. Inst. Elect. Eng.*, **57**, 306, 1920; U. Sborgi and P. Marchetti, *Nuovo Cimento*, (6), **22**, 151, 1921; F. Exner, *Monatsh.*, **12**, 276, 1891; F. Kohlrausch, *Pogg. Ann. Jubelb.*, 290, 1874; *Pogg. Ann.*, **148**, 143, 1873; W. Beetz, *ib.*, **127**, 45, 1896; **156**, 456, 1875; *Wied. Ann.*, **2**, 94, 1877; E. Pirani, *ib.*, **21**, 64, 1884; A. Coehn, *Electrolytische Untersuchungen*, Erlangen, 1888; A. Coehn and Y. Osaka, *Zeit. anorg. Chem.*, **34**, 86, 1903; N. R. Dhar, *Zeit. anorg. Chem.*, **118**, 75, 1921; **119**, 202, 1921; J. Regnaud, *Ann. Chim. Phys.*, (3), **44**, 453, 1855; *Compt. Rend.*, **43**, 47, 1856; G. C. Schmidt, *Zeit. phys. Chem.*, **106**, 105, 1923; E. Newbery, *Journ. Chem. Soc.*, **109**, 1051, 1916; A. Heydweiller, *Zeit. phys. Chem.*, **89**, 281, 1915; W. Ostwald, *ib.*, **11**, 501, 1893; F. Fischer and O. Hähnel, *Zeit. Elektrochem.*, **14**, 366, 433, 1908; V. Kohlschütter and T. Goldschmidt, *ib.*, **14**, 221, 1908; V. Kohlschütter, *ib.*, **12**, 869, 1906; **14**, 437, 1908; V. Kohlschütter and R. Müller, *ib.*, **12**, 365, 1906.

¹⁸ W. Jäger and H. Diesselhorst, *Abhand. Phys. Tech. Reichsanst.*, **3**, 269, 1890; J. Dewar and J. A. Fleming, *Phil. Mag.*, (5), **40**, 95, 1895; W. H. Steele, *ib.*, (5), **87**, 218, 1894; K. Noll, *Wied. Ann.*, **53**, 874, 1894; F. Wagner, *Ann. Physik*, (4), **27**, 955, 1908; G. Borelius and F. Gunnerson, *ib.*, (4), **65**, 520, 1921; E. F. Northrup, *Met. Chem. Engg.*, **15**, 193, 1917; P. G. Tait, *Trans. Roy. Soc. Edin.*, **27**, 125, 1872; P. W. Bridgman, *Proc. Amer. Acad.*, **53**, 269, 1918; Lord Kelvin (W. Thomson), *B.A. Rep.*, **20**, 1855; E. H. Hall, *Proc. Nat. Acad. Science*, **6**, 613, 1920; W. M. Latimer, *Journ. Amer. Chem. Soc.*, **44**, 2136, 1922.

¹⁹ J. Königsberger, *Wied. Ann.*, **66**, 698, 1898; A. P. Wills, *Phil. Mag.*, (5), **45**, 432, 1898; K. Honda, *Ann. Physik*, (4), **22**, 1027, 1910; M. Owen, *ib.*, (4), **37**, 659, 1912; *Proc. Acad. Amsterdam*, **14**, 637, 1911; L. Lombardi, *Mem. Accad. Torino*, (2), **47**, 1, 1897; T. Ishiwara, *Science Rep. Tohoku Univ.*, **9**, 233, 1920; H. St. C. Deville, *Ann. Chim. Phys.*, (3), **43**, 11, 1855; J. C. Poggendorff, *Pogg. Ann.*, **97**, 643, 1856; P. Riess, *ib.*, **73**, 618, 1848; F. Unwin, *Proc. Roy. Soc. Edin.*, **34**, 208, 1914; J. W. Richards, *Aluminium*, Philadelphia, 67, 1896.

§ 5. The Chemical Properties of Aluminium

J. B. A. Dumas¹ found that when aluminium is gradually heated in vacuo, while the pump is active, **occluded gas** is released somewhat suddenly towards a red heat; 200 grms. of metal occupying 80 c.c. gave 89.5 c.c. of gas at 17° and 755 mm. press. The gas contained 1.5 c.c. of **carbon dioxide**, and 88 c.c. of **hydrogen**—carbon monoxide, nitrogen, and oxygen were absent. Gas is evolved when cathode rays are generated in evacuated tubes with aluminium electrodes. This subject has been studied by R. von Hirsch and F. Soddy. E. Cohnstädt said that the gas given off by aluminium electrodes is water vapour and not hydrogen, and added that glass and aluminium surfaces will retain water even when heated to 500° or dried over phosphorus pentoxide. J. Czochralsky studied the absorption of nitrogen, air, sulphur dioxide, oxygen, carbon monoxide and dioxide, hydrogen, and coal gas by aluminium. He found that molten aluminium does not begin to dissolve any of the common gases until about 900°, but at higher temp., considerable amounts may be dissolved, and retained in the form of minute blowholes in the solid metal. The following table shows the amounts of gas, in volumes per cent., dissolved at the high temp. and retained by the solid metal at ordinary temp.:

	N ₂	O ₂	Air	CO	CO ₂	SO ₂	H ₂	Town gas
1200°	0.4	2.5	1.3	1.3	2.5	5.4	6.5	5.5
1500°	3	12	6	8	12	7	15	12.5

In the case of the first six gases very small amounts of the absorbed gases combine with the metal with formation of aluminium nitride, oxide, carbide or sulphide, and the metal structure shows characteristic inclusions of these constituents. The mechanical properties of the metal after treatment with any of the above gases showed practically no change, but in all cases blisters and splitting of the edges

occurred during rolling. The most suitable temp. for rolling metal containing many gas-pores was found to be between 300° and 350°. G. Neumann and F. Streintz found that sheet aluminium absorbed 1.1 to 2.7 vols. of hydrogen at n.p.t.; the gas is absorbed when hydrogen is made the cathode in an electrolytic cell. H. G. Deming and B. C. Hendricks found aluminium to be impermeable to hydrogen at temp. up to 550°. E. Duter said that an *aluminium hydride* is formed during the electrolysis of distilled water with an aluminium cathode, and added that it is immediately decomposed by water. M. Guichard and P. R. Jourdain measured the gases evolved when old and new aluminium is heated in *vacuo*. The gas comes partly from the surface, and partly from the body of the metal. The proportion of carbon dioxide in the gases exhibits the most marked variation. A. Berliner found that at 440°, aluminium exercises no perceptible influence on the union of hydrogen and oxygen, due, he suggests, to the fact that aluminium occludes no appreciable quantity of hydrogen. F. Paneth and co-workers could find no evidence of the formation of an aluminium hydride.

Both F. Wöhler,² and H. St. C. Deville agree that "moist or dry air has no action on aluminium," and G. Werther said that he has kept sheet aluminium for many years exposed to air without being able to detect the formation of any oxide; but E. von Bibra found an impure sample was covered with oxide after being exposed to the air for some months. G. H. Bailey found the corrosive action of air or oxygen at ordinary temp. is negligibly small. H. St. C. Deville was enthusiastically emphatic on the resistance of aluminium to oxidation in air and oxygen:

Aluminium may be melted in air with impunity, and therefore air or oxygen cannot sensibly affect it. The metal resisted oxidation at the highest temp. of a cupel furnace. When the metal button is covered with a layer of oxide which tarnishes it, the expansion of the melted metal causes small branches to shoot from its surface, which are very brilliant and do not lose their lustre in spite of the oxidizing atm. F. Wöhler has also observed this property on trying to melt the metal with a blowpipe. E. M. Péligot has profited by it to cupel aluminium. I have seen buttons of impure metal cupelled with lead and become very malleable. With pure aluminium the resistance of the metal to direct oxidation is so considerable that at the m.p. of platinum it is hardly appreciably touched, and does not lose its lustre. It is well known that the more oxidizable metals take this property away from it; but silicon itself, which is much less oxidizable, when alloyed with it makes it burn with great brilliancy, because aluminium silicide is formed.

These statements give a wrong impression, and illustrate the danger of presenting a case like a skilled advocate before a jury, exalting the importance of evidence for one side, and belittling the evidence on the other. The proper attitude, of course, is to present the case as an impartial judge weighing fairly the evidence presented by both sides. H. St. C. Deville's position will be clear from the historical notes. J. W. Mallet said that pure aluminium is more readily oxidized in air than is the impure metal. In air, commercial aluminium gradually becomes coated with a thin film of oxide so that the metal soon loses its brilliancy and acquires a matte surface which gives it the appearance of old zinc. The film protects the metal from further oxidation. Air and rain-water also corrode aluminium. A. Liversidge said that "the surface becomes rough and speckled with grey spots mixed with larger light grey patches; it also becomes rough to the touch, the grey patches can be seen to project above the surface, and under the microscope, they present a blistered appearance. This incrustation is held tenaciously, and does not wash off, neither is it removed on rubbing with a cloth." The coating can, however, be removed by washing with dil. acid. When aluminium is melted in air, it acquires a surface film of oxide which restrains the free flow of the metal; this film also protects the melted metal from further oxidation. As H. Moissan showed, aluminium burns with a vivid incandescence when heated in the electric furnace, although here it is possible that the metal first volatilizes and it is the vapour which burns. Hence, a white cloud of alumina issues from high temp. electric furnaces in which aluminium is present.

H. Buff observes that fine pulverulent aluminium is soon oxidized by exposure

to air. N. B. Pilling and R. E. Bedworth found that at 600° there are two distinct stages in the oxidation of aluminium. A thin layer of oxide is slowly formed: the process occupies 60–80 days. Oxidation then ceases because of the complete impenetrability of the film. The weight of the oxide film is 0.1 mgrm. per sq. cm., and it would be 0.00002 cm. thick if of normal density. F. Wöhler, and M. Degousse showed that aluminium-leaf burns brightly in air, and in oxygen, yielding a brilliant bluish light and forming alumina—C. Matignon found that in air some aluminium nitride is formed during the combustion. A. Duboin said some aluminium suboxide, AlO , is formed when a mixture of a mol of alumina and four gram-atoms of aluminium is ignited. According to W. Muthmann and K. Kraft, the ignition temp. of aluminium in oxygen is 580°. Aluminium foil and wire also burn in oxygen. According to F. Wöhler, aluminium foil is best ignited in oxygen by wrapping it round a splinter of wood. A. M. Villon showed that finely powdered aluminium burns brilliantly when projected into a flame, and has largely displaced magnesium powder for flash-light mixtures because it is cheaper; it gives almost as strong an actinic light, and does not give such unpleasant smoke or fumes—A. M. Villon recommended a mixture of 100 parts of aluminium, 25 parts of lycopodium, and 5 parts of ammonium nitrate. J. M. Eder has studied the actinic power of the light.

The aluminium dust of commerce is finely divided aluminium metal with a coating of oil, usually stearine or some similar material. This coating evidently serves to prevent oxidation in air and to protect the metal particles from the action of moisture, as it is stated that the product loses its lustre if no oil be added. Aluminium dust is so light that it is easily blown about a room, and, as the workmen seldom take precautions to prevent this, the workrooms are soon coated with dust. According to A. Leighton, experiments do not show the exact conditions under which an ignition of the aluminium dust is obtained, they do show that it may ignite at temp. even lower than those necessary for the ignition of coal dust; but more heat is needed to ignite aluminium dust. Hence precautions should be taken to prevent loose aluminium powder from being blown into the air.

In making aluminium powder, the metal is pounded in stamp-mills, sorted according to size of grain, and polished in polishing mills. Very fine sorts are subjected to a rubbing treatment after sifting and before polishing, by grinding the metal dust with a soln. of gum arabic. Serious explosions have occurred in the sifting and polishing machines, due apparently to the ignition of dust by accidental sparks in the machinery, so that, in order to minimize the danger, rules for use in factories making aluminium-bronze powders have been formulated by *Der Sueddeutsche edel- und unedelmetall Berufsgenossenschaft für die Herstellung von Aluminium in Pulver*. Ordinary aluminium bronze powders do not flash when blown through a flame, but the finer kinds can be ignited in this way or even by a lighted match. H. Stockmeier states that in addition to the danger arising from accidental sparking from machinery starting the oxidation of the powder as a dust explosion, there is also a risk due to the production of hydrogen by the action of water on aluminium dust, e.g. in washing out the gum—the action begins at 30°, for it is not appreciable at 20°; and R. J. Zink suggested that the action of water on the small amount of aluminium carbide in aluminium produces inflammable hydrocarbons, thus 0.1 per cent. of aluminium carbide in 10 kgrms. of aluminium could give 4.8 litres of hydrogen. The subject has also been discussed by O. Edelmann, M. M. Richter, M. Bamberger and H. von Jüptner, O. Bauer, etc.

According to E. Kohn-Abrest, aluminium powder is not oxidized by eight days' heating in air at 100°, but oxidation can be detected after eight days' exposure to 175°. When aluminium powder is heated in a current of air, it begins to absorb oxygen at 400°; between 400° and 625°, the rate of absorption increases steadily and remains constant between 625° and 750°. At 800°, a further absorption of oxygen commences, which increases as the temp. is raised to 1000°, and then remains constant between 1000° and 1200°. When aluminium powder is heated during one hour at 1000°, or for the same period at temp. rising from 500° to 1050°, 59 per cent. of oxygen is absorbed, but no further absorption of oxygen occurs when the heating is continued for another two hours at 1000°. The product is a homogeneous pearl-grey powder, which decomposes hydrochloric acid with effervescence. It is pointed out that the formation of a suboxide AlO would require the absorption of nearly 59 per cent. of oxygen. H. Hinze found that amalgamated aluminium is rapidly oxidized in air, and aluminium which has been rubbed with mercury or a

salt of mercury is quickly oxidized in air. When aluminium is allowed to stand on mercury covered with a thick film of oxide, H. F. Hunt and L. J. Steele found that, although no amalgamation is perceptible, the aluminium is rapidly converted into its hydroxide. The action is not so rapid when the metal is kept beneath dirty mercury, and is very slight when aluminium is floated on freshly distilled mercury. The action is most rapid with aluminium which has had its surface amalgamated. G. le Bon found that aluminium foil coated with a thin film of mercury is quickly oxidized by exposure to air, and a strip of the metal placed vertically in a vessel containing water and mercury is continuously corroded at its lower end until completely disintegrated. Since aluminium which has been pressed on moist platinum, silver, or tin behaves similarly, H. Hinze assumed that the increased oxidizability of aluminium is an electro-chemical effect, and is a good illustration of H. E. Armstrong's theory of chemical action. The phenomenon has also been studied by C. Jehn, P. Spica, C. Reichard, G. A. Maack, E. O. Erdmann, etc.—*vide infra*, aluminium amalgam. V. Zunino's analysis of the voluminous, grey, spongy mass formed when aluminium is immersed in mercury, and afterwards exposed to moist air, agrees with $\text{Al}_2\text{O}_3 \cdot 5\text{H}_2\text{O}$, or $\text{Al}(\text{OH})_3 \cdot \text{H}_2\text{O}$. J. H. Baille and C. Féry gave the composition $\text{Al}_2\text{O}(\text{OH})_4$. P. R. Jourdain said that still more water is absorbed in a moist atm., and in a dry atm. or in vacuo at 200° , water is slowly lost, but the weight does not become constant even after several days. He also showed that some carbonate and peroxide are present in the product.

According to H. St. C. Deville,³ **water** has no action on aluminium either at ordinary temp., at 100° , or at a red heat bordering on the m.p. of the metal. He said :

I boiled a fine wire in water for half an hour and it lost not a particle in weight. The same wire was put in a glass-tube heated to redness by an alcohol lamp and traversed by a current of steam, but after several hours it had not lost its polish, and had the same weight. To obtain any sensible action it is necessary to operate at the highest heat of a reverberatory furnace—a white heat. Even then the oxidation is so feeble that it develops only in spots, producing almost inappreciable quantities of alumina. This slight alteration and the analogies of the metal allow us to admit that it decomposes water but feebly

He added that the metal prepared by reducing cryolite with sodium is almost unavoidably contaminated with slag composed of the chlorides of sodium and aluminium; and when treated with water the aluminium chloride acts like an acid disengaging hydrogen. When the metal thus tarnishes in water, the presence of chlorides can be detected in the liquid. F. Wöhler, and R. Bunsen also found that the metal they prepared acted on water at 100° . H. St. C. Deville was not quite correct. According to W. Smith, there is a very slight action when aluminium powder and water are heated in a platinum dish to incipient boiling; but if heated in an ordinary test-tube, a vigorous evolution of hydrogen was observed. It is here assumed that the water dissolved a little alkali from the glass, and so attacked the metal. A. Liversidge found that commercial aluminium is attacked by rain-water, almost as readily as zinc is attacked. M. C. Schuyten showed that a drop of potassium permanganate soln. accelerates the decomposition by boiling water, but this is not the case with chlorates, perchlorates, or nitrates. J. H. Gladstone and A. Tribe also found that in the presence of a trace of iodine, of hydriodic acid, or of aluminium chloride, bromide, or iodide, or zinc chloride, aluminium decomposes water at ordinary temp. or at 100° . In all cases, hydrogen and aluminium hydroxide are formed. A. Ditte explained the action of water on aluminium by showing that the products of the reaction, hydrogen and alumina, deposit on the metal covering it with a thin protective film. If the conditions be such that the film is removed, the action becomes manifest. Boiling, for instance, removes the hydrogen, and if aluminium chloride, sulphate or nitrate be present in the water, the alumina may be removed, and the action goes on until a subsalt is formed which is sparingly soluble or insoluble. This covers the metal with a new protective film. L. Hugouenq found that purified aluminium is not attacked by purified water, but aluminium of

commerce is attacked owing to the formation of local couples. C. Tissier said that the formation of the couple dispels the passivity of the aluminium. A. Scala, F. Schönfeld and G. Himmelfarb, and many others have studied the action of water on this metal. C. Matignon showed that aluminium powder is slowly attacked by water at 100°; and that the powder when ignited in air and plunged into steam, continues to burn with the evolution of hydrogen. H. J. Gladstone and A. Tribe showed that if aluminium be dipped in an acidified soln. of cupric sulphate or platinic chloride, and washed, it gives only a little hydrogen with water at 12°, but copious quantities are evolved at 100°. J. H. Baille and C. Féry found that amalgamated aluminium decomposes water at ordinary temp., and that the change is especially rapid with very thin sheets of metal amalgamated on the surface. G. le Bon, W. van Rijn, and P. Spica confirmed this observation. The aluminium foil is amalgamated by dipping it in an aq. soln. of mercuric chloride, and afterwards washing it in water. When a strip of aluminium is dipped in water containing a few drops of hydrochloric acid and a very small quantity of mercuric chloride, the formation of alumina can be observed in a few minutes, and the strip when removed from the liquid oxidizes very rapidly in air. The mercury-amalgam couple or, as J. Wislicenus called it, *excited or activated aluminium*, was shown by W. R. Ormandy and J. B. Cohen, and J. Wislicenus to be a valuable reducing agent, more active in some cases than the zinc-copper couple—e.g. in reducing nitrates and nitrites to ammonia. According to F. Mylius and F. Rose, if aluminium be immersed in water exposed to air, some hydrogen peroxide is formed. H. T. Barnes and G. W. Shearer inferred from the behaviour of aluminium electrodes that a film is formed over the surface of aluminium exposed to air or to water, and that the reaction in the case of water develops hydrogen peroxide. The development of hydrogen peroxide is dependent on the presence of dissolved oxygen; if air be absent, no hydrogen peroxide is formed. O. Ohmann⁴ found that an intimate mixture of a gram of aluminium powder with 4.3 grms. of sodium peroxide is readily inflamed with a slight explosion by the addition of a few drops of water.

E. Heyn and O. Bauer found that aluminium undergoes two types of corrosion; it may corrode uniformly, forming a coating of oxide over the whole surface, or it may be attacked locally, forming blisters and exfoliations. The latter is the more dangerous in the industrial application of aluminium. They found that local pitting occurred with hard or cold-worked aluminium, and that tap-water produces a slight uniform corrosion after several months' exposure with soft or annealed sheet; and local corrosion, blistering, or disintegration with hard sheet. Distilled water did not cause blistering even with hard sheet. Local corrosion was attributed to (i) the initial stresses in hard sheet causing strains and buckling when released by corrosion; and to (ii) the electropositive character of hard- or cold-worked aluminium to the soft or annealed metal. This conclusion was confirmed by G. H. Bailey, and L. Guillet. E. Heyn and O. Bauer found the relative rates of corrosion of hard and soft sheet aluminium by distilled water exposed freely to air, to be respectively 45 and 54. The metal is not attacked by air, or water in the absence of air or oxygen; or, as G. H. Bailey expressed it, except in waters containing free acid or alkali, no aluminium is dissolved, and the corrosion is purely a question of oxidation of aluminium to alumina at the expense of the oxygen dissolved in the water. The greater the degree of purity of the water, the less the action. According to H. S. Rawdon and co-workers, failure occurs owing to the attack on the impurities which are found along the intercrystalline boundaries, but, on annealing after cold work, the impurities no longer coincide with the crystal boundaries, and corrosion is not truly intercrystalline in character. E. Heyn and O. Bauer, and G. H. Bailey found that the rate of attack is augmented by a rise of temp. Thus, at 20° and 70°, the relative rates of attack are 39 : 1.10. The silicon content of the aluminium, between 0.57 and 0.86 per cent., had no appreciable influence on the result; G. H. Bailey also found that when the proportion of silicon is higher than that of iron, the action is less pronounced in the case of water and acids, and more pronounced in salt soln.;

he stated that the attack by aluminium is notably accentuated if the aluminium contains sodium or copper. L. Guillet confirmed the conclusion with respect to copper. A. Barillé found that aluminium is slowly attacked by *seltzer water*, forming a flocculent precipitate of aluminium hydroxide. A. Trillat studied the corrosion of aluminium in the liquids encountered in the brewing, milk, and cheese industries.

According to F. Wöhler, and H. St. C. Deville, soln. of **sodium or potassium hydroxide** act vigorously on aluminium, transforming it into alkali aluminate and setting free hydrogen. G. H. Bailey represented the speed of the reaction with two different samples of commercial metal and tap-water, *N*-H₂SO₄, *N*-HCl, and *H*-NaOH in terms of the number of grains per sq. yd. dissolved per day :

Tap-water	<i>N</i> -H ₂ SO ₄	<i>N</i> -HCl	<i>N</i> -NaOH
0.80	10.0	35.5	708
0.85	7.7	29.8	898

J. W. Mallet found that the purified metal **resists attack** better than the commercial metal. J. W. Richards found the best commercial metal reacted with a cold dil. soln. of potassium hydroxide with one-seventh the rate of aluminium alloyed with 3 per cent. of copper, and with one-seventieth the rate of aluminium alloyed with 2 per cent. of copper and one per cent. of zinc. A. Stutzer found electrolytic aluminium is attacked more slowly than the metal made by the sodium process, and he attributed this to the presence of sodium in the latter, but J. W. Richards suggests that the truer explanation rests on the higher degree of purity of the electrolytic metal. A. Cavazzi said that the reaction is represented by $2Al + 6MOH = 2Al(OM)_3 + 3H_2$; the speed of the reaction increases with the temp. and conc. of the soln., but J. Bogussky and J. Zaljesky found that the speed of soln. is not proportional to the conc. of the alkali. A. J. Hale and H. S. Foster studied the attack by hydroxide soln. A. Röhrig found the presence of sodium silicate inhibits the attack by the alkali-lye—*vide infra*. S. Kappel found that aluminium in contact with air and a soln. of potassium hydroxide readily produces the nitrite, and in the cold, nitrates and hydrogen peroxide are formed. A boiling soln. of potassium or sodium ethoxide attacks aluminium only with the oxidation of the alcohol to form water. J. Czochralsky showed that the blackening of aluminium vessels with use is not directly dependent on the proportion of iron present as an impurity, but is rather dependent on the alkalinity of the water which comes in contact with the metal. A soln. of **calcium hydroxide**, or lime-water, also acts rapidly on aluminium, but the resulting calcium aluminate is insoluble in water, and is precipitated on the metal protecting it from further action. E. Beckmann found that a soln. of **barium hydroxide** rapidly dissolves aluminium until the soln. contains the molar proportion Al₂O₃ : BaO ; the reaction is then slower and aluminium hydroxide begins to separate out ; with hot soln. barium aluminate is formed.

C. H. Crowe, and K. L. Meissner have studied the action of alkali chloride soln. on aluminium. A soln. of **sodium chloride** acts feebly on aluminium. This subject has been investigated by A. E. Hunt, J. W. Richards, G. H. Bailey, C. Tissier, A. Ditte, E. Donath, F. Zmerzlikar, E. Heyn and O. Bauer, and A. J. Hale and H. S. Foster. W. Smith found that hot conc. soln. of sodium chloride attack the metal with the evolution of hydrogen, and the soln. become alkaline ; it is assumed that in the presence of sodium chloride, the aluminium attacks the water setting free hydrogen, and the aluminium hydroxide so formed reacts with the sodium chloride, forming a basic aluminium chloride and sodium hydroxide. The action of a soln. of sodium chloride in the presence of an acid was found by A. E. Hunt, W. Smith, and A. Ditte to be greater than when either is alone. A. Ditte said that the attack by alkali halides is prevented by the formation of a protective film of aluminium hydroxide, and that the presence of the dil. acid dissolves the hydroxide, and enables the saline soln. to continue its action. The action is also faster near the surface because atm. oxygen plays a rôle in the reaction. He also showed that the

carbon dioxide plays a part analogous to that of acetic acid, and that the resulting sodium carbonate readily reacts with aluminium as indicated below. A. Ditte also found that soln. of **potassium chloride, sodium and potassium bromides, and potassium iodide** act like soln. of sodium chloride. He represented the reaction by the equations: $6\text{NaCl} + 2\text{Al} + 6\text{H}_2\text{O} = 2\text{AlCl}_3 + 6\text{NaOH} + 3\text{H}_2 + 157.3$ Cals.; and $3\text{NaOH} + \text{AlCl}_3 = 3\text{NaCl} + \text{Al}(\text{OH})_3 + 28.7$ Cals. The corrosive action of **sea-water** was studied by A. E. Hunt, H. C. H. Carpenter and C. A. Edwards, etc. A. Ditte said that the action of sea-water is analogous to that of sodium chloride on aluminium; and that **calcium chloride** and **magnesium chloride** soln. act similarly; A. J. Hale and H. S. Foster, and C. H. Crowe examined the action of soln. of these salts.

According to C. Formenti and M. Levy, aluminium reacts with soln. of many **sulphates**, forming alums. According to W. Smith, when aluminium powder is heated to 100° in a platinum vessel with a soln. of **sodium nitrate** or **potassium nitrate**, there is a faint evolution of hydrogen, whereas in a soft glass vessel, there is a vigorous action, and an evolution of much gas. This is due to the presence of alkali developed by the action of the water on the glass. W. Smith assumes that the reaction is: $6\text{Al} + 14\text{H}_2\text{O} + 2\text{NaNO}_3 = 6\text{Al}(\text{OH})_3 + 2\text{NaOH} + 2\text{NH}_3 + \text{H}_2$. The alkali derived from the glass and from the sodium nitrate continually increases so that there is an ever-increasing reducing action and finally there is a tempestuous evolution of hydrogen and ammonia. E. Donath, and F. Zmerzlikar studied the attack of aluminium by soln. of nitrates. W. R. E. Hodgkinson and A. H. Coote found that aluminium has no action on a soln. of **ammonium nitrate**. The action of ammonium salt soln. in producing brown films on aluminium was the subject of a patent by C. Göttig. A boiling soln. of **ammonium phosphate**, made faintly alkaline with ammonia, was found by W. Smith to be attacked with the formation of a white phosphate, and he assumes that the boiling soln. is decomposed into ammonia and phosphoric acid, and that the former, *in statu nascendi*, decomposes the water, forming aluminium hydroxide and hydrogen; the hydroxide and phosphoric acid produce aluminium phosphate. A hot soln. of **ammonium arsenate** acts on aluminium, forming a mixture of hydrogen, arsine, etc.

A. Cavazzi, and W. Smith found that when aluminium powder is boiled with a *N*-soln. of **sodium carbonate**, there is so copious an evolution of hydrogen and carbon dioxide that the soln. froths vigorously. The reaction is also vigorous with foil and sheet aluminium. It is assumed that the aluminium first reacts with the water, forming hydrogen and aluminium hydroxide, and the latter reacts with the sodium carbonate forming sodium aluminate: $2\text{Al} + 3\text{H}_2\text{O} + \text{Na}_2\text{CO}_3 = 2\text{NaAlO}_2 + 3\text{H}_2 + \text{CO}_2$. Since a boiling soln. of sodium carbonate does not react with aluminium hydroxide, W. Smith makes the supplementary hypothesis that the reaction can occur in the presence of nascent hydroxide. A. Ditte said that the reaction between sodium carbonate and aluminium furnishes sodium aluminate and hydrocarbonate, and it ceases when all the carbonate is transformed into hydrocarbonate. A. J. Hale and H. S. Foster examined the action of sodium carbonate soln. R. Seligman and P. Williams showed that sodium silicate forms a coating of aluminium silicate on the metal, and prevents the attack by sodium carbonate used for cleaning aluminium.

C. Weltzien⁵ found that aluminium is attacked by **hydrogen peroxide**, and O. Droste noted that an aluminium beaker containing a 3 per cent. soln. of hydrogen peroxide was quickly corroded. 99.46 per cent. aluminium with 0.03 per cent. of iron and 0.51 per cent. of silicon is rapidly dissolved with the exception of a few specks of silicon together with some adherent aluminium. A white precipitate of $\text{Al}(\text{OH})_3 \cdot \text{H}_2\text{O}$, but no colloidal aluminium hydroxide, is formed. He added that aluminium vessels are not suited for liquids which contain or can form **oxygen** or **ozone**. The slow action of aluminium in decomposing hydrogen peroxide was attributed, by H. T. Barnes and G. W. Schearer, to the protective action of the surface film of oxide.

Aluminium is an active element, and under proper conditions reacts with many other elements, forming salts, etc. According to H. Moissan,⁶ it is superficially attacked by **fluorine** at ordinary temp., and the thin layer of aluminium fluoride protects the metal from further attack; but at a red heat, the action is very energetic. C. Matignon said that aluminium burns vigorously in the halogens, the hydrogen halides, and the non-metallic halides. F. Wöhler noted the combustion of the metal in **chlorine**, but H. Gautier and G. Charpy found that liquid chlorine at its b.p. has no action, but at -20° , combination occurs with incandescence. G. H. Bailey said that the corrosive action of chlorine at ordinary temp. is negligibly small. According to E. R. Hodges, **bromine** vapour reacts with warm aluminium foil with brilliant incandescence. H. Gautier and G. Charpy found that with liquid bromine there is an energetic reaction at 15° , and a fragment of aluminium on liquid bromine becomes incandescent and runs about the surface of the liquid like potassium does on water. With bromine-water, there is a regular evolution of hydrogen, and after a time, some oxybromide separates. C. Friedel and L. Roux said that aluminium sub-bromide is formed if the aluminium be in excess. J. Nicklès found that bromine or **iodine** in dried ether reacts vigorously with aluminium, forming either the bromide or the iodide.

Gaseous **hydrogen chloride** readily attacks aluminium even at a low temp., but, according to J. B. Cohen, there is no action if the gas be thoroughly dried; nor, according to L. Kahlenberg and H. Schlundt, does a soln. of that gas in dried liquid hydrogen cyanide attack the metal. F. Stockhausen and L. Gattermann, and E. Kohn-Abrest found that powdered aluminium is not acted on by 2 hrs.' exposure to cold dry hydrogen chloride, but is rapidly attacked if previously heated in hydrogen to 300° ; once the reaction has commenced, it continues without the application of more external heat—*vide* the preparation of aluminium chloride. Both F. Wöhler, and H. St. C. Deville noted the rapid dissolution of aluminium in **hydrochloric acid**. This acid is *le véritable dissolvant* of aluminium. The action is quicker with conc. than with dil. acid, and quicker hot than cold. A. J. Hale and H. S. Foster studied the action of hydrochloric acid; and F. and W. Mylius, the thermal changes in the attack of the metal by this acid. A. Sieverts and P. Lueg found that if the initial conc. of the acid be C milliequivalents per 20 c.c.; x c.c. the amount of hydrogen evolved at the time t ; v_m c.c. denotes the vol. of a millimol of hydrogen under standard conditions; and B the vol. of hydrogen under standard conditions eq. to the initial quantity of metal, then, the velocity of the reaction $dx/dt = K(C - 2x/v_m)(B - x)^{\frac{1}{2}}$. At 20° , they found the velocity constant, K , to be

Conc. of acid . . .	0.5N	0.67N	N	1.33N	1.67N	2N
K	0.40	1.04	4.2	9.8	16.1	22.7

and that K is very nearly proportional to the 3rd power of the conc. of the acid. At 20° with N -acid, $K=4.2$, and at 30° , $K=5.65$. According to J. W. Mallet, the purified metal is not so readily attacked by solvents generally as is the impure metal. It is assumed that the galvanic action of local couples keeps the surface of the impure metal free from a protecting layer of gas. J. W. Richards said that the presence of silicon renders the metal particularly susceptible to rapid attack, and during the reaction some silicon escapes as hydride. This can be prevented by keeping an oxidizing agent like bromine in the acid. If the best commercial aluminium, and an alloy with 3 per cent. of nickel, be treated with 3 per cent. hydrochloric acid, the less pure metal dissolves 30 times as fast as the other. If a little hydrochloric acid be added to other acids, the metal is dissolved presumably as aluminium chloride, and the latter then reacts, forming a salt of the acid and reproducing hydrochloric acid. The catalytic action is thus cyclic. The accelerating influence of reducing agents—nitrobenzene, etc.—on the dissolution of metals in acids was discussed by H. J. Prins. A. Sieverts and P. Lueg found that there is a marked period of induction in the action of hydrochloric acid, and that the speed of dissolution is greatly inhibited by a number of alkaloids.

With *N*-acid, and 2.5 millimol of the following alkaloids per litre, the value of *K* was 4.30 with caffeine; 4.2, cocaine; 4.1, cinchonine; 2.44, morphine; 2.40, conine; 2.13, quinine; 1.97, narcotine; 1.83, brucine; 1.80, codeine; 1.17, nicotine; 1.08, veratrine; and 1.03, β -naphthoquinoline.

The effect is due to the adsorption of the "poison" by the metal which renders the surface inactive. **Hydrobromic and hydriodic acids** react similarly to hydrochloric acid. R. Seligman and P. Williams found that $\frac{1}{2}$ *N*-hydrobromic acid attacks aluminium with but half the velocity of $\frac{1}{2}$ *N*-hydrochloric acid. G. H. Bailey made some observations on this subject. With **hydrofluoric acid**, the aluminium fluoride which is produced has a low solubility, so that a protective coating of the fluoride may remain on the metal when the conc. of the acid is great enough.

A. D. White found that **hypochlorous acid** attacks aluminium slowly, hydrogen is evolved and aluminium hydroxide is deposited, some chlorine is then formed; if an excess of aluminium be used, and the evolution of gas has ceased, the filtered soln. deposits aluminium hydroxide when carbon dioxide is passed therein. It is assumed that the soln. contains aluminium hypochlorite, and that the first product of attack by the acid is this salt and hydrogen; the aluminium is also slowly oxidized and hydrochloric acid is formed. The interaction of hypochlorous and hydrochloric acids gives chlorine; some oxygen appears in the gas evolved, and is due to the spontaneous decomposition of the hypochlorite. Aluminium is slowly attacked by a soln. of **calcium hypochlorite** (bleaching powder) and calcium aluminate is said to be a product of the action. D. Tommasi stated that only a trace of chloride was formed after aluminium had been in contact with **chloric acid** for six hours. W. S. Hendrixson found that aluminium slowly dissolves in cold dil. chloric acid, and whatever the conc., hydrogen is given off, and, as in the case of zinc, some acid is reduced, and some chloride is formed. The ratio of chlorate to chloride formed with *N*-acid is 1 : 7, and with 2*N*-acid 1 : 5. The metal also becomes coated with aluminium oxide. D. Venditori found finely divided aluminium reduces chloric acid to hydrochloric acid in the presence of acids; **perchloric acid** is not affected. Acidified soln. of **chlorates** and **perchlorates** behave in an analogous manner. G. Gore found that with an aluminium-platinum couple in a soln. of **iodic acid**, the aluminium is strongly attacked.

A. Orłowsky⁷ could detect no signs of a reaction in the cold between aluminium and **sulphur** or a soln. of sulphur in carbon disulphide. W. Spring said that under a press. of 6500 atm. the reaction between sulphur and aluminium is incomplete, although a polysulphide is formed. According to H. St. C. Deville, aluminium at a red heat does not react with sulphur vapour, but, at a "high temp. it combines directly with sulphur to give aluminium sulphide." According to H. Fonzes-Diaçon, and C. Matignon, a mixture of eq. proportions of precipitated sulphur and finely powdered aluminium can be ignited by burning magnesium, and aluminium sulphide is formed. A mixture of **selenium** and aluminium behaves in a similar manner. F. Wöhler also obtained compounds of aluminium with selenium and **tellurium**. G. H. Bailey said that the corrosive action of **hydrogen sulphide** at ordinary temp. is negligibly small. According to H. St. C. Deville, hydrogen sulphide has no action on aluminium, and the same remark applies to an aq. soln. of hydrogen sulphide, or of **ammonium sulphide**. J. Margottet also said that hydrogen sulphide is without action on aluminium, but J. W. Richards noted that hydrogen sulphide is absorbed by the molten metal, and the metal then flows sluggishly; just before setting the gas is rejected "so actively that a crackling sound can be heard several feet away . . . at the same time, the sluggish metal becomes quite fluid." The gas entangled in the solidifying metal also produces cavities or blowholes. C. Matignon found that aluminium can be burnt in the vapour of **carbon disulphide**, forming carbon and aluminium sulphide but not carbide; he also burnt aluminium powder in **sulphur dioxide** producing the oxide and sulphide; G. H. Bailey found the corrosive action of sulphur dioxide at ordinary temp. is negligibly small. A. Cavazzi found that when a mixture of aluminium filings and sugar charcoal is heated in the vapour

of carbon disulphide, a little aluminium sulphide is formed. Aluminium reacts with **sulphurous acid**, forming, according to P. Schweitzer, a mixture of aluminium sulphite, sulphate, trithionate, and thiosulphate. P. Degener said that sulphurous acid attacks the metal only in the presence of alkali chlorides. C. Matignon burnt aluminium in the vapour of **sulphur chloride**.

According to F. Wöhler, cold conc. **sulphuric acid** does not attack aluminium, but the hot acid dissolves it rapidly with the evolution of sulphur dioxide. H. St. C. Deville showed that sulphuric acid diluted in the proportion most suitable for attacking zinc has no action on aluminium, and the action is not assisted by contact with a foreign metal. He found that after several months' contact with dil. sulphuric acid, a slight action could be detected. H. E. Roscoe said conc. and dil. sulphuric acids have no action on aluminium. As a matter of fact, dil. and conc. sulphuric acids act very slowly on aluminium in the cold and more rapidly when hot. A. J. Hale and H. S. Foster studied the action of sulphuric acid on aluminium. According to R. Seligman, anhydrous sulphuric acid is without action on aluminium, whereas ordinary oil of vitriol is markedly corrosive. P. Pascal and co-workers found that aluminium is not seriously attacked by sulphuric acid over 98 per cent. P. B. Ganguly and B. C. Banerji found the action is most vigorous near the surface of the acid when an aluminium rod is partly immersed in the dil. acid. G. A. le Roy reduced the loss in weight suffered by plates of metal in sulphuric acid, to loss in grams per sq. metre in 12 hrs., and he found with purified and commercial aluminium at 15°-20°:

Sp. gr. of acid	. . .	1.842	1.711	1.580	1.263
Loss { pure Al	. . .	18.40	24.50	19.00	4.60
{ comm. Al	. . .	21.00	25.80	—	—

and at 150°, with acid of sp. gr. 1.842, the losses were respectively 240 and 267. Hence, it is impracticable to use aluminium for pans, pumps, tank linings, etc., used in handling sulphuric acid. It will be observed that the attack on purified aluminium is slower than on the impure metal. A. Ditte found that cold 2.5 per cent. sulphuric acid at first acts very slowly, but after several hours, the air condensed on the surface of the metal is removed, and the metal slowly dissolves with the evolution of hydrogen. The hydrogen collects on the surface of the metal protecting it from further attack. J. M. Weeren gave a similar explanation with respect to zinc. Any agent which breaks up or removes this gaseous film, hastens the attack by the acid. Soln. of many metal chlorides reduced by aluminium behave in this way; for instance, the addition of a few drops of platinum chloride to the acid leads to the deposition of platinum on the aluminium, the surface is roughened, the gas escapes quicker, and the solvent action is more rapid. Gold, mercury, and copper chlorides act similarly; zinc and iron chlorides have no such stimulating action. The rate of attack by the cold acid gradually slows down because of the deposition of an undissolved basic sulphate, $3Al_2SO_4 \cdot Al_2(SO_4)_3 \cdot 18H_2O$, on the metal protecting it from the acid. Even very dil. sulphuric attacks aluminium if the metal is prevented from being covered with the film of gas—*e.g.* by boiling. It is probable that the metals deposited on the aluminium, as also the impurities in the aluminium, act as electronegative elements to the electropositive aluminium; local couples are formed, and the gas is disengaged from the electronegative element, not the aluminium. A. Ditte, and F. Winteler mention the separation of sulphur during the action of conc. sulphuric acid on aluminium, but W. Smith detected no such formation of sulphur. According to M. G. Levi and co-workers, aluminium rapidly dissolves in aq. soln. of **potassium persulphate** without the development of gas; with **ammonium persulphate** the dissolution is slower. G. A. Maack produced selenium and tellurium respectively from aq. soln. of **selenous and tellurous acids** by aluminium.

Melted aluminium was shown by F. Briegleb and A. Geuther⁸ to absorb **nitrogen**, and J. W. Mallet prepared a nitride (*q.v.*); some nitride is formed when aluminium is burnt in air. Gaseous **ammonia** does not act on the metal at ordinary temp.,

but at 700°, A. H. White and L. Kirschbraun found that the nitride is formed. G. G. Henderson and J. C. Galletly heated aluminium in a stream of ammonia and obtained only a small proportion of nitride. F. Wöhler found that aqua ammonia acts slowly on the metal, producing a little alumina, part of which dissolves. A. J. Hale and H. S. Foster studied the action of aq. ammonia on aluminium. W. Smith found that a hot conc. soln. of ammonia generates hydrogen and forms aluminium hydroxide. A. Ditte said that the action with aq. ammonia continues so long as the aluminate dissolves in the excess of alkali, and stops as soon as a film of aluminate forms on the metal. S. Kappel said that aq. ammonia in contact with air and aluminium forms nitrites. C. Göttig, and A. Ditte mention that a yellow to brown layer of the unattacked impurities remains on the surface after treatment with ammonia. According to T. Curtius and J. Rissom, **hydrazoic acid**, HN_3 , attacks aluminium a little, forming aluminium hydroxide, not the azide. According to C. Matignon, aluminium powder can burn in **nitrous oxide**, **nitric oxide**, and **nitrogen peroxide**, forming alumina and the nitride. P. Sabatier said that aluminium filings are not attacked when heated in nitric oxide, and that nitrogen peroxide is without action at 500°. E. Müller and H. Barck found the action of nitric oxide was only slight below 600°; at 600°, 8 per cent. was decomposed. J. J. Sudborough found **nitrosyl chloride** attacks aluminium in the cold. F. W. Bergstrom found that **sodium amide**, or a soln. of sodium in liquid ammonia, reacts with amalgamated aluminium, forming *sodium amidocaluminate*, $\text{Na}[\text{Al}(\text{NH}_2)_4]$; **potassium amide** acts similarly, forming *potassium amidocaluminate*, $\text{K}[\text{Al}(\text{NH}_2)_4]$.

According to H. St. C. Deville, and F. Wöhler, dil. or conc. **nitric acid** has no action on aluminium at ordinary temp., and the former said that good results were obtained by substituting aluminium for platinum in Grove's battery. W. Smith noted that with hot nitric acid, at the b.p., nitrous fumes are evolved, but the action ceases when cooled below 50°. According to A. Ditte, the action of nitric acid resembles that of sulphuric acid in that cold 3 per cent. acid acts very slowly, but cold 6 per cent. acid acts more quickly. When the plate of metal has become rough or matte by the action, the gas escapes more freely from the surface, and the action is faster. The gas contains no hydrogen, and is mainly nitrogen and nitric oxide; a little ammonium nitrate is formed. The reaction does not stop with the formation of the neutral nitrate, for a white sparingly soluble basic salt, $5\text{Al}_2\text{O}_3 \cdot 2\text{Al}(\text{NO}_3)_3 \cdot 30\text{H}_2\text{O}$, is deposited. According to T. B. Stillmann, nitric acid of sp. gr. 1.15 attacks aluminium turnings more readily than an acid of sp. gr. 1.45; and with an acid of sp. gr. 1.35, the salt $\text{Al}(\text{NO}_3)_3 \cdot 9\text{H}_2\text{O}$ is deposited. C. M. van Deventer found that 20–25 per cent. nitric acid attacks aluminium slowly at 25°–30°; the main reaction is $\text{Al} + 4\text{HNO}_3 = \text{Al}(\text{NO}_3)_3 + \text{NO} + 2\text{H}_2\text{O}$, a little nitrogen and some ammonia are also formed. A. Ditte found that with 3 per cent. nitric acid mixed with a little platinum chloride, very little gas is produced, but much ammonium nitrate is formed; and E. Divers and T. Haga found that hydroxylamine is produced when nitric acid, mixed with a little hydrochloric acid, acts on aluminium, and that the reaction is independent of the aluminium chloride in the soln. The action of nitric acid on aluminium has also been studied by R. Woy, J. W. Richards, H. E. Roscoe, A. Quartaroli, A. J. Hale and H. S. Foster, G. Lunge and E. Schmid, and G. A. le Roy. In general, cold dil. and conc. nitric acid attacks platinum very slowly, for the metal becomes passive under the action of this acid. The conc. acid attacks aluminium violently at 100°. P. Pascal and co-workers found that the presence of sulphuric acid facilitates the action of nitric acid on aluminium, and the presence of ammonium nitrate also favours the attack; but nitric acid alone at any conc. does not seriously attack the metal. J. W. Mallet found that purified aluminium is not so readily attacked as the impure metal.

R. Seligman and P. Williams have overhauled the various statements regarding the effect of nitric acid and found that the most important condition affecting the rate of dissolution of aluminium in nitric acid is temp., Fig. 29. Over a considerable

range of temp. an increase of 10° C. is sufficient to increase the rate of dissolution by 100 per cent. The practical importance of this factor, to which no reference has heretofore been made, is very great. The life of aluminium vessels used for the storage or transport of nitric acid can be greatly increased where it is possible to keep the temp. down. Next to temp., conc. plays the most prominent part in determining the rate of dissolution of aluminium in nitric acid, Fig. 29. The most active solvents are mixtures containing between 20 per cent. and 40 per cent. by volume of nitric acid of 1.42 sp. gr., whilst on the other hand some acids made from atmospheric nitrogen, and containing 94.7 per cent. of true nitric acid, were found to be almost without effect on aluminium. A sample of the metal suspended in this acid for 71 days lost only 0.0004 gm., eq. to a rate of dissolution of 0.015 mgrm. of aluminium per 100 sq. cm. per 24 hours. The extreme inactivity of acid of this strength is held to account for the great success which has attended the use of aluminium transport vessels by the Norwegian makers of nitric acid. Contrary to the statement made by A. Trillat, the presence of up to 0.05 per cent. chlorine in nitric acid was not found

to affect the rate of attack of the latter upon aluminium. Similarly, no acceleration could be noted on the addition of up to 0.01 per cent. of iodine. On the other hand, the presence of traces of sulphuric acid was found to promote the rate of attack, 0.04 per cent. of sulphuric acid being sufficient to raise the rate of dissolution from 36 to 62 mgrms. per 100 sq. cms. per 24 hrs. The rate of attack is increased by the presence of the lower oxides of nitrogen. If the acid be kept free from such lower oxides the rate of attack on aluminium can be reduced considerably. The effect of the oxides of nitrogen produced by the interaction of nitric acid and aluminium in stimulating the attack is held to account for the fact often observed in practice that dissolution is most rapid in crevices or corners where the acid cannot circulate freely and where such products therefore accumulate. The effect of the physical state of the aluminium is considerable, the metal being attacked very much more readily when amorphous than when crystalline. The observation has been made that a partial change to the more resistant form is brought about by exposure for a few hours to a temp. of 125° , but that by a longer exposure to this temp. the metal loses its comparative immunity from attack. A similar change to the more resistant form has been observed to commence at a temp. as low as 100° . Moreover, it has also been noticed that metal which has been freshly annealed at 540° is more resistant to attack than metal which has been allowed to stand for about ten days after annealing. The composition of the metal is of very much smaller importance than has heretofore been assumed to be the case. Nevertheless, the purer metal is generally the most resistant to the attack of nitric acid. The statement by O. Guttman that a mixture of nitric and sulphuric acids attacks aluminium less readily than the acids alone is erroneous. The attack by nitric acid on aluminium of high quality is quite uniform and no instance of local action or pitting was observed.

H. Fonzes-Diacon, and C. Matignon prepared aluminium phosphide by igniting with a piece of magnesium wire a mixture of red **phosphorus** and aluminium; L. Losana studied the action of less than 0.1 per cent. of phosphorus on the properties of aluminium. H. Fonzes-Diacon and C. Matignon showed that a heated mixture of **arsenic** and aluminium gave the arsenide; and the antimonide was obtained from a mixture of aluminium, **antimony**, and sodium peroxide. Q. A. Mansuri found that with arsenic a compound Al_3As_2 , *aluminium ditritarsenide*, is formed. B. Reinitzer and H. Goldschmidt found **phosphoryl chloride** acts on aluminium

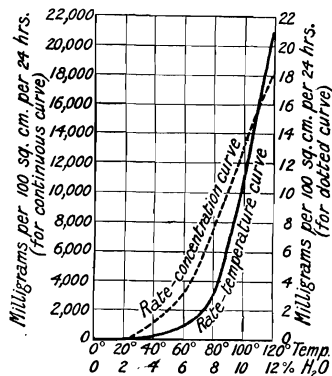

FIG. 29.—Effect of Temperature and Concentration on the Rate of Dissolution of Aluminium in Nitric Acid.

similarly to what it does on magnesium and zinc, forming phosphorus trichloride, aluminium metaphosphate and chloride, phosphoric anhydride, pyrophosphoryl chloride, and a little phosphorus suboxide; H. Goldschmidt represented the action of **phosphorus pentachloride** on aluminium, $2Al + 3PCl_5 = 2AlCl_3 + 3PCl_3$. C. Matignon found that aluminium powder burns in the vapours of phosphorus, **antimony and arsenic chlorides**. According to G. A. Maack, an aq. soln. of **arsenious oxide** is not changed by aluminium; an acid soln. gives arsenic and arsine; and an alkaline soln., arsenic—for ammonium arsenate, *vide supra*. According to O. Ruff and K. Staib, with **arsenic trichloride**, the reaction is symbolized: $3AsCl_3 + 3Al = 2AlCl_3 + AlAs_3Cl_3$. Antimony is immediately precipitated from a soln. of an **alkali antimonite**; with a hydrochloric acid soln. of **antimony trichloride**, stibine is evolved; and an aq. soln. of **potassium antimony tartrate** is not decomposed. Dil. or conc. **phosphoric acid** attacks aluminium with the development of hydrogen—F. Winteler said with the separation of phosphorus, but W. Smith denied this.

For the action of aluminium on **boron**, *vide* aluminium boride. H. Moissan^o found that aluminium reacts with **boron sulphide** at a red heat forming aluminium sulphide and boride. A. Lubbert and M. Roscher found that aluminium foil 0.001 in. thick is dissolved in 4 days by a 4 per cent. soln. of **boric acid**; and G. Lunge and E. Schmid found that a similar soln. dissolved 29.5 mgrms. of sheet aluminium per sq. metre per day at ordinary temp. C. and A. Tissier, H. St. C. Deville, and G. H. Bailey found the corrosive action of soln. of boric acid is negligibly small. F. Wöhler found that melted **borates** are reduced to boron by aluminium at a high temp. H. St. C. Deville showed that if aluminium be melted under borax, some aluminium borate is formed. Hence borate slags rapidly corrode the metal. H. St. C. Deville, and J. W. Mallet noted that aluminium unites with **carbon**; and H. Moissan obtained a carbide by heating aluminium powder with lampblack. J. W. Mallet, and L. Franck found that **carbon monoxide** is reduced by heated aluminium, forming alumina and carbon—A. Guntz and A. Masson said aluminium carbide is formed at the same time: $6Al + 3CO = Al_4C_3 + Al_2O_3$. G. H. Bailey said the corrosive action of carbon monoxide or dioxide at ordinary temp. is negligibly small. At ordinary temp., N. Wender also found dry **carbon dioxide** to be without action on aluminium, and with the moist gas the action is *ganz unbedeutend*. L. Franck represented the reaction with dry carbon dioxide, $4Al + 3CO_2 = 2Al_2O_3 + 3C$. K. Brunner found that aluminium powder burns vigorously when heated in an atm. of carbon dioxide, and graphitic carbon is formed. According to A. Guntz and A. Masson, the action is greatly accelerated if a little iodine or aluminium chloride or iodide vapour be mixed with the carbon monoxide or dioxide. According to A. Brochet and J. Petit, aluminium is rapidly attacked by soln. of **potassium cyanide** even in the cold. For the action of **carbonyl chloride**—*vide* aluminium chloride. L. Hugouenq found that 92 per cent. **alcohol attacks** aluminium even less than does water; the attack is accelerated in contact with other metals—very little by cadmium; more by chromium or cobalt; still more by platinum, tin, gold, silver, brass, and mercury; and quickest of all by copper, lead, bismuth, iron, zinc, and nickel. According to R. Seligman and P. Williams, dry fatty acids—*e.g.* a mixture of stearic, palmitic, and oleic acids—dry alcohols—*e.g.* methyl, ethyl, butyl, amyl, and benzyl alcohols—and dry phenol, cresol, and α - and β -naphthols rapidly attack aluminium at the b.p. of the organic compound, but if a small amount of water be present, the reaction is inhibited, or if it has already commenced, it is at once inhibited. It is assumed that the metal is normally protected by the film which covers it, but this film breaks down when exposed to the attack of the dehydrated substances considered. The presence of even the minutest traces of water is sufficient to inhibit the attack, owing either to the fact that the salts, peroxides, or alkyloxides, as the case may be, are immediately decomposed by water, aluminium hydroxide being formed, or because the aluminium exposed by the breakdown of the film is immediately reoxidized by water. G. Lunge and E. Schmid investigated the effect of various alcoholic liquids

on aluminium—with 50 per cent. alcohol, the rate of dissolution is 10·2 milligrams per sq. metre per day. C. Matignon also burnt aluminium powder in carbon monoxide and dioxide; he also found that aluminium burns in the vapour of **formic acid**, $3\text{HCOOH} + 4\text{Al} = 2\text{Al}_2\text{O}_3 + 3\text{H}_2 + 3\text{C}$. R. Seligman and P. Williams found that a 77 per cent. aq. soln. rapidly attacks aluminium, and a crystalline formate is produced. A. Lubbert and M. Roscher found that aluminium foil 0·001 in. thick was completely dissolved by four days' immersion in 1, 5, and 10 per cent. soln. of formic and acetic acids; but results with foil do not represent the corrosion of heavier sheet metal, and G. Lunge and E. Schmid found that 1 and 5 per cent. soln. of acetic acid dissolved respectively 73·0 and 64·2 mgrms. of aluminium per sq. metre per day at ordinary temp. According to C. Matignon, aluminium does not burn in the vapour of **acetic acid**. H. St. C. Deville said that the action of acetic acid, diluted to the conc. of the strongest vinegar, on aluminium is inappreciable or is extremely slow. A. Ditte assumed that if the protective film of hydrogen be removed by mechanical means, or if the action takes place in vacuo, aluminium is readily dissolved by acetic acid. F. Heeren found that acetic acid dissolves aluminium in the cold, more rapidly when heated, and hydrogen is evolved. W. Smith found that the solvent action is small, and, as H. St. C. Deville also showed, the action is much hastened if a little sodium chloride be present. According to R. Seligman and P. Williams, the rates of soln. of acetic acid of different conc. expressed in mgrms. of aluminium dissolved per 100 sq. cms. in 24 hrs. at boiling temp., are :

Per cent. acid . . .	99·9	90	80	60	40	20	5	1	0·2
Rate soln.	7	165	295	410	533	582	610	1200	770

The attack by cold acetic acid is small, and the rate of dissolution increases with increasing dilution until the acid has a conc. of one per cent.; they found that with cold acid (20°):

Per cent. acid . . .	99·2	98	90	70	25	10	2·5	1	0·5
Rate soln.	0·00	0·01	0·26	0·60	0·65	0·90	0·85	1·100	1·4

and with the cold acid of still lower conc., the rate of soln. rose to a maximum 3·20 with 0·02 per cent. acid; and fell to 1·00 with 0·004 per cent. acid. The immunity of aluminium to ordinary conc. acetic acid is explained by the formation of a continuous film of an insoluble gelatinous basic acetate or oxide on the surface of the metal. The attack with the boiling acid is uniform; local action has been observed with the cold acid, and is produced by oxygen. With cold acid, too, the presence of oxygen promotes the reaction, for the speed is reduced to less than half if the oxygen atm. be replaced by one of hydrogen; with acetic acid of higher conc., the presence of oxygen was found to exert a retarding influence on the rate of dissolution. At the boiling temp., the oxygen is rapidly removed in the course of ebullition. While the rate of action with the 99 per cent. acid is but one-tenth that of the 90 per cent. acid, extraordinary to relate, the removal of the last trace of water from acetic acid raises the speed a hundred-fold; and conversely, the addition of 0·05 per cent. of water to a corrosive acid stops the action.

A. Ditte, and P. Degener found that acetic acid first forms a layer of hydrogen on the metal, and later on, a layer of hydroxide is formed. This is dissolved if an alkali or alkaline earth halide be present, and hence those salts hasten the attack. E. R. Hodges made some observations on the solubility of acetic acid, and showed that in the presence of hydrogen peroxide the activity of the acid is greatly augmented. He added that air or oxygen is necessary for the reaction, showing that the oxidation of the metal must precede the production of the acetate. M. Balland found that the action of vinegar is so slight as not to prevent the use of aluminium for cooking vessels. R. Seligman and P. Williams also found that with dil. acetic acid of about 10 per cent. conc., the addition of up to 1 per cent. of sodium chloride, potassium bromide, potassium iodide, or potassium nitrate has practically no effect in the case of boiling acid, whereas an eq. amount of sodium sulphate raises the rate

of dissolution appreciably. In cold 10 per cent. acetic acid, however, 1 per cent. of sodium chloride is sufficient to raise the rate of dissolution tenfold, whereas potassium bromide effects a much smaller increase in the rate of attack, and potassium iodide and potassium nitrate none at all. 0.5 per cent. of sulphuric acid in the form of sodium sulphate raises the rate of dissolution fourfold in the case of dil. acid at normal temp. With acids of about 80 per cent. conc. in the cold, 1 per cent. of sodium chloride was found to raise the rate of dissolution from 3.6 to 270 mgrms. of aluminium dissolved per hundred sq. cms. per 24 hours. The same amounts of potassium bromide and potassium iodide increase the rate of dissolution approximately tenfold, but 0.5 per cent. of sulphuric acid in the form of sodium sulphate cannot be said to have any effect on the rate of attack by 80 per cent. acid in the cold, and potassium nitrate reduces the rate of dissolution to one-fourth of its previous value. The most serious effect of the addition of the substances experimented with was noted in the case of 80 per cent. acid at b.p. Here the rate of dissolution is raised by 1 per cent. of sodium chloride from 290 to 16,000. By 1 per cent. of potassium bromide the rate is only increased from 290 to 485, whilst potassium iodide and potassium nitrate may be said to have no effect; 0.5 per cent. of sulphuric acid in the form of sodium sulphate somewhat increases the rate of dissolution. The effect of the addition of chlorides to acetic acid is far greater than that of the addition of bromides or iodides. This is due to the greater activity of the liberated acid. Potassium iodide has very little effect with hot acetic acid, but with the cold acid, the attack depends on the liberation of iodine. If the iodine be removed, the rate of attack falls to that of the acid alone; with the boiling acid the iodine is volatilized.

R. Seligman and P. Williams found that the action of conc. propionic acid, and of butyric acid is entirely analogous to that of acetic acid. T. H. Easterfield and C. M. Taylor found that above 300°, aluminium is attacked by stearic acid producing the corresponding ketone, stearone, by the aluminium stearate originally formed. R. Seligman and P. Williams found that with a mixture of 55 per cent. palmitic acid, 40 per cent. stearic acid, and 5 per cent. oleic acid, no action occurred when heated for 6 hrs. below 270°, but the metal was attacked occasionally at temp. between 270° and 300°. Above 300°, attack invariably took place and, once started, continued if the heating were stopped until the temp. had fallen as low as 100°. The form of attack is very similar to that of butyric acid, although far more rapid. When the acid was heated in a current of dry hydrogen, it was found that the attack started as low as 200°.

A. Lubbert and M. Roscher found that 10 per cent. soln. of palmitic acid, or stearic acid, or pure oleic acid dissolve aluminium foil 0.001 in. thick in 4 days. They also obtained similar results with 1, 5, and 10 per cent. soln. of lactic acid, tartaric acid, citric acid, and phenol. E. R. Hodges said that a cold conc. soln. of tartaric or citric acid does not attack aluminium. G. Lunge and E. Schmid found a 5 per cent. soln. of lactic acid dissolves from sheet aluminium 79.5 mgrms. of aluminium per sq. metre per day at ordinary temp., and that with 1 and 5 per cent. soln. of tartaric and citric acids, and phenol the amounts dissolved are respectively 43.0 and 28.2, 31.7 and 35.8, and 8.2 and 3.8; while with a 0.25 per cent. soln. of salicylic acid, 105.8 is dissolved. A. Ditte made similar observations with respect to citric, oxalic, tartaric, and other acids as those he made with acetic acid. A. Lubbert and M. Roscher found that thin aluminium foil, 0.001 in. thick, is dissolved by two days' immersion in a 2 per cent. soln. of gallic acid, or in 1, 5, and 10 per cent. soln. of oxalic acid. E. E. Mathieu-Plessy found an aq. soln. of oxalic acid attacks aluminium at 200°. E. R. Hodges found that a cold sat. soln. of oxalic acid attacks aluminium slowly, while a hot soln. acts more quickly; the speed slackens at 57°, and below 30° the action is very slow. A. Ditte also studied the effect of oxalic, tartaric and citric acids, and found that the metal is attacked at the first moment of contact which covers the surface of the metal with a layer of hydrogen, and that later on the metal is covered with a film of hydroxide which is gradually dissolved if alkali or alkaline earth halides be present, and hence these salts hasten the attack. R. Degener obtained similar results. A. Benedicenti and S. Rebello-Alves found that aluminium combines with *protein* compounds when the two are shaken together. A. Lubbert and M. Roscher studied the action of red and white *wines*, *coffee*, and *tea*; M. Balland, wine, *beer*, *cider*, *coffee*, *milk*, *oil*, *butter*, *fat*, *urine*, *saliva*, and *damp earth*; G. Rupp, various kinds of liquid and solid foods; and G. Lunge and E. Schmid, *claret*, *hock*, *brandy*, *beer*, *tea*, and *coffee*. The latter said the action of coffee, tea, and beer is practically zero. D. Klein and A. Berg said that aluminium is not attacked by soln. of *sugar*. K. W. Charitschkoff found that aluminium is superior to copper, and equal to iron, in its power of resisting the action of *petroleum* products. J. W. Richards¹⁰ made some observations on the corrosive effects of organic secretions, saliva, and perspiration.

Numerous other observations have been reported on the action of food stuffs, etc., on aluminium cooking and domestic utensils. The general results show that only small traces are dissolved, and, as G. Lunge and R. E. Schmidt said: "There is no danger of any injurious effect on the human body seeing that the food itself contains much more than is dissolved, in fact they could not act injuriously unless quantities hundreds of times larger were regularly entering the stomach." H. St. C. Deville¹¹ also said that the possible compounds which aluminium can form with the materials used *dans la cuisine sont d'une innocuité absolue*. The *Lancet* (1913) also concluded that "any suspicion that aluminium may communicate poisonous qualities to food in the process of cooking may be safely dismissed." The dark stains sometimes produced on aluminium were found by C. K. Tinkler and H. Masters to be produced by a ferruginous impurity.

According to E. Vigouroux, **silicon** does not unite with aluminium when the two elements are heated together, but if a third element be present a mixed silicide is formed (*q.v.*); F. E. Weston and H. R. Ellis could not make the silicide by heating aluminium powder with **silica**; in all cases silicon is formed. According to E. Vigouroux, the reduction occurs at 800°. C. Friedel and L. Roux found that **silicon tetrachloride** acts on aluminium at a red heat, forming free silicon and aluminium chloride. By treating **sodium fluosilicate** with an excess of aluminium, A. Pacz made silicon-aluminium alloys, and by replacing silicon in the complex fluoride by boron, beryllium, scandium, lanthanum, zirconium, iron, cobalt, nickel, copper, and vanadium, corresponding alloys were formed. G. Rauter said the reaction begins at 360°–370°. E. Kohn-Abrest found that when aluminium is heated in a **porcelain** boat at 1100° in vacuo, a yellow film of aluminium silicide is formed. Aluminium vapour attacks porcelain liberating silicon, which is absorbed by the molten aluminium. Molten aluminium was found by D. P. Smith to blacken **glass**. A. L. Williams found that, unlike copper, aluminium did not frit with fused **mica**. C. and A. Tissier, H. St. C. Deville, and F. Wöhler found that glass and **silicates** generally are reduced to silicon by molten aluminium at a high temp. Hence silicate slags rapidly corrode the metal. If the metal be melted in **fireclay** there is a risk of contamination; the silicate in the best plumbago crucibles was found by J. W. Richards to increase the percentage of silicon in aluminium melted therein. H. St. C. Deville found that if aluminium be melted in a glass vessel an alloy of silicon and aluminium, and an alkali aluminate are formed. Magnesia-lined crucibles or furnace beds can be used satisfactorily for melting aluminium.

As indicated above, an aq. soln. of the **alkali hydroxides** is a very active solvent for aluminium; but H. St. C. Deville showed that these remarks do not apply to the fused hydroxide, which does not attack aluminium; he said: "A bead of the pure metal may be dropped into melted sodium hydroxide, contained in a silver vessel, at a red heat, without observing the least disengagement of hydrogen." A. Cavazzi also showed that aluminium is not in the least affected by fused alkali hydroxide provided no extraneous water is present. According to N. N. Beketoff, aluminium reacts with potassium hydroxide at high temp.; some potassium is formed and volatilized. A. Rossel and L. Frank found that when a mixture of **sodium dioxide** and aluminium powder is exposed to damp air, moisture is absorbed and spontaneous inflammation ensues; if the mixture be moistened, a very high temp. is produced. The mixture is dangerous and requires handling with care. According to J. W. Mallet, **calcium, strontium, and barium oxides** are partly reduced at a high temp. by aluminium and the reduced metals are volatilized. N. N. Beketoff obtained alloys of aluminium with up to 33 per cent. barium by heating baryta with an excess of aluminium. J. H. T. Aumann found that **magnesium oxide** is also partially reduced by aluminium. F. E. Weston and H. R. Ellis found that aluminium reduces lime when heat is supplied, and that magnesia is not reduced. Both calcium and magnesium reduce alumina when the mixture is ignited with a fuse.

C. and A. Tissier¹² first noted the reduction of the **metal oxides** by aluminium; they did not succeed in reducing zinc or manganese oxide in this way; but they reduced iron oxide, forming an iron-aluminium alloy; there was a strong explosion with copper oxide, and with lead oxide, 50 grms., and aluminium foil, 2.9 grms., the

crucible was broken to pieces and the doors of the furnace blown off. Aluminium oxide has a very high heat of formation—about 131·2 Cals., and this is equal to or slightly lower than the heats of formation of the oxides of calcium, strontium, lithium, and magnesium, but larger than the heats of formation of sodium, potassium, rubidium, silicon, boron, and most of the other metal oxides. Hence, unless these magnitudes alter adversely with rise of temp. it would be anticipated that aluminium would reduce the metal oxides at high temp. Some such hypothesis guided H. Goldschmidt, who found that the oxides of the alkalies and alkaline earths are reduced with difficulty by aluminium, but practically all the other metal oxides are reduced by heating them with aluminium powder, and he obtained either the metal, or an alloy of the metal, with aluminium, from the oxides of chromium, manganese, iron, copper, titanium, boron, tungsten, molybdenum, nickel, cobalt, zirconium, vanadium, niobium, tantalum, cerium, thorium, barium, calcium, sodium, potassium, lead, and tin. He said :

In a thermite reaction, a metallic compound is reduced by one of several metals or metallic alloys in such a way that when the mixture is ignited at one place, the reaction continues of its own accord, so that under complete oxidation of the reducing element, a fluid slag is formed, while the reduced metal is obtained as a homogeneous uniform regulus ; if the oxide is used in excess, the reduced metal is free, or practically free, from the element used as a reducing agent.

The solid oxide is intimately mixed with rather less than an eq. quantity of granulated aluminium, and is placed in a crucible lined with magnesia. Owing to the high ignition temp. of the mixture, the reaction is started either by burning magnesium, or by the aid of a special ignition powder—a mixture of barium dioxide and aluminium—which is placed on top of the mixture of oxide and aluminium, and lighted with a match. When the reaction has been started in one spot it is propagated throughout the mass with great rapidity. So much heat is generated that the reduced metal is melted. Reductions of this type are called **thermite reactions**, or **aluminothermic reactions**. In these reactions the heat is developed with great rapidity, and the local rise of temp. is very great—estimated in some cases to be 3000° in 60 secs. The system may be likened to a furnace from which gaseous products are not evolved, and in which metals themselves are used as fuel. The process is employed for the production of carbon-free metals or alloys like chromium, manganese, molybdenum, ferro-titanium, ferro-vanadium, ferro-boron, cupro-manganese, etc. A mixture of finely divided aluminium with ferric oxide (or the oxide of some other metal), approximating to $2\text{Al} + \text{Fe}_2\text{O}_3$, is sold under the registered name *thermit*, and it is used in joining or welding iron and steel rails, pipes, etc., and in repairing fractured parts of machinery—engine frames, crank-shafts, etc. The process has been described by W. H. Wahl, E. Stütz, etc. A suitable mould is fitted round the part to be repaired, and molten iron produced by the thermit reaction is allowed to flow into the place where the joint is to be made. A. Colani, C. Matignon, R. Trannoy, and H. Fonzes-Diacon prepared phosphides, arsenides, silicides, and borides by simultaneously reducing two oxides by the thermite reaction. H. Moissan, E. Wedekind, A. Stavenhagen and E. Schuchard, etc., have prepared aluminium alloys by this process. W. H. Greene and W. H. Wahl dissolved the metal oxide in cryolite and reduced it to the metal by means of aluminium.

H. Goldschmidt also showed that other compounds can be reduced by aluminium powder—for example, the **metal sulphides** are more easily reduced than the oxides, as might be anticipated from the smaller heat of formation. The heats of formation of zinc, magnesium, manganese, potassium, sodium, strontium, and calcium sulphides are greater than this, cadmium, iron, etc., less. H. Ditz examined the process with iron sulphides. The **metal sulphates** react more vigorously than the sulphides, and C. Matignon said that mixtures of the sulphates and aluminium powder are often more explosive than with the nitrates. C. and A. Tissier, for instance, found that a violent explosion occurs when potassium and sodium sulphates are melted with aluminium. A. Rossel and L. Frank found that the reduction of **barium**

sulphate and of calcium sulphate is attended by a violent explosion; some sulphur is formed. F. Faktor reduced sodium thiosulphate by heating it with aluminium, and obtained aluminium sulphide. C. Matignon found that the metal chlorides are not suitable for reduction by aluminium on account of their volatility. A. Rossel and L. Frank reduced sodium chloride with aluminium, and they obtained some chlorine in the reaction with chromic chloride. The Chemische Fabrik Griesheim-Elektron reduced potassium fluoride with aluminium: $6KF + Al = 3K + K_3AlF_6$. According to J. W. Richards, when fluorspar is melted it gives off a little hydrofluoric acid vapour, produced by a reaction with the hygroscopic moisture, this forms a little aluminium fluoride; otherwise, the molten fluoride has no action on aluminium. He also stated that cryolite attacks finely divided aluminium at a temp. exceeding 1100° with the possible formation of a subfluoride; but the metal *en masse* is not attacked. When aluminium powder is fused with silver chloride, a silver-aluminium alloy is formed, and when the vapour of mercurous chloride is passed over heated aluminium, mercury and aluminium chloride are volatilized, and the aluminium is melted by the heat of the reaction. C. and A. Tissier found that potassium carbonate is less vigorously reduced by aluminium than the sulphate, some carbon and alkali aluminate being formed. There was no deflagration. According to J. W. Mallet, if a mixture of aluminium and dry sodium carbonate be heated in a carbon or lime crucible, or in a graphite crucible lined with lampblack, sodium is formed and volatilized, and there remains a regulus of aluminium, crystals of alumina, aluminium nitride, and carbon. It is assumed that carbon is separated and sodium aluminate is first formed, and the latter is then reduced by more aluminium. The corrosion and pitting of aluminium when cleaned with soda soln. is eliminated by adding enough sodium silicate to combine with the calcium in the water and form a protective coating of aluminium silicate on the metal. Mixtures of sodium carbonate and silicate are sold under the trade names *carbosil*, *pearl dust*, and *aquamol* for cleaning aluminium vessels. A. Röhrig studied the protective action of sodium silicate on aluminium against attack by soln. of sodium hydroxide and carbonate.

H. St. C. Deville said that aluminium can be fused with potassium nitrate without the least change, even at a red heat. If the temp. be high enough to decompose the nitre, the metal forms potassium aluminate with the liberated potassium oxide, and the reaction is sometimes accompanied by deflagration. Aluminium is purified by fusion with nitre in an iron crucible, but if the fusion be conducted in a fireclay crucible, aluminium silicide is formed, and this is readily oxidized by the alkalis. S. Mierzinsky found that nitre at a red heat oxidizes powdered aluminium, and a blue flame is produced. Nitre is sometimes used as an ingredient in aluminium flash-light powders. According to G. Roth, a mixture of aluminium powder and ammonium nitrate can be used as an explosive; the reaction is symbolized $3NH_4NO_3 + 2Al = 3N_2 + 6H_2O + Al_2O_3$. A number of explosives in which ammonium nitrate and aluminium are mixed with carbon, hydrocarbons, with or without oxidizing agents, has been described by C. E. Bichel, H. von Dahmen, etc.—*e.g. ammonal*. C. and A. Tissier observed no change when a mixture of calcium phosphate and aluminium foil is heated to whiteness. A. Rossel and L. Frank found that many phosphates—*e.g. ammonium sodium hydrophosphate, sodium metaphosphate, bone meal, phosphorite, and magnesium pyrophosphate*—can be heated with aluminium with the formation of aluminium phosphide, alumina, and an aluminate, and some phosphorus is volatilized. If silica be simultaneously present, the whole of the phosphorus is volatilized: $6NaPO_3 + 10Al + 3SiO_2 = 3Na_2SiO_3 + 5Al_2O_3 + 6P$. According to A. Duboin, a mixture of 3 mols of normal calcium phosphate with 8 gram-atoms of aluminium burns with a brilliant flame in air or in an atm. of hydrogen, and when the product of the reaction is treated with water, some phosphine is set free.

According to H. St. C. Deville,¹³ the action of aluminium on any salt can be readily deduced from the action of the metal on the corresponding acid of the salt.

Hence, it could be predicted that in general aluminium will precipitate no metal, not even silver, from acid soln. of the sulphates and nitrates, and this is in agreement with F. Wöhler's observations; but, as C. and A. Tissier have shown, metals may be precipitated from hydrochloric acid soln. Likewise, in alkaline soln., silver, lead, and the more electropositive elements will be precipitated. According to G. A. Maack, the precipitation of metals from soln. of their salts by aluminium is usually easiest in alkaline or ammoniacal soln., less easy in acid soln., and most difficult in neutral soln. Soln. of nitrates are decomposed with the greatest difficulty, and soln. of the chlorides are decomposed most easily; and the addition of an alkali chloride to the nitrate soln. facilitates the reduction. The metallic precipitation is generally accompanied by the evolution of hydrogen. C. Formenti and M. G. Levi investigated the reduction of salts of gold, platinum, palladium, cadmium, lead, tin, beryllium, cerium, niobium, thorium, zirconium, chromium, uranium, thallium, zinc, iron, manganese, mercury, antimony, arsenic, bismuth, silver, copper, cobalt, nickel, silicon, and boron by aluminium. In many cases, the aluminium does not completely replace the metal which is contained in the salt, and the reduced metal is often mixed with more or less aluminium, forming an alloy. In other cases, the metal which first separates subsequently forms a basic salt or is oxidized. The reduction of metallic chlorides takes place the more readily the greater the difference between the heat of formation of aluminium chloride and that of the metallic chloride, and this is also the case with other salts.

The above statements are illustrated by the action of aluminium on **cupric salts**. According to G. A. Maack, neither a cold nor a hot soln. of copper nitrate is reduced by aluminium except in the presence of free acid or an alkali. S. Mierzinsky said that a green basic salt is obtained from the nitrate. G. A. Maack found that a dil. aq. soln. of cupric sulphate is slowly reduced in the cold, and S. Mierzinsky obtained dendrites or octahedra after the mixture had stood two days. G. A. Maack observed that the precipitation is accelerated if sulphuric acid, ammonium or sodium chloride, or sugar be present, and if a drop of potassium hydroxide be added, a dark red precipitate begins to form immediately. An ammoniacal soln. of cupric sulphate is not precipitated by aluminium; copper is immediately precipitated from a soln. of cupric chloride, but some hours are required with a soln. of cupric acetate. A. Cossa, and N. Tarugi applied the reducing power of aluminium on cupric salts to the quantitative determination of copper. With **silver salts**, G. A. Maack observed that aluminium precipitates the metal from a soln. of silver sulphate; F. Wöhler and G. A. Maack, from ammoniacal silver oxide; and A. Cossa, from silver chloride. S. Mierzinsky found that with a feebly acid or neutral soln. of silver nitrate the metal is precipitated in dendrites after standing about 6 hrs. A. Cossa, G. A. Maack, N. Tarugi, and C. H. Hirzel made similar observations; according to J. B. Senderens, aluminium hydroxide and nitric oxide are formed; S. Mierzinsky found that aluminium precipitates silver as a crystalline powder from an ammoniacal soln. of silver chloride, or chromate. F. Wöhler noted that aluminium in contact with zinc reduces a silver nitrate soln. so long as the two metals are in contact. Aluminium rapidly reduces gold from soln. of **gold salts**. C. Moldenhauer found that with an aq. soln. of potassium cyanoaurate: $6\text{KAuCy}_2 + 6\text{KOH} + 2\text{Al} = 6\text{Au} + 12\text{KC}_y + \text{Al}_2\text{O}_3 + 3\text{H}_2\text{O}$. C. H. Crowe studied the action of normal soln. of chlorides, sulphates, and nitrates of the sodium, potassium, and magnesium on aluminium.

According to J. Margottet, all metal chlorides excepting those of potassium and sodium are reduced from their aq. soln., but this statement cannot include the chlorides of the other alkali metals, and those of the metals of the alkaline earths, or the **magnesium salts**. Soln. of aluminium salts give aluminium hydroxide when treated with magnesium. G. A. Maack found that soln. of **zinc salts**—chloride, nitrate, or sulphate—are scarcely changed by aluminium, but both he and A. Cossa precipitated zinc from an alkaline soln. of zinc salts—hydrogen is at the same time evolved. G. A. Maack found that cadmium is slowly and partially precipitated by aluminium from an ammoniacal soln. of **cadmium salts**; aq. soln. of cadmium

chloride are completely reduced; soln. of cadmium sulphate are scarcely affected; and aluminium has no action on soln. of cadmium nitrate. According to S. Mierzinsky, **mercurous salts** are reduced by aluminium; for instance, an alcoholic soln. of mercurous chloride deposits mercury and this more quickly if the soln. be heated; and a soln. of mercurous and potassium iodides is similarly reduced. Aluminium decomposes soln. of the **mercuric salts**—chloride, cyanide, and nitrate; and also, according to G. A. Maack, the sulphate, potassium mercuric sulphide, nitrate at 50°–60°; or, according to A. Cossa, potassium mercuric iodide, and an alcoholic soln. of the chloride. In each case, the separated mercury forms aluminium amalgam, which then attacks the water, forming aluminium hydroxide and mercury. R. Varet found that with mercuric cyanide dissolved in water-free ammoniacal alcohol, a double salt of mercury and aluminium is formed. L. Bernegau studied the action of aluminium on the different salts of mercury. By treating a soln. of mercuric chloride with aluminium in the presence of water, or other solvent, Gehe and Co. found that a colloidal mixture of mercurous chloride, aluminium oxychloride, and hydroxide is produced.

H. St. C. Deville found that aluminium is attacked by soln. of **aluminium salts** with the evolution of hydrogen; and, according to C. Formenti and M. Levy, aluminium chloride is reduced to a subchloride. G. Lemoine found that the quantity of hydrogen set free is greater than corresponds with the amount of metal dissolved, and therefore inferred that aluminium acts catalytically on the decomposition of water. A soln. of **alum** does not attack the metal, but in the presence of sodium chloride the metal is dissolved with the evolution of hydrogen. In neither case has the salt any marked action, but the two salts jointly attack the metal severely. A. Cossa found that soln. of **thallium salts** are reduced by aluminium. According to G. A. Maack, **tin salts** are reduced by aluminium—soln. of stannous and stannic chlorides rapidly, and sodium stannate slowly—F. Wöhler obtained needle-like crystals of tin from a soln. of potassium stannate. Crystals of lead were found by S. Mierzinsky to be slowly precipitated by aluminium from soln. of **lead salts**—nitrate or acetate; G. A. Maack found a trace of lead was obtained from a soln. of lead nitrate after a week's time; and lead acetate is not affected even if the soln. be warmed. F. Wöhler said that no lead is precipitated from neutral or acid soln. of lead nitrate, but a lead-tree is obtained from alkaline soln.; some gas is developed at the same time. S. Mierzinsky found aluminium precipitates lead and chromic oxide from an alkaline soln. of lead chromate. A. Cossa also studied this reaction. G. A. Maack found that lead is obtained by leaving lead sulphate for some time in contact with aluminium and sulphuric acid. G. A. Maack found that **bismuth salts** are incompletely reduced by aluminium; soln. of **tungstates and molybdates** are reduced to blue lower oxides, and **uranyl sulphate** is likewise reduced. With manganese salts and aluminium, G. A. Maack found that the chloride is immediately decomposed while the sulphate and nitrate are scarcely, if at all, affected. W. Crookes found a boiling soln. of potassium permanganate slowly oxidizes aluminium. G. A. Maack found that **ferric salts**—chloride and sulphate—are slowly reduced, precipitating iron and giving off hydrogen; while **potassium ferrocyanide and ferricyanide** give blue precipitates. R. Böttger said that potassium ferricyanide is not reduced by aluminium. G. A. Maack found that **nickel and cobalt chlorides** are reduced by aluminium, and soln. of the other salts are but slowly changed. Soln. of **platinum salts** are rapidly reduced. A. Korczynsky studied the catalytic action of aluminium or its salts on the hydrogenation of aromatic hydrocarbons.

Some reactions of analytical interest.—The salts of aluminium have an acid, astringent taste, with a slightly sweet flavour, and, unless coloured by the acid radical, they are colourless. The salts are not precipitated by hydrochloric acid, or hydrogen sulphide in acid soln.; aq. **ammonia** produces a white gelatinous or colloidal precipitate of aluminium hydroxide which is slightly soluble in the reagent, but is less soluble in the presence of ammonium salts. The precipitate is deflocculated or peptized when the salts are removed from the precipitate by washing; this is

prevented by washing with a soln. of ammonium chloride or nitrate. Freshly precipitated aluminium hydroxide is readily soluble in dil. acids, but it is not so easily dissolved if it has stood for some time. F. Jackson¹⁴ said that the precipitation of the hydroxide by ammonia can be detected in soln. containing one part of aluminium salt in 8000 parts of water. A similar precipitation occurs when **potassium or sodium hydroxide** is added to the soln. of aluminium salt, but in this case the precipitate is soluble in an excess of the reagent owing to the production of a soluble alkali aluminate, Al(OM)_3 . The addition of a dil. acid to an alkali aluminate first precipitates aluminium hydroxide, and with a further addition all is dissolved. The aluminates are decomposed by the addition of ammonium salts. Aluminium hydroxide is soluble in tartaric, malic, citric, and many other organic acids, also in starch, sugar, etc. Hence, the presence of these compounds prevents the precipitation of aluminium hydroxide by alkali-lye, or aq. ammonia. Aluminium hydroxide is also precipitated by **ammonium sulphide** because the aluminium sulphide is hydrolyzed as fast as it is formed; by a boiling soln. of **sodium thio-sulphate** owing to the hydrolysis of the aluminium thiosulphate; by acidifying the soln. with hydrochloric acid, and boiling with **sodium or ammonium nitrite**, as recommended by G. Wynkoop, and E. Schirm (iron, and chromium, but not zinc, manganese, cobalt, or nickel hydroxides, are precipitated); by adding **phenylhydrazine**, as recommended by W. H. Hess and E. D. Campbell, and E. T. Allen (chromium, titanium, zirconium, and thorium are precipitated, but not ferrous iron, beryllium, manganese, zinc, cobalt, or nickel); by **potassium, sodium, or ammonium carbonate or hydrocarbonate**, because the aluminium carbonate is hydrolyzed by water; and, according to J. N. von Fuchs, by **calcium or barium carbonate** suspended in water—here, too, aluminium carbonate is presumably formed and hydrolyzed.

No precipitation occurs if an **alkali acetate** be added to a cold neutral soln. of an aluminium salt, but if the soln. be boiled the aluminium acetate is partially hydrolyzed, and a basic acetate, $\text{Al(OH)}_2(\text{C}_2\text{H}_3\text{O}_2)$, is precipitated. The reaction is reversible, for the precipitate redissolves as the soln. cools. The presence of tartaric acid and many other organic acids prevents the precipitation. Similar results are obtained with an **alkali succinate** or an **alkali formate**. Aluminium salt soln. give no precipitate with **alkali tartrates, alkali oxalates, tartaric acid, oxalic acid, or hydrofluosilicic acid**. A gelatinous precipitate of aluminium phosphate, AlPO_4 , is produced when an **alkali or ammonium phosphate** is added to a soln. of an aluminium salt. The precipitate is soluble in mineral acids, but, unlike the phosphates of magnesium and of the alkaline earths, it is insoluble in acetic acid. Aluminium phosphate is soluble in alkali-lye, and when the soln. is boiled with ammonium chloride, a mixture of aluminium phosphate and hydroxide is precipitated; the addition of barium chloride to the soln. precipitates barium phosphate, and leaves the aluminate in soln.

If **potassium sulphate** be added to a conc. soln. of an aluminium salt, crystals of alum are formed. According to E. F. Anthon, **sodium tungstate** precipitates aluminium salts completely; and, according to I. von Ittner, **potassium ferrocyanide** gives a white precipitate—slowly when cold, rapidly when heated—the precipitate soon becomes green and blue. When tincture of **morin** is added to a dil. soln. of an aluminium salt, F. Goppelsröder obtained a fine green fluorescence not given by beryllium and the rare earths; a decoction of **campechy wood** was found by G. Horsley and E. Schumacher-Kopp, to give characteristic colours; and a **tincture of cochineal** was found by C. Luckow to behave similarly. According to F. W. Atack, **alizarin** gives a red colour which can be recognized when one part of aluminium is present in 10 million parts of soln. When aluminium compounds are heated with sodium carbonate on charcoal before the blowpipe, they give a white, infusible, brightly glowing oxide, which, when moistened with cobalt nitrate soln. and again heated, furnish a blue infusible mass of Thenard's blue.

Some uses of aluminium.—In its early days aluminium was unlucky in that exaggerated statements of its wonderful properties were in circulation. Anticipation

transcended reality. The high place finally accorded to the metal fell short of first expectations. Some were disappointed, and exaggerated the importance of its defects. Hence, said H. Moissan¹⁵: *l'aluminium est le métal de l'avenir pour les uns, et le métal de la déception pour les autres*. J. W. Richards has said that one of the greatest metallurgical achievements of the nineteenth century was undoubtedly the addition of aluminium to the metals of everyday life. Aluminium is now manufactured in numerous forms, wires, bars, tubes, sheets, powder, foil, and ingots. It is used in the manufacture of domestic utensils. Its lightness, difficulty of corrosion, ease in keeping clean, and high thermal conductivity make its use for cooking-utensils particularly advantageous. It is used largely for military equipments when it is necessary to reduce to a minimum the weight to be carried by each soldier; it is used in the canteens, for buttons, belt-plates, tent-rings, the scabbards and handles of swords, etc. Its use in chemical laboratories for air-baths, water-baths, Bunsen burners, hot-water filtering funnels, and condenser tubes has been discussed by T. H. Norton; and its use in the construction of chemical plant by R. Seligman. It is used in the construction of surgical instruments—handles of knives and saws, speculum instruments, etc. Aluminium plates have been used as a substitute for the stone in lithographic work. Alloys with aluminium as the predominant metal are largely used for constructional purposes—parts of bicycles, motor cycles, motor cars, torpedo boats, yachts, aeroplanes, etc. The high electrical conductivity of aluminium and its non-magnetic properties enable aluminium or its alloys to replace much of the brass work in electrical apparatus. Its use as an electrical conductor was discussed by M. Wunder. It is used for portable telephone and telegraphic work—*vide supra*, electrical conductivity of aluminium. It is used for letters and signs to be attached to glass and wood. Aluminium-leaf is used as wrapping foil, and for decorative work, where it has largely superseded silver-leaf for this purpose. Powdered aluminium is used in large quantities as a decorative paint called by the trade-name *aluminium bronze*.

Aluminium is largely used in the manufacture of steel ingots and castings—A. Borsig, R. L. Packard, B. Talbot, etc. Up to 4 ozs. are added as the steel is being poured into the ingot moulds or group of moulds. It increases the soundness of the tops of ingots and thus decreases the scrap which more than compensates for the cost of the small proportion of aluminium used. Aluminium quietens the ebullition of steel. When steel, without the addition, is poured from the ladle into the ingot mould, it boils for 10–15 mins. before freezing at the top, and when freezing, it rises 8–10 ins. in the mould; with the addition of aluminium, the steel comes up to the required level and remains there, freezing over within 30–45 secs.; the steel is afterwards poured into the mould. The steel with the addition is more homogeneous; it has a greater tensile-strength; the castings have a smoother surface, and are less afflicted with blowholes. The aluminium removes any oxygen or oxides and acts as a deoxidizer. It also renders the steel less liable to oxidize during casting. Aluminium improves the casting of ordinary cast iron. The uses of aluminium in thermite reductions, and in the manufacture of explosives, and flash-light powders have already been described. J. W. Richards gives a list of about 200 commercial and technical applications of aluminium. Aluminium can be autogenously welded,¹⁶ but the difficulty in soldering the metal is a disadvantage.

REFERENCES.

¹ J. B. A. Dumas, *Compt. Rend.*, **90**. 1027, 1880; E. Cohnstädt, *Ann. Physik*, (4), **33**. 223, 1912; F. Paneth, M. Matthies, and E. Schmidt-Hebbel, *Ber.*, **55**. 775, 1922; J. Czochralsky, *Zeit. Metallkunde*, **14**. 277, 1922; G. Neumann and F. Streintz, *Monatsh.*, **12**. 642, 1892; *Wied. Ann.*, **46**. 431, 1892; R. von Hirsch and F. Soddy, *Phil. Mag.*, (6), **14**. 779, 1907; M. Guichard and P. R. Jourdain, *Compt. Rend.*, **155**. 160, 1912; E. Duter, *ib.*, **109**. 108, 1889; A. Berliner, *Wied. Ann.*, **35**. 791, 1888; H. G. Deming and B. C. Hendricks, *Journ. Amer. Chem. Soc.*, **45**. 2857, 1923.

² F. Wöhler, *Liebig's Ann.*, **53**. 422, 1845; **113**. 249, 1859; **116**. 127, 1860; E. von Bibra, *ib.*, **114**. 382, 1860; H. Buff, *ib.*, **110**. 357, 1859; H. St. C. Deville, *L'aluminium*, Paris, 1859;

Ann. Chim. Phys., (3), 43. 11, 1855; J. H. Baille and C. Féry, *ib.*, (6), 17. 246, 1889; G. Werther, *Journ. prakt. Chem.*, (1), 81. 320, 1860; G. H. Bailey *Journ. Soc. Chem. Ind.*, 39. 120, T, 1920; H. Hinze, *Dingler's Journ.*, 227. 277, 1877; C. Jehn and H. Hinze, *Ber.*, 7. 1498, 1874; C. Jehn, *Arch. Pharm.*, (3), 12. 126, 1878; *Pharm. Centr.*, 48. 142, 1907; C. Reichard, *ib.*, 48. 103, 1907; E. O. Erdmann, *Wied. Ann.*, 48. 780, 1893; H. F. Hunt and L. J. Steele, *Journ. Soc. Chem. Ind.*, 15. 849, 1896; V. Zunino, *Gazz. Chim. Ital.*, 30. i, 194, 1900; P. Spica, *ib.*, 31. i, 67, 1901; *Boll. Chim. Farm.*, 40. 341, 1901; G. le Bon, *Compt. Rend.*, 131. 706, 1900; C. Matignon, *ib.*, 130. 1391, 1900; A. Duboin, 132. 826, 1901; P. R. Jourdain, *ib.*, 150. 391, 1602, 1910; E. Kohn-Abrest, *ib.*, 141. 323, 1905; *Bull. Soc. Chim.*, (3), 31. 232, 1904; H. Moissan, *ib.*, (3), 11. 825, 1894; N. B. Pilling and R. E. Bedworth, *Chem. Trad. Journ.*, 72. 317, 1923; G. A. Maack, *Untersuchungen über das Verhalten des Magnesiums und Aluminiums zu den Salzlösungen verschiedener Metalle*, Göttingen, 1862; R. J. Zink, *Chem. Zig.*, 35. 1370, 1911; H. Stockmeier, *ib.*, 30. 580, 1906; O. Edelmann, *ib.*, 30. 935, 951, 1906; M. M. Richter, *ib.*, 30. 324, 1906; 32. 136, 1908; 33. 220, 1909; J. W. Mallet, *Chem. News*, 46. 178, 1882; A. Liversidge, *ib.*, 71. 134, 1895; W. Muthmann and K. Kraft, *Liebig's Ann.*, 325. 261, 1902; M. Degousse, *Répert. Chim. App.*, 435, 488, 1859; A. M. Villon, *Bull. Soc. Phot.*, 8. 134, 1892; M. Bamberger and H. von Jüptner, *Zeit. anorg. Chem.*, 26. 353, 1913; A. Leighton, *Tech. Pap. Bur. Mines*, 152, 1919; H. E. Armstrong, *B.A. Rep.*, 962, 1885; *Proc. Roy. Soc.*, 40. 287, 1886; 70. 99, 1902; 74. 86, 1904; *Journ. Chem. Soc.*, 49. 112, 1886; 67. 1122, 1895; 83. 1088, 1903; O. Bauer, *Zeit. angew. Chem.*, 20. 239, 1914.

³ H. St. C. Deville, *L'aluminium*, Paris, 1859; *Ann. Chim. Phys.*, (3), 43. 11, 1855; A. Ditte, *ib.*, (6), 20. 404, 1980; F. Wöhler, *Liebig's Ann.*, 53. 422, 1845; 113. 249, 1859; 116. 127, 1860; R. Bunsen, *Pogg. Ann.*, 92. 648, 1854; A. Duboin *Compt. Rend.*, 132. 826, 1901; C. Matignon, *ib.*, 130. 1391, 1900; G. le Bon, *ib.*, 131. 706, 1900; F. Mylius and F. Rose, *Zeit. Instr.*, 13. 77, 1893; L. Hugouenq, *Journ. Pharm. Chim.*, (6), 1. 537, 1895; M. C. Schuyten, *Chem. Zig.*, 20. 129, 1896; W. Smith, *Journ. Soc. Chem. Ind.*, 23. 475, 1904; A. Liversidge, *Chem. News*, 71. 135, 1895; W. R. Ormandy and J. B. Cohen, *Journ. Chem. Soc.*, 57. 811, 1890; J. H. Gladstone and A. Tribe, *ib.*, 28. 822, 1875; J. Wislicenus, *Journ. prakt. Chem.*, (2), 54. 18, 1896; C. Tissier, *Bull. Soc. Chim.*, (1), 1. 380, 1859; W. van Rijn, *Chem. Weekb.*, 5. 1, 1908; H. T. Barnes and G. W. Shearer, *Journ. Phys. Chem.*, 12. 155, 468, 1908; R. Scala, *Atti Accad. Lincei*, (5), 22. i, 43, 95, 1913; F. Schönfeld and G. Himmelfarb, *Wochenschr. Brauerei*, 29. 409, 1912; M. Traube-Mengarini and A. Scala, *Atti Accad. Lincei*, (5), 19. ii, 605, 1910; A. Scala, *ib.*, (5), 22. i, 43, 95, 1913; J. H. Baille and C. Féry, *Ann. Chim. Phys.*, (6), 17. 246, 1889; P. Spica, *Gazz. Chim. Ital.*, 31. ii, 67, 1901; *Boll. Chim. Farm.*, 40. 341, 1901.

⁴ E. Heyn and O. Bauer, *Mit. Materialprüfungsamt.*, 29. 2, 1911; G. H. Bailey, *Journ. Soc. Chem. Ind.*, 39. 121, T, 1920; *Journ. Inst. Metals*, 9. 79, 1913; H. S. Rawdon, A. I. Krynitsky, and J. F. T. Berliner, *Chem. Met. Eng.*, 26. 154, 1922; O. Ohmann, *Ber.*, 53. 1427, 1920; L. Guillet, *Rév. Met.*, 10. 769, 1913; W. Smith, *Journ. Soc. Chem. Ind.*, 22. 132, 1903; 23. 475, 1904; W. R. E. Hodgkinson and A. H. Cooze, *Chem. News*, 90. 142, 1904; J. W. Mallet, *ib.*, 46. 178, 1882; C. Göttig, *German Pat., D.R.P.*, 86610, 1894; C. Tissier, *Compt. Rend.*, 41. 362, 1855; A. Ditte, *ib.*, 127. 919, 1898; 128. 195, 1899; C. Formenti and M. Levy, *Boll. Chim. Farm.*, 40. 689, 1901; *Gazz. Chim. Ital.*, 32. i, 34, 1902; A. Cavazzi, *ib.*, 15. 202, 1885; A. E. Hunt, *Journ. Franklin Inst.*, 133. 241, 1892; J. W. Richards, *ib.*, 139. 69, 1895; *Aluminium*, Philadelphia, 97, 1896; A. Liversidge, *Chem. News*, 71. 134, 1895; 77. 207, 1898; A. Trillat, *Bull. Soc. Nat. Ind.*, 133. 813, 1921; E. Donath, *Zeit. angew. Chem.*, 8. 141, 1895; F. Zmerlikar, *ib.*, 8. 468, 1895; A. Stutzer, *ib.*, 3. 695, 1890; A. Ditte, *Compt. Rend.*, 127. 919, 1898; 128. 195, 793, 971, 1899; *Ann. Chim. Phys.*, (7), 16. 152, 1899; H. St. C. Deville, *ib.*, (3), 43. 11, 1855; A. Barillé, *Journ. Pharm. Chim.*, (7), 61. 110, 1912; F. Wöhler, *Liebig's Ann.*, 113. 249, 1860; K. L. Meissner, *Zeit. Metallkunde*, 14. 434, 1922; J. Czochralsky, *ib.*, 12. 431, 1920; S. Kappel, *Arch. Pharm.*, (3), 25. 448, 1887; J. Bogusky and J. Zaljesky, *Chem. Zig.*, 14. 146, 1890; E. Beckmann, *Journ. prakt. Chem.*, (2), 26. 392, 1882; *Ber.*, 14. 2151, 1881; A. J. Hale and H. S. Foster, *Journ. Soc. Chem. Ind.*, 34. 461, 1915; H. C. H. Carpenter and C. A. Edwards, *Rep. Alloys Research Committee*, 8. 216, 1907; C. H. Crowe, *Canadian Chem. Met.*, 6. 151, 1922; A. Röhrig, *Chem. Zig.*, 47. 528, 1923; R. Seligman and P. Williams, *Journ. Inst. Metals*, 28. 297, 1922.

⁵ H. T. Barnes and G. W. Shearer, *Journ. Phys. Chem.*, 12. 155, 468, 1908; C. Weltzien, *Bull. Soc. Chim.*, (1), 5. 262, 1866; O. Droste, *Chem. Zig.*, 37. 1317, 1913; O. Ohmann, *Ber.*, 53. 1427, 1920.

⁶ H. Moissan, *Le fluor et ses composés*, Paris, 206, 1900; *Bull. Soc. Chim.*, (3), 5. 880, 1891; F. Wöhler, *Liebig's Ann.*, 113. 249, 1860; H. Gautier and G. Charpy, *Compt. Rend.*, 113. 597, 1891; C. Matignon, *ib.*, 130. 1390, 1900; J. Nicklès, *ib.*, 52. 869, 1861; C. Friedel and L. Roux, *ib.*, 100. 1191, 1885; J. B. Cohen, *Chem. News*, 54. 305, 1886; J. W. Mallet, *ib.*, 46. 178, 1882; G. Gore, *ib.*, 49. 1, 1884; L. Kahlenberg and H. Schlundt, *Journ. Phys. Chem.*, 6. 447, 1903; F. and W. Mylius, *Zeit. anorg. Chem.*, 114. 27, 1920; F. Mylius, *Zeit. Metallkunde*, 14. 233, 1922; H. J. Prins, *Proc. Acad. Amsterdam*, 23. 1449, 1922; A. Sieverts and P. Lueg, *Zeit. anorg. Chem.*, 126. 193, 1923; J. W. Richards, *Aluminium*, Philadelphia, 91, 1896; A. D. White, *Journ. Soc. Chem. Ind.*, 22. 132, 1903; A. J. Hale and H. S. Foster, *ib.*, 34. 464, 1915; G. H. Bailey, *ib.*, 39. 120, T, 1920; W. S. Hendrixson, *Journ. Amer. Chem. Soc.*, 26. 747, 1904; D. Tommasi, *Mem. Ist. Lombardo*, (3), 1. 799, 1867; E. Kohn-Abrest, *Bull. Soc. Chim.*, (4), 5. 768, 1909; F. Stockhausen and L. Gattermann, *Ber.*, 25. 3521, 1892; R. Selgman and P. Williams, *Journ. Soc. Chem. Ind.*, 36. 410, 1917; D. Venditori, *Gazz. Chim. Ital.*, 37. ii, 383, 1907; E. R. Hodges,

Chem. News, **121**, 178, 1920; **123**, 141, 1921; H. St. C. Deville, *Ann. Chim. Phys.*, (3), **43**, 15, 1855.

⁷ A. Orlowsky, *Journ. Russ. Phys. Chem. Soc.*, **13**, 547, 1881; W. Spring, *Bull. Acad. Belg.*, (3), **5**, 492, 1883; *Bull. Soc. Chim.*, (2), **39**, 461, 1883; *Chem. News*, **48**, 66, 1883; M. G. Levi, E. Migliorini, and G. Ercolini, *Gazz. Chim. Ital.*, **38**, i, 583, 1908; H. St. C. Deville, *Ann. Chim. Phys.*, (3), **43**, 11, 1855; J. W. Richards, *Aluminium*, Philadelphia, **86**, 97, 1896; H. Fonze-Diacon, *Contribution à l'étude des sélénures métalliques*, Montpellier, 1901; *Compt. Rend.*, **130**, 1314, 1900; C. Matignon, *ib.*, **130**, 1391, 1900; J. Margottet, *ib.*, **52**, 931, 1861; A. Ditte, *ib.*, **110**, 583, 782, 1890; *Ann. Chim. Phys.*, (6), **19**, 68, 1891; J. Uhl, *Ber.*, **23**, 2151, 1890; J. M. Weeren, *ib.*, **24**, 1798, 1891; F. Wöhler, *Pogg. Ann.*, **11**, 159, 1827; P. B. Ganguly and B. C. Banerji, *Zeit. anorg. Chem.*, **124**, 140, 1922; A. Sieverts and P. Lueg, *ib.*, **126**, 193, 1923; R. Seligman, *Journ. Soc. Chem. Ind.*, **35**, 93, 1916; P. Degener, *Hyg. Rund.*, **9**, 116, 1899; *Zeit. angew. Chem.*, **20**, 274, 1899; P. Schweitzer, *Amer. Chemist*, (2), **1**, 296, 1871; G. A. le Roy, *Bull. Soc. Ind. Rouen*, **19**, 232, 1891; F. Winteler, *Die Aluminium-Industrie*, Braunschweig, **21**, 1903; W. Smith, *Journ. Soc. Chem. Ind.*, **23**, 475, 1904; A. J. Hale and H. S. Foster, *ib.*, **34**, 464, 1915; A. Cavazzi, *Mem. Accad. Bologna*, (4), **7**, 27, 1887; G. A. Maack, *Untersuchungen über das Verhalten des Magnesiums und Aluminiums zu den Salzlösungen verschiedener Metalle*, Göttingen, 1862; G. H. Bailey, *Journ. Soc. Chem. Ind.*, **39**, 120, T, 1920; H. E. Roscoe, *ib.*, **8**, 463, 1889; *Chem. News*, **59**, 283, 1889; P. Pascal, C. Garnier, and M. Labourrassé, *Mém. poudres*, **20**, 21, 1923; *Bull. Soc. Chim.*, (4), **29**, 701, 1923.

⁸ F. Briegleb and A. Geuther, *Liebig's Ann.*, **123**, 236, 1862; J. W. Mallet, *Journ. Chem. Soc.*, **30**, 349, 1876; E. Divers and T. Haga, *ib.*, **47**, 623, 1885; T. Curtius and J. Rissom, *Journ. prakt. Chem.*, (2), **58**, 297, 1898; C. Göttig, *German Pat.*, D.R. P. 86610, 1896; J. W. Richards, *Aluminium*, Philadelphia, **90**, 1896; C. Matignon, *Compt. Rend.*, **130**, 1391, 1900; P. Sabatier and J. B. Senderens, *ib.*, **114**, 1429, 1892; **115**, 236, 1892; A. Ditte, *ib.*, **110**, 573, 782, 1890; **127**, 919, 1898; **128**, 195, 1899; *Ann. Chim. Phys.*, (6), **20**, 404, 1890; (7), **16**, 152, 1899; H. St. C. Deville, *ib.*, (3), **43**, 11, 1855; *Compt. Rend.*, **38**, 279, 1854; H. Fonze-Diacon, *ib.*, **130**, 1314, 1900; F. Wöhler, *Liebig's Ann.*, **113**, 249, 1860; W. Smith, *Journ. Soc. Chem. Ind.*, **23**, 475, 1904; R. Seligman and P. Williams, *ib.*, **35**, 665, 1916; A. J. Hale and H. S. Foster, *ib.*, **34**, 464, 1915; R. Woy, *Zeit. öffentl. Chem.*, **9**, 158, 1903; T. B. Stillmann, *Journ. Amer. Chem. Soc.*, **19**, 711, 1897; A. H. White and L. Kirschbraun, *ib.*, **28**, 1343, 1906; O. Guttman, *ib.*, **15**, 850, 1896; J. W. Mallet, *Chem. News*, **46**, 178, 1882; C. M. van Deventer, *Chem. Weekb.*, **4**, 69, 1907; Q. A. Mansuri, *Journ. Chem. Soc.*, **121**, 2272, 1922; L. Losana, *Giorn. Chim. Ind. App.*, **5**, 67, 1923; A. Quartaroli, *Gazz. Chim. Ital.*, **53**, i, 345, 1923; G. Lunge and R. E. Schmid, *Zeit. angew. Chem.*, **5**, 7, 1892; *Chem. News*, **65**, 110, 1892; H. E. Roscoe, *Proc. Roy. Inst.*, **12**, 451, 1889; A. le Roy, *Bull. Soc. Ind. Rouen*, **19**, 232, 1892; B. Reinitzer and H. Goldschmidt, *Ber.*, **12**, 845, 1880; H. Goldschmidt, *Chem. Centr.*, (3), **12**, 493, 1881; F. Winteler, *Die Aluminium-Industrie*, Braunschweig, **21**, 1903; J. J. Sudborough, *Journ. Chem. Soc.*, **59**, 655, 1891; G. G. Henderson and J. C. Galletly, *Journ. Soc. Chem. Ind.*, **27**, 387, 1908; S. Kappel, *Arch. Pharm.*, (3), **24**, 897, 1887; P. Pascal, C. Garnier, and M. Labourrassé, *Bull. Soc. Chim.*, (4), **29**, 701, 1921; *Mém. poudres*, **20**, 21, 1923; O. Ruff and K. Staib, *Zeit. anorg. Chem.*, **117**, 191, 1921; G. A. Maack, *Untersuchungen über das Verhalten des Magnesiums und Aluminiums zu den Salzlösungen verschiedener Metalle*, Göttingen, 1862; A. Trillat, *Bull. Soc. Enc. Nat., Ind.*, **122**, 547, 1915; F. W. Bergstrom, *Journ. Amer. Chem. Soc.*, **45**, 2788, 1923; E. Müller and H. Barck, *Zeit. anorg. Chem.*, **129**, 309, 1923.

⁹ H. Moissan, *Compt. Rend.*, **115**, 203, 1892; A. Ditte, *ib.*, **127**, 919, 1898; *Ann. Chim. Phys.*, (7), **16**, 152, 1899; A. Guntz and A. Masson, *Compt. Rend.*, **124**, 187, 1897; C. Matignon, *ib.*, **130**, 1392, 1900; E. E. Mathieu-Plessy, *ib.*, **97**, 1033, 1883; D. Klein and A. Berg, *ib.*, **102**, 1170, 1886; *Bull. Soc. Chim.*, (2), **45**, 864, 1886; L. Franck, *ib.*, (3), **11**, 439, 1894; N. Wender, *Pharm. Post*, **25**, 201, 1892; K. Brunner, *Ber.*, **38**, 1432, 1905; L. Hugonienq, *Journ. Pharm. Chim.*, (6), **1**, 537, 1895; G. Rauter, *Liebig's Ann.*, **270**, 236, 1892; F. Wöhler, *ib.*, **113**, 249, 1860; W. Smith, *Journ. Soc. Chem. Ind.*, **23**, 475, 1904; R. Seligman and P. Williams, *ib.*, **35**, 88, 1916; **36**, 409, 1917; **37**, 159, 1918; A. J. Hale and H. S. F. Foster, *ib.*, **34**, 464, 1915; F. Heeren, *Mit. Gewerbever. Hannover*, **340**, 1855; P. Degener, *Hyg. Rund.*, **9**, 116, 1899; *Zeit. angew. Chem.*, **20**, 274, 1899; A. Brochet and J. Petit, *Bull. Soc. Chim.*, (3), **31**, 359, 1255, 1904; *Chem. News*, **91**, 67, 1905; H. St. C. Deville, *Ann. Chim. Phys.*, (3), **43**, 15, 1855; J. W. Mallet, *Journ. Chem. Soc.*, **30**, 349, 1876; T. H. Easterfield and C. M. Taylor, *ib.*, **99**, 2298, 1911; A. Lubbert and M. Roscher, *Pharm. Centr.*, **32**, 542, 1891; G. Lunge and E. Schmid, *Zeit. angew. Chem.*, **5**, 7, 1892; *Chem. News*, **65**, 110, 1892; G. Rupp, *Dingler's Journ.*, **283**, 19, 1892; M. Balland, *Compt. Rend.*, **114**, 1536, 1892; **121**, 381, 1895; *Ann. Chim. Anal. App.*, **3**, 109, 1898; C. and A. Tissier, *Guide pratique de la recherche, de l'extraction, et de la fabrication de l'aluminium et des métaux alcalins*, Paris, 1858; *Compt. Rend.*, **43**, 1198, 1865; K. W. Charit-schkoff, *Proc. Russ. Tech. Soc.*, **11**, 16, 1896; G. A. Maack, *Untersuchungen über das Verhalten des Magnesiums und Aluminiums zu den Salzlösungen verschiedener Metalle*, Göttingen, 1862; E. R. Hodges, *Chem. News*, **121**, 178, 1920; **123**, 141, 1921; G. H. Bailey, *Journ. Soc. Chem. Ind.*, **39**, 120, T, 1920; A. Benedicenti and S. Rebello-Alves, *Arch. Internal. Pharmacodynamie*, **26**, 397, 1922.

¹⁰ A. Arche, *Dingler's Journ.*, **284**, 255, 1892; F. Zmerziukar, *Zeit. angew. Chem.*, **8**, 468, 1895; C. Winkler, *ib.*, **5**, 69, 1892; W. Ouhmüller and R. Heise, *Arb. Kais. Ges. Amt.*, **8**, 377, 1892; L. Aubry, *Chem. Ztg.*, **15**, 1078, 1892; R. Kobert, *ib.*, **15**, 821, 1892; M. Plagge, *ib.*, **15**.

1198, 1892; N. Wender, *Pharm. Centrbl.*, **35**, 298, 1892; F. Göpel, *Zeit. Instr.*, **12**, 419, 1892; C. Schmitz, *Hygien. Rund.*, **4**, 33, 1894; H. Moissan, *Compt. Rend.*, **128**, 895, 1899; A. Ditte, *ib.*, **128**, 195, 793, 971, 1899; F. A. Q. van Gelder, *Nederl. Tijds. Pharm.*, **7**, 117, 1895; J. W. Richards, *Journ. Franklin Inst.*, **139**, 69, 1895; A. E. Hunt, *ib.*, **133**, 241, 1892; G. J. Hough, *Journ. Amer. Chem. Soc.*, **20**, 302, 1898; F. Schönfeld, *Wochenschr. Brauerei*, **22**, 79, 1905; F. L. Nathan and E. Schmid, *Centrb. Bakteriolog.*, **14**, 289, 1905; E. Kohn-Abrest, *Bull. Assoc. Chem. Sucr. Dist.*, **24**, 1395, 1907; R. Köhler, *Chem. Centr.*, (4), **5**, i, 873, 1893; V. A. Fillingier, *Zeit. Untersuch. Nabr. Genuss.*, **16**, 232, 1908; C. Bleisch, *Zeit. Ges. Brau.*, **35**, 49, 1912; G. H. Bailey, *Journ. Soc. Chem. Ind.*, **39**, 120, T, 1920; G. Lunge and B. E. Schmidt, *Zeit. angew. Chem.*, **5**, 1, 1892.

¹¹ E. Kohn-Abrest, *Compt. Rend.*, **150**, 169, 1910; C. Friedel and L. Roux, *ib.*, **100**, 1191, 1885; E. Vigouroux, *ib.*, **120**, 1161, 1895; **141**, 951, 1905; G. Rauter, *Liebig's Ann.*, **270**, 236, 1892; F. E. Weston and H. B. Ellis, *Trans. Faraday Soc.*, **3**, 170, 1907; D. P. Smith, *Zeit. anorg. Chem.*, **56**, 109, 1907; J. W. Richards, *Aluminium*, Philadelphia, 103, 1896; H. St. C. Deville, *Ann. Chim. Phys.*, (3), **43**, 15, 1855; F. Wöhler, *Liebig's Ann.*, **113**, 249, 1860; C. and A. Tissier, *Guide pratique de la recherche de l'extraction, et de la fabrication de l'aluminium et des métaux alcalins*, Paris, 1858; R. Seligman and P. Williams, *Journ. Inst. Metals*, **28**, 297, 1922; A. Röhrig, *Chem. Ztg.*, **47**, 528, 1923; *Metal Ind.*, **23**, 125, 1923; A. L. Williams, *Phil. Mag.*, (6), **40**, 281, 1920; N. N. Beketoff, *ib.*, (4), **31**, 306, 1865; *Zeit. Chem.*, (2), **1**, 376, 1864; A. Rossel and L. Franck, *Bull. Soc. Chim.*, (3), **11**, 200, 1894; J. W. Mallet, *Journ. Chem. Soc.*, **30**, 349, 1876; H. T. Aumann, *Chem. News*, **38**, 108, 1878; A. Cavazzi, *Gazz. Chim. Ital.*, **15**, 202, 1885; A. Pacc, *U.S. Pat. No.* 1464625, 1923; *Lancet*, **184**, 1, 54, 1913; C. K. Tinkler and H. Masters, *Analyst*, **49**, 30, 1924.

¹² C. and A. Tissier, *Guide pratique de la recherche, de l'extraction, et de la fabrication de l'aluminium et des métaux alcalins*, Paris, 1858; *Compt. Rend.*, **43**, 1187, 1856; H. Goldschmidt, *German Pat.*, D.R.P. 96317, 1895; *Zeit. Elektrochem.*, **4**, 494, 1898; **6**, 53, 1899; *Zeit. angew. Chem.*, **11**, 821, 1898; *Electrochem. Ind.*, **8**, 360, 1908; *Stahl Eisen*, **18**, 408, 1898; *Liebig's Ann.*, **361**, 19, 1898; *Chem. Trade Journ.*, **71**, 539, 1922; H. Goldschmidt and C. Vautin, *Journ. Soc. Chem. Ind.*, **17**, 543, 1898; C. Matignon, *Monit. Scient.*, (4), **14**, 353, 1914; *Compt. Rend.*, **156**, 1157, 1913; C. Matignon and B. Trannoy, *ib.*, **141**, 190, 1905; A. Colani, *ib.*, **141**, 33, 1905; A. Duboin, *ib.*, **132**, 826, 1901; H. St. C. Deville, *ib.*, **44**, 19, 1857; H. Fonzes-Diacon, *ib.*, **130**, 1314, 1900; J. W. Richards, *Aluminium*, Philadelphia, 102, 1896; S. Mierzinsky, *Die Fabrikation des Aluminiums und des Alkalimetalle*, Wien, 1885; G. Roth, *Brit. Pat. No.* 6651, 1905; *German Pat.*, D.R.P. 172327, 1900; Chemische Fabrik Grödenheim-Elektron, *ib.*, 140737, 1902; H. von Dahmen, *Brit. Pat. No.* 16277, 1900; C. E. Bichel, *Zeit. angew. Chem.*, **18**, 1889, 1905; J. W. Mallet, *Journ. Chem. Soc.*, **30**, 349, 354, 1876; F. Faktor, *Pharm. Post.*, **38**, 527, 1905; A. Rossel and L. Franck, *Bull. Soc. Chim.*, (3), **11**, 200, 1894; *Ber.*, **27**, 52, 1894; W. H. Wahl, *Journ. Franklin Inst.*, **160**, 187, 1905; E. Stütz, *ib.*, **160**, 435, 1905; W. H. Greene and W. H. Wahl, *ib.*, **135**, 218, 453, 1893; *Brit. Pat. No.* 2066, 1893; H. Ditz, *Met.*, **4**, 787, 1907; R. N. Hart, *Welding*, New York, 1913; E. Wedekind, *Ber.*, **35**, 3932, 1902; A. Stavenhagen and E. Schuchard, *ib.*, **35**, 909, 1902; H. Moissan, *Bull. Soc. Chim.*, (3), **15**, 1282, 1896; C. H. Crowe, *Canadian Chem. Met.*, **6**, 151, 1922; A. Röhrig, *Chem. Ztg.*, **47**, 528, 1923; *Metal Ind.*, **23**, 125, 1923.

¹³ H. St. C. Deville, *Ann. Chim. Phys.*, (3), **43**, 11, 1855; G. Lemoine, *Compt. Rend.*, **129**, 291, 1899; C. and A. Tissier, *ib.*, **43**, 1187, 1856; **44**, 350, 1857; A. Masson, *ib.*, **44**, 1217, 1857; J. Margottet, *ib.*, **52**, 931, 1861; J. B. Senderens, *ib.*, **104**, 504, 1887; B. Varet, *ib.*, **114**, 224, 1892; *Bull. Soc. Chim.*, (2), **7**, 172, 1892; C. Formenti and M. Levi, *Boll. Chim. Farm.*, **40**, 689, 1901; *Gazz. Chim. Ital.*, **32**, i, 34, 1902; N. Tarugi, *ib.*, **32**, ii, 223, 1903; W. Crookes, *Chem. News*, **15**, 204, 1867; W. Smith, *Journ. Soc. Chem. Ind.*, **23**, 475, 1904; F. Wöhler, *Liebig's Ann.*, **53**, 422, 1845; **113**, 249, 1860; **116**, 127, 1860; S. Mierzinsky, *Die Fabrikation des Aluminiums und des Alkalimetalle*, Wien, 1885; C. Moldenhauer, *German Pat.*, D.R.P. 74532, 1893; *Brit. Pat. No.* 16561, 1893; G. A. Maack, *Untersuchungen über das Verhalten des Magnesiums und Aluminiums zu den Salzlösungen verschiedener Metalle*, Göttingen, 1862; C. H. Hirzel, *Zeit. Pharm.*, **10**, 145, 177, 1858; R. Böttger, *Dingler's Journ.*, **206**, 155, 1872; A. Cossa, *Nuovo Cimento*, (2), **3**, 75, 1870; L. Bernegau, *Ber. deut. pharm. Ges.*, **6**, 18, 1896; A. Korczynsky, *Bull. Soc. Chim.*, (4), **29**, 283, 1921; C. H. Crowe, *Canadian Chem. Met.*, **6**, 151, 1922; Gehe and Co., *German Pat.*, D.R.P. 360650, 1920.

¹⁴ F. Jackson, *Journ. Amer. Chem. Soc.*, **25**, 992, 1903; J. N. von Fuchs, *Schweigger's Journ.*, **62**, 184, 1831; F. W. Atack, *Journ. Soc. Chem. Ind.*, **34**, 936, 1915; G. Wynkoop, *Journ. Amer. Chem. Soc.*, **19**, 434, 1897; W. H. Hess and E. D. Campbell, *ib.*, **21**, 776, 1899; E. T. Allen, *ib.*, **25**, 421, 1903; E. Schirm, *Chem. Ztg.*, **33**, 877, 1909; **35**, 979, 1911; F. Goppelsröder, *Zeit. anal. Chem.*, **7**, 195, 1868; G. Horsley and E. Schumacher-Kopp, *ib.*, **31**, 222, 1892; C. Luckow, *ib.*, **3**, 362, 1864; E. F. Anthon, *Journ. prakt. Chem.*, (1), **8**, 399, 1836; (1), **9**, 6, 8, 337, 1836; I. von Itner, *Beiträge zur Geschichte des Blausäure*, Freyburg, 1809.

¹⁵ T. H. Norton, *Journ. Amer. Chem. Soc.*, **19**, 153, 1897; J. W. Richards, *Aluminium*, Philadelphia, 1896; *Mineral Ind.*, **22**, 14, 1913; R. Seligman, *Science Progress*, (2), **6**, 615, 1912; H. Moissan, *Compt. Rend.*, **128**, 895, 1899; A. E. Hunt, *Journ. Franklin Inst.*, **144**, 81, 171, 1897; E. H. Sberbondy, *Automobile*, **33**, 834, 1915; A. L. Clayton, *ib.*, **33**, 330, 1915; J. E. Schipper, *ib.*, **30**, 673, 1914; E. V. Pannell, *Metal Ind.*, **13**, 453, 1915; S. Germain, *Journ. Four Elect.*, **21**, 143, 1912; J. T. W. Echevarri, *Journ. Inst. Metals*, **1**, 125, 1909; R. Weiss, *Bull. Soc. Mulhouse*, **4**, 1902; P. Pastrovich, *Chem. Rev. Fet. Harz Ind.*, **9**, 278, 1902; A. F. Yarrow, *Engg.*, **59**, 470, 1895; J. Wild, *Zeit. Ges. Brauwesen*, **35**, 61, 1912; C. Bleisch, *ib.*, **35**, 49, 1912;

A. C. Chapman, *Journ. Inst. Brew.*, **17**, 660, 1911; F. Schönfeld, *Wochenschr. Brauerei*, **22**, 79, 1905; B. Talbot, *Eng. News*, **54**, 443, 1905; A. Borsig, *Bull. Soc. Chim.*, (3), **11**, 374, 1894; R. L. Packard, *Journ. Amer. Chem. Soc.*, **15**, 276, 1894; M. Wunder, *Zeit. Metallkunde*, **13**, 179, 1921.

¹⁰ E. Pannell, *Journ. Amer. Inst. Metals*, **9**, 182, 1915; R. Mawson, *Amer. Mach.*, **41**, 1065, 1915; F. Carnevali, *Journ. Inst. Metals*, **8**, 282, 1912; R. Seligman, *ib.*, **2**, 281, 1909; M. V. Schoop, *Electrochem. Met. Ind.*, **7**, 193, 1909; *Chem. Ztg.*, **31**, 749, 1907; S. Cowper-Coles, *Western Elect.*, **34**, 111, 1904; *Electrochem. Met. Ind.*, **3**, 240, 1903; J. W. Richards, *Journ. Franklin Inst.*, **137**, 160, 1894; *Aluminium*, Philadelphia, 464, 1896; H. Lange, *Amer. Mach.*, **26**, 1185, 1903; M. Bablon, *Bull. Soc. Chim.*, (2), **20**, 317, 1873; M. Bourbouze, *Compt. Rend.*, **98**, 1490, 1884; J. Novel, *ib.*, **116**, 256, 1893.

§ 6. The Atomic Weight and Valency of Aluminium

The hydrogen equivalent of aluminium approximates to 9. In 1812, J. J. Berzelius¹ gave AlO_3 for the formula of alumina; this made the at. wt. of the metal 9×6 ; but in 1826, after he had recognized the existence of sesquioxides, he wrote the formula Al_2O_3 , and this made the at. wt. 9×3 . T. Thomson, however, wrote the formula AlO , which made the at. wt. 18, and this view was adopted by J. L. Gay Lussac in 1833. L. Gmelin's equivalent number for aluminium, $9 \times 1\frac{1}{2}$, was based on the sesquioxide formula.

J. J. Berzelius' at. wt., 27 nearly, is in approximate agreement with Dulong and Petit's rule; it is in harmony with Mitscherlich's isomorphous rule applied to the oxides and salts of trivalent aluminium, iron, chromium, and manganese, and with the alums in which, besides the elements just mentioned, other trivalent elements—gallium, indium, thallium, titanium, vanadium, rhodium, ruthenium, and iridium—may take part. The location of aluminium in the third group of the periodic table as head of the family of certain elements of the rare earth series, emphasizes certain trivalent characters of this element. For a long time it was assumed that aluminium enters into combination as a hexavalent group Al_2 analogous to ferric. The earlier determinations of the vapour density of aluminium chloride by H. St. C. Deville and L. Troost in the vicinity of 400° gave results corresponding with the formula Al_2Cl_6 , but determinations at higher temp., 1000° , by L. F. Nilson and O. Pettersson² corresponded with the simpler formula AlCl_3 ; at intermediate temp., intermediate values are obtained since the reaction $\text{Al}_2\text{Cl}_6 \rightleftharpoons 2\text{AlCl}_3$ is involved. These results were confirmed by C. Friedel and J. M. Crafts, Fig. 59. In 1865, W. Odling and G. B. Buckton prepared aluminium methide, $\text{Al}(\text{CH}_3)_3$; and L. Roux and E. Louise showed that the vapour density of aluminium ethide, near the b.p., corresponds with $\text{Al}_2(\text{C}_2\text{H}_5)_6$, and at a higher temp. the compound decomposes. G. Quincke, however, found that "when the vapour density is determined at as low a temp. as possible—a few degrees above its b.p.—the results with aluminium methide agree with the formula $\text{Al}(\text{CH}_3)_3$, and not with $\text{Al}_2(\text{CH}_3)_6$ as reported by L. Roux and E. Louise, and V. Meyer." A. Combes also found that the vapour density of aluminium acetylacetonate, about 45° above its b.p., agrees with the formula $\text{Al}(\text{C}_5\text{H}_7\text{O}_2)_3$. A. Werner and W. Schmuylhoff found the mol. wt. of aluminium chloride in boiling pyridine to be AlCl_3 , but the argument is faulty because pyridine forms a well-defined complex salt with aluminium chloride. E. P. Kohler found that the bromide and iodide in boiling carbon disulphide behave as if they had the doubled formulæ Al_2Br_6 and Al_2I_6 ; but in boiling nitrobenzene, aluminium chloride has the formula AlCl_3 , and in freezing nitrobenzene, the bromide and iodide have the respective formulæ AlBr_3 and AlI_3 . In general, if aluminium chloride unites with a solvent, it has the simpler mol. AlCl_3 , but in an indifferent solvent like carbon disulphide, it has the doubled mol. formula—*vide infra*, aluminium chloride.

It was assumed that chlorine is univalent, and it therefore follows that in the doubled molecule, Al_2Cl_6 , aluminium is at least quadrivalent $\text{Cl}_3 \equiv \text{Al} - \text{Al} \equiv \text{Cl}_3$; and J. Traube tried to evade the difficulty by assuming that the aluminium is here

sexivalent $\text{Cl}_3\equiv\text{Al}\equiv\text{Al}\equiv\text{Cl}_3$. E. P. Kohler, however, claimed that the explanation is simpler if it be assumed that one or more of the chlorine atoms are trivalent :

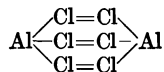
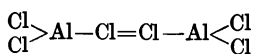

At higher temp., the molecule splits by breaking the double linkages of the chlorine atoms. C. T. Heycock and F. H. Neville measured the lowering of the f.p. of a soln. of aluminium in tin, and inferred that the solute is in the mol. form Al_2 ; W. Ramsay likewise made a similar inference from the lowering of the vap. press. of mercury by aluminium. In both cases it is assumed that no compounds are formed.

J. J. Berzelius³ made a single determination of the at. wt. of aluminium by igniting dry aluminium sulphate, and from the ratio $\text{Al}_2\text{O}_3 : 3\text{SO}_3$ so obtained, it follows that $\text{Al} = 27.31$; H. Baubigny obtained 27.06 by an analogous process. W. W. Mather analyzed aluminium chloride, and from the ratio $\text{AlCl}_3 : 3\text{AgCl}$ computed $\text{Al} = 28.8$. J. B. A. Dumas analyzed aluminium chloride, and from the ratio $\text{AlCl}_3 : 3\text{Ag}$ computed the at. wt. 27.45; H. Krepelka, 26.972 with $\text{Ag} = 107.88$, and $\text{Cl} = 35.458$; and J. W. Mallet from the ratio, $\text{AlBr}_3 : 3\text{Ag}$, 27.09. C. Tissier oxidized aluminium, and from the ratio $2\text{Al} : 3\text{O}$, computed 27.14; M. Isnard by a similar process obtained 27.0, J. Thomsen, 26.99, and E. Kohn-Abrest, 27.09. T. W. Richards and H. Krepelka analyzed aluminium bromide, and from the ratio $\text{AlBr}_3 : 3\text{AgBr}$ obtained for the at. wt. 26.963. A. Terreil heated aluminium in a stream of dry hydrogen chloride, and measured the hydrogen evolved, and from the ratio, $\text{Al} : 3\text{H}$, computed 27.4; J. W. Mallet treated aluminium with a soln. of sodium hydroxide, and by measuring the vol. of hydrogen computed 27.095 from the ratio $\text{Al} : 3\text{H}$, and he also burnt the hydrogen, and weighed the water; from the ratio $2\text{Al} : 3\text{H}_2\text{O}$ he obtained 27.07. J. Thomsen also determined the $\text{Al} : 3\text{H}$ ratio by a process similar to that used by J. W. Mallet, and obtained 26.97; J. Torrey obtained 26.967; while E. Kohn-Abrest dissolved aluminium in hydrochloric acid, burnt the hydrogen to water, and so obtained 27.25 from the ratio $2\text{Al} : 3\text{H}_2\text{O}$. From these observations, B. Brauner deduces 27.05 ± 0.05 , or 27.1, as the best representative value for the at. wt. of aluminium; and F. W. Clarke, 27.04. The International Table of Atomic Weights gives 27.1.

The atomic number of aluminium is 13. No isotopes have been detected by F. W. Aston.⁴ E. Rutherford and J. Chadwick found that long-range particles were liberated from aluminium when bombarded by α -rays. These particles were assumed to be hydrogen nuclei produced by the decomposition of the atoms of aluminium. The distribution of momentum in terms of the initial velocity of the α -particles has been measured, and it is estimated that there is a 42 per cent. gain in energy as a result of the assumed disintegration of the aluminium. The electronic structure of the aluminium atom has been discussed by J. D. M. Smith, N. V. Sidgwick, etc.

REFERENCES.

- ¹ J. J. Berzelius, *Gilbert's Ann.*, **40**, 260, 1812; *Pogg. Ann.*, **7**, 397, 1826; **8**, 1, 177, 1826; T. Thomson, *Ann. Phil.*, (2), **3**, 161, 1822; J. L. Gay Lussac, *Cours de chimie comprenant l'histoire des sels, la chimie végétale et animale*, Paris, 1828; L. Gmelin, *Handbuch der theoretischen Chemie zum Behuf seiner Vorlesungen entworfen*, Frankfurt-am-Main, 1817;—Vide this work, **1**, 5, 7.
- ² L. F. Nilson and O. Pettersson, *Zeit. phys. Chem.*, **1**, 456, 1887; **4**, 206, 1889; *Ann. Chim. Phys.*, (6), **19**, 145, 1890; H. St. C. Deville and L. Troost, *ib.*, (3), **58**, 257, 1860; C. Friedel, *ib.*, (6), **19**, 171, 1890; C. Friedel and J. M. Crafts, *Compt. Rend.*, **106**, 73, 602, 1888; **107**, 600, 1888; L. Roux and E. Louise, *ib.*, **106**, 1764, 1888; *Bull. Soc. Chim.*, (2), **50**, 497, 1888; A. Combes, *ib.*, (3), **1**, 343, 1889; *Compt. Rend.*, **108**, 405, 1889; V. Meyer, *Ber.*, **21**, 701, 1888; V. and C. Meyer, *ib.*, **12**, 1199, 1879; J. Traube, *ib.*, **25**, 1716, 1892; G. Quincke, *ib.*, **22**, 551, 1889; *Zeit. phys. Chem.*, **3**, 164, 1889; W. Ostwald, *ib.*, **3**, 47, 1889; W. Odling and G. B. Buckton, *Proc. Roy. Soc.*, **14**, 19, 1865; *Phil. Mag.*, (4), **29**, 316, 1865; A. Werner and W. Schmujooff, *Zeit. anorg. Chem.*, **15**, 24, 1897; E. P. Kohler, *Amer. Chem. Journ.*, **24**, 385, 1900; C. T. Heycock and F. H. Neville, *Journ. Chem. Soc.*, **57**, 376, 656, 1890; W. Ramsay, *ib.*, **55**, 521, 1889.

⁸ J. J. Berzelius, *Pogg. Ann.*, **8**, 177, 1826; W. W. Mather, *Amer. Journ. Science*, (1), **27**, 241, 1835; J. Torrey, *Amer. Chem. Journ.*, **10**, 74, 1888; C. Tissier, *Compt. Rend.*, **46**, 1105, 1858; M. Isnard, *ib.*, **66**, 508, 1868; H. Baubigny, *ib.*, **97**, 1369, 1883; E. Kohn-Abrest, *ib.*, **139**, 669, 1904; J. B. A. Dumas, *Ann. Chim. Phys.*, (3), **55**, 151, 1858; *Bull. Soc. Chim.*, (3), **33**, 121, 1905; A. Terreil, *ib.*, (2), **31**, 153, 1879; J. W. Mallet, *Phil. Trans.*, **171**, 1003, 1880; *Proc. Roy. Soc.*, **30**, 329, 574, 1880; *Chem. News*, **41**, 212, 285, 1880; J. Thomsen, *Zeit. anorg. Chem.*, **11**, 14, 1895; **15**, 447, 1897; B. Brauner, *ib.*, **34**, 207, 1903; R. Abegg, *Handbuch der anorganischen Chemie*, **3**, i, 54, 1906; F. W. Clarke, *A Recalculation of the Atomic Weights*, Washington, 262, 1910; T. W. Richards and H. Krepelka, *Journ. Amer. Chem. Soc.*, **42**, 2221, 1920; H. Krepelka, *ib.*, **46**, 1343, 1924.

⁴ E. Rutherford and J. Chadwick, *Phil. Mag.*, (6), **42**, 809, 1921; (6), **44**, 417, 1922; F. W. Aston, *ib.*, (6), **45**, 934, 1923; J. D. M. Smith, *Journ. Soc. Chem. Ind.—Chem. Ind.*, **42**, 1073, 1923; N. V. Sidgwick, *ib.*, **42**, 1203, 1923.

§ 7. Alloys and Intermetallic Compounds of Aluminium

Aluminium readily alloys with other metals and a large number of intermetallic compounds has been described. These compounds do not usually form solid soln. with one another or with the component metals, so that, as J. W. Richards,¹ and E. F. Law have emphasized, the useful alloys of aluminium with another metal M are those in which a small proportion of aluminium enhances the useful properties of the metal M; and those in which a small proportion of M imparts advantageous qualities to the aluminium. Bibliographies have been compiled by M. Sack, and P. D. Merica.

H. St. C. Deville² stated that aluminium readily unites with small proportions of sodium, and that one alloy with one to two per cent. of the alkali metal decomposes water in the cold. C. H. Mathewson found that molten sodium and aluminium are not mutually soluble, and form no compounds, Fig. 30; and D. P. Smith obtained similar results with potassium and aluminium, Fig. 31. The f.p. curves of the immiscible liquids have two arrests, one corresponding with the alkali metal and the other with aluminium. The dotted lines in the diagrams represent what is assumed to be the solubility curves of the one constituent in the other.

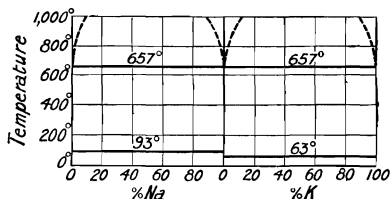

FIGS. 30 and 31.—Freezing-point Curves of Binary Mixtures of Aluminium with Sodium and Potassium.

J. Percy and A. Dick³ seem to have been the first to draw attention to the alloys produced by adding aluminium to copper; they said that “a small proportion of aluminium increases the hardness of copper, does not injure its malleability, makes it susceptible of a beautiful polish, and varies its colour from red-gold to pale-yellow.” C. and A. Tissier showed specimens in 1856, and the alloys were described a week afterwards by H. Debray. The last-named showed that aluminium unites with copper with the development of much heat—according to F. Tomlinson, the addition of 10 per cent. of aluminium to molten copper raises the temp. 134°; H. C. H. Carpenter said 40°. The term *aluminium bronze* is applied to alloys of copper and aluminium containing up to nearly 11 per cent. of the latter metal; thus, there are one per cent. bronzes, 5 per cent. bronzes, and the term without any qualification is understood to apply to 10 per cent. aluminium bronze.

The alloys can be produced by adding aluminium to molten copper, by thermite reactions; by thermoelectric reactions, etc.⁴ Their manufacture has been discussed by R. J. Anderson. The constitution of the alloys has been the subject of many investigations.⁵ H. C. H. Carpenter and C. A. Edwards' equilibrium diagram is shown in Fig. 32. There are seven solid phases designated α , α' , β , γ , γ' , δ , and ϵ ; all are solid soln. There are two minima, one at 545° with 68 per cent. of aluminium, and one at 1038° with 9 per cent. of this metal. There is a maximum at 1050°

corresponding with the compound Cu_3Al , and another imperfect one at about 588° corresponding with CuAl_2 . The solidus and liquidus curves of the α -phase lie rather close together, so that the compositions of the portions which crystallize first are not very different from those which crystallize last.

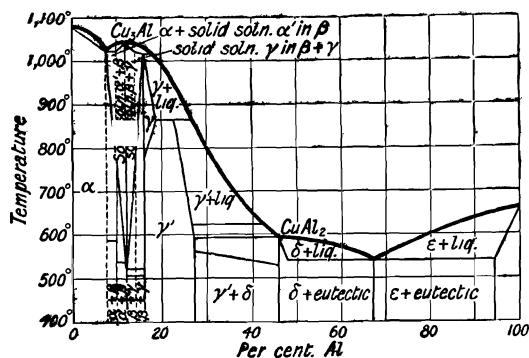

FIG. 32.—Equilibrium Diagram of Aluminium and Copper Alloys.

There is a complex series of solid soln. containing less than 12.5 per cent. of aluminium. The character of these soln. depends on the rate of cooling, and different authorities are not in agreement as to the interpretation of the structure of alloys annealed at different temp. If the alloy with 10.7 per cent. of aluminium be used as the anode in a soln. of ferric chloride in dil. hydrochloric acid, the more electropositive constituent β dissolves, and the solid soln. α' remains in yellow grains approximating $4\text{Cu} + \text{Al}$ in composition. The system has also been studied by J. H. Andrew, B. E. Curry, S. H. Woods, M. Wählert, L. Guillet, A. A. Blue, B. Ohtani and T. Hemmi, D. Stockdale, T. Usihara, K. E. Bingham and J. L. Haughton, A. G. C. Gwyer, W. Campbell and J. A. Mathews, N. A. Puschin, H. Gautier, H. le Chatelier, C. T. Heycock and F. H. Neville, M. L. V. Gayler, P. D. Merica and co-workers, etc. J. D. Edwards studied the process of solidification of these alloys; and A. Portevin and G. Arnou, the effect of annealing on the structure and mechanical properties of the aluminium bronzes. O. Bauer and H. Arndt studied the segregation in these alloys. J. H. Chamberlain found that the changes in vol. which occur with alloys of aluminium with about 15 per cent. of copper are due to the absorption of the δ -alloy by the ϵ -alloy.

D. Stockdale showed that the temp., θ , of the liquidus curve of the copper-aluminium alloys with x per cent. of aluminium is $\theta = 891 + 25x - x^2$, when x is between 9 and 18; and $\theta = 169 + 97.4x - 2.8x^2$, with x between 18 and 22. The maximum with the latter equation is 1016° , when $x = 17.4$ per cent. D. Stockdale then argued that this maximum really represents a compound **copper hemialuminide**, Cu_2Al .

The **copper tritaluminide**, Cu_3Al , appears in the equilibrium diagram, and W. Louguinine and A. Schukareff made it by adding to fused copper about one per cent. more aluminium than corresponds with the formula. L. Guillet obtained it by a thermite reaction with cupric oxide and aluminium. The prismatic crystals are golden-yellow. K. Becker and F. Ebert, from the X-radiogram, found the side of the elementary cubic cells is 3.47 Å. The sp. gr. at 20° is 7.52, so that there is a considerable contraction during the formation of the compound. H. Behrens gave 3.4 for the hardness. W. Louguinine and A. Schukareff gave 123.5 cal. per gram for the heat of formation. L. Guillet said that oxygen attacks it first at a high temp. and then very rapidly; moist carbon dioxide acts at ordinary temp.; chlorine at 200° , forming AlCl_3 and CuCl_2 —the latter forms a protective skin on the alloy; boiling water or dil. potassium hydroxide does not perceptibly attack the compound; nitric acid dissolves it in the cold; sulphuric acid reacts giving hydrogen, sulphur dioxide, and sulphur; dil. hydrochloric acid has no action while the hot conc. acid attacks the alloy slowly; and it is dissolved by aqua regia. The equilibrium diagram does not show evidence of the existence of *copper aluminide*, CuAl , but L. Guillet claims to have made it as a grey powder by the thermite reaction with cupric oxide and aluminium, and treating the product with hydrochloric acid; and H. le Chatelier, by the action of dil. hydrochloric acid or potassium hydroxide on an alloy rich in

aluminium. L. Guillet found its sp. gr. to be 5.76 at 20°—calculated by the mixture rule 5.02. W. Louguinine and A. Schukareff estimated its heat of formation to be 20.8 cal. per gram; L. Rolla gave 32.38 cal. per mol. L. Guillet found that the alloy is easily oxidized, but moist carbon dioxide has no action; it is attacked by a cold conc. soln. of potassium hydroxide; it is slowly attacked by sulphuric acid; dil. hydrochloric acid attacks it slowly, and the hot conc. acid more rapidly. The other reactions are like those for copper tritaluminide. The equilibrium diagram shows the existence of **copper dialuminide**, CuAl_2 . L. Guillet made it by the action of cupric oxide on aluminium in the thermite reaction. G. Tammann and K. Dahl studied the brittleness and fracture of these alloys. W. Rosenhain reported that the X-radiogram of copper dialuminide corresponds with a face-centred lattice parallelepiped with edges 4.31 Å. and 2.42 Å. There the aluminium atoms approach within the range 2.42 Å., whereas in the aluminium lattice the closest approach is 2.86 Å. No application of external press. could force the aluminium atoms as closely together as they are in the compound. The quadratic prisms have a sp. gr. 5.37 at 20°—the value calculated from the mixture rule is 4.04. B. E. Curry gave 585° for the f.p. G. D. Roos gave 76.4 cal. per gram for the heat of fusion. W. Louguinine and A. Schukareff give 57.2 cal. per gram, and G. D. Roos gave 76.4 cal. per mol for the heat of formation. L. Guillet found the compound to be rapidly attacked by cold dil. potassium hydroxide; to be dissolved by boiling nitric acid; to be slowly attacked by sulphuric acid; and to be rapidly dissolved by cold hydrochloric acid. It is not dissolved by cold aqua regia, but is slowly attacked at a higher temp. A. Meyer found that a 10 min. immersion in a 4 per cent. alcoholic soln. of picric acid darkens CuAl_2 without affecting the remainder of the alloy.

W. Louguinine and A. Schukareff claim to have made a compound, *tetracopper ennealuminide*, Cu_4Al_9 , by melting the component metals. The sp. gr. of the silver-white crystalline mass is given as 4.118 at 20°, and the sp. ht. as 0.1502. They also reported *copper trialuminide* to be formed as a silver-white crystalline mass of sp. gr. 4.042 at 20°, and sp. ht. 0.1586 between 20° and 100°. G. D. Roos gave -13.53 cal. per mol for the heat of formation. There is no evidence that these products are anything more than solid soln.

According to H. C. H. Carpenter and C. A. Edwards, the **colour** of the alloys of copper and aluminium was silver-white when over 25 per cent. of aluminium was present; as the proportion of the latter metal is decreased the colour became pale-grey, lead-grey, and a reddish tinge appeared with 18 per cent. of aluminium; the colour passed through different tints of red and was a pale golden-yellow with 8 per cent. of aluminium; and with less than 3.5 per cent. of aluminium, the colour of copper appeared. C. and A. Tissier, H. Behrens, F. Regelsberger, W. Campbell, W. Louguinine and A. Schukareff, L. Guillet, A. M. Portevin, E. H. and A. H. Cowles and C. F. Mabery, P. Morin and E. H. Moreau, etc., have made observations on the colour of these alloys. H. Behrens, and most of the observers on the constitution of the alloys have studied the **internal structure**; E. C. Bain, W. Rosenhain, A. Westgren and G. Phragmen, and K. Becker and F. Ebert, the **X-radiograms**; W. Fränkel and R. Seng, A. M. Portevin and J. Philippon, and A. A. Blue, the heat treatment; W. Campbell, the **fracture** of the alloys; and O. Bauer, the **liquation**. H. C. H. Carpenter and C. A. Edwards, W. Louguinine and A. Schukareff, L. Guillet, L. Schleiffarth, A. Riche, G. W. A. Kahlbaum and E. Sturm, B. Ohtani and T. Hemmi, etc., have measured the **specific gravity**; C. and A. Tissier, H. Debray, H. Behrens, H. C. H. Carpenter and C. A. Edwards, J. D. Edwards and T. A. Moormann, F. Auerbach, K. Bornemann and F. Sauerwald, B. W. Hales, and J. G. A. Rhodin investigated the method of estimating the composition of aluminium copper alloys from sp. gr. The dilatometric transformation was investigated by P. Braesco; the **specific volume**, by K. Bornemann and F. Sauerwald; the **hardness**, by T. Ishihara, B. Ohtani and T. Hemmi, C. and A. Tissier, H. Behrens, L. Guillet, B. E. Curry, etc.; the **age-hardening**, by M. L. V. Gayler; the

at. vol. of the solute atoms, by A. L. Norbury; G. Tammann and K. Dahl, the **brittleness**; the **malleability** and **ductility**, by B. E. Curry and S. H. Woods, L. Guillet, F. W. Webb, H. Tomlinson, W. Rosenhain, P. Morin and E. H. Moreau, P. Breuil, etc.; the **tensile strength**, by H. C. H. Carpenter and C. A. Edwards, J. O. Arnold, B. Ohtani and T. Hemmi, A. Portevin and F. le Chatelier, E. le Blant, A. Morley and G. A. Tomlinson, H. Lange, L. Schleiffarth, L. Tetmeyer, H. le Chatelier, A. K. Huntington, R. A. Hadfield, G. Tammann and K. Dahl, etc.; the **elastic modulus**, and the recovery of the alloy from overstrain, by A. Morley and G. A. Tomlinson; and the **sonorousness**, by the Chemische Fabrik Schering. H. le Chatelier, and P. Hidnert measured the **thermal expansion**; J. W. Richards, the **thermal conductivity**; W. Louguinine, the **specific heat**; and W. Louguinine and A. Schukareff, G. D. Roos, and L. Rolla, the **heat of formation**. P. Breuil, L. Sempell, and those who have studied the constitutions have made observations on the **melting point**. K. Bornemann and F. Sauerwald, and H. Alterthum studied the dissociation of copper aluminide at different temp. The **electrical conductivity** and **electrical resistance** have been studied by R. Benoit, L. Guillet and M. Ballay, L. Weiler, W. Broniewsky, H. le Chatelier, O. D. Chwolson, and G. W. A. Kahlbaum. The electrical conductivity of copper-aluminium alloys, measured by E. Bornemann and K. Wagemann, shows a maximum between 30–40 at. per cent. of aluminium, a marked change of direction corresponding with CuAl_2 , a less distinct one with AlCu_3 ; and a maximum with 80–90 at. per cent. of aluminium. W. Broniewsky found the electrical conductivity curve corresponded with the existence of Al_2Cu_3 . The **electromotive force** of the cell $\text{Al} | \text{Ca}(\text{OH})_2 \text{ soln.} | \text{Cu}_n\text{Al}$ was measured by N. A. Puschin; and the electrolytic valve action and electrolytic corrosion by W. S. Rowland; and the **thermo-electric properties**, by H. Pécheux. The effect of tin on copper-aluminium alloys was studied by M. Wählert. The *Reports on the Light Alloys* (London, 1921) by the Advisory Committee for Aeronautics describes the properties of cupriferous aluminium alloys.

H. St. C. Deville said that aluminium bronze cannot differ much from the other alloys of copper, but B. S. Proctor found that it has a small advantage over ordinary brass in its power to resist corrosion, and its surface, when tarnished, is more easily cleaned. E. Wilson found that the attack by the atm. increases as the proportion of copper is raised. H. Stockmeier, and R. Kayser found that aluminium bronze slowly decomposes water at 20° , and more rapidly at 60° . Observations on the corrosive action of sea-water, and soln. of various salts have been made by A. Ditte, H. C. H. Carpenter and C. A. Edwards, J. W. Richards, H. le Chatelier, W. S. Rowland, H. Behrens, etc. C. F. Mabery found hydrogen chloride gas removes all the aluminium from heated aluminium bronze. M. Balland, H. Moissan, and E. Defaçqz examined the action of hydrochloric acid; W. Louguinine and A. Schukareff, of bromine water; H. Behrens, of sulphuric acid; J. W. Richards, of nitric acid; and F. Schultze, of some organic acids. C. and A. Tissier, and L. Petit-Devaucelle have made observations on this subject. B. S. Proctor found ammonia and coal gas have a slight action; H. St. C. Deville found hydrogen sulphide attacks the alloy less readily than the copper alloys.

H. St. C. Deville,⁶ and C. R. A. Wright found that aluminium and silver are readily alloyed by direct fusion. All alloys with less than about 50 per cent. of silver are more fusible than aluminium, as illustrated by the fusion curves, Fig. 33. L. Guillet made the alloys by reducing silver oxide by the aluminothermic reaction. C. Tissier fused aluminium with silver sulphide, and found aluminium sulphide in the slag. M. Rietz and M. Herold made aluminium-silver alloys by electrolysis. G. I. Petrenko constructed the fusion curve diagram shown in Fig. 33. The f.p. falls from the m.p. of aluminium to that of the eutectic at 567° ; on the rising curve there is a break at 721° and 11.15 per cent. of aluminium corresponding with **silver hemialuminide**, Ag_2Al ; and another break at 771° and 7.72 per cent. of aluminium corresponding with **silver tritaluminide**, Ag_3Al . Both compounds are dimorphous, and form solid soln. as indicated in the diagram. C. T. Heycock and F. H. Neville,

and H. Gautier also made observations on the f.p. curve of silver-aluminium alloys. C. H. Hirzel reported as silver-white alloys $AlAg_4$ of sp. gr. 9.374; $AlAg_2$ of sp. gr. 8.744; and $AlAg$ of sp. gr. 6.733. G. Guillet claimed to have made Ag_4Al_3 by the action of dil. hydrochloric acid on the powdered trita- or hemi-aluminides; he gave 7.08 for the sp. gr., and said that it is not soluble in nitric acid, or in cold hydrochloric acid; and dissolves slowly in hot sulphuric acid. H. Behrens, and G. I. Petrenko studied the microstructure of these alloys. C. T. Heycock and F. H. Neville made X-ray photographs of sections of the $4Al+Ag$ -alloy. In general, the addition of a little silver to aluminium makes the metal whiter, increases its hardness, enables it to take a better polish, and makes it denser and stronger. G. le Grix and W. Broniewsky measured the hardness of the alloys, and found a maximum corresponding with *silver ditritaluminide*, Ag_3Al_2 , and a minimum with silver tritaluminide. G. Tammann and K. Dahl investigated the brittleness, and fracture. The so-called *tiers-argent* is an alloy made by C. and A. Tissier with two-thirds aluminium and one-third silver; it has many advantages over silver-copper alloys. The alloy with 5 per cent. of silver has a high malleability, and a sp. gr. 2.8. Both these alloys have been made into dessert-spoons, forks, and articles generally made of silver. The so-called *aluminium-silver* is an alloy of copper, nickel, and aluminium. G. I. Petrenko said that alloys with up to 7.72 per cent. of aluminium are quite stable in air. H. Debray said that the alloy with 3 per cent. of silver is not attacked by hydrogen sulphide; on the contrary, S. Mierzinsky said that every alloy of silver and aluminium is more quickly attacked by this gas than silver alone, and in this statement, added J. W. Richards, the latter is wrong. G. le Grix and W. Broniewsky measured the electrical conductivity of the alloys at different temp. N. A. Puschin found that the e.m.f. of the cell $Al | Ca(OH)_2 \text{ soln.} | Ag_xAl$ showed a break corresponding with *silver aluminide*, $AgAl$, but not with Ag_2Al and Ag_3Al , but W. Broniewsky showed that such an alloy always has a heterogeneous structure. W. Broniewsky measured the thermo-electric force, and C. A. Kraus, the electrical conductivity.

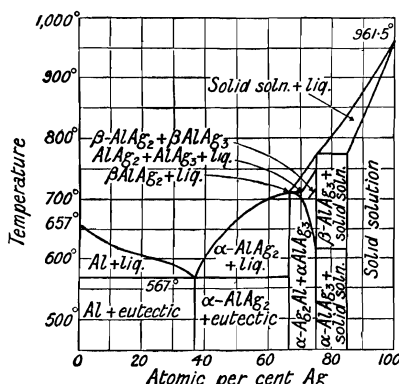

FIG. 33.—Freezing-point Curve of Mixtures of Silver and Aluminium.

C. and A. Tissier⁷ said that aluminium can carry as much as 10 per cent. of *gold* without impairing its malleability or ductility; but W. C. Roberts-Austen found that the addition of a small amount of aluminium quickly lowers the malleability of gold. C. T. Heycock and F. H. Neville found that the addition of aluminium to gold lowers the f.p. of the latter metal, and an alloy containing 21.5 at. per cent. of aluminium freezes as low as 525°, Fig. 34. Further addition of aluminium raises the f.p. until a maximum is reached at 625°, corresponding with **gold hemialuminide**, Au_2Al . The f.p. curve then falls again, reaching another minimum or eutectic point at about 570°, corresponding with 40 at. per cent. of aluminium. From that point, the curve rises rapidly to 1060°, the f.p. of **gold dialuminide**, $AuAl_2$, the purple compound discovered by W. C. Roberts-Austen. After passing this maximum, the curve falls again and has a minimum close to the f.p. of pure aluminium. This curve, on which a large number of points has been determined, shows the existence of the compounds Au_2Al and $AuAl_2$, whilst other singularities, less well marked than those mentioned, point to the formation at various stages of less stable compounds, probably **gold tetritaluminide**, Au_4Al ; **gold trialuminide**, Au_3Al_3 (or Au_5Al_2); and **gold aluminide**, $AuAl$. As the curve is followed, the different substances that crystallize out may be traced in the changing colour of the alloys, which are at first yellow, owing to the presence of free gold, then white,

then purple, and finally white again as the aluminium end of the curve is reached. C. T. Heycock and F. H. Neville further studied alloys with up to 5 per cent. of aluminium. The inset in Fig. 34 is an enlargement of the diagram about the first eutectic, indicated the existence of two series of solid soln. (α and β), and of the

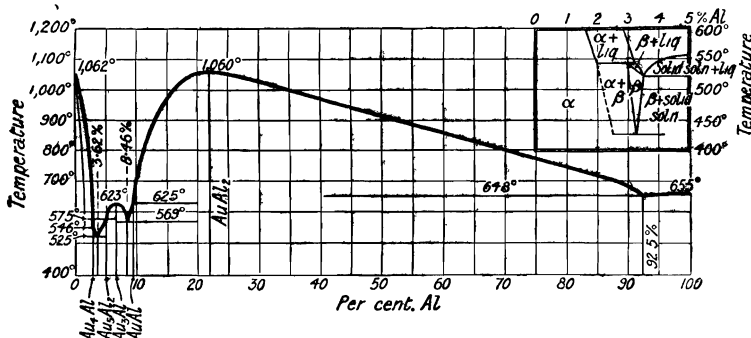

FIG. 34.—Freezing-point Curve of Mixtures of Aluminium and Gold.

compound Al_3Au_8 . This compound is found in all the alloys containing from 18 to 28 atomic per cent. of aluminium. Recalescence phenomena associated with the cooling curves of alloys containing from 10 to 27 atoms per cent. of aluminium point also to the formation of AlAu_4 . J. A. Matthews could not prepare gold dialuminide.

G. F. Andrews found the colour of gold-aluminium alloys:

Per cent. gold	White violet-brown	Pale violet	Very pale violet	Violet	Pinkish-violet	Pale violet	Violet-pink
. 5	10	15	50	78	90	94	

The alloys are said to be of little practical use except for decorative purposes. The so-called *Nürnberg gold* is a ternary alloy approximating copper, 90; gold, 2.5; and aluminium, 7.5 per cent. C. T. Heycock and F. H. Neville, and W. C. Roberts-Austen and F. Osmond studied the minute structure of these alloys; C. T. Heycock and F. H. Neville, X-radiograms; W. C. Roberts-Austen, the m.p., the tensile strength, and the elongation of the gold-aluminium alloys; and C. H. Desch, the eutectic mixtures. W. C. Roberts-Austen showed the great heat of combination by melting 30 grms. of gold in a crucible and keeping the temp. at 1155° ; 0.3 gm. of cold aluminium was stirred into the molten metal. The temp. fell to 1045° , and then rose briskly to 1380° —i.e. 225° above the initial temp. of the gold.

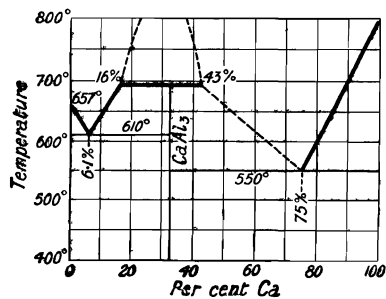

FIG. 35.—Freezing-point Curves of Mixtures of Aluminium and Calcium.

the f.p. curve, Fig. 35, shows two eutectic points at 610° and 6.1 per cent. (components aluminium and CaAl_2) and 550° and 75 per cent. (components calcium and CaAl_2) of calcium respectively. Between 16 per cent. and 43 per cent. of calcium, the alloys separate into two liquid layers, which react at

F. Wöhler⁸ prepared an alloy of aluminium and with 8.6 per cent. of calcium by melting approximately equal parts of sodium and aluminium with a large excess of calcium chloride. He regarded the alloy as a mechanical mixture, but found it to be acted upon by neither air nor water. Poulenc Frères and M. Meslans, and E. Jüngst and R. Mewes also prepared calcium-aluminium alloys. K. Arndt noted the great development of heat when the two metals are combined under molten potassium chloride. L. Donsky found that

692° to form **calcium trialuminide**, CaAl_3 . Alloys containing 0.8 per cent. of calcium have the colour of aluminium, and are somewhat harder than that metal. Those containing a moderate amount of calcium are brittle and porous, and those rich in the latter metal are less brittle and are unstable in the air. J. M. Breckenridge studied the electrical conductivity of these alloys and found a break in the curve with CaAl_3 ; the electrochemical potential curves of these alloys also gave a maximum corresponding with CaAl_3 . O. Ruff and H. Hartman studied the action of nitrogen on a heated alloy of calcium and aluminium. Alloys of *barium* and aluminium were made by E. Jüngst and R. Mewes. E. Stansfield made an alloy with 60 per cent. of barium by the thermite process. N. N. Beketoff also claimed to have made an alloy with 24–33 per cent. of barium by melting a mixture of barium chloride and hydroxide with aluminium. If barium chloride alone be used, the aluminium floats on the molten chloride without reaction. E. Beckmann obtained results different from those of N. N. Beketoff—*vide supra*. C. Vickers tried the effect of barium on aluminium, but with no favourable results.

G. Oosterheld⁹ found that molten *beryllium* and aluminium are miscible in all proportions, but they do not form a *beryllium aluminide*. The f.p. curve, Fig. 36, has two branches with a eutectic at 644° and 4 at. per cent. of beryllium. Solid soln., α , are obtained at the beryllium end of the series with up to 3 at. per cent. of aluminium. J. Parkinson¹⁰ prepared an alloy of aluminium and *magnesium* by melting the two metals under a layer of sodium chloride (not fluorspar or cryolite) in a crucible lined with magnesia. L. Mach used a similar process with potassium chloride as a flux. F. Wöhler made an alloy of aluminium with 30.8 per cent. of magnesium, and found it to be tin-white and brittle, and to ignite at a red heat, burning with a flame like that of magnesium alone; he also made an alloy with 64 per cent. of magnesium which was malleable, and was destroyed without evolving hydrogen after leaving it in contact with water for a day. Both alloys appear to contain a definite compound because when treated with a soln. of ammonium chloride, they disengage hydrogen abundantly, and deposit a brilliant, tin-white, metallic powder—insoluble in a soln. of ammonium chloride or of sodium hydroxide. It burns with brilliant sparks when thrown into a flame. H. Pécheux made alloys by melting the components out of contact with air; E. Jüngst and R. Mewes, by heating magnesium chloride with sufficient aluminium to volatilize all the chlorine as aluminium chloride; and the Deutsche Magnaliumgesellschaft, by the electrolysis of molten magnesium halides—*e.g.* tachhydrite or carnallite—with an alloy of magnesium and aluminium as cathode.

The m.p. have been studied by O. Boudouard, who found maxima corresponding with MgAl_4 , MgAl , and Mg_2Al , but these conclusions are not reliable since too few a number of mixtures were examined, and only the initial f.p. were determined. More detailed observations were made by G. Grube, and G. Eger, who found evidence of the formation of Al_3Mg_4 . H. Schirmeister made some observations on the f.p. of these alloys. G. D. Roos gave 164.8 Cals. for the heat of formation of Mg_4Al_3 , and W. Biltz and G. Hohorst, 49 cal. The last-named also gave 2.151 for the sp. gr. of Mg_4Al_3 at 25°/4°, and 83.0 for the mol. vol. K. Becker and F. Ebert found from the X-radiogram that the length of side of the cubical cells was 4.80 Å., and sp. gr. 2.62. The results of D. Hanson and M. L. V. Gayler are illustrated by Fig. 37. They found maxima corresponding with **magnesium ditritaluminide**, Mg_3Al_2 , and with **magnesium sesquialuminide**, or *trihemialuminide*, Mg_2Al_3 . It will be observed that the compound Mg_3Al_2 does not occur just at the maximum, and this may be

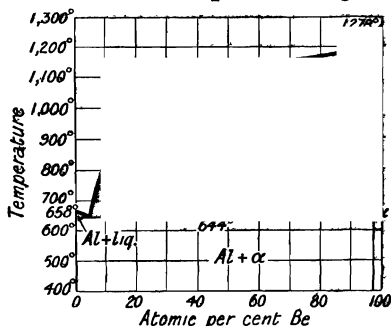

FIG. 36.—Freezing-point Curve of Mixtures of Beryllium and Aluminium.

due to the decomposition of the compound when it is melted, for the presence of a compound is shown on the liquidus curve either by a maximum, or by a point of inflection; the former occurs when the dissociation temp. of the compound lies above the f.p. curve, and the latter when it lies below one of the branches of the curve but not below the eutectic. The maximum on the diagram corresponds with G. Grube's **magnesium tri-tetritaluminide, Mg_4Al_3** . This compound also appears on the ternary diagram of magnesium, aluminium, and copper, Fig. 38. The fact that D. Hanson and M. L. V. Gayler found the alloy $4Mg+3Al$ to melt over a range of temp. of 5° led them to infer that the existence of Mg_4Al_3 has not been definitely established. B. Ohtani, and P. D. Merica and co-workers studied the thermal diagram of these alloys.

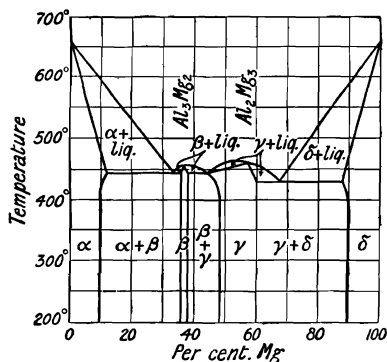

FIG. 37.—Freezing-point Curve of Mixtures of Magnesium and Aluminium.

According to G. Grube, the microscopic structure of the magnesium-aluminium alloys showed that those containing 0–35 per cent. of aluminium consist of primary crystals of solid soln. rich in aluminium, surrounded by another solid soln. with about 35 per cent. of magnesium. With about 30 per cent. of magnesium the primary crystals are dendritic, and this led O. Boudouard to assume the existence of a compound Al_4Mg . Alloys with 35–54 per cent. of magnesium consist of a homogeneous solid soln.; those with 54–68 per cent. of magnesium consist of crystals assumed to be Al_3Mg_4 embedded in a eutectic; and alloys with 68 to 100 per cent. of magnesium consist of crystals of magnesium embedded in a eutectic. D. Hanson and M. L. V. Gayler, and B. Ohtani also studied the micro-structure of these alloys; and K. Becker and F. Ebert the X-radiograms. The alloys with 10–15 per cent. of magnesium are silver-white, polish readily, have a fine grained fracture, a sp. gr. which increases as the proportion of magnesium rises, the m.p. is between 600° and 700° ; and the sp. ht. exceeds that of aluminium. According to A. Wilm, alloys containing small quantities of magnesium are hardened by quenching, but the process is quite different from the hardening of steel. If quenched from 500° in cold water, the metal is at first soft, but the hardness increases in the course of a few days. The initial hardness is independent of the quenching temp., but the hardness attained after storage increases with the quenching temp. up to 470° , beyond which it is constant. Quenched duralumin was shown by E. Heyn and E. Wetzel to undergo an appreciable expansion on standing. K. Becker and F. Ebert examined X-radiograms of these alloys; J. T. Rooney, B. Ohtani, M. Hanzel, L. Aitchison, etc., studied the mechanical properties of these alloys. Alloys of magnesium and aluminium containing 5 to 30 per cent. magnesium have approximately the same mechanical properties as brass and are used for making screws, nuts, wire, tubes, and sheets. The hardness increases with the magnesium content. With 70 per cent. magnesium, the alloy is as hard as mild steel. The tensile strength of alloys containing 2 to 10 per cent. magnesium is considerably improved by quenching from about 500° . M. L. V. Gayler studied the age hardening of these alloys. J. Schumann and L. Mach studied the reflection of light of wavelength 1850–2800 on these alloys. C. A. Kraus, and B. Ohtani studied the electrical conductivity of these alloys. J. Klaudy and A. Miethe have studied the chemical reactions of the alloys, and found that their behaviour closely resembles that of aluminium. H. Pécheux said that alloys with 15–34 per cent. of magnesium are not changed in air; they are readily attacked by conc. and dil. acids, but sulphuric acid does not attack the alloys rich in aluminium. L. Rolla studied the corrosion of these alloys. Distilled water and hydrogen peroxide readily attack all the alloys

especially if the alloys be in the form of filings, $Mg + 2H_2O = Mg(OH)_2 + H_2$. Potassium hydroxide soln. acts more quickly the higher the proportion of contained aluminium. An aq. soln. of cupric sulphate acts vigorously, $3CuSO_4 + 2Al = Al_2(SO_4)_3 + 3Cu$.

Ternary alloys of magnesium, aluminium, and copper, have been studied by R. Vogel, and M. L. V. Gayler. R. Vogel's observations are summarized in Fig. 38.

The stippled regions show the zones of existence of various forms of mixed crystals with the ternary compound **copper tetramagnesium hexaluminide**, $CuMg_4Al_6$. L. Mach patented alloys with from 2-30 parts magnesium to 100 parts of aluminium—possibly alloyed with a little copper, nickel, etc., in such proportions that the sp. gr. of the alloy does not exceed that of aluminium. The alloys are called by the trade name *magnalium*. The Deutsche Magnaliumgesellschaft raised the m.p. by adding antimony. Magnalium has also been discussed by R. E. Barnett, W. G. H. Wolff, J. Klaudy, etc. Magnalium has two advantages over aluminium; its

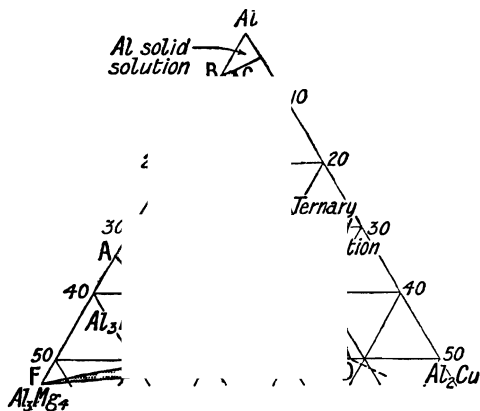

Fig. 38.—Ternary System, Al— Al_2Mg_3 — Al_2Cu .

tensile strength is greater, and it can be filed, drilled, and turned much cleaner without dragging, tearing, or clogging the tool. It is more liable to oxidize when hot. R. E. Barnett said it is less liable to corrosion in the atm. of a laboratory than is zinc, copper, or brass. The alloys on the market show Cu, 1.76; Mg, 1.60; Ni, 1.16 with traces of iron and antimony; Sn, 3.15; Cu, 0.21; Mg, 1.58; Pb, 0.72; and about 0.3 per cent. of iron. Another sample was intermediate in composition. J. Disch measured the thermal expansion of *electron*—an alloy of aluminium and magnesium—between -190° and about 300° . H. S. Rawdon and co-workers studied the attack by corrosive liquids. The alloy *duralumin*, introduced by A. Wilm, contains over 90 per cent. of aluminium; about 0.5 per cent. of magnesium; 3.5-5.5 per cent. of copper; and 0.5-0.8 per cent. of manganese. Duralumin has been studied by C. Grard, K. R. Koch and C. Dannecker, C. Fendler and W. Stueber, L. Guillet and co-workers, A. Giannelli, E. Heyn and E. Wetzel, L. M. Cohn, and J. McKechnie. The sp. gr. ranges from 2.75 to 2.84; the m.p. is near 650° ; the Brinell's hardness is 60-70. By cold-working annealed duralumin, high degrees of strength can be obtained. Unlike most high-aluminium alloys, duralumin can be hardened by quenching like steel, but unlike steel, it does not matter whether the hardening process is applied to the annealed or cold-worked material. Duralumin exhibits the remarkable property of ageing. When annealed and quenched, it shows no signs of increased hardness, but there is a perceptible increase after it has stood an hour, and the hardness increases more rapidly up to the sixth hour, and the increase continues for about 48 hrs., after which no further change is perceptible. S. Konno, and E. Heyn and E. Wetzel studied the changes in length during the ageing of duralumin; K. L. Meissner, the corrosion; and A. Knerr, the welding and soldering of duralumin. B. Ohtani, and V. Fuss also studied the ternary system Mg—Al—Cu.

The first aluminium made by H. St. C. Deville¹¹ contained zinc derived from the retorts which had been made from a mixture of fireclay and old zinc retorts crushed to small fragments (grog). H. Debray found aluminium with 3 per cent. of zinc was harder than aluminium and quite malleable; C. and A. Tissier also made alloys of these two metals, which, said A. H. Sexton, readily unite when in the molten state. C. R. A. Wright reported that the two metals form "true" alloys and that

they are miscible in all proportions. Some of the early solders for aluminium were made of zinc with from 6–20 per cent. of aluminium. R. Basset, M. Dullo, and A. W. S. van Oldruitenborgh, made zinc-aluminium alloys by reducing sodium aluminium chloride with zinc; C. H. Hirzel, by melting the two metals under a layer of sodium or potassium chloride; E. D. Self, by adding zinc to aluminium melted in a graphite crucible, and preventing oxidation by fat; and E. S. Shepherd, by using graphite crucibles free from silicates and preventing oxidation by coal gas.

The constitution of the alloys has been studied by H. Gautier, T. Hemmi, G. Charpy, C. T. Heycock and F. H. Neville, W. Sander and K. L. Meissner, A. S. Federoff, E. S. Shepherd, G. Eger, A. Ssaposnikoff, A. Sturm, O. Bauer and

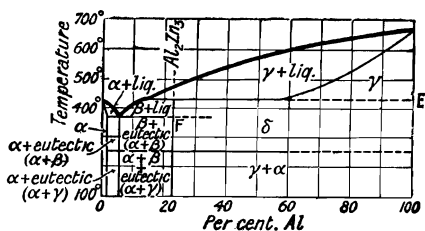

FIG. 39.—Equilibrium Diagram of Mixtures of Zinc and Aluminium.

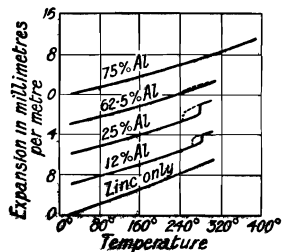

FIG. 40.—Thermal Expansion of Zn-Al Alloys.

O. Vogel, M. Wählert, H. Pécheux, E. Crepaz, L. Losana and E. Carozzi, J. L. Haughton and K. E. Bingham, etc. The equilibrium diagram shown in Fig. 39 is due to W. Rosenhain and S. L. Archbutt. The eutectic line to the right of the point *F*, Fig. 39, is metastable, and it disappears if the reaction along the line *E* is completed by sufficiently slow cooling, or by annealing at 400°. They established the formation, at 443°, of dendritic crystals of unstable zinc ditritaluminide, Zn_3Al_2

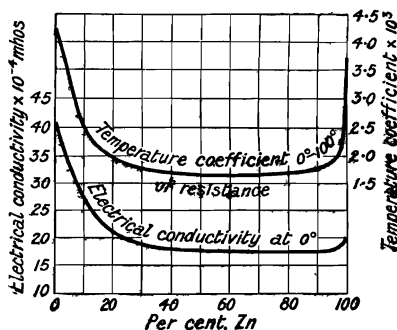

FIG. 41.—Electrical Conductivity, and Temperature Coefficient of Resistance of Zinc Aluminium Alloys.

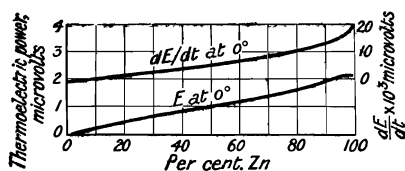

FIG. 42.—Thermoelectric Power, *E*, at 0° of Zinc-Aluminium Alloys.

which decompose at 256° with a vigorous evolution of heat. The solid soln. are α , β , γ , and δ . The existence of the unstable aluminide was not shown by E. S. Shepherd's equilibrium diagram, and he assumed that the alloys are formed of two solid soln. The curves for the thermoelectric power, and the rate of change of thermoelectric power with temp., Fig. 42, as well as the electrical conductivity, and the temp. coeff. of the resistance, Fig. 41, by W. Broniewsky, are typical of alloys which are soluble in one another to a limited extent, and in which the solid soln. thus formed mix with each other mechanically. The central portions of the curves are nearly linear and are typical of mechanical mixtures.

The microstructure of the alloys has been examined by E. S. Shepherd,

W. Campbell, E. A. Lewis, J. W. Richards, C. T. Heycock and F. H. Neville, W. Rosenhain and S. L. Archbutt. C. T. Heycock and F. H. Neville showed that there is no foundation for C. R. A. Wright's statement that the molten alloy separates into two layers. A. M. Portevin studied the microstructure of the eutectic. E. Heyn and E. Wetzel studied the vol. changes during the ageing of these alloys. E. S. Shepherd measured the sp. gr. and sp. vol.; K. Bornemann and F. Sauerwald, the sp. vol. and expansion; J. W. Richards, E. D. Self, W. Rosenhain and S. L. Archbutt, A. H. Sexton, T. Isihara, and A. Ssaposchnikoff, the hardness; A. Ssaposchnikoff, W. F. Durand, W. Rosenhain and S. L. Archbutt, the elastic modulus; the tensile strength, by C. R. Carpenter, G. Charpy, E. S. Sperry, E. Wilson, M. Bassé and M. Selve, and W. Rosenhain and S. L. Archbutt; and torsion tests, compression tests, alternating-stress tests, and impact tests, by W. Rosenhain and S. L. Archbutt. O. Bauer studied the liquation of these alloys and O. Bauer and H. Arndt, segregation in these alloys. W. Louguinine and A. Schukareff measured the heat of formation; E. Wilson, A. Schulze, and W. Smirnoff, the coeff. of thermal expansion. The results by A. Schulze are shown in Fig. 40. The disturbances in the curve are due to the formation of Al_2Zn_3 . The dotted lines represent results on a falling temp., the others are on a rising temp. The m.p. were determined by J. W. Richards, W. F. Durand, and those who have worked on the equilibrium diagram, Fig. 39; and C. T. Heycock and F. H. Neville, the at. depression of the f.p. P. Braesco measured the heating curves. E. S. Shepherd said the surface tension is lower than that of aluminium, because the fluidity of the alloys is greater than that of aluminium. L. Schleiffarth found the addition of zinc to aluminium facilitates the production of sound castings. E. Wilson, A. Sturm, J. G. A. Rhodin, and B. W. Hales examined the method of estimating the composition of alloys of zinc and aluminium from the sp. gr. They found that copper and zinc have nearly the same influence on the sp. gr. of aluminium. A. Battelli, and H. Pécheux measured the electrical conductivity and resistance. W. Fränkel and E. Scheuer studied the effect of ageing on the electrical and mechanical properties. W. Broniewsky's curves for the electrical conductivity at 0° , and the temp. coeff. of the resistance between 0° and 100° are shown in Fig. 41; observations were also made by L. Holborn and E. Lechner. Measurements of the thermoelectric power against copper were made by H. Pécheux, and against copper by A. Battelli; W. Broniewsky's curves for the thermoelectric power, E , and of the rate of change of thermoelectric power per degree are given in Fig. 42. E. S. Shepherd found that these alloys are more stable than the other alloys of aluminium because of the close proximity of the component elements in the voltaic series. C. Montemartini and E. Colonna found that with dil. nitric acid between 7° - 10° , with 1 grm. of alloy, the following amounts of ammonia are formed:

HNO_3 {c.c.	2500	1000	120	70	45
Per cent.	0.25	1.00	10.00	27.5	45.0
Ammonia formed	0.00253	0.00758	0.02737	0.00641	0.00132 grm.

and with more conc. nitric acid, no ammonia is formed. L. Rolla studied the corrosion of these alloys. W. Rosenhain and S. L. Archbutt studied the corrosive action of sea-water. M. Wählert studied the effect of additions of iron. H. E. Brauer and W. M. Peirce measured the effect of impurities on the oxidation and swelling of these alloys.

Some zinc-aluminium alloys have received special trade-names, e.g., the alloy with one-third zinc and two-thirds aluminium is called *alzene*.¹² There are two light aluminium alloys, *ziskon*, with about one-fourth its weight of zinc, and *zisium*, which was originally called *zalium*. Both have been prepared for use in making scientific instruments. C. d'Albert speaks of the use of alloys with 12-20 per cent. of zinc in the automobile industry. The Deutsche Gold- und Silber-Scheideanstalt patented the use of up to 0.5 per cent. of aluminium along with zinc in Parkes' process for desilvering lead.

The ternary alloys of zinc, copper, and aluminium are called *aluminium brasses*. They are usually made either by adding aluminium to molten brass, or zinc to molten aluminium bronze. Combinations were studied by J. Bauer,¹³ M. Wählert and M. G. Farmer. J. W. Richards said that Al-brasses flow well, give sharp sound castings, are more ductile and malleable, a greater tensile strength, and a greater power of resisting corrosion than ordinary brass. E. H. Schulz and M. Wählert, V. Fuss, and V. Jares studied the ternary system: Al—Cu—Zn; V. Fuss, Zn—Al—Mg; and M. Levi-Malvano and M. Marantonio, Cu—Zn—Cu₃Al. O. Bauer, and L. Rolla studied the corrosion of these alloys; and J. L. Haughton and K. E. Bingham, the constitution. H. C. H. Carpenter and C. A. Edwards have worked out the equilibrium diagram, Fig. 43. The areas *ABC*, *BCDE*, and *DEF* correspond respectively with the separation from the liquid of the α , β , and the constituents corresponding with γ , δ , ϵ , and the aluminide CuAl₂ of the copper-aluminium alloys. The boundaries of the phases in the last-named area have not been determined. There is no evidence on the liquidus surface of a true ternary compound or eutectic deposited from liquid alloys with over 40 per cent. of copper, though the curvature of the isothermal lines probably indicates the existence of a ternary eutectic near that point. The univariant line *BC* connects two non-variant

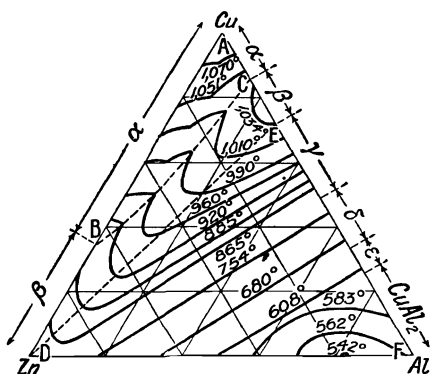

FIG. 43.—Isothermal Lines in the Equilibrium Liquidus Diagram of the Ternary System, Cu—Zn—Al.

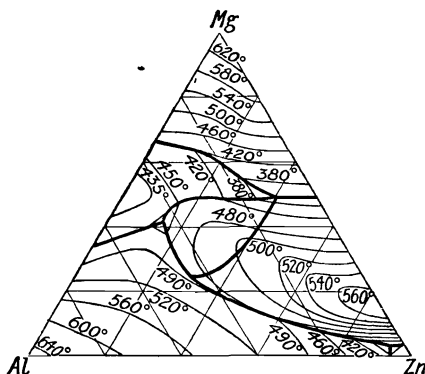

FIG. 44.—Isothermal Lines in the Equilibrium Diagram of the Ternary System, Zn—Mg—Al.

points of the copper-zinc and copper-aluminium systems. J. L. Haughton measured the electrical conductivity of the Cu—Al—Zn alloys at different temp.

G. Eger constructed the equilibrium diagram, Fig. 44, of the ternary system Al—Mg—Zn. They are completely miscible in the liquid state, but in the solid state they are only partially soluble in one another. A peritectic horizontal in the Al₃Mg₄—Zn₂Mg system indicates the probable existence of the ternary compound **magnesium zinc aluminide**, Mg₇Zn₆Al₃, which decomposes on melting, and which is capable of forming solid soln. This system was also studied by W. Sander and K. L. Meissner. The *Reports of the Light Alloys* (London, 1921) by the Advisory Committee for Aeronautics describes the properties of many zinciferous aluminium alloys.

Cadmium readily forms alloys with aluminium. C. R. A. Wright¹⁴ found that with equal parts of the two metals at 100° above the m.p., two layers are formed—the upper with 3·39 per cent. of cadmium, and the lower with 0·22 per cent. of aluminium. The presence of tin prevents the separation. W. Campbell and J. A. Mathews made observations on this subject, and A. G. C. Gwyer constructed the equilibrium diagram, Fig. 45. Here no compounds of the two elements are indicated.

H. St. C. Deville¹⁵ said that *mercury* is not able to unite with aluminium, but something is wrong, for A. Cossa made aluminium amalgam by melting the two

metals in an indifferent gas; and C. Tissier, by rubbing mercury on aluminium dipping in a soln. of potassium hydroxide. According to I. Fogh, also, H. C. Oersted made the amalgam in 1825. If the surface of aluminium be well-cleaned or moistened with the alkaline soln. a shining amalgam is formed immediately it comes in contact with the mercury. J. B. Baille and C. Fèry said that if aluminium foil be placed in a tube with mercury, it oxidizes rapidly, and becomes heated, while the mercury becomes covered with a thin layer of aluminium. By heating the two elements in an atm. of carbon dioxide in sealed tubes on a sand-bath, the amalgamation proceeds faster, the higher the temp., and the process is very active at the b.p. of mercury; the vapour of mercury does not attack aluminium, only liquid mercury attacks aluminium—*au contraire*, V. Biernacky, and N. Tarugi said that the vapour of mercury amalgamates with aluminium. L. B. Baille and C. Fèry continued that aluminium has a definite solubility in mercury. As the tubes containing the hot sat. soln. of aluminium in mercury are cooled, a crystalline paste separates, floating on the liquid. This paste was strained off, and heated in a current of hydrogen in a covered crucible so as to distil off the mercury. Arborescent crystals of aluminium remained; their composition corresponded with *mercury ditribal-*

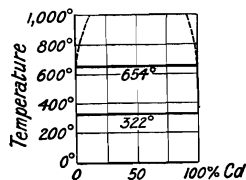

Fig. 45.—Freezing-point Curves of Cadmium-Aluminium Alloys.

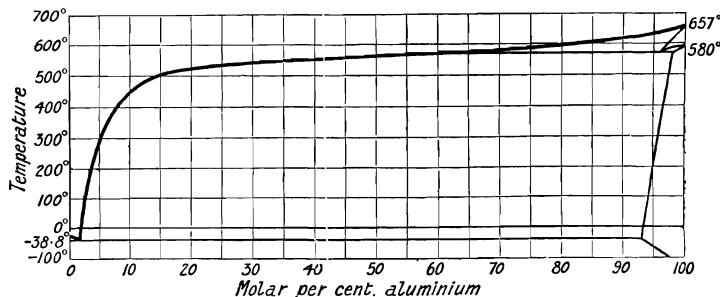

Fig. 46.—Freezing-point Curve of Mixtures of Mercury and Aluminium.

minide, Hg_3Al_2 . A. Smits and G. J. de Gruijter measured the f.p. of mixtures of mercury and aluminium, and their results are indicated in Fig. 46. The curve is comparatively simple. No compound is formed. There is a slight break at about 580° corresponding with the transition-point of aluminium. W. Ramsay, V. Biernacky, C. Jehn, and N. Tarugi made the amalgam by the direct union of the elements. P. Casamajor found that if aluminium, in contact with a zinc rod, be dipped into mercury covered with acidulated water, aluminium amalgam is formed.

L. P. Cailletet, and C. Tissier made aluminium amalgam by the action of ammonium or sodium amalgam on aluminium in the presence of water. C. Klauer states that if potassium amalgam be introduced into a hole bored in a crystal of alum, it immediately acquires a rotary motion which sometimes continues for half an hour; at the same time, the alkali amalgam becomes more viscid, and takes up much aluminium. L. Bernegau found that dry aluminium gradually forms an amalgam if rubbed with mercury salts—C. Reichard used mercurous or mercuric oxide, or mercuric amidochloride alone or made into a paste with mercurous chloride—mercuric sulphide alone or mixed with mercurous chloride gives no amalgam, but, according to H. Hurt, if the sulphide be moistened with a soln. of sodium hydroxide or hydrochloric acid, an amalgam is formed. J. Schumann found a mixture of aluminium foil with 75 per cent. of mercuric oxide reacts vigorously when moistened with water. Aluminium with a clean surface obtained by washing with,

say, a soln. of alkali hydroxide, is amalgamated when dipped in an aq. soln. of mercuric chloride. This process has been used by J. B. Cohen and co-workers, H. Wislicenus and co-workers, and E. Kohn-Abrest and co-workers. E. Kohn-Abrest said that aluminium foil is scarcely affected if the soln. of mercuric chloride be less conc. than 0.01 per cent., but the action increases as the conc. of the soln. increases. P. Nicolardot said that purified aluminium (99.2 per cent.) is more sensitive than this, for if the surface be clean, the action can be detected in soln. with a conc. less than 0.001 per cent. Both workers showed that the reaction is inhibited if the aluminium contains copper; but is not influenced by the traces of iron or silicon found in the commercial metal. J. P. Joule obtained aluminium amalgam by the electrolysis of soln. of an aluminium salt with a mercury cathode. L. P. Cailletet, C. Tissier, W. Kettembeil, and R. E. Myers used a similar process; the last-named said the process does not work with a soln. of aluminium sulphate. L. P. Cailletet obtained aluminium amalgam by connecting an aluminium wire with the negative pole of a battery and dipping it into mercury covered with acidulated water; M. Krouchkoll added that if aluminium and iron be both connected with the negative pole of a battery, and similarly treated, an amalgam of the two metals is formed. A. Roger electrolyzed a soln. of an alkali aluminate with an anode made from a mixture of alumina and carbon, and a mercury cathode.

According to C. Tissier, aluminium is made more electropositive by amalgamation, for, said J. Klaudy, it precipitates far more positive metals from soln. C. M. van Deventer found that in neutral and alkaline soln., unlike aluminium, it is more positive than zinc; and, added J. W. Richards, its reactivity approaches that of the metals of the alkaline earths. R. Kremann and R. Müller measured the electromotive behaviour of aluminium mercury alloys; L. Kahlenberg and J. A. Montgomery studied the effect of amalgamation on the potential of aluminium (*q.v.*); and alloys of aluminium with copper, zinc, or nickel. The amalgam very quickly loses its lustre in air, and is readily oxidized to alumina: the growth of the oxide is so fast that it has some resemblance to the so-called Pharaoh's serpents. The surface oxidation protects the portion underneath so that it takes may be 24 hrs. for the aluminium to oxidize completely. If the amalgam be warmed and agitated in air, more or less anhydrous alumina is formed, and it is coloured reddish owing to the simultaneous formation of a little mercuric oxide. M. Krouchkoll said that a mixed amalgam of iron and aluminium oxidizes more slowly in air than aluminium amalgam. Observations on this subject have been made by C. Tissier, J. Klaudy, C. M. van Deventer, L. B. Baille and C. Fèry, G. le Bon, W. J. Humphreys, A. Cossa, W. Ramsay, C. Jehn, H. Heuze, M. Robin, E. O. Erdmann, J. Schumann, P. Spica, etc.—*vide supra*, the chemical properties of aluminium. Aluminium amalgam decomposes water at ordinary temp. The reaction has been studied by J. B. Cohen and W. R. Ormandy, G. le Bon, C. Reichard, P. Spica, L. B. Baille and C. Fèry, C. M. van Deventer, A. Cossa, J. Klaudy, L. Hugouenq, E. Kohn-Abrest and co-workers, O. Mohr, H. Wislicenus, P. A. E. Richards, V. Zunino, H. Henze, E. O. Erdmann, F. Mylius and F. Rose, V. Biernacky, P. R. Jourdain, etc.—*vide supra*. According to J. Klaudy, acids readily attack aluminium amalgam, and added H. Wislicenus, even acids so dil. that they are without action on aluminium. C. Tissier, L. B. Baille and C. Fèry, L. P. Cailletet, C. M. van Deventer, and E. Kohn-Abrest have studied this reaction; nitric acid, which scarcely affects aluminium *en masse*, dissolves out the aluminium from the mercury. L. B. Baille and C. Fèry state that aluminium amalgam is attacked by a soln. of potassium hydroxide, forming potassium aluminate. The reducing action of aluminium amalgam on nitrates and nitrites has been studied by J. B. Cohen and W. R. Ormandy; on alkali chromates, dichromates, and ferricyanides by C. M. van Deventer; and on potassium permanganate by J. Klaudy. F. W. Bergstrom found that amalgamated aluminium reacts with sodamide in liquid ammonia soln. to form a definite crystalline compound, **sodium tetramido-aluminate**, $\text{Na}\{\text{Al}(\text{NH}_2)_4\}$ or $\text{Al}(\text{NH}_2)_2\cdot\text{NHNa}\cdot\text{NH}_3$, which loses one mol. of ammonia on heating in a vacuum above 90°, forming

$Al(NH_2)_2.NHNa$. The actions of potassamide on amalgamated aluminium and on magnesium are analogous in character. A soln. of sodium in liquid ammonia reacts with amalgamated aluminium to form the same compound. The mercury does not play an essential part in the reaction. J. B. Baille and C. Fèry state that if antimony amalgam be mixed with aluminium amalgam, small crystals of antimony are formed on the surface; the aluminium then oxidizes so that the mercury is freed from both metals. This recalls the action of lead on a molten alloy of tin and aluminium which results in the expulsion of the aluminium. The action of aluminium amalgam on alcohol has been studied by H. Wislicenus and co-workers, D. P. Konowaloff, W. Tischtschenko, and J. Klaudy; on alkyl iodides, by H. Wislicenus, H. Fleck, etc. C. Radziewanowsky used the amalgam in the synthesis of aromatic hydrocarbons. The energetic reducing action of the aluminium couple on organic compounds has been studied by H. Wislicenus and co-workers, J. B. Cohen and co-workers, F. H. van der Laan, J. Klaudy, A. Lieben, M. Harriot and A. Kling, H. F. Hunt and L. J. Steele, etc. E. Kohn-Abrest and co-workers found aluminium amalgam precipitates tannin and many alkaloids—nicotine, quinine, cocaine, etc., from soln.

REFERENCES.

- ¹ J. W. Richards, *Aluminium*, Philadelphia, 1896; E. F. Law, *Trans. Faraday Soc.*, **6**, 1815, 1910; M. Sack, *Zeit. anorg. Chem.*, **35**, 249, 1903; P. D. Merica, *Chem. Met. Ind.*, **19**, 135, 200, 329, 587, 635, 729, 780, 1918; E. C. Hill, *Mech. World*, **68**, 169, 1920.
- ² H. St. C. Deville, *Ann. Chim. Phys.*, (3), **43**, 11, 1855; C. H. Mathewson, *Zeit. anorg. Chem.*, **43**, 191, 1906; D. P. Smith, *ib.*, **56**, 109, 1908.
- ³ J. Percy and A. Dick, *Phil. Mag.*, (4), **10**, 364, 1855; H. Debray, *Compt. Rend.*, **43**, 925, 1856; C. and A. Tissier, *ib.*, **43**, 885, 1856; H. C. H. Carpenter and C. A. Edwards, *Rep. Alloys Research Committee*, **8**, 57, 1907; F. Tomlinson, *ib.*, **8**, 271, 1907; W. C. Roberts-Austen, *Proc. Roy. Soc.*, **49**, 347, 1891; P. Morin and E. H. Moreau, *Gén. Ind.*, 291, 1891.
- ⁴ P. Morin, *Gén. Ind.*, 167, 1864; P. Morin and E. H. Moreau, *ib.*, 291, 1863; A. A. Blue, *Chem. Met. Engg.*, **25**, 1043, 1921; W. P. Thompson, *Journ. Soc. Chem. Ind.*, **5**, 206, 1886; F. C. Calvert and R. Johnson, *Phil. Mag.*, (4), **10**, 240, 1855; C. H. Mehner, *Dingler's Journ.*, **261**, 174, 1886; Chemische Fabrik Soehring, *ib.*, **270**, 212, 1867; H. C. H. Carpenter and C. A. Edwards, *Rep. Alloys Research Committee*, **8**, 57, 1907; T. S. Hunt, *Chem. News*, **53**, 64, 1886; H. N. Warren, *ib.*, **70**, 102, 1894; C. A. Faure, *German Pat.*, *D.R.P.* 55096, 1889; Schweizerische Metallurgische Gesellschaft, *ib.*, 47165, 1887; L. Grabau, *ib.*, 44511, 1886; M. Rietz and M. Herold, *ib.*, 58136, 1890; H. Behrens, *Das mikroskopische Gefüge der Metalle und Legierungen*, Hamburg, 107, 1894; A. Strange, *Phil. Mag.*, (4), **24**, 508, 1862; *Chem. News*, **7**, 220, 1863; L. Guillet, *Contribution à l'étude des alliages d'aluminium*, Paris, 1902; *Compt. Rend.*, **133**, 684, 1901; *Bull. Soc. d'Enc.*, **101**, ii, 222, 1902; R. J. Anderson, *Chem. Met. Engg.*, **23**, 735, 1920; E. C. Hill, *Mechanical World*, **68**, 169, 1920; C. F. Mabery, *Amer. Chem. Journ.*, **9**, 11, 1887; E. H. and A. H. Cowles and C. F. Mabery, *Amer. Journ. Science*, (3), **30**, 310, 1885; E. H. and A. H. Cowles, *U.S. Pat. Nos.* 319795, 324659, 1884; *Brit. Pat. Nos.* 9781, 1885; 9676, 1901; P. L. V. Héroult, *ib.*, 7426, 1887; J. Clark, *ib.*, 10594, 15946, 1886; R. E. Green, *ib.*, 5914, 9358, 1889; J. M. A. Gérard-Lésouyer, *ib.*, 18994, 1888; L. Petit-Devauelle, *ib.*, 7013, 1889; C. A. Burghardt and W. J. Twining, *ib.*, 2602, 9389, 12856, 1887; M. Errard, *Ann. Gén. Civil*, **6**, 189, 1867; F. Fischer, *Zeit. Ver. deut. Ing.*, **30**, 769, 1888; W. Hampe, *Chem. Ztg.*, **12**, 391, 1888; **13**, 50, 1889; O. Schmidt, *ib.*, **12**, 458, 1888; J. B. Baille, *French Pat. No.* 324981, 1907; P. Lebeau, *Internat. Cong. App. Chem.*, **5**, iv, 477, 1904; F. von Kügelgen, *Zeit. Elektrochem.*, **7**, 564, 1901; J. Walter, *ib.*, **3**, 388, 1897; A. G. C. Gwyer, *Zeit. anorg. Chem.*, **57**, 114, 1908; R. J. Anderson, *Mét. Chem. Engg.*, **23**, 617, 735, 1920.
- ⁵ B. Ohtani and T. Hemmi, *Journ. Chem. Ind. Japan*, **24**, 1353, 1921; B. E. Curry, *Journ. Phys. Chem.*, **11**, 427, 1907; B. E. Curry and S. H. Woods, *ib.*, **11**, 461, 1907; W. S. Rowland, *ib.*, **12**, 180, 1908; J. W. Richards, *Aluminium*, Philadelphia, 535, 1896; *Journ. Franklin Inst.*, **139**, 69, 1895; H. le Chatelier, *Compt. Rend.*, **109**, 1079, 1889; **109**, 24, 1889; **111**, 456, 1890; **120**, 835, 1050, 1895; **128**, 1444, 1899; *Bull. Soc. Enc. Nat. Ind.*, (4), **10**, 569, 1895; *Metallographist*, **4**, 18, 1901; A. M. Portevin, *Compt. Rend.*, **171**, 350, 1920; A. M. Portevin and F. le Chatelier, *ib.*, **177**, 311, 1923; L. Guillet, *ib.*, **101**, 236, 1902; **173**, 979, 1921; *Rév. Mét.*, **2**, 567, 1905; **5**, 421, 1908; *Contribution à l'étude des alliages d'aluminium*, Paris, 1902; *Compt. Rend.*, **141**, 465, 1905; **144**, 847, 1907; H. Pécheux, *ib.*, **148**, 1041, 1909; H. Gautier, *Bull. Soc. Enc. Nat. Ind.*, (5), **1**, 1300, 1896; L. Guillet and M. Ballay, *Rev. Mét.*, **20**, 398, 1923; N. A. Puschin, *Journ. Russ. Phys. Chem. Soc.*, **39**, 528, 1907; W. Campbell and J. A. Mathews, *Journ. Amer. Chem. Soc.*, **24**, 264, 1902; W. Campbell, *ib.*, **26**, 1290, 1904; *Journ. Franklin Inst.*, **158**, 161, 1904; J. A. Mathews, *ib.*, **153**, 123, 1902; O. Bauer, *Zeit. Metallkunde*, **13**, 497, 1921; H. C. H. Carpenter and C. A. Edwards, *Rep. Alloys Research Committee*, **8**, 57, 1907; C. A. Edwards, *Metal Ind.*, **7**, 271, 1915; **9**, 47,

1916; J. D. Edwards, *ib.*, **19**, 193, 1921; *Chem. Met. Engg.*, **24**, 217, 1921; J. D. Edwards and T. A. Moormann, *ib.*, **24**, 61, 1921; W. Louguinine and A. Schukareff, *Arch. Sciences Genève*, (4), **15**, 66, 1903; *Journ. Chim. Phys.*, **1**, 9, 1903; M. Wählert, *Metal. Erz*, **18**, 298, 1921; A. G. C. Gwyer, *Zeit. anorg. Chem.*, **57**, 114, 1908; G. W. A. Kahlbaum and E. Sturm, *ib.*, **46**, 264, 1905; G. D. Roos, *ib.*, **94**, 329, 1916; O. Brunck, *Ber.*, **34**, 3733, 1901; A. A. Blue, *Met. Chem. Engg.*, **25**, 1043, 1921; H. Behrens, *Das mikroskopische Gefüge der Metalle und Legierungen*, Hamburg, 107, 1894; P. Morin and E. H. Moreau, *Gén. Ind.*, **291**, 1863; C. T. Heycock and F. H. Neville, *Journ. Chem. Soc.*, **73**, 720, 1898; W. Fränkel and R. Seng, *Zeit. Metallkunde*, **12**, 225, 1920; F. Regelsberger, *Zeit. angew. Chem.*, **4**, 474, 1891; C. Tissier, *Compt. Rend.*, **52**, 931, 1861; C. and A. Tissier, *ib.*, **43**, 885, 1856; A. M. Portevin and G. Arnou, *ib.*, **154**, 511, 1912; M. Balland, *ib.*, **124**, 1313, 1897; P. Breuil, *ib.*, **140**, 587, 1905; R. Benoit, *ib.*, **76**, 342, 1873; E. Defaqqz, *ib.*, **125**, 276, 1174, 1897; H. Debray, *ib.*, **43**, 925, 1856; A. Ditte, *ib.*, **128**, 273, 1899; *Ann. Chim. Phys.*, (7), **17**, 415, 1899; L. Schleiffarth, *Chem. Ztg.*, **14**, 1409, 1890; H. St. C. Deville, *Ann. Chim. Phys.*, (3), **43**, 11, 1855; W. Louguinine, *ib.*, (5), **27**, 398, 1882; A. Riche, *ib.*, (4), **30**, 351, 1873; W. Broniewsky, *ib.*, (8), **25**, 5, 1912; *Compt. Rend.*, **149**, 853, 1909; F. Auerbach, *Ann. Physik*, (4), **3**, 108, 1900; F. W. Webb, *Proc. Inst. Civ. Eng.*, **150**, 87, 1902; H. Tomlinson, *Phil. Trans.*, **174**, 1, 1883; *Proc. Roy. Soc.*, **38**, 488, 1885; **40**, 343, 1886; **42**, 362, 1887; **43**, 88, 1887; A. Morley and G. A. Tomlinson, *Phil. Mag.*, (6), **11**, 380, 1906; A. Strange, *ib.*, (4), **24**, 508, 1862; *Chem. News*, **7**, 220, 1863; H. Lange, *Dingler's Journ.*, **211**, 322, 1874; L. Tetmeyer, *ib.*, **275**, 254, 1890; Chemische Fabrik Schering, *ib.*, **270**, 212, 1887; G. Tammann and K. Dahl, *Zeit. anorg. Chem.*, **126**, 104, 1923; D. Stockdale, *Metal. Ind.*, **22**, 647, 1923; J. Stockdale, *Journ. Inst. Metals*, **28**, 273, 1922; M. L. V. Gayler, *ib.*, **28**, 213, 1922; T. Ishihara, *Science Rep. Tohoku Univ.*, **11**, 207, 1922; T. Matsuda, *ib.*, **11**, 223, 1922; O. Bauer and K. Arndt, *Stahl Eisen*, **42**, 1346, 1922; K. E. Bingham and J. L. Haughton, *Metal Ind.*, **22**, 337, 1923; *Proc. Roy. Soc.*, **99**, A, 47, 1921; *Journ. Inst. Metals*, **29**, 79, 1923; D. Hanson and M. L. V. Gayler, *ib.*, **29**, 491, 1923; R. C. Reader, *ib.*, **29**, 297, 1923; *Metal Ind.*, **22**, 473, 1923; E. C. Bain, *Chem. Met. Eng.*, **28**, 21, 1923; K. Becker and F. Ebert, *Zeit. Physik*, **16**, 165, 1923; J. O. Arnold, *Engg.*, **85**, 565, 598, 1908; R. A. Hadfield, *Journ. Soc. Chem. Ind.*, **9**, 1131, 1890; A. K. Huntington, *Rev. Met.*, **5**, 443, 1908; W. Rosenhain, *Metal Ind.*, **17**, 410, 1920; **18**, 8, 85, 1921; *Nature*, **112**, 833, 1923; *Rev. Mét.*, **5**, 442, 1908; E. le Blanc, *ib.*, **5**, 446, 1908; P. Dejean, *ib.*, **3**, 240, 1906; A. M. Portevin and J. Philippon, *ib.*, **18**, 533, 1921; F. G. A. Wilm, *Electrochem. Met. Ind.*, **6**, 30, 1908; L. Weiler, *Centr. Opt. Mech.*, **6**, 28, 1885; O. D. Chwolson, *Bull. Acad. St. Petersburg*, **10**, 379, 1877; E. Wilson, *Elect. Engg.*, **4**, 397, 1908; B. S. Proctor, *Chem. News*, **4**, 59, 1861; L. Sempell, *Met.*, **4**, 670, 1907; L. Petit-Devaucelle, *Brit. Pat. No.* 7013, 1889; C. F. Mabery, *Amer. Chem. Journ.*, **9**, 11, 1887; *Ber.*, **22**, 2658, 1889; H. Stockmeier, *Pharm. Centrhl.*, **39**, 763, 1898; R. Kayser, *Zeit. öffent. Chem.*, **3**, 93, 1897; F. Schultze, *Deut. Ind. Ztg.*, **19**, 245, 1875; L. Rolla, *Gazz. Chim. Ital.*, **45**, 1, 185, 1915; E. Bornemann and K. Wagemann, *Ferrum*, **11**, 276, 1914; J. H. Andrew, *Journ. Inst. Metals*, **13**, 249, 1915; J. G. A. Rhodin, *Trans. Faraday Soc.*, **16**, 134, 1919; B. W. Hales, *Eng.*, **129**, 439, 1920; A. Morley and G. A. Tomlinson, *Phil. Mag.*, (6), **11**, 380, 1906; P. Braesco, *Ann. Physique*, **14**, 5, 1920; P. Hidnert, *Thermal Expansion of Copper and some of its Important Industrial Alloys*, Washington, 1921; K. Bornemann and F. Sauerwald, *Zeit. Elektrochem.*, **29**, 85, 1923; *Zeit. Metallkunde*, **14**, 145, 254, 1922; H. Alterthum, *ib.*, **15**, 199, 1923; E. H. and A. H. Cowles, *Brit. Pat. Nos.* 9781, 1885; 9676, 1901; *U.S. Pat. Nos.* 319795, 324659, 1884; H. Moissan, *Compt. Rend.*, **121**, 851, 1895; **125**, 276, 1897; A. L. Norbury, *Trans. Faraday Soc.*, **19**, 140, 1923; J. H. Chamberlain, *Journ. Inst. Metals*, **10**, 193, 1913; K. Becker and F. Ebert, *Zeit. Physik*, **16**, 165, 1923; A. Meyer, *Zeit. Metallkunde*, **15**, 257, 1923; P. D. Merica, R. G. Waltenberg, and J. R. Freeman, *Trans. Amer. Inst. Min. Met. Eng.*, **64**, 3, 1921; M. L. V. Gayler, *Journ. Inst. Metals*, **28**, 213, 1922; G. Tammann and K. Dahl, *Zeit. anorg. Chem.*, **126**, 104, 1923; A. Westgren and G. Phragman, *Nature*, **113**, 122, 1924.

⁶ H. St. C. Deville, *Ann. Chim. Phys.*, (3), **43**, 11, 1855; W. Broniewsky, *ib.*, (8), **25**, 80, 1912; *Compt. Rend.*, **150**, 1755, 1910; G. le Grix and W. Broniewsky, *Rev. Mét.*, **10**, 1059, 1913; C. R. A. Wright, *Journ. Soc. Chem. Ind.*, **13**, 1016, 1894; C. Tissier, *Compt. Rend.*, **52**, 931, 1861; H. Debray, *ib.*, **43**, 925, 1856; C. and A. Tissier, *ib.*, **43**, 885, 1856; H. Gautier, *Bull. Soc. d'Enc. Ind.*, (5), **1**, 1312, 1896; L. Guillet, *ib.*, **101**, 264, 1902; C. T. Heycock and F. H. Neville, *Journ. Chem. Soc.*, **73**, 714, 1899; *Phil. Trans.*, **189**, A, 68, 1897; H. Behrens, *Das mikroskopische Gefüge der Metalle und Legierungen*, Hamburg, 107, 1894; C. H. Hirzel, *Bayer. Kunst. Gewerbeblatt*, **451**, 1858; G. I. Petrenko, *Zeit. anorg. Chem.*, **46**, 49, 1905; N. A. Puschin, *Journ. Russ. Phys. Chem. Soc.*, **39**, 528, 1907; J. W. Richards, *Aluminium*, Philadelphia, 519, 1896; C. A. Kraus, *Journ. Amer. Chem. Soc.*, **44**, 1216, 1922; G. Tammann and K. Dahl, *Zeit. anorg. Chem.*, **126**, 104, 1923; S. Mierzinsky, *Die Fabrikation des Aluminiums und des Alkalimetalle*, Wien, 1885; M. Rietz and M. Herold, *Dingler's Journ.*, **281**, **81**, 110, 1891.

⁷ C. and A. Tissier, *Compt. Rend.*, **52**, 931, 1861; W. C. Roberts-Austen, *Journ. Soc. Arts*, **36**, 1125, 1888; *Proc. Roy. Soc.*, **50**, 367, 1892; W. C. Roberts-Austen and F. Osmond, *Bull. Soc. d'Enc. Ind.*, (5), **1**, 1137, 1896; *Phil. Trans.*, **187**, A, 417, 1896; G. F. Andrews, *Journ. Amer. Chem. Soc.*, **16**, 485, 1894; C. T. Heycock and F. H. Neville, *Journ. Chem. Soc.*, **73**, 719, 1898; *Phil. Trans.*, **194**, A, 201, 1900; **214**, A, 267, 1914; *Proc. Roy. Soc.*, **66**, 2021, 1900; E. Matthey, *ib.*, **51**, 447, 1892; J. A. Matthews, *Eng. Min. Journ.*, **72**, 821, 1901; C. H. Desch, *Trans. Faraday Soc.*, **6**, 165, 1911; J. W. Richards, *Aluminium*, Philadelphia, 501, 1896.

⁶ F. Wöhler, *Liebig's Ann.*, **138**, 255, 1866; H. Schlegel, *Ueber das metallische Calcium*, Leipzig, 1907; L. Donsky, *Zeit. anorg. Chem.*, **57**, 185, 1908; O. Ruff and H. Hartman, *ib.*, **121**, 161, 1922; J. M. Breckenridge, *Chem. Met. Engg.*, **8**, 340, 1910; E. Jüngst and R. Mewes, *German Pat., D.R.P.* 157615, 1902; Poulenx Frères and M. Meslans, *ib.*, 144777, 1902; K. Arndt, *Ber.*, **38**, 1972, 1905; E. Beckmann, *Journ. prakt. Chem.*, (2), **26**, 396, 1882; N. N. Beketoff, *Bull. Soc. Chim.*, (1), **1**, 22, 1859; E. Stansfield, *Mem. Proc. Manchester Lit. Phil. Soc.*, **46**, 4, 1902; C. Vickers, *Trans. Amer. Electrochem. Soc.*, **40**, 15, 1921.

⁹ G. Oesterheld, *Zeit. anorg. Chem.*, **97**, 3, 1916.

¹⁰ F. Wöhler, *Liebig's Ann.*, **138**, 253, 1866; J. Schumann and L. Mach, *Sitzber. Akad. Wien*, **108**, 154, 1899; O. Boudouard, *Compt. Rend.*, **132**, 1326, 1901; **133**, 1003, 1901; *Bull. Soc. Chim.*, (3), **27**, 6, 1902; *Bull. Soc. Enc. Nat. Ind.*, **100**, ii, 773, 1901; B. Ohtani, *Journ. Chem. Ind. Japan*, **25**, 36, 1922; C. A. Kraus, *Journ. Amer. Chem. Soc.*, **44**, 1216, 1922; M. L. V. Gayler, *Journ. Inst. Metals*, **28**, 213, 1922; *ib.*, **29**, 507, 1923; *Metal. Ind.*, **22**, 281, 1923; E. Heyn and E. Wetzel, *Mitt. Inst. Forsch.*, **1**, 4, 1922; K. L. Meissner, *Zeit. Metallkunde*, **14**, 434, 1922; L. Aitchison, *Metal Ind.*, **22**, 222, 1923; *Journ. Inst. Metals*, **29**, 17, 1923; M. L. V. Gayler, *ib.*, **29**, 17, 1923; K. Becker and F. Ebert, *Zeit. Physik*, **16**, 165, 1923; G. Grube, *Zeit. anorg. Chem.*, **45**, 225, 1905; G. D. Roos, *ib.*, **94**, 329, 1916; W. Biltz and G. Hohorst, *ib.*, **121**, 1, 1922; G. Eger, *Internat. Zeit. Metallog.*, **4**, 29, 1913; D. Hanson and M. L. V. Gayler, *Journ. Inst. Metals*, **24**, 1, 1920; J. Parkinson, *Journ. Chem. Soc.*, **20**, 117, 1867; A. Wilm, *Met.*, **8**, 225, 650, 1911; Schirmeister, *Metal Erz*, **11**, 522, 1914; R. E. Barnett, *Journ. Soc. Chem. Ind.*, **24**, 832, 1905; Klaudy, *Oesterr. Chem. Ztg.*, **2**, 636, 1899; *Pharm. Ztg.*, **32**, 704, 1899; M. Hanzel, *Zeit. etallkunde*, **13**, 319, 1921; A. Miethe, *Stahl Eisen*, **20**, 921, 1900; E. Jüngst and R. Mewes, *German Pat., D.R.P.* 157615, 1902; Deutsche Magnaliumgesellschaft, *ib.*, 107868, 1899; G. H. Wolff, *ib.*, 105502, 1898; L. Mach, *Brit. Pat. Nos.* 24878, 5224, 5225, 1899; *Eng. Min. Journ.*, **68**, 664, 1899; H. Pécheux, *Compt. Rend.*, **138**, 1501, 1904; **140**, 1535, 1905; **142**, 575, 06; A. M. Portevin, *Rev. Mét.*, **5**, 274, 1903; J. Coulson, *Metal Ind.*, **13**, 455, 1915; H. W. Gillett, *ib.*, **11**, 167, 1913; K. R. Koch and C. Dannecker, *Ann. Physik*, (4), **47**, 197, 1915; C. Fendler and W. Stueber, *Hyg. Rund.*, **24**, 59, 1914; L. M. Cohn, *Elektrotech. Machinebau*, **30**, 809, 829, 1912; **31**, 430, 1913; *Ver. Förd. Gewerbefleiss.*, **89**, 643, 1910; J. Disch, *Zeit. Physik*, **5**, 173, 1921; H. S. Rawdon, A. I. Krynsky, and J. F. T. Berliner, *Chem. Met. Engg.*, **26**, 154, 1922; J. T. Rooney, *ib.*, **22**, 60, 1920; R. Vogel, *Zeit. anorg. Chem.*, **107**, 265, 1919; W. Fränkel and E. Scheuer, *Zeit. Metallkunde*, **14**, 49, 111, 1922; L. Rolla, *Gazz. Chim. Ital.*, **52**, i, 79, 1922; C. Grand, *Rev. Mét.*, **17**, 286, 1920; L. Gullet, J. Durand, and J. Galibourg, *ib.*, **17**, 202, 1920; S. Konno, *Science Rep. Tohoku Univ.*, **1**, 269, 1922; K. Becker and F. Ebert, *Zeit. Physik*, **16**, 165, 1923; J. Klaudy, *Oesterr. Chem. Ztg.*, **2**, 636, 1899; A. Miethe, *Stahl Eisen*, **20**, 921, 1900; J. McKechnie, *Rep. Alloys Research Committee*, **10**, 500, 1912; K. Becker and F. Ebert, *Zeit. Physik*, **16**, 165, 1923; P. D. Merica, R. G. Waltenberg, and J. R. Freeman, *Trans. Amer. Inst. Met. Eng.*, **64**, 3, 1921; M. L. V. Gayler, *Journ. Inst. Metals*, **28**, 213, 1922; J. L. Houghton and K. E. Bingham, *Proc. Roy. Soc.*, **99**, A, 47, 1921; A. Knerr, *Zeit. Metallkunde*, **15**, 286, 1923; V. Fuss, *ib.*, **16**, 24, 1924; L. Giannelli, *L'Industria*, **35**, 299, 1921; E. Heyn and E. Wetzel, *Mitt. Inst. Metallforsch.*, **1**, 10, 1922; E. Ohtani, *Journ. Japan. Soc. Chem. Ind.*, **26**, 427, 1923.

¹¹ H. St. C. Deville, *Ann. Chim. Phys.*, (3), **43**, 11, 1855; W. Broniewsky, *ib.*, (8), **25**, 1, 1912; C. and A. Tissier, *Compt. Rend.*, **43**, 885, 1856; H. Debray, *ib.*, **43**, 926, 1856; W. Smirnof, *ib.*, **155**, 351, 1912; H. Pécheux, *ib.*, **138**, 1105, 1904; **139**, 1202, 1904; M. Dullo, *Bull. Soc. Chim.*, (2), **5**, 472, 1866; R. Basset, *Génie Ind.*, **22**, 1864; E. Wilson, *Journ. Inst. Elect. Eng.*, **31**, 323, 1902; C. Montemartini and E. Colonna, *L'Ind. Chim.*, **7**, 293, 1907; A. Battelli, *Atti Ist. Veneto*, (6), **5**, 1148, 1887; C. R. A. Wright, *Proc. Roy. Soc.*, **45**, 461, 1889; *Journ. Soc. Chem. Ind.*, **13**, 1014, 1894; R. E. Barnett, *ib.*, **21**, 832, 1905; C. H. Hirzel, *Bayer. Kunst. Gewerbellatt*, 451, 1858; J. W. Richards, *Aluminium*, Philadelphia, 528, 1896; *Eng. Min. Journ.*, **72**, 715, 1901; W. Campbell, *Journ. Franklin Inst.*, **154**, 1, 131, 201, 1902; E. D. Self, *ib.*, **123**, 209, 313, 388, 1887; L. Schleiffarth, *Chem. Ztg.*, **14**, 1410, 1890; W. F. Durand, *Iron. Ind.*, **22**, 296, 1897; A. H. Sexton, *Mech. Eng.*, **19**, 865, 1907; E. S. Shepherd, *Journ. Phys. Chem.*, **9**, 506, 1905; W. Rosenhain and S. L. Archbutt, *Phil. Trans.*, **211**, A, 315, 1911; *Rep. Alloys Research Committee*, **10**, 319, 1912; *Journ. Inst. Metals*, **6**, 236, 1911; W. Rosenhain, *Proc. Roy. Soc.*, **85**, A, 389, 1911; W. Canick and G. Lear, *ib.*, **72**, 277, 1903; A. W. S. van Oldrutenborgh, *German Pat., D.R.P.* 57807, 1890; M. Bassé and M. Selve, *ib.*, 112546, 1899; H. Gautier, *Bull. Soc. d'Enc. Ind.*, (5), **1**, 1308, 1896; G. Charfy, *ib.*, (5), **2**, 394, 1897; H. Gautier, *Contributions à l'étude des alliages*, Paris, 1901; C. T. Heycock and F. H. Neville, *Journ. Chem. Soc.*, **71**, 398, 1897; W. Louguinine and A. Schukareff, *Arch. Sciences Genève*, (4), **13**, 5, 1902; *Journ. Chim. Phys.*, **1**, 9, 1903; M. Levi-Malvano and M. Marantonio, *Gazz. Chim. Ital.*, **41**, 1, 282, 1911; **42**, i, 353, 1912; E. S. Sperry, *Brass World*, **6**, 3, 1910; *Mech. Engg.*, **25**, 206, 1910; *Amer. Brassfounder's Assoc.*, **47**, 1909; O. Bauer and O. Vogel, *Mitt. Materialprüfungsam.*, **32**, 146, 1915; *Internat. Zeit. Metallog.*, **8**, 101, 1916; G. Eger, *ib.*, **4**, 29, 1913; K. Bornemann and F. Sauerwald, *ib.*, **14**, 254, 1922; W. Sander and K. L. Meissner, *ib.*, **14**, 385, 1922; T. Isihara, *Science Rep. Tohoku Univ.*, **11**, 207, 1922; E. Heyn and E. Wetzel, *Mitt. Kaiser Wilhelm Inst. Metallforsch.*, **1**, 4, 1922; O. Bauer and H. Arndt, *Stahl Eisen*, **42**, 1346, 1922; H. E. Brauer and W. M. Peirce, *Trans. Amer. Inst. Met. Eng.*, **68**, 796, 1922; A. S. Federoff, *Journ. Russ. Phys. Chem. Soc.*, **49**, 394, 1917; H. C. H. Carpenter and C. A. Edwards, *ib.*, **2**, 209, 1912; R. Lorenz and D. V. Plumbridge, *Zeit. anorg. Chem.*, **83**, 243, 1913; *Ueber die binären und ternären Legierungen des*

Aluminiums, Zinks, Cadmiums und Zinns, Edinburgh, 1911; A. M. Portevin, *Rev. Mét.*, **8**, 721, 1911; *Journ. Inst. Metals*, **29**, 257, 1922; D. Ewen and T. Turner, *ib.*, **4**, 128, 1910; J. McKechnie, *Rep. Alloys Research Committee*, **10**, 500, 1912; E. A. Lewis, *Chem. News*, **86**, 211, 1902; H. C. H. Carpenter, *Mech. Eng.*, **25**, 329, 1910; M. Wählert, *Metal. Erz.*, **18**, 298, 1921; A. Schulze, *Phys. Zeit.*, **22**, 403, 1921; L. Holborn and E. Lechner, *Tätigkeitsber. Phys. Tech. Reichsanst.*, **28**, 1919; W. Fränkel and E. Scheuer, *Zeit. Metallkunde*, **14**, 49, 111, 1922; L. Rolla, *Gazz. Chim. Ital.*, **52**, i, 79, 1922; J. G. A. Rhodin, *Trans. Faraday Soc.*, **14**, 134, 1919; B. W. Hales, *Eng.*, **129**, 439, 1920; A. Ssaposchnikoff, *Journ. Russ. Phys. Chem. Soc.*, **40**, 95, 1908; A. Sturm, *Der spezifische elektrische Widerstand und dessen Temperaturkoeffizient bei Aluminium-Zink-Legierungen von verschiedenem Mischungsverhältnis*, Rostock, 1904; P. Braesco, *Ann. Chim. Phys.*, (9), **14**, 5, 1920; O. Bauer, *Zeit. Metallkunde*, **13**, 497, 1921; T. Hemmi, *Journ. Soc. Chem. Ind. Japan*, **25**, 511, 1922; E. Crepez, *Giorn. Chim. Ind. Appl.*, **5**, 285, 1923; L. Losana and E. Carozzi, *Gazz. Chim. Ital.*, **53**, ii, 546, 1923; J. L. Haughton and K. E. Bingham, *Proc. Roy. Soc.*, **99**, A, 47, 1921.

¹² Anon., *Mech. World*, **41**, 41, 1907; R. E. Barnett, *Journ. Soc. Chem. Ind.*, **24**, 832, 1905; C. d'Albert, *Rev. Mét.*, **5**, 447, 1908; Deutsche Gold- und Silber-Scheideanstalt vorm. Rössler, *German Pat.*, *D.R.P.* 64416, 1892.

¹³ J. W. Richards, *Aluminium*, Philadelphia, 530, 1896; M. Wählert, *Metal. Erz.*, **18**, 298, 1921; V. Jares, *Zeit. Metallkunde*, **10**, 1, 1919; J. Bauer, *U.S. Pat. No.* 40388, 186 M. G. Farmer, *ib.*, 44086, 1864; O. Bauer, *Zeit. Metallkunde*, **12**, 129, 1920; L. Tetmayer, *Dingler Journ.*, **275**, 254, 1890; G. Eger, *Internat. Zeit. Metallg.*, **4**, 29, 1913; W. Sander and K. L. Meissn *ib.*, **15**, 180, 1923; H. C. H. Carpenter and C. A. Edwards, *ib.*, **2**, 209, 1912; J. L. Haughton and K. E. Bingham, *Proc. Roy. Soc.*, **99**, A, 47, 1921; M. Levi-Malvano and M. Marantonio, *Ga Chim. Ital.*, **41**, ii, 282, 1911; **42**, i, 353, 1912; J. L. Haughton, *Trans. Faraday Soc.*, **16**, 3 1921; E. H. Schulz and M. Wählert, *Metal. Erz.*, **16**, 170, 1919; V. Fuss, *Zeit. Metallkunde*, **24**, 1924.

¹⁴ C. R. A. Wright, *Journ. Soc. Chem. Ind.*, **13**, 1016, 1894; W. Campbell and J. A. Mathe *Journ. Amer. Chem. Soc.*, **24**, 255, 1902; A. G. C. Gwyer, *Zeit. anorg. Chem.*, **57**, 150, 1908.

¹⁵ H. St. C. Deville, *L'aluminium*, Paris, 1859; J. B. Cohen and W. R. Ormandy, *B.A. Rep.*, **550**, 1889; *Ber.*, **28**, 1505, 1896; *Journ. Chem. Soc.*, **57**, 811, 1890; W. Ramsay, *ib.*, **55**, 521, 1889; W. J. Humphreys, *ib.*, **69**, 1679, 1896; J. B. Cohen and P. Hartley, *ib.*, **87**, 1360, 1905; J. B. Cohen and H. D. Dakin, *ib.*, **75**, 893, 1899; **79**, 1111, 1901; J. B. Cohen and F. W. Sharrow, *ib.*, **75**, 887, 1899; H. R. Hurst and J. B. Cohen, *ib.*, **87**, 826, 1895; J. B. Cohen and H. T. Calvert, *ib.*, **73**, 163, 1898; P. A. E. Richards, *Chem. News*, **74**, 30, 1890; H. F. Hunt and L. J. Steele, *Journ. Soc. Chem. Ind.*, **15**, 849, 1896; D. P. Konowaloff, *Russ. Pharm. Journ.*, **35**, 328, 1897; J. Schumann, *Untersuchungen von Amalgam*, Leipzig, 1891; H. C. Oested, *Øfvers. Danske. Vid. Selsk.*, **4**, 15, 1825; I. Fogh, *ib.*, **3**, 15, 1921; F. Mylius and F. Rose, *Zeit. Instr.*, **13**, 77, 1893; W. Tischtschenko, *Journ. Russ. Phys. Chem. Soc.*, **31**, 694, 1899; W. Kettembell, *Studien über elektrolytische Amalgambildung und Versuche zur Metalltrennung durch Amalgambildung*, Leipzig, 1903; V. Biernacky, *Wied. Ann.*, **59**, 664, 1896; F. Neesen, *ib.*, **51**, 34, 1894; E. O. Erdmann, *ib.*, **43**, 750, 1893; N. Tarugi, *Gazz. Chim. Ital.*, **34**, ii, 486, 1904; A. Lieben, *Monatsh.*, **16**, 211, 1896; A. Cossa, *Zeit. Chem.*, (2), **6**, 281, 443, 1870; *Nuovo Cimento*, (2), **3**, 75, 1870; P. Casamajor, *Amer. Chemist*, **6**, 452, 1876; L. Bernegau, *Ber. deut. pharm. Ges.*, **6**, 18, 1896; C. Reichard, *Pharm. Centr.*, **48**, 103, 569, 1907; H. Hurt, *ib.*, **51**, 677, 1910; C. Tissier, *Compt. Rend.*, **49**, 54, 1859; M. Hanriot and A. Kling, *ib.*, **156**, 1380, 1913; L. P. Cailletet, *ib.*, **44**, 1250, 1857; *Séances Soc. Française Phys.*, **73**, 1884; J. B. Baille and C. Féry, *Ann. Chim. Phys.*, (6), **17**, 246, 1889; F. H. van der Laan, *Rec. Trav. Chim. Pays-Bas*, **28**, 46, 1907; J. P. Joule, *Chem. Gaz.*, **8**, 339, 1850; A. Roger, *Brit. Pat. No.*, 6431, 1895; R. E. Myers, *Journ. Amer. Chem. Soc.*, **26**, 1124, 1904; E. Kohn-Abrest, *Ann. Falsif.*, **5**, 384, 1913; *Bull. Assoc. Chim. Sucr. Dist.*, **28**, 938, 1911; *Bull. Soc. Chim.*, (4), **7**, 283, 1910; (4), **11**, 570, 1912; *Compt. Rend.*, **155**, 1179, 1912; E. Kohn-Abrest, M. Rochas, and M. Rivera-Maltes, *ib.*, **154**, 1600, 1912; G. le Bon, *ib.*, **131**, 706, 1900; P. R. Jourdain, *ib.*, **150**, 394, 1910; M. Rochas and M. Rivera-Maltes, *Ann. Falsif.*, **6**, 131, 1913; H. Wislicenus, *Journ. prakt. Chem.*, (2), **54**, 55, 1896; H. Wislicenus and L. Kaufmann, *Ber.*, **28**, 1323, 1895; C. Radziewanowsky, *ib.*, **28**, 1138, 1895; C. M. van Deventer, *Chem. Weekb.*, **4**, 625, 1907; J. Klaudy, *Mitt. Tech. Gew. Mus.*, **217**, 1892; C. Klauer, *Liebig's Ann.*, **10**, 89, 1834; H. Fleck, *ib.*, **276**, 129, 1893; M. Robin, *Rev. Mét.*, **5**, 753, 1908; O. Mohr, *Wochschr. Brauerei*, **30**, 309, 1913; H. Henze, *Dingler's Journ.*, **228**, 277, 1878; C. Jehn and A. Henze, *Arch. Pharm.*, (3), **6**, 19, 1875; *Ber.*, **7**, 1498, 1874; P. Nicolardot, *Bull. Soc. Chim.*, (4), **11**, 410, 1912; C. Jehn, *Pharm. Centr.*, **48**, 142, 1907; M. Krouchkoll, *Journ. Phys.*, (2), **3**, 139, 1884; J. W. Richards, *Aluminium*, Philadelphia, 506, 1896; P. Spica, *Boll. Chim. Farm.*, **40**, 341, 1901; *Gazz. Chim. Ital.*, **31**, ii, 67, 1901; V. Zunino, *ib.*, **30**, i, 194, 1900; L. Hugouneq, *Journ. Pharm. Chim.*, (6), **1**, 537, 1895; A. Smits and G. J. de Gruijter, *Proc. Acad. Amsterdam*, **23**, 7, 1920; R. Kremann and R. Müller, *Zeit. Metallkunde*, **12**, 289, 1920; L. Kahlenberg and J. A. Montgomery, *Trans. Amer. Electrochem. Soc.*, **36**, 277, 287, 1919; F. W. Bergstrom, *Journ. Amer. Chem. Soc.*, **45**, 2788, 1923.

§ 8. The Occurrence of Aluminium Oxides

Crystalline alumina occurs in nature as the mineral **corundum**, *corindon*, or *adamantine spar*. There are three main varieties distinguished by the structure, and by the degree of purity. (1) The transparent or translucent gem-stones named according to their colours—the true or oriental *ruby* is red varying in tint from pale rose to carmine-red, brownish-red, and bluish-red—the most prized variety is said to be pigeon's blood-red. The red colour is attributed to the presence of a little chromic oxide. The *sapphire* varies in colour from a pale blue to a deep indigo-blue. The paler varieties are sometimes described as feminine in contrast to the deeper and richer varieties called masculine. "Oriental" is sometimes prefixed to the name of the corundum gem-stones to distinguish them from other minerals possessing the same colour—e.g. the oriental topaz or yellow sapphire is yellow; the oriental emerald is green; and the oriental amethyst or violet-ruby is purple—the true amethyst is a variety of quartz. A variety of sapphire having a stellate opalescence when viewed in the direction of the vertical axis of the crystal is the stellate or asteriated sapphire. The six-rayed star reflected from the basal plane is due to the presence of numerous thin twin-lamellæ in the mineral. (2) Common *corundum* is transparent with no pronounced colour—for the tint varies from blue to grey, brown, or black. (3) *Émery*, a kind of granular corundum mixed with more or less magnetite or hæmatite.

The sapphire, *σάπφειρος*, of Theophrastos,¹ the *saphiros* of Pliny and of the ancient Greeks and Romans, were the *lapis lazuli* of the present day. It is, however, possible that the ancients included other minerals in the term, because Pliny said that the best purple sapphires come from Median. The origin of the term "sapphire" is not known; C. A. S. Hofmann said that it is a Grecian word taken from Island of Sapphirine in the Arabian Sea, but C. C. von Leonhard believed that the island was named after the mineral, and that the term is of Semitic origin; while S. Fränkel assumed that although the word is employed by Moses (Exodus, 24. 10), it was imported into the Semitic language. Émery is the *Armenian whetstone*, or the *ἀκόννη ἐξ ἀρμενίας* of Theophrastos; the *smiris*, or *σμιρίς*, of Dioscorides; the *naxim* (from Naxos) of Pliny; the *smiris* of G. Agricola; and the *smergel* or *smirgel* of J. G. Wallerius. In 1609, A. B. de Boot defined the sapphire, asteria or sel gemma, ruby, and smiris. The similarity in the crystalline form led J. B. L. Romé de l'Isle to suggest the identity of these minerals, and R. J. Haüy placed the ruby and sapphire into one class which he named *télesie*, from *τέλειος*, perfect, but he regarded smirgel as *fer oxydé quartzifère*, and corundum as *un substance terreux*. S. A. Papavasiliou described the deposits at Naxos. T. Bergman analyzed sapphire and found Al₂O₃, 58; SiO₂, 35; CaO, 5; Fe₂O₃, 2; R. Chenevix also reported 5-7 per cent. of silica in sapphire, ruby, and corundum. M. H. Klaproth supposed that in addition to alumina, corundum and sapphire contained a new earth; S. Tennant showed that emery from Naxos is largely composed of alumina, and H. Rose stated that any silica found in the analysis of corundum is derived from the agate mortar used in the grinding. Numerous analyses have been made by J. L. Smith, K. Pfeil, A. Terreil, and others. The following are by J. L. Smith:

	Al ₂ O ₃	Fe ₂ O ₄	CaO	SiO ₂	H ₂ O
Sapphire, India . . .	97.51	1.89	—	0.80	—
Ruby, India . . .	97.32	1.09	—	1.21	—
Corundum, India . . .	93.12	0.91	1.02	0.96	2.86
Corundum, Nicaria . . .	87.52	7.50	0.82	2.01	0.68
Émery, Naxos . . .	68.53	24.10	0.86	3.10	4.72
Émery, Samos . . .	70.10	22.21	0.62	4.00	2.10

The best rubies are found in clays and river sands at Mogok in Upper Burma; a less important locality occurs in the Sagyin Hills, Mandalay, also in Upper Burma. First-class rubies occur in the Capelan Mountains near Syriam (Pegu Ava). Less

valued rubies are found in the provinces of Chantabun and Krat in Siam; at Bilin and Merowitz (Bohemia), and in the sand of the River Expailly (Auvergne). There are ruby mines in Badakshan on the Upper Oxus; and in Ceylon. The American localities are Newton (New Jersey), Lownes County (Georgia), Macon County (North Carolina), etc. Blue and star sapphires are brought from Ceylon; they have also been found near Simla Pass (Himalaya Mountains). The deposits of green and yellow sapphires in Central Queensland have been described by B. Dunstan. T. H. Holland has described the corundum deposits of India; J. Morozewicz, Russia; F. Zirkel, Austria; G. A. F. Molengraaf, South Africa; J. H. Pratt, United States; A. Lacroix, France; M. F. Heddle, Scotland; J. W. Retgers, Holland; etc. The emery deposits of Asia Minor and of the Grecian Archipelago have been described by J. L. Smith and A. Hänig, and those in the United States, by J. H. Pratt.

Bluish crystals occurring in some meteorites—F. Wöhler, E. Cohen, and E. Weinschenk—are thought to be crystallized alumina or corundum. It was supposed by A. A. Julien, T. M. Chatard, etc., that corundum was not primarily a pyrogenic mineral, and its presence in igneous rocks was attributed to accidental inclusions. The work of J. Morozewicz, and A. Lagorio has shown that corundum is of igneous origin, for it and spinel are among the first minerals to separate from soln. of alumina in molten basic glasses. They conclude:

(1) When the magma is a calcium-sodium-potassium silicate, alumina held in soln. by such a magma will separate out as corundum, except when the ratio of the alumina to the other bases is more than 1 : 1 and the ratio of the silica is less than six. (2) If magnesia and iron are present in the magma thus composed, corundum will not form unless there is more than enough alumina to unite with the magnesia and iron. (3) When the magma is composed of a magnesium silicate without excess of magnesia, all the alumina held by such a magma will separate out as corundum. (4) Where there is an excess of magnesia in the magma just described, this excess will unite with a portion of the alumina to form spinel, and the rest of the alumina will separate out as corundum. (5) Where there is chromic oxide present in a magma composed essentially of a magnesium silicate (as the peridotite rocks) and only a very little alumina and magnesia are present, these, uniting, separate out with chromic oxide to form the mineral chromite, and no corundum or spinel is formed. (6) When peridotite magmas contain, besides the alumina, oxides of the alkalis and alkali earths, as soda, potash, and lime, a portion of the alumina is used in uniting with these oxides and silica to form feldspar. (7) There is a strong tendency for the alumina to unite with the alkali and alkali-earth oxides to form double silicates like feldspars, whether such silicates form the chief minerals of the resulting rock or are present only in relatively small amount. There is, however, but little tendency for the alumina to unite with magnesia to form double silicates when the magma is a magnesium silicate.

In addition to colloidal alumina,² there are three possible hydrated forms of this oxide:

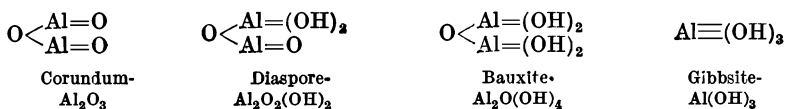

Clays, idealized by the formula $\text{Al}_2\text{O}_3 \cdot 2\text{SiO}_2 \cdot 2\text{H}_2\text{O}$, and nontronite idealized by $\text{Fe}_2\text{O}_3 \cdot 2\text{SiO}_2 \cdot 2\text{H}_2\text{O}$, may be regarded as the end-products of the weathering of felspathic rocks in the temperate climes, but in tropical and subtropical countries the process is said to extend further; the aluminosilicates are more completely decomposed, for aluminium and ferric hydroxides appear to be the end-products. It is not clear how the relatively small difference of temp. between temperate and tropical climes can produce such a difference in the decomposition products in aluminosilicate rocks. The deposits of red earths and soils, called by F. Buchanan (1807) *laterites*—from *later*, a brick or tile—found in India, Hawaiian Islands, Rhodesia, French Guinea, West Australia, Mozambique, etc., are mixtures of clay, silica, hydrated ferric and aluminium oxides, etc. Like clays (*q.v.*) they may be found *in situ*, or they may have been transported by streams of water, and

deposited elsewhere. During the leaching, the laterite may have been freed from certain extraneous matters, and contaminated with others. Analyses of laterites have been reconstructed to show that when an allowance has been made for the accompanying quartz, and clay, the contained water agrees with the assumption that the residue is of the bauxite type mixed possibly with some gibbsite, diasporite, and limonite. As emphasized by C. O. Swanson, there is no sharp line of demarcation between bauxite and laterite; and he regards them as a peculiar type of clay. A. Luz, after reviewing the evidence on the formation of laterites, concluded that the different stages in the weathering of the basic aluminosilicates are: (i) the formation of colloidal aluminium silicate; (ii) colloidal alumina and silica; (iii) crystalline hydrargillite; and (iv) crystalline diasporite.

According to E. Dittler and C. Doelter, commercial bauxites are to be regarded as rocks since they are compounded of various minerals—diasporite, gibbsite, and the amorphous aluminium hydroxide bauxite, together with intermixed limonite, hæmatite, and clay. Such mixtures have been named *diasporite*, *gibbsitite*, or *bauxitite*, according to the predominance of one or other of these constituent minerals. The two former are referred to as *crystalloidal alumolites*, and the latter as *colloidal alumolites*.

The weathering theory of the formation of bauxite is employed to explain deposits in Germany,³ Hungary,⁴ Spain,⁵ British Guiana,⁶ at Auvergne (France),⁷ Ireland,⁸ Arkansas,⁹ South Africa,¹⁰ etc. The deposits in Auvergne are derived from gneiss rocks; those in Hesse, Ireland, and Australia from basaltic rocks; and those in Arkansas from syenitic rocks. The French bauxites are associated with cretaceous rocks, and they have been regarded as deposits from hot waters carrying alumina in soln.¹¹ The Georgia-Alabama bauxite field¹² is also assumed to have been deposited from lagoons.

In 1821, P. Berthier¹³ analyzed *alumine hydratée des Beaux*, near Arles, Department Bouches-du-Rhône, and found Al_2O_3 , 52.0; Fe_2O_3 , 27.6; H_2O , 20.4 per cent. and a trace of chromic oxide. A. P. Dufrenoy named this product *beauxite* and classed it with gibbsite, although he recognized that the composition of the two substances is very different. H. St. C. Deville called it **bauxite**. J. F. L. Hausmann regarded it as a mixture of hydrated alumina and ferric oxide, and represented its composition by $\text{Al}_2\text{O}_3 \cdot 2\text{H}_2\text{O}$, intermediate between gibbsite and diasporite. A. Flechner named the deposit at Wochein (Styria), *wocheinite*; and C. Adam, the deposit at Clache (Dalmatia), *clachite*—*vide infra*, colloidal aluminium hydroxides. Bauxite is a mixture of hydrated aluminium oxides in which the molar ratio $\text{Al}_2\text{O}_3 : \text{H}_2\text{O}$ varies from 1:1 to 1:3. The old standard formula $\text{AlO}(\text{OH})_4$ thus belongs to an idealized compound. The colour varies from white to pale cream or red and dark brown; hence *ferruginous bauxites* are red-coloured, and *non-ferruginous bauxites* are white or cream-coloured. Bauxite usually has a concretionary structure, and the size of the concretions distinguishes between *pebble ore*, and *pisolitic ore*—*πίστρον*, a pea, and *oölitic ore*—*ὄόν*, an egg. The *amorphous ore* has scarcely any trace of the concretionary structure, and it may be soft and friable, or hard and compact.

The bauxite produced in the *United Kingdom* comes from Ireland, where it is found associated with the pisolitic iron ores and laterites at Clegnagh, Essatholam, Tuftarney, Glenarm, Irish Hill, Straid, etc., in County Antrim. There is also a deposit at Killygreen, County Londonderry. The deposits have been described by G. A. J. Cole, E. Hull, and G. H. Kinahan. The bauxite lies next to the upper basalt unless, as is sometimes the case, a layer of lignite intervenes. The stratum of bauxite generally merges into iron ore running 30–60 per cent. Fe_2O_3 . The upper part of the iron ore contains small nodules of iron oxide the size of peas. These gradually diminish in size as the stratum merges into bauxite clay. The bauxite varies in thickness from 2 ins. up to 2 ft.; under the bauxite is a layer of bole 2 ft. to 10 ft. thick; this is followed by a stratum of slate-coloured clay called lithomarge, 20 ft. to 30 ft. thick. The lithomarge contains SiO_2 , 49.75; Al_2O_3 , 29.88; Fe_2O_3 , 6.61; H_2O , 5.48 per cent. There are intrusive dykes here and there. Bauxite mining began in Ireland in 1871. The alumina in Irish bauxite is almost all soluble in sulphuric acid, while about 8 per cent. of the alumina in French bauxite is insoluble. The dark

bluish variety of bauxite has usually the highest proportion of alumina. The dried and ground bauxite from Irish Hill had the following percentage composition :

	Al ₂ O ₃	Fe ₂ O ₃	H ₂ O	SiO ₂	TiO ₂	CaO	MgO
1st quality . . .	53·83	1·57	29·27	8·67	5·80	0·62	0·13
2nd quality . . .	52·00	4·57	24·00	12·00	6·20	0·79	0·20
3rd quality . . .	46·13	15·14	23·39	10·40	4·21	0·18	0·26

With K₂O respectively 0·01, 0·02, and 0·04 ; Na₂O, 0·00, 0·02, 0·04 ; H₂SO₄, 0·07, 0·07, and 0·10 ; mere traces of phosphoric oxide, and hygroscopic moisture lost at 100°, 7·50, 0·90, and 0·85.

In *France*, there is a band lying almost parallel with the Mediterranean in the departments of Hérault, Bouches-du-Rhône, Var, and Alpes-Maritimes. The bauxite from Villeveyrac (Hérault) is white and contains a high proportion of alumina with but little iron and silica. It is used in the manufacture of aluminium salts. The red-banded bauxite of Baux (Arles) contains about 60 per cent. of alumina. It is used in the manufacture of aluminium. The dark red bauxite of Thoronet and Luc (Var) has a splintery or conchoidal fracture. Valuable deposits of bauxite occur in *Italy* near Abruzzi and Tannium. F. Kerner-Marilaun studied the bauxite deposits of the East Adriatic. In *Jugo-Slavia*, bauxite occurs in Dalmatia, Rammaljane, Blaca, Konjsko, and Kalun. In *Rumania*, there are deposits in the Bihar Mountains, and at Fata Oarza. A siliceous bauxite has been reported from Catalonia in *Spain*. A deposit of high-grade bauxite has been found on Mount Ejuanema on the *Gold Coast*. Many laterite deposits in *India* were highly aluminous. The richest deposits are in the Baihir plateau, and near Katni in the Central Provinces. Bauxite also occurs near Chota Nagpur, Sarguja, Bihar and Orissa ; in Bhopal and Rewah, Central India ; Satara, Bombay ; and in the Madras Presidency. Deposits have been found in *Australia*—various parts of Queensland, and New South Wales ; in Yankabilla, South Australia ; and on the Darling Range and Eastern Goldfield of West Australia. The chief occurrences in the *United States* are in Arkansas, Georgia, Alabama, and Tennessee—perhaps 80 per cent. of the output being obtained from mines in Arkansas. Deposits occur in *Dutch Guiana*, *French Guiana*, and *British Guiana*.

Numerous analyses of bauxites have been reported.¹⁴ A selection is shown in Table V. According to F. Laur, the average alumina in thousands of shipments

TABLE V.—ANALYSES OF BAUXITES.

—	Al ₂ O ₃	Fe ₂ O ₃	H ₂ O	SiO ₂	TiO ₂	CaO	MgO
Vogelsberg . . .	50·92	15·70	28·60	1·10	3·20	0·80	0·16
Monte Turchio . . .	55·01	24·29	12·72	3·05	2·44	0·58	0·25
Pescina . . .	41·13	24·81	17·31	6·28	2·70	8·24	—
Villeveyrac . . .	65·00	17·60	14·00	1·90	1·50	—	—
Villeveyrac . . .	76·90	0·10	15·80	2·20	4·00	—	—
Thoronet . . .	69·30	12·90	14·10	0·30	3·40	—	—
W. Australia . . .	44·66	19·08	27·02	5·96	3·10	—	—
Georgia . . .	52·94	12·29	28·40	2·83	3·78	—	—
Arkansas . . .	46·44	22·15	26·68	4·89	—	—	—
Arkansas . . .	62·05	1·66	30·31	2·00	3·50	—	—
Gold Coast . . .	60·55	9·75	25·59	1·42	2·21	0·73	—
Dalmatia . . .	57·9	24·3	12·0	1·2	4·2	0·3	—
Bihar (grey) . . .	69·0	3·0	15·0	12·0	—	—	—
Bihar (red) . . .	55·6	25·3	11·0	3·0	—	—	—
Katni . . .	65·48	3·77	19·38	0·38	11·61	—	—

of French bauxites was 66–69 per cent. ; the sum of the three variables, water, silica, and ferric oxides, approximated to 27 per cent. ; and the accessory substances averaged 3 to 4 per cent. A. Cobenzl, and M. Ragg attributed the blue colour to the presence of colloidal ferrous oxide. Titanium is almost invariably present, and when not reported, it may be assumed that the amount has not been determined ; its amount ranges usually from 1 to 10 per cent., although higher proportions are sometimes found. According to T. L. Watson, the amount of titanium is usually highest in the pisolitic ores and lowest in structureless bauxite. A. von Liebrich, and J. Lang state that it occurs as free titanite oxide, or ferric titanite oxide. Silica is always present in bauxites in amounts varying from one to several per cent. : it is probably

present as clay and quartz. H. Arsandaux said that the silica in bauxite is more often present as clay than as quartz; and, in agreement with P. Berthier, the iron is present as oxide rather than as hydroxide. The low-grade bauxites with, say, 30 to 35 per cent. silica may be usually regarded as bauxitic clays. It may be added that a series of natural products can be obtained passing by insensible gradations from corundum through bauxites, laterites, clays, arenaceous clays, on to silica; or from corundum, through the ferruginous clays, on to hæmatite. D. C. Wysor has discussed the nature of the bauxitic or diaspore clays of Missouri and Arkansas. Common impurities, not always reported in analyses because usually present in but small proportions, are compounds of calcium, magnesium, potassium, and sodium—phosphates, sulphates, and carbonates. H. St. C. Deville found minute quantities of vanadium to be contained in some samples of bauxite. There are also present traces of molybdenum, tungsten, etc., not separated from the alumina by the usual precipitating agents. R. L. y Gamboa found gallium in bauxite.

A. Lacroix said that under the microscope, bauxite is *absolument colloïdes*; and F. Cornu has described the gel characteristics of *die isotropen Substanzen des Bauxites*. H. Stremme discussed the colloidal nature of many of the aluminosilicates. F. Slavik gave 1.60–1.61 for the refractive index of bauxite. E. Löwenstein measured the vap. press. of bauxites.

R. S. Bayer obtained a residual soln. after removing all the known elements, and reported that it contained a new element which he named *bauxium*. The soln. on spectroscopic examination was later shown to contain a mixture of the elements just named along with traces of lead, copper, bismuth, etc. A mixture of ammonium vanadate and tungstate gives all the reactions which R. S. Bayer thought to be characteristic of bauxium.

REFERENCES.

- ¹ J. G. Wallerius, *Mineralogie*, Stockholm, 267, 1747; G. Agricola, *De natura fossilium*, Basileæ, 1546; Pliny, *Historia naturalis*, 36. 10, 30; 37. 9, 15, 25, 29, 39, 44, 49, c. 77 A.D.; Dioscorides, *Περὶ ἕλης ἱατρικῆς*, 5. 165, c. 50 A.D.; Theophrastos, *Περὶ λίθου*, 43, c. 315 B.C.; C. A. S. Hofmann, *Handbuch der Mineralogie*, Freiberg, 1. 547, 1811; C. C. von Leonhard, *Handbuch der Oryktognosie*, Heidelberg, 393, 1821; S. Fränkel, *Mitt. Br.*, 20, 1907; A. B. de Boot, *Gemmarum et lapidum historia*, Hanovix, 92, 1609; J. B. L. Romé de l'Isle, *Cristallographie*, Paris, 2. 213, 1783; R. J. Haiüy, *Traité de minéralogie*, Paris, 2. 92, 480, 1801; 3. 8, 1801; S. A. Papavasiliou, *Zeit. deut. geol. Ges.*, 55. 1, 1913; X. Landerer, *Berg, Hütt. Ztg.*, 35. 310, 1876; A. J. M. Brochant, *Mém. Soc. Savant. Lit.*, 1. 55, 1802; C. Gréville, *Phil. Trans.*, 88. 403, 1798; Comte de Bournon, *ib.*, 88. 428, 1798; 92. 233, 1802; R. Chenevix, *ib.*, 92. 327, 1802; S. Tennant, *Gilbert's Ann.*, 12. 249, 1802; M. H. Klaproth, *Beiträge zur chemischen Kenntniss der Mineralkörper*, Berlin, 1. 47, 88, 1795; H. Rose, *Pogg. Ann.*, 51. 279, 1840; J. C. Delaméthérie, *Journ. Phys.*, 30. 12, 1787; T. Bergman, *De terra gemmarum*, Upsala, 1777; J. L. Smith, *Amer. Journ. Science*, (2), 10. 354, 1850; (2), 11. 53, 1851; (2), 13. 83, 1852; K. Pfeil, *Centr. Min.*, 145, 1902; *Ueber die Aufschliessung der Silikat und anderer schwer zersetzbar Mineralien mit Borsäure anhydrid*, Heidelberg, 1901; A. Terreil, *Compt. Rend.*, 59. 1047, 1864; E. Cohen, *Meteoritenkunde*, Stuttgart, 1. 317, 1894; E. Weinschenk, *Ann. Nat. Hofmus.*, 4. 100, 1889; F. Wöhler, *Sitzber. Akad. Wien*, 8. 502, 1852; A. A. Julien, *Proc. Boston Soc. Nat. Hist.*, 2. 141, 1882; T. M. Chatard, *Bull. U.S. Geol. Sur.*, 42. 45, 1887; J. Morozewicz, *Tschermak's Mitt.*, 18. 212, 1898; A. Lagorio, *Zeit. Kryst.*, 24. 285, 1895; B. Dunstan, *The Sapphire Fields of Anatie*, Brisbane, 1902; T. H. Holland, *A Manual of the Geology of India*, Calcutta, i, 1, 1898; J. L. Smith, *Amer. Journ. Science*, (2), 10. 357, 1850; F. Zirkel, *Lehrbuch der Petrographie*, Leipzig, 1. 461, 1893; G. A. F. Molengraaf, *Neues Jahrb. Min. B.B.*, 9. 174, 1895; J. H. Pratt, *Corundum*, Washington, 1906; A. Lacroix, *Bull. Soc. Geol.*, 2. 11, 1891; *Bull. Soc. Min.*, 13. 100, 1890; M. F. Hedde, *Min. Mag.*, 9. 389, 1890; J. W. Retgers, *Rec. Trav. Chim. Pays-Bas*, 11. 169, 1892; A. Hänig, *Emery and the Emery Industry*, London, 1912.
- ² P. Lake, *Mem. Geol. Sur. India*, 24. iii, 17, 1890; G. C. du Bois, *Tschermak's Mitt.*, (2), 22. 1, 1903; C. Klement, *ib.*, 8. 26, 1886; W. J. McGee, *Geol. Mag.*, 310, 1880; T. H. Holland, *ib.*, 59, 1903; M. Maclaren, *ib.*, 536, 1906; J. R. Kilroe, *ib.*, 534, 1908; E. S. Simpson, *ib.*, 393, 1912; W. G. Woolnough, *ib.*, 385, 1918; A. Holmes, *ib.*, 529, 1914; F. P. Mennell, *ib.*, 350, 1909; J. B. Harrison, *ib.*, 439, 488, 553, 1910; 120, 1911; H. and F. J. Warth, *ib.*, 154, 1903; *Min. Mag.*, 13. 172, 1902; L. L. Ferrom, *ib.*, 454, 507, 559, 1911; 28. 77, 123, 1915; *Rec. Geol. Sur. India*, 34. 167, 1906; 53. 250, 1922; F. R. Mallet, *ib.*, 14. 139, 1881; W. R. Dunstan, *ib.*, 37. ii, 213, 1908; R. C. Burton, *ib.*, 48. 204, 1917; A. Luz, *Koll. Zeit.*, 14. 81, 1914; W. Maxwell, *Lavas and Soils of the Hawaiian Islands*, Honolulu, 1898; E. C. J. Mohr, *Bull. Dept. Agric. Indes Néerlandaises*, 17, 1908; 28, 1909; M. Bauer, *Neues Jahrb. Min.*, ii, 192, 1898; J. M. Campbell, *Trans. Inst. Min. Met.*, 19. 432, 1910; *Min. Mag.*, 17. 67, 120, 171, 220, 1917;

J. Chautard and G. Lemoine, *Bull. Soc. Min. Ind.*, (4), 9. 305, 1908; *Compt. Rend.*, **146**. 239, 1908; H. Arsandaux, *ib.*, **149**. 682, 1909; **150**. 1698, 1910; J. Chautard, *Compt. Rend. Min. Ind.*, **119**, 1908; A. Atterberg, *Centr. Min.*, **361**, 1909; W. Meigen, *Geol. Rund.*, **2**. 197, 1911; A. Lacroix, *Nouv. Arch. Mus. Hist. Nat.*, (5), **15**. 255, 1913; *Le minéralogie de Madagascar*, Paris, 1923; J. M. van Bemmelen, *Zeit. anorg. Chem.*, **66**. 322, 1910; E. Dittler and C. Doelter, *Centr. Min.*, **104**, 1912; F. W. Clarke, *The Data of Geochemistry*, Washington, **488**, 1920; C. O. Swanson, *Journ. Amer. Cer. Soc.* **6**. 1248, 1923; F. Buchanan (Hamilton), *A Journey from Madras through Mysore, Canara, and Malabar*, London, **2**. 441, 1807; G. C. du Bois, *Tschermak's Mitt.* (2), **22**. **1**, 1903; R. Lenz, *Chemische Untersuchungen über Laterits*, Freiburg, 1908.

³ A. Streng, *Zeit. deut. geol. Ges.*, **39**. 621, 1887; T. Petersen, *Ber. Oberrhein. geol. Ver.*, **26**. 38, 1893; J. Lang, *Ber.*, **17**. 2892, 1884; R. Delkeskamp, *Zeit. prakt. Geol.*, **11**. 306, 1904; A. Köbrich, *ib.*, **12**. 23, 1905; A. von Liebrich, *Beitrag zur Kenntniss des Bauxits vom Vogelsberge*, Zurich, 1892; E. Hüffner, *Chem. Ztg.*, **44**. 785, 1920; H. Münster, *Die Brauneisenerzlagertstätten des Seen- und Ohmtals am Nordrand des Vogelsgebirges*, Giessen, 1905; W. Henatsch, *Ueber Bauxite und ihre Verarbeitung*, Breslau, 1879.

⁴ J. von Szadeczky, *Földt. Köz.*, **35**. 247, 1905; B. von Horvath, *ib.*, **41**. 254, 341, 1911; **47**. 795, 1915; *Magyar Földt.*, **47**, 1916; **51**, 1917; R. Lachmann, *Zeit. prakt. Geol.*, **15**. 353, 1908.

⁵ P. H. Sampelayo, *Bol. Inst. Geol. Espana*, **41**. 3, 1921.

⁶ J. B. Harrison, *Report on Bauxite in British Guiana*, Demerara, 1917.

⁷ E. Augé, *Bull. Soc. Geol.*, (3), **16**. 345, 1880.

⁸ G. A. J. Cole, *Mem. Geol. Sur. Ireland*, Interbasaltic rocks, 1912; *Trans. Roy. Soc. Dublin*, (2), **6**. 105, 1896; G. H. Kinahan, *Trans. Manchester Geol. Soc.*, **22**. 458, 1894; W. Peile, *ib.*, **22**. 524, 1894; G. G. Blackwell, *ib.*, **22**. 525, 1894; C. H. Williams, *ib.*, **22**. 518, 1894.

⁹ J. F. Williams, *Ann. Rep. Arkansas Geol. Sur.*, **2**. 124, 1890; J. C. Branner, *Journ. Geol.*, **5**. 263, 1897; C. W. Hayes, *Ann. Rep. U.S. Geol. Sur.*, **21**. iii, 435, 1901; W. J. Mead, *Econ. Geol.*, **10**. 29, 1915; D. C. Wysox, *ib.*, **11**. 42, 1916; S. J. Thugutt, *Neues Jahrb. Min. B.B.*, **9**. 609, 1895; W. C. Brögger, *Zeit. Kryst.*, **16**. 50, 1890; F. W. Clarke, *The Data of Geochemistry*, Washington, 493, 1920; W. A. Nelson, *Bull. Amer. Geol. Soc.*, **34**. 525, 1923.

¹⁰ A. L. Hall, *Union of S. Africa Geol. Sur.*, **15**, 1920; Anon., *Bull. Imp. Inst.*, **19**. 93, 1921.

¹¹ T. L. Watson, *Bull. Geol. Sur. Georgia*, **11**, 1904; H. Coquand, *Bull. Soc. Geol.*, (2), **28**. 98, 1870; M. Augé, *ib.*, (3), **16**. 345, 1880; S. Meunier, *ib.*, (3), **17**. 64, 1888; *Compt. Rend.*, **96**. 1737, 1883; F. Laur, *Compt. Rend. Soc. Ind. Min.*, **430**, 1908; *Trans. Amer. Inst. Min. Eng.*, **24**. 234, 1894.

¹² J. W. Spencer, *Ann. Rep. Geol. Sur. Georgia*, **214**, 1893; H. McCalley, *Ann. Rep. Geol. Sur. Alabama*, **2**, 1897; C. W. Hayes, *Ann. Rep. U.S. Geol. Sur.*, **16**. iii, 547, 1895; *Trans. Amer. Inst. Min. Eng.*, **24**. 243, 1894; O. Veatch, *Bull. Geol. Sur. Georgia*, **18**, 1904; T. L. Watson, *ib.*, **11**, 1909; *Amer. Geol.*, **28**. 25, 1901.

¹³ P. Berthier, *Ann. Mines*, (2), **6**. 531, 1821; H. St. C. Deville, *Ann. Chim. Phys.*, (3), **61**. 309, 1861; A. P. Dufrenoy, *Traité de minéralogie*, Paris, **2**. 347, 1844; **3**. 799, 1847; J. F. L. Hausmann, *Handbuch der Mineralogie*, Göttingen, **350**, 1847; A. Flechner, *Zeit. deut. geol. Ges.*, **18**. 181, 1866; C. Adam, *Tableau minéralogique*, Paris, **73**, 1869; Anon., *The Mineral Industry of the British Empire—Aluminium and Bauxite*, London, 1921; F. Kerner-Marilaun, *Montan. Rund.*, **14**. 73, 1922; E. Hull, *The Physical Geology and Geography of Ireland*, London, **89**, 1891; G. H. Kinahan, *Trans. Manchester Geol. Soc.*, **22**. 458, 1895; C. H. Williams, *ib.*, **22**. 518, 1895; W. Peile, *ib.*, **22**. 522, 1895; G. G. Blackwell, *ib.*, **22**. 525, 1895; G. A. J. Cole, *Mem. Geol. Sur. Ireland (Interbasaltic rocks)*, **112**, 1912; *Trans. Roy. Soc. Dublin*, (2), **6**. 105, 1896; H. Segar, *Dingler's Journ.*, **224**. 334, 1880.

¹⁴ A. von Liebrich, *Beitrag zur Kenntniss des Bauxits vom Vogelsberge*, Zurich, 1892; *Zeit. Kryst.*, **23**. 296, 1894; W. Henatsch, *ib.*, **4**. 642, 1880; *Ueber Bauxite und ihre Verarbeitung*, Berlin, 1879; J. Lang, *Ber.*, **17**. 2894, 1884; J. von Szadeczky, *Földt. Köz.*, **35**. 247, 1905; M. Lill von Lillienbach, *Jahrb. Geol. Reichsanst. Wien*, **16**. **11**, 1865; *Oest. Zeit. Berg. Hütt.*, **13**. 280, 1865; C. Formente, *Gazz. Chim. Ital.*, **32**. i, 453, 1902; G. d'Achiardi, *Proc. Verb. Soc. Toscana*, **13**. 33, 1903; E. Augé, *Bull. Soc. Geol.*, **16**. 345, 1888; H. St. C. Deville, *Ann. Chim. Phys.*, (3), **61**. 309, 1861; H. and F. J. Warth, *Geol. Mag.*, **154**, 1903; J. M. van Bemmelen, *Zeit. anorg. Chem.*, **42**. 310, 1904; H. Arsandaux, *Compt. Rend.*, **148**. 937, 1115, 1909; *Bull. Soc. Min.*, **36**. 70, 1912; P. Berthier, *Ann. Mines*, (2), **6**. 531, 1831; W. Peile, *Trans. Manchester Geol. Soc.*, **22**. 524, 1894; G. G. Blackwell, *ib.*, **22**. 525, 1895; F. Laur, *Trans. Amer. Inst. Min. Eng.*, **25**. 234, 1894; *Proc. Inst. Civ. Eng.*, **120**. ii, 442, 1895; *Métaux Alliages*, **1**, **2**, **3**, **4**, **5**, **6**, **8**, **9**, **10**, **11**, **12**, 1914; **3**, **4**, **10**, **12**, 1915; F. Slavik, *Rozprawy Ceske Akad.*, **26**. 60, 1917; *Bull. Acad. Bohême*, **22**. 32, 1918; D. C. Wysox, *Journ. Amer. Cer. Soc.*, **6**. 501, 1923; E. Löwenstein, *Zeit. anorg. Chem.*, **63**. 69, 1909; *Ueber Hydrate deren Dampfspannung sich kontinuierlich mit der Zusammensetzung ändert*, Hamburg, 1909; A. Cobenzl, *Farben-Ztg.*, **25**. 20, 1919; M. Ragg, *ib.*, **25**. 151, 1919; T. L. Watson, *A Preliminary Report on the Bauxite Deposits of Georgia*, Atlanta, 1904; H. Stremme, *Centr. Min.*, **661**, 1908; **197**, 1911; **80**, 1914; F. Cornu, *ib.*, **326**, 1909; *Zeit. prakt. Geol.*, **85**, **143**, 1909; *Koll. Zeit.*, **4**. 90, 1909; A. Lacroix, *Minéralogie de la France et de ses colonies*, Paris, **3**. 342, 1901; R. S. Bayer, *Bull. Soc. Chim.*, (3), **11**. 1155, 1894; R. L. y Gamboa, *Anal. Fis. Quim.*, **21**. 305, 1923; T. P. Maynard, *Amer. Chem. Age*, **30**. 86, 1922.

§ 9. Aluminium Oxides

J. E. Ashby¹ reported that when alumina is heated red-hot, and quenched in alcohol, it becomes black; and claimed that the black colour is not due to carbon from the decomposition of the alcohol because it also appears when the alumina is quenched in conc. aq. ammonia. He suggested the black colour is due to the formation of a suboxide. The object of H. St. C. Deville in working on aluminium was to prepare **aluminium suboxide**, AlO , analogous to ferrous oxide, FeO . He tried to make the subchloride, AlCl_2 , by passing the vapour of the trichloride, AlCl_3 , over the metallic powder formed by reducing alumina with potassium. He obtained fine globules of aluminium embedded in a mass of potassium aluminium chloride, $\text{AlCl}_3 \cdot \text{KCl}$, but no subchloride. His attention was thence diverted to the metal, and he did not make any further experiments on the suboxide. No aluminium suboxide has yet been unequivocally demonstrated as a chemical individual. G. A. Kenngott said that if calcined and powdered diaspore, corundum, or artificial alumina be moistened with water, and heated in a reducing flame, a suboxide is produced; and E. Beetz said that in the electrolysis of soln. of sodium chloride with aluminium electrodes, the cathode becomes covered with a black layer of what he regarded as aluminium suboxide, analogous to magnesium suboxide obtained under similar conditions. A. Duboin stated that by igniting an intimate mixture of a mol of alumina with four gram-atoms of aluminium at one point, the whole mass becomes incandescent, and aluminium suboxide, AlO , is formed. E. Kohn-Abrest claimed to have made a pearl-grey powder by heating aluminium in air to 1000° for about an hour; he said that the product is homogeneous, and gives hydrogen when treated with hydrochloric acid; analyses correspond with Al_4O_3 or Al_2O . J. Pionchon claimed to have made a suboxide, Al_6O_7 , or $3\text{Al}_2\text{O}_3 \cdot \text{Al}_2\text{O}$, by heating aluminium in the oxy-hydrogen blowpipe flame fed with comparatively little oxygen. The grey powder remaining after the brilliant combustion, dissolves partially in hydrochloric acid evolving hydrogen, and leaving a residue of alumina. These experiments agree with the assumption that the grey powder is a mixture of alumina and finely divided aluminium. According to C. Winkler, a mol of alumina mixed with a gram-atom of magnesium and heated in a current of hydrogen gave a black powder which was assumed to be a mixture of 40 per cent. of the suboxide, AlO , with undecomposed alumina, and magnesia.

According to E. Grobet,² on adding sodium hydroxide to dil. soln. of aluminium nitrate, insoluble aluminium hydroxide, and soluble sodium metaluminate, and sodium ortho-aluminate are successively formed. When dil. soln. of aluminium sulphate or chloride or potash alum are used, aluminium hydroxide, basic sodium aluminate, $\text{Al}(\text{ONa})_3 \cdot \text{Al}(\text{OH})_3$, and sodium ortho-aluminate are formed successively. Conc. soln. of aluminium chloride, nitrate, or sulphate produce under the same treatment a basic salt of the type, $\text{AlX}_3 \cdot \text{Al}(\text{OH})_3$, which is followed by the hydroxide, metaluminate, and ortho-aluminate. Conc. soln. of potash alum yield a basic salt, $\text{Al}_2(\text{SO}_4)_3 \cdot 2\text{Al}(\text{OH})_3$, aluminium hydroxide, a basic aluminate, $\text{Al}(\text{ONa})_3 \cdot \text{Al}(\text{OH})_3$, and the ortho-aluminate. In preparing **hydrated alumina**, $\text{Al}_2\text{O}_3 \cdot n\text{H}_2\text{O}$, an alkali hydroxide is added to a soln. of an aluminium salt; or, preferably, aq. ammonia is used because the precipitate is insoluble in an excess, and it introduces no non-volatile constituent into the system. The slimy mass is difficult to wash. To facilitate the washing, it is best to conduct the precipitation with boiling soln. and wash the hot precipitate with a hot soln. of ammonium nitrate or chloride. The ignition of the washed precipitate furnishes alumina.

According to J. J. Berzelius, and C. F. Bucholz, if ammonia be added to a soln. of alum a basic sulphate will be formed. H. Krämer said not if the alum soln. be added to the ammonia; but G. C. Wittstein and S. von Thielau still found the precipitate contained sulphates. J. J. Berzelius precipitated a hot soln. of alum free from iron, with alkali carbonate, digested the precipitate with the mother liquid to decompose what he regarded

as a basic sulphate, washed it thoroughly with water; dissolved it in hydrochloric acid; re-precipitated with ammonia, and ignited. J. von Liebig treated a soln. of alum with barium chloride, evaporated the filtrate to dryness, and washed the chlorides of barium and potassium from the ignited product by means of water acidulated with hydrochloric acid. G. Ekmann and O. Petterson added barium chloride to a soln. of potash alum, and precipitated the hydroxide by adding ammonia to the filtrate; the washed precipitate was dissolved in hydrochloric acid and again precipitated with ammonia. After a third treatment they found the precipitate to be quite free from alkali.

These processes are not sufficiently economical to be worked on a large scale. One of the easiest methods of making alumina is that recommended by J. L. Gay Lussac, namely, to ignite at a red heat ammonia-alum which has been dehydrated and partially decomposed at a low temp. A little sulphuric acid still remains with the alumina. C. Brunner showed that, if necessary, this can be removed by moistening the mass with a soln. of sodium carbonate, drying and again igniting. When the product is washed with water, the sulphuric acid is removed as sodium sulphate. The alumina is now contaminated with a little sodium hydroxide which cannot be removed by washing. If potash-alum be ignited, most of the potassium sulphate is washed out before the last ignition. F. Wöhler recommended igniting a mixture of aluminium sulphate with 20 per cent. of sodium carbonate, and afterwards washing the sodium sulphate from the alumina. M. Buchner has suggested several methods of making granular hydrated alumina.

The preparation of alumina from bauxite or aluminous earths.—The bauxite used in the preparation of aluminium must be freed from the contained silica, titanite oxide, and ferric oxide, if the aluminium is to be obtained of the required degree of purity. The Irish bauxite containing on the average: Al_2O_3 , 56; Fe_2O_3 , 3; SiO_2 , 12; TiO_2 , 3; water, 26 per cent., has been employed for this purpose; but, according to F. R. Low, it is considered uneconomical to work bauxite with over about 3 per cent. of silica. The French bauxite may have up to 75 per cent. alumina. The process of purification involves two main operations: (i) the preparation of sodium aluminate and the soln. of this salt to separate it from the ferric oxide; and (ii) the precipitation of hydrated alumina from this soln. At Salindres, where H. St. C. Deville's aluminium process was employed, alumina was obtained from bauxite by L. le Chatelier's process.

An intimate mixture of powdered bauxite and 39 per cent. sodium carbonate, is heated in a reverberatory furnace; when the reaction is completed, the sodium aluminate is leached from the insoluble ferric oxide with a dil. soln. of aluminate from the preceding charge. The conc. liquor is treated with carbon dioxide to precipitate the alumina. The furnace charge is again washed with water, and the dil. soln. is employed for leaching the next charge. The liquor is agitated while it is being treated with carbon dioxide; the precipitation occupies about 5–6 hrs. The soln. of sodium carbonate is decanted from the alumina, and evaporated to furnish most of the alkali carbonate required for the next charge of bauxite. The moist alumina is treated in a centrifugal washer to remove the adherent sodium carbonate, washed with water, and again centrifuged. The product contains 47.5 per cent. of alumina, 50.0 per cent. of water, and 2.5 per cent. of sodium carbonate.

According to G. and F. Löwig, a soln. of alkali aluminate can be precipitated with hydroxide of calcium, strontium, barium, or magnesium, forming the alkali hydroxide and a mixed precipitate of hydrated alumina and lime, strontia, baryta, or magnesia. The precipitate is washed by decantation and divided into two portions—one is dissolved in hydrochloric acid, and the other made into a mush with water. The latter is gradually added to the former until very little alumina remains in soln. Hydrated alumina is thus precipitated, and the chloride of the alkaline earths or magnesia passes into soln.

Instead of precipitating the alumina from the aq. soln. of sodium aluminate by treatment with carbon dioxide, in **C. J. Bayer's process**³ the hydrated alumina is precipitated by adding hydrated alumina itself. In 1833, P. A. von Bonsdorff showed that a sat. soln. of gelatinous aluminium hydroxide in potash-lye, slowly deposits crystals of gibbsite, when kept in a closed vessel for some days. A. Mitscherlich, and L. Péan de St. Gilles showed that aluminium hydroxide becomes sparingly

soluble in acids when it has been allowed to stand for some time; and M. Berthelot attributed this to *une condensation moléculaire de l'alumine*. The hydrated alumina precipitated in C. J. Bayer's process is in the crystalline form, and C. J. Bayer, and A. Ditte assumed that two varieties of hydrated alumina are involved—the gelatinous and the crystalline; and that the crystalline form is far less soluble than the gelatinous. A soln. sat. with the gelatinous hydroxide must therefore be super-saturated with respect to the crystalline form; consequently, if the soln. of the gelatinous hydrate be seeded with the crystalline hydrate, precipitation will occur. F. Russ has adopted a similar explanation; he called the more soluble and less stable form the α -hydrate, and the crystalline, less soluble and more stable form the β -hydrate. The precipitation of the latter from a soln. of the former depends on the rate of transformation of the α - to the β -hydrate; and this is favoured by hydroxyl ions. F. Russ measured the solubility of the β -hydrate (mols Al_2O_3) in soln. of sodium hydroxide of different conc. (mols Na_2O per 100 mols of H_2O), at 19° , as shown in Fig. 47. There is a rapid increase in solubility with increasing conc. of alkali for soln. with over 5.2 mols Na_2O per 100 mols of water. He also found the times at which precipitation occurred with soln. of the gelatinous α -hydrate in soda-lye of different conc., between 19° – 22° :

Sp. gr. of lye	. 1.013	1.063	1.111	1.173	1.240	1.304	1.391	1.530	1.570
Time (days)	. 6	$\frac{1}{2}$	$\frac{1}{2}$	3	1	1	2	6	38
	Small colloidal			Large			Small		
	Crystalline								

In the second and third cases the precipitate became crystalline in about 10 days. After allowing the mixtures to stand 22 weeks, at about 20° , the amounts of hydrated alumina precipitated from soln. of different conc. are indicated in Fig. 48. The

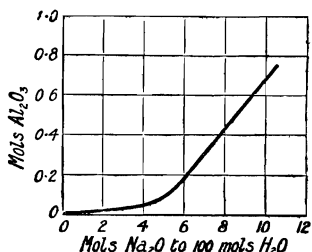

FIG. 47.—Solubility of Alumina in Solutions of Sodium Hydroxide.

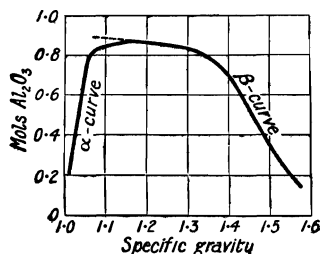

FIG. 48.—Precipitation of Alumina from Solution in Sodium Hydroxide.

β -curve is the reciprocal of the solubility curve; the α -curve is not so easily interpreted because of the transformation of a certain proportion of the α - into the β -hydrate. The curve also shows that the maximum precipitation occurs with soln. of sp. gr. approximately 1.2.

J. Sutherland has described the process employed at Larne Harbour. The bauxite is ground, calcined, and then agitated under press, with a conc. soln. of sodium hydroxide—sp. gr. 1.45. Sodium aluminate passes into soln., while the ferric oxide, silica, and titanio oxide remain undissolved. The soln. is diluted to a sp. gr. 1.23, and passed through filter presses, and then through wood-pulp supported on $\frac{1}{8}$ th in. mesh sieves. The liquor is then ready for the precipitation. This is effected by agitating the liquor in tanks for about 36 hrs. with some of the aluminium hydrate from the preceding charge. The precipitation continues until the molar ratio $\text{Al}_2\text{O}_3 : \text{Na}_2\text{O}$ is about 1 : 6. In practice about 70 per cent. of the alumina in the soln. of sodium aluminate is precipitated. The mixture is allowed to settle for a short time, the clear liquor is run into weak liquor tanks, and the slurry of hydrated alumina is pumped into filter presses where the alumina is washed, dried, and calcined to about 1100° . Enough hydrated alumina is left in the precipitation tank to begin the decomposition of the next charge. The liquor is then conc. by evaporation up to a sp. gr. 1.45 and used for extracting alumina from the next charge of bauxite.

C. M. Hall proposed to extract the alumina from bauxite by heating the powdered mineral with a soln. of calcium hydroxide and sodium carbonate or hydroxide under high press. He claimed that calcium phosphate, carbonate, and silicate remain undissolved while sodium aluminate passes into soln. The hydrated alumina is then precipitated in the usual way. F. R. Lowe described the extraction of alumina by this process. The Chemische Fabrik Greisheim-Elektron found that there is no need to work at a high press. if a temp. of 180° – 200° be employed with potash-lye, or 350° – 500° with soda-lye. F. Curtius, and F. Kunheim have suggested modifications of the process for obtaining a soln. of sodium aluminate from bauxite. To separate alumina of a high degree of purity from the soln. obtained by treating bauxite with sodium hydroxide, J. A. Bradburn and J. D. Pennock proposed a kind of fractional precipitation of hydrated alumina with carbon dioxide or calcium hydroxide. E. Everhart agitated the disintegrated bauxite ore with a deflocculating agent, such as sodium hydroxide soln., until the clay matter is all in suspension; granular bauxite remains. R. S. Sherwin leached a sintered mixture of bauxite or clay with lime and a sodium compound. Silica is precipitated when the soln. is heated under press.

Fused sodium chloride does not react with bauxite, but if steam be present sodium aluminate is formed and hydrogen chloride evolved. This process was recommended by R. A. Tilghmann.⁴ A proposal has been made by J. H. C. Behnke to obtain alumina from bauxite by calcining a mixture of the mineral with sodium sulphate, carbon, and ferric oxide. According to F. Lauer, it is advantageous to use a little sodium carbonate with the sulphate. The frit is leached with water when sodium aluminate and sulphate pass into soln. The hydrated alumina is precipitated in the usual way; the insoluble residue has to be roasted and fused over again. M. Platsch, K. Lieber, A. Clemm, and D. A. Peniakoff have suggested modifications of this process. E. Collet⁵ fused the bauxite with lime and a little sodium carbonate, treated the powdered product with a soln. of sodium hydroxide, and precipitated the alumina by carbon dioxide. R. von Wagner boiled bauxite in a soln. of sodium sulphate whereby hydrogen sulphide was evolved and a soln. of sodium aluminate formed.

According to H. S. Blackmore, phosphorus, selenium, and tellurium can be removed from bauxite and other refractory minerals by passing the vapour of carbon disulphide or hydrocarbons over the heated mineral. C. F. Claus prepared a soln. of alkali aluminate by making briquettes with a mixture of bauxite or bauxite and hydrated alumina with sodium or potassium chloride; heating the briquettes in a continuous chamber kiln to 400° – 500° in a current of heated sulphur dioxide, steam, and air whereby sulphates are formed, and hydrogen chloride evolved; and reducing the sulphate to sulphide by heating with water gas, carbon monoxide, or hydrogen. The alkali sulphide then reacts with the aluminate, forming alkali aluminate and evolving hydrogen sulphide. The product is then leached with water. C. M. Hall claimed to prepare pure alumina from bauxite by heating in a carbon-lined electric furnace a mixture of bauxite, carbon, and aluminium powder. The proportion of the latter is determined by the amount of ferric oxide, silica, and titanite oxide in the bauxite, and if the ferric oxide is low, some may be advantageously added. The reduced iron, silicon, and titanium form an alloy with the small portion of aluminium added. The alloy collects at the bottom of the furnace. The alumina remaining is powdered, and the metallic particles removed by a magnet.

In some cases, the bauxite has been digested with sulphuric acid and aluminium sulphate obtained from the soln. As R. Helmhacker⁵ showed, some ferric sulphate is also formed. F. Lauer treated the soln. with zinc plates to precipitate the iron; J. W. and T. Chadwick and J. W. Kynaston used arsenious oxide; J. J. Hood and A. G. Salomon used stannic acid; C. Fahlberg, lead dioxide; J. W. Kynaston, manganese dioxide; J. Beveridge used antimonious acid or potassium ferrocyanide; C. V. Petraeus, and T. Robinson used sulphides of the alkalis or alkaline earths; and J. L. Kessler used phosphoric acid. M. Ducla treated the mixed iron and aluminium sulphates with a mixture of milk of lime and calcium carbonate, and separated the precipitated alumina from the ferric oxide by dissolution in soda-lye. A. Wacker described an electrolytic process of purification of aluminium

salts. J. Morel treated bauxite with a mixture of sulphur dioxide, air, and steam below 800° so as to form the soluble sulphate, from which alumina was precipitated by sodium thiosulphate. A. Hurtur converted aluminium sulphate into alumina by ignition in hydrogen. A. L. Pedemonte heated the bauxite in a reducing atm., separated the reduced iron by electromagnets, dissolved the product in acid, evaporated to remove silica, etc.

Some native alum earths furnish a soln. of aluminium sulphate by simply leaching with water. *Alunite*—a basic potassium aluminium sulphate—is roasted between 800° – 900° , and the product treated with sulphuric acid. The conc. soln. furnishes crystals of alum. J. Blumenwitz has described the process in detail. H. F. Chappel heated the alunite at a temp. high enough to volatilize the potassium sulphate, and form alumina. According to A. Mitscherlich, alum shales are roasted at a low temp. and then exposed to the atm. The pyrites are oxidized and sulphuric acid is produced, which forms aluminium sulphate. The latter is leached from the mass with dil. sulphuric acid—*vide infra*, alum. The process has been discussed by P. Guyot, F. Trögler, M. Vinck, A. H. Seger, K. W. Jurisch, etc. J. Webster transformed alum to alumina by heating a mixture of alum and pitch to about 250° ; the product was mixed with dil. hydrochloric acid and made into briquettes with about 5 per cent. of carbon. The briquettes were heated in a current of steam and air; when leached with water, potassium sulphate passes into soln., and alumina remains behind. F. Jourdain fused leucite with lime, and extracted the mass with water to get the alkali aluminate into soln. The alumina was precipitated with carbon dioxide.

The preparation of alumina from cryolite.—J. Thomsen⁶ worked up cryolite into alumina and sodium carbonate as indicated in connection with sodium carbonate—2, 20, 28. According to F. Lauterborn, cryolite is decomposed into aluminium and sodium fluorides when boiled with water. H. Bauer boiled a mixture of cryolite and calcium carbonate with water: $2\text{Na}_3\text{AlF}_6 + 3\text{H}_2\text{O} + 6\text{CaCO}_3 = 2\text{Al}(\text{OH})_3 + 3\text{CO}_2 + 3\text{Na}_2\text{CO}_3 + 6\text{CaF}_2$; the alkali carbonate and hydrated alumina form soluble sodium aluminate. H. St. C. Deville used a somewhat similar process at Javel. If steam be passed over molten cryolite at a red heat, C. A. Dorenius found that hydrogen fluoride is evolved and sodium aluminate, mixed with some fluoride, is formed. C. Pieper, and L. Grabau discussed the purification of soln. of aluminium fluoride. L. Schuch treated finely powdered cryolite with conc. soda-lye, and obtained sodium aluminate in soln., and sodium fluoride as a sediment. W. J. Williams, and L. Grognot discussed the conversion of the alumina in aluminium iron phosphate minerals into sodium aluminate.

The preparation of alumina from clays and other aluminosilicates.—A large field is open for the utilization of clay or other aluminosilicates, for the manufacture of aluminium. The cost of separating from alumina the dangerous impurity, silica, has prevented the many proposals from competing with bauxite as the cheapest raw material available. So important is bauxite to the aluminium industry that R. Sylvany⁷ could say: "Without the discovery of important bauxite fields the alum and aluminate industries would not have developed, and the aluminium industry would not exist." If cheap methods of desilicifying china clays should ever be discovered, it will appear as if the availability of supplies of bauxite accelerated the growth of the aluminium industry along the path of least resistance. Many of the suggestions which have been made involve the treatment of the aluminosilicate with sulphuric acid, or with some heavy metal sulphate, and the soln. of aluminium sulphate finally produced is crystallized from the soln. as alum. The processes generally have been discussed by A. and P. Buisine, J. Bronn, H. Debray, M. Feigensohn, etc.; and by K. W. Jurisch in his *Die Fabrikation von schwefelsaurer Thonerde* (Berlin, 1894).

L. Grabau treated the clay, as free as possible from iron compounds, with dil. hydrofluoric acid, and obtained a soln. of aluminium fluoride—the silica is volatilized as silicon tetrafluoride. H. Pemberton and J. Spiller have discussed a process in which felspar is

treated similarly with a mixture of sulphuric and hydrofluoric acids. A. Sobrero roasted the clay, free from iron and calcium compounds, mixed the powdered mass with conc. sulphuric acid, and heated it to about 70°, when aluminium sulphate was formed. This was extracted with water and the soln. treated with potassium sulphate for alum; P. Spence and co-workers added potassium chloride in place of the sulphate. H. Peterson used a modification of the process for lepidolite. F. Lauer roasted the material with iron pyrites to form sulphates which react with the clay, forming aluminium sulphate. This mixture is leached with water when the last-named salt passes into soln., and the basic iron sulphates are left as slime. The sulphate in soln. is converted into alum. R. Hasenclever and W. Helbig, H. Tanaka and T. K. Shikenjo, M. Buchner, M. de Lammine, F. W. Howorth, F. Gruy, H. Müller, M. Metcalf, A. Claude, W. H. Gossage, T. Richardson, etc., have described processes for extracting alumina from clay. When clay has been heated to 500°–600°, it is more readily attacked by acids than the original clay. J. Heibling made briquettes from a mixture of the clay with ammonium and potassium sulphates. After calcination at 270°–280°, the extract with water furnished alum. H. Müller heated a mixture of the clay with powdered calcspar, dolomite, or magnesite along with alkali hydroxide or carbonate, or a mixture of alkali sulphate and carbon. When the sintered mass is leached with water, a soln. of alkali aluminate and an insoluble alkaline earth silicate are formed. E. Fleischer, and F. Projahn used modifications of this process. L. Lossier fused the aluminosilicate with cryolite or fluorspar, and again with sodium chloride. The mass forms two layers—the upper one contains sodium chloride and aluminium fluoride, the lower one, sodium and calcium aluminosilicate. A. H. Cowles heated briquettes made from clay, sodium chloride, and charcoal in a stream of air and steam. The carbon keeps the mass porous and allows the gases readily to penetrate the mass. W. Gossage, and H. Grüneberg and J. Vorster failed to utilize this reaction with the charcoal omitted. A sodium aluminosilicate is formed, $2\text{Na}_2\text{O} \cdot 2\text{SiO}_2 \cdot \text{Al}_2\text{O}_3$; this is mixed with lime and heated in a rotary kiln: $2\text{Na}_2\text{O} \cdot \text{Al}_2\text{O}_3 \cdot 2\text{SiO}_2 + 4\text{CaO} = 2\text{Ca}_2\text{SiO}_4 + 2\text{Na}_2\text{O} \cdot \text{Al}_2\text{O}_3$. The sodium aluminate is soluble in water, and the calcium silicate can be used in the manufacture of hydraulic cement. In P. Miguet's process, clay, lime, and scrap iron, with a reducing agent, are heated in the electric furnace, forming silica, calcium aluminate, and ferrosilicon: $\text{Al}_2\text{O}_3 \cdot 2\text{SiO}_2 \cdot 2\text{H}_2\text{O} + \text{Fe} + 4\text{C} + \text{CaO} = \text{FeSi}_2 + 4\text{CO} + \text{CaO} \cdot \text{Al}_2\text{O}_3 + 2\text{H}_2\text{O}$. The lighter calcium aluminate floats on the regulus, and is tapped off, cooled, crushed, and leached with a soln. of sodium carbonate whereby sodium aluminate and calcium carbonate are formed: $\text{CaO} \cdot \text{Al}_2\text{O}_3 + \text{Na}_2\text{CO}_3 = \text{CaCO}_3 + \text{Na}_2\text{O} \cdot \text{Al}_2\text{O}_3$. Aluminium hydroxide is obtained from the soln. in the usual way. The ferrosilicon is a marketable by-product. C. E. Williams and C. E. Simms examined the process, but found that it is not profitable. S. D. Cheine heated a mixture of clay, baryta, and scrap iron, and treated the product in a similar way.

G. Levi, and E. Langguth, and M. Packard discussed the treatment of leucite, sodalite, and nephelite. If these aluminosilicates be heated under a press. of 16–20 atm. with a soln. of alkali hydroxides or carbonates, alkali aluminates are not formed, but the alkali silicate passes into soln., and alumina remains. The Aktieselskabet Høyangfaldene Norsk Aluminium Co., and D. Tyrer heated to 1200° an intimate mixture of the aluminiferous material with lime and a little fluorspar as a flux. The cold mass was digested with a 10–15 per cent. soln. of sodium carbonate, and the alumina separated from the hot filtered soln. in the usual way. P. Askenasy and V. Gerber proceeded similarly, but used a mixture of baryta and lime and sodium chloride as a flux. The Aluminium Co. extracted the alumina from silicates, etc., in which the contained aluminium will form the volatile chloride when the ore is heated with a suitable chloride. G. Bergen and W. Kühne heated the clay with magnesium chloride, pyritic bituminous shale and iron filings, and collected the aluminium chloride which distilled off. A. L. Mond extracted the alumina with hydrochloric acid, etc. J. D. Gaté passed an electric current through a bath of sodium chloride at 1100°–1200°, in which the aluminium ore—say orthoclase—is immersed; the sodium which is formed partly reduces the silicate, forming soluble silicates and aluminates. These are withdrawn and dissolved in water. The precipitated alumina and silica are separated by the selective dissolution of the alumina in dil. soln. of sodium hydroxide.

M. Amenc and co-workers treated blast furnace slag with hydrochloric acid; the soln. was diluted, and decanted from the precipitated silica; the alumina was precipitated with calcium carbonate and afterwards taken up with sulphuric acid. E. Raynaud heated aluminous material with sulphides of the alkalies or alkaline earths, or with a mixture of sulphate and carbon; the alkali salts are extracted with water. U. Pomilio crystallized potassium chloride from the hydrochloric acid soln. of leucite, and separated the alumina by electrolysis.

A soln. of sodium aluminate is formed as a by-product in Serpek's process (*q.v.*) for the fixation of nitrogen. Here, aluminium nitride is prepared by heating a mixture of bauxite and carbon to 1500°–1800°, in a stream of producer gas consisting mainly of carbon monoxide and nitrogen. When the resulting product is treated with soda-lye, ammonia and sodium aluminate are formed.

The formation of crystalline alumina (corundum).—Corundum crystals were

first prepared by M. A. Gaudin⁸ in 1837 by heating to a very high temp. a previously calcined and powdered mixture of alum and potassium sulphate, or alumina and potassium sulphide, contained in a crucible lined with carbon. Since then, the crystals have been obtained in many ways. These have been described generally by F. Fouqué and A. Michel-Lévy, L. Bourgeois, J. Morozewicz, S. Meunier, etc., J. Morozewicz classified the methods of synthesizing corundum, (i) Crystallization of molten alumina; (ii) crystallization from a molten flux; (iii) the decomposition of aluminosilicates at high temp.; and (iv) the decomposition of aluminium salts at a high temp.

(1) *The preparation of corundum directly from alumina.*—M. A. Gaudin obtained spheres with crystal facets, by melting alumina in the oxy-hydrogen blowpipe flame. E. S. Shepherd and G. A. Rankin⁹ found that precipitated alumina acquired a crystalline structure by simple heating at about 200°. H. Moissan melted alumina in an electric furnace, and found, on cooling, that crystallization had taken place; if the alumina be mixed with chromic oxide crystals of ruby are formed. The by-product obtained in the reduction of chromic oxide by aluminium in the thermite process contains minute rubies. The crystals of artificial ruby were described by A. des Cloizeaux, G. Melzer, F. Rinne, O. Mügge, J. Klauudy, etc. M. Buchner made the by-product into pottery. The mixture has the trade-name *corubin*. The crystals of alumina are also sometimes found in electric furnaces used in the preparation of aluminium. G. Döllner obtained corundum by heating a mixture of aluminium and boric oxide or chromic oxide by the thermite reaction; W. Hampe also obtained the crystals in preparing aluminium boride; W. Gintl, by reducing bauxite with carbon in an electric furnace; and J. W. Mallet, by reducing magnesia with aluminium at a high temp. A. Verneuil prepared artificial rubies in the form of spheroids having a diameter of 5 to 6 mm. and weighing 2.5 to 3 grms. (12 and 15 carats) by allowing a blowpipe flame, rich in hydrogen or carbon, to play on the extremity of a small cylinder of alumina, while a mixture of alumina and 2.5 per cent. of chromium oxide in the form of a powder is mechanically blown with the oxygen into the tube of the blowpipe, and thus deposited on the surface of the fused mass of alumina. The artificial stones thus obtained are identical in physical and crystallographical properties with the natural gems, from which, however, they can be detected by the presence of minute bubbles visible only under the microscope. A general view of the apparatus is illustrated in Fig. 49. The screw support, *S*, permits the moving of the molten mass into the proper zone of the flame, when it becomes necessary to increase the press. of the oxygen in the blowpipe, etc. The raw materials, contained in a wire-cloth basket placed in the chamber, *C*, are sifted by the slight impacts of the hammer, *B*, upon the anvil, *E*, which forms the top of the basket; and the powder, carried along in the central tube of the blowpipe, becomes distributed through the flame and undergoes fusion therein as soon as it reaches a support formed of a thin stick of alumina placed in the centre of the furnace, *F*. This powder, falling upon the alumina previously raised to a white heat, becomes agglomerated thereon, forming a cone, the point of which gradually rises until it reaches a zone of the flame hot enough to cause it to undergo fusion and form a filament. If, now, the press. of the oxygen be increased, this filament is converted at its apex into a sphere, the diameter of which it will gradually increase up to the extreme limits which with the heat of the blowpipe it is capable of reaching. *Les rubis reconstitués* have been discussed by H. Marour, I. H. Levin, E. Jannettaz, C. Doelter, I. Friedländer, H. von Löhr, H. Wild, R. Böttger, V. Merz, etc. A. Verneuil prepared sapphire blue crystals by a method similar to that employed for rubies, but with a mixture of alumina containing 1.5 per cent. of magnetic oxide of iron, and 0.5 per cent. of titaníc oxide under reducing conditions in the oxy-hydrogen flame.

P. Hautefeuille synthesized corundum by the action of moist hydrogen fluoride on alumina at a red heat; and W. Bruhns heated alumina for 10 hrs. at 300° in a platinum tube with water containing a trace of ammonium fluoride, but at 250°, no crystallization occurred. C. Friedel obtained corundum and diaspore by heating

amorphous alumina with a soda-lye at 450° – 500° ; at 530° – 535° , only corundum was formed; and at 400° , only diaspore. J. Morris heated a mixture of alumina and carbon in a stream of carbon dioxide at a red heat. According to M. Houdard, by heating alumina with five times its weight of aluminium sulphide in the electric furnace, the crucible being suitably insulated to allow of slow cooling, a mass is obtained, which, on treatment with hydrochloric acid, leaves rhombohedral crystals of alumina. Attempts to produce coloured alumina crystals by means of chromium, under these conditions, were unsuccessful.

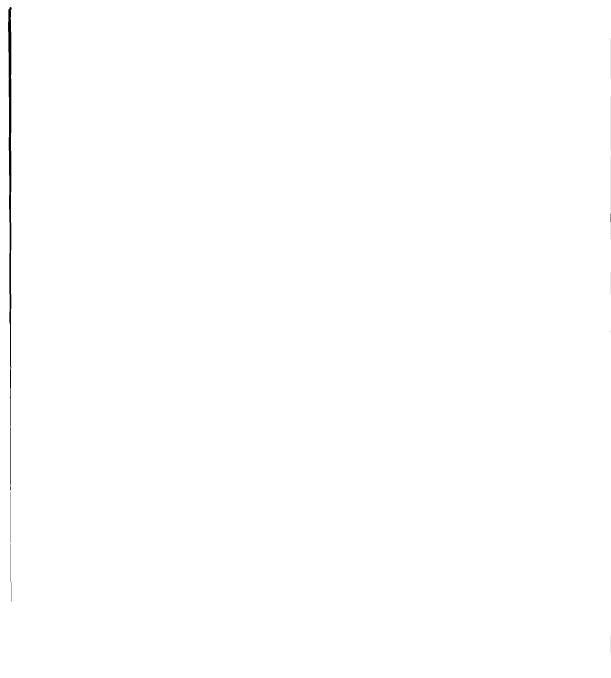

FIG. 49.—A. Verneuil's Apparatus for the Synthesis of Rubies.

(2) *The preparation of corundum by the crystallization of alumina from molten fluxes.*—M. A. Gaudin, as indicated above, heated alumina with potassium sulphate or sulphide; P. Hautefeuille and A. Perrey, alkali sulphide; L. Elsner, and R. Böttger, potassium dichromate; J. J. Ebelmen, borax (not boric acid); E. Frémy and C. Feil, lead oxide; F. Parmentier, potassium molybdate; S. Meunier, cryolite; J. Morozewicz, and A. Brun, a mixture of alkali or alkaline earth oxide and silica—*vide supra*; G. Medanich, potassium tungstate and calcium fluoride; P. Hautefeuille and A. Perrey, molten napheline and leucite (not artificial potassium nepheline). According to O. Hönigschmid, the product obtained on igniting a mixture of borax, aluminium turnings, and sulphur consists of crystalline alumina (artificial

corundum), with much amorphous boron and crystalline aluminium boride. H. A. Richmond and R. MacDonald melted the alumina with iron to remove silica. The slowly-cooled product was used as an abrasive.

(3) *The preparation of corundum by the decomposition of aluminosilicates.*—S. Meunier, and A. Lacroix obtained crystals of alumina by heating a mixture of cryolite and a silicate in a platinum crucible; F. Fouqué and A. Michel-Lévy, by heating fluorspar and microcline; and W. Vernadsky, by cooling molten potash mica.

(4) *The preparation of corundum by the decomposition of aluminium salts.*—According to C. Doelter, crystals of alumina are formed *auf nassem Wege* by heating aluminium salts with alkali carbonate. H. de Sénarmont, and C. R. C. Tichborne showed that when an aq. soln. of an aluminium salt is heated in a sealed tube at 350°, crystals of corundum are formed. E. Weinschenk prepared crystals of corundum, possibly accompanied by diaspore, by heating a soln. of aluminium sulphate with urea in a sealed tube at 180°–190°. A. Daubrée obtained crystals of corundum by the action of the vapour of aluminium fluoride on red-hot lime; H. St. C. Deville and H. Caron, by decomposing aluminium fluoride by boric oxide at a high temp.; H. Debray, by the action of an excess of alkali sulphate on red-hot aluminium phosphate—L. Grandeau found that if the temp. does not exceed 1400°, a complex alkali aluminium phosphate is formed; L. Schuch, by heating cryolite white hot in a current of steam; J. W. Mallet, by heating aluminium with sodium hydroxide in a carbon crucible; and S. Meunier, by heating aluminium chloride with magnesium or zinc and steam, or aluminium chloride and steam in a porcelain tube. According to P. Hautefeuille, alumina is not changed by heating it in a stream of hydrogen chloride, but aluminium salts furnish crystals of alumina—the oxalate or hydrocarbonate at a dull red heat, and the sulphate at a higher temp.—if chromic oxide be present, rubies are formed. H. Loyer prepared crystals of ruby by heating a mixture of alkali aluminate and chromic oxide in a stream of chlorine: $4\text{NaAlO}_2 + 2\text{Cl}_2 = 2\text{Al}_2\text{O}_3 + 4\text{NaCl} + \text{O}_2$.

V. Kohlschütter¹⁰ and co-workers prepared alumina, dispersed in a gaseous medium, by making the metal the electrode of an electric arc, and oxidizing the vapour. The resulting fume was precipitated by a high tension electric field. R. Bradfield discussed the washing of colloidal alumina by the centrifuge.

REFERENCES.

¹ H. St. C. Deville, *Ann. Chim. Phys.*, (3), **43**, 11, 1855; *L'aluminium*, Paris, 1859; A. Duboin, *Compt. Rend.*, **132**, 826, 1901; E. Kohn-Abrest, *ib.*, **141**, 323, 1905; J. Pionchon, *ib.*, **117**, 328, 1893; C. Winkler, *Ber.*, **23**, 783, 1890; G. A. Kenngott, *Journ. prakt. Chem.*, (1), **101**, 4, 484, 1867; E. Beetz, *Pogg. Ann.*, **127**, 54, 1866; J. E. Ashby, *Proc. Roy. Soc.*, **7**, 322, 1855; *Proc. Roy. Inst.*, **2**, 66, 1854.

² J. L. Gay Lussac, *Ann. Chim. Phys.*, (2), **5**, 101, 1817; H. St. C. Deville, *ib.*, (3), **43**, 5, 1855; (3), **61**, 333, 1861; *Compt. Rend.*, **54**, 324, 1861; *L'aluminium*, Paris, 1859; E. Grobet, *Journ. Chim. Phys.*, **19**, 331, 1922; C. Brunner, *Pogg. Ann.*, **98**, 488, 1856; F. Wöhler, *Liebig's Ann.*, **53**, 422, 1845; J. von Liebig, *ib.*, **17**, 43, 1836; C. F. Bucholz, *Beiträge zur Erweiterung und Berichtigung der Chemie*, Erfurt, **1**, 74, 1799; J. J. Berzelius, *Lehrbuch der Chemie*, Dresden, **1**, i, 825, 1825; H. Krämer, *Arch. Pharm.*, (2), **79**, 268, 1854; G. C. Wittstein and S. von Thielau, *Pharm. Viertelj.*, **4**, 451, 1855; G. Ekmann and O. Petterson, *Ueber das Atomgewicht des Selen*, Upsala, 1876; M. Buchner, *German Pat.*, *D.R.P.* 299181, 301675, 302412, 1914; 304281, 1916; *Brit. Pat. No.* 172303, 1917; A. L. Pedemonte, *ib.*, 195295, 1922; L. le Chatelier, *ib.*, 413, 1988, 1858; 957, 1859; 2654, 1860; G. and F. Löwig, *German Pat.*, *D.R.P.* 93, 1877; F. R. Low, *Chem. Trade Journ.*, **73**, 361, 1923.

³ C. J. Bayer, *German Pat.*, *D.R.P.P.* 43977, 1887; 65604, 1892; *Brit. Pat. Nos.* 10093, 1887; 5296, 1892; J. A. Bradburn and J. D. Pennock, *ib.*, 17933, 1891; C. M. Hall, *ib.*, 14572, 14573, 1900; R. S. Sherwin, *U.S. Pat. No.* 1422004, 1922; J. Sutherland, *Proc. Inst. Mech. Eng.*, 380, 1896; F. Russ, *Zeit. anorg. Chem.*, **41**, 216, 1904; A. Ditte, *Compt. Rend.*, **116**, 183, 386, 509, 1893; M. Berthelot, *ib.*, **81**, 844, 1157, 1875; *Ann. Chim. Phys.*, (4), **29**, 480, 1873; L. Péan de St. Gilles, *ib.*, (3), **46**, 57, 1856; P. A. von Bonsdorff, *Pogg. Ann.*, **27**, 275, 1833; A. Mitscherlich, *Journ. prakt. Chem.*, (1), **83**, 468, 1861; F. Curtius, *German Pat.*, *D.R.P.* 175416, 1904; F. Kunheim, *ib.*, 68394, 1872; Schweizerische Sodafabrik, *ib.*, 355301, 1921; Chemische Fabrik Griesheim-Elektron, *ib.*, 182775, 1905; E. Everhart, *U.S. Pat. No.* 1397414, 1921; F. R. Lowe, *Chem. Trade Journ.*, **73**, 361, 1923.

* F. Lauer, *German Pat.*, D.R.P. 52726, 1889; A. Clemm, *ib.*, 180554, 185030, 1907; J. H. C. Behnke, *ib.*, 7256, 1879; D. A. Peniakoff, *ib.*, 80063, 1893; 93952, 1897; K. Lieber, *ib.*, 5610, 1878; M. Platsch, *ib.*, 381348, 1920; E. Collett, *ib.*, 377664, 1922; H. S. Blackmore, *Brit. Pat. No.* 23707, 1896; C. M. Hall, *ib.*, 14572, 14573, 1900; 2260, 1902; C. F. Claus, *ib.*, 4311, 1891; R. von Wagner, *Wagner's Jahresb.*, 11, 332, 1865; R. A. Tilghmann, *Brit. Pat. No.* 11556, 1847.

* A. Mitscherlich, *Journ. prakt. Chem.*, (1), 83, 482, 1861; F. Trögler, *Oesterr. Chem. Ztg.*, 7, 1, 29, 1904; M. Vinck, *French Pat. No.* 106853, 1875; P. Guyot, *Chem. News*, 53, 27, 1886; J. Webster, *Monit. Scient.*, (3), 13, 279, 1883; *Brit. Pat. No.* 2580, 1881; J. J. Hood and A. G. Salomon, *ib.*, 1881, 1887; J. L. Kessler, *ib.*, 1419, 1895; M. Ducla, *Compt. Rend.*, 84, 949, 1877; C. V. Petraeus, *U.S. Pat. Nos.* 225300, 225302, 1879; J. Beveridge, *Journ. Soc. Chem. Ind.*, 5, 16, 1886; K. W. Jurisch, *Die Fabrikation von schwefelsaurer Tonerde*, Berlin, 1894; R. Helmhaecker, *Berg. Hütt. Ztg.*, 56, 14, 1897; F. Lauer, *Dingler's Journ.*, 213, 87, 1879; *Brit. Pat. No.* 173, 1879; J. W. and T. Chadwick and J. W. Kynaston, *ib.*, 4078, 1879; A. L. Pedemonte, *ib.*, 195295, 1922; A. Hurtar, *ib.*, 203798, 1922; F. Jourdan, *ib.*, 195084, 1923; T. Robinson, *ib.*, 150, 1887; M. Buchner, *ib.*, 195998, 1921; J. Morel, *ib.*, 149769, 1919; H. F. Chappel, *U.S. Pat. No.* 1401136, 1921; J. W. Kynaston, *German Pat.*, D.R.P. 21526, 1882; A. Wacker, *ib.*, 379512, 1922; C. Fahlberg, *Bull. Soc. Chim.*, (2), 33, 154, 1882; J. Blumenwitz, *Die Alaunfabrikation der Herrschaft Munkacs in Ungarn*, Wien, 1868; A. H. Seger, *Die technische Verwerthung schwefelkiesführender Schiefer und Thone der Stein- und Braunkohlenformation Kritik des heutigen Standes der Alaun- und Vitriol gewinnung und Mittel zu deren*, Neuwied, 1869.

* C. A. Dorenius, *Brit. Pat. No.* 18969, 1900; *U.S. Pat. No.* 72538, 1903; *German Pat.*, D.R.P. 139626, 1900; H. Bauer, *ib.*, 54824, 1890; L. Grabau, *ib.*, 70155, 1892; C. Pieper, *ib.*, 35212, 1884; F. Lauterborn, *Dingler's Journ.*, 242, 70, 1881; J. Thomsen, *ib.*, 166, 441, 1862; 167, 362, 1863; L. Schuch, *ib.*, 165, 443, 1862; W. J. Williams, *Journ. Soc. Chem. Ind.*, 4, 148, 1885; L. Grognot, *Rev. Gén. Chim. Pure App.*, 9, 149, 1906; H. St. C. Deville, *L'aluminium*, Paris, 1859.

* F. Lauer, *Brit. Pat. No.* 3387, 1877; D. Tyrer, *ib.*, 172087, 1920; H. Grüneberg and J. Vorster, *ib.*, 2639, 1874; W. Gossage, *ib.*, 2050, 1862; F. W. Howorth, *ib.*, 169301, 1920; M. de Lammine, *Ber.*, 6, 846, 1873; L. Grabau, *German Pat.*, D.R.P. 69791, 1892; G. Levi, *ib.*, 174698, 1904; M. Packard, *ib.*, 182442, 1920; E. Raynaud, *ib.*, 107502, 1898; E. Fleischer, *ib.*, 62275, 1891; F. Projahn, *ib.*, 112173, 1899; D. A. Peniakoff, *ib.*, 94845, 1895; L. Lossier, *ib.*, 31089, 1884; P. Askenasy and V. Gerber, *ib.*, 306355, 1917; Aktieselskabet Høyangfaldene Norsk Aluminium Co., *ib.*, 332389, 1919; M. Metcalf, *Génie Ind.*, 15, 311, 1858; *French Pat. No.* 33197, 1857; A. Claude, *ib.*, 80, 1844; W. H. Gossage, *Brit. Pat. No.* 13424, 1850; T. Richardson, *ib.*, 733, 1860; P. and H. Spence and W. B. Lewellyn, *ib.*, 23036, 1904; 9148, 1914; 161606, 1919; A. Matheson, *ib.*, 167555, 1920; H. G. Wildman, *ib.*, 161310, 1920; *U.S. Pat. No.* 1326384, 1919; E. Martin, *ib.*, 1394854, 1921; Aluminium Co., *ib.*, 1392043, 1392044, 1921; R. Sylvany, *Met. Ind.*, 8, 403, 1916; R. Hasenlever and W. Helbig, *Zeit. Ver. deut. Ing.*, 14, 705, 1870; *Dingler's Journ.*, 199, 284, 1871; H. Peterston, *ib.*, 224, 176, 1877; A. Sobrero, *L'Institut.*, 163, 1876; H. Debray, *Monit. Scient.*, (3), 12, 75, 1882; F. Gruy, *Zeit. angew. Chem.*, 8, 290, 1894; J. Bronn, *ib.*, 14, 844, 868, 1901; J. Heibling, *Compt. Rend.*, 119, 609, 1894; A. Minet, *ib.*, 110, 342, 1890; 111, 603, 1890; 112, 231, 1891; H. Müller, *Journ. prakt. Chem.*, (1), 59, 257, 1853; *Chem. Ztg.*, 4, 618, 1880; M. Feigensohn, *ib.*, 29, 783, 1905; H. Pemberton, *Chem. News*, 47, 5, 1883; J. Spiller, *ib.*, 47, 23, 1883; E. Langguth, *Zeit. prakt. Geol.*, 13, 80, 1905; M. Amenc, M. Khandi, M. Fabre, and M. Milius, *French Pat. No.* 106229, 1875; *Bull. Soc. Chim.*, (2), 25, 238, 1876; A. and P. Buisine, *ib.*, (3), 9, 311, 1893; A. H. Cowles, *Journ. Ind. Eng. Chem.*, 5, 331, 1913; U. Pomilo, *Chem. Ind.*, 7, 425, 1922; Metallbank und Metallurgische Geo. A.G., *German Pat.*, D.R.P. 355302, 1917; Rhenania Ver. Chem. Fab. A.G., *ib.*, 355303, 1918; P. Miguet, *U.S. Pat. No.* 1376563, 1920; C. E. Williams and C. E. Simms, *Journ. Amer. Cer. Soc.*, 5, 333, 1922; F. M. McClenahan, *U.S. Pat. Nos.* 1426890, 1426891, 1922; G. A. Blanc, *Brit. Pat. Nos.* 181677, 181678, 1922; J. D. Gaté, *ib.*, 174908, 1921; H. Pedersen, *ib.*, 169301, 1920; A. L. Mond, *ib.*, 205563, 1922; M. Buchner, *ib.*, 195998, 1923; G. Bergen and W. Kühne, *German Pat.*, D.R.P.P. 364720, 379627, 1923; S. D. Cheine, *Comm. Tech. Science Russ.*, 5, 71, 1921; H. Tanaka and T. K. Shikenjo, *Japan Pat. No.* 40177, 1921.

* F. Fouqué and A. Michel-Lévy, *Synthèse des minéraux et des roches*, Paris, 1882; L. Bourgeois, *Reproduction artificielle des minéraux*, Paris, 1884; S. Meunier, *Les méthodes de synthèse en minéralogie*, Paris, 1891; J. Morozewicz, *Tschermak's Mitt.*, (2), 18, 23, 1898; M. A. Gaudin, *Compt. Rend.*, 4, 999, 1837; 44, 716, 1857; 69, 1342, 1869; R. Quenssl, *Geol. För. Förh. Stockholm*, 44, 667, 1922.

* A. Verneuil, *Ann. Chim. Phys.*, (8), 3, 20, 1904; *La synthèse du rubis*, Paris, 1891; *La Nature*, 32, 177, 1904 (I am indebted to the publishers of *La Nature* for permission to use Fig. 49); *Compt. Rend.*, 104, 737, 1887; 106, 565, 1888; 111, 667, 1890; 135, 791, 1902; 150, 185, 1910; 151, 1065, 1910; H. Moissan, *ib.*, 115, 1035, 1892; F. Parmentier, *ib.*, 94, 1713, 1882; E. Frémy and C. Feil, *Phil. Mag.*, (5), 5, 17, 1878; *Compt. Rend.*, 85, 1029, 1877; S. Meunier, *ib.*, 90, 701, 1880; 104, 1111, 1887; H. Debray, *ib.*, 52, 985, 1861; A. Daubrée, *ib.*, 39, 135, 1864; H. St. C. Deville and H. Caron, *ib.*, 46, 764, 1858; *Ann. Chim. Phys.*, (4), 5, 104, 1865; J. J. Ebelmen, *ib.*, (3), 22, 213, 1848; (3), 33, 34, 1861; L. Grandeaun, *ib.*, (6), 8, 207, 1886; M. Houdard, *Compt. Rend.*, 144, 1349, 1907; A. C. Becquerel, *ib.*, 67, 1081, 1868; P. Hautefeuille and A. Perrey, *ib.*, 106, 487, 1888; 110, 1038, 1890; *Bull. Soc. Min.*, 13, 147, 1890; *Ann. Chim. Phys.*,

(6), 21. 419, 1890; P. Hautefeuille, *ib.*, (4), 4. 129, 153, 1865; A. de Schulten, *Bull. Soc. Min.*, 19. 157, 1896; *Compt. Rend.*, 122. 1427, 1896, 136. 1444, 1903; A. des Cloizeaux, *ib.*, 106. 567, 1888; H. de Sénarmont, *ib.*, 32. 762, 1851; C. R. C. Tichborne, *Chem. News*, 24. 123, 199, 209, 220, 1872; 25. 133, 1872; J. Morris, *ib.*, 66. 71, 309, 1892; J. W. Mallet, *ib.*, 38. 94, 109, 1878; *Liebig's Ann.*, 186. 155, 1876; E. Weinschenk, *Zeit. Kryst.*, 17. 503, 1890; G. Melczer, *ib.*, 35. 567, 1902; L. Elsner, *Journ. prakt. Chem.*, (1), 17. 175, 1839; R. Böttger, *Liebig's Ann.*, 29. 85, 1839; W. Hampe, *ib.*, 183. 75, 1876; I. Friedländer, *Verh. Ver. Bedförd. Gewerbf.*, 4, 1901; H. Wild, *Centr. Min.*, 180, 1908; A. Brun, *Arch. Sciences Genève*, (3), 25. 239, 1891; J. Morozewicz, *Tschermak's Mitt.*, 18. 23, 1899; H. von Löhr, *ib.*, 25. 526, 1906; O. Mügge, *ib.*, 19. 165, 1900; J. Klaudy, *ib.*, 21. 78, 1902; V. Merz, *Ber.*, 11. 518, 1878; G. Medanich, *Neues Jahrb. Min.*, ii, 31, 1903; W. Bruhns, *ib.*, ii, 62, 1889; F. Rinne, *ib.*, i, 168, 1900; E. S. Shepherd and G. A. Rankin, *Amer. Journ. Science*, (4), 28. 321, 1909; I. H. Levin, *Journ. Ind. Eng. Chem.*, 5. 495, 1913; C. Friedel, *Bull. Soc. Min.*, 14. 7, 1891; A. Lacroix, *ib.*, 10. 157, 1887; E. Jannettaz, *ib.*, 9. 321, 1886; H. Loyer, *Bull. Soc. Chim.*, (3), 17. 339, 345, 387, 1897; L. Schuch, *Verhalten des Kryoliths*, Göttingen, 1862; G. Döllner, *German Pat.*, D.R.P. 97408, 1897; W. Gintl, *Zeit. angew. Chem.*, 14. 1173, 1901; M. Buchner, *ib.*, 17. 985, 1904; W. Vernadsky, *Die Sillimanitgruppe*, Moskau, 83, 1891; C. Doelter, *Edelsteinkunde*, Leipzig, 102, 1893; H. Marour, *Rev. Chim. Pur. App.*, 6. 72, 1903; H. A. Richmond and R. MacDonald, *Canadian Pat. No.* 220855, 1922; P. Ebell, *Dingler's Journ.*, 220. 64, 1876; O. Hönigschmid, *Monatsh.*, 28. 1107, 1907; F. Fouqué and A. Michel-Lévy, *Synthèse des minéraux et des roches*, Paris, 1882.

¹⁰ V. Kohlschütter and J. L. Tüschler, *Zeit. Elektrochem.*, 27. 225, 1921; V. Kohlschütter and N. Neuenschwander, *ib.*, 29. 246, 1923; R. Bradfield, *Journ. Amer. Chem. Soc.*, 44. 965, 1922.

§ 10. The Properties of Aluminium Oxide

According to G. A. Kenngott,¹ aluminium oxide has no taste or smell. The colour is white or water-clear; the blue, red, yellow, brown, grey, or more rarely, violet or green colours of different varieties of corundum—e.g. the sapphire, ruby, etc.—are due to the presence of pigmentary oxides. P. von Jeremejeff² found corundum crystals with blue and red ends, or with a yellow middle and blue ends. E. Frémy showed that chromium oxide is probably the colouring agent in rubies by synthesizing the gem-stone from alumina and chromic oxide; he also suggested that chromium oxide is the colouring agent in the sapphire, but in a different state of oxidation from what it is in the ruby. J. W. Retgers inclined to the belief that the colouring agent is probably a small quantity of hydrocarbon, and not an inorganic constituent at all. L. Wöhler and K. von Kraatz-Koschlau could find no chromic oxide in rubies or in sapphires, but it must be remembered that an exceedingly small amount of the oxide has high tinctorial powers, and that quite a series of colours—red, blue, yellow, and green can be obtained from chromium oxide; it requires an oxidizing atm. to develop the red colour. The red colour of the ruby, heated under reducing conditions, may become green or appear colourless because of the low tinctorial powers of the green oxide. This explains the observations of C. Doelter, F. Rinne, and G. A. Kenngott, who noted that rubies sometimes became green or colourless when heated. C. Doelter found that some rubies could be heated white hot without change of colour. Whether or not the change occurs really depends on the nature of the atm. C. Doelter found that sapphires are decolorized at a white heat in air or oxygen, and he said that the colouring agent of sapphires is more likely to be organic than in the case of rubies. J. Morozewicz produced rose, yellow, greenish-yellow, red, or pale blue corundum by using iron oxide, and he considered the colouring agent is more likely to be iron oxide than chromic oxide. G. Forchhammer found that Siberian corundum contained 1.45 per cent. of ferric oxide and 0.34 per cent. of phosphoric oxide, and he considered the colouring agent to be iron phosphate. H. St. C. Deville and H. Caron obtained some blue patches in their experiments on the synthesis of rubies from alumina and chromic oxide, and they therefore inferred that the sapphire blue is produced by chromium in a lower state of oxidation than in rubies. In their experiments on bauxite, W. Gintl obtained blue patches of corundum which showed on analysis, TiO₂, 0.65; FeO, 0.79; MnO, 0.50; CaO, 1.85; MgO, 0.35; Na₂O, 2.07; SiO₂, 12.28; and Al₂O₃, 81.88. A. J. Moses found

traces of ferric oxide and 0.1 per cent. of titanic oxide in artificial sapphires; and A. Verneuil found in sapphires from Australia, India, and Montana from 0.031 to 0.058 per cent. of titanic oxide and 0.56 to 0.92 per cent. of ferric oxide. A. Verneuil's syntheses of sapphires led him to believe that this coloration is produced by iron and titanium oxides. W. Hermann's observations on the action of reducing and oxidizing gases on heated corundum led him to infer that iron oxides act as tinctorial agents.

As indicated by C. F. Bucholz, and J. von Liebig, washed, precipitated alumina forms a light voluminous powder after ignition at a red heat. Fused alumina forms a white, hard, crystalline mass. The crystals of corundum belong to the trigonal system. According to G. Melzer, the axial ratios are $a : c = 1 : 1.3652$, and $\alpha = 85^\circ 43\frac{2}{3}'$; W. P. Davey gave $1 : 2726$. Observations on the crystals have been made by H. de Sénarmont, A. des Cloiseaux, J. J. Ebelmen, L. Grandeau, O. Mügge, H. St. C. Deville and H. Caron, E. Frémy, A. Verneuil, J. H. Pratt, F. Rinne, etc. W. Crookes found that when snow-white alumina is exposed to the cathode rays, the amorphous powder acquires a pink colour, and is slowly crystallized.

There is a considerable variation in the form of the crystals of corundum from different localities; the prismatic, the flat, and the tabular forms are common; pyramidal crystals are not so common. The small crystals are usually well developed with smooth faces and edges; the larger crystals are often rough, striated, and tapering slightly towards the end like a barrel—hence the term *barrel corundum*. Penetration twins are not common. The most prominent twinning plane is parallel to the rhombohedron; and a repetition of the twinning may form a series of plates or laminae in twin position. This gives a laminated or striated structure due to minute re-entrant and salient angles. W. E. Hidden observed crystals with a twinning plane parallel to the base. The fracture of corundum is irregular and conchoidal, and, as shown by J. L. Bournon, and J. W. Judd, certain specimens of corundum and sapphires exhibit no sign of cleavage. What was once thought to be cleavage was found by O. Mügge, M. Bauer, G. Tschermak, J. W. Judd, A. Lasaulx, to be a parting produced by mechanical or chemical forces, or possibly by both acting together. Corundum with the parting planes is inferior as an abrasive for cutting wheels, etc. The lustre of corundum is adamantine to vitreous; and that of emery is submetallic. The lustre on the basal plane of corundum is sometimes pearly. **Corrosion figures** in harmony with the trigonal system have been described by M. Bauer, R. Brauns, and G. Melzer.

According to G. A. Rankin and H. E. Merwin, alumina occurs in two distinct forms: α -alumina is the ordinary crystalline variety represented by corundum; and β -alumina, which is formed in small quantities in hexagonal crystals often in groups of overlapping triangular plates when pure alumina is melted and slowly cooled. The presence of magnesia (say, 0.5 per cent.) assists the transformation of α - to β -alumina, whereas the presence of lime or silica facilitates the formation of the α -variety. It has not been found possible to convert β -alumina to α -alumina by holding the former at temp. above or below the m.p., and it is therefore suspected that β -alumina is monotropic with respect to α -alumina.

F. Rinne, W. P. Davey and E. O. Hoffman, C. Mauguin, and J. A. Hedvall have studied the **X-radiograms** of alumina. The lattice is a rhombohedron with hexagonal axes 4.86 Å., and a vertical axis 6.62 Å. Thus, except for the difference in the axial ratio, the structure is identical with that of calcite. F. Rinne's illustration of the group Al_2O_3 as a chemical molecule in the crystal molecule is shown in Fig. 50. According to L. H. Milligan, the X-radiogram of alumina, prepared by the calcination of the crystalline hydroxide at 325° , gives no trace of the original hydroxide structure; and it is similar neither to diaspor which is the crystalline monohydrate $\text{Al}_2\text{O}_3 \cdot \text{H}_2\text{O}$, nor to corundum which is

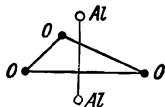

FIG. 50.—The Alumina Molecule in the Crystal Lattice.

crystalline, anhydrous Al_2O_3 . It does, however, show a distinct set of lines which are indicative of a crystalline condition. The absorption of water does not alter its structure, and none of the hydroxide is produced. Alumina, prepared by calcination at 600° , shows a faint pattern similar to the preceding sample, but the bulk of the material is probably amorphous. When calcination temp. somewhat above 1000° are employed, the product gives the pattern of corundum faintly and still higher ignition temp. increase the intensity of this pattern until it equals that of pure corundum. J. Beckenkamp also studied the space-lattice of corundum.

Reported values for the **specific gravity** of alumina vary from the 3.5311 of M. J. Brisson³ and the 3.562 by P. van Muschenbroek to the 4.152 at 4° of A. le Royer and J. B. A. Dumas. A. H. Church gave 3.979 to 4.03 at 15.5° ; L. Grandeau, 3.98 at 14° ; and E. Madelung and R. Fuchs, 3.9804; F. G. Schaffgotsch gave 3.994 as a mean of nine determinations with the ruby; and L. F. Nilson and O. Pettersson, 3.990 for the sapphire. J. J. Ebelmen gave 3.928 for the sp. gr. of crystalline alumina. The best representative value for the sp. gr. of crystalline alumina is 3.99. The sp. gr. of the amorphous alumina increases with the temp. of calcination; thus J. W. Mellor and A. D. Holdcroft found that after heating precipitated alumina to

	600°	700°	800°	900°	1200°
Sp. gr. at 15°	2.82	2.83	3.39	3.53	3.92

H. Rose found the sp. gr. rose to 3.999 after ignition in a hard porcelain furnace, presumably about 1500° , and F. G. Schaffgotsch, to 4.008 after ignition. The sp. gr. of ignited alumina is therefore the same as that of corundum or crystalline alumina. C. J. St. C. Deville found the sp. gr. of crystals of corundum fell from 4.022 to 3.992 after melting in the blast gas flame. The hardness of corundum is exceeded by that of the diamond. F. Auerbach found the mineral to be rather harder in the direction of its principal axis than it is in other directions. A. Reis and L. Zimmermann, T. A. Jaggar, J. L. Smith, W. H. Emerson, and A. Rosiwal, have made observations on this subject. M. Bauer found that the hardness varies with different specimens; that of the sapphire is about 9 on Mohs' scale; and that of the ruby is 8.8 to 9.0. The hardness of emery is due to the contained corundum. The hardness is not the same as the abrasive efficiency; thus two examples of corundum may have the same hardness so far as power of scratching or being scratched by other substances is concerned, and yet have a different cutting or abrasive efficiency. E. Madelung and R. Fuchs gave for the **compressibility** coeff., 0.38×10^{-6} megabar per sq. cm. According to F. Auerbach, the **modulus of elasticity** of corundum is very high, being 2.5 times that of steel, and exceeded only by that of iridium; the observed values are: Iridium 52,500, corundum 52,000, and steel 21,000 kgrms. per sq. mm.

According to H. Fizeau,⁴ the coeff. of linear **thermal expansion** of blue Indian corundum is $\alpha = 0.0_5619$ at 40° when taken parallel to the chief axis, and 0.0_5543 when taken at right angles to that axis. Hence, the coeff. of cubical expansion is 0.0_41705 . F. Pfaff gives 0.0_56765 for the coeff. of linear and 0.0_41995 for the coeff. of cubical expansion taken between 0° and 100° . B. Bogitsch measured the thermal expansion of bauxite bricks. F. E. Neumann gave 0.1942 for the **specific heat** of corundum; H. V. Regnault, 0.19762 for the sp. ht. of corundum between 8° and 98° , and 0.21732 for that of sapphire between 7° and 97° ; and J. Joly gave 0.1981 for the pale blue, prismatic crystals between 12.6° and 100° . L. F. Nilson and O. Pettersson gave 0.1827 for the sp. ht. of alumina, and 0.1879 for that of the sapphire. W. A. Tilden gave for the increase in the sp. ht. of alumina with rise of temp.,

	$15^\circ-100^\circ$	$15^\circ-195^\circ$	$15^\circ-315^\circ$	$15^\circ-420^\circ$	$15^\circ-510^\circ$
Sp. ht.	0.2003	0.2195	0.2311	0.2400	0.2460

According to H. von Wartenberg and G. Witzel, the **molecular heat** of alumina at 230° is 10.8 cal.; and at 1308° 28 to 30 cal. E. Jannetaz gave 0.9 for the ratio

of the **thermal conductivity** in the direction of the large and small axes. A. Weber gave 0.025 cal. per cm. per sec. per degree for the thermal conductivity of aluminium oxide.

L. B. G. de Morveau⁵ fused alumina to a white enamel in a flame fed with oxygen; H. Davy fused it in the circuit of a voltaic battery; and F. Stromeyer, R. Hare, M. A. Gaudin, and E. D. Clarke, in the oxy-hydrogen blowpipe flame. The last-named said that molten ruby solidified to a white opaque globule, and that corundum and alumina each formed a yellow transparent glass. H. Moissan said that the **melting point** of alumina in a carbon crucible is 2250°, and added that the liquid crystallizes on cooling. C. W. Kanolt found that **bauxite** clay melted at 1795°; bauxite, 1820°; and purified alumina, 2010°; and later he gave 2050° for the m.p. of alumina. O. Ruff and co-workers gave 2010° ± 10° for the m.p. of alumina. E. F. Northrup melted the oxide in a crucible of titanite or zirconium oxide. E. Tiede and E. Birnbrauer found that in a vacuum furnace, alumina melts at 1890°, and volatilization begins at 1750°. O. Ruff gave 2040° as the best representative value for the m.p. of alumina containing 0.3 per cent. sodium oxide which volatilized early; 0.1 per cent. silica, and 0.05 per cent. of ferric oxide, and a trace of calcium oxide. For the **vapour pressure** in mm., O. Ruff and P. Schmidt found

	1830°	1840°	1930°	2018°	2070°	2125°
Vap. press.	7	11	108	230	300	750 mm.

According to H. Moissan, alumina can be completely volatilized at 2250°, and if the volatilization takes place in a carbon tube some aluminium metal and carbide are formed. W. R. Mott gave 3400° to 3700° for the **boiling point** of alumina, a number not consistent with O. Ruff and P. Schmidt's vap. press. curve.

J. J. Berzelius⁶ showed that when a number of oxides—chromium, tantalum, rhodium, etc.—are heated to redness, some internal change occurs which is attended by the evolution of heat, and in some cases—*e.g.* zirconia—the mass becomes incandescent. H. le Chatelier found that the heating curve of alumina is dependent on the mode of preparation of the oxide. Thus, alumina precipitated from sodium aluminate furnishes a diminution corresponding with an endothermal change—decomposition of hydrates, etc.—below 360°, while alumina precipitated from an aluminium salt, and that prepared by the calcination of the nitrate show a hump in the curve corresponding with an exothermal reaction. These results were confirmed by J. W. Mellor and A. D. Holdcroft, H. S. Houldsworth and J. W. Cobb, etc.

If a thermocouple be placed in a mass of the uncalcined oxide in a crucible being heated in a furnace on a rapidly rising temp. so that the temp. is recorded every half-minute, a curve resembling that shown diagrammatically in Fig. 51 is obtained.

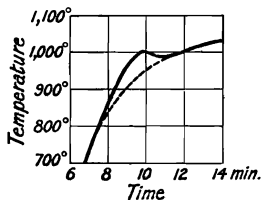

FIG. 51.—Portion of Heating Curve of Alumina showing Exothermal Change starting about 850°.

The dotted line shows the course which would be followed by the curve if the oxide suffered no molecular change. The temp. of the oxide rushes beyond that of the crucible, and it then cools down until it coincides with the rising temp. of the crucible. The phenomenon can be called **calorescence**—*calor*, heat.

Before this change has occurred, alumina is very hygroscopic, but is not so after the calorescence is completed; the sp. gr. increases very much during the change; and the solubility in acids decreases in a marked degree. J. J. Berzelius found that gadolinite behaves similarly, and K. A. Hofmann and F. Zerban observed that the calorescence or glowing of this mineral occurs at a definite temp., *viz.* 430°. P. Scheerer observed a similar change with allanite, and he studied the action with gadolinite in some detail. He found that the vol. before and after calcination are as 1 : 0.943. He attributed this to an inter-molecular change involving a change in the relative positions of the molecules and a decrease of the inter-molecular distances. This he illustrates by assuming that the spherical

molecules are openly packed before calcination, and closely packed after calcination. A. Damour observed a greater change—1:0·922—with Cingalese zircon than with gadolinite, and O. Hauser found risörite exhibited a still greater vol. change—1:0·90—and the mineral loses its water. Ammonium magnesium phosphate glows, loses ammonia, and is converted into magnesium pyrophosphate on calcination; and the mineral sipplite loses basic water, glows brilliantly, and forms, according to J. W. Mallet, pyrocolumbate. P. Scheerer's ingenious explanation is not of universal application, because H. Rose showed that samarskite exhibits the phenomenon of glowing but its sp. gr. is reduced so that there is an increase in vol. W. Ramsay and M. W. Travers found that fergusonite also decreases in sp. gr. from 5·62 to 5·37 when heated, and the mineral glows strongly at 500°–600°. H. V. Regnault assumed that the oxides observed by J. J. Berzelius should have a smaller sp. ht. after calcination than before, but he was not able to prove it, although H. Rose showed that the sp. ht. of gadolinite is reduced about one-fourteenth. With samarskite, H. Rose observed no difference in the sp. ht. and no glow effect on calcination. The nature of the molecular change which occurs on calcining these compounds has not been established. According to J. A. Hedvall, the X-radiograms of the different forms—artificial and natural—are the same, and the existence of different modifications has not been established. The evolution of heat, said H. le Chatelier, in the calcination of alumina is attended by a molecular change in the oxide. The thermal value of the change of alumina from the amorphous to the crystalline state was found by W. G. Mixter to be 10 Cals. M. Berthelot gave $(2Al, 3O) = 393·6$ Cals. nearly for the **heat of formation** of alumina, and J. B. Baille and C. Fèry gave 380·2 Cals. According to J. W. Richards, the heat of formation is 387·20 Cals. at 0°, 421·408 Cals. at 900°, and 391·236 Cals. at 1100°, or, at θ° , $(2Al, 3O) = 387·20 + 192·6\theta - 0·1716\theta^2$ Cals. W. G. Mixter gave for amorphous alumina $Na_2O + Al_2O_3 = 2NaAlO_2 + 40$ Cals.

The **double refraction** of corundum is feeble and negative, being from 0·008–0·009, that is, about the same as quartz. The **index of refraction** is high, being, on the average, 1·765. That of the diamond for the red Li-line is 2·4135; garnet (pyrope), 1·7776; sapphire, $\omega = 1·7678$, $\epsilon = 1·7598$; ruby, $\omega = 1·7675$, $\epsilon = 1·7592$; tourmaline, $\omega = 1·6347$, $\epsilon = 1·6172$; and emerald (beryl), $\omega = 1·5491$, $\epsilon = 1·5480$. Measurements were made by W. H. Wollaston,⁷ D. Brewster, W. H. Miller, A. des Cloizeaux, and R. Brauns. G. Melzer found that the indices of refraction for natural crystals with the *C*-ray ranged from $\omega = 1·7643$ – $1·7687$, and $\epsilon = 1·7563$ – $1·7602$; with the *D*-ray, $\omega = 1·7675$ – $1·7715$, and $\epsilon = 1·7594$ – $1·7632$; and with the *F*-ray, $\omega = 1·7751$ – $1·7764$, and $\epsilon = 1·7668$ – $1·7682$. For artificial crystals with the *C*-line, $\omega = 1·7681$ – $1·7714$, and $\epsilon = 1·7597$ – $1·7628$; with the *D*-line, $\omega = 1·7715$ – $1·7745$, and $\epsilon = 1·7630$ – $1·7667$; and with the *F*-line, $\omega = 1·7789$ – $1·7818$, and $\epsilon = 1·7706$ – $1·7731$. The crystals are normally uniaxial, but some varieties are abnormally biaxial. The optical anomalies of crystals of corundum have been studied by A. des Cloizeaux, E. Mallard, E. Bertrand, G. Tschermak, A. Lasaulx, and R. Brauns.

The **pleochroism** in ordinary light is strongly marked in the deeper coloured varieties, especially rubies and sapphires. For example, the ruby may be deep coloured when viewed in the direction of the vertical axis, and a much lighter colour, or even colourless, when viewed at right angles to this direction; the sapphire may be deep blue in the direction of the vertical axis, and greenish-blue, greenish-white, or bluish-white when viewed at right angles. R. Brauns, J. W. Judd, O. Mügge, and F. Rinne have described the pleochroitic minerals. The pleochroism of the corundum gem-stones enables them to be distinguished from spinels and garnets. H. E. Ives and co-workers studied the emissivity and illuminating power of mantles made of alumina and heated by Bunsen's flame. V. Agafonoff measured the **absorption spectrum** of a rose-coloured Cingalese ruby and found an absorption band between the blue violet and the Cd-line. The absorption spectrum has also been investigated by F. Rinne, A. Miethe, and M. Chaumet. W. W. Coblenz found the **ultra-red emission spectrum** in the oxy-hydrogen flame has emission bands

at 1.4μ , 2μ , 3.1μ , 4.7μ , 5.2μ , and 7.5μ . The **reflecting power** for light of wave-length $\lambda=0.60\mu$ is 84.1 per cent. ; for $\lambda=0.95\mu$, 87.7 per cent. ; for $\lambda=4.4\mu$, 20.8 per cent. ; for $\lambda=8.8\mu$, 1.99 per cent. ; and for $\lambda=24\mu$, 6.5 per cent. F. Henning and W. Heuse also examined the ultra-red spectrum of the ruby. The transparency of corundum to the **X-rays** has been investigated by C. Doelter, who found it to be about one-tenth as transparent as the diamond, and he arranges some minerals in the order of their resistance to the passage of the X-rays : diamond, corundum, talc, quartz, rock-salt, etc. F. Bordas found that sapphires are discoloured by exposure to X-rays.

In 1820, P. Heinrich⁸ stated that alumina exhibits a feeble **phosphorescence** when exposed to all kinds of stimuli. D. Hahn stated that Cingalese ruby exhibits a fine yellow **thermoluminescence** ; the glow was very feeble with Cingalese and Brazilian sapphires ; a grey corundum was found to give a bluish thermoluminescence at a low temp., and the glow became more intense as the temp. was raised, but it completely vanished after the mineral had been heated some time. Some samples of corundum and emery show no thermoluminescence. S. C. Lind and D. C. Bardwell observed no thermoluminescence with natural sapphire, and only a faint glow with artificial crystals. E. L. Nichols and H. L. Howes studied the luminescent spectrum of incandescent alumina. E. Newbery and H. Lupton said that a ruby from Carolina appeared green when strongly heated but regained its colour on cooling, the mineral showed a slight thermoluminescence which rapidly disappeared on further heating ; they also found that exposure to **radium radiations** for 10 days had no appreciable effect on the colour, because the colouring matter is not exotic, for rubies are coloured intrinsically by chromic oxide ; on the other hand, F. Bordas found that a sapphire exposed to radium bromide was coloured red, violet, blue, green, yellow, and brown. S. C. Lind and D. C. Bardwell found colourless crystals of sapphire generally become yellow ; pink crystals become orange ; and blue crystals become greyish or brownish-green ; no fluorescence occurred. Light-coloured ruby was not changed, but synthetic ruby was slightly darkened ; no fluorescence occurred. J. O. Perrine observed no ultra-violet fluorescence with alumina. C. Doelter studied the action of radium and ultra-violet radiations on sapphire. E. L. Nichols and D. T. Wilber noted that alumina exhibits **flame luminescence** in the zone of a hydrogen flame between reduction and oxidation. E. L. Nichols found that at 1000° in the oxy-hydrogen flame, alumina appears blue, not red. The brightness of the radiation at 1000° is 1900 times that of a black body at 665° , and twice as bright as that at 1500° . E. Becquerel showed that the phosphorescence of corundum increases in intensity as the amount of contained chromic oxide increases ; and W. Crookes made a similar observation with respect to the phosphorescence under the influence of the **cathode rays**. According to H. Jackson, this kind of phosphorescence depends on the degree of exhaustion of the tube :

At a high exhaustion, the alumina glowed with a splendid crimson light. As the exhaustion proceeded, a spot of about 3 mm. in diameter in the direct line of the centres of the electrodes glowed for a moment with increased brilliancy. This quickly died out, and for a short time the spot appeared black by contrast with the surrounding colour. Then came in rapid succession the various stages noticed on heating a substance up to a white heat. As the vacuum became higher, this bright light died out as it came, and once more the central spot looked black. Then when the vacuum was so high that the discharge nearly stopped in the tube, the phosphorescence of the central spot returned, and the glow was confined to this spot ; but now the phosphorescence was blue.

L. de Boisbaudran said that purified alumina does not phosphoresce when exposed in vacuo to these rays, but if 15^{-5} part of chromic oxide be present, a distinct phosphorescence is produced, and with 10^{-3} part of chromic oxide, the effect is brilliant. It is inferred from the work of W. Crookes, L. de Boisbaudran, E. Becquerel, G. C. Schmidt, and W. Arnold that pure alumina does not phosphoresce. W. Wein showed that alumina prepared by precipitation and dehydration of the

hydroxide is not fluorescent or phosphorescent under the influence of the cathode rays, while that which is prepared by burning the powdered metal in air or oxygen is fluorescent and phosphorescent under the cathode rays, and also gives off oxygen under the influence of these rays. J. A. Wilkinson showed that the difference is not due to the formation of aluminium peroxide by the burning aluminium, but is rather due to the presence of sodium peroxide derived from the combustion of the sodium contained as an impurity in the metal. J. Rossignol, J. Ewles, and E. L. Nichols and D. T. Wilber studied the cathodo-luminescence of alumina. G. C. Schmidt found that alumina phosphoresces under the influence of the **canal rays** only when the alumina is impure; but J. Tafel takes the contrary view. J. A. Wilkinson's work shows that the difference in the reports is the result of inattention to the unsuspected impurities in the so-called pure alumina. According to F. Beijerinck, corundum is a non-conductor of electricity; and A. A. Somerville found powdered alumina to be one of the best of electrical insulators. For E. Thomson's **magneto-optical effect**, *vide* zinc oxide.

Alumina at a red heat is not affected by **hydrogen**, but H. N. Warren⁹ obtained aluminium by reducing alumina with hydrogen while contained in a lime tube heated by the oxy-hydrogen blowpipe flame—*vide* aluminium. According to W. N. Hartley and co-workers:

The actual energy supplied before alumina is reduced by carbon, carbon monoxide, or hydrogen is —82·5 Cals., —62·7 Cals., or —72·9 Cals., respectively. The carbon monoxide value is thus shown to be less than that in either of the other two reactions. Alumina is reduced to the metallic state in the oxy-hydrogen flame, and the reduction takes place more easily when the alumina is mixed with some dense form of carbon. In the first instance, the flame alone supplied hydrogen only as the reducing agent, consequently, the energy required for every atom of oxygen removed was 72·9 Cals. in the form of extraneous heat which was necessary not only for initiating the process, but also maintaining it. When solid carbon was used this was a somewhat higher figure, being 82·5 Cals., but this very reduction process with solid carbon would result in the formation of carbon monoxide which could then operate upon another mol. of alumina, which places the extreme limits of the energy required for reduction as between 63 Cals. and 82·5 Cals. From this it would appear that the reduction of alumina may be carried out in the oxy-hydrogen flame by a purely chemical action if the extraneous energy required to initiate and maintain the action does not exceed 82·5 Cals. per atom of oxygen removed.

According to J. Dewar, a gram of dry alumina at the temp. of liquid air adsorbs 70 c.c. of **air** at atm. press., but under reduced press. the adsorption rapidly decreases. M. Reichardt and E. Blumtrill found that aluminium hydroxide, air-dried and dried at 100°, absorbs from air, respectively, 11 and 69 c.c. of gas per 100 grms., and the gas contained respectively 41 and 83 per cent. of nitrogen; 0 and 19 per cent. of oxygen; and 59 and 0 per cent. of carbon dioxide. This remarkably selective absorption has potential applications. F. Scheermesser also noted that carbon dioxide is strongly adsorbed by alumina. C. F. Cross found that alumina dehydrated at a low red heat absorbs **water** corresponding with $\text{Al}(\text{OH})_3$ when exposed to a moist atm., whereas alumina ignited over the gas flame rehydrates to $\text{Al}_2\text{O}(\text{OH})_4$; and after blowpipe ignition, it rehydrates approximately to $\text{AlO}(\text{OH})$ —*vide* aluminium hydroxides. According to J. W. Mellor and A. D. Holdcroft, 100 grms. of alumina, which have been dehydrated at 800°, absorb 10·75 grms. of moisture, and that dehydrated at 1200°, 0·01 gm.; F. M. G. Johnson utilized this fact and found alumina dehydrated at a low temp. is a better drying agent for gases than calcium chloride, sulphuric acid, etc. H. Adkins discussed the use of alumina as a dehydration and decarboxylation agent, and S. Medforth, the accelerating influence on nickel as a catalyst in the reduction of carbon monoxide or dioxide by hydrogen. For the **Pouillet effect** with alumina, *vide* 1. 9, 9.

H. Moissan found that, at ordinary temp., **fluorine** reacts with alumina, *toute la masse devient lumineuse*, forming the fluoride, and liberating oxygen; but **chlorine** has no apparent action on alumina at a red heat. These facts are taken to correspond with the heats of formation of the oxide, Al_2O_3 , 380·2 Cals., of the chloride, AlCl_3 ,

161·4 Cals., and of the fluoride, AlF_3 , 249·0 Cals. The heat of formation of the fluoride thus exceeds that of the chloride, and that of the oxide exceeds that of the fluoride. The reaction $2\text{Al}_2\text{O}_3 + 6\text{Cl}_2 = 4\text{AlCl}_3 + 3\text{O}_2 - 114·8$ Cals. being endothermic does not occur. Aluminium chloride, however, is but incompletely decomposed by oxygen at a red heat; and R. Weber found that at a white heat some aluminium chloride is formed by the action of chlorine on alumina. If alumina be mixed with carbon and heated in a stream of chlorine, aluminium chloride is formed by an exothermal reaction, $\text{Al}_2\text{O}_3 + 3\text{Cl}_2 + 3\text{C} = 3\text{CO} + 2\text{AlCl}_3 + 30·2$ Cals., the so-called *H. C. Oersted's reaction*, because the heat of formation of carbon monoxide, CO , 29·2 Cals., is capable of doing chemical work in the reaction. A. Duboin and A. Gautier showed that boron and silicon can take the place of carbon in *H. C. Oersted's reaction*, forming aluminium chloride, and in the one case boric oxide, and in the other case silica, but not silicon tetrachloride or silicochloroform. Similarly, the heated oxide is decomposed by carbon tetrachloride, as shown by E. Demarçay, and L. Meyer; the last-named obtained a similar result with chloronaphthalene; and H. N. Warren passed the mixed vapours of petroleum and chlorine over heated alumina and obtained aluminium chloride—*vide* aluminium chloride. If alumina be heated with an excess of **ammonium chloride**, part of the alumina is volatilized as chloride. L. Troost and P. Hautefeuille found that the vapour of **boron trichloride** also forms aluminium chloride and aluminium borate. According to A. Duboin and A. Gautier, **bromine** and **iodine** react on a mixture of boron and alumina in an analogous manner. A. Daubrée found the vapour of **phosphorus pentachloride** attacks heated corundum more slowly than amorphous alumina, forming phosphoryl chloride, and aluminium phosphate, and, according to R. Weber, a double compound of aluminium and phosphorus trichlorides. L. Troost and P. Hautefeuille found that **silicon fluoride** at a red heat reacts rapidly with alumina, forming, according to A. Daubrée, topaz. When **hydrogen chloride** is passed over a heated mixture of alumina and silicon, L. Troost and P. Hautefeuille found that aluminium chloride but no silicon chloride is formed. G. Gore found dry liquid hydrogen chloride converts alumina into the chloride without dissolving the product—*vide* aluminium chloride for the action of the gas. The solubility, or perhaps the rate of soln., of alumina in acids is greatly affected by the temp. at which the solid has been calcined. Like many others, H. le Chatelier found that if the temp. of calcination exceeds 850° , alumina becomes insoluble in acids. H. Rose said that calcined alumina dissolved slowly in boiling **hydrochloric acid**. J. W. Mellor and A. D. Holdercroft found that the amount dissolved by hydrochloric acid during 2 hrs.' shaking at 14° , from alumina calcined for 10 hrs. at

	606°	700°	800°	900°	1200°
Per cent. dissolved	42·96	20·40	7·84	5·92	0·00

O. Hönigschmid found that calcined alumina is indifferent towards acids, even a mixture of **hydrofluoric acid** and **nitric acid**. A. Mitscherlich said that corundum and crystallized alumina are insoluble in cold acids, but boiling **sulphuric acid** (8 : 3) attacks corundum slowly, and if the mixture be heated in a sealed tube, the dissolution is completed. A. Gautier found heated alumina is attacked by hydrogen sulphide, $4\text{Al}_2\text{O}_3 + 9\text{H}_2\text{S} = 3\text{SO}_2 + 9\text{H}_2 + 2(\text{Al}_2\text{O}_3 \cdot \text{Al}_2\text{S}_3)$. E. Frémy found **carbon disulphide** at a red heat forms aluminium sulphide. The reduction of alumina by **carbon** is discussed in connection with aluminium, and the carbides. K. Nischk found that alumina in the presence of copper can be reduced by carbon, forming an alloy of copper with several per cent. of aluminium. L. Kahlenberg and W. J. Trantman found alumina is not reduced by **silicon**. The action of **calcium carbide**, **potassium**, and **magnesium** on alumina is discussed in connection with aluminium. E. Botolfsen showed that alumina is reduced by **calcium**. C. W. Scheele found alumina to be insoluble in **hydrocyanic acid**. O. Hönigschmid showed that calcined alumina is but slowly attacked by conc. soln. of **alkali hydroxide**, and by fused sodium hydroxide, or a mixture of fused **sodium**

carbonate and nitrate, but it is readily attacked by fused potassium hydro-sulphate. E. J. Mills and C. W. Meanwell found that when fused with sodium sulphate, sulphur trioxide is evolved, and this the more the smaller the proportion of alumina. According to F. de Lalande and M. Prud'homme, a mixture of alumina and sodium chloride decomposes at a red heat in a stream of dry air or oxygen, and chlorine is evolved. G. Marchal found the reaction between calcium sulphate and alumina begins at 940°–950°. P. Ebell found that molten glass dissolves comparatively large quantities of alumina, and that most of this crystallizes out on cooling.

Bauxite has been used to a limited extent in making refractory bricks chiefly for rotary cement kilns, and for open-hearth basic steel furnaces where not only are fire-resisting qualities required but also a resistance to the corrosive action of slags. The bauxite is used alone, or admixed with a binding agent—milk of lime or plastic fireclay. The bauxite may also be used to fortify ordinary fireclay. Bauxite bricks have an abnormally high shrinkage when in use unless they have been burned specially to a high temp. In order to lessen this shrinkage, the bauxite may be pre-calcined so as to convert it into corundum. A number of patents¹⁰ have been obtained for the use of corundum or fused alumina in refractory goods. O. Ruff and W. Goebel¹¹ studied the preparation of plastic masses of alumina for making vessels of various kinds. The use of fused bauxite or corundum as a refractory has been discussed by A. Bigot, A. Granger, etc. One trade name for fused alumina is *alundum*. Other trade names have been given to the product—*corindite*, *diamantine*, *aloxite*, *oxyalumina*, *adamite*, *electrite*, etc. The by-product in the thermite reduction of chromic oxide is *corubin*. In the preparation of alundum, calcined bauxite is fused in a water-cooled arc-furnace. The impurities are to a certain extent reduced, and they partially segregate, as impure ferro-silicon, at the bottom of the fused mass. The fused alumina is crushed and mixed with the necessary proportion of a plastic clay and felspar to enable it to be moulded, and to impart the necessary binding power in the fired product. Numerous articles for the laboratory are made of alundum.

REFERENCES.

¹ G. A. Kenngott, *Journ. prakt. Chem.*, (1), 101, 484, 1867; L. R. Milligan, *Journ. Phys. Chem.*, 26, 247, 1922; G. Melzer, *Zeit. Kryst.*, 35, 561, 1901; A. des Cloizeaux, *Compt. Rend.*, 106, 567, 1888; H. de Sénarmont, *ib.*, 32, 762, 1851; E. Frémy and A. Verneuil, *Compt. Rend.*, 104, 733, 1887; 106, 565, 1888; J. J. Ebelmen, *Ann. Chim. Phys.*, (3), 22, 240, 1848; (3), 33, 62, 1851; L. Grandeau, *ib.*, (6), 8, 207, 1886; H. St. C. Deville and H. Caron, *ib.*, (4), 5, 104, 1858; W. R. Miller and W. Phillips, *Introduction to Mineralogy*, London, 243, 1852; F. Rinne, *Neues Jahrb. Min.*, i, 168, 1900; M. Bauer, *ib.*, ii, 213, 1896; R. Brauns, *ib.*, i, 47, 1906; C. F. Bucholz, *Beiträge zur Erweiterung und Berichtigung der Chemie*, Erfurt, 1, 74, 1799; J. von Liebig, *Liebig's Ann.*, 17, 43, 1836; O. Mügge, *Neues Jahrb. Min.*, i, 220, 1884; i, 146, 1886; *Tschermak's Mitt.*, (2), 19, 165, 1900; G. Tschermak, *ib.*, (2), 1, 364, 1878; J. H. Pratt, *Corundum*, Washington, 15, 1906; W. E. Hidden, *Amer. Journ. Science*, (4), 13, 474, 1902; W. Crookes, *Chem. News*, 74, 39, 1896; J. L. Bournon, *Phil. Trans.*, 92, 233, 1802; J. W. Judd, *Min. Mag.*, 11, 50, 1895; A. Lasaulx, *Zeit. Kryst.*, 10, 346, 1885; J. Joly, *Proc. Roy. Soc.*, 41, 250, 1887; V. Kohlschütter and J. L. Tüscher, *Zeit. Elektrochem.*, 27, 255, 1921; G. A. Rankin and H. E. Merwin, *Journ. Amer. Chem. Soc.*, 38, 568, 1916.

² P. von Jeremejeff, *Zeit. Kryst.*, 15, 536, 1889; F. Rinne, *Neues Jahrb. Min.*, i, 170, 1900; ii, 47, 1916; G. A. Kenngott, *ib.*, 313, 1867; E. Frémy, *Compt. Rend.*, 111, 667, 1890; H. St. C. Deville and H. Caron, *ib.*, 66, 765, 1858; A. Verneuil, *ib.*, 150, 185, 1910; 151, 1065, 1910; *Ann. Chim. Phys.*, (8), 3, 20, 1904; J. Beckenkamp, *Zeit. Kryst.*, 58, 7, 1923; W. P. Davey, *Phys. Rev.*, (2), 21, 716, 1923; W. P. Davey and E. O. Hoffman, *ib.*, (2), 15, 333, 1920; J. A. Hedvall, *Zeit. anorg. Chem.*, 120, 327, 1922; J. W. Retgers, *Zeit. phys. Chem.*, 12, 601, 1893; L. Wöhler and K. von Kraatz-Koschlaw, *Tschermak's Mitt.*, (2), 18, 456, 1899; J. Morozowicz, *ib.*, (2), 18, 62, 1899; O. Mügge, *ib.*, (2), 19, 166, 1900; G. Forchhammer, *Pogg. Ann.*, 91, 581, 1854; C. Doelter, *Erdsteinkunde*, Leipzig, 88, 1893; A. J. Moses, *Amer. Journ. Science*, (4), 30, 271, 1910; W. Gintl, *Zeit. angew. Chem.*, 14, 1173, 1901; I. H. Levin, *Journ. Ind. Eng. Chem.*, 5, 495, 1913; J. W. Judd, *Min. Mag.*, 11, 50, 1895; R. Brauns, *Centr. Min.*, 588, 1905; G. Melzer, *Zeit. Kryst.*, 35, 561, 1901; V. Kohlschütter and J. L. Tüscher, *Zeit. Elektrochem.*, 27, 255, 1921; C. F. Bucholz, *Beiträge zur Erweiterung und Berichtigung der Chemie*, Erfurt, 1, 74, 1799; J. von

Liebig, *Liebig's Ann.*, **17**, 43, 1836; H. de Sénarmont, *Compt. Rend.*, **32**, 762, 1851; A. des Cloizeaux, *ib.*, **106**, 567, 1888; J. J. Ebelmen, *Ann. Chim. Phys.*, (3), **22**, 240, 1848; (3), **33**, 62, 1851; L. Grandeau, *ib.*, (6), **8**, 207, 1886; J. H. Pratt, *Corundum*, Washington, **15**, 1906; W. Crookes, *Chem. News*, **74**, 39, 1896; W. E. Hidden, *Amer. Journ. Science*, (4), **13**, 474, 1902; J. L. Bournon, *Phil. Trans.*, **92**, 233, 1802; M. Bauer, *Neues Jahrb. Min.*, ii, 213, 1896; G. Tschermak, *Tschermak's Mitt.*, (2), **1**, 364, 1878; A. Lasaulx, *Zeit. Kryst.*, **10**, 346, 1885; G. A. Rankin and H. E. Merwin, *Journ. Amer. Chem. Soc.*, **38**, 568, 1916; W. Hermann, *Zeit. anorg. Chem.*, **60**, 369, 1908; L. H. Milligan, *Journ. Phys. Chem.*, **26**, 247, 1922; C. Mauguin, *Compt. Rend.*, **178**, 785, 1924.

³ E. Madelung and R. Fuchs, *Ann. Physik*, (4), **65**, 293, 1921; M. J. Brisson, *Pésanteur spécifique des corps*, Paris, 1877; A. le Royer and J. B. A. Dumas, *Ann. Pharm. Chim.*, **92**, 408, 1821; E. Filhol, *Ann. Chim. Phys.*, (3), **21**, 415, 1847; J. J. Ebelmen, *ib.*, (3), **22**, 240, 1848; (3), **33**, 62, 1851; L. Grandeau, *ib.*, (6), **8**, 207, 1886; J. L. Smith, *Amer. Journ. Science*, (2), **10**, 354, 1850; (2), **11**, 53, 1851; (2), **42**, 83, 1866; C. J. St. C. Deville, *Phil. Mag.*, (4), **11**, 144, 1854; *Compt. Rend.*, **20**, 1453, 1845; **40**, 769, 1855; L. F. Nilson and O. Pettersson, *ib.*, **91**, 232, 1880; E. Frémy and C. Feil, *ib.*, **85**, 1029, 1877; H. Rose, *Pogg. Ann.*, **74**, 429, 1847; H. G. F. Schroder, *ib.*, **106**, 226, 1859; W. H. Emerson, *Trans. Amer. Inst. Min. Eng.*, **29**, 230, 1899; O. Höning Schmid, *Monatsh.*, **28**, 1107, 1907; C. G. Williams, *Chem. News*, **28**, 101, 1873; *Proc. Roy. Soc.*, **21**, 409, 1873; *Phil. Mag.*, (4), **46**, 314, 1873; P. van Muschenbroek, *Phil. Trans.*, **33**, 370, 1726; F. G. Schaffgotsch, *Pogg. Ann.*, **71**, 129, 1847; A. H. Church, *Geol. Mag.*, **2**, 321, 1875; J. W. Mellor and A. D. Holdcroft, *Trans. Cer. Soc.*, **9**, 94, 1911; A. Liversidge, *Journ. Amer. Chem. Soc.*, **16**, 205, 1894; M. Bauer, *Edelsteinkunde*, Leipzig, 299, 319, 1896; T. A. Jaggard, *Amer. Journ. Science*, (4), **4**, 411, 1897; A. Rosiwal, *Verh. geol. Reichsanst.*, **17**, 475, 1896; *Mitt. Wien. Min. Geo.*, **69**, 1917; F. Auerbach, *Weid. Ann.*, **58**, 369, 1896; *Ann. Physik*, (4), **3**, 116, 1900; A. Reis and L. Zimmermann, *Zeit. phys. Chem.*, **102**, 298, 1922.

⁴ H. Fizeau, *Compt. Rend.*, **62**, 1101, 1133, 1866; *Ann. Chim. Phys.*, (4), **8**, 335, 1866; H. V. Regnault, *ib.*, (3), **1**, 129, 1841; F. Pfaff, *Pogg. Ann.*, **107**, 148, 1859; F. E. Neumann, *ib.*, **23**, **1**, 1831; B. Bogitsch, *Compt. Rend.*, **173**, 1358, 1921; J. Joly, *Proc. Roy. Soc.*, **41**, 250, 1887; E. Jannetaz, *Bull. Soc. Min.*, **15**, 138, 1892; L. F. Nilson and O. Pettersson, *Compt. Rend.*, **91**, 232, 1880; A. Weber, *Ueber die Wärmeleitfähigkeit gepresster Salze nach der Methode des getheilten Stabes*, München, 1900; W. A. Tilden, *Journ. Chem. Soc.*, **87**, 551, 1905; H. von Wartenberg and G. Witzel, *Zeit. Elektrochem.*, **25**, 209, 1919.

⁵ L. B. G. de Morveau, *Journ. Phys.*, **19**, 310, 382, 1782; R. Hare, *Memoir of the Supply and Application of the Blowpipe*, Philadelphia, 1802; E. D. Clarke, *The Gas Blowpipe*, London, 1819; *Ann. Phil.*, **17**, 421, 1821; E. F. Northrup, *U.S. Pat. No.* 1378189, 1921; H. Davy, *Phil. Trans.*, **98**, **1**, 333, 1808; F. Stromeyer, *Schweigger's Journ.*, **19**, 424, 1817; M. A. Gaudin, *Compt. Rend.*, **4**, 999, 1837; **44**, 716, 1857; **69**, 1347, 1869; H. Moissan, *ib.*, **115**, 1035, 1892; **119**, 935, 1894; *Bull. Soc. Chim.*, (3), **9**, 955, 1893; (3), **13**, 803, 1895; *Ann. Chim. Phys.*, (7), **4**, 136, 1895; C. W. Kanolt, *Journ. Washington Acad.*, **2**, 337, 1912; **3**, 315, 1913; O. Ruff and O. Goecke, *Zeit. angew. Chem.*, **24**, 1459, 1911; O. Ruff, H. Seiferheld, and J. Suda, *Zeit. anorg. Chem.*, **82**, 273, 1913; O. Ruff and G. Lanschke, *ib.*, **97**, 73, 1916; E. Tiede and E. Birnbräuer, *ib.*, **87**, 129, 1914; O. Ruff and P. Schmidt, *ib.*, **117**, 172, 1921; O. Ruff, *ib.*, **82**, 386, 1913; **99**, **81**, 1916; O. Ruff and E. Jelinek, *ib.*, **97**, 311, 1916; W. R. Mott, *Trans. Amer. Electrochem. Soc.*, **34**, 255, 1918.

⁶ H. le Chatelier, *Compt. Rend.*, **104**, 1517, 1887; *Bull. Soc. Min.*, **10**, 207, 1887; J. W. Mellor and A. D. Holdcroft, *Trans. Cer. Soc.*, **9**, 94, 1911; **10**, 169, 1912; **13**, 83, 1914; H. S. Houldsworth and J. W. Cobb, *ib.*, **22**, 111, 1923; J. J. Berzelius, *Schweigger's Journ.*, **16**, 405, 1816; *Lehrbuch der Chemie*, Dresden, **1**, i, 841, 1825; P. Scheerer, *Pogg. Ann.*, **51**, 493, 1840; W. G. Mixer, *Amer. Journ. Science*, (4), **26**, 125, 1908; J. A. Hedvall, *Zeit. anorg. Chem.*, **120**, 327, 1922; M. Berthelot, *Ann. Chim. Phys.*, (5), **15**, 185, 1878; (5), **16**, 442, 1879; (7), **22**, 479, 1901; J. B. Baillie and C. Féry, *ib.*, (6), **17**, 246, 1889; H. V. Regnault, *ib.*, (3), **1**, 129, 1841; J. W. Richards, *Journ. Franklin Inst.*, **139**, 295, 1895; K. A. Hofmann and F. Zerban, *Ber.*, **36**, 3095, 1903; H. Rose, *Journ. prakt. Chem.*, (1), **73**, 391, 1853; A. Damour, *Compt. Rend.*, **58**, 154, 1864; J. W. Mallet, *Amer. Journ. Science*, (3), **14**, 397, 1877; (3), **22**, 52, 1881; O. Hauser, *Ber.*, **40**, 3118, 1907; W. Ramsay and M. W. Travers, *Proc. Roy. Soc.*, **62**, 325, 1898; *Zeit. phys. Chem.*, **25**, 568, 1898.

⁷ A. des Cloizeaux, *Nouvelles recherches sur les propriétés optiques des cristaux*, Paris, 522, 1867; *Ann. Mines*, (5), **11**, 307, 1857; (5), **14**, 354, 1858; E. Mallard, *ib.*, (7), **10**, 150, 1876; F. Bordas, *Compt. Rend.*, **145**, 710, 800, 874, 1907; **146**, 21, 1908; W. H. Wollaston, *Phil. Trans.*, **92**, 365, 1802; D. Brewster, *Quart. Journ. Science*, **22**, 355, 1827; W. H. Miller in W. Phillips, *Elementary Introduction to Mineralogy*, London, 243, 1852; R. Brauns, *Die optischen Anomalien der Krystalle*, Leipzig, 287, 1891; *Centr. Min.*, **588**, 1905; *Neues Jahrb. Min.*, i, 49, 1906; F. Rinne, *ib.*, i, 170, 1900; C. Doelter, *ib.*, i, 257, 1897; J. W. Judd, *Min. Mag.*, **11**, 69, 1897; M. Chautem, *Compt. Rend.*, **134**, 1139, 1902; H. V. Vogel, *Ber.*, **10**, 373, 1877; A. Miethe, *Ber. deut. phys. Ges.*, **5**, 715, 1907; G. Melzer, *Zeit. Kryst.*, **25**, 578, 1901; A. Lasaulx, *ib.*, **10**, 346, 1885; E. Bertrand, *Bull. Soc. Min.*, **1**, 95, 1878; O. Mügge, *Tschermak's Mitt.*, (2), **19**, 166, 1899; V. Agafonoff, *Proc. Russ. Min. Soc.*, (2), **39**, 497, 1902; *Neues Jahrb. Min.*, ii, 342, 1904; H. E. Ives, E. F. Kingsbury, and E. Karrer, *Journ. Franklin Inst.*, **186**, 401, 1918; W. W. Coblentz, *ib.*, **174**, 549, 1912; *Investigations of Infra-red Spectra*, Washington, **7**, 107, 1908; F. Henning and W. Heuse, *Zeit. Physik*, **20**, 132, 1923; G. Tschermak, *Tschermak's Mitt.*, (2), **1**, 364, 1878.

⁸ D. Hahn, *Die Phosphorescenz der Mineralien*, Halle, 1874; P. Heinrich, *Die Phosphorescenz der Körper nach allen Umständen untersucht und erläutert*, Nürnberg, 23, 155, 1820; E. Becquerel, *Ann. Chim. Phys.*, (3), 57, 46, 1859; (3), 62, 90, 1861; *Compt. Rend.*, 103, 1224, 1886; 104, 334, 1887; L. de Boisbaudran, *ib.*, 103, 1107, 1886; 104, 330, 478, 554, 824, 1887; 105, 261, 1887; 107, 311, 468, 490, 1888; F. Boudas, *ib.*, 145, 710, 800, 874, 1907; 146, 21, 1908; W. Crookes, *Proc. Roy. Soc.*, 32, 206, 1887; 42, 25, 1887; *Chem. News*, 55, 25, 1887; 56, 59, 72, 1887; E. L. Nichols and D. T. Wilber, *Phys. Rev.*, (2), 17, 269, 707, 1921; D. T. Wilber, *ib.*, (2), 20, 101, 1922; E. L. Nichols and H. L. Howen, *ib.*, (2), 19, 300, 1922; *Journ. Amer. Optical Soc.*, 6, 42, 1923; E. L. Nichols, *Trans. Amer. Illum. Eng. Soc.*, 16, 331, 1921; W. Arnold, *Wied. Ann.*, 61, 318, 1897; G. C. Schmidt, *Ann. Physik*, (4), 13, 624, 1904; J. Tafel, *ib.*, (4), 11, 613, 1903; H. Jackson, *Journ. Chem. Soc.*, 65, 734, 1894; E. Newbery and H. Lupton, *Mem. Proc. Manchester Lit. Phil. Soc.*, 62, 10, 1918; J. A. Wilkinson, *Journ. Phys. Chem.*, 13, 691, 1909; W. Wien, *Phys. Zeit.*, 3, 440, 1902; J. Beijerinck, *Neues Jahrb. Min. B.B.*, 11, 455, 1897; J. Ewles, *Phil. Mag.*, (6), 45, 957, 1923; J. Rossignol, *Compt. Rend.*, 176, 1459, 1923; A. A. Somerville, *Met. Chem. Engg.*, 10, 422, 1912; E. Thomson, *Nature*, 107, 520, 619, 1921; D. T. Wilber, *Proc. Rev.*, (2), 20, 101, 1922; S. C. Lind and D. C. Bardwell, *Journ. Franklin Inst.*, 196, 375, 1923; *Amer. Min.*, 8, 171, 1923; J. O. Perrine, *Phys. Rev.*, (2), 22, 48, 1923; C. Doelter, *Sitzber. Akad. Wien*, 129, 399, 1920.

⁹ H. N. Warren, *Chem. News*, 55, 192, 1887; 70, 102, 1894; J. Dewar, *ib.*, 97, 4, 1908; C. F. Cross, *Journ. Chem. Soc.*, 35, 796, 1879; E. J. Mills and C. W. Meanwell, *ib.*, 39, 533, 1881; J. W. Mellor and A. D. Holderroft, *Trans. Cer. Soc.*, 9, 94, 1911; F. M. G. Johnson, *Journ. Amer. Chem. Soc.*, 34, 911, 1912; H. Adkins, *ib.*, 44, 2175, 1922; H. Adkins and B. H. Nissen, *ib.*, 45, 809, 1923; 46, 130, 1924; H. C. Oersted, *Cefvers. Danske Vid. Selsk. Forh.*, 15, 1825; E. Demarçay, *ib.*, 104, 111, 1887; A. Duboin and A. Gautier, *ib.*, 129, 217, 1899; A. Gautier, *ib.*, 143, 7, 1906; F. Scheermesser, *Woch. Ann. Landw.*, 10, 51, 1870; *Ueber die Absorption von Gasen durch Erdgemische*, Jena, 1871; W. N. Hartley and H. Ramage, *Journ. Chem. Soc.*, 79, 61, 1901; W. N. Hartley, *Proc. Roy. Soc.*, 79, A, 255, 1907; A. Daubrée, *Ann. Mines*, (4), 19, 691, 1851; G. Gore, *Phil. Mag.*, (4), 29, 541, 1865; L. Meyer, *Ber.*, 20, 681, 1887; A. A. Somerville, *Met. Chem. Engg.*, 10, 422, 1912; H. Rose, *Pogg. Ann.*, 52, 595, 1841; 74, 569, 1848; R. Weber, *ib.*, 107, 375, 1859; 112, 619, 1861; H. Moissan, *Le fluor et ses composés*, Paris, 229, 1900; *Bull. Soc. Chim.*, (3), 13, 803, 1895; *Compt. Rend.*, 119, 935, 1894; L. Troost and P. Hautefeuille, *ib.*, 70, 185, 1870; 75, 1710, 1819, 1872; *Bull. Soc. Chim.*, (2), 13, 213, 1870; F. de Lalande and M. Prud'homme, *ib.*, (2), 17, 290, 1872; A. Mitscherlich, *Journ. prakt. Chem.*, (1), 81, 110, 1860; M. Reichardt and E. Blumtrill, *ib.*, (1), 98, 476, 1866; C. W. Scheele, *De materia virginte caerulei Berolinensis*, Stockholm, 1783; E. Frémy, *Ann. Chim. Phys.*, (3), 38, 322, 1853; E. Botolfson, *ib.*, (9), 18, 5, 1922; O. Hönigschmid, *Monatsh.*, 28, 1107, 1907; P. Ebell, *Dingler's Journ.*, 220, 64, 155, 1876; G. Marchel, *Compt. Rend.*, 177, 1300, 1923; S. Medsforth, *Journ. Chem. Soc.*, 123, 1452, 1923; H. le Chatelier, *Bull. Soc. Chim.*, (2), 47, 300, 1887; K. Nischk, *Zeit. Elektrochem.*, 29, 373, 1923; L. Kahlenberg and W. J. Trantman, *Trans. Amer. Electrochem. Soc.*, 39, 377, 1921.

¹⁰ A. Bouvier, *French Pat. No. 357445*, 1905; C. G. Sudre and C. V. Thierry, *Brit. Pat. No. 1491*, 1901; F. Quetser, *ib.*, 9830, 1901; British Thomson-Houston Co., *ib.*, 22869, 1907; F. Engelhorn, *ib.*, 15539, 16714, 1906.

¹¹ F. B. Jacobs, *Abrasive and Abrasive Wheels, their Nature, Manufacture and Use*, New York, 1919; *Brit. Pat. No. 16529*; 1900; A. C. Higgins, *U.S. Pat. No. 775654*, 1904; M. A. Williamson and P. A. Boeck, *Journ. Ind. Eng. Chem.*, 4, 672, 1912; M. Buchner, *Zeit. angew. Chem.*, 17, 985, 1904; A. Bigot, *Trans. Cer. Soc.*, 17, 267, 1917; A. Granger, *ib.*, 21, 89, 1921; A. J. Aubrey, *Electrochem. Met. Ind.*, 4, 466, 1907; A. F. Greaves-Walker, *Trans. Amer. Cer. Soc.*, 8, 297, 1906; R. M. Howe and R. F. Ferguson, *Journ. Amer. Cer. Soc.*, 6, 496, 1923; O. Ruff and W. Goebel, *Zeit. anorg. Chem.*, 133, 220, 1924.

§ 11. Aluminium Hydroxides, and Peroxides

J. D. Dana,¹ and H. Lienau assume that there are three aluminium hydroxides, *viz. diaspore*, $\text{Al}_2\text{O}_3 \cdot \text{H}_2\text{O}$, *i.e.* $\text{AlO}(\text{OH})$; *bauxite*, $\text{Al}_2\text{O}_3 \cdot 2\text{H}_2\text{O}$, *i.e.* $\text{Al}_2\text{O}(\text{OH})_4$; and *gibbsite* $\text{Al}_2\text{O}_3 \cdot 3\text{H}_2\text{O}$, *i.e.* $\text{Al}(\text{OH})_3$. The first and last are clearly defined hydroxides, but the individuality of bauxite is not so manifest, and the term is used generically for natural products with hydrated alumina as the dominant constituent. F. Cornu and K. A. Redlich, and B. Wohlin maintain that there are only the mono- and tri-hydroxides, and that bauxite is simply a mixture of the two. In support of this, B. Wohlin found that when bauxites of the mono-hydrate type are heated they showed a decided heat absorption at 540° while they were being dehydrated. Those of the trihydrate type showed a heat absorption at 310° , which

was their dehydration temp. The minerals which had a composition corresponding to a dihydrate showed heat absorptions at both 310° and 540° .

The mineral **diaspore** was described by R. J. Haüy² at the beginning of the nineteenth century; it was analyzed by L. N. Vauquelin. R. J. Haüy named it diaspore after *διασπείρω*, to scatter, because, when introduced in a flame the mineral *se dissipe en une multitude de parcelles*. The source of R. J. Haüy's specimen was not known. G. Rose found a similar mineral during his travels in the Urals. Specimens from various localities have been analyzed by A. E. Nordenskiöld, C. H. Hess, A. Defrénoy, C. U. Shepard, A. Damour, R. Hermann, J. L. Smith, E. Hussak, C. T. Jackson, A. Löwe, M. Waterkamp, etc. The mineral may be regarded as **aluminium monohydroxide**, or as **meta-aluminic acid**, HAO_2 , whose salts—the meta-aluminates—are represented by the *spinel*s. H. de Sénarmont,³ E. Weinschenk, and G. Friedel obtained artificial diaspore accompanying corundum in the process they employed for synthesizing corundum (*q.v.*). A. C. Becquerel also separated soln. of potassium aluminate and chromic chloride by parchment paper and obtained a deposit of crystals of diaspore on the membrane—*vide supra*, laterite.

Diaspore occurs in nature in rhombic bipyramidal crystals with axial ratios, according to N. von Kokscharoff, $a : b : c = 0.93722 : 1, 1 : 0.60387$. According to K. Walther, aluminium monohydroxide is dimorphous, for he obtained a mineral from Cerro Redondo, Minas, Uruguay, which he named *kayserite*—after E. Kayser. Its composition was $\text{AlO}(\text{OH})$, and the monoclinic crystals had a micaceous cleavage. The fracture of diaspore is conchoidal. The crystals are isomorphous with *göthite*, $\text{Fe}_2\text{O}_3 \cdot \text{H}_2\text{O}$, or HFeO_2 , and with *manganite*, $\text{Mn}_2\text{O}_3 \cdot \text{H}_2\text{O}$, or HMnO_2 . The crystals are colourless, but if contaminated with ferric oxide they may be tinted cream, grey, or brown; violet crystals have also been reported. The pleochroism of the coloured crystals has been described by W. Haidinger, appearing violet-blue in one direction, reddish plum-blue in another, and pale asparagus-green in a third direction. Diaspore may occur in foliated masses, in thin plates, or it may be stalactitic. The sp. gr. ranges from 3.3–3.5; and the hardness, 6–7. K. Walther gave 5–6 for the hardness of *kayserite*. G. Spezia fused diaspore to a colourless glass, by heating it in the flame of a blowpipe fed with oxygen. According to A. Mitscherlich, the mineral loses no water at 100° , but water is given off at a red heat. According to A. des Cloizeaux, the double refraction is strong and positive; and A. Michel-Lévy and A. Lacroix give for the indices of refraction in Na-light, $\alpha = 1.702$, $\beta = 1.722$, $\gamma = 1.750$. K. Walther gave for the indices of refraction of *kayserite*, $\alpha = 1.68$, and γ below 1.74; and the birefringence was 0.055. A. Kenngott said that when powdered and calcined diaspore is moistened with water, it has an alkaline reaction. According to A. Damour, diaspore is not attacked by acids or potash-lye; but after calcination it is soluble in sulphuric acid. According to F. Beijerinck, diaspore is a non-conductor of electricity.

H. Davy⁴ analyzed a mineral found by W. Wavel at Barnstaple (Devonshire) and reported it to contain approximately 70 per cent. alumina and 30 per cent. water with about 1.4 of calcium oxide and some fluorine. He said that B. G. Babington proposed to call the mineral *wavellite*, but “if a name founded on its chemical properties be preferred, it may be denominated *hydrargillite*, from *ὑδωρ*, water; *ἀργίλλος*, clay.” J. J. Berzelius, and J. N. von Fuchs, however, showed that what H. Davy assumed to be alumina was really aluminium phosphate. The term *wavellite* now refers to the aluminium phosphate, and *hydrargillite* to the hydrated alumina, but for a time, as a result of H. Davy's mistake, the two minerals were confused. T. Thomson called the Devonshire mineral *devonite*, and J. N. von Fuchs, *lasionite*. C. Dewey found a mineral at Richmond (Mass.) containing water and alumina, and called it **gibbsite** in honour of G. Gibbs. Analyses made by J. Torrey, B. Silliman, and J. L. Smith and G. J. Brush corresponded with $\text{Al}(\text{OH})_3$; G. Rose applied H. Davy's name **hydrargillite** to a similar hydrate found in the Urals; and analyses by R. Hermann, F. von Kobell, K. von Hauer,

J. H. Gladstone, A. von Liebrich, F. Kovar, L. L. Fermor, A. E. Nordenskjöld, H. Warth, A. Mitscherlich, H. Gorceix, A. de Schulten, J. da Costa Sena, E. Jannettaz, and W. C. Eustis of other specimens agree with C. Dewey's gibbsite. G. J. Brush, and G. A. Kenngott discussed the more appropriate term gibbsite or hydrargillite for the mineral. Crystallized gibbsite or hydrargillite is comparatively rare. According to A. de Schulten,⁵ the crystals of trihydrated alumina obtained by many processes are of artificial gibbsite, or hydrargillite, or **aluminium trihydroxide**, $\text{Al}_2\text{O}_3 \cdot 3\text{H}_2\text{O}$, or $\text{Al}(\text{OH})_3$ —*e.g.* it is formed when a sat. soln. of aluminium hydroxide in dil. ammonia is warmed on a water-bath so that the ammonia is but slowly expelled; or when a slow current of carbon dioxide is passed over the surface of a warm alkaline soln. of alumina. J. M. van Bemmelen also showed that the aluminium hydroxide precipitated by L. le Chatelier's process (*vide supra*) by passing carbon dioxide through a boiling soln. of alkali aluminate; or by C. J. Bayer's process, by the action of aluminium hydroxide on a soln. of alkali aluminate (*vide supra*) is crystalline trihydroxide. M. Buchner treated the aluminium salt in the solid state with alkali soln., or the salt was moistened with a very little water and subjected to the action of gaseous ammonia. The salt was also dissolved in its water of crystallization and treated with ammonia, or a metallic oxide or hydroxide, with or without steam. Crystals of this hydroxide were also made by P. A. von Bonsdorff, as previously indicated; F. Wöhler obtained the crystals by boiling a piece of aluminium in water for many hours; C. Weltzien, by the action of hydrogen peroxide on aluminium; and A. Cossa, by the action of water on aluminium amalgam. A. C. Becquerel obtained crystals of the same product by separating soln. of potassium aluminate and aluminium chloride by a diaphragm. T. Schlösing obtained the same trihydrated alumina by calcining the enneahydrated nitrate at 140° ; and M. Dullo obtained this hydrate in the form of a white powder by the electrolysis of an aq. soln. of alum.

Some colloidal forms have been reported. Thus, T. A. Nicolaewsky applied the term *shanyawskite* or *schanyawskite*—after A. L. Shanyawskite or A. L. Schanyawskite—to an amorphous hydrated alumina, approximating $\text{Al}_2\text{O}_3 \cdot 4\text{H}_2\text{O}$, which he found in crevices in the dolomite near Moscow. O. Pauls suggested that bauxite contains a large proportion of a colloid which he called *alumogel*; M. Kispatic, and F. Tucan called the colloidal alumina in bauxite corresponding to diaspore, $\text{Al}_2\text{O}_3 \cdot \text{H}_2\text{O}$, *sporogelite*, and F. Cornu called it *a-kliachite*, while that corresponding to hydrargillite, $\text{Al}_2\text{O}_3 \cdot 3\text{H}_2\text{O}$, was called *a-kliachite*. The *kliachite* is also called *chiachite* or *kljakite*—after *Kliache* in Dalmatia. *Vide bauxites*.

The artificial crystals of gibbsite are white, the natural crystals may be grey, greenish-grey, brown, or yellow. W. Haidinger showed that the coloured crystals may be pleochroic. Crystals of gibbsite are not common; the mineral is usually stalactitic, or it may occur in small mammillary masses with a faint fibrous structure. N. von Kokscharoff supposed the mineral to be trigonal, but A. des Cloizeaux, and W. C. Brögger showed that the crystals are monoclinic prisms, with axial ratios $a : b : c = 1.70890 : 1 : 1.91843$, and $\beta = 85^\circ 29\frac{1}{4}'$. P. Groth suggested that gibbsite, $\text{Al}(\text{OH})_3$, and boric acid, $\text{B}(\text{OH})_3$, are isomorphous. O. Mügge described the basal cleavage; and W. C. Brögger, the twinning. According to L. H. Milligan, X-ray diagrams of crystalline aluminium hydroxide, prepared by Bayer's process, resemble those of the mineral gibbsite, thus showing it to be a definite crystalline compound. The sp. gr. ranges from 2.3–2.4—A. de Schulten gave 2.423; the hardness is between 2 and 3. According to J. M. van Bemmelen, at 170° , the composition remains $\text{Al}_2\text{O}_3 \cdot 3\text{H}_2\text{O}$, *i.e.* $\text{Al}(\text{OH})_3$, but after 20 hrs.' heating to 200° , the composition approximates $\text{Al}_2\text{O}_3 \cdot 2\text{H}_2\text{O}$; if heated for a long time at 225° , $\text{Al}_2\text{O}_3 \cdot \text{H}_2\text{O}$ is formed, and this change is completed at 300° ; and if heated to 320° , still more water is given off. W. Ramsay, T. Carnelley and J. Walker, and E. Martin investigated the dehydration of aluminium hydroxide—*vide infra*. L. H. Milligan showed that crystalline aluminium hydroxide remains constant in composition, $\text{Al}(\text{OH})_3$, up to 145° . The evolution of water commences just over 145° , and is almost complete at 200° ; about 8 per cent. of the original aluminium hydroxide remains undecomposed at

this temp. There is no evidence of the formation of other hydrates. The water absorbed by alumina dehydrated as low as 275° , is simply adsorbed, and does not combine chemically with the alumina. T. Hagiwara found that aluminium hydroxide lost only 0.18 mol of water at 180° , but if previously ground with four times its weight of quartz, it lost 2.01 mols. This is taken to mean that the affinity of a substance for water is lessened by subdivision, since the chemically combined water becomes adsorbed water.

H. Rose, and C. F. Cross found that dehydrated alumina recombines with water with the evolution of heat, and this the less the higher the temp. at which the alumina has been heated—*vide* aluminium oxide. A. Mitscherlich found that the hydroxide dehydrated at about 240° reforms the trihydrate in moist air. J. Thomsen gives for the heat of formation ($2\text{Al}, 3\text{O}, 3\text{H}_2\text{O}$), 388.80 Cals.; and (Al, 3O, 3H), 296.94 Cals. The double refraction is strong and positive. W. C. Brögger gave for the indices of refraction $\alpha=\beta=1.5347$, and $\gamma=1.5577$; and F. Slavik gave 1.560–1.573. W. W. Coblenz found a wide band at 3μ in the ultra-red transmission spectrum of bauxite, and other bands at 4.7μ , 5.8μ , and 7μ . In the ultra-red transmission spectrum of hydrargillite, W. W. Coblenz found one large water-band at 3μ ; and in that of diaspore a band at 3μ , and smaller bands at 1.9μ , 5.8μ , and 6.7μ . In the ultra-red reflection spectrum, there are no marked absorption bands up to 8μ ; there is a broad band between 9.4μ and 10.3μ with maxima at 9.45μ , 9.8μ , and 10.2μ . The region 12μ to 13μ is complex, but there is a maximum at 12.8μ . There are also maxima at 8.55μ , 13.8μ , and 14.6μ . F. Beijerinck said that gibbsite is a non-conductor of electricity. F. Wöhler, P. A. von Bonsdorff, A. Cossa, and V. Zunino noted the relative chemical inertness of crystallized aluminium trihydroxide. The crystalline trihydroxide is said to be insoluble in water, aq. ammonia, alcohol, and to be almost insoluble in cold sulphuric, hydrochloric, or nitric acid, and alkali-lye; to be very slowly soluble in boiling hydrochloric acid; and rapidly soluble in hot sulphuric acid. J. M. van Bemmelen found that the crystalline hydrate has not the power of adsorbing salts from soln. to any marked degree.

Hydrated alumina not only occurs crystalline in the form of definite hydroxides, but it may be obtained in a non-crystalline or amorphous state, as exemplified by the colloidal **alumina hydrogel** which is very sparingly soluble in water, and the so-called soluble hydrate in the form of an **alumina hydrosol**. The formation of alumina hydrogel by adding ammonia, or alkali hydroxides, has been described in connection with the formation of aluminium oxide. E. J. Mills and R. L. Barr⁶ found that by adding sodium carbonate to a soln. of alum, the mixture remains clear until the molar ratio $\text{Na}_2\text{CO}_3 : \text{Al}_2(\text{SO}_4)_3$ is 3 : 5; when the ratio is 7.5 : 5 half the alumina is precipitated as hydroxide, and when the ratio is 12 : 5, all the alumina is precipitated. The amount precipitated in the first half of the reaction is proportional to the amount of sodium carbonate, and after that an increasing amount is precipitated. According to C. Renz, when a soln. of aluminium nitrate is precipitated by an excess of ammonia, a small quantity of aluminium hydroxide remains dissolved, but freshly precipitated and washed alumina is quite insoluble in ammonia. When a soln. of potassium aluminate is precipitated by the calculated quantity of ammonium chloride and a large excess of ammonium hydroxide is rapidly added, the precipitate completely redissolves. The modification of aluminium hydroxide soluble in ammonia is best prepared by addition of the calculated quantity of ammonium sulphate to a soln. of barium aluminate to which an excess of ammonia has been added. On filtering off the barium sulphate, a clear soln. is obtained, containing 0.1 grm. of alumina in 50 c.c., and on evaporation, it leaves the hydroxide as a white, not horny mass, dissolving less readily in acids than the ordinary modification. The filtration and washing of the hydrogel causes it to lose its property of dissolving in ammonia so that it appears as if there are two varieties of the hydrogel, one soluble and the other insoluble in aq. ammonia. The product was investigated by E. Wendehorst, G. Jander and B. Weber, L. Blum, R. Fittig, F. Tucan,

P. P. von Weimarn, etc. According to G. Lösekann, hydrogen sulphide precipitates hydrated alumina from alkaline soln., and the precipitate dissolves when the mixture is boiled—presumably by a reversal of the reaction. E. Schlumberger found that when the precipitated hydroxide is washed to remove the alkali salts, it loses to a large extent its solubility in acids. The product is assumed to be a mixture of soluble and insoluble colloids which may be separated by dil. hydrochloric acid, or alkali-lye. He said that the composition of the precipitated hydrates is not very definite, and he claimed to have made $\text{Al}_{10}\text{O}_{22}\text{H}_{14}$, *i.e.* $10\text{Al}(\text{OH})_3$ less $8\text{H}_2\text{O}$, or $5\text{Al}_2\text{O}_3 \cdot 7\text{H}_2\text{O}$; and $\text{Al}_6\text{O}_{14}\text{H}_{10}$, *i.e.* $6\text{Al}(\text{OH})_3$ less $4\text{H}_2\text{O}$, or $3\text{Al}_2\text{O}_3 \cdot 5\text{H}_2\text{O}$. The latter hydrate is represented by the formula :

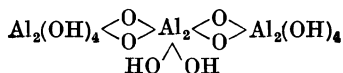

but a formula cannot materialize a *compound*. It is said to be very hygroscopic, to swell up in cold conc. sulphuric acid, but not to dissolve unless the acid is heated, when it forms normal aluminium salts; on the other hand, it dissolves with great ease in cold, dil. hydrochloric acid to a viscous, opalescent, but homogeneous liquid, which passes through filter-paper. This liquid, which is acid and astringent, appears to coagulate when conc., and the dried coagulum forms a gummy mass of the composition, $\text{Al}_6\text{O}_{14}\text{H}_{10} \cdot \text{HCl}$. When the soln. of the *hydrochloride* is dialyzed, normal aluminium chloride is eliminated, and the original basic hydroxide remains. W. Pauli regarded the colloidal particles as complexes like $\text{Al}(\text{OH})_3 \cdot \text{Al}(\text{OH})_2\text{Cl}$, etc.—*vide* oxychlorides. According to R. Willstätter and H. Kraut, aluminium hydroxide is prepared (i) as a pale yellow, plastic mass by precipitating aluminium sulphate with conc. ammonia and subsequent protracted heating of the precipitate with ammonia; (ii) as a very pale yellow, viscous, plastic mass prepared in the same manner as (i), but with avoidance of protracted heating; (iii) as a pure white, very voluminous, and very finely divided substance, by precipitating aluminium sulphate with dil. ammonia without protracted heating; and (iv) as a pure white, coarse powder by passing a slow current of carbon dioxide through a soln. of potassium aluminate. The chemical behaviour of the products towards a one per cent. soln. of sodium hydroxide, warm 12 per cent. acetic acid, or 1, 15, or 50 per cent. hydrochloric acid, differs in the several cases, and cannot be explained on purely chemical or purely colloid-chemical grounds. The existence of definite hydrates in the preparations is indicated by the results of their desiccation over sulphuric acid and by their step-wise dehydration at gradually increasing temp. The adsorptive capacity of the different varieties for the enzymes invertase and lipase is affected to a very marked extent by the dilution of the soln. V. Kohlschütter and co-workers investigated the dependence of the properties of dispersed aluminium hydroxide on the mode of preparation.

D. Tommasi found that the hydrate precipitated by ammonia, has the composition $\text{Al}(\text{OH})_3$ after it has stood under water for 3 months—probably the product is here the crystalline hydrate, because its solubility in hydrochloric, nitric, or acetic acid or in alkali-lye is said to be as difficult as that of the calcined oxide, although it is easily soluble in conc. sulphuric acid. L. Péan de St. Gilles found that after boiling precipitated alumina with water for 20 hrs. the composition approximates $\text{Al}_2\text{O}_3 \cdot 2\text{H}_2\text{O}$; but if heated with water to 260° – 300° , in a sealed tube, A. Mitscherlich found 17.78–18.00 per cent. of water was retained. J. Löwe found that the hydrate precipitated by ammonium chloride from alkaline soln., and dried at 100° , is nearly $\text{Al}_2\text{O}_3 \cdot 2\text{H}_2\text{O}$. E. T. Allen is of the opinion that precipitated alumina has the composition $\text{Al}(\text{OH})_3$, whether prepared by precipitating warm or in the cold with ammonia, by boiling a soluble aluminate with ammonium chloride, by boiling the basic carbonate with water or dil. ammonia, or by the prolonged action of water on soluble aluminates. The last form is crystalline and does not lose water over sulphuric acid; the amorphous varieties under such conditions, or by heating at 110° , lose a mol. of water, leaving the hydrate, $\text{Al}_2\text{O}_3 \cdot \text{H}_2\text{O}$, which is hygroscopic and reverts to $\text{Al}(\text{OH})_3$.

Alumina hydrogel dries to a white, hard, horny mass which, like dried glue, sticks to the tongue, and with water it forms a sticky mass. Alumina precipitated in the cold from not too dil., colloid-free soln. was found by F. Haber to be amorphous when tested by the X-radiogram method. Alumina prepared by peptizing the acetate—*vide infra*—and filtering through a colloid filter, left a membrane of alumina which gave evidence of a crystalline structure. S. Hakomori studied the failure of ammonia to precipitate aluminium hydroxide in the presence of tartaric acid or glycerol, but without coming to very definite conclusions. J. Löwe said that the alumina precipitated from alkaline soln. by ammonium chloride is more opaque than that precipitated by ammonia. J. J. Berzelius found that the precipitate dried at 110° was eq. to $\text{Al}(\text{OH})_3$. E. T. Allen said that the hydrate has the greatest sp. gr. when precipitated from basic carbonate soln., but the sp. gr. of the crystalline hydrate is greater than that of the most dense hydrogel. A. Mitscherlich noted that the dried precipitate loses a little water at 130°, and the greater part is expelled between 150° and 280°, so that at the latter temp. the residue has the composition $\text{Al}_2\text{O}_3 \cdot \text{H}_2\text{O}$; the remaining water is retained until the temp. is bright red. The Compagnie des Produits Chimiques found the precipitate is readily dehydrated if the calcined mass is moistened with hydrofluoric acid and recalcined, although the final product then contains about one per cent. of fluoride. W. Ramsay, and T. Carnelley and J. Walker measured the rate at which water is given off at different temp., but found no signs of a discontinuity corresponding with the formation of definite hydrates. J. M. van Bemmelen also showed that, when heated, alumina hydrogel is constantly changing molecularly, so that at no period can it be represented as a chemical individual with a simple formula. W. Ramsay found that the hydrate, heated at 100°, has 29.5 per cent. of water; at 145°, 23.5 per cent.; at 200°, 19.8 per cent.; and at 300°, 15 per cent. W. Müller-Erbach made some observations on this subject.

The attempts to fix a definite formula for alumina hydrogel have not been successful. J. M. van Bemmelen precipitated it by ammonia, and found that the colloid obtained (i) with very dil. soln. of aluminium chloride and ammonia, when rapidly washed and dried in air, had the composition $\text{Al}_2\text{O}_3 \cdot 4.3\text{H}_2\text{O}$; but if obtained (ii) from conc. soln., $\text{Al}_2\text{O}_3 \cdot 4.45\text{H}_2\text{O}$; if the latter be boiled with water 24 hrs., (iii), or allowed to stand under water 6 mons., (iv), and then dried in air, the composition is $\text{Al}_2\text{O}_3 \cdot 4.4\text{H}_2\text{O}$. In spite of the similarity in composition, the four substances behave differently when allowed to stand in air sat. with water vapour, or when dried at 100°, or over conc. sulphuric acid. The water lost at 140° and 300° is different; but in all cases, when dried between 250° and 300°, the composition approximates $\text{Al}_2\text{O}_3 \cdot \text{H}_2\text{O}$. When (iii) has been heated to 100°, its composition corresponds with $\text{Al}_2\text{O}_3 \cdot 3\text{H}_2\text{O}$; but (ii) has 1.85 mols of water after standing at 100° for one hour, and 1.4 mols of water after standing at 100° for six hours or more, while if it has stood an hour over conc. sulphuric acid, it contains 1.99 mols of water, and after 9 days, 1.6 mols of water. In general, the more water the colloid has lost by heat, or the longer it has stood under water, the more difficultly soluble it is in nitric or hydrochloric acid. The power of reabsorbing water also decreases as the period of drying is extended. For instance, (i) and (ii) when dried at 100° until they have respectively the compositions $\text{Al}_2\text{O}_3 \cdot 2.3\text{H}_2\text{O}$ and $\text{Al}_2\text{O}_3 \cdot 1.8\text{H}_2\text{O}$, can absorb the original quantity of water from a moist atm.; but if dried over sulphuric acid, the former can take up 1.4 mols of water and the latter 1.8 mols. If (i) is heated to 300° until its composition is $\text{Al}_2\text{O}_3 \cdot 0.9\text{H}_2\text{O}$, it forms $\text{Al}_2\text{O}_3 \cdot 3.3\text{H}_2\text{O}$ in a moist atm.

According to J. M. van Bemmelen, alumina hydrogels, whether freshly precipitated or dried, adsorb acids, bases, and salts from soln. W. Pauli considers that complexes $\text{Al}(\text{OH})_3 \cdot \text{Al}(\text{OH})_2\text{Cl}$, etc., are formed. H. von Zehmen studied the reversible hydration and dehydration of the colloidal alumina prepared by H. Wislicenus. On heating, the loss of water takes place stepwise between 100° and 200°, inasmuch as a definite percentage of water is lost at any given temp.; 6.5 per cent. is lost at 100°, a further 3 per cent. at 150°, and 2–3 per cent. at 200°;

and above 200°, there is no further loss. On keeping in an open dish, practically the whole of the water is reabsorbed in one day, and the small residue in four to five days. The maximum absorption of water is 60 per cent., and this amount is taken up in a few weeks by keeping the fibrous material in an atm. sat. with water vapour. In taking up water, swelling occurs; thus 1.97 grms. of material dried at 200°, had a volume of 5.60 c.c., and on keeping for three days in an atm. sat. with water vapour, it increased in weight to 3.12 grms. and in volume to 6.30 c.c. According to A. Tian, the hydrosols of the metal hydroxides are usually not very stable; it is exceptional for the hydrosol produced by the hydrolysis of the metal salt to flocculate. This is because the tendency of the particles of the hydrosol to unite to form particles of greater size is reversible owing to the chemical forces tending to peptization, and an equilibrium is established. The adsorption of salts, etc., by alumina hydrogel was studied by R. Warington, D. Strömholm, H. Rheinboldt and E. Wedekind, H. von Euler and R. Nilsson, H. B. Weiser and E. B. Middleton, S. Wosnessensky, etc. It is impossible to precipitate hydrated alumina from soln. containing other salts, without adsorption phenomena. This explains the trouble the early chemists had in precipitating alumina from alum soln. The product always contained adsorbed sulphates, and this is the origin of the statement that the precipitate is contaminated by a basic sulphate. N. R. Dhar and K. C. Sen found that when aluminium hydroxide gel is peptized by alkali hydroxides, it is negatively charged owing to the adsorption of hydroxyl ions. The adsorptive power of alumina for sucrose, leucine, phosphates, and nucleic acids has been studied by H. von Euler and E. Erikson. A. Charriou showed that if precipitated aluminium hydroxide containing adsorbed chromic acid be washed with a 5 per cent. soln. of a salt of a monobasic acid (chloride, bromide, iodide, nitrate, or acetate), no chromic acid is removed and no further substance adsorbed. With soln. of salts of a polybasic acid (carbonate, sulphate, sulphide, oxalate, tartrate, citrate, phosphate, or arsenate), interchange occurs between adsorbed chromic acid and polybasic acid. Sulphuric acid adsorbed by aluminium hydroxide is not displaced by monobasic acids, but completely so by polybasic acids. Phosphoric acid adsorbed by aluminium hydroxide is not displaced by carbonate or chromate soln. Carbonic and chromic acids are mutually displaceable from adsorption in aluminium hydroxide, that acid being displaced which is present in smaller concentration. When arsenious sulphide is precipitated by means of hydrogen sulphide in presence of a barium salt, the precipitate contains adsorbed barium. When the precipitate is washed with a soln. of sodium or potassium chloride, no displacement of barium occurs, whilst with soln. of aluminium, ferric and chromic chlorides, an interchange of barium and the trivalent metal takes place. A. Ivanitzkaja and L. Orlova studied the coagulation of alumina sols by electrolytes. M. A. Rakuzin found aluminium hydroxide adsorbs gum arabic from its aq. soln. irreversibly; while potassium metasilicate and sodium fluosilicate are adsorbed reversibly. H. von Euler and E. Erikson showed that sucrose and leucine are not adsorbed, while nucleic acid is adsorbed. They also studied the adsorption of phosphoric acid. According to H. Heidenhain, aluminium hydroxide, in the presence of a large excess of alkali tartrate, is neutral in the cold towards phenolphthalein, and, consequently, under these conditions acids can be titrated in the presence of acids. F. Mylius and F. Förster state that alumina hydrogel reacts like an acid towards iodeosin. W. H. van de Sande Bakhuyzen found that the solubility of the amphoteric oxide passes through a minimum when increasing quantities of acid and base are added. V. Kohlschütter and co-workers found that sol formation precedes the dissolution of aluminium hydroxide in conc. hydrochloric acid, but not in soda-lye; with aluminium oxide, sol formation precedes dissolution in both acids and bases. A. Massink has studied this subject. R. Schwarz and H. Stock found aluminium hydroxide acts as a negative catalyst on the photochemical decomposition of silver bromide emulsions.

R. Phillips noted that alumina hydrogel, freshly precipitated and washed in the cold, is readily soluble in acids, but if kept under water for some days, it becomes

sparingly soluble; and L. Péan de St. Gilles, D. Tommasi, J. M. van Bemmelen, and many others have noted this ageing of alumina hydrogel by keeping under water, or by boiling with water, whereby the product becomes sparingly soluble in acids or alkali-lye. By means of X-radiograms, J. Böhm and H. Niclassen noted the passage from the amorphous to the crystalline state during the ageing of the gel. Like aluminium oxide, the hydroxide is converted into a product soluble in water, by fusion with the hydroxides of the alkalis or alkaline earths; with alkali hydrosulphate or pyrosulphate; or, according to H. C. McNeil, in fused barium chloride. P. N. Raikow said that alumina is not affected by carbon dioxide, and F. Sestini found that 100 c.c. of water, sat. with this gas at ordinary press., dissolve 0.001 grm. of alumina. T. Curtius and J. Rissom noted that hydrated alumina is not soluble in aq. hydrazoic acid. According to a patent of Hermania, the hydrolysis of soln. of basic aluminium salts is retarded if 0.1 per cent. of phosphoric acid or soluble phosphate be present.

C. Renz prepared a form of hydrated alumina soluble in ammonia—*vide supra*. The reports as to the solubility of precipitated alumina in ammonia are conflicting. C. Renz, and F. J. Malaguti and J. Durocher discussed the solubility of alumina in aq. ammonia. Alumina hydrogel is flocculated by salt soln., and deflocculated or peptized when these salts are removed by washing. H. B. Weiser and E. B. Middleton studied the conc. of different salts required to precipitate colloidal alumina—the order, beginning with the lowest, is ferrocyanide, thiosulphate, ferricyanide, citrate, sulphate, oxalate, phosphate, chromate, dithionate, dichromate, chloride, nitrate, bromide, and iodide. The adsorption of the salts by the precipitated colloid was also measured. N. Schilow studied the adsorption of soln. of electrolytes by alumina. Peptized alumina hydrogel will pass through filter-paper, and in some respects behave as if it were in soln. Hence, no doubt, some mal-inferences have been made as to the solubility of alumina. P. Klein found colloidal alumina is not precipitated by a number of non-conducting organic liquids. If ammonium salts are present, as is usually the case in analytical work, boiling the precipitate with the ammoniacal mother liquid may decompose the ammonium salts, resulting in the escape of ammonia and the production of free acid which dissolves the alumina. If fluorides be present, F. P. Veitch, W. R. Bloor, L. J. Curtman, and F. W. Hinrichsen showed that some alumina may escape precipitation; and J. W. Mellor showed that this is also the case if sulphates be present. The solubility of aluminium hydroxide in soln. of aluminium sulphate has been measured by R. Kremann and K. Hüttinger.

E. H. Archibald and Y. Habasian found that at 20°, the ammonia solubility of aluminium hydroxide, expressed in grams of aluminium hydroxide, $\text{Al}(\text{OH})_3$, per 100 c.c., increases as the conc. of the ammonium hydroxide increases, until a conc. of about 0.5*N*- NH_4OH is attained when the solubility decreases as the conc. of the ammonia increases; thus,

<i>N</i> - NH_4OH	0.050	0.100	0.125	0.200	0.500	1.000
Solubility $\text{Al}(\text{OH})_3$	0.007	0.008	0.025	0.038	0.045	0.024

In the presence of ammonium nitrate, the solubility decreases, and in the presence of potassium nitrate the solubility increases. Thus, with *N*-soln. of ammonia at 20° containing the salts just indicated in amounts represented as per cent. by weight:

Salt	NH_4NO_3				KNO_3	
	5	10	20	30	5	10
Solubility $\text{Al}(\text{HO})_3$	0.0187	0.0082	0.0045	0.0035	0.0760	0.1310

L. de Boisbaudran found that if ammonium salts be present hydrated alumina is dissolved by aq. ammonia; J. Hanamann found a litre of 4 per cent. aq. ammonia dissolves 0.053 grm. of Al_2O_3 , and the solubility is raised if ammonium chloride be present. In view of the observations of E. H. Archibald and Y. Habasian, these statements are open for revision. A boiling soln. of ammonium carbonate does not dissolve hydrated alumina, but, according to J. Weeren, if beryllium

hydroxide be present, some alumina is dissolved. H. W. Fischer showed that alumina is soluble in an aq. soln. of aluminium chloride. A. Müller-Jacobs said that hydrated alumina is soluble in the alkylamines, and C. Renz said that methylamine, ethylamine, dimethylamine, and diethylamine readily dissolve hydrated alumina, and that the alumina is not precipitated from its soln. in methylamine by ammonia, ammonium chloride, or by acids.

In addition to the previously described mono-, di-, and tri-hydrated aluminas respectively represented by diaspore, idealized bauxite, and gibbsite or hydrargillite, E. J. Maumené said that alumina forms hexahydrates, and A. Villiers claimed to have made hexahydrated alumina, $\text{Al}_2\text{O}_3 \cdot 6\text{H}_2\text{O}$, *i.e.* *sesquihydrated aluminium hydroxide*, $2\text{Al}(\text{OH})_3 \cdot 3\text{H}_2\text{O}$, by keeping alumina hydrogel suspended in well-cooled water. V. Zunino said that pentahydrated alumina, $\text{Al}_2\text{O}_3 \cdot 5\text{H}_2\text{O}$, *i.e.* *monohydrated aluminium hydroxide*, $\text{Al}(\text{OH})_3 \cdot \text{H}_2\text{O}$, is formed by the action of moist air on aluminium amalgam. A. Mitscherlich claimed to have made hemihydrated alumina, $2\text{Al}_2\text{O}_3 \cdot \text{H}_2\text{O}$, *i.e.* *aluminium dioxyhydroxide*, $\text{Al}_2\text{O}_3(\text{OH})$. There are also E. Schlumberger's products, $3\text{Al}_2\text{O}_3 \cdot 5\text{H}_2\text{O}$, and $5\text{Al}_2\text{O}_3 \cdot 7\text{H}_2\text{O}$, indicated above. The individuality of none of these hydrates has been established.

Ordinary alumina hydrogel is considered by W. B. Hardy ⁷ to be an irreversible colloid; but R. P. Rose prepared a reversible gel by adding hydrochloric acid to a soln. of aluminium hydroxide in dil. acetic acid. Dil. soln. in propionic, butyric, hydrobromic, hydriodic, or nitric acid also gave an alumina hydrosol, which is reversibly coagulated by adding aluminium salts, or hydrochloric and other acids; but irreversible coagulation occurs when potassium or sodium sulphate is added. A. Müller also prepared the reversible colloid.

A. Tian inferred that when a hydrolytic equilibrium is established slowly, one of the products tends to assume the colloidal state. The hydrolysis will be retarded by two reactions, (i) the ionic reverse of the hydrolysis taking place in the aq. phase; and (ii) the reaction between the soluble product of the hydrolysis and the gel. The second reaction will be slower as the colloidal particles grow larger because less surface per unit mass is available. The total rate of hydrolysis will thus depend on the rate of growth of the colloidal particles. A. Massink has discussed the solubility of aluminium hydroxide.

J. L. Gay Lussac, in 1810, showed that an aq. soln. of aluminium acetate undergoes reversible hydrolysis when the temp. is raised. He said:

The precipitation of alumina on boiling and the redissolving at a lower temp. are facts which are of interest to the general theory of chemistry and which are rather exceptional. If the precipitation were due to volatilization of the acetic acid, the alumina would not redissolve when the temp. is lowered. As a matter of fact, similar changes can be observed in a strongly acid soln. or in hermetically sealed flasks. Since the precipitation does not depend on the volatilization of the acid, it is evident that it is due to the heat which wrenches apart the mols. of acid and alumina, carrying each out of the sphere of action of the other, and causing their separation. With less heat, the same mols. come within each other's sphere of activity and combine.

In 1853, W. Crum worked with a more dilute and more basic soln. than J. L. Gay Lussac, and found that a white crystalline precipitate of a basic aluminium acetate, $(\text{CH}_3\text{COO})_2\text{Al} \cdot \text{OH}$, is obtained by boiling a conc. soln. of aluminium acetate, $(\text{CH}_3\text{COO})_3\text{Al}$; and a more protracted boiling completes the hydrolysis. W. Crum said:

By the continued action of heat on a weak soln. of binacetate of alumina, $\text{Al}_2\text{O}_3 \cdot (\text{CH}_3\text{COO})_4(\text{OH})_2$, a permanent separation of the constituents of the salt takes place, although no acid escapes and no alumina is precipitated. The properties of the alumina are, at the same time, materially changed. A soln. of binacetate of alumina, diluted so as to contain not more than one part of alumina in two hundred of water, was placed in a closed vessel which was immersed to the neck in boiling water, and kept in that state day and night for ten days. It had then nearly lost the astringent taste of alum, and acquired the taste of acetic acid. Being afterwards boiled in an open capsule, acetic acid was freely given off, and when the boiling had continued about five hours (the loss of water being continually restored), the liquid was found to have retained not more than one-eleventh of its original quantity of acetic acid, or about one eq. to five and a half of alumina.

The colourless, tasteless, and neutral sol—alumina hydrosol—of aluminium

hydroxide so obtained was called *meta-alumina*. A colloidal soln., it will be remembered, is one containing a finely divided phase which is prevented from flocculating, so that there is no particular need for the term *meta-alumina*. According to W. D. Bancroft, water will hydrolyze any salt until the product of the concentrations of the hydrogen and hydroxyl ions reaches a value of about 10^{-14} . If either base or acid is very sparingly soluble, the hydrolysis will run farther than if both are strong electrolytes. Equilibrium will be reached much more rapidly if the soln. is heated. Whether the insoluble base precipitates or remains in colloidal soln. will depend on the conditions of the experiment. That hydrolysis has taken place can be shown in a number of different ways. J. L. Gay Lussac deduced it from seeing the precipitated alumina; and W. Crum, from the change in the taste of the soln. J. Splichal showed that if a trace of sulphuric acid is present as impurity, the hydrosol will be quickly coagulated. S. Murachi and T. Okazaki made the hydrosol by diluting a sat. soln. of aluminium acetate in dil. acetic acid, adding hydrogen dioxide (sodium dioxide, or potassium persulphate) and dialyzing the liquid for about 10 hrs. at 50° - 80° .

W. B. Bentley and R. P. Rose consider the sol obtained by digesting freshly precipitated aluminium hydroxide in hot, 8 per cent. acetic acid, to be a sol of basic aluminium acetate. Crum's sol is opalescent, and it can be kept for years without change. The conc. sol is viscous. J. Splichal found that W. Crum's process does not give good results unless the acetate be free from sulphate. E. Schlumberger made colloidal soln. of alumina; and W. Biltz found that the colloidal particles are positively charged because, if, say, 100 volts be passed through the conc. sol contained in a U-tube, in half an hour the liquid near the negative electrode becomes turbid—anodic cataphoresis—and that near the positive electrode becomes clear. Similar remarks apply to colloidal aluminium hydroxide prepared by T. Graham's process, namely, by the dialysis of a soln. of aluminium hydroxide in one of aluminium chloride or acetate. T. Graham's sol acted as a mordant, whereas W. Crum's did not. W. Biltz and W. Geibel made an optical study of the colloidal soln.; and J. H. Hildebrand found that the sol produced by Graham's dialytic process shows submicrons very plainly in the ultramicroscope. S. Kawamura measured the viscosities of the hydrosol. J. H. Gladstone and W. Hibbert determined the f.p. of the sol, and obtained a result indicating a mol. wt. varying from 409.6 to 1073 on the assumption that the method employed for dil. soln. is valid for colloidal soln. The conc. soln. of colloidal alumina is not coagulated by acetic, formic, boric, arsenious, or cyanuric acid, but it is coagulated by hydrochloric, nitric, sulphuric, citric, chromic, or molybdic acid, and by many organic acids. Alkalies have a strong coagulating power; nitrates and chlorides are not very active; while sodium, magnesium, or calcium sulphate coagulates the colloid very quickly. It is therefore probable, added T. Graham, that the extraordinary coagulating action of salts upon hydrated alumina must prevent the latter substance from ever appearing in a soluble state when liberated from combination by means of a base. S. Wosnessensky found colloidal alumina is not coagulated by single electrolytes excepting lime-water or baryta-water; but marked coagulation occurred with bi- or ter-valent metal salts and alkali hydroxides. S. Utzino found that the maximum stability of colloidal soln. of aluminium hydroxide in the presence of glucose does not occur with the finest state of subdivision.

J. B. Cammerer⁸ found that aluminium hydroxide is soluble in a 2 per cent. soln. of hydrogen dioxide. When the product is conc. by evaporation, it furnishes a syrupy liquid which yields a crystalline mass, sparingly soluble in cold water. The soln. had an acid reaction, but it is not clear whether the original soln. of hydrogen peroxide was free from acid. P. R. Jourdain showed that hydrogen dioxide is contained in the product obtained by the oxidation of aluminium amalgam in air. A. Terni found that when an excess of 30 per cent. hydrogen dioxide is added to a soln. of aluminium hydroxide in 50 per cent. potassium hydroxide, there is obtained an amorphous white precipitate having the composition $\text{Al}_2\text{O}_3 \cdot \text{Al}_2\text{O}_4 \cdot 10\text{H}_2\text{O}$, which

reacts as if it were a true **aluminium peroxide**. It is assumed that Al_2O_4 is the initial product of the oxidation of aluminium hydroxide by hydrogen dioxide, and that this product is gradually hydrolyzed to furnish the oxide $\text{Al}_2\text{O}_3 \cdot \text{Al}_2\text{O}_4 \cdot 10\text{H}_2\text{O}$. J. A. Wilkinson prepared aluminium peroxide by adding sodium dioxide to a soln. of an aluminium salt until the precipitate first formed just dissolved, and then adding hydrogen peroxide. The precipitated aluminium peroxide, dried at 110° , gave no signs of phosphorescence when exposed to the cathode rays.

REFERENCES.

- ¹ F. Cornu and K. A. Redlich, *Zeit. Koll.*, **4**, 90, 1908; J. D. Dana, *A System of Mineralogy*, New York, 1911; H. Lienau, *Chem. Ztg.*, **27**, 422, 1903; B. Wohlin, *Sprech.*, **46**, 719, 1913.
- ² R. J. Haüy, *Traité de minéralogie*, Paris, **4**, 358, 1801; L. N. Vauquelin, *Ann. Chim. Phys.*, (1), **42**, 113, 1802; J. G. Children, *Ann. Phil.*, (2), **3**, 17, 1822; G. Rose, *Reise nach dem Ural, dem Altai, und dem Kaspischen Meere*, Berlin, **1**, 150, 1837; C. T. Jackson, *Amer. Journ. Science*, (2), **42**, 108, 1866; C. Ü. Shepard, *ib.*, (2), **12**, 215, 1851; J. L. Smith, *ib.*, (2), **11**, 55, 1851; S. B. Sharples, *ib.*, (2), **47**, 319, 1869; A. Damour, *Compt. Rend.*, **21**, 322, 1845; *L'Institut.*, **78**, 1853; *Ann. Chim. Phys.*, (3), **16**, 324, 1846; C. H. Hess, *Pogg. Ann.*, **18**, 255, 1830; A. Löwe, *ib.*, **61**, 307, 1844; A. E. Nordenskjöld, *Zeit. Kryst.*, **15**, 98, 1889; A. Dufrenoy, *Ann. Mines*, (3), **10**, 577, 1836; R. Hermann, *Journ. prakt. Chem.*, (1), **106**, 70, 1869; E. Hussak, *Tschermak's Mitt.*, (2), **18**, 351, 1899; M. Waterkamp, *Centr. Min.*, **522**, 1916; Y. Chitani, *Journ. Geol. Soc. Tokyo*, **22**, 384, 1915.
- ³ N. von Kokscharoff, *Materialien zur Mineralogie Russlands*, St. Petersburg, **3**, 169, 1858; W. Haidinger, *Pogg. Ann.*, **61**, 309, 1844; A. Mitscherlich, *Journ. prakt. Chem.*, (1), **83**, 469, 1861; A. Kennigott, *Neues Jahrb. Min.*, **438**, 1867; A. Damour, *Ann. Chim. Phys.*, (3), **16**, 324, 1846; A. des Cloizeaux, *Nouvelles recherches sur les propriétés optiques des cristaux*, Paris, **565**, 1867; G. Spezia, *Zeit. Kryst.*, **14**, 503, 1888; E. Weinschenk, *ib.*, **17**, 503, 1890; A. Michel-Lévy and A. Lacroix, *Les minéraux des roches*, Paris, **178**, 1888; *Compt. Rend.*, **106**, 777, 1888; H. de Sénarmont, *ib.*, **32**, 763, 1851; A. C. Becquerel, *ib.*, **67**, 1081, 1868; G. Friedel, *Bull. Soc. Min.*, (2), **14**, 7, 1891; F. Beijerinck, *Neues Jahrb. Min. B.B.*, **11**, 455, 1897; K. Walther, *Zeit. deut. geol. Ges.*, **73**, 272, 1921.
- ⁴ H. Davy, *Phil. Trans.*, **95**, 155, 1621, 1805; *Nicholson's Journ.*, (2), **14**, 267, 1806; J. N. von Fuchs, *Schweigger's Journ.*, **18**, 288, 1816; **24**, 121, 1818; J. J. Berzelius, *Ann. Chim. Phys.*, (2), **12**, 19, 1819; C. Dewey, *Amer. Journ. Science*, (1), **2**, 249, 1820; B. Silliman, *ib.*, (2), **7**, 441, 1849; (2), **9**, 408, 1850; (2), **11**, 121, 1851; J. L. Smith and G. J. Brush, *ib.*, (2), **16**, 51, 1853; G. J. Brush, *ib.*, (2), **31**, 361, 1861; J. Torrey, *New York Med. Phys. Journ.*, **1**, 68, 1822; *Edin. Phil. Journ.*, **7**, 388, 1822; G. Rose, *Pogg. Ann.*, **48**, 564, 1839; R. Hermann, *Journ. prakt. Chem.*, (1), **40**, 11, 1847; A. Mitscherlich, *ib.*, (1), **83**, 468, 1861; F. von Kobell, *ib.*, (1), **41**, 152, 1847; (1), **50**, 491, 1850; K. von Hauer, *Jahrb. Geol. Reichsanst. Wien*, **4**, 397, 1853; G. A. Kennigott, *Uebersichte der Resultate mineralogischer Forschungen*, **64**, 1854; **43**, 1860; **53**, 1865; T. Thomson, *Outlines of Mineralogy, Geology, and Mineral Analysis*, London, 1836; J. H. Gladstone, *Phil. Mag.*, (4), **23**, 461, 1862; A. von Liebrich, *Zeit. Kryst.*, **23**, 296, 1894; F. Kovar, *ib.*, **34**, 705, 1901; A. E. Nordenskjöld, *ib.*, **15**, 98, 1889; L. L. Fermor, *ib.*, **45**, 308, 1908; H. Warth, *Min. Mag.*, **13**, 172, 1902; H. Gorceix, *Bull. Soc. Min.*, **6**, 29, 1883; J. da Costa Sena, *ib.*, **7**, 221, 1884; E. Jannettaz, *ib.*, **1**, 70, 1878; A. de Schulten, *ib.*, **19**, 159, 1896; W. C. Eustis, *Chem. News*, **48**, 98, 1883.
- ⁵ J. M. van Bemmelen, *Rec. Trav. Chim. Pays-Bas*, **7**, 75, 1888; F. Wöhler, *Liebig's Ann.*, **113**, 249, 1859; C. Weltzien, *ib.*, **138**, 120, 1866; M. Dullo, *Bull. Soc. Chim.*, (2), **5**, 78, 1866; A. Cossa, *Nuovo Cimento*, (2), **3**, 228, 1870; P. A. von Bonsdorff, *Pogg. Ann.*, **27**, 275, 1833; A. C. Becquerel, *Compt. Rend.*, **67**, 1081, 1868; **79**, 82, 1874; A. de Schulten, *ib.*, **122**, 1427, 1896; *Bull. Soc. Min.*, **19**, 157, 1897; W. Ramsay, *Journ. Chem. Soc.*, **32**, 395, 1877; T. Carnelley and J. Walker, *ib.*, **53**, 59, 1888; C. J. Bayer, *Brit. Pat. No.* 10093, 1887; 5296, 1892; L. le Chatelier, *ib.*, **413**, 1888, 1858; E. Martin, *Monit. Scient.*, (5), **5**, 225, 1915; T. Schlösing in L. Grandeau, *Traité d'analyse*, Paris, **105**, 1877; W. C. Brögger, *Zeit. Kryst.*, **16**, 18, 1890; A. des Cloizeaux, *Nouvelles recherches sur les propriétés optiques des cristaux*, Paris, **648**, **715**, 1867; A. Michel-Lévy and A. Lacroix, *Les minéraux des roches*, Paris, **226**, 1888; *Compt. Rend.*, **106**, 777, 1888; W. Haidinger, *Sitzber. Akad. Wien*, **13**, 6, 1853; F. Beijerinck, *Neues Jahrb. Min. B.B.*, **11**, 455, 1897; N. von Kokscharoff, *Materialien zur Mineralogie Russlands*, St. Petersburg, **4**, 90, 1862; *Bull. Acad. St. Petersburg*, **5**, 372, 1862; F. Slavik, *Rozpravy Ceske Akad.*, **26**, 60, 1917; *Bull. Akad. Bohême*, **22**, 32, 1918; W. W. Coblenz, *Investigations of Infra-red Spectra*, Washington, **3**, 41, 1906; T. Hagiwara, *Koll. Zeit.*, **32**, 154, 1923; P. Groth, *Tabellarische Uebersicht der Mineralien*, Braunschweig, **25**, 85, 1874; O. Mügge, *Neues Jahrb. Min.*, **i**, 56, 1884; A. Mitscherlich, *Journ. prakt. Chem.*, (1), **83**, 468, 1861; J. Thomsen, *ib.*, (2), **11**, 233, 402, 1875; (2), **12**, 85, 271, 1875; H. Rose, *Pogg. Ann.*, **74**, 429, 1848; C. F. Cross, *Journ. Chem. Soc.*, **35**, 796, 1879; V. Zunino, *Gazz. Chim. Ital.*, **30**, **i**, 194, 1900; L. H. Milligan, *Journ. Phys. Chem.*, **26**, 247, 1922; M. Buchner, *German Pat.*, *D.R.P.* 299763, 301612, 1914; T. A. Nicolaewsky, *Bull. Acad. St. Petersburg*, (6), **6**, 715, 1912; F. Cornu, *Koll. Zeit.*, **4**, 15, 1908; F. Tucan,

Centr. Min., 56, 387, 495, 768, 1913; C. Doelter and E. Dittler, *ib.*, 193, 1913; M. Kispatic, *Neues Jahrb. Min. B.B.*, 34, 513, 1913; O. Pauls, *Zeit. prakt. Geol.*, 21, 545, 1913.

* C. Renz, *Ber.*, 36, 2751, 1903; G. Lösekann, *ib.*, 12, 56, 1879; D. Tommasi, *Rev. Chim. Pure App.*, (7), 8, 246, 1905; E. J. Mills and R. L. Barr, *Journ. Chem. Soc.*, 41, 341, 1882; T. Carnelley and T. Walker, *ib.*, 53, 59, 1888; R. Warrington, *ib.*, 21, 1, 1868; W. Ramsay, *ib.*, 32, 395, 1877; J. M. van Bemmelen, *Rec. Trav. Chim. Pays-Bas*, 7, 75, 1888; *Zeit. anorg. Chem.*, 18, 98, 1898; *Journ. prakt. Chem.*, (2), 26, 227, 1882; A. Mitscherlich, *ib.*, (1), 83, 455, 1861; T. Curtius and J. Rissom, *ib.*, (2), 58, 297, 1898; E. Schlumberger, *Bull. Soc. Chim.*, (3), 13, 60, 1895; L. de Boisbaudran, *ib.*, (2), 26, 436, 1876; J. J. Berzelius, *Lehrbuch der Chemie*, Dresden, 1, i, 825, 1825; J. Löwe, *Zeit. Chem.*, (1), 3, 247, 1860; W. Müller-Erzbach, *Wied. Ann.*, 25, 357, 1885; L. Péan de St. Gilles, *Ann. Chim. Phys.*, (3), 46, 57, 1855; D. Tommasi, *Compt. Rend.*, 91, 231, 1880; A. Tian, *ib.*, 172, 1402, 1921; E. T. Allen, *Chem. News*, 82, 75, 1900; Compagnie des produits chimiques d'alais et camargue, *German Pat.*, D.R.P. 165612, 1905; D. Strömholm, *Arkiv. Kem. Min. Geol.*, 2, 9, 1906; H. Heidenhain, *Pharm. Rund.*, 8, 189, 1890; F. Mylius and F. Förster, *Ber.*, 24, 1482, 1891; R. Phillips, *B.A. Rep.*, 58, 1848; *Phil. Mag.*, (3), 33, 357, 1848; *Chem. Gaz.*, 6, 349, 1848; H. Wislicenus, *Zeit. angew. Chem.*, 23, 204, 1920; H. von Zehmen, *Koll. Zeit.*, 27, 233, 1920; H. C. McNeil, *Journ. Amer. Chem. Soc.*, 28, 590, 1906; F. P. Veitch, *ib.*, 22, 246, 1900; W. R. Bloor, *ib.*, 29, 1603, 1907; L. J. Curtman and H. Dubin, *ib.*, 34, 1485, 1912; P. N. Raikow, *Chem. Ztg.*, 31, 55, 1907; A. Ivanitzkaja and L. Orlova, *Koll. Beihefte*, 18, 1, 1923; S. Wosnessensky, *Koll. Zeit.*, 31, 333, 1922; A. Charriou, *Compt. Rend.*, 176, 1890, 1923; H. B. Weiser and E. B. Middleton, *Journ. Phys. Chem.*, 24, 630, 1920; V. Kohlschütter, *Zeit. anorg. Chem.*, 105, 1, 1919; V. Kohlschütter and N. Neunschwander, *Zeit. Elektrochem.*, 29, 246, 1923; R. Willstätter and H. Kraut, *Ber.*, 56, B; 149, 1117, 1923; F. Haber, *ib.*, 55, B, 1717, 1922; R. Schwarz and H. Stock, *Zeit. wiss. Photochem.*, 22, 26, 1922; F. J. Malaguti and J. Durocher, *Ann. Chim. Phys.*, (3), 17, 421, 1846; N. R. Dhar and K. C. Sen, *Journ. Phys. Chem.*, 27, 376, 1923; H. von Euler and E. Erikson, *Zeit. physiol. Chem.*, 128, 1, 9, 1923; H. Rheinboldt and E. Wedekind, *Koll. Beihefte*, 17, 115, 1923; S. Hakomori, *Journ. Chem. Soc. Japan*, 43, 629, 1922; F. Sestini, *Gazz. Chim. Ital.*, 20, 313, 1890; V. Zunino, *ib.*, 30, i, 194, 1900; J. Hanamann, *Pharm. Viertelj.*, 12, 527, 1863; J. Weeren, *Pogg. Ann.*, 92, 97, 1854; A. Müller-Jacobs, *Dingler's Journ.*, 252, 219, 1884; H. B. Weiser and E. B. Middleton, *Journ. Phys. Chem.*, 24, 630, 1920; F. W. Hinrichsen, *Ber.*, 40, 1497, 1907; *Zeit. anorg. Chem.*, 58, 83, 1908; W. Pauli, *Zeit. Koll.*, 28, 49, 1921; J. W. Mellor, *A Treatise on Quantitative Inorganic Analysis*, 180, 1913; R. Kremann and K. Hüttinger, *Jahrb. Geol. Reichsanst. Wien*, 58, 637, 1908; E. H. Archibald and Y. Habasian, *Trans. Roy. Soc. Canada*, (3), 11, 1, 1917; E. J. Maumené, *Bull. Soc. Chim.*, (3), 13, 309, 1895; A. Villiers, *ib.*, (3), 13, 309, 1895; H. W. Fischer, *Zeit. anorg. Chem.*, 40, 39, 1904; P. Klein, *Koll. Zeit.*, 29, 247, 1921; A. Massink, *Chem. Weekb.*, 19, 66, 1922; W. H. van de Sande Bakhuyzen, *ib.*, 19, 41, 1922; N. Schilow, *Zeit. phys. Chem.*, 100, 425, 1922; Hermania, *German Pat.*, D.R.P. 372246, 1921; M. A. Rakuzin, *Journ. Russ. Phys. Chem. Soc.*, 53, 357, 1921; H. von Euler and R. Nilsson, *Zeit. physiol. Chem.*, 131, 107, 1923; W. Pauli, *Koll. Zeit.*, 28, 49, 1921; *Trans. Faraday Soc.*, 16, 15 (App.), 1921; E. Wendehorst, *Beiträge zur quantitativen Bestimmung und Trennung der Aluminiums*, Göttingen, 1921; G. Jander and B. Weber, *Zeit. anorg. Chem.*, 131, 266, 1923; L. Blum, *Zeit. angew. Chem.*, 35, 244, 1922; *Zeit. annal. Chem.*, 27, 19, 1888; R. Fittig, *ib.*, 2, 349, 1863; F. Tucan, *Neues Jahrb. Min. B.B.*, 34, 401, 1912; P. P. von Weimarn, *Zeit. Koll.*, 4, 38, 1909; H. von Euler and E. Erikson, *Zeit. physiol. Chem.*, 128, 1, 1923. J. Böhm and H. Nicllassen, *Zeit. anorg. Chem.*, 132, 1, 1923.

[†] J. L. Gay Lussac, *Ann. Chim. Phys.*, (1) 74, 193, 1810; W. Crum, *Journ. Chem. Soc.*, 6, 216, 1854; *Proc. Phil. Soc. Glasgow*, 3, 298, 1853; T. Graham, *Phil. Journ.*, 151, 183, 1861; J. H. Hildebrand, *Journ. Amer. Chem. Soc.*, 35, 847, 1913; W. B. Bentley and R. P. Rose, *ib.*, 35, 1490, 1913; R. P. Rose, *Koll. Beihefte*, 6, 1, 1914; W. Biltz and W. Geibel, *Nachr. Gött.*, 141, 1906; A. Müller, *ib.*, 43, 320, 1905; 57, 312, 1908; 37, 1095, 1904; E. A. Schneider, *ib.*, 23, 1353, 1890; *Liebig's Ann.*, 257, 359, 1890; J. H. Gladstone and W. Hibbert, *Phil. Mag.*, (5), 28, 38, 1889; E. Schlumberger, *Bull. Soc. Chim.*, (3), 13, 62, 1895; S. Kawamura, *Journ. Coll. Science Tokyo*, 25, 8, 1908; W. B. Hardy, *Zeit. phys. Chem.*, 33, 385, 1900; *Proc. Roy. Soc.*, 66, 95, 1900; S. Splichal, *Chem. Listy*, 15, 53, 88, 110, 140, 164, 1921; W. D. Bancroft, *Journ. Phys. Chem.*, 26, 501, 1922; A. Massink, *Chem. Weekbl.*, 19, 66, 1922; A. Tian, *Compt. Rend.*, 172, 1179, 1921; M. A. Rakuzin, *Journ. Russ. Phys. Chem. Soc.*, 53, 357, 1921; S. Wosnessensky, *Koll. Zeit.*, 33, 32, 1923; S. Utzino, *ib.*, 32, 149, 1923; J. Splichal, *Chem. Listy*, 15, 53, 88, 110, 140, 164, 1921; S. Murachi and T. Okazaki, *Japan Pat. No.* 41726, 1922.

[‡] A. Terni, *Atti Accad. Lincei*, (5), 21, ii, 104, 1912; J. B. Cammerer, *Chem. Ztg.*, 15, 957, 1891; P. R. Jourdain, *Compt. Rend.*, 150, 1602, 1910; J. A. Wilkinson, *Journ. Phys. Chem.*, 13, 691, 1909.

§ 12. The Aluminates

The solubility of aluminium hydroxide in acids results in the formation of salts whose characters show that aluminium hydroxide is a weak base; on the other hand, the solubility of the hydroxide in a soln. of alkali hydroxide, and the formation

of the so-called alkali aluminate can be attributed to the feeble acidic properties of aluminium hydroxide. Otherwise stated, *aluminium hydroxide is amphoteric*; and, in aq. soln., it is assumed to be ionized in two ways, namely:

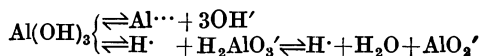

J. K. Wood¹ was unable to determine the basic constant because, although a soln. with 0.0375 mol of aluminium chloride is hydrolyzed to the extent of 4 per cent. at 25°, there is no means of establishing the assumed mode of hydrolysis, $\text{AlCl}_3 + \text{H}_2\text{O} = \text{HCl} + \text{Al(OH)Cl}_2$. He showed that a $\frac{1}{10}N$ -soln. of sodium metaaluminate is hydrolyzed to the extent of 35 per cent. at 25°; if so, the hydrolysis constant is 1.2×10^{-13} , and the acidic ionization constant is 6.3×10^{-13} . G. Carrara and G. B. Vespignani found aluminium hydroxide to be more energetic as a base than as an acid; they also measured the conductivity and speed of hydrolysis of methyl acetate by some metal hydroxides and found that the order of decreasing activity is Mg, Cu, Zn, Cd, Al, Fe, so that, contrary to E. A. Schneider, they believe that ferric hydroxide is not a more energetic base than aluminium hydroxide. Working with crystalline aluminium hydroxide, R. E. Slade also found that aluminic acid is stronger as a base than as an acid, and its ionization constant, K , is at least 10^{-10} , the same order as that of boric acid; and working with colloidal aluminium hydroxide, W. Blum obtained for the acid constant $K = 10^{-8.3}$. According to J. Heyrovsky, the process by which aluminium hydroxide dissolves in alkalis is not the same as if it could send into soln. one, two, or three of its hydrogen atoms as ions, and thus react like, say, phosphoric acid. It does not neutralize bases like an acid by means of hydrogen ions, but rather does it remove hydroxyl ions and form complex anions, $\text{Al(OH)}_3 + \text{OH}' = \text{Al(OH)}_4'$, like compounds do when redissolving in an excess of reagents, e.g. AgCy_2' , HgI_4'' , etc. It neutralizes not by its acidity but by its affinity for hydroxyl ions. The hydrolysis of aluminates is then not affected by the scarcity of hydrogen ions from aluminic acid, but by the incompleteness of the complex ion formation.

A. Hantzsch found that the mol. conductivity of sodium aluminate soln. continually increases with time, and this is taken to show that a fairly rapid hydrolysis occurs with time although no precipitation occurred in 96 hrs. The first product of the hydrolysis is alumina hydrosol, which then changes into the gel form, and then changes to crystalline aluminium hydroxide. G. Carrara and G. B. Vespignani said that the degree of hydrolysis of potassium aluminate is fourteen times that of aluminium sulphate in aq. soln.

A number of salts has been isolated from soln. of aluminium or aluminium hydroxide in alkali-lye, and some appear to be well-defined chemical individuals—salts of metaluminic acid, HAlO_2 . There has been some discussion as to whether the alleged alkali metaluminate in soln. is a myth. E. G. Mahin and co-workers, for example, hold that the colloidal properties of aluminium hydroxide play such an important part in conditioning its solubility in bases, that there is room for doubt as to whether the alleged aluminates, as definite salts, exist at all.

E. G. Mahin's arguments rest on (i) the fact that the reaction between ammonium nitrate and sodium aluminate precipitates a slightly greater quantity of aluminium hydroxide than is represented by the assumption that an aluminate, NaAlO_2 , is involved in the reaction: $\text{NaAlO}_2 + \text{NH}_4\text{NO}_3 = \text{NH}_4\text{AlO}_2 + \text{NaNO}_3$, followed by the instantaneous hydrolysis of the ammonium aluminate: $\text{NH}_4\text{AlO}_2 + 2\text{H}_2\text{O} = \text{NH}_4\text{OH} + \text{Al(OH)}_3$, where the ratio $[\text{NH}_4\text{NO}_3]/[\text{Al}_2\text{O}_3]$ is 2 : 1. It is therefore assumed that the precipitation is due to a coagulation of alumina hydrosol. As W. Blum showed, there are some disturbing factors involved—e.g. spontaneous decomposition—which invalidate the conclusion. (ii) In the electrolysis of aq. soln. of the alleged aluminate the ratio between the oxygen evolved and the aluminium hydroxide precipitated should be constantly 1 : 2. E. G. Mahin, in some cases, obtained rather more aluminium hydroxide than is required on the assumption that it is wholly a product of electrolysis but the disturbances due to re-soln. of some of the precipitate by the anode liquor, and the possible spontaneous decomposition of the aluminate soln. render the argument inconclusive.

A. B. Prescott, and A. Cavazzi maintained that since a mol of sodium hydroxide is needed for the dissolution of a mol of aluminium hydroxide, no matter whether the soln. be dil. or conc., the soln. must contain the metaluminate. W. Herz found that while freshly precipitated aluminium hydroxide behaves in this way, if the hydroxide be dried, an ortho-aluminate of the composition Na_2AlO_3 is formed, but R. E. Slade found that the ratio of Na : Al in the solubility determinations ranges from 2 : 1 to 10 : 1 according to the conditions of precipitation, and the mode and duration of the drying of the hydroxide. The solubility ratio, therefore, is not a good criterion for deducing a formula for the salt in soln., and there is no evidence for assuming that the soln. contains AlO_3''' -ions; colloidal alumina is always present as an unstable phase under these conditions. F. M. Lyte argued that in dil. soln. the aluminate is NaAlO_2 , because six mols react with a mol of aluminium sulphate precipitating 8 mols of aluminium hydroxide, $\text{Al}_2(\text{SO}_4)_3 + 6\text{NaAlO}_2 + 12\text{H}_2\text{O} = 3\text{Na}_2\text{SO}_4 + 8\text{Al}(\text{OH})_3$; in conc. soln., he said, it is probable that some other aluminate is present. J. K. Wood's solubility determinations of aluminium and of aluminium hydroxide in soln. of sodium hydroxide after allowing for a slight excess of alkali over the amount required to form aluminate owing to the partial hydrolysis of the salt, agree with the assumption that sodium metaluminate is formed, but not the ortho-salt. Observations on this subject were also made by H. St. C. Deville, A. Ditte, F. Russ, A. Glässner, etc. According to G. Carrara and G. B. Vespignani, the aq. soln. contains only the meta-aluminate, even if a large excess of potassium hydroxide is present. A. A. Noyes and W. R. Whitney determined the lowering of the f.p. by soln. of the sodium metaluminate, and assuming that both sodium hydroxide and sodium aluminate are completely ionized, the soln. of alumina in sodium hydroxide would give the same f.p. as sodium hydroxide alone if the aluminate be NaAlO_2 , but a different f.p. if it be $(\text{NaAlO}_2)_n$, because two ions would be produced by a mol. of either NaOH or NaAlO_2 ; three ions, by $\text{Na}_2\text{Al}_2\text{O}_4$; four ions, by $\text{Na}_3\text{Al}_3\text{O}_6$; etc. Observation showed that the f.p. of a 0.227*N*-soln. of potassium hydroxide was not altered by the dissolution of $\frac{1}{3}$, $\frac{2}{3}$, or one gram-atom of aluminium; a 0.465*N*-soln. was not changed by $\frac{1}{3}$, $\frac{1}{2}$, or $\frac{2}{3}$ gram-atom of aluminium; and 0.233*N*-soln. of sodium or potassium hydroxide was not changed by $\frac{1}{2}$ and $\frac{2}{3}$ mol of aluminium hydroxide or $\frac{1}{2}$ and $\frac{2}{3}$ gram-atom of aluminium. Assuming that the hydrolysis of the soln. is insignificant, the work of A. A. Noyes and W. R. Whitney shows that the formula of the alkali aluminate in soln. is MAIO_2 . If hydrolysis is appreciable, then, as E. G. Mahin and co-workers have shown, the conclusion is invalid because each mol. of NaAlO_2 would furnish three ions: $\text{NaAlO}_2 + \text{H}_2\text{O} \rightleftharpoons \text{Na}^+ + \text{OH}^- + \text{HALO}_2$, which would modify the f.p. accordingly. R. E. Slade's observations on the f.p. of the soln. also led him to conclude that the soln. of alkali aluminate contain mol. of NaAlO_2 . E. G. Mahin and co-workers inferred that because the heat of soln. of aluminium hydroxide in 1000 times its eq. of sodium hydroxide, is very small, being roughly only 0.864 Cal. per mol., the thermo-chemical datum lends no support to the assumption that a compound is formed during the process. But, as W. Blum pointed out, if the heat of soln. of aluminium hydroxide is negative, as is the case with boric acid, this argument is of no moment. R. E. Slade's observations were confirmed by J. Heyrovsky for sodium and ammonium hydroxides.

Conductivity determinations of soln. of alkali aluminate, by R. E. Slade and W. G. Polack, W. Blum, J. H. Hildebrand, A. Hantzsch, and G. Carrara and G. B. Vespignani, show that the salt of a monobasic acid is present undergoing hydrolysis; no change in conductivity occurs without the simultaneous deposition of aluminium hydroxide. J. H. Hildebrand, and W. Blum have measured the variation in the conc. of the H^- -ion as alkali-lye is progressively added to soln. of aluminium chloride while aluminium hydroxide is being precipitated, and then dissolved in the excess of alkali-lye. The results are indicated in Fig. 52. The neutralization curve with hydrochloric acid and sodium hydroxide is given for reference. Here, the point of inflexion represents the neutralization of the soln. With

aluminium chloride and potassium and sodium hydroxides, say the latter, *A* represents the commencement of the precipitation; *B*, the completion of the precipitation; and *C*, the completion of the soln. of the precipitate. From *A* to *B*, therefore, $\text{AlCl}_3 + 3\text{NaOH} = \text{Al}(\text{OH})_3 + 3\text{NaCl}$; and from *B* to *C*, $\text{Al}(\text{OH})_3 + \text{NaOH} = 2\text{H}_2\text{O} + \text{NaAlO}_2$. Consequently, since $bc = \frac{1}{3}ab$, the results are in agreement with the assumption that the metaluminates NaAlO_2 and KAlO_2 exist in aq. soln., and are in opposition to the hypothesis that any marked proportion of aluminium hydroxide is present. The curve also shows that the precipitation of aluminium hydroxide begins when the H^+ -ion conc. is about 10^{-3} , and ends when that conc. is 10^{-7} .

N. G. Chatterji and N. R. Dhar showed that the conductivity of a soln. of sodium hydroxide is not appreciably changed by the addition of aluminium hydroxide, and hence they conclude that such soln. are cases of true peptization, and not of chemical combination. J. H. Hildebrand failed to detect colloidal particles in aluminate soln. by means of the ultramicroscope, but if the soln. is hydrolyzed some colloidal alumina should be present. Hence, as R. E. Slade and W. G. Polack have said, the ultramicroscope affords no conclusive evidence either way.

E. T. Allen and H. F. Rogers prepared a microcrystalline powder of pentahydrated **lithium hydrometaluminate**, $\text{LiH}(\text{AlO}_2)_2 \cdot 5\text{H}_2\text{O}$, by dissolving aluminium in an aq. soln. of lithium hydroxide free from carbonate. The product was washed once in cold water, then with alcohol, with ether, and then dried over calcium chloride. It is more stable towards water than sodium or potassium aluminates, being decomposed only after continued boiling. It is sparingly soluble in cold water. No lithium aluminate other than this salt could be prepared in soln. When kept two weeks in vacuo over sulphuric acid at a summer's temp., the trihydrate, $\text{LiH}(\text{AlO}_2)_2 \cdot 3\text{H}_2\text{O}$, was formed. Z. Weyberg obtained birefringent (possibly rhombic), rounded granules of **lithium metaluminate**, LiAlO_2 , by fusing for several hours a mixture of silica, alumina, and lithium carbonate, in the proportions $2\text{SiO}_2 : \text{Al}_2\text{O}_3 : \text{Li}_2\text{O}$, with an excess of sodium sulphate. F. M. Jäger and A. Simek made the metaluminate by fusing a mixture of alumina and lithium carbonate at 900° , and then at 1200° . They did not succeed in melting the carbonate at temp. up to 1625° ; but R. Ballo and E. Dittler said that lithium metaluminate melts between 1900° and 2000° , and is homogeneous on cooling. The compound can retain about 12.5 molar per cent. of alumina in solid soln., but beyond that proportion corundum crystallizes out. F. M. Jäger and A. Simek found that it forms microscopic, hexagonal or octagonal, crystals with a pronounced double refraction; the indices of refraction are 1.604 and 1.615 for the *D*-line; and the sp. gr. is 2.554 at 25.1° .

J. J. Berzelius was unable to fuse a mixture of alumina and sodium carbonate on charcoal before the blowpipe flame, although he said that combination occurs. F. G. Schaffgotsch found that a mol of alumina fused with an excess, or, according to E. Mallard, with an eq. amount of sodium carbonate, rapidly expels rather more than a mol of carbon dioxide. R. C. Wallace showed that although the gas is driven off at 1100° to 1200° , melting does not occur under 1800° . The product on cooling is crystalline, and usually of a bright red colour owing to the presence of a trace of iron abstracted from the crucible. With increasing proportions of alumina, the m.p.

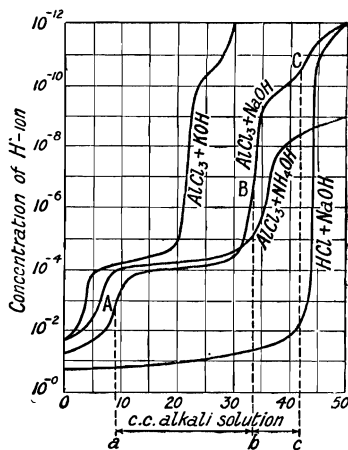

FIG. 52.—Variation in the Concentration of the H^+ -ion during the Precipitation of Aluminium Hydroxide, and the Dissolution of the Precipitate in Alkali-lye (25°).

is raised so that a mixture with 81.1 per cent. of alumina is only partially fused at 1950°. H. Grüneberg and J. Vorster heated a mixture of sodium chloride and alumina in a current of steam. The fused product furnishes a white enamel with a conchoidal fracture. It melts readily; dissolves easily and completely in cold water; and weathers on exposure to air, forming a surface efflorescence of sodium carbonate. There is, here, nothing to show that a chemical individual is produced. W. G. Mixer gives for the heat of formation from amorphous alumina, $\text{Na}_2\text{O} + \text{Al}_2\text{O}_3 = 2\text{NaAlO}_2 + 40.00$ Cals., and from crystalline alumina, 30.00 Cals. C. Tissier reported aluminates, $3\text{Na}_2\text{O} \cdot \text{Al}_2\text{O}_3$, *i.e.* Na_3AlO_3 , sodium orthoaluminate; $3\text{Na}_2\text{O} \cdot 2\text{Al}_2\text{O}_3$; and $\text{Na}_2\text{O} \cdot \text{Al}_2\text{O}_3$ to be formed in the dry way; but, with no other test for the individuality of a compound than fusing molar proportions of the constituents, an indefinitely large number of such compounds could be obtained. J. A. Wilkinson said that sodium aluminate fluoresces and phosphoresces under the cathode rays in the same way as does aluminium oxide made by burning the metal in air. The residue is coloured deep blue, presumably by the soln. of sodium in the aluminate. The preparation of aq. soln. of sodium aluminate from bauxite, etc., and the general properties of the soln. have been previously described. A. Cavazzi, and J. G. Bogussky and J. Zaljesky obtained a viscid mass by evaporating the aq. soln. of sodium aluminate, but E. T. Allen and H. F. Rogers said that by repeatedly digesting with alcohol the conc. soln. containing equimolar proportions of Al_2O_3 and Na_2O , a hard mass, possibly, dihydrated sodium aluminate, $\text{NaAlO}_2 \cdot 2\text{H}_2\text{O}$, is formed. F. Goudrian studied the system $\text{Na}_2\text{O} - \text{Al}_2\text{O}_3 - \text{H}_2\text{O}$ at 30°, and found two

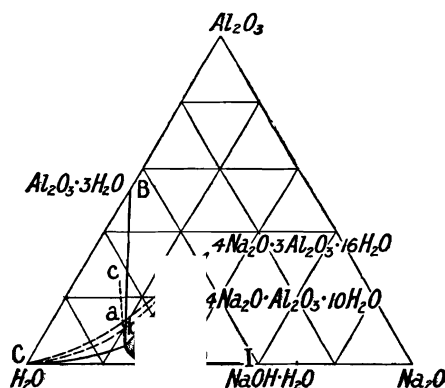

FIG. 53.—Equilibrium with the Ternary System, $\text{Na}_2\text{O} - \text{Al}_2\text{O}_3 - \text{H}_2\text{O}$, at 30°.

stable salts, hexadecahydrated sodium trialuminate, $4\text{Na}_2\text{O} \cdot 3\text{Al}_2\text{O}_3 \cdot 16\text{H}_2\text{O}$, in diamond-shaped crystals; and decahydrated sodium monoaluminate, $4\text{Na}_2\text{O} \cdot \text{Al}_2\text{O}_3 \cdot 10\text{H}_2\text{O}$, in needle-like crystals. Both salts are very hygroscopic, and form incongruent sat. soln. The conditions of equilibrium are illustrated by Fig. 53. *A* is a triple point representing the coexisting phases $\text{Al}_2\text{O}_3 \cdot 3\text{H}_2\text{O}$; $4\text{Na}_2\text{O} \cdot 3\text{Al}_2\text{O}_3 \cdot 16\text{H}_2\text{O}$; and soln.; *G*, the phases $4\text{Na}_2\text{O} \cdot 3\text{Al}_2\text{O}_3 \cdot 16\text{H}_2\text{O}$; $4\text{Na}_2\text{O} \cdot \text{Al}_2\text{O}_3 \cdot 10\text{H}_2\text{O}$; and soln.; and *H*, the phases $4\text{Na}_2\text{O} \cdot \text{Al}_2\text{O}_3 \cdot 10\text{H}_2\text{O}$; $\text{NaOH} \cdot \text{H}_2\text{O}$; and soln. The line *BA* represents a soln. in equilibrium with the solid phase $\text{Al}_2\text{O}_3 \cdot 3\text{H}_2\text{O}$; the line *AG*, with the solid phase $4\text{Na}_2\text{O} \cdot 3\text{Al}_2\text{O}_3 \cdot 16\text{H}_2\text{O}$;

GH, with the solid phase $4\text{Na}_2\text{O} \cdot \text{Al}_2\text{O}_3 \cdot 10\text{H}_2\text{O}$; and *HI*, with the solid phase $\text{NaOH} \cdot \text{H}_2\text{O}$. The dotted curves *Ca*, *Cb*, and *Cc* represent metastable states. R. Fricke, and E. Grobet have made observations on this subject. C. Matignon found the aluminate, NaAlO_2 , melted at 1650°, and is formed from a mixture of alumina and sodium carbonate at 1100°–1200°. Aluminates of the type $(n+1)\text{Na}_2\text{O} \cdot \text{Al}_2\text{O}_3$ dissociate below 1650° with the loss of sodium oxide until $\text{Na}_2\text{O} \cdot \text{Al}_2\text{O}_3$ is obtained.

A grey mass, soluble in water and acids, is obtained by fusing alumina with potassium hydroxide or carbonate; and soln. of potassium aluminate were prepared by A. B. Prescott, and A. Cavazzi as previously described, by the action of a soln. of potassium hydroxide on aluminium or alumina. O. Unverdorben evaporated a boiling soln. to a small bulk, extracted the excess of uncombined potassium hydroxide with alcohol, and obtained a residue with equimolar proportions of K_2O and Al_2O_3 . E. Frémy precipitated a soln. of potassium aluminate with ammonium carbonate, and concentrated, in vacuo, the aq. soln. obtained by leaching a fused mixture of alumina and potassium hydroxide, and obtained a

crystalline mass, which, after purification by re-crystallization from water, contained $KAlO_2 \cdot H_2O$. According to E. T. Allen and H. F. Rogers, hard, nodular crystals of sesquihydrated **potassium aluminate**, $KAlO_2 \cdot 1\frac{1}{2}H_2O$, separate when the soln. obtained by dissolving aluminium in 10 per cent. aq. soln. of potassium hydroxide, is evaporated in vacuo over sulphuric acid. If the alkali be not in excess, the aluminate is hydrolyzed and crystalline aluminium hydroxide is deposited, whilst the metal continues to dissolve indefinitely instead of in the proportion corresponding with A. Cavazzi's equation: $2Al + 2KOH + 2H_2O = 2KAlO_2 + 3H_2$. The salt is insoluble in alcohol; soluble in water with partial hydrolysis; it is hygroscopic, and is decomposed by carbon dioxide. The aq. soln. was found by E. Frémy to have an alkaline reaction, and a caustic taste; he also said that when the salt has been dehydrated by heating, it is no longer completely soluble in water. F. Braun measured the compressibility of the soln. Many properties of the aq. soln. have already been indicated. P. A. von Bonsdorff noted that the aq. soln. is decomposed and aluminium hydroxide precipitated by carbon dioxide. L. B. G. de Morveau, C. F. Bucholz, and J. W. Döbereiner showed that acids and ammonium salts precipitate aluminium hydroxide, while aq. soln. of the alkaline earths precipitate the corresponding aluminates, quantitatively, according to F. Kuhlmann, in the case of lime-water. F. W. Bergstrom made **potassium amminoaluminate**, $Al(NHK)(NH_2)_2$, by the action of a soln. of potassium amide in liquid ammonia on amalgamated aluminium.

W. Blum found that an aq. soln. of ammonium hydroxide dissolves a small but appreciable amount of alumina, even when the soln. is just alkaline to phenolphthalein with a H^- ion conc. of 10^{-9} ; and, as previously indicated, E. H. Archibald and Y. Habasian measured the solubility of aluminium hydroxide in that menstruum. By analogy with the alkali aluminates, it is here assumed that the soln. contains partially hydrolyzed **ammonium aluminate**, NH_4AlO_2 . W. Blum's determination of the H^- ion conc. during the precipitation of aluminium hydroxide by adding ammonium hydroxide does not give any definite evidence of the formation of ammonium aluminate, because of the low alkalinity of the aq. soln. The maximum conc. of the ammonium aluminate in soln. is obviously dependent on the alkalinity of the resulting soln., and its ability to repress the hydrolysis of the aluminate. C. Renz dismissed the possibility of the existence of ammonium aluminate even though by an indirect method—dissolution of aluminium hydroxide in baryta water, and the subsequent addition of ammonium sulphate—he was able to obtain a clear soln., free from barium salt and sulphates, which contained 0.2 grm. alumina per 100 c.c. The fact that freshly precipitated aluminium hydroxide is readily soluble in organic amines is in agreement with the hypothesis that ammonium aluminate is formed in soln. J. Brezina reported the formation of tetramethylammonium aluminate.

J. J. Berzelius prepared what has been called *cupric aluminate*, of unknown composition, by treating the double fluoride of aluminium and copper with ammonia. An excess of ammonia does not extract the cupric oxide. According to J. A. Hedvall and J. Heuberger, when cupric oxide and aluminium oxide are heated together, a reaction starts at about 700° and proceeds quickly between 750° and 850° . The product, which forms a chocolate-coloured powder, has, when freed from unchanged oxides, the composition $CuO \cdot Al_2O_3$, and is therefore of the spinel type. It is very resistant to solvents in general. When fused with potassium chloride, it undergoes partial decomposition, and the undecomposed portion crystallizes, on cooling, in well-formed cubes and octahedra. A. C. Becquerel separated aq. soln. of cupric nitrate and alkali aluminate by a collodion film, and obtained blue crystals admixed with cupric hydroxide on the membrane. A purple of Cassius in which the stannic oxide is replaced by alumina has been made—*vide* purple of Cassius (3. 23, 11).

The early workers, F. C. Achard, A. L. Lavoisier, and J. P. J. d'Arcet,² tried heating mixtures of lime and alumina, and with the furnace temp. then available, they were able to fuse mixtures of alumina with 25 to 50 per cent. of lime, but not mixtures with a higher proportion of lime. N. G. Sefström found mixtures $3CaO + Al_2O_3$, and $CaO + Al_2O_3$, could be fused to vitreous masses. Several

unmethodical observations have been made on the relations between lime and alumina. J. J. Ebelmen obtained corundum free from lime by fusing alumina with calcium chloride and boric oxide; similar results were obtained by using baryta in place of the calcium compound. H. St. C. Deville, C. Tissier, W. Heldt and E. Landrin examined the products obtained by heating various mixtures of lime and alumina—the two last-named from the point of view of cements. E. Solvay found that a heated mixture of calcium chloride and alumina react in dry air with the evolution of chlorine, and in moist air with the evolution of hydrogen chloride. Similar results were obtained by M. A. Gaudin with mixtures of barium chloride and alumina, and he made **barium aluminate** by the action of steam on a red-hot mixture of barytes, carbon, and alumina. G. Arth made barium aluminate, to be used as a de-encrusting agent, by heating barytes with bauxite and extracting the mass with water. The soln. deposits barium hydroxide until its sp. gr. is 1.029, when barium aluminate appears. E. S. Shepherd, G. A. Rankin, and F. E. Wright explored the binary system $\text{CaO}-\text{Al}_2\text{O}_3$, and they found evidence of the existence of compounds with the molar ratio $\text{CaO} : \text{Al}_2\text{O}_3 = 3 : 1, 1 : 1, 5 : 3,$ and $3 : 5$. The results are indicated in Fig. 54; they have been extended to ternary systems with silica, and applied to the chemical changes which occur during the manufacture and use of Portland cement. E. D. Campbell studied the formation of mixed crystals of calcium ferrite and aluminate. P. H. Bates investigated the cementing qualities of the four **calcium aluminates** made by heating alumina and lime in the necessary proportions. The so-called *satin-white* is a mixture of calcium aluminate with calcium sulphate. Its preparation is described by A. Cobenzl, etc. Rochette Frères prepared calcium aluminate almost free from other oxides by heating bauxite, or other aluminium ore, with lime and carbon or silicon, aluminium or calcium

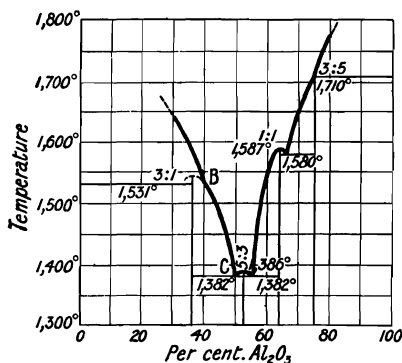

FIG. 54.—Freezing-point Curve of the Binary System, $\text{CaO}-\text{Al}_2\text{O}_3$.

carbide in an electric furnace, whereby all the foreign oxides are reduced to the metallic state.

C. W. Scheele found that hydrated alumina removes the whole of the lime from lime-water, forming an insoluble product. F. Kuhlmann added lime-water to an aq. soln. of potassium aluminate, and precipitated calcium aluminate, potassium hydroxide remained in the mother-liquor; likewise, O. Unverdorben precipitated calcium aluminate by adding a soln. of potassium aluminate to one of calcium chloride; and E. Pelouze, by adding calcium chloride to a soln. of alum and potassium hydroxide. L. N. Vauquelin prepared strontium and barium aluminates by the action of boiling strontia-water or baryta-water on aluminium hydroxide; and O. Unverdorben obtained barium aluminate as a gelatinous precipitate by adding a soln. of barium chloride to one of potassium aluminate; but E. Beckmann said that a soln. of baryta-water and aluminium chloride reacts: $2\text{AlCl}_3 + 3\text{BaO} + \text{Aq.} = \text{Al}_2\text{O}_3 + 3\text{BaCl}_2 + \text{Aq.}$ J. Heyrovsky prepared dil. soln. of aluminates of calcium, strontium, and barium, and measured their f.p. P. Miguet patented a process for making the aluminates of the alkaline earths from clays. H. le Chatelier found that when soln. of alkali aluminate and lime-water are mixed, crystallization begins very quickly and continues for hours; the product is a mass of crystals which are optically active. The composition corresponds with hemicosihydrated **tetracalcium dialuminate**, $\text{Ca}_4\text{Al}_2\text{O}_7 \cdot 21\text{H}_2\text{O}$, i.e. $4\text{CaO} \cdot \text{Al}_2\text{O}_3 \cdot 21\text{H}_2\text{O}$, and he said that at 40° the dodecahydrate is formed, and the compound becomes anhydrous when calcined. H. le Chatelier made the crystals illustrated by Fig. 55, by fusing a mixture of one molar part of alumina with 1.5 to 2 molar parts of calcium oxide. Unfortunately,

said he, the fused masses are not completely crystallized, and even after recalcination a vitreous part remains which causes a little uncertainty as to the exact composition of the crystallized aluminate. The work of E. S. Shepherd, G. A. Rankin, and F. E. Wright, Fig. 54, shows that **tricalcium dialuminate**, $\text{Ca}_3\text{Al}_2\text{O}_6$, or $3\text{CaO}\cdot\text{Al}_2\text{O}_3$, is unstable at its m.p., so that there is no true m.p., although all is completely fused at 1550° . Both CaO and $3\text{CaO}\cdot\text{Al}_2\text{O}_3$ separate at 1531° , while along the liquidus curve *BC*, Fig. 54, the compound $3\text{CaO}\cdot\text{Al}_2\text{O}_3$ is the stable phase. Consequently, it is probable that both N. G. Sefström, and C. Tissier made this compound. E. D. Campbell found that the tricalcium aluminate may be crystallized from a soln. of calcium oxide in $5\text{CaO}\cdot 3\text{Al}_2\text{O}_3$ as solvent provided the conc. of the calcium oxide at the beginning of the crystallization is sufficient to form the tricalcium aluminate with all the alumina. E. S. Shepherd, G. A. Rankin, and F. E. Wright showed that the crystals belong to the cubic system; the fracture is conchoidal; the hardness is 6; and the isotropic crystals have an index of refraction 1.710 ± 0.001 with Na-light. This compound is an important constituent of Portland cement clinker. When in contact with water, it yields the amorphous hydrate, $3\text{CaO}\cdot\text{Al}_2\text{O}_3\cdot n\text{H}_2\text{O}$, which

Fig. 55.—Crystals of Tricalcium Aluminate,
 $\text{Ca}_3\text{Al}_2\text{O}_6$, or $\text{Ca}_3\text{Al}_4\text{O}_9$.

Fig. 56.—Hydration of Tricalcium
Dialuminate.

slowly crystallizes. H. le Chatelier represented the hydration process by the equation: $3\text{CaO}\cdot\text{Al}_2\text{O}_3 + \text{Ca}(\text{OH})_2 + \text{Aq.} = \text{Al}_2\text{O}_3\cdot 4\text{CaO}\cdot 12\text{H}_2\text{O}$. The effect of the hydration is shown in Fig. 56. E. Candlot showed that the formula of the hydrated salt is more probably $3\text{CaO}\cdot\text{Al}_2\text{O}_3\cdot n\text{H}_2\text{O}$. C. Löwig claims to have made it by boiling alkali aluminate with lime-water; but E. T. Allen and H. F. Rogers showed that by adding an aq. soln. of potassium aluminate to hot lime-water, the hexahydrated salt, $3\text{CaO}\cdot\text{Al}_2\text{O}_3\cdot 6\text{H}_2\text{O}$, is precipitated. They also prepared hexahydrated **tristrontium dialuminate**, $\text{Sr}_3\text{Al}_2\text{O}_6\cdot 6\text{H}_2\text{O}$, by boiling aluminium with conc. strontium-water; hydrogen is evolved, but no further action then occurs, and in the cold, the metal dissolves, and the salt separates. The same compound is better obtained by adding a soln. of potassium aluminate, containing an excess of potassium hydroxide, to a hot soln. of strontium chloride or hydroxide; it forms a white, heavy, granular, crystalline powder sparingly soluble in water, by which it is only slowly decomposed, and it is sensitive to the action of carbon dioxide. It resembles closely the corresponding calcium compound. E. Beckmann obtained hydrated **tribarium dialuminate**, $\text{Ba}_3\text{Al}_2\text{O}_6\cdot 7.5$ to $11\text{H}_2\text{O}$, or $3\text{BaO}\cdot\text{Al}_2\text{O}_3\cdot 7.5$ to $11\text{H}_2\text{O}$, by evaporating a soln. of a mol of dibarium dialuminate, 16 mols of barium hydroxide in 30 parts by weight of boiling water. The badly-developed crystals have water

of crystallization dependent on the temp. of evaporation. The salt is sparingly soluble in cold water, and 100 parts of boiling water dissolve 6.7 parts of salt; the aq. soln. on evaporation gives a mixture of barium hydroxide and dibarium dialuminate. At 100°, the salt has 6.5–7.0H₂O; at 150°, 6H₂O; at 165°, 3H₂O; at 225°, 2H₂O; and much water is retained by all the hydrated barium aluminates at the m.p. of potassium dichromate, a temp. at which barium hydroxide becomes anhydrous baryta. No oxygen is absorbed if the salt is heated in a current of air; but in a stream of carbon dioxide, two mols of the gas are absorbed.

C. Zulkowsky obtained a porcelain-like mass by sintering a mixture of a mol of alumina with two mols of calcium oxide at about 1500°. When treated with water, it breaks down into calcium and aluminium hydroxides: $2\text{CaO} \cdot \text{Al}_2\text{O}_3 + 4\text{H}_2\text{O} = \text{Al}_2\text{O}(\text{OH})_4 + 2\text{Ca}(\text{OH})_2$. E. Dufau could not prepare **dicalcium dialuminate**, $2\text{CaO} \cdot \text{Al}_2\text{O}_3$, or $\text{Ca}_2\text{Al}_2\text{O}_5$; nor did E. S. Shepherd, G. A. Rankin, and F. E. Wright obtain any evidence of the formation of such a compound in their study of the binary system, Fig. 52. E. T. Allen and H. F. Rogers obtained the hexa- or heptahydrate, $\text{Ca}_2\text{Al}_2\text{O}_5 \cdot 6$ or $7\text{H}_2\text{O}$, by dissolving aluminium in lime-water kept saturated with calcium hydroxide. After some days, crystals of the salt appear on the metal; these are scraped off and washed with water, then with alcohol, and finally in ether. The salt is very sparingly soluble in water and very slowly decomposed by that menstruum. C. Zulkowsky heated a mixture of the 2 mols of baryta with one of alumina and obtained what he regarded as **dibarium dialuminate**, $2\text{BaO} \cdot \text{Al}_2\text{O}_3$, or $\text{Ba}_2\text{Al}_2\text{O}_5$, which, he said, behaves like the calcium salt towards water. According to E. T. Allen and H. F. Rogers, aluminium dissolves vigorously in hot conc. baryta-water, forming a heavy crystalline powder which, after washing with cold water, and then with alcohol, has the composition $\text{Ba}_2\text{Al}_2\text{O}_5 \cdot 5\text{H}_2\text{O}$, or $2\text{BaO} \cdot \text{Al}_2\text{O}_3 \cdot 5\text{H}_2\text{O}$. It is moderately soluble in water, and easily decomposed thereby. E. Beckmann boiled precipitated aluminium hydroxide with more than the calculated quantity of baryta-water; filtered the soln.; and on evaporation obtained crystals, which, according to A. Fock, are triclinic pinacoids with axial ratios and angles $a : b : c = 0.8545 : 1 : 0.9888$ and $\alpha = 99^\circ 20'5''$, $\beta = 91^\circ 52'$, and $\gamma = 109^\circ 26'5''$. The crystals decrepitate if rapidly heated, and when slowly heated to 125°, lose no appreciable quantity of water; at 155°, they lose 2 mols of water; at 180°, they gradually lose more water, but at 300°, one mol of water is still retained and is expelled only at a red heat. The salt is sparingly soluble in cold water, and 100 parts of hot water slowly dissolve 5 parts of the salt. The soln. is more or less turbid, and reacts alkaline, but on crystallization furnishes the original salt. The soln. is decomposed by carbon dioxide, and the dry salt absorbs that gas.

According to E. S. Shepherd, G. A. Rankin, and F. E. Wright, the well-defined maximum in the f.p. curve of lime and alumina, Fig. 54, at 1386° corresponds with the formation of **pentacalcium hexaluminate**, $5\text{CaO} \cdot 3\text{Al}_2\text{O}_3$, or $\text{Ca}_5\text{Al}_6\text{O}_{14}$. The eutectic $3\text{CaO} \cdot \text{Al}_2\text{O}_3 - 5\text{CaO} \cdot 3\text{Al}_2\text{O}_3$ occurs at 1382° with 51 per cent. of alumina. The crystals are isotropic and belong to the cubic system; the fracture is conchoidal; the sp. gr. is 2.828 at 25°/25°; the hardness 5; and the refractive index for Na-light 1.608 ± 0.002 —the refractive index of a glass of the same composition is 1.662. Solid soln. were looked for but not found. This compound also occurs in an unstable form which readily changes to the isotropic form. It is obtained in radial, fibrous aggregates by rapid cooling; the hardness is 5; the refractive index $\alpha = 1.687 \pm 0.002$; $\gamma = 1.692 \pm 0.002$; the birefringence is weak and negative. The crystal form is probably rhombic. In contact with water, this compound decomposes, producing **amorphous** $3\text{CaO} \cdot \text{Al}_2\text{O}_3 \cdot n\text{H}_2\text{O}$, and aluminium hydroxide. G. Friedel heated in a platinum-lined, steel tube to 500°, six grms. of calcium oxide with a soln. of aluminium chloride (eq. to 3 grms. of metal) in 40–55 c.c. of water. The thin, tabular, rhombic crystals of trihydrated **tetracalcium hexaluminate**, $4\text{CaO} \cdot 3\text{Al}_2\text{O}_3 \cdot 3\text{H}_2\text{O}$, or $\text{Ca}_4\text{Al}_6\text{O}_{18} \cdot 3\text{H}_2\text{O}$, so obtained had the axial ratios $a : b : c = 0.5176 : 1 : 0.7463$. No sign of a tetracalcium hexaluminate appears on the equilibrium diagram, Fig. 54.

E. S. Shepherd, G. A. Rankin, and F. E. Wright prepared the spinel analogue

calcium metaluminate, $\text{Ca}(\text{AlO}_2)_2$, or $\text{CaO} \cdot \text{Al}_2\text{O}_3$, and it appeared as a maximum on the f.p. curve, Fig. 54, at 1587° . The eutectic $5\text{CaO} \cdot 3\text{Al}_2\text{O}_3 - \text{CaO} \cdot \text{Al}_2\text{O}_3$ is at 1382° and 53 per cent. Al_2O_3 . Hence, the compound was probably made by N. G. Sefström, C. Zulkowsky, Rochette Frères, H. St. C. Deville, and J. J. Ebelmen. By heating a mixture of 100 parts of alumina and 60 parts of calcium oxide to a high temp. in an electric furnace, E. Dufau obtained this same compound in colourless needles, but he did not succeed in making polycalcium aluminates in this way. The excess of admixed calcium oxide is removed by boiling the powdered mass with alcohol containing one per cent. of nitric acid, and washing the residue with alcohol and finally with ether. E. S. Shepherd and co-workers did not obtain single crystals of this compound; the elongated needles and prisms are intricately twinned individuals. The birefracting crystals belong either to the monoclinic or triclinic systems—probably the former. E. Dufau gave $3 \cdot 671$ for the sp. gr. at 20° , and he said that the crystals are softer than glass. E. S. Shepherd and co-workers said that the hardness is about 6.5; the extinction oblique; the birefringence strong, about 0.002; and the refractive indices for Na-light are $\alpha = 1.641 \pm 0.002$; $\beta = 1.654 \pm 0.003$; and $\gamma = 1.661 \pm 0.002$. Calcium metaluminate like the analogous beryllium salt, chrysoberyl, and like calcium chromate, and calcium ferrite, does not belong to the group of spinels. According to E. Dufau, the compound is quite stable in dry air. C. Zulkowsky said that with water it is decomposed and sets hydraulically, $\text{Ca}(\text{AlO}_2)_2 + 2\text{H}_2\text{O} = 2\text{AlO}(\text{OH}) + \text{Ca}(\text{OH})_2$; E. S. Shepherd stated that it is attacked slowly by cold and rapidly by hot water, forming amorphous $3\text{CaO} \cdot \text{Al}_2\text{O}_3 \cdot n\text{H}_2\text{O}$, and $\text{Al}(\text{OH})_3$. According to E. Dufau, it is readily soluble in hydrochloric acid, and but slightly affected by nitric, sulphuric, or hydrofluoric acid. Fluorine attacks it only when assisted by heat; but chlorine, bromine, iodine, or sulphur has no action at the softening temp. of glass. It is decomposed when heated with potassium carbonate or hydroxide; and when heated with carbon in the electric furnace, it forms calcium and aluminium carbides. E. T. Allen and H. F. Rogers prepared tetra- or penta-hydrated **strontium metaluminate**, $\text{Sr}(\text{AlO}_2)_2 \cdot 4$ or $5\text{H}_2\text{O}$, as a gelatinous mass, not in a pure condition, by the action of cold strontia-water on aluminium; they also reported pentahydrated **barium metaluminate**, $\text{Ba}(\text{AlO}_2)_2 \cdot 5\text{H}_2\text{O}$, to be formed as an amorphous powder by dissolving aluminium in a cold sat. soln. of baryta-water. The powder is easily decomposed by water and by carbon dioxide. H. St. C. Deville obtained a tetrahydrate by calcining a mixture of alumina with barium nitrate or carbonate, crystallizing the aq. extract, and recrystallizing from an alcoholic soln. E. Beckmann reported a hexahydrate which E. T. Allen and H. F. Rogers believe to be really the pentahydrate. J. A. Hedvall and N. von Zweigbergk thought a compound was formed when barium dioxide is heated with alumina.

The equilibrium diagram, Fig. 54, shows that a eutectic between $\text{CaO} \cdot \text{Al}_2\text{O}_3 - 3\text{CaO} \cdot 5\text{Al}_2\text{O}_3$ occurs at 1580° with 67.5 per cent. of alumina; but **tricalcium decaluminate**, $3\text{CaO} \cdot 5\text{Al}_2\text{O}_3$, or $\text{Ca}_3\text{Al}_{10}\text{O}_{18}$, breaks down at about 1710° , and has no true m.p., although it is quite fused at 1725° . The crystals are rounded and belong either to the tetragonal or hexagonal system. The hardness is about 6.5. The birefringence is fairly strong, 0.032, and the refractive index for Na-light is $\omega = 1.617 \pm 0.002$, and $\epsilon = 1.651 \pm 0.002$. There is an unstable form of this compound with a sp. gr. 3.05 at $25^\circ/25^\circ$. The relation between the two is monotropic, but even when rapidly quenched the unstable form inverts so readily that homogeneous crystals could not be obtained. The crystals are probably rhombic. The hardness is 5.5 to 6.0; the birefringence is about 0.013; the refractive index for Na-light is $\alpha = 1.662 \pm 0.003$; $\beta = 1.671 \pm 0.002$; and $\gamma = 1.674 \pm 0.002$.

E. Candlot found that when calcium aluminate is treated with calcium chloride, **calcium chloroaluminate**, $3\text{CaO} \cdot \text{CaCl}_2 \cdot \text{Al}_2\text{O}_3 \cdot 10\text{H}_2\text{O}$, is formed. It is decomposed by contact with water, and is said to be momentarily formed during the action of a sat. soln. of calcium chloride on the anhydrous aluminate. According to H. Steinmetz, calcium chloroaluminate, $\text{Ca}(\text{CaCl})\text{AlO}_3 \cdot 5\text{H}_2\text{O}$, has a transition point

at 35·8°, and its vol. then decreases. E. Candlot also obtained **calcium trioxotrisulphatodialuminate**, $3\text{CaO} \cdot 3\text{CaSO}_4 \cdot \text{Al}_2\text{O}_3 \cdot 30\text{H}_2\text{O}$, by the action of calcium sulphate on the aluminate. This product is formed during the destructive action of sea-water on Portland cement. H. Kühl and H. Albert prepared **calcium trisulphatodialuminate**, $\text{Ca}_3\text{O}_2(\text{AlO}_2)_2 \cdot 3\text{CaSO}_4$, by heating lime-water and a soln. of aluminium sulphate separately to various temp. between 0° and 100°, mixing the soln. in theoretical proportions, and maintaining the mixture at the same temp. for various periods up to 28 days. Below 40°, a precipitate consisting of minute needles of the salt was readily formed, but above 40°, a much smaller quantity of the salt (contaminated with a variable amount of calcium hydroxide, which is less soluble in hot water) was formed. This is supposed to furnish an explanation of the smaller expansion during the setting of mixtures of gypsum and portland cement above 40° than below that temp.

Barium aluminate has been recommended for the removal of calcium sulphate from boiler water on the commercial scale, it is found that a quantity of barium aluminate less than is required by the equation, $\text{BaAl}_2\text{O}_4 + \text{CaSO}_4 = \text{BaSO}_4 + \text{CaAl}_2\text{O}_4$, is sufficient to precipitate the sulphate; the resulting liquid, however, is not entirely free from dissolved salts, and is always found to contain lime in soln. The subject has also been discussed by D. A. Peniakoff. A. Winkler sintered mixtures of alumina, potassium hydroxide, and lime, and the products have been called *potassium calcium aluminates*, although there is nothing to show that chemical individuals were formed.

The occurrence of the rare mineral *chrysoberyl* has been described in connection with beryllium. It is not the chrysoberyl of the ancients, for that is a variety of beryl. A. G. Werner³ called it *krisoberil*; D. L. G. Karsten, D. G. J. Lenz, etc., called it *chrysoberyl*; and R. J. Häuy, *cymophane*. It was analyzed by M. H. Klaproth, J. A. Arfvedson, H. Seybert, G. Bergemann, A. von Awdéeff, A. Damour, etc. *Alexandrite* was described by N. G. Nordenskjöld. Chrysoberyl approximates in composition to **beryllium aluminate**, $\text{Be}(\text{AlO}_2)_2$. J. J. Ebelmen obtained it by melting a mixture of alumina, beryllia, calcium carbonate, and boric oxide for about 3 days at 1500°–1600°; P. Hautefeuille and A. Perrey heated a mixture of alumina, beryllia, potassium sulphate, and carbon to about 1100° for 4 hrs.; washed the cold product with acidulated water; removed the excess of beryllia with sulphuric acid, and the excess of carbon by oxidation. H. St. C. Deville and H. Caron heated a mixture of aluminium and beryllium fluorides in a carbon crucible arranged within a smaller carbon crucible, containing fused boric acid, embedded in the centre of the mixture. In a few hours, fine crystals of chrysoberyl were obtained. A. Lacroix obtained crystals of chrysoberyl by heating a beryllium salt with cryolite, and a silicate. If a chromium compound is present in the above syntheses, green crystals of alexandrite are obtained. The crystals are pleochroic, and they were found by G. Melczer to be pseudo-hexagonal, rhombic bipyramids with axial ratios $a : b : c = 0.4707 : 1 : 0.5823$. L. Frischmann studied the twinning of the crystals. The crystals have a formal resemblance to those of olivine. J. J. Ebelmen gave 3.759 for the sp. gr., and the hardness is 8.5. A. Reis and L. Zimmermann discussed the hardness of chrysoberyl. L. F. Nilson and O. Pettersson gave 0.2004 for the sp. ht.; G. Melczer gave for the three refractive indices α, β, γ , 1.7440, 1.7431, and 1.7489 respectively for Li-light; 1.7443, 1.7470, and 1.7530 for Na-light; and 1.7474, 1.7503, and 1.7566 for Tl-light. The double refraction is positive, $\gamma - \alpha = 0.009$.

According to H. Abich,⁴ if equi-molar parts of magnesium and aluminium salts be mixed in aq. soln. with enough ammonium chloride to keep the magnesium in soln., the addition of ammonia precipitates the aluminium and nearly all the magnesium as hydroxides so as to form a kind of hydrated spinel; J. N. von Fuchs found the precipitate contained much ammonia. According to W. Heldt, some aluminium hydroxide is precipitated by adding magnesium hydroxide to a soln. of an aluminium salt; and magnesium sulphate gives a white gelatinous precipitate when added to a soln. of potassium aluminate, but calcined magnesia is not changed

in an aq. soln. of potassium aluminate. J. Heyrovsky made a dil. soln. of magnesium aluminate and measured the f.p. J. J. Berzelius was unable to fuse a mixture of alumina and magnesia at the temp. of a smith's forge, but a calcined mixture of alumina with half per cent. of magnesia evolves much heat on being moistened with water, and when extracted with hydrochloric acid leaves a residue of **magnesium aluminate**. W. Heldt also made somewhat analogous observations with mixtures of alumina and magnesia. E. S. Shepherd, G. A. Rankin, and F. E. Wright found only one well-defined magnesium aluminate, $MgO \cdot Al_2O_3$, or $Mg(AlO_2)_2$ —artificial *spinel*—on the f.p. curve of mixtures of alumina and magnesia. The solid phases between 0 and 71.6 per cent. of alumina are magnesia and magnesium aluminate; the eutectic is at 1956° ; and the solid phases between 71.6 and 100 per cent. of alumina are magnesium aluminate and alumina. J. J. Ebelmen obtained crystals of artificial spinel by heating a mixture of alumina, magnesia, calcium carbonate, and boric oxide—the crystals were coloured red if a small proportion of chromium be included; blue with cobalt; and black with ferric oxide—the cold, crushed mass was washed with hot conc. hydrochloric acid. W. Guertler used alkali metaborate as the solvent. E. Dufau heated a mixture of alumina and magnesia in an electric furnace, digested the cold mass with nitric acid, and separated the crystals of spinel with a heavy liquid—methylene iodide; no basic aluminate was obtained, but S. Meunier said that a *basic magnesium aluminate* can be obtained by melting magnesia, and cryolite with a large excess of alumina. Needle-like crystals, accompanied by corundum, occur in the cold mass. S. Meunier also made spinel by fusing a mixture of alumina, magnesia, cryolite, and aluminium chloride—without the latter, no spinel was formed; nor was it produced from a mixture of magnesia, alumina, and fluorspar, or from a mixture of magnesia and cryolite. He also prepared crystals of spinel by heating water, aluminium chloride, and magnesium in a sealed tube; A. Daubr e obtained spinel and corundum by passing the vapour of aluminium chloride over heated magnesia or by heating a mixture of lime with magnesium and aluminium chlorides. J. Morris made spinel by stirring an intimate mixture of carbon, and aluminium and magnesium chlorides into a paste with water; moulding the mass into briquettes; and heating the dried briquettes to redness in a stream of carbon dioxide for 50–500 hrs.

J. Morozewicz studied the conditions of formation of spinel in silicate magmas. W. Vernadsky observed spinel in the product obtained by fusing biotite; C. Doelter, clinchlore, and tourmaline; F. W. Clarke and E. A. Schneider, clinchlore, and xanthophyllite; W. Salomon, tourmaline, pyrope, and spessarite; F. Fouqu e and A. Michel-L vy, a mixture of nephelite and augite; C. Doelter and E. Hussak, a mixture of fayalite and sarcolite; M. Vucnik, a mixture of magnetite and anorthite; and B. Vukits, mixtures of elaeolite and augite or corundum. F. W. Clarke discussed the bearing of these observations on the occurrence of spinel in nature. P. Niggli studied the ternary system Al_2O_3 — MgO — CaO .

Spinel, or *magnesia spinel*, occurs in colourless, holosymmetric crystals belonging to the cubic system. V. S. Deleano and E. Dittler measured the velocity of crystallization of spinel from the molten state. W. H. Bragg, L. Vegard, M. L. Huggins, P. F. Kerr, and S. Nishikawa found that the X-radiogram of magnesium aluminate corresponds with the cubic lattice of the diamond. W. Hermann's experiments on the action of oxidizing and reducing gases on heated spinel led him to the belief that the oxides of iron act as tinctorial agents in the blue and green spinels. It is found in nature coloured red with chromium oxide, and this variety has been regarded as a gem-stone, *precious spinel*, from very early times; to distinguish it from ruby, it is also called *ruby spinel* (deep red), or *balas ruby* (rose red); yellow or orange-red spinel is also called *rubicelle*; and violet spinel, *almadine*. Theophrastus in his *Περὶ λίθων* refers to the *ἀνθρακίμος*, so called because it is not injured by fire; the term is usually translated as carbuncle, and Pliny in his *Historia naturalis* (37. 25–29) refers to the *lychnis*, and to the *carbunculus*, so called because of its resemblance to fire. It is generally supposed that these terms refer to what are now known as

spinel ruby, and corundum ruby. G. Agricola, C. Cappeller, and J. G. Wallerius also confused these minerals. J. B. L. Romé de l'Isle first clearly demonstrated the difference in the crystal forms of *rubis spinelle* and corundum ruby. Analyses have been published by J. J. Berzelius, T. Thomson, H. Abich, T. Scheerer, A. Erdmann, F. Pisani, H. Rose, A. Damour, A. Hilger, etc. The sp. gr. of ruby spinel is 3.548 and of blue spinel 3.542, according to J. J. Ebelmen, and 3.57 at 15°, according to E. Dufau—the sp. gr. of corundum is greater than this. Similarly the hardness of spinel ruby, 8.0, is smaller than that of corundum ruby, which is 8.8 to 9.0. A. Reis and L. Zimmermann gave 8.0 for the hardness of spinel. H. Fizeau found the coeff. of cubical expansion of Singalese ruby spinel to be 0.0001787 at 40°; and H. Kopp gave 0.194 for the sp. ht. between 14° and 47°. The refractive index is high, but smaller than that of corundum ruby. A. des Cloizeaux found for ruby spinel, 1.7121 for the Li-ray, 1.7155 for the Na-ray, and 1.726 for the blue ray; and for a blue spinel G. Melczer obtained 1.7185–1.7200 with Na-light. O. Mügge observed radioactive haloes in some specimens of spinel. E. Dufau said that spinel is attacked with difficulty by chlorine, bromine, or iodine, but it is attacked, when warm, by fluorine; hydrofluoric and hydrochloric acids attack it with difficulty. H. Abich also found that hydrochloric acid has very little action on spinel, and he noted that sulphuric acid dissolves about one-third when the mixture is heated until the acid begins to evaporate; E. Dufau found that sulphuric acid has very little action on spinel, and A. Mitscherlich found that spinel dissolves in 2 hrs. in a mixture of sulphuric acid (3:1); or when boiled in a mixture of sulphuric and hydrofluoric acids. H. Abich said spinel is not at all attacked by nitric acid. E. Dufau found that spinel is not reduced by carbon in the electric furnace; it is not attacked by fused alkali carbonate, but it is readily decomposed by fused alkali hydroxide. F. H. Riddle described the manufacture of tubes and crucibles from spinel.

F. Hochstetter⁵ found a hydrated magnesium aluminium hydroxide as a secondary mineral on serpentine at Snarum, Norway, and he called it *hydrotalcite* because it looked like talc; R. Hermann called a specimen from Shishimsk, Ural, *völknerite*—after Capt. Völkner; and a related mineral from Oxbow and Somerville, New York, was called by C. U. Shepard, *houghite*—after F. B. Hough. Analyses were made by R. Hermann, and S. W. Johnson. The composition approximates $\text{Al}(\text{OH})_3 \cdot 3\text{Mg}(\text{OH})_2 \cdot 3\text{H}_2\text{O}$, or $\text{Mg}_3\text{AlO}_6 \cdot 6\text{H}_2\text{O}$. The crystals are hexagonal; the sp. gr. is 2.04 to 2.09; and the hardness 2. W. W. Coblenz found the ultra-red transmission spectrum has bands at 7.5 μ , 2 μ , 3 μ , and 4.7 μ . The opacity is complete at 6 μ . There is a band at 9.9 μ in the ultra-red reflection spectrum.

In 1806, G. Ekeberg⁶ analyzed the zinc analogue of spinel found in some schists at Fahlun (Sweden), and he named it *automolite*, from *αὐτόμολος*, a deserter, in allusion to the zinc occurring in an unexpected place; but C. E. von Moll objected to such an idea in nature, and called it *gahnite*, after J. G. Gahn, the discoverer. Analyses by G. Ekeberg, H. Abich, F. A. Genth, T. Thomson, A. Damour, F. von Kobell, F. Pisani, F. Mauro, J. D. Dana, H. Hedström, etc., correspond with the formula for **zinc aluminate**, $\text{Zn}(\text{AlO}_2)_2$. More or less ferrous iron may replace the zinc; and in the *dysluite* of W. H. Keating, and in the *kreittonnite* of F. von Kobell, some ferric iron replaces the alumina, and some manganese oxide the magnesia—possibly isomorphous mixtures or solid soln.; *franklinite*, $(\text{Zn}, \text{Mn})\text{Fe}_2\text{O}_4$, and *magnetite*, $\text{Fe}(\text{FeO}_2)$, and *chromite*, $\text{Fe}(\text{CrO}_2)_2$, may be regarded as advanced or extreme stages in the substitution, or extreme members of the series of mixed crystals. J. J. Berzelius found that aluminium hydroxide abstracts zinc oxide from the aq. soln. of ammoniacal zinc oxide; and zinc aluminate is precipitated from the same soln. by adding a sat. soln. of potassium aluminate. T. Sander found a precipitate is obtained on mixing soln. of potassium aluminate and zincate. J. J. Ebelmen, and J. R. Mourelto synthesized gahnite by heating a mixture of zinc oxide, alumina, and boric oxide; S. Meunier, by heating to bright redness a mixture of alumina, zinc oxide, cryolite, and aluminium chloride. A. Daubrée, by passing the vapours of aluminium and zinc chlorides over red-hot lime; H. St. C. Deville and H. Caron,

by vaporizing a mixture of zinc and aluminium fluorides in the presence of boric oxide. A. Stelzner found gahnite in the walls of a zinc muffle at Freiberg, and G. J. Brush at New Jersey. W. Biltz regarded the violet colour of zinc aluminate as a result of the union of compounds of elements in different states of oxidation. E. V. Shannon described a blue cobaltiferous gahnite from Maryland. The crystals are cubic and are isomorphous with spinel. W. H. Bragg studied the X-radiogram; and M. L. Huggins, the electronic structure. According to J. J. Ebelmen, the sp. gr. is 4.58, and the crystals are harder than quartz. H. Hedström gave 4.39 for the sp. gr., and W. Orloff 7.5 to 8 for the hardness. A. Reis and L. Zimmermann gave 8.0 for the hardness of zinc spinel. H. Rosenbuch gave 1.765 for the refractive index. According to J. J. Berzelius, gahnite bakes together when heated with sodium carbonate but is not dissolved; it is slightly soluble in fused borax or microcosmic salt; but fuses to a clear glass with a mixture of borax and sodium carbonate. Gahnite is virtually insoluble in acids and alkali-lye. J. J. Ebelmen failed to prepare *cadmium aluminate* by heating a mixture of alumina, cadmium oxide, and boric oxide, for aluminium borate was formed, while the cadmium volatilized.

J. Smithson⁷ described *plomb-gomme* as a native hydrated *lead aluminate*—*vide* lead phosphates. E. J. Kohlmeyer found it difficult to melt lead oxide and alumina because at the necessary temp. lead oxide rapidly volatilizes. A. Stavenhagen and E. Schuchardt found that the product has a blue cathodoluminescence. L. F. Hawley made **thallous aluminate**, $Tl_4Al_2O_5 \cdot 7H_2O$, by the dissolving aluminium in a cold soln. of thallous hydroxide. It is insoluble in absolute alcohol, and readily soluble in dil. acids and alkali hydroxides. It is slowly hydrolyzed by water, and the aq. soln. is decomposed by carbon dioxide, forming thallous carbonate and aluminium hydroxide.

J. J. Ebelmen⁸ prepared crystals of **manganous aluminate**, $Mn(AlO_2)_2$, or *manganese spinel*, belonging to the cubic system by heating a mixture of alumina, manganous oxide, and boric oxide for three days to 1500°–1600°; and E. Dufau, by heating a mixture of aluminium and manganic oxide in an electric furnace. The mass was treated with boiling hydrochloric acid. J. A. Krenner found crystals of manganese spinel in some blast furnace slag; *dysluite* may be regarded as manganese spinel in which much of the alumina has been displaced by ferric oxide—*vide supra*. According to E. Dufau, the sp. gr. of manganese spinel at 20° was 4.12; the crystals scratch quartz. The salt is easily oxidized when heated in air, and rapidly attacked by chlorine; at a red heat with fluorine it becomes incandescent. Sulphur, bromine, and iodine react at the softening temp. of glass. It is insoluble in hydrochloric acid, is attacked by hydrofluoric and nitric acids, and readily dissolved by sulphuric acid. Fused potassium chlorate, nitrate, hydroxide, and carbonate easily decompose manganese spinel.

The ferrous analogue of spinel, **ferrous aluminate**, $Fe(AlO_2)_2$, *i.e.* *iron spinel*, is represented by the mineral *hercynite*, discovered at Ronsberg by F. X. M. Zippe,⁹ and named from the Latin term for the Bohemian Forest—*silva hercynia*. The mineral was analyzed by B. Quadrat. It occurs as black magnetic specks in the Saxon granulites. It also occurs massive and granular; it is black in colour; its sp. gr. is 3.91–3.95; and its hardness is 7.5–8. J. J. Ebelmen obtained a mass covered with brown intersecting needles by heating a mixture of alumina, ferric oxide, and boric oxide for three days at 1500°–1600°. The minerals spinel ruby, hercynite, gahnite, magnetite, magnesioferrite, $Mg(FeO_2)_2$, jacobsite, $Mn(FeO_2)_2$, franklinite, $(Zn, Mn)(FeO_2)_2$, and chromite, $Fe(CrO_2)_2$, form a natural group of cubic minerals, $M''R_2'''O_4$, in which there are many intermediate forms. The basic element may be magnesium, ferrous iron, zinc, or manganese; and where R''' may be trivalent aluminium, iron, manganese, or chromium.

In illustration, the *ceylanite* of J. C. Delamétherie, the *zeylanite* of D. L. G. Karsten, the *pleonaste* of R. J. Haüy, the *ceylonite* of C. F. Rammelsberg, and the *cardite* of Comte de Bournon is an *iron-magnesia spinel*, varying in colour from dark green, brown, or black, and have a composition corresponding with isomorphous mixtures represented by

(Mg, Fe)O.(Al, Fe)₂O₃. These minerals have been reported in garnetiferous gneisses, and metamorphic rocks. The so-called *chlorospinel* occurs in grass-green or greyish-green regular octahedrons, of sp. gr. 3.593, and is considered by G. Rose to be a magnesia spinel with part of the alumina replaced by ferric oxide. It also contains about 0.27 per cent. of copper oxide. The mineral *picotite* is a chrome-ceylonite and was first described by Picot de la Peyrouse and named by J. C. Delamétherie *lherzolite* from Lherz, where the mineral was first obtained as heavy black grains in olivine rocks; it is also found in serpentine. J. F. W. Charpentier named the mineral *picotite* after its discoverer. It contains about 7 per cent. of chromic oxide as well as magnesia, alumina, and ferrous and ferric oxides—(Mg, Fe)O(Al, Fe, Cr)₂O₃. The *högbonnité* of A. Gavelin approximates MgO(Al₂O₃.Fe₂O₃.TiO₂)₂. It occurs in Swedish Lapland. The sp. gr. is 3.81; the hardness, 6½; the axial ratio *a*:*c* of the rhombohedral crystals is 1:1.55; and the indices of refraction, $\omega=1.853$, and $\epsilon=1.803$.

About the end of the eighteenth century, J. G. Gahn¹⁰ discovered the fine blue colour which is produced when alumina, or a substance containing alumina as free as possible from iron, is ignited with a salt of cobalt. It was mentioned by C. F. Wenzel. J. J. Berzelius described it in 1812. The colour is improved if phosphates or arsenates are present, and the product obtained by calcining a mixture of alumina with cobalt phosphate or arsenate was described by L. J. Thénard; and the colour produced by calcining alumina with cobalt oxide or cobalt salts came to be called *Thénard's blue*, or *cobalt-ultramarine*, *Leyden blue*, or *Leithner's blue*. According to P. Louyet, a mixture of cobalt and aluminium hydroxides does not assume the true blue colour at a temp. below the m.p. of glass, a red heat renders the mixture black or grey; but if cobalt phosphate or arsenate is used, the blue is developed at a red heat. J. J. Ebelmen did not succeed in making crystals of **cobalt aluminate**, CoO.Al₂O₃, analogous with the spinels by the process he employed for other spinels—*vide supra*. W. Stein, and S. Burgstaller regarded Thénard's blue as a solid soln. of cobalt oxide in alumina. J. A. Hedvall heated the mixture of the two oxides with potassium chloride and obtained crystals of cobalt aluminate which he regards as a true chemical compound—sp. gr. 4.37 at 18°. He also obtained a green aluminate, 4CoO.3Al₂O₃. M. Rüger also prepared cobalt aluminate; and he showed that the green intermediate product obtained by heating the mixture of cobalt oxide and alumina at 900° is a solid soln. of aluminate.

REFERENCES.

- ¹ R. E. Slade, *Zeit. anorg. Chem.*, **77**, 457, 1912; *Zeit. Elektrochem.*, **17**, 261, 1911; **18**, 1, 1912; W. Herz, *ib.*, **17**, 403, 1911; *Zeit. anorg. Chem.*, **25**, 155, 1900; F. Russ, *ib.*, **41**, 216, 1904; A. Hantzsch, *ib.*, **30**, 296, 1902; R. C. Wallace, *ib.*, **63**, 1, 1909; *Trans. Cer. Soc.*, **9**, 172, 1910; J. J. Berzelius, *The Use of the Blowpipe in Chemical Analysis*, London, 1822; J. A. Hedvall and J. Heuberger, *Zeit. anorg. Chem.*, **116**, 137, 1921; W. Blum, *Journ. Amer. Chem. Soc.*, **35**, 1499, 1913; **36**, 2383, 1914; E. G. Mahin, *ib.*, **36**, 2381, 1914; E. G. Mahin, D. C. Ingraham, and O. J. Stewart, *ib.*, **35**, 30, 1913; A. B. Prescott, *ib.*, **2**, 27, 1880; *Chem. News*, **42**, 29, 1880; F. M. Lyte, *ib.*, **51**, 109, 201, 1885; J. H. Hildebrand, *Journ. Amer. Chem. Soc.*, **35**, 864, 1913; F. Goudriaan, *Proc. Acad. Amsterdam*, **23**, 129, 1920; *Rec. Trav. Chim. Pays-Bas*, **41**, 82, 1922; J. M. van Bemmelen, *ib.*, **7**, 75, 1888; A. C. Becquerel, *Compt. Rend.*, **67**, 1061, 1868; **79**, 82, 1874; H. Krämer, *Arch. Pharm.*, (2), **79**, 268, 1854; R. Fricke, *Zeit. Elektrochem.*, **28**, 357, 1922; J. Heyrovsky, *Chem. News*, **125**, 198, 1922; *Bull. Akad. Bohême*, **25**, 1922; *Journ. Chem. Soc.*, **117**, 1013, 1920; R. Ballo and E. Dittler, *Zeit. anorg. Chem.*, **76**, 39, 1912; A. A. Noyes and W. R. Whitney, *Zeit. phys. Chem.*, **15**, 694, 1894; *Tech. Quart.*, **7**, 1, 1894; Z. Weyberg, *Centr. Min.*, **645**, 1906; J. K. Wood, *Journ. Chem. Soc.*, **93**, 417, 1908; E. Grobet, *Journ. Chim. Phys.*, **19**, 331, 1921; A. Glässner, *Chem. Ind.*, **25**, 186, 1902; E. T. Allen and H. F. Rogers, *Amer. Chem. Journ.*, **24**, 304, 1900; L. B. G. de Morveau, *Ann. Chim. Phys.*, (1), **31**, 246, 1799; E. Mallard, *ib.*, (4), **28**, 105, 1875; H. St. C. Deville, *ib.*, (3), **61**, 333, 1861; E. Frémy, *ib.*, (3), **12**, 362, 1844; *Compt. Rend.*, **15**, 1106, 1842; C. Tissier, *ib.*, **48**, 627, 1849; A. Ditte, *ib.*, **116**, 183, 386, 1893; F. Braun, *Wied. Ann.*, **30**, 250, 1887; J. G. Bogusky and J. Zaljesky, *Chem. Ztg.*, **14**, 146, 1890; O. Unverdorben, *Pogg. Ann.*, **7**, 723, 1826; P. A. von Bonsdorff, *ib.*, **27**, 275, 1833; F. G. Schaffgotsch, *ib.*, **43**, 117, 1838; J. A. Wilkinson, *Journ. Phys. Chem.*, **13**, 691, 1909; W. G. Mixer, *Amer. Journ. Science*, (4), **26**, 125, 1908; F. Kuhlmann, *Liebigs Ann.*, **41**, 228, 1842; E. A. Schneider, *ib.*, **257**, 359, 1890; *Ber.*, **23**, 1349, 1890; C. F. Bucholz, *Taschenbuch Scheidekünstler Apotheker.*, **33**, 156, 1812; F. M. Jäger and A. Simek, *Proc. Acad. Amsterdam*, **17**, 239, 251, 1914; C. K. Bayer, *Brit. Pat. No.* 10093, 1887; 5296, 1892; J. W. Döbereiner, *Schweigger's Journ.*, **10**, 113, 1814; R. E. Slade

and W. G. Polack, *Trans. Faraday Soc.*, **10**, 150, 1914; E. H. Archibald and Y. Habasian, *Trans. Roy. Soc. Canada*, (3), **11**, 1, 1917; C. Renz, *Ber.*, **36**, 2751, 1903; H. Grüneberg and J. Vorster, *Brit. Pat. No.* 2639, 1874; A. Cavazzi, *Gazz. Chim. Ital.*, **15**, 205, 1885; G. Carrara and G. B. Vespignani, *ib.*, **30**, ii, 35, 1900; N. G. Chatterji and N. R. Dhar, *Chem. News*, **121**, 253, 1920; E. Grobet, *Journ. Chim. Phys.*, **19**, 331, 1922; F. W. Bergstrom, *Science*, (2), **53**, 578, 1922; J. Brezina, *Chem. Listz*, (2), **16**, 25, 1922; C. Matignon, *Compt. Rend.*, **177**, 190, 1923.

² J. P. J. d'Arcet, *Mémoire sur l'action d'un feu égal*, Paris, 1766; N. G. Sefström, *Pogg. Ann.*, **15**, 612, 1829; A. L. Lavoisier, *Recueil Acad.*, 466, 1782; F. C. Achard, *Mém. Acad. Berlin*, **24**, 64, 1780; C. W. Scheele, *Svenska Vet. Acad. Handl.*, **37**, 30, 1776; E. Candlot, *Bull. Soc. Enc.*, (4), **4**, 212, 1889; (4), **5**, 505, 682, 685, 1890; Rochette Frères, *Brit. Pat. No.* 141666, 1919; E. D. Campbell, *Journ. Ind. Eng. Chem.*, **11**, 116, 1919; H. Steinmetz, *Zeit. phys. Chem.*, **52**, 449, 1905; F. Kuhlmann, *Liebig's Ann.*, **41**, 228, 1842; G. Arth, *Bull. Soc. Chim.*, (3), **27**, 297, 1902; D. A. Peniakoff, *Bull. Soc. Chim. Belg.*, **19**, 122, 1905; O. Unverdorben, *Pogg. Ann.*, **7**, 723, 1826; E. Pelouze, *Ann. Chim. Phys.*, (3), **33**, 13, 1851; L. N. Vauquelin, *ib.*, (1), **96**, 213, 1815; (2), **21**, 138, 1822; J. J. Ebelmen, *ib.*, (3), **22**, 213, 1848; (3), **33**, 34, 1851; H. St. C. Deville, *ib.*, (3), **46**, 455, 1856; *Compt. Rend.*, **54**, 324, 1862; E. Landrin, *ib.*, **94**, 1054, 1882; C. Tissier, *ib.*, **48**, 627, 1859; E. Dufau, *ib.*, **131**, 541, 1900; H. le Chatelier, *Ann. Mines*, (8), **11**, 345, 1887; *Bull. Soc. Chim.*, (2), **42**, 82, 1884; *Recherches expérimentales sur la constitution des mortiers hydrauliques*, Paris, 1884; New York, 1905 (I am indebted to the publisher, M. Dunod, Paris, for permission to use Figs. 55 and 56); *Compt. Rend.*, **96**, 1058, 1883; M. A. Gaudin, *ib.*, **54**, 687, 1862; J. Heyrovsky, *Chem. News*, **125**, 198, 1922; E. Solvay, *Bull.*, **11**, 262, 1878; E. Beckmann, *ib.*, **14**, 2151, 1881; *Journ. prakt. Chem.*, (2), **26**, 397, 1882; A. Winkler, *ib.*, (1), **67**, 455, 1856; W. Heldt, *ib.*, (1), **94**, 144, 1865; E. T. Allen and H. F. Rogers, *Amer. Chem. Journ.*, **24**, 304, 1900; C. Zulkowsky, *Chem. Ind.*, **24**, 369, 1901; C. Löwig, *Färber-Ztg.*, **43**, 1878; A. Cobenzl, *Chem. Ztg.*, **44**, 661, 1920; *Chem. Met. Engg.*, **24**, 221, 1921; G. Friedel, *Bull. Soc. Min.*, **26**, 121, 1904; G. A. Rankin and F. E. Wright, *Amer. Journ. Science*, (4), **39**, 1, 1915; E. S. Shepherd, G. A. Rankin, and F. E. Wright, *ib.*, (4), **28**, 293, 1915; *Journ. Ind. Eng. Chem.*, **3**, 211, 1911; G. A. Rankin, *ib.*, **7**, 466, 1915; G. E. Rankin and H. E. Merwin, *Journ. Amer. Chem. Soc.*, **38**, 568, 1916; P. H. Bates, *Journ. Franklin Inst.*, **192**, 668, 1921; P. H. Bates and A. A. Klein, *Tech. Paper Bur. Standards*, **78**, 1917; A. A. Klein and A. J. Phillips, *ib.*, **43**, 1914; *Trans. Amer. Cer. Soc.*, **16**, 313, 1914; *Journ. Washington Acad.*, **4**, 573, 1914; A. Fock, *Zeit. Kryst.*, **7**, 63, 1883; P. Miguot, *U.S. Pat. No.* 1376563, 1921; J. A. Hedvall and N. von Zweigbergk, *Zeit. anorg. Chem.*, **108**, 119, 1919; H. Kühl and H. Albert, *Zement*, **12**, 279, 285, 1923.

³ A. G. Werner, *Berg. Journ.* **373**, 387, 1789; **84**, 1790; R. J. Haüy, *Journ. Mines*, **4**, 5, 1798; D. G. J. Lenz, *Handbuch der Mineralogie*, Leipzig, 1822; D. L. G. Karsten, *Tabellarische Uebersicht der mineralogisch-einfachen Fossilien*, Berlin, 1791; M. H. Klaproth, *Beiträge zur chemischen Kenntniss der Mineralkörpers*, Berlin, **1**, 97, 1795; G. Bergemann, *De chrysoberyllo dissertatio*, Göttingen, 1826; H. Seybert, *Amer. Journ. Science*, (1), **8**, 105, 1824; J. A. Arfvedson, *Kongl. Vet. Acad. Handl. Stockholm*, **43**, 404, 1822; *Phil. Mag.*, (1), **62**, 355, 1823; A. von Awdéoff, *Pogg. Ann.*, **56**, 118, 1842; A. Damour, *Ann. Chim. Phys.*, (3), **7**, 173, 1843; J. J. Ebelmen, *ib.*, (3), **22**, 213, 1848; (3), **33**, 34, 1851; H. St. C. Deville and H. Caron, *ib.*, (4), **5**, 104, 1858; P. Hautefeuille and A. Perrey, *Compt. Rend.*, **106**, 487, 1888; A. Lacroix, *Bull. Soc. Min.*, **10**, 157, 1887; N. G. Nordenskjöld, *Proc. Russ. Min. Soc.*, **83**, 1842; L. F. Nilson and O. Pettersson, *Compt. Rend.*, **91**, 232, 1880; L. Frischmann, *Sitzber. Akad. München*, **i**, 429, 1867; G. Melcozer, *Zeit. Kryst.*, **35**, 56, 1901; A. Reis and L. Zimmermann, *Zeit. phys. Chem.*, **102**, 298, 1922.

⁴ E. S. Shepherd, G. A. Rankin, and F. E. Wright, *Amer. Journ. Science*, (4), **28**, 293, 1909; G. Melcozer, *Zeit. Kryst.*, **35**, 567, 1901; W. Heldt, *Journ. prakt. Chem.*, (1), **94**, 159, 1865; A. Mitscherlich, *ib.*, (1), **81**, 108, 1860; J. N. von Fuchs, *Schweigger's Journ.*, **24**, 384, 1818; J. J. Berzelius, *Lehrbuch der Chemie*, Dresden, **1**, **1**, 828, 1825; *Gehlen's Journ.*, **6**, 304, 1808; A. Erdmann, *Kongl. Vet. Acad. Handl. Stockholm*, **1**, 1848; H. Abich, *ib.*, **6**, 1842; *Pogg. Ann.*, **23**, 305, 355, 1831; T. Scheerer, *ib.*, **65**, 294, 1845; H. Rose, *ib.*, **50**, 652, 1840; S. Meunier, *Bull. Soc. Min.*, **10**, 187, 1887; *Compt. Rend.*, **90**, 701, 1880; **104**, 1111, 1887; E. Dufau, *ib.*, **135**, 963, 1902; *Journ. Pharm. Chim.*, (6), **14**, 25, 1901; *Bull. Soc. Chim.*, (3), **25**, 669, 1901; J. J. Ebelmen, *Ann. Chim. Phys.*, (3), **22**, 213, 1848; (3), **33**, 34, 1851; A. Daubrée, *Compt. Rend.*, **39**, 135, 1854; F. Pisani, *ib.*, **63**, 49, 1866; J. Morris, *Brit. Pat. No.* 18496, 1894; W. Guertler, *German Pat.*, *D.R.P.* 182200, 1904; J. Morozewicz, *Tschermak's Mitt.*, (2), **18**, **1**, 105, 1899; *Centr. Min.*, **148**, 1905; M. Vucnik, *ib.*, **297**, 1904; B. Vukits, *ib.*, **710**, 743, 1904; W. Salomon, *Zeit. deut. geol. Ges.*, **42**, 525, 1890; W. Vernadsky, *Sur le groupe de la sillimanite et de rôle de l'alumine dans les silicates*, Moscow, 1891; *Bull. Soc. Nat. Moscou*, (2), **5**, **1**, 1891; L. Vegard, *Phil. Mag.*, (6), **32**, 65, 1916; M. L. Huggins, *Phys. Rev.*, (2), **21**, 509, 1923; V. S. Deleano and E. Dittler, *Centr. Min.*, **753**, 1911; C. Doelter, *Neues Jahrb. Min.*, **i**, **1**, 1897; C. Doelter and E. Hussak, *ib.*, **i**, 157, 1884; A. Hilger, *ib.*, **399**, 1866; F. W. Clarke and E. A. Schneider, *Bull. U.S. Geol. Sur.*, **118**, **30**, 1893; F. Fouqué and A. Michel-Lévy, *Synthèse des minéraux et des roches*, Paris, **64**, 1882; F. H. Riddle, *Trans. Amer. Cer. Soc.*, **19**, 404, 1917; A. Reis and L. Zimmermann, *Zeit. phys. Chem.*, **102**, 298, 1922; J. Heyrovsky, *Chem. News*, **125**, 198, 1922; W. Hermann, *Zeit. anorg. Chem.*, **60**, 369, 1908; H. von Eskermann, *Geol. För. Förh. Stockholm*, **44**, 757, 1922; F. W. Clarke, *The Data of Geochemistry*, Washington, 336, 1920; J. B. L. Romé de l'Isle, *Cristallographie*, Paris, **2**, 224, 1783; A. des Cloizeaux, *Manuel de minéralogie*, Paris, 1852; H. Kopp, *Liebig's Ann. Suppl.*, **3**, 289, 1865; H. Fizeau, *Compt.*

Reid., **62**, 1101, 1133, 1866; *Ann. Chim. Phys.*, (4), **8**, 335, 1866; G. Agricola, *De natura fossilium*, Basilea, 293, 1546; J. G. Wallerius, *Mineralogia*, Stockholm, 115, 1747; C. Cappeller, *Prodromus crystallographica*, Lucerne, 1723; T. Thomson, *Outlines of Mineralogy, Geology, and Mineral Analysis*, London, 1. 214, 1836; A. Damour, *Bull. Soc. Geol.*, (2), **19**, 413, 1862; W. H. Bragg, *Phil. Mag.*, (6), **30**, 305, 1915; S. Nishikawa, *Proc. Math. Phys. Soc. Tokyo*, **8**, 199, 1915; P. Niggli, *Forts. Min. Kryst. Pet.*, **6**, **44**, 1920; O. Mügge, *Nachr. Gött.*, **1**, 1923; P. F. Kerr, *Econ. Geol.*, **19**, **1**, 1924.

* F. Hochstetter, *Journ. prakt. Chem.*, (1), **27**, 376, 1842; R. Hermann, *ib.*, (1), **40**, 11, 1847; (1), **46**, 257, 1849; C. U. Shepard, *Amer. Journ. Science*, (2), **12**, 210, 1851; S. W. Johnson, *ib.*, (2), **12**, 361, 1851; W. W. Coblentz, *Investigations of Infra-red Spectra*, Washington, **3**, **30**, 1906.

° G. Ekeberg, *Göthen's Journ.*, **5**, 418, 1808; *Afhang. Fis. Kem. Min.*, **1**, **84**, 1806; C. E. von Moll, *Efemeriden der Berg- und Hüttenkunde*, **3**, 78, 1807; J. R. Mourelle, *Rev. Gén. Science*, **26**, 394, 1915; H. Abich, *Konigl. Vet. Acad. Handl. Stockholm*, **6**, 1842; F. A. Genth, *Amer. Journ. Science*, (2), **33**, 196, 1862; G. J. Brush, *ib.*, (3), **1**, 28, 1871; L. Vanuxem and W. H. Keating, *Journ. Acad. Nat. Sciences Philadelphia*, **2**, 277, 1921; F. von Kobell, *Journ. prakt. Chem.*, (1), **44**, 99, 1848; J. D. Dana, *Zeit. Kryst.*, **10**, 490, 1885; F. Pisani, *Compt. Rend.*, **55**, 924, 1862; A. Daubrée, *ib.*, **39**, 153, 1854; H. St. C. Deville and H. Caron, *ib.*, **46**, 764, 1858; T. Thomson, *Outlines of Mineralogy, Geology, and Mineral Analysis*, London, **1**, 221, 1836; J. J. Ebelmen, *Ann. Chim. Phys.*, (3), **33**, 34, 1851; A. Stelzner and H. Schulze, *Neues Jahrb. Min.*, **i**, 120, 1881; A. Stelzner, *ib.*, **i**, 170, 1882; T. Sander, *Liebig's Ann.*, **9**, 181, 1834; A. Damour, *Bull. Soc. Min.*, **1**, 93, 1878; S. Meunier, *ib.*, **10**, 194, 1887; F. Mauro, *Gazz. Chim. Ital.*, **9**, 70, 1879; A. Reis and L. Zimmermann, *Zeit. phys. Chem.*, **102**, 298, 1922; W. H. Bragg, *Phil. Mag.*, (6), **30**, 305, 1915; *Nature*, **95**, 561, 1915; H. Hedström, *Geol. Foren. Stockholm Föhr.*, **23**, 42, 1901; *Neues Jahrb. Min.*, **i**, 165, 1902; W. Ortlöf, *Zeit. phys. Chem.*, **19**, 223, 1896; H. Rosenbuch, *Mikroskopische Physiographie der petrographisch wichtigen Mineralien*, Stuttgart, 1892; J. J. Berzelius, *Lehrbuch der Chemie*, Dresden, **2**, **i**, 310, 1826; *The Use of the Blowpipe in Chemical Analysis*, London, 1822; W. Biltz, *Zeit. anorg. Chem.*, **127**, 169, 1923; M. L. Huggins, *Phys. Rev.*, (2), **21**, 509, 1923; E. V. Shannon, *Amer. Min.*, **8**, 147, 1923.

† L. F. Hawley, *Journ. Amer. Chem. Soc.*, **29**, 300, 1907; J. Smithson, *Ann. Phil.*, (1), **14**, 31, 1819; E. J. Kohlmeier, *Metall Erz.*, **10**, 449, 1913; A. Stavenhagen and E. Schuchardt, *Ber.*, **35**, 911, 1902.

° J. J. Ebelmen, *Ann. Chim. Phys.*, (3), **22**, 213, 1848; (3), **33**, 34, 1851; E. Dufau, *Compt. Rend.*, **135**, 963, 1902; J. A. Krenner, *Zeit. Kryst.*, **43**, 473, 1903.

° F. X. M. Zippe, *Die Mineralien Böhmens*, Prag, 31, 1839; *Baumgartner's Zeit.*, **6**, 9, 1840; B. Quadrat, *Liebig's Ann.*, **55**, 357, 1845; N. W. Fischer, *Pogg. Ann.*, **74**, 115, 1848; G. Rose, *ib.*, **50**, 652, 1840; J. J. Ebelmen, *Ann. Chim. Phys.*, (3), **22**, 213, 1848; (3), **33**, 34, 1851; J. C. Delamétherie, *Journ. Phys.*, **42**, 23, 1793; *Théorie de la terre*, Paris, **2**, 281, 1797; D. L. G. Karsten, *Mineralogische Tabellen*, Berlin, **28**, 72, 1800; R. J. Haüy, *Traité de minéralogie*, Paris, 1801; C. F. Rammelsberg, *Handbuch der Mineralogie*, Tübingen, 1853; J. L. Comte de Bournon, *Traité de minéralogie*, Paris, 1808; J. F. W. Charpentier, *Journ. Mines*, **32**, 321, 1812; *Gilbert's Ann.*, **47**, 205, 1814; P. de la Peyrouse, *Mém. Acad. Toulouse*, **3**, 410, 1829; A. des Cloizeaux, *Manuel de minéralogie*, Paris, **1**, 65, 1862; A. Gavelin, *Bull. Geol. Inst. Upsala*, **15**, 289, 1916.

10 J. A. Hedvall, *Arkiv Kemi Min. Geol.*, **5**, 16, 1914; *Ueber Reaktionsprodukte von Kobalt-oxiden mit anderen Metalloxyden bei hohen Temperaturen*, Upsala, **110**, 1915; L. J. Thénard, *Ann. Chim. Phys.*, (1), **42**, 210, 1802; J. G. Gahn, *Ann. Phil.*, **11**, 40, 1818; *Schweigger's Journ.*, **29**, 295, 1820; J. J. Berzelius, *Lärobok i Kemi*, Upsala, **302**, 1812; J. J. Ebelmen, *Ann. Chim. Phys.*, (3), **22**, 211, 1848; P. Louyet, *Bull. Soc. Bruxelles*, **16**, 428, 1849; *Phil. Mag.*, (3), **35**, 154, 1849; W. Stein, *Journ. prakt. Chem.*, (2), **3**, 428, 1871; S. Burgstaller, *Abhand. Ver. Böhmen Lotos*, **3**, 61, 83, 1912; C. F. Wenzel, *Einleitung in die höhere Chemie*, Leipzig, 1773; F. F. von Leithner, *Dingler's Journ.*, **83**, 121, 1842; M. Rüger, *Ker. Rund.*, **31**, 79, 87, 99, 110, 1923.

§ 13. Aluminium Fluoride

The mineral *fluellite*, $\text{AlF}_3 \cdot \text{H}_2\text{O}$, was discovered by A. Levy¹ in 1824. It is a rare mineral—colourless or white, with or without a tinge of yellow—found at Stenna-gwyn (Cornwall) in minute crystals along with wavellite and uranite on quartz. In 1824, J. J. Berzelius² dissolved alumina in hydrofluoric acid, and on evaporation, obtained a syrup which formed a hydrated gum-like mass dissolving slowly in cold water and rapidly in hot. J. J. Berzelius noted that when heated, the hydrated compound loses hydrogen fluoride and forms a basic aluminium fluoride; indeed, L. Schuch converted aluminium fluoride into alumina and hydrogen fluoride by heating it in a stream of water vapour, $2\text{AlF}_3 + 3\text{H}_2\text{O}$

$\rightleftharpoons \text{Al}_2\text{O}_3 + 6\text{HF}$. C. Brunner found that when alumina is heated to redness, it absorbs the vapour of hydrogen fluoride, and gives off water, but quantitative results were not obtained. According to H. St. C. Deville, if either product be heated in a carbon tube in a stream of hydrogen, at a white heat, most of the aluminium fluoride sublimes and forms rhombohedral crystals. According to P. Hautefeuille, if alumina be heated to a high temp. in a stream of moist hydrogen fluoride crystals of corundum, Al_2O_3 , and of aluminium fluoride are produced.

H. St. C. Deville obtained aluminium fluoride by distilling a mixture of aluminium sulphate and cryolite in a stream of hydrogen; and also by heating a mixture of fluorspar and alumina in a stream of hydrogen chloride; M. Strakosch and C. O. Weber heated a mixture of sodium fluoride with aluminium sulphate and extracted the aluminium fluoride with water; A. Cossa obtained aluminium fluoride by heating a mixture of aluminium sulphate and magnesium fluoride. H. St. C. Deville prepared aluminium fluoride by decomposing silicon tetrafluoride with alumina, and he removed the silicon by means of a mixture of hydrofluoric and nitric acids; he also made aluminium fluoride by heating hydrofluosilicic acid with alumina or china clay; and L. Troost and P. Hautefeuille, by heating alumina in a stream of silicon fluoride. H. Moissan obtained aluminium fluoride by the action of fluorine on aluminium; in the cold the metal is superficially attacked, but when heated the reaction is complete; C. Poulenc also prepared the same compound by the action of hydrogen fluoride on aluminium at 1000° ; W. K. van Haagen and E. F. Smith used alumina.

According to H. St. C. Deville and A. de Schulten, anhydrous aluminium fluoride crystallizes in colourless, transparent, obtuse rhombohedra, but, according to C. Poulenc, the crystals are probably triclinic. C. H. D. Bödeker gave the sp. gr. as 3.065 to 3.13 at 12° . W. Biltz gave 27.1 for the mol. vol. P. P. Fedoteeff and W. Iljinsky found the m.p., or rather the freezing temp., of aluminium fluoride to be 1000° ; N. A. Puschin and A. V. Baskoff give 1040° . E. Baud's value for the heat of formation of aluminium fluoride from its elements is 499 Cals., which is the greatest of all the aluminium-halogen compounds. O. Pettersson gives the heat of formation $2\{\text{Al}(\text{OH})_3, 3\text{HF}_{\text{aq.}}\} = 3 \times 23.415$ Cals.; E. Baud gives the heat of soln. of $\text{AlF}_3 \cdot 3.5\text{H}_2\text{O}$ at 15° as -3.33 Cals.; of $2\text{AlF}_3 \cdot \text{H}_2\text{O}$ at 15° as 51.15 Cals.; the heat of formation $2\text{AlF}_{3\text{solid}} + \text{H}_2\text{O}_{\text{gas}} = 2\text{AlF}_3 \cdot \text{H}_2\text{O}_{\text{solid}} + 33.33$ Cals., and with liquid water, 23.68 Cals. Similarly, $2\text{AlF}_{3\text{solid}} + 7\text{H}_2\text{O}_{\text{liquid}} = 2\text{AlF}_3 \cdot 7\text{H}_2\text{O}_{\text{soluble}} + 64.95$ Cals., and for insoluble $2\text{AlF}_3 \cdot 7\text{H}_2\text{O}$, 65.95 Cals. In spite of a little ionization, A. Speransky found the mol. wt. of aluminium fluoride in aq. soln. to be greater than corresponds with the formula AlF_3 . H. St. C. Deville reported that anhydrous aluminium fluoride is inert chemically, for it is not attacked by water or acids; it is slightly attacked by boiling sulphuric acid, but is not changed by boiling potash-lye; it is decomposed by heating it with calcium oxide at a white heat, and with fused sodium carbonate when a part of the fluorine is volatilized as sodium fluoride. L. Schuch said that the crystals are decomposed completely into alumina and hydrogen fluoride when heated in a current of steam; E. Baud found that aluminium fluoride volatilizes with partial decomposition when heated in a stream of hydrogen; and that the volatilization of aluminium fluoride at a red heat is attended by much decomposition. E. Frémy and C. Feil obtained aluminium borate by fusing aluminium fluoride with boric oxide; A. von Bartal observed no change when carbonyl chloride is passed over cold or heated aluminium fluoride. W. Hampe heated cryolite with aluminium and obtained what he regarded either as aluminium subfluoride, AlF_2 , or a double salt of this subfluoride with sodium fluoride. W. Diehl contested the validity of W. Hampe's conclusion, but W. Hampe further claimed to have formed the same compound by the electrolysis of cryolite.

A. Mazzucchelli says that the contradictory observations which have been reported on the various hydrates of aluminium fluoride are due to complications traceable to metastability and supersaturation; to the slowness with which the solids and soln. attain a state of equilibrium; and to the existence of hydrates

with the same composition but with different solubilities and degrees of resistance to the action of heat. A. Mazzucchelli obtained silky filaments of **monohydrated aluminium fluoride**, $\text{AlF}_3 \cdot \text{H}_2\text{O}$, by evaporating a dil. aq. soln. or a small quantity of a conc. neutral soln. of the salt to dryness, on a water-bath. This product is sparingly soluble in water, by which it is transformed into $\text{AlF}_3 \cdot 3\text{H}_2\text{O}$. The mineral fluellite, $\text{AlF}_3 \cdot \text{H}_2\text{O}$, crystallizes in bipyramids belonging to the rhombic system, and having the axial ratios $a : b : c = 0.770 : 1 : 1.8776$; hardness 3; sp. gr. 2.17; and refractive index 1.47. A. Mazzucchelli states that a soln. of aluminium fluoride is most conveniently prepared by suspending 42 grms. of basic aluminium acetate and 54 grms. of alumina in about 100 c.c. of water and 66 grms. of 40 per cent. hydrofluoric acid. Soln. occurs either at once or after boiling for a short time. The soln. gradually deposits a gelatinous or colloidal hydrate of aluminium fluoride approximately **trihydrated aluminium fluoride**, $\text{AlF}_3 \cdot 3\text{H}_2\text{O}$. The same dil. soln. gradually deposit a crystalline crust of a similar composition, $\text{AlF}_3 \cdot 3\text{H}_2\text{O}$. L. H. Milligan said the product is granular if the soln. contains free acid eq. in amount to the aluminium.

A. Mazzucchelli also found that if 75 c.c. of water be used in place of 100 c.c. in the preceding method of preparation, the liquid becomes very much heated, and, on cooling, deposits crystals of **hemiheptadecahydrated aluminium fluoride**, $\text{AlF}_3 \cdot 8\frac{1}{2}\text{H}_2\text{O}$, which can also be obtained as a felted mass of short needles by cooling below 0° , a more dil. soln. of aluminium fluoride. A sat. aq. soln. of hemiheptadecahydrated aluminium fluoride at 11° contains 3.85 grms. of AlF_3 , and at -0.2° , 1.20 grms. The crystals effloresce rapidly and become opaque, even in a sealed tube; the soluble metastable hydrate passes into the trihydrated fluoride, which is the most stable hydrate under ordinary conditions. According to E. Baud, and A. Mazzucchelli, when two volumes of alcohol are added to one volume of a neutral soln. of alumina in hydrofluoric acid, a crystalline precipitate of **hemiheptahydrated aluminium fluoride**, $\text{AlF}_3 \cdot 3\frac{1}{2}\text{H}_2\text{O}$, which is readily soluble in water, is obtained. The soln. is acid to litmus, and neutral to methyl orange. Another form of hemiheptahydrated aluminium fluoride almost insoluble in water is made by evaporating at 100° a soln. of alumina in aq. hydrofluoric acid. The hemiheptahydrated fluoride remains unchanged in vacuo or over sulphuric acid; it loses 2 mols of water at 100° ; half a mol between 150° and 170° ; and another half mol. between 210° and 250° . The residual hemihydrated *aluminium fluoride*, $\text{AlF}_3 \cdot \frac{1}{2}\text{H}_2\text{O}$, does not decompose at a bright red heat. The hemiheptahydrated fluoride gradually changes to the trihydrated fluoride in contact with water. The heat of soln. of the soluble form of $\text{AlF}_3 \cdot 3\frac{1}{2}\text{H}_2\text{O}$ is 1 Cal. less than that of the insoluble form, and this corresponds with the heat evolved in the transformation of the soluble into the insoluble modification. A. von Bartsch found that carbonyl chloride does not react with aluminium fluoride even at a red heat. G. L. Clark found aluminium fluoride adsorbs ammonia very slowly, forming **aluminium amminochloride**, $\text{AlF}_3 \cdot \text{NH}_3$.

REFERENCES.

- ¹ A. Levy, *Ann. Phil.*, (2), 8, 242, 1824; *Edin. Journ. Science*, 12, 178, 1825.
- ² J. J. Berzelius, *Pogg. Ann.*, 1, 23, 1824; C. Brunner, *ib.*, 98, 488, 1856; L. Troost and P. Hautefeuille, *Compt. Rend.*, 75, 1819, 1872; E. Frémy and C. Feil, *ib.*, 85, 1029, 1878; A. de Schulten, *ib.*, 152, 1261, 1911; C. Poulenc, *Compt. Rend.*, 115, 941, 1892; H. St. C. Deville, *ib.*, 43, 970, 1856; *Ann. Chim. Phys.*, (3), 48, 79, 1856; (3), 61, 330, 1861; C. Poulenc, *ib.*, (7), 11, 66, 1894; P. Hautefeuille, *ib.*, (4), 4, 153, 1864; E. Baud, *ib.*, (8), 1, 60, 1904; *Compt. Rend.*, 135, 1337, 1902; *Sur quelques combinaisons du chlorure et du fluorure d'aluminium*, Paris, 1903; A. Cossa, *Gazz. Chim. Ital.*, 7, 212, 1877; Oesterreichische Anilinfabrik von M. Strakosch & Co. and C. O. Weber, *German Pat.*, D.R.P. 37079, 1885; W. Biltz, *Zeit. anorg. Chem.*, 121, 257, 1922; A. von Bartsch, *ib.*, 56, 49, 1907; P. P. Fedoteff and W. Iljinsky, *ib.*, 80, 113, 1913; H. von Helmolt, *ib.*, 3, 127, 1893; N. A. Puschin and A. V. Baskoff, *ib.*, 81, 347, 1913; L. H. Milligan, *U.S. Pat. No.* 1403183, 1922; H. Moissan, *Le fluor et ses composés*, Paris, 1900; C. Friedel, *Bull. Soc. Chim.*, (2), 21, 241, 1874; L. Schuch, *Liebig's Ann.*, 128, 108, 1863; A. Mazzucchelli, *Atti Accad. Lincei*, (5), 16, i, 775, 1907; O. Pettersson, *Zeit. phys. Chem.*, 5, 259, 1890;

A. Speransky, *Journ. Russ. Phys. Chem. Soc.*, **24**, i, 304, 1893; W. K. van Haagen and E. F. Smith, *Journ. Amer. Chem. Soc.*, **33**, 1504, 1911; C. H. D. Bödeker, *Die Beziehungen zwischen Dichte und Zusammensetzung bei festen und liquiden Stoffen*, Leipzig, 1860; W. Hampe, *Chem. Ztg.*, **4**, 1, 29, 49, 1889; W. Diehl, *ib.*, **4**, 162, 1889; G. L. Clark, *Amer. Journ. Science*, (5), **7**, 1, 1924.

§ 14. The Fluoaluminates

Aluminium fluoride forms a number of double compounds with other metal fluorides. The majority of compounds with the alkali fluorides seem to be salts of the complex **hydrofluoaluminic acid**, $3\text{HF}\cdot\text{AlF}_3$, or H_3AlF_6 . This acid has not been isolated, but H. St. C. Deville¹ reported two acid compounds of aluminium fluoride, namely, (i) $2\text{HF}\cdot 3\text{AlF}_3\cdot 5\text{H}_2\text{O}$, prepared by half saturating hydrofluoric acid with aluminium hydroxide, and adding alcohol. The oily liquid which separates soon crystallizes; and (ii) $\text{HF}\cdot 2\text{AlF}_3\cdot 5\text{H}_2\text{O}$, prepared by evaporating the preceding soln., washing the crystalline residue with boiling water, and drying it in air.

By pouring an excess of a soln. of ammonium fluoride into one of aluminium fluoride, E. Baud obtained a gelatinous precipitate which soon settles. It is supposed to be **ammonium pentafluoaluminate**, $2\text{NH}_4\text{F}\cdot\text{AlF}_3\cdot 1\frac{1}{2}\text{H}_2\text{O}$, or $(\text{NH}_4)_2\text{AlF}_5\cdot 1\frac{1}{2}\text{H}_2\text{O}$. The heat of soln. is $-17\cdot 09$ Cals.; and 100 parts of water dissolve one part of the salt. J. J. Berzelius boiled aluminium hydroxide in an aq. soln. of ammonium fluoride and found part of the ammonia is expelled and a transparent jelly which dries to a white powder is formed. H. von Helmholt washed the gelatinous precipitate with dil. alcohol, and found it to be the ammonium analogue of cryolite—**ammonium hexafluoaluminate**, $(\text{NH}_4)_3\text{AlF}_6$, or $3\text{NH}_4\text{F}\cdot\text{AlF}_3$ —with conc. soln. octahedral crystals, belonging to the cubic system, are precipitated. The salt is feebly soluble in water, and, according to H. von Helmholt, ammonia does not precipitate alumina from the soln.; while, according to J. J. Berzelius, the salt is not soluble in water containing ammonia or ammonium fluoride, and either of these compounds precipitates the salt from its aq. soln. When heated, the salt gives off ammonia, and then ammonium hydrogen fluoride, leaving a residue of aluminium oxyfluoride. J. Petersen prepared a similar salt.

J. J. Berzelius² obtained lithium fluoaluminate as a white powder, insoluble in water, by treating lithium hydrofluoride with aluminium hydroxide. N. A. Puschin and A. V. Baskoff found the m.p. curve of lithium fluoride is of the type shown in Fig. 54. The curve falls from 870° to a eutectic at 706° with 14.5 molar per cent. of aluminium fluoride, and then rises to a maximum over 783° —say 800° —when the mixture corresponds with the lithium analogue of cryolite, **lithium hexafluoaluminate**, $3\text{LiF}\cdot\text{AlF}_3$, or Li_3AlF_6 ; the temp. then falls to the eutectic 691° with 37 mol per cent. of aluminium fluoride. The curve was not further explored. The mineral *cryolithionite* is a double **sodium lithium fluoaluminate**, $\text{Na}_3\text{Li}_3\text{Al}_2\text{F}_{12}$, or $2\text{AlF}_3\cdot 3\text{NaF}\cdot 3\text{LiF}$. It occurs as cubic crystals at Ivigtut (Greenland) and in the Ilmen Mountains (Urals). According to N. V. Ussing, the hardness is 2–3; sp. gr., 2.774–2.778; index of refraction for the Li-line, 1.3382; for the Na-line, 1.3395; and for the Tl-line, 1.3408. The crystals decrepitate when heated to redness; they soften at 700° , and, according to N. V. Ussing, melt at 710° . The solid is rather more soluble in water than cryolite—100 c.c. of water at 18° dissolve 0.074 grm. of cryolithionite. The aq. soln., on evaporation, gives small cubic crystals, which are decomposed by warm sulphuric acid.

The minerals containing sodium and aluminium fluorides are: *cryolite*, which has a composition corresponding with $\text{AlF}_3\cdot 3\text{NaF}$; *cryolithionite*, with $2\text{AlF}_3\cdot 3\text{NaF}\cdot 3\text{LiF}$; *chiolite*, with $3\text{AlF}_3\cdot 5\text{NaF}$, or with $\text{AlF}_3\cdot 1\frac{1}{3}\text{NaF}$; and *ralstonite*, with $3\text{Al}(\text{F}, \text{OH})_3\cdot (\text{Na}_2, \text{Mg})\text{F}_2\cdot 2\text{H}_2\text{O}$; *pachnolite* and *thomsenolite*, which are dimorphic forms with the composition $\text{AlF}_3\cdot \text{CaF}_2\cdot \text{NaF}\cdot \text{H}_2\text{O}$. According to G. F. Schumacher,³ a sample of cryolite was brought from Greenland to Copenhagen in 1795, but was thought to be barytes until P. C. Abildgaard found it to contain

fluorine and aluminium; the residue was found by M. H. Klaproth, and L. N. Vauquelin in 1800, to be sodium; and R. J. Haüy described it, in 1801, as *fluatè d'alumine et de soude des chimistes*. The resemblance of the mineral to snow, and its still greater likeness, when wet, to ice, suggested to P. C. Abildgaard the name *kryolith*, *kryolite*, or **cryolite**—*κρύος*, frost; and *λίθος*, stone. E. F. Glocker called it *Eisstein*—ice-stone. The mineral was later described by J. B. d'Andrada and D. L. G. Karsten. In 1811, K. L. Giesecke discovered a large deposit of cryolite at the place now known as Ivigtut in Frederikshaab, in the south-west of Greenland. This is virtually the only deposit of commercial importance known at the present time; although comparatively small deposits have been found at Miask (Ural Mountains); in the granite at the north-east base of St. Peter's dome, Pike's Peak, Colorado; Yellowstone National Park, Wyoming; and at Aragonien Huesca, Spain. The fluorine compounds, says F. W. Clarke, are rarely found in eruptive rocks; they are especially characteristic of deep-seated or plutonic rocks, where the gaseous exhalations have been retained under press., and are commonly regarded as of pneumatolytic origin. F. Johnstrup says that the bed of cryolite is a concretionary secretion in eruptive granite; and R. Baldauf supposes it to have been formed by the action of fluoriferous gases upon the original granite magma.

The minerals—quartz, siderite, galenite, sphalerite, pyrite, chalcopyrite, and wolframite—irregularly scattered through the mass of cryolite, are separated by hand-sorting. There are also mineral impurities—pachnolite, thomsenolite, arksuktite, gearsuktite, ralstonite, prosopite, ivigtite, and hagemannite—all comparatively rare, or found only in association with cryolite; these are separated from cryolite in the process of manufacture since they suffer no change under the chemical treatment by which cryolite is decomposed. The cryolite mines were opened by D. Schmidt in 1857, and the Danish Government, which owns the mines, claims one-fifth of every cubic fathom (13.6 tons of 2240 lbs.) of cryolite mined and shipped from Greenland. The cryolite is mined mainly in summer; it is then sorted into first and second grades.

Cryolite was formerly the chief source of aluminium, but was superseded by bauxite. H. Rose, and A. Dick obtained aluminium from cryolite in 1855 by fusing the mineral packed with alternate layers of sodium in a magnesia-lined crucible. Cryolite is still used in the production of the metal, but not as a source of supply, for it is used as a solvent for the alumina since, when fused, it dissolves over 21 per cent. of alumina. During electrolysis the alumina is decomposed. A small amount of soda and alumina is manufactured from cryolite by J. Thomsen's process. Cryolite is also used as an opacifying agent in the manufacture of opaque glass—e.g. *cryolite glass* or *hot-cast porcelain*—and enamels.

J. J. Berzelius⁴ prepared **sodium fluoaluminate** by adding aluminium hydroxide to an aq. soln. of sodium hydrofluoride until the acidity was neutralized; if sodium fluoride alone is used, half the sodium is liberated as hydroxide and remains in soln. as sodium aluminate; L. Schuch, and O. T. Christensen showed the reaction is probably that symbolized: $6\text{NaF} + 2\text{Al}_2\text{O}_3 \rightleftharpoons \text{Na}_3\text{AlF}_6 + 3\text{NaAlO}_2$. E. Baud also mixed a dil. soln. of sodium fluoride with the correct quantity of aluminium fluoride. H. St. C. Deville neutralized a mixture of aluminium hydroxide and sodium carbonate with hydrofluoric acid. The soln. in either case were evaporated to a gelatinous mass which dries to a white powder. The Société Anon. d'Alum precipitates the double salt by adding sodium chloride to a soln. of aluminium hydroxide in an excess of hydrofluoric acid. L. Schuch mixed cryolite with soda-lye of sp. gr. 1.26, whereby a soln. of sodium aluminate was formed: $\text{Na}_3\text{AlF}_6 + 4\text{NaOH} = 6\text{NaF} + \text{NaAlO}_2 + 2\text{H}_2\text{O}$; if carbon dioxide be passed through the boiling soln. pulverulent sodium aluminate is precipitated and the admixed aluminium hydroxide can be removed by treatment with acetic acid. H. St. C. Deville prepared sodium fluoaluminate by melting aluminium chloride or sodium chloroaluminate with sodium fluoride; and by treating the soln. of aluminium fluoride, obtained by the action of hydrofluosilicic acid on china clay, with sodium

fluoride. H. Howard also reported processes for making what was called artificial cryolite.

H. St. C. Deville prepared sodium fluoaluminate by melting sodium fluoride with aluminium fluoride; this binary system has been studied by P. P. Fedotieff and W. P. Ilinsky, and N. A. Puschin and A. V. Baskoff; they found the only compounds of the binary mixture were $3\text{NaF}\cdot\text{AlF}_3$, and $5\text{NaF}\cdot 3\text{AlF}_3$, the latter being analogous with the mineral *chiolite*. The fusion curve is indicated in Fig. 57. There are two eutectics, the compound $5\text{NaF}\cdot 3\text{AlF}_3$ breaks up at 735° into $3\text{NaF}\cdot\text{AlF}_3$ and AlF_3 . The cooling curve of solid sodium hexafluoaluminate shows, at 600° , a break which is interpreted to mean that there is a polymorphic transformation into the variety stable at ordinary temp. It will be observed that the fall of the curve shows that the addition of sodium fluoride to cryolite reduces the fusion temp. from 1000° down to 735° .

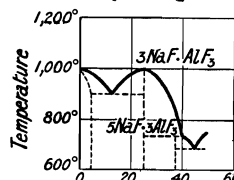

Fig. 57.—Freezing Curves of Mixtures of Aluminium and Sodium Fluorides.

Sodium fluoaluminate prepared by the wet processes is a white powder resembling magnesia, but cryolite may occur in monoclinic prisms with axial ratios, according to J. A. Krenner,⁵ $a : b : c = 0.96625 : 1 : 1.38824$, and $\beta = 89^\circ 49'$; usually, however, it occurs massive. According to R. Nacken, the monoclinic crystals of cryolite pass into a cubic modification at about 550° – 570° ; and F. Cornu suggests that the cubic modification $(3\text{NaF}\cdot\text{AlF}_3)_2$ is isomorphous with cryolithionite, $\text{Li}_3\text{Na}_3\text{Al}_2\text{F}_{12}$ —*vide infra*. The colour varies from snow-white to yellowish or reddish-white; it breaks in three directions with rectangular cleavages; it is brittle with an uneven fracture; and is translucent with a vitreous lustre. The hardness is between 2 and 3; and its sp. gr. between 2.95 and 3.0. The fusibility of cryolite was early noted by J. J. Berzelius—it can be fused in the flame of a candle; its m. p. is a little below 1000° —N. V. Ussing gives 920° . W. Moldenhauer gives 985° ; F. R. Pyne and Y. S. Hardcastle give 1000° ; N. A. Puschin and A. V. Baskoff give 1020° . The powder sticks together when heated to 870° . J. J. Berzelius noted that cryolite fuses at a red heat, and, on cooling, forms an opaque glass; O. Mügge found that on cooling molten cryolite, a crust with a skin of crystal skeletons resembling snow stars is formed. This crust is isotropic, and O. Mügge therefore argues that the crystals are either cubic or hexagonal—probably the latter. J. Smithson found that when the fused mineral is exposed to the air for a long time, it loses its ready fusibility owing to the loss of hydrogen fluoride. R. Nacken also found that it cannot be heated in an open vessel at atm. press., without the sublimation of some aluminium fluoride; and O. Mügge noticed that when small fragments are heated they first become turbid, then clarify, and afterwards evolve vapours of sodium fluoride. P. Oeberg's value for the sp. ht. is 0.2522, and A. Joly's value, 0.2548. The crystals have a feeble and positive double refraction; J. A. Krenner's value for the index of refraction is 1.364 for sodium light; M. Websky's value for candle-light is 1.3343; and O. B. Böggild's value is 1.3390. T. Liebisch and H. Rubens studied the optical properties of crystals of cryolite in the infra-red spectrum. E. Newbery and H. Lupton noted that the colour of the salt suffered no change on exposure to radium-rays; and there was a slight thermoluminescence. K. Arndt and H. Probst studied the electrolysis of cryolite—*vide* aluminium metal. When the crystals are gradually warmed, D. Hahn found that they show a yellowish luminescence, which, with rather stronger heating, does not become paler, but with still stronger heating is lost. F. Kreutz found cryolite to be blackened by a prolonged exposure to the cathode rays, and decolorized by exposure to the air for a few minutes; he recalls J. W. Taylor's and F. Kreutz's statements that cryolite from the deepest layers in the mines is black, and only when exposed to the air does the surface become white. E. Wartmann, and F. Beijerinck say cryolite is a non-conductor of electricity, but H. St. C. Deville showed that it becomes a conductor and melts at a lower temp. if other alkali halides be present.

F. Johnstrup⁶ says cryolite is easily attacked by atm. moisture. At 12°, 100 parts of water dissolve 0.0366 part of cryolite, and the solubility is augmented if carbon dioxide be present. F. Lauterborn proposed the decomposition of cryolite by boiling with water in order to extract sodium fluoride. L. Pfaundler observed no chemical action when bromine is passed over molten cryolite. F. Wöhler found that when heated with ammonium chloride, some ammonium fluoride is volatilized, part of the sodium fluoride is converted into the chloride, and the product is more fusible than cryolite alone. J. J. Berzelius says that hydrofluoric acid is evolved when cryolite is heated with conc. sulphuric acid; and F. Wöhler found that both sodium and aluminium sulphates are formed, and a process by J. F. Persoz for the extraction of soda from cryolite was based on this reaction. F. Leydolt and H. Baumhauer have studied the etching figures of cryolite with sulphuric acid. F. Wöhler detected no reaction when cryolite is boiled with a soln. of aluminium sulphate. N. N. Beketoff observed that aluminium metal is formed when cryolite is heated with magnesium; H. St. C. Deville observed a similar result when cryolite is heated with sodium. C. Tissier observed no reaction when cryolite is boiled with a soln. of magnesium hydroxide, but L. Schuch observed that boiling soln. of sodium hydroxide form sodium fluoride and sodium aluminate. J. Thomsen's process for extracting alumina and soda (*q.v.*) from cryolite is based on the decomposition which occurs when cryolite is heated with calcium carbonate or oxide, and subsequently leached with water. R. von Wagner proposed baryta in place of lime, but the substitute was too costly. F. G. Spilsbury patented a process in which cryolite was decomposed by heating it with milk of lime, and C. Tissier tried it, but obtained only a 33 per cent. yield. D. Sauerwein showed that at least six mols of lime are needed for one of cryolite if the decomposition is to be complete: $2\text{Na}_3\text{AlF}_6 + 7\text{Ca}(\text{OH})_2 = 6\text{NaOH} + \text{Ca}(\text{AlO}_2)_2 + 6\text{CaF}_2 + 4\text{H}_2\text{O}$. H. Bauer proposed melting cryolite with $2\frac{1}{2}$ times its weight of calcium sulphate: $2\text{Na}_3\text{AlF}_6 + 3\text{CaSO}_4 = 3\text{Na}_2\text{SO}_4 + 3\text{CaF}_2 + 2\text{AlF}_3$, and removing the soluble salts by leaching with water; he also proposed boiling cryolite with a mixture of its own weight of calcium carbonate, 30–40 parts of water, and one per cent. of sodium hydroxide. L. Schuch also decomposed cryolite by boiling it with sodium silicate whereby insoluble aluminium silicate and soluble sodium fluoride are formed—the decomposition is incomplete. J. Lemberg observed that with a soln. of calcium chloride at 100°, part of the sodium in powdered cryolite is replaced by calcium and pachnolite is formed. C. Nöllner obtained similar results with soln. of calcium, barium, or magnesium chloride or strontium nitrate. J. Lemberg also studied the action of lead nitrate soln. on cryolite. E. Paterno and U. Alvisi noted the slow evolution of hydrofluoric acid when powdered cryolite is heated with a soln. of oxalic acid.

N. V. Ussing found rhombic dodecahedra belonging to the cubic system in the cryolite at Ivigtut, Greenland. The composition corresponds with sodium lithium fluoaluminates, $\text{Li}_3\text{Na}_3\text{Al}_2\text{F}_{12}$, and was named *cryolithionite*. The crystals contain liquid inclusions and also cryolite. The cleavage is parallel to the faces of the rhombic dodecahedron; the sp. gr. is 2.77; the hardness $2\frac{1}{2}$ to 3; and the refractive index for Na-light, 1.3395. The m.p. is 710°, and when the magma cools, rectangular arborescent crystals are formed. A litre of water at 18° dissolves about 0.8 part of the mineral. The mineral is said to be crystallographically related more to garnet, $\text{Ca}_3\text{Si}_3\text{Al}_2\text{O}_{12}$, than to cryolite. F. Cornu⁷ said that the cubic form of cryolite is probably isomorphous with this mineral. Cryolithionite contains a higher proportion of lithium than any known mineral. W. Cross and W. F. Hillebrand found a native form of cryolite at El Paso (Colorado, U.S.A.) with about two-thirds of the sodium replaced by potassium, and the mineral was called *elpasolite*. The crystals are isotropic—cubes or octahedra.

Two compounds of aluminium and potassium fluorides have been described, and also some hydrated forms. J. J. Berzelius precipitated potassium pentafluoroaluminates, K_2AlF_5 , or $2\text{KF} \cdot \text{AlF}_3$, by stirring an aq. soln. of aluminium fluoride with insufficient potassium fluoride for complete saturation—if a slight excess of

potassium fluoride be employed, he noted that **potassium hexafluoroaluminate**, $\text{AlF}_3 \cdot 3\text{KF}$, or K_3AlF_6 , is formed; and that a permanent precipitate of K_3AlF_6 is formed in a soln. of alum. only when an excess of potassium fluoride is added. According to J. J. Berzelius, also, potassium pentafluoroaluminate is formed, by digesting aluminium hydroxide with aq. potassium hydrogen fluoride—the first portions of the aluminium hydroxide dissolve, but when more of the aluminium hydroxide is added, the salt K_2AlF_5 separates out: $6\text{KHF}_2 + \text{Al}_2\text{O}_3 = 2\text{K}_2\text{AlF}_5 + 3\text{H}_2\text{O} + 2\text{KF}$; while if the gelatinous precipitate be boiled with the supernatant liquid, potassium hexafluoroaluminate, K_3AlF_6 —the potassium analogue of cryolite—is formed, and if the boiling be continued still further the salt is hydrolyzed and a basic salt is formed. L. Schuch obtained gelatinous aluminium hexafluoroaluminate by boiling aluminium hydroxide with potassium fluoride. E. Baud used very dil. aq. soln. of the component salts, and obtained a gelatinous precipitate whose composition corresponded with $\text{K}_3\text{AlF}_6 \cdot 3\frac{1}{2}\text{H}_2\text{O}$. H. St. C. Deville also prepared the last-named compound by fusing aluminium chloride with an excess of potassium fluoride; A. Duboin, by fusing alumina with potassium fluosilicate and an excess of potassium fluoride; and N. A. Puschin and A. V. Baskoff, by fusing together mol. proportions of the component salts. The curve resembles that shown in Fig. 53; there is a eutectic at 837° when 7.5 mol per cent. of aluminium fluoride is present, and there is also another eutectic at 568° with about 40 mol per cent. of aluminium fluoride is present; between the two eutectic points the curve rises to a maximum at 1030° when the composition approximates to $3\text{KF} \cdot \text{AlF}_3$. At 570° , there is also evidence of the formation of a second compound—**potassium ennefluoroaluminate**, $2\text{AlF}_3 \cdot 3\text{KF}$, or $\text{K}_3\text{Al}_2\text{F}_9$, the potassium analogue of chiolite—on the cooling curve of mixtures with 25 to 40 mol per cent. of aluminium fluoride. There is also a break in the cooling curve of $\text{AlF}_3 \cdot 3\text{KF}$ at about 302° , corresponding with the formation of a polymorphic variety analogous to that observed with cryolite. Mixtures of the two fluorides with 35 mol per cent. of aluminium fluoride are rose-coloured.

According to J. J. Berzelius, the precipitated forms of the potassium fluoroaluminates are gelatinous colloids with similar properties. They dry to white powders which give off their water at a red heat. They are decomposed with the evolution of hydrofluoric acid, when boiled with sulphuric acid, and aluminium hydroxide is precipitated from the soln. by ammonia. J. L. Gay Lussac and L. J. Thénard add that the gelatinous precipitate is but sparingly soluble in acids, and still less so in water. According to E. Baud, 100 grms. of water at 16° dissolve 0.385 grm. of the precipitated $\text{AlF}_3 \cdot 3\text{KF} \cdot 3\frac{1}{2}\text{H}_2\text{O}$; the heat of soln. is -20.22 Cals., and the heat of formation, 18.81 Cals. The m.p. of potassium hexafluoroaluminate is 1035° . A. Duboin has examined the optical properties of potassium cryolite; the double refraction is feebly negative, and while not establishing its isomorphism with cryolite, he says the two salts are probably isomorphous.

N. A. Puschin and A. V. Baskoff obtained fusion curves for mixtures of aluminium fluoride with rubidium and caesium fluorides; the curves are, in general, similar to those obtained with potassium fluoride. With rubidium fluoride there is a eutectic at 790° with 6.5 molar per cent. of aluminium fluoride; a maximum at 985° corresponding with the m.p. of **rubidium hexafluoroaluminate**, $3\text{RbF} \cdot \text{AlF}_3$, or Rb_3AlF_6 ; a second eutectic at 570° , and a break in the cooling curve of the hexafluoride at 350° is taken to represent a polymorphic transformation. Mixtures with about 35 mol per cent. of aluminium fluoride are rose-coloured. Similarly with caesium fluoride; there is a eutectic at 685° with 5.5 mol per cent. of aluminium fluoride; a maximum at 823° corresponding with the m.p. of **caesium hexafluoroaluminate**, $3\text{CsF} \cdot \text{AlF}_3$, or Cs_3AlF_6 ; a eutectic at 490° ; and a break in the cooling curve of the hexafluoride corresponding with a polymorphic transformation. Mixtures with up to 15 mol per cent. of aluminium fluoride are green; with 22.5 to 25 mol per cent., colourless; with 28.5 to 31.5 mol per cent., rose-red; and with 40 mol per cent., colourless; N. A. Puschin and A. V. Baskoff say that besides $\text{Na}_3\text{Al}_2\text{F}_9$ and $\text{K}_3\text{Al}_2\text{F}_9$ there is

evidence of the formation of **rubidium ennefluodialuminate**, $\text{Rb}_3\text{Al}_2\text{F}_9$, but the compounds themselves have not been examined, and the evidence is inadequate. No solid soln. were observed with mixtures of aluminium and the alkali fluorides. The double compounds of the alkali and aluminium fluorides of the cryolite type M_3AlF_6 , or $3\text{RF}\cdot\text{AlF}_3$,

M.p.	LiF	NaF	KF	RbF	CsF
Transformation	800°	1020°	1035°	985°	823°
	—	600°	300°	350°	—

J. J. Berzelius prepared pale bluish-green needle-like crystals of **cupric fluoaluminate** which he did not analyze. The crystals dissolve slowly in water; and R. F. Weinland and O. Köppen⁸ found that aluminium fluoride unites with cupric fluoride to form three double salts. **Undecahydrated cupric heptafluoaluminate**, $\text{AlF}_3\cdot 2\text{CuF}_2\cdot 11\text{H}_2\text{O}$, or $\text{Cu}_2\text{AlF}_7\cdot 11\text{H}_2\text{O}$, is obtained from soln. containing 1 mol per cent. aluminium fluoride to 2 or more mol per cent. copper fluoride. It crystallizes in spherical aggregates of blue leaflets and does not effloresce over sulphuric acid. **Octodecahydrated cupric dodecafluoaluminate**, $2\text{AlF}_3\cdot 3\text{CuF}_2\cdot 18\text{H}_2\text{O}$, crystallizes in deep blue prisms resembling feldspar, from soln. containing 2 mol per cent. aluminium fluoride to 3 mol per cent. copper fluoride in the presence of only small quantities of hydrofluoric acid. If much acid is present, **octohydrated cupric hydrohexafluoaluminate**, $\text{AlF}_3\cdot \text{CuF}_2\cdot 8\text{HF}\cdot 8\text{H}_2\text{O}$, is formed; this crystallizes in large, blue rhombohedra from soln. containing 1 mol per cent. aluminium fluoride to 1 mol per cent. or less of copper fluoride and an excess of hydrofluoric acid, and effloresces rapidly on exposure to the air with evolution of water and hydrofluoric acid.

It is somewhat doubtful if double compounds of aluminium fluoride with the fluorides of the alkaline earths have been prepared. Fused mixtures of calcium and aluminium fluorides have a eutectic between 815° and 820°. P. Pascal and

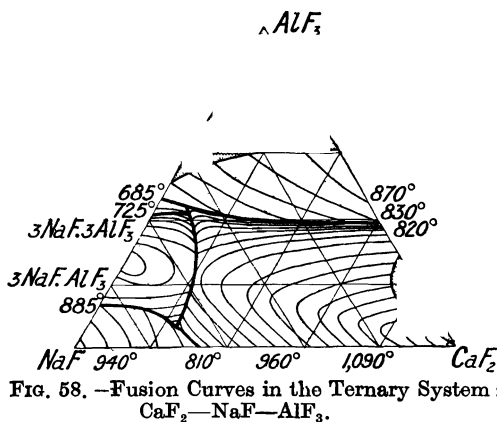

A. Jouniaux's equilibrium diagram between cryolite and fluorspar is shown in Fig. 6, where the dotted lines represent the solidus curves, the continuous lines the liquidus curves. P. P. Fedotieff and W. P. Ilinsky found the typical V-curve between calcium and aluminium fluorides with the eutectic at about 805° and 52 per cent. of aluminium fluoride. They also studied the m.p. of ternary mixtures of aluminium, sodium, and calcium fluorides. The results are shown in Fig. 58; the shaded portions of the diagram were not explored. F. Röder⁹ prepared

crystals of **barium fluoaluminate** by fusing a mixture of cryolite with about $1\frac{1}{2}$ times its weight of barium chloride, and 10 times its weight of sodium chloride. The composition of the crystals did not agree closely with the formula $\text{BaF}_2\cdot\text{AlF}_3$. Similar results were obtained with **strontium fluoaluminate**. It is probable that the product in each case was a solid soln. of mixed crystals of two salts. The product was attacked by water.

A. Nöllner digested powdered cryolite for three months at 100° with a conc. soln. of calcium chloride, and, after washing and drying the product at 100°, he noted that about five-sixths of the sodium had been replaced by calcium. He represented the product as $3(\frac{1}{3}\text{Na}_2\text{Ca})\text{F}\cdot\text{AlF}_3\cdot\text{H}_2\text{O}$; and the residue remaining after a six days' digestion at 180°, by $3(\frac{1}{3}\text{Na}_2\text{Ca})\text{F}\cdot\text{AlF}_3\cdot\frac{1}{2}\text{H}_2\text{O}$. There is possibly here a reversible reaction: $3\text{NaF}\cdot\text{AlF}_3 + \text{CaCl}_{2\text{aq}} \rightleftharpoons 2\text{NaCl}_{\text{aq}} + \text{NaF}\cdot\text{CaF}_2\cdot\text{AlF}_3$. The reaction can be completed if the calcium chloride be in sufficient excess; indeed, J. Lemberg

completed the conversion by digesting powdered cryolite for a month with a conc. soln. of calcium chloride.

According to W. Flight's analysis, the mineral *evigtokite* found in the Greenland cryolite bed has a composition corresponding with **dihydrated calcium heptafluoroaluminate**, $\text{AlF}_3 \cdot 2\text{CaF}_2 \cdot 2\text{H}_2\text{O}$, or $\text{Ca}_2\text{AlF}_7 \cdot 2\text{H}_2\text{O}$. The mineral *pachnolite*—from $\pi\acute{\alpha}\chi\upsilon\eta$, frost—is regarded as **hydrated sodium calcium hexafluoroaluminate**, $\text{NaF} \cdot \text{CaF}_2 \cdot \text{AlF}_3 \cdot \text{H}_2\text{O}$. It was discovered by H. Kopp at Ivigtut, Greenland; F. Wöhler called it *pyroconite*—from $\pi\acute{\upsilon}\rho$, fire; $\kappa\omicron\nu\iota\alpha$, powder—because it falls to powder when ignited. Analyses were made by H. Kopp, F. Wöhler, G. Hagemann, and G. A. König. According to P. Groth, the crystals are monoclinic with axial ratios $a : b : c = 1.1626 : 1 : 1.5320$, and $\beta = 89^\circ 40'$; the hardness is 3–4; the sp. gr. 2.929, according to F. Wöhler, and 2.923, according to H. Kopp; and index of refraction for sodium light 1.4119, according to O. B. Böggild. H. Kopp noted that, when heated, hydrofluoric acid and water are given off. According to H. Kopp, the ratio Na : Ca is as 4 : 3, and, according to G. von Rath, as 1 : 1. The mineral has been reported from Ivigtut in Greenland, and St. Peter's Dome in Colorado. E. S. Larsen and co-workers found a mineral which they called *creedite* in the fluorite deposits of Creede Quadrangle, Colorado. W. F. Foshag also examined the mineral. Its composition corresponds with $2\text{CaF}_2 \cdot 2\text{Al}(\text{OH}, \text{F})_3 \cdot 2\text{H}_2\text{O} \cdot \text{CaSO}_4$, which recalls the doubled formula of pachnolite, $2\text{CaF}_2 \cdot 2\text{AlF}_3 \cdot 2\text{H}_2\text{O} \cdot 2\text{NaF}$. It occurs in radiated masses which are colourless, sometimes showing delicate purple bands. The crystals are monoclinic with axial ratios $a : b : c = 1.16199 : 1 : 1.1597$, and $\beta = 85^\circ 30'$. The cleavage is pinacoidal, parallel to the (100)-face. The optic axial angles for Li-, Na-, and Tl-light are respectively $2\gamma = 64^\circ 30'$, $64^\circ 22'$, and $64^\circ 20'$. The sp. gr. is 2.713 to 2.730. The indices of refraction are $\alpha = 1.461$, $\beta = 1.478$, and $\gamma = 1.485$. The optical character is negative. The analogous mineral *thomsenolite* has a similar composition; and, according to J. A. Krenner, it crystallizes in the monoclinic system with the axial ratios $a : b : c = 0.9975 : 1 : 1.0329$, and $\beta = 86^\circ 48'$; the hardness is 2; and the sp. gr. between 2.93 and 3.0. O. B. Böggild gives the indices of refraction for sodium light as $\alpha = 1.4072$; $\beta = 1.4136$; and $\gamma = 1.4150$. It occurs at Ivigtut in Greenland; St. Peter's Dome in Colorado; the Urals in Russia; and a sample has been reported from Japan; it was also described by E. Sharsen and R. C. Wells. The white earthy mineral resembling china clay, called *gearksutite*, has a composition corresponding with $\text{Al}(\text{F}, \text{OH})_3 \cdot \text{CaF}_2 \cdot \text{H}_2\text{O}$. It consists, according to P. Groth, of very small needles with a feeble double refraction. It occurs at Ivigtut and Evigtokit, in Greenland; St. Peter's Dome in Colorado; and in the Urals in Russia. The monoclinic crystals of *prosoquite* have the composition $2\text{Al}(\text{F}, \text{OH})_3 \cdot \text{Ca}(\text{F}, \text{OH})_2$, and, according to A. des Cloizeaux, the axial ratios $a : b : c = 1.3188 : 1 : 0.5950$, and $\beta = 85^\circ 40'$; the hardness is between 4 and 5; and the sp. gr. 2.88–2.89. It occurs at Altenburg in Saxony; at Schlaggenwald in Bohemia; St. Peter's Dome in Colorado; Tovele in Utah; and at Mount Bischoff in Tasmania. A form of pachnolite contaminated with ferruginous matters—*e.g.* ochre—cryolite was called *hagemannite* by C. U. Shepard. F. Johnstrup regards it as a decomposition product of cryolite and iron spar. Octahedral crystals, white or colourless, of *ralstonite* occur coloured more or less yellow with iron oxide, in the cryolite beds at Ivigtut in Greenland; at St. Peter's Dome in Colorado; and in Japan. The hardness is between 4 and 5; the sp. gr. 2.6. According to O. G. Nordenskjöld, S. L. Penfield and D. N. Harper, and K. Jimbo, the composition approximates $(\text{Na}_2, \text{Ca}, \text{Mg})\text{F}_2 \cdot 3\text{Al}(\text{F}, \text{OH})_3 \cdot 2\text{H}_2\text{O}$, or $(\text{Na}_2, \text{Mg})\text{F}_2 \cdot 3\text{Al}(\text{F}, \text{OH})_3 \cdot 2\text{H}_2\text{O}$. A. Nöllner prepared **magnesium sodium fluoaluminates**, $\text{AlF}_3 \cdot 3(\frac{1}{3}\text{Na}\frac{2}{3}\text{Mg})\text{F} \cdot \text{H}_2\text{O}$, and $\text{AlF}_3 \cdot 3(\frac{1}{3}\text{Na}\frac{2}{3}\text{Mg})\text{F} \cdot \text{H}_2\text{O}$, respectively with five-sixths and two-thirds of the sodium in cryolite replaced by magnesium by digesting powdered cryolite with a conc. aq. soln. of magnesium chloride respectively for three months at 100° , and for six days at 180° . By reheating the products of these operations with conc. aq. soln. of calcium chloride, A. Nöllner obtained triple salts, **magnesium calcium sodium fluoaluminates**— $\text{AlF}_3 \cdot 3(\frac{3}{12}\text{Na}\frac{2}{12}\text{Ca}\frac{7}{12}\text{Mg})\text{F} \cdot \text{H}_2\text{O}$ and

$\text{AlF}_3 \cdot 3\left(\frac{3}{12}\text{Na} \cdot \frac{4}{12}\text{Ca} \cdot \frac{5}{12}\text{Mg}\right)\text{F} \cdot \text{H}_2\text{O}$. F. Röder also prepared crystals of **magnesium fluoaluminate** analogous with those of barium fluoaluminate.

J. J. Berzelius¹⁰ evaporated a soln. of zinc oxide and alumina in hydrofluoric acid, and obtained long, colourless, needle-like crystals probably corresponding with **zinc octofluodialuminate**, $\text{ZnF}_2 \cdot 2\text{AlF}_3$, or ZnAl_2F_8 , which were soluble in water, ammonia precipitated a hydrated zinc aluminate, or a mixture of zinc and aluminium hydroxides from the aq. soln. R. F. Weinland and O. Köppen prepared **heptahydrated zinc pentafluoaluminate**, $\text{AlF}_3 \cdot \text{ZnF}_2 \cdot 7\text{H}_2\text{O}$, by mixing soln. of aluminium hydroxide and of zinc hydroxide or carbonate in dil. hydrofluoric acid, and evaporating over lime. The product can be crystallized in colourless needle-like crystals from dil. hydrofluoric acid. Small, greenish-white, rhombohedral crystals of **heptahydrated ferrous pentafluoaluminate**, $\text{FeF}_2 \cdot \text{AlF}_3 \cdot 7\text{H}_2\text{O}$, were obtained in a similar way. These crystals do not oxidize on exposure to air, or effloresce over sulphuric acid. Green crystals of **heptahydrated nickel pentafluoaluminate**, $\text{NiF}_2 \cdot \text{AlF}_3 \cdot 7\text{H}_2\text{O}$; and reddish-white crystals of **heptahydrated cobalt pentafluoaluminate**, $\text{CoF}_2 \cdot \text{AlF}_3 \cdot 7\text{H}_2\text{O}$, were similarly obtained by R. F. Weinland and O. Köppen. White crystals of **thallous dodecafluoaluminate**, $3\text{TlF} \cdot 3\text{AlF}_3$, were prepared by F. Ephraim and P. Barteczko by the action of a soln. of thallous fluoride in hydrofluoric acid upon aluminium hydroxide; and by the evaporating on a water-bath a soln. of the theoretical quantities of the component salts in just sufficient water for the dissolution. The crystals are so stable that they are not completely decomposed by heating them with a soln. of sodium carbonate, or by heating with sulphuric acid. F. Fischer and K. Thiele obtained evidence of the existence of a *lead fluoaluminate* when lead carbonate is dissolved in a soln. of alumina in an excess of hydrofluoric acid.

REFERENCES.

- ¹ H. St. C. Deville, *Ann. Chim. Phys.*, (3), **61**, 329, 1361; E. Baud, *ib.*, (8), **1**, 66, 1904; *Compt. Rend.*, **135**, 1337, 1902; H. von Helmholtz, *Zeit. anorg. Chem.*, **3**, 127, 1893; J. J. Berzelius, *Pogg. Ann.*, **1**, 41, 1824; J. Petersen, *Journ. prakt. Chem.*, (2), **40**, 55, 1889.
- ² J. J. Berzelius, *Pogg. Ann.*, **1**, 41, 1824; N. V. Ussing, *Tschermak's Mitt.*, (2), **23**, 300, 1904; O. B. Böggild, *Mineralogia Groenlandica*, Copenhagen, 1905; N. A. Puschin and A. V. Baskoff, *Zeit. anorg. Chem.*, **81**, 347, 1913.
- ³ G. F. Schumacher, *Schriv. Nat. Selsk.*, **4**, 188, 1797; P. C. Abildgaard, *Scheerer's Journ.*, **2**, 502, 1799; J. B. d'Andrada, *ib.*, **4**, 38, 1800; F. W. Clarke, *Data of Geochemistry*, Washington, 1920; D. L. G. Karsten, *Mineralogische Tabellen*, Berlin, 1800; K. L. Giesecke, *Bericht eine mineralogische Reise in Groenland—1806—13*, Copenhagen, 1878; M. H. Klaproth, *Beiträge zur chemischen Kenntnis der Mineralkörper*, Berlin, **3**, 214, 1802; W. C. Henderson, *Journ. Franklin Inst.*, **145**, 47, 1898; H. Rose, *Pogg. Ann.*, **90**, 152, 1855; A. Dick, *Phil. Mag.*, (4), **10**, 364, 1855; E. F. Glocker, *Handbuch der Mineralogie*, Nürnberg, **968**, 1831; R. J. Haüy, *Traité de minéralogie*, Paris, **2**, 398, 1801; H. St. C. Deville, *Ann. Chim. Phys.*, (3), **61**, 337, 1861; O. T. Christensen, *Journ. prakt. Chem.*, (2), **35**, 161, 1887; R. Baldauf, *Zeit. prakt. Geol.*, **18**, 432, 1910; O. B. Böggild, *Zeit. Kryst.*, **51**, 591, 1913; F. Johnstrup, *Neues Jahrb. Min.*, **i**, 29, 1886; L. N. Vauquelin, *Ann. Chim. Phys.*, (1), **37**, 39, 1800; J. Thomsen, *Dingler's Journ.*, **166**, 441, 1862; **167**, 362, 1863.
- ⁴ J. J. Berzelius, *Pogg. Ann.*, **1**, 41, 1824; H. St. C. Deville, *Ann. Chim. Phys.*, (3), **49**, 82, 1857; (3), **61**, 333, 1861; E. Baud, *ib.*, (8), **1**, 65, 1904; *Compt. Rend.*, **135**, 1337, 1902; L. Schuch, *Liebig's Ann.*, **126**, 108, 1863; O. T. Christensen, *Journ. prakt. Chem.*, (2), **35**, 161, 1887; Société Anon. d'Alum, *Ber.*, **6**, 1479, 1873; P. P. Fedotieff and W. P. Ilinsky, *Zeit. anorg. Chem.*, **80**, 113, 1913; **129**, 93, 1923; N. A. Puschin and A. V. Baskoff, *ib.*, **81**, 347, 1913; *Journ. Russ. Phys. Chem. Soc.*, **45**, 82, 1913; H. Howard, *U.S. Pat. No.* 1475155-8, 1923.
- ⁵ J. A. Krenner, *Neues Jahrb. Min.*, **504**, 1877; J. J. Berzelius, *Pogg. Ann.*, **1**, 41, 1824; A. Krantz, *ib.*, **98**, 511, 1856; J. Smithsonian, *Ann. Phil.*, **4**, 363, 1822; **7**, 100, 1824; H. St. C. Deville, *Ann. Chim. Phys.*, (3), **49**, 82, 1857; N. V. Ussing, *Tschermak's Mitt.*, (2), **23**, 300, 1904; E. Newbery and H. Lupton, *Mem. Manchester Lit. Phil. Soc.*, **62**, 10, 1918; R. Nacken, *Centr. Min.*, **38**, 546, 1908; F. Cornu, *ib.*, **546**, 1908; O. Mügge, *ib.*, **35**, 1908; F. R. Pyne and Y. S. Hardcastle, *Trans. Amer. Electrochem. Soc.*, **10**, 64, 1905; P. Oeberg, *Cøfvers. Dan. Vid. Selsk. Förh.*, **19**, 1904; A. Joly, *Proc. Roy. Soc.*, **41**, 250, 1887; F. Kreutz, *Anz. Akad. Kracow*, **114**, 1896; K. Arndt and H. Probst, *Zeit. Elektrochem.*, **29**, 323, 1923; W. Moldenhauer, *Met.*, **6**, 19, 1909; J. W. Taylor, *Phil. Mag.*, (4), **11**, 551, 1856; (4), **12**, 140, 1856; M. Websky, *Neues Jahrb. Min.*, **816**, 1867; O. B. Böggild, *Zeit. Kryst.*, **51**, 612, 1913; E. Wartmann, *Mém. Soc. Genève*, **12**, **1**, 1853; F. Beijerinck, *Neues Jahrb. Min. B. B.*, **11**, 462, 1897; N. A. Puschin and A. V. Baskoff, *Zeit. anorg. Chem.*, **81**, 347, 1913; *Journ. Russ. Phys. Chem. Soc.*, **45**, 82, 1913; T. Liebisch and H. Rubens, *Sitzber. Akad. Berlin*, **211**, 1921; D. Hahn, *Die Phosphoreszenz der Mineralien*, Halle, 1874.

* L. Pfundler, *Sitzber. Akad. Wien*, **46**, 266, 1862; F. Wöhler, *Liebig's Ann.*, **97**, 267, 1856; L. Schuch, *ib.*, **126**, 108, 1863; **127**, 61, 1863; J. J. Berzelius, *Pogg. Ann.*, **1**, 41, 1824; N. N. Beketoff, *Zeit. Chem.*, **8**, 376, 1865; H. St. C. Deville, *Ann. Chim. Phys.*, (3), **46**, 415, 1856; J. F. Person, *ib.*, (3), **56**, 109, 1859; C. Tissier, *Compt. Rend.*, **56**, 848, 1863; **48**, 628, 1859; J. Thomsen, *Dingler's Journ.*, **166**, 441, 1862; B. von Wagner, *Wagner's Jahresb.*, **9**, 343, 1863; D. Sauerwein, *Mitt. Gewerbe. Hannover*, 170, 1862; F. G. Spilsbury, *Brit. Pat. No.* 1443, 1856; H. Bauer, *German Pat.*, D.R.P. 52636, 64824, 1889; F. Lauterborn, *ib.*, 14495, 1881; F. Johnstrup, *Neues Jahrb. Min.*, **1**, 29, 1886; F. Leydolt, *Institu.*, **23**, 357, 1865; H. Baumhauer, *Zeit. Kryst.*, **11**, 133, 1886; J. Lemberg, *Zeit. deut. Geol. Ges.*, **52**, 495, 1900; **23**, 619, 1876; C. Nöllner, *ib.*, **33**, 199, 1881; E. Paterno and U. Alvisi, *Rend. Accad. Lincei*, **7**, 327, 1898; D. Hahn, *Phosphoreszenz der Mineralien*, Halle, 1874; N. V. Ussing, *Oefvers. Danske Vid. Selsk. Förh.*, **3**, 1904.

⁷ J. J. Berzelius, *Pogg. Ann.*, **1**, 43, 1824; **4**, 130, 1825; H. St. C. Deville, *Ann. Chim. Phys.*, (3), **46**, 450, 1856; **8**, 1, 66, 1904; *Compt. Rend.*, **136**, 1337, 1902; A. Duboin, *ib.*, **114**, 1361, 1892; **115**, 56, 1892; *Bull. Soc. Min.*, **15**, 191, 1892; L. Schuch, *Liebig's Ann.*, **126**, 108, 1863; N. A. Puschin and A. V. Baskoff, *Zeit. anorg. Chem.*, **81**, 347, 1913; W. Cross and W. F. Hillebrand, *Amer. Journ. Science*, (3), **26**, 233, 1883; J. L. Gay Lussac and L. J. Thénard, *Recherches physico-chimiques*, Paris, 1811; F. Cornu, *Centr. Min.*, 546, 1908; P. P. Fedotieff and W. P. Ilinsky, *Zeit. anorg. Chem.*, **129**, 93, 1923.

⁸ R. F. Weinland and O. Köppen, *Zeit. anorg. Chem.*, **22**, 273, 1900; P. P. Fedotieff and W. P. Ilinsky, *ib.*, **129**, 93, 1923; J. J. Berzelius, *Pogg. Ann.*, **1**, 46, 1824; P. Pascal and A. Jouniaux, *Bull. Soc. Chim.*, (4), **15**, 312, 1914.

⁹ A. Nöllner, *Zeit. deut. Geol. Ges.*, **33**, 148, 1881; J. Lemberg, *ib.*, **28**, 620, 1876; H. Kopp, *Liebig's Ann.*, **127**, 61, 1863; F. Wöhler, *ib.*, **180**, 231, 1876; G. vom Rath, *Neues Jahrb. Min.*, **830**, 1863; A. des Cloizeaux, *Bull. Soc. Min.*, **5**, 313, 1882; J. A. Krenner, *Math. Nat. Ber. Budapest*, **1**, 13, 1883; N. von Kokscharoff, *Contributions to the Mineralogy of Russia*, St. Petersburg, **8**, 425, 1878; **9**, 6, 1884; P. Groth, *Zeit. Kryst.*, **7**, 461, 1883; O. B. Böggild, *ib.*, **51**, 591, 1913; P. Pascal and A. Jouniaux, *Bull. Soc. Chim.*, (4), **13**, 439, 1913; F. Röder, *Ueber krystallisierte wasserfreie Fluorverbindungen*, Göttingen, 1862; E. S. Larsen and R. C. Wells, *Proc. Nat. Acad. Sciences*, **2**, 360, 1916; E. S. Larsen and E. T. Wherry, *Proc. Washington Acad.*, **7**, 178, 1917; W. F. Foshag, *Proc. U.S. Nat. Museum*, **59**, 419, 1921; W. Flight, *Journ. Chem. Soc.*, **43**, 140, 1883; C. U. Shepard, *Amer. Journ. Science*, (2), **42**, 246, 1866; S. L. Penfield and D. N. Harper, *ib.*, (3), **32**, 380, 1886; G. Hagemann, *ib.*, (2), **42**, 93, 1866; F. Johnstrup, *Natur. Förh. Stockholm*, **250**, 1883; O. G. Nordenskjöld, *Geol. Förh. Stockholm*, **2**, 81, 1874; K. Jimbo, *Journ. Coll. Imp. Tokyo*, **11**, 234, 1899; T. Wada, *Minerals of Japan*, Tokyo, 1904; G. A. König, *Proc. Acad. Philadelphia*, **42**, 1876.

¹⁰ J. J. Berzelius, *Pogg. Ann.*, **1**, 23, 1824; R. F. Weinland and O. Köppen, *Zeit. anorg. Chem.*, **22**, 266, 1899; F. Ephraim and P. Barteczko, *ib.*, **61**, 243, 1909; F. Fischer and K. Thiele, *ib.*, **67**, 306, 1910.

§ 15. Aluminium Chloride

Several investigators have reported the formation of an **aluminium subchloride**, AlCl_2 , or AlCl , possibly analogous with indium monochloride or indium and gallium dichlorides in the same family group. Thus, C. Friedel and L. Roux¹ claim to have made it by passing the vapour of aluminium chloride over metallic aluminium heated just to the fusion point. The brownish-grey substance which is formed contains aluminium, chlorine, and silicon. If aluminium and aluminium chloride are heated at 300° , in sealed tubes filled with carbonic anhydride, there is no appreciable action, but at 360° (in the vapour of mercury) the aluminium is slightly attacked, and large crystals of pure aluminium chloride condense on the cool upper part of the tube. When the tubes are heated by the vapour of sulphur, the aluminium is strongly attacked, and a greyish substance with a somewhat metallic appearance is deposited on the sides of the tube. This substance decomposes water with evolution of hydrogen, and contains silicon, chlorine, and aluminium. C. Formenti and M. G. Levi also reported the formation of hydrated aluminium subchloride by the action of metallic aluminium on a solution of aluminium chloride and the simultaneous evolution of hydrogen. L. F. Nilson and O. Pettersson say that the origin of the grey substance in C. Friedel and L. Roux's experiments must be attributed to the presence of traces of silicon possibly forming aluminium silicide; and the lower proportion of chlorine in the product, to the formation of an oxychloride, and they add that "there is no reason to believe in the existence of any aluminium chloride lower than AlCl_3 ".

The preparation of aluminium chloride.—Anhydrous aluminium chloride is obtained by the action of chlorine or hydrogen chloride on the metal or alloys of the metal, and also, under special conditions, on the oxide. In 1860, F. Wöhler² prepared aluminium chloride by passing a stream of chlorine over heated aluminium; and the product sublimes. Aluminium leaf does not inflame of itself in chlorine gas, but R. Böttger did get it to inflame when in contact with brass. C. A. Matignon says, that if the powdered metal, which has begun to burn in air, be immersed in chlorine or the hydrogen chloride, it continues to burn brilliantly. H. Gautier and G. Charpy found aluminium did not inflame in boiling liquid chlorine, but at -20° aluminium inflames with incandescence. H. D. Gibbs made aluminium chloride by the action of chlorine on aluminium below 0° . J. B. Cohen says that thoroughly dried hydrogen chloride does not attack aluminium, but it does so if moist; and P. Askenasy patented a process for preparing aluminium chloride, by passing gaseous hydrogen chloride over the metal heated by a sulphur-bath. G. Gore found that aluminium dissolves in liquid hydrogen chloride, forming a colourless solution. G. Gustavson, L. F. Nilson and O. Pettersson, R. Escales, E. Köhn-Abrest, and F. Stockhausen and L. Gattermann made aluminium chloride by passing chlorine or hydrogen chloride over aluminium heated in a wide glass tube. L. Gattermann's directions are:

A hard glass tube—1.5 to 2 cms. diameter—is drawn to a narrow tube at one end which is to be connected with a train of two wash-bottles, containing sulphuric acid and connected with a generator delivering hydrogen chloride. The wash-bottles should be fairly large since the acid is liable to foam with a rapid current of hydrogen chloride. The wide end of

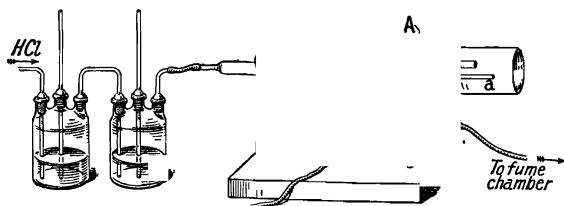

FIG. 59.—The Preparation of Aluminium Chloride.

the hard glass tube is fitted by means of a cork into a wide-necked bottle; the cork is also fitted with an exit tube, 8 mm. in diameter, *aa*, extending from the middle of the bottle, and leading to the fume chamber. An asbestos board *A* is also arranged as in Fig. 59, to protect the bottle from the heat of the furnace. The tube is fitted with an asbestos plug, then with enough aluminium shavings to half fill the tube when laid horizontally, and finally a second asbestos plug is placed at the end of the layer of aluminium shavings. The shavings should have been previously washed free from oil or grease by boiling them with alcohol, and then drying at 120° in an air-bath. The tube is then laid in the furnace as indicated in Fig. 59 with the asbestos board and bottle as close to the furnace as possible. A rapid stream of hydrogen chloride is passed through the apparatus to drive out the air as shown when the exit gas is completely absorbed by water. The tube is then heated throughout its entire length—first with a small flame and then with a gradually increasing flame. The vapours of aluminium chloride collect in the bottle, and the reaction is ended as soon as the aluminium has disappeared from the glass tube. The aluminium chloride is preserved by well closing the bottle, or in a desiccator. L. Gattermann states that for success, the following points require attention: (1) All parts of the apparatus must be perfectly dry. (2) The air must be removed as completely as possible, since, otherwise, an explosion of oxygen and hydrogen may take place. (3) The portion of the tube extending beyond the furnace must be as short as possible, to prevent the aluminium chloride from condensing in it, which results in a stopping up of the apparatus. In order that the cork may not burn, it is protected by an asbestos plate, provided with a circular hole in the centre. (4) The aluminium must not be heated to melting. If this should happen at any particular point, the flames must be immediately lowered. (5) The hydrochloric acid current must be extremely rapid. One should not be able to count single bubbles of the gas, but they should follow one another uninterruptedly. The evolution of a small quantity of a smoky vapour from the outlet-tube will always occur, but the greatest part of the aluminium chloride is condensed even if the hydrogen chloride rushes through the wash-bottles. Should the first experiment be unsuccessful, in consequence of a stoppage of the tube, the method for correcting this will readily suggest itself.

H. N. Warren heated an alloy of aluminium with 90 per cent. of iron in a stream of chlorine, and purified the product by redistillation over iron turnings; and

C. F. Mabery heated an alloy of aluminium with 60 to 86 per cent. of copper in a graphite retort in a stream of hydrogen chloride and claimed that the product was free from iron and silicon. H. Rose found aluminium metal reduced potassium chloride to the metal with the formation of aluminium chloride; F. R. Michel obtained a similar result with sodium chloride; F. Flavitzky, with zinc chloride; and A. Cossa, with mercuric chloride. Neither F. Wöhler nor F. Flavitzky obtained an appreciable reduction of magnesium chloride by aluminium. The Aluminium Co. has patented the production of the chloride from aluminium dross. B. T. Brooks treated the molten metal with chlorine under press.

In 1825, H. C. Oersted first prepared anhydrous aluminium chloride by passing chlorine gas over a heated mixture of alumina with carbon. True, R. Weber has shown that at a white heat, a perceptible quantity of aluminium chloride is formed by the action of chlorine gas on alumina, $2\text{Al}_2\text{O}_3 + 6\text{Cl}_2 = 4\text{AlCl}_3 + 3\text{O}_2$, but the reaction is incomplete, and it proceeds with great difficulty, in marked contrast with the comparatively vigorous action of chlorine on a heated mixture of alumina and carbon whereby carbon monoxide is simultaneously formed: $\text{Al}_2\text{O}_3 + 3\text{C} + 3\text{Cl}_2 = 3\text{CO} + 2\text{AlCl}_3$. The heat of formation of aluminium oxide, Al_2O_3 , is 391.6 Cals.; and of aluminium chloride, AlCl_3 , 161.4 Cals. Consequently, the heat of the reaction: $\text{Al}_2\text{O}_3 + 3\text{Cl}_2 = 2\text{AlCl}_3 + 3\text{O}$, is $322.8 - 380.2 = -57.4$ Cals., so that the reaction is endothermal. The heat evolved during the formation of carbon monoxide is 29.2 Cals., so that in the reaction: $\text{Al}_2\text{O}_3 + 3\text{Cl}_2 + 3\text{C} = 3\text{CO} + 2\text{AlCl}_3$, $322.8 + 87.6 - 380.2 = 30.2$ Cals. are evolved. Hence, it may be said that the energy evolved during the combustion of the carbon is utilized in promoting the decomposition of alumina.

F. Wöhler recommended rubbing precipitated aluminium hydroxide into a thick paste with powdered charcoal, sugar, and oil. The mixture was carbonized by heating it in a covered crucible, and then packed into a porcelain tube, connected at one end with a tube delivering dried chlorine, and at the other end with a tubulated glass vessel for the escape of the gas. As soon as the tube is filled with chlorine gas, heat is applied, and aluminium chloride carried along by the stream of carbon monoxide, condenses partly as a powder in the globe, and partly in transparent yellow drops which solidify to a crystalline solid at the end of the porcelain tube which may thereby be choked up. According to H. St. C. Deville, the carbon monoxide is usually accompanied by some silicon tetrachloride and possibly also carbonyl chloride. At the end of the operation, the solid is detached from the tube by a strong iron wire, and mixed with the powder which collects in the receiver. J. von Liebig recommended purifying the product by sublimation in a small retort. Any oxidizing gases present should be removed, and P. A. Favre accordingly recommended heating the chlorine with some producer gas so as to remove the free oxygen. If the alumina be contaminated with potassium sulphate, J. von Liebig showed that some potassium sulphide or sulphur chloride may be formed and that the latter will contaminate the aluminium chloride. Hence, J. von Liebig takes special precautions to ensure the absence of sulphates, and he mixed an aq. soln. of aluminium chloride with powdered sugar or starch, and ignited the dried mass in a closed vessel. The carbonized mixture was then treated with chlorine as in F. Wöhler's process. R. Bunsen, and H. St. C. Deville have described apparatus for the preparation of aluminium chloride by this process. Crude aluminium chloride has a yellow tinge usually attributed to the presence of ferric chloride, but supposed by R. Weber to be due to the presence of an aluminium thio-chloride, or free chlorine. R. Weber recommended purifying the yellow aluminium chloride by mixing it with aluminium powder and then resubliming it under a slight press.; J. B. A. Dumas used a similar process, but the result under ordinary atm. press. is not so good as when a small press. is used. H. St. C. Deville passed the vapour of the crude aluminium chloride over heated iron turnings, which transforms any volatile ferric chloride into less volatile ferrous chloride; and any sulphur chloride into a mixture of ferrous chloride and sulphide, FeCl_2 and FeS .

The formation of metal chlorides by the action of chlorine on a heated mixture of the oxide and carbon is sometimes called *Oersted's reaction*. H. St. C. Deville showed that gaseous hydrogen chloride acts in a similar manner to chlorine. The reaction also proceeds if volatile carbon compounds be mixed with the chlorine or hydrogen chloride which is passed over the heated oxide—for instance, P. A. Favre conducted a mixture of naphthalene vapour and hydrogen chloride over heated alumina; and H. N. Warren used a mixture of petroleum vapour and chlorine or

hydrogen chloride. A carbon chloride can be used in place of the mixture of hydrocarbon and chlorine—for instance, E. Demarçay, P. Camboulives, and H. Quantin used carbon tetrachloride; E. Chauvenet, C. Baskerville, and W. Heap and E. Newbery, carbonyl chloride; and H. N. Warren, chloronaphthalene. L. Burgess heated aluminium carbide with hydrogen chloride. F. P. Venable and D. H. Jackson found the reaction is satisfactory at 450°. E. R. Wolcott heated oil-shales to get the oils, and treated the carbonaceous residue with a chloridizing agent to get aluminium chloride. A. McD. McAfee, G. H. King and G. I. Roberts, and L. S. Abbott modified the process in a number of ways. D. F. Smith and H. Essex treated aluminium carbide with chlorine. G. H. King and G. I. Roberts heated alumina over 1000° in a stream of chlorine and producer gas. For the direct preparation of aluminium chloride from clays, *vide* alumina.

Sulphur compounds can be used in place of carbon compounds—for instance, P. Curie heated alumina or china clay in a mixture of carbon disulphide and hydrogen chloride—if carbon disulphide be used alone aluminium sulphide is formed, and this is converted by hydrogen chloride into aluminium chloride; similarly, C. A. Matignon and F. Bourion heated the alumina in a mixture of chlorine and sulphur chloride: $4\text{Al}_2\text{O}_3 + 3\text{S}_2\text{Cl}_2 + 9\text{Cl}_2 = 8\text{AlCl}_3 + 6\text{SO}_2$. The Consortium für Elektrochemische Industrie Gesellschaft passed sulphur chloride and chlorine over a heated mixture of alumina and carbon. They found that the first product condensed is an addition compound of S_2Cl_2 and AlCl_3 . The components can be separated by distillation. G. Berger and W. Kühne heated clay with pyrites at 200°, and the resulting product was mixed with carbon and heated in a stream of chlorine to volatilize the aluminium chloride. The latter was mixed with sodium and strontium chloride, fused, and electrolyzed for aluminium. According to H. B. North and A. M. Hageman, alumina is not attacked by sulphuryl chloride at 200°. F. W. Hall heated a mixture of alumina, sulphur, and chlorine. Further, H. Rose found that alumina is converted into the chloride by repeated calcination with an excess of ammonium chloride; R. Weber, and A. Daubrée used phosphorus chloride, PCl_3 , and obtained both aluminium chloride and the double compound $\text{AlCl}_3 \cdot \text{PCl}_3$; while L. Troost and P. Hautefeuille found that boron trichloride, BCl_3 , or silicon tetrachloride, SiCl_4 , can be used for chlorinating alumina. G. Gore found that alumina is transformed into the chloride by liquid hydrogen chloride without passing into soln. The Armour Fertilizer Co. treated the nitride with chlorine.

E. Baud found that commercial aluminium chloride contains carbonyl chloride, and it is purified by fractional sublimation in a stream of nitrogen or hydrogen. E. Bühlmann prepared sublimed aluminium chloride for use in organic chemistry by charging a test-tube (0.35×18 cm.) with 40 grms. of aluminium chloride.

Surround the lower part of the tube with iron gauze, close the mouth of the tube with a sheet-iron cover, and wrap the upper part of the tube with cotton cloth. Heat the tube with a bunsen burner, allowing cold water to drop steadily on the cloth during the heating. Yield, 37–38 grms. in 20 minutes.

According to F. Wöhler, when anhydrous aluminium chloride is exposed to the air, it rapidly deliquesces, forming a clear liquid; the chloride also dissolves in water with a hissing noise and the development of much heat. A similar soln. is obtained by dissolving the metal in hydrochloric acid, by saturating hydrochloric acid with alumina, and by the double decomposition of soln. of aluminium sulphate and barium chloride—with calcium chloride, E. Thorey³ found a double calcium and aluminium chloride is formed. According to P. A. von Bonsdorff, when the aq. soln. is spontaneously evaporated in dry air, or, according to T. Gladycz, in vacuo, crystals of hexahydrated aluminium chloride, $\text{AlCl}_3 \cdot 6\text{H}_2\text{O}$, are formed. E. Borsbach found similar crystals to be precipitated when hydrogen chloride is passed into or when conc. hydrochloric acid is added to a cold conc. soln. of aluminium chloride. L. M. Dennis prepared hexahydrated aluminium chloride of a high degree of purity from the salt of ordinary commercial purity by the following process:

Commercial anhydrous aluminium chloride is dissolved in water, and, after being filtered through glass wool, is mixed with conc. hydrochloric acid, and the soln., cooled with a freezing mixture, is sat. with dry hydrogen chloride. The crystals which rapidly form are washed by decantation with conc. hydrochloric acid until free from iron, and the excess of acid is removed as far as possible by the aid of the pump. The crystals are then placed on porous tiles and exposed to the air until free from hydrogen chloride; in moist air, water is absorbed, but if kept at 20° their weight becomes constant after about 48 hrs. The crystals, $\text{AlCl}_3 \cdot 6\text{H}_2\text{O}$, do not change when kept over sulphuric acid, but if heated in a stream of dry hydrogen chloride, a basic salt is formed.

C. von Hauer prepared crystals of the same salt by heating aluminium hydroxide with conc. hydrochloric acid in a sealed tube, and then cooling the soln. H. Howard passed hydrogen chloride into a conc. soln. of aluminium chloride, and washed the crystals which separated with a soln. of basic aluminium chloride; and G. A. Blanc obtained aluminium chloride by the action of hydrochloric acid on leucite, and saturated the hot soln. with hydrogen chloride in order to precipitate the aluminium chloride, and leave the potassium chloride in soln. According to E. Lubarsky, if dil. soln. are cooled to -8° , they deposit crystals of **enneahydrated aluminium chloride**, $\text{AlCl}_3 \cdot 9\text{H}_2\text{O}$, but the equilibrium diagram of the binary system $\text{AlCl}_3 - \text{H}_2\text{O}$ has not yet been explored.

The aq. soln. loses hydrogen chloride when evaporated, particularly at elevated temp., and if the evaporation is carried to dryness, J. Ordway found a basic product is formed which is completely soluble in water, and with repeated evaporation much alumina or aluminium hydroxide is formed. As in the case of magnesium chloride, the evaporation of the soln. in a stream of hydrogen chloride enables the soln. to be conc. without forming the hydroxide. H. Ley computed the degree of hydrolysis of aq. soln. of aluminium chloride from their effect on the inversion of cane sugar, and found a $\frac{1}{32}N$ -soln. is 8.8 per cent. hydrolyzed; a $\frac{1}{16}N$ -soln., 13.8 per cent.; a $\frac{1}{8}N$ -soln., 20.1 per cent.; a $\frac{1}{4}N$ -soln., 28.7 per cent.; and a $\frac{1}{2}N$ -soln., 41.8 per cent. hydrolyzed. The hydrolysis is thus smaller than with ferric chloride in agreement with the stronger basic properties of $\text{Al}(\text{OH})_3$ over $\text{Fe}(\text{OH})_3$. H. de Sénarmont found that if an aq. soln. be strongly heated in a sealed tube anhydrous alumina separates out. P. A. von Bonsdorff says that the crystals do not effloresce when confined in a desiccator over sulphuric acid, but they deliquesce rapidly in an ordinary atm. P. Sabatier observed very little change after the crystals had been confined over sulphuric acid in vacuo during the summer months. The crystals do not melt when heated, but they give off water and hydrogen chloride, leaving 21.605 per cent. of alumina as a residue in the form of the original crystals. The anhydrous chloride cannot be obtained by heating the hydrated salt. F. A. Gooch and F. M. McClenahan found that the speed of dehydration of aluminium chloride is reduced by hydrogen chloride below 130°, but above this temp., as also in air, water and hydrogen chloride are simultaneously evolved; they assume that the water is intimately associated with the chlorine in the molecular complex and can be represented by the graphic formula:

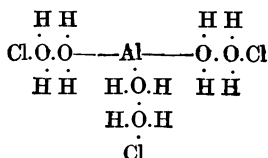

Contrast this with the behaviour of the hydrated barium and magnesium chlorides. W. Madelung also worked on the constitution of aluminium chloride. E. P. Kohler has shown that aluminium chloride in aq. soln., or in any solvent known to combine with it, has a molecular weight in agreement with the formula AlCl_3 , whereas in a saturated indifferent solvent like carbon disulphide, the molecular weight is Al_2Cl_6 . It is assumed by A. S. Cushman that the linkage $-\text{O}(\text{H}_2)-\text{O}(\text{H}_2)-$ is not strong enough to hold the large complex together, while the linkage $-\text{Cl}=\text{Cl}-$ can do so.

The properties of aluminium chloride.—According to F. Wöhler,⁴ and H. St. C. Deville and L. Troost, anhydrous aluminium chloride forms colourless or white hexagonal plates which K. Seubert and W. Pollard say are composed of three individuals twinned together, and they show rhombic symmetry. The angles of extinction are 120° , and the crystals are optically negative. C. Friedel and L. Roux obtained fine crystals by heating the salt in a sealed tube to about 400° . According to F. Wöhler, hexahydrated aluminium chloride forms “regular six-sided prisms with the terminal faces of a rhombohedron” belonging, according to L. M. Dennis and A. H. Gill, to the trigonal system with the axial ratio $a:c=1:0.5356$, and $\alpha=111^\circ 40'$. The double refraction is strong, and the refraction index about 1.6. W. Biltz and co-workers gave 2.398 to 2.440 at $20^\circ/4^\circ$ for the sp. gr. of aluminium chloride, and the mol. vol., 54.7; and at 190° , the sp. gr. of fused aluminium chloride is 1.33, and the mol. vol. 100. W. Biltz and A. Voigt gave for the sp. gr. 1.33 at 190° ; 1.31 at 200° ; 1.28 at 210° ; 1.255 at 220° ; and 1.23 at 230° . The coeff. of thermal expansion of the liquid is therefore 0.002.

J. von Liebig noted that when heated under atm. press., small quantities of anhydrous aluminium chloride can be volatilized without melting, but large quantities when rapidly heated, melt and boil. F. Wöhler found the more or less impure salt melts when heated under petroleum, forming a brownish-red liquid which does not dissolve in the oil. In a sealed tube, K. Seubert and W. Pollard found the salt melts between 193° and 194° ; and C. Friedel and J. M. Crafts give the m.p. between 186° and 190° at 2.5 atm. press. Hexahydrated aluminium chloride decomposes when heated without melting. According to J. von Liebig, anhydrous aluminium chloride boils between 180° and 185° , and C. Friedel and J. M. Crafts found the b.p. to be 167.8° at 0.33 atm. press.; 171.1° at 0.41 atm.; 175.7° at 0.57 atm.; 182.7° at 0.99 atm.; 204.2° at 2.37 atm.; 207.5° at 2.64 atm.; and 213° at 3.6 atm. press. According to L. Rotinjanz and W. Suchodsky, the critical temp. on the absolute scale is 629.5° K. and the sublimation point 456° K., and the ratio $T_c/T_b=0.724$. The sp. ht. of aluminium chloride was found by E. Baud to be 0.188. J. Thomsen found the heat of formation (Al_2Cl_6) to be 321.87 Cals.; (Al_2Cl_6 , aq.), 153.69 Cals.; and (Al_2 , Cl_6 , aq.), 475.56 Cals. M. Berthelot gives $\text{Al}(\text{OH})_3+3\text{HCl}_{\text{aq.}}=18.6$ Cals. E. E. Somermeier found the heat of dissolution of aluminium in $\text{HCl}+19.15\text{H}_2\text{O}$ to be 128.06 Cals. per gram-atom. P. Sabatier found the heat of soln. of AlCl_3 in 900 mols of water to be 26.4 Cals. at 15.5° . K. Jauch found the sp. ht. of soln. with N eq. of aluminium chloride per litre to be

N	0.5	1.0	2.0	3.0	4.0
Sp. ht.	0.9593	0.9257	0.8632	0.8098	0.7630

H. St. C. Deville and L. Troost found the vapour density at 350° and at 440° , 9.34, when the calculated value for Al_2Cl_6 is 9.25. C. Friedel and J. M. Crafts also found that between 218° and 432° the chloride has a vapour density of 9.19 in accord with the formula Al_2Cl_6 . According to L. F. Nilson and O. Pettersson, the chloride dissociates as the temp. approaches 758° when the vapour density is 4.802. At 800° the dissociation is complete, for the vapour density is 4.542 at 835° , and 4.557 at 943° . This corresponds with the formula AlCl_3 , whose theoretical vapour density is 4.6. Towards 1117° there are signs of a decomposition, for the vapour density is then 4.269, 4.247 at 1244° , and 4.277 at 1260° . It is therefore inferred that the mol. has the formula Al_2Cl_6 below 440° ; that it is partially dissociated $\text{Al}_2\text{Cl}_6\rightleftharpoons 2\text{AlCl}_3$ between 440° and 600° ; and above 600° , the mol. has the formula AlCl_3 (Fig. 60). V. Meyer and H. Zublin add that aluminium chloride is partially dissociated above 100° . A. Werner found that in pyridine soln. the mol. is probably AlCl_3 ; E. Beckmann obtained similar results for soln. in ether; and E. P. Kohler for soln. in boiling or freezing nitrobenzene. E. P. Kohler showed that the formation of addition products with pyridine and nitrobenzene vitiates the mol. wt. determinations in these solvents unless precautions be taken to correct the results. According to W. Biltz, the f.p. of aq. soln. agree with the assumption

that the mols. are associated, not less than Al_2Cl_6 , but E. P. Kohler has shown that in water soln. or in any solvent that is known to combine with it, aluminium chloride has a mol. wt. corresponding with the formula AlCl_3 , whereas in an indifferent solvent like carbon disulphide, it has the doubled mol. wt.

J. R. Collins measured the ultra-red absorption spectrum of soln. of aluminium chloride. W. Jevons found aluminium chloride becomes phosphorescent when

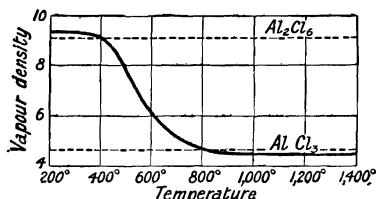

Fig. 60.—Effect of Temperature on the Vapour Density of Aluminium Chloride.

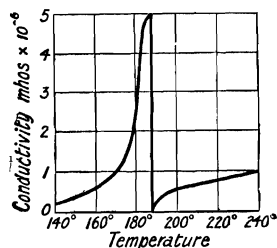

Fig. 61.—Electrical Conductivity of Aluminium Chloride.

exposed to active nitrogen. H. Buff stated that fused anhydrous aluminium chloride can be electrolyzed, but W. Hampe states that if quite pure the molten salt does not conduct electricity. W. Biltz and A. Voigt found the electrical conductivity increases from zero at ordinary temp. to 10^6 mhos at the m.p., when it drops abruptly to zero, and slowly rises again, Fig. 61.

Mhos $\times 10^6$	146°	164°	182°	189°	200°	227°	245°
	0.29	0.70	2.6	5.0	0.56	0.86	1.1

Observations were also made by A. Benrath. H. Ley found the mol. conductivity, μ , of a mol of the salt AlCl_3 in v litres of water to be:

v	32	64	128	256	512	1024
μ	99.9	106.9	114.1	123.8	131.0	138.0

and he also studied the degree of hydrolysis as indicated above. According to R. J. Meyer, the eq. conductivity rises from 99.9 for a soln. of a mol of AlCl_3 in 32 litres to 138 for a dilution 1024 litres; so that $\lambda_{1024} - \lambda_{32}$ is 38.1, a little greater than for scandium chloride. For trivalent salts this difference usually amounts to about 26 units, and the increased value with aluminium and scandium chlorides is explained by the high ionic mobility of the hydrogen ions of the acid set free by hydrolysis. H. C. Jones and F. H. Getman have calculated the degree of hydration of the salt in conc. aq. soln. from the electrical conductivity and the f.p. of aq. soln. A. Heydweiller measured the sp. gr. and electrical conductivity of soln. of aluminium chloride. A. B. Bryan measured the conductivity of flames charged with aluminium chloride; and F. E. Bartell and D. C. Carpenter studied the rate of osmosis. F. Guthrie found that a mixture of hexahydrated aluminium chloride with three to four times its weight of ice gave a soln. at -13° . F. E. Bartell and D. C. Carpenter measured the difference of potential of water and soln. of aluminium chloride separated by a permeable membrane. F. E. Bartell and O. E. Madison found that in the osmosis of soln. of aluminium chloride, the membrane becomes electropositive to the soln., and the soln. side of the membrane is electropositive, and the osmosis is positive. F. E. Bartell and L. B. Sims studied the swelling of colloidal membranes by soln. of aluminium chloride.

G. T. Gerlach found 100 grms. of a sat. soln. contained 41.13 grms. of aluminium chloride, AlCl_3 , at 15° , and the sp. gr. of the soln. was 1.354; aq. soln. containing

Per cent. AlCl_3 .	5	10	15	20	25	30	35	40
Sp. gr.	1.0361	1.0734	1.1125	1.1537	1.1968	1.2422	1.2905	1.3415

F. Wöhler noted that anhydrous aluminium chloride fumes in moist air, and smells of hydrogen chloride. According to M. Berthelot, when heated with oxygen to redness, there is a partial displacement of the chlorine, either due to the formation of an oxychloride or to the balanced reaction: $2\text{Al}_2\text{O}_3 + 6\text{Cl}_2 \rightleftharpoons 4\text{AlCl}_3 + 3\text{O}_2$ —the heat of formation of Al_2O_3 is 391.6 Cals., and of Al_2Cl_6 , 301.8 Cals.

P. Hautefeuille and A. Perrey⁵ prepared what they regarded as **aluminium oxychlorides** by the combustion of aluminium in a mixture of vapour of aluminium chloride and oxygen; and in a mixture of chlorine and oxygen. The composition of the products was indefinite. The white crystals are decomposed by water, and dissolve in dil. acids and alkalis. D. Tommasi reported that aluminium acts briskly on cupric chloride at ordinary temp., forming copper, hydrogen, and an aluminium oxychloride whose composition varies with the temp.; and he added that if aluminium be allowed to act on the product, an oxychloride of the composition $\text{AlCl}_3 \cdot 6\text{Al}(\text{OH})_3 \cdot 6\text{H}_2\text{O}$ is produced. A soln. of this compound is decomposed by a drop of sulphuric acid with the precipitation of aluminium hydroxide; it is sparingly soluble in acid, and is possibly an isomeric modification of the hydroxide.

L. Liechti and W. Suida examined the solubility of aluminium hydroxide in soln. of aluminium chloride, and they found that when the former is added to the latter in quantity sufficient to form the basic salt $\text{Al}_2\text{Cl}_4(\text{OH})_2$, the alumina dissolved only on heating and the soln. remained clear on cooling. To this clear soln. a further quantity of aluminium hydroxide was added sufficient to form the compound $\text{Al}_2\text{Cl}_2(\text{OH})_4$. It was, however, found that no more alumina could be made to dissolve, the precipitate even increasing, and on filtering it was found that the soln. contained an equal number of mols of normal Al_2Cl_6 and of HCl. The nascent $\text{Al}_2\text{Cl}_2(\text{OH})_4$ had apparently decomposed according to the following formula: $7\text{Al}_2\text{Cl}_2(\text{OH})_4 + 2\text{H}_2\text{O} = 5\text{Al}_2(\text{OH})_6 + 2\text{Al}_2\text{Cl}_6 + 2\text{HCl}$. In the same way it was proved that, on adding aluminium hydroxide to $\text{Al}_2(\text{SO}_4)_3$ soln. sufficient to produce the basic compound $\text{Al}_4(\text{SO}_4)_3(\text{OH})_6$, no alumina at all dissolved, the filtrate only containing $\text{Al}_2(\text{SO}_4)_3$. Here, too, we must suppose that the nascent basic compound decomposes as follows: $\text{Al}_4(\text{SO}_4)_3(\text{OH})_6 = \text{Al}_2(\text{OH})_6 + \text{Al}_2(\text{SO}_4)_3$. E. Schlumberger prepared a colloidal form of aluminium hydroxide which he regarded as having the composition $\text{Al}_3\text{O}_{14}\text{H}_{10}$, and he found it to dissolve in cold dil. hydrochloric acid, forming a viscous opalescent liquid which gives a gum-like coagulum supposed to be a hydrochloride $\text{Al}_3\text{O}_{14}\text{H}_{10} \cdot \text{HCl}$, but is more likely to be colloidal alumina with adsorbed acid—similar remarks apply to the nitrate, acetate, and sulphate. According to M. Adolf and co-workers, it is impossible to remove all the chlorine from the products of hydrolysis of aluminium chloride by washing. A quantity of chlorine, which is greatly in excess of that contained in the hydrochloric acid required for peptization, always remains. On boiling well-washed aluminium hydroxide with dil. hydrochloric acid, sols of various compositions are obtained up to a limiting composition represented by the formula $[\text{Al}(\text{OH})_3]_2, \text{AlOCl}$. Of these, two have been investigated. *Aluminium hydroxydichloride*, $\text{AlCl}_2 \cdot \text{OH}$, behaves as a ternary electrolyte, and, on dilution, it is strongly dissociated, the process being complete at a dilution 0.00106*N*. This compound shows a remarkably small degree of hydrolysis, amounting only to 0.1 per cent. at 0.068*N*, and in a 0.00106*N* soln. is only 0.25 per cent. The compound aluminyl monochloride $\text{Al}(\text{OH})_2\text{Cl}$ or AlOCl , behaves as a binary electrolyte. The conductivity data indicate that a complex ionization occurs in this case of the type $\text{Al}(\text{OH})_2\text{Cl} | \text{AlO}$, indicating a compound in which one aluminium atom of the complex acts as the central atom of a negative complex, whilst the other furnishes a stable univalent positive ion. The peptization of aluminium hydroxide leads to a sol of the composition represented by the formulæ: (1) $10\text{Al}(\text{OH})_3 \cdot 4\text{AlOCl} \cdot \text{AlO} | \text{Cl}$; (2) $12\text{Al}(\text{OH})_3 \cdot 5\text{AlOCl} \cdot \text{AlO} | \text{Cl}$; (3) $16\text{Al}(\text{OH})_3 \cdot 7\text{AlOCl} \cdot \text{AlO} | \text{Cl}$. On the other hand, no complex ionization of the form $\text{Al}(\text{OH})_4 | \text{AlO}$ has been observed in the case of aluminium hydroxide.

According to O. C. Ralston, the reaction between moisture and aluminium chloride often does not take place at once, but the hydrochloric acid is given off slowly on standing. If the surface of a mass of anhydrous aluminium chloride is allowed to "glaze" with a coating of aluminium chloride hydrate ($\text{AlCl}_3 \cdot 6\text{H}_2\text{O}$) and the mass is then sealed in a tight container, the water of the hydrate slowly diffuses to the remaining anhydrous material and reacts to form aluminium oxide and hydrochloric acid gas. As the reaction proceeds the pressure of the gas finally becomes strong enough to burst the container. A glass bottle filled with aluminium chloride which has been exposed to the open air for a few minutes before being placed in the bottle may blow its stopper in this way. Large drums filled with the commercial product have been known to "explode," probably from this cause.

When aluminium chloride is heated with water vapour, H. Kunheim noted the formation of hydrogen chloride and aluminium hydroxide. H. Rose stated that when distilled with sulphur trioxide it forms chlorine, sulphur dioxide, and aluminium sulphate. R. Weber studied the reaction between aluminium chloride and sulphur chloride, S_2Cl_2 , and he observed the formation of a double compound, $2\text{AlCl}_3 \cdot \text{SCl}_4$; O. Ruff also prepared $\text{AlCl}_3 \cdot \text{SCl}_4$ by the action of sulphur chloride, SCl_2 , on a soln. of aluminium chloride in sulphuryl chloride, SO_2Cl_2 , thus: $3\text{SCl}_2 + \text{AlCl}_3 = \text{AlCl}_3 \cdot \text{SCl}_4 + \text{S}_2\text{Cl}_2$. F. Wöhler, and E. Baud noted the formation of double compounds with hydrogen sulphide, $2\text{AlCl}_3 \cdot \text{H}_2\text{S}$, and $\text{AlCl}_3 \cdot \text{H}_2\text{S}$. The first-named compound is prepared with liquid hydrogen sulphide but dissociates at -45° into hydrogen sulphide and $2\text{AlCl}_3 \cdot \text{H}_2\text{S}$, which is stable at ordinary temp. and press. R. Weber also prepared $2\text{AlCl}_3 \cdot \text{SeCl}_4$ and $2\text{AlCl}_3 \cdot \text{TeCl}_4$. E. Baud, O. Ruff, and A. Adrianowsky studied the formation and properties of $2\text{AlCl}_3 \cdot \text{SO}_2$ and $\text{AlCl}_3 \cdot \text{SO}_2$. The latter is prepared by subliming aluminium chloride in a current of sulphur dioxide; it dissociates at 80° , forming $2\text{AlCl}_3 \cdot \text{SO}_2$, which can be distilled at 200° . The heat of formation of $\text{AlCl}_3 \cdot \text{SO}_2$ is 14.46 Cals., and the heat of soln. 298.62 Cals.; the heat of formation of $2\text{AlCl}_3 \cdot \text{SO}_2$ is 18.33 Cals., and the heat of soln. at 15° , 150.54 Cals. J. A. Besson prepared double compounds of aluminium chloride with thionyl bromide or thionyl chloride. F. Wöhler, and A. Recoura prepared *aluminium chlorosulphate*, $\text{Al}(\text{SO}_4)\text{Cl} \cdot 6\text{H}_2\text{O}$, by the action of boiling fuming hydrochloric acid on aluminium sulphate. V. Thomas obtained the double compound $2\text{AlCl}_3 \cdot \text{NO}$ by slowly subliming aluminium chloride in an atm. of nitric oxide; and R. Weber, $\text{AlCl}_3 \cdot \text{NOCl}$, by the action of the gases from aqua regia on aluminium chloride. E. Baud found that acetylene is absorbed by anhydrous aluminium chloride in the cold, and rapidly at 70° – 130° , forming a black volatile compound, $7(\text{C}_{10}\text{H}_{15.6}) \cdot 2\text{Al}_2\text{Cl}_6$. According to W. E. Henderson and W. C. Gangloff, dry acetylene acts on an alcoholic soln. of aluminium chloride, forming well-defined colourless crystals of $\text{AlCl}_3 \cdot 2\text{C}_2\text{H}_2 \cdot 2\text{H}_2\text{O}$; and with ethylene, giving $\text{AlCl}_3 \cdot 3\text{C}_2\text{H}_4 \cdot \text{H}_2\text{O}$.

When an aq. soln. of aluminium chloride is treated with ammonia, aluminium hydroxide is precipitated, and J. J. Berzelius thought that the precipitate formed when insufficient ammonia is added to saturate completely the soln. is a basic chloride or oxychloride. In all probability the product is colloidal aluminium hydroxide, with adsorbed chloride. E. C. Franklin found aluminium chloride to be insoluble in liquid ammonia. According to E. Baud, if a stream of well-dried ammonia be passed over sublimed aluminium chloride much heat is evolved, the mass becomes liquid, and then solidifies to a voluminous white powder, **aluminium hexamminochloride**, $\text{AlCl}_3 \cdot 6\text{NH}_3$. The last mol. of ammonia is taken up very slowly. When treated with hydrogen chloride, there is no perceptible action below -15° ; at 0° , the reaction is very slow, and at 15° vigorous producing ammonium chloride, ammonia, and $6\text{AlCl}_3 \cdot \text{NH}_3$. J. M. Stillmann and M. B. Yoder found that when heated in air, ammonium chloride and alumina $\text{Al}_2\text{O}_3 \cdot \text{H}_2\text{O}$ are formed. E. Baud says the hexamminochloride is less hygroscopic than the chloride; and that on exposure to air, it absorbs moisture and loses ammonia, forming aluminium hydroxide and ammonium chloride. The heat of formation $\text{AlCl}_3 \cdot 3\text{NH}_3$ is 134.11 Cals. E. Baud noted that when the hexamminochloride is cooled with liquid ammonia, and the latter is allowed to evaporate with the temp. below -22° , **aluminium enneamminochloride**, $\text{AlCl}_3 \cdot 9\text{NH}_3$, is formed with a vap. press. of 1790 mm. at 0° ;

978 mm. at -10.7° ; 760 mm. at -14.6° ; 481 mm. at -22.3° ; and 189 mm. at -37° . There is no break in the curve. The heat of formation, $\text{AlCl}_3 \cdot 6\text{NH}_3 + 3\text{NH}_3$, is 24.81 Cals. E. Baud found that when the hexamminochloride is heated below 150° , the evolution of ammonia is not very marked, but at that temp. ammonia is evolved and **aluminium pentamminochloride**, $\text{AlCl}_3 \cdot 5\text{NH}_3$, is formed. J. M. Stillmann and M. B. Yoder obtained the same product by heating the hexamminochloride for 12 hrs. at 100° in a stream of hydrogen. The heat of formation $\text{AlCl}_3 \cdot 3\text{NH}_3$ is 38.84 Cals. E. Baud obtained **aluminium triamminochloride**, $\text{AlCl}_3 \cdot 3\text{NH}_3$, by heating the pentamminochloride to 275° ; and H. Rose, and J. F. Persoz, by treating aluminium chloride with ammonia until the mass becomes liquid. The heat of formation $\text{AlCl}_3 + 3\text{NH}_3$ is 83.77 Cals. J. M. Stillmann and M. B. Yoder heated aluminium hexamminochloride in an atm. of hydrogen for 10 hrs. between 200° and 240° . Analyses of the semi-liquid hygroscopic mass agreed with **aluminium diamminochloride**, $\text{AlCl}_3 \cdot 2\text{NH}_3$. G. L. Clark reported the temp. at which these different amines dissociate at 100 mm. press., to be -13° for the ennea-ammine; 77° for the hexamine; 280° for the pentamine; 427° for the triamine; and 752° for the monamine. According to E. Baud, if aluminium triamminochloride be heated to 280° it melts, and at 400° , distils as a colourless liquid which rapidly solidifies to a white translucent mass with the composition $6\text{AlCl}_3 \cdot \text{NH}_3$ —**aluminium hexita-amminochloride**. H. Rose obtained a similar product by the distillation of one of the higher amino compounds in a stream of hydrogen. H. Rose assigned to this product the formula $\text{AlCl}_3 \cdot \text{NH}_3$, but E. Baud showed that an excess of ammonia was present in H. Rose's product, and that with repeated distillation $6\text{AlCl}_3 \cdot \text{NH}_3$ is formed. By distilling $6\text{AlCl}_3 \cdot \text{NH}_3$ in a stream of ammonia, the product contains $\text{AlCl}_3 + 2 \cdot 33\text{NH}_3$ and evolves 38.83 Cals.—but is not a chemical individual. The compound forms a clear soln. with water. H. Rose reported that aluminium chloride absorbs about 3.67 per cent. of phosphine in 5 hrs. in the cold, but is sublimed in a stream of the gas, forming crystals of the double compound $3\text{AlCl}_3 \cdot \text{PH}_3$; small quantities of this compound dissolve in water with the evolution of phosphine not spontaneously inflammable in air, larger quantities give the spontaneously inflammable gas. The latter gas is also obtained when the compound is treated with ammonia. E. Baudrimont, and R. Weber prepared $\text{AlCl}_3 \cdot \text{POCl}_3$; and W. Casselmann, $\text{AlCl}_3 \cdot \text{POCl}_3$. With carbonyl chloride, E. Baud prepared the three compounds: $2\text{AlCl}_3 \cdot 5\text{COCl}_2$ melting at -2° ; $2\text{AlCl}_3 \cdot 3\text{COCl}_2$; and $4\text{AlCl}_3 \cdot \text{COCl}_2$ —the two last-named compounds are said to occur in commercial aluminium chloride.

Hexahydrated aluminium chloride is soluble in alcohol; and in ether. According to F. S. Havens, this salt is quite insoluble in alcohol; and he further found that it is quite insoluble in aq. ether saturated with hydrogen chloride, and if ether be added to an aq. soln. of this salt, and the well-cooled liquid be sat. with hydrogen chloride, hexahydrated aluminium chloride is precipitated while the chlorides of beryllium, zinc, copper, mercury, and bismuth remain in soln. W. Eidmann says hexahydrated aluminium chloride is insoluble in methylal; and A. Werner, in pyridine, and benzene. A number of double salts of aluminium chloride with the metal chlorides, and with various organic compounds—and chlorides, ketones, esters, nitro-compounds, amines, etc., is known. When bottles of aluminium chloride are sealed with paraffin, the salt blackens the seal. A soln. of aluminium chloride may segregate into two layers on standing. Most of the chloride remains with the lower darker-coloured layer.

According to F. Wöhler, aluminium chloride is reduced when heated with potassium, but not under naphtha. N. N. Beketoff did not succeed in reducing aluminium chloride by heating it with zinc. A. Daubrée found that when calcined to redness with calcium oxide it forms corundum; and with magnesium oxide, corundum and spinel. A soln. of aluminium chloride acts as an antiseptic and is utilized in dyeing. The addition of aluminium chloride accelerates the hydration of calcium oxide, of plaster of Paris, $\text{CaSO}_4 \cdot \frac{1}{2}\text{H}_2\text{O}$, and of Portland cement—in the latter case provided less than 2.91 per cent. be used. The aluminium chloride

retards the hydration of anhydrous calcium sulphate—*Estrichgips*. A mixture with thionyl chloride, SOCl_2 , or sulphur monochloride, S_2Cl_2 , develops chlorine. These and many other reactions, which either do not occur at all or proceed with difficulty, will readily take place if aluminium chloride be present as a catalytic agent. O. Ruff assumes that an intermediate compound is formed— $\text{AlCl}_3\cdot\text{SOCl}_2$. Similarly, thionyl chloride and sulphur give sulphur chloride and sulphur dioxide, and the reactions are symbolized: $\text{AlCl}_3 + \text{SOCl}_2 \rightleftharpoons \text{AlCl}_3\cdot\text{SO} + \text{Cl}_2$, followed by $\text{AlCl}_3\cdot\text{SO}_2 \rightleftharpoons \text{AlCl}_3 + \text{SO}_2$. Analogous reactions accelerated by aluminium chloride are the formation of iodine chloride and sulphur dioxide from sulphuryl chloride and iodine; of molybdenum pentachloride from thionyl chloride and molybdenum dichloride; of hydrogen chloride, sulphur dioxide, and sulphur from thionyl chloride, SOCl_2 , and hydrogen sulphide; and of sulphur chloride from sulphur and a soln. of phosphorus pentachloride in phosphoryl chloride at 100° .

Aluminium chloride is also a valuable catalytic agent in the so-called Friedel and Crafts' reaction—typified by the synthesis of toluene, $\text{C}_6\text{H}_5\cdot\text{CH}_3$, by passing the vapour of methyl chloride, CH_3Cl , into a boiling soln. of anhydrous aluminium chloride in benzene: $\text{C}_6\text{H}_6 + \text{CH}_3\text{Cl} = \text{HCl} + \text{C}_6\text{H}_5\cdot\text{CH}_3$; the aluminium chloride acts as a carrier, possibly by forming an unstable intermediate compound with benzene and methyl chloride. The subject was discussed by J. F. Norris. Aluminium chloride is thus used as a catalytic agent and also as a condensing agent in organic chemistry. It was formerly employed in the preparation of aluminium. The largest amount of aluminium chloride is used in refining petroleum, when it converts the unsaturated components into saturated compounds; it converts high boiling hydrocarbons into others of low b.p.; and it removes sulphur, partly as hydrogen sulphide and partly as aluminium sulphide.

Chloroaluminates.—A number of double compounds of aluminium chloride with other metallic chlorides and ammonium chloride has been prepared—principally by E. Baud.⁶ **Ammonium tetrachloroaluminate**, $\text{NH}_4\text{Cl}\cdot\text{AlCl}_3$, or NH_4AlCl_4 , was made by heating the calculated quantities of the component salts in a closed vessel at 250° or 300° . The mixture is melted, and, on cooling, forms a crystalline mass which can be distilled unchanged at a red heat in a stream of hydrogen or nitrogen. The heat of formation $\text{NH}_4\text{Cl} + \text{AlCl}_3$ is 13·26 Cals., the heat of soln. at 15° , 60·48 Cals. This compound was also prepared by J. Kendall and co-workers, and its m.p. found to be 304° .

J. Kendall and co-workers made **lithium tetrachloroaluminate**, $\text{LiCl}\cdot\text{AlCl}_3$. F. Wöhler found that when the vapour of aluminium chloride is passed over heated sodium chloride a yellow compound is formed which does not give off aluminium chloride when strongly ignited, and which dissolves in water, forming a soln. which yields crystals of sodium chloride on evaporation. H. St. C. Deville and H. Rose also prepared the same compound. The composition is represented by the formula $\text{NaCl}\cdot\text{AlCl}_3$, or NaAlCl_4 —**sodium tetrachloroaluminate**. The compound was once used in the manufacture of aluminium and was made industrially by heating a mixture of alumina, carbon, and sodium chloride in a clay retort to a white heat in a stream of chlorine when the sodium tetrachloroaluminate sublimes. M. Dullo made it by heating a mixture of sodium chloride, carbon, and clay in a current of chlorine until silicon tetrachloride begins to form, indicating that all the available alumina has been transformed into sodium chloroaluminate. J. Kendall and co-workers made this salt; R. Bunsen obtained the same compound by fusing together the component salts; and said that the m.p. is below 200° , while H. St. C. Deville said about 185° . E. Baud gives the heat of formation $\text{AlCl}_3 + \text{NaCl}$ as 5·95 Cals., and the heat of soln. at 15° as 70·71 Cals. H. St. C. Deville found that when the vapour is passed over strongly heated iron, ferrous chloride and an alloy of aluminium and iron is formed; and when heated with potassium hydrogen sulphate, thionyl chloride and chlorine are formed. H. Bassett observed that the salt is reduced to aluminium by boron, arsenic, antimony, tin, zinc, mercury, and by the amalgams of tin, zinc, and antimony. R. Bunsen obtained aluminium by the electrolysis of the fused salt.

E. Baud also found that the alkali chlorides of the type $MCl \cdot AlCl_3$ absorb ammonia to form **alkali hexammino-tetrachloroaluminates**, $MCl \cdot AlCl_3 \cdot 6NH_3$. The heats of formation and soln. of the ammonium compound are respectively 126.04 Cals., and -2.73 Cals.; of the sodium compound, 177.93 Cals. and 5.61 Cals.; and of the potassium compound 126.08 Cals., and -3.04 Cals. The salt dissolves in water and the soln. deposits sodium chloride on evaporation. H. C. Jones and K. Ota found the electrical conductivity of dil. soln. is very little different from the calculated conductivities of the components, but with 1.0 to 1.5*N*-soln. the conductivity deviates 13 per cent. from the calculated value. E. Baud made **sodium enneachloro-dialuminate**, $3NaCl \cdot 2AlCl_3$, or $Na_3Al_2Cl_9$, by heating aluminium chloride with sodium chloride to about 500° ; the molten portion has the composition $AlCl_3 \cdot 1\frac{1}{2}KCl$, while the excess of alkali chloride remains undissolved. The heat of formation $1\frac{1}{2}NaCl + AlCl_3$ is 7.64 Cals., and the heat of soln. at 15° , 68.48 Cals. By fusing together calculated quantities of the component salts, E. Baud made $3NaCl \cdot AlCl_3$, **sodium hexachloroaluminate**, with the heat of formation 9.6 Cals., and a heat of soln. at 15° , 54.86 Cals.

R. Weber made **potassium tetrachloroaluminate**, $KCl \cdot AlCl_3$, or $KAlCl_4$, by fusing together the component salts, and by heating potassium chloride with the double compounds of aluminium chloride with phosphorus pentachloride or sulphur dichloride. J. Kendall and co-workers made this salt. According to A. F. E. Degen, if potash be present when Oerstedt's process is used for making aluminium chloride, there are formed colourless drops of aluminium tetrachloroaluminate which solidify, on cooling, to a crystalline mass which deliquesces slowly in air, and dissolves in water with the evolution of heat. E. Baud gives for the heat of formation 13.19 Cals., and for the heat of soln. at 15° , 60.22 Cals. E. Baud made **potassium enneachloro-dialuminate**, $K_3Al_2Cl_9$, or $3KCl \cdot 2AlCl_3$, by a process similar to that used for the corresponding sodium salt; its heat of formation $1\frac{1}{2}KCl + AlCl_3$ is 15.26 Cals., and the heat of soln., at 15° , 7.64 Cals. Similar remarks apply to the preparation of **potassium hexachloroaluminate**, $3KCl \cdot AlCl_3$, or K_3AlCl_6 , with a heat of formation 18.318 Cals., and a heat of soln. at 15° , 46.652 Cals. The evidence that these are definite compounds is not conclusive. E. H. Ducloux prepared colourless crystals of **cæsium chloroaluminate**, thought to be $CsCl \cdot AlCl_3$. J. Kendall and co-workers made **cuprous tetrachloroaluminate**, $CuCl \cdot AlCl_3$, melting at 233° . E. Chauvenet, P. Job and G. Urbain established the existence of **cupric octochloroaluminate**, $CuCl_2 \cdot 2AlCl_3$, and of **cupric heptachloroaluminate**, $2CuCl_2 \cdot AlCl_3$, by thermochemical analyses of the aq. soln. E. Baud reported the formation of **silver tetrachloroaluminate**, $AgCl \cdot AlCl_3$, or $AgAlCl_4$, when the two components are heated in a sealed tube at 300° ; the product is less stable than the corresponding alkali salts; its heat of formation is 2.5 Cals., and its heat of soln. at 22° , 75.72 Cals. J. Kendall and co-workers made this salt. E. Baud also made **calcium octodecachloro-tetraluminate**, $4AlCl_3 \cdot 3CaCl_2$, with a heat of formation 18.56 Cals., and a heat of soln. at 16° , 346.8 Cals.; it melts below 300° . For the chloroaluminate $3CaO \cdot CaCl_2 \cdot Al_2O_3 \cdot 10H_2O$, *vide* calcium aluminate. The corresponding **strontium octodecachlorotetraluminate**, $4AlCl_3 \cdot 3SrCl_2$, also melts below 300° , its heat of formation is 17.42 Cals., and its heat of soln. at 19° , 328.78 Cals. J. Kendall and co-workers, and E. Baud made **barium octochloro-dialuminate**, $BaCl_2 \cdot 2AlCl_3$. The latter found the m.p. to be 290° . It crystallizes in silky needles recalling some native varieties of spinel; its heat of formation is 5.39 Cals., and when heated to 500° , it loses some aluminium chloride, and forms **barium octodecachlorotetraluminate**, $4AlCl_3 \cdot 3BaCl_2$, with a heat of formation of 14.6 Cals. J. Kendall and co-workers made **magnesium octochloroaluminate**, $MgCl_2 \cdot 2AlCl_3$. The corresponding **zinc octodecachlorotetraluminate**, $4AlCl_3 \cdot 3ZnCl_2$, is a pasty translucent mass, less stable than the preceding compounds, with a negative heat of formation, and a heat of soln. at 15° , 275.98 Cals.

E. Beckmann found that on adding baryta-water in excess to a soln. of aluminium chloride, the precipitated alumina is dissolved, and on evaporating an hydrated **barium**

oxychloroaluminate, $\text{Al}_2\text{O}_3 \cdot \text{BaO} \cdot 3\text{BaCl}_2 + \text{Aq.}$, crystallizes out in microscopic rhombic crystals. The substance may also be obtained when a cold conc. soln. of the barium aluminate, $\text{Al}_2\text{O}_3 \cdot 2\text{BaO} + \text{Aq.}$, is sat. with barium chloride. Under other conditions, a compound of the formula $\text{Al}_2\text{O}_3 \cdot \text{BaO} \cdot \text{BaCl}_2$, can be prepared. Similarly, when a current of carbonic anhydride is passed into an aq. soln. of these substances, the aluminium and a portion of the barium is precipitated, only the halogen salt remaining in soln.

REFERENCES.

- ¹ C. Friedel and L. Roux, *Compt. Rend.*, **100**, 1911, 1885; C. Formenti and M. G. Levi, *Boll. Chim. Farm.*, **40**, 689, 1901; L. F. Nilson and O. Pettersson, *Zeit. phys. Chem.*, **2**, 657, 1887; *Journ. Chem. Soc.*, **53**, 814, 1888.
- ² H. C. Oersted, *Øfvers. Danske Vid. Selsk. Förh.*, **15**, 1825; F. Wöhler, *Liebig's Ann.*, **116**, 256, 1860; *Pogg. Ann.*, **11**, 146, 1827; R. Bunsen, *ib.*, **92**, 648, 1854; J. von Liebig, *ib.*, **18**, 43, 1830; R. Weber, *ib.*, **103**, 269, 1858; **104**, 421, 1858; **112**, 619, 1861; H. Rose, *ib.*, **74**, 569, 1858; H. St. C. Deville, *Ann. Chim. Phys.*, (3), **43**, 23, 1854; (3), **46**, 438, 1856; J. B. A. Dumas, *ib.*, (3), **55**, 251, 1859; F. Bourion, *ib.*, (8), **20**, 547, 1910; M. Shoeld, *U.S. Pat. No.* 1375116, 1921; H. D. Gibbs, *ib.*, 1422560, 1922; 1402973, 1922; H. Howard, *ib.*, 1430449, 1922; F. W. Hall, *ib.*, 1405115, 1422568, 1922; L. Burgess, *ib.*, 1405183, 1922; A. McD. McAfee, *ib.*, 1405734, 1922; *Canadian Pat. No.* 222309, 1922; B. T. Brooks, *ib.*, 222312, 1922; G. H. King and G. I. Roberts, *ib.*, 222315, 222316, 1922; L. S. Abbott, *ib.*, 222317, 1922; D. F. Smith and H. Essex, *ib.*, 222320, 1922; R. Haddan, *Brit. Pat. No.* 191582, 1921; G. Berger and W. Kühne, *German Pat.*, *D.R.P.* 364740, 1921; E. R. Wolcott, *Brit. Pat. No.* 175006, 1920; H. N. Warren, *Chem. News*, **55**, 192, 1887; **60**, 158, 1889; P. Curie, *ib.*, **28**, 307, 1874; J. B. Cohen, *ib.*, **54**, 305, 1886; P. Askenasy, *German Pat.*, *D.R.P.* 76909, 1894; P. A. Favre, *ib.*, 62907, 1891; *Compt. Rend.*, **107**, 339, 1888; E. Baud, *ib.*, **140**, 1688, 1905; E. Demarçay, *ib.*, **104**, 111, 1887; L. Troost and P. Hautefeuille, *ib.*, **75**, 1710, 1819, 1872; H. St. C. Deville, *ib.*, **29**, 321, 1849; C. A. Matignon and F. Bourion, *ib.*, **138**, 631, 760, 1904; H. Quantin, *ib.*, **106**, 1074, 1888; P. Camboulives, *ib.*, **150**, 175, 221, 1910; E. Chauvenet, *ib.*, **152**, 87, 1911; C. A. Matignon, *ib.*, **130**, 1391, 1900; H. Gautier and G. Charpy, *ib.*, **113**, 597, 1891; R. Böttger, *Polyt. Notizbl.*, **19**, 257, 1864; G. Gustavson, *Journ. prakt. Chem.*, (2), **63**, 110, 1901; G. Gore, *Phil. Mag.*, (4), **29**, 541, 1865; C. F. Mabery, *Ber.*, **22**, 2658, 1889; F. Stockhausen and L. Gattermann, *ib.*, **25**, 3521, 1892; F. Flavitzky, *ib.*, **6**, 193, 1873; L. Meyer, *ib.*, **20**, 681, 1887; K. Seubert and W. Pollard, *ib.*, **24**, 2575, 1891; Consortium für Elektrochemische Industrie Gesellschaft, *Brit. Pat. No.* 176811, 1922; C. Baskerville, *Science*, (2), **50**, 443, 1919; F. P. Venable and D. H. Jackson, *Journ. Elisha Mitchell Soc.*, **35**, 87, 1920; *Journ. Amer. Chem. Soc.*, **42**, 2531, 1920; A. Cossa, *Nuovo Cimento*, (2), **228**, 1870; R. Escales, *Journ. Amer. Chem. Soc.*, **18**, 909, 1897; H. B. North and A. M. Hageman, *ib.*, **35**, 352, 1913; A. Daubrée, *Ann. Mines*, (4), **19**, 694, 1851; E. Köhn-Abrest, *Bull. Soc. Chim.*, (4), **5**, 768, 1909; F. R. Michel, *Ueber kristallisierte Verbindungen des Aluminiums mit Metallen*, Göttingen, 1860; L. F. Nilson and O. Pettersson, *Zeit. phys. Chem.*, **1**, 459, 1887; L. Gattermann, *Die Praxis des organischen Chemikers*, Leipzig, 1909; Aluminium Co., *Brit. Pat. No.* 163975, 1920; Armour Fertilizer Co., *ib.*, 160759, 1921; W. Heap and E. Newbery, *ib.*, 130626, 1919; E. Billmann, *Bull. Soc. Chem.*, (4), **33**, 995, 1923; B. H. Jacobsen, *Brit. Pat. No.* 181385, 190688, 1922.
- ³ E. Thorey, *Russ. Journ. Pharm.*, **10**, 321, 1871; W. Madelung, *Liebig's Ann.*, **427**, 35, 1922; T. Gladycz, *Chem. Ind.*, **6**, 74, 1883; C. von Hauer, *Südb. Akad. Wien*, **39**, 438, 1860; L. M. Dennis, *Zeit. anorg. Chem.*, **9**, 339, 1895; E. Lubarsky, *ib.*, **18**, 387, 1898; E. Borsbach, *Ber.*, **23**, 440, 1890; H. Ley, *Ber.*, **30**, 2194, 1897; *Zeit. phys. Chem.*, **30**, 193, 1889; J. Ordway, *Amer. Journ. Science*, (2), **26**, 203, 1858; F. A. Gooch and F. M. McClenahan, *ib.*, (4), **17**, 365, 1904; H. de Sénarmont, *Compt. Rend.*, **32**, 762, 1851; P. A. von Bonsdorff, *Pogg. Ann.*, **27**, 279, 1833; F. Wöhler, *ib.*, **11**, 146, 1827; *Liebig's Ann.*, **53**, 422, 1845; H. Howard, *U.S. Pat. No.* 1430449, 1922; P. Sabatier, *Bull. Soc. Chim.*, (3), **1**, 88, 1889; E. P. Kohler, *Amer. Chem. Journ.*, **24**, 385, 1900; A. S. Cushman, *ib.*, **26**, 505, 1901; G. A. Blanc, *Brit. Pat. No.* 176770, 1922; *German Pat.*, *D.R.P.* 379511, 1922.
- ⁴ F. Wöhler, *Pogg. Ann.*, **11**, 146, 1827; H. St. C. Deville and L. Troost, *Compt. Rend.*, **45**, 821, 1857; C. Friedel and L. Roux, *ib.*, **100**, 1191, 1885; C. Friedel and J. M. Crafts, *ib.*, **106**, 1764, 1887; C. Friedel, *Ann. Chim. Phys.*, (6), **19**, 171, 1891; E. Baud, *ib.*, (8), **1**, 8, 1904; M. Berthelot, *ib.*, (7), **22**, 479, 1901; K. Seubert and W. Pollard, *Ber.*, **24**, 2575, 1891; V. Meyer and H. Zublin, *ib.*, **13**, 811, 1880; L. M. Dennis and A. H. Gill, *Zeit. anorg. Chem.*, **9**, 339, 1895; A. Werner, *ib.*, **15**, 1, 1897; E. E. Sommersier, *Phys. Rev.*, (2), **1**, 141, 1913; F. E. Bartell and O. E. Madison, *Journ. Phys. Chem.*, **24**, 593, 1920; F. E. Bartell and D. C. Carpenter, *ib.*, **27**, 101, 252, 346, 1923; F. E. Bartell and L. B. Sims, *Journ. Amer. Chem. Soc.*, **44**, 289, 1922; A. Heydweiller, *Zeit. anorg. Chem.*, **116**, 42, 1921; W. Biltz, *Zeit. phys. Chem.*, **40**, 201, 1902; *Zeit. anorg. Chem.*, **115**, 251, 1921; **121**, 261, 1922; W. Biltz and W. Wein, *ib.*, **121**, 257, 1922; W. Biltz and A. Voigt, *ib.*, **126**, 39, 1923; K. Jauch, *Zeit. Physik*, **4**, 441, 1920; A. B. Bryan, *Phys. Rev.*, (2), **18**, 275, 1921; J. R. Collins, *ib.*, (2), **20**, 486, 1922; J. von Liebig, *Liebig's Ann.*, **17**, 43, 1836; H. Buff, *ib.*, **103**, 218, 1857; **110**, 257, 1859; E. Beckmann, *Zeit. phys. Chem.*, **46**,

860, 1903; H. Ley, *ib.*, **30**, 245, 1901; A. Benrath, *ib.*, **64**, 698, 1908; L. Rotinjanz and W. Suchodsky, *ib.*, **87**, 635, 1914; L. F. Nilson and O. Pettersson, *ib.*, **1**, 459, 1887; **2**, 657, 1888; **4**, 206, 1889; *Journ. Chem. Soc.*, **53**, 829, 1888; E. P. Kohler, *Amer. Chem. Journ.*, **24**, 385, 1900; H. C. Jones and F. H. Getman, *ib.*, **31**, 303, 1904; J. Thomsen, *Journ. prakt. Chem.*, (2), **11**, 233, 283, 1875; (2), **12**, 85, 271, 1875; P. Sabatier, *Bull. Soc. Chim.*, (3), **1**, 88, 1889; F. Guthrie, *Phil. Mag.*, (4), **49**, 206, 1875; W. Hampe, *Chem. Ztg.*, **11**, 54, 816, 1887; G. T. Gerlach, *Zeit. anal. Chem.*, **8**, 250, 1869; R. J. Meyer, *Zeit. anorg. Chem.*, **86**, 271, 1914; R. J. Meyer and O. Hauser, *Die chemische Analyse der seltenen Erden*, Stuttgart, 34, 1912; A. Daubrée, *Compt. Rend.*, **39**, 135, 1854; W. Jevons, *Nature*, **111**, 705, 1923.

⁵ M. Berthelot, *Compt. Rend.*, **86**, 787, 1878; *Ann. Chim. Phys.*, (3), **15**, 185, 1878; (5), **16**, 442, 1878; E. Baudrimont, *ib.*, **2**, 41, 1864; H. Rose, *ib.*, (2), **51**, 28, 1832; E. Baud, *ib.*, (8), **1**, 28, 1904; *Compt. Rend.*, **134**, 1429, 1902; **140**, 1688, 1905; P. Hautefeuille and A. Perrey, *ib.*, **100**, 1219, 1885; C. Friedel and J. M. Crafts, *ib.*, **84**, 1450, 1892, 1877; **85**, 74, 672, 1877; H. Kunheim, *Ueber Einwirkung des Wasserdampfes auf Chlormetalle bei hoher Temperatur*, Göttingen, 1861; F. Wöhler, *Pogg. Ann.*, **11**, 146, 1827; K. Weber, *ib.*, **101**, 465, 1857; **104**, 259, 1858; **107**, 375, 1859; **118**, 471, 1863; C. R. C. Tichborne, *Chem. News*, **24**, 199, 209, 220, 1871; *Bull. Soc. Chim.*, (2), **17**, 26, 1872; A. Adrianowsky, *ib.*, (2), **31**, 495, 1879; D. Tommasi, *ib.*, (2), **37**, 443, 1885; E. Schlumberger, *ib.*, (3), **13**, 56, 1895; W. E. Henderson and W. C. Gangloff, *Journ. Amer. Chem. Soc.*, **38**, 1382, 1916; A. Daubrée, *Compt. Rend.*, **39**, 135, 1854; V. Thomas, *ib.*, **121**, 128, 1895; J. A. Besson, *ib.*, **123**, 884, 1896; A. Recoura, *ib.*, **135**, 163, 736, 1902; *Bull. Soc. Chim.*, (3), **27**, 1155, 1902; N. N. Beketoff, *ib.*, (1), **1**, 22, 1859; L. Liechti and W. Suida, *Dingler's Journ.*, **251**, 177, 1883; O. Ruff, *Ber.*, **35**, 4453, 1902; **34**, 1757, 3509, 1901; W. Casselmann, *Liebig's Ann.*, **98**, 220, 1856; A. Werner, *Zeit. anorg. Chem.*, **15**, 1, 1897; W. Eidmann, *Ein Beitrag zur Erkenntnis des Verhaltens chemischer Verbindungen in nichtwässrigen Lösungen*, Giessen, 1899; F. S. Havens, *Amer. Journ. Science*, (4), **6**, 45, 1898; H. Rose, *Pogg. Ann.*, **24**, 298, 1831; J. M. Stillmann and M. B. Yoder, *Amer. Chem. Journ.*, **17**, 748, 1895; E. C. Franklin, *ib.*, **20**, 820, 1898; E. Baud, *Compt. Rend.*, **130**, 131, 1900; **132**, 134, 553, 690, 1901; **133**, 869, 1901; **134**, 1429, 1902; *Ann. Chim. Phys.*, (8), **1**, 8, 1904; J. F. Persoz, *ib.*, (2), **44**, 320, 1830; M. Adolf, W. Pauli, and F. Jandraschitsch, *Koll. Zeit.*, **29**, 281, 1921; O. C. Ralston, *Chem. News*, **127**, 246, 1923; G. L. Clark, *Amer. Journ. Science*, (5), **7**, 1, 1924; J. F. Norris, *Journ. Ind. Eng. Chem.*, **16**, 184, 1924.

⁶ E. Baud, *Compt. Rend.*, **133**, 869, 1901; *Ann. Chim. Phys.*, (8), **1**, 8, 1904; H. St. C. Deville, *ib.*, (3), **43**, 27, 1855; H. Rose, *Pogg. Ann.*, **96**, 157, 1855; R. Bunsen, *ib.*, **92**, 648, 1854; F. Wöhler, *ib.*, **11**, 146, 1827; K. Weber, *ib.*, **107**, 375, 1859; H. C. Jones and K. Ota, *Amer. Chem. Journ.*, **22**, 5, 1899; J. Kendall, E. D. Crittenden, and H. K. Miller, *Journ. Amer. Chem. Soc.*, **45**, 963, 1923; E. Chauvenet, P. Job, and G. Urbain, *Compt. Rend.*, **171**, 855, 1920; H. Basset, *Dingler's Journ.*, **173**, 359, 1864; M. Dullo, *Bull. Soc. Chim.*, (2), **5**, 472, 1866; A. F. E. Degen, *Liebig's Ann.*, **18**, 332, 1836; E. Beckmann, *Journ. prakt. Chem.*, (2), **26**, 413, 1882; *Ber.*, **14**, 2151, 1881; E. H. Ducloux, *Anal. Assoc. Quim. Argentina*, **9**, 15, 1921.

§ 16. Aluminium Bromide

C. Friedel and L. Roux¹ claim to have made aluminium sub-bromide analogous with the corresponding subchloride (*q.v.*). C. Löwig prepared anhydrous aluminium bromide by a process analogous to that employed by H. C. Oersted for the chloride; R. Weber, G. Gustavson, and H. St. C. Deville and L. Troost made it by passing bromine vapour over heated aluminium foil; and they purified the product by redistillation. J. W. Mallet redistilled the aluminium bromide from aluminium in an atm. of nitrogen. The preparation of highly purified aluminium bromide was studied by T. W. Richards and H. Krepelka. I. A. Kablukoff recommends the following process for preparing large quantities of aluminium bromide:

The beak of a glass retort is connected with a sloping, hard glass tube heated in a combustion furnace and bent at the lower end so as to fit into a glass receiver. After the retort is charged with aluminium chips and the hard glass tube is heated sufficiently to prevent bromine or aluminium bromide from condensing in it, bromine is allowed to fall gradually on to the aluminium from a tap-funnel, bromine vapour from the receiver being conducted to a draught by means of a tube. After redistillation, the aluminium bromide is obtained as a colourless liquid solidifying to a white mass. Any iron in the aluminium is precipitated according to the reaction: $\text{Fe}_2\text{Br}_6 + 2\text{Al} = \text{Al}_2\text{Br}_6 + 2\text{Fe}$.

R. Weber, J. B. Berthemot, and C. Löwig made needle-like crystals of **hexahydrated aluminium bromide**, $\text{AlBr}_3 \cdot 6\text{H}_2\text{O}$, by evaporating an aq. soln. of the salt over conc. sulphuric acid; or by treating a soln. of aluminium hydroxide in hydrobromic acid in a similar manner. According to R. Weber, the crystals when heated

decompose into water, hydrogen bromide, and alumina. J. L. Kreider found that when hexahydrated aluminium bromide is heated between 100° and 210° both water and hydrogen bromide are simultaneously evolved whether the salt be heated in air or in an atm. of hydrogen bromide, but the action in the latter case is retarded. Unlike hexahydrated magnesium bromide, there is no evidence of a differentiation of the water mols. during the dehydration, and he therefore represents this salt by the graphic formula :

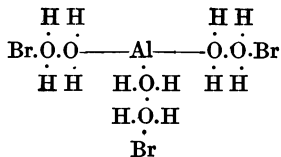

On cooling a 46 per cent. soln. of aluminium bromide by means of a calcium chloride freezing mixture, after some under cooling, crystallization occurs with a rise of temp. to -9°. The crystals are employed for inoculating a somewhat dil. soln. of aluminium bromide and a mass of colourless needle-like crystals of **pentadecahydrated aluminium bromide**, $\text{AlBr}_3 \cdot 15\text{H}_2\text{O}$, are obtained. They are dried by press. between filter paper; they melt at -7.5°, forming a turbid liquid at -5°, which becomes clear at 0°, and decomposes at 7°.

Anhydrous aluminium bromide forms lustrous rhombohedral plates of sp. gr. 2.54. R. Weber found the crystals melt at about 90° to a colourless mobile liquid which boils between 265° and 270°. W. Biltz and co-workers gave 3.01 for the sp. gr. at 25°/4, and 88.7 for the mol. vol.; and W. Biltz and A. Voigt found the sp. gr. at different temp. to be

Sp. gr.	100°	125°	150°	175°	200°	225°	265°
	2.64	2.57	2.52	2.46	2.40	2.35	2.26

The coeff. of thermal expansion is 0.001. J. W. Mallet says the m.p. is 93°, and the b.p. 263.3° at 747 mm. press. L. Rotinjanz and W. Suchodsky give 772° K. for the critical temp., and the absolute boiling temp. 533° K., so that the ratio $T_b/T_c=0.690$. According to H. St. C. Deville, the vapour density is 18.62 at 444° in agreement with 18.5, the theoretical value for Al_2Br_6 . I. A. Kablukoff gives 0.08912 for the sp. ht. of aluminium bromide between 22° and 76°; for the latent heat of fusion 10.47 cal. per gram; and for the mol. depression of the f.p., 262°. E. P. Kohler found the effect of this salt on the b.p. of carbon disulphide and nitrobenzene agreed with the formula Al_2Br_6 ; E. Beckmann also obtained a similar result with boiling soln. in bromine, and by the f.p. method. W. Biltz found the effect on the f.p. of water agreed with the formula Al_2Br_6 , or possibly with the ionization of the complex $\text{Al}[\text{AlBr}_6] \rightleftharpoons \text{Al}^{++} + \text{AlBr}_6^{--}$. W. Finkelstein found the mol. wt. from the f.p. of aluminium bromide in bromine corresponds with Al_2Br_6 for all conc. The soln. is an electrical conductor. M. Prud'homme, and E. van Aubel discussed the relation between the m.p., the b.p., and the critical temp. J. Thomsen gave for the heat of formation $(\text{Al}, \text{Br}_3)=120$ Cals., M. Berthelot, 126 Cals.; and N. N. Beketoff, 123 Cals.; G. Gustavson gives for the heat of soln., 90.118 Cals. As in the case of aluminium bromide, W. Hampe says that molten aluminium bromide is a non-conductor of electricity if heated up to its b.p. provided the salt be of a high degree of purity. W. Biltz and A. Voigt found the conductivity curve of aluminium bromide was similar to that of the chloride, Fig. 60,

Mho $\times 10^7$	195°	232°	260°	266°	270°
	0.90	1.6	2.0	2.4	2.6

According to W. A. Isobekoff, and W. A. Plotnikoff, soln. of the halogen salts in fused aluminium bromide are conductors.

M. Berthelot found that water reacts with aluminium bromide with explosive violence, R. Weber said that it decomposes when heated in air, and M. Berthelot

added that when heated to dull redness in oxygen, it burns to alumina. W. A. Plotnikoff found soln. of aluminium bromide in ethyl bromide conduct the electric current more feebly than aq. soln. ; and that the mol. conductivity of normal soln. in ethyl bromide is three times as great as a $\frac{1}{10}$ N-soln. Aluminium appears on the cathode during the electrolysis of these solns. H. E. Patten found the metal attacks the solvent, forming butane: $2Al + 6C_2H_5Br = 2AlBr_3 + 3C_4H_{10}$. R. Weber found aluminium bromide to dissolve in carbon disulphide, and that the soln. fumes strongly in air. W. Eidmann found it to be soluble in acetone. Like aluminium chloride, this salt was found by R. Weber and W. A. Plotnikoff to form a white compound, $AlBr_3 \cdot H_2S$, with hydrogen sulphide, melting at 84° .

According to R. Weber, aluminium bromide absorbs ammonia at ordinary temp. The speed of absorption is at first slow, and then rapid ; the product swells up and forms a voluminous powder of **aluminium aminobromide** which loses ammonia when exposed to the air or when warmed. The amino-compound can be sublimed in a sealed tube without melting ; and when treated with water, ammonia is evolved and aluminium hydroxide is formed. W. A. Plotnikoff obtained with phosphoryl chloride a compound which has the formula $2AlBr_3 \cdot 2POCl_3$ in a soln. of carbon disulphide ; W. A. Plotnikoff has described the compound $AlBr_3 \cdot Br_4 \cdot CS_2$ as a result of the action of bromine on a soln. of aluminium bromide in carbon disulphide. It melts in a sealed tube at $86^\circ - 90^\circ$, and it decomposes at a higher temp. ; it is reddened in sunlight or by moisture ; it is soluble in many organic liquids ; and is converted by water into C. Hell and F. Urech's *trithiobromide*, $C_2Br_6S_3$. W. A. Plotnikoff also prepared complexes with phosphorus tribromide and ethyl bromide, $AlBr_3 \cdot PBr_3 \cdot C_2H_5Br$, ethylidene bromide, etc., may be substituted for ethyl bromide ; similarly with phosphorus pentabromide, $AlBr_3 \cdot PBr_5 \cdot C_2H_5Br$.

Aluminium bromide reacts with carbonyl chloride, forming aluminium chloride : $AlBr_3 + 3COCl_2 = AlCl_3 + 3COClBr$, provided the carbonyl chloride be in excess, while if the aluminium bromide be in excess, **aluminium dichlorobromide**, $AlBrCl_2$, is formed. A. von Bartsch prepared the last-named compound by passing carbonyl chloride into aluminium bromide in a flask heated in a water-bath and connected with a second flask placed in a freezing mixture until the contents of the first flask became solid. The distillate in the second flask consisted mainly of bromine with some carbonyl bromide. From part of the solid residue in the first flask, anhydrous aluminium chlorobromide was obtained, by sublimation in a vacuum, as small, brick-red leaflets which fume and deliquesce in the air. The compound sublimes practically unchanged at $100^\circ - 120^\circ / 15 - 20$ mm., and melts when heated at $142^\circ - 143^\circ$ in a sealed tube. Another portion of the solid residue was dissolved in ice-cold water, and on careful evaporation **hexahydrated aluminium dichlorobromide**, $AlCl_2Br \cdot 6H_2O$, was obtained in small, light red to yellow crystals. The hydroxide does not fume in the air, but is deliquescent and easily soluble in water ; it does not melt even when heated in a sealed tube, but at higher temp. loses water and decomposes.

J. Kendall and co-workers prepared **ammonium tetrabromoaluminate**, $NH_4Br \cdot AlBr_3$, melting at 232° ; **ammonium heptabromoaluminate**, $NH_4Br \cdot 2AlBr_3$, melting at 104.2° ; **ammonium decabromoaluminate**, $NH_4Br \cdot 3AlBr_3$, melting at 97.8° ; **lithium tetrabromoaluminate**, $LiBr \cdot AlBr_3$, melting at 197° ; **lithium heptabromoaluminate**, $LiBr \cdot 2AlBr_3$, melting at 197° ; **lithium dodecibromoaluminate**, $LiBr \cdot 7AlBr_3$, melting at 114.8° ; **sodium tetrabromoaluminate**, $NaBr \cdot AlBr_3$, melting at 201° ; **sodium heptabromoaluminate**, $NaBr \cdot 2AlBr_3$; and **sodium tricosibromoaluminate**, $2NaBr \cdot 7AlBr_3$, melting at 95.6° . R. Weber prepared what he regarded as a double salt, **potassium tetrabromoaluminate**, $AlBr_3 \cdot KBr$, by fusing together the component salts. J. Kendall made the same salt, melting at 191.5° ; **potassium heptabromoaluminate**, $KBr \cdot 2AlBr_3$, melting at 95.8° ; **silver tetrabromoaluminate**, $AgBr \cdot AlBr_3$, melting at 215.6° ; **silver heptabromoaluminate**, $AgBr \cdot 2AlBr_3$; **calcium octobromoaluminate**, $CaBr_2 \cdot 2AlBr_3$, melting at 306° ; and **barium octobromoaluminate**, $BaBr_2 \cdot 2AlBr_3$. E. Beckmann also made **barium oxybromoaluminate**,

$\text{Al}_2\text{O}_3 \cdot \text{BaO} \cdot \text{BaBr}_2 \cdot \text{Aq.}$, analogous to the corresponding chloride. J. Kendall and co-workers made **magnesium octobromoaluminate**, $\text{MgBr}_2 \cdot 2\text{AlBr}_3$; **zinc octobromoaluminate**, $\text{ZnBr}_2 \cdot 2\text{AlBr}_3$, melting at 111.5° ; **cadmium octobromoaluminate**, $\text{CdBr}_2 \cdot 2\text{AlBr}_3$, melting at 224° ; **mercurous tetrabromoaluminate**, $\text{HgBr} \cdot \text{AlBr}_3$, melting at 261° ; and two forms of **mercuric octobromoaluminate**, $\text{HgBr}_2 \cdot 2\text{AlBr}_3$, melting respectively at 102.8° and 103.9° . M. I. Konowaloff, W. A. Plotnikoff, G. Gustavson, and others have studied the compounds of aluminium chloride with various organic compounds. G. Gustavson, and J. A. Besson used aluminium bromide as a brominating agent in organic synthesis.

REFERENCES.

¹ C. Friedel and L. Roux, *Compt. Rend.*, **100**, 1191, 1885; H. C. Oersted, *Øfvers. Danske Vid. Selsk. Forh.*, **15**, 1825; R. Weber, *Pogg. Ann.*, **101**, 469, 1857; **103**, 264, 1857; C. Löwig, *ib.*, **14**, 485, 1828; G. Gustavson, *Journ. prakt. Chem.*, (2), **63**, 110, 1901; (2), **75**, 328, 1907; J. W. Mallet, *Phil. Trans.*, **171**, 1003, 1880; *Chem. News*, **41**, 212, 1880; H. St. C. Deville and L. Troost, *Ann. Chim. Phys.*, (3), **58**, 279, 1860; J. B. Berthelot, *ib.*, (3), **44**, 394, 1855; J. L. Kreider, *Amer. Journ. Science*, (4), **20**, 97, 1905; *Zeit. anorg. Chem.*, **46**, 357, 1905; I. L. Panfiloff, *Journ. Russ. Phys. Chem. Soc.*, **27**, 77, 1895; E. P. Kohler, *Amer. Chem. Journ.*, **24**, 385, 1900; W. Finkelstein, *Zeit. phys. Chem.*, **105**, 10, 1923; E. Beckmann, *Ber.*, **14**, 2151, 1881; *Zeit. anorg. Chem.*, **51**, 96, 1906; *Zeit. phys. Chem.*, **46**, 853, 1904; W. Biltz, *ib.*, **40**, 185, 1902; G. Gustavson, *Journ. Russ. Phys. Chem. Soc.*, **17**, 57, 1885; M. I. Konowaloff, *ib.*, **30**, 12, 1898; I. A. Kablukoff, *ib.*, **40**, 485, 1908; W. A. Isobekoff and W. A. Plotnikoff, *ib.*, **43**, 18, 1911; T. W. Richards and H. Krepelka, *Journ. Amer. Chem. Soc.*, **42**, 2221, 1920; W. Biltz and W. Wein, *Zeit. anorg. Chem.*, **121**, 257, 1922; W. Biltz and A. Voigt, *ib.*, **126**, 39, 1922; M. Prud'homme, *Journ. Chim. Phys.*, **18**, 359, 1920; *Ann. Chim. Phys.*, (9), **15**, 212, 1921; E. van Aubel, *Bull. Acad. Belg.*, (5), **7**, 469, 1921; J. Kendall, E. D. Crittenden, and H. K. Miller, *Journ. Amer. Chem. Soc.*, **45**, 963, 1923; W. A. Plotnikoff, *Journ. Russ. Phys. Chem. Soc.*, **31**, 1020, 1899; **33**, 429, 1901; **34**, 466, 1902; **45**, 1162, 1913; **48**, 891, 1916; *Zeit. anorg. Chem.*, **38**, 133, 1904; A. von Bartal, *ib.*, **55**, 152, 1907; **56**, 49, 1907; N. N. Beketoff, *Bull. Acad. St. Petersburg*, (5), **10**, 79, 1899; J. A. Besson, *Compt. Rend.*, **123**, 884, 1896; M. Berthelot, *ib.*, **86**, 787, 1878; *Bull. Soc. Chim.*, (2), **31**, 254, 1879; J. Thomsen, *Journ. prakt. Chem.*, (2), **11**, 233, 283, 1875; (2), **12**, 85, 271, 1875; W. Hampe, *Chem. Ztg.*, **11**, 54, 1887; W. Eidmann, *Ein Beitrag zur Erkenntnis des Verhaltens chemischer Verbindungen in nichtwässrigen Lösungen*, Giessen, 1899; L. Rotinjanz and W. Suchodsky, *Zeit. phys. Chem.*, **87**, 635, 1914; H. E. Patten, *Journ. Phys. Chem.*, **8**, 548, 1904; C. Hell and F. Urech, *Ber.*, **15**, 273, 1882.

§ 17. Aluminium Iodide

According to F. Wöhler,¹ aluminium does not alter when heated in iodine vapour, but R. Weber found that if heated with about ten times its weight of iodine in a sealed tube the combination was attended by the evolution of light and heat. The brown product can be purified by repeated sublimation with an excess of aluminium in a sealed tube. R. Weber also formed the same compound by heating aluminium with silver iodide in a sealed tube. G. Gustavson heated the two elements in a stream of dry carbon dioxide and obtained aluminium iodide; and he obtained the same compound by leaving a mixture of eq. proportions of the two elements and three times their weight of carbon disulphide in a stoppered vessel for about two days at the ordinary temp. The iodide dissolves in the solvent as fast as it is formed. The action is slower with benzene or ethyl iodide as solvent. I. L. Panfiloff made an aq. soln. by digesting aluminium with iodine in the presence of warm water, and R. Weber by dissolving aluminium hydroxide in hydriodic acid.

By evaporating an aq. soln. of aluminium iodide over conc. sulphuric acid, R. Weber obtained yellowish or white crystals of **hexahydrated aluminium iodide**, $\text{AlI}_3 \cdot 6\text{H}_2\text{O}$, which, when heated, give off water, iodine, and hydrogen iodide, leaving residual alumina. I. L. Panfiloff treated a 58 per cent. soln. of aluminium iodide as in the case of aluminium bromide, and obtained yellowish or white needles of **pentadecahydrated aluminium iodide**, $\text{AlI}_3 \cdot 15\text{H}_2\text{O}$, which begin to melt at -25° and are completely fluid at -18° . F. Ephraim and I. Kornblum made **aluminium sulphitoiodide**, $\text{AlI}_3 \cdot \text{SO}_2$, by direct union of the constituents at a low temp.

Anhydrous aluminium iodide forms white deliquescent plates which can be purified by crystallization from carbon disulphide. The crystals have a sp. gr. of 2.63, and melt to a mobile liquid at 185°. W. Biltz and co-workers gave 3.98 for the sp. gr. at 25°/4°, and 102.5 for the mol. vol. W. Biltz and A. Voigt found

Sp. gr..	200°	205°	210°	220°	230°	240°	382°
	3.20	3.18	3.17	3.15	3.12	3.10	2.78

According to L. Rotinjanz and W. Suchodsky, aluminium iodide boils at 350° or 623° K., and has a critical temp. of 955° K., so that the ratio $T_b/T_c=0.652$. H. St. C. Deville and L. Troost found the vapour density at 444° to be 27.0 (air unity) when the theoretical value for the formula Al_2I_6 is 28.2. E. Beckmann found the mol. wt. of a soln. of aluminium iodide in molten iodine agrees with the formula Al_2I_6 ; and E. P. Kohler obtained a similar result for soln. in boiling carbon disulphide. M. Prud'homme, and E. van Aubel discussed the relation between the m.p., the b.p., and the critical temp. The heat of formation is 86.3 Cals., according to M. Berthelot; J. Thomsen gives 70.3 Cals. and the heat of soln. 89 cal. W. Biltz and A. Voigt found the electrical conductivity curve to be general like that of aluminium chloride, Fig. 61,

Mho $\times 10^6$.	209°	226°	238°	260°	270°
	2.6	3.9	4.7	6.3	7.4

According to R. Weber, aluminium iodide decomposes very easily when heated in air, losing iodine and forming alumina; the vapour of aluminium iodide is inflammable, burning with an orange-red flame, forming a cloud of alumina; and M. Berthelot found a mixture of the vapour of aluminium iodide and air explodes in contact with a flame, and he explains this by the difference in the heats of formation— Al_2I_6 , 172.6 Cals.; Al_2O_3 , 391.6 Cals. Aluminium iodide fumes in air, and deliquesces rapidly. It readily dissolves in water with the evolution of much heat; when the aq. soln. is boiled, it decomposes, as also is the case with aq. or alcoholic soln. in the presence of zinc or aluminium. According to R. Weber, hydrogen sulphide has no action on aluminium iodide.

According to R. Weber, aluminium iodide does not absorb ammonia, but E. C. Franklin finds it to be very soluble in liquid ammonia, forming a clear colourless soln. from which **aluminium icosiamminiodide**, $AlI_3 \cdot 20NH_3$, crystallizes on cooling to -33° ; at 8° to 13° , these crystals lose ammonia, and form **aluminium hexamminiodide**, $AlI_3 \cdot 6NH_3$. Considerable quantities of potassium amide, KNH_2 , can be added to the soln. of aluminium iodide in liquid ammonia without forming a permanent precipitate, for the precipitate which first appears dissolves when the liquid is agitated. With limited amounts of potassium iodide, aluminium triiodotriamide, $Al_2(NH_2)_3I_3$, or $AlI_3 \cdot Al(NH_2)_3$, is formed: $3KNH_2 + 2AlI_3 = 3KI + AlI_3 \cdot Al(NH_2)_3$. At ordinary temp., this salt separates from its soln. with six mols. of ammonia of crystallization—forming **aluminium hexamminotriiodotriamide**, $Al(NH_2)_3 \cdot AlI_3 \cdot 6NH_3$; at low temp. the salt separates with about twenty mols. of ammonia of crystallization, and when treated with potassium amide this compound produces insoluble **aluminium amminiodopentamide**, $Al_2(NH_2)_5I \cdot NH_3$, or $Al(NH_2)_3 \cdot Al(NH_2)_2I \cdot NH_3$, which, when heated to 160° , loses two mols. of ammonia, producing **aluminium iodoimidotriamide**, $Al(NH_2)_3 \cdot AlNHI$. The salt is soluble in carbon disulphide, from which it crystallizes when a hot soln. is cooled; it is also soluble in alcohol; and, according to G. Gustavson, in ether. Carbon tetrachloride, CCl_4 , and hexachloride, C_2Cl_6 , react vigorously with the liberation of iodine, and G. Gustavson represents the reaction in a soln. of carbon disulphide: $4AlI_3 + 3CCl_4 = 3CI_4 + 4AlCl_3$. A. von Bartal found liquid carbonyl chloride reacts vigorously with aluminium iodide dissolved in carbon disulphide, but no new compounds were isolated from the products—*vide* the corresponding reaction with aluminium bromide.

R. Weber heated powdered potassium iodide with aluminium iodide in a sealed tube and obtained a crystalline mass of **potassium tetraiodoaluminate**, $AlI_3 \cdot KI$,

or $KAlI_4$, which melts readily, and is not easily decomposed at high temp. It dissolves in water with the evolution of much heat. Similar remarks apply to **sodium tetraiodoaluminate**, $NaAlI_4$. E. Beckmann prepared **barium oxyiodoaluminate**, $Al_2O_3 \cdot BaO \cdot BaI_2 \cdot 4Aq.$, analogous to the corresponding chloride. A. Duboin alternately dissolved aluminium and mercuric iodides in water until saturated and obtained a clear yellow liquid, D^{20}_{15} 3.05, which, when placed in dry air for several months, absorbs oxygen, becoming much deeper in colour, and depositing crystals of the **mercuric oxyiodoaluminate**, $HgO \cdot 2AlI_3 \cdot 3HgI_2 \cdot 15H_2O$, having D^{20}_{15} 3.97. A soln. of aluminium iodide dissolves silver iodide, giving a liquid, D^{19}_{15} 2.34. This, on spontaneous evaporation, deposits yellow crystals of **silver oxyiodoaluminate**: $2AlI_3 \cdot 5AgI \cdot 2AgO \cdot 13H_2O$, which alter extremely rapidly in air.

REFERENCES.

¹ F. Wöhler, *Pogg. Ann.*, **11**, 147, 1827; R. Weber, *ib.*, **101**, 465, 1857; **103**, 259, 1857; G. Gustavson, *Journ. prakt. Chem.*, (2), **63**, 110, 1901; *Liebig's Ann.*, **172**, 173, 1874; *Journ. Russ. Phys. Chem. Soc.*, **13**, 288, 1881; I. L. Panfiloff, *ib.*, **27**, 77, 1895; W. Biltz and W. Wein, *Zeit. anorg. Chem.*, **121**, 257, 1922; A. von Bartal, *ib.*, **56**, 49, 1907; W. Biltz and A. Voigt, *ib.*, **126**, 39, 1923; M. Prud'homme, *Journ. Chim. Phys.*, **18**, 359, 1920; *Ann. Chim. Phys.*, (9), **15**, 212, 1921; E. van Aubel, *Bull. Acad. Belg.*, (5), **7**, 469, 1921; A. Duboin, *Compt. Rend.*, **145**, 713, 1907; L. Rotinjanz and W. Suchodsky, *Zeit. phys. Chem.*, **87**, 635, 1914; H. St. C. Deville and L. Troost, *Ann. Chim. Phys.*, (3), **58**, 257, 1860; M. Berthelot, *ib.*, (7), **22**, 479, 1901; *Bull. Soc. Chim.*, (2), **31**, 254, 1879; E. Beckmann, *Zeit. anorg. Chem.*, **77**, 200, 275, 1912; *Ber.*, **14**, 2151, 1882; E. P. Kohler, *Amer. Chem. Journ.*, **24**, 385, 1900; E. C. Franklin, *Journ. Amer. Chem. Soc.*, **27**, 847, 1905; J. Thomsen, *Thermochemische Untersuchungen*, Leipzig, **3**, 240, 1883; F. Ephraim and I. Kornblum, *Ber.*, **49**, 2007, 1916.

§ 18. Aluminium Sulphides

F. Wöhler¹ distilled sulphur over aluminium without combination, but, according to F. G. Reichel, if sulphur vapour be carried in a stream of hydrogen over red-hot aluminium, or, according to F. Wöhler, if sulphur be thrown into red-hot aluminium, a vigorous reaction ensues, and **aluminium sulphide**, Al_2S_3 , is formed. F. Knapp and P. Ebell obtained it by adding sulphur to molten aluminium. W. Spring said that a little sulphide is formed when a mixture of sulphur and aluminium is compressed at 65 atm. W. Stein obtained aluminium sulphide by burning aluminium in sulphur vapour; and H. Fonzes-Diacon, by igniting a mixture of sulphur and fine aluminium powder by means of a piece of burning magnesium. The combustion is propagated through the mass; C. Matignon prepared it in a similar manner. W. Biltz and F. Caspari purified the product by sublimation in vacuo at 1100°–1250°, when it forms crystals resembling asbestos. Good crystals are obtained by sublimation, in nitrogen under atm. press., from a carbon tube at 1500°–1600°. The yellow sublimate, more volatile than aluminium sulphide, is silicon sulphide.

H. St. C. Deville said that neither hydrogen sulphide nor potassium sulphide acts on red-hot aluminium, and F. G. Reichel made a similar observation with respect to ammonium sulphide. Aluminium, however, reacts readily with many other sulphides, forming aluminium sulphide and an alloy of the metal and aluminium. H. Fonzes-Diacon ignited a mixture of aluminium powder and antimony sulphide by means of a piece of burning magnesium, the combustion is rapidly propagated through the mass; A. Mourlot heated aluminium with an excess of antimony sulphide in an electric furnace, the antimony volatilized, and crystalline aluminium sulphide remained. A. Mourlot also used a mixture of aluminium and zinc sulphide; C. Tissier, silver sulphide; and C. T. J. Vautin, lead or other metal sulphide.

According to F. G. Reichel, a mixture of alumina and sulphur or sulphur and carbon does not furnish aluminium sulphide, but A. H. Bucherer obtained the sulphide by the action of sulphur on a white-hot mixture of alumina and carbon. C. W. Vincent obtained the sulphide by heating alumina with sodium sulphide; W. Stein, by heating alumina with sodium carbonate and sulphur; and T. Petitjean, and M. Herzog, by heating alumina with soda, sulphur, and tar. O. Schumann found that traces only of aluminium sulphide are formed when hydrogen sulphide is passed over red-hot alumina. A. Gautier found hydrogen sulphide furnishes *aluminium oxysulphide* $\text{Al}_2\text{O}_3 \cdot \text{Al}_2\text{S}_3$, when passed over alumina at a white heat, $4\text{Al}_2\text{O}_3 + 9\text{H}_2\text{S} = 2(\text{Al}_2\text{O}_3 \cdot \text{Al}_2\text{S}_3) + 3\text{SO}_2 + 9\text{H}_2$. E. Frémy showed that if carbon disulphide be employed, aluminium sulphide is readily formed. E. Frémy said:

It is well known that sulphur has no action on alumina. I thought it might be possible to replace the oxygen by sulphur if I introduced or intervened a second affinity as that of carbon for oxygen. Decompositions produced by two affinities are very frequent in chemistry; it is thus that carbon and chlorine, by acting simultaneously on silica or alumina, produce silicon or aluminium chloride, while either alone could not decompose it. . . . I thought that carbon disulphide ought to act at a high temp. on silica, magnesia, and alumina producing easily their sulphides. Experiment confirmed this view. . . . To facilitate the reaction with alumina, and to protect the sulphide from the decomposing action of the alkalis contained in the porcelain tube which was used, I found it sometimes useful to mix the oxides with carbon and to form the mixture into bullets resembling those employed in the preparation of aluminium chloride. I ordinarily placed the bullets in little carbon boats, and heated the tube to whiteness in the current of vaporized carbon bisulphide. The presence of divided carbon does not appear useful in the preparation of this sulphide. Aluminium sulphide being non-volatile (under these conditions) it is always mixed with some—about 63.5 per cent.—undecomposed alumina. Indeed, it is impossible to transform entirely all the alumina into sulphide.

W. Stein used a similar process, but H. N. Warren failed to obtain sulphide either at a red or at a white heat. L. P. B. E. Cumenge made the carbon disulphide at one end of the same retort as the aluminium sulphide was made. D. G. Reillon, S. C. Montague, and O. L. B. L. Bourgerel passed carbon disulphide into a red-hot mixture of alumina and carbon: $2\text{Al}_2\text{O}_3 + 3\text{C} + 3\text{CS}_2 = 2\text{Al}_2\text{S}_3 + 6\text{CO}$. D. A. Peniakoff prepared aluminium sulphide by heating aluminium sulphate, phosphate, manganate, or chromate with carbon disulphide, or carbonyl sulphide: $\text{Al}_2(\text{SO}_4)_3 + 6\text{CS}_2 = \text{Al}_2\text{S}_3 + 6\text{CO}_2 + 12\text{S}$; and $2\text{AlPO}_4 + 4\text{CS}_2 = \text{Al}_2\text{S}_3 + \text{P}_2\text{S}_5 + 4\text{CO}_2$. O. Schumann did not succeed in reducing aluminium sulphate to the sulphide by heating it in a current of hydrogen, but A. Violi reduced the sulphate by heating it with sulphur. D. A. Peniakoff said that when the aluminium halides, or alkali aluminium halides, are fused with sodium sulphide, aluminium sulphide is obtained in a form suitable for reduction to aluminium: $2\text{AlF}_3 + 3\text{Na}_2\text{S} = \text{Al}_2\text{S}_3 + 6\text{NaF}$; $2\text{Na}_3\text{AlF}_6 + 3\text{Na}_2\text{S} = \text{Al}_2\text{S}_3 + 12\text{NaF}$. According to F. Lauterborn, aluminium sulphide is formed by heating a mixture of alumina and calcium sulphide. H. S. Blackmore heated a soln. of alumina in molten alkali fluoride, chloride, or aluminate in a stream of carbon disulphide. T. R. Haglund heated alumina, coal and carbides, and a sulphur compound.

F. Wöhler's sulphide prepared in 1829 was a black, vitreous mass; E. Frémy's, prepared 24 years later, was also a vitreous mass; A. Mourlot's was a crystalline mass. W. Biltz and F. Caspari's product, purified by sublimation, forms long, white, hexagonal, needle-like crystals with a sp. gr. 2.02 at $13^\circ/13^\circ$ —A. Mourlot gave 2.37. W. Biltz and F. Caspari found the m.p. to be $1100^\circ \pm 10^\circ$; and mixtures with alumina melted at a lower temp. and formed solid soln. A mixture of the sulphide with 27 per cent. of oxide melted at 997° . P. Sabatier gave for the heat of formation $(2\text{Al}, 3\text{S}) = 124.4$ Cals., and for the heat of decomposition with water at 12° , $\text{Al}_2\text{S}_3 + \text{Aq.}$, 74 Cals.

F. Wöhler noted that when aluminium sulphide is exposed to air, it gradually swells up emitting hydrogen sulphide, and finally crumbling to a greyish-white powder. In accord with the fact that aluminium sulphide is a salt of a very weak acid, and of a very weak, practically insoluble base, water hydrolyzes the sulphide into

aluminium hydroxide and hydrosulphuric acid: $\text{Al}_2\text{S}_3 + 6\text{H}_2\text{O} = 3\text{H}_2\text{S} + 2\text{Al}(\text{OH})_3$, probably, added W. Biltz and F. Caspari, with the formation of intermediate compounds, since the prolonged action of moist hydrogen sulphide gives the oxysulphide $\text{Al}_2\text{O}_3 \cdot \text{Al}_2\text{S}_3 \cdot \text{H}_2\text{O}$. The action of water on aluminium sulphide has been proposed as a very convenient means of generating hydrogen sulphide. The hydrolysis by warm water is turbulent. A. Mourlot said the crystalline sulphide is not attacked by water so rapidly as the amorphous sulphide. According to E. Frémy, aluminium sulphide at a red heat is decomposed by steam; and crystals of corundum are formed. P. Curie said that hydrochloric acid furnishes the chloride and hydrogen sulphide. M. Houdard said that when heated in the electric furnace, aluminium sulphide, mixed with carbon, is not volatilized or transformed into carbide nor does it dissolve any carbon. H. C. Geelmuyden said that aluminium sulphide is not reduced by calcium carbide. F. G. Reichel said that iron and copper decompose aluminium sulphide at a red heat; and T. Petitjean said that iron and hydrocarbons reduce it to aluminium. The reduction of aluminium sulphide has been suggested as a convenient means of preparing the metal (*q.v.*). M. Houdard noted that alumina is soluble in fused aluminium sulphide, and crystallizes as corundum on cooling.

F. F. Regelsberger melted alumina with sulphur in an electric furnace, and obtained a product with about 90 per cent. of what he regarded as **aluminium subsulphide**, AlS , which loses hydrogen sulphide when exposed to atm. air, and is decomposed by water, acids, or alkalis with the evolution of hydrogen and hydrogen sulphide: $2\text{AlS} + 6\text{HCl} = 2\text{AlCl}_3 + 2\text{H}_2\text{S} + \text{H}_2$. W. Biltz and F. Caspari obtained the sub-sulphide by heating the ordinary sulphide to 2100° in an atm. of an inert gas.

D. A. Peniakoff obtained complex sulphides by heating aluminium sulphate or phosphate with a sulphide of the alkalis, alkaline earths, zinc, or manganese in a stream of carbon disulphide, $2\text{Al}_2\text{O}_3 + 4\text{R}'_3\text{PO}_4 + 11\text{CS}_2 = 2(\text{Al}_2\text{S}_3 \cdot 3\text{R}'_2\text{S}) + 2\text{P}_2\text{S}_5 + 11\text{CO}_2$; and with the sulphate, $\text{Al}_2(\text{SO}_4)_3 + 3\text{R}''\text{S} + 6\text{S} = \text{Al}_2\text{S}_3 \cdot 3\text{R}''\text{S} + 6\text{SO}_2$. M. M. Jännigen prepared **sodium sulphoaluminate**, $\text{Na}_6\text{Al}_2\text{S}_6$, or $\text{Al}_2\text{S}_3 \cdot 3\text{Na}_2\text{S}$, by heating aluminium oxide with sodium carbonate in an atm. of carbon disulphide; and he made **potassium sulphoaluminate**, $\text{K}_6\text{Al}_2\text{S}_6$, or $\text{Al}_2\text{S}_3 \cdot 3\text{K}_2\text{S}$, in a similar manner. H. St. C. Deville described a complex sulphide of aluminium and potassium obtained by passing sulphur vapour over a strongly ignited mixture of carbon with potash-alum. The product was said to decompose water with violence. D. Gratama repeated the work and obtained a product which was spontaneously inflammable; yielding no gas with water, and only a slight evolution of hydrogen sulphide when treated with hydrochloric acid. The filtered soln. contained no aluminium. No double sulphide was formed.

H. Ditz thought it possible that *copper sulphoaluminate* is formed by the action of aluminium on cupric sulphide. L. Cambi investigated the system $\text{Ag}_2\text{S} - \text{Al}_2\text{S}_3$ by thermal analysis. His results are summarized in Fig. 62 so far as mixtures containing 40 molar per cent. of aluminium sulphide are concerned. There is evidence of the formation of **silver enneadecasulphodecaluminate**, $4\text{Ag}_2\text{S} \cdot 5\text{Al}_2\text{S}_3$, or $\text{Ag}_8\text{Al}_{10}\text{S}_{19}$, which melts unchanged at 1038° , and forms homogeneous, flesh-coloured, birefringent crystals. There is also evidence of the formation of a second compound, decomposing at 325° , very near the eutectic, and containing 60 to 70 molar per cent. of silver sulphide. M. M. Jännigen reported the formation of **calcium, strontium, and barium sulphoaluminates** by the process he used for the sodium salt. D. A. Peniakoff made these salts by the process indicated above.

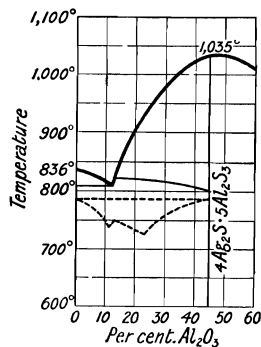

FIG. 62.—Freezing-point Curves of Silver and Aluminium Sulphides.

M. Houdard heated a mixture of one gram-atom of magnesium and two gram-atoms of aluminium in a stream of carbon disulphide, and obtained a crystalline mass of **magnesium sulphoaluminate**, $MgS.Al_2S_3$, analogous in crystalline form to spinel. The compound is decomposed by oxygen-free water, by 90 per cent. alcohol, and by acetic acid diluted with alcohol. D. A. Peniakoff made *zinc sulphoaluminate* as indicated above.

REFERENCES.

¹ F. Wöhler, *Pogg. Ann.*, **11**, 146, 1827; *Liebig's Ann.*, **53**, 422, 1845; G. Schumann, *ib.*, **187**, 305, 1877; F. G. Reichel, *Journ. prakt. Chem.*, (2), **12**, 55, 1875; W. Stein, *ib.*, (2), **3**, 43, 1871; A. H. Bucherer, *Zeit. angew. Chem.*, **5**, 483, 1892; H. Fonzes-Diacon, *Bull. Soc. Chim.*, (4), **1**, 36, 1907; *Compt. Rend.*, **130**, 1314, 1900; C. Matignon, *ib.*, **130**, 1391, 1900; C. Tissier, *ib.*, **52**, 931, 1861; M. Houdard, *ib.*, **144**, 801, 1114, 1349, 1907; A. Gautier, *ib.*, **143**, 7, 1906; P. Sabatier, *ib.*, **90**, 819, 1880; H. C. Geelmuyden, *ib.*, **130**, 1026, 1900; A. Mourlot, *ib.*, **123**, 54, 1896; *Ann. Chim. Phys.*, (7), **17**, 552, 1899; E. Frémy, *ib.*, (3), **38**, 322, 1853; H. St. C. Deville, *ib.*, (3), **43**, 5, 1855; (3), **46**, 415, 1856; *Compt. Rend.*, **43**, 970, 1856; M. Herzog, *Ind. Blatt.*, **22**, 339, 1885; C. T. J. Vautin, *Brit. Pat. No. 751*, 1893; D. A. Peniakoff, *ib.*, 7273, 1896; 11555, 1896; L. P. B. E. Cumenge, *ib.*, 461, 1868; D. G. Reillon, S. C. Montague, and O. L. B. L. Bourgerel, *ib.*, 4576, 1887; H. S. Blackmore, *Journ. Soc. Chem. Ind.*, **16**, 219, 1897; H. N. Warren, *Chem. News*, **65**, 135, 1892; P. Curie, *ib.*, **28**, 307, 1873; W. Biltz and F. Caspari, *Zeit. anorg. Chem.*, **71**, 182, 1911; F. Knapp and P. Ebell, *Dingler's Journ.*, **229**, 69, 173, 1878; T. Petitjean, *London Journ. Arts*, (4), **7**, 282, 1858; W. Spring, *Ber.*, **16**, 1011, 1885; A. Violi, *Annali Chim.*, (3), **63**, 311, 366, 1876; C. W. Vincent, *Phil. Mag.*, (4), **14**, 127, 1857; F. Lauterborn, *German Pat.*, *D.R.P.* 14495, 1880; M. M. Jänrigen, *ib.*, 80944, 1895; F. F. Regelsberger, *Zeit. Elektrochem.*, **4**, 547, 1898; D. Gratama, *Rec. Trav. Chim. Pays-Bas*, **3**, 4, 1884; L. Cambi, *Atti Accad. Lincei*, (5), **21**, ii, 837, 1912; H. Ditz, *Met.*, **4**, 787, 1907; T. R. Haglund, *Swedish Pat. No. 54107*, 1923; T. R. Haglund, O. Magnusson, and H. Lundin, *ib.*, 53941, 1923.

§ 19. Aluminium Sulphates

Technical processes for preparing aluminium sulphate from clay, bauxite, etc. have been previously described,¹ or are indicated in connection with alum. This salt is obtained in soln. by dissolving aluminium hydroxide in sulphuric acid. H. V. Collet-Descotils boiled ammonia alum with aqua regia until all the ammonia was destroyed. The soln. does not crystallize readily. J. Boek recommended concentrating the soln. in vacuo until crystals are formed, and more soln. added from time to time, which results in the production of very large crystals. The Norske Aktieselskab for Elektrokem. Ind. electrolyzed a soln. of aluminium sulphate containing a little sodium sulphate in a diaphragm cell at 60°-80°; the free acid developed in the anode compartment dissolved the raw material labradorite in the anode compartment, and thus aluminium sulphate is extracted from that felspar. Basic aluminium sulphate deposits on the anode. J. Morel made aluminium sulphate by heating bauxite with a mixture of air, steam, and sulphur dioxide at a temp. not exceeding 800°. W. Fulda heated aluminium hydroxide with ammonium sulphate, and reconverted the ammonia to sulphate by the gypsum process; and he later recommended ammonia-alum in place of ammonium sulphate.

H. von Kéler and G. Lunge found in commercial aluminium sulphate 0.00050 to 0.0054 per cent. of iron presumably present as ferric sulphate; 0.53 to 1.05 per cent. of free sulphuric acid; and in one sample they found 0.00156 per cent. of zinc. F. Wirth and B. Bakke² were unable to separate ferric sulphate from aluminium sulphate by crystallization, but it is possible to do so if the ferric salt be reduced to ferrous sulphate by hydrogen sulphide, sulphur dioxide, etc. Arsenic, and alkali sulphates are often present. C. F. Mohr found that the commercial salt is usually contaminated with a little alum. M. Müller described the manufacture of an impure aluminium sulphate suitable as a precipitating agent in sizing paper.

There are some different statements as to the water of crystallization. P. M. Delacharlony holds that the crystals are normally the **hexadecahydrated**

aluminium sulphate, $Al_2(SO_4)_3 \cdot 16H_2O$, and the assumption that the salt is octodecahydrated is based on analyses of samples containing ferric sulphate; he also says that samples of native sulphate from Rio Saldana and Bolivia have the composition $Al_2(SO_4)_3 \cdot 16H_2O$. On the other hand, analyses of J. B. J. D. Bous-singault, F. Varrentrapp, E. Lenssen, C. F. Rammelsberg, T. J. Herapath, C. Hart-wall, H. Rose, F. Field, J. Jurasky, P. Zellner, L. Barth, etc., show that the salt is **octodecahydrated aluminium sulphate**, $Al_2(SO_4)_3 \cdot 18H_2O$. R. J. Kane said that the octodecahydrate crystallizes from its soln. in hydrochloric acid in beautiful tabular crystals. The mineral *alumogen* is also an octodecahydrate of the normal sulphate. The hybrid term *alumogenc* was first applied by F. S. Beudant; N. Mill used *davite*; E. F. Glocker, *keramohalite* and *stypterite*; J. J. N. Huot, *saldamite*; C. U. Shepard, *sofatarite*; and J. F. Hausmann, *halotrichite*. The native sulphate is found as a product of volcanic action and as a product of the decomposition of pyrites and alum shales. B. Boutzoureano reported the formation of **trihydrated aluminium sulphate**, $Al_2(SO_4)_3 \cdot 3H_2O$, in regular tetrahedral crystals. O. Schmatolla said that **hexahydrated aluminium sulphate**, $Al_2(SO_4)_3 \cdot 6H_2O$, is formed as a white powder when aluminium sulphate is heated for a long time with conc. sulphuric acid, washed with ice-cold water, and dried at 100° . C. von Hauer precipitated what he regarded as **decahydrated aluminium sulphate**, $Al_2(SO_4)_3 \cdot 10H_2O$, in tabular crystals, by adding alcohol to a dil. aq. soln. of the sulphate. Both these hydrates are said to form the octodecahydrate on exposure to a moist atm. A. Gawalowsky said that **heptadeca-hydrated aluminium sulphate**, $Al_2(SO_4)_3 \cdot 17H_2O$, is obtained from the soln. produced by incompletely saturating sulphuric acid with gelatinous aluminium hydroxide. E. Metzger said that **heptacosihydrated aluminium sulphate**, $Al_2(SO_4)_3 \cdot 27H_2O$, is formed when a sat. aq. soln. of aluminium sulphate is exposed to a winter's cold; or if the ordinary hydrate is made into a mush with water and cooled below 9.5° .

A. B. Poggiale measured the **solubility** of aluminium sulphate in water between 0° and 100° . Expressing the results in grams $Al_2(SO_4)_3$ per 100 grms. of sat. soln.

Solubility	0°	10°	20°	40°	60°	80°	100°
	23.8	25.1	26.7	31.4	37.2	42.2	47.1

The solid phase over the whole range is $Al_2(SO_4)_3 \cdot 18H_2O$. R. Kremann and K. Hüttinger explored the system at still lower temp. with the idea of finding what hydrates exist at these temp. The octodecahydrate is the solid phase down to the eutectic at -4° . Expressing the results as before :

Solubility	-1.02°	-1.43°	-2.04°	-2.65°	-2.85°	-4°	7.73°
	8.09	10.7	14.3	17.5	19.2	23.1	24.8
Solid phase	Ice					18-hydrate	

These results are plotted in Fig. 63. R. Kremann and K. Hüttinger also measured

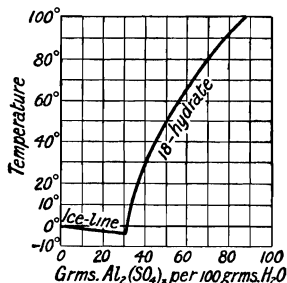

FIG. 63.—Solubility of Aluminium Sulphate in Water.

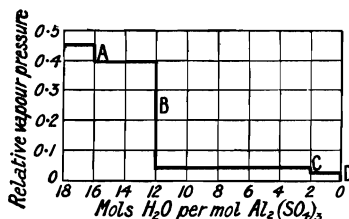

FIG. 64.—Relative Vapour Pressure of the Hydrates of Aluminium Sulphate.

the **vapour pressure** while the water is being gradually withdrawn, and they found breaks in the curve, Fig. 64, corresponding with *A*, the passage from the octodeca- to the hexadecahydrate; the passage from the hexadecahydrate to **dodecahydrated**

aluminium sulphate, $\text{Al}_2(\text{SO}_4)_3 \cdot 12\text{H}_2\text{O}$; *C*, the passage from the dodecahydrate to **dihydrated aluminium sulphate**, $\text{Al}_2(\text{SO}_4)_3 \cdot 2\text{H}_2\text{O}$; and *D*, the passage from the dihydrate to the anhydrous salt. This, of course, assumes that basic sulphates are not formed during the dehydration of the octodecahydrate.

According to C. J. B. Karsten, when hydrated aluminium sulphate is heated, it first melts in its water of crystallization, intumescs, and finally leaves a white perous mass of the anhydrous sulphate, $\text{Al}_2(\text{SO}_4)_3$; and, as F. Stromeyer also showed, if heated still further, it loses the whole of its contained sulphur trioxide, without melting. K. Friedrich said that decomposition begins at 770° . L. Wöhler and co-workers found the partial press. of the SO_3 with decomposing aluminium sulphate is:

	580°	620°	660°	680°	700°	720°	740°
Press. SO_3	20·4	30·2	47·0	54·0	72·2	95·5	154·5 mm.
	572°	621°	681°	702°	720°	742°	748°
Total press.	28	51	120	180	261	480	692 mm.

C. R. Fresenius found that 5–10 mins.' heating over a blast-flame suffices to expel the sulphur trioxide; but, as F. Varrentrapp showed, a lower temp. is not sufficient to do this; and F. Stolba found that over the bunsen flame, the residue is eq. to $2\text{Al}_2\text{O}_3 \cdot \text{SO}_3$ after 4 hrs.' heating.

The octodecahydrated salt furnishes acicular or lamellar **crystals**; the mineral occurs in delicate fibrous masses or crusts, and also massive. J. Jurasky said the crystals are monoclinic. A. Gawalowsky obtained smooth tetrahedral crystals with truncated edges. C. F. Rammelsberg said that the heptacosihydrate forms trigonal crystals with axial ratio and angle $a : c = 1 : 1.5408$, and $\alpha = 83^\circ 0'$. The **specific gravity** of the anhydrous sulphate was found by C. J. B. Karsten to be 2.74; L. Playfair and J. P. Joule gave 2.171; P. A. Favre and C. A. Valson, 2.672 at 22.5° ; and O. Pettersson, 2.713 at 17° . For the octodecahydrate, L. Playfair and J. P. Joule gave 1.671; E. Filhol, 1.569; P. A. Favre and C. A. Valson, 1.767 at 22.1° ; and J. Dewar, 1.6913 at 17° , and 1.7184 at -188° . According to C. Reuss, the sp. gr. of aq. soln. of purified aluminium sulphate (40 per cent. water), referred to water at 4° unity, are as follow:

Per cent. $\text{Al}_2(\text{SO}_4)_3$	1	5	10	15	20	25
Sp. gr. at 15°	1.0170	1.0569	1.1071	1.1574	1.2074	1.2572
Sp. gr. at 25°	—	1.0503	1.1022	1.1522	1.2002	1.2483
Sp. gr. at 35°	—	1.0450	1.0960	1.1460	1.1920	1.2407
Sp. gr. at 45°	—	1.0356	1.0850	1.1346	1.1801	1.2295

and with commercial aluminium sulphate containing Al_2O_3 , 13.52; SO_3 , 31.58; Fe, 0.33; K_2O , 0.93; and H_2O , 52.27 per cent.:

Per cent. $\text{Al}_2(\text{SO}_4)_3$	1	5	10	15	20	25
Sp. gr. at 15°	1.0069	1.0377	1.0730	1.1097	1.1440	1.1798

Measurements were also made by F. Fouqué, H. C. Jones, P. A. Favre and C. A. Valson, W. L. Badger and J. S. France, J. Wagner, H. Sentis, C. Chéneveau, etc. The vap. press. of the sulphur trioxide in the thermal decomposition of anhydrous aluminium sulphate was studied by L. and P. Wöhler and W. Plüddemann. For soln. at 12.5° with w per cent. of anhydrous salt, J. G. MacGregor found the sp. gr. $S = S_0 + 0.0092083w$, where S_0 represents the sp. gr. of water at 12.5° , and for w up to 2.5 per cent. J. Wagner found the **viscosity** of N -, $\frac{1}{2}N$ -, $\frac{1}{4}N$ -, and $\frac{1}{8}N$ -soln. of aluminium sulphate at 25° , to be respectively 1.4064, 1.1782, 1.0825, and 1.0381. P. H. Prausnitz measured the osmosis of soln. of aluminium sulphate through membranes with pores of various size. W. L. Badger and J. S. France measured the f.p. and b.p. of soln. of aluminium sulphate of different conc. The f.p. rises from about 30° at a sp. gr. 1.30 to a maximum of 85° at sp. gr. 1.60, and then falls to about 70° at a sp. gr. of 1.80; the b.p. increases from 101° at a sp. gr. of 1.30 to 118° at a sp. gr. 1.76. G. Tammann measured the lowering of the **vapour pressure** of water at 100° by aluminium sulphate and found that with 9.92, 23.80,

and 40.25 grms. of $\text{Al}_2(\text{SO}_4)_3$ per 100 grms. of water the vap. press. was lowered respectively 7.2 mm., 20.0 mm., and 51.5 mm. L. F. Nilson and O. Pettersson gave 0.1855 for the **specific heat** of the anhydrous salt between 0° and 100° . J. C. G. de Marignac gave for the sp. ht. of soln. with two-thirds of a mol $\text{Al}_2(\text{SO}_4)_3$, in 50, 100, and 200 mols of water 0.9041, 0.9465, and 0.9722 respectively, between 21° – 53° . According to J. Thomsen, the **heat of formation**, $(2\text{Al}, 3\text{O}, 3\text{SO}_3, \text{aq.})=451.77$ Cals.; M. Berthelot gave $(2\text{Al}, 3\text{S}, 12\text{O}, \text{aq.})=879.7$ Cals., and for the heat of neutralization, $2\text{Al}(\text{OH})_3+3\text{H}_2\text{SO}_4+\text{Aq.}=\text{Al}_2(\text{SO}_4)_3+\text{Aq.}+21$ Cals.; $(\text{Al}(\text{OH})_3, 3\text{HCl}, \text{aq.})=27.4$ Cals.; and S. U. Pickering gave $(\text{Al}(\text{OH})_3, 3\text{HF}, \text{aq.})=34.1$ Cals. L. Wöhler and co-workers gave 17 Cals. for the heat involved in the loss of a mol of SO_3 from a mol of aluminium sulphate. P. A. Favre and C. A. Valson gave 56.0 Cals. for the **heat of solution** of $\text{Al}_2(\text{SO}_4)_3 \cdot 6\text{H}_2\text{O}$; and 8.2 Cals. for the octodecahydrate. L. and P. Wöhler and W. Plüddemann found 17 cal. for the heat of dissociation of anhydrous aluminium sulphate.

The **electrical conductivity** of aq. soln. of aluminium sulphate was measured by F. Kohlrausch,³ F. S. Svenson, P. Walden, and H. C. Jones and co-workers. The last-named found for the molecular conductivity, μ , with soln. containing a mol of the salt in v litres of water :

v	.	.	4	8	32	128	512	2048	4096
μ	0°	.	51.9	65.21	89.50	121.87	164.08	222.31	262.35
	25°	.	92.40	114.44	158.01	219.04	301.01	425.03	514.06
	65°	.	152.8	185.7	266.2	395.1	594.6	943.0	1221.2

The percentage **degree of ionization**, α , calculated from these data :

v	.	.	4	8	32	128	512	2048	4096
α	0°	.	19.8	24.9	34.1	46.5	62.5	84.7	100.0
	65°	.	12.5	15.2	21.8	32.4	48.7	72.2	100.0

This is on the assumption that the salt is not hydrolyzed in soln. H. Ley found that the **hydrolysis** is smaller than with soln. of the chloride—*vide infra*. H. C. Jones also calculated the temp. coeff. of the conductivity of these soln. J. F. Daniell and W. A. Miller made some observations on the **transport numbers**.

According to J. J. Berzelius, hydrated aluminium sulphate is permanent in air; actually, the crystals show a marked tendency to effloresce; but if a little ferric sulphate be present, the salt may appear to be hygroscopic. The salt has a highly acid taste. According to F. Wöhler, when aluminium sulphate is heated in a stream of **hydrogen**, it furnishes alumina, which, according to O. Schumann, is almost free from sulphate. For the action of **water**, *vide infra*, **basic salts**. R. Willstätter prepared an aluminium sulphate with **hydrogen peroxide** of crystallization. H. Rose found that when repeatedly calcined with **ammonium chloride**, the aluminium is almost wholly volatilized presumably by being first converted into chloride; and A. B. Prescott found that when evaporated with an excess of **hydrochloric acid**, about 10 per cent. passes into aluminium chloride. A. Recoura boiled aluminium sulphate with hydrochloric acid, and on cooling the soln. obtained a crystalline deposit which he regarded as **aluminium chlorosulphate**, $\text{Al}(\text{SO}_4)\text{Cl}$. According to C. J. B. Karsten, and F. J. Knapp, a conc. soln. of aluminium sulphate can be mixed with **sodium chloride** without any separation, and on evaporation some sodium sulphate and aluminium chloride are formed; and, according to G. Friedel, with **calcium chloride**, some calcium sulphate is produced. A. Cossa found that when aluminium sulphate is heated with **magnesium fluoride**, some magnesium sulphate is formed. According to S. E. Moody, a mixture of **potassium iodide and iodate** reacts with a soln. of aluminium sulphate, forming a basic salt which when boiled is completely hydrolyzed: $\text{Al}_2(\text{SO}_4)_3+5\text{KI}+\text{KIO}_3+3\text{H}_2\text{O}=2\text{Al}(\text{OH})_3+3\text{K}_2\text{SO}_4+3\text{I}_2$; F. A. Gooch and R. W. Osborne found that the reaction is about five-sixths completed with a mixture of **potassium bromide and bromate**; and is very much less with a mixture of **potassium chloride and chlorate**. A. Violi found that aluminium sulphide is formed by fusing the sulphate with **sulphur**. According to A. Seyewetz and

G. Chicandard, **sodium thiosulphate** reacts with aluminium sulphate, $\text{Al}_2(\text{SO}_4)_3 + 3\text{Na}_2\text{S}_2\text{O}_3 = \text{Al}_2\text{O}_3 + 3\text{Na}_2\text{SO}_4 + 3\text{SO}_2 + 3\text{S}$, in boiling soln., and in the cold, $\text{Al}_2(\text{SO}_4)_3 + 3\text{Na}_2\text{S}_2\text{O}_3 = 3\text{Na}_2\text{SO}_4 + \text{Al}_2(\text{S}_2\text{O}_3)_3$, and the latter then decomposes $\text{Al}_2(\text{S}_2\text{O}_3)_3 + 3\text{H}_2\text{O} = 3\text{H}_2\text{S} + \text{Al}_2(\text{SO}_4)_3$. According to A. d'Heureuse, **iron**, or **zinc** has only a slight action when calcined with aluminium sulphate. F. Kunheim studied the action of **carbon** on aluminium sulphate in the electric arc furnace. J. J. Berzelius reported that hydrated aluminium sulphate is scarcely soluble in **alcohol**; and W. F. O. de Coninck found that 100 grms. of **glycol** dissolve 16.82 grms. of aluminium sulphate.

Acid aluminium sulphates.—The solubility of aluminium sulphate in sulphuric acid has been measured by F. Wirth who found that at 25°, the solid phase was the octodecahydrate, and expressing the results in grams per 100 grms. of sat. soln.,

H_2SO_4	0	5	10	20	30	40	50	60	70	75
$\text{Al}_2(\text{SO}_4)_3$	27.8	29.2	26.2	19.5	11.6	4.8	1.5	1.0	2.3	4.0

The presence of sulphuric acid at first raises the solubility of aluminium sulphate in water, but a further increase in the amount of the acid depresses the solubility very considerably; from 20*N*-acid onwards there is a slight increase in solubility without any change in the solid phase.

Three acid aluminium sulphates have been reported :



These salts can also be regarded as *hydrosulphato-aluminic acids*; the salts of the first member forming the class of salts called *alums*. E. Baud found that when aluminium hydroxide or bauxite is boiled with dil. sulphuric acid (1 : 1), **trihydrated aluminium dihydrosulphate**, $\text{Al}_2(\text{SO}_4)_3 \cdot \text{H}_2\text{SO}_4 \cdot 3\text{H}_2\text{O}$, or $\text{Al}_2(\text{SO}_4)_2(\text{HSO}_4)_2 \cdot 3\text{H}_2\text{O}$, is formed, and it crystallizes in colourless needles which, after washing with acetone, can be dried on a porous tile. The salt is also formed when aluminium sulphate is dissolved in sulphuric acid at 110°–112°; and, according to F. Wirth, a mixture of conc. sulphuric acid and aluminium sulphate solidifies in a few hours, forming this same salt. The crystals dissolve slowly in cold but rapidly in warm water. H. St. C. Deville made some observations on this subject. F. Jeremin noted that when conc. sulphuric acid is gradually added to a conc. aq. soln. of aluminium sulphate, there is a precipitation of hydrated aluminium sulphate, and with 5 c.c. of soln. to 0.3 c.c. of acid, the precipitate has the composition $\text{Al}_2(\text{SO}_4)_3 \cdot 22\text{H}_2\text{O}$; but with equal volumes of acid and soln., the precipitate is decahydrated **aluminium tetrahydrosulphate**, $\text{Al}_2(\text{SO}_4)_3 \cdot 2\text{H}_2\text{SO}_4 \cdot 10\text{H}_2\text{O}$, or $\text{Al}_2(\text{SO}_4)(\text{HSO}_4)_4 \cdot 10\text{H}_2\text{O}$, and with 20 c.c. of acid to 5 c.c. of soln., there is scarcely any turbidity produced. The maximum precipitation occurs with 5 c.c. of soln. and 1.5 c.c. of acid. J. Kendall and A. W. Davidson found the molar solubility of anhydrous aluminium sulphate in anhydrous sulphuric acid at 25° to be below 0.01. According to R. Silberberger, heptahydrated aluminium hexahydrosulphate, $\text{Al}_2(\text{SO}_4)_3 \cdot 3\text{H}_2\text{SO}_4 \cdot 7\text{H}_2\text{O}$, *sulphatoaluminic acid*, $\text{Al}_2(\text{HSO}_4)_6 \cdot 7\text{H}_2\text{O}$, or, as he calls it, *aluminosulphuric acid*, is prepared by adding aluminium sulphate to cold conc. sulphuric acid and warming, when a voluminous white precipitate separates. On diluting with ether, filtering, and washing with ether, the acid is obtained as a white powder, decomposing in moist air and dissolving in water, the soln. soon decomposing into aluminium sulphate and sulphuric acid. The addition of barium chloride to conc. sulphuric acid soln. of aluminium sulphate furnishes a complex *barium sulphatoaluminat*e which immediately decomposes.

Basic aluminium sulphates.—The alleged formation of basic aluminium sulphates by the hydrolysis of aq. soln. of aluminium sulphate has been previously described. L. Liechti and W. Suida⁵ observed no visible hydrolysis on heating or diluting a soln. of 200 grms. $\text{Al}_2(\text{SO}_4)_3 \cdot 18\text{H}_2\text{O}$ in a litre of water; with a soln. of 200 grms. $\text{Al}_2(\text{SO}_4)_3 \cdot 18\text{H}_2\text{O}$ and 31.82 grms. of sodium carbonate per litre, there was no visible change on heating, but a precipitate formed when the soln. was diluted

four-fold ; with a soln. three-fourths as conc. there was no visible change on heating, but dissociation occurred on diluting ten-fold. With a soln. made from 200 grms. of $Al_2(SO_4)_3 \cdot 18H_2O$ and 45.7 grms. of sodium hydrocarbonate per litre, a jelly was formed on heating, and a precipitate remained on cooling ; while diluting the soln. one-half caused a precipitate to appear in the cold. A soln. of 300 grms. of $Al_2(SO_4)_3 \cdot 18H_2O$ and 151.3 grms. of sodium hydrocarbonate per litre, became turbid in a very short time. Hence, hydrolysis occurs more readily (i) the more basic the soln., (ii) the more dilute the soln., and (iii) the higher the temp. L. Liechti and W. Suida added that sodium sulphate accelerated the hydrolysis, but L. Liechti and H. Schwitzer said it retarded the decomposition. The latter statement accords with H. Schmid's observation that sodium sulphate retards the precipitation of alumina by sodium carbonate.

According to H. G. Denham, the percentage **hydrolysis**, 100x, of aq. soln. of aluminium sulphate, calculated on the assumption that the reaction is represented by $Al_2(SO_4)_3 + 2H_2O \rightleftharpoons 2Al(SO_4)HO + H_2SO_4$, for soln. with a mol of the salt in v litres of water at 25°, is :

v	4	8	16	32	64	256
100x	0.522	0.743	1.160	2.016	3.492	9.600

Values have also been obtained by H. Ley, L. Kahlenberg and co-workers, L. Bruner, and G. Carrara and G. B. Vespignani. According to J. L. Gay Lussac, aluminium hydroxide dissolves in aq. soln. of aluminium sulphate. The freshly prepared hydroxide dissolves fastest, and attains equilibrium more quickly than the aged hydroxide. R. Kremann and K. Hüttinger measured the solubility of aluminium hydroxide in soln. of aluminium sulphate of different conc. at 20°, 40°, and 60°. Expressing conc. in grams of sulphate and hydroxide per 100 grms. of water, and molar proportions $Al_2O_3 : SO_3 : H_2O$ as a ratio, the results at 20° are :

$Al_2(SO_4)_3$	2.37	5.0	9.1	15.0	20.0	31.6	33.0	34.73
$Al(OH)_3$	0.15	0.30	1.30	1.04	1.40	4.20	2.75	0.92
Solid phase	1 : 1 : 9			1 : 2 : 12			1 : 3 : 16	

The results for two temp. are indicated in Fig. 65, where the solid phase is $Al_2O_3 \cdot SO_3 \cdot 9H_2O$ along *ab* and *ab'* ; $Al_2O_3 \cdot 2SO_3 \cdot 12H_2O$ along *bc* and *b'c'* ; and $Al_2(SO_4)_3 \cdot 16H_2O$, along *cd* and *c'd'*. They represent the constitution of these two hydrated basic salts as derivatives of $Al_2O(OH)_4$, thus :

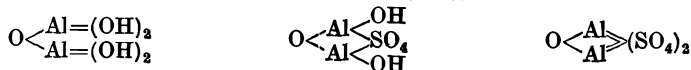

Numerous other basic hydrates have been reported. Many are no doubt intermediate stages in the hydrolysis of the normal sulphate, and available evidence is not sufficient to establish their chemical individuality. S. U. Pickering regarded them as mixtures whose composition depends on the conditions under which they were prepared. Thus, O. Schmatolla, under various conditions of precipitation, obtained hydrated basic products with $Al_2O_3 : SO_3$ as 6 : 1, 12 : 1, 24 : 1, and 48 : 1. L. B. Miller, F. S. Williamson, and E. J. Thericault and W. M. Clark studied the products of the partial alkalization of soln. of alum.

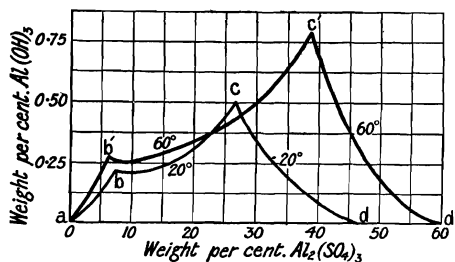

FIG. 65.—Solubility of Aluminium Hydroxide in Solutions of Aluminium Sulphate at 25°.

E. Schlumberger reported that the precipitate formed when aluminium sulphate is exactly neutralized with alkali-lye consists of dihydrated tetraluminium decahydroxy-sulphate having the composition $2Al_2O_3, 3SO_3, 7H_2O$. He called it *hydrate sulfodialuminique*.

The same sulphate is precipitated when sodium aluminate is neutralized with alum, or when a soln. of alum, to which alkali has been added until a slight permanent precipitate is formed, is boiled, or when a soln. of aluminium acetate is boiled with alkali sulphates. It is stable only in the presence of alkali sulphates, and is partially dissolved by water. The dry substance loses $2\text{H}_2\text{O}$ at 130° , and forms the pentahydrate but is otherwise stable. It is soluble in cold acetic acid, but is reprecipitated on boiling, and redissolves on cooling, in this resembling the ordinary aluminium mordanting soln., the essential constituent of which appears to be an acetate and sulphate. He considers the hydrate to be constituted $\{\text{Al}_2(\text{OH})_5\}_2\text{SO}_4$. According to F. S. Williamson, E. Schlumberger's product is a mixture. When 2 to 4 mols of sodium hydroxide are added to a soln. of one mol of aluminium sulphate, the precipitate has the composition $\text{Al}_2(\text{SO}_4)_3 \cdot (\text{Al}_2\text{O}_3)_4 \cdot 15\text{H}_2\text{O}$, *i.e.* **deca-aluminium hydroxytrisulphate**, $\text{Al}_2(\text{SO}_4)_3 \cdot 8\text{Al}(\text{OH})_3 \cdot 3\text{H}_2\text{O}$. The substance loses less than one-tenth of its water over conc. sulphuric acid at ordinary temp., and all is lost at 150° . Less than one-third is taken up again at lower temp. so that the reaction is not reversible.

D. Köchlin-Schouch, and W. Crum made the decahydrate, $2\text{Al}_2\text{O}_3 \cdot \text{SO}_3 \cdot 10\text{H}_2\text{O}$, by boiling aluminium acetate with a soln. of potassium sulphate; L. F. Bley made the dodecahydrate by adding an excess of alkali carbonate to a soln. of alum. The decahydrate is represented in nature by the rhombic mineral *felsöbanyite* which, according to W. Haidinger has the sp. gr. 2.33, and hardness 1.5. It was found in snow-white or yellowish masses at Kapnik (Hungary). The pentadecahydrate, $2\text{Al}_2\text{O}_3 \cdot \text{SO}_3 \cdot 15\text{H}_2\text{O}$, is represented by the mineral *paraluminate*, closely related to aluminate, which occurs near Halle, Huelgoet (Brittany), etc. Analyses were made by P. Berthier, C. Steinberg, H. Backs, E. Wolff, R. Dieck, L. J. Lasaigne, and R. Geist. The related *pissophane*—from *pissoa*, pitch; *phos*, appearance—of A. Breithaupt, analyzed by O. L. Erdmann, contains much ferric oxide.

H. Debray reported $5\text{Al}_2\text{O}_3 \cdot 3\text{SO}_3 \cdot 20\text{H}_2\text{O}$ to be formed by boiling an excess of an aq. soln. of aluminium sulphate with zinc; L. F. Bley, $3\text{Al}_2\text{O}_3 \cdot 2\text{SO}_3 \cdot 2\text{H}_2\text{O}$, by the incomplete precipitation of a soln. of aluminium sulphate with aq. ammonia; C. J. Bayer, $3\text{Al}_2\text{O}_3 \cdot 2\text{SO}_3 \cdot 9\text{H}_2\text{O}$, by boiling a soln. of aluminium sulphate with an excess of aluminium hydroxide; A. Löwe, and H. Debray, $4\text{Al}_2\text{O}_3 \cdot 3\text{SO}_3 \cdot 36\text{H}_2\text{O}$, and $8\text{Al}_2\text{O}_3 \cdot 5\text{SO}_3 \cdot 25\text{H}_2\text{O}$, by the action of zinc on a cold soln. of aluminium sulphate in excess; N. Athanasesco, $3\text{Al}_2\text{O}_3 \cdot 4\text{SO}_3 \cdot 9\text{H}_2\text{O}$, in colourless rhombohedra, by heating a 3 per cent. soln. of normal aluminium sulphate to 250° in a sealed tube; and C. F. Rammelsberg, $3\text{Al}_2\text{O}_3 \cdot 4\text{SO}_3 \cdot 30\text{H}_2\text{O}$, as a crust on the sides of a glass bottle in which dil. sulphuric acid sat. with aluminium hydroxide, was kept many years. R. Phillips found a moderately dil. sulphuric acid soln. of aluminium hydroxide, on being mixed with water, deposits for many months a basic salt of composition similar to C. F. Rammelsberg's salt; and J. L. Gay Lussac added that the filtrate has a similar composition, and becomes turbid as often as it is warmed. S. U. Pickering found that the addition of sodium hydroxide to a soln. of aluminium sulphate completes the precipitation when the quantity added reaches 1.833 eq. implying the possible formation of $5\text{Al}_2\text{O}_3 \cdot 6\text{SO}_3 \cdot n\text{H}_2\text{O}$. J. Gadamer reported $\text{Al}_2(\text{SO}_4)_3 \cdot \text{Al}_2(\text{OH})_6 \cdot 9\text{H}_2\text{O}$, or $2\text{Al}_2\text{O}_3 \cdot 3\text{SO}_3 \cdot 12\text{H}_2\text{O}$, to be formed by slowly evaporating a mixed soln. of potassium chromate and aluminium sulphate—the first crop of crystals is potash-alum, then potassium dichromate, and then the 2 : 3 : 12 salt, while chromic acid remains in soln. F. Göbel, and N. Mill also reported $2\text{Al}_2\text{O}_3 \cdot 3\text{SO}_3 \cdot n\text{H}_2\text{O}$.

O. Schmatolla obtained a basic sulphate $\text{Al}_2\text{O}_3 \cdot \text{SO}_3 \cdot n\text{H}_2\text{O}$ by the action of calcium carbonate on a cold soln. of aluminium sulphate. According to J. J. Berzelius, heptahydrated **aluminium tetrahydroxy sulphate**, $\text{Al}_2(\text{SO}_4)(\text{OH})_4 \cdot 7\text{H}_2\text{O}$, or $\text{Al}_2\text{O}_2(\text{SO}_4) \cdot 9\text{H}_2\text{O}$, is produced by washing the precipitate obtained by adding aq. ammonia to a soln. of aluminium sulphate. L. F. Bley—*vide supra*—said that the product is more basic than J. J. Berzelius supposed. C. Böttinger found that the tetrahydrate, $\text{Al}_2(\text{OH})_4\text{SO}_4 \cdot 4\text{H}_2\text{O}$, or $\text{Al}_2\text{O}_3 \cdot \text{SO}_3 \cdot 6\text{H}_2\text{O}$, is deposited when an aq. soln. with 5 grms. of aluminium sulphate and 1.5 grms. of sodium chloride is heated in a sealed tube at 140° . The heptahydrate is represented by the earthy mineral *aluminite* of D. L. G. Karsten, the *hallite* of J. C. Delamétherie, the *reine Tonerde* of A. G. Werner, the *native argill* of R. Kirwan, the *websterite* of J. Brooke, and F. S. Beudant. It was analyzed by F. Stromeyer, A. Dufrenoy, C. Steinberg, etc. Its sp. gr. is 1.705 and hardness between 1 and 2.

According to P. Marguerite, when ammonia alum is decomposed by heat, anhydrous aluminium sulphate is first obtained, but pushing the decomposition somewhat further, sulphuric acid is volatilized; so that by carefully regulating the heat, a residue can be finally obtained almost entirely soluble in water, and consisting mainly of hexahydrated **aluminium dihydroxydisulphate**, $\text{Al}_2\text{O}_3 \cdot 2\text{SO}_3 \cdot 12\text{H}_2\text{O}$, or $\text{Al}_2(\text{SO}_4)_2(\text{OH})_2 \cdot 11\text{H}_2\text{O}$. This salt, which has not been before described, is entirely different in appearance from the ordinary sulphate. It

crystallizes in rhombohedrons and not in nacreous scales ; its solubility in water at 15° is about 45 per cent., but it can be separated from the ordinary sulphate by fractional crystallization. A. Maus obtained this hydrosulphate by evaporating to dryness a hot filtered soln. of normal or basic aluminium sulphate and hydroxide. The product is a sticky mass. H. Spence made it by mixing a soln. of aluminium sulphate with enough calcium hydroxide or carbonate to give the necessary basicity. The filtered soln. was evaporated in vacuo. The mineral *alumian* was obtained by A. Breithaupt from Sierra Almagrera (Spain) ; it has the same composition as P. Marguerite's salt. Its sp. gr. is 2.702–2.781, and its hardness 2 to 3. In the progressive dehydration of alumian, R. Kremann and K. Hüttinger found breaks in the vap. press. curve corresponding with the hydrates 1 : 2 : 12 ; 1 : 2 : 11 ; and 1 : 2 : 10.

What has been regarded as a *basic subsulphate* was obtained by F. Fischer as a blue anode deposit when sulphuric acid of sp. gr. 1.175 is electrolyzed with aluminium electrodes. Layers of a bluish-green tint are deposited on the anode, especially when the electrolyte is kept cool ; the portions of the deposit next to the electrode are, however, intensely blue. Microscopic examination indicated that this blue deposit is not a uniform substance. It is not acted on by distilled water. Dil. hydrochloric acid of such a strength as to act vigorously on aluminium at the ordinary temp. has scarcely any action on it. When warmed with hydrochloric acid, hydrogen is evolved, traces of silicic acid remaining ; the filtrate gives a precipitate with barium chloride and also contains aluminium. The product is free from sulphide and contains a *basic aluminium sulphate*, a little silicic acid, and traces of iron. When heated, it becomes white.

REFERENCES.

- ¹ H. V. Collet-Descotils, *Ann. Mines*, (1), 1. 319, 369, 1816 ; H. Pemberton, *Brit. Pat. No.* 1799, 1868 ; H. Fleck, *Journ. prakt. Chem.*, (1), 99. 243, 1866 ; W. Crum, *Journ. Chem. Soc.*, 6. 216, 1854 ; H. von Kéler and G. Lunge, *Zeit. angew. Chem.*, 7. 669, 1894 ; J. Bock, *German Pat.*, D.R.P. 131314, 1901 ; *Brit. Pat. No.* 9545, 1902 ; W. C. Ferguson, *Journ. Amer. Chem. Soc.*, 16. 153, 1894 ; Det Norske Aktieselskab for Elektrokem. Ind., *U.S. Pat. No.* 1382808, 1921 ; J. Morel, *Brit. Pat. No.* 149769, 1919 ; M. Müller, *German Pat.*, D.R.P. 352289, 1917 ; W. Fulda, *ib.*, 354328, 367134, 1921 ; J. Persoz, *Ann. Chim. Phys.*, (3), 56. 102, 1859.
- ² P. M. Delacharlonny, *Compt. Rend.*, 96. 844, 1883 ; 111. 229, 1890 ; *Chem. News*, 47. 199, 1883 ; *Ann. Chim. Phys.*, (6), 1. 425, 1884 ; J. B. J. D. Boussingault, *ib.*, (2), 30. 109, 1825 ; (2), 52. 348, 1833 ; A. B. Poggiale, *ib.*, (3), 8. 467, 1843 ; E. Filhol, *ib.*, (3), 21. 415, 1847 ; B. Boutzouano, *ib.*, (6), 18. 289, 1889 ; J. C. G. de Marignac, *ib.*, (5), 8. 410, 1876 ; *Arch. Sciences Genève*, (2), 55. 113, 1876 ; F. S. Beudant, *Traité élémentaire de minéralogie*, Paris, 449, 1824 ; 2. 488, 1832 ; C. U. Shepard, *Treatise on Mineralogy*, New Haven, 188, 1835 ; E. F. Glocker, *Handbuch der Mineralogie*, Nürnberg, 689, 1839 ; *Generum et specierum mineralium secundum ordines naturales digestorum synopsis*, Halle, 297, 1847 ; J. J. N. Huot, *Manuel de minéralogie*, Paris, 2. 451, 1841 ; J. F. Hausmann, *Handbuch der Mineralogie*, Göttingen, 2. 1174, 1847 ; T. J. Herepath, *Chem. Gaz.*, 4. 422, 1846 ; H. Rose, *Pogg. Ann.*, 27. 317, 1833 ; C. F. Rammelsberg, *ib.*, 43. 130, 399, 1838 ; *Handbuch der kristallographischen Chemie*, Berlin, 88, 1855 ; L. Barth, *Sitzber. Akad. Wien*, 24. 289, 1857 ; C. von Hauer, *ib.*, 13. 449, 1854 ; J. Jurassky, *Haidinger's Ber.*, 2. 332, 1847 ; C. Hartwall, *Amer. Journ. Science*, (2), 17. 56, 1854 ; N. Mill, *Quart. Journ. Science*, 25. 382, 1828 ; F. Varrentrapp, *Dingler's Journ.*, 166. 443, 1862 ; E. Lenssen, *Journ. prakt. Chem.*, (1), 85. 89, 1862 ; J. Thomsen, *ib.*, (2), 11. 232, 402, 1875 ; (2), 12. 233, 402, 1875 ; F. Field, *Journ. Chem. Soc.*, 22. 259, 1869 ; C. W. Hayes, *Bull. U.S. Geol. Sur.*, 315. 215, 1907 ; W. P. Headden, *Proc. Colorado Scientific Soc.*, 8. 62, 1905 ; W. L. Badger and J. S. France, *Journ. Ind. Eng. Chem.*, 15. 364, 1923 ; O. Schmatolla, *Zeit. angew. Chem.*, 16. 205, 1903 ; F. Wirth, *ib.*, 26. 81, 1913 ; F. Wirth and B. Bakke, *Zeit. anorg. Chem.*, 87. 47, 1914 ; E. Metzger, *Zeit. Ges. Naturw.*, 7. 24, 1856 ; L. and P. Wöhler and W. Plüddemann, *Ber.*, 41. 703, 1908 ; R. Kremann and K. Hüttinger, *Jahrb. Geol. Reichsanst. Wien*, 58. 637, 1908 ; R. J. Kane, *Phil. Mag.*, (3), 8. 353, 1836 ; J. J. Berzelius, *Pogg. Ann.*, 8. 177, 1826 ; C. F. Mohr, *Liebig's Ann.*, 34. 345, 1840 ; F. Stromeyer, *Schweigger's Journ.*, 19. 424, 1817 ; C. J. B. Karsten, *ib.*, 65. 394, 1832 ; F. Stolba, *Chem. Centr.*, (3), 5. 135, 1874 ; C. R. Fresenius, *Zeit. anal. Chem.*, 4. 355, 1865 ; L. Playfair and J. P. Joule, *Journ. Chem. Soc.*, 2. 401, 1845 ; S. U. Pickering, *ib.*, 53. 865, 1888 ; P. A. Favre and C. A. Valsou, *Compt. Rend.*, 77. 579, 1873 ; *Ann. Chim. Phys.*, (6), 14. 112, 317, 1888 ; L. F. Nilson and O. Pettersson, *ib.*, 91. 232, 1880 ; O. Pettersson, *Nova Acta Upsala*, 9. 4, 1873 ; 10. 7, 1876 ; J. Dewar, *Chem. News*, 85. 277, 1902 ; 91. 216, 1905 ; J. G. MacGregor, *ib.*, 62. 223, 232, 1890 ; *Trans. Roy. Soc. Canada*, 8. 19, 1890 ; C. Reuss, *Ber.*, 17. 2888, 1884 ; K. Friedrich, *Centr. Min.*, 174, 207, 1912 ; M. Berthelot, *Thermochimie*, Paris, 2. 330, 1897 ; H. C. Jones, *Hydrates in Aqueous Solution*, Washington, 1907 ; *The Electrical Conductivity, Dissociation, and Temperature Coefficients of Conductivity of a number of Salts and Organic Acids*, Washington, 60, 1912 ;

H. C. Jones and E. Mackay, *Amer. Chem. Journ.*, **19**, 83, 1897; P. Walden, *Zeit. phys. Chem.*, **1**, 529, 1887; J. Wagner, *ib.*, **5**, 31, 1890; *Wied. Ann.*, **18**, 259, 1883; H. Ley, *Ber.*, **30**, 2194, 1897; F. S. Svenson, *Ueber die elektrische Leitungsfähigkeit bei einigen Elektrolyten*, Lund, 1877; J. F. Daniell and W. A. Miller, *Phil. Trans.*, **134**, 1, 1844; F. Kohlrausch, *Wied. Ann.*, **6**, 145, 1879; L. and P. Wöhler and W. Plüddemann, *Ber.*, **41**, 703, 1908; W. Fulda, *German Pat.*, D.R.P. 354323, 1921; F. Fouqué, *Ann. Observat. Paris*, **9**, 172, 1868; H. Sentsis, *Tension superficielle de l'eau et des solutions salines*, Grenoble, 1897; C. Chéneveau, *Ann. Chim. Phys.*, (8), **12**, 145, 1907; G. Tammann, *Mém. Acad. St. Petersburg*, (7), **35**, 1, 1887; P. H. Prausnitz, *Koll. Zeit.*, **29**, 293, 1921; A. Gawalowsky, *Zeit. Oester. Apoth. Ver.*, **44**, 460, 1906; M. Müller, *German Pat.*, D.R.P. 352289, 1917; P. Zellner, *Schweigger's Journ.*, **18**, 344, 1816.

³ A. Recoura, *Bull. Chim. Soc.*, (4), **27**, 1155, 1902; *Compt. Rend.*, **135**, 163, 1902; S. E. Moody, *Amer. Journ. Science*, (4), **20**, 181, 1905; F. A. Gooch and R. W. Osborne, *ib.*, (4), **24**, 167, 1907; G. Friedel, *Bull. Soc. Min.*, **14**, 8, 1891; H. Rose, *Pogg. Ann.*, **74**, 569, 1848; A. d'Heureuse, *ib.*, **75**, 255, 1847; R. Willstätter, *Ber.*, **36**, 1828, 1903; A. B. Prescott, *Chem. News*, **36**, 178, 1877; A. Violi, *Annali Chim.*, (3), **63**, 311, 366, 1876; A. Cossa, *Gazz. Chim. Ital.*, **7**, 212, 1877; C. J. B. Karsten, *Lehrbuch der Salinenkunde*, Berlin, **2**, 316, 1847; F. J. Knapp, *Dingler's Journ.*, **181**, 314, 1866; J. J. Berzelius, *Pogg. Ann.*, **8**, 177, 1826; P. M. Delacharlonny, *Compt. Rend.*, **96**, 844, 1883; W. F. O. de Coninck, *Bull. Acad. Belg.*, **257**, 359, 1905; F. S. Svenson, *Ueber die elektrische Leitungsfähigkeiten bei einiger Elektrolyten*, Lund, 1877; F. Kunheim, *Ueber die Einwirkung des Lichtogens auf Gemische von Sulphaten mit Kohle*, Berlin, 1900; F. Wöhler, *Pogg. Ann.*, **11**, 146, 1827; *Liebig's Ann.*, **53**, 422, 1845; O. Schumann, *ib.*, **187**, 305, 1877; A. Seyewetz and G. Chicandard, *Bull. Soc. Chim.*, (3), **13**, 12, 1895; J. F. Daniell and W. A. Miller, *Phil. Trans.*, **124**, 1, 1844; F. Kohlrausch, *Wied. Ann.*, **6**, 145, 1879; H. C. Jones and E. Mackay, *Amer. Chem. Journ.*, **19**, 83, 1897; H. C. Jones, F. H. Getman, and H. P. Bassett, *Hydrates in Aqueous Solution*, Washington, 88, 1907; H. Ley, *Zeit. phys. Chem.*, **30**, 193, 1899.

⁴ F. Wirth, *Zeit. anorg. Chem.*, **79**, 360, 1913; J. Kendall and A. W. Davidson, *Journ. Amer. Chem. Soc.*, **43**, 979, 1921; F. Jeremin, *Journ. Russ. Phys. Chem. Soc.*, **13**, 468, 1888; H. St. C. Deville, *Ann. Chim. Phys.*, (3), **61**, 309, 1860; E. Baud, *Compt. Rend.*, **137**, 494, 1903; R. Silberberger, *Monatsh.*, **25**, 220, 1904.

⁵ H. Ley, *Zeit. phys. Chem.*, **30**, 193, 1899; L. Bruner, *ib.*, **32**, 133, 1900; L. Kahlenberg, D. J. Davis, and R. E. Fowler, *Journ. Amer. Chem. Soc.*, **21**, 1, 1899; W. C. Ferguson, *ib.*, **16**, 153, 1894; H. G. Denham, *Journ. Chem. Soc.*, **93**, 41, 1908; W. Crum, *ib.*, **6**, 216, 1854; S. U. Pickering, *ib.*, **91**, 1981, 1907; *Chem. News*, **45**, 121, 133, 146, 1882; G. Carrara and G. B. Vespignani, *Gazz. Chim. Ital.*, **30**, ii, 35, 1900; R. Kremann and K. Hüttinger, *Jahrb. Geol. Reichsanst. Wien*, **58**, 637, 1908; F. Fischer, *Zeit. anorg. Chem.*, **43**, 341, 1905; O. Schmatolla, *Zeit. angew. Chem.*, **16**, 202, 1903; L. F. Bley, *Liebig's Ann.*, **89**, 174, 1854; *Journ. prakt. Chem.*, (1), **39**, 1, 1846; A. Löwe, *ib.*, (1), **79**, 428, 1860; J. J. Berzelius, *Pogg. Ann.*, **1**, 43, 1824; **4**, 130, 1825; E. Schlumberger, *Bull. Soc. Chim.*, (3), **13**, 41, 1895; H. Debray, *ib.*, (2), **7**, 9, 1867; D. Köchlin-Schouch, *Bull. Soc. Mulhouse*, **1**, 299, 1828; *Dingler's Journ.*, **27**, 218, 1828; L. Liechti and W. Suida, *ib.*, **251**, 177, 1883; L. Liechti and H. Schwitzer, *Mitt. Gewerbe Museums Wien*, **3**, 59, 1886; H. Schmid, *Chem. Ztg.*, **19**, 776, 808, 1895; C. J. Bayer, *ib.*, **11**, 38, 53, 97, 1887; *Brit. Pat. No.* 10093, 1887; 5296, 1892; H. Spence, *French Pat. No.* 331836, 1903; *U.S. Pat. No.* 754824, 1904; *German Pat.*, D.R.P. 167419, 1903; C. Böttinger, *Liebig's Ann.*, **244**, 224, 1888; N. Athanasesco, *Compt. Rend.*, **103**, 271, 1886; P. Marguerite, *ib.*, **90**, 1354, 1880; C. F. Rammelsberg, *Pogg. Ann.*, **43**, 583, 1838; A. Maus, *ib.*, **11**, 80, 1827; R. Phillips, *Ann. Phil.*, **20**, 280, 1822; J. Gadamer, *Zeit. Oester. Apoth. Ver.*, **49**, 679, 1895; W. Haidinger, *Sitzber. Akad. Wien*, **12**, 183, 1854; R. Geist, *Zeit. Nat. Ver. Halle*, **13**, 268, 1864; R. Dieck, *ib.*, **13**, 265, 1864; J. L. Lassaigne, *Ann. Chim. Phys.*, (2), **29**, 98, 1825; J. L. Gay Lussac, *ib.*, (1), **74**, 193, 1810; (2), **21**, 223, 1822; P. Berthier, *Mém. Acad.*, **288**, 1839; C. Steinger, *Journ. prakt. Chem.*, (1), **32**, 495, 1844; H. Backs, *ib.*, (1), **34**, 185, 1845; E. Wolff, *ib.*, (1), **34**, 193, 1845; J. J. Berzelius, *Lehrbuch der Chemie*, Dresden, **2**, ii, 684, 1826; O. L. Erdmann, *Journ. tech. ökon. Chem.*, **13**, 108, 1832; *Schweigger's Journ.*, **62**, 104, 1831; F. Göbel, *ib.*, **60**, 401, 1830; A. Breithaupt, *Vollständige Charakteristik der Mineralsystems*, Dresden, **101**, 1832; *Berg. Hütt. Ztg.*, **17**, 53, 1858; A. G. Werner, *Versuch einer Mineralogie*, Leipzig, **176**, 1780; D. L. G. Karsten, *Mineralogische Tabellen*, Berlin, **48**, 1808; J. C. Delamétherie, *Leçons de minéralogie*, Paris, 1812; J. Brooke, *Familiar Introduction to Crystallography*, London, 1823; F. S. Beudant, *Traité de minéralogie*, Paris, **449**, 1824; R. Kirwan, *Elements of Mineralogy*, London, **1**, 175, 1794; F. Stromeyer, *Untersuchungen über die Mischung der Mineralkörper*, Göttingen, **99**, 1821; A. Dufrenoy, *Traité de minéralogie*, Paris, **2**, 366, 1845; N. Mill, *Quart. Journ. Science*, **25**, 302, 1828; F. S. Williamson, *Journ. Phys. Chem.*, **27**, 284, 1923; L. B. Miller, *U.S. Pub. Health Rep.*, **38**, 1995, 1923; E. J. Thercault and W. M. Clark, *ib.*, **38**, 181, 1923.

§ 20. The Complex Salts of Aluminium Sulphate

The aluminium salts have a marked tendency to form complexes; and this is well illustrated by the sulphate which forms a series of complex salts of the type $R_2'SO_4 \cdot Al_2(SO_4)_3 \cdot 24H_2O$, or $R'Al(SO_4)_2 \cdot 12H_2O$, where R' represents a univalent

radicle; these salts are grouped under the generic term **alums**. The univalent elements which take part in the formation of alums are: thallium, cæsium, rubidium, potassium, and sodium—and possibly lithium and silver—as well as the univalent radicles ammonium, hydroxylamine, and alkyl-ammonium. Ten trivalent elements can act instead of aluminium; thus, titanium, vanadium, chromium, manganese, iron, cobalt, gallium, indium, iridium, and rhodium. Excluding lithium, silver, hydroxylamine, and alkylammonium, this makes 66 members of the alum-family. In addition, a number of selenic alums have been obtained in which selenium replaces the sulphur; and E. von Gerichten¹ obtained other alums in which one component is a selenate and the other a sulphate. This would make 264 alums. Only a fraction of these combinations has been obtained. No attempt has been made to prepare some of them, and with others, the attempt has failed owing to the instability of the complex. Allowing for the relatively low stability of the trivalent forms of some of the elements, as a rule, the greater the mol. wt. of the univalent radicle, the greater the stability of the alum, and conversely, the greater the mol. wt. of the trivalent metal the less the stability of the alum. Thus, sodium forms alums only with the lighter trivalent elements—aluminium, vanadium, and chromium; the only stable potash alums are those of aluminium and chromium; and with some trivalent elements the rubidium and cæsium alums are the only stable forms. If an element will form an alum, J. Locke has stated that it will do so more readily with cæsium sulphate than with any of the other alkali sulphates. He said, "If an alum cannot be formed with cæsium sulphate, it cannot be formed at all." The sulphate-alums which have been reported are indicated in Table VI.

TABLE VI.—ALUM-FORMING ELEMENTS (SULPHATES).

—	Al	Cr	Fe	Co	Ga	In	V	Ti	Mn	Rh	Ir
Na	1	1	0	0	0	0	0	0	0	0	0
K	1	1	1	0	1	0	1	0	0	1	1
NH ₄	1	1	1	0	1	1	1	0	0	1	1
Rb	1	1	1	1	1	1	1	1	1	1	1
Cs	1	1	1	1	1	1	1	1	1	1	1
Tl	1	1	1	1	1	0	1	0	0	1	1

F. B. Venable tried to make double alkali alums by crystallization from mixed soln. of potash-alum and soda-alum, but he obtained only a variable mixture of crystals of the two salts, in which the inferior solubility of potash-alum makes this salt predominate in the isomorphous crystals. H. Schiff, and R. Krickmeyer obtained similar results with mixtures of potash-alum and ammonia-alum. S. Kern claimed to have made *silver alum*, or **silver aluminium sulphate**, $Ag_2SO_4 \cdot Al_2(SO_4)_3 \cdot 24H_2O$, by evaporating a soln. of molar proportions of the constituent salts; and A. H. Church and A. B. Northcote by heating silver sulphate, aluminium sulphate, and water contained in a sealed tube on an oil-bath. The latter say that the octahedral crystals are decomposed by water.

Some of the alums occur in nature. The so-called *mendozite* found at San Juan Mendoza, east of the Andes, was analyzed by T. Thomson,² but the water of crystallization is not that of the alums. J. J. N. Huot called it *natroalum*. C. U. Shepard proposed calling soda-alum *solfatarite*; and he reported that the native alum on the island of Milo is a soda-alum, but later he accepted C. Hartwell's analyses, which makes it an alunogen. According to E. Divers, the native soda-alum from Shimane, Idzumo, Japan, has the typical alum formula. The mineral *tamarugite* obtained by H. Schulze from the Pampa del Tamarugal, Cerros Pintados, Chili, has the composition of soda-alum, but only half the water of crystallization of an

alum proper. L. Domeyko's *alumbre nativo* has a similar composition. The mineral *stüvenite* from Copiapo is a soda-alum with up to half the sodium replaced by magnesium (*vide infra*). In 1792 S. Breislak, and in 1795 M. H. Klaproth, showed that the alum from Miseno and Solfatara, near Naples, is potash-alum. The latter said: "The *grotto di alume* at Miseno, Naples, serves as a laboratory where nature alone, unassisted by art, is constantly producing perfect alum." J. D. Dana called native alum *kalinite*. It occurs as an efflorescence on argillaceous minerals—*e.g.* the alum shales of Whitby; at Hurler and Campsie near Glasgow; at the volcanoes of Lipari and Sicily; Cape Sable, Maryland; Sevier, Tennessee; Brandfeldern, Saarbrücken, etc. F. Š. Beudant, and W. Grüner showed that ammonia alum occurs as a mineral which was called by F. von Kobell *tschermigite*, after Tschermig, Bohemia, where the salt occurs. It has also been obtained from Wamsutter (Wyoming), Dux (Bohemia), Tokod (Hungary), and the crater at Etna. Analyses were made by C. H. Pfaff, W. A. Lampadius, F. Stromeyer, L. R. Lecanu and M. Blanchet, etc. T. Garnett, speaking of one of the sulphur wells of Harrogate, said: "I have discovered alum therein, and I suspect salited clay." A. Hunter found none. R. H. Davis analyzed one of the old alum wells of Harrogate and found 89.47 grains of aluminium sulphate, 3.14 potassium sulphate, and 2.19 ammonium sulphate per gallon.

L. Kralovansky³ stated that the evaporation, at temp. below 11°, of a mixed soln. of lithium and aluminium sulphates furnishes octahedral and dodecahedral crystals of *lithia-alum*, or **lithium aluminium sulphate**, $\text{Li}_2\text{SO}_4 \cdot \text{Al}_2(\text{SO}_4)_3 \cdot 24\text{H}_2\text{O}$, or dodecahydrated *lithium disulphato-aluminate*, $\text{LiAl}(\text{SO}_4)_2 \cdot 12\text{H}_2\text{O}$. *Au contraire*, C. F. Rammelsberg was not able to prepare the double sulphate and said that it does not exist. F. A. H. Schreinemakers and A. J. C. de Waal, in their study of the ternary system, $\text{Li}_2\text{SO}_4 - \text{Al}_2(\text{SO}_4)_3 - \text{H}_2\text{O}$, found for the percentage composition of the soln. at 30°:

Li_2SO_4 25.1	21.93	16.10	13.63	11.73	6.75	3.44	0
$\text{Al}_2(\text{SO}_4)_3$ 0	5.34	14.89	20.76	22.08	24.34	26.12	28.0
Solid phases		Li ₂ SO ₄ ·H ₂ O			Al ₂ (SO ₄) ₃ ·18H ₂ O			

The line *ab*, Fig. 66, represents the solubility of hydrated lithium sulphate; *bd*, the solubility of the same salt in a metastable condition; *b*, a transition point; *bc*, the solubility of octodecahydrated aluminium sulphate. Consequently, the only solid phases at 30° are $\text{Li}_2\text{SO}_4 \cdot \text{H}_2\text{O}$ and $\text{Al}_2(\text{SO}_4)_3 \cdot 18\text{H}_2\text{O}$; but this does not say what would occur at the lower temp. expressly mentioned by L. Kralovansky.

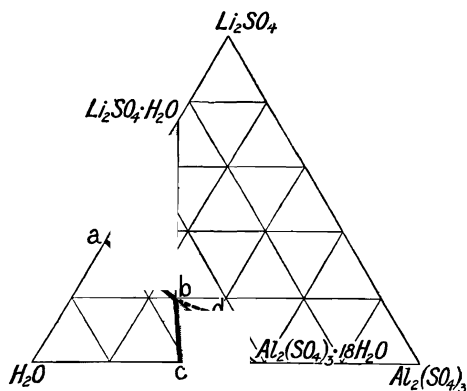

FIG. 66.—Ternary System, $\text{Li}_2\text{SO}_4 - \text{Al}_2(\text{SO}_4)_3 - \text{H}_2\text{O}$, at 30°.

K. G. Wellner⁴ stated that *soda-alum* crystallizes from the mother liquid remaining after the separation of potash-alum when soap-boiler's lye, containing sodium chloride, has been employed in the preparation. P. Zellner obtained octahedral crystals of soda-alum by the spontaneous evaporation of a mixed soln. of sodium and aluminium sulphates. Analyses of the salt by K. G. Wellner, P. Zellner,

A. Ure, T. Graham and W. R. Smith agreed with **sodium aluminium sulphate**, $\text{Na}_2\text{SO}_4 \cdot \text{Al}_2(\text{SO}_4)_3 \cdot 24\text{H}_2\text{O}$, or dodecahydrated *sodium disulphatoaluminate*, $\text{NaAl}(\text{SO}_4)_2 \cdot 12\text{H}_2\text{O}$. According to J. B. Spence, the crystals are obtained from soln. of sp. gr. 1.30, if more conc., say by cooling a hot conc. soln., a viscid mass is obtained, which crystallizes very slowly. These statements have been confirmed

by J. M. Wadmore, E. Augé, G. Dumont, etc. G. Bergeron, and W. Beatson have described the manufacture of soda-alum. E. Augé said that the soln. of the mixed salts cannot be evaporated in the ordinary way to the density necessary for crystallization without employing a temp. of at least 73°–80°, and the soda-alum soln. when heated to this degree is rendered incapable of crystallizing. E. Augé obviates this difficulty by conducting the evaporation under reduced press., and obtains the required sp. gr. (1.38 to 1.46) at a temp. of about 48°—in no case exceeding 60°. J. Bock added that if the soln. is made slightly alkaline by the addition of basic aluminium sulphate, the formation of the viscid mass does not occur. W. R. Smith said that the best way of making soda-alum is to dissolve the component salts in an amount of water sufficient to give a soln. moderately supersaturated at ordinary temp., and then cool the soln. inducing crystallization by stirring or seeding. This gives small crystals similar to alum-meal; if larger crystals are desired, the soln. should be slowly evaporated at ordinary temp. As in the case of lithia-alum, the existence of soda-alum has been denied—*e.g.* W. Ostwald has said that the place of potassium in potash-alum cannot be taken by sodium or lithium. The individuality of soda-alum is now well established, but that of lithia-alum is still *sub judice*.

The general method of preparing alums is to crystallize the complex salt from a mixed soln. of the component salts. L. Geschwind,⁵ K. W. Jurisch, F. Jünemann, D. G. Fahrenheit, J. M. Wilson, and L. Pommier have written monographs on the manufacture of alum. The analyses of T. Thomson, L. J. Thénard and M. Roard, L. N. Vauquelin, T. Graham, and J. Löwe show that *potash-alum* corresponds with **potassium aluminium sulphate**, $K_2SO_4 \cdot Al_2(SO_4)_3 \cdot 24H_2O$, or dodecahydrated *potassium disulphato-aluminate*, $KAl(SO_4)_2 \cdot 12H_2O$. As indicated in connection with the history of aluminium, the manufacture of alum from alum-rock or alunite—a basic potassium aluminium sulphate, *vide infra*—dates from early times. The aq. extract from the roasted ore contains sufficient potassium and aluminium to furnish a crop of crystals of potash-alum. L. Duncan has described the process with the ore at Tonopah. A. Matheson, J. L. Silsbee, etc., have suggested modifications of the process. T. H. Wright treated a soln. of potassium chloride with magnesium sulphate, and added a soln. of aluminium sulphate to make the sp. gr. about 1.384. The soln. was heated to 90°, and cooled for crystals of potash-alum. As shown by A. F. Gehlen, the so-called *Roman alum*, as formerly prepared, had a higher degree of purity than ordinary alum; the crystals were usually cubic. Alum is to-day manufactured of an equally high degree of purity. H. T. S. Britton studied the ternary system, $Al_2(SO_4)_3 - K_2SO_4 - H_2O$, at 25°, and his results are summarized in Fig. 67, where the ordinates represent the number of grams of water in which 100 grms. of the solute dissolve to give a sat. soln. Indications of the solid phases K_2SO_4 , alum, $Al_2(SO_4)_3 \cdot 18H_2O$, were obtained. Potash alum is also made from alum shales which contain pyrites, and sometimes, according to H. Müller, organic sulphides. Various processes of manufacture have been indicated in connection with the extraction of alumina (*q.v.*).

W. A. Lampadius discussed the formation of alum from mixtures of pyrites and clay. The sulphides in the alum-shales and alum-clays can be oxidized by weathering or by a low-temp. roasting. The oxidized ore is leached with dil. sulphuric acid, and the soln. mixed with potassium sulphate; the hot conc. soln. is rapidly cooled while being agitated, when small crystals of *alum-meal* are deposited. This product is drained and washed with the mother liquor from the block-alum crystallization. The alum-meal is purified by dissolving it to form a hot sat. soln., which is clarified by the addition of a little size to precipitate the suspended matters. The clear soln. is decanted into vats fitted with movable

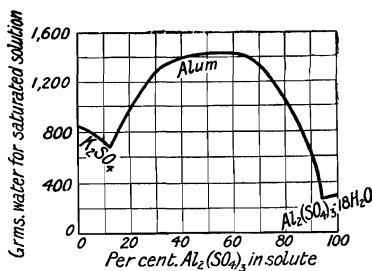

FIG. 67.—The Ternary System, $K_2SO_4 - Al_2(SO_4)_3 - H_2O$, at 25°.

staves. Large crystals of *block-alum* collect on the staves. In a few days, the staves are removed, and holes bored in each mass of block-alum to allow the mother liquor to drain away. The block-alum is then broken up for the market. When the shales contain much iron, the ferric sulphate can be converted into chloride by the addition of potassium chloride alone or mixed with the sulphate. The iron then remains in soln. as ferric chloride instead of crystallizing as an isomorphous iron alum. J. Bock studied the conditions favourable for the formation of large crystals.

Alum is also manufactured from blast furnace slags, bauxites and other hydrated forms of alumina, clays and other aluminosilicates. J. W. Hinchley described the manufacture of alum from leucite. These silicates may or may not be advantageously calcined at a low temp. to make them more susceptible to attack by sulphuric acid. C. Schwartz considered the best calcining temperature to be about 500°, and the best concentration of the acid to be that with a sp. gr. between 1.297 and 1.530. According to L. Geschwind, the calcination temperature employed in France is 1000°—*vide* “clays” for the effect of the temperature of calcination on the solubility. On a manufacturing scale other factors are involved—*e.g.* the tendency of the mass being extracted to retain its porous granular form, or to disintegrate into a compact powder not easily penetrated by the acid. In preparing crude soln. of aluminium sulphate, powdered bauxite is boiled with dil. sulphuric acid until nearly neutral. The dil. liquor containing finely-divided residue in suspension is allowed to settle, and the liquor cleared by filter-press or other means. To eliminate the difficulties attending the removal of finely divided, undissolved residue from the liquor, W. B. Llewellyn and H. and P. Spence use a bauxite or clay which retains its form, without disintegration, during the extraction with acid.

The granular material—ignited or not ignited—is placed in a series of vats with false bottoms; a hot soln. of aluminium sulphate with free acid from a previous extraction is first allowed to percolate through the mass, and afterwards other hot or boiling soln., containing progressively more and more free acid, are passed through the materials. Weak liquors from previous operations and finally water are allowed to circulate through the exhausted bauxite, which is then allowed to drain. The exhausted bauxite is replaced by fresh material, which then takes its place in the cycle of operations. The clear neutral or basic soln. of aluminium sulphate can then be purified from iron, and converted into alum, etc. The process has also been adapted to aluminous clays, etc.

P. Spence (1870) described a process of making alum from mineral phosphates; T. J. Herapath prepared alum from the ashes of boghead coal; and G. Clemm utilized the sulphates from the Stassfurt deposits by adding to each mol of aluminium chloride in hydrochloric acid soln., one mol of schönite and 2 mols of kieserite: $2\text{AlCl}_3 + \text{K}_2\text{SO}_4 + 3\text{MgSO}_4 = 3\text{MgCl}_2 + \text{K}_2\text{SO}_4 \cdot \text{Al}_2(\text{SO}_4)_3$. The alum readily crystallizes out leaving the magnesium chloride in soln. Some have prepared alum by using potassium chloride, *e.g.* T. H. Wright treated a soln. of that salt with sodium sulphate, and then added aluminium sulphate to the slightly acid soln. Potash-alum crystallizes out. The use of potassium chloride in place of the sulphate hinders the formation of iron-alum isomorphous with ordinary alum, and is used where sufficient iron sulphate is present to supply the necessary sulphuric acid to produce alum. The alkali chloride converts the ferric and ferrous sulphates to the more soluble chlorides. An excess of alkali chloride would attack the aluminium sulphate, and produce aluminium chloride which would be lost. A. R. Lindblad and S. H. Hultman have discussed the removal of iron from aluminium sulphates.

The manufacture of *ammonia-alum* is conducted in a manner analogous to that of potash-alum when ammonium sulphate, produced from waste liquors from gas-works, is used in place of potassium sulphate. The analyses of F. Stromeyer, A. Riffault, and G. Forchhammer have shown this salt corresponds with **ammonium aluminium sulphate**, $(\text{NH}_4)_2\text{SO}_4 \cdot \text{Al}_2(\text{SO}_4)_3 \cdot 24\text{H}_2\text{O}$, or dodecahydrated *ammonium disulphatoaluminate*, $\text{NH}_4\text{Al}(\text{SO}_4)_2 \cdot 12\text{H}_2\text{O}$. W. Meyer-ling prepared typical crystals of *hydroxylamine-alum*, or **hydroxylamine**

aluminium sulphate, $(\text{NH}_3\text{OH})_2\text{SO}_4 \cdot \text{Al}_2(\text{SO}_4)_3 \cdot 24\text{H}_2\text{O}$, or dodecahydrated *hydroxyl-amine disulphatoaluminate*, $(\text{NH}_3\text{OH})\text{Al}(\text{SO}_4)_2 \cdot 12\text{H}_2\text{O}$, in an analogous manner. Typical crystals of *rubidia-alum*, or **rubidium aluminium sulphate**, $\text{Rb}_2\text{SO}_4 \cdot \text{Al}_2(\text{SO}_4)_3 \cdot 24\text{H}_2\text{O}$, or dodecahydrated *rubidium disulphato-aluminate*, $\text{RbAl}(\text{SO}_4)_2 \cdot 12\text{H}_2\text{O}$; and of *cæsia-alum*, or **cæsium aluminium sulphate**, $\text{Cs}_2\text{SO}_4 \cdot \text{Al}_2(\text{SO}_4)_3 \cdot 24\text{H}_2\text{O}$, or dodecahydrated *cæsium disulphatoaluminate*, $\text{CsAl}(\text{SO}_4)_2 \cdot 12\text{H}_2\text{O}$, were prepared by G. Kirchhoff and R. Bunsen from a soln. of the component salts. S. Kern claims to have made typical crystals of *silver-alum*, or **silver aluminium sulphate**, $\text{Ag}_2\text{SO}_4 \cdot \text{Al}_2(\text{SO}_4)_3 \cdot 24\text{H}_2\text{O}$, or *silver disulphatoaluminate*, $\text{AgAl}(\text{SO}_4)_2 \cdot 12\text{H}_2\text{O}$, by evaporating mixed soln. of the component salts; and A. H. Church and A. B. Northcote, by heating in an oil-bath a mixture of silver sulphate with aluminium sulphate and water until the silver salt had all dissolved; on cooling, typical crystals of silver-alum were formed. J. W. Retgers has denied the existence of silver-alum.

The cubic **crystals** of alum appear as octahedra when crystallized from aq. soln. In 1772, A. M. Sieffert,⁶ and in 1802, N. le Blanc, showed that if the soln. be made alkaline by the addition of lime, or alkali carbonate, the crystals are in cubes—*cubic alum*. F. S. Beudant likewise obtained cubic crystals by the addition of a little borax; C. von Hauer, ammonia; and H. Kopp, alkali-lye. E. Jannettaz examined the effect of aluminium and ammonium chlorides, and hydriodic and sulphuric acids; and T. J. Pelouze and E. Frémy, P. A. Schemjatschensky, N. S. Kurnakoff, A. Schubnikoff, F. S. Beudant, A. Stiassny, F. Klepatschewsky, H. Kopp, J. F. Persoz, A. Polis, A. Knop, and R. Weber, the effect of hydrochloric acid. Other observations have been made by A. Scacchi, H. A. Miers, F. Klocke, L. Wulff, P. Gaubert, A. Rauber, Z. Weyberg, H. Przibram, A. Körbs, and A. Rota. L. Vegard and co-workers studied the **X-radiograms** of potash- and ammonia-alums, and could find no distinction between the water of crystallization and the other constituents of alum. The subject has been also discussed by J. J. P. Valetton, C. Schäfer and M. Schubert, T. Terada, and P. Niggli. L. Vegard and H. Schjelderup showed that the sides of the unit cubes containing four chemical molecules of potash-alum are 12.08×10^{-8} cms., and of ammonia-alum, 12.00×10^{-8} cms. R. W. G. Wyckoff said that the hemihedral structure of the alums has in a unit cell four mols. with the composition $\text{R}'\text{R}''(\text{SO}_4)_2 \cdot 12\text{H}_2\text{O}$, and in this space group the four sulphate oxygen atoms cannot be exactly alike. Three are similarly placed, but four are different from the other three; the 12 mols. of water fall into two groups—six in each. The **corrosion figures** have been examined by F. Klocke, and L. Wulff; the **rates of dissolution** of the difference faces of the crystal, by J. J. P. Valetton; and the **percussion figures**, by M. Kuhara.

The formation of **supersaturated solutions** by cooling hot sat. soln. in closed vessels was described by H. Löwel; and L. de Boisbaudran, by mixing conc. soln. of the component salts in a vessel protected from atm. dust. The last-named found that if a soln. be evaporated at 75° – 80° while protected from dust, the supersaturated soln. furnishes a hard glassy mass which does not crystallize in contact with crystals of alum, but if moisture be present, the glass becomes opaque and crystalline. A. Jeannel found that when the glassy mass does crystallize much heat is evolved, and the mass expands considerably; he also found that a thin layer of a soln. of alum does not crystallize on glass. According to J. M. Thomson and W. P. Bloxam, a supersaturated soln. of alum may be inoculated with either potassium sulphate or octodecahydrated aluminium sulphate without crystallization. H. Schiff, and B. Krickmeyer found that ammonia- and potash-alum form a continuous series of **mixed crystals**; F. P. Venable studied the mixed crystals of soda- and potash-alums. C. Soret reported that soda-alum can be obtained in monoclinic prisms with axial ratios $a : b : c = 2.5060 : 1 : 0.9125$, and $\beta = 109^\circ 1'$, by pouring a layer of alcohol over a sat. aq. soln. of soda-alum at 8° – 12° . P. Groth assumes that soda-alum is dimorphous—monoclinic and cubic. C. Soret's analysis corresponded with $\text{Na}_2\text{SO}_4 \cdot \text{Al}_2(\text{SO}_4)_3 \cdot 23\text{H}_2\text{O}$; but N. I. Surgunoff's investigation shows that the salt

is dicosihydrated $\text{Na}_2\text{SO}_4 \cdot \text{Al}_2(\text{SO}_4)_3 \cdot 22\text{H}_2\text{O}$, or *henadecahydrated sodium disulphato-aluminate*, $\text{NaAl}(\text{SO}_4)_2 \cdot 11\text{H}_2\text{O}$ —corresponding with T. Thomson's analysis of mendozite—and if the supersaturated soln. crystallizes at 20° or less, cubic crystals are formed, and if at a higher temp., monoclinic crystals are produced.

The **specific gravity** of *lithia-alum* is not recorded; that of *soda-alum* has been determined by R. Krickmeyer—1.675; H. Schiff⁷—1.641; O. Pettersson—1.691 (18°); C. Soret—1.73; A. Ure—1.60; H. J. Buignet—1.567; that of *potash-alum* by H. Schiff—1.722; O. Pettersson—1.752; R. Krickmeyer, and M. le Blanc and P. Rohland—1.757; A. Dufrenoy—1.753; H. J. Buignet—1.757; F. Stolba—1.7505; W. C. Smith—1.753; J. H. Hassenfratz—1.17109; H. Kopp—1.724; L. Playfair and J. P. Joule—1.726, or 1.75125 at 4° ; H. G. F. Schröder—1.711; and C. Soret—1.666—1.669; that of *rubidia-alum* by J. Redtenbacher—1.874; C. Setterberg—1.884 at 20.6° ; C. Soret—1.852; that of *cæsia-alum* by J. Redtenbacher—2.003; E. Hart and H. B. Huselton—1.945; and C. Soret—1.911; and that of *ammonia-alum* by L. Playfair and J. P. Joule—1.625; R. Krickmeyer—1.645; H. Schiff—1.621; H. J. Buignet—1.653; O. Pettersson—1.642 at 18.8° ; W. C. Smith—1.661; H. Kopp—1.626; A. Breithaupt—1.602; and C. Soret—1.631. The best representative values between 18° and 20° are:

Sp. gr.	Na	K	Rb	Cs	NH_4 -alum
.	1.68	1.75	1.88	1.95	1.64

T. Thomson gave 1.88 for mendozite. C. Soret gave for his monoclinic soda-alum, 1.728—1.733. For dehydrated potash-alum, L. Playfair and J. P. Joule gave 2.228; and O. Pettersson, 2.6875 at 15° ; for dehydrated rubidia-alum, the last-named gave 2.7821 at 14.9° ; and for dehydrated ammonia-alum, L. Playfair and J. P. Joule gave 2.039. W. Spring measured the effect of *temperature* on the sp. gr., and found this to be:

	0°	10°	20°	30°	50°	70°	90°	100°
Potash-alum	1.7546	1.7542	1.7538	1.7532	1.7521	1.7474	1.7067	—
Rubidia-alum	1.8667	1.8648	1.8639	1.8635	1.8624	1.8611	1.8578	1.8554
Cæsia-alum	2.0215	2.0210	2.0205	2.0200	2.0189	2.0173	2.0107	2.0061
Ammonia-alum.	1.6357	1.6351	1.6346	1.6345	1.6336	1.6328	1.6209	1.6275

J. Dewar gave 1.6414 for the sp. gr. of potash-alum at the temp. of liquid air, about -180° ; when the sp. gr. at 17° is 1.6144. W. Spring also measured the effect of *pressure* (20,000 atm.) on the sp. gr.:

	Not pressed.	Once pressed.	Twice pressed.
Potash-alum	1.758 (21°)	1.756 (16.5°)	1.750 (16.5°)
Cæsia-alum	1.988 (18°)	2.000 (20°)	2.005 (20°)
Ammonia-alum	1.641 (18°)	1.629 (16.5°)	1.634 (18°)

A. Ure found that an *aqueous solution* of soda-alum sat. at 15.5° had a sp. gr. 1.296, and contained 110 parts of salt per 100 parts of water. E. F. Anthon gave 1.045 for the sp. gr. of a soln. of potash-alum sat. at 8° ; and G. T. Gerlach gave

Potash-alum	4	8	12	13 per cent.
Sp. gr. $17.1^\circ/17.1^\circ$	1.0205	1.0415	1.0635	1.0690

Measurements with soln. of potash-alum were made by A. Michel and L. Kraft, E. Forster, M. le Blanc and P. Rohland, and F. Stolba. F. Fouqué found the sp. gr. of a 11 per cent. soln. of potash-alum to be 1.0093 and 1.0090 respectively at 0° and 12° ; and of a 34.2 per cent. soln., 1.0304 and 1.0298 respectively at 0° and 9° . He likewise found the sp. gr. of a 3.2 per cent. soln. of rubidia-alum to be 1.0025 and 1.0021 respectively at 0° and 12° . J. G. MacGregor found that the sp. gr., *D*, of a soln. of potash-alum at 20° containing *w* per cent. of the anhydrous salt, up to $w=2.5$, is $D=D_0+0.0095187w$, where D_0 represents the sp. gr. of water at 20° . According to R. Broom, the dissolution of 4.99 grms. of dehydrated potash-alum in 100 c.c. of water is attended by a contraction of 0.033 per cent. G. T. Gerlach measured the sp. gr. of soln. of ammonia-alum; and M. Hoek and J. A. C. Oudeman,

of soda-alum. J. Beckenkamp measured the **torsion modulus** or rigidity of crystals of potash-alum, and found 1806 kgrms. per sq. mm. for a cube face, and 1987 kgrms. per sq. mm. for an octahedron face. D. M. Torrance and N. Knight showed that **diffusion** phenomena of aq. soln. of sodium aluminium sulphate corresponded with a large amount of dissociation. W. Voigt measured the **elasticity constants** of the crystals of potash-alum and found the elastic anisotropy to be small.

The coeff. of **thermal expansion** of potash-, rubidia-, cæsia-, and ammonia-alums can be calculated readily from the data by W. Spring⁸ on the effect of temp. on the sp. gr. E. Wiedemann observed that potash-alum contracts when heated above 51.3° in a mercury dilatometer, and explained the phenomenon by assuming that the complex mol. dissociate into their constituent mol. E. N. Ivanova showed that the alleged contraction is a mal-observation due to the slow filling of the interstices of alum by mercury. The **specific heat** of potash-alum between 15° and 22° was found by E. Baud to be 0.349; and between -188° and 18°, by J. Dewar, 0.256. W. Nernst and F. Schweser found the mol. ht. to be 165.66 at -183.5°, and 27.83 at -247.3°. K. Bindel found for 6.3, 16.6, and 39.4 per cent. soln. of potash-alum the respective sp. ht. 0.943, 0.860, and 0.714; and for 5.8, 15.5, and 37.4 per cent. soln. of ammonia-alum, respectively 0.942, 0.858, and 0.691.

T. Graham said that potash-alum loses three-fourths of its water of crystallization at 64.5°, and he accordingly represented it by the formula $K_2SO_4 \cdot Al_2(SO_4)_3 \cdot 6H_2O + 18H_2O$. K. Kraut found that the same proportion of water is lost when the salt is confined over conc. sulphuric acid for 180 days. W. Müller-Erbach measured the **vapour pressure** of the crystals of soda-, potash-, and ammonia-alums, and from the loss of water by potash-alum confined over sulphuric acid of different conc., he inferred, like T. Graham, that 18 of the 24 mols of water are more loosely attached than the other six; with soda-alum, he found one-half the water is more loosely attached than the other half; and with ammonia-alum, nine mols are more loosely attached than the others. H. G. F. Schröder found all the water is lost in vacuo at 185°. G. F. Gerhardt found 20 mols of water are lost at 120°, and all at 200°, and at the same time the salt becomes sparingly soluble in water. S. Lupton said 23 mols of water are lost at 180°-190° from potash- and ammonia-alums; and, according to G. J. Mulder:

	40°	47°	56°	82°	101°	119°	172°	201°
Percentage loss H ₂ O	2.7	9.6	27.2	29.6	34.2	37.4	42.8	44.5

J. W. Mallet found that finely powdered ammonia-alum confined over conc. sulphuric acid at 20°-27°, lost the following proportions of water in mols:

Mols H ₂ O lost	1	2	3	4	5	6	7	8	9	10
Hours	75	78.5	78.5	90	96	122	155	170	182	231

and 11 mols in 282 hrs.; 12 mols in 459 hrs.; 13 mols in 744 hrs.; 14 mols in 1121 hrs.; and 19 mols in 9646 hrs. E. T. Erickson found that the mineral tschermigite loses three-fourths of its water at 105°, and nearly all at 200°; decomposition begins at 360°, and on ignition the total loss is 88.06 per cent. K. Kraut showed that all the water is lost when potash-alum is heated in a current of air at 100° for 120 hrs., and that there is no loss of sulphur trioxide, while the salt retains its faculty of readily dissolving in water. J. Juttke said that the loss of water in air begins at 34°, and at that temp. 5 mols of water are lost in 85 hrs.; at 42°, 11 mols; at 65°, 19 mols; at 91°, 19 mols; and at 100°, 24 mols. Hence no more water is lost between 65° and 91° than is lost at 65°. P. Zellner said that soda-alum begins to lose water at 40°-50°, and the crystals become turbid. J. M. Wadmore found that soda-alum loses about half its water at 50°, and A. Ure said all is lost at a red heat, and the residue is completely soluble in water. S. Macischevsky measured the vap. press. of soln. of ammonia-alum and of potash-alum, and found that each salt gave two curves intersecting in the case of the former at 82.7°, and in the case of the latter at 79.5°. These points represent a chemical change in these alums.

When the alums are heated, they melt in their water of crystallization; C. M. Marx found the **melting point** of potash-alum to be 92° ; G. J. Mulder, 92.5° ; and W. A. Tilden, H. Erdmann, and J. Locke gave for the different alums:

	Na-	K-	NH ₄ -	Rb-	Cs-alum
M.p. (W. A. Tilden)	61°	84.5°	92°	99°	105°-106°
M.p. (H. Erdmann)	—	92.5°	—	105°	120.5°
M.p. (J. Locke)	63°	91°	95°	109°	122°

so that W. A. Tilden's results appear to be too low. E. Hart and H. B. Huselton found the m.p. of cæsium alum to be 117° . C. M. Marx observed the under-cooling of molten potash-alum. According to C. Hertwig, molten potash-alum at 100° becomes more and more viscid and finally solidifies to a clear vitreous mass; at 120° , the molten alum swells and loses water, and after 12 hrs. is converted into a porous mass containing 5 mols of water; even at 280° , the mass still retains one-half mol of water. A. Naumann said that potash-alum which has been kept at 78° for some time forms, when melted, a turbid liquid. H. Löwel, and A. Naumann heated potash-alum in a sealed tube at 100° , and the latter stated that the liquid becomes turbid, forming dehydrated alum, and the separated water hydrolyzes the salt, forming a basic potassium aluminium sulphate; at 200° , the product, according to H. Löwel, is $K_2SO_4 \cdot 3Al_2(SO_4)_3$. According to E. Wiedemann, potash-alum expands regularly when heated up to 30° , when water begins to be given off; the salt melts at 90° ; on cooling to the original temp., there is a contraction of 1.42 per cent., but ammonia-alum melts at 92° , and when cooled to its initial temp., the original volume is restored. H. Erdmann also found rubidia-alum at 205° melts to a clear liquid, then begins to boil, and forms the anhydrous salt; if the molten salt be cooled before it has lost water, it forms a sticky mass. When potash-alum is gradually heated to a temp. below redness, it loses water, swells up very much, and leaves a loose, friable, porous mass of dehydrated alum—the so-called *alumen ustum*, or *burnt alum*. At a white heat, the sulphuric acid is expelled from the aluminium sulphate, leaving a residue of alumina and potassium sulphate; if heated in a retort, the distillate has been called *spirit of alum*, which is a soln. of sulphurous and sulphuric acids. According to C. Brunner, at a certain period of the decomposition, potassium hydrosulphate can be detected in the residue. When ammonia-alum is similarly treated, alumina alone remains, the ammonium sulphate is volatilized. P. A. Favre and C. A. Valson found that the ammonium sulphate volatilizes with far greater difficulty than when alone.

G. Tammann found the **lowering of the vapour pressure** of water by ammonia alum for soln. of 10.97, 34.41, and 67.99 grms. of $(NH_4)_2SO_4 \cdot Al_2(SO_4)_3$ per 100 grms. of water to be respectively 10.9, 36.9, and 96.4 mm. G. J. Mulder found the **boiling point** of a soln. of 210.6 parts of potash-alum in 100 parts of water to be 111.9° ; T. Griffiths found a soln. with 52 parts of potash-alum in 100 parts of water to boil at 104.5° ; and G. T. Gerlach found for *w* grms. of potash-alum in 100 parts of water:

	0	7	16.7	296	615	971	2632	∞
Boiling point	100	101°	102°	103°	104°	105°	106°	106.7°

M. Plessy gave 12.4 Cals. for the **heat of solution** of $KAl(SO_4)_2 \cdot 5H_2O$, and -10.12 Cals. for $KAl(SO_4)_2 \cdot 12H_2O$; for $NH_4Al(SO_4)_2 \cdot 12H_2O$, the heat of soln. is -9.6 Cals. According to F. Rüdorff, when 14 parts of potash-alum are mixed with 100 parts of water, the temp. can fall from 10.8° to 9.4° . H. C. Jones and E. Mackay measured the **lowering of the freezing points** of aq. soln. of the alums, and inferred that the alums in aq. soln. are almost completely broken down into their constituent salts in dil. soln., but not completely in more conc. soln. R. Dubrisay studied the temp. of miscibility of soln. of alkali and aluminium sulphates.

The **index of refraction** of crystals of soda-alum has been measured by C. Soret; ⁹ of potash-alum, by C. Soret, H. Dufet, A. Borel, A. Mühlheims, D. Brewster, F. Kohlrausch, J. Grailich, J. Stefan, and A. Fock; of ammonia-alum, by A. Borel,

J. Grailich, and C. Soret; and of rubidia- and cæsia-alums by C. Soret. The results by the last-named are indicated in Table VII. E. Forster calculated the sp. refraction

TABLE VII.—REFRACTIVE INDICES OF THE ALUMS.

λ	Na-alum 17°-18°	K-alum 14°-17°	NH ₄ -alum 15°-21°	Rb-alum 7°-21°	Cs-alum 15°-25
G(431)	1·44804	1·46854	1·46923	1·46618	1·46821
F(486)	1·44412	1·46420	1·46481	1·46192	1·46386
b(518)	1·44231	1·46229	1·46288	1·45999	1·46203
E(527)	1·44185	1·46168	1·46234	1·45955	1·46141
D(589)	1·43884	1·45862	1·45939	1·45660	1·45856
C(656)	1·43653	1·45630	1·45693	1·45417	1·45618
B(686)	1·43563	1·45527	1·45599	1·45328	1·45517
a(718)	1·43492	1·45463	1·45509	1·45232	1·45437

of the mols. of water-free alum in aq. soln. to be 0·1809 at 24°. The **anomalous double refraction** of potash-alum has been studied by E. Reusch, E. Mallard, F. Klocke, R. Brauns, R. Krickmeyer, and F. Pockels; and of ammonia-alum, by F. Klocke. The refractive index of crystallizing soln. of potash- and ammonia-alums was measured by H. A. Miers and F. Isaac. E. Aschkinass found a small reflection band in the **ultra-red reflection spectrum** of potash-alum at 9·05 μ ; and W. W. Coblentz, a maximum at 9·1 μ . The **ultra-red transmission spectrum** has water bands at 1·5 μ and 2 μ . W. Crookes studied the adsorption of heat rays from an electric arc by a sat. soln. of ammonia-alum 5 cms. thick, and found that a thermometer registered 170°, when it registered 197° if water alone was used. C. Schäfer and M. Schubert, S. B. Nicholson and E. Pettit, and L. Vegard and H. Schjelderup studied the ultra-red vibration frequencies of the alums, and concluded that any hypothesis which would distinguish the water of crystallization from water of constitution could not be reconciled with the observed relations between the high-frequency reflection spectra. The removal of the water of crystallization is necessarily accompanied by the destruction of that structure which is characteristic of the hydrated salt. An aq. soln. of alum permits the passage of all visible rays but of only a few ultra-red rays; a soln. of iodine in carbon disulphide cuts off all visible light rays and is permeable to ultra-red rays. T. E. Aurén found the mol. absorption of X-rays by alum to be the sum of the at. absorptions of the constituent elements.

F. S. Svenson¹⁰ measured the **electrical conductivity** of aq. soln. of soda-, potash-, and ammonia-alums. H. C. Jones and co-workers found for the mol. conductivity, μ , of potash- and ammonia-alums for soln. with a mol of the salt in v litres of water:

v	4	8	32	218	512	1024	2048	4096
K $\left\{ \begin{array}{l} \mu \text{ at } 0^\circ \\ \mu \text{ at } 65^\circ \end{array} \right.$	—	78·9	101·2	127·6	158·8	177·8	197·5	218·8
	196·1	240·6	317·4	426·2	557·1	—	769·4	—
NH ₄ $\left\{ \begin{array}{l} \mu \text{ at } 0^\circ \\ \mu \text{ at } 65^\circ \end{array} \right.$	—	80·0	102·5	130·1	162·2	181·0	201·8	224·2
	—	236·5	—	—	578·5	—	831·5	—

The alums, in dil. soln., have a conductivity which is almost exactly the mean of the conductivities of their constituents, from which it follows that the complex alum mols. are broken down completely in such soln. into the mols. of the simpler sulphates, and that these simpler mols. ionize as if alone, barring the effect on the ionization produced when the soln. are not isohydric. In conc. soln., the alums show a conductivity less than the mean of the conductivities of their constituents. The difference becomes more marked as the conc. increases, and is of the same order as that observed for other double sulphates. It is much greater than that found in the case of mixtures of sulphates incapable of yielding a double salt. This must be regarded as evidence that the alums are partially undecomposed into the constituent mols. in such soln., or that the ionization into the simple ions into which the single

sulphate break down is not complete. This is confirmed by the f.p. determinations. J. F. Daniell and W. A. Miller made some observations on the **transport numbers** of the alums in aq. soln. J. Curie, H. Starke, and W. Schmidt measured the **dielectric constant** of potash-alum; for $\lambda = \infty$, this constant is 6.67, and for $\lambda = 75$ cms., 6.25.

L. Kralovansky¹¹ said that the **solubility** of lithia-alum in water at ordinary temp. is 4.17 grms. of the salt in 100 parts of cold water and 115 grms. of the salt in 100 parts of hot water. P. Zellner said that 100 parts of water at 13° dissolve 46.7 parts of the salt, and 100 parts of the salt if the water is boiling. A. Ure said that 100 parts of water at 15.5° dissolve 110 parts of soda-alum. W. R. Smith found for the percentage solubility of soda-alum:

	10°	15°	20°	25°	30
Na-alum	26.9	27.9	29.0	30.1	31.4

There is a transition temp. about 30° with soda-alum in contact with its sat. soln. Above 28°, said E. Augé, the soln. seems to lose its faculty of crystallizing. J. M. Wadmore, E. Augé, and W. A. Tilden have also made observations on the solubility of soda-alum in water. E. Augé said that at temp. approaching 0° hydrated sodium sulphate crystallizes from the aq. soln. The solubility of potash-alum has been measured by R. Brandes, J. B. Richter, J. Locke, L. Marino, A. B. Poggiale, J. Redtenbacher, the Earl of Berkeley, etc. The best representative values for the percentage solubilities are:

	0°	15°	30	45°	60°	m.p.
K-alum.	2.87	4.80	7.74	12.48	19.85	54.45

To these G. J. Mulder added: 100°, 60.63; 110°, 66.67; and 111.9°, 67.81 per cent. in which the solid phase is $\text{KAl}(\text{SO}_4)_2 \cdot n\text{H}_2\text{O}$. The Earl of Berkeley found that a solid separated from soln. at about 68°. C. J. B. Karsten said that potash-alum is almost insoluble in soln. of aluminium sulphate. C. Reuss, and L. Marino made observations on this subject; expressing the results in mols of salt per 1000 mols of water, the latter found, with alum and aluminium sulphate as solid phases:

	0°	20°	35°	50°	65°	77°
$\text{Al}_2(\text{SO}_4)_3$	6.1	15.1	24.1	33.5	43.1	50.5 mols.
K_2SO_4	2.3	3.1	3.6	6.1	12.3	18.9 "

and with alum and potassium sulphate as solid phases, L. Marino found:

	0°	10°	30°	40°	60°	80°
$\text{Al}_2(\text{SO}_4)_3$	0.1	0.5	1.0	1.9	6.7	28.1 mols.
K_2SO_4	7.8	9.9	15.2	16.8	34.6	53.4 "

G. J. Mulder found that at 10°, 100 parts of water sat. with potassium sulphate dissolved 0.86 part of potash-alum. F. P. Venable found that the solubility of potash-alum is reduced by the presence of soda-alum; the amounts in grams of potash-alum dissolved by soln. containing the following amounts in grams of soda-alum, at 25°, are:

Na-alum	4.8	10.0	12.1	15.4	21.1	33.7	55.6	76.7
K-alum	7.8	6.1	5.7	5.3	4.7	3.8	2.7	1.7

A. Fock measured the effect of thalia-alum on the solubility of potash-alum; and C. von Hauer, the effect of chrome-alum and of ferric-alum; and G. J. Mulder, the effect of magnesium sulphate. C. J. B. Karsten found that potash-alum crystallizes unchanged from its soln. in presence of potassium nitrate or chloride. According to P. L. Geiger, if burnt alum be quenched in water it remains undissolved for many months, but if it has been exposed to air for a fortnight, it regains its peculiar taste, and dissolves with ease. The solubility of potash-alum in *alcohol* is very small.

The solubilities of rubidia-alum and cæsia-alum have been measured by C. Setterberg, J. Redtenbacher, E. Hart and H. B. Huselton, the Earl of Berkeley, and F. Godeffroy. The best representative values for the percentage solubilities are:

	0°	15°	30°	45°	60°	80°	100·4°	m.p.
Rb-alum . . .	0·715	1·25	2·15	3·85	6·89	17·77	—	58·5
Cs-alum . . .	0·21	0·35	0·60	1·04	1·96	5·21	18·60	62·00

The Earl of Berkeley found that a solid separated from the soln. of rubidia-alum at 80°. The solubility of ammonia-alum was determined by F. Pohl, A. B. Poggiale, G. J. Mulder, and J. Locke. The best representative values for the percentage solubility are :

	0°	10°	20°	40°	60°	80°	m.p.
NH ₄ -alum . . .	2·53	4·31	6·19	11·00	17·40	26·00	52·20

and G. J. Mulder added that at 110·6°, the solubility is 67·50 per cent. with a hydrate NH₄Al(SO₄)₂·nH₂O as solid phase. According to F. Guthrie, the eutectic or cryohydric temp. is -0·20° with 4·3 per cent. of dehydrated alum—this last number is too large. F. Rüdorff measured the effect of aluminium and ammonium sulphates on the solubility of ammonia-alum. By raising the *pressure* up to 400 atm., E. von Stackelberg found that the potash-alum content of a gram of the soln. was raised from 0·115 to 0·142 grm.

Ammonia- and potash-alums have an indescribable taste, for they are sour and yet sweet. O. Schumann found that when potash-alum is heated in a stream of **hydrogen**, sulphur dioxide and water are formed and the residue contains a little sulphate but no sulphide, and is but partially soluble in hydrochloric acid. E. Augé stated that soda-alum is only very slightly efflorescent in **air**, and may be kept several months without alteration. Statements to the contrary are said to be based on observations with the impure salt. When crystals of potash-alum are exposed to the air, they become an opaque-white superficially, some ammonia is absorbed from the air, and a basic sulphate formed. According to K. Kraut, alum which has lost 18 mols of water over conc. sulphuric acid absorbs the lost water from the atm. during 3 months' exposure, while H. von Blücher said that burnt alum absorbed 18 mols of water from the atm. after 47 days' exposure to air in summer, and more water continues to be absorbed. The soln. reddens litmus. T. Graham¹² F. Rüdorff, and C. L. Parsons and W. W. Evans showed by diffusion experiments that the two sulphates can be separated by diffusion, and J. C. G. de Marignac concluded that the complex salt is formed only at the moment of crystallization. G. T. Gerlach pointed out that the slight volume changes which occur on mixing the component salts indicated that some combination does occur in soln. While H. C. Jones and E. Mackay showed by f.p. and conductivity measurements that dil. soln. of alum in **water** behave like soln. of the mixed sulphates; in conc. soln. alone are there signs of the formation of complexes. If this be so, the liberated aluminium sulphate in dil. aq. soln. of alum should be more or less hydrolyzed by water as in the case of aq. soln. of aluminium sulphate alone (*q.v.*), except possibly some protective action by the alkali sulphate. C. R. C. Tichborne found aq. soln. of potash-alum decompose at about 100° with the separation of insoluble flecks which can be recognized by illuminating the soln. The Earl of Berkeley also noted separations with aq. soln. of potash-alum at 68°, and with rubidia-alum at 80°. A. Naumann said a basic aluminium sulphate separates as a white precipitate when aq. soln. of alum are boiled. It was found that with pure alum soln. the decomposition was most rapid at first, gradually becoming less for equal intervals of time, so that a state of equilibrium in the liquid was reached only after a very long time. Dilution of the soln. favoured decomposition. Free sulphuric acid, added to alum soln., prevented the decomposition, partially or entirely, according to the amount added. Neutral potassium sulphate, on the contrary, expedited the decomposition—*vide* basic aluminium sulphates. A. Mitscherlich obtained löwigite by heating potash-alum with water in a sealed tube at 170°-230°. According to R. Willstätter, alum can take up **hydrogen peroxide** of crystallization.

According to J. W. Thomas, **hydrogen chloride** is without action on dehydrated potash-alum. In studying the effect of **hydrochloric acid** on

the crystalline form of potash-alum (*q.v.*), P. A. Schemjatschensky sometimes obtained crystals of complex *potassium chlorosulphatoaluminate*, $6\{KAl(SO_4)_2 \cdot 12H_2O\} \cdot K_2SO_4 \cdot 8KCl \cdot 6AlCl_3$. J. B. Richter noted that when potash-alum is heated with **potassium or sodium chloride**, hydrogen chloride is set free; while if a conc. soln. of the alum is boiled with potassium chloride, sodium chloride, or **ammonium chloride**, a sparingly soluble basic sulphate is precipitated. These reactions were also discussed by R. von Wagner, and F. J. Knapp. J. B. Richter also observed that a mixed soln. of alum, sodium chloride, and potassium nitrate dissolves gold. When crystals of potash-alum are kept under cold conc. **sulphuric acid** for a fortnight, a white pasty mass is formed which when treated with water becomes hot, and when dissolved in boiling water, yields, on cooling, octahedral crystals of $K_2SO_4 \cdot Al_2(SO_4)_3 \cdot 14H_2O$, according to C. Hertwig; or $K_2SO_4 \cdot Al_2(SO_4)_3 \cdot 24H_2O$, according to W. Heintz. Boiling sulphuric acid converts alum into an insoluble white powder which, according to C. F. Gerhardt, is converted by water into crystals of ordinary alum, but, according to A. Laurent, into crystals of an acid sulphate, $Al_2(SO_4)_3 \cdot H_2SO_4$. W. F. Salm-Horstmar said that if alumina be melted with **potassium hydrosulphate**, and the cold mass extracted with hot water, small six-sided crystals of a product approximating to water-free alum are produced. When burnt alum is heated with **carbon**, a pyrophoric mixture containing alumina and potassium sulphide is formed. J. Thomsen found that the thermal value of the reaction between **potassium hydroxide** and potash-alum is 30.53 Cals., and he assumed, in consequence, that $Al_2(SO_4)_3 + 6KOH = 3K_2SO_4 + 2Al(OH)_3 + 30.53$ Cals., but A. V. E. Young believes that the deduction is invalidated by the significant side reactions which occur. L. B. Miller studied the fractional precipitation of alumina from soln. of alum—*vide* aluminium hydroxide. N. R. Dhar and co-workers found that **copper hydroxide** precipitates aluminium hydroxide from a soln. of potash-alum, and while copper goes into soln. some is retained by the precipitate. J. Löwe said that **zinc** in contact with platinum dipped in an aq. soln. of alum furnishes hydrogen, and a basic aluminium sulphate.

Many dyes are capable of combining directly with the fibre of the cloth to be dyed in such a way that the colouring matter is not removed by water and soap; in other cases, the fibres can be permanently dyed by previously treating them with aluminium hydroxide. The fibre absorbs the hydroxide from aq. soln. of aluminium salts—the so-called *red-liquor*, *mordant d'alumine*, or *Rothbeize*—and the dye can unite with the aluminium hydroxide to form insoluble lakes so that the aluminium hydroxide is an intermediary agent or *mordant* enabling the fibre to be dyed. W. W. Paddon¹³ regards the effect of alum on fibres to be strictly an adsorption phenomenon in which both sulphuric acid and alumina are involved; and not a chemical union with the fibre as advocated by E. Knecht.

Lower hydrated forms of alum.—The *dodecahydrate* of sodium aluminium sulphate has been previously described in connection with soda-alum. According to L. Marino,¹⁴ if a supersaturated soln. of potash-alum in its own weight of water at 40° be seeded with crystals of ammonium thallic sulphate, $(NH_4)_2SO_4 \cdot Ti_2(SO_4)_3 \cdot 8H_2O$, crystals of the *heptahydrate*, $K_2SO_4 \cdot Al_2(SO_4)_3 \cdot 14H_2O$, are formed which readily pass into ordinary alum. P. T. Cleve's analysis of the sodium aluminium sulphate found on St. Barth (West India) corresponds with the *hexahydrate*, $Na_2SO_4 \cdot Al_2(SO_4)_3 \cdot 12H_2O$. L. Marino reported a *tetrahydrate*, $K_2SO_4 \cdot Al_2(SO_4)_3 \cdot 8H_2O$, to be formed in needle-like crystals by holding molten potash-alum at 85°–86°, and as soon as crystals begin to form, by sealing the mass in a tube to prevent the loss of water, and holding the temp. at 95°. He also made the *tetrahydrate* $(NH_4)_2SO_4 \cdot Al_2(SO_4)_3 \cdot 8H_2O$ in a similar way.

Basic alums.—According to A. Mitscherlich,¹⁵ when an alkali is gradually added to an aq. soln. of alum, the precipitate produced redissolves on stirring until a certain proportion of alkali has been added, any further addition produces a permanent precipitate. The soln. which is on the point of giving a precipitate is called in commerce *neutral alum*, and it is used in mordanting cloth for dyeing. If the soln.

be heated to 40°, a precipitate is formed corresponding with **potassium aluminium hydroxysulphate**, $K_2SO_4 \cdot Al_2(SO_4)_3 \cdot 4Al(OH)_3$, or *potassium hexahydroxy-disulphato-trialuminate*, $KAl_3(SO_4)_2(OH)_6$, or $K[Al(OH)_2]_3(SO_4)_2 \cdot 3H_2O$. This compound is represented in nature by the mineral *alunite*. A. Mitscherlich obtained it in a crystalline form by heating the neutral alum in a sealed tube at 230°. He also made a *soda-alunite*—**sodium aluminium hydroxysulphate**—and an *ammonia-alunite*—**ammonium aluminium hydroxysulphate**—in a similar way. The *alumen de Tolpha* mentioned in connection with the history of aluminium; the *Alaunstein* of A. G. Werner; the *alun de Rome* of R. J. Haüy; the *Alaunspath* of A. Breithaupt; or the *aluminilite* of J. C. Delamétherie, was called *alunite* by F. S. Beudant, and this term has remained. Analyses were made by L. Cordier, A. Mitscherlich, C. F. Rammelsberg, M. Sauvage, F. Fridau, J. Gautier-Lacroze, etc. The idealized summary of the analyses is $K_2SO_4 \cdot Al_2(SO_4)_3 \cdot 4Al(OH)_3$. The mineral occurs at Tolfa (Italy), Montioni (Tuscany), Muzsai and Bereghszasz (Hungary), Milo, Argentiera, and Nevis (Grecian Archipelago), Mont Dore (France), etc. It is supposed to have been formed by the action of volcanic gases containing sulphur dioxide on felspathic trachytes, etc. The rhombohedral crystals belong to the trigonal system, and have the axial ratio $a:c=1:1.245$, and $\alpha=89^\circ 14'$; the sp. gr. is 3.15 to 3.26; H. Bowley gave 2.65 for the sp. gr., and 1.58 for the index of refraction; the double refraction is negative. Alunite loses water at 350°, and at a dull red heat, about 530°, it gives off water and sulphur trioxide; after calcination in the blowpipe flame, water extracts potassium sulphate and leaves alumina. H. Bowley saw that at 300° there is no decomposition; at 400°, 4.5 mols. of water are lost; at 500°, the remaining 1.5 mols. are expelled; at 800°, dissociation into potassium sulphate, alumina, sulphur trioxide, and water is complete; and at 960°, potassium aluminate is formed. H. Bowley found alunite to be sparingly soluble in water. Alunite is not dissolved by boiling conc. hydrochloric acid; but it is decomposed by that acid in a sealed tube at 200°, and if pre-calcined, it is decomposed by that acid. It is soluble in boiling sulphuric acid of sp. gr. 1.854, but it dissolves more quickly in dil. acid. H. Bowley said that alunite is readily soluble in warm dil. soln. of hydrofluoric acid, sodium or potassium hydroxide, sodium carbonate, and hot conc. sulphuric acid. It is fairly readily attacked by a soln. of calcium hydroxide or carbonate. He also described a *soda-alunite*.

A. Mitscherlich also obtained a kind of hydrated alunite, $K_2SO_4 \cdot Al_2(SO_4)_3 \cdot 4Al(OH)_3 \cdot 3H_2O$, or $K[Al(OH)_2]_3(SO_4)_2 \cdot 1\frac{1}{2}H_2O$, by heating a soln. of potassium sulphate with less aluminium sulphate than is needed for the preparation of alunite. By the action of zinc, or of alkali hydroxides or carbonates on soln. of potash-alum, H. Debray, W. Crum, C. Rössler, A. Riffault, and L. F. Bley obtained precipitates which approximated in composition to the product just indicated. It is represented by the mineral *löwigite*, found in compact masses associated with alunite, and at Tabrze (Upper Silesia); it has been described by A. Mitscherlich, P. Berthier, C. F. Rammelsberg, F. Römer, C. Löwig, etc. A similar basic ammonium salt was obtained by A. Maus, A. Riffault, and A. Mitscherlich by using aq. ammonia in place of potash-lye.

The blue hair-like crystals from Moldawa (Rumania), analyzed by J. Percy,¹⁶ and by F. A. Genth, correspond with $2Al_2O_3 \cdot 9CuO \cdot 3SO_3 \cdot 21H_2O$, or with $Al_2O_3 \cdot 4CuO \cdot SO_3 \cdot 8H_2O$. It was called *lettsomite*—after W. G. Lettsom; E. F. Glocker called it *cyanotrichite*—*κύανος*, blue; *θρίξ*, hair; and it has also been called *velvet copper ore*, or *cuivre velouté*. The mineral *woodwardite* from Cornwall was analyzed by A. H. Church, R. Warrington, and F. Pisani, and it corresponds with $11CuO \cdot 9.6Al_2O_3 \cdot 9SO_3 \cdot 23H_2O$. There is nothing to show the chemical nature of these products, and whether or not they represent *copper sulphato-aluminates*.

G. Arth¹⁷ obtained fine acicular crystals on allowing a soln. of barium aluminate and calcium sulphate to stand for 24 hrs. The analysis corresponded with $CaO : Al_2O_3 : SO_4 = 5.76 : 1 : 2.67$ —say 6 : 1 : 3 with nH_2O . O. Rebuffat indicated the formation of *calcium sulphato-aluminate*, $11CaO \cdot 2Al_2O_3 \cdot 5SO_3 \cdot 52H_2O$, by the

action of calcium sulphate and hydroxide on calcium aluminate. He also discussed the action of sea-water on this product and its bearing on Portland cement. A. A. Klein and A. J. Phillips have also discussed the calcium sulphato-aluminates; but they are not well enough defined to be recognized as chemical individuals. For $3\text{CaO} \cdot 3\text{CaSO}_4 \cdot \text{Al}_2\text{O}_3 \cdot 30\text{H}_2\text{O}$, *vide* calcium aluminate.

There are a number of double sulphates of the type $\text{MSO}_4 \cdot \text{Al}_2(\text{SO}_4)_3 \cdot 24\text{H}_2\text{O}$, in which M may be Mg, Zn, Fe²⁺, or Mn. They are called **pseudo-alums**, and they are not isomorphous with ordinary alums. Very little is known about the pseudo-alums, and it is even doubtful if they have $24\text{H}_2\text{O}$. The so-called *magnesia-alum* is represented by the mineral *pickeringite*—named after J. Pickering—found in acicular crystals, fibrous masses, or efflorescences on shales near Iquique (Peru), Nova Scotia, Island of Negros, etc. It is probably formed by the action on the shale of decomposing pyrites. Analyses were made by H. Schulze,¹⁸ D. L. Brackenbusch, E. Goldsmith, etc. R. J. Kane assigned to it the formula $\text{MgSO}_4 \cdot \text{Al}_2(\text{SO}_4)_3 \cdot 24\text{H}_2\text{O}$, but, according to A. Hayes, and H. How, the analyses correspond with **magnesium aluminium sulphate**, $\text{MgSO}_4 \cdot \text{Al}_2(\text{SO}_4)_3 \cdot 22\text{H}_2\text{O}$, or *magnesium tetrasulphato-aluminate*, $\text{MgAl}_2(\text{SO}_4)_4 \cdot 22\text{H}_2\text{O}$.

Part of the magnesium in magnesia-alum may be replaced by manganese to form what E. F. Glocker called *apjohnite*. J. Apjohn called it *manganese-alum*. Analyses were made by F. Stromeyer, J. Apjohn, J. L. Smith, G. A. Kenngott, L. D. Gale, etc. A variety from Alcaparossa, Chili, containing some soda-alum was called *stüvenite*—after E. Stüven—by L. Darapsky; and a related variety from Cerros Pintados, Chili, was called *sesquimagnesia alum*, $1\frac{1}{2}\text{MgSO}_4 \cdot \text{Al}_2(\text{SO}_4)_3 \cdot 26\frac{1}{2}\text{H}_2\text{O}$, by L. Darapsky. A variety from Sonoma Co., California, was called *sonomate*—by E. Goldsmith. The composition approximated to $3\text{MgSO}_4 \cdot \text{Al}_2(\text{SO}_4)_3 \cdot 33\text{H}_2\text{O}$. C. Doelter described a variety from S. Antao, one of the Cape Verde Islands, which he called *dumreicherite*—after A. von Dumreicher. Its composition was $4\text{MgSO}_4 \cdot \text{Al}_2(\text{SO}_4)_3 \cdot 36\text{H}_2\text{O}$. L. Darapsky obtained a variety with the composition $6\text{MgSO}_4 \cdot \text{Al}_2(\text{SO}_4)_3 \cdot 54\text{H}_2\text{O}$, from Pampa de Aroma, Chili, and he called it *aromite*. A similar mineral was obtained from Copiapo, Chili. G. Roster found a mineral which he named *microallumogene*, and hence also *microallumogin*, and *picralluminite*, at Vigneria, Island of Elba. The analysis corresponds with $2\text{MgSO}_4 \cdot \text{Al}_2(\text{SO}_4)_3 \cdot 28\text{H}_2\text{O}$. Other analyses agree with $3\text{MgSO}_4 \cdot \text{Al}_2(\text{SO}_4)_3 \cdot 33\text{H}_2\text{O}$.

C. Klauer obtained a product with the composition $3\text{MgSO}_4 \cdot \text{Al}_2(\text{SO}_4)_3 \cdot 36\text{H}_2\text{O}$ by allowing a soln. of magnesium and aluminium sulphates in dil. sulphuric acid to evaporate spontaneously. R. J. Kane reported the formation of a *zinc-alum*, **zinc aluminium sulphate**, $\text{ZnSO}_4 \cdot \text{Al}_2(\text{SO}_4)_3 \cdot 24\text{H}_2\text{O}$, by crystallization from a soln. of the components. E. Bertrand and A. Damour found hexagonal plates of a basic zinc aluminium sulphate, $12\text{Al}(\text{OH})_3 \cdot \text{Al}_2(\text{SO}_4)_3 \cdot 2\{6\text{Zn}(\text{OH})_2 \cdot \text{ZnSO}_4\} \cdot 12\text{H}_2\text{O}$, or $\text{Al}_6\text{Zn}_6\text{S}_2\text{O}_{21} \cdot 18\text{H}_2\text{O}$, in the zinc mines of Laurium, Greece; they named the mineral *zincaluminite*. The sp. gr. was 2·26, and the hardness 2·5–5·3.

REFERENCES.

- ¹ F. P. Venable, *Chem. News*, **40**, 198, 1879; E. von Gerichten, *Liebig's Ann.*, **168**, 214, 1873; *Ber.*, **6**, 162, 1873; H. Schiff, *Liebig's Ann.*, **107**, 81, 1858; R. Krickmeyer, *Zeit. phys. Chem.*, **21**, 78, 1896; S. Kern, *Chem. News*, **31**, 209, 1875; A. H. Church and A. B. Northcote, *ib.*, **9**, 155, 1864; J. Locke, *Amer. Chem. Journ.*, **20**, 581, 1898.
- ² T. Thomson, *Phil. Mag.*, (3), **22**, 188, 1843; *Ann. Lyceum New York*, **3**, 19, 1828; C. U. Shepard, *Amer. Journ. Science*, (1), **16**, 203, 1829; (1), **22**, 287, 1832; *A Treatise on Mineralogy*, New Haven, 397, 1857; H. Schulze, *Verh. Ver. Santiago*, **2**, 56, 1889; L. Domeyko, *Elementos de Mineralogía*, Santiago, 30, 1879; M. H. Klaproth, *Beiträge zur chemischen Kenntniss der Mineralkörper*, Berlin, 1, 311, 1795; S. Breislak, *Essais Minéralogique sur la solfatara*, Paris, 1792; J. D. Dana, *A System of Mineralogy*, London, 652, 1868; W. Grüner, *Gilbert's Ann.*, **69**, 218, 1821; W. A. Lampadius, **70**, 182, 1822; **74**, 133, 1823; F. von Kobell, *Tafeln zur Bestimmung der Mineralien*, München, 1853; C. H. Pfaff, *Handbuch der analytischen Chemie*, Altona, **2**, 47, 1825; F. Stromeyer, *Pogg. Ann.*, **31**, 137, 1834; L. R. Lecanu and M. Blanchet, *Journ. Pharm. Chim.*, (2), **13**, 419, 1827; J. J. N. Huot, *Manuel de minéralogie*, Paris, **2**, 448, 1841; F. S. Beudant, *Traité élémentaire de minéralogie*, Paris, **2**, 497, 1832; E. Divers, *Chem. News*, **44**, 218, 1881; R. H. Davis, *Journ. Chem. Soc.*, **39**, 19, 1881; T. Garnett, *The Mineral Waters of Harrogate*, London, 1791; A. Hunter, *The Waters of Harrogate and its Vicinity*, London, 1830; E. T. Erickson, *Journ. Washington Acad. Science*, **12**, 49, 1922; C. Hartwell, *Amer. Journ. Science*, (2), **17**, 56, 1854.

³ L. Kralovansky, *Schweigger's Journ.*, **54**, 349, 1828; C. F. Rammelsberg, *Sitzber. Akad. Berlin*, 385, 1848; F. A. H. Schreinemakers and A. J. C. de Waal, *Chem. Weekbl.*, **3**, 539, 1906.

⁴ K. G. Wellner, *Gilbert's Ann.*, **70**, 102, 185, 1822; *Schrift. Nat. Ges. Leipzig*, 131, 1822; P. Zellner, *Schweigger's Journ.*, **13**, 344, 1813; J. M. Wadmore, *Proc. Chem. Soc.*, **21**, 150, 1906; W. R. Smith, *Journ. Amer. Chem. Soc.*, **31**, 245, 1909; W. Ostwald, *Grundlinien der anorganischer Chemie*, Leipzig, 1900; London, 556, 1902; J. B. Spence, *Chem. News*, **22**, 181, 1870; F. M., D. D., and H. Spence, *Brit. Pat. No.* 5644, 1900; A. Ure, *Quart. Journ. Science*, **13**, 276, 1822; G. Bergeron, *French Pat. No.* 107654, 1875; W. Beatson, *Brit. Pat. No.* 2272, 1874; E. Augé, *ib.*, 6443, 16711, 11975, 1889; *Compt. Rend.*, **110**, 1139, 1890; G. Dumont, *German Pat.*, D.R.P. 141670, 1901; J. Bock, *ib.*, 178236, 1905; T. Graham, *Phil. Mag.*, (3), **9**, 26, 1836; T. H. Wright, *U.S. Pat. No.* 1359011, 1920.

⁵ J. Bock, *French Pat. No.* 369729, 374297, 1907; *Brit. Pat. No.* 5295, 1907; H. Müller, *Journ. prakt. Chem.*, (1), **59**, 257, 1853; *Zeit. deut. geol. Ges.*, **6**, 707, 1854; G. Clemm, *French Pat. No.* 60456, 1863; T. J. Herapath, *Chem. Gaz.*, **11**, 169, 1853; L. Geschwind, *Industries du sulfate d'aluminium, des aluns, et des sulfates de fer*, Paris, 1899; London, 1901; S. Stein, *Sitzber. Niederrh. Ges. Bonn*, 139, 1879; H. T. S. Britton, *Journ. Chem. Soc.*, **121**, 982, 1922; F. Jünemann, *Die Fabrikation des Alauns der schwefelsauren und der essigsauren Tonerde*, Wien, 1882; L. Duncan, *Chem. Met. Eng.*, **24**, 529, 1921; L. Pommiere, *Sulfate d'alumine et alun*, Paris, 1884; K. W. Jurisch, *Die Fabrikation der schwefelsauren Tonerde*, Berlin, 1894; J. Löwe, *Zeit. anal. Chem.*, **3**, 247, 1864; T. Thomson, *Ann. Phil.*, (2), **3**, 161, 1822; L. J. Thénard and M. Roard, *Ann. Chim. Phys.*, (1), **59**, 58, 106, 1807; *Nicholson's Journ.*, **18**, 275, 1807; L. N. Vauquelin, *Bull. Soc. Enc. Nat. Ind.*, (1), **2**, 149, 1803; *Ann. Chim. Phys.*, (1), **50**, 154, 1804; *Mém. Acad.*, **66**, 1806; *Journ. Mines*, **5**, 429, 1797; **16**, 49, 1804; *Nicholson's Journ.*, **1**, 318, 1797; J. D. Riedel, *German Pat.*, D.R.P. 359975, 1920; W. A. Lampadius, *Journ. Mines*, **16**, 465, 1804; *Phil. Mag.*, **23**, 65, 1806; T. Graham, *ib.*, (3), **9**, 26, 1836; T. H. Wright, *U.S. Pat. No.* 1396675, 1921; A. Matheson, *Brit. Pat. No.* 167555, 1920; J. L. Silsbee, *U.S. Pat. No.* 1386031, 1921; J. Persoz, *Ann. Chim. Phys.*, (3), **56**, 102, 1859; A. R. ffault, *ib.*, (2), **16**, 359, 1821; D. G. Fahrenheit, *Phil. Trans.*, **33**, 114, 1726; J. M. Wilson, *Phil. Mag.*, (4), **9**, 413, 1855; S. Kern, *Chem. News*, **31**, 209, 1875; A. H. Church and A. B. Northote, *ib.* **9**, 155, 1864; J. C. Bell, *ib.*, **12**, 234, 1865; J. W. Hinchley, *Journ. Soc. Chem. Ind.—Chem. Ind.*, **43**, 158, 1924; J. W. Retgers, *Zeit. phys. Chem.*, **3**, 497, 1889; G. Kirchhoff and R. Bunsen, *Pogg. Ann.*, **113**, 351, 1861; F. Stromeyer, *ib.*, **31**, 137, 1834; W. Meyerling, *Ber.*, **10**, 1946, 1877; G. Forchhammer, *Ann. Phil.*, (2), **5**, 416, 1823; A. F. Gehlen, *Gehlen's Journ.*, **2**, 364, 1806; C. Schwartz, *Ber.*, **17**, 2887, 1884; R. R. Linblad and S. H. Hultman, *Swedish Pat. No.* 53132, 53133, 53134, 1922; P. Spence, *Brit. Pat. No.*, 1090, 1845; 13335, 1850; 2275, 3870, 1855; 1676, 1870; P. and F. M. Spence, *ib.*, 1704, 1875; 2579, 1877; P. and H. Spence and W. B. Llewellyn, *ib.*, 3805, 22590, 1912; 112881, 119924, 1918; R. Laming, *ib.*, 14260, 1852; J. T. Wilson, *ib.*, 13389, 1850; J. D. Riedel, *German Pat.*, D.R.P. 368650, 375703, 1920.

⁶ A. M. Sieffert, *Neues Hamburg. Mag.*, **163**, 1772; *Almanach Scheidekünstler*, **1**, 6, 1780; N. le Blanc, *De la cristallotechnie ou essai sur les phénomènes de la cristallisation*, Paris, 1802; C. von Hauer, *Sitzber. Akad. Wien*, **40**, 566, 1860; *Journ. prakt. Chem.*, (1), **94**, 241, 1865; H. Kopp, *Einleitung in die Krystallographie*, Braunschweig, 109, 1849; *Liebig's Ann.*, **94**, 122, 1855; H. Schiff, *ib.*, **107**, 81, 1858; A. Knop, *Molekularconstitution und Wachstum der Krystalle*, Leipzig, 77, 1867; *Zeit. Kryst.*, **4**, 260, 1880; J. J. P. Valetton, *ib.*, **56**, 434, 1921; *Phys. Zeit.*, **21**, 606, 1920; E. Jannettaz, *Bull. Soc. Chim.*, (2), **13**, 103, 1870; R. Weber, *Pogg. Ann.*, **109**, 379, 1860; A. Sacchi, *Mem. Accad. Torino*, (2), **21**, 45, 1862; H. A. Miers, *Phil. Trans.*, **202**, 459, 1903; F. Klocke, *Zeit. Kryst.*, **2**, 126, 293, 1878; **4**, 76, 1880; L. Wulff, *ib.*, **5**, 81, 1881; Z. Weyberg, *ib.*, **36**, 40, 1901; H. Przibram, *ib.*, **39**, 576, 1904; A. Körbs, *ib.*, **43**, 41, 1907; P. Groth, *Chemische Krystallographie*, Leipzig, **2**, 564, 1908; N. I. Surgunoff, *Bull. Acad. St. Petersburg*, (6), **3**, 1057, 1909; F. Klepitschewsky, *Journ. Russ. Phys. Chem. Soc.*, **20**, 116, 1888; A. Stiassny, *Dingler's Journ.*, **202**, 191, 1871; P. A. Schumjatschensky, *Mém. Acad. St. Petersburg*, (8), **30**, 1, 1913; A. Schubnikoff, *ib.*, (8), **30**, 817, 1913; T. Terada, *Proc. Math. Phys. Soc. Tokyo*, **7**, 290, 1914; P. Niggli, *Phys. Zeit.*, **19**, 225, 1918; R. W. G. Wyckoff, *Amer. Journ. Science*, (4), **5**, 209, 1923; N. S. Kurnakoff, *Zeit. Kryst.*, **5**, 591, 1881; M. Kuhara, *Mem. Coll. Eng. Kyoto Univ.*, **2**, 53, 1918; P. Gaubert, *Bull. Soc. Min.*, **18**, 141, 1895; C. Soret, *Arch. Sciences Genève*, (3), **11**, 62, 1884; (3), **13**, 9, 1885; H. Löwel, *Ann. Chim. Phys.*, (3), **43**, 414, 1855; L. de Boisbaudran, *ib.*, (4), **9**, 176, 1866; J. F. Persoz, *ib.*, (3), **25**, 257, 1849; A. Jeannel, *Compt. Rend.*, **61**, 412, 1865; J. M. Thomson and W. P. Eloxam, *Journ. Chem. Soc.*, **41**, 379, 1882; R. Krickmeyer, *Zeit. phys. Chem.*, **21**, 78, 1896; O. Pettersson, *Ber.*, **9**, 1561, 1876; **15**, 1739, 1882; A. Polis, *ib.*, **13**, 360, 1880; A. Rota, *Atti Accad. Lincei*, (5), **7**, ii, 125, 1898; A. Rauber, *Die Regeneration der Krystalle*, Leipzig, 1895; Dorpat, 1904; F. S. Beudant, *Ann. Mines*, (1), **3**, 239, 289, 1818; T. Thomson, *Ann. Lyceum New York*, **3**, 19, 1828; T. J. Pelouze and E. Frémy, *Traité de chimie générale*, Paris, 1867; C. Schäfer and M. Schubert, *Ann. Physik*, (4), **50**, 283, 1916; (4), **59**, 583, 1919; L. Vegard and H. Schjelderup, *ib.*, (4), **54**, 146, 1917; L. Vegard, *ib.*, (4), **63**, 753, 1920; F. P. Venable, *Chem. News*, **40**, 198, 1879.

⁷ H. Schiff, *Liebig's Ann.*, **107**, 64, 1858; H. Kopp, *ib.*, **36**, 1, 1840; H. J. Buignet, *Journ. Pharm. Chim.*, (3), **40**, 161, 337, 1860; H. G. F. Schröder, *Dichtigkeitsmessungen*, Heidelberg, 1873; J. H. Hassenfratz, *Ann. Chim. Phys.*, (1), **28**, 3, 1798; A. Dufrenoy, *Ann. Mines*, (3), **9**, 165, 1836; O. Pettersson, *Nova Acta Upsala*, (3), **9**, 4, 1873; W. Spring, *Sur un nouveau dilatomètre*, Bruxelles, 1883; *Bull. Acad. Belg.*, (3), **6**, 507, 1883; *Bull. Soc. Chim.*, (2), **40**, 515, 1883;

Ber., 15. 1254, 1882; 16. 2723, 1883; 17. 408, 1884; C. Setterberg, *ib.*, 15. 1740, 1882; E. Wiedemann, *Wied. Ann.*, 17. 561, 1883; E. N. Ivanova, *Journ. Russ. Phys. Chem. Soc.*, 48. 1905, 1916; E. Hart and H. B. Huselton, *Journ. Amer. Chem. Soc.*, 36. 2082, 1914; F. Stolba, *Journ. prakt. Chem.*, (1), 97. 503, 1866; A. Breithaupt, *ib.*, (1), 11. 151, 1837; L. Playfair and J. P. Joule, *Mem. Chem. Soc.*, 2. 401, 1845; *Journ. Chem. Soc.*, 1. 138, 1849; W. C. Smith, *Amer. Journ. Pharm.*, 53. 145, 1882; C. Soret, *Compt. Rend.*, 99. 867, 1884; *Arch. Sciences Genève*, (3), 11. 62, 1884; (3), 13. 9, 1885; T. Thomson, *Ann. Lyceum New York*, 3. 19, 1828; J. Redtenbacher, *Sitzber. Akad. Wien*, 51. 248, 1865; J. Dewar, *Chem. News*, 85. 277, 1902; J. W. Retgers, *Zeit. phys. Chem.*, 3. 289, 1889; R. Krickmeyer, *ib.*, 21. 78, 1896; M. le Blanc and P. Rohland, *ib.*, 19. 277, 1896; A. Ure, *Quart. Journ. Science*, 13. 276, 1822; G. T. Gerlach, *Chem. Ind.*, 9. 241, 1886; *Zeit. anal. Chem.*, 26. 503, 1887; 28. 466, 1889; J. G. MacGregor, *Chem. News*, 62. 223, 232, 1890; R. Broom, *Proc. Roy. Soc. Edin.*, 13. 172, 1885; E. F. Anthon, *Dingler's Journ.*, 160. 374, 1861; A. Michel and L. Kraft, *Ann. Chim. Phys.*, (3), 41. 471, 1864; E. Forster, *Mitt. Natur. Bern*, 1, 1878; *Untersuchungen über die Beziehungen die zwischen dem spezifischen Brechungsvermögen und der Concentration der Salzlösungen bestehen*, Bern, 1881; F. Fouqué, *Ann. Observat. Paris*, 9. 172, 1868; M. Hoek and J. A. C. Oudemans, *Quantité d'éther dans les liquides*, La Haye, 1864; G. Tammann, *Mém. Acad. St. Petersburg*, (7), 35. 1, 1887; J. Beckenkamp, *Zeit. Kryst.*, 10. 41, 1885; 12. 418, 1887; W. Voigt, *Nachr. Gött.*, 85, 1919; D. M. Torrance and N. Knight, *Chem. News*, 117. 270, 1918.

⁸ J. Juttke, *Ueber die Bindung des Krystallwassers in einiger Alaunen*, Berlin, 1887; T. Graham, *Phil. Mag.*, (3), 9. 26, 1836; *Phil. Trans.*, 127. 47, 1837; E. Wiedemann, *Wied. Ann.*, 17. 561, 1883; E. N. Ivanova, *Journ. Russ. Phys. Chem. Soc.*, 48. 1905, 1916; K. Kraut, *Liebigs Ann. Suppl.*, 4. 126, 1865; C. F. Gerhardt, *Journ. Pharm. Chim.*, (3), 12. 65, 1847; F. T. Erickson, *Journ. Washington Acad. Sciences*, 12. 49, 1922; S. Lupton, *Chem. News*, 30. 272, 1874; P. Kraft, *Ber.*, 40. 4770, 1907; H. G. F. Schröder, *ib.*, 4. 471, 1871; A. Naumann, *ib.*, 10. 456, 1877; W. Müller-Erzbach, *ib.*, 21. 2533, 1888; *Zeit. phys. Chem.*, 2. 539, 1888; H. Erdmann, *Arch. Pharm.*, 232. 17, 1894; C. Hertwig, *Pogg. Ann.*, 55. 99, 1842; C. Brunner, *ib.*, 98. 488, 1856; E. Hart and H. B. Huselton, *Journ. Amer. Chem. Soc.*, 36. 2082, 1914; H. Löwel, *Ann. Chim. Phys.*, (3), 43. 418, 1855; W. A. Tilden, *Journ. Chem. Soc.*, 45. 266, 1884; G. J. Mulder, *Scheikundige verhandeligen*, Rotterdam, 92, 1864; H. von Blücher, *Pogg. Ann.*, 50. 541, 1840; C. M. Marx, *Journ. prakt. Chem.*, (1), 22. 143, 1841; J. Dewar, *Proc. Roy. Soc.*, 76. A. 325, 1905; E. Baud, *Journ. Phys.*, (4), 2. 569, 1903; J. Locke, *Amer. Chem. Journ.*, 20. 581, 1898; 26. 166, 1901; H. C. Jones and E. Mackay, *ib.*, 19. 83, 1897; J. W. Mallet, *ib.*, 4. 241, 334, 426, 1882; *Chem. News*, 63. 72, 90, 101, 108, 1882; R. Dubrisay, *Compt. Rend.*, 170. 1582, 1920; J. M. Wadmore, *Proc. Chem. Soc.*, 21. 150, 1905; S. Macischevsky, *Journ. Russ. Phys. Chem. Soc.*, 48. 1916, 1916; A. Ure, *Quart. Journ. Science*, 13. 276, 1822; T. Griffiths, *ib.*, 18. 90, 1825; P. Zellner, *Schweigger's Journ.*, 18. 344, 1816; P. A. Favre and C. A. Valson, *Compt. Rend.*, 75. 803, 1872; M. Plessy, *ib.*, 97. 1033, 1887; G. T. Gerlach, *Ueber Siedetemperaturen der Salzlösungen*, Wiesbaden, 1887; *Zeit. anal. Chem.*, 26. 413, 1887; D. Brewster, *Treatise on New Philosophical Instruments*, Edinburgh, 1813; *Quart. Journ. Science*, 22. 355, 1827; W. Nernst and F. Schwers, *Sitzber. Akad. Berlin*, 355, 1914; K. Bindel, *Wied. Ann.*, 40. 370, 1890; *Specifiche Gewichte, spezifische Wärmen und Lösungswärmen über sättigter Salzlösungen*, Leipzig, 1888; W. Spring, *Sur un nouveau dilatomètre*, Bruxelles, 1883; *Bull. Acad. Belg.*, (3), 6. 507, 1883; *Bull. Soc. Chim.*, (2), 40. 515, 1883; *Ber.* 16. 2723, 1883.

⁹ C. Soret, *Arch. Sciences Genève*, (3), 12. 576, 1884; A. Borel, *ib.*, (3), 34. 230, 1895; *Compt. Rend.*, 120. 1406, 1895; H. Dufet, *Bull. Soc. Min.*, 14. 145, 1891; A. Mühlheims, *Zeit. Kryst.*, 14. 223, 1888; A. Fock, *ib.*, 4. 583, 1880; E. Aschkinass, *Ann. Physik*, (4), 1. 422, 1900; W. W. Coblenz, *Investigations of Infra-Red Spectra*, Washington, 3. 24, 1906; 4. 50, 1908; E. Reusch, *Pogg. Ann.*, 132. 618, 1867; E. Mallard, *Ann. Mines*, (7), 10. 60, 1876; *Explication des phénomènes optiques anomaux dans des substances cristallines*, Paris, 62, 1876; W. Crookes, *Chem. News*, 123. 81, 1921; R. Brauns, *Die optischen Anomalien der Krystalle*, Leipzig, 1891; *Neues Jahrb. Min.*, ii, 102, 1883; i, 96, 1885; F. Klocke, *ib.*, ii, 249, 1881; i, 76, 1880; F. Pockels, *Neues Jahrb. Min. B.B.*, 8. 217, 1892; F. Kohlrusch, *Wied. Ann.*, 4. i, 1878; J. Stefan, *Sitzber. Akad. Wien*, 63. 239, 1871; J. Grailich, *Krystallographische-optische Untersuchungen*, Wien, 1858; H. A. Miers and F. Isaac, *Journ. Chem. Soc.*, 89. 413, 1906; E. Forster, *Mitt. Natur. Bern*, 1, 1878; *Untersuchungen über die Beziehungen die zwischen dem spezifischen Brechungsvermögen und der Concentration der Salzlösungen bestehen*, Bern, 1881; C. Schäfer and M. Schubert, *Ann. Physik*, (4), 50. 283, 1916; (4), 59. 583, 1919; L. Vegard and H. Schjelderup, *ib.*, (4), 54. 146, 1917; L. Vegard, *ib.*, (4), 63. 753, 1920; T. E. Aurén, *Mémoires. Nobel Inst.*, 4. 10, 1922; R. Krickmeyer, *Zeit. phys. Chem.*, 21. 78, 1896; S. B. Nicholson and E. Pettit, *Phys. Rev.*, (2), 22. 199, 1923.

¹⁰ F. S. Svenson, *Ueber die elektrische Leitungsfähigkeit bei einigen Electrolyten*, Lund, 1877; H. C. Jones and E. Mackay, *Amer. Chem. Journ.*, 19. 83, 1897; H. C. Jones, *The Electrical Conductivity, Dissociation, and Temperature Coefficients of Conductivity of Aqueous Solutions of a Number of Salts and Organic Acids*, Washington, 1912; J. F. Daniell and W. A. Miller, *Phil. Trans.*, 134. I, 1844; J. Curie, *Ann. Chim. Phys.*, (6), 17. 385, 1889; H. Starke, *Wied. Ann.*, 60. 629, 1897; W. Schmidt, *Ann. Physik*, (4), 9. 919, 1902; (4), 11. 114, 1903.

¹¹ L. Kralovansky, *Schweigger's Journ.*, 54. 349, 1828; P. Zellner, *ib.*, 18. 344, 1916; F. Guthrie, *Phil. Mag.*, (4), 40. 1, 206, 266, 1875; *Chem. News*, 31. 49, 1875; A. Ure, *Quart. Journ. Science*, 13. 276, 1822; W. R. Smith, *Journ. Amer. Chem. Soc.*, 31. 245, 1909; E. Hart and

I. B. Huselton, *ib.*, **36**, 2082, 1914; P. L. Geiger, *Mag. Pharm.*, **8**, 199, 1824; W. A. Tilden, *Journ. Chem. Soc.*, **45**, 269, 409, 1884; E. Augé, *Compt. Rend.*, **110**, 1139, 1890; J. M. Wadmore, *Proc. Chem. Soc.*, **21**, 150, 1906; A. B. Poggiale, *Ann. Chim. Phys.*, (2), **72**, 368, 1839; (3), **8**, 467, 1843—J. Locke showed that in his published tables, A. B. Poggiale had transposed the results for ammonia- and potash-alums, *Amer. Chem. Journ.*, **20**, 581, 1898; **26**, 116, 1901; R. Brandes, *Schweigger's Journ.*, **51**, 420, 1887; L. Marino, *Gazz. Chim. Ital.*, **35**, ii, 351, 1905; F. Godefroy, *Ber.*, **9**, 1363, 1876; F. Rüdorff, *ib.*, **18**, 1160, 1885; C. Reuss, *ib.*, **17**, 2888, 1884; Earl of Berkeley, *Phil. Trans.*, **203**, A, 214, 1904; J. Locke, *Amer. Chem. Journ.*, **26**, 166, 1901; A. Fock, *Zeit. Kryst.*, **28**, 397, 1897; C. Setterburg, *Liebig's Ann.*, **211**, 104, 1882; E. von Stackelberg, *Zeit. phys. Chem.*, **20**, 337, 1896; G. J. Mulder, *Scheikundige Verhandelingen*, Rotterdam, **90**, 194, 1864; C. J. B. Karsten, *Philosophie der Chemie*, Berlin, **172**, 1843; C. von Hauer, *Sitzber. Akad. Wien*, **53**, 221, 1866; F. Pohl, *ib.*, **41**, 597, 1860; F. P. Venable, *Chem. News*, **40**, 198, 1879; J. Redtenbacher, *Journ. prakt. Chem.*, (1), **94**, 442, 1865; J. B. Richter, *Anfangsgründe der Stöchiometrie*, Breslau, **3**, 183, 1794.

¹² T. Graham, *Phil. Trans.*, **140**, 1, 1850; Earl of Berkeley, *ib.*, **203**, A, 214, 1904; J. C. G. de Marignac, *Ann. Chim. Phys.*, (5), **2**, 546, 1874; F. Rüdorff, *Ber.*, **21**, 4, 1888; A. Naumann, *ib.*, **8**, 1630, 1875; R. Willstätter, *ib.*, **36**, 1828, 1903; G. T. Gerlach, *Zeit. anal. Chem.*, **28**, 485, 1889; H. C. Jones and E. Mackay, *Amer. Chem. Journ.*, **19**, 83, 1897; A. V. E. Young, *ib.*, **8**, 23, 1886; C. L. Parsons and W. W. Evans, *Journ. Amer. Chem. Soc.*, **32**, 1378, 1910; E. Augé, *Compt. Rend.*, **110**, 1139, 1890; A. Laurent, *ib.*, **29**, 5, 1847; P. A. Schemjatschensky, *Mém. Acad. St. Petersburg*, (8), **30**, 1, 1913; K. Kraut, *Liebig's Ann. Suppl.*, **4**, 216, 1865; H. von Blücher, *Pogg. Ann.*, **50**, 541, 1840; C. Hertwig, *ib.*, **55**, 99, 1842; W. Heintz, *ib.*, **55**, 331, 1842; A. Mitscherlich, *Journ. prakt. Chem.*, (1), **83**, 474, 1861; W. F. Salm-Horstmar, *ib.*, (1), **52**, 319, 1851; J. Löwe, *Jahresb. Phys. Ges. Frankfurt*, **76**, 1859; *ib.*, (1), **79**, 428, 1860; C. R. C. Tichborne, *Chem. News*, **24**, 103, 1871; **25**, 133, 1872; O. Schumann, *Liebig's Ann.*, **187**, 307, 1877; J. B. Richter, *Anfangsgründe der Stöchiometrie*, Breslau, **2**, 269, 276, 1794; J. W. Thomas, *Journ. Chem. Soc.*, **33**, 367, 1878; R. von Wagner, *Wagner's Jahresb.*, **12**, 256, 1866; F. J. Knapp, *Dingler's Journ.*, **191**, 314, 1866; C. F. Gerhardt, *Journ. Pharm. Chim.*, (3), **12**, 65, 1847; J. Thomsen, *Thermochemische Untersuchungen*, Leipzig, **1**, 366, 1882; N. R. Dhar, K. C. Sen, and N. G. Chatterji, *Koll. Zeit.*, **33**, 29, 1923.

¹³ W. W. Paddon, *Journ. Phys. Chem.*, **26**, 790, 1922; E. Knecht, *A Manual of Dyeing*, London, **237**, 1910.

¹⁴ L. Marino, *Gazz. Chim. Ital.*, **35**, ii, 356, 1905; P. T. Cleve, *Svensk. Vet. Akad. Handl.*, **9**, 12, 31, 1885.

¹⁵ A. G. Werner, *Berg. Journ.*, **376**, 1789; A. Maus, *Pogg. Ann.*, **11**, 81, 1827; A. Breithaupt, *Vollständige Charakteristik der Mineral-Systeme*, Dresden, 1823; F. S. Beudant, *Traité de minéralogie*, Paris, **449**, 1824; R. J. Haüy, *Traité de minéralogie*, Paris, 1801; J. C. Delaméthérie, *Théorie de la terre*, Paris, **2**, 113, 1797; M. Sauvage, *Ann. Mines*, (4), **10**, 85, 1846; L. Cordier, *ib.*, (1), **4**, 205, 1819; (1), **5**, 303, 1820; H. V. Collet-Descotils, *ib.*, (1), **1**, 319, 369, 1816; P. Berthier, *ib.*, (4), **2**, 459, 1842; F. Fridau, *Liebig's Ann.*, **76**, 106, 1850; J. Gautier-Lacroze, *Compt. Rend.*, **57**, 362, 1863; A. Mitscherlich, *Journ. prakt. Chem.*, (1), **81**, 108, 1860; (1), **83**, 464, 1861; *Zeit. deut. geol. Ges.*, **14**, 254, 1862; C. Löwig, *ib.*, **8**, 247, 1856; F. Römer, *ib.*, **8**, 246, 1856; H. Bowley, *Proc. Roy. Soc. West Australia*, **7**, 48, 1921; C. F. Rammelsberg, *Handbuch der Mineralchemie*, Leipzig, **289**, 1860; H. Debray, *Bull. Soc. Chim.*, (2), **7**, 9, 867; L. F. Bley, *Journ. prakt. Chem.*, (1), **39**, 17, 1846; A. Riffault, *Ann. Chim. Phys.*, (2), **16**, 355, 1821; C. Rössler, *Zeit. anal. Chem.*, **17**, 150, 1878; W. Crum, *Journ. Chem. Soc.*, **6**, 216, 1854.

¹⁶ J. Percy, *Phil. Mag.*, (3), **36**, 103, 1850; E. F. Glockner, *Grundriss der Mineralogie*, Nürnberg, **587**, 1839; F. A. Genth, *Amer. Journ. Science*, (3), **40**, 118, 1890; A. H. Church, *Chem. News*, **13**, 85, 113, 1866; A. H. Church and R. Warrington, *Journ. Chem. Soc.*, **19**, 130, 1866; F. Pisani, *Compt. Rend.*, **65**, 1142, 1867; E. F. Glockner, *Generum et specierum mineralium secundum ordines naturales digestorum synopsis*, Halle, **298**, 1847.

¹⁷ G. Arth, *Bull. Soc. Chim.*, (3), **27**, 301, 1902; O. Rebuffat, *Gazz. Chim. Ital.*, **31**, i, 55, 1901; **32**, ii, 158, 1902; A. A. Klein and A. J. Phillips, *Trans. Amer. Cer. Soc.*, **16**, 313, 1914; *Tech. Paper Bur. Standards*, **43**, 1914; *Journ. Washington Acad.*, **4**, 573, 1914.

¹⁸ A. Hayes, *Amer. Journ. Science*, (1), **46**, 360, 1844; J. L. Smith, *ib.*, (2), **18**, 379, 1854; L. D. Gale, *ib.*, (2), **15**, 434, 1853; F. Stromeyer, *Schweigger's Journ.*, **69**, 255, 1833; *Pogg. Ann.*, **31**, 137, 1834; G. A. Kenngott, *Uebersicht der Resultate mineralogischer Forschungen*, Leipzig, **12**, 1859; R. J. Kane, *Trans. Irish Acad.*, **17**, 423, 1837; *Phil. Mag.*, (2), **8**, 495, 1836; *Ann. Chim. Phys.*, (2), **72**, 368, 1839; E. Bertrand and A. Damour, *Bull. Soc. Min.*, **4**, 135, 1881; H. How, *Journ. Chem. Soc.*, **16**, 200, 1863; J. Apjohn, *Phil. Mag.*, (3), **12**, 103, 1838; *Proc. Roy. Irish Acad.*, **1**, 51, 1839; D. L. Brackenbusch, *Las especies minerales de la republica Argentina*, Buenos Aires, **74**, 1789; C. Doelter, *Zur Kenntniss der vulcanischen Gesteine und Mineralien der capverd'schen Inseln*, Graz, **93**, 1882; E. F. Glockner, *Generum et specierum mineralium secundum ordines naturales digestorum synopsis*, Halle, **298**, 1847; C. F. Rammelsberg, *Handbuch der Mineralchemie*, Leipzig, **2**, 273, 1875; A. Frenzel, *Tschermak's Mitt.*, **303**, 1877; G. Roster, *Boll. Com. Geol.*, **302**, 1876; *Neues Jahrb. Min.*, **531**, 1877; C. Klauer, *Liebig's Ann.*, **14**, 261, 1835; E. Goldsmith, *Proc. Acad. Philadelphia*, **263**, 333, 1876; L. Darapsky, *Neues Jahrb. Min.*, **i**, 131, 1887; **i**, 49, 1890; *Verh. Ver. Santiago*, **1**, 107, 1886; H. Schulze, *ib.*, **2**, 58, 1889.

§ 21. Aluminium Carbonates

According to F. Scheermesser,¹ freshly prepared aluminium hydroxide dried in air absorbs carbon dioxide, for when the product heated to 140°, 986–1480 vols. of this gas are dislodged. P. R. Jourdain assumed that the carbon dioxide which he obtained by heating in vacuo the product of the oxidation of aluminium amalgam in air, showed that some aluminium carbonate is formed. N. T. de Saussure stated that aluminium hydroxide is partially soluble in an aq. soln. of carbonic acid, and is reprecipitated on warming the soln. or exposing it to air. *Au contraire*, C. Langlois found that if freshly precipitated aluminium hydroxide be suspended in water, it does not dissolve during the passage of carbon dioxide, but gas is absorbed by the solid.

In 1801, N. T. de Saussure stated that when an alkali carbonate is added to a soln. of an aluminium salt, the precipitate is not, as might be anticipated, **aluminium carbonate**, $\text{Al}_2(\text{CO}_3)_3$, but rather a compound of alumina with a small quantity of the alkali carbonate. J. Davy observed no difference in the effect of water, and of water sat. with carbon dioxide under press., upon alumina. J. J. Berzelius noted that the aluminium hydroxide precipitated by potassium carbonate cannot be washed free from the latter salt, and he doubted the existence of an aluminium carbonate. The effervescence with acid is attributed to presence of alkali carbonate. H. Rose found that the carbon dioxide in the precipitated carbonate corresponded with the adsorbed alkali. P. N. Raikow found freshly precipitated aluminium hydroxide does not absorb carbon dioxide, and this agrees with the measurements of the press. of carbon dioxide over aluminium hydroxide. G. Magnus pointed out that if a soln. of aluminium hydroxide in a hot soln. of potassium carbonate be cooled some aluminium hydroxide is precipitated and some is retained in soln., and can be precipitated by hydrochloric acid or by ammonium carbonate. L. F. Bley stated that either a basic carbonate or a basic double carbonate is formed when an excess of alkali carbonate acts on a soln. of alum or of aluminium sulphate. In many cases, the precipitate contains a carbonate although it is quite free from alkali carbonate. C. Langlois said with respect to the precipitate obtained by adding an alkali carbonate to an aluminium salt :

It is generally believed that this precipitate is nothing but alumina, still retaining a little alkali carbonate to which is due the effervescence with acids. . . . By washing the precipitate with a sufficient quantity of water, it can be obtained entirely free from alkaline salt, and it then continues to effervesce, which proves that a part of the alumina remains combined with carbonic acid. A very basic compound of carbonic acid and aluminium hydroxide is unquestionably produced. This compound is destroyed at a temp. which does not exceed 100°.

J. Barratt said that when an aluminium salt is precipitated by an alkaline carbonate, no aluminium carbonate is formed; but several more or less indefinite, basic aluminium carbonates have been described—by A. Gawalowsky, T. Parkman, J. S. Muspratt and J. Danson, R. Phillips, V. Urbain and M. Renoul, K. Seubert and M. Elten, W. C. Day, etc.—as precipitates when an alkali or ammonium carbonate is added to a soln. of an aluminium salt. The analyses are so discordant, that the products obtained vary in composition with the basicity of the acid contained in the aluminium salt, with the conditions under which the precipitate is formed; and with the amount of washing to which the precipitate has been subjected. The products represent different stages in the hydrolysis of aluminium carbonate, and are mixtures of the undecomposed aluminium carbonate or of a basic carbonate and the hydroxide. E. Schlumberger obtained what he regarded as $\{\text{Al}_2(\text{OH})_5\}_2\text{CO}_3 \cdot \text{H}_2\text{O}$, by the action of a large excess of sodium carbonate on aluminium salts of the monobasic acids, or of carbon dioxide on cold soln. of alkali aluminates.

L. F. Bley showed that the precipitate obtained by adding ammonium carbonate to a soln. of potash-alum often contains ammonia; H. Rose regarded it as $(\text{NH}_4)_2\text{O} \cdot \text{Al}_2\text{O}_3 \cdot 2\text{CO}_2 \cdot 4\text{H}_2\text{O}$; and M. Barth said that the precipitate obtained by

adding a soln. of aluminium chloride to an excess of a cold soln. of ammonium carbonate is a mixture of a double **ammonium aluminium carbonate** with either aluminium hydroxide or carbonate. According to C. Löwig, when a soln. of an alkali aluminate is treated with alkali hydrocarbonate or free carbon dioxide, aluminium hydroxide and alkali carbonate are formed; but by allowing the soln. of alkali aluminate to flow into a soln. of alkali hydrocarbonate, with the simultaneous introduction of carbon dioxide, a **potassium aluminium carbonate** is formed with the composition $K_2O \cdot Al_2O_3 \cdot 2CO_2 \cdot 5H_2O$ when dried at 80° . If the use of carbon dioxide be omitted, the precipitate is a hard horny mass. A. Ditte reported the basic double carbonate, $3K_2O \cdot 2Al_2O_3 \cdot 5CO_2$, to be formed when a soln. of potassium carbonate is added to one of potassium aluminate until the precipitate persists when the soln. is agitated. C. Löwig made **sodium aluminium carbonate**, $Na_2O \cdot Al_2O_3 \cdot 2CO_2 \cdot nH_2O$, by a process similar to that which he employed for the potassium salt. L. F. Bley obtained a basic double carbonate, $2Na_2O \cdot Al_2O_3 \cdot 3CO_2 \cdot 23H_2O$, by adding an excess of sodium sesquicarbonate to a boiling soln. of alum. W. C. Day also prepared this salt. The rare mineral *dawsonite*, analyzed by B. J. Harrington, G. Friedel, and M. Chaper, has a composition corresponding with $NaAl(OH)_2CO_3$, mixed with some impurities, chiefly calcite. The monoclinic crystals were examined by A. des Cloizeaux; their sp. gr. is 2.40.

According to J. H. and G. Gladstone, the hydrated aluminosilicate, *collyrite*, found at Hove (Sussex), is associated with a mineral called *hovite* containing calcium carbonate with a sufficient excess of carbon dioxide to convert all the lime into hydrocarbonate, $Ca(HCO_3)_2$, but this hypothesis is considered to be unsatisfactory in view of the known solubility of calcium hydrocarbonate and its instability in the solid state; it is therefore suggested that the excess of carbon dioxide is either combined as a hydrated **calcium aluminium carbonate**, or it replaces part of the silica in collyrite. W. C. Day believes *hovite* to be a basic calcium aluminium carbonate. C. Löwig prepared a basic **magnesium aluminium carbonate**, $2Al(OH)_3 \cdot MgCO_3$, by slowly adding a soln. of magnesium hydrocarbonate to a soln. of an alkali aluminate, or conversely. M. Crespi and E. Moles made complexes with the camphor group.

REFERENCES.

- ¹ N. T. de Saussure, *Journ. Phys.*, **52**, 290, 1801; M. Crespi and E. Moles, *Anal. Soc. Espan. Fis. Quim.*, **20**, 692, 1922; J. S. Muspratt and J. Danson, *Journ. Chem. Soc.*, **2**, 216, 1850; J. Barratt, *ib.*, **13**, 90, 1860; *Chem. News*, **1**, 110, 1860; W. C. Day, *Amer. Chem. Journ.*, **19**, 707, 1897; L. F. Bley, *Journ. prakt. Chem.*, (1), **39**, 1, 1846; R. Phillips, *Phil. Mag.*, (3), **33**, 357, 1848; H. Rose, *Pogg. Ann.*, **91**, 452, 1854; C. Langlois, *Ann. Chim. Phys.*, (3), **48**, 502, 1856; A. Gawalowsky, *Zeit. Ester. Apoth. Ver.*, **43**, 449, 1905; *Pharm. Post*, **38**, 405, 756, 1906; T. Parkman, *Amer. Journ. Science*, (3), **24**, 321, 1862; V. Urbain and M. Renoul, *Journ. Pharm. Chim.*, (4), **30**, 340, 1880; *Compt. Rend.*, **88**, 1133, 1879; A. Ditte, *ib.*, **116**, 183, 386, 1893; W. Wallace, *Chem. Gaz.*, **16**, 410, 1858; J. H. and G. Gladstone, *Phil. Mag.*, (4), **23**, 462, 1862; F. Scheermesser, *Ann. Landwirts.*, **10**, 50, 1870; M. Barth, *Liebig's Ann.*, **202**, 372, 1880; P. N. Raikow, *Chem. Ztg.*, **31**, 87, 1907; F. K. Cameron and W. O. Robinson, *Journ. Phys. Chem.*, **12**, 572, 1908; E. Schlumberger, *Bull. Soc. Chim.*, (3), **13**, 46, 1895; K. Seubert and M. Elten, *Zeit. anorg. Chem.*, **4**, 67, 1893; H. Schwarz, *Dingler's Journ.*, **166**, 283, 1862; C. Löwig, *German Pat.*, *D.R.P.* 19784, 1882; 70175, 1892; B. J. Harrington, *Canadian Nat.*, **7**, 305, 1874; (2), **10**, 84, 1881; A. des Cloizeaux, *Bull. Soc. Min.*, **1**, 8, 1878; G. Friedel, *ib.*, **4**, 28, 1881; M. Chaper, *ib.*, **4**, 155, 1881; P. R. Jourdain, *Compt. Rend.*, **150**, 1602, 1910; G. Magnus, *Pogg. Ann.*, **21**, 58, 1831; J. J. Berzelius, *Lehrbuch der Chemie*, Dresden, **2**, ii, 671, 1826; J. Davy, *Edin. Phil. Journ.*, **45**, 61, 1847.

§ 22. The Aluminium Nitrates

C. F. Wenzel¹ attempted to neutralize alumina with nitric acid, and concluded that "the ratio of alumina to the most conc. nitric acid is nearly as 349 : 240," showing that he had only partially saturated the base. Aluminium hydroxide or the metal dissolves in nitric acid and, as shown by W. F. Salm-Horstmar,

J. M. Ordway, T. B. Stillmann, etc., the acid soln. furnishes crystals of the *enneahydrate* of **aluminium nitrate**, $\text{Al}(\text{NO}_3)_3 \cdot 9\text{H}_2\text{O}$. in rhombic prisms or plates. If the soln. be evaporated, and not kept strongly acid, a tenacious gum-like mass is produced instead of crystals. J. J. Hood made a soln. of the normal nitrate by double decomposition between aluminium sulphate and potassium, ammonium, calcium, or barium nitrate. According to R. Seligman and P. Williams, when aluminium is left in contact with nitric acid of sp. gr. 1.42, at 20° , the metal slowly dissolves, and the acid becomes saturated with aluminium nitrate, which deposits in large crystals until the aluminium has all dissolved, or the acid has been exhausted. In all soln. with acid of 1.42 sp. gr., except those with carbamide, an unstable *hexahydrate*, $\text{Al}(\text{NO}_3)_3 \cdot 6\text{H}_2\text{O}$, is first formed. The hexahydrate is alone stable in nitric acid of sp. gr. 1.5, and in nitric acid of sp. gr. 1.42 it is soon transformed into the enneahydrate. It was shown qualitatively that the hexahydrate is more soluble

than the enneahydrate. M. Z. Jovitschitsch prepared crystals of the *hemipentadecahydrate*, $\text{Al}(\text{NO}_3)_3 \cdot 7\frac{1}{2}\text{H}_2\text{O}$, by the action of conc. nitric acid on calcined alumina; and R. Seligman showed that either this hydrate or an *octohydrate*, $\text{Al}(\text{NO}_3)_3 \cdot 8\text{H}_2\text{O}$, is the stable form in an acid of sp. gr. 1.46. A. Ditte also reported the formation of a *dihydrate*, $\text{Al}(\text{NO}_3)_3 \cdot 2\text{H}_2\text{O}$. In his study of the ternary system, $\text{HNO}_3 - \text{Al}(\text{NO}_3)_3 - \text{H}_2\text{O}$, at 25° , K. Inamura found only three stable hydrates. The *enneahydrate*, $\text{Al}(\text{NO}_3)_3 \cdot 9\text{H}_2\text{O}$, is stable in 73 per cent. nitric acid of sp. gr. 1.435, or more dil. acids; the *octohydrate*, $\text{Al}(\text{NO}_3)_3 \cdot 8\text{H}_2\text{O}$, is stable in 73–81 per cent. nitric acid of sp. gr.

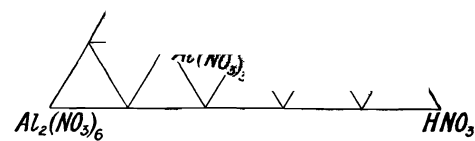

FIG. 68.—Ternary System, $\text{Al}(\text{NO}_3)_3 - \text{HNO}_3 - \text{H}_2\text{O}$, at 25° .

1.1435–1.1463; and the *hexahydrate*, $\text{Al}(\text{NO}_3)_3 \cdot 6\text{H}_2\text{O}$, is stable in nitric acid more conc. than 81 per cent. HNO_3 . The results are plotted in Fig. 68; a selection of the percentage numbers is as follows:

$\text{Al}_2(\text{NO}_3)_6$. . .	39.04	34.24	25.32	17.57	5.05	1.25	0.24	0.21
HNO_3	. . .	0.15	6.15	17.15	23.65	47.08	72.06	80.58	88.86
H_2O	. . .	60.81	59.61	57.53	53.78	47.87	26.69	19.18	10.93
Solid phase	. . .	Al(NO ₃) ₃ ·9H ₂ O				8H ₂ O		6H ₂ O	

According to A. S. Eakle, the enneahydrate deposited from soln. containing periodate, appears in thin plates belonging to the rhombic system with axial ratios $a : b : c = 0.8925 : 1 : 1.0202$; while some prismatic crystals examined by C. Soret, and belonging to the monoclinic system, had the axial ratios $a : b : c = 1.13398 : 1 : 1.91913$, and $\beta = 131^\circ 36'$ —according to N. I. Surgunoff, these monoclinic crystals are isomorphous with the corresponding ferric salt. P. W. Bridgman examined aluminium nitrate up to 12,000 kgrms. press., and at 20° , 100° , and 200° , but observed no allotropic changes. The salt decomposed into a brownish mass. K. Jauch found the sp. ht. of soln. with N eq. of aluminium nitrate per litre to be:

N	. . .	0.5	1.0	2.0	3.0	4.0	5.0
Sp. ht.	. . .	0.9563	0.9127	0.8546	0.8008	0.7504	0.7140

According to J. M. Ordway, after the enneahydrate has been heated 36 hrs. on a water-bath, there remains the eq. of $\text{Al}(\text{NO}_3)_3 \cdot 1\frac{1}{2}\text{H}_2\text{O}$. A. Ditte found that if the crystals are heated until red vapours begin to be evolved, and the residue be dissolved in monohydrated nitric acid, white needle-like crystals of hydrated aluminium nitrate appear. According to T. Schlösing, the crystals melt at 73° , and form a

colourless liquid which becomes crystalline when cooled; at 140°, aluminium hydroxide is produced, $\text{Al}(\text{OH})_3 \cdot 1\frac{1}{2}\text{H}_2\text{O}$; and at 200°–250°, said H. St. C. Deville, granular alumina remains. A method of separating alumina from lime and magnesia has been based on the fact that the nitrates of the two last-named bases resist temp. at which aluminium nitrate is decomposed. According to J. M. Ordway, a mixture of equal parts of crystals of aluminium nitrate and ammonium hydrocarbonate acts as a freezing mixture, lowering the temp. from +10.5° to –23.3°. J. R. Collins measured the ultra-red spectrum of aq. soln. of the nitrate. H. C. Jones and F. H. Getman measured the electrical conductivity and f.p. of the soln. According to H. C. Jones, the mol. electrical conductivity, μ , of soln. with a mol of the nitrate in v litres, at 0°, is:

v	.	.	4	8	32	128	512	1024	4096
μ at 0°	.	.	102.82	115.67	126.32	156.18	166.97	173.45	187.89
μ at 65°	.	.	338.6	393.6	487.3	583.9	685.9	750.5	908.2

A. Heydweiller gave the sp. gr. and electrical conductivity of soln. of aluminium nitrate. The percentage degrees of ionization, α , calculated from these data are:

v	.	.	4	8	32	128	512	1024	4096
α at 0°	.	.	54.7	61.6	72.5	83.1	88.9	92.3	100.0
α at 65°	.	.	37.3	43.4	53.6	64.3	75.5	82.6	100.0

These results are based on the assumption that no hydrolysis occurs. J. Walker and E. Aston computed that a $\frac{1}{2}N$ -soln. at 80° is hydrolyzed to the extent of 0.7 per cent. H. C. Jones also computed the temp. coeff. of the electrical conductivity of the soln.

The crystals are deliquescent in moist air. The salt dissolves readily in water and nitric acid. L. H. Milligan found the solubility of the enneahydrate in nitric acid of different conc. and temp. Representing conc. in per cent. by weight, and sp. gr. at $\theta^\circ/20^\circ$:

		0.4°–0.5°		19.8°–20°		40°		60°	
HNO_3	.	19.75	50.65	15.45	71.35	11.95	64.50	4.93	32.65
$\text{Al}(\text{NO}_3)_3$.	19.65	1.50	27.10	0.74	34.6	4.15	44.30	29.10
Sp. gr.	.	1.311	1.335	1.350	1.415	1.399	1.400	1.459	1.461

The salt is readily soluble in alcohol. W. Eidmann also found the nitrate to be soluble in acetone. The aq. soln. has an acid taste, and reddens blue litmus. According to J. J. Berzelius, aq. ammonia precipitates a gelatinous basic nitrate from the aq. soln. C. F. Hollunder stated that the aq. soln. deposits flakes of aluminium hydroxide slowly in the cold, rapidly when heated. According to L. Liechti and W. Suida, aluminium nitrate, $\text{Al}_2(\text{NO}_3)_6$, is obtained from the normal aluminium sulphate and lead nitrate, and gives the following compounds when treated with sodium hydrocarbonate: $\text{Al}_2(\text{NO}_3)_5\text{OH}$, $\text{Al}_2(\text{NO}_3)_4(\text{OH})_2$, $\text{Al}_2(\text{NO}_3)_3(\text{OH})_3$, and $\text{Al}_2(\text{NO}_3)_2(\text{OH})_4$. By continuing the addition of alkali, a gelatinous precipitate was obtained. E. Schlumberger prepared what he regarded as nitrate of the base:

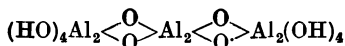

by dissolution in cold dil. nitric acid. When the soln. is evaporated to dryness, it gives a coagulum, $\text{Al}_2\text{O}_3 \cdot 14\text{H}_2\text{O} \cdot \text{HNO}_3$. N. M. Laporte prepared **potassium aluminium nitrate**, $\text{Al}(\text{NO}_3)_3 \cdot 3\text{KNO}_3 \cdot 10\text{H}_2\text{O}$, by crystallization from mixed soln. of the component salts.

REFERENCES.

- ¹ C. F. Wenzel, *Lehre von der Verwandtschaft der Körper*, Dresden, 1777; J. R. Collins, *Phys. Rev.*, (2), 20, 486, 1922; W. F. Salm-Horstmar, *Journ. prakt. Chem.*, (1), 49, 208, 1850; J. M. Ordway, *Amer. Journ. Science*, (2), 9, 30, 1850; (2), 26, 203, 1858; C. Soret, *Arch. Sciences Genève*, (3), 16, 460, 1886; A. S. Eakle, *Zeit. Kryst.*, 26, 585, 1896; M. Z. Jovitschitsch, *Monatsh.*, 33, 9, 1912; T. B. Stillmann, *Journ. Amer. Chem. Soc.*, 19, 711, 1897; L. H. Milligan, *ib.*, 44.

567, 1922; H. St. C. Deville, *Ann. Chim. Phys.*, (3), **38**, 5, 1853; A. Ditte, *ib.*, (5), **18**, 320, 1879; *Compt. Rend.*, **89**, 576, 641, 1879; L. Liechti and W. Suida, *Dingler's Journ.*, **251**, 177, 1883; T. Schlösing in L. Grandeau, *Traité d'analyse*, Paris, 105, 1877; J. Walker and E. Aston, *Journ. Chem. Soc.*, **67**, 576, 1895; R. Seligman and P. Williams, *ib.*, **109**, 612, 1916; C. F. Hollunder, *Kastner's Archiv.*, **12**, 424, 1827; J. J. Berzelius, *Lehrbuch der Chemie*, Dresden, 2, ii, 670, 1826; W. Eidmann, *Ein Beitrag zur Erkenntnis des Verhaltens chemischer Verbindungen in nichtwässrigen Lösungen*, Giessen, 1899; H. C. Jones and F. H. Getman, *Amer. Chem. Journ.*, **31**, 303, 1904; *Ber.*, **37**, 1511, 1904; H. C. Jones, *The Electrical Conductivity, Dissociation, and Temperature Coefficients of Conductivity of Aqueous Solutions of a Number of Salts and Organic Acids*, Washington, 60, 1912; E. Schlumberger, *Bull. Soc. Chim.*, (3), **13**, 59, 1895; N. I. Surgunoff, *Bull. Acad. St. Petersburg*, (6), **7**, 407, 1913; P. W. Bridgman, *Proc. Amer. Acad.*, **51**, 581, 1916; K. Inamura, *Journ. Tokyo Chem. Soc.*, **41**, 1, 1920; A. Heydweiller, *Zeit. anorg. Chem.*, **116**, 42, 1921; N. M. Laporte, *U.S. Pat. No. 1377081*, 1921; J. J. Hood, *Brit. Pat. No. 149783*, 1919; K. Jauch, *Zeit. Physik*, **4**, 441, 1920.

§ 23. The Aluminium Phosphates

Aluminium forms a number of phosphates. There is the *orthophosphate*, AlPO_4 ; the primary and secondary orthophosphates, $\text{Al}(\text{H}_2\text{PO}_4)_3$, and $\text{Al}_2(\text{HPO}_4)_3$, as well as some mixed combinations; there is also the *pyrophosphate*, $\text{Al}_4(\text{P}_2\text{O}_7)_3$, and the acid pyrophosphate, $\text{Al}_2\text{H}_6(\text{P}_2\text{O}_7)_3$; as well as the *metaphosphate*, $\text{Al}(\text{PO}_3)_3$. In addition there are a number of normal phosphates which occur native.

A. Breithaupt¹ named an apple-green mineral, which he obtained from Messbach, Voigtland, and imperfectly analyzed, *variscite*—from Variscia, an old name for Voigtland. The analyses of the variscite by T. Petersen, A. N. Chester, R. L. Packard, A. Lacroix, W. T. Schaller, and R. Helmhacker—correspond with $\text{AlPO}_4 \cdot 2\text{H}_2\text{O}$, mixed, may be, with some impurities. The mineral *kallais* of A. Damour, and A. Lacroix corresponds with $\text{AlPO}_4 \cdot 2\frac{1}{2}\text{H}_2\text{O}$, and is regarded as identical with the colloidal gel-form of variscite. According to the analyses of C. U. Shepard, J. H. Teall, and A. Carnot, *redondite* from the Island of Redonda, Antilles, etc., agrees roughly with variscite in composition, allowing for some of the alumina being replaced by ferric oxide. C. W. Blomstrand's analysis of *berlimite*, from Westana, Sweden, corresponds with $\text{AlPO}_4 \cdot \frac{1}{2}\text{H}_2\text{O}$. E. Boricky's analysis of *zepharovichite* from Trenc, Bohemia, corresponds with $\text{AlPO}_4 \cdot 3\text{H}_2\text{O}$. F. Slavik gave 1.55 for the refractive index of zepharovichite. R. Hermann, A. Kenngott, and F. A. Genth analyzed a phosphate—named *richmondite*—associated with the gibsbsite of Richmond, Mass., to which the formula $\text{AlPO}_4 \cdot 4\text{H}_2\text{O}$ has been assigned. O. Grosspietsch described a white colloidal form of aluminium phosphate from Jakubeny, Bukovina.

The aluminium phosphates have probably been formed in nature by the direct action of phosphatic soln. on igneous rocks, or on limestones containing clays. The phosphates were probably leachings from beds of guano. H. Leitmeier and H. Hellwig agitated soln. of ammonium phosphate for several months with kaolin, feldspar, etc., and obtained products similar to many of those found in nature. A. Gautier regards an earthy mineral which he named *minervite*, because it was obtained from Minerva grotte, Hérault, as an impure hemiheptahydrated aluminium orthophosphate, $\text{AlPO}_4 \cdot 3\frac{1}{2}\text{H}_2\text{O}$. Analyses by A. Carnot, and A. Lacroix make minervite appear to be a complex alkali aluminium phosphate. A. Gautier claimed also to have found crystals of minervite in the earthy mass.

A. de Schulten obtained well-defined crystals of **aluminium orthophosphate**, AlPO_4 , by heating in a sealed tube at 250° for several hours, a conc. soln. of sodium aluminate acidified with phosphoric acid. The presence of sodium phosphate seems to be necessary for the production of good crystals because if a mixture of phosphoric acid and aluminium hydroxide or chloride be heated under similar conditions, a fine crystalline powder is obtained. E. Erlenmeyer obtained a monohydrate $\text{AlPO}_4 \cdot \text{H}_2\text{O}$, by boiling in a flask fitted with a reflux condenser, aluminium dihydrophosphate with 20 times its weight of water for 4 hrs. and filtering the soln. hot. A. Gautier synthesized minervite by the action of a soln. of 3 mols of ammonium hydrophosphate on a mol of gelatinous aluminium hydroxide at 30° ; washing the product with cold water; dissolving it in hydrochloric acid; and precipitating by the addition of sodium acetate.

According to C. F. Rammelsberg, the orthophosphate is obtained as a gelatinous precipitate by adding a soln. of sodium hydrophosphate to one of alum and washing until the runnings are free from sulphates. M. Millot precipitated aluminium phosphate from a soln. of aluminium phosphate in an acid, by the addition of aq.

ammonia. N. R. Dhar and co-workers found lime is readily adsorbed by the precipitated phosphate.

H. Ludwig said that the precipitated orthophosphate does not have the composition represented by the formula AlPO_4 with $\text{Al}_2\text{O}_3 : \text{P}_2\text{O}_5$ in the ratio 1 : 1. P. Schweitzer made a similar claim, although the analyses of C. F. Rammelsberg, G. C. Wittstein, and M. Millot correspond with the 1 : 1 ratio. According to F. K. Cameron and L. A. Hurst, aluminium phosphate prepared by adding a soln. of sodium phosphate to one of aluminium phosphate, and washing the product alternately with hot and cold water until free from sulphates, contained 77.42 per cent. PO_4 and 21.49 per cent. Al—theory for AlPO_4 is 77.80 per cent. PO_4 and 22.20 per cent. Al. A phosphate was prepared by using ammonium phosphate as precipitant, and partly neutralizing the acid-liquid with ammonium carbonate; the washed product was heated over a blast-lamp. It contained 81.33 per cent. PO_4 , and 21.16 per cent. Al. Another phosphate made by precipitation with sodium phosphate from a soln. of aluminium sulphate in the presence of sodium acetate, contained 48.79 per cent. PO_4 and 19.82 per cent. Al. H. Ludwig also noted that the precipitation of aluminium phosphate from its soln. in hydrochloric acid, by the addition of sodium acetate, is highly basic. M. Millot said that the proportion of water in $\text{AlPO}_4 : \text{H}_2\text{O} = 1 : 1$; G. C. Wittstein, 1 : 4; and C. F. Rammelsberg, 1 : 4.5 if air-dried, and 1 : 3 or 4 if dried over sulphuric acid. W. J. Sell prepared **colloidal aluminium orthophosphate** sol by mixing a 5 per cent. soln. of AlCl_3 with an equal vol. of a 10 per cent. soln. of $(\text{NH}_4)_2\text{HPO}_4$, and adding aq. ammonia until the soln. smells feebly ammoniacal. The crystalloids are removed by dialysis. The soln. is neutral, and tasteless; and it can be flocculated by adding different salts. C. Elschner described the colloidal phosphate he found on Washington Island, South Seas, showing Liesegang's rings, and supposed to have been formed by the decomposition of lava by guano constituents. H. Leitmeier and H. Hellwig studied the formation of phosphates by the prolonged action of ammonium phosphate soln. on aluminophosphates.

According to W. T. Schaller, the crystals of variscite belong to the rhombic system and have the axial ratios $a : b : c = 0.8952 : 1 : 1.0957$. The salt prepared by A. de Schulten was in the form of hexagonal prisms of sp. gr. 2.59. The sp. gr. of crystalline variscite is 2.54, and of gel variscite 2.135; that of berlinite, 2.64; that of zepharovichite, 2.384 or 2.37 after subtracting 5 per cent. of free quartz; and that of richmondite, 2.20–2.38. The hardness of crystalline variscite is 4, that of gel variscite about 2; that of berlinite, the same as quartz; and that of zepharovichite, 5.5. The crystals do not lose weight at a bright red heat, and do not melt at a white heat. A. Gautier found a sample of minervite which lost 13.40 per cent. of water at 100° ; or 23.95 per cent. at 180° ; and all the water, *i.e.* 28.30 per cent., at a red heat. W. T. Schaller found that pale-green crystalline variscite lost 5.09 per cent. of water at 110° in one day, and 12.48 per cent. in 3 days; it lost 19.81 per cent. at 140° ; and 22.50 per cent. at 163° . R. Helmhacker found that gel variscite over conc. sulphuric acid, lost 16.11 per cent. of water at 100° ; 19.64 per cent. at 110° ; 23.22 per cent. at 130° ; and 26.50 per cent. at 160° . Variscite has the indices of refraction $\alpha = 1.447$, $\beta = 1.448$, $\gamma = 1.450$; the double refraction $\gamma - \alpha = 0.003$ is quite small. The mineral is pleochroic. W. T. Schaller found a green-coloured dimorphous variety of variscite which he named *lucanite*. The rhombic crystals have the axial ratios, 0.8729 : 1 : 0.9788; sp. gr., 2.566; hardness, 5; refractive indices, $\alpha = 1.546$, $\beta = 1.556$, $\gamma = 1.578$; the birefringence, $\gamma - \alpha = 0.03$, is high; and it is not pleochroic. W. W. Coblenz found that in the ultra-red transmission spectrum of variscite the water absorption bands at 1.5μ , 2μ , and 4.75μ are almost obliterated, and those at 3μ and 6μ are shifted, being probably composites. No marked evidence of a band peculiar to the PO_4 -radicle was obtained. In the ultra-red reflection spectrum there are maxima at 9.25μ and 9.7μ . The latter is not well defined and corresponds with a band found in apatite, but it is not definitely proved to be peculiar to the PO_4 -group.

J. N. von Fuchs said aluminium phosphate is insoluble in water, but F. K. Cameron and L. A. Hurst found that 35 days' shaking of three samples of aluminium phosphate resulted in the dissolution of respectively 0.241, 0.134, and 0.081 grm. of PO_4 per litre. This shows the slow soln. of phosphoric acid, and that while a greater proportion passes into soln. with increasing proportions of water to solid, the conc. of the soln. is less. With soln. of **potassium chloride** or **sulphate**, and **sodium nitrate**, the amount of phosphoric acid passing into soln. is less, as the proportion of alkali salt increases. According to G. T. Gerlach, the presence of **carbon dioxide** in the soln. has no effect on the solubility even in the presence of lime or magnesia. W. F. Sutherst said that the presence of **calcium hydroxide** increased the solubility of aluminium phosphate in aq. soln., but **calcium carbonate** has no effect whatever. A. de Schulten's crystals were insoluble in conc. **nitric acid** and **hydrochloric acid**, and were attacked with difficulty by conc. **sulphuric acid**. Variscite is insoluble in boiling hydrochloric acid, but if the mineral has been pre-heated, it is soluble in that acid. G. S. Fraps found that the calcined mineral is about 10 times more soluble in 0.2*N*-nitric acid than the ordinary mineral. J. N. von Fuchs, G. C. Wittstein, and H. Löwig commented on the solubility of precipitated aluminium phosphate in mineral acids and its low solubility in **acetic acid**. According to F. J. Otto, if a soln. of aluminium phosphate in hydrochloric acid be mixed with tartaric acid, and then with ammonia and magnesium chloride, the alumina remains in soln., and the phosphoric acid is all precipitated as ammonium magnesium phosphate. J. N. von Fuchs found that **lead acetate** precipitates part of the phosphoric acid as lead phosphate from a nearly neutral soln. of aluminium phosphate; and H. Rose, that **silver nitrate** precipitates silver phosphate from an ammoniacal soln. of aluminium phosphate. According to C. F. Rammelsberg, by adding potassium sulphate to the soln. of aluminium phosphate in sulphuric acid, nearly all the aluminium separates as crystals of alum. According to F. Sestini, a litre of 2 per cent. acetic acid dissolves 0.395 grm. of precipitated aluminium phosphate, and a litre of 10 per cent. acetic acid, 0.300 grm. The soln. does not become appreciably turbid when boiled. G. T. Gerlach found that **oxalic acid** and **citric acid** are about equally effective, and more so than acetic acid, in bringing phosphoric acid into soln., and that free aluminium hydroxide, while greatly reducing the action of acetic acid, does not affect oxalic and citric acids. According to E. A. Schneider, the solubility is increased by aluminium sulphate or chloride. Aluminium phosphate was found by M. Millot to be more readily dissolved than ferric phosphate by soln. of **ammonium oxalate** or **ammonium citrate**. E. Erlenmeyer has measured the solubility in citrate soln. Aluminium phosphate is decomposed by fused **sodium carbonate**; and when heated with **alkali sulphate**, L. Grandeau noted that crystalline alumina, and a complex alkali aluminium phosphate are formed. According to T. Schlösing, aluminium phosphate is not decomposed when heated with **carbon**, but with **iron** and **silica**, some iron phosphide is formed.

According to H. Ludwig, aluminium phosphate gives up very little phosphoric acid to aq. **ammonia**, and a little alumina passes into soln. L. L. de Koninck and A. Thiriart state that aq. ammonia dissolves aluminium phosphate only in the presence of an excess of alkali phosphate or arsenate, and that it is precipitated from the soln. by acetic acid. C. F. Rammelsberg stated that a soln. of **potassium carbonate** abstracts only part of the phosphoric acid, but L. N. Vauquelin found that with a prolonged digestion all the phosphoric acid and some alumina pass into soln. J. N. von Fuchs found that aluminium phosphate is readily dissolved by a soln. of **potassium hydroxide**, and is precipitated unchanged from that soln. by ammonium chloride; **calcium hydroxide** or **chloride**, or **barium chloride** precipitates all the phosphoric acid in the soln. as calcium or barium phosphate, while the alumina remains in soln.; and a soln. of silicic acid precipitates a double aluminium potassium silicate leaving the phosphoric acid in soln. H. Ludwig found that hydrogen

sulphide, or ammonium sulphide, precipitates an aluminium phosphate from the alkaline soln. while some phosphoric acid remains in soln. According to H. Rose, and E. Fleischer, aluminium phosphate dissolves readily in soln. of **alum, aluminium acetate**, or other **aluminium salts**; consequently, the addition of the first few drops of sodium phosphate to an aluminium salt soln. gives no precipitation. H. Rose said that the alum soln. becomes turbid when heated, and clear again on cooling. L. Liechti and W. Suida found that a soln. containing 2 mols of **aluminium sulphate** can dissolve a mol of aluminium phosphate.

A. F. de Fourcroy dissolved aluminium phosphate in phosphoric acid and obtained a sticky mass on evaporation; the product fused to a clear glass. M. Millot obtained what he regarded as hydrated **aluminium hydrophosphate**, $\text{Al}_2(\text{HPO}_3)_3 \cdot 6\frac{1}{2}\text{H}_2\text{O}$, by boiling a clear mixture of six mols of ammonium dihydrophosphate and two mols of aluminium sulphate in the presence of sulphuric acid to prevent the precipitation of aluminium hydroxide. The salt loses 3 mols. of water at 110° , and after calcination it is insoluble in acids. E. Erlenmeyer, and P. Hautefeuille and J. Margottet obtained **aluminium hydrophosphate**, $\text{Al}(\text{H}_2\text{PO}_4)_3$, by evaporating on a water-bath a soln. of a mol of normal aluminium phosphate in 11 mols of phosphoric acid. The resulting white powder contains micro-crystalline particles. The salt is soluble in a little cold water, but when a dil. soln. (1 : 20) is boiled normal aluminium phosphate is deposited. Some products are not well defined—thus, E. Erlenmeyer reported $\text{Al}_4(\text{H}_2\text{PO}_4)_2 \cdot (\text{HPO}_4)_5$; M. Millot, $\text{Al}_2(\text{H}_2\text{PO}_4)_2(\text{HPO}_4)_2 \cdot 5\text{H}_2\text{O}$; and E. Erlenmeyer, $\text{Al}_2(\text{H}_2\text{PO}_4)_4(\text{HPO}_4) \cdot 2\text{H}_2\text{O}$. B. de C. Marchand obtained soft, white, or cream-coloured aluminium phosphate of the composition $\text{Al}_2\text{O}_3 \cdot 2\text{P}_2\text{O}_5 \cdot 8\text{H}_2\text{O}$ in a deposit of bat guano at Ermelo. It is probably a colloidal adsorption product.

According to G. C. Wittstein, and H. Rose, the addition of normal sodium pyrophosphate to a soln. of aluminium chloride or of alum, precipitates white **aluminium pyrophosphate**, which dissolves in an excess of either constituent of the parent soln., and is not re-precipitated by the addition of ammonia, or ammonium sulphide, and is not soluble in acetic acid. A. Schwarzenberg's analysis corresponds with $\text{Al}_4(\text{P}_2\text{O}_7)_3 \cdot 10\text{H}_2\text{O}$, and he found that the soln. in sulphurous acid gives a precipitate on boiling. Normal aluminium pyrophosphate dissolves in aq. ammonia and alkali-lye. P. Hautefeuille and J. Margottet obtained doubly refracting needles of **aluminium hydroxyphosphate**, $\text{Al}_2\text{H}_6(\text{P}_2\text{O}_7)_3 \cdot \text{H}_2\text{O}$, by keeping a soln. of alumina in phosphoric acid, at 150° – 200° , for some time.

R. Maddrell prepared **aluminium metaphosphate**, $\text{Al}(\text{PO}_3)_3$, by evaporating to dryness a soln. of alumina in phosphoric acid, and heating the residue to 316° . F. Warschauer found aluminium metaphosphate crystallizes from aq. soln. in tetrahedra. He made the salt by gradually adding aluminium hydroxide to a soln. of phosphoric acid, and evaporating the soln. on a water-bath; P. Hautefeuille and J. Margottet, by melting alumina with four times its weight of metaphosphoric acid. The dominant form of the crystals is a combination of the cube with the octahedron, or triakisoctahedron. The faces are frequently curved. Aluminium metaphosphate crystallizes in pseudo-cubic crystals from fused metaphosphoric acid containing a small quantity of trisilver phosphate, but if the silver phosphate is present in notable proportion, birefractive crystals which act strongly on polarized light are obtained in addition to the metaphosphate. These crystals are formed exclusively by fusing 2 parts alumina with 4.6 parts metaphosphoric acid and 8 parts silver phosphate, and the same result is obtained by fusing aluminium metaphosphate with about three times its weight of silver phosphate. The double phosphate thus obtained has the composition $2\text{Al}_2\text{O}_3 \cdot \text{Ag}_2\text{O} \cdot 4\text{P}_2\text{O}_5$, and forms colourless perfectly transparent crystals derived from rhombic prisms. It is not very stable in the fused mixture, and the presence of a slight excess of metaphosphoric acid causes the formation of monoclinic crystals of aluminium pyrophosphate, $\text{Al}_2\text{O}_3 \cdot 2\text{P}_2\text{O}_5$, free from silver. The presence of an excess of silver phosphate converts the original crystals of the pyrophosphate into acute octahedrons,

apparently derived from a monoclinic prism, and having the composition $2\text{Al}_2\text{O}_3, 3\text{P}_2\text{O}_5$. The salt is insoluble in water and in acids. K. R. Johnson found the sp. gr. to be 2.779.

According to L. Liechti and W. Suida,² sodium phosphate, Na_2HPO_4 , does not produce a precipitate when treated with an excess of aluminium sulphate. They found that it requires two mols of aluminium sulphate to keep one mol of aluminium phosphate in soln. By treating a soln. of alum with sodium phosphate in excess, C. E. Munroe obtained a basic aluminium phosphate, $2\text{Al}_2\text{O}_3 \cdot \text{P}_2\text{O}_5 \cdot 8\text{H}_2\text{O}$, or **aluminium trihydroxyphosphate**, $\text{AlPO}_4 \cdot \text{Al}(\text{OH})_3 \cdot 2\frac{1}{2}\text{H}_2\text{O}$. G. C. Wittstein obtained a product with nearly the same composition by digesting normal aluminium phosphate with aq. ammonia for 24 hrs. J. N. von Fuchs, and M. Millot obtained $3\text{Al}_2\text{O}_3 \cdot 2\text{P}_2\text{O}_5 \cdot 8-12\text{H}_2\text{O}$, or **aluminium trihydroxydiphosphate**, $2\text{AlPO}_4 \cdot \text{Al}(\text{OH})_3 \cdot n\text{H}_2\text{O}$, by the action of aq. ammonia on aluminium phosphate. C. F. Rammelsberg also obtained a basic phosphate by the action of aq. ammonia on a soln. of aluminium phosphate in hydrochloric acid. These basic salts appear to be intermediate stages in the dephosphorization of aluminium phosphate. As might have been anticipated, the basic aluminium phosphates are represented in nature. The mineral *wavellite* was for a time confused with gibbsite or hydrargillite (*q.v.*). Analyses have been made by J. J. Berzelius, H. Erdmann, R. Hermann, F. L. Sonnenschein, A. H. Church, J. N. von Fuchs, G. Städelcr, F. Zambonini, F. A. Genth, F. Pisani, A. Gages, A. J. Moses and L. McL. Luquer, H. Gorceix, A. Carnot, E. F. Smith, etc. The analyses show from 1.7 to 3.6 per cent. of fluorine. C. F. Rammelsberg gives the formula $3\text{Al}_2\text{O}_3 \cdot 2\text{P}_2\text{O}_5 \cdot 12\text{H}_2\text{O}$; A. Carnot, $2(\text{Al}_2\text{O}_3 \cdot \text{P}_2\text{O}_5) \cdot \text{Al}_2(\text{O}_3, \text{F}_6) \cdot 13\text{H}_2\text{O}$; and P. Groth, $(\text{Al}(\text{OH})_3(\text{PO}_4)_2 \cdot 5\text{H}_2\text{O})$, or pentahydrated aluminium trihydroxyphosphate. The crystals are rhombic bipyramids, with $a : b : c = 0.5573 : 1 : 0.4084$, according to G. Cesaro; or $0.55725 : 1 : 0.40572$, according to H. Ungemach. The sp. gr. often determined along with the above-named analyses range from 2.33 to 2.492; F. Slavik gave 2.410, and hardness 3 to 4. The m.p. is high—F. Zambonini, F. Slavik, C. F. Plattner, and R. Cusack did not succeed in melting it; but G. Spezia fused it on its edges. F. Slavik gave 1.545 for the refractive index. A. des Cloizeaux, A. Lacroix, and G. Cesaro measured the optical constants; the double refraction is positive $\gamma - \alpha = 0.0245$. W. W. Coblenz found the ultra-red transmission spectrum showed water-bands at 1.5μ and 2μ ; but the mineral was opaque at 3μ . The mineral is soluble in acids, and in alkali-lye; and G. S. Fraps found the solubility is increased if the mineral has been calcined. B. Kosmann, and F. Cornu and A. Himmelbauer described a *lime-wavellite* which is possibly a mixture of calcium and aluminium phosphates.

The so-called *pseudo-wavellite* of F. Henrich contains 13 per cent. CaO; about one per cent. of BaO and SrO; and 2-3 per cent. of rare earths. The amorphous mineral *vashegyite* from Vashegy (Hungary), analyzed by K. Zimanyl, is represented by the formula $4\text{Al}_2\text{O}_3 \cdot 3\text{P}_2\text{O}_5 \cdot 30\text{H}_2\text{O}$. Its sp. gr. is 1.964; its hardness 2. The earthy mineral *trolleite* was analyzed by C. W. Blomstrand, and represented by the formula $4\text{Al}_2\text{O}_3 \cdot 3\text{P}_2\text{O}_5 \cdot 3\text{H}_2\text{O}$. Its sp. gr. is 3.10, and its hardness 5.5. R. Hermann's *planerite* found in the Urals, has a composition corresponding with a mixture $4(\text{Al}_5\text{P}_4\text{O}_{19} \cdot 9\text{H}_2\text{O})$, $3(\text{Cu, Fe})\text{O} \cdot \text{H}_2\text{O}$. The cryptocrystalline mineral *cœruleolactite* has a composition corresponding with $3\text{Al}_2\text{O}_3 \cdot 2\text{P}_2\text{O}_5 \cdot 10\text{H}_2\text{O}$, according to the analyses of T. Peterson, and F. A. Genth. The sp. gr. is 2.57-2.696, and the hardness 5. H. Leitmeir considers *cœruleolactite* to be a variety of planerite. C. W. Blomstrand, and G. T. Prior and L. J. Spencer analyzed the mineral *augelite*, and the latter represented it by the formula $2\text{Al}_2\text{O}_3 \cdot \text{P}_2\text{O}_5 \cdot 3\text{H}_2\text{O}$, or $\text{AlPO}_4 \cdot \text{Al}(\text{OH})_3$. The monoclinic crystals have the axial ratios $a : b : c = 1.6419 : 1 : 1.2708$ and $\beta = 67^\circ 33' 5''$; the sp. gr. is 2.696 at 22° ; the hardness is 4 to 5; and the indices of refraction $\alpha = 1.5736$, $\beta = 1.5759$, and $\gamma = 1.5877$. Water begins to be evolved at 360° . The mineral is slowly dissolved by hot conc. hydrochloric acid. The mineral *peganite*, according to the analyses of R. Hermann, and A. Breithaupt, has the composition $2\text{Al}_2\text{O}_3 \cdot \text{P}_2\text{O}_5 \cdot 6\text{H}_2\text{O}$; the crystals are rhombic bipyramids; the sp. gr. is 2.46; the hardness 3.0-3.5. L. F. Navarro and P. Castro-Barca reported a cryptocrystalline, feebly birefringent mineral occurring in yellowish-green crusts on the granite at Pontevedra, Spain. They called it *bolivarite*. Its sp. gr. is 2.05; hardness 2; and composition $\text{AlPO}_3 \cdot \text{Al}(\text{OH})_3 \cdot \text{H}_2\text{O}$. It thus resembles *peganite* very closely. R. Hermann's analysis of *fischerite* corresponds with

$2\text{Al}_2\text{O}_3 \cdot \text{P}_2\text{O}_5 \cdot 8\text{H}_2\text{O}$; the crystals are rhombic bipyramids which N. von Kokscharoff found to have the axial ratios $a : b : c = 0.5917 : 1 : -$. According to F. Cornu, and J. Krenner, the mineral also occurs in a colloidal state. E. S. Larsen showed that a colloidal form of fischerite agreed with planerite, and a fibrous form with vashegyite; while E. T. Wherry made the Ural fischerite agreed with wavellite. F. Slavik gave 1.533 for the refractive index of the colloid. The sp. gr. is 2.46; the hardness 5; and the double refraction positive. V. von Zepharovich, and F. Kovai analyzed the mineral *sphärite* from St. Benigna (Bohemia) with a composition corresponding with $5\text{Al}_2\text{O}_3 \cdot 2\text{P}_2\text{O}_5 \cdot 16\text{H}_2\text{O}$. F. Slavik gave 1.563–1.575 for the refractive index; its sp. gr. is 2.53–2.617. The analyses of the amorphous mineral *evansite* by D. Forbes, F. Becke, F. Kretschmer, H. G. Smith, F. Kovai, and W. T. Schaller correspond with the formula $3\text{Al}_2\text{O}_3 \cdot \text{P}_2\text{O}_5 \cdot 18\text{H}_2\text{O}$, or $\text{AlPO}_4 \cdot 2\text{Al}(\text{OH})_3 \cdot 6\text{H}_2\text{O}$. The sp. gr. ranges from 1.842 to 1.939; the hardness is about 3; the index of refraction 1.485. W. T. Schaller found the loss of water when progressively heated to different temp. to be 107°, 20.00 per cent.; 175°, 7.36 per cent.; 255°, 3.13 per cent.; 290°, 0.94 per cent.; dark redness, 3.90 per cent.; and before the blowpipe flame, 1.61 per cent. R. Hermann reported an aluminium phosphate from the mines at Gumeshevsk, Ural, with Al_2O_3 , 37.48 per cent.; P_2O_5 , 33.94; and H_2O , 20.93 with a number of accessory constituents. He called it *planerite*—after M. Planer. The sp. gr. was 2.65; hardness, 5; and birefringence, $\gamma - \alpha = 0.0173$. H. Leitmeier has described a crystalline and amorphous aluminium phosphate, $\text{Al}_6\text{P}_4\text{O}_{19} \cdot 18\text{H}_2\text{O}$, or planerite, from Jakubeny near Bukovina. It lost $10\text{H}_2\text{O}$ at 100°. Its index of refraction was 1.5167; and it adsorbed copper oxide from an ammoniacal soln. of cupric sulphate. O. Grosspitsch gave 1.998 for the sp. gr., and said that H. Leitmeier had got wrong with the analysis, and that the mineral is not planerite, but a mixture of $\text{Al}(\text{OH})_3 \cdot \text{P}_2\text{O}_5 \cdot \text{H}_2\text{O}$, and $\text{Al}_2\text{F}(\text{OH})\text{PO}_3 \cdot \text{H}_2\text{O}$.

L. J. Cohen³ prepared **ammonium aluminium dihydrophosphate**, $(\text{NH}_4)_2\text{H}_2\text{PO}_4 \cdot \text{AlPO}_4$, by adding a large excess of ammonium hydrophosphate, $(\text{NH}_4)_2\text{HPO}_4$, to a strongly acid soln. of aluminium chloride. The salt is partially hydrolyzed when repeatedly washed with water. J. J. Berzelius precipitated **lithium aluminium phosphate** by adding a lithium salt to a sat. soln. of aluminium phosphate in potash-lye. C. F. Rammelsberg represented its composition $2\text{Li}_3\text{PO}_4 \cdot \text{AlPO}_4 \cdot 15\text{H}_2\text{O}$. Lithium aluminium phosphate is represented in nature by the mineral *amblygonite*— $\acute{\alpha}\mu\beta\lambda\upsilon\varsigma$, blunt; $\gamma\acute{o}\nu\upsilon$, angle. L. Moissenet's *montebrasite* from Montebras, and *hebronite* from Hebron (Maine) were identified with amblygonite by C. F. Rammelsberg. Analyses were made by H. Backlund, J. J. Berzelius, C. F. Rammelsberg, L. Moissenet, F. von Kobell, F. Pisani, S. L. Penfield, W. T. Schaller, H. Lasne, etc. The best representative formula was discussed by S. L. Penfield, C. F. Rammelsberg, and H. Lasne; that most generally accepted is $\text{LiPO}_4 : \text{Al}(\text{OH}, \text{F})_3$, wherein a part of the lithium may be replaced by sodium or potassium. The mineral usually occurs in earthy masses, the crystals, according to J. D. Dana, belong to the triclinic system, and have axial ratios $a : b : c = 0.73337 : 1 : 0.76332$, and $\alpha = 108^\circ 51\frac{1}{4}'$; $\beta = 97^\circ 48\frac{1}{4}'$; and $\gamma = 106^\circ 26\frac{3}{4}'$. The sp. gr. is 3.03 to 3.07; and the hardness 6. A. Lacroix and A. Michel-Lévy, and A. des Cloizeaux examined the optical properties of the crystals—the double refraction is negative; the indices of refraction for Na-light are $\alpha = 1.579$; $\beta = 1.593$; and $\gamma = 1.597$. The mineral fuses readily before the blowpipe flame. It is readily dissolved by sulphuric acid, but less readily by hydrochloric acid.

An earthy variety called *natronamblygonite*, analyzed by W. T. Schaller, corresponds with $\text{NaPO}_4 \cdot \text{Al}(\text{OH}, \text{F})$ in which some sodium is replaced by lithium. Its sp. gr. is 3.01–3.06; and its hardness 5.5. It readily fuses; and it dissolves with difficulty in sulphuric acid. The mineral *morinite* analyzed by A. Carnot and A. Lacroix has a composition $3\text{AlPO}_4 \cdot \text{Na}_2\text{HPO}_4 \cdot 3\text{CaF}_2 \cdot 8\text{H}_2\text{O}$, or $\text{Na}_2\text{H}(\text{PO}_3)_3 \cdot (\text{AlF})_3 \cdot (\text{CaF})_3 \cdot \text{PO}_4 \cdot 8\text{H}_2\text{O}$. The crystals are monoclinic; the sp. gr. 2.94; and the hardness $4\frac{1}{2}$. A. Lacroix' *soumansite* closely resembles morinite. The *wardite* of J. M. Davidson is considered to be either $\text{Al}_2(\text{OH})_3\text{PO}_4 \cdot \frac{1}{2}\text{H}_2\text{O}$, or $\text{NaAlPO}_4 \cdot \text{Al}(\text{OH})_3 \cdot \frac{1}{2}\text{H}_2\text{O}$.

L. Ouvrard obtained thin mica-like plates of **sodium aluminium phosphate**, $\text{Na}_3\text{PO}_4 \cdot 2\text{AlPO}_4$, by cooling a sat. soln. of alumina in molten sodium pyrophosphate, and extracting the cold mass with water. The sp. gr. is 2.1 at 20°; the salt is soluble in nitric acid. C. N. Pahl obtained microscopic prisms of the composition $4\text{Na}_2\text{O} \cdot 2\text{Al}_2\text{O}_3 \cdot 5\text{P}_2\text{O}_5 \cdot 30\text{H}_2\text{O}$, or $2\text{Na}_4\text{P}_2\text{O}_7 \cdot \text{Al}_4(\text{P}_2\text{O}_7)_3 \cdot 30\text{H}_2\text{O}$, **sodium aluminium pyrophosphate**, by crystallization from a soln. of aluminium pyrophosphate in one of sodium pyrophosphate. J. F. Persoz also obtained what he

regarded as a double pyrophosphate by adding sodium pyrophosphate to a soln. of an aluminium salt. K. Wallroth, and L. Ouvrard obtained $\text{Na}_2\text{O} \cdot \text{Al}_2\text{O}_3 \cdot 2\text{P}_2\text{O}_5$, or $\text{NaPO}_3 \cdot \text{AlPO}_4$, from a soln. of alumina in molten microcosmic salt. The sp. gr. is 2.7 at 20°. In L. Grandeau's synthesis of corundum by fusing a mixture of aluminium phosphate and potassium sulphate, he obtained an indefinite potassium aluminium phosphate. L. Ouvrard dissolved alumina or aluminium phosphate in molten sodium ortho- or pyro-phosphate—preferably with some potassium chloride as well—and, on slow cooling and extraction with water, obtained lamellar crystals of potassium aluminium phosphate, $3\text{K}_2\text{O} \cdot \text{Al}_2\text{O}_3 \cdot 3\text{P}_2\text{O}_5$. The crystals are probably monoclinic, and the sp. gr. 2.3 at 20°. He also obtained monoclinic prisms of potassium aluminium pyrophosphate, $\text{K}_2\text{O} \cdot \text{Al}_2\text{O}_3 \cdot 2\text{P}_2\text{O}_5$, by slowly cooling a soln. of alumina in molten potassium metaphosphate, and extracting the mass with water. The sp. gr. is 2.8 at 20°; the crystals are insoluble in acids.

The **copper aluminium phosphates** are represented in nature by *henwoodite*, and *turquoise*. The former, found by J. H. Collins⁴ in Cornwall, has the composition $\text{CuO} \cdot 2\text{Al}_2\text{O}_3 \cdot \text{P}_2\text{O}_5 \cdot 10\text{H}_2\text{O}$; sp. gr. 2.67; and hardness, 4–4.5. The turquoise has been used as an ornament from remote antiquity; and excavations in Egypt show that it was employed in that country prior to the first dynasty—over 5500 B.C., according to W. M. F. Petrie—a time into which history does not penetrate. The name **turquoise** is French in form and means Turkish, since the gem came into Europe *via* Turkey. Theophrastus in his *Περί Λίθων* (c. 315 B.C.) mentions a copper-stained fossil ivory, which no doubt refers to what is now known as *bone turquoise*, or *odontolite*—*ὄδους*, tooth. Pliny in his *Historia naturalis* (c. 77 A.D.) refers to the *callais* which is generally regarded as greenish-blue turquoise, also to *callaina*, which may have been a greenish turquoise, and to *callaica*, which is regarded as nothing but *callaina*. There is, however, some doubt about the modern equivalents of Pliny's terms. There are numerous references to the turquoise by subsequent writers—e.g. J. D. Mylius, G. Agricola, A. B. de Boot, T. Nicols, etc. Up to the beginning of the nineteenth century, odontolite was confused with the turquoise. The early analyses by J. F. John, B. Lagrange, and G. de W. Fischer showed that the two are essentially different. Analyses by R. Hermann, A. H. Church, A. Carnot, A. Frenzel, P. Zellner, P. D. Nikolajeff, S. L. Penfield, F. W. Clarke, T. Petersen, G. T. Moore, W. T. Schaller, J. M. Curran, F. A. Genth, W. P. Blake, etc., range from :

CuO	Al ₂ O ₃	Fe ₂ O ₃	P ₂ O ₅	H ₂ O
2.02–9.00	31.6–50.75	0.21–7.8	13.93–34.89	11.86–21.0 per cent.

with FeO, 0.91–5.32; CaO, 0.13–7.93; MgO, 0–0.15; MnO, 0–0.68; SiO₂, 0–12.57 per cent. The analyses show a fairly wide range in composition due partly to faulty methods, and partly to the variations which are common to minerals in an amorphous state. There has been some discussion as to the constitution of the mineral. F. W. Clarke regards the mineral as a variable mixture of the two salts $2\text{Al}_2\text{O}_3 \cdot \text{P}_2\text{O}_5 \cdot 5\text{H}_2\text{O}$ and $2\text{CuO} \cdot \text{P}_2\text{O}_5 \cdot 4\text{H}_2\text{O}$ —or the formula becomes $\text{Al}_2\text{HPO}_4(\text{OH})_4$, coloured with the cupric phosphate. P. Groth writes the formula of an idealized turquoise, $\text{PO}_4\text{Al}_2(\text{OH})_3 \cdot \text{H}_2\text{O}$, or $\text{PO}_4\text{H}\{\text{Al}(\text{OH})_2\}_2$ in which part of the Al₂ may be replaced by Cu₃, Fe₃, or Ca₃. A. Carnot gave $(\text{Al}_2, \text{Cu}_3, \text{Fe}_3)\text{O}_3 \cdot \text{P}_2\text{O}_5 \cdot \text{Al}_2\text{O}_3 \cdot 5\text{H}_2\text{O}$. S. L. Penfield believed that the iron and copper are essential constituents of turquoise, and not impurities; and since the water is not expelled at a low temp., he assumed that the hydrogen is present as hydroxyl-groups and not as water of crystallization. He said that turquoise can be regarded as a derivative of orthophosphoric acid, H_3PO_4 , in which the hydrogen atoms are replaced by the univalent radicles $\{\text{Al}(\text{OH})_2\}'$, $\{\text{Fe}(\text{OH})_2\}'$, and $\{\text{Cu}(\text{OH})\}'$ in no fixed ratios, although the $\text{Al}(\text{OH})_2'$ radicle always predominates. This gives $\{\text{Al}(\text{OH})_2, \text{Fe}(\text{OH})_2, \text{Cu}(\text{OH}), \text{H}\}_3\text{PO}_4$ for the formula of idealized turquoise. W. T. Schaller derives the formula of triclinic turquoise from $\text{CuO} \cdot 3\text{Al}_2\text{O}_3 \cdot 2\text{P}_2\text{O}_5 \cdot 9\text{H}_2\text{O}$, isomorphous with chalcociderite, $\text{CuO} \cdot 3\text{Fe}_2\text{O}_3 \cdot 2\text{P}_2\text{O}_5 \cdot 9\text{H}_2\text{O}$; and in conformity with S. L. Penfield's arguments, he writes the formula $\text{CuOH} \cdot \{\text{Al}(\text{OH})_2\}_6\text{H}_5(\text{PO}_4)_4$. His analyses show that the radicles

$\text{Al}(\text{OH})_2$, $\text{Cu}(\text{OH})$, and H are present in the proportions 6 : 1 : 5. According to M. Bauer, and N. Heaton, imitations of the turquoise are made by subjecting to hydraulic press. for a long period, freshly precipitated and moist mixtures of precipitated aluminium phosphate and copper phosphate. The synthetic turquoise is very difficult to distinguish from the mineral.

The colour of turquoise ranges from a fine sky-blue to an unsightly green; the most approved tint for the gem-stone is the so-called sky-blue or robin's egg blue. Comparatively few stones are free from the green tinge and the value usually lessens as the green tinge predominates. In some cases, there are inclusions of foreign matter—limonite, quartz, vein matter, etc.—and if an appreciable amount is present, the material is called *turquoise matrix*. The colour of turquoise is due to copper, tinted more or less with iron. H. Bücking said the colour is due to copper phosphates; G. T. Moore, to a copper aluminate; and F. W. Clarke, to a hydrated copper phosphate. S. L. Penfield, and W. T. Schaller have shown that the colour is more probably due to the presence of copper as an integral part of the molecule. The colours of some samples of turquoise fade soon after the mineral has been mined; other samples retain a good colour for an indefinitely long period. The cause of the alteration in colour is not known, although it has been attributed to a spontaneous dehydration of the molecule. W. T. Schaller noticed that crystallized turquoise retained its colour up to 200° ; while H. Bücking noted a change in colour at the temp. of molten Canada balsam as used in the preparation of microscopic slides. Turquoise occurs massive; a crystalline specimen was identified in 1911. W. T. Schaller found that the crystals belong to the triclinic system with axial ratios $a : b : c = 0.7910 : 1 : 0.6051$, and $\alpha = 92^\circ 58'$; $\beta = 93^\circ 30'$; and $\gamma = 107^\circ 41'$. The crystals are transparent and pleochroic. Microscopic studies have been made by G. de W. Fischer, H. Bücking, W. T. Schaller, B. Silliman, G. T. Moore and V. von Zepharovich, F. W. Clarke and J. S. Diller, S. L. Penfield, D. W. Johnson, etc. In general, a thin slice of the mineral under the microscope appears as a confused mass of irregular grains with a high index of refraction. In some cases, there is a fibrous texture. The sp. gr. of turquoise usually ranges from 2.60–2.88, although A. Frenzel found a sample having a sp. gr. 2.39; and W. P. Blake, one of 2.426. Turquoise is soft in comparison with other gem-stones; its hardness varies a little, usually about 6, the same as felspar. It is rather brittle. H. Bücking found that when blue turquoise is heated, it first becomes green and blackens, and finally assumes a dark brown colour. Unlike glassy imitations, which fused quietly when heated in a crucible or with the tip of a blowpipe flame, natural turquoise decrepitates or crumbles with a crackling sound when heated. W. T. Schaller found that blue crystalline turquoise can be heated to 200° without changing its colour, but between 200° and 400° most of the water is given off; all the water is lost at 600° , and the colour is then green; at higher temp., the colour is brown. G. T. Moore and V. von Zepharovich found the loss of water at different temp. to be:

	180°	c. 530°	c. 570°	c. 740°	c. 830°	c. 1200°
Loss H_2O . . .	2.57	16.72	0.10	0.13	0.22	0.35 per cent.
Colour		Browning begins			Chocolate brown	

The total loss of water was 20.09 per cent. R. Cusack gave 1500° for the m.p. W. T. Schaller found the indices of refraction of the crystals to be $\alpha = 1.61$, $\gamma = 1.65$; the double refraction is strong. Massive turquoise is also doubly refracting. A. Lacroix gave for the mean index of refraction 1.63. W. W. Coblenz found the mineral not sufficiently transparent to the ultra-red rays to show unequivocally the water-band at 3μ . There are small maxima in the ultra-red transmission spectrum at 3.3μ , 5.1μ , 5.3μ , 5.6μ , 6.3μ , and 7.6μ . No bands belonging to the PO_4 -radicle could be identified. A. Buguet and A. Gascard, and C. Doelter found that turquoise is slightly transparent to X-rays. According to S. L. Penfield, powdered turquoise is only partially dissolved when heated in a sealed tube with hydrochloric acid, and the residue retains its blue colour; he hence infers that the colouring

agent is chemically combined as an integral part of the mineral. M. Bauer said that the action of nitric acid on turquoise varies. In some cases, the mineral dissolves, but in other cases, the colouring matter is destroyed. W. T. Schaller found crystalline turquoise is not soluble in boiling hydrochloric acid, but it is soluble if the mineral has been heated until it is brown. P. Hautefeuille and J. Margottet melted a mixture of alumina, metaphosphoric acid, and silver phosphate, and obtained colourless, doubly refracting, rhombic, prismatic crystals of **silver aluminium phosphate**, $2\text{Al}_2\text{O}_3 \cdot \text{Ag}_2\text{O} \cdot 4\text{P}_2\text{O}_5$.

The **calcium aluminium phosphates** are represented by a number of minerals. Thus, according to the analysis of A. H. Church,⁵ *tavistockite*, from Tavistock (Devonshire), has a composition approaching $\text{Ca}_3(\text{PO}_4)_2 \cdot 2\text{Al}(\text{OH})_3$, or $3\text{CaO} \cdot \text{Al}_2\text{O}_3 \cdot \text{P}_2\text{O}_5 \cdot 3\text{H}_2\text{O}$.

The *amphithalite* of L. J. Ingelström is less calcareous; the *cirrolite* of C. W. Blomstrand approximates $5\text{CaO} \cdot 3\text{P}_2\text{O}_5 \cdot 2\text{Al}_2\text{O}_3 \cdot 3\text{H}_2\text{O}$. There are a number of minerals with mixed bases in place of lime. For instance, the *jezekite* of F. Slavik occurs in monoclinic crystals with axial ratios $a : b : c = 0.8959 : 1 : 1.0241$, and $\beta = 105^\circ 31'5''$. Its composition approximates $\text{Al}_2\text{O}_3 \cdot \text{CaO} \cdot \text{P}_2\text{O}_5 \cdot 2(\text{Na}, \text{Li})\text{F} \cdot 2(\text{Na}, \text{Li})\text{OH}$; its sp. gr. is 2.940; its hardness $4\frac{1}{2}$; its indices of refraction $\alpha = 1.55$, $\beta = 1.56$, $\gamma = 1.59$. F. Slavik's mineral, *lacroixite*, has a composition corresponding with $8(\text{Ca}, \text{Mn})\text{O} \cdot 3\text{Al}_2\text{O}_3 \cdot 3\text{P}_2\text{O}_5 \cdot 8\text{Na}(\text{F}, \text{OH}) \cdot 4\text{H}_2\text{O}$, and occurs in monoclinic crystals with $a : b : c = 0.82 : 1 : 1.60$; the sp. gr. is 3.126; the hardness, 4.5; and the mean index of refraction 1.57. C. W. Blomstrand's *attakolite* has the composition $6(\text{Ca}, \text{Mn})\text{O} \cdot 4\text{P}_2\text{O}_5 \cdot 5\text{Al}_2\text{O}_3 \cdot 6\text{H}_2\text{O}$. The sp. gr. is 3.09; and the hardness 5. F. Slavik's *roscherite* has the composition $3\text{CaO} \cdot 2\text{FeO} \cdot 3\text{MnO} \cdot 2\text{Al}_2\text{O}_3 \cdot 4\text{P}_2\text{O}_5 \cdot 10\text{H}_2\text{O}$, or $\text{R}''_2\text{Al}(\text{OH})(\text{PO}_4)_2 \cdot 2\text{H}_2\text{O}$. It forms monoclinic crystals with $a : b : c = 0.94 : 1 : 0.88$, and $\beta = 99^\circ 50'$; sp. gr., 2.916; hardness, 4.5; and high negative double refraction. In the *eosphorite* of G. J. Brush and E. S. Dana, the composition approximates $2\text{RO} \cdot \text{P}_2\text{O}_5 \cdot \text{Al}_2\text{O}_3 \cdot 4\text{H}_2\text{O}$, where R denotes Mn and Fe, with a little Ca and Na. The crystals are rhombic bipyramids with $a : b : c = 0.7768 : 1 : 0.51502$; its sp. gr. is 3.3; and the hardness 5. The composition of the mineral *childrenite*, analyzed by C. F. Rammelsberg, and A. H. Church, approximates $2\text{R}''\text{O} \cdot \text{Al}_2\text{O}_3 \cdot \text{P}_2\text{O}_5 \cdot 4\text{H}_2\text{O}$, analogous, according to S. L. Penfield, with eosphorite, only the manganous oxide in childrenite is nearly one-third that in eosphorite. The rhombic crystals, according to W. H. Miller, have the axial ratios $a : b : c = 0.77801 : 1 : 0.52575$; the sp. gr. is $3.22\text{--}3.247$; and the hardness 4.5–5. J. Drugman examined these two minerals. According to the analyses of L. J. Ingelström, and C. W. Blomstrand, the mineral *tearagophosphate* has a composition corresponding with $3(\text{Fe}, \text{Mn}, \text{Mg}, \text{Ca})\text{O} \cdot 3\text{Al}_2\text{O}_3 \cdot 2\text{P}_2\text{O}_5 \cdot 3\text{H}_2\text{O}$; and, according to the former, *gersbyite* has the composition $3\text{RO} \cdot 9\text{Al}_2\text{O}_3 \cdot 4\text{P}_2\text{O}_5 \cdot 17\text{H}_2\text{O}$, where R denotes Fe, Mg, Ca, and Mn. In 1854, L. J. Ingelström reported rhombohedral crystals of a mineral *svanbergite*, whose analysis corresponded with $3\text{CaO} \cdot 3\text{Al}_2\text{O}_3 \cdot 2\text{SO}_3 \cdot \text{P}_2\text{O}_5 \cdot 6\text{H}_2\text{O}$, **calcium aluminium sulphatophosphate**. Its sp. gr. was 3.29; and hardness 6. The mineral *lazulite* with the higher proportions of calcium—say 3 per cent. CaO—has been called *calcium-lazulite*. T. L. Watson found a specimen corresponding with $(\text{Fe}, \text{Mg}, \text{Ca})\text{O} \cdot \text{Al}_2\text{O}_3 \cdot \text{P}_2\text{O}_5 \cdot \text{H}_2\text{O}$ on Graves Mountain, Georgia.

The mineral *hamlinite*, or *boumanite*, is the natural representative of **strontium aluminium pyrophosphate**, and the analyses of S. L. Penfield,⁶ and H. L. Bowman correspond with $\{\text{Al}(\text{OH})_2\}_3(\text{SrOH})\text{P}_2\text{O}_7$, or $2\text{SrO} \cdot 3\text{Al}_2\text{O}_3 \cdot 2\text{P}_2\text{O}_5 \cdot 7\text{H}_2\text{O}$, where Sr represents strontium with about one-seventh barium. It has been described by R. H. Solly, E. Hussak, and B. Jezek. According to the latter, the crystals are ditrigonal with $a : c = 1 : 1.18504$; sp. gr. $3.159\text{--}3.283$; hardness, 4.5; indices of refraction, $\epsilon = 1.63870$, and $\omega = 1.62945$; the double refraction is positive. The mineral *goyazite* of A. Damour was shown by W. T. Schaller, and E. Hussak to be probably the same as hamlinite. The mineral *gorceixite* of E. Hussak is a **barium aluminium phosphate**, $\text{Ba}(\text{Ca}, \text{Sr}, \text{Ce})\text{O} \cdot 2\text{Al}_2\text{O}_3 \cdot \text{P}_2\text{O}_5 \cdot 5\text{H}_2\text{O}$. It was analyzed by H. Gorceix, A. Damour, and E. Boutan. The sp. gr. is $3.036\text{--}3.123$.

The mineral *lazulite* is a **magnesium aluminium phosphate**. It has also been called *false lapis lazuli*, *klaprothite*, *blue spar*, *mountain blue*, *natural smalt*, *blue felspar*, *mollite*, *voraulite*, etc. Analyses by C. F. Rammelsberg,⁷ J. N. von Fuchs, J. L. Smith and G. J. Brush, R. Brandes, L. J. Ingelström, C. W. Blomstrand, J. Gamper, and A. Lacroix correspond with $2\text{R}_3(\text{PO}_4)_2 \cdot 3\text{Al}_2(\text{PO}_4)_3 \cdot 2\text{H}_6\text{Al}_2\text{O}_6$, or, according to P. Groth, $(\text{Mg}, \text{Fe}, \text{Ca})(\text{PO}_4)_2(\text{AlOH})_2$. The crystals, according to K. Prüfer, are monoclinic prisms with the axial ratios $a : b : c = 0.97496 : 1 : 1.6483$,

and $\beta=89^{\circ} 13\frac{3}{4}'$; the sp. gr. is 2.78–3.122; the hardness, 5–6; and, according to A. Michel-Lévy and A. Lacroix, the indices of refraction are $\alpha=1.603$, $\beta=1.632$, and $\gamma=1.639$. The optical properties were investigated by A. von Lasaulx. W. W. Coblenz found a large water-band at 3μ in the ultra-red transmission spectrum of lazulite. There is also a band at 4.3μ . The amorphous mineral *kehoite* from Kehoeit (Lawrence Co.) is a **zinc aluminium phosphate**, which, according to the analysis of W. P. Headden, has the composition $2(\text{Al}_2\text{P}_2\text{O}_5 \cdot 9\text{H}_2\text{O}) \cdot 2\text{Al}_2(\text{OH})_6 \cdot \text{Zn}_3\text{P}_2\text{O}_8 \cdot 3\text{H}_2\text{O}$.

REFERENCES.

- ¹ A. de Schulten, *Compt. Rend.*, **98**, 1583, 1884; M. Millot, *ib.*, **82**, 89, 1876; *Bull. Soc. Chim.*, (2), **22**, 244, 1874; (2), **26**, 267, 1876; A. Gautier, *Compt. Rend.*, **116**, 1271, 1491, 1893; **121**, 151, 1895; *Bull. Soc. Chim.*, (3), **9**, 884, 1893; *Ann. Mines*, (9), **5**, 1, 1894; A. Carnot, *ib.*, (9), **8**, 319, 1895; A. Lacroix, *Bull. Soc. Min.*, **33**, 35, 1910; T. Schlösing in L. Grandeaun, *Traité d'analyse*, Paris, 70, 1877; L. Grandeaun, *Compt. Rend.*, **95**, 921, 1883; **100**, 1134, 1885; P. Hautefeuille and J. Margottet, *ib.*, **96**, 860, 1883; **106**, 136, 1888; W. J. Sell, *Proc. Cambridge Phil. Soc.*, **12**, 388, 1904; H. Ludwig, *Arch. Pharm.*, (2), **59**, 19, 1849; C. F. Rammelsberg, *Pogg. Ann.*, **64**, 251, 405, 1845; H. Rose, *ib.*, **76**, 16, 1849; G. C. Wittstein, *Repert. Pharm.*, (2), **13**, 224, 1838; (2), **14**, 332, 1838; J. N. von Fuchs, *Schweigger's Journ.*, **24**, 123, 1818; L. N. Vauquelin, *Quart. Journ. Science*, **15**, 168, 1823; *Ann. Chim. Phys.*, (1), **96**, 213, 1815; (2), **21**, 188, 1822; E. Erlenmeyer, *Ber.*, **14**, 1869, 1881; *Liebig's Ann.*, **194**, 196, 1878; A. Schwarzenberg, *ib.*, **65**, 147, 1849; B. de C. Marchand, *South African Journ. Science*, **15**, 638, 1918; E. Fleischer, *Zeit. anal. Chem.*, **6**, 28, 1867; L. L. de Koninck and A. Thiriart, *ib.*, **20**, 90, 1881; W. C. Young, *Analyst*, **15**, 61, 83, 1890; F. Sestini, *Gazz. Chim. Ital.*, **20**, 313, 1890; L. Liechti and W. Suida, *Mitt. tech. Museum Wien*, **1**, 3, 1893; K. R. Johnson, *Ber.*, **22**, 976, 1889; P. Schweitzer, *ib.*, **3**, 310, 1870; R. Maddrell, *Journ. Chem. Soc.*, **3**, 273, 1851; *Phil. Mag.*, (3), **30**, 322, 1847; F. K. Cameron and L. A. Hurst, *Journ. Amer. Chem. Soc.*, **26**, 885, 1904; G. T. Gerlach, *Landw. Ver. Stat.*, **46**, 201, 1895; E. A. Schneider, *Zeit. anorg. Chem.*, **8**, 87, 1894; F. J. Otto, *Schweigger's Journ.*, **66**, 288, 1832; **67**, 148, 1833; A. F. de Fourcroy, *Annal. Paris Nat. Hist. Museum*, **1**, 25, 1803; W. F. Sutherst, *Chem. News*, **85**, 157, 1902; *Agric. Gaz.*, **55**, 204, 1902; A. Lacroix, *Minéralogie de la France et de ses colonies*, Paris, **4**, 480, 1910; *Bull. Soc. Min.*, **28**, 15, 1905; O. Grosspietsch, *Verh. Geol. Reichsanst. Wien*, **149**, 1919; F. Slavik, *Rozprawy Ceske Akad.*, **26**, 60, 1917; *Bull. Acad. Bohême*, **22**, 32, 1918; W. W. Coblenz, *Investigations of Infra-red Spectra*, Washington, **3**, 30, 1906; **4**, 90, 1906; C. Elschner, *Koll. Zeit.*, **31**, 94, 1922; H. Leitmeier and H. Hellwig, *Doelter's Festschrift*, **41**, 1920; R. Helmhacker, *Tschermak's Mitt.*, (2), **2**, 247, 1880; W. T. Schaller, *Bull. U.S. Geol. Sur.*, **509**, 67, 1912; **610**, 56, 69, 1919; *Zeit. Kryst.*, **50**, 334, 1912; F. A. Genth, *ib.*, **13**, 393, 1891; A. Kenngott, *Zürich Vierteljahr.*, **11**, 225, 1866; T. Petersen, *Neues Jahrb. Min.*, **537**, 1871; F. Warschauer, *Zeit. anorg. Chem.*, **36**, 137, 1903; A. N. Chester, *Amer. Journ. Science*, (3), **13**, 295, 1877; R. L. Packard, *ib.*, (3), **47**, 297, 1894; A. Damour, *Compt. Rend.*, **59**, 936, 1864; A. Breithaupt, *Journ. prakt. Chem.*, (1), **10**, 506, 1837; C. W. Blomstrand, *ib.*, (1), **105**, 338, 1868; R. Hermann, *ib.*, (1), **40**, 32, 1847; *Bull. Soc. Moscow*, **4**, 496, 1868; G. S. Fraps, *Journ. Ind. Eng. Chem.*, **3**, 335, 1911; E. Boricky, *Sitzber. Akad. Wien*, **59**, 593, 1869; C. U. Shepard, *Amer. Journ. Science*, (2), **47**, 428, 1869; J. H. Teall, *Journ. Geol. Soc.*, **54**, 230, 1898; N. R. Dhar, K. C. Sen, and N. G. Chatterji, *Koll. Zeit.*, **33**, 29, 1923.
- ² K. Zimanyl, *Math. Term. Artesite*, **27**, 64, 1909; C. W. Blomstrand, *Journ. prakt. Chem.*, (1), **105**, 338, 1868; R. Hermann, *ib.*, (1), **33**, 286, 1844; (1), **88**, 193, 1863; (1), **106**, 69, 1869; F. L. Sonnenschein, *ib.*, (1), **53**, 344, 1851; J. N. von Fuchs, *Schweigger's Journ.*, **24**, 121, 1818; H. Erdmann, *ib.*, **69**, 154, 1833; J. J. Berzelius, *ib.*, **27**, 63, 1819; G. Städeler, *Liebig's Ann.*, **109**, 305, 1859; C. E. Munroe, *Amer. Journ. Science*, (3), **1**, 329, 1871; A. H. Church, *Journ. Chem. Soc.*, **26**, 110, 1873; L. Liechti and W. Suida, *Dingler's Journ.*, **251**, 177, 1883; F. Pisani, *Compt. Rend.*, **75**, 79, 1872; A. Carnot, *ib.*, **118**, 995, 1894; M. Millot, *Compt. Rend.*, **82**, 89, 1876; F. A. Genth, *Amer. Journ. Science*, (2), **23**, 423, 1857; *On the Mineralogy of Pennsylvania*, Harrisburg, **143**, 1875; F. Zambonini, *Atti Accad. Lincei*, (5), **11**, i, 123, 1902; A. J. Moses and L. Mod. Luquer, *School Mines Quart.*, **8**, 236, 1892; H. Gorceix, *Bull. Soc. Min.*, **6**, 27, 1883; A. Lacroix, *ib.*, **9**, 4, 1886; H. Ungemach, *ib.*, **35**, 537, 1912; E. F. Smith, *Amer. Chem. Journ.*, **5**, 272, 1883; C. F. Rammelsberg, *Handbuch der Mineralchemie*, Leipzig, **319**, 1875; *Pogg. Ann.*, **64**, 405, 1845; F. Slavik, *Rozprawy Ceske Akad.*, **26**, 60, 1917; *Bull. Acad. Bohême*, **22**, 32, 1918; *Zeit. Kryst.*, **39**, 298, 1903; W. T. Schaller, *ib.*, **44**, 5, 1907; G. C. Wittstein, *Repert. Pharm.*, (2), **14**, 332, 1838; A. des Cloizeaux, *Ann. Chim. Phys.*, (4), **27**, 405, 1872; F. Kretschmer, *Jahrb. Geol. Reichsanst. Wien*, **52**, 421, 1902; F. Becke, *Tschermak's Mitt.*, (2), **1**, 465, 1878; G. Csaro, *Mem. Acad. Bruxelles*, **53**, 136, 1897; V. von Zepharovich, *Sitzber. Akad. Wien*, **56**, 27, 1867; C. F. Plattner, *Probirkunst mit dem Löthrohre*, Leipzig, **214**, 1907; G. Spezia, *Atti Accad. Torino*, **22**, 419, 1887; R. Cusack, *Proc. Roy. Irish Acad.*, **4**, 399, 1897; G. S. Fraps, *Journ. Ind. Eng. Chem.*, **3**, 335, 1911; F. Cornu and A. Himmelbauer, *Neues Jahrb. Min.*, ii, **173**, 1906; A. Gages, *Journ. Geol. Soc. Dublin*, **8**, 73, 1858; P. Groth, *Tabellarische Uebersicht der Mineralien*, Braunschweig, 1898; B. Kosmann, *Zeit. deut. geol. Ges.*, **21**, 802, 1869; T. Petersen, *Neues Jahrb. Min.*, **355**, 1871; A. Breithaupt, *ib.*, **819**, 1872; L. F. Navarro and P. Castro-Barca, *Bol. Soc. Espanola*

Hist. Nat., 21. 326, 1921; F. Henrich, *Ber.*, 55. B, 3013, 1922; W. W. Coblenz, *Investigations of Infra-red Spectra*, Washington, 30, 1906; C. T. Prior and L. J. Spencer, *Min. Mag.*, 11. 16, 1895; L. J. Spencer, *ib.*, 12. 1, 1897; F. Cornu, *Zeit. Koll.*, 4. 15, 1909; J. Krenner, *Föld. Ertesito*, 3. 78, 1882; N. von Kokscharoff, *Contributions to the Mineralogy of Russia*, St. Petersburg, 1. 31, 1853; F. Kovai, *Abhand. Akad. Böhm.*, 15, 1896; D. Forbes, *Phil. Mag.*, (4), 28. 341, 1864; H. G. Smith, *Proc. Roy. Soc. N.S.W.*, 27. 382, 1893; E. S. Larsen, *Amer. Min.*, 2. 31, 1917; E. T. Wherry, *ib.*, 2. 32, 1917; H. Leitmeier, *Zeit. Kryst.*, 55. 353, 1916; O. Grosspietsch, *Verh. Geol. Reichsanst. Wien*, 149, 1919; R. Hermann, *Bull. Soc. Nat. Moscou*, 35. 240, 1862.

³ L. J. Cohen, *Journ. Amer. Chem. Soc.*, 29. 714, 1907; C. F. Rammelsberg, *Handbuch der Mineralchemie*, Leipzig, 309, 1875; *Pogg. Ann.*, 64. 251, 405, 1845; *Neues Jahrb. Min.*, i, 15, 1883; L. Moissenet, *Compt. Rend.*, 73. 327, 1871; F. Pisani, *ib.*, 73. 1479, 1871; A. des Cloizeaux, *ib.*, 57. 357, 1863; H. Lasne, *ib.*, 132. 1191, 1901; A. Lacroix and A. Michel-Lévy, *ib.*, 106. 777, 1888; *Les minéraux des roches*, Paris, 1888; J. J. Berzelius, *Gilbert's Ann.*, 65. 321, 1820; F. von Kobell, *Sitzber. Akad. München*, 2. 284, 1872; S. L. Penfield, *Chem. News*, 40. 208, 1879; *Amer. Journ. Science*, (3), 18. 296, 1879; W. T. Schaller, *ib.*, (4), 17. 191, 1904; *Zeit. Kryst.*, 49. 235, 1911; J. D. Dana, *A System of Mineralogy*, London, 781, 1892; A. Carnot and A. Lacroix, *Bull. Soc. Min.*, 31. 150, 1908; A. Lacroix, *Minéralogie de la France et de ses colonies*, Paris, 4. 542, 1910; L. Ouvrard, *Ann. Chim. Phys.*, (6), 16. 336, 1889; L. Grandeau, *ib.*, (6), 8. 207, 1886; C. N. Pahl, *Bull. Soc. Chim.*, (2), 22. 122, 1874; K. Wallroth, *ib.*, (2), 39. 319, 1883; J. F. Persoz, *Liebig's Ann.*, 65. 170, 1847; A. Gautier, *Ann. Mines*, (9), 5. 1, 1895; A. Carnot, *ib.*, (9), 8. 319, 1895; *Compt. Rend.*, 121. 151, 1895. F. Zambonini, *Zeit. Kryst.*, 42. 87, 1906; E. Casoria, *Ann. Scuola Agric. Portici*, 6, 1904; J. M. Davidson, *Amer. Journ. Science*, (4), 2. 154, 1896; J. Hector, *Juror's Rep. N.Z. Exhib.*, 423, 1865; H. Backlund, *Geol. För. Förh. Stockholm*, 40. 757, 1918.

⁴ J. H. Collins, *Min. Mag.*, 1. 13, 1876; W. M. F. Petrie, *Researches in Sinai*, London, 280, 1906; J. D. Mylius, *Opus medico-chymicum*, Francofurti, 360, 1618; G. Agricola, *De natura fossilium*, Basil, 1657; A. B. de Boot, *Gemmarum et lapidum historia*, Lugduni Batavorum, 1647; T. Nicols, *Arcula gemmea*, London, 1653; J. F. John, *Bull. Scient. Nat.*, 440, 1827; *Gehlen's Journ.*, 3. 93, 1807; *Mém. Soc. Imp. Nat. Moscou*, 1. 131, 1806; G. de W. Fischer, *ib.*, 1. 140, 1806; *Essai sur la turquoise et sur la calcite*, Moscou, 1810; B. Lagrange, *Ann. Chim. Phys.*, (1), 59. 180, 1806; P. Hautefeuille and J. Margottet, *Compt. Rend.*, 96. 849, 1883; A. Carnot, *ib.*, 118. 995, 1894; *Ann. Mines*, (9), 8. 324, 1895; *Bull. Soc. Min.*, 18. 119, 1895; R. Hermann, *Journ. prakt. Chem.*, (1), 33. 282, 1844; A. H. Church, *Chem. News*, 10. 290, 1864; A. Frenzel, *Tschermak's Mitt.*, (2), 5. 184, 1883; W. W. Coblenz, *Investigations of Infra-red Spectra*, Washington, 3. 42, 1906; P. D. Nikolajeff, *Proc. Russ. Min. Soc.*, 20. 10, 1885; S. L. Penfield, *Zeit. Kryst.*, 33. 542, 1900; *Amer. Journ. Science*, (4), 10. 346, 1900; G. F. Kunz, *ib.*, (3), 30. 275, 1885; W. P. Blake, *ib.*, (3), 25. 197, 1883; F. W. Clarke and J. S. Diller, *ib.*, (3), 32. 211, 1886; B. Silliman, *ib.*, (3), 22. 70, 1881; F. A. Genth, *ib.*, (3), 40. 115, 1890; T. Petersen, *Jahresb. Phys. Ver. Frankfurt a.M.*, 4. 1898, 1897; G. T. Moore, *Zeit. Kryst.*, 16. 247, 1885; G. T. Moore and V. von Zepharovich, *ib.*, 10. 248, 1885; W. T. Schaller, *ib.*, 50. 123, 1912; H. Bücking, *ib.*, 2. 163, 1878; 10. 245, 1885; *Neues Jahrb. Min.*, 655, 1878; C. Doelter, *ib.*, ii, 94, 1896; N. Heaton, *Journ. Roy. Soc. Arts*, 59. 584, 1911; J. M. Curran, *Proc. Roy. Soc. N.S.W.*, 30. 252, 1897; P. Groth, *Tabellarische Uebersicht der Mineralien*, Braunschweig, 1898; M. Bauer, *Zeit. angew. Chem.*, 22. 2177, 1909; *Edelsteinkunde*, Leipzig, 486, 1909; A. Buguet and A. Gascard, *Compt. Rend.*, 122. 457, 1896; R. Cusack, *Proc. Roy. Irish Acad.*, (3), 4. 399, 1898; A. Lacroix, *Minéralogie de la France et de ses colonies*, Paris, 4. 529, 1910; D. W. Johnson, *School Mines Quart.*, 24. 493, 1903; J. E. Pogue, *The Turquoise*, Washington, 1915; P. Zellner, *Ists*, 637, 1834.

⁵ A. H. Church, *Journ. Chem. Soc.*, 18. 263, 1865; 26. 103, 1873; L. J. Ingelström, *Zeit. Kryst.*, 25. 435, 1896; 28. 311, 1897; *Cēfvers. Akad. Förh. Stockholm*, 11. 156, 1854; 23. 93, 1866; C. W. Blomstrand, *ib.*, 25. 197, 1868; F. Slavik, *Abhand. Akad. Böhm.*, 4, 1914; G. J. Brush and E. S. Dana, *Amer. Journ. Science*, (3), 16. 35, 1878; (3), 18. 47, 1879; W. H. Miller, *Introduction to Mineralogy*, London, 519, 1852; S. L. Penfield, *Amer. Journ. Science*, (3), 19. 315, 1880; C. F. Rammelsberg, *Pogg. Ann.*, 85. 435, 1852; T. L. Watson, *Journ. Washington Akad. Science*, 11. 386, 1921; J. Drugman, *Min. Mag.*, 17. 193, 1915.

⁶ R. H. Solly, *Min. Mag.*, 14. 80, 1905; H. L. Bowman, *ib.*, 14. 390, 1907; B. Jezek, *Mitt. Akad. Prag.*, 17. 2, 1908; *Zeit. Kryst.*, 48. 660, 1911; S. L. Penfield, *ib.*, 28. 590, 1897; W. T. Schaller, *ib.*, 50. 106, 1916; E. Hussak, *Ann. Hofmuseum. Wien*, 19. 85, 1904; *Tschermak's Mitt.*, (2), 25. 340, 1906; A. Damour, *Bull. Soc. Min.*, 7. 205, 1884; *Bull. Soc. Geol.*, 2. 542, 1866; H. Gorceix, *Ann. Mines*, (8), 3. 197, 1884; E. Boutan, *Le diamant*, Paris, 128, 1886.

⁷ C. F. Rammelsberg, *Pogg. Ann.*, 64. 260, 1845; *Handbuch der Mineralchemie*, Leipzig, 322, 1875; Suppl., 149, 1886; R. Brandes, *Schweigger's Journ.*, 30. 385, 1820; J. N. von Fuchs, *ib.*, 24. 373, 1818; J. L. Smith and G. J. Brush, *Amer. Journ. Science*, (2), 16. 370, 1853; W. P. Headen, *ib.*, (3), 46. 22, 1893; W. W. Coblenz, *Investigations of Infra-red Spectra*, Washington, 3. 42, 1906; L. J. Ingelström, *Journ. prakt. Chem.*, (1), 64. 253, 1855; *Cēfvers. Akad. Förh. Stockholm*, 11. 156, 1854; C. W. Blomstrand, *ib.*, 25. 201, 1868; J. Gämper, *Jahrb. geol. Reichsanst. Wien*, 28. 614, 1878; A. Lacroix, *Bull. Soc. Min.*, 31. 244, 1908; A. Michel-Lévy, *Les minéraux des roches*, Paris, 229, 1888; P. Groth, *Tabellarische Uebersicht der Mineralien*, Braunschweig, 1898; A. von Lasaulx, *Sitzber. Niederhein. Ges. Nat.*, Bonn, 274, 1883; K. Prüfer, *Haidinger Abhand. Wien*, 1. 169, 1847.

CHAPTER XXXIV

GALLIUM

§ 1. History of Gallium

GALLIUM was discovered by Lecoq de Boisbaudran.¹ The discovery was due to *une conception théorique* based on his views on the spectra of the elements. He observed that the spectral lines of the incandescent vapours of the different members of a family of metals are repeated with the same *disposition générale*, exhibiting regular variations. He found that with the aluminium family there was a missing term between indium and aluminium to which belonged *un corps hypothétique* with properties intermediate between those of the elements just mentioned. Aided by the spectroscope, he sought for this substance under unfavourable conditions in 1863, and in the autumn of 1868 he collected some zinc blende at Pierrefitte (Haute Pyrenees) with the object of renewing the quest. Work was recommenced in 1874, and the existence of *un nouvel élément* established during the night of August 27–28, 1875. It was named *gallium en l'honneur de la France*—Gallia being the Latin name for France. The discovery was communicated in *un paquet cacheté* to l'Académie des Sciences on August 29, 1875, and the packet was opened on September 20, 1875. P. E. Browning has compiled a bibliography of the literature of this element.

L. de Boisbaudran said that from the position attributed to *l'élément inconnu* in the chemical family he was able to predict approximately its properties, but he did not think it proper to publish these speculations, *nées de l'imagination*, without making serious efforts to control them by *résultats positifs*. Meanwhile, D. I. Mendeléeff was studying the periodic law, and in order to justify his argument that certain blanks in the periodic table were due to unknown elements, he stated that the lacuna below aluminium must belong to an undiscovered element which he named *eka-aluminium*. Bolder than L. de Boisbaudran, D. I. Mendeléeff (1869) attributed certain properties to eka-aluminium, and in 1875, he showed that gallium was vested with those very qualities—*vide*, 1. 6, 4. A comparison of the prediction and of the observed results is made in Table I. M. M. P. Muir, and C. Winkler have discussed this subject.

TABLE I.—COMPARISON OF THE PROPERTIES OF EKA-ALUMINIUM AND GALLIUM.

D. I. Mendeléeff's Eka-aluminium, El	L. de Boisbaudran's Gallium, Ga
1. At. wt. about 68.	1. At. wt. 69.9.
2. <i>Metal</i> of sp. gr. 5.9; m.p. low; non-volatile; unaffected by air; should decompose steam at a red heat; and dissolve slowly in acids and alkalis.	2. <i>Metal</i> of sp. gr. 5.94; m.p. 30.15°; non-volatile at moderate temp.; not changed in air; action of steam unknown; and dissolves slowly in acids and alkalis.
3. <i>Oxide</i> —formula El_2O_3 ; sp. gr. 5.5; should dissolve in acids to form salts of the type ElX_3 . The hydroxide should dissolve in acids and alkalis.	3. <i>Oxide</i> — Ga_2O_3 ; sp. gr. unknown; dissolves in acids, forming salts of the type GaX_3 . The hydroxide dissolves in acids and alkalis.
4. <i>Salts</i> should have a tendency to form basic salts; the sulphate should form alums; the sulphide should be precipitated by H_2S or $(\text{NH}_4)_2\text{S}$. The anhydrous chloride should be more volatile than zinc chloride.	4. The <i>salts</i> readily hydrolyze and form basic salts; alums are known; the sulphide is precipitated by H_2S and by $(\text{NH}_4)_2\text{S}$ under special conditions. The anhydrous chloride is more volatile than zinc chloride.
5. The element will probably be discovered by spectrum analysis.	5. Was discovered by the aid of the spectroscope.

In 1887, E. Linnemann² announced a new element in the *orthite* from Arendal; he named it *austrium*. This element is considered by L. de Boisbaudran, and R. Pribram to be impure gallium, because it exhibits the two characteristic lines of that element—the differences in the number and intensity of the observed spectral lines are caused by variations in the working conditions. R. Pribram, however, said that orthite shows spectroscopically a new element yet to be isolated; he called it *austrium* and said that it is quite different from E. Linnemann's *austrium*. This has not been confirmed.

REFERENCES.

- ¹ L. de Boisbaudran, *Ann. Chim. Phys.*, (5), 10, 100, 1877; *Chem. News*, 35, 148, 157, 167, 1877; *Compt. Rend.*, 81, 493, 1100, 1875; 82, 163, 1036, 1876; 83, 611, 824, 1044, 1876; D. I. Mendeléeff, *ib.*, 81, 969, 1875; *Journ. Russ. Phys. Chem. Soc.*, 1, 60, 1869; 3, 47, 1871; *Liebig's Ann. Suppl.*, 8, 133, 1872; M. M. P. Muir, *Phil. Mag.*, (5), 3, 281, 1877; C. Winkler, *Ber.*, 30, 13, 1897; P. E. Browning, *Index to the Literature of Gallium*, Washington, 1904.
- ² E. Linnemann, *Monatsh.*, 7, 121, 1886; R. Pribram, *ib.*, 21, 148, 1900; *Zeit. Elektrochem.*, 8, 866, 1902; L. de Boisbaudran, *Compt. Rend.*, 102, 1436, 1886; 114, 815, 1892.

§ 2. The Occurrence of Gallium

Gallium is one of the scarcest of elements, but, according to W. Vernadsky,¹ W. N. Hartley and H. Ramage, it occurs widely distributed in nature in minute quantities. J. H. L. Vogt, and F. W. Clarke and H. S. Washington estimated the 10-mile crust, the hydrosphere and lithosphere contained 0.00000000x per cent. of gallium. Very small amounts of gallium occur in many zinc blendes. L. de Boisbaudran found it in the brown blende of Pierrefitte, Sweden, and Schwarzenberg (Saxony); in the yellow blende of Mandesse, and Asturien; in the black blende of Bensberg; in the blende of Alston Moor (Cumberland), and Rio Tuerto (Spain). The Pierrefitte blende contained 0.0014–0.0022 grm. of gallium per kgrm.; the Bensberg blende is somewhat richer, containing 0.016 grm. per kgrm. H. B. Cornwall, F. L. Bartlett, and W. F. Hillebrand and J. A. Scherrer, found it in a number of American zinc blendes; C. Rimatori, in Sardinia zinc blendes; and J. B. Kirkland, in Australian blendes from Peelwood (N.S.W.). G. Urbain, A. del Campo y Cerdan, H. C. Fogg and C. James, and W. N. Hartley and H. Ramage have discussed the occurrence of gallium in zinc blendes. The last-named found gallium in twelve out of fourteen zinc blendes which they examined; the first-named detected gallium in nearly all the 64 samples which he examined; and A. del Campo y Cerdan, in 60 of the 65 specimens investigated. Gallium, indium, and germanium were found in 29 cases; gallium and germanium in 18; gallium and indium in 4; and germanium and indium without gallium in none. Four samples showed gallium alone. L. de Boisbaudran found a little gallium in the tutia from the zinc furnaces of the Société de la Vieille-Montagne. B. Delachanal and A. Mermet found gallium in the residue remaining after the distillation of zinc—approximately 0.002 grm. of gallium in 10 kgrms. of zinc, or 1:5000000. P. E. Browning and H. S. Uhler found mercury-like globules of an alloy of gallium with about 10 per cent. of indium, some lead and zinc, on the surface of a residue obtained in the distillation of zinc. L. de Boisbaudran observed no gallium in the ribbon blende from Vieille Montagne, zinc from Vieille Montagne, tutia from Corphalie, galena from Pierrefitte, calamine from Sardinia and Le Gard, and in commercial hydrochloric and nitric acids. W. N. Hartley and H. Ramage demonstrated the presence of gallium, spectroscopically, in 35 out of 91 iron ores they examined—siderite, pyrites, etc.; it was found in seven magnetites; in metallic iron; in the flue dust of blast furnaces; in fifteen aluminium ores; usually in china clay and bauxite; in commercial alum; and in four out of twelve manganese ores. C. Boulanger and J. Bardet, and R. L. y Gamboa also found gallium to be present in commercial aluminium—in one case 0.017 per cent. of gallium—and in many bauxites; J. Lunt, O. Pufahl, and J. S. Thomas and W. Pugh found about half per cent. of gallium in germanite.

W. N. Hartley and H. Ramage found gallium to be present in meteoric iron, and the spectroscope showed it to be present in the sun; the latter observation was confirmed by J. N. Lockyer. W. N. Hartley has also discussed the occurrence of gallium in the sun and stars. The presence of gallium was found by J. Bardet in some French mineral waters.

REFERENCES.

¹ L. de Boisbaudran, *Ann. Chim. Phys.*, (5), **10**, 100, 1877; *Chem. News*, **35**, 148, 157, 167, 1877; H. B. Cornwall, *Amer. Chem. Journ.*, **2**, 44, 1880; F. L. Bartlett, *Eng. Min. Journ.*, **48**, 342, 1889; J. B. Kirkland, *Rep. Australian Assoc. Science*, **4**, 266, 1893; W. N. Hartley and H. Ramage, *Proc. Roy. Soc.*, **60**, 35, 393, 1893; **68**, 97, 1901; *Journ. Chem. Soc.*, **71**, 533, 1897; *Proc. Roy. Soc. Dublin*, **7**, 1, 1898; **8**, 703, 1899; H. Ramage, *Chem. News*, **108**, 280, 1913; W. N. Hartley, *Astrophys. Journ.*, **11**, 163, 1900; B. Delachanal and A. Mermet, *Bull. Soc. Chim.*, (2), **25**, 197, 1876; C. Rimatori, *Atti Accad. Lincei*, (5), **13**, 277, 1904; J. N. Lockyer, *Compt. Rend.*, **86**, 1457, 1878; G. Urbain, *ib.*, **149**, 602, 1909; J. Bardet, *ib.*, **157**, 224, 1913; C. Boulanger and J. Bardet, *ib.*, **157**, 718, 1913; W. Vernadsky, *Bull. Acad. St. Petersburg*, (6), **4**, 1129, 1910; *Centr. Min.*, 758, 1912; F. W. Clarke and F. S. Washington, *Proc. Nat. Acad. Sciences*, **8**, 108, 1922; J. H. L. Vogt, *Zeit. prakt. Geol.*, **6**, 225, 314, 377, 413, 1898; **7**, 10, 274, 1899; A. del Campo y Cerdan, *Anal. Fis. Quim.*, **12**, 80, 1914; R. L. y Gamboa, *ib.*, **21**, 280, 1923; W. F. Hillebrand and J. A. Scherrer, *Journ. Ind. Eng. Chem.*, **8**, 225, 1916; P. E. Browning and H. S. Uhler, *Amer. Journ. Science*, (4), **41**, 351, 1916; L. Moser, *Oester. Chem. Ztg.*, **26**, 67, 1923; H. C. Fogg and C. James, *Journ. Amer. Chem. Soc.*, **41**, 947, 1919; J. S. Thomas and W. Pugh, *Journ. Chem. Soc.*, **125**, 816, 1924; J. Lunt, *Rep. S. African Assoc.*, **1**, 1923; O. Pufahl, *Metall. Erz*, **19**, 324, 1922.

§ 3. The Extraction of Gallium

L. de Boisbaudran ¹ employed the following process for extracting gallium from its ores:

The ore, according to its nature, is dissolved in aqua regia, hydrochloric or sulphuric acid. The cold liquid is treated with plates of zinc, which precipitate copper, arsenic, lead, cadmium, indium, thallium, mercury, silver, bismuth, tin, gold, and selenium; the soln. is filtered, when the escape of hydrogen is still considerable. The liquid is then heated with a large excess of zinc. The gelatinous deposit is washed, and redissolved in hydrochloric acid. The new liquid is heated with an excess of zinc, and a second gelatinous precipitate is obtained. Into the hydrochloric soln. of this second precipitate formed by zinc a current of hydrogen sulphide is passed, the liquid is filtered, the excess of hydrogen sulphide driven off, and the soln. is fractionated with sodium carbonate, ceasing when the ray G_{α} 417.0 ceases to be visible with the hydrochloric soln. of the precipitate. The oxides or sub-salts are taken up with sulphuric acid; the soln. is carefully evaporated until white sulphuric acid vapours are no longer, or but slightly, given off. It is allowed to cool, and stirred with water, which dissolves the mass after the lapse of a time varying from some hours to a couple of days. The soln. of the sulphate, almost neutral, is diluted with much water, and raised to the boiling-point. The sub-salt of gallium is separated by filtration whilst hot. This basic salt is dissolved in a little sulphuric acid, and the liquid is mixed with a slight excess of potassium hydroxide, so as to dissolve the gallium, but to leave the iron. It is filtered, and the oxide of gallium is precipitated by a prolonged current of carbon dioxide. This oxide is redissolved in a minimum of sulphuric acid, a slight excess of ammonium acetate, feebly acid, is added, and it is then treated with hydrogen sulphide. Under these conditions the gallium is not precipitated. The acid liquid is filtered, diluted with water, and raised to a boil. The bulk of the gallium is precipitated and filtered whilst hot. The mother-liquor, concentrated, and boiled with aqua regia in order to destroy ammoniacal salts, is added to the other gallium residues. The precipitate formed on heating the acetic acid soln. is redissolved in sulphuric acid, a slight excess of potassium hydroxide is added, and it is then filtered. The soln. in alkali-lye is electrolyzed. The gallium is easily detached from platinum electrode on pressing it between the fingers under warm water. The metal is then immersed for about half an hour in nitric acid at about 60° or 70°, quite free from chlorine, and diluted with an equal volume of water. After washing, it may be regarded as pure.

The small proportion of gallium in the ores renders the preparation of the metal costly and laborious. The extraction of gallium from zinc ores was described by H. C. Fogg and C. James; and from germanite, by J. S. Thomas and C. James. L. de Boisbaudran and E. Jungfleisch used the following modification of the above process for extracting gallium from the blende of Bensberg, the richest ore available;

The pulverized mineral is roasted in a gas furnace, when the gallium remains fixed, while the greater part of the indium is volatilized. The residue is treated with a quantity of sulphuric acid sufficient to dissolve almost all the zinc, leaving, however, in the mass so much subsulphate of this mineral that the filtrate may be rendered turbid by cold water. We thus obtain commercial zinc sulphate and a residue containing the gallium. This residue is redissolved in an excess of sulphuric acid. After the reduction of the per-salt of iron by means of metallic zinc, the filtrate is precipitated fractionally with sodium carbonate, the progress of the operation being watched with the spectroscope. The precipitates are re-dissolved in sulphuric acid, and a second reduction with zinc and a fractional precipitation with sodium carbonate follow. All the gallium in the 4300 kilos. of ore was thus concentrated in about 100 kilos. of still moist material. To remove the iron the reductions with zinc and the fractional precipitations with sodium carbonate are repeated several times. The galliferous precipitate is redissolved in sulphuric acid, evaporated to the elimination of most of the excess of acid, and boiled with much water. The filtrate deposits a sediment containing titanitic acid. The liquid, which is very much charged with zinc, is treated with hydrogen sulphide, mixed with ammonium acetate, and again treated with hydrogen sulphide. Zinc sulphide is thrown down along with gallium, which is thus freed from alumina. The additions of zinc sulphate, of ammonium acetate, and the currents of hydrogen sulphide, are repeated as long as the sulphide gives the rays of gallium. The sulphuric soln. of the galliferous sulphides of zinc is carefully fractioned with sodium carbonate, and guided by spectral examination the zinc is thus completely separated. The product is again dissolved in the theoretical quantity of sulphuric acid and treated with hydrogen sulphide when a little cadmium, lead, indium, zinc, etc., are deposited as sulphides; and the liquid, largely diluted with water, is raised to the boil. By filtering when hot we collect a bulky sub-salt of gallium which is immediately washed in boiling water, for on cooling it dissolves in its mother liquor. This basic salt is very readily attacked by alkali-lye, which leaves undissolved iron, indium, etc. The alkaline liquor on treatment with hydrogen sulphide gas, and then by very slight acidulation with sulphuric acid, yields a deposit principally consisting of indium sulphide. The very slightly acid liquid is next boiled with a large excess of water, when the sub-salt is again deposited. Metallic gallium is isolated by the electrolysis of the soln. of the sub-salt in alkali-lye. The metallic deposit is only obtained advantageously under certain special conditions. The intensity of the electric current should vary according to the conc. of the liquid, but the surface of the negative electrode must be small in comparison with that of the positive electrode. If the metal is deposited in the cold it often forms long rows of crystals resembling needles fixed to the electrode by one of their ends, and sometimes reaching 3 cms. in length. Above 30°, the metal flows in drops, which collect at the bottom of the electrode. The crude metal has been further purified by filtering it through dense linen, shaking it while hot with water acidulated with hydrochloric acid, and by repeated recrystallization.

W. N. Hartley and H. Ramage also separated gallium from iron. P. E. Browning and L. E. Porter separated gallium and zinc by the fractional crystallization of cæsium-gallium alum. R. L. y Gamboa separated gallium from aluminium by precipitating the former in hydrochloric acid soln. containing potassium arsenite, by means of hydrogen sulphide. The arsenic sulphide carries down all the gallium as sulphide. F. Bates purified gallium in the following manner:

Crude gallium was dissolved in aqua regia, treated with sulphuric acid, and heated until it fumes so as to remove nitric acid. After dilution, small amounts of lead sulphate were filtered off. The soln. was then diluted, treated with hydrogen sulphide, and filtered to remove the hydrogen-sulphide group of elements. The filtrate was boiled to expel hydrogen sulphide and treated with ammonium hydroxide. The precipitate was filtered off, dissolved, and reprecipitated three times to free it from zinc. The final separation from indium was based on the solubility of gallium hydroxide in a soln. of sodium hydroxide and the insolubility of indium hydroxide in that reagent. The sodium hydroxide separation was carried through three times. The deposition of gallium was finally carried out by electrolysis of the alkaline soln.

The electrolytic deposition of gallium from alkaline soln. of its salts or hydroxide has been studied by L. Schucht, L. Ehrlich, and G. Kuert. P. E. Browning and H. S. Uhler obtained the metal in the form of a gallium-tree when operating at 0°; at ordinary temp., the metal appears in liquid globules. L. M. Dennis and J. A. Bridgman showed that by the fractional electrolysis of a slightly acid soln. of the sulphates of gallium, indium, and zinc, zinc may be removed entirely, and the gallium obtained almost free from indium. T. W. Richards and S. Boyer found that the separation of gallium from indium by the process

based on the difference in the solubilities of the hydroxides in alkali-lye leaves several per cent. of indium with the gallium. The electrolytic process based on the fact that gallium is less easily deposited than indium, and more easily deposited than zinc, gives good results.

REFERENCES.

¹ L. de Boisbaudran and E. Jungfleisch, *Bull. Soc. Chim.*, (2), **31**, 50, 1879; *Chem. News*, **35**, 148, 157, 167, 1877; *Compt. Rend.*, **86**, 475, 1878; L. de Boisbaudran, *ib.*, **82**, 1098, 1876; **83**, 636, 1876; L. Schucht, *Berg. Hütt. Ztg.*, **39**, 121, 1880; *Chem. News*, **41**, 280, 1880; L. Ehrlich, *ib.*, **51**, 115, 1885; *Chem. Ztg.*, **9**, 78, 1885; G. Kunert, *ib.*, **9**, 1826, 1885; W. N. Hartley and H. Ramage, *Proc. Roy. Soc.*, **60**, 35, 393, 1896; *Journ. Chem. Soc.*, **81**, 533, 1897; F. Bates, *Scient. Paper Bur. Standards*, 371, 1920; P. E. Browning and H. S. Uhler, *Amer. Journ. Science*, (4), **41**, 351, 1916; L. M. Dennis and J. A. Bridgman, *Journ. Amer. Chem. Soc.*, **40**, 1531, 1918; T. W. Richards and S. Boyer, *ib.*, **41**, 133, 1919; P. E. Browning and L. E. Porter, *ib.*, **43**, 126, 1921; R. L. y Gamboa, *Ann. Soc. Espan. Fis. Quim.*, **21**, 280, 1923; J. S. Thomas and W. Pugh, *Journ. Chem. Soc.*, **125**, 816, 1924; H. C. Fogg and C. James, *Journ. Amer. Chem. Soc.*, **41**, 947, 1919.

§ 4. The Physical Properties of Gallium

Gallium is a greyish metal with a colour resembling that of steel; it has a greenish-blue reflex, and when molten it appears like tin or silver. According to L. de Boisbaudran,¹ with repeatedly reflected light the colour is bluish-green. T. Carnelley studied the relation between the colour and at. wt. of the gallium family of elements. L. de Boisbaudran and E. Jungfleisch obtained **crystals** by introducing a platinum wire supporting a little solid gallium into the molten metal, undercooled 10°–15° below its m.p.; in three to ten seconds, octahedral crystals are formed. If the crystals are not promptly withdrawn, the metal becomes heated too near its m.p., solidification is retarded, and plate-like crystals are formed. The lustrous crystals are difficult to measure because their surfaces are slightly curved. The metal crystallizes in bipyramids probably belonging to the monoclinic system, according to L. de Boisbaudran, or to the tetragonal system, according to A. des Cloizeaux. The solid metal has a crystalline texture.

The **specific gravity** of the samples first prepared by L. de Boisbaudran was 4.7 at 15°/15°, but he later found this result is too low—possibly owing to interstices filled with air or water; he later obtained 5.935 at 24.45°/24.45° for the solid and 6.07 for the liquid at 24.7°. Like water, therefore, the solid contracts on melting. T. W. Richards and S. Boyer found that the purest sample of gallium they prepared had a sp. gr. 5.885 in the solid state and 6.081 in the liquid state; gallium contaminated with indium had sp. gr. 5.975 and 6.166 respectively in the solid and liquid states. The presence of indium has thus little influence on the expansion which occurs when gallium freezes. E. Donath and J. Mayrhofer studied the at. vol. of gallium with respect to its position in the periodic table. Gallium is hard; and it gives a bluish-grey streak on paper. The **malleability** is low. It can be extended under the hammer, but it soon becomes brittle, breaking in the direction of the crystalline cleavage on shock, or when suddenly bent. Thin foil was obtained by melting the metal between sheets of glass. T. W. Richards and S. Boyer found the **compressibility** of the purest gallium, *i.e.* the fractional change in vol. caused by one megabar press., between 100–500 megabars, to be 2.09×10^{-6} per unit vol. per megabar, at 30°; and that of gallium contaminated with some indium, 1.97×10^{-6} . The compressibility of the liquid at 30° is 3.97×10^{-6} , a value very near that of mercury, and nearly twice the value for solid gallium. This agrees with general experience that the compressibility of a substance in the solid state is less than that of the same substance in the liquid state irrespective of the volumes occupied.

L. de Boisbaudran measured the **melting point** of six samples of gallium successively deposited from the same soln. The first and last fractions had respectively the values 30.14° and 30.16°—the mean of all six samples was 30.15°;

an earlier determination on a less pure sample gave 29.5° . M. Berthelot found the m.p. to be 30° , and W. Guertler and M. Pirani give this as the best representative value. The metal thus liquefies when held in the fingers, and it very readily remains in a state of surfusion. The fusion point was not changed by keeping the metal in boiling water for 2 hrs. to destroy any potassium which might be present. T. W. Richards and S. Boyer obtained 30.8° for the m.p. of the metal purified by the electrolytic process, and 26.9° for that purified by the hydroxide process without electrolysis. From T. W. Richards and S. Boyer's value for the sp. gr. of the liquid and solid at the m.p. W. R. Mott gave 30.1° for the m.p., and 1700° for the **boiling point**. According to W. R. Fielding, the metal is more polymerized in the liquid than in the solid state at the m.p. P. W. Bridgman computed that gallium contracts 0.00529 c.c. per gram in passing from the solid to the liquid state, and increasing press. accordingly depress the m.p. The m.p. at different press., p , in kgrms. per sq. cm. are:

p .	:	:	0	1000	2000	4000	6000	8000	10,000	12,000
m.p.	:	:	29.85°	27.8°	25.7°	21.4°	17.0°	12.6°	8.1°	2.55°

L. de Boisbaudran said that melted gallium adheres readily to glass, on which it forms a fine mirror whiter than that produced by mercury; but, added L. de Boisbaudran and E. Jungfleisch, after cooling and solidification, the metal can be readily detached from glass. L. de Boisbaudran found the metal to be but slightly volatile even at a red heat. F. Bates said that little is known concerning the **boiling point** of gallium, but a few experiments which have been made show that it is over 1500° . L. de Boisbaudran suggested using gallium in place of mercury as a thermometer liquid for high temp. M. Berthelot found the **specific heat** of solid gallium to be 0.079 between 12° and 23° ; and that of the liquid between 12.5 and 119° , to be 0.082; the atomic heat of the solid is therefore 5.52, and that of the liquid 5.59. A. Eucken gave for the mol. ht. of liquid gallium $C_p=5.6$, and for the solid $C_p=5.5$. From the slope of the press.-m.p. curve 0.00203, and Clapèyron's equation, P. W. Bridgman computed the latent **heat of fusion** to be 18.5 cal. per gram. M. Berthelot found by seeding surfused gallium at 13° , the heat of fusion to be 19.11 cal. per gram of metal. P. W. Robertson discussed some relations between the physical constants of gallium.

The **spark spectrum** of gallium was shown by L. de Boisbaudran to furnish two violet lines $\lambda=4172.2$ and 4033.18 —the former is much more intense than the latter.

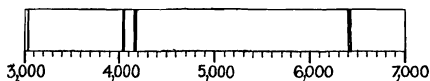

FIG. 1.—Spark Spectrum of Gallium

The flame spectrum is feeble and rapidly vanishes. There are three other feeble lines for $\lambda=6396.99$ and 6413.92 ; and one still more feeble for $\lambda=3020.61$, Fig. 1—by F. Bates. Four of these five lines are in the visible spectrum. P. E. Browning

and H. S. Uhler found indications of the possibility of two faint gallium lines $\lambda=5353.81$ and 5359.8 . Lines have also been observed by B. Delachanal and A. Mermet, G. D. Liveing and J. Dewar, E. Klein, E. Demarçay, W. N. Hartley and co-workers, F. Exner and H. Haschek. While H. Kayser said that so little is really known that *alles in allem ist das Spektrum des Gallium noch so gut wie unbekannt*. The **series spectra** of the family have been studied by J. R. Rydberg, W. M. Hicks, A. Fowler, J. A. Carroll, and F. Paschen and K. Meissner. H. S. Uhler and J. W. Tanch studied the **arc spectrum** of gallium; and W. Grotrian, the **absorption spectrum**. W. Duane and K. T. Hu, and H. S. Uhler and C. D. Cooksey measured the **X-ray spectrum** of gallium, and found, in Angström units, $a_2a'_1=1.34161$; $a_1a=1.33785$; and $\beta_1\beta=1.20591$. The high-frequency spectrum was also studied by M. de Broglie. F. L. Möhler and A. E. Ruark gave for the **ionization potentials**, $2p_2=5.960$; $2p_1=5.871$; and for the **resonance potentials**, $2p_2-2p_1=0.102$; $2p_2-2s=3.060$; $2p_2-3d_{1,2}=4.294$. According to J. H. Gladstone, the **specific refraction**, calculated from the rubidia alum, is 0.2120; and the **atomic refraction** approximately 14.8; the sp. refraction is 0.166, and the atomic refraction 11.6

with the H_{α} -line. W. J. Pope gave 16.52 for the at. refraction of gallium with the D -line.

A. Guntz and W. Broniewsky found the specific **electrical resistance** of gallium at 0° to be 53.4 when the absolute value of a gallium filament is 1.3686, and of mercury of the same volume 2.4095; at higher temp. the values are:

Sp. resistance	0°	17.4°	18.6°	26.4°	29°	30.3°	46.1°	18.6°
	53.4	56.5	57.0	55.8	m.p.	27.2	28.4	28.0
	Solid				Liquid			

According to P. W. Bridgman, the sp. resistance of liquid gallium at the m.p. is 25.92×10^{-6} units; and relative sp. resistance, R , of liquid gallium at different press., p kgrms. per sq. cm., and temp.

p	0	1000	2000	4000	6000	8000	10,000	12,000
R 30°	0.6456	0.6415	0.6380	0.6308	0.6238	0.6171	0.6105	0.6044
R 65°	0.6647	0.6605	0.6564	0.6488	0.6418	0.6349	0.6283	0.6223
R 100°	0.6824	0.6783	0.6743	0.6667	0.6593	0.6522	0.6451	0.6386

so that the average press. coeff. of the resistance between 0 and 12,000 kgrms. per sq. cm. is -0.0531 at 30° , -0.0532 at 65° , and -0.0534 at 100° . No discontinuities were observed, showing that there is probably no new modification in the region observed. The relation between press. and resistance is linear at 0° to 12,000 kgrms. per sq. cm. press., the coeff. being -0.05247 ; and in a glass capillary tube -0.05191 . The temp. coeff. of the resistance for the unconstrained solid is 0.003963 between 0° and 21.5° . The sp. resistance of solid gallium was 1.733 times that of the liquid at the m.p.; A. Guntz and W. Broniewsky found 2.09 for this ratio. P. W. Bridgman found that for the supercooled liquid down to 0° , the resistance curve is a regular prolongation of the curve at the m.p., while A. Guntz and W. Broniewsky, and A. Schulze found the resistance, R , to pass through a minimum and to increase again in the unstable region:

$R \times 10^6$	0°	17.4°	18.6°	26.4°	29.0°	30.3°	46.1°
	53.4	56.5	57.0	55.8	m.p.	27.2	28.4

at the m.p. the resistance of the solid is 57×10^{-6} , and of the liquid, 27×10^{-6} . J. Regnaud found that liquid gallium is electronegative to the solid metal, and he made a cell with liquid gallium acting as the positive, solid gallium as negative electrode—in a neutral aq. soln. of gallium sulphate. S. Meyer, and M. Owen found the metal to be diamagnetic.

REFERENCES.

- ¹ L. de Boisbaudran and E. Jungfleisch, *Bull. Soc. Chim.*, (2), **31**, 50, 1879; *Compt. Rend.*, **86**, 475, 1878; L. de Boisbaudran, *ib.*, **81**, 493, 1875; **82**, 168, 1876; **83**, 611, 1044, 1876; **114**, 815, 1892; *Ann. Chim. Phys.*, (5), **10**, 100, 1897; *Journ. Phys.*, **5**, 277, 1876; *Chem. News*, **35**, 148, 157, 167, 1877; A. Eucken, *Ber. deut. phys. Ges.*, **18**, 18, 1916; W. Grottrian, *Zeit. Physik*, **12**, 218, 1923; **18**, 169, 1923; E. Klein, *Astrophys. Journ.*, **56**, 373, 1922; A. Schulze, *Zeit. Metallkunde*, **15**, 155, 1923; **16**, 48, 1924; A. Fowler, *Report on Series in Line Spectra*, London, 155, 1922; J. A. Carroll, *Proc. Roy. Soc.*, **103**, A, 334, 1923; M. Berthelot, *Bull. Soc. Chim.*, (2), **31**, 229, 1879; *Compt. Rend.*, **86**, 786, 1878; J. Regnaud, *ib.*, **86**, 1457, 1878; M. de Broglie, *ib.*, **159**, 304, 1914; A. Guntz and W. Broniewsky, *ib.*, **147**, 1474, 1908; *Journ. Chim. Phys.*, **7**, 464, 1909; T. W. Richards and S. Boyer, *Chem. News*, **122**, 173, 1921; *Journ. Amer. Chem. Soc.*, **41**, 133, 1919; L. M. Dennis and J. A. Bridgman, *ib.*, **40**, 1531, 1918; E. Donath and J. Mayrhofer, *Ber.*, **16**, 1588, 1883; F. Bates, *Scient. Papers Bur. Standards*, **371**, 1920; J. H. Gladstone, *Phil. Mag.*, (5), **20**, 162, 1885; (5), **35**, 207, 1893; *Proc. Roy. Soc.*, **60**, 140, 1897; W. J. Pope, *Journ. Chem. Soc.*, **69**, 1530, 1896; B. Delachanal and A. Mermat, *Bull. Soc. Chim.*, (2), **26**, 194, 1876; S. Meyer, *Monatsh.*, **20**, 380, 1899; H. S. Uhler and C. D. Cooksey, *Phys. Rev.*, (2), **10**, 645, 1917; J. R. Rydberg, *Svenska Vet. Akad. Handl.*, **23**, 11, 1890; E. Demarçay, *Spectres électriques*, Paris, 1895; F. Exner and E. Haschek, *Sitzber. Akad. Wien*, **108**, 1071, 1899; *Tabelle der Funkenspectra*, Wien, 1902; *Tabelle der Bogenspectra*, Wien, 1904; G. D. Liveing and J. Dewar, *Proc. Roy. Soc.*, **28**, 471, 1879; H. Ramage, *ib.*, **70**, 1, 1901; W. N. Hartley and H. W. Moss, *ib.*, **79**, A, 242, 1907; **87**, A, 38, 1912; W. N. Hartley and H. Ramage, *ib.*, **60**, 35, 393, 1896; **68**, 97, 1901; *Trans. Roy. Soc. Dublin*, (2), **7**, 339, 1901;

W. N. Hartley, *Astrophys. Journ.*, **11**, 163, 1900; T. Carnelley, *Phil. Mag.*, (5), **18**, 130, 1884; P. E. Browning and H. S. Uhler, *Amer. Journ. Science*, (4), **41**, 351, 1916; H. Kayser, *Handbuch der Spectroscopie*, Leipzig, **5**, 460, 1910; W. M. Hicks, *Phil. Trans.*, **212**, A, 33, 1912; **213**, A, 323, 1913; F. Paschen and K. Meissner, *Ann. Physik*, (4), **43**, 1223, 1914; M. Owen, *ib.*, (4), **37**, 657, 1912; *Proc. Acad. Amsterdam*, **14**, 637, 1911; P. W. Bridgman, *Proc. Amer. Acad.*, **56**, 61, 1921; H. S. Uhler and J. W. Tanch, *Astrophys. Journ.*, **55**, 291, 1922; W. R. Mott, *Trans. Amer. Electrochem. Soc.*, **34**, 555, 1918; W. Guertler and M. Pirani, *Zeit. Metallkunde*, **11**, 1, 1919; W. B. Fielding, *Chem. News*, **122**, 280, 1921; **123**, 1, 1921; A. W. Hull, *Phys. Rev.*, (2), **17**, 571, 1921; F. L. Mohler and A. E. Ruark, *Journ. Amer. Opt. Soc.*, **7**, 819, 1923; P. W. Robertson, *Journ. Chem. Soc.*, **81**, 1233, 1902; A. des Cloizeaux, *Bull. Soc. Min.*, **3**, 111, 1880; W. Duane and K. F. Hu, *Phys. Rev.*, (2), **14**, 516, 1919.

§ 5. The Chemical Properties of Gallium

J. N. Lockyer¹ said that when gallium is heated in vacuo, no **occluded gas** is given off. According to L. de Boisbaudran and E. Jungfleisch, gallium preserves its lustre in **air**, and even in the laboratory where the air is usually loaded with acid vapours. L. de Boisbaudran said that in air at a red heat the metal is oxidized only superficially. A. Dupré found that dry **oxygen** at 285° exerts no visible action on the metal; at incipient redness, the metal loses its lustre and is covered by a very thin greyish-blue pellicle; at a full red heat, a distinct film of oxide is formed and this protects the metal from further oxidation; and at a bright red heat, a slight sublimate of oxide is formed in the hottest parts of the tube. L. de Boisbaudran and E. Jungfleisch stated that gallium remains bright in boiling **water** free from air, but, in water containing air, the metal tarnishes slowly. When crystallized gallium is thrown into hot water, it crackles, and bubbles of gas escape—possibly hydrogen occluded when the metal was electro-deposited. Gallium unites with **chlorine**, **bromine**, and **iodine** in the cold and in decreasing order of activity. The metal is slowly dissolved by **hydrochloric acid**, cold or hot, with the evolution of hydrogen. The action of acids is faster with the solid than with the liquid metal. The metal is slowly dissolved by **nitric acid**—faster when hot than when cold. With monohydrated nitric acid, free from nitrous vapours, the action is almost nil at ordinary temp., but at 40°–50°, the action proceeds slowly, forming a grey deposit which dissolves very slowly. **Aqua regia** is a better solvent than nitric acid, but the action is not rapid. Gallium dissolves in a soln. of **potassium hydroxide**, and hydrogen is evolved. According to F. Bates, **cadmium** readily alloys with gallium, and he used the alloy in place of cadmium alone for a cadmium vapour lamp. When solidified, the alloy does not adhere to the fused silica walls of the lamp. W. Ramsay found that gallium readily amalgamates with **mercury**. L. de Boisbaudran found that gallium readily alloys with **aluminium**, and mixtures rich in gallium are liquid at ordinary temp.; they readily decompose water, evolving hydrogen and leaving a solid residue of the metal gallium, and aluminium hydroxide. Gallium also alloys with **platinum**, **indium**, etc. Gallium forms two series of salts, in one the metal is a dyad, and in the other a triad. Gallous salts have reducing properties, and they are unstable. A. Korczynsky studied the catalytic effect of gallium and its salts on the hydrogenation of aromatic hydrocarbons.

Reactions of analytical interest.—The gallic salts are colourless or white; the sulphate and nitrate are readily soluble in water; the sulphate forms alums. The aq. soln. are hydrolyzed when boiled, and a basic salt is precipitated. Gallic salts give no precipitate with **hydrochloric acid**. The soln., acidified with hydrochloric, sulphuric, tartaric, or acetic acid, gives no precipitate with **hydrogen sulphide**, even if ammonium or alkali tartrates are present, but if zinc, silver, copper, manganese, iron, or arsenic are present in a feebly acid soln., some gallium is carried down with the precipitate, but not if the soln. be strongly acidified. Gallium is not precipitated by ammonium sulphide, but in presence of other salts, like those of zinc, the gallium is precipitated with the zinc sulphide. Gallic hydroxide is precipitated by soln.

of **potassium hydroxide**, or by aqua **ammonia**, and the precipitate is soluble in an excess. The presence of tartaric acid hinders the precipitation by ammonia. A white precipitate is obtained with **alkali or ammonium carbonate**, and in the latter case the precipitate is soluble in an excess of the precipitant. Gallium hydroxide is precipitated by **barium or calcium carbonate** in the cold. Similar precipitates are obtained by adding **cupric oxide or manganous sulphide**—in the latter case hydrogen sulphide is evolved. The precipitation with cupric oxide is utilized for separating gallium from salts of lead, cobalt, nickel, iron, thallium, beryllium, and the rare earths. When a boiling dil. soln. of a gallic salt, acidified with acetic acid, is treated with ammonium acetate, gallic hydroxide is precipitated if the precipitant is not in too great an excess. **Potassium ferrocyanide** gives a precipitate in soln. strongly acidified with hydrochloric acid. L. E. Porter and P. E. Browning based a method of analysis on this reaction which is very sensitive, a precipitate is produced in a soln. containing 1 part of gallium in 200,000 parts of soln. No precipitation occurs with **potassium ferricyanide**. The metal **zinc** gives a precipitate only with alkaline soln. of gallium salts; the gallium forms insoluble flecks of gallic oxide or of a basic salt; the reaction with **cadmium** is incomplete; and with **iron**, a long boiling is needed. In gravimetric analysis, gallium is precipitated by ammonia and weighed as sesquioxide.

The atomic weight of gallium.—The hydrogen eq. of gallium in gallous salts is about 35, and in gallic salts, 23·3. It is assumed that in the former case the metal is dyadic, and in the latter triadic, and that the at. wt. approximates 70 because this corresponds (i) with the smallest quantity of gallium in gallium trichloride when tested by the vapour density method of Avogadro; (ii) with Dulong and Petit's specific heat rule; (iii) with Mitscherlich's isomorphous law where the gallic alums are isomorphous with aluminium, indium, and thallium alums; and (iv) with the position assigned to it in the periodic table. (v) C. Runge and J. Precht's method, based on the linear relation of the logarithms of the at. wt. and the logarithm of the doublet separation of members of a family, was shown by W. M. Watts to agree with an at. wt. of about 70. L. de Boisbaudran determined the ratio ammonia gallic alum, and gallic oxide, $(\text{NH}_4)_2\text{SO}_4 \cdot \text{Ga}_2(\text{SO}_4)_3 \cdot 24\text{H}_2\text{O} : \text{Ga}_2\text{O}_3$, and hence computed the at. wt. 70·08; and he also dissolved gallium in nitric acid, and ignited the nitrate so as to obtain gallic oxide, and from the ratio $2\text{Ga} : \text{Ga}_2\text{O}_3$, computed the at. wt. 69·7. In some preliminary experiments, T. W. Richards, W. M. Craig, and J. Sameshima determined the ratio $\text{GaCl}_3 : 3\text{AgCl}$, and hence computed the at. wt. 70·10; and T. W. Richards and W. M. Craig obtained 69·716. The International Table gives 69·9 for the best representative value. From the lowering of the vap. press. of soln. of gallium in mercury, W. Ramsay inferred that gallium is monatomic in the dil. soln.—this presupposes that no gallium mercurides are formed. The **atomic number** of gallium is 31. F. W. Aston found that gallium has two **isotopes** with at. masses 69 and 71.

REFERENCES.

- ¹ J. N. Lockyer, *Chem. News*, **40**, 101, 1879; L. de Boisbaudran and E. Jungfleisch, *Bull. Soc. Chim.*, (2), **31**, 50, 1879; *Compt. Rend.*, **86**, 475, 577, 1878; A. Dupré, *ib.*, **86**, 720, 1878; L. de Boisbaudran, *ib.*, **81**, 493, 1100, 1875; **82**, 1036, 1098, 1876; **83**, 611, 636, 663, 824, 1044, 1876; **86**, 756, 1240, 1878; **93**, 294, 329, 815, 1881; **94**, 695, 1154, 1227, 1439, 1625, 1882; **95**, 18, 157, 410, 503, 703, 1192, 1332, 1882; **96**, 152, 1696, 1838, 1883; **97**, 66, 142, 295, 521, 623, 730, 1463, 1883; **98**, 711, 781, 1884; **99**, 526, 1884; **102**, 647, 1436, 1886; **104**, 184, 330, 1584, 1887; *Ann. Chim. Phys.*, (5), **10**, 100, 1877; (6), **11**, 429, 1877; *Chem. News*, **35**, 148, 157, 167, 1877; F. Bates, *Scient. Papers Bur. Standards*, 371, 1920; C. Runge and J. Precht, *Phys. Zeit.*, **4**, 285, 1903; *Phil. Mag.*, (6), **5**, 476, 1903; W. M. Watts, *ib.*, (6), **9**, 279, 1906; A. Korczynsky, *Bull. Soc. Chim.*, (4), **29**, 283, 1921; W. Ramsay, *Journ. Chem. Soc.*, **55**, 521, 1889; T. W. Richards, W. M. Craig, and J. Sameshima, *Journ. Amer. Chem. Soc.*, **41**, 131, 1919; T. W. Richards and W. M. Craig, *ib.*, **45**, 1155, 1923; L. E. Porter and P. E. Browning, *ib.*, **43**, 111, 1921; *Chem. News*, **122**, 104, 1921; F. W. Aston, *Journ. Soc. Chem. Ind.—Chem. Ind.*, **42**, 935, 1923; *Nature*, **112**, 449, 1923; *Phil. Mag.*, (6), **47**, 385, 1924.

§ 6. Gallium Oxides and Hydroxides

Gallium forms *gallium sesquioxide*, *gallic oxide*, or **gallium trioxide**, Ga_2O_3 ; and what may be a lower oxide, *gallous oxide* or **gallium monoxide**, GaO —but the existence of the latter is not so well established as that of the former. L. de Boisbaudran¹ obtained gallic oxide by the action of nitric acid on gallium, or by heating the nitrate. A. Dupré also found that the oxide obtained by igniting the nitrate is a white friable mass which, if heated in a stream of dry hydrogen, partly sublimes, and is partly reduced; at a cherry-red heat, said he, a bluish-grey substance is produced which resembles the pellicle formed on the oxidation of gallium; notwithstanding the blue tint, the oxide does not appear to contain appreciable traces of the metal, for on treatment with nitric acid there is no evolution of nitrous fumes. It dissolves also in dil. sulphuric acid without the evolution of any gas, and the soln. reduces potassium permanganate. It is therefore inferred that the greyish-blue matter is a lower oxide of gallium, probably gallous oxide, for the sulphuric acid soln. of gallic oxide does not reduce permanganate. L. de Boisbaudran prepared a brown oxide with similar properties to A. Dupré's gallous oxide by the action of water on gallous chloride.

Gallic oxide is infusible at a red heat. According to L. F. Nilson and O. Petterson, the sp. ht. of the oxide is 0.1062, and the mol heat, 19.54. L. de Boisbaudran found that chromiferous gallic oxide gives a fine red fluorescence in the cathode rays. 0.1 per cent. of chromic oxide is sufficient. The oxides of samarium, dysprosium, and terbium also act as phosphorogens on gallic oxide. E. L. Nichols and H. L. Howes studied the luminescent spectrum of the incandescent oxide. Gallic oxide is soluble in hydrochloric or sulphuric acid, in an aq. soln. of alkali hydroxide, and in aq. ammonia; but if the oxide has been strongly heated, its solubility in these menstrua is so slow that L. de Boisbaudran said that it is insoluble. The calcined oxide may be brought into soln. by fusion with potassium hydrosulphate, or hydroxide. As indicated above, A. Dupré found that at a cherry-red heat, hydrogen reduces gallic oxide to a lower oxide; at a bright-red heat, the oxide is reduced to metal. C. Winkler found the oxide is reduced when heated with magnesium, forming a reguline metal.

According to L. de Boisbaudran, the precipitate obtained by treating soln. of gallium salts with alkali carbonates or hydrocarbonates; by alkali hydroxides; by aqua ammonia; and by ammonium carbonate, is probably **gallic hydroxide**, $\text{Ga}(\text{OH})_3$. According to L. M. Dennis and J. A. Bridgman, the precipitate of hydroxide obtained by boiling a soln. of gallium sulphate with sodium trinitride, or sodium sulphite, is more curdy and more easily washed than the gelatinous precipitate obtained with aq. ammonia. The precipitated hydroxide dissolves in aq. soln. of ammonia, ammonium carbonate, or alkali hydroxide. Aq. ammonia or alkali hydroxide does not give a precipitate with soln. of gallium salts in the presence of tartaric acid, presumably, said L. de Boisbaudran, because complex gallic tartrates are formed. Gallic hydroxide is readily soluble in acids, forming soln. of the corresponding salts.

REFERENCES.

¹ E. L. Nichols and H. L. Howes, *Phys. Rev.*, (2) **19**, 300, 1922; L. de Boisbaudran, *Chem. News*, **35**, 148, 157, 167, 1877; *Bull. Soc. Chim.*, (2), **29**, 385, 1878; *Compt. Rend.*, **93**, 294, 329, 815, 1881; **104**, 1584, 1887; **105**, 1228, 1887; A. Dupré, *ib.*, **86**, 720, 1878; C. Winkler, *Ber.*, **23**, 788, 1890; L. F. Nilson and O. Petterson, *ib.*, **13**, 1455, 1880; L. M. Dennis and J. A. Bridgman, *Journ. Amer. Chem. Soc.*, **40**, 1531, 1918.

§ 7. Gallium Halides

The *fluorides of gallium* have not been investigated. According to L. de Boisbaudran,¹ gallium forms two chlorides, namely, *gallous chloride*, or **gallium dichloride**, GaCl_2 ; and *gallic chloride*, or **gallium trichloride**, GaCl_3 . Gallous chloride is obtained by heating gallic chloride with gallium; heating an excess of gallium in chlorine; or, in soln., by dissolving gallium in a little conc. hydrochloric acid. When the last-named soln. is diluted with water, a soln. of gallic chloride is formed, and bubbles of hydrogen gas are given off—the gas carries some entrained spray of the soln., hence the older suggestion that it is *gallium hydride*. The white or pale grey solid is very hygroscopic, and in air forms deliquescent crystals. The salt melts at 164° , and boils at 535° . The fused salt is readily under-cooled. According to L. F. Nilson and O. Pettersson, the vapour density between 1000° and 1100° is 4.82, and between 1300° and 1400° , 3.56—the theoretical value for GaCl_2 is 4.86. W. Hampe found the molten salt is a good electrical conductor—globules of metal separate at the cathode, but the chlorine at the anode converts the gallous into gallic chloride. According to L. de Boisbaudran, a little water dissolves gallous chloride, forming a syrup which has strong reducing properties; with further dilution, there is a vigorous evolution of hydrogen, and a brown gallous oxide is precipitated.

Gallic chloride is formed by the action of an excess of chlorine or hydrogen chloride on the metal at about 240° . The reaction is attended by the evolution of much heat. Good crystals were obtained by melting or subliming the product. L. M. Dennis and J. A. Bridgman, and T. W. Richards, W. M. Craig, and J. Same-shima found that the preparation of gallic chloride by burning gallium in dry chlorine, and distilling the product first in chlorine, then in nitrogen, and then in vacuo, gave a product whose spark spectrum showed it to be free from other metals. L. de Boisbaudran found the m.p. to be 75.5° ; and the b.p., 210° – 215° . The molten salt has a tendency to under-cooling, it is also readily superheated to 240° , and the liquid absorbs dry gases, rejecting them again on cooling. The soln. of chlorine in the superheated liquid is yellow. According to W. Hampe, the sp. gr. of the liquid at $80^\circ/80^\circ$ is 2.36. The vapour density of the gas has been determined by L. de Boisbaudran, C. Friedel and J. M. Crafts, and by L. F. Nilson and O. Pettersson, with the average results:

	237°	273°	307°	360°	440°	606°	1000°–1100°
Vapour density .	11.73	11.9	10.61	8.84	6.52	6.14	5.18

the calculated value for Ga_2Cl_6 is 12.16 and for GaCl_3 , 6.08. W. Hampe found that fused gallic chloride is not such a good electrical conductor as gallous chloride, and no metal separates at the cathode “evidently owing to its entering into combination with gallic chloride to form gallous chloride.” L. de Boisbaudran found that anhydrous gallic chloride is very hygroscopic; it fumes and deliquesces in air giving off hydrogen chloride. It dissolves in a little water with the evolution of much heat to form a non-crystallizable syrup; and in an excess of water, the salt is hydrolyzed, furnishing a white precipitate—oxychloride—which dissolves but slowly in dil. hydrochloric acid. A soln. of gallic chloride in dil. hydrochloric acid gives a precipitate—oxychloride—when boiled, and this redissolves as the soln. cools. If a slightly acid soln. of gallic chloride is dried at a gentle heat, it furnishes needle-like crystals and leaflets which act strongly on polarized light. Gallic chloride volatilizes slightly when repeatedly evaporated with hydrochloric acid, or aqua regia. C. Wilgerodt found that a little gallic chloride in benzene stimulates the chlorination of the benzene by chlorine.

A neutral or feebly acid soln. of gallic chloride slowly becomes turbid when allowed to stand for some time in the cold, and the reaction is rapid on heating. The product is considered by L. de Boisbaudran to be **gallic oxychloride**. He also found that a specimen of hydrated gallium chloride, prepared in 1878, and enclosed in a

sealed tube, remained unaltered for some time, but was found in 1881 to have changed to a mass of small crystals, surrounded by a liquid which had a strongly acid reaction. The crystals were small octahedrons with truncated angles, and without action on polarized light. They are only slightly soluble in water or nitric acid, but dissolve slowly in hydrochloric acid, and immediately in potash. Analysis leads to the formula $6\text{GaOCl}\cdot 14\text{H}_2\text{O}$.

L. de Boisbaudran and E. Jungfleisch found that bromine acts on gallium less vigorously than chlorine. They prepared *gallous bromide*, or **gallium dibromide**, GaBr_2 , and *gallic bromide*, or **gallium tribromide**, GaBr_3 , by processes similar to those employed for the chlorides. The properties are analogous, but the bromide is less volatile. They also found that gallium must be warmed to start the reaction with iodine; they prepared an impure *gallous iodide*, or **gallium diiodide**, GaI_2 , as a yellow crystalline mass which melts to a viscid red liquid, and *gallic iodide*, or **gallium triiodide** GaI_3 , in colourless, needle-like crystals which readily sublime. Otherwise the iodides resemble the chlorides.

REFERENCE 3.

¹ L. de Boisbaudran, *Ann. Chim. Phys.*, (6), **11**, 429, 1887; *Compt. Rend.*, **93**, 294, 329, 1881; **94**, 695, 1882; **95**, 18, 1882; L. de Boisbaudran and E. Jungfleisch, *ib.*, **86**, 578, 1878; L. F. Nilson and O. Pettersson, *ib.*, **107**, 527, 1888; C. Freidel and J. M. Crafts, *ib.*, **107**, 306, 1888; C. Freidel, *ib.*, **93**, 329, 1881; W. Hampe, *Chem. Ztg.*, **11**, 1109, 1158, 1888; L. M. Dennis and J. A. Bridgman, *Journ. Amer. Chem. Soc.*, **40**, 1531, 1918; T. W. Richards, W. M. Craig, and J. Sameshima, *ib.*, **41**, 131, 1919; C. Wilgerodt, *Journ. prakt. Chem.*, (2), **35**, 142, 1887; (2), **34**, 264, 1887; L. Meyer, *ib.*, (2), **34**, 502, 1887.

§ 8. Gallium Sulphides, Sulphates, and Nitrates

When hydrogen sulphide is allowed to act on a conc. soln. of gallic chloride in an ammoniacal soln. of ammonium tartrate, L. de Boisbaudran obtained a precipitate which he considered to be **gallic sulphide**. Hydrogen sulphide does not render turbid a slightly acid soln. of gallium chloride or sulphate; and no precipitate is obtained even if acid ammonium acetate is present. The case is quite different if a little zinc or other heavy metal is present, and L. de Boisbaudran¹ assumed, without proof, that the white precipitate formed by hydrogen sulphide in a soln. of gallium acetate containing a little zinc is a mixture of the two sulphides. He said:

The precipitation of gallium sulphide by hydrogen sulphide in the presence of salts of zinc offers a rather curious instance of the effects which are produced in a very large number of chemical reactions. If the precipitated sulphides, obtained in soln. prepared by the successive addition of zinc chloride to a soln. rich in gallium, be examined by the spectro-scope, it will be seen that they appear to remain at first almost constant, or at least to decrease slowly, then more and more rapidly until the ray $\text{Gaa } 417.1$ is no longer visible. Thus, the quantity of gallium precipitated by zinc sulphide does not seem to be a function of the conc. of the liquid. Within certain limits it seems to be almost in proportion to the amount of zinc sulphide formed. Is there not here an indication of a combination between the two substances, or perhaps more probably a surface-attraction analogous to the fixation of a colouring matter upon a mordant?

A. Dupré dissolved his gallium monoxide in sulphuric acid, and obtained a soln. which reduced permanganate, and which did not form an alum with ammonium sulphate. He therefore inferred that the soln. contained **gallous sulphate**, GaSO_4 . L. de Boisbaudran prepared **gallic sulphate**, $\text{Ga}_2(\text{SO}_4)_3 \cdot n\text{H}_2\text{O}$, by dissolving the metal, the oxide, or the hydroxide in sulphuric acid. The slow evaporation of the aq. soln., or the cooling of a conc. soln., furnishes crystals in the form of leaflets having a pearly appearance, and sometimes grouped in stars or shining masses. The salt is very soluble in water; it is not deliquescent. A neutral aq. soln. decomposes on boiling, and if the soln. is sufficiently dilute, very little gallium remains in soln.; on

cooling, the precipitate redissolves. If acetic acid be present, the boiling soln. does not become turbid. Gallic sulphate is soluble in 60 per cent. alcohol, but it is insoluble in ether. If the soln. be evaporated and dried until the evolution of white sulphuric acid vapour almost ceases, an acid gallic sulphate is formed which does not lose its solubility in water or dil. alcohol, but it requires a long time to dissolve. If heated to redness, gallic oxide is formed. L. F. Nilson and O. Pettersson found the sp. ht. is 0·1460, and the mol. ht., 61·90.

L. de Boisbaudran prepared what he called *ammonia gallium alum*, $(\text{NH}_4)_2\text{SO}_4 \cdot \text{Ga}_2(\text{SO}_4)_3 \cdot 24\text{H}_2\text{O}$, or dodecahydrated **ammonium gallic disulphate**, $\text{NH}_4\text{Ga}(\text{SO}_4)_2 \cdot 12\text{H}_2\text{O}$, by crystallization from a mixed soln. of the component salts. It crystallizes in cubes having octahedral faces, and in octahedra with cubic faces. The crystals have no action on polarized light, and they resemble in all respects the crystals of other alums. The soln. can be readily obtained in a supersaturated state; and if a small crystal be kept for some time under water to deprive it of the crystalline germs attached to its surface, and then laid in a supersaturated soln. of ordinary ammonia alum, its growth is resumed, and it determines the crystallization of the liquid. C. Soret also prepared ammonia gallium alum, as well as *potash gallium alum*, $\text{K}_2\text{SO}_4 \cdot \text{Ga}_2(\text{SO}_4)_3 \cdot 24\text{H}_2\text{O}$, or dodecahydrated **potassium gallic disulphate**, $\text{KGa}(\text{SO}_4)_2 \cdot 12\text{H}_2\text{O}$; *rubidia gallium alum*, $\text{Rb}_2\text{SO}_4 \cdot \text{Ga}_2(\text{SO}_4)_3 \cdot 24\text{H}_2\text{O}$, or dodecahydrated **rubidium gallic disulphate**, $\text{RbGa}(\text{SO}_4)_2 \cdot 12\text{H}_2\text{O}$; and *cæsia gallium alum*, $\text{Cs}_2\text{SO}_4 \cdot \text{Ga}_2(\text{SO}_4)_3 \cdot 24\text{H}_2\text{O}$, or dodecahydrated **cæsium gallic disulphate**, $\text{CsGa}(\text{SO}_4)_2 \cdot 12\text{H}_2\text{O}$, by crystallization from a soln. of the component salts. C. Soret found the sp. gr. and the refractive indices, μ , of these four gallic alums, at 15°-25°, to be :

Gallic alum	NH ₄	K	Rb	Cs
Sp. gr.	1·777	1·895	1·962	2·113
$\left. \begin{array}{l} a \\ B \\ C \\ D \\ E \\ b \\ F \\ G \end{array} \right\} \mu$	1·46390	1·46118	1·46152	1·46047
	1·46485	1·46195	1·46238	1·46146
	1·46575	1·46296	1·46332	1·46243
	1·46835	1·46528	1·46579	1·46495
	1·47146	1·46842	1·46890	1·46785
	1·47204	1·46904	1·46930	1·46841
	1·47412	1·47093	1·47126	1·47034
	1·47834	1·47548	1·47581	1·47481

There was no optical anomaly with the potash and ammonia gallic alums; the refractive index of cæsia gallic alum is smaller than that of rubidia gallic alum, a result also observed with the chromic alums. The sp. refraction of rubidia gallic alum by J. H. Gladstone is 0·2348; the molecular refraction is 269·63; and the sp. dispersion is 0·077. L. de Boisbaudran found ammonia gallic alum is soluble in water and dil. alcohol. According to L. M. Dennis and J. A. Bridgman, at 25°, 100 c.c. of a sat. aq. soln. contain 30·84 grms. of ammonia gallic alum, or 1·51 grms. of cæsia gallic alum; or one part of the ammonia or cæsia salt dissolves respectively in 3·24 and 66·2 parts of water. One part of the ammonia or cæsia salt dissolves respectively in 4600 and 25,800 parts of 50 per cent. alcohol at 25°, or 100 c.c. of the soln. contain 0·0217 and 0·00387 gm. of the respective alums. One part of ammonia gallic alum dissolves in 11,400 parts of 70 per cent. alcohol at 25°, and one part of cæsia gallic alum in 28,000 parts of 70 per cent. alcohol, or 100 c.c. of the soln. contain 0·00875 and 0·00356 gm. of the respective alums. One part of ammonia or cæsia gallic alum dissolves respectively in 620 or 4380 parts of a soln. containing 30 c.c. of water, 50 c.c. of absolute alcohol, and 15 c.c. of conc. sulphuric acid at 25°. A conc. soln. of ammonia gallic alum becomes slightly turbid on boiling, and clears completely on cooling. When the soln. is very dil. the boiling causes the formation of an abundant white precipitate; this is probably a basic salt. If filtered when hot, only traces of gallium remain in the liquid. The precipitate may then be washed over the filter, at first with boiling, then with cold water, without sensible loss of gallium, but if it is left in contact with the mother liquor it is completely redissolved

on cooling. The dil. soln. of gallium alum does not become turbid on boiling if a little sulphuric acid is added. A certain quantity of acetic acid produces the same effect; doubtless an equilibrium is then maintained between the ammonium acetate and the sulphate, and the small portion of sulphuric acid set at liberty holds the gallium sulphate in soln. If an aq. soln. be allowed to stand for some time in an open vessel, a basic salt is precipitated which rapidly dissolves in hydrochloric acid, and slowly in sulphuric acid.

Gallium carbonate has not been prepared. **Gallic nitrate**, $\text{Ga}(\text{NO}_3)_3$, is formed by dissolving the metal, oxide, or hydroxide in nitric acid; A. Dupré² prepared it by heating the metal with monohydrated nitric acid to 40° – 50° . The nitric acid soln., after being deprived of a part of its acid over the open fire, was heated in a stove to 110° , when a commencement of decomposition was manifested. The salt, partly decomposed, was then taken up in water, evaporated to a syrup on the water-bath, and placed, whilst cooling, in a desiccator. The nitrate then forms a white compact mass, very deliquescent, and giving off an odour of nitric acid, which, as well as the moisture, may be removed in a vacuum, or in a current of dry air at 40° . The dry nitrate, heated to 200° in a current of dry air, loses 63.8 per cent. of its weight; gallic oxide remains. *Gallium phosphate* has not been studied.

REFERENCES.

¹ L. de Boisbaudran, *Chem. News*, **35**. 148, 157, 167, 1877; *Ann. Chim. Phys.*, (5), **10**. 126, 1877; *Compt. Rend.*, **82**. 1098, 1876; **83**. 636, 824, 1876; **93**. 815, 1881; A. Dupré, *ib.*, **86**. 720, 1878; L. F. Nilson, *ib.*, **91**. 232, 1880; L. F. Nilson and O. Pettersson, *Ber.*, **13**. 1455, 1880; C. Soret, *Arch. Sciences Genève*, (3), **14**. 96, 1885; (3), **20**. 530, 1888; J. H. Gladstone, *Phil. Mag.*, (5), **20**. 162, 1885; L. M. Dennis and J. A. Bridgman, *Journ. Amer. Chem. Soc.*, **40**. 1531, 1918.

² A. Dupré, *Compt. Rend.*, **76**. 720, 1878.

CHAPTER XXXV

INDIUM

§ 1. The History and Occurrence of Indium

IN the summer of 1863, F. Reich and T. Richter¹ examined two zinc blendes from Freiberg. These ores had been freed from the greater part of their arsenic and sulphur by roasting, and the residue was evaporated to dryness with hydrochloric acid and distilled. The crude zinc chloride so obtained was examined with the spectro-scope for thallium since that element has been previously found in similar ores from the Freiberg mines. Instead of the thallium lines, however, they obtained an indigo-blue line. After the crude product had been purified, the spectrum showed an intense indigo-blue line, and a second fainter blue line. The new metal was named *indium* from the indigo-blue lines of its spectrum. P. E. Browning has compiled a bibliography of the literature of this element.

Indium does not occur native. According to W. Vernadsky, and W. N. Hartley and H. Ramage, the element is widely distributed, but in very minute quantities. J. H. L. Vogt and F. W. Clarke and H. S. Washington estimate that the ten-mile crust, the hydrosphere, and the lithosphere of the earth contain 0·00000000x per cent. of indium. It occurs in numerous zinc blendes. F. Reich and T. Richter reported 0·1 per cent., and T. Richter 0·025 to 0·04 per cent. in the blende from Freiberg; J. Kachler reported it in a blende from Schlaggenwald (Bohemia); N. S. Maskelyne, in a blende from Durham; C. Winkler found 0·0062 per cent. on christophite, a zinc blende from Breitenbrun (Saxony); H. B. Cornwall, F. L. Bartlett, and W. F. Hillebrand and J. A. Scherrer, in American zinc blendes; and C. Rimatori, in Sardinian zinc blendes to the extent of 0·1231 per cent. F. Reich and T. Richter found indium to follow the zinc in the extraction of the last-named element from its ores. C. Winkler found 0·0448 per cent.; and R. E. Meyer, 0·0142 per cent. G. Urbain examined the ultra-violet spectrum of 64 samples of zinc blende, and found indium to be present chiefly in those blendes containing little or no germanium. A. del Campo y Cerdan found indium in 37 of the 68 samples of zinc blende; in 29 cases he found gallium, indium, and germanium to be present; gallium and indium were present in 4 cases, and indium alone in one specimen. In no case did germanium and indium occur together in the absence of gallium. W. N. Hartley and H. Ramage have discussed the occurrence of indium in zinc blendes. R. Böttger found 0·1 per cent. of indium in the flue-dust of the Goslar zinc works; and A. Thiel, 0·2 per cent. in the flue-dust of the lead works at Clausthal. B. Delachanel and A. Mernet, P. E. Browning and H. S. Uhler, and A. Steng found indium in some zinc residues and furnace products. For an indium-gallium alloy from zinc furnaces—*vide* gallium. J. A. Tanner found indium to be contained in smithsonite from Virginia and Tennessee; A. and G. de Negri found it in calamine from Oriela (Bergamo); and J. B. Kirkland, in zinc ore from Peelwood (New South Wales). A. Thiel found indium in copper from Oker. F. Hoppe-Seyler found about 0·0228 per cent. of indium in wolframite from Zinnwald, but E. A. Atkinson did not find it in other wolfram ores. W. N. Hartley and H. Ramage examined about 168 samples of iron-ore bauxites, etc., and found indium to be present in thirty—notably the siderites, manganese ores, and tin ores. J. N. Lockyer found that indium lines are present in the solar spectrum.

REFERENCES.

¹ F. Reich and T. Richter, *Chem. News*, **8**, 236, 280, 1863; **10**, 219, 1864; *Journ. prakt. Chem.*, (1), **89**, 441, 1863; (1), **90**, 179, 1863; (1), **92**, 480, 864; C. Winkler, *ib.*, (1), **94**, 1, 1865; (1), **95**, 414, 1865; (1), **98**, 344, 1866; (1), **102**, 273, 1867; R. Böttger, *ib.*, (1), **98**, 26, 1866; J. Kachler, *ib.*, (1), **96**, 447, 1866; *Anz. Akad. Wiss.*, **2**, 192, 1865; W. Vernadsky, *Bull. Acad. St. Petersburg*, (6), **4**, 1129, 1910; (6), **5**, 187, 1007, 1911; *Centr. Min.*, **753**, 1912; G. Urbain, *Compt. Rend.*, **149**, 602, 1909; T. Richter, *ib.*, **64**, 827, 1868; *Chem. News*, **17**, 8, 1868; W. F. Hillebrand and J. A. Scherrer, *Journ. Ind. Eng. Chem.*, **8**, 225, 1916; J. A. Tanner, *Chem. News*, **30**, 141, 1874; H. B. Cornwall, *ib.*, **28**, **28**, 1373; *Amer. Chemist*, **3**, 242, 1873; **7**, 339, 1878; A. del Campo y Cerdan, *Ann. Fis. Quim.*, **12**, 80, 1914; F. Hoppe-Seyler, *Liebig's Ann.*, **140**, 247, 1866; *Bull. Soc. Chim.*, (2), **7**, 395, 1867; B. Delachanel and A. Mermet, *ib.*, (2), **25**, 197, 1876; A. Thiel, *Ber.*, **37**, 175, 1904; *Zeit. anorg. Chem.*, **39**, 119, 1904; **40**, 280, 1904; E. A. Atkinson, *Journ. Amer. Chem. Soc.*, **20**, 797, 1898; J. H. L. Vogt, *Zeit. prakt. Geol.*, **6**, 225, 314, 377, 413, 1898; **7**, 10, 274, 1899; F. W. Clarke and H. S. Washington, *Proc. Nat. Acad. Sciences*, **8**, 108, 1922; J. N. Lockyer, *Proc. Roy. Soc.*, **27**, 279, 1878; W. N. Hartley and H. Ramage, *ib.*, **60**, 399, 1897; **68**, 99, 1901; *Journ. Chem. Soc.*, **71**, 533, 1897; A. and G. de Negri, *Gazz. Chim. Ital.*, **8**, 120, 1878; P. E. Browning and H. S. Uhler, *Amer. Journ. Science*, (4), **41**, 351, 1916; R. E. Meyer, *Das Indium*, Leipzig, 1868; *Liebig's Ann.*, **150**, 137, 1869; C. Rimatori, *Atti Accad. Lincei*, (5), **13**, 1, 277, 1904; A. Streng, *Berg. Hütt. Ztg.*, **24**, 191, 1865; N. S. Maskelyne, *Nature*, **17**, 5, 1877; F. L. Bartlett, *Eng. Min. Journ.*, **48**, 342, 1889; J. B. Kirkland, *Rep. Australian Assoc. Science*, **4**, 266, 1893; P. E. Browning, *Index to the Literature of Indium*, Washington, 1905; L. Moser, *Oester. Chem. Ztg.*, **26**, 67, 1923.

§ 2. The Extraction of Indium

F. Reich and T. Richter¹ extracted indium from black blende from the Himmelfahrt mine of Freiberg, by the following process. The yield was 0.1 per cent.

Finely powdered blende is dissolved in nitric acid and the soln. treated with hydrogen sulphide. In this way copper, lead, arsenic, tin, cadmium, and molybdenum are precipitated, and then separated by filtration. The filtrate is afterwards treated with a large excess of ammonia by which the greater part of the zinc is separated in soln., and indium oxide and other metals precipitated. The washed precipitate is now dissolved in acetic acid, and this soln. again treated with hydrogen sulphides, whereby indium sulphide contaminated with some iron, zinc and manganese sulphide, is thrown down. This precipitate is dissolved in hydrochloric acid with a little nitric acid, excess of ammonia is again added, and the precipitate rapidly filtered and washed. It is advisable to repeat this operation in order to remove the last traces of zinc and manganese. On dissolving this second precipitate in acetic acid, and treating the soln. with hydrogen sulphide, a beautiful yellow precipitate of indium sulphide is obtained, which, however, still contains some iron. To separate this, the sulphide is again dissolved in hydrochloric acid, the soln. oxidized with nitric acid, and then, by the careful addition of ammonia or sodium carbonate, a small quantity of indium oxide and the iron may be thrown down. The filtrate from this precipitate on the further addition of ammonia yields pure hydrated oxide; or, if treated with sodium carbonate at a boiling heat, gives a pure indium carbonate.

L. de Boisbaudran noted that when zinc blende is roasted, most of the indium remains in the residue. C. Winkler roasted the blende to convert the indium and zinc into sulphates. The product was extracted with water, and the soln. boiled with zinc. The indium, copper, cadmium, lead, etc., are precipitated as metals. The indium is isolated as in the extraction of indium from zinc. A. R. von Schrötter, F. Stolba, P. Weselsky, C. Winkler, and E. Jungfleisch have also discussed processes for the extraction of indium from zinc blende.

T. Richter dissolved the indiferous zinc in hydrochloric acid, and treated the soln. as in the case of zinc blende. C. Winkler employed the following process:

The zinc was treated with a quantity of dil. sulphuric acid insufficient to dissolve all the metal; after standing some weeks, a spongy mass of lead, copper, arsenic, iron, indium, cadmium, and zinc remained. 10 kgrms. of metal gave 208 grms. of residue which contained 4.312 grms. of indium. The product was mixed with conc. sulphuric acid, and heated strongly so as to volatilize most of the acid. The resulting greyish-white mass was extracted with water. The sulphates of copper, cadmium, zinc, iron, and indium pass into soln. The addition of ammonia precipitates indium hydroxide contaminated with hydroxides of

iron, zinc, and cadmium. The washed precipitate was dissolved in a little hydrochloric acid, the ferric iron reduced to ferrous chloride by sulphur dioxide, and the indium hydroxide precipitated from the soln. by barium carbonate. C. Winkler also separated the iron from the indium by treating the soln. with an eq. amount of sodium chloride, and evaporating it to dryness. The product was extracted with cold water, and the soln. treated with hydrogen sulphide. To eliminate the iron, it is necessary to dissolve the indium sulphide in hydrochloric acid, and repeat the operation a number of times. The soln. is finally treated with ammonia to precipitate indium hydroxide.

The separation of indium from indiferous zinc has been discussed by R. E. Meyer, and H. Rössler and C. Wolf; from the flue-dust of zinc furnaces, by R. Böttger, F. L. Bartlett, and C. Winkler; and from the flue-dust of lead furnaces, by A. Thiel.

C. J. Bayer obtained the oxide by treating indiferous zinc with insufficient hydrochloric acid to dissolve the metal. After standing for some days, the spongy residue is washed, dissolved in nitric acid, and the soln. evaporated with a slight excess of sulphuric acid. When the filtered soln. is treated with ammonia, indium and ferric hydroxides are precipitated. The washed precipitate is dissolved in hydrochloric acid, and the nearly neutral soln. boiled with an excess of sodium hydrosulphite; a fine crystalline powder of basic indium sulphite is precipitated. The product is purified by dissolving it in sulphurous acid, and on boiling the filtered soln. the basic sulphite free from iron is again precipitated. The basic sulphite is dissolved in sulphuric acid, and indium hydroxide precipitated by the addition of ammonia. F. C. Mathers dissolved the impure hydroxide in hydrochloric acid; mixed the soln. with ammonium chloride; and precipitated with ammonia. Three or four repetitions of the operation remove the zinc, an excess of potassium thio-sulphate was added to the hydrochloric acid soln., and the mixture extracted with ether. Ferric thiocyanate was removed. The aq. soln. was treated with ammonia for indium hydroxide. C. Renz, and L. M. Dennis and W. C. Geer separated indium from iron and aluminium chlorides by treating an alcoholic soln. of the anhydrous chloride with pyridine when a colourless precipitate of indium pyridine chloride, $\text{InCl}_3 \cdot 3\text{C}_5\text{H}_5\text{N}$, was obtained; the iron and aluminium chlorides remained in soln. A. Thiel purified the oxide by transforming it into the bromide, InBr_3 , and subliming the product in a stream of carbon dioxide—the ferrous bromide remains behind. A. Thiel, and F. C. Mathers also purified indium by the fractional electrolysis of a soln. feebly acidified with nitric acid.

F. Reich and T. Richter, R. Böttger, and C. Winkler found that indium oxide can be reduced to the metal by heating it in a stream of hydrogen, or coal gas. C. Winkler obtained the metal by heating the oxide with sodium under a layer of sodium chloride. If the metal be reduced with sodium, the alloy of sodium and indium is decomposed by water, and the remaining indium is fused under a layer of sodium carbonate, or potassium cyanide; he did not recommend reducing the chloride with sodium, because of the violence of the reaction. If the oxide be reduced by heating it with carbon, so high a temp. is required that some metal is lost by volatilization. H. Rössler and C. Wolf precipitated indium by placing zinc in a soln. of the chloride. L. Schucht obtained indium by the electrolysis of soln. of the sulphate. L. M. Dennis and W. C. Geer found that indium is readily precipitated by the electrolysis of a soln. of the chloride or nitrate in pyridine, hydroxylamine, or formic acid; if oxalic acid or oxalates are present, the precipitation is incomplete; and in the presence of acetates, the deposited metal is spongy. They recommend the following process: Indium oxide is dissolved in the calculated quantity of 6*N*-sulphuric acid, and mixed with 25 c.c. of formic acid of sp. gr. 1.2, and 5 c.c. of aq. ammonia, sp. gr. 0.908. The soln. is made up to 200 c.c. and electrolyzed with a current of 9–12 amp. In the absence of formic acid, the platinum cathode is attacked. A. Thiel electrolyzed a soln. feebly acidified with nitric acid with a current of 0.8 amp. at 3 volts to precipitate the copper, lead, and antimony; after adding some ammonium sulphate, indium is deposited with a current of 5 volts. L. G. Kollock and E. F. Smith determined indium by deposition with a mercury cathode, or from warm cyanide or tartrate soln. with a rotating anode.

REFERENCES.

¹ F. Reich and T. Richter, *Journ. prakt. Chem.*, (1), **89**, 441, 1863; (1), **90**, 174, 1863; (1), **92**, 480, 1864; C. Winkler, *ib.*, (1), **94**, 1, 1865; (1), **95**, 414, 1865; (1), **98**, 344, 1866; (1), **102**, 273, 1867; R. Böttger, *ib.*, (1), **98**, 26, 1866; J. Kachler, *ib.*, (1), **95**, 441, 1865; A. R. von Schrötter, *ib.*, (1), **96**, 447, 1867; P. Weselsky, *ib.*, (1), **94**, 443, 1865; T. Richter, *Compt. Rend.*, **64**, 827, 1868; *Chem. News*, **17**, 8, 1868; L. de Boisbaudran, *Compt. Rend.*, **83**, 636, 1876; E. Jungfleisch, *Bull. Soc. Chim.*, (2), **31**, 50, 1879; F. Stolba, *Chem. News*, **22**, 312, 1870; *Dingler's Journ.*, **198**, 223, 1870; H. Rössler and C. Wolf, *ib.*, **193**, 490, 1869; *Chem. News*, **20**, 227, 1869; F. L. Bartlett, *Eng. Min. Journ.*, **48**, 342, 1889; A. Thiel, *Studien über das Indium*, Münster, 1904; *Zeit. anorg. Chem.*, **39**, 119, 1904; **40**, 286, 1889; *Ber.*, **37**, 175, 1904; F. C. Mathers, *ib.*, **40**, 1220, 1907; *Journ. Amer. Chem. Soc.*, **29**, 485, 1907; L. M. Dennis and W. C. Geer, *ib.*, **26**, 437, 1904; *Ber.*, **37**, 961, 1904; C. Renz, *ib.*, **37**, 2110, 1904; *Zeit. anorg. Chem.*, **36**, 100, 1903; *Beiträge zur Kenntnis des Indiums und Thalliums*, Breslau, 1902; L. Schucht, *Berg. Hütt. Ztg.*, **39**, 122, 1880; L. G. Kollock and E. F. Smith, *Journ. Amer. Chem. Soc.*, **32**, 1248, 1910; C. J. Bayer, *Liebig's Ann.*, **158**, 372, 1871; R. E. Meyer, *ib.*, **150**, 137, 1869; *Das Indium*, Leipzig, 1868.

§ 3. The Physical Properties of Indium

F. Reich and T. Richter¹ found indium to be a silver-white metal with a colour which C. Winkler likened to that of platinum. T. Carnelley discussed the relation between the colour of indium compounds and the position of the metal in the periodic table. A. Thiel and A. Sachs found that the electro-deposited metal furnishes octahedral **crystals** belonging to the cubic system. The crystals are isomorphous with gallium and aluminium, but not with zinc. According to E. C. Bain, and A. W. Hull, the **X-radiogram** of indium corresponds with that of the face-centred tetragonal lattice with sides 4.58 Å., and closest approach of the atoms 3.33 or 3.24 Å. According to F. Reich and T. Richter, the **specific gravity** of the metal which has been fused is 7.128 at 20.4°, while the rolled metal has a sp. gr. 7.277 at 20.4°. A. Ditte gave 7.15, and C. Winkler 7.362 (15°) for the sp. gr. of the metal; C. Winkler later gave 7.421 at 16.8°, and 7.422 for the hammered metal. A. Thiel found the sp. gr. of the crystals to be 7.12 at 13°/4°. T. W. Richards and J. H. Wilson gave 7.277 at 20°; and T. W. Richards and J. Sameshima, 7.310 at 20°; E. Donath and J. Mayrhofer discussed the at. vol. C. Winkler said that the melted metal can be frozen in a thin-walled glass tube without cracking the tube or showing any appreciable change in volume; he also said that the metal is much softer than lead, very ductile, and can be rolled to the thinnest foil. S. Bottone represented the **hardness** by 0.0984 on his scale; for lead his value is 0.057. C. A. Edwards gave 1.0 for Brinell's hardness; and 1.28 for the **plasticity** number when that of copper is 49.3. A. Thiel found that the metal is soft enough to yield under pressure by the fingers. W. C. Roberts-Austen found the **tensile strength** of indium with 0.29 per cent. of impurity to be 7.99 tons per sq. in.; the elongation on 3 ins., 26.5 per cent.; and the reduction of area at the fracture, 72 per cent. N. S. Kurnakoff and S. F. Schemtschuschny gave 3.06 kgrms. per sq. mm. for the flowing press. T. W. Richards and J. Sameshima found the **compressibility** of indium at 25° over a range from 100 to 500 megabars, to be 0.0000027, or about two-thirds that of mercury. H. Fizeau found the coeff. of **thermal expansion** to be 0.0000459. According to C. Winkler, the **melting point** is 176°, while A. Thiel gave 155° ± 1°—and W. R. Mott, 155.0°—W. Guertler and M. Pirani give this as the best representative value. According to C. Winkler, indium is less volatile than zinc or cadmium, and it shows no signs of **volatilization** when heated to the softening temperature of glass in a stream of hydrogen. A. R. von Schrötter sublimed the metal by heating it in a stream of hydrogen; and J. N. Lockyer, by heating it in vacuo. A. Ditte said the metal boils at a red heat. W. R. Mott gave 1450° for the **boiling point**. M. Lémeray, and H. F. Wiebe studied the relation between the m.p. and the thermal expansion. R. Pohl and P. Pringsheim made mirrors of indium by condensing the vapour on quartz plates. C. T. Heycock

and F. H. Neville measured the lowering of the f.p. of sodium by indium. R. W. Bunsen gave 0.05695 for the **specific heat** between 0° and 100°; D. I. Mendeléeff found 0.055. A. Ditte gave the value 37.502 Cals. for the **heat of combustion** of one eq. of indium.

According to F. Reich and T. Richter, the Bunsen flame is coloured bluish-red by indium salts and the **flame spectrum** gives two lines 4511.55 and 4101.95, Fig. 1,

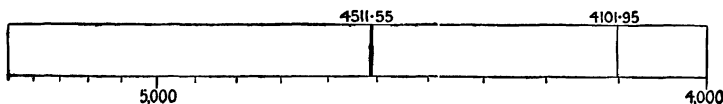

FIG. 1.—Line Spectrum of Indium.

which lie close to the violet potassium line. The 4101.95 line, however, is observed only when a large excess of indium is present. The flame spectrum does not persist very long because of rapid volatilization in the gas-flame. The spark spectrum furnishes these two lines, and in addition a number of other lines, the more important of which are 3256.22, 3039.46, 2941.39, 2890.35, 2710.39, 2306.20, etc. W. N. Hartley and H. Ramage observed a band spectrum in the oxy-hydrogen flame. According to E. Cappel, $\frac{1}{30000}$ th mgrm. of indium can be detected from the **spark spectrum** of a soln. S. Wleügl said that $\frac{1}{3000}$ th mgrm. is the smallest amount of indium which can be recognized spectroscopically. F. Hoppe-Seyler discussed the testing of minerals for indium by means of the spectroscope. Photographs of the spectra have been made by R. Capron, W. N. Hartley, etc. The flame spectrum has been studied by L. de Boisbaudran, W. N. Hartley and H. Ramage; the spark spectrum, by A. de Gramont, W. Schulemann, A. Hagenbach and H. Konen, A. R. von Schrötter, J. Müller, C. Winkler, R. Thalén, L. de Boisbaudran, A. W. Clayden and C. T. Heycock, W. N. Hartley, E. Demarçay, F. Exner and E. Haschek, and J. M. Eder and E. Valenta; the **arc spectrum**, by H. Kayser and C. Runge, H. S. Uhler and J. W. Tanch, F. Exner and E. Haschek; and the **ultra-violet spectrum**, by F. Exner and E. Haschek, J. L. Schön, etc. The **series spectra** were studied by A. Fowler, and J. A. Carroll. The effect of *temperature* has been investigated by E. Cappel; and the effect of *pressure* by J. F. Mohler, and W. J. Humphreys. The **absorption spectrum** of the vapour of indium has been studied by J. N. Lockyer and W. C. Roberts-Austen, and W. Grotrian, G. D. Liveing and J. Dewar. According to J. Formanek, soln. of colourless indium salts give no absorption spectrum; but if the soln., not too dil., is mixed with tincture of alkanna, the colour gradually becomes reddish-violet, and bands appear about 5961, 5537, and 5168. The **structure of the spectrum** has been studied by H. Kayser and C. Runge, W. Grotrian, P. G. Nutting, W. M. Hicks, F. Paschen and K. Meissner, etc. According to the former, the two subordinate series have the pairs of lines $10^8\lambda^{-1} = 44515.4 - 13908n^{-2} - 1311032n^{-4}$; $10^8\lambda^{-1} = 46728.6 - 139308n^{-2} - 1311032n^{-4}$; and $10^8\lambda^{-1} = 44535.0 - 126766n^{-2} - 643584n^{-4}$; $10^8\lambda^{-1} = 46748.2 - 126766n^{-2} - 643584n^{-4}$. The relations between the spectra of aluminium, indium, and thallium are illustrated by Figs. 26 and 27, 5. 33, 4. E. Friman studied the high frequency or **X-ray spectrum**. F. C. Blake and W. Duane, and M. Siegbahn gave in Angström units, or 10^{-8} cm. units; for the *K*-series, $a_2\alpha' = 0.515$; $a_1\alpha = 0.510$; $\beta_1\beta = 0.453$; and $\beta_2\gamma = 0.440$; for the *L*-series, D. Coster, E. Hjalmar, and M. Siegbahn gave $a_2\alpha = 3.77242$; $a_1\alpha = 3.76367$, $a_3\alpha'' = 3.74991$; $\beta_1\beta = 3.54783$; $\beta_2\gamma = 3.332$; and $\gamma_1\delta = 3.15529$. R. Pohl and P. Pringsheim studied the **photoelectric effect** of indium. F. L. Mohler and A. E. Ruark gave for the **ionization potential**, $2p_2 = 5.761$, and $2p_1 = 5.488$; and for the **resonance potential**, $2p_2 - 2p_1 = 0.273$; $2p_2 - 2s = 3.009$; and $2p_2 - 3d_{1,2} = 4.06$.

The **atomic refraction** of indium in combination was found by J. H. Gladstone to be 13.7, and later he gave 17.4. T. Erhard found the **specific resistance**, *R*, of indium wires to be 8.37×10^{-6} ohms at 0°; and A. W. Smith gave :

$R \times 10^6$	24° 9·27	80° 11·48	121° 13·09	142° 14·63	154° 29·10	181° 30·11	222° 31·87	280° 34·87
	Solid				Liquid			

or $R=0.08903(1+0.004744\theta)$ mercury units. There is a break in the curve in passing from the liquid to the solid state, and the resistance of each varies linearly with the temp., and is less with the liquid than with the solid. H. Schulze, and T. Erhard found 4.77×10^{-3} for the temp. coeff., $(dR/d\theta)R_0$, of the resistance of indium between -5.4° and 96° ; and they gave $R=8.370 \times 10^{-6}(1+0.004744\theta)$. P. W. Bridgman found 4.07×10^{-3} ; and A. W. Smith gave 5.24×10^{-3} for the temp. coeff. of the solid, and 3.98×10^{-3} for that of the liquid. W. Tuyn and H. K. Onnes showed that the metal becomes superconducting in the vicinity of 3.407° K. to 3.409° K. P. W. Bridgman observed that with indium under different press. the press. coeff. of the electrical resistance is :

°C	R	Pressure coefficient		
		0 kgrm.	12000 kgrms. per sq. cm.	Average
0°	1.0000	-0.0 ₄ 1226	-0.0 ₆ 891	-0.0 ₄ 1021
25°	1.1002	1297	896	1051
50°	1.2015	1368	911	1081

This shows that the average press. coeff. increases linearly with temp., but the increase is less than one-third as much as the increase of resistance; the departure from linearity increases at the higher temp. more rapidly than the initial resistance.

T. Erhard found that the **thermoelectric force** of indium soldered with different metals when the temp. of the cold and hot junctions are respectively 0° and 98.6° , is in the order —Al, Sn, **In**, Zn, Ag, Au, Cu, Fe +; while with the cold and hot junctions respectively 0° and 5° or 10° , the order is —Al, Sn, Au, Zn, **In**, Ag, Cu, Fe +. Indium is electronegative to zinc, and electropositive towards iron and copper; A. R. von Schrötter found indium to be more electronegative than zinc or cadmium; and A. Thiel said that the **solution pressure** of indium is from 10^2 to 10^3 atm., being between that of iron and of lead. T. Erhard found that the **electromotive force** of the cell $\text{In} | \text{InCl}_3, \text{MCl}_2 | \text{M}$, is 0.381 Daniell units for $\text{M}=\text{Zn}$; 0.160 for $\text{M}=\text{Fe}$; and 0.584 for $\text{M}=\text{Cu}$. A. Thiel measured the potential of indium—with a decinormal calomel electrode 0.620 volt—against molar, tenth-molar, and hundredth-molar soln. of indium chloride, and found it to be respectively 0.094, 0.108, and 0.119 volt at 25° . The metal is negative to the soln. According to M. Owen, indium is diamagnetic; and K. Honda said that the **magnetic susceptibility** at 18° is about -0.1×10^{-6} mass units.

REFERENCES.

- ¹ F. Reich and T. Richter, *Journ. prakt. Chem.*, (1), **89**, 441, 1863; (1), **90**, 179, 1863; (1), **92**, 480, 1864; C. Winkler, *ib.*, (1), **94**, 1, 1865; (1), **95**, 414, 1865; (1), **98**, 344, 1866; (1), **102**, 373, 1867; J. Kachler and A. R. von Schrötter, *ib.*, **95**, 447, 1866; D. I. Mendeleeff, *Bull. Acad. St. Petersburg*, (3), **16**, 445, 1870; S. Wleügl, *Zeit. anal. Chem.*, **20**, 115, 1881; A. Thiel, *Zeit. anorg. Chem.*, **40**, 286, 1904; N. S. Kurnakoff and S. F. Schemtschuschny, *ib.*, **64**, 149, 1909; A. Ditte, *Compt. Rend.*, **72**, 762, 858, 1871; **73**, 108, 1871; J. N. Lockyer, *ib.*, **89**, 514, 1879; H. Fizeau, *ib.*, **68**, 1125, 1869; M. Lémeray, *ib.*, **131**, 1291, 1900; A. de Gramont, *ib.*, **144**, 1101, 1907; **151**, 308, 1910; **159**, 5, 1914; R. W. Bunsen, *Phil. Mag.*, (4), **41**, 161, 1871; *Liebig's Ann.*, **138**, 282, 1866; *Pogg. Ann.*, **141**, 28, 1870; J. Müller, *ib.*, **124**, 637, 1865; E. Cappel, *ib.*, **139**, 628, 1870; E. Donath and J. Mayrhofer, *Ber.*, **16**, 1588, 1883; T. Carnelley, *ib.*, **17**, 2152, 1884; E. Friman, *Phil. Mag.*, (6), **32**, 497, 1916; J. H. Gladstone, *ib.*, (5), **20**, 162, 1885; (5), **35**, 204, 1893; *Proc. Roy. Soc.*, **60**, 140, 1897; *Chem. News*, **67**, 94, 1893; W. C. Roberts-Austen, *ib.*, **57**, 133, 1888; *Phil. Trans.*, **179**, 339, 1888; *Proc. Roy. Soc.*, **43**, 425, 1888; H. Ramage, *ib.*, **70**, 1, 1902; J. N. Lockyer and W. C. Roberts-Austen, *ib.*, **23**, 344, 1875; G. D. Liveing and J. Dewar, *ib.*, **27**, 132, 1878; **28**, 367, 1879; H. Wilde, *ib.*, **53**, 369, 1893; A. R. von Schrötter, *Anz. Akad. Wien*, **4**, 82, 1867; *Journ. prakt. Chem.*, (1), **95**, 442, 1865; A. Sachs, *Zeit. Kryst.*, **38**, 495, 1903; H. F. Wiebe, *Ber. deut. phys. Ges.*, **4**, 91, 1906; T. Erhard, *Wied. Ann.*, **14**, 504, 1881; A. Fowler, *Report on Series in Line Spectra*, London, 185, 1922; J. A. Carroll, *Proc. Roy. Soc.*, **103**, A, 334, 1923; W. M. Hicks, *Phil. Trans.*, **212**, A, 33, 1912; **213**, A, 323, 1913; J. L. Schön, *Wied. Ann.*, **9**, 483, 1880; **10**, 143, 1883; H. Kayser and C. Runge, *ib.*, **48**, 126, 1893; W. N. Hartley and H. Ramage, *Trans. Roy. Soc. Dublin*, (2), **7**, 339, 1901; *Phil. Trans.*, **175**, 63, 1884; W. N. Hartley,

Phil. Trans., 175. 49, 1884; *Journ. Chem. Soc.*, 41. 84, 1882; *Trans. Roy. Soc. Dublin*, (2), 1. 231, 1883; W. N. Hartley and H. W. Moss, *Proc. Roy. Soc.*, 79. A, 242, 1907; 87. A, 38, 1912; E. Demarcay, *Spectres électriques*, Paris, 1895; J. F. Möhler, *Astrophys. Journ.*, 4. 175, 1896; W. J. Humphreys, *ib.*, 6. 169, 1897; P. G. Nutting, *ib.*, 23. 64, 1906; H. S. Uhler and J. W. Tanch, *ib.*, 55. 291, 1922; H. Schulze, *Zeit. Metallkunde*, 15. 155, 1923; W. R. Mott, *Trans. Amer. Electrochem. Soc.*, 34. 555, 1918; C. T. Heycock and F. H. Neville, *Journ. Chem. Soc.*, 61. 895, 1892; J. M. Eder and E. Valenta, *Sitzber. Akad. Wien*, 118. 511, 1909; F. Exner and E. Haschek, *ib.*, 108. 1071, 1899; *Tabelle der Funkenspectra*, Wien, 1902; *Tabelle der Bogenspectra*, Wien, 1904; *Die Spektren der Elemente bei normalen Druck*, Leipzig, 1911; A. Hagenbach and H. Konen, *Atlas der Emissionsspectra*, Jena, 1905; H. Kayser, *Handbuch der Spectroscopie*, Leipzig, 5. 581, 1910; W. Schulemann, *Zeit. wiss. Phot.*, 10. 263, 1912; M. Owen, *Proc. Acad. Amsterdam*, 14. 637, 1911; *Ann. Physik*, (4), 37. 657, 1912; F. Paschen and K. Meissner, *ib.*, (4), 43. 1223, 1914; K. Honda, *ib.*, (4), 32. 1027, 1910; P. W. Bridgman, *Proc. Amer. Acad.*, 52. 573, 1917; J. Formanek, *Die Qualitative Spektralanalyse*, Berlin, 130, 1905; S. Bottone, *Amer. Journ. Science*, (3), 6. 457, 1873; A. W. Smith, *Ohio Journ. Science*, 244, 1916; R. Thalén, *Nova Acta Upsala*, (3), 6. 9, 1868; L. de Boisbaudran, *Spectres lumineux*, Paris, 1874; W. Grotrian, *Zeit. Physik*, 12. 218, 1923; A. W. Hull and W. P. Davey, *Phys. Rev.*, (2), 17. 529, 1922; A. W. Hull, *ib.*, (2), 17. 571, 1921; *Science*, (2), 52. 227, 1920; W. Guertler and M. Pirani, *Zeit. Metallkunde*, 11. 1, 1919; T. W. Richards and J. Sameshima, *Journ. Amer. Chem. Soc.*, 42. 49, 1920; R. Capron, *Photographed Spectra*, London, 1877; A. W. Clayden and C. T. Heycock, *Phil. Mag.*, (5), 2. 287, 1876; T. W. Richards and J. H. Wilson, *Zeit. phys. Chem.*, 72. 129, 1910; *Carnegie Inst. Pub.*, 118, 1909; F. Hoppe-Seyler, *Liebig's Ann.*, 140. 247, 1866; E. C. Bain, *Met. Chem. Engg.*, 25. 657, 1921; R. Pohl and P. Fringsheim, *Ber. deut. phys. Ges.*, 14. 506, 546, 1912; F. C. Blake and W. Duane, *Phys. Rev.*, (2), 10. 697, 1917; M. Siegbahn, *Jahrb. Rad. Elektron.*, 13. 296, 1916; D. Coster, *Compt. Rend.*, 174. 378, 1922; E. Hjalmar, *Zeit. Physik*, 3. 262, 1920; F. L. Mohler and A. E. Ruark, *Journ. Amer. Opt. Soc.*, 7. 819, 1923; W. Tuyn and H. K. Onnes, *Proc. Acad. Amsterdam*, 26. 504, 1923; C. A. Edwards, *Proc. Manchester Assoc. Eng.*, 225, 1919; *Journ. Inst. Metals*, 20. 61, 1918; C. A. Edwards and M. A. Herbert, *ib.*, 25. 175, 1921.

§ 4. The Chemical Properties of Indium

According to J. N. Lockyer,¹ when indium is heated in vacuo, occluded hydrogen is evolved. No *indium hydride* has been found. C. Winkler stated that when indiferous hydrochloric or sulphuric acid is treated with zinc, the evolved hydrogen does not burn with an indium-coloured flame, nor when the gas is obtained by the action of the acid on indiferous zinc or on indium. F. Reich and T. Richter found that if indium oxide is reduced by hydrogen, the issuing gas burns with a violet-blue flame; according to C. Winkler, the coloration persists if the gas be passed through dil. acids; and if the gas be confined over water for some hours, a grey film is deposited on the walls of the vessel, and the gas then burns without giving the coloration. It is probable that these effects are produced by particles mechanically suspended in the gas. The blue colour acquired by indium sesquioxide, In_2O_3 , when partially reduced in a stream of hydrogen, is attributed by A. Thiel to the formation of an intermediate oxide, InO or In_2O .

According to F. Reich and T. Richter, indium retains its lustre in **air** and even under boiling **water**. A. Thiel found that when the metal in contact with water is exposed to air, some hydroxide is formed in a few hours. The metal, however, is not affected by dry air at ordinary temp. Indium retains its lustre when heated to a temp. a little above the m.p., a film of the monoxide is then formed, and at a still higher temp., the sesquioxide is formed; at a red heat, in air, or oxygen, A. Ditte found that indium burns with a blue flame, forming indium trioxide, In_2O_3 . Indium unites directly with the **halogens** when warm; and when heated with **sulphur**, the elements unite with incandescence. F. Reich and T. Richter found that indium dissolves slowly in cold dil. **mineral acids**, but more rapidly when heated—hydrogen is evolved and a salt of the metal formed. According to C. Winkler, with conc. **sulphuric acid** in the cold, hydrogen is evolved and anhydrous indium sulphate separates out; with hot conc. sulphuric acid, sulphur dioxide is evolved; with conc. **hydrochloric acid**, the metal rapidly dissolves with the evolution of hydrogen. According to C. Winkler, the action of cold **nitric acid** is slow, rapid when heated, and nitric oxide is evolved. According to J. J. Ackworth and H. E. Armstrong,

ammonia is found among the products of reduction with nitric acid. Indium is not attacked by a soln. of potassium hydroxide. According to C. Winkler, **acetic acid** does not dissolve indium, but it is dissolved by a soln. of **oxalic acid**.

C. T. Heycock and F. H. Neville found that indium readily alloys with **sodium**; and W. C. Roberts-Austen, with **gold**. T. W. Richards and J. H. Wilson prepared **indium amalgams** and measured the sp. gr. at 20°, and the potential of conc. cells. J. H. Hildebrand studied the vap. press. of these amalgams. L. de Boisbaudran studied alloys of **gallium** and indium in the atomic proportions, In : Ga = 2 : 1, 1 : 1, 1 : 2, and 1 : 4. P. E. Browning and H. S. Uhler obtained an alloy of sp. gr. 5.95 at 20°; m.p. 29.5°; and when heated in vacuo at 1600°, the indium distills off. The alloy is only slightly attacked by acids, or alkali-lye. N. S. Kurnakoff and N. A. Puschin studied the alloys of **lead** and **tin**; and A. Thiel noted that when indium is electrolytically deposited on **platinum** an alloy is formed.

Many indium salts are readily formed by dissolving the oxide, hydroxide, or carbonate in acids. According to L. F. Nilson and O. Pettersson, indium behaves as a bi- and ter-valent element; some ill-defined univalent indium salts—halides, oxide, and sulphide—have been reported. The trivalent indium salts are alone stable in aq. soln., and, according to A. Thiel, the indium salts are much hydrolyzed in aq. soln., but to a less extent than gallium, showing that trivalent indium forms a stronger base than gallium. A. Ditte said that zinc and indium are related very intimately—the two metals occur together, and they resemble one another very closely in their analytical reactions—and in emphasizing this relationship, F. Reich and T. Richter stated that they had failed to prepare an alum, but C. Soret, P. C. Chabré and E. Rengade, and H. Rössler showed that indium alums can be readily formed.

Reactions of analytical interest.—Indium sulphate, nitrate, and chloride are colourless solids readily soluble in water. According to F. Reich and T. Richter, and C. Winkler, when the aq. soln. of an indium salt is treated with a soln. of **potassium or sodium hydroxide**, or **ammonia**, white indium hydroxide, $\text{In}(\text{OH})_3$, is precipitated; the presence of tartaric acid retards the precipitation, but G. Wyruboff noted the precipitation by alkalis does occur even in the presence of an excess of tartaric and similar acids. C. Winkler, and F. Reich and T. Richter found that the precipitate is peptized to a turbid liquid when treated with a soln. of potassium or sodium hydroxide, and when the alkaline soln. is boiled, or when treated with ammonium chloride, indium hydroxide is precipitated. The precipitate is not dissolved by aq. ammonia. According to A. Thiel and H. Kölsch, in quantitative work the precipitated hydroxide is best heated in the blast gas-flame, and weighed as sesquioxide. According to C. Renz, indium salts, like those of zinc, magnesium, and copper, are quantitatively precipitated by heating with **organic bases** like dimethylamine, guanidine, and piperidine; and L. M. Dennis and W. C. Geer obtained gelatinous indium hydroxide by treatment with a soln. of **hydroxylamine**. J. F. Spencer and M. I. Wallace found that the reaction of indium salts with **organic halides** is slower than is the case with aluminium salts. According to C. Winkler, and F. Reich and T. Richter, white gelatinous indium carbonate is precipitated by a soln. of **sodium or ammonium carbonate**; the precipitate is soluble in an excess of a soln. of ammonium carbonate, but when the soln. is boiled, indium carbonate is re-precipitated; it is not soluble in a soln. of potassium or sodium carbonate. **Sodium hydrocarbonate** behaves like the normal carbonate. When a cold soln. of an indium salt is digested with **barium carbonate**, a basic carbonate of indium is precipitated, and this enables indium to be separated from zinc, manganese, cobalt, nickel, and ferrous salts. According to C. Winkler, a soln. of **sodium hydrophosphate** gives a white voluminous precipitate which forms a turbid soln. with potassium hydroxide lye; **oxalic acid** and the **alkali oxalates** added to a conc. neutral soln. give a crystalline precipitate; R. E. Meyer found **sodium succinate and formate** behave towards neutral indium salt soln. as in the case of ferric salts—precipitation begins with the formate in the cold. According to F. Reich and T. Richter, **potassium ferrocyanide** gives a white

precipitate, and **potassium chromate** a yellow precipitate; but no precipitation occurs with soln. of **potassium ferricyanide, thiocyanate, or dichromate**. When a soln. of an indium salt is mixed with **sodium acetate**, and boiled, basic indium acetate is precipitated. F. Reich and T. Richter, and C. Winkler found that when a neutral soln. of an acetic acid soln. of an indium salt is treated with **hydrogen sulphide**, all the indium is precipitated as yellow sulphide, In_2S_3 ; soln. strongly acidified with mineral acids do not give a precipitate until they are diluted. When an alkaline soln. of an indium salt is treated with hydrogen sulphide, or when a neutral soln. is treated with **ammonium sulphide**, a white precipitate of indium hydrosulphide, or ammonium indium sulphide is formed; yellow indium sulphide becomes white and partially dissolves when boiled with yellow ammonium sulphide, and, on cooling, the soln. deposits the white precipitate. According to R. E. Meyer, colourless ammonium sulphide does not dissolve the hydrosulphide; similarly, **potassium hydrosulphide**, KHS, in excess does not dissolve the precipitate, but **potassium monosulphide**, K_2S , gives a yellow precipitate with soln. of indium salts, and the precipitate forms a colourless soln. with an excess of the reagent. This soln. is not changed by acetic acid, but a little hydrochloric acid precipitates the yellow sulphide, which dissolves when more acid is added; sulphur dioxide precipitates from the soln. white hydrosulphide mixed with some sulphur; boiling does not alter the soln.; and exposure to air results in the oxidation of the potassium monosulphide, and the precipitation of yellow sulphide. According to C. Winkler, when **sodium thiosulphate** is treated with a neutral soln. of an indium salt, a precipitate of indium sulphite and sulphur is formed, and when boiled, a basic sulphate is formed; with acid soln., sodium thiosulphate forms yellow indium sulphide, but most of the indium remains in soln.; and with acetic acid soln., all the indium is precipitated as basic sulphate. O. Brunck found **sodium hyposulphite** gives no precipitate with acid soln. of indium salts, but when boiled with neutral soln., yellow indium sulphide is precipitated. According to R. E. Meyer, **hydrocyanic acid** precipitates no cyanide from soln. of indium sulphate and the behaviour thus differs from soln. of zinc and cadmium salts; **potassium cyanide** gives a white precipitate, soluble in excess; by much dilution, the soln. is decomposed after some time, and indium hydroxide is precipitated when the dil. soln. is boiled; conc. soln. are coloured brown by this treatment owing to the formation of decomposition products of the cyanide. According to F. Reich and T. Richter, indium is precipitated from its salt soln. by **zinc or cadmium**. F. C. Mathers obtained a quantitative separation from iron by precipitation of the latter with **nitroso- β -naphthol**. A. C. Huysse used the ready formation of octahedral crystals of caesium indium alum as a *microchemical test*; and P. Kley, the formation of crystals of the double chloride of indium and rubidium or caesium. The analytical reactions of indium have been studied by I. Wada and S. Ato.²

The atomic weight of indium.—In 1864, J. A. R. Newlands³ predicted that when the eq. of indium is determined, it will be found to bear a simple relation to the elements of the group to which it will be assigned. F. Reich and T. Richter shortly afterwards obtained the value 76 on the assumption that the metal is a dyad, but D. I. Mendeléeff and L. Meyer argued that the metal must be a triad, at. wt. 114, if it is to fit naturally in the periodic table; and L. Meyer showed that if indium is a triad it likewise fits the at. vol. curve. The sp. hts. also fit Dulong and Petit's rule if the element be a triad. The indium alums are isomorphous with the corresponding alums of aluminium, gallium, and thallium. L. Benoist found that the transparency of the elements to the X-rays is independent of its state of aggregation, or temp., and whether the element is free or combined; and when the eq. transparencies of the elements are plotted against the at. wt., a hyperbolic curve is obtained. R. Benoist found that with an at. wt. about 114, the eq. transparency of indium obtained by observations on the free element and on indium acetylacetonate, fitted in the curve. The spectroscopic method of C. Runge and J. Precht for estimating at. wt. by plotting the

ordinates as logarithms of the at. wt., and the logarithms of distances apart of the pairs of series spectral lines gave W. M. Watts an at. wt. approximating 114—vide Figs. 26 and 27, 5. 33, 4. F. L. Nilson and O. Pettersson determined the vapour density of the chlorides, and obtained results in agreement with the mol. formulæ InCl , InCl_2 , and InCl_3 . According to Avogadro's rule, this makes the at. wt. of indium nearly 115. P. C. Chabrié and E. Rengade found that the raising of the b.p. of soln. of indium acetylacetonate, $\text{In}\{(\text{CH}_3\text{CO})_2 : \text{CH}\}_3$, in ethylene bromide gave a mol. wt. 405 when the theoretical value for trivalent indium is 410. C. T. Heycock and F. H. Neville measured the lowering of the f.p. of sodium, tin, lead, and bismuth by indium; the result with tin corresponded with a diatomic molecule, In_2 ; and the result with sodium, with a monatomic molecule, In . It is assumed that no complexes are formed. From the change in the electrical resistance and the thermal expansion, W. Broniewsky inferred that the molecule of indium is polyatomic. T. W. Richards and J. H. Wilson studied the e.m.f. of conc. cells of indium amalgam, and inferred that the metal is dissolved mainly in the monatomic form, though J. H. Hildebrand inferred that the solute is mainly InHg_n —probably InHg_4 .

F. Reich and T. Richter first determined the at. wt. of indium by dissolving weighed quantities of the metal in nitric acid, precipitating the soln. with ammonia and igniting the washed precipitate. From the ratio $2\text{In} : \text{In}_2\text{O}_3$ they obtained the value 111.2; and by dissolving indium sulphide in nitric acid, and precipitating the sulphate as barium sulphate, they calculated 112.0 from the ratios $\text{In}_2\text{S}_3 : \text{In}_2\text{O}_3 : 3\text{BaSO}_4$. Both results are too low. Soon afterwards, C. Winkler dissolved the metal in nitric acid, evaporated the soln. to dryness, ignited the residue, and obtained indium trioxide; from the ratio $2\text{In} : \text{In}_2\text{O}_3$, he computed the at. wt. 113.44; R. Bunsen similarly obtained 113.84; and A. Thiel, 113.73–114.01. The last-named showed that this method is not reliable because the oxide retains gaseous inclusions, and is slightly volatile. C. Winkler precipitated gold from a soln. of sodium chloroaurate, by means of indium, and from the ratio $\text{In} : \text{Au}$, computed the at. wt. 114.03. A. Thiel then analyzed the indium halides; from the ratio $\text{InCl}_3 : 3\text{AgCl}$, he computed the at. wt. 115.01; and from $\text{InBr}_3 : 3\text{AgBr}$, the at. wt. 114.83; and from the ratios $\text{In} : \text{InCl}_3$ and $\text{In} : \text{InI}_3$ he obtained respectively 115.4 and 115.3. F. C. Mathers obtained 114.834 from the ratio $\text{InCl}_3 : 3\text{AgCl}$, and 114.803 from $\text{InBr}_3 : 3\text{AgBr}$. A. Bilecky, S. E. Phillips, and G. D. Hindrichs discussed the at. wt. of indium. F. W. Clarke computed 114.864 ± 0.0040 for the best representative value; B. Brauner, 114.8; and the International Table gives 114.8. The atomic number is 49. F. W. Aston obtained no isotopes, for the element gave only one mass-spectral line corresponding with an at. wt. 115; the faint evidence of an isotope was not conclusive. According to G. Kirsch and H. Pettersson, when indium chloride is bombarded with α -rays from radium-c, no long-range particles indicating atomic disintegration are evolved; L. F. Bates and J. S. Rogers made observations on this subject.

REFERENCES.

- ¹ J. N. Lockyer, *Chem. News*, **40**, 101, 1879; *B.A. Rep.*, 317, 1879; C. Winkler, *Journ. prakt. Chem.*, (1), **94**, 1, 1865; (1), **95**, 414, 1865; (1), **96**, 344, 1866; (1), **102**, 373, 1867; F. Reich and T. Richter, *ib.*, (1), **89**, 441, 1863; (1), **90**, 179, 1863; (1), **92**, 480, 1864; H. Rössler, *ib.*, **7**, 13, 1873; J. J. Ackworth and H. E. Armstrong, *Journ. Chem. Soc.*, **32**, 54, 1877; J. F. Spencer and M. L. Wallace, *ib.*, **93**, 1832, 1909; A. Thiel, *Zeit. anorg. Chem.*, **40**, 286, 1904; *Studien über das Indium*, Münster, 1904; A. Thiel and H. Kölsch, *Zeit. anorg. Chem.*, **66**, 288, 1910; A. Ditte, *Compt. Rend.*, **72**, 762, 1871; **73**, 108, 1871; C. Renz, *Ber.*, **34**, 2763, 1901; **36**, 2751, 4394, 1903; *Beiträge zur Kenntnis des Indiums und Thalliums*, Breslau, 1902; L. M. Dennis and W. C. Geer, *ib.*, **37**, 961, 1904; O. Brunck, *Liebig's Ann.*, **336**, 281, 1904; R. E. Meyer, *Das Indium*, Leipzig, 1868; G. Wyruboff, *Bull. Soc. Min.*, **30**, 278, 1907; F. C. Mathers, *Journ. Amer. Chem. Soc.*, **30**, 209, 1908; A. C. Huysse, *Nederl. Tijds. Pharm.*, **11**, 355, 1899; *Zeit. anal. Chem.*, **39**, 9, 1900; P. Kley, *Chem. Ztg.*, **25**, 563, 1901; L. F. Nilson and O. Pettersson, *Zeit. phys. Chem.*, **2**, 657, 1888; *Journ. Chem. Soc.*, **53**, 814, 1888; P. C. Chabrié and E. Rengade, *Compt. Rend.*, **131**, 1300, 1900; **132**, 472, 1901; *Bull. Soc. Chim.*, (3), **25**, 666, 1901; C. Sorot, *Arch. Sciences Genève*, (3), **14**, 96, 1885; L. de Boisbaudran, *Compt. Rend.*, **100**, 761, 1885; N. S. Kurnakoff and

N. A. Puschin, *Journ. Russ. Phys. Chem. Soc.*, **38**, 1146, 1906; W. C. Roberts-Austen, *Phil. Trans.*, **179**, 339, 1888; **187**, 417, 1896; T. W. Richards and J. H. Wilson, *Zeit. phys. Chem.*, **72**, 129, 1910; *Carnegie Inst. Pub.*, **118**, 1909; J. H. Hildebrand, *Journ. Amer. Chem. Soc.*, **35**, 501, 1913; C. T. Heycock and F. H. Neville, *Journ. Chem. Soc.*, **57**, 385, 1890; **61**, 888, 1892; P. E. Browning and H. S. Uhler, *Amer. Journ. Science*, (4), **41**, 351, 1916.

² I. Wada and S. Ato, *Rep. Japan. Inst. Phys. Chem. Research*, **1**, 190, 1922.

³ J. A. R. Newlands, *Chem. News*, **10**, 59, 95, 240, 1864; F. Reich and T. Richter, *ib.*, **10**, 219, 1864; *Journ. prakt. Chem.*, (1), **92**, 480, 1864; H. Rössler, *ib.*, (2), **7**, 13, 1873; C. Winkler, *ib.*, (1), **94**, 1, 1865; (1), **102**, 280, 1867; W. Broniewsky, *Phys. Zeit.*, **7**, 521, 1906; A. Billeky, *Chem. Zig.*, **26**, 399, 1902; G. D. Hindrichs, *Monit. Scient.*, (4), **22**, 155, 1908; L. Benoist, *Compt. Rend.*, **124**, 146, 1897; **132**, 325, 545, 772, 1901; *Journ. Phys.*, (3), **10**, 653, 1901; C. T. Heycock and F. H. Neville, *Journ. Chem. Soc.*, **57**, 385, 1890; **61**, 888, 1892; T. W. Richards and J. H. Wilson, *Zeit. phys. Chem.*, **72**, 129, 1910; *Carnegie Inst. Pub.*, **118**, 1901; J. H. Hildebrand, *Journ. Amer. Chem. Soc.*, **35**, 501, 1913; C. Runge and J. Precht, *Phys. Zeit.*, **4**, 285, 1903; *Phil. Mag.*, (6), **5**, 476, 1903; W. M. Watts, *ib.*, (6), **8**, 279, 1906; B. Brauner, in R. Abegg, *Handbuch der anorganischen Chemie*, Leipzig, **3**, i, 378, 1906; F. W. Clarke, *A Recalculation of the Atomic Weights*, Washington, **271**, 1910; *Amer. Chem. Journ.*, **3**, 263, 1881; L. M. Dennis and W. G. Geer, *Ber.*, **37**, 961, 1904; J. Meyer, *Zeit. anorg. Chem.*, **47**, 281, 1905; S. E. Phillips, *Chem. News*, **26**, 2, 1872; F. L. Nilson and O. Pettersson, *Zeit. phys. Chem.*, **2**, 657, 1888; *Compt. Rend.*, **107**, 527, 1888; D. I. Mendeléeff, *Bull. Acad. St. Petersburg*, (4), **16**, 45, 1871; L. Meyer, *Liebigs Ann. Suppl.*, **7**, 354, 1870; L. F. Bates and J. F. Rogers, *Nature*, **112**, 435, 1923; G. Kirsch and H. Pettersson, *ib.*, **112**, 394, 1923; P. C. Chabrié and E. Rengade, *Compt. Rend.*, **131**, 1300, 1900; **132**, 472, 1901; *Bull. Soc. Chem.*, (3) **25**, 566, 1901; A. Thiel, *Ber.*, **37**, 175, 1904; *Zeit. anorg. Chem.*, **39**, 119, 1904; **40**, 280, 1904; F. C. Mathers, *Ber.*, **40**, 1220, 1907; F. W. Aston, *Nature*, **113**, 92, 1924.

§ 5. The Oxides of Indium

Indium oxidizes when heated above its m.p., and C. Winkler¹ showed that at a red heat it burns with a violet flame, forming brown flakes which deposit on the walls of the vessel as yellow **indium trioxide**, In_2O_3 , or *indium sesquioxide*; the flakes are denser than the *lana philosophica* obtained by the combustion of zinc. F. Reich and T. Richter obtained this oxide by calcining the hydroxide or the carbonate; C. Winkler, by calcining the nitrate or one of the lower oxides; and C. J. Bayer, by calcining the sulphite. The oxide prepared by calcining the nitrate retains some nitric oxide very tenaciously, and J. Meyer, and A. Thiel removed the gas by treating the oxide with water and calcining it at 950° – 1050° .

The **colour** of the oxide prepared by F. Reich and T. Richter, and C. Winkler was reddish-brown when hot, and a paler colour when cold; A. Thiel said the colour is yellow like chlorine, and a darker coloration shows that ferric oxide is present. According to C. Renz, the oxide occurs in two forms—(i) a yellow, non-crystalline, compact or powdered mass, soluble in acids; (ii) yellow trigonal **crystals** very resistant towards acids. The latter form is produced at a high temp. Boiling with sulphuric acid is a good means of separating the two forms. The trigonal crystals are isomorphous with those of ferric oxide. Needle-like crystals were obtained by A. Thiel by calcining the nitrate at a high temp. The **specific gravity** is 7.179. C. Renz said that it melts with great difficulty. J. Meyer said that the **volatilization** of the oxide begins at 900° , and the rapidity of volatilization increases as the temp. rises, but after 10 hrs. at 1100° only about 0.01 per cent. was lost. A. Thiel said that the freshly prepared oxide is more volatile at 1000° – 1450° , than if the oxide has been previously calcined. C. Renz found that the calcined oxide contains many isotropic crystals which were assumed to be those of cubic **indiosindic oxide**, In_3O_4 ; isomorphous with ferrosferric oxide, Fe_3O_4 . A. A. Read observed no change when indium oxide in a lime crucible is heated by the tip of an oxy-coal gas flame. A. Thiel and H. Kölsch showed that the alleged volatility of indium oxide, determined by the loss in weight on calcination, is really due to the loss of oxygen, $3\text{In}_2\text{O}_3 = 2\text{In}_3\text{O}_4 + \text{O}$. L. F. Nilson and O. Pettersson found the **specific heat** between 0° and 100° to be 0.0807. A. Ditte gave for the **heat of formation**, $(2\text{In}, 3\text{O}) = 239.8$ Cals.; and for the **heat of neutralization**, $\text{In}_2\text{O}_3 + 3\text{H}_2\text{SO}_{4\text{aq.}} = \text{In}_2(\text{SO}_4)_{3\text{aq.}} + 3\text{H}_2\text{O} + 72.78$ Cals. K. Angstrom, and L. F. Nilson and O. Pettersson said that the oxide is diamagnetic.

According to C. Winkler, when indium trioxide is heated to 300° in a stream of **hydrogen**, it acquires a black colour and the action then stops. The powder gives up no metal to mercury. It is assumed that the trioxide is reduced to **indium dioxide**, In_2O_2 , or InO . C. Winkler also claimed to have produced intermediate oxides, In_7O_9 , In_4O_5 , In_7O_6 , and In_6O_5 , by heating the trioxide in hydrogen to different temp. There is, however, very little to justify the inference that definite compounds are in question. C. Winkler, and A. Thiel found that when indium oxide is heated with **sulphur** or **hydrogen sulphide**, indium trisulphide, In_2S_3 , is formed. L. M. Dennis and W. C. Geer found that dry **ammonia** gas reduces the oxide at 200°–300° with some volatilization, as observed by A. Thiel. The latter found that the calcined oxide dissolves slowly in cold **acids**, but more rapidly when warmed. Hot dil. **sulphuric acid** is a good solvent. F. Reich and T. Richter found that the oxide is reduced by **carbon** in a stream of hydrogen, but, according to C. Winkler, the metal beads coalesce to a button only when a flux is present. C. Winkler reduced the oxide by heating it with **sodium** or with **magnesium**.

When indium salt soln. are treated with aq. ammonia or alkali-lye, F. Reich and T. Richter obtained gelatinous **indium hydroxide**, $\text{In}(\text{OH})_3$. R. E. Meyer found the precipitate to be soluble in an excess of alkali-lye, but again to separate from the soln. on boiling or standing; the hydroxide is but slightly soluble in aq. ammonia. L. M. Dennis and W. C. Geer found that a similar precipitate is obtained with a soln. of hydroxylamine, but not with hydroxylamine hydrochloride. C. Renz found the simple aliphatic primary and secondary amines also precipitate the hydroxide. C. J. Bayer obtained a similar precipitate by boiling a soln. of indium chloride with potassium nitrite. R. E. Meyer used the reaction with potassium cyanide—*vide supra*—in order to prepare the hydroxide free from iron. The air-dried precipitate was found by C. Winkler to have the composition $10\text{In}(\text{OH})_3 \cdot 3\text{H}_2\text{O}$; and when dried at 100°, $\text{In}(\text{OH})_3$. T. Carnelley and J. Walker found that the air-dried precipitate lost water at a rate nearly uniform up to 150° when its composition was $\text{In}(\text{OH})_3$; and the rate of loss at a higher temp. increased until the composition was $\text{InO}(\text{OH})$, without giving any evidence of the formation of a stable hydrate. Soon after passing 250°, the rate of loss abruptly diminished, and the curve became nearly vertical, showing that the last traces of water are lost very slowly. Complete dehydration occurred at 650°. The hydroxide was found by F. Stolba to be insoluble in a boiling soln. of ammonium chloride; C. Renz noted that it behaves towards amines like ferric hydroxide. P. C. Chabré and E. Rengade noted that when indium hydroxide is heated with acetyl acetone, prismatic crystals of **indium acetylacetonate**, $\text{In}\{\text{CH} : (\text{CH}_3\text{COO})_2\}$, are formed, and A. Thiel observed that the hydroxide is insoluble in ethylamine in the presence of chlorohydrates, and this enables it to be separated from aluminium hydroxide. A. Thiel also noted the analogy in the behaviour of precipitated indium and aluminium hydroxides in forming colloidal soln. when washed free from electrolytes. The soln. in aq. ammonia and dimethylamine are colloidal.

Indium hydroxide has basic properties, for, when treated with acids, salts are formed; it also possesses the properties of a weak acid, furnishing a series of **metaindates** which can be regarded as salts of monobasic **metaindic acid**, $\text{InO}(\text{OH})$, or HInO_2 . For example, C. Renz obtained **magnesium metaindate**, $\text{Mg}(\text{InO}_2)_2$, by boiling an excess of magnesia with an aq. soln. of indium trichloride, decanting the soln., and washing the precipitate with a soln. of ammonium chloride. The white powder is insoluble in water, but soluble in hydrochloric acid.

REFERENCES.

- ¹ F. Reich and T. Richter, *Journ. prakt. Chem.*, (1), **89**, 441, 1863; (1), **90**, 179, 1863; (1), **92**, 480, 1864; C. Winkler, *ib.*, (1), **94**, 1, 1865; (1), **95**, 414, 1865; (1), **98**, 344, 1866; (1), **102**, 373, 1867; F. Stolba, *Dingler's Journ.*, **198**, 223, 1870; C. J. Bayer, *Liebig's Ann.*, **158**, 375, 1871; R. E. Meyer, *ib.*, **150**, 137, 1869; *Das Indium*, Leipzig, 1868; J. Meyer, *Zeit. anorg. Chem.*, **47**, 281, 1905; A. Thiel and H. Kölsch, *ib.*, **66**, 288, 1910; A. Thiel, *ib.*, **40**, 286, 1904; **48**, 201, 1906; *Studien über das Indium*, Münster, 1904; C. Renz, *Beiträge zur Kenntnis des*

Indiums und Thalliums, Breslau, 1902; *Ber.*, **34**, 2763, 1901; **36**, 1847, 2751, 4394, 1903; **37**, 2111, 1904; L. M. Dennis and W. C. Geer, *ib.*, **37**, 961, 1904; K. Angstrom, *ib.*, **13**, 1465, 1880; L. F. Nilson and O. Pettersson, *ib.*, **13**, 1459, 1880; *Compt. Rend.*, **91**, 232, 1880; A. Ditte, *ib.*, **72**, 858, 1871; **73**, 108, 1871; A. A. Read, *Journ. Chem. Soc.*, **65**, 313, 1894; T. Carnelley and J. Walker, *ib.*, **53**, 59, 1888; P. C. Chabrié and E. Rengade, *Compt. Rend.*, **131**, 1300, 1900; **132**, 472, 1901; *Bull. Soc. Chim.*, (3), **25**, 566, 1901.

§ 6. Indium Halides

A. Thiel¹ prepared colourless rhombic pyramids of **trihydrated indium trifluoride**, $\text{InF}_3 \cdot 3\text{H}_2\text{O}$, by the evaporation on a water-bath of a soln. of indium sesquioxide in dil. hydrofluoric acid. These crystals are said to be almost dehydrated by a prolonged heating at 100° . The crystals are strongly doubly refracting. A litre of water at 25° dissolves 84 grms. of the salt. The aq. soln. decomposes when boiled, and indium hydroxide separates out: $2\text{InF}_3 + 6\text{H}_2\text{O} = 6\text{HF} + 2\text{In}(\text{OH})_3$. The fluoride is reduced to the metal when heated in a stream of hydrogen. P. C. Chabrié and A. Bouchonnet prepared white needles of **enneahydrated indium trifluoride**, $\text{InF}_3 \cdot 9\text{H}_2\text{O}$, by the slow evaporation on a water-bath of a soln. of well-washed indium hydroxide in hydrofluoric acid. The crystals fume when exposed to air; they are sparingly soluble in cold water; insoluble in alcohol and ether; and readily soluble in cold hydrochloric acid and hot nitric acid. When indium chloride is treated with an excess of ammonium fluoride, large, colourless, octahedral crystals of an **ammonium fluoindate** separate out, and the reaction has been suggested by A. C. Huysse, and P. Kley as a *microchemical test* for indium.

C. Winkler,² and L. F. Nilson and O. Pettersson prepared **indium trichloride**, InCl_3 , by passing a current of chlorine over the heated lower chlorides; F. Reich and F. Richter, by passing chlorine over the heated oxide, or better, an intimate mixture of the oxide and carbon. The product was purified by redistillation in a stream of carbon dioxide. A. Thiel prepared the trichloride by the action of moist hydrogen chloride on the metal between 120° and 320° . Indium trichloride forms white lustrous plates. A. Thiel found the sp. gr. of the solid to be 4.0. Indium trichloride does not volatilize appreciably below 440° , but readily volatilizes at about 600° . W. Odling noted that vaporization begins at a dark red heat. W. Hampe said that this chloride melts readily to a pale yellow liquid which boils at a rather higher temp. Vapour density determinations by H. Biltz, V. and C. Meyer, and by L. F. Nilson and O. Pettersson show that between 600° and 850° , the mol. wt. agrees with the formula InCl_3 , but at a higher temp., 1100° – 1200° , the vapour density falls from the theoretical value 7.58 (air unity) for InCl_3 , to 6.23, indicating that the trichloride is dissociating, probably forming a lower chloride. W. Hampe said that the electrical conductivity at the m.p. is small, but much greater at the b.p. The trichloride is very deliquescent, and C. Winkler found that it readily dissolves in water with a loud hissing noise, and the development of much heat. The aq. soln. was found by A. Thiel to be slightly hydrolyzed, but not much hydrogen chloride is lost when the aq. soln. is evaporated at 100° , but F. Reich and T. Richter obtained an insoluble **indium oxychloride** as a residue when the aq. soln. is evaporated at a high temp. A. Thiel made the oxychloride InOCl , as a white powder, very sparingly soluble in water, by the action of chlorine mixed with oxygen on indium dichloride. C. Winkler did not confirm this observation. The aq. soln. is very difficult to crystallize, the eq. conductivity of aq. soln. with three gram-eq. per litre is 10.2; with 0.003 gram-eq., 101; and with 0.0003 gram-eq., 225. A. Thiel also gave the potential of the normal electrode (-0.620 volt) against *N*-soln. as 0.094 volt; against 0.1*N*-soln., 0.108 volt; and against 0.01*N*-soln., 0.119 volt. C. Willgerodt found indium trichloride acted as a catalytic agent in chlorinating benzene.

L. M. Dennis and W. C. Geer found that when indium trichloride is vaporized in a stream of dry ammonia, a volatile white crystalline addition product, **indium aminochloride**, is formed; and R. E. Meyer dissolved indium sesquioxide in a soln. of ammonium chloride in hydrochloric acid, conc. the soln. by evaporation;

on cooling, small lustrous colourless crystals of, presumably, **ammonium tetrachloroindate**, $\text{NH}_4\text{InCl}_4 \cdot \frac{1}{2}\text{H}_2\text{O}$, were obtained. The crystals were readily soluble in water, but were not hygroscopic. R. C. Wallace obtained rhombic bipyramidal crystals of **monohydrated ammonium pentachloroindate**, $(\text{NH}_4)_2\text{InCl}_5 \cdot \text{H}_2\text{O}$, with axial ratios $a:b:c=0.9668:1:1.4005$, and sp. gr. 2.281 at 20° . R. E. Meyer similarly prepared deliquescent needles of **lithium hexachloroindate**—presumably $\text{Li}_3\text{InCl}_6 \cdot n\text{H}_2\text{O}$ —in a similar manner. By a similar process, too, R. E. Meyer prepared crystals of **dihydrated potassium hexachloroindate**, $\text{K}_3\text{InCl}_6 \cdot 1\frac{1}{2}\text{H}_2\text{O}$, or better, according to R. C. Wallace, $\text{K}_3\text{InCl}_6 \cdot 2\text{H}_2\text{O}$, in white transparent tetragonal bipyramids to which A. Fock assigns the axial ratio $a:c=1:0.8187$, and R. C. Wallace, the sp. gr. 2.483 at 20° ; the crystals have a feebly negative double refraction, and are isomorphous with the corresponding dihydrated hexabromoindate. They are easily soluble in water; and they always contain an excess of potassium chloride which crystallizes along with the indium salt. P. Kley said that the crystals are sparingly soluble in hydrochloric acid. P. Kley prepared **rubidium hexachloroindate**, $3\text{RbCl} \cdot \text{InCl}_3$, from a soln. of indium hydroxide in conc. hydrochloric acid, by adding rubidium chloride; the colourless octahedra are formed so readily that the reaction is recommended as a microchemical test for indium. R. C. Wallace prepared rhombic bipyramids of **monohydrated rubidium pentachloroindate**, $\text{Rb}_2\text{InCl}_5 \cdot \text{H}_2\text{O}$, have the axial ratios $a:b:c=0.9725:1:1.4084$, and sp. gr. 3.089 at 20° . Isomorphous crystals of **monohydrated caesium pentachloroindate**, $\text{Cs}_2\text{InCl}_5 \cdot \text{H}_2\text{O}$, with axial ratios $a:b:c=0.9841:1:1.4033$, and sp. gr. 3.350 at 20° . These crystals are isomorphous with the corresponding ammonium salt, with the corresponding chloro- and bromo-indates and thallates, and with potassium and ammonium chloroferrates— $\text{K}_2\text{FeCl}_5 \cdot \text{H}_2\text{O}$ and $(\text{NH}_4)_2\text{FeCl}_5 \cdot \text{H}_2\text{O}$. **Caesium hexachloroindate**, $3\text{CsCl} \cdot \text{InCl}_3$, is formed in a similar manner to rubidium hexachloroindate, and the reaction is even more sensitive. E. H. Ducloux recommended this as a *microchemical test* for indium.

L. de Boisbaudran, and A. Thiel prepared colourless crystals of **indium dichloride**, InCl_2 , by heating the metal in a stream of dry hydrogen chloride; the amber-yellow liquid so formed solidifies to a white crystalline mass. L. F. Nilson and O. Pettersson's value for the vapour density at 958° corresponds with the partial dissociation of the more complex molecule $\text{In}_2\text{Cl}_4 \rightleftharpoons 2\text{InCl}_2$, the dissociation is complete between 1300° and 1400° . According to A. Thiel, indium dichloride in contact with water decomposes into metallic indium and the trichloride with the intermediate formation of indium monochloride. L. F. Nilson and O. Pettersson say that indium reduces indium dichloride to **indium monochloride**, InCl , when the mixture is distilled in a stream of carbon dioxide. The dark red solid melts to a blood-red liquid. The vapour density between 1100° and 1400° corresponds with the simple formula InCl . Water decomposes indium monochloride into indium trichloride and metallic indium. C. Winkler suggested that the dark-brown mass which is formed when chlorine is passed over warm indium, just before clouds of the trichloride appear, is possibly indium subchloride.

The action of bromine on indium is analogous with that of chlorine, and three indium bromides have been reported— InBr , InBr_2 , and InBr_3 —together with **indium oxybromide**, stated by R. E. Meyer³ to be formed as an amorphous non-volatile solid by the action of bromine vapour on heated indium sesquioxide. The oxybromide is stated to be very resistant towards boiling acids and alkalis; but A. Thiel questions whether such a salt really exists. A. Thiel prepared **indium monobromide**, InBr , by passing bromine over warm indium for a short time, and heating the reddish-brown product in a stream of carbon dioxide for about an hour in contact with an excess of the metal. The liquid solidifies to a carmine-red mass which easily sublimes. Hot water decomposes it, forming indium and indium dibromide; it is easily soluble in acids—particularly when these are conc. and hot. The vapour density of indium monobromide at 1130° is 207, that calculated for InBr is 195.

While indium monobromide is the first product of the action of bromine on indium, the further action of bromine on heated indium gives a dark yellow liquid—**indium dibromide**, InBr_2 —which on solidification furnishes a horn-like mass which is almost without colour. The product can be sublimed in a stream of carbon dioxide. Water converts indium dibromide into a mixture of the tri- and mono-bromides; and, with a more prolonged contact, or when heated, into indium and indium tribromide. It is easily soluble in acids. While the vapour density of indium monobromide at 1330° is nearly normal, that of the dibromide shows that a considerable fraction is dissociated into the monobromide and bromine.

R. E. Meyer, and A. Thiel prepared **indium tribromide**, InBr_3 , by the action of bromine vapour carried by a current of carbon dioxide over heated indium. The product after many sublimations is colourless or white, and easily volatile. In general properties indium tribromide resembles the trichloride. K. Jauch found the sp. ht. of soln. of N eq. of indium bromide per litre to be :

N	.	.	.	0.5	1.0	2.0	3.0	4.0
Sp. ht.	.	.	.	0.9418	0.8922	0.8020	0.7285	0.6652

A. Heydweiller found for soln. of N gram-eq. of indium tribromide, InBr_3 , with the eq. wt. 118.19, the sp. gr., D , at 18° with respect to water at the same temp.; the sp. ht., C ; the electrical conductivity, K ; the eq. conductivity, λ ; the refractive index, μ , for the three hydrogen lines; the refraction eq. by the formula $R = M(\mu^2 - 1) / D(\mu^2 + 2)$ for sodium light; the refraction eq., R_α , for long waves; and w the eq. rotatory power for sodium light with respect to water at the same temp. :

N	.	.	0	0.1003	0.2000	0.4992	1.0038	1.9986	3.7875
K_{18}	.	.	—	0.00540	0.00935	0.01848	0.02878	0.03964	0.04185
λ	.	.	—	53.85	46.75	37.02	28.67	19.83	11.04
D	.	.	1.00000	1.00993	1.01992	1.04916	1.09822	1.19466	1.36718
C	.	.	1.000	—	—	0.9419	0.8924	0.8028	0.6786
μ_a	.	.	1.33140	—	—	1.33909	1.34670	1.36156	1.38820
μ_β	.	.	1.33739	—	—	1.34546	1.35339	1.36894	1.39684
μ_γ	.	.	1.34054	—	—	1.34890	1.35705	1.37304	1.40181
R_D	.	.	—	—	—	12.80	12.80	12.77	12.73
R_α	.	.	—	—	—	12.30	12.32	12.30	12.27
w	.	.	—	—	—	—	9.346	9.286	8.934

The mono- and di-halides of indium are unstable in aq. soln. and change into the trihalide and metal. This is symbolized in terms of the ionic hypothesis: $3\text{In}' \rightleftharpoons \text{In}''' + 2\text{In}$; and $3\text{In}'' \rightleftharpoons 2\text{In}''' + \text{In}$. In addition, the salts are appreciably hydrolyzed in aq. soln. Like the cadmium halides, the indium trihalides form complex anions. The abnormally low values for the eq. conductivities of these salts in conc. soln. are taken as evidence of the formation of complex anions. F. Kohlrausch plotted what he called *die lineare Konzentration*, that is, N^\dagger , as a function of the eq. conductivity, as indicated in Fig. 2; these curves emphasize the low values for conc. soln. of cadmium and lithium bromides which form complexes, when contrasted with the normal value for cadmium chlorate which does not form complex ions.

R. C. Wallace has prepared a number of complex bromides. The alkali bromoindates of the series, $\text{M}_2\text{InBr}_5 \cdot \text{H}_2\text{O}$, form rhombic bipyramids—for example, **monohydrated ammonium pentabromoindate**, $(\text{NH}_4)_2 \cdot \text{InBr}_5 \cdot \text{H}_2\text{O}$, has the sp. gr. 3.167 at 20° ; the rhombic crystals of **monohydrated rubidium pentabromoindate**, $\text{Rb}_2 \cdot \text{InBr}_5 \cdot \text{H}_2\text{O}$, have the axial ratios $a : b : c = 0.9803 : 1 : 1.3951$, and the sp. gr. 3.409 at 20° ; and **monohydrated caesium pentabromoindate**, $\text{Cs}_2 \cdot \text{InBr}_5 \cdot \text{H}_2\text{O}$, the axial ratios $0.9734 : 1 : 1.4180$, and the sp. gr. 3.776 at 20° . These salts are isomorphous with the

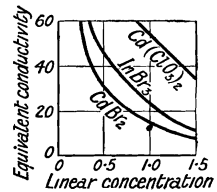

FIG. 2.—Equivalent Conductivity and Linear Concentration of Solutions of Indium and Cadmium Bromides.

corresponding chloroindates, chlorothallates, and chloroferrates, $(\text{NH}_4)_2\text{FeCl}_5 \cdot \text{H}_2\text{O}$. There are also tetragonal crystals of **dihydrated potassium hexachloroindate**, $\text{K}_3\text{InBr}_6 \cdot 2\text{H}_2\text{O}$, with a sp. gr. 3.140 at 20° , and isomorphous with the corresponding chloroindates, chlorothallates, and bromothallates.

Iodine unites directly with indium, and much heat is developed. R. E. Meyer, and A. Thiel prepared **indium triiodide**, InI_3 , by passing iodine vapour, in a stream of carbon dioxide, over heated indium. R. E. Meyer said that indium triiodide forms yellow hygroscopic crystals which, at about 199° , readily melt to a reddish-brown liquid which cools to a yellow crystalline mass. Indium triiodide can be slowly distilled in a stream of carbon dioxide at a high temp., but A. Thiel said that the salt dissociates at the high temp. of the distillation, forming iodine and one of the lower indium iodides. Indium triiodide is soluble in a small proportion of water or alcohol, forming a yellowish-brown soln. which, on the addition of more water or alcohol, forms a red emulsion, or a red powder. Chloroform gives a colourless soln.; and xylene, a yellow soln. A. Thiel reported the probable formation of *indium chloroiodide* when indium triiodide is treated with chlorine.

A. Thiel and H. Kölsch⁴ measured the f.p. of fused mixtures of indium and iodine, and obtained the curve shown in Fig. 3, where the f.p. of mixtures with one gram-atom of indium are plotted against composition. There is a definite maximum in the curve corresponding with the formation of **indium diiodide**, InI_2 , melting at about 212° . The diiodide has not been definitely isolated since, when the attempt is made to prepare it by fusing together the elements, and distilling the product, the molten iodide dissociates largely into the mono- and triiodides: $2\text{InI}_2 = \text{InI} + \text{InI}_3$.

A. Thiel and H. Kölsch prepared **indium monoiodide**, InI , by heating iodine with an excess of indium, Fig. 3. Small quantities should be used, or the reaction carried out in an atm. of carbon dioxide.

The product is then distilled in an atm. of carbon dioxide at 700° ; indium monoiodide is also formed by the repeated distillation of the triiodide in an atm. of hydrogen. The brownish-red solid melts at 351° , and boils at about 700° . It is not decomposed by hot water, but in contact with air, oxidation takes place according to the equation: $2\text{InI} + 3\text{H}_2\text{O} + \text{O}_2 = 2\text{In}(\text{OH})_2 + 2\text{HI}$. This reaction is slow with cold water, and the hydroxide is obtained in colloidal soln.; with hot water, the hydroxide is in a more granular form easily filtered. Sulphur dioxide converts it into indium sulphide, In_2S_3 ; and hydrogen sulphide into indium sulphide and indium triiodide. Indium monoiodide dissolves in dilute acids with the evolution of hydrogen; it is insoluble in alcohol, ether, and chloroform.

REFERENCES.

¹ A. Thiel, *Zeit. anorg. Chem.*, **40**, 280, 1904; P. C. Chabré and A. Bouchonnet, *Compt. Rend.*, **140**, 90, 1905; A. C. Huysse, *Nederl. Tijds. Pharm.*, **11**, 355, 1899; *Zeit. anal. Chem.*, **39**, 9, 1900; P. Kley, *Chem. Ztg.*, **25**, 563, 1901.

² C. Winkler, *Journ. prakt. Chem.*, (1), **102**, 283, 1867; C. Willgerodt, *ib.*, (2), **35**, 142, 391, 1887; F. Reich and T. Richter, *ib.*, (1), **89**, 441, 1863; (1), **90**, 175, 1863; (1), **92**, 480, 1864; L. F. Nilson and O. Pettersson, *Zeit. phys. Chem.*, **2**, 657, 1888; *Compt. Rend.*, **107**, 527, 1888; A. Thiel, *Ber.*, **37**, 175, 1904; *Zeit. anorg. Chem.*, **39**, 119, 1904; **40**, 280, 1904; C. Renz, *ib.*, **36**, 104, 1903; *Ber.*, **37**, 2111, 1904; H. Biltz, *ib.*, **21**, 2770, 1888; L. M. Dennis and W. C. Geer, *ib.*, **37**, 961, 1904; V. and C. Meyer, *ib.*, **12**, 612, 1879; E. H. Ducloux, *Anal. Assoc. Quim. Argentina*, **9**, 215, 1921; K. Jauch, *Zeit. Physik*, **4**, 441, 1920; W. Odling, *Chem. News*, **25**, 42, 1872; W. Hampe, *Chem. Ztg*, **11**, 1109, 1887; P. Kley, *ib.*, **25**, 563, 1901; R. E. Meyer, *Liebig's Ann.*, **150**, 137, 1869; L. F. Nilson, *Ber.*, **9**, 1052, 1142, 1876; A. Fock, *Zeit. Kryst.*, **6**, 174, 1882; R. C. Wallace, *ib.*, **49**, 417, 1911; A. Thiel, *Ber.*, **37**, 175, 1904; *Zeit. anorg. Chem.*, **39**, 119, 1904; **40**, 280, 1904; L. de Boisbaudran, *Compt. Rend.*, **100**, 701, 1885.

³ A. Thiel, *Zeit. anorg. Chem.*, **40**, 328, 1904; A. Heydweiller, *ib.*, **88**, 103, 1914; R. E. Meyer,

Liebig's Ann., **150**, 137, 1869; R. C. Wallace, *Zeit. Kryst.*, **49**, 417, 1911; K. Jauch, *Zeit. Physik.*, **4**, 441, 1921; F. Kohlrausch, *Wied. Ann.*, **26**, 161, 1885; **50**, 385, 1893.

⁴ A. Thiel, *Zeit. anorg. Chem.*, **40**, 280, 1904; A. Thiel and H. Kölsch, *ib.*, **66**, 238, 1910; R. E. Meyer, *Liebig's Ann.*, **150**, 137, 1869.

§ 7. Indium Sulphides

According to C. Winkler,¹ sulphur and indium can be triturated together at 200°, without combining, but union occurs with incandescence at a red heat. A. Thiel made **indium trisulphide**, In_2S_3 , by heating indium with an excess of sulphur in a sealed tube at about 500°; and he obtained scarlet-red lustrous crystals by heating indium trioxide in a stream of hydrogen sulphide. According to F. Reich and T. Richter, and R. E. Meyer, indium sulphide is formed when a soln. of an indium salt is treated with potassium monosulphide, K_2S , or a feebly acid soln. with hydrogen sulphide. The precipitation is prevented by mineral acids except when the acidity is very slight; but with acetic acid soln. the precipitation is complete, and much sulphur is at the same time separated. C. Winkler stated that one part of indium dissolved in 30 parts of conc. hydrochloric acid, and diluted with at least 2000 parts of water, is completely precipitated by hydrogen sulphide. He also prepared lustrous yellow crystals of the sulphide by heating an intimate mixture of indium trioxide, sulphur, and sodium carbonate for some time at a red heat, and extracting the soluble matters with hot water. O. Brunck boiled a neutral soln. of an indium salt with sodium thiosulphate and obtained a precipitate of indium sulphide, but in the absence of free acids, the precipitation is not complete. C. Winssinger, and S. E. Linder and H. Picton prepared a **colloidal sol** of indium trisulphide by passing hydrogen sulphide into water in which indium hydroxide is suspended. The golden-yellow sol may be boiled to remove the excess of hydrogen sulphide without flocculation, but the addition of an electrolyte—acetic acid, ammonium chloride, and salts generally—coagulates the sulphide.

Indium sulphide appears in yellow or orange plates; in more or less impure brown crystalline masses; and as a yellow colloid. According to C. Winkler, and A. Thiel, the sulphide is not volatile at a red heat, but when roasted in air, it is ultimately converted into the trioxide. Indium sulphide is soluble in conc. mineral acids. F. Hoppe-Seyler used the sulphide for the spectroscopic detection of indium in ores. When the trisulphide is heated to redness in a stream of hydrogen, A. Thiel and H. Kölsch found a dark yellowish-brown sublimate of **indium monosulphide**, In_2S , is produced in minute needle-like crystals. It melts when heated in the absence of air, forming a dark brown liquid, which in air passes into the trisulphide and trioxide. It is readily dissolved by acids, and A. Thiel studied the action of bromine water and hydrogen peroxide. A. Thiel and H. Kölsch prepared a soft reddish-brown mass of **indium disulphide**, In_2S_2 , or InS , by heating the metal in a stream of hydrogen sulphide.

According to S. E. Linder and H. Picton, when hydrogen sulphide is passed over indium hydroxide, the colour remains white for ten minutes and then gradually changes to a pale yellow; it is supposed that the white product is normal **indium hydrosulphide**, $\text{In}(\text{HS})_3$. A similar white sulphide was obtained by C. Winkler, by treating indium trisulphide with ammonium hydrosulphide. According to F. Reich and T. Richter, a white precipitate is formed when ammonium sulphide is added to an ammoniacal soln. of an indium salt mixed with tartaric acid, or, according to C. Winkler, to a neutral soln. of an indium salt. The last-named also made it by passing hydrogen sulphide into a soln. obtained by adding an excess of ammonium carbonate to an indium salt; or by cooling a boiling soln. of indium sulphide in ammonium polysulphide. R. E. Meyer made it by treating a soln. of an indium salt with potassium hydrosulphide. When washed and dried, it gives off hydrogen sulphide and becomes yellow. The first action of acids is to change it to the yellow sulphide, before it dissolves. It is possible that the white precipitate produced by the alkali sulphide is a hydrated alkali indium sulphide; and that with ammonium

sulphide, a hydrated ammonium indium sulphide. R. Schneider obtained **potassium sulphoindate**, $KInS_2$, or $K_2S.In_2S_3$, by melting together indium trioxide, potassium carbonate, and sulphur in the proportions 1 : 6 : 6, and extracting the mass with water. The insoluble, hyacinth-red, quadratic plates were stable in air. The salt is partly oxidized when heated in air; it is not reduced by hydrogen at a red heat; it is decomposed by acids; and it is coloured brown by a soln. of silver nitrate owing to the formation of **silver sulphoindate**, $AgInS_2$. By substituting sodium carbonate for potassium carbonate in the process just described and extracting the mass with cold water, a soln. is obtained which slowly deposits dihydrated **sodium sulphoindate**, $NaInS_2.H_2O$, or $Na_2S.In_2S_3.2H_2O$.

REFERENCES.

¹ F. Reich and T. Richter, *Journ. prakt. Chem.*, (1), **89**, 441, 1863; (1), **90**, 179, 1863; (1), **92**, 480, 1864; C. Winkler, *ib.*, (1), **94**, 1, 1865; (1), **95**, 414, 1865; (1), **98**, 344, 1866; (1), **102**, 373, 1867; R. Schneider, *ib.*, (2), **9**, 216, 1874; F. Hoppe-Seyler, *ib.*, (1), **100**, 381, 1867; *Liebig's Ann.*, **140**, 247, 1866; O. Brunck, *ib.*, **336**, 281, 1904; R. E. Meyer, *ib.*, **150**, 137, 1869; *Das Indium*, Leipzig, 1868; A. Thiel, *Zeit. anorg. Chem.*, **40**, 324, 1904; A. Thiel and H. Kölsch, *ib.*, **66**, 288, 1910; C. Winssinger, *Bull. Acad. Belg.*, (3), **15**, 390, 1888; *Bull. Soc. Chim.*, (2), **49**, 452, 1888; S. E. Linder and H. Picton, *Journ. Chem. Soc.*, **61**, 114, 1892.

§ 8. Indium Sulphates

The soln. obtained by dissolving indium oxide, hydroxide, or carbonate in sulphuric acid can be evaporated to a thick syrup without crystallization. R. E. Meyer¹ found that if the acid-liquor is allowed to stand in a desiccator for a long time a deliquescent crystalline mass of hydrated **indium hydrosulphate**, $In_2(SO_4)_3.H_2SO_4.8H_2O$, or $InH(SO_4)_2.4H_2O$, is produced. According to C. Winkler, if the acid soln. be heated so as to remove the excess of acid, a gum-like mass is obtained, which, when dried at 100°, has a composition corresponding with ennea-hydrated **indium sulphate**, $In_2(SO_4)_3.9H_2O$; while if the acid soln. be evaporated to dryness, a white powder is obtained which appears to be a basic sulphate. According to A. Thiel, the hydrated salt intumescens when gradually heated to 250°–300°, and forms a white froth. F. Reich and T. Richter, and C. Winkler obtained small, white, opaque crystals of indium sulphate by concentrating an acid soln. According to L. F. Nilson and O. Pettersson, the sp. gr. is 3.438; and the sp. ht. 0.129 between 0° and 100°. A. Ditte gave 49.039 Cals. as the heat of formation by the dissolution of a gram-eq. of indium in sulphuric acid, and for $In_2O_3 + 3H_2SO_{4aq.} = In_2(SO_4)_{3aq.} + 3H_2O + 72.78$ Cals.

A number of complex indium sulphates has been prepared. The ammonium, rubidium, and cesium indium alums have been reported; F. Reich and T. Richter, H. Rössler, and R. E. Meyer failed to make the lithium, sodium, and potassium indium alums. H. Rössler prepared *ammonium indium alum*, or dodecahydrated **ammonium disulphatoindate**, $(NH_4)_2SO_4.In_2(SO_4)_3.24H_2O$, or $NH_4In(SO_4)_2.12H_2O$, by slow crystallization from a conc. soln. of the constituent sulphates. *Rubidium indium alum*, or dodecahydrated **rubidium disulphatoindate**, $RbIn(SO_4)_2.12H_2O$; and *cesium indium alum* or dodecahydrated **cesium disulphatoindate**, $CsIn(SO_4)_2.12H_2O$, were prepared by P. C. Chabrié and E. Rengade in a similar manner. The crystals are regular octahedrons. The crystals of the ammonium salt have no inclination to effloresce in air, but those of the rubidium and cesium salts do so. C. Soret gave 2.011 for the sp. gr. of the ammonium indium alum; 2.065 for the rubidium salt; and 2.241 for the cesium salt. The m.p. of the rubidium salt is 42° (J. Locke); and that of the ammonium salt 36°, according to H. Rössler, and 37°–38°, according to C. Soret. H. Rössler found that the m.p. of the ammonium salt is also a transition temp., $NH_4In(SO_4)_2.12H_2O \rightleftharpoons NH_4In(SO_4)_2.4H_2O + 8H_2O$; the resulting **tetrahydrated ammonium disulphatoindate** is also obtained by crystallization from a soln. of the alum at 36°. C. Soret found the indices of refraction, μ , of these three alums between 17° and 21° to be:

	G-	F-	b-	E-	D-	C-	B-	α -line
λ	4310	4860	5170	5270	5890	6560	6860	7180
$\left\{ \begin{array}{l} \text{NH}_4 \\ \text{Rb} \\ \text{Cs} \end{array} \right.$	1.47750	1.47234	1.47015	1.46953	1.46636	1.46352	1.46259	1.46193
	1.47402	1.46955	1.46751	1.46694	1.46381	1.46126	1.46024	1.45942
	1.47562	1.47105	1.46897	1.46842	1.46522	1.46283	1.46170	1.46091

The solubility of indium ammonium sulphate in grams of salt per 100 grms. of water was given by H. Rössler as about 200 at 16° and about 400 at 30°; P. C. Chabrié and E. Rengade gave for the rubidium salt 44.28 at 15°; and for the caesium salt, 3.04 at 16.5°, and J. Locke gave 11.73 at 25°. H. Rössler, and P. C. Chabrié and E. Rengade found that the aq. soln. have an acid reaction owing to hydrolysis, and when heated, they become turbid owing to the separation of basic sulphates, and in the case of the caesium salt, indium hydroxide. H. Rössler said that the ammonium salt is insoluble in alcohol.

Salts analogous to tetrahydrated ammonium disulphatoindate—*vide supra*—were prepared by H. Rössler when he attempted to make the sodium and potassium indium alums. The aq. soln. of H. Rössler's tetrahydrated **sodium disulphatoindate**, $\text{NaIn}(\text{SO}_4)_2 \cdot 4\text{H}_2\text{O}$, or $\text{Na}_2\text{SO}_4 \cdot \text{In}_2(\text{SO}_4)_3 \cdot 8\text{H}_2\text{O}$, and tetrahydrated **potassium disulphatoindate**, $\text{KIn}(\text{SO}_4)_2 \cdot 4\text{H}_2\text{O}$, or $\text{K}_2\text{SO}_4 \cdot \text{In}_2(\text{SO}_4)_3 \cdot 8\text{H}_2\text{O}$, became turbid when boiled. With the potassium salt, H. Rössler obtained the basic salt: $\text{KIn}(\text{SO}_4)_2 \cdot 2\text{In}(\text{OH})_3$, **potassium hexahydroxydisulphatoindate**.

REFERENCES.

¹ F. Reich and T. Richter, *Journ. prakt. Chem.*, (1), **89**. 441, 1863; (1), **90**. 179, 1863; (1), **92**. 480, 1864; C. Winkler, *ib.*, (1), **94**. 1, 1865; (1), **95**. 414, 1865; (1), **98**. 344, 1866; (1), **102**. 373, 1867; H. Rössler, *ib.*, (2), **7**. 18, 1873; A. Thiel, *Zeit. anorg. Chem.*, **40**. 324, 1904; R. E. Meyer, *Das Indium*, Leipzig, 1868; *Liebig's Ann.*, **150**. 137, 1869; L. F. Nilson and O. Pettersson, *Ber.*, **13**. 1462, 1880; *Compt. Rend.*, **91**. 232, 1880; A. Ditte, *ib.*, **72**. 762, 1871; **73**. 108, 1871; P. C. Chabrié and E. Rengade, *ib.*, **131**. 1300, 1900; **132**. 472, 1901; *Bull. Soc. Chim.*, (3), **25**. 566, 1901; J. Locke, *Amer. Chem. Journ.*, **26**. 166, 1901; C. Soret, *Arch. Sciences Genève*, (3), **10**. 300, 1883; (3), **12**. 553, 1884; (3), **13**. 5, 1885; (3), **20**. 520, 1888.

§ 9. Indium Carbonate, Nitrate, and Phosphate

According to F. Reich and T. Richter,¹ white crystalline **indium carbonate** is precipitated from a soln. of an indium salt by the addition of an alkali carbonate. When calcined, the oxide is formed. According to C. Winkler, the carbonate is insoluble in soln. of potassium or sodium carbonate, but soluble in one of ammonium carbonate; when this soln. is boiled the carbonate is again precipitated.

A soln. of indium nitrate is formed by the action of nitric acid on indium oxide, hydroxide, or carbonate; the neutral soln. crystallizes with great difficulty, and when evaporated in a desiccator, it forms a syrupy liquid from which thin deliquescent plates of trihydrated **indium nitrate**, $\text{In}(\text{NO}_3)_3 \cdot 3\text{H}_2\text{O}$, can be obtained; the acid soln. furnishes groups of acicular or columnar crystals. A mol. of the salt loses two mols. of water at 100°; at a higher temp., nitric acid is given off and a basic nitrate is produced; and at a still higher temp., the oxide is produced. The retention of occluded gases by the calcined nitrate is discussed in connection with the oxide. L. M. Dennis and W. C. Geer prepared white ammonium nitrateindate, by crystallization from a mixed soln. of ammonium and indium nitrates.

C. Winkler found that indium salt soln. give a white precipitate with soln. of sodium hydrophosphate. The soln. of **indium phosphate** in potash-lye soon becomes turbid.

REFERENCES.

¹ F. Reich and T. Richter, *Journ. prakt. Chem.*, (1), **89**. 441, 1863; (1), **90**. 179, 1863; (1), **92**. 480, 1864; C. Winkler, *ib.*, (1), **94**. 1, 1865; (1), **95**. 414, 1865; (1), **98**. 344, 1866; (1), **102**. 373, 1867; L. M. Dennis and W. C. Geer, *Ber.*, **37**. 962, 1904; *Journ. Amer. Chem. Soc.*, **26**. 437, 1904.

CHAPTER XXXVI

THALLIUM

§ 1. The History and Occurrence of Thallium

At the beginning of 1861, W. Crookes¹ extracted selenium from the seleniferous deposit of a sulphuric acid factory at Tilkerode in the Harz. The residue remaining after distillation was supposed to contain tellurium, but, when examined spectroscopically, a bright green line was observed; this was attributed to the presence of a new element which was named **thallium**, "from the Greek *θαλλός*, or Latin *thallus*, a budding twig—a word which is frequently employed to express the beautiful green tint of young vegetation; and which I have chosen because the green line which it communicates to the spectrum recalls with peculiar vividness the fresh colour of vegetation in spring." This discovery was announced in a paper on March 30, 1861: *On the existence of a new element, probably of the sulphur group*. About a year later, A. Lamy observed the green spectral line from the chamber deposit of the sulphuric acid works at Loos where Belgian pyrites were roasted. He established the metallic nature of thallium, and on May 16, 1862, he described the chemical and physical properties of *le nouveau métal*. He showed that thallium forms at least two series of compounds, and that one series of compounds closely resembles the analogous compounds of the alkali metals, and the other, those of lead. Soon afterwards numerous investigations were made on the properties of thallium and its compounds. There has been some discussion of the priority of the discovery of thallium. W. Crookes at first regarded thallium as a homologue of selenium; but A. Lamy recognized its metallic nature and its relations with lead, and with the alkali metals. A. Lamy consequently claimed, as G. Urbain puts it, that thallium did not belong to the tellurium group; that the reactions cited by W. Crookes were illusory; that the green line emanated from an impurity in the materials; and that he himself, not W. Crookes, was the discoverer of thallium. The weighing of the evidence on both sides, shows that W. Crookes is to be regarded as the discoverer of this element; and that the green spectral line is a veritable characteristic of this element. H. L. Wells and S. L. Penfield raised the question whether thallium is a mixture of the two alkali metals with at. wts. 170 and 220 which are missing in the periodic table; but the results of their experiments were nugatory. No element other than thallium could be obtained by the fractional crystallization of the nitrate. V. Meyer has also discussed the elementary nature of thallium. M. Doan has compiled a bibliography of the literature on this element.

Thallium does not occur free. J. H. L. Vogt² estimated the ten-mile crust, the hydrosphere, and lithosphere of the earth contained 0.0000000x per cent. of thallium; and F. W. Clarke and H. S. Washington, 0.0000000x per cent. According to H. A. Rowland, the solar spectrum shows no sign of the presence of thallium. The element is an essential constituent of some very scarce minerals which W. Vernadsky said are always of a secondary character and appear to have been formed by the weathering or decomposition of selenium or sulphur compounds. In these minerals, thallium seems to be isomorphically associated with the alkali metals in many aluminosilicates, sulphates, and chlorides; and with silver or lead in selenides and sulphides. A. E. Nordenskjöld found the non-crystalline mineral

crookesite from Skrikerum (Sweden) has a composition approximating $(\text{Cu, Tl, Ag})_2\text{Se}$ with 16.27 to 18.55 per cent. of thallium; J. A. Krenner and J. Loczka, and V. M. Goldschmidt found *lorandite*, TlAsS_2 , from Allchar (Macedonia) had 59.51 per cent. of thallium. It was associated with realgar, and the monoclinic crystals had the axial ratios $a:b:c=1.3291:1:1.0780$, and $\beta=52^\circ 71'$. R. H. Solly, and G. F. H. Smith found *hutchinsonite* in the dolomite of Lengenbach (Binnental) is a sulphoarsenide of thallium, lead, silver, and copper approximating $(\text{Tl, Ag, Cu})_2\text{S.PbS.2As}_2\text{S}_3$, with about 20 per cent. of arsenic; and B. Jezek, and F. Krehlik found that the composition of *urbaite*, from Allchar (Macedonia), approximates $\text{TlAs}_2\text{SbS}_5$, with 29–30 per cent. of thallium. It occurs in small, deep red, translucent, rhombic crystals with axial ratios $a:b:c=0.5659:1:0.4836$.

W. N. Hartley and H. Ramage found spectroscopic indications of thallium in many rocks, and it occurs in a number of minerals as a secondary constituent. Thus, W. Crookes found it in many cupriferous pyrites; W. Vernadsky, in pyrites and marcasite; A. Lamy, in pyrites from Theux, Namur, Phillippeville, Alais, Nantes, Spain, and Bolivia; E. Carstanjen, in pyrites from Meggen; J. W. Gunning, in pyrites from Ruhrort; J. Antipoff, in pyrites from Poland to the extent of 0.3 to 0.5 per cent. thallium; L. Marquardt, in pyrites from Altenhuden; and L. J. Igelström, in the hematite (iron glance) of Sjögrube (Orebro). A. R. von Schrötter found up to 0.006 per cent. of thallium in the lepidolite of Mähren, and in the mica of Zinnwald. C. F. Schönbein also found thallium in lepidolite; W. Vernadsky, also, in lepidolite from Lipowka, in muscovite from Mursinka, zinnwaldite (lithia-mica) from Zinnwald, and Onon; and orthoclase from Mursinka. F. L. Bartlett found thallium in the zinc blende of Leadville, and F. von Kobell in the zinc blende of Geroldseck (Breisgau); F. Exner and E. Haschek, in Cornish pitchblende; E. Linnemann, in the orthite of Arendal; A. de Gramont, in berzelinite, Cu_2Se , and in frenzelite, Bi_2Se_3 ; F. Bischoff found one per cent. of thallium, and T. L. Phipson, 0.01 per cent. of thalious oxide in samples of pyrolusite; W. Vernadsky, in manganite; W. T. Röppler, in pyritiferous anthracite; O. Vogel, in pitchblende from Johanngeorgenstadt; W. Vernadsky, in some uranium and platinum ores. L. Palmieri found thallium and lithium in the sublimation products of a crater of Vesuvius, and A. Cossa found thallium in the breccia of the lava in the island of Valkano. J. Schramm reported thallium and rubidium, but no caesium in the carnallite of Kalusz (Galica), thallium only in the sylvine, and none of these three elements in the kainite. F. Hammersbacher found thallium in the carnallite of Stassfurt, but more in the sylvine. A. Cossa found traces of thallium in the potash alum of the Island of Volcano. R. Böttger found thallium, rubidium, and caesium in the mineral waters of Nauheim, Orb, and Dürrenberg; E. Ludwig and J. Mauthner found thallium in the waters of Carlsbad; and G. J. Mulder, in those of Java.

Thallium also occurs in products derived from thalliferous ores. For instance, W. Crookes found it in the lead chamber deposits of Tilkerode; A. Lamy, in those of Loos; and R. Böttger, in those of Oker, where it is derived from the roastings of the pyrites. F. Wöhler found thallium in the flue-dust of furnaces roasting thalliferous pyrites at Theux (0.5–0.75 per cent. thallium), and at Ringenkuhl; E. Carstanjen, at Meggen (3.5 per cent. thallium); J. W. Gunning, at Ruhrort (1 per cent. thalious chloride); D. Playfair, and others have made similar observations. W. Crookes found 0.29 per cent. of thallium in the raw sulphur obtained from Spanish pyrites, and in the sulphur of Lipari; R. Böttger found thallium in sulphuric acid, and W. Crookes in the hydrochloric acid derived from thalliferous sulphuric acid. R. Bunsen obtained 0.05 per cent. of thalious chloride from the zinc sulphate lye of Goslar which was obtained from Rammelsberg ore. A. Ströng found thallium in zinc and cadmium obtained from thalliferous zinc ores—B. Kosmann found 1.4 per cent. of thallium in a sample of zinc. H. N. Warren reported thallium in platinum; W. B. Herapath, and W. P. Jorissen and J. A. Vollgraff, in bismuth; G. Werther, in tellurium; W. Crookes, in cadmium sulphide; and C. Zimmermann, in uranyl hydroxide.

R. Böttger found thallium widely diffused in the vegetable kingdom, for he found it in wine, chicory, tobacco, beet root, beech wood, etc.

A. Holmes and R. W. Lawson have discussed the possibility of thallium or isotopes of thallium being end-products of the radioactive decay of actinium and of thorium.

REFERENCES.

- ¹ W. Crookes, *Chem. News*, **3**, 193, 1861; **7**, 290, 1363; **8**, 159, 219, 231, 243, 255, 279, 1863; **9**, 1, 36, 54, 1844; *Journ. Chem. Soc.*, **17**, 112, 1864; *Proc. Roy. Soc.*, **12**, 150, 1862; *Phil. Trans.*, **163**, 377, 1874; *Researches on the Atomic Weight of Thallium*, London, 1874; A. Lamy, *Compt. Rend.*, **54**, 1255, 1862; **57**, 442, 1863; *Ann. Chim. Phys.*, (3), **67**, 385, 1862; (4), **5**, 410, 421, 1865; *Bull. Soc. Chim.*, (2), **11**, 210, 1869; *De l'existence d'un nouveau métal, le thallium*, Lille, 1862; *Leçon sur le thallium*, Paris, 1863; M. Doan, *Index to the Literature of Thallium*, Washington, 1899; H. L. Wells and S. L. Penfield, *Amer. Journ. Science*, (3), **47**, 463, 1894; *Zeit. anorg. Chem.*, **6**, 312, 1894; V. Meyer, *Probleme der Atomistik*, Heidelberg, 1896; G. Urbain, *Journ. Soc. Chem. Ind.—Chem. Ind.*, **42**, 768, 1923.
- ² A. E. Nordenskjöld, *Svenska Vet. Akad. Hand.*, **10**, 1866; *Liebig's Ann.*, **145**, 127, 1868; F. Bischoff, *ib.*, **129**, 375, 1864; C. Zimmermann, *ib.*, **232**, 300, 1886; F. Wohler, *ib.*, **142**, 263, 1867; R. Bunsen, *ib.*, **133**, 108, 1865; J. Schramm *ib.*, **219**, 374, 1883; F. Hammersbacher, *ib.*, **176**, 82, 1875; R. Böttger, *ib.*, **128**, 240, 1863; *Journ. prakt. Chem.*, (1), **89**, 378, 1863; (1), **90**, 145, 479, 1863; R. H. Solly, *Min. Mag.*, **14**, 72, 1906; G. F. H. Smith, *ib.*, **14**, 283, 1906; A. Holmes and R. W. Lawson, *Sitzber. Akad. Wien*, **123**, 1373, 1914; *Nature*, **93**, 109, 479, 1914; *Phil. Mag.*, (6), **28**, 823, 1914; (6), **29**, 673, 1915; V. M. Goldschmidt, *Zeit. Kryst.*, **30**, 272, 1898; B. Jezek, *ib.*, **51**, 364, 1912; F. Kröhlik, *ib.*, **51**, 379, 1912; L. J. Igelström, *ib.*, **26**, 594, 1896; H. A. Rowland, *Amer. Journ. Science*, (3), **41**, 243, 1891; *Chem. News*, **63**, 133, 1891; W. N. Hartley and H. Ramage, *Journ. Chem. Soc.*, **71**, 533, 1897; W. Vernadsky, *Bull. Acad. St. Petersburg*, (6), **3**, 821, 1909; A. Cossa, *Gazz. Chim. Ital.*, **8**, 235, 1878; *Compt. Rend.*, **94**, 457, 1882; A. de Gramont, *ib.*, **120**, 778, 1895; A. Lamy, *ib.*, **54**, 1255, 1862; **55**, 836, 1862; *Ann. Chim. Phys.*, (3), **67**, 385, 1863; E. Carstanjen, *Journ. prakt. Chem.*, (1), **102**, 69, 1867; G. Werther, *ib.*, (1), **89**, 189, 1863; C. F. Schönbein, *ib.*, (1), **93**, 35, 1864; F. von Kobell, *ib.*, (2), **3**, 176, 1871; A. R. von Schrötter, *ib.*, (1), **91**, 45, 1864; (1), **93**, 275, 1864; *Sitzber. Akad. Wien*, **48**, 734, 1863; **50**, 268, 1864; J. W. Gunning, *Arch. Néerl.*, (1), **3**, 86, 1869; *Scheikundige bijdragen uit het Laboratorium van het Athenæum illustre te Amsterdam*, **1**, 95, 1868; J. Antipoff, *Journ. Russ. Phys. Chem. Soc.*, **28**, 384, 1897; L. Marquardt, *Neues Jahrb. Min.*, **680**, 1868; F. L. Bartlett, *Eng. Min. Journ.*, **48**, 342, 1889; E. Linnemann, *Monatsh.*, **7**, 121, 1886; W. T. Röppler, *Amer. Journ. Science*, (2), **35**, 420, 1863; O. Vogel, *Zeit. anorg. Chem.*, **5**, 42, 1894; L. Palmieri, *Atti Accad. Neapel*, **10**, 124, 1871; J. A. Krenner and J. Loczka, *Math. Term. Ertesia*, **12**, 471, 1894; *Chem. News*, **71**, 91, 1895; E. Ludwig and J. Mauthner, *Tschernmak's Mitt.*, (2), **2**, 269, 1880; W. B. Herapath, *Pharm. Journ.*, **4**, 302, 1863; *Chem. News*, **7**, 77, 1863; B. Kosmann, *Dingler's Journ.*, **261**, 176, 1886; A. Streng, *ib.*, **177**, 329, 1865; *Berg. Hutt. Ztg.*, **24**, 23, 1865; F. Exner and E. Haschek, *Sitzber. Akad. Wien*, **121**, 1077, 1912; T. L. Phipson, *Compt. Rend.*, **78**, 563, 1874; *Chem. News*, **33**, 243, 1876; D. Playfair, *ib.*, **39**, 245, 1879; H. N. Warren, *ib.*, **55**, 241, 1887; G. J. Mulder, *ib.*, **8**, 8, 1863; W. Crookes, *ib.*, **3**, 193, 303, 1861; **6**, 1, 1862; **7**, 109, 133, 145, 194, 218, 290, 1863; **8**, 159, 195, 219, 231, 243, 255, 279, 1863; **9**, 1, 37, 54, 1864; **15**, 204, 1867; J. H. L. Vogt, *Zeit. prakt. Geol.*, **6**, 225, 314, 377, 413, 1898; **7**, 10, 274, 1899; F. W. Clarke and H. S. Washington, *Proc. Nat. Acad. Sciences*, **8**, 108, 1922; W. P. Jorissen and J. A. Vollgraff, *Zeit. phys. Chem.*, **90**, 557, 1914; L. Moser, *Oester. Chem. Ztg.*, **26**, 67, 1923.

§ 2. The Extraction of Thallium

The thallium minerals are so very scarce that they are not used as sources of the metal. W. Crookes¹ described processes for the extraction of thallium from some Belgian and Spanish pyrites, but the methods are not employed because it is so much easier to extract thallium from the mud of the lead chambers, and the flue-dust of sulphuric acid works burning thalliferous pyrites. The flue-dust is a kind of concentrate of the thallium in the pyrites. G. Sisson and J. E. Edmondson found the dust collected between the pyrites kiln and the Glover's Tower of a sulphuric acid works contained 0.25 per cent. of thallium, representing one part of thallium per million parts of pyrites burnt. The metal is also extracted from the mother liquors after the separation of zinc sulphate. The general methods are based on the sparing solubility of thallose chloride or iodide; on the ready formation of a thallium alum which can be easily purified; on the formation of

a sulphide sparingly soluble in alkaline soln., and on the non-precipitability of thalious salts by sodium carbonate.

A. Lamy obtained thallium from the mud of the lead chamber of a sulphuric acid works by first neutralizing the mass with lead oxide or lime; extracting the product 3-5 times with hot water; concentrating the soln. to about one-tenth its volume; precipitating thalious chloride by adding hydrochloric acid; washing with dil. hydrochloric acid; and decomposing the product with hot sulphuric acid. The thalious hydrosulphate was dissolved in water, and freed from lead, silver, and mercury by hydrogen sulphide. The filtrate was conc. by evaporation, and the thallium precipitated by adding zinc, or by electrolysis.

R. Böttger boiled the mud with 4-6 times its weight of water; made the soln. alkaline with sodium carbonate; and boiled the liquid. The soln. was filtered from the black precipitate, mixed with potassium cyanide, boiled, filtered, and treated with hydrogen sulphide. The thalious sulphide so obtained was boiled several times with a conc. soln. of oxalic acid; the filtrate was neutralized with sodium carbonate and the treatment with potassium cyanide and hydrogen sulphide repeated. The thalious sulphide was dissolved in nitric acid of sp. gr. 1.2, evaporated with conc. sulphuric acid, and a cold soln. of the resulting sulphate was treated with zinc to precipitate the thallium.

W. Crookes obtained thallium from flue-dust by a process somewhat analogous to that employed by A. Lamy for chamber-mud. The dust is boiled with dil. sulphuric acid, and the thallium precipitated from the filtered and conc. soln. by the addition of zinc. R. Böttger mixed the neutralized soln. of the flue-dust with sodium thiosulphate; passed in hydrogen sulphide to precipitate the thalious sulphide; and treated the product with nitric acid, etc., as indicated above. F. Wöhler precipitated thalious chloride from the sulphuric acid soln., by adding a soluble chloride. The thalious chloride was converted into sulphate and the soln. electrolyzed. F. Wöhler fused the electrodeposited metal with potassium cyanide out of contact with air. E. Carstanjen used a similar process, but precipitated the thallium with zinc. R. Nietzki, and M. Schaffner precipitated thalious iodide from the aq. extract from the flue-dust; converted the iodide to sulphide by sodium sulphide; and the sulphide to sulphate by sulphuric acid. The thallium was precipitated by zinc or by electrolysis, and the metal fused in a stream of hydrogen or in contact with oxalic acid.

J. W. Gunning, J. Krause, F. Stolba, and F. Förster have also described processes for extracting thallium from the flue-dust; and A. R. von Schrötter, a process for the extraction of thallium from lepidolite and mica. R. Bunsen treated with zinc the mother liquor from the zinc sulphate crystallization vats. The deposit was extracted with dil. sulphuric acid to dissolve the cadmium and thallium; and the thalious iodide precipitated from the soln. by the addition of potassium iodide.

W. Crookes, and A. Lamy found thallium oxide is reduced by hydrogen with difficulty; A. Lamy obtained thallium by treating the carbonate with carbon; by fusing the chloride with zinc; or by heating the chloride with potassium or sodium; G. Werther reduced the iodide by fusion with potassium cyanide; and J. E. Willm obtained thallium by heating the oxalate.

W. Crookes purified thallium or thalious chloride by converting it into sulphate. The slightly acid soln. was treated with hydrogen sulphide to remove traces of mercury, silver, arsenic, antimony, and bismuth; the filtered soln. was treated with aq. ammonia to remove traces of iron and aluminium. The filtrate was conc. by evaporation until crystals of thalious sulphate separated out. Thallium is best obtained from the soln. of thalious sulphate by electrolysis. The electrodeposition of thallium has been discussed by L. Schucht, G. Neumann, W. J. Müller, F. Förster, M. Bose, M. E. Heiberg, G. W. Morden, etc. A. S. Cushman, and F. Ephraim and P. Barteczko used a somewhat analogous process. T. W. Richards and C. P. Smyth thus describe the preparation of purified thallium:

Nuggets of crude metal, containing perhaps 7 per cent. of lead and small amounts of other impurities, were dissolved in dil. pure sulphuric acid. Most of the lead remained undissolved, partly as a metallic powder and partly as precipitated sulphate. The cooled and somewhat dil. soln. was filtered; to it was added dil. redistilled hydrochloric acid drop by drop, with constant stirring. Very little, if any, lead was found in the precipitated thalious chloride, which was washed several times by decantation. Pure conc. redistilled sulphuric acid converted the solid thalious chloride into sulphate. This thallium sulphate, which on dilution gave no precipitate of lead sulphate, was crystallized by cooling to 0°. The long needles of the salt were thoroughly dried, recrystallized at least twice (sometimes thrice) in a silica dish, by cooling with ice a soln. almost saturated at the b.p. The solubility curve is steep and the process efficient. From this sulphate, which must have been amply pure enough for our purpose, metallic thallium was prepared by the electrolysis of the sat. soln. of the sulphate in water; the electrodes were short platinum wires exposing not more than 1 cm. of their length to the soln. The anode was placed on the bottom of the beaker containing the soln. (being protected above by a long glass tube into which it was sealed), while the cathode merely dipped beneath the surface. The heavy red-brown deposit of peroxide at the anode remained at the bottom of the beaker and therefore did not contaminate the crystalline spongy mass of thallium deposited on the cathode above. A current of about 1 amp. was used and the thallium was removed at frequent intervals from the cathode by means of a small glass fork, and it was rinsed thoroughly with pure water, pressed together, and kept under pure boiled water until fused.

G. Bredig and F. Haber² prepared **colloidal thallium** by the electrolysis of a soln. of potash-lye (1 : 20) with a thallium cathode. T. Svedberg obtained organosols in ether by his electrical disintegration process. S. Bodfors and P. Frölich found T. Svedberg's method gave good results for colloidal thallium.

REFERENCES.

¹ W. Crookes, *Chem. News*, **3**, 303, 1861; **7**, 109, 1863; **8**, 159, 1863; **29**, 147, 1874; *Phil. Trans.*, **163**, 277, 1873; W. J. Müller, *Zeit. Elektrochem.*, **11**, 755, 1905; **15**, 696, 1909; *Zeit. phys. Chem.*, **69**, 460, 1911; L. Schucht, *Berg. Hütt. Ztg.*, **39**, 122, 1880; *Chem. News*, **47**, 209, 1883; G. Neumann, *Ber.*, **21**, 356, 1888; F. Förster, *Zeit. Elektrochem.*, **2**, 653, 1897; E. J. Chapman, *Phil. Mag.*, (5), **2**, 397, 1876; F. Wöhler, *Liebig's Ann.*, **142**, 263, 1867; **164**, 74, 1872; R. Bunsen, *ib.*, **133**, 108, 1865; R. Böttger, *ib.*, **126**, 266, 1863; **128**, 248, 1863; A. Schumann, *ib.*, **249**, 340, 1888; F. Förster, *Zeit. anorg. Chem.*, **15**, 71, 1897; F. Ephraim and P. Barteczko, *ib.*, **61**, 238, 1909; M. E. Heiberg, *ib.*, **35**, 347, 1903; M. Bose, *ib.*, **44**, 237, 1905; J. Krause, *Dingler's Journ.*, **217**, 323, 1875; F. Stolba, *Sitzber. Böhm. Ges. Wiss.*, **330**, 1873; J. W. Gunning, *Arch. Néerl.*, (1), **3**, 86, 1868; *Scheikundige bijdragen uit het Laboratorium van het Athenæum illustre te Amsterdam*, **1**, 95, 1868; M. Schaffner, *Sitzber. Akad. Wien*, **63**, 176, 1871; A. R. von Schrötter, *ib.*, **51**, 268, 1865; R. Nietzki, *Arch. Pharm.*, (3), **7**, 385, 1875; F. L. Bartlett, *Eng. Min. Journ.*, **48**, 342, 1889; A. S. Cushman, *Amer. Chem. Journ.*, **24**, 227, 1900; G. Werther, *Journ. prakt. Chem.*, (1), **91**, 385, 1864; (1), **92**, 128, 351, 1864; E. Carstanjen, *ib.*, (1), **101**, 55, 1867; (1), **102**, 65, 129, 1867; A. Lamy, *Ann. Chim. Phys.*, (3), **67**, 385, 1863; (4), **3**, 373, 1864; J. E. Willm, *ib.*, (4), **5**, 5, 1865; *Recherches sur le thallium*, Paris, 1865; J. Nicklès, *Compt. Rend.*, **58**, 537, 1864; *Journ. Pharm. Chim.*, (4), **4**, 127, 1866; G. W. Morden, *Journ. Amer. Chem. Soc.*, **31**, 1045, 1909; T. W. Richards and C. P. Smyth, *ib.*, **44**, 524, 1922; G. Sisson and J. E. Edmondson, *Journ. Soc. Chem. Ind.*, **38**, 70, T, 1919.

² G. Bredig and F. Haber, *Ber.*, **31**, 2745, 1898; T. Svedberg, *ib.*, **39**, 1711, 1906; S. Bodfors and P. Frölich, *Koll. Beihefte*, **16**, 301, 1922.

§ 3. The Physical Properties of Thallium

According to W. Crookes,¹ the **colour** of thallium is white with a bluish-grey tinge, somewhat paler than lead. A freshly-cut surface has a bright metallic lustre which soon dulls on exposure to air. The **crystal constants** of thallium have not been determined. K. Becker and F. Ebert found that the **X-radiogram** corresponds with a face-centred tetragonal lattice, with $a=4.75$ Å., and $c=5.40$ Å. S. Nishikawa and G. Asahara studied the effect of annealing and rolling on the X-radiogram and showed that there is an abrupt change in the pattern at about 227°. W. L. Bragg estimates the **atomic radius** to be 2.25 Å., and M. N. Saha estimated 0.99 Å. Thallium precipitated by zinc or by electrolysis appears in needles or plates; a bar of the metal is crystalline and when bent emits a sound like the

“cry of tin.” According to A. Lamy, the **specific gravity** of thallium is 11·862; G. Werther gave 11·777–11·900; L. de la Rive gave 11·808 for wire at 11°, and 11·858 at 11° for the cast metal; W. Crookes gave 11·91 for wire, 11·88 for the pressed metal, and 11·81 for the cast metal. T. W. Richards and J. H. Wilson gave 11·85 for the sp. gr. of thallium at 20°. D. Omodei gave 11·509 for the sp. gr. of thallium at the m.p.; and H. Endo, 11·7270. The latter found thallium gives a 3·23 per cent. expansion during solidification; D. Omodei gave 4·3 per cent.; and M. Töpler, 3·1 per cent. W. Crookes, and A. Lamy found that the metal is soft enough to be scratched by the finger-nail, and to be cut with a knife; it is scratched by lead. According to J. R. Rydberg, the **hardness** of thallium is 1·2 when that of lead is 1·5. C. A. Edwards gave 6·95 for the hardness of thallium when that of tin is 15·6, and copper, 53. P. Nicolardof showed that thallium is hardened by hammering. C. A. Edwards and M. A. Herbert gave 3·2 for the **plasticity** number when that of copper is 49·3. J. H. Hildebrand and co-workers computed the **internal pressure**. The **malleability** of thallium is high, and the tenacity low. A. Lamy found it could be rolled into plates 0·015 mm. thick. According to W. C. Roberts-Austen, thallium with 0·193 per cent. of impurity has a **tensile strength** of 6·21 tons per sq. in., and an elongation of 8·6 per cent. on 3 ins. H. von Wartenberg found that thallium can dissolve some oxygen, presumably as thallos oxide, and retain its ductility. Thallium with 0·5 per cent. of oxygen can be drawn like thallium alone into short wires, but if 1·3 per cent. of oxygen is present, it loses this property. T. W. Richards and co-workers found the **compressibility** of thallium, i.e. the average fractional change of volume between 100 and 500 megabars press., to be $2·3 \times 10^{-6}$ per megabar, at 20°; P. W. Bridgman gave $3·4 \times 10^{-6}$ at 30°, and $3·67 \times 10^{-6}$ at 75°, and he found that if v denotes the vol. at θ° and atm. press., and δv , the change in vol. by the application of a press. p kgrms. per sq. cm., then :

$\frac{p}{\delta v/v} \times 10^7$ at 30°	· 3000	6000	9000	12,000
$\frac{p}{\delta v/v} \times 10^7$ at 75°	-0·00978	-0·01872	-0·02700	-0·03505
	-0·01011	-0·01908	-0·02724	-0·03554

and $-(da/adt) = 1·53 \times 10^{-5}$ for extruded thallium, where a denotes the coeff. of linear expansion. N. Werigin, J. Lewkojeff, and G. Tammann measured the velocity of flow of solid thallium at different temp. under high press., and found evidence of a transformation at about 187°. N. S. Kurnakoff and S. F. Schemschuschny found the flowing press. to be 5·8 kgrms. per sq. mm.

M. Levin found that thallium exists in two allotropic forms which are enantiotropic $\alpha\text{-Tl} \rightleftharpoons \beta\text{-Tl}$ with the **transition temperature** at 226°; according to R. S. Williams, the temp. is not affected by the presence of antimony. G. I. Petrenko gave 227° for the transition temp.; M. Chikashigé, 231·8°; N. S. Kurnakoff and N. A. Puschin, 227°; K. Lewkonja, 230·5°; L. Densky, 224°; G. Voss, 238°; M. Werner, 226°; T. W. Richards and C. P. Smyth, 235·3°; N. S. Kurnakoff, S. F. Schemtschuschny, and V. Tararin, 229°; P. Pavlovitch, 234°; G. D. Roos, 233°; P. Fuchs, 231°–233°; and S. Nishikawa and G. Asahara, 227°. M. Werner studied the effect of press. up to 3000 kgrms. per sq. cm. on the transition temp., and found the slope at the transition temp. is only -2° per 1000 kgrms.; so that the transition temp. falls from 226° for $p=1$ kgrm. per sq. cm., to 220° for $p=3000$ kgrms. per sq. cm. As the temp passes through 226°, the volume contracts 0·000044 c.c. per gram, and dT/dp is 0·002° per kgrm. P. W. Bridgman sought for a third modification, but none appeared up to 12,000 kgrms. per sq. cm. at 200°.

According to H. Fizeau, the coeff. of **linear expansion** is 0·00003021 at 40°, and 0·0000325 at 50°; and the coeff. of **cubical expansion** of the liquid between 302° and 351° is 0·000150, according to D. Omodei, and 0·000128, according G. Pacher. A gram of thallium expands on melting 0·0027 c.c. or 3·1 per cent., according to M. Töpler, or 3·22 per cent., according to G. Pacher. A. Lamy gave 0·0325 for the **specific heat**; and H. V. Regnault gave 0·0335. H. C. Schmitz found the sp. ht. between -192° and 20° to be 0·0300, and 0·0326 between 20° and 100° ;

while P. Nordmeyer and A. L. Bernoulli obtained 0.0379 between -185° and 20° . H. Bürger found

	-80°	-50°	-20°	0°	50°	100°	150°	180°
Sp. ht. . . .	0.0288	0.0288	0.0289	0.0291	0.0296	0.0305	0.0316	0.0324
At. ht. . . .	5.875	5.876	5.986	5.939	6.058	6.225	6.446	6.609

The sp. ht. dQ/dT at θ° is represented by $0.028757 + 0.075505(\theta + 80)^2$; and between -80° and θ° , and $Q = 0.028757(\theta + 80) + 0.071835(\theta + 80)^3$. T. W. Richards and F. G. Jackson gave 0.0296 for the mean sp. ht. between -192° and 20° ; and W. Nernst and F. Schwerns, gave 0.0277 at -177.3° , and 0.0143 at -250.1° . G. N. Lewis and co-workers, and E. D. Eastman gave 14.6 cal. per degree for the **entropy** of thallium at 25° and atm. press. According to H. C. Schmitz, the at. ht. at -85° is 6.12, and at 60° , 6.65. E. van Aubel discussed the theoretical value of the at. ht. A. Lamy said thallium has a low **thermal conductivity**, while W. Crookes regarded it as a good conductor. W. B. Brown found a drop of about one-tenth in the thermal conductivity of thallium at about 120° , which is supposed to represent a polymorphic change.

A. Lamy gave 290° for the **melting point** of thallium; W. Crookes, 285° ; D. Omodei, 204.05 ; C. T. Heycock and F. H. Neville, 303.7° ; N. S. Kurnakoff and N. A. Puschin, 301.2° – 301.7° ; R. S. Williams, P. Pavlovitch, and M. Chikashigé, 301° ; A. von Vegesack, 302° ; K. Lewkonja, 299.4° ; N. S. Kurnakoff, S. F. Schemtschuschny, and V. Tararin, 301.2° ; P. Fuchs, 301.7° ; T. W. Richards and C. P. Smyth, 303.5° ; H. Endo, and W. R. Mott, 303.7° ; G. D. Roos, 302° ; F. Doerinckel, 311° ; G. I. Petrenko, 303° – 304° ; and G. K. Burgess gave $302^{\circ} \pm 1^{\circ}$ for the best representative value; and W. Guertler and M. Pirani, 301° . C. T. Heycock and F. H. Neville gave 301° – 302° for the f.p. of thallium, and they also gave 5.12 cal. per gram for the **latent heat of fusion**, while F. W. Robertson gave 7.2 cal.; T. W. Richards and C. P. Smyth, 8.3 cal.; G. N. Lewis and M. Randall, 7.1 cal.; and G. D. Roos, 7.38 cal. per gram. C. T. Heycock and F. H. Neville measured the lowering of the f.p. of sodium, cadmium, tin, lead, and bismuth by thallium. According to W. Crookes, thallium volatilizes at a red heat, boils at a white heat, and it can be distilled in a stream of hydrogen. G. W. A. Kahlbaum, K. Roth, and P. Siedler distilled thallium in vacuo. F. Krafft and A. Knocke found that thallium begins to volatilize at 174° in vacuo, and the **boiling point** is 818° under the press. of its own vapour 150 mm., or at 1462° at 760 mm. press. H. Biltz and V. Meyer gave 1650° nearly; E. Isaac and G. Tammann gave 1515° for the b.p. under normal press.; W. R. Mott, 1280° ; G. E. Gibson, 1660° ; and H. von Wartenberg gave for the **vapour pressure** 0.056 mm. at 634° ; 1.329 mm. at 783° ; 24.31 mm. at 970° ; and 760 mm. at 1306° ; and for the **latent heat of vaporization**, 28 Cals.; G. E. Gibson gave 38 Cals. The **vapour density**—air unity—at 1636° was found by H. Biltz and V. Meyer to be 16.115; and 14.248 at 1728° ; H. Biltz gave 14.77 at 1649° . The calculated values for a monatomic mol., Tl, is 14.167; H. von Wartenberg obtained a vap. density 220—H unity—between 1320° and 1690° .

The **atomic refraction** or eq. refraction of thallium, according to J. H. Gladstone,² is 21.6 with the H_{α} -line; and, according to W. J. Pope, 22.14 with the D -ray. C. A. Valson has made some observations on this subject. J. C. McLennan gave for the index of refraction, μ , of thallium vapour at 540° , for light of wave-length λ ,

λ	4358.56	4861.49	5460.97	5769.45	5790.49	5893	6234.31	6563.04
μ	1.000229	1.000110	1.000293	1.000222	1.000144	1.000165	1.000309	1.000142

He also obtained an anomalous dispersion for wave-lengths 5350.65 Å., and 6000 Å. H. R. von Traubenberg found 23.3×10^{-4} cm. for the range of the α -rays from radium-C in thallium. J. Stark and G. von Wendt studied the **Stark effect** with **canal rays**.

The discovery of thallium by W. Crookes was due to its producing a characteristic green spectral line, and this was confirmed by the observations of A. Lamy.

Thallium and its compounds colour the non-luminous gas-flame an intense green, but, as R. Bunsen showed, the coloration does not persist very long on account of the volatility of the thallium salts. The intense green thallium line has the wave length $\lambda=5350\cdot7$. Its position is very near the barium band $\lambda=5347\cdot0$, the Ba, of R. Bunsen and G. Kirchhoff: but the two are not liable to be confused because the barium band is broader and less intense than the thallium line. According to A. Perot and C. Fabry, the green thallium line is really a triplet. J. Nicklès said that the presence of sodium chloride prevents the appearance of the green ray, but W. Crookes showed that this is wrong. C. Fredenhagen found that the chlorine flame is not coloured by thallium. F. Kurlbaum and G. Schulze said that the temp. of an alcohol flame coloured by thalious chloride is 1476° , and if coloured by sodium chloride, 1409° . A. Lamy said $0\cdot000002$ mgrm. of thallium can be detected from its flame spectrum. W. Schuler, and A. de Gramont also studied the sensitiveness of the spectral lines. The most intense lines in the arc spectrum are 2709·33, 2767·96, 2918·42, 2921·66, 3229·89, 3519·37, 3529·53, 3775·89, 5350·70; and in the spark spectrum, 3519·37, 3529·53, 3775·89, and 5350·70.

The **flame spectrum** has been studied by J. Müller, F. Bernard, E. Ketteler, J. Plücker and W. Hittorf, E. Mascart, R. Rühlmann, A. Cornu, L. de Boisbaudran, A. Gouy, J. N. Lockyer, G. D. Liveing and J. Dewar, A. A. Michelson, D. Cochain, J. M. Eder and E. Valenta, A. Hagenbach and H. Konen, H. Auerbach, C. Fritsch, etc. J. Papish said that thallium chloride dissociates in Bunsen's flame and the free metal colours the flame and may be deposited on a cold surface as a brown mirror; with the hydrogen flame in air, metallic thallium also deposits from the innermost core, but the luminescence of the outer core is probably due to an oxide.

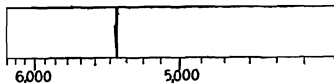

FIG. 1.—Flame Spectrum of Thallium.

The **spark spectrum** has been investigated by W. Huggins, R. Thalén, L. de Boisbaudran, R. Capron, W. N. Hartley and co-workers, E. Demarçay, A. Hagenbach and H. Konen, F. Exner and E. Haschek, J. M. Eder and E. Valenta, J. H. Pollok, etc.; the **arc spectrum**, by J. Tyndall, R. Capron, H. Kayser and C. Runge, H. A. Rowland, A. Hagenbach and H. Konen, F. Exner and E. Haschek, J. M. Eder and E. Valenta, C. E. Gissing, and W. Huppers, B. E. Moore, etc.; the **ultra-violet spectrum**, by W. A. Miller, E. Mascart, G. D. Liveing and J. Dewar, A. Cornu, L. and E. Bloch, F. Exner and E. Haschek, E. Néculcéa, R. W. Wood and D. V. Guthrie, etc.; the **ultra-red spectrum**, by H. Becquerel, E. P. Lewis, F. Paschen, etc.; the **band spectrum**, by J. Plücker and W. Hittorf, H. Konen, W. N. Hartley, etc.; and the **cathode ray spectrum**, by E. P. Lewis. The high frequency or **X-ray spectrum** has been studied by M. Siegbahn and E. Friman, D. Coster, E. Hjalmar, etc. The **absorption spectrum** of the vapour has been examined by J. N. Lockyer and W. C. Roberts-Austen, W. Grotrian, J. C. McLennan and co-workers, J. A. Carroll, etc. Thallium salts give no absorption spectrum. According to J. Formanek, if tincture of alkanna be mixed with an aq. soln. of thallium nitrate, the liquid is not changed, but if a few drops of ammonia are added, the liquid becomes blue, and it shows two absorption bands—one at $\lambda=6288$, and the other at $\lambda=5770$. The nature of the spectral lines, and the **series spectra** of thallium have been discussed by C. Ciamician, G. D. Liveing and J. Dewar, W. Grotrian, A. Fowler, J. A. Carroll, A. Cornu, W. N. Hartley, H. Wilde, J. Barnes, L. Janicki, P. G. Nutting, etc. H. Kayser and C. Runge found two subordinate series of lines:

FIRST SERIES.

$$10^6\lambda^{-1} = 41542\cdot7 - 132293n^{-2} - 1265223n^{-4}$$

$$10^6\lambda^{-1} = 49337\cdot6 - 132293n^{-2} - 1265223n^{-4}$$

SECOND SERIES.

$$10^6\lambda^{-1} = 41506\cdot4 - 122617n^{-2} - 790683n^{-4}$$

$$10^6\lambda^{-1} = 49301\cdot3 - 122617n^{-2} - 790683n^{-4}$$

The relationship between the spectra of aluminium, gallium, indium, and thallium has been discussed in connection with the first-named element.

F. L. Mohler, and W. J. Humphreys studied the effect of *pressure* on the thallium

lines; R. W. Wood and D. V. Guthrie, and H. Finger, the effect of the *medium*; C. Fievez, the action of a *magnetic field*; A. A. Michelson, the **Zeeman effect**; J. N. Lockyer, and J. Steinhausen, the *enhanced lines*; G. D. Liveing, the differences in the spectra at the anode and cathode; and O. Lummer and E. Pringsheim, and F. Schön, H. Geisler, the *anomalous dispersion*. J. Stark and G. von Wendt³ found that the compounds of thallium emit characteristic lines when acted upon by **canal rays**, and these have been studied by H. Smith, E. Beckmann and H. Linder, etc. In the **X-ray spectrum** the M-series was measured by W. Duane and co-workers, and M. Siegbahn and E. Jönsen; and the L-series, by D. Coster, M. de Broglie, W. Duane and R. A. Patterson, and M. Siegbahn, who found, in Angström units, or 10^{-8} cm. units, $\alpha_2\alpha' = 1.21603$; $\alpha_1\alpha = 1.20471$; $\beta_1\beta = 1.01266$; $\beta_2\gamma = 1.00786$; $\gamma_1\delta = 0.86529$; $\epsilon = 1.385$; $\eta = 1.125$; $\gamma_2\theta = 0.8447$; $\beta_4\nu = 1.0371$; $\beta_3\phi = 0.9978$; $\gamma_3\chi = 0.8379$; and $\gamma_4\psi = 0.8100$. The M-series of the X-ray spectrum was reported by G. Wentzel, and E. Hjalmar, who gave $\alpha_1 = 5.468$; $\alpha' = 5.461$; $\alpha = 5.4499$; $\beta_1 = 5.254$; $\beta = 5.2384$, and $\gamma = 4.802$. W. Duane and co-workers studied the absorption of X-rays by thallium. M. N. Saha made observations on the **ionizing potential** of thallium vapour; and F. L. Mohler and co-workers found this to be 6.04 volts. F. L. Mohler and A. E. Ruark found for the ionizing potential $2p_2 = 6.082$; and $2p_1 = 5.120$; and for the **resonance potentials**, $2p_2 - 2p_1 = 0.962$; $2p_2 - 2s = 3.269$; and $2p_2 - 3d_{1,2} = 4.47$. J. E. P. Wagstaff gave 2.6×10^{12} for the **vibration frequency**.

According to W. Crookes,⁴ thallium is a good conductor of electricity, but, according to A. Lamy, it is a bad one. Measurements of the **electrical conductivity** have been made by J. R. Benoit, A. Schulze, L. de la Rive, and A. Matthiessen and C. Vogt. J. Dewar and J. A. Fleming's results for solid thallium between -183° and 98.5° , re-calculated by H. Dickson, and G. Vicentini and D. Omodei's value for liquid thallium at 294° , are, in reciprocal ohms (mhos) per cm. cube,

	-83°	-78°	-40°	0°	20°	60°	98.5°	294°
Mhos $\times 10^{-4}$	24.5	8.46	6.83	5.68	5.28	4.54	4.05	1.35

The effect of *temperature* on the **electrical resistance**, R , at θ° between 0° and 100° , is represented by A. Matthiessen and C. Vogt as $R = R_0(1 + 0.0040264\theta + 0.058844\theta^2)^\circ$ where R_0 represents the value at 0° ; J. Dewar and J. A. Fleming gave $R = R_0(1 + 0.00398\theta)$ between 0° and 100° ; P. W. Bridgman found $R = R_0(1 + 0.00517\theta)$ between 0° and 100° ; and G. Vicentini and D. Omodei, gave $R = R_0(1 + 0.004108\theta + 0.053016\theta^2 + 0.088183\theta^3)$ for the solid between 0° and 294° , and $R = R_0(1 + 0.00035\theta)$ for the liquid between 294° and 350° . M. Werner found an abrupt change in the electrical conductivity of thallium wire at the transition temp. 226° ; and the temp. coeff. of the two modifications are different. G. Vicentini and D. Omodei's curve does not show this change. M. Werner gives $R = R_0(1 + 0.0023\theta)$ for the interval 0° to 226° ; and $R = R_0(1 + 0.00265\theta)$ for the interval 226° to 302° , the m.p. A. Schulze gave for the sp. resistance of the solid at the m.p., 37×10^{-6} , and of the liquid, 74×10^{-6} . According to C. A. Crommelin, and W. Tuyn and H. K. Onnes, thallium becomes a super-conductor of electricity at 2.3° K. P. W. Bridgman found a discontinuity in the resistance of thallium at a low temp. before the metal becomes super-conducting. The effect of *pressure* was studied by P. W. Bridgman, who found the following relative values for the resistance between 0° and 100° , and between 0 and 1200 kgrms. per sq. cm. press.:

	0°	25°	50°	75°	100°
R	1.000	1.1292	1.2585	1.3877	1.5170
{ 0 kgrm.	-0.041319	-0.041358	-0.041393	-0.041425	-0.041456
Press. { 12000 kgrms.	-0.041017	-0.041023	-0.041028	-0.041028	-0.041024
Coeff. { average	-0.041151	-0.041165	-0.041183	-0.041203	-0.041226

A. Stein discussed a relation between the m.p. and the electrical resistance of thallium and other metals. A. T. Waterman studied the electronic theory of the

conductivity. W. P. Davey calculated the **atomic radius** of Tl⁺ ion in thalious chloride to be 1.77 Å.

M. Werner measured the **Seebeck effect**, that is, **thermoelectrical force** of the thallium-copper couple. There is a slight discontinuity in the e.m.f., E , at 226°, and he represents the values of E between 0° and 225° by $E=24+0.016119(\theta-225)+0.00039768(\theta^2-225^2)$; and between 225° and 249°, by $E=24-1.0677(\theta-225)+0.0026042(\theta^2-225^2)$. W. H. Steele made an observation on the thermoelectric force of the couple at 200°. P. W. Bridgman gave for the thallium-lead couple at atm. press. $10^6 E=1.659\theta-0.00134\theta^2-0.0000056\theta^3$ volts; for P , the **Peltier effect**, $10^6 P=(1.659-0.00268\theta-0.0000168\theta^2)(\theta+273)$ volts; and for σ , the **Thomson effect**, $10^6 \sigma=(-0.00268-0.0000336\theta)(\theta+273)$ volts per degree. For couples composed of one branch of compressed and one branch of uncompressed thallium, P. W. Bridgman found the thermoelectric force in volts $\times 10^6$ to be for press., p , in kgrms. per sq. cm.:

	10°	20°	40°	60°	80°	100°
$p \left\{ \begin{array}{l} 2,000 \text{ . . .} \\ 6,000 \text{ . . .} \\ 12,000 \text{ . . .} \end{array} \right.$	+0.88	+1.81	+3.84	+6.07	+8.43	+10.87
	2.47	5.07	10.59	16.48	22.70	29.21
	4.26	8.78	18.53	29.15	40.49	52.46

The e.m.f. is positive and increases regularly with temp. and press. Similarly for the Peltier effect in joules per coulomb $\times 10^6$:

	0°	20°	40°	60°	80°	100°
$p \left\{ \begin{array}{l} 2,000 \text{ . . .} \\ 6,000 \text{ . . .} \\ 12,000 \text{ . . .} \end{array} \right.$	+23	+28	+33	+38	+42	+46
	66	78	89	101	112	124
	112	136	160	183	206	229

The Peltier effect is positive and increases with temp. and press. Likewise also for the Thomson heat effect in joules per coulomb per degree $\times 10^8$:

	0°	20°	40°	60°	80°	100°
$p \left\{ \begin{array}{l} 2,000 \text{ . . .} \\ 6,000 \text{ . . .} \\ 12,000 \text{ . . .} \end{array} \right.$	+16	+15	+12	+12	+9	+6
	38	32	28	27	26	26
	79	73	67	60	55	50

The Thomson heat effect increases with press. except at the maximum temp. and press., but it decreases regularly with rising temp. J. C. McLennan found the **ionizing potential** for the single line spectrum of thallium vapour to be 2.28 volts—analogueous with the corresponding 4.9 volts of mercury vapour; and the value 8.29 volts—analogueous with the 10.27 volts of mercury vapour. F. L. Mohler and A. E. Ruark studied the different stages in the excitation of the thallium spectrum. H. Greinacher studied the **flame ionization** by thallium salts. A. Lamy found thallium to be diamagnetic, and K. Honda found the **magnetic susceptibility** at ordinary temp. to be -2.9×10^{-8} vol. units. Observations were also made by S. Meyer, and M. Owen.

B. Neumann⁵ found the absolute potential of thallium in $N-TlNO_3$ to be +0.112 volt; in $N-Tl_2SO_4$, +0.114 volt; and in $N-TlCl$, 0.151 volt. N. T. M. Wilsmore gave for the sequence of metals in the electrochemical series:

K . . .	Mn	Zn	Cd	Fe	Tl	Co	Ni . . .	H
+3.20 . . .	+1.075	+0.770	+0.420	+0.340	+0.322	+0.232	+0.228 . . .	0

Thallium has therefore a decided tendency to assume the ionic state. J. F. Spencer, R. Abegg, I. Shukoff, and F. J. Brislee made observations on this subject. There is a marked difference between the **potential difference** of thallium and a sat. thallium amalgam. T. W. Richards and C. P. Smyth found that purified compact thallium possesses at 20° an electrode potential 2.1 millivolts higher than sat. thallium amalgam. When immersed in a soln. normal in thalious ions and connected with a normal calomel electrode, the total potential 0.6192 volt is indicated at 25°. The potential of pure thallium is not influenced by quenching the metal, which is so soft that no important strain can exist in it. α -thallium is the only phase of the pure metal stable at room temp. Finely divided electrolytic thallium

sponge gives a potential 0.6 millivolt higher than the compact fused form. The difference is probably due to the fine state of division, and disappears on long standing. The difference of potential shown by β -thallium (if it could exist at ordinary temp.) would probably be nearly three times as great. G. Jones and C. W. Schumb measured the potential of the thallium electrode in a sat. soln. of thalious chloride, and the e.m.f. of $\text{Tl} \mid \text{TlCl}_{\text{sat.}}, 0.1N\text{-KCl} \mid \text{HgCl}$, with normal and decinormal calomel electrodes at 25° and 0°, and found $E = +0.71821$ volt at 25° and $+0.7582$ volt at 0°; and with $N\text{-KCl}$, $E = +0.7290$ volt at 25° and $+0.7102$ volt at 0°. This gives for the normal potential of the thallium electrode, $+0.5885$ volt at 0° and $+0.6188$ volt at 25°. G. Tammann studied the potential difference of thallium and fused cuprous, silver, stannic, and lead chlorides, and of thalious chloride with magnesium, manganese, or aluminium. R. Kremann and co-workers investigated the e.m.f. of the cell $\text{Tl} \mid N\text{-Na}_2\text{SO}_4 \mid \text{Tl}_{n-1}\text{Na}_n$, and similarly with the potassium alloys. G. N. Lewis and C. L. von Ende showed that early measurements gave anomalous results with Nernst's formula for the relation between the thallium potential and the conc. of the thallium ion, because adequate precautions were not taken to prevent the oxidation of the thallium electrode by the oxygen dissolved in the soln. As a consequence, the conc. of the thalious ion next to the electrode is increased, and the percentage change is greater the more dil. the soln. H. G. Denham assumed that metallic thallium in the presence of thalious ions forms sub-thalious ions; F. Kohlrausch and H. von Steinwehr attributed an analogous trend in the conductivity of thalious chloride soln. to the tendency of thallium to form complex ions; and it might also be supposed that a double ion Tl_2^{++} is formed as in the case of univalent mercury. G. N. Lewis and C. L. von Ende found that if C denotes the conc. of the salt in soln.; α , the degree of ionization computed from conductivity measurements; C_1 , the ionic conc.; and E , the potential against the sat. thalious chloride electrode, then the values of E calculated by Nernst's equation show no anomaly in the e.m.f. behaviour of the thalious ion when precautions are taken to prevent electrode oxidation:

	C	α	C_1	E (obs.)	E (calc.)
TlNO_3	0.1000	0.79	0.0790	-0.0422	-0.0438
TlNO_3	0.0333	0.88	0.0293	-0.0183	-0.0182
TlCl (sat.)	0.0161	0.89	0.0143	0	0
TlNO_3	0.0100	0.93	0.0093	+0.0113	+0.0113
TlBr (sat.)	0.00199	0.97	0.00193	+0.0513	+0.0516

The potential of purified thallium against hypothetical normal thalious chloride is 0.6170 volt at 25° when the normal calomel electrode is zero. There is here no evidence supporting H. G. Denham's conclusion that thallium forms sub-thalious Tl_2 -ions. T. W. Richards and C. P. Smyth's observations led them to the following conclusion:

α -thallium dissolves mercury, increasing in hardness and volume up to about 5 per cent. of mercury. When more mercury is added, another solid phase of about the same hardness and volume, but containing more mercury, appears. These two phases appear to exist mixed together in equilibrium, over the range from about 5 per cent. to 10 per cent. of mercury at 20°. With more than about 10 per cent. of mercury, the α -thallium solid soln. ceases to exist and the other phase continues to dissolve mercury in solid soln. until it is saturated (with perhaps 15 per cent. of mercury). The other solid phase is probably a solid soln. of mercury in β -thallium, which appears in definite crystalline form, making the amalgam friable after the admixture of an α -thallium has been eliminated. β -thallium can exist at ordinary temp. only in the presence of much mercury, but it is always the form present in equilibrium with the liquid amalgam.

According to L. Jonas, when a soln. of thalious hydroxide is electrolyzed, thallium is deposited on the cathode and an oxide on the anode. The oxide contains slightly less oxygen than is required by the formula Tl_2O_3 , its composition being better represented by $17\text{Tl}_2\text{O}_3, \text{Tl}_2\text{O}$. The quantity deposited is equal to that calculated by means of Faraday's law. The process is reversed when the direction of the

current is reversed. The chemical reaction in the cell $\text{Tl}_2\text{O}_3 \mid \text{Tl}\cdot\text{OH}' \mid \text{Tl}$ is, therefore, $\text{Tl}_2\text{O}_3 + 4\text{Tl} + 3\text{H}_2\text{O} \rightleftharpoons 6\text{Tl}' + 6\text{OH}'$, and the e.m.f. is given by $E = E_0 - RT/4F \log C^6\text{Tl}'\cdot C^6\text{OH}'$. The experimental results agree satisfactorily with the calculation. The e.m.f. of the cells of the **thallium accumulator** used lies between 0.55 and 0.65 volt, and the capacity per kilogram is no greater than that of the lead accumulator. J. Regnault measured the e.m.f. of the cell $\text{Zn} \mid \text{ZnSO}_4, \text{Tl}_2\text{SO}_4 \mid \text{Tl}$. W. Ostwald gave 10 Cals. per valence for the **heat of ionization**. K. Fajans and M. Born calculated the vol. and heat of ionization of Tl' -ions. K. G. Falk found the **transport number** of the cation in thallic sulphate soln. to be 0.479, and W. A. Bain, 0.472; and A. A. Noyes and K. G. Falk gave 7.60 units for the **speed of migration** of the cation at 25°.

W. J. Müller examined the anodic polarization of thallium in $\frac{1}{10}N$ -sodium hydroxide, the current increases regularly with the polarization, and thallium dissolves in the univalent form up to an applied e.m.f. of 10 volts. With the anode in N -sodium hydroxide, there are three points on the polarization-strength of current curve at which the polarization remains practically constant with increased current, the first, at -0.7 volt, represents the dissolution of thallium in the univalent form; the second, at ± 0 volt, probably represents the dissolution in the bivalent form; the third, at $+1.1$ volt, has not been fully investigated. When the polarized oxidized electrode is allowed to discharge, halts are observed at -0.3 and -0.6 volt. When the applied e.m.f. in $\frac{1}{10}N$ -sulphuric acid is gradually raised, a point is reached at which the current remains practically constant on further increasing the e.m.f., and pulsations occur. The current in these circumstances is proportional to the surface of the electrode, and stirring increases it considerably. The explanation advanced is that thallic sulphate forms on the anode, and gives rise to a considerable resistance, but as it diffuses away, it allows the current to pass. Stirring naturally accelerates the diffusion of the salt, and thus increases the current. In both N - and $N/10$ -sulphuric acid with larger applied e.m.f., abnormal polarization occurs, so that thallium shows two different states of **passivity**. In the former soln., yellow crystals are formed on the anode, which probably represent a mixture of thallic and thallic sulphate. Complicated phenomena also occur when sodium sulphate is used as electrolyte.

REFERENCES.

- ¹ W. Crookes, *Chem. News*, **8**, 159, 195, 219, 231, 243, 255, 279, 1863; A. Lamy, *Ann. Chim. Phys.*, (3), **67**, 385, 1863; *Compt. Rend.*, **54**, 1255, 1862; L. de la Rive, *ib.*, **56**, 588, 1863; H. Fizeau, *ib.*, **68**, 1125, 1869; H. V. Regnault, *ib.*, **55**, 887, 1862; G. Werther, *Journ. prakt. Chem.*, (1), **91**, 385, 1864; (1), **92**, 128, 351, 1864; H. Bürger, *Die Abhängigkeit der spezifischen Wärme des Thalliums von der Temperatur. Untersuchungen an Transformatoren*, Zürich, 1908; G. D. Roos, *Ueber die Schmelzwärme und die Bildungswärme von Metallverbindungen und über das Zustandsdiagramm der Hg-Tl-Legierungen*, Leipzig, 1916; T. W. Richards, W. N. Stull, F. N. Brink, and F. Bonnet, *Journ. Amer. Chem. Soc.*, **31**, 157, 1909; T. W. Richards, *ib.*, **37**, 1643, 1915; T. W. Richards and C. P. Smyth, *ib.*, **44**, 524, 1922; G. N. Lewis and M. Randall, *ib.*, **43**, 253, 1921; G. N. Lewis and G. E. Gibson, *ib.*, **39**, 2554, 1917; G. N. Lewis, G. E. Gibson, and W. M. Latimer, *ib.*, **44**, 1008, 1922; T. W. Richards and J. H. Wilson, *Carnegie Inst. Pub.*, **118**, 1909; *Zeit. phys. Chem.*, **72**, 129, 1910; J. R. Rydberg, *ib.*, **33**, 353, 1900; T. W. Richards and F. G. Jackson, *ib.*, **70**, 414, 1910; W. C. Roberts-Austen, *Phil. Trans.*, **179**, 339, 1888; T. W. Richards, *Zeit. Elektrochem.*, **13**, 519, 1907; H. von Wartenberg, *ib.*, **15**, 868, 1909; **19**, 482, 1913; *Zeit. anorg. Chem.*, **56**, 320, 1907; M. Werner, *ib.*, **83**, 275, 1913; A. von Vegesack, *ib.*, **52**, 30, 1907; M. Chikashigé, *ib.*, **51**, 328, 1906; K. Lewkonja, *ib.*, **52**, 452, 1907; L. Densky, *ib.*, **57**, 49, 1908; G. Voss, *ib.*, **57**, 185, 1908; N. S. Kurnakoff, S. F. Schemtschuschny, and V. Tararin, *ib.*, **83**, 200, 1913; G. D. Roos, *ib.*, **94**, 358, 1916; P. Fuchs, *ib.*, **107**, 308, 1919; P. Pavlovitch, *Journ. Russ. Phys. Chem. Soc.*, **47**, 29, 1915; W. Guertler and M. Pirani, *Zeit. Metallkunde*, **11**, 1, 1919; M. N. Saha, *Nature*, **107**, 682, 1921; M. Levin, *ib.*, **45**, 31, 1905; R. S. Williams, *ib.*, **50**, 127, 1906; N. S. Kurnakoff and S. F. Schemtschuschny, *ib.*, **64**, 149, 1909; G. W. A. Kahlbaum, K. Roth, and P. Siedler, *ib.*, **29**, 177, 1902; E. Isaac and G. Tammann, *ib.*, **55**, 58, 1907; G. I. Petrenko, *ib.*, **50**, 133, 1906; F. Doerinckel, *ib.*, **48**, 185, 1906; N. S. Kurnakoff and N. A. Puschin, *ib.*, **30**, 86, 1902; *Journ. Russ. Phys. Chem. Soc.*, **33**, 565, 1902; N. Werigin, J. Lewkojeff, and G. Tammann, *Ann. Physik*, (4), **10**, 647, 1903; P. W. Bridgman, *Proc. Amer. Acad.*, **52**, 91, 1916; **58**, 166, 1923; M. Töppler, *Wied. Ann.*, **53**, 343, 1894; G. Facher,

- Nuovo Cimento*, (4), 2, 143, 1895; D. Omodei, *Atti Accad. Siena*, (4), 2, 515, 1890; H. C. Schmitz, *Proc. Roy. Soc.*, 72, 177, 1903; P. Nordmeyer and A. L. Bernoulli, *Ber. deut. phys. Ges.*, 5, 175, 1907; W. Nernst and F. Schwepers, *Sitzber. Akad. Berlin*, 355, 1914; C. T. Heycock and F. H. Neville, *Journ. Chem. Soc.*, 61, 895, 1892; 65, 31, 1894; F. W. Robertson, *ib.*, 81, 1240, 1902; F. Krafft and A. Knocke, *Ber.*, 42, 204, 1909; H. Biltz and V. Meyer, *ib.*, 22, 725, 1889; H. Biltz, *Sitzber. Akad. Berlin*, 67, 1895; G. K. Burgess, *Journ. Washington Acad.*, 1, 16, 1911; *Chem. News*, 104, 165, 1911; W. L. Bragg, *Phil. Mag.*, (6), 40, 169, 1921; A. S. Nishikawa and G. Asahara, *Phys. Rev.*, (2), 15, 38, 1920; H. R. von Traubenberg, *Zeit. Physik*, 2, 268, 1914; J. Stark and G. von Wendt, *Ann. Physik*, (4), 38, 669, 690, 1912; G. E. Gibson, *Einige Dampfdruck und Dampfdichtebestimmungen mit einem neuen Quarzmanometer*, Breslau, 1911; W. R. Mott, *Trans. Amer. Electrochem. Soc.*, 34, 555, 1918; K. Becker and F. Ebert, *Zeit. Physik*, 16, 165, 1923; C. A. Edwards, *Journ. Inst. Metals*, 20, 61, 1918; C. A. Edwards and M. A. Herbert, *ib.*, 25, 175, 1921; E. van Aubel, *Bull. Acad. Belg.*, (5), 7, 155, 1921; H. Endo, *Journ. Inst. Metals*, 30, 121, 1923; P. Nicolardot, *Compt. Rend.*, 168, 558, 1919; E. D. Eastman, *Journ. Amer. Chem. Soc.*, 45, 80, 1923; J. H. Hildebrand, T. R. Hogness, and N. W. Taylor, *ib.*, 45, 2828, 1923; W. B. Brown, *Phys. Rev.*, (2), 22, 171, 1923.
- ² W. Crookes, *Chem. News*, 3, 193, 303, 1861; 6, 1, 89, 1862; 9, 54, 1864; *Phil. Mag.*, (4), 21, 301, 1861; *Phil. Trans.*, 153, 173, 1863; W. A. Miller, *ib.*, 152, 861, 1862; *Proc. Roy. Soc.*, 12, 159, 407, 1862; *Phil. Mag.*, (4), 25, 304, 1863; (4), 26, 228, 1863; A. A. Michelson, *ib.*, (5), 34, 280, 1892; *B.A. Rep.*, 170, 1892; *Nature*, 59, 440, 1899; *Astrophys. Journ.*, 7, 131, 1898; *Astron. Astrophys.*, 11, 884, 1892; H. A. Rowland, *ib.*, 12, 321, 1893; *Phil. Mag.*, (5), 36, 49, 1893; A. Lamy, *Ann. Chim. Phys.*, (3), 67, 385, 1863; *Compt. Rend.*, 54, 1255, 1862; J. Nicklès, *ib.*, 58, 132, 1864; F. Bernard, *ib.*, 58, 1153, 1864; L. de Boisboudran, *ib.*, 77, 1152, 1873; *Spectres lumineux*, Paris, 1874; R. Capron, *Photographed Spectra*, London, 1877; A. Gouy, *Compt. Rend.*, 84, 231, 1877; H. Becquerel, *ib.*, 97, 71, 1883; 99, 374, 1884; *Ann. Chim. Phys.*, (5), 30, 5, 1863; A. Perot and C. Fabry, *ib.*, (7), 16, 115, 1899; *Compt. Rend.*, 126, 407, 1898; D. Cochain, *ib.*, 116, 1055, 1893; A. de Gramont, *ib.*, 134, 1205, 1902; 144, 1101, 1907; 151, 308, 1910; 159, 5, 1914; C. A. Valsou, *ib.*, 76, 224, 1873; L. and E. Bloch, *ib.*, 171, 909, 1920; *Journ. Phys. Rad.*, (6), 2, 229, 1921; J. Müller, *Pogg. Ann.*, 118, 641, 1863; R. Bunsen and G. Kirchhoff, *ib.*, 110, 161, 1860; R. Rühlmann, *ib.*, 132, 1, 1867; R. Bunsen, *ib.*, 155, 230, 366, 1875; E. Ketteler, *ib.*, 124, 390, 1865; *Sitzber. Akad. Berlin*, 630, 1864; H. Kayser and C. Runge, *ib.*, 1892, 1891; *Wied. Ann.*, 48, 126, 1893; F. Kurlbaum and G. Schulze, *Ber. deut. phys. Ges.*, 4, 239, 1906; C. Fievez, *Bull. Acad. Belg.*, (3), 9, 381, 1885; W. Huggins, *Phil. Trans.*, 154, 139, 1864; J. Plücker and W. Hittorf, *ib.*, 155, 1, 1865; H. Kayser, *Handbuch der Spectroscopie*, Leipzig, 6, 709, 1912; J. Formanek, *Die qualitative Spektralanalyse*, Berlin, 129, 1905; R. Thalén, *Om spectralanalys*, Upsala, 1866; *Nova Acta Reg. Soc. Upsala*, (3), 6, 9, 1868; E. Mascart, *Ann. Scient. École Norm.*, 4, 7, 1866; *Compt. Rend.*, 68, 402, 1869; L. and E. Bloch, *ib.*, 171, 909, 1920; A. Cornu, *ib.*, 73, 332, 1871; 100, 1181, 1885; *Journ. Phys.*, (2), 5, 93, 1886; *Phil. Mag.*, (4), 42, 237, 1871; J. Tyndall, *Nature*, 7, 384, 1873; E. Demarçay, *Spectres électriques*, Paris, 1895; E. Néculcea, *Recherches théoriques et expérimentales sur la constitution des spectres ultraviolets d'étincelles oscillantes*, Paris, 1906; F. Schön, *Beiträge zur Kenntniss der anomalen Dispersion von Metalldämpfen*, Jena, 1907; J. N. Lockyer and W. C. Roberts-Austen, *Proc. Roy. Soc.*, 23, 344, 1875; J. N. Lockyer, *ib.*, 43, 117, 1887; G. D. Liveing and J. Dewar, *ib.*, 27, 132, 1878; 36, 471, 1884; G. D. Liveing, *Proc. Cambridge Phil. Soc.*, 12, 337, 1904; *Phil. Trans.*, 174, 187, 1883; W. N. Hartley and W. E. Adeney, *ib.*, 175, 63, 1884; W. N. Hartley, *ib.*, 175, 325, 1884; 185, A, 161, 1894; *Journ. Chem. Soc.*, 41, 84, 1882; *Trans. Roy. Soc. Dublin*, (2), 1, 231, 1882; (2), 9, 85, 1908; *Astron. Astrophys.*, 11, 223, 1892; *Proc. Roy. Soc.*, 49, 488, 1891; J. P. Gassiot, *ib.*, 12, 536, 1863; W. N. Hartley and H. W. Moss, *ib.*, 79, A, 242, 1907; 87, A, 38, 1912; J. A. Carroll, *ib.*, 103, A, 334, 1923; J. H. Gladstone, *ib.*, 60, 140, 1896; W. N. Hartley and H. Ramage, *Trans. Roy. Soc. Dublin*, (2), 7, 339, 1901; J. H. Pollok, *Proc. Roy. Soc. Dublin*, 11, 338, 1909; 13, 202, 1912; H. Wilde, *ib.*, 53, 369, 1893; *Compt. Rend.*, 125, 708, 1897; *Chem. News*, 73, 304, 1896; G. Ciamician, *Sitzber. Akad. Wien*, 76, 494, 1877; J. M. Eder and E. Valenta, *Atlas typischer Spectren*, Wien, 1911; *Sitzber. Akad. Wien*, 118, 511, 1077, 1909; F. Exner and E. Haschek, *ib.*, 108, 1071, 1899; *Wellenlängentabellen für spectralanalytische Untersuchungen auf Grund der ultravioletten Funkenspectren der Elemente*, Leipzig, 1902; *Wellenlängentabellen für spectralanalytische Untersuchungen auf Grund der ultravioletten Bogenspectren der Elemente*, Leipzig, 1904; *Die Spectren der Elemente bei normalen Druck*, Leipzig, 1911-2; A. Hagenbach and H. Konen, *Atlas der Emission-spectra*, Jena, 1905; C. E. Gissing, *Spark spectra of the Metals*, London, 1910; W. Schuler, *Versuche über die Empfindlichkeit der spectralanalytischen Reaktionen*, Bonn, 1901; *Ann. Physik*, (4), 5, 931, 1901; L. Janicki, *ib.*, (4), 19, 36, 1906; (4), 29, 833, 1909; F. Paschen, *ib.*, (4), 29, 625, 1909; (4), 33, 717, 1910; C. Fredenhagen, *ib.*, (4), 20, 133, 1906; *Phys. Zeit.*, 8, 729, 1907; W. Grotrian, *Zeit. Physik*, 12, 218, 1923; F. L. Mohler, P. D. Foote, and A. E. Ruark, *Science*, (2), 57, 475, 1923; F. L. Mohler and P. D. Foote, *Phil. Mag.*, (6), 37, 33, 1919; D. Coster, *Phys. Rev.*, (2), 19, 20, 1922; J. C. McLennan, *Proc. Roy. Soc.*, 100, A, 191, 1921; J. C. McLennan, J. F. T. Young, and H. J. C. Ireton, *Trans. Roy. Soc. Canada*, 13, 7, 1919; *Proc. Roy. Soc.*, 98, A, 95, 1920; J. Papish, *Proc. Indiana Acad. Science*, 166, 1918; H. Konen, *Ann. Physik*, (4), 9, 742, 1902; J. M. Eder, *Denks. Akad. Wien*, 60, 1, 1893; J. M. Eder and E. Valenta, *ib.*, 68, 531, 1899; F. Paschen and E. Beck, *Physica*, 1, 261, 1921; E. P. Lewis, *Phys. Zeit.*, 3, 398, 1902; *Astrophys. Journ.*, 2, 106, 1895; 16, 31, 1902; J. F. Mohler, *ib.*, 4, 175, 1896; P. G. Nutting, *ib.*, 23, 64, 1906; R. W. Wood and D. V. Guthrie, *ib.*, 29, 211, 1909;

W. J. Humphreys, *ib.*, 6. 169, 1897; J. Barnes, *ib.*, 19. 190, 1904; *Phil. Mag.*, (6), 7. 485, 1904; M. Siegbahn and E. Friman, *ib.*, (6), 32. 39, 1916; E. Hjalmar, *Zeit. Physik*, 7. 341, 1921; A. Fowler, *Report on Series in Line Spectra*, London, 155, 1922; B. E. Moore, *Astrophys. Journ.*, 58. 86, 104, 1922; G. O. Lummer and E. Pringsheim, *Phys. Zeit.*, 4. 430, 1903; C. Fritsch, *ib.*, 9. 900, 1908; G. E. Gibson, *ib.*, 12. 1145, 1912; W. von Bolton, *Zeit. Elektrochem.*, 9. 913, 1903; H. Koenen and H. Finger, *ib.*, 15. 165, 1909; J. Steinhausen, *Zeit. wiss. Phot.*, 3. 45, 1905; H. Auerbach, *ib.*, 7. 30, 41, 1909; H. Finger, *ib.*, 7. 329, 369, 1909; H. Geisler, *ib.*, 7. 80, 1909; W. Huppers, *ib.*, 13. 46, 1913; W. J. Pope, *Chem. Soc.*, 69. 1630, 1896; J. H. Gladstone, *Proc. Roy. Soc.*, 60. 140, 1896; J. Stark and G. von Wendt, *Ann. Physik*, (4), 38. 669, 690, 1912; C. A. Valson, *Compt. Rend.*, 76. 224, 1873; H. R. von Traubenberg, *Zeit. Physik*, 2. 268, 1914.

³ J. Stark and G. von Wendt, *Ann. Physik*, (4), 38. 669, 690, 1912; H. Smith, *Phil. Mag.*, (6), 25. 461, 1913; E. Beckmann and H. Linder, *Zeit. phys. Chem.*, 82. 641, 1913; M. N. Saha, *Nature*, 107. 482, 1921; D. Coster, *Phys. Rev.*, (2), 18. 218, 1921; *Zeit. Physik*, 6. 185, 1921; E. Hjalmar, *ib.*, 15. 65, 1923; W. Duane, F. Fricke, and W. Stenström, *Proc. Nat. Acad. Science*, 6. 607, 1920; W. Duane and R. A. Patterson, *ib.*, 6. 509, 1920; M. de Broglie, *Compt. Rend.*, 169. 962, 1919; M. Siegbahn, *Jahrb. Rad. Elektron.*, 13. 296, 1916; G. Wentzel, *Zeit. Naturwiss.*, 10. 369, 1922; J. E. P. Wagstaff, *Phil. Mag.*, (6), 47. 84, 1924; F. L. Mohler and A. E. Ruark, *Journ. Amer. Opt. Soc.*, 7. 819, 1923; F. L. Mohler, P. D. Foote, and A. E. Ruark, *Science*, (2), 57. 475, 1923; F. L. Mohler and P. D. Foote, *Phil. Mag.*, (6), 37. 33, 1919.

⁴ J. R. Benoit, *Compt. Rend.*, 76. 342, 1873; L. de la Rive, *ib.*, 56. 249, 1863; W. P. Davey, *Phys. Rev.*, (2), 19. 248, 1922; H. Greinacher, *Phys. Zeit.*, 23. 65, 1922; P. W. Bridgman, *Proc. Amer. Acad.*, 52. 573, 1917; 53. 269, 1913; *Journ. Washington Acad. Science*, 11. 455, 1921; A. Schulze, *Zeit. Metallkunde*, 15. 155, 1923; 16. 48, 1924; F. L. Mohler and A. E. Ruark, *Phys. Rev.*, (2), 21. 718, 1923; G. Vieontini and D. Omodei, *Atti Accad. Torino*, 25. 30, 1889; *Nuovo Cimento*, (3), 27. 204, 1890; A. Matthiessen and C. Vogt, *Pogg. Ann.*, 118. 431, 1863; *Phil. Mag.*, (4), 26. 242, 1863; J. Dewar and J. A. Fleming, *ib.*, (5), 36. 271, 1893; H. Dickson, *ib.*, (5), 45. 525, 1898; W. H. Steele, *ib.*, (5), 37. 218, 1894; A. Lamy, *Compt. Rend.*, 55. 836, 1862; S. Meyer, *Monatsh.*, 20. 369, 797, 1899; K. Honda, *Ann. Physik*, (4), 32. 1027, 1910; M. Owen, *ib.*, (4), 37. 657, 1912; *Proc. Acad. Amsterdam*, 14. 637, 1911; W. Tuyn and H. K. Onnes, *ib.*, 26. 504, 1923; *Arch. Néerl.*, (3), 6. 284, 1923; A. Stein, *Phys. Zeit.*, 13. 287, 1912; W. Crookes, *Phil. Trans.*, 153. 173, 1863; *Journ. Chem. Soc.*, 17. 112, 1864; M. Werner, *Zeit. anorg. Chem.*, 83. 275, 1913; W. Ostwald, *Zeit. phys. Chem.*, 11. 501, 1893; J. C. McLennan, *Journ. Franklin Inst.*, 181. 191, 1916; A. T. Waterman, *Phys. Rev.*, (2), 22. 259, 1923; C. A. Crommelin, *Jahrb. Rad. Elektron.*, 19. 38, 1922.

⁵ G. Neumann, *Ber.*, 21. 356, 1888; B. Neumann, *Zeit. phys. Chem.*, 14. 228, 1894; N. T. M. Wilmshere, *ib.*, 35. 291, 1900; J. F. Spencer, *ib.*, 76. 360, 1911; R. Abegg and J. F. Spencer, *Zeit. anorg. Chem.*, 46. 406, 1905; G. N. Lewis and C. L. von Ende, *Journ. Amer. Chem. Soc.*, 32. 732, 1910; K. Fajans, *Ber. deut. phys. Ges.*, 21. 549, 1919; T. W. Richards and C. P. Smyth, *ib.*, 44. 544, 1922; J. Regnaud, *Ann. Chim. Phys.*, (3), 44. 453, 1855; *Compt. Rend.*, 43. 47, 1856; 64. 611, 1867; M. Born, *Zeit. Physik*, 1. 45, 1920; I. Shukoff, *Ber.*, 38. 2691, 1905; F. J. Brislée, *Trans. Faraday Soc.*, 4. 159, 1909; H. G. Denham, *Journ. Chem. Soc.*, 93. 833, 1908; F. Kohrausch and H. von Steinwehr, *Sitzber. Akad. Berlin*, 581, 1902; L. Schucht, *Berg. Hütt. Ztg.*, 39. 122, 1880; *Chem. News*, 47. 209, 1883; L. Jonas, *Zeit. Elektrochem.*, 9. 523, 1903; W. J. Müller, *ib.*, 11. 755, 1905; 15. 696, 1909; *Zeit. phys. Chem.*, 69. 460, 1909; G. Jones and W. C. Schumb, *Proc. Amer. Acad.*, 56. 199, 1921; R. Kremann and P. von Reininghaus, *Zeit. Metallkunde*, 12. 273, 1920; R. Kremann and E. Preszfreund, *ib.*, 13. 19, 1921; W. Ostwald, *Zeit. phys. Chem.*, 11. 501, 1893; W. A. Ben, *ib.*, 26. 439, 1899; K. G. Falk, *Journ. Amer. Chem. Soc.*, 32. 1555, 1910; A. A. Noyes and K. G. Falk, *ib.*, 33. 1436, 1911; A. Gutbier and W. Dieterle, *Zeit. Elektrochem.*, 29. 457, 493, 1923; G. Tammann, *Zeit. anorg. Chem.*, 133. 267, 1924.

§ 4. The Chemical Properties of Thallium

Le thallium est destiné à faire époque dans l'histoire de la chimie par l'étonnant contraste qui se manifeste entre ses caractères chimiques et ses propriétés physiques. Il n'y a pas d'exagération à dire qu'au point de vue de la classification généralement acceptée pour les métaux, le thallium offre une réunion de propriétés contradictoires qui autoriserait à l'appeler le métal paradoxal, l'ornithorrhynque des métaux.—J. B. A. DUMAS.¹

Thallium forms two series of salts—thallous and thallic compounds—in which the element is respectively uni- and ter-valent. The general properties of the two series are very different. In the early days there were difficulties in assigning thallium a place in a particular family of elements. W. Crookes' premise that it belonged to the sulphur family was soon abandoned. The physical properties of the metal—appearance, sp. gr., hardness, m.p., and electrical conductivity—were

found to be analogous with those of lead, so also were many of the chemical properties of the salts of univalent thallium analogous with those of bivalent lead—*e.g.* the sparing solubility and colour of the thalious halides, and chromate, and the behaviour of the aq. soln. towards zinc are also analogous to the corresponding lead salts. The differences in valency, etc., however, were too pronounced to allow thallium to be included with the lead family of elements. Univalent thallium resembles the alkali metals in the flame spectra; the ready oxidation of the metal in air, the solubility of the hydroxide, sulphate, and carbonate in water; the existence of thallia-alums, and thallium chloroplatinate; and the isomorphism of its salts with those of potassium, rubidium, and caesium. C. F. Rammelsberg, and G. N. Wyrouboff investigated the isomorphism of the sulphates, alums, phosphates, and tartrates; A. Fock, the dithionates; H. W. B. Roozeboom, the chlorates; H. E. Roscoe, the perchlorates; and J. W. Retgers, and C. van Eyk, the nitrates. Here again the differences were too marked to permit thallium being included with the family of alkali metals. Tervalent thallium has analogies with the aluminium family, it has but a small tendency to form alums; and in the low stability of the chloride and its tendency to form complexes, it resembles gold. D. I. Mendeléeff, in introducing the periodic classification, argued strongly in favour of including thallium with the aluminium family. He showed that in arranging the elements in the order of their at. wt., aluminium comes between magnesium and silicon, and thallium between mercury and lead. Just as the higher oxide of mercury is alone analogous with magnesium oxide, so does the highest oxide of lead show an analogy with silica, and the highest oxide of thallium show an analogy with alumina. Magnesium and mercuric oxides are strongly basic, aluminium and thallic oxides are feebly basic, while lead and silicon dioxides are feebly acidic. Lead, thallium, and mercury form a basic oxide lower than plumbic and mercuric oxides, while silicon, aluminium, and magnesium do not form well-defined lower oxides. The higher oxides HgO , Tl_2O_3 , and PbO_2 are peroxidic relative to the lower oxides Hg_2O , Tl_2O , and PbO , and give off oxygen when heated; the higher chloride of mercury is stable, that of thallium unstable, and that of lead very unstable.

Thallium does not form any compound with **hydrogen**. A. Sieverts,² and D. P. Smith found that the quantity of gaseous hydrogen occluded by thallium can scarcely be detected, although, as T. W. Richards and C. P. Smyth pointed out, hydrogen formed at the cathode during electrolysis might be occluded to a greater extent as is the case with iron. L. Troost and P. Hautefeuille detected no analogy with the alkali metals in the tendency of thallium to form hydrides. Only a few c.c. are absorbed by the metal at 500° and 760 mm. press. W. B. Herapath assumed that a *thallium hydride* was formed which burnt with a green-coloured flame, but W. Crookes could not confirm this observation in the action of acids on zinc in the presence of thallium salts, or in the action of acids on a zinc-thallium alloy. When hydrogen is passed over red-hot thallium, the gas may carry along fine particles of the metal which colour the flame of the burning gas.

When a freshly cut surface is exposed to **air**, A. Lamy noted that it is gradually covered by a dark grey film which protects the metal from further change; at 100°, the metal rapidly becomes brown, but regains its lustre when dipped in water owing to the dissolution of the oxide. G. Gore said that attack by air is very slow in the cold, and rapid at 100°. C. F. Schönbein found that thallium is not changed at ordinary temp. in dry **oxygen**, and in thoroughly dried **ozone**, also, no change is perceptible, but in the presence of moisture, a brown film of oxide is immediately formed. A. Lamy found that when melted in oxygen, the metal inflames and becomes incandescent. According to J. B. A. Dumas, below a red heat the metal oxidizes, forming thallic oxide; at a red heat, a mixture of crystalline thallic and thalious oxide alone is formed. W. Crookes, A. Lamy and E. J. Chapman noted that when heated above its m.p. in air, thallium gives brown fumes. W. Crookes said that when the moist metal is exposed to air, crystals of thallium carbonate are formed. A. Lamy found that **water** alone at ordinary temp. does not act on thallium, nor

does the metal decompose boiling water ; but W. Crookes found that the red-hot metal decomposes steam. C. Weltzien, and G. Wyruboff said a mixture of thalious and thallic hydroxides are simultaneously formed : $2\text{Tl} + 4\text{H}_2\text{O} = \text{TlOH} + \text{Tl}(\text{OH})_3 + 2\text{H}_2$. R. Böttger noted that the metal is attacked by water with dissolved air, forming a mixture of thalious hydroxide and carbonate ; and added that thallium is best preserved under water which has been well boiled, under an aq. soln. of glycerol, or under a soln. of thalious carbonate. J. Schiel recommended keeping the metal under water in which some drops of petroleum had been shaken. A. Kölliker emphasized the rapid oxidation (and dissolution) of thallium in aerated water. According to C. F. Schönbein, **hydrogen peroxide** produces a brown crust of thallic hydroxide which is later reduced to thalious hydroxide with the evolution of oxygen ; K. Birnbaum also studied this reaction.

H. Moissan found that **fluorine** acts on thallium so vigorously that the metal becomes incandescent ; A. Lamy, that thallium is attacked when heated in **chlorine** gas, and V. Thomas, that dried liquid chlorine has very little action on the metal. A. Lamy found that thallium unites with **bromine**, and, added J. Nicklès, the action is faster in the presence of water or alcohol. W. Crookes noted that **iodine** unites with heated thallium. R. Lepsius found that when thallium is heated in a stream of **hydrogen chloride**, hydrogen is evolved and thalious chloride formed. According to F. Kuhlmann, **hydrochloric acid**, and the halide acids, attack thallium with difficulty owing to the sparing solubility of the thallium halide, but **hydrofluoric acid**, which forms a readily soluble fluoride, attacks the metal tardily. W. Crookes found that aq. **chloric acid** dissolves thallium, forming thalious chlorate ; and H. E. Roscoe found that **perchloric acid** likewise attacks the metal, forming thalious perchlorate.

According to W. Crookes, and A. Lamy, when thallium is melted with **sulphur**, **selenium**, or **tellurium**, the elements unite chemically. H. Pelabon has studied the union of thallium with sulphur, selenium, and tellurium. A. Röhrig found warm **sulphurous acid** attacks thallium very slowly, forming thalious sulphite. W. Crookes, and A. Lamy found thallium dissolves in **sulphuric acid**, forming thalious sulphate. W. O. Rabe showed that the dil. acid acts slowly, while the conc. acid acts more rapidly. According to A. Ditte, thallium dissolves in dil. sulphuric acid at a low temp. with the evolution of hydrogen, while the conc. acid forms sulphur dioxide, hydrogen sulphide, and free sulphur. F. W. Clarke stated that boiling **telluric acid** does not attack thallium. P. Nicolardot found thallium is not attacked by boiling **sulphur chloride**, S_2Cl_2 —presumably a protective layer of chloride is formed. H. G. Denham found that thallium is dissolved by a soln. of **thalious sulphate**, and he assumed that a subsulphate is formed.

H. Flemming said that **nitrogen** does not unite directly with thallium ; and F. H. Newman observed no absorption of this gas by thallium on the cathode of a discharge tube. C. A. Seely also found that liquid **ammonia** is without action ; and R. Weber, that **nitrogen pentoxide** has no action. E. Carstanjen found that thallium is more readily attacked by **nitric acid** than by the other mineral acids, and with dil. nitric acid, hydrogen is evolved. W. Crookes showed that thalious nitrate is the main product, but if an excess of conc. nitric acid is used, much thallic nitrate is formed ; while J. J. Acworth and H. E. Armstrong found that with dil. nitric acid (1 : 2), at 30° , the evolved gas contains 69·78 per cent. of nitric oxide, 19·15 per cent. of nitrous oxide, and 11·07 per cent. of nitrogen. With warm aqua regia, G. Werther, and E. Willm noted that thallic chloride is formed. J. J. Sudborough noted the formation of a complex, $\text{TlCl} \cdot \text{TlCl}_3 \cdot 2\text{NOCl}$, when thallium and **nitrosyl chloride** are heated in a sealed tube to 100° .

According to E. Carstanjen, **phosphorus** does not act on thallium when the two elements are melted together ; but H. Flemming found that when phosphorus vapour is passed over molten thallium, a thin dark-coloured crust of possibly thallium phosphide is formed. E. Carstanjen found that thallium and **arsenic** or **antimony**, or **bismuth** readily alloy when melted together. Q. A. Mansuri obtained the f.p.

curves shown in Fig. 2 for binary alloys of arsenic and thallium. The two elements do not act on one another chemically, nor do they form solid soln. There is a eutectic at 215° with 8.01 per cent. of arsenic; with increase of arsenic the f.p. of the alloys rise to 240° . Alloys with 13 to about 40 per cent. of arsenic begin to freeze at 240° and form two layers—the upper one being rich in arsenic, and the lower one rich in thallium; with over about 40 per cent. of arsenic, the two layers disappear, and the soln. becomes uniform.

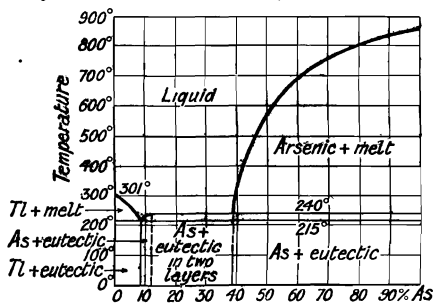

FIG. 2.—Freezing-point Curves of Alloys of Thallium and Arsenic.

alloys, Fig. 4, evidence of the formation of the *thallium tritapenabismuthide*, Bi_5Tl_3 , and less decisive evidence with respect to *thallium tritabismuthide*, BiTl_3 . R. Kremann and A. Lobinger found the e.m.f. behaviour indicated the existence

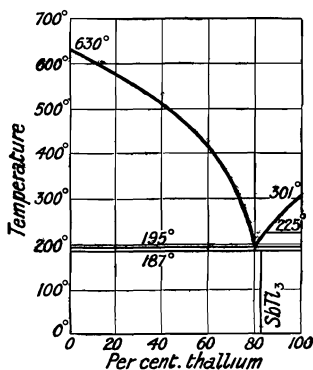

FIG. 3.—Freezing-point Curve of Thallium-Antimony Alloys.

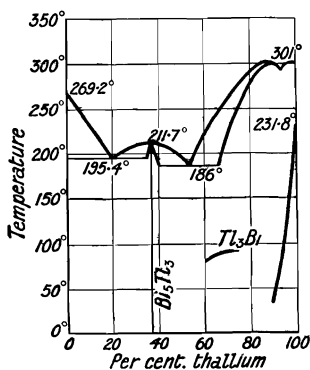

FIG. 4.—Freezing-point Curve of Thallium-Bismuth Alloys.

of the compounds Bi_5Tl_3 and BiTl_3 . N. S. Kurnakoff and co-workers found no evidence of the compound Bi_5Tl_3 . N. S. Kurnakoff and N. A. Puschin, and C. T. Heycock and F. H. Neville studied the fusion curve of mixtures of these elements; D. Omodei, the thermal expansion.

According to H. Moissan, **carbon, boron, or silicon** does not dissolve to an appreciable extent in thallium, nor do the two elements unite directly. H. Flemming said that thallium does not unite with **carbon dioxide** even if the temp. be raised to the softening point of glass. **Organic acids** attack thallium with difficulty. Thallium is covered by a dark crust when placed in **petroleum**; likewise also in **benzene**, and at the same time the liquid becomes turbid; in **chloroform**, dirty yellow flocks separate; absolute **methyl, ethyl, or isobutyl alcohol**, according to T. Svedberg, takes up appreciable quantities of thallium in a short time. R. Böttger found thallium is quickly attacked by neutral **methyl ether** free from alcohol; and in **ethyl ether** a yellowish-brown powder is formed and the liquid becomes turbid. J. F. Spencer and M. L. Wallace found that boiling **α -bromonaphthalene** forms thallic bromide; and boiling **iodobenzene**, thallic iodide. J. L. Sammis found a soln. of **cupric oleate** in pyridine does not attack thallium. A. Korczynsky studied the catalytic action of thallium and its salts on the hydrogenation of aromatic

hydrocarbons. Thallium was found by W. C. Reid to precipitate the metal from soln. of **copper, silver, gold, mercury, and lead**. W. Crookes said that a soln. of **potassium permanganate** is reduced by thallium at ordinary temp.

The **physiological action** of thallium and its salts has been discussed by W. Crookes,³ A. Lamy, J. J. Paulet, L. Grandeau, E. Jeanselme, H. Castex, J. Blake, H. Erdmann, A. Curci, B. Stadion, W. Luck, etc. The **uses** of thallium are not important. Any advantages offered by thallium or its compounds are counterbalanced by the cost. The chromate is stated by T. W. Salter⁴ to furnish a richer yellow pigment than lead chromate. A. Lamy, and O. Schott say that if lead in glasses be replaced by thallium the product has a higher refractive index, and is better suited for the preparation of imitations of gem-stones. J. Gädicke and A. Miethé, and L. Vanino and co-workers recommend it in magnesium, etc., for increasing the luminosity. G. Meyer, H. Kreisler, and A. Hantzsch and W. H. Glover used the flame coloured with thallium as a source of monochromatic light. Thallous salts have also been recommended in testing for ozone; in the separation of chlorides and iodides (V. Thomas, and P. Jannasch and K. Aschoff); and in some microscopic tests (H. Behrens).

Reactions of analytical interest.—The thallous salts are colourless and usually soluble in water, although the chloride, bromide, iodide, sulphide, and chromate are but sparingly soluble. Thallous salts are readily reduced to thallous salts, and when an aq. soln. of thallic sulphate or nitrate is boiled, thallic hydroxide is precipitated. With **hydrochloric acid**, and soluble chlorides, thallous salts, in not too dil. a soln., give a white precipitate of thallous chloride which is slightly soluble in water, but less soluble in water containing a little hydrochloric acid. Thallic salts under similar conditions give no precipitate. H. Behrens⁵ detected 0.00016 mgrm. of thallium by using this reaction as a microscopic test. With **potassium iodide**, yellow thallous iodide is formed even with dil. soln., and this is considered to be a very sensitive test for thallium. Unlike lead iodide, thallous iodide dissolves but sparingly in a cold soln. of sodium thiosulphate. According to H. Behrens, 0.0003 mgrm. can be detected by using this reaction as a microscopic test. Thallic salts give a brown precipitate which is a mixture of thallic and thallous iodides. F. Ephraim found that with a mixture of potassium iodide and antimony chloride, orange-red thallous iodoantimonite, $3\text{TlI} \cdot 2\text{SbI}_3$, separates. When **hydrogen sulphide** is passed into a soln. of thallous sulphate, acidified with mineral acids, no precipitation occurs, but with neutral soln., black thallous sulphide, Tl_2S , is incompletely precipitated. If arsenic, antimony, or copper salts be present, thallous sulphide is precipitated with the sulphides of those metals. With soln. acidified with acetic acid, the precipitation is complete. Thallous sulphide is readily dissolved by mineral acids; it is insoluble in acetic acid and alkaline sulphides; and it is readily oxidized to thallous sulphate when exposed to air. It is but slightly attacked by acetic acid. The precipitate is not soluble in aq. ammonia, alkali or ammonium sulphide, or potassium sulphide. When heated, the thallous sulphide first melts and then volatilizes. Thallic salt soln. behave in a similar manner towards hydrogen sulphide. Thallium salts give with **ammonium sulphide**, $(\text{NH}_4)_2\text{S}$, a precipitate of thallous sulphide. Similar results are obtained with hydrogen sulphide in alkaline soln.

Thallous salt soln. give no precipitate when treated with aq. **ammonia**, or **alkali hydroxides**, but thallic salts give brown thallic hydroxide, which changes to $\text{TlO}(\text{OH})$ when exposed to air. The precipitate dissolves very slowly in acids, and is not soluble in an excess of alkali-lye. The presence of tartaric acid hinders the precipitation. Thallous carbonate is fairly soluble in water, so that **alkali carbonates** precipitate thallous carbonate only from conc. soln.; with thallic salts, thallic hydroxide is precipitated. Soln. of **alkali chromates** precipitate yellow thallous chromate—soluble in cold nitric or sulphuric acids—from soln. of thallous salts; and no precipitate with soln. of thallic salts. With not too dil. soln. of thallous salts, **hydrochloroplatinic acid** precipitates pale yellow thallous chloroplatinate,

Tl_2PtCl_6 ; H. Behrens claimed to detect 0.000008 mgrm. of thallium by this reagent used as a micro-test. A white crystalline precipitate soluble in boiling water is formed when **potassium thiocyanate** is added to a soln. of a thalious salt. A soln. of **sodium thiosulphate** gives a white precipitate with thalious salt soln., the precipitate is soluble in boiling water, and when an acid is added to the soln., thalious sulphide is precipitated. Neutral soln. of thalious salts give a precipitate of thallic oxide with **potassium permanganate**; in acid soln., the thalious salt is oxidized to a thallic salt. Thalious sulphate, when treated with **aluminium sulphate**, gives colourless octahedral crystals of thallia alura, $TlAl(SO_4)_2 \cdot 12H_2O$. According to M. Cunningham and F. M. Perkin, and S. M. Tanatar and S. Petroff, a pale red, sparingly soluble precipitate is produced when **sodium cobaltinitrite** is added to a thalious salt soln. According to L. Marino, small quantities of thallic salts in the presence of thalious salts can be detected by the production of a blue coloration with **α -naphthol** and **dimethyl-p-phenylene-diamine**. **Zinc, aluminium and magnesium** precipitate black crystals of thallium from soln. of thallium salts.

The atomic weight of thallium.—Thallium has a hydrogen eq. of about 204 in thalious salts, and 68 in thallic salts. The at. wt. approaching 204 is in accord with the vapour density of the halide, and with the mol. wt. of the salts in soln. It is also in accord with sp. ht. rule; with the isomorphic rule in connection with the alums; and with the periodic scheme of classification. In 1862, A. Lamy⁶ analyzed thalious sulphate, and from the ratio $Tl_2SO_4 : BaSO_4$, he calculated the at. wt. 205.22; and M. Heberling from the same ratio obtained 204.97. A. Lamy analyzed thalious chloride, and from the ratio $TlCl : AgCl$ obtained 203.87; M. Heberling from a similar ratio obtained 203.22; and H. L. Wells and S. L. Penfield, 204.48. G. Werther analyzed thalious iodide, and from the ratio $TlI : AgI$, obtained 203.81. W. Crookes converted thallium into the nitrate, and from the ratio $Tl : TlNO_3$ obtained 204.04 ($N=14.01$). C. Lepierre, from the ratio $Tl_2O_3 : 2Tl$ obtained 204.14; from $Tl_2O_3 : 2Tl$, 204.16; from $2TlNO_3 : Tl_2O_3$, 204.04 ($N=14.01$), $Tl_2SO_4 : Tl_2O_3$, 203.99; and from $Tl_2O_3 : 3H_2O$, 204.29. A study of the different ratios gave F. W. Clarke 204.04; B. Brauner, 204; and the International Table for 1922, 204.0. The **atomic number** is 81. F. W. Aston⁷ attempted to find the **isotopes** of thallium, but was not successful. W. P. Jorissen and J. A. Vollgraf did not succeed in producing thallium from bismuth by the action of the cathode rays, although they found that bismuth commonly contains a trace of thallium.

REFERENCES.

¹ J. B. A. Dumas, J. Pelouze, and H. St. C. Deville, *Compt. Rend.*, **55**, 866, 1862; *Ann. Chim. Phys.*, (3), **67**, 418, 1863; D. I. Mendeléeff, *Liebig's Ann. Suppl.*, **8**, 133, 1872; *Chem. News*, **40**, 231, 243, 255, 267, 279, 291, 303, 1879; **41**, 2, 27, 39, 49, 61, 71, 83, 93, 106, 113, 125, 1880; R. Otto, *Journ. prakt. Chem.*, (1), **102**, 185, 1867; O. L. Erdmann, *ib.*, (1), **89**, 378, 1863; C. F. Rammelsberg, *Ber.*, **3**, 276, 1870; G. N. Wyruboff, *Bull. Soc. Min.*, **3**, 69, 75, 128, 136, 198, 1880; A. Fock, *Zeit. Kryst.*, **6**, 161, 1881; H. W. B. Roozeboom, *Zeit. phys. Chem.*, **8**, 513, 1891; J. W. Retgers, *ib.*, **4**, 593, 1889; C. van Eyk, *ib.*, **30**, 418, 1899; H. E. Roscoe, *Journ. Chem. Soc.*, **19**, 127, 1866; W. Crookes, *Chem. News*, **3**, 193, 1861.

² W. B. Herapath, *Pharm. Journ.*, (2), **4**, 302, 1863; L. Troost and P. Hautefeuille, *Ann. Chim. Phys.*, (5), **2**, 273, 1874; W. Crookes, *Chem. News*, **3**, 193, 1861; **7**, 290, 1863; **8**, 159, 219, 231, 234, 255, 279, 1863; **9**, 1, 37, 54, 1864; *Journ. Chem. Soc.*, **17**, 112, 1864; *Proc. Roy. Soc.*, **12**, 150, 1862; *Phil. Trans.*, **163**, 277, 1874; *Researches on the Atomic Weight of Thallium*, London, 1874; T. W. Richards and C. P. Smyth, *Journ. Amer. Chem. Soc.*, **44**, 524, 1922; A. Sieverts, *Zeit. Elektrochem.*, **16**, 708, 1910; D. P. Smith, *Journ. Phys. Chem.*, **23**, 186, 1919; A. Korczynsky, *Bull. Soc. Chim.*, (4), **29**, 283, 1921; C. A. Seely, *Journ. Franklin Inst.*, **61**, 110, 1871; W. C. Reid, *ib.*, **12**, 242, 1865; A. Lamy, *Compt. Rend.*, **54**, 1255, 1862; **57**, 442, 1863; *Ann. Chim. Phys.*, (3), **67**, 385, 1862; (4), **5**, 410, 421, 1865; *Bull. Soc. Chim.*, (2), **11**, 210, 1869; *De l'existence d'un nouveau métal, le thallium*, Lille, 1862; *Leçon sur le thallium*, Paris, 1863; R. S. Williams, *Zeit. anorg. Chem.*, **50**, 129, 1906; M. Chikashigé, *ib.*, **51**, 330, 1906; C. F. Schönbein, *Journ. prakt. Chem.*, (1), **93**, 35, 1864; R. Weber, *ib.*, (2), **6**, 351, 1872; E. Carstanjen, *ib.*, (1), **102**, 82, 1867; A. Röhrig, *ib.*, (2), **37**, 229, 1888; G. Werther, *ib.*, (1), **89**, 189, 1864; (1), **91**, 385, 1864; (1), **92**, 128, 351, 1864; E. J. Chapman, *Phil. Mag.*, (4), **2**, 397, 1876; R. Böttger, *Dingler's Journ.*, **197**, 379, 1870; G. Gore, *Phil. Mag.*, (4), **29**, 546, 1865; J. Schiel, *Ber.*, **12**, 507, 1879; F. W. Clarke, *ib.*, **11**, 1507, 1878; R. Lepsius, *ib.*, **21**, 556, 1888; T. Svedberg, *ib.*, **39**, 1711, 1906; C. Weltzien,

Liebig's Ann., **138**, 129, 1866; K. Birnbaum, *ib.*, **138**, 133, 1866; H. Flemming, *Jenaische Zeit. Med. Naturwiss.*, **4**, 33, 1868; Q. A. Mansuri, *Metal. Ind.*, **21**, 388, 1922; *Journ. Inst. Metals*, **28**, 453, 1922; J. J. Acworth and H. E. Armstrong, *Journ. Chem. Soc.*, **32**, 54, 1877; J. F. Spencer and M. L. Wallace, *ib.*, **93**, 1832, 1908; H. E. Roscoe, *ib.*, **19**, 504, 1866; J. J. Sudborough, *ib.*, **59**, 657, 1891; H. G. Denham, *Proc. Chem. Soc.*, **24**, 76, 1908; J. L. Sammis, *Journ. Phys. Chem.*, **10**, 607, 1906; W. O. Rabe, *Zeit. phys. Chem.*, **38**, 175, 1901; A. Ditte, *Ann. Chim. Phys.*, (6), **19**, 68, 1891; H. Pelabon, *ib.*, (8), **17**, 536, 1909; J. B. A. Dumas, *ib.*, (3), **67**, 422, 1863; H. Moissan, *ib.*, (6), **24**, 224, 1891; V. Thomas, *ib.*, (8), **11**, 204, 1907; E. Willm, *ib.*, (4), **5**, 1865; *Bull. Soc. Chim.*, (1), **5**, 354, 1863; (2), **2**, 89, 1864; F. Kuhlmann, *Compt. Rend.*, **58**, 1037, 1864; P. Nicolardot, *ib.*, **147**, 1305, 1908; J. Nicklès, *ib.*, **58**, 537, 1864; *Journ. Pharm. Chim.*, (4), **4**, 127, 1866; C. T. Heycock and F. H. Neville, *Journ. Chem. Soc.*, **65**, 31, 65, 1894; *Chem. News*, **62**, 280, 1890; D. Omodei, *Atti. Accad. Fisiocritici Siena*, (4), **2**, 15, 1890; N. S. Kurnakoff and N. A. Puschin, *Journ. Russ. Phys. Chem. Soc.*, **33**, 565, 1902; *Zeit. anorg. Chem.*, **30**, 86, 1902; A. Kölliker, *Chem. Ztg.*, **43**, 231, 1919; N. S. Kurnakoff, S. F. Sohemtschuschny and V. Tararin, *ib.*, **83**, 200, 1913; G. Wyruboff, *Bull. Soc. Chim.*, **12**, 544, 1889; F. H. Newman, *Proc. Phys. Soc.*, **33**, 73, 1921; R. Kremann and A. Lobinger, *Zeit. Metallkunde*, **12**, 246, 1920.

³ W. Crookes, *Chem. News*, **8**, 159, 1863; J. J. Paulet, *Compt. Rend.*, **57**, 494, 1863; A. Lamy, *ib.*, **57**, 442, 1863; J. Blake, *ib.*, **111**, 57, 1890; H. Castex, *Contribution à l'étude toxicologique des sels de thallium et en particulier du sulfate*, Toulouse, 1900; L. Grandeau, *L'Inst.*, **333**, 1863; E. Jeanselme, *Monatsh. prakt. Dermat.*, **102**, 1899; H. Erdmann, *Zeit. angew. Chem.*, **6**, 379, 1893; B. Stadion, *Pharm. Centrbl.*, **54**, 1863; A. Curci, *Ann. Chim.*, **22**, 481, 1895; W. Luck, *Beiträge zur Wirkung des Thalliums*, Dorpat, 1891.

⁴ L. Vanino and E. Zumbusch, *Journ. prakt. Chem.*, (2), **80**, 69, 1909; L. Vanino and R. Lambrecht, *German Pat.*, **D.R.P.** 188969, 1906; V. Thomas, *Compt. Rend.*, **134**, 1141, 1902; T. W. Salter, *Chem. News*, **37**, 96, 1878; A. Lamy, *Bull. Soc. Chim.*, (2), **5**, 164, 1867; O. Schott, *Dingler's Journ.*, **273**, 129, 1889; *Ver. Beförderung Gewerbefleißes*, **162**, 1888; J. Gädicke and A. Miethé, *Ber.*, **21**, 422, 1888; A. Hantzsch and W. H. Glover, *ib.*, **39**, 4153, 1906; G. Meyer, *Ber. deut. phys. Ges.*, **3**, 59, 1905; P. Jannasch and K. Aschoff, *Zeit. anorg. Chem.*, **1**, 248, 1892; H. Behrens, *Zeit. anal. Chem.*, **30**, 152, 1891; H. Kreuzler, *Ber. deut. phys. Ges.*, **3**, 59, 1905.

⁵ L. Marino, *Gazz. Chim. Ital.*, **37**, 55, 1907; H. Behrens, *Zeit. anal. Chem.*, **30**, 138, 1891; M. Cunningham and F. M. Perkin, *Journ. Chem. Soc.*, **95**, 1569, 1909; S. M. Tanatar and S. Petroff, *Journ. Russ. Phys. Chem. Soc.*, **42**, 94, 1910; F. Ephraim, *Zeit. anorg. Chem.*, **58**, 353, 1905.

⁶ A. Lamy, *Ann. Chim. Phys.*, (3), **67**, 410, 1862; G. Werther, *Journ. prakt. Chem.*, (1), **92**, 197, 1864; M. Heberling, *Liebig's Ann.*, **134**, 12, 1865; W. Crookes, *Phil. Trans.*, **163**, 277, 1873; *Chem. News*, **9**, 37, 54, 1864; C. Lepierre, *Bull. Soc. Chim.*, (3), **9**, 166, 1893; (3), **11**, 423, 1894; *Compt. Rend.*, **116**, 580, 1893; H. L. Wells and S. L. Penfield, *Amer. Journ. Science*, (3), **47**, 466, 1894; *Zeit. anorg. Chem.*, **6**, 315, 1894; G. D. Hinrichs, *Monit. Scient.*, (4), **21**, 733, 1897; F. W. Clarke, *Chem. News*, **63**, 76, 1891; *A Recalculation of the Atomic Weights*, Washington, **273**, 1910; B. Brauner, in R. Abegg, *Handbuch der anorganischen Chemie*, Leipzig, **3**, i, 405, 1906.

⁷ F. W. Aston, *Phil. Mag.*, (6), **45**, 934, 1923; W. P. Jorissen and J. A. Vollgraff, *Zeit. phys. Chem.*, **90**, 557, 1915.

§ 5. The Alloys of Thallium

A. Lamy¹ found that thallium readily alloys with many metals. E. Carstanjen obtained alloys of thallium with potassium, sodium, magnesium, zinc, cadmium, mercury, aluminium, tin, lead, antimony, and bismuth; most of these were not very stable in air, and E. J. Chapman obtained brittle alloys with gold, antimony, bismuth, and platinum; malleable alloys with copper, silver, and lead; and an easily oxidized alloy with tin. E. Carstanjen found that sodium and thallium unite without incandescence when the elements are melted together; potassium and thallium behave similarly but become feebly incandescent. The alloys are crystalline and silver-white. The f.p. curves of thallium with each of these elements are shown in Figs. 5 and 6. With sodium, there is a eutectic with the ratio Tl:Na=1:12.89 at 64.1°; a break with the ratio 1:6.11 at 77.9°—possibly owing to the formation of *hexasodium thallide*, Na₆Tl; a break with the ratio 1:2.37 at 153.7°—owing to the formation of **sodium hemithallide**, Na₂Tl; a distectic point or maximum with the ratio 1:1 at 306.8°—owing to the formation of **sodium thallide**, NaTl; and a eutectic with the ratio 1.73:1 at 237.7°. R. Kremann and P. von Reiningshaus studied the e.m.f. of alloys of sodium and thallium in cells Tl | N-Na₂SO₄ | Tl_{1-n}Na_n, and found evidence of NaTl, but not of Na₂Tl or of

Na_5Tl . The f.p. curve with potassium has a transition point with the ratio $\text{Tl}:\text{K}=1:2.03$ at 242.2° —corresponding with **potassium hemithallide**, K_2Tl ; a diatectic point or maximum when the ratio is 1:1, at 335° —corresponding with **potassium thallide**, KTl , and a eutectic with the ratio 6.31:1 at 172.5° .

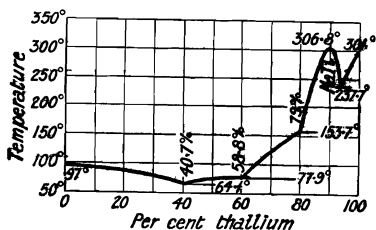

FIG. 5.—Freezing Points of Alloys of Thallium and Sodium.

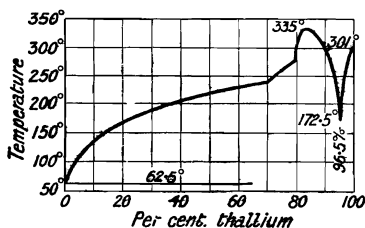

FIG. 6.—Freezing Points of Alloys of Thallium and Potassium.

E. Carstanjen found the alloys readily oxidize in air; and they dissolve violently in water giving off hydrogen. They can be preserved under petroleum. C. T. Heycock and F. H. Neville found that thallium readily dissolves in molten sodium and a gram-atom of thallium in 100 gram-atoms of sodium lowers the m.p. 4.12° – 4.72° . R. Kremann and E. Pressfreund studied the e.m.f. of the thallium-potassium alloys, as in the case of the sodium alloys.

W. Crookes found that when thallium is melted with *copper* much of the former is volatilized. E. Carstanjen melted the two elements under borax. F. Doerinckel

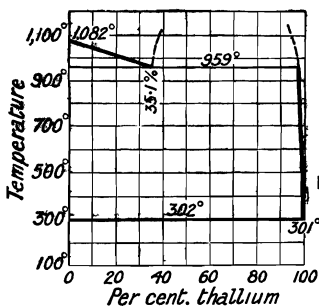

FIG. 7.—Freezing-point Curve of Alloys of Copper and Thallium.

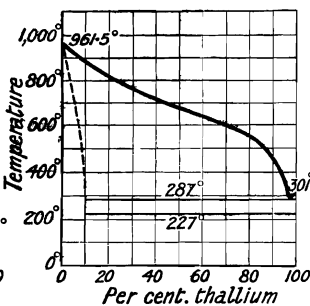

FIG. 8.—Freezing-point Curve of Alloys of Silver and Thallium.

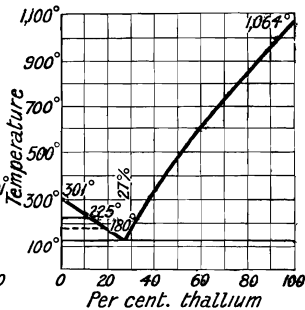

FIG. 9.—Freezing-point Curve of Alloys of Gold and Thallium.

observed the formation of no compounds or mixed crystals, Fig. 7. The two elements are only partially miscible; at 959° (the m.p. of copper) the layer rich in copper contains 35.1 per cent. by weight of thallium, the layer rich in the latter metal only 1.8 per cent. of copper. The eutectic point of the alloy rich in thallium lies at 302° , a little below the m.p. of thallium. W. Crookes said that the alloys with an excess of copper are golden yellow, those with an excess of thallium are white. E. Carstanjen said that sulphuric acid attacks only the thallium; nitric acid dissolves both constituents with the separation of thallium nitrate. W. Crookes prepared alloys of *silver* and thallium and found that they could be cupelled like silver-lead alloys. C. T. Heycock and F. H. Neville found the lowering of the f.p. of alloys with 0 to 20 per cent. of thallium is proportional to the conc. of the last-named metal. According to G. I. Petrenko, the f.p. curve of this system, Fig. 8, consists of two branches which meet in a eutectic point at 287° ; the eutectic mixture contains 2.5 per cent. weight of silver. The m.p. of thallium is 303° – 304° . The elements form only one series of mixed crystals which contain 0–10 per cent. by weight of thallium. A. L. Bernoulli measured the electrical resistance of these alloys, and

their thermoelectric force against copper; C. Hardebeck, and R. Schenk compared the electrical and thermal conductivity of silver-thallium alloys. M. Levin detected no compounds of gold and thallium in his study of the f.p. curve, Fig. 9, of these alloys. He found that the f.p. of both gold and thallium are lowered by the addition of the other metal; the two branches of the f.p. curve intersect at a eutectic point corresponding with a temp. of 131° and with 27 per cent. of thallium. C. T. Heycock and F. H. Neville measured the lowering of the f.p. of thallium by gold. F. Osmond and W. C. Roberts-Austen measured the tensile strength of these alloys.

L. Donsky studied alloys of thallium with up to 15 per cent. of calcium. He found that the eutectic temp. lies about 6° higher than the m.p. of thallium, from which the conclusion is drawn that mixed crystals rich in calcium are present; at the eutectic temp. these are in equilibrium with calcium trithallide, CaTl_3 , and the fused matrix. Between 6 per cent. and 16 per cent. of calcium, calcium thallide, CaTl (needles), separates; at 524° this compound reacts with the fused mass to form CaTl_3 (bluish crystals), which separate primarily from about 0.5–6 per cent. of calcium. The alloys are harder than thallium, brittle, and oxidize rapidly in the air. Those containing more than 6 per cent. of calcium do not decompose water at the ordinary temp. N. Baar found that calcium and thallium also form calcium tetratritathallide, Ca_2Tl_4 , at 555° , Fig. 10; he also found evidence of CaTl_4 at 524° , and CaTl at 969° . There is a eutectic at 692° with 38 per cent. of calcium, and a limited number of solid soln. are formed, so that the transformation point of thallium is raised by the addition of calcium. G. Tamrann studied the chemical activity of these alloys.

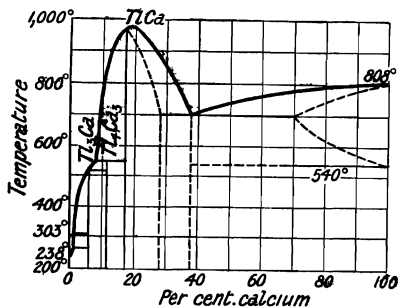

FIG. 10.—Freezing-point Curve of Alloys of Calcium and Thallium.

According to S. Mellor,² magnesium and thallium can be alloyed in any proportion; the alloy with 5 per cent. of thallium is more malleable than magnesium; and the alloys rich in thallium oxidize readily. E. Carstanjen made wire from an alloy of equal parts of the two metals. According to G. Grube, with addition of thallium the m.p. of magnesium, Fig. 11, falls to a eutectic point corresponding with 405° and 72.5 per cent. of thallium. It next rises to a maximum at 76 per cent. and 412.9° . From this maximum it falls to a second eutectic point at 392.9° and 84.8 per cent. of thallium, and then to further eutectic points at 355.4° and 89.3 per cent. of thallium and at 205.2° and 97.1 per cent. of thallium, and finally rises to the m.p. of thallium. From the course of the curve, with its sharp maximum and two concealed maxima, the existence of three compounds is inferred, namely, octomagnesium trithallide, Tl_3Mg_8 , magnesium hemithallide, TlMg_2 , and magnesium ditritathallide, Tl_2Mg_3 . Tl_3Mg_8 melts at 412.9° to a homogeneous liquid. TlMg_2 undergoes transformation at 392.9° in accordance with the equation $\text{TlMg}_2 \rightleftharpoons 0.0796 \text{Tl}_3\text{Mg}_8 + \text{fused alloy } (0.9204 \text{ Tl} + 1.9204 \text{ Mg})$. Tl_2Mg_3 has a transformation point at 355.4° : $\text{Tl}_2\text{Mg}_3 \rightleftharpoons 0.1194 \text{TlMg}_2 + \text{fused alloy } (1.8806 \text{ Tl} + 2.8806 \text{ Mg})$. Thallium-magnesium alloys blacken in the air by oxidation, especially in presence of moisture. S. Mellor found the alloys burn more vigorously and more slowly than magnesium alone. E. Carstanjen prepared alloys of zinc and thallium. According to A. von Vegesack, the two metals have only a limited miscibility, Fig. 12. At its m.p., zinc dissolves about 2.5 per cent. of thallium, and the m.p. of zinc is then lowered about 3° ; at its m.p., thallium dissolves about 5 per cent. of zinc, and its m.p. lowered about 4° . No chemical compounds or mixed crystals were observed. C. T. Heycock and F. H. Neville found one atomic per cent. of thallium in zinc lowered the f.p. 5.1° . C. di Capua measured the hardness of these alloys. E. Carstanjen found the alloys to be readily soluble in sulphuric acid with the

evolution of hydrogen. R. Kremann and A. Lobinger studied the e.m.f. of thallium-zinc alloys; A. Matthiessen and C. Vogt, the electrical conductivity; and D. Omodei, the thermal expansion. E. Carstanjen also prepared *thallium-cadmium* alloys; and N. S. Kurnakoff and N. A. Puschin found the f.p. curve is of the simple V-type with the eutectic at 203.5° and with the atomic proportion Cd: Tl=1:2.67, *i.e.* 81.7 per cent. of thallium, Fig. 13. C. di Capua also studied

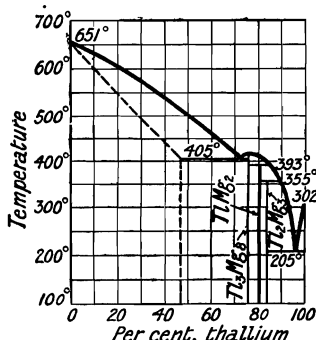

FIG. 11.—Freezing-point Curve of Alloys of Magnesium and Thallium.

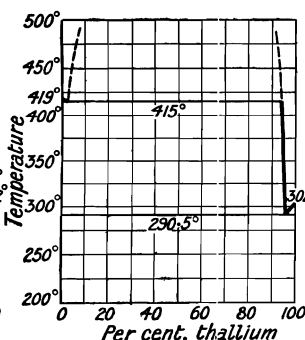

FIG. 12.—Freezing-point Curve of Alloys of Zinc and Thallium.

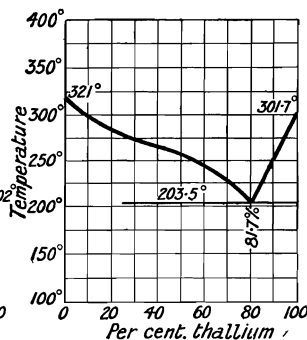

FIG. 13.—Freezing-point Curve of Alloys of Cadmium and Thallium.

the hardness and other properties of cadmium-thallium alloys; A. W. Smith, the thermal conductivity; and R. Kremann and A. Lobinger, their e.m.f., and no sign of a compound of thallium with zinc or cadmium was observed. E. Carstanjen prepared ternary Tl—Cd—Bi alloys; and C. F. Heycock and F. H. Neville, Tl—Cd—Ag, and Tl—Cd—Au alloys.

W. Crookes³ obtained crystalline **thallium amalgams**. Thallium was shown by J. Nicklès to amalgamate with mercury. W. Ramsay, J. Regnaud, A. Sucheni, K. Bornemann and G. von Rauschenplat, etc., prepared alloys by direct union of the metals; and T. W. Richards and J. H. Wilson, by electrolysis with a mercury cathode of a soln. of thallos sulphate in the presence of ammonium oxalate to prevent the formation of peroxides at the anode. P. Pavlovitch, and N. S. Kurnakoff and N. A. Puschin measured the f.p. curve of thallium amalgams. The curve drops, Fig. 14, from the f.p. of mercury -39° to a eutectic at -60° with 8.5 at. per cent. of thallium; it then rises to a maximum at 15° with 33.3 at. per cent. of thallium corresponding with **mercury hemithallide**, Hg_2Tl ; there is another eutectic at 3.5° and 40 at. per cent. of thallium; the curve then rises steadily to the m.p. of thallium. The curve, Fig. 14, has been revised by G. D. Roos. P. Pavlovitch, and

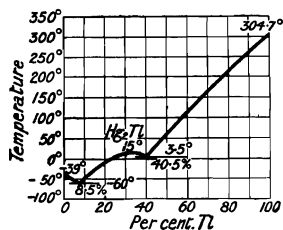

FIG. 14.—Freezing-point Curve of Alloys of Thallium and Mercury.

L. Rolla said that the maximum on the f.p.-composition curve does not correspond with a definite compound. C. H. Desch found the rules of A. Gorboff, and F. M. Flawitzky to have only a limited application. J. H. Hildebrand's vap. press. determinations suggested the possible existence of *mercury hexitathallide*, Hg_6Tl ; the existence of J. Regnaud's Hg_5Tl , and Hg_5Tl_2 , and E. Carstanjen's HgTl_2 have not been confirmed; they were made by alloying the two metals in the requisite proportions. A. Sucheni, N. S. Kurnakoff and N. A. Puschin, and K. Bornemann made observations on this subject. W. J. Humphreys studied the diffusion of thallium in mercury. L. Rolla found that the hardness-composition curve is continuous; and T. W. Richards and C. P. Smyth found that the hardness of solid thallium amalgams increased until 5 per cent. of mercury

had been added, further additions of mercury softened the amalgam; they also found that the sp. gr. of solid thallium amalgams indicate an increase in volume during amalgamation; and the curve shows a slight inflexion at about 5 per cent. of mercury. H. Feninger measured the viscosity of the amalgams; and F. Schmidt, the surface tension. T. W. Richards and co-workers obtained for the heat of soln., Q joules per gram-atom of thallium in amalgam, when p per cent. of thallium was present.

	0.92	5.21	8.76	10.43	11.81	17.33	24.55	36.26
Q_{20} . . .	2706	1590	486	45	-234	-1497	-2611	-3579
Q_{30} . . .	—	—	—	—	—	-1614	-2711	-3670

G. N. Lewis and M. Randall calculated values for this constant from the data of T. W. Richards and F. Daniels. P. Pavlovitch found a break in the electrolytic potential-composition curve at 27 to 28 at. per cent. of thallium, and it was thought to represent a compound Hg_3Tl , which forms solid soln. with both components. T. W. Richards and J. H. Wilson found 13.504, 13.515, and 13.527 for the sp. gr. of amalgams with 1.854, 1.410, and 0.793 per cent. of thallium at 20°. L. Rolla found the sp. vol. to be those calculated for mixtures, and to give no evidence of chemical combination. W. Ramsay studied the lowering of the vap. press. of mercury by thallium, and hence deduced an at. wt. 204.2. E. Beckmann and O. Liesche observed the raising of the b.p. of mercury by thallium. J. H. Hildebrand and E. D. Eastman studied the vap. press., and heat of dilution; D. MacIntosh and F. M. G. Johnson recommended 5 per cent. thallium amalgam as a liquid for thermometers down to -60°. G. Tammann measured the lowering of the f.p. of mercury by thallium. R. H. Gerke studied the free energy of the thallium amalgams, and found -51 cal. per gram for the thallium, and -523 cal. per gram for the mercury. H. Feninger, K. Bornemann and G. von Rauschenplat measured the electrical conductivity and resistance of the amalgams. P. Pavlovitch found the electrical conductivity appears as a maximum with amalgams having 26 to 28 at. per cent. of thallium. J. F. Spencer, A. Sucheni, G. Mayr, V. Rothmund, and T. W. Richards and co-workers measured the potential difference of soln. of thallium salts and thallium amalgams, and G. N. Lewis and M. Randall applied the results to calculate various physical properties of thallium. For T. W. Richards and C. P. Smyth on the potential difference of thallium and thallium amalgams, *vide* thallium. J. Regnaud found thallium to be electro-negative towards its amalgams. J. Nicklès found that thallium is dissolved from the amalgam by acidulated water.

E. Carstanjen⁴ melted *aluminium and thallium* under borax and obtained what he regarded as an alloy of the two metals, but F. Doerinckel found that the two metals are not soluble in one another to any appreciable extent, Fig. 15; and they do not enter into chemical combination, or form mixed crystals. N. S. Kurnakoff and N. A. Puschin found that *thallium and indium* alloys give two f.p. curves which intersect at 180°, and 44.5 at. per cent. of thallium. There is a break near the transition point, 180°. Expressing the composition of the binary alloys in terms of the at. per cent. of indium:

In . . .	100	95.88	73.72	61.30	50.25	37.87	25.51	12.23	0
F.p. . .	154.0°	154.0°	158.6°	169.3°	216.3°	228.9°	256.5°	284.0°	301.0°

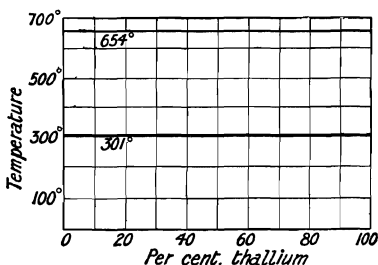

FIG. 15.—Freezing-point Curve of Alloys of Aluminium and Thallium.

The one curve is convex to the conc.-axis and rises steadily from the m.p. of indium to 180° with 44.5 at. per cent. of thallium and represents solid soln. of thallium in indium (cubic system) with 0 to 48.5 at. per cent. of thallium. The other curve is concave to the conc.-axis, and represents solid soln. with from 44.5 to 100 per

cent. of thallium; but there is a gap in the series between 48.5 and 56 at. per cent. of thallium. Alloys with 0 to 44.5 and 56–100 at. per cent. of thallium show one, not two, arrest on the cooling curve.

REFERENCES.

- ¹ A. Lamy, *Ann. Chim. Phys.*, (3), **67**, 385, 1863; (4), **3**, 375, 1864; (4), **5**, 410, 1865; R. Kremann and E. Pressfreund, *Zeit. Metallkunde*, **13**, 19, 1921; R. Kremann and P. von Reininghaus, *ib.*, **12**, 273, 1920; E. Carstanjen, *Journ. prakt. Chem.*, (1), **101**, 55, 1867; (1), **102**, 65, 129, 1867; N. S. Kurnakoff and N. A. Puschin, *Journ. Russ. Phys. Chem. Soc.*, **33**, 565, 1901; *Zeit. anorg. Chem.*, **30**, 86, 1902; F. Doerinckel, *ib.*, **48**, 186, 1906; G. I. Petrenko, *ib.*, **50**, 133, 1906; M. Levin, *ib.*, **45**, 31, 1905; L. Donsky, *ib.*, **57**, 206, 1908; N. Baar, *ib.*, **70**, 369, 1911; C. T. Heycock and F. H. Neville, *Journ. Chem. Soc.*, **55**, 666, 1889; **65**, 31, 1894; *Phil. Trans.*, **189**, A, 25, 1897; F. Osmond and W. C. Roberts-Austen, *ib.*, **179**, A, 339, 1888; **187**, A, 417, 1896; A. L. Bernoulli, *Ann. Physik*, (4), **33**, 702, 1910; *Zeit. Elektrochem.*, **15**, 647, 1909; R. Schenck, *ib.*, **15**, 660, 1909; C. Hardebeck, *Ueber das Verhalten einiger Legierungen zum Gesetze von Wiedemann und Franz*, Aachen, 1909; *Ann. Physik*, (4), **32**, 261, 1910; W. Crookes, *Phil. Trans.*, **153**, 173, 1863; *Journ. Chem. Soc.*, **17**, 112, 1864; E. J. Chapman, *Phil. Mag.*, (5), **2**, 397, 1876; G. Tammann, *Zeit. anorg. Chem.*, **118**, 93, 1921.
- ² S. Mellor, *Chem. News*, **15**, 245, 1867; C. T. Heycock and F. H. Neville, *Journ. Chem. Soc.*, **71**, 383, 1897; E. Carstanjen, *Journ. prakt. Chem.*, (1), **101**, 55, 1867; (1), **102**, 65, 129, 1867; R. Kremann and A. Lobinger, *Zeit. Metallkunde*, **12**, 246, 1920; G. Grube, *Zeit. anorg. Chem.*, **46**, 76, 1905; A. von Vegesack, *ib.*, **52**, 30, 1907; N. S. Kurnakoff and N. A. Puschin, *ib.*, **30**, 86, 1902; *Journ. Russ. Phys. Chem. Soc.*, **33**, 565, 1901; C. di Capua, *Atti Accad. Lincei*, (5), **32**, i, 282, 1923; (5), **32**, ii, 343, 1923; D. Omodei, *Atti Accad. Fisicocritici Siena*, (4), **2**, 15, 1890; C. T. Heycock and F. H. Neville, *Journ. Chem. Soc.*, **65**, 31, 1894; **71**, 383, 1897; A. Matthiessen and C. Vogt, *Pogg. Ann.*, **122**, 19, 1864; *Phil. Trans.*, **154**, 167, 1864; A. W. Smith, *Phys. Rev.*, (2), **23**, 307, 1924.
- ³ A. Gorboff, *Journ. Russ. Phys. Chem. Soc.*, **41**, 1241, 1909; N. A. Puschin, *ib.*, **32**, 635, 1900; F. M. Flawitzky, *ib.*, **37**, 862, 1905; N. S. Kurnakoff and N. A. Puschin, *ib.*, **32**, 830, 1902; **33**, 565, 1901; *Zeit. anorg. Chem.*, **30**, 104, 1902; E. Beckmann and O. Liesche, *ib.*, **89**, 171, 1914; G. D. Roos, *ib.*, **94**, 329, 385, 1916; *Über die Schmelzwärme und die Bildungswärme von Metallverbindungen und über des Zustandsdiagramm der Hg-Tl-Legierungen*. Leipzig, 1916; A. Sucheni, *Zeit. Elektrochem.*, **12**, 727, 1906; J. F. Spencer, *ib.*, **11**, 683, 1905; V. Rothmund, *Zeit. phys. Chem.*, **15**, 23, 1894; T. W. Richards and J. H. Wilson, *ib.*, **72**, 137, 1910; G. Tammann, *ib.*, **3**, 443, 1889; T. W. Richards and F. Daniels, *Journ. Amer. Chem. Soc.*, **41**, 1732, 1919; *Internat. Cong. App. Chem.*, **8**, 562, 1912; J. H. Hildebrand, *Journ. Amer. Chem. Soc.*, **35**, 511, 1913; J. H. Hildebrand and E. D. Eastman, *ib.*, **37**, 2452, 1915; T. W. Richards and C. P. Smyth, *ib.*, **44**, 624, 1922; **45**, 1455, 1923; G. N. Lewis and M. Randall, *ib.*, **43**, 233, 1921; G. Mayr, *Nuovo Cimento*, (6), **19**, i, 116, 1920; P. Pavlovitch, *Journ. Russ. Phys. Chem. Soc.*, **47**, 29, 1915; L. Rolla, *Gazz. Chim. Ital.*, **45**, i, 29, 1915; D. McIntosh and F. M. G. Johnson, *ib.*, **34**, 910, 1912; J. Regnaud, *Compt. Rend.*, **64**, 611, 1867; E. Carstanjen, *Journ. prakt. Chem.*, (1), **102**, 84, 1867; C. H. Desch, *Trans. Faraday Soc.*, **6**, 165, 1911; K. Bornemann, *Met.*, **7**, 106, 1910; K. Bornemann and G. von Rauschenplat, *ib.*, **9**, 481, 1912; G. von Rauschenplat, *Die elektrische Leitfähigkeit der Metallegierungen im flüssigen Zustande*, Halle, 1912; W. Ramsay, *Journ. Chem. Soc.*, **55**, 531, 1889; W. J. Humphreys, *ib.*, **69**, 1687, 1896; J. Nicklès, *Journ. Pharm. Chim.*, (4), **4**, 127, 1866; W. Crookes, *Phil. Trans.*, **153**, 173, 1863; *Journ. Chem. Soc.*, **17**, 112, 1864; R. H. Gerke, *Journ. Amer. Chem. Soc.*, **45**, 2507, 1923; H. Feninger, *Die elektrische Leitfähigkeit und innere Reibung verdünnter Amalgame*, Freiburg, 1914; J. Regnaud, *Compt. Rend.*, **64**, 611, 1867; *Bull. Soc. Chim.*, (2), **8**, 169, 1867; F. Schmidt, *Ann. Physik*, (4), **39**, 1108, 1912; P. Pavlovitch, *Journ. Russ. Phys. Chem. Soc.*, **47**, 29, 1915.
- ⁴ E. Carstanjen, *Journ. prakt. Chem.*, (1), **102**, 84, 1867; F. Doerinckel, *Zeit. anorg. Chem.*, **48**, 185, 1906; N. S. Kurnakoff and N. A. Puschin, *ib.*, **52**, 430, 1907; *Journ. Russ. Phys. Chem. Soc.*, **38**, 1165, 1907.

§ 6. Thallium Oxides

In his early observations, W. Crookes¹ assumed that a *thallium suboxide* can be prepared, but A. Lamy could not verify its existence, and W. Crookes himself did not mention it later. R. Lorenz suggested that the black film which forms on a thallium anode in potassium nitrate or sulphate soln. is a suboxide which, on further electrolysis, passes into thallic hydroxide. *Thallic oxide*, Tl_2O , and *thallic oxide*, Tl_2O_3 , are well-defined basic oxides; there are in addition, an ill-defined intermediate oxide *thallosic oxide*, $Tl_2O \cdot Tl_2O_3$, or TlO , and *thallic peroxide*, Tl_3O_5 . In addition there are the hydrated compounds: *thallous hydroxide*, $Tl(OH)$, i.e. $Tl_2O \cdot H_2O$;

metathallic hydroxide, $TlO.OH$, i.e. $Tl_2O_3.H_2O$; and a doubtful *thallic hydroxide*, $Tl(OH)_3$, or $Tl_2O_3.3H_2O$.

W. Crookes, and A. Lamy observed that **thallous oxide**, Tl_2O , is formed when thallium oxidizes in air; if the oxidation occurs about dull redness, the higher oxide is formed. A. Lamy obtained it by heating to 100° thallous hydroxide out of contact with air. Thallous oxide is a black powder. A. Lamy found that thallous oxide melts at about 300° , forming a dark yellow liquid which rapidly attacks glass, producing a silicate. W. O. Rabe said that thallous oxide is yellow at ordinary temp., and becomes dark red when heated; it is not melted at 870° . J. Thomsen gave for the heat of formation, $(2Tl, O)=42.24$ Cals. W. Crookes, and A. Lamy found that thallous oxide is slowly reduced when heated to redness in hydrogen; H. Flemming said that the reduction proceeds more rapidly in a stream of carbon monoxide. According to G. Wyrouboff, thallous oxide is slowly oxidized to thallic oxide by air at ordinary temp., and rapidly, when heated. A. Lamy found that thallous oxide rapidly absorbs moisture from the air, forming yellow thallous hydroxide; the oxide is also soluble in water, and in alcohol, forming, in the latter case, alcoholates. Thus, with absolute ethyl alcohol, *thallous ethoxide*, $C_2H_5.O.Tl$, is formed as a very refracting liquid of sp. gr. 3.5, which is decomposed by water into ethyl alcohol and thallous hydroxide. Thallous oxide is readily attacked by chlorine, bromine, or iodine, forming thallous halide and oxygen. Acids convert thallous oxide into thallous salts. G. Rauter found that when thallous oxide and silicon tetrachloride are heated to $360^\circ-370^\circ$, thallous chloride and silica are formed; similarly with silicon tetrafluoride. C. Winkler found thallous oxide is completely reduced when heated with magnesium.

R. Böttger found that if thallium is kept under water which contains air in soln., **thallous hydroxide**, $TlOH$, is formed, and F. Bahr made the hydroxide by passing oxygen through cold water and thallium turnings. The liquid is kept agitated during the passage of the gas. When the sat. soln. is further shaken, yellow crystals of thallous hydroxide separate, and further crystals are obtained by evaporation in a vacuum desiccator over potassium hydroxide. The crystals are then collected by means of a special filter in an atm. of hydrogen, washed with ice-cold water and alcohol, and dried in hydrogen. The product is free from lead. A. Lamy made the hydroxide by the action of water on thallous oxide; by the action of an eq. quantity of barium hydroxide on a soln. of thallous sulphate; and by the action of calcium hydroxide on thallium oxalate. R. de Forcrand obtained a good yield of the hydroxide, as a yellow crystalline powder, by adding to thallous ethoxide in the cold an equal vol. of water, and drying the precipitate on porous plates out of contact with air. J. E. Willm made a conc. soln. of the hydroxide by repeatedly heating thallium to 100° and dipping it in water; and G. Bredig made a **colloidal solution** of thallous hydroxide by making an arc between thallium electrodes under water.

A. Lamy stated that thallous hydroxide crystallizes from its aq. soln. in long yellow needles. According to A. Lamy, the dried hydroxide at 100° , or at ordinary temp. in vacuo, is transformed into black thallous oxide. F. Bahr measured the vap. press., p mm., of the hydroxide and found:

	46°	79.1°	83°	91.8°	101.6°	110°	122.2°	135.7°	140.0°
p	13	42	73	110	163	279	364	673	770

The results are represented by $\log p = -Q/2.3RT + 1.75 \log T + 3.6$, where T denotes $^\circ K.$, and Q the heat of the reaction, $2TlOH = Tl_2O + H_2O$, which, from the equation $d(\log p)/dT = -Q/RT^2$, is 14.1 Cals., and from W. Nernst's equation $Q = 4.57T(7.15 \log T + 3.6 - \log p)$ is 15.2 Cals.—J. Thomsen gave $(Tl_2O, H_2O_{liq.}) = 3.23$ Cals., and allowing 9.65 Cals. for the vaporization of water at 100° , the heat of the reaction $2TlOH = Tl_2O + H_2O$ becomes 12.88 Cals., which is rather low. The dissociation temp. at 760 mm. press. is 139° . J. Thomsen gave for the heats of formation $(2Tl, O, H_2O) = 85.4$ Cals., and $(Tl, O, H) = 56.9$ Cals.; and for the heat of soln. of

a mol in 235 mols of water, -3.15 Cals. R. de Forcrand gave for the heat of soln. of the oxide and hydroxide in dil. hydrofluoric acid 3.117 Cals., J. Thomsen gave 3.231 Cals., hence, added the former, the heat of hydration is far removed from that of the alkali metals, but thalious hydroxide is nevertheless an equally powerful base; and towards the feeble acids, phenols, etc., it shows even stronger basic properties than the alkali hydroxides. E. Petersen gave for the heat of neutralization, $\text{TlOH}_{\text{aq.}} + \text{HCl}_{\text{aq.}} = \text{TlCl} + 13.74$ Cals., and J. Thomsen, 13.84 Cals. The latter also gave $2\text{TlOH}_{\text{aq.}} + \text{H}_2\text{SO}_{4\text{aq.}} = \text{Tl}_2\text{SO}_{4\text{aq.}} + 31.13$ Cals.; and $\text{TlOH}_{\text{aq.}} + \text{HNO}_{3\text{aq.}} = \text{TlNO}_{3\text{aq.}} + 13.69$ Cals. F. Bahr showed that thalious hydroxide in vacuo is darkened by light, but he was unable to determine the nature of the reaction. He also measured the solubility, S , of the hydroxide in water and found in grams per litre

	0°	18.5°	29°	32.1°	40°	54.1°	78.5°	99.2°
S	25.44	34.34	39.85	41.12	49.5	64.97	103.3	148.3
Sp. gr.	1.231	1.317	1.342	1.377	1.446	—	—	—

where the sp. gr. are at $15^\circ/4^\circ$. The curve is continuous and shows no change of sign in the solid phase. The hydroxide is soluble in alcohol. J. E. Willm *accidentellment* obtained rhombic crystals of a monohydrate, $\text{Tl}(\text{OH})\cdot\text{H}_2\text{O}$, free from carbon dioxide. A. Lamy found the aq. soln. to be colourless and strongly alkaline. Both G. Werther, and O. L. Erdmann found that thalious hydroxide turns turmeric brown, and the coloration vanishes after it has stood for some time. From the effect of thallium hydroxide on the speed of hydrolysis of ethyl acetate, W. Ostwald inferred that it is a strong base of the same order as potassium, sodium, and lithium hydroxides. F. M. Raoult gave 33.1 for the mol. lowering of the f.p. W. Ostwald found the eq. conductivity, λ , of soln. containing a mol of the hydroxide in v litres of water, at 20° :

v	:	:	:	4	8	16	32	64	128	256	512
λ	:	:	:	182	200	217	230	238	244	248	248

A soln. of thalious hydroxide precipitates metal hydroxides from metal salt soln.—copper, zinc, aluminium, etc. According to F. Bahr, the aq. soln. readily absorbs oxygen and carbon dioxide from the atm., and, consequently, care is necessary in its preparation; for, as A. Lamy, G. Werther, and T. Carnelley and J. Walker showed, it is nearly always contaminated with carbonate. According to A. Lamy, a soln. of thalious hydroxide is oxidized to brown thallic hydroxide by chlorine, hydrogen peroxide, or other oxidizing agents; and paper soaked in thalious hydroxide soln. was used by C. F. Schönbein, E. Schöne, H. Schröder, C. Arnold and C. Mentzel, etc., as a test for ozone, which colours the paper or soln. brown. A. Lamy and F. Bahr found soln. of thalious hydroxide rapidly attack glass. L. F. Hawley found that a cold soln. of thallium hydroxide reacts with aluminium, forming *thalious aluminate* (*q.v.*). V. Cuttica and co-workers found that with nitrosyl chloride, *thallosic trinitrosyl chloride*, $\text{TlCl}_2\cdot 3\text{NOCl}$, is formed, and with vanadyl chloride, *thalious vanadyl oxychloride*, $\text{Tl}_2\text{O}\cdot\text{VOCl}_3$, is formed.

Some ill-defined intermediate oxides—*thallosic oxides*—have been described. In the electrolysis of soln. of thalious hydroxide with a thallium cathode, and an anode of the oxide, L. Jones obtained a deposit, containing $\text{Tl}_2\text{O}_3 : \text{Tl}_2\text{O} = 17 : 1$. G. Wyröboff obtained $2\text{Tl}_2\text{O}_3 \cdot 3\text{Tl}_2\text{O}$ by keeping thallium under water for a long time. C. F. Schönbein obtained small quantities of an insoluble yellow oxide by the simultaneous reduction of hydrogen peroxide and thallic oxide, or by oxidizing thallium with hydrogen peroxide. W. O. Rabe prepared what he regarded as $\text{Tl}_2\text{O}_3 \cdot \text{Tl}_2\text{O}$, or $(\text{TlO})_n$, by mixing 15 grms. of a 10 per cent. aq. soln. of thalious sulphate with 175–200 grms. of 20 per cent. potassium hydroxide. The clear filtered soln. was cooled to -15° , and 3.5 grms. of a 3 per cent. soln. of hydrogen peroxide added with constant shaking. A red precipitate was formed, which rapidly gave place to the new bluish-black, lustrous oxide; the latter was separated by filtration, and washed with cooled, anhydrous alcohol and ether. Even cold water decomposes the oxide into a mixture of thallic oxide and thalious hydroxide, and dil. sulphuric and nitric acids act in an analogous way; neither free oxygen nor hydrogen peroxide is produced. On being kept in the air, the oxide absorbs carbon dioxide according to the equation: $\text{Tl}_2\text{O}_3 \cdot \text{Tl}_2\text{O} + \text{CO}_2 = \text{Tl}_2\text{O}_3 + \text{Tl}_2\text{CO}_3$; it becomes slowly oxidized at the ordinary temp. in

air free from carbon dioxide. When a current of oxygen is passed over it at the ordinary temp., it is oxidized completely to thallic oxide, which is remarkable, inasmuch as thallic salts are acted on only by powerful oxidizing agents.

According to A. Lamy,² molten thallium unites with oxygen with incandescence, forming **thallic oxide**, Tl_2O_3 ; below a red heat, thallic oxide is formed, at a red heat, a mixture of thallic and thallic oxides, and at a bright red heat, thallic oxide. He also made it by dehydrating thallic hydroxide at 300° ; A. Strecker, and K. Birnbaum, at 100° ; and T. Carnelley and J. Walker, at 230° – 450° ; J. E. Willm treated thallic triaminchloride with water: $2TlCl_3 \cdot 3NH_3 + 3H_2O = 6NH_4Cl + Tl_2O_3$. According to W. O. Rabe, when an alkaline soln. of a thallium salt is treated with a 3–5 per cent. soln. of hydrogen peroxide, anhydrous thallic oxide, Tl_2O_3 , separates as a dark brown, flocculent precipitate which slowly changes to small, lustrous crystals of chocolate-brown colour. If precautions are taken to keep the temp. low and the peroxide is used in excess, the yield is almost quantitative—the excess of hydrogen peroxide undergoes decomposition in a catalytic manner without affecting the thallic oxide. When, on the other hand, the experiment is carried out at 80° – 100° in strongly alkaline soln. (10–35 per cent. of potassium hydroxide), a black modification of the same oxide is obtained as a heavy, sandy, practically anhydrous powder. W. Crookes, R. Böttger, H. Flemming, R. Lorenz, F. Wöhler, M. E. Heiberg, and M. Bose obtained thallic oxide by electrolysis. This oxide is deposited on the anode when a neutral soln. of thallic sulphate or nitrate is electrolyzed between platinum electrodes when the difference of potential between anode and electrolyte exceeds 1.43 volts; if the anodic difference of potential exceeds 1.81 volts, with thallic nitrate, or 2.27 volts with thallic sulphate, thallic hydroxide is deposited.

Thallic oxide usually appears as a black or brown powder; C. Lepierre obtained it in hexagonal plates. The black and brown oxides prepared by W. O. Rabe contained a little (occluded) water—the former 0.23 per cent., the latter 0.73 per cent.—this water was lost after heating a few hours at 500° . M. Lachaud and C. Lepierre gave 5.56 for the sp. gr. at 0° —this is far too low; V. Thomas found 9.95–9.99; and W. O. Rabe gave 9.65 for the brown oxide at 21° , and 10.19 for the black oxide at 22° . T. Carnelley and L. T. O'Shea gave 759° for the m.p.; and W. O. Rabe, $725^\circ \pm 10^\circ$; the last-named added that the m.p. has not been unequivocally determined, since no containing vessel has been found to resist attack by the molten oxide. Thallic oxide begins to give off oxygen at 800° , and decomposes rapidly at 1000° . According to T. Carnelley and J. Walker, thallic metahydroxide slowly loses its water at 230° ; the weight remains constant at 360° , and it slowly gives off oxygen up to 440° ; the weight remains constant between 440° and 565° , and the composition then corresponds with $3Tl_2O_3 \cdot Tl_2O$; between 565° and 585° , oxygen is quickly evolved and thallic oxide remains. At 815° , oxygen is absorbed, forming thallic oxide and thallic oxide is volatilized. G. Werther and M. E. Heiberg observed that when thallic oxide is kept at 100° , or even at 60° – 70° , in an ordinary drying oven heated by a Bunsen burner, it continues to gain in weight, and simultaneously undergoes reduction to the thallic state. They were of opinion that the increase of weight is due to the formation of thallic carbonate and sulphate, the sulphur coming from the gases given off by the burner. W. O. Rabe found that with the ordinary oxide and the black oxide, no carbonate is formed, but a mixture of normal and acid thallic sulphates. The reduction is comparatively slow at 65° , but at 115° the brown oxide is completely transformed into a mixture of the two sulphates in 468 hrs. The black is similarly, but much more slowly, converted. When the oxides are heated under such conditions that the gases from the burner cannot reach them, the weight remains constant.

G. Werther found that at a red heat thallic oxide is reduced by **hydrogen** to thallic oxide and the metal; H. Flemming observed that **carbon monoxide** acts similarly. W. O. Rabe said that the brown oxide is partially reduced when boiled with **water**, but the black oxide is scarcely affected; the brown oxide is easily, and the black oxide is with difficulty, dissolved by dil. mineral acids. According to

A. Lamy, **sulphuric acid** does not act in the cold on thallic oxide, but when heated, thallic sulphate and oxygen are produced; with cold **hydrochloric acid**, thallic chloride is formed without the development of gas, although there may be a partial reduction. E. Carstanjen found that when dry **hydrogen sulphide** is passed over dry thallic oxide, inflammation occurs, may be with a feeble explosion. R. Böttger noted that a mixture of thallic oxide and **sulphur** or **antimony sulphide** explodes when triturated in a mortar. G. Wyruboff found that thallic oxide does not absorb **carbon dioxide** either at ordinary temp. or when heated. E. Carstanjen dissolved in hydrochloric acid the precipitate obtained by adding ammonia to a soln. of thallium salt; again added ammonia, and again dissolved the precipitate in hydrochloric acid; on once more adding ammonia, a white granular precipitate was formed which was completely decomposed by water into thallic hydroxide. The precipitate is assumed to be thallic hexamminoxide, $Tl_2(NH_3)_6O_3$; it can be washed with alcohol, and dried at 100° without decomposition. C. Winkler found thallic oxide is reduced when heated with **magnesium**, forming thallic oxide and the metal.

A. Lamy found that by treating thallosic chloride with alkali hydroxide: $2Tl_2Cl_6 + 6KOH = 6KCl + 6TlCl + Tl_2O_3 \cdot H_2O + 2H_2O$, the product $Tl_2O_3 \cdot H_2O$, or $TlO(OH)$, is **thallic metahydroxide**—the trihydroxide, $Tl(OH)_3$, is thallic orthohydroxide. J. E. Willm found the precipitate is difficult to wash, and he made it by the action of alkali-lye or aq. ammonia on a hot soln. of thallic chloride; and by passing chlorine through a mixture of a thallos salt with alkali carbonate or hydroxide—A. Strecker used sodium hypochlorite in place of chloride. C. F. Schönbein made the hydroxide by the action of moist ozone on thallium; by passing ozonized air into a soln. of thallic hydroxide; by exposing thallium amalgam in contact with water to oxygen or air; by the action of permanganic acid, or permanganates on thallium, thallic oxide, or thallos salts; by the action of hydrogen peroxide on thallium but not on thallos hydroxide—C. Weltzien gave $4Tl + 4H_2O_2 = 2TlOH + 2H_2O + Tl_2O_3 \cdot H_2O$. W. Crookes, G. Werther, R. Böttger, H. Flemming, R. Lorenz, and M. Bose made the hydroxide as a pulverulent powder which collected at the platinum anode during the electrolysis of neutral, ammoniacal, or alkaline soln. of thallic sulphate or nitrate.

Thallic metahydroxide is a reddish-brown powder, which, according to W. Crookes, and A. Lamy, contains a mol.—i.e. 3.8 per cent.—of water, $Tl_2O_3 \cdot H_2O$, when dried at 100° ; A. Strecker said that 0.37 per cent. of water is present; while K. Birnbaum said that the oxide dried at 100° , and G. Werther the oxide dried at 115° , is free from water. T. Carnelley and J. Walker said that the oxide is dehydrated completely at 230° ; W. O. Rabe, at 500° . G. Werther added that even at 60° to 70° the hydroxide is partially reduced to thallic hydroxide, and it then readily absorbs carbon dioxide from the air. R. J. Meyer found that the freshly precipitated hydroxide is partially dehydrated when boiled with the mother liquid; the product is darker in colour, settles rapidly, and contains 1 per cent. of water. According to J. Thomsen, the heat of formation is $(2Tl, 3O, 3H_2O) = 86.34$ Cals.; $(Tl_2O, O_2, 3H_2O) = 44.1$ Cals.; and $(TlOH, O, H_2O) = 20.4$ Cals. Metathallic hydroxide is but sparingly soluble in water; the solubility product was found by R. Abegg and J. F. Spencer to be 10^{-53} at 25° . C. F. Schönbein found hydrogen peroxide is reduced by the metahydroxide, provided, said C. Weltzien, and J. E. Willm, hydrochloric acid be present. A. Lamy found that precipitated metathallic hydroxide dissolves in hydrochloric, sulphuric, and other acids; while the dried product dissolves in hydrochloric acid with the evolution of chlorine, and in sulphuric acid with the evolution of oxygen; J. E. Willm, and A. Strecker found that sulphur dioxide converts it into thallic sulphate; arsenious oxide, into thallic arsenate, Tl_3AsO_4 ; oxalic acid does not reduce the hydroxide in the cold, but when heated reduction is complete; and tartaric acid reduces it with the evolution of carbon dioxide and the formation of thallic tartarate and formate. According to G. Werther, metathallic hydroxide does not dissolve in alkali-lye, nor is it decomposed by that liquid. J. E. Willm found that the

hydroxide is soluble in a hot conc. soln. of ammonium chloride, and ammonia is at the same time evolved.

According to D. Carnegie, molten potassium hydroxide dissolves small quantities of thallic oxide, and the resulting yellow mass when treated with water yields a reddish-brown precipitate of the hydrated thallic oxide. If, however, the fusion is continued for some time, a mass of very light, glistening, microscopic, hexagonal plates of **thallic hydroxide**, $\text{Ti}(\text{OH})_3$, or $\text{Ti}_2\text{O}_3 \cdot 3\text{H}_2\text{O}$, is produced. The crystals are brown in colour but transmit yellow light; they are not changed at 340° , and are readily soluble in dil. hydrochloric and sulphuric acids, but generally a slight reduction to thalious salt takes place. The formula was based on a determination of the contained thallium. H. Marshall stated that the brown precipitate obtained by the hydrolysis of thallic sulphate is thallic hydroxide, $\text{Ti}(\text{OH})_3$.

According to E. Carstanjen, when chlorine is passed into a conc. soln. of potassium hydroxide in which metathallic hydroxide is suspended, an intense violet-red coloration appears and which is assumed to be due to the formation of **potassium thallate**. The soln. can be evaporated without decomposition, diluted, and filtered. Acids convert it into thalious salt with the evolution of oxygen; with hydrochloric acid, chlorine is evolved. A. Piccini found that a similar liquid is formed when thallium hydroxide is submitted to electrolysis, using a plate of thallium as an electrode, as also on adding potassium hypochlorite to a quarter of its weight of caustic potash to which the thallium sulphate is subsequently added. On digesting the whole and adding barium nitrate, a violet precipitate is finally obtained. The results of analyses made to determine the relation between thallium and barium in this precipitate led to discordant results, but sufficient evidence was afforded to point to a formula, TiO_2 , for the oxide of thallium. The isolation of this oxide brings out a further point of analogy of the thallium compounds to those of lead. B. Lepsius stated that the violet coloration is not due to the formation of a higher oxide of thallium, but rather due to the presence of a small amount of manganese, as impurity in the reagents employed. G. Gallo and G. Cenni found that when a soln. of thalious sulphate, slightly acidified with sulphuric acid, is electrolyzed, the whole of the thallium is deposited on the anode in the form of an oxide, which is not the sesquioxide as is generally supposed, but which, when dried at 160° – 200° , has a composition corresponding with Ti_3O_5 , a complex of **thallium dioxide**, $\text{Ti}_2\text{O}_3 \cdot \text{TiO}_2$, possibly

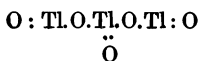

With hydrochloric acid, chlorine is evolved and $\text{TiCl}_3 \cdot 3\text{TiCl}$ is formed; presumably the oxide decomposes: $8\text{Ti}_3\text{O}_5 = 3\text{Ti}_2\text{O}_3 + 9\text{Ti}_2\text{O} + 11\text{O}_2$. From the position of thallium between mercury and lead in the periodic system, the existence of a peroxide of thallium is not surprising—both lead and mercury peroxides have been reported.

REFERENCES.

- ¹ W. Crookes, *Chem. News*, **3**, 193, 1861; **7**, 290, 1863; **8**, 159, 219, 231, 243, 255, 279, 1863; **9**, 1, 37, 54, 1864; *Journ. Chem. Soc.*, **17**, 112, 1864; *Proc. Roy. Soc.*, **12**, 150, 1862; *Phil. Trans.*, **163**, 277, 1874; *Researches on the Atomic Weight of Thallium*, London, 1874; A. Lamy, *Compt. Rend.*, **54**, 1255, 1862; **57**, 442, 1863; *Ann. Chim. Phys.*, (3), **67**, 385, 1862; (4), **5**, 410, 421, 1865; *Bull. Soc. Chim.*, (2), **11**, 210, 1869; *De l'existence d'un nouveau métal, le thallium*, Lille, 1862; *Leçon sur le thallium*, Paris, 1863; R. Lorenz, *Zeit. anorg. Chem.*, **12**, 439, 1896; F. Bahr, *ib.*, **71**, 79, 1911; W. O. Rabe, *ib.*, **48**, 427, 1906; **55**, 130, 1907; G. Rauter, *Liebig's Ann.*, **270**, 249, 1892; E. Schöne, *ib.*, **196**, 58, 1878; L. F. Hawley, *Journ. Amer. Chem. Soc.*, **29**, 301, 1907; R. de Forcrand, *Compt. Rend.*, **176**, 873, 1923; H. Flemming, *Jena. Zeit. Med. Naturwiss.*, **4**, 33, 1868; C. Winkler, *Ber.*, **23**, 788, 1890; C. Arnold and C. Mentzel, *ib.*, **35**, 1824, 1902; H. Schröder, *ib.*, **15**, 262, 1882; G. Bredig, *Zeit. angew. Chem.*, **11**, 941, 1898; G. Wyruboff, *Bull. Soc. Min.*, **12**, 530, 1889; J. Thomsen, *Journ. prakt. Chem.*, (2), **12**, 98, 1875; O. L. Erdmann, *ib.*, (1), **89**, 381, 1863; W. Ostwald, *ib.*, (2), **33**, 352, 1886; (2), **35**, 115, 1887; C. F. Schönbein, *ib.*, (1), **33**, 35, 1864; (1), **101**, 321, 1867; G. Werther, *ib.*, (1), **91**, 385, 1864; L. Jonas, *Zeit. Elektrochem.*, **9**, 523, 1903; E. Petersen, *Zeit. phys. Chem.*, **4**, 384, 1889; T. Carnelley and J. Walker, *Journ. Chem. Soc.*, **53**, 59, 1888; J. E. Willm, *Ann. Chim. Phys.*, (4), **5**, 5, 1865; R. Böttger, *Dingler's*

Journ., 197. 379, 1870; *Liebig's Ann.*, 127. 175, 1863; F. M. Raoult, *Compt. Rend.*, 97. 941, 1883; V. Cuttica, A. Tarchi, and P. Alinari, *Gazz. Chim. Ital.*, 53. ii, 189, 1923.
² W. Crookes, *Chem. News*, 3. 193, 1861; 7. 290, 1863; 8. 159, 219, 231, 243, 255, 279, 1863; 9. 1, 37, 54, 1864; *Journ. Chem. Soc.*, 17. 112, 1864; *Proc. Roy. Soc.*, 12. 150, 1862; *Phil. Trans.*, 163. 277, 1874; *Researches on the Atomic Weight of Thallium*, London, 1874; A. Lamy, *Compt. Rend.*, 54. 1255, 1862; 58. 442, 1863; *Ann. Chim. Phys.*, (3), 87. 385, 1862; (4), 5. 410, 421, 1865; *Bull. Soc. Chim.*, (2), 11. 210, 1869; *De l'existence d'un nouveau métal, le thallium*, Lille, 1862; *Leçon sur le thallium*, Paris, 1863; V. Thomas, *Compt. Rend.*, 138. 1697, 1904; C. Lepierre, *ib.*, 116. 580, 1893; M. Lachaud and C. Lepierre, *ib.*, 113. 196, 1891; W. O. Rabe, *Zeit. anorg. Chem.*, 48. 427, 1906; 50. 158, 1906; 55. 130, 1907; 58. 23, 1908; M. E. Heiberg, *ib.*, 35. 347, 1903; M. Bose, *ib.*, 44. 237, 1905; R. Lorenz, *ib.*, 12. 439, 1898; R. J. Meyer, *ib.*, 24. 365, 1900; R. Abegg and J. F. Spencer, *ib.*, 44. 379, 1905; K. Birnbaum, *Liebig's Ann.*, 138. 133, 1866; A. Strecker, *ib.*, 135. 207, 1865; C. Weltzien, *ib.*, 138. 129, 1866; F. Wöhler, *ib.*, 146. 263, 375, 1868; R. Böttger, *ib.*, 137. 175, 1866; *Dingler's Journ.*, 197. 379, 1870; *Journ. prakt. Chem.*, (1), 90. 27, 1863; G. Werther, *ib.*, (1), 91. 385, 1864; C. F. Schönbein, *ib.*, (1), 93. 35, 1864; E. Carstanjen, *ib.*, (1), 101. 55, 1867; T. Carnelley and J. Walker, *Journ. Chem. Soc.*, 53. 88, 1888; T. Carnelley and L. T. O'Shea, *ib.*, 45. 409, 1884; G. Wyruboff, *Bull. Soc. Min.*, 12. 544, 1889; C. Winkler, *Ber.*, 23. 788, 1890; H. Flemming, *Jena. Zeit. Med. Naturwiss.*, 4. 33, 1868; J. E. Willm, *Ann. Chim. Phys.*, (4), 5. 5, 1865; H. Marshall, *Proc. Roy. Soc. Edin.*, 22. 596, 1899; D. Carnegie, *Chem. News*, 60. 113, 1889; J. Thomsen, *Thermochemische Untersuchungen*, Leipzig, 3. 354, 1883; A. Piccini, *Gazz. Chim. Ital.*, 17. 450, 1887; G. Gallo and G. Cenni, *ib.*, 39. i, 285, 1908; *Atti Accad. Lincei*, (5), 17. ii, 276, 1908; B. Lepsius, *Verh. Deut. Naturf. Aerzte*, 63. 103, 1891.

§ 7. Thallium Fluorides

F. Kuhlmann¹ found that metallic thallium is slowly attacked by hydrofluoric acid, forming thallos fluoride, but the reaction is far too slow to be useful in the preparation of this compound. J. Gewecke, however, used this process and he heated the metal with 40 per cent. hydrofluoric acid in a platinum dish. E. H. Büchner prepared **thallos fluoride**, TlF, by dissolving thallos carbonate in dil. hydrofluoric acid; E. Petersen neutralized thallos hydroxide with hydrofluoric acid; and J. Gewecke, and F. Ephraim and P. Barteczko dissolved thallium sulphide in the same acid.

Metallic thallium was dissolved in dil. sulphuric acid, and the soln. treated with hydrogen sulphide. The soln. was filtered from the precipitated lead sulphide, made alkaline with ammonia, and again treated with hydrogen sulphide so as to precipitate thallos sulphide. The sulphide was filtered off, thoroughly washed, and treated with hydrofluoric acid. A brown residue may appear but this also dissolves in the acid on warming—excepting a little insoluble sulphur. The conc. of the soln. by evaporation furnishes white crystals of thallos fluoride.

H. L. Wells and H. W. Foote treated a soln. of thallos sulphate with an excess of hydrofluoric acid. The aq. soln. of thallos fluoride on cooling furnished F. Kuhlmann, and J. E. Willm with deliquescent rhombic or hexagonal plates which rapidly attack glass, and which melt and volatilize when heated. These crystals are said to be either **monohydrated thallos fluoride**, TlF.H₂O, or hemihydrated thallos fluoride, TlF. $\frac{1}{2}$ H₂O.

The evaporation of the soln. of thallos fluoride on a water-bath, or at ordinary temp., furnishes colourless octahedral crystals of the anhydrous salt. E. H. Büchner found that 100 parts of water at 15° dissolve 80 parts of the salt; the solubility increases with a rise of temp. The aq. soln. has an acid reaction. K. Jauch found the sp. ht. of soln. with *N* eq. of thallos fluoride per litre to be

<i>N</i>	.	.	0.5	1.0	2.0	3.0	4.0
Sp. ht.	.	.	0.9485	0.8881	0.8021	0.7312	0.6712

E. Franke, and F. Kohlrausch and H. von Steinwehr have measured the electrical conductivity of aq. soln. of thallos fluoride. The equivalent conductivity in reciprocal ohms at 25°, is, according to E. Franke, 115.9 when $v=32$; 120.6 for $v=64$; 123.7 for $v=128$; 126.2 for $v=256$; 128.1 for $v=512$; and 130.1 for $v=1024$. A. Heydweiller gave the sp. gr. and conductivity of soln. of thallos fluoride. A. A. Noyes and K. G. Falk found the percentage ionization of soln.

with 5, 10, 20, and 50 millieq. of the salt per litre to be respectively 96.1, 93.6, 90.8, and 86.5. The salt is sparingly soluble in alcohol; and, according to G. Gore, insoluble in liquid ammonia. Thallous fluoride melts and partially volatilizes when heated, and a colourless crystalline mass remains when the molten salt is cooled; it can be distilled in a current of steam. H. von Wartenberg and O. Bosse found the vap. press. of thallous fluoride to be 431 mm. at 282°, 587 mm. at 292°, and 753 mm. at 298°. The b.p. is therefore near 298°. The vap. press., p , at T° K. is represented by $\log p = -25152/4.571T + 9.639$. E. Petersen gave for the heat of formation: $\text{TlOH} + \text{HF} = \text{TlF} + \text{H}_2\text{O} + 16.44$ Cals. When the salt is exposed to sunlight it is coloured violet or black; but it can be kept exposed to the air in darkness without change.

E. H. Büchner evaporated over sulphuric acid a soln. of thallous fluoride in an excess of hydrofluoric acid, and obtained octahedral crystals of **thallous hydrofluoride**, TlF.HF . The crystals are stable in air, up to 100°, but above this temp. they decompose into hydrogen and thallous fluorides. E. Petersen gave $\text{TlF}_{\text{aq.}} + \text{HF}_{\text{aq.}} = \text{TlF.HF}_{\text{aq.}} - 0.583$ Cal. The crystals dissolve in an equal weight of water, forming a soln. with an acid reaction. Thallous fluoride forms double salts with a number of metal fluorides. For example, P. Barteczko prepared **thallous ennefluoroaluminate**, $3\text{TlF}.2\text{AlF}_3$, by dropping a conc. soln. of thallous fluoride into a soln. of aluminium fluoride. The double salt separates out as a white crystalline precipitate. He also stated that no other double fluoride of thallium can be prepared by precipitation. The salt is slowly decomposed by sodium carbonate, and this is taken to indicate the presence of a complex compound. J. Barlot evaporated to dryness a soln. of thallium in hot dil. hydrofluoric acid, and obtained **thallium dihydrofluoride**, H_2TlF_3 , which crystallizes from water in white elongated prisms; when heated, hydrogen fluoride is given off; the aq. soln. reacts acid, but does not attack glass since the fluorine is masked. It is regarded as a complex acid, **hydrotrifluothallous acid**, which forms two types of salts, **potassium hydrotrifluothallite**, KHTlF_3 , and **potassium trifluothallite**, K_2TlF_3 .

H. Moissan found that fluorine acts on metallic thallium, forming what has been stated to be **thallic fluoride**, TlF_3 , the reaction proceeds so vigorously that the metal melts and becomes red hot, but it is open to doubt if thallic fluoride has been isolated. According to J. E. Willm, when conc. hydrofluoric acid acts on freshly precipitated thallous hydroxide, a dark olive-green substance insoluble in water and in cold hydrochloric acid is formed, and similarly, when thallic nitrate is treated with hydrofluoric acid. When the product is warmed, it turns brown and melts to an orange liquid, which solidifies on cooling to a white mass; if heated still more, thallous fluoride sublimes. J. E. Willm's product, said J. Gewecke, is not thallic fluoride, but rather **thallic oxyfluoride**, TlOF , and for the preparation of this compound he recommended a process similar to that employed by J. E. Willm. Thallium sesquioxide is scarcely affected by standing for a long time in contact with hydrofluoric acid, and the product of the action has not a uniform composition; thallic chloride is almost insoluble in hydrofluoric acid, and it forms a white powder the composition of which has not been investigated; thallic chloride with silver fluoride in aq. soln. forms silver chloride and thallic hydroxide; if a 40 per cent. soln. of hydrofluoric acid be used, thallic oxyfluoride is formed. When dried thallium sesquioxide is heated with potassium hydrogen fluoride, and extracted with anhydrous hydrofluoric acid, white **potassium heptafluodithallate**, $\text{KF}.2\text{TlF}_3$, is formed, which is extremely sensitive to the presence of moisture; for it is immediately decomposed by water becoming brown, giving off hydrogen fluoride, and forming thallic hydroxide.

REFERENCES.

- ¹ F. Kuhlmann, *Compt. Rend.*, **58**, 1036, 1864; G. Gore, *Proc. Roy. Soc.*, **21**, 140, 1873; J. E. Willm, *Ann. Chim. Phys.*, (4), **5**, 5, 1865; H. Moissan, *ib.*, (6), **24**, 224, 1891; E. H. Büchner, *Journ. prakt. Chem.*, (1), **96**, 404, 1865; *Sitzber. Akad. Wien*, **52**, 644, 1865; F. Ephraim and

P. Barteczko, *Zeit. anorg. Chem.*, **61**, 238, 1909; E. Petersen, *Zeit. phys. Chem.*, **4**, 386, 1889; E. Franke, *ib.*, **16**, 463, 1895; F. Kohlrausch and H. von Steinwehr, *Sitzber. Akad. Berlin*, 581, 1902; A. Heydweiller, *Zeit. anorg. Chem.*, **116**, 42, 1921; K. Jauch, *Zeit. Physik*, **4**, 441, 1920; H. von Wartenberg and O. Bosse, *Zeit. Elektrochem.*, **28**, 384, 1922; J. Barlot, *Compt. Rend.*, **171**, 1143, 1920; A. A. Noyes and K. G. Falk, *Journ. Amer. Chem. Soc.*, **34**, 454, 1912; H. L. Wells and H. W. Foote, *Amer. Journ. Science*, (4), **3**, 466, 1897; J. Gewecke, *Liebig's Ann.*, **366**, 235, 1909; H. E. Roscoe, *Chem. News*, **14**, 217, 242, 1866; P. Barteczko, *Doppelfluoride und -chloride des einwertigen Thalliums*, Leipzig, 1909; L. Heymann, *Ueber Doppelfluoride des einwertigen Thalliums*, Bern, 1910; F. Ephraim and L. Heymann, *Ber.*, **42**, 4456, 1909.

§ 8. Thallium Chlorides

Thallium forms at least four chlorides with the empirical composition— $TlCl$, Tl_2Cl_3 , $TlCl_2$, and $TlCl_3$. A. Lamy¹ prepared **thallium monochloride**, or **thallous chloride**, $TlCl$, by adding hydrochloric acid or a soluble chloride to a soln. of a thallic salt. M. Heberling made it by reducing a hydrochloric acid soln. of a thallic salt with sulphur dioxide; and E. Carstanjen used stannous chloride as reducing agent. J. Hausmann also prepared the salt suspended in gelatine jelly. F. Ephraim and P. Barteczko precipitated thallic chloride by the addition of hydrochloric acid to a soln. of thallium sulphate.

Precipitated thallic chloride is a white curdy mass which becomes more compact on standing; it crystallizes from hot soln. in cubes and octahedra. W. P. Davey found the X-radiogram of thallic chloride shows the crystal unit is a body-centred cube with side 3.85 Å., and the closest approach of the atoms is 3.34 Å. B. Gossner² obtained crystal skeletons from hot potassium hydroxide and sodium sulphate soln.; and E. Carstanjen, cubic crystals from hot sodium carbonate soln. The crystals, said W. Stortenbeker, are isomorphous with potassium chloride. W. P. Davey and F. G. Wick found the X-radiogram of thallic chloride, like that of caesium chloride, corresponds with a simple cube lattice of side 3.85 Å. According to M. Heberling, the white chloride soon becomes violet when exposed to light; the effect is said to occur only when impurities—lead or silver chlorides—are present, for the purified salt remains white after a prolonged exposure to light. H. Stolzenberg and M. E. Huth found that molten thallium chloride, m.p. 407°, becomes anisotropic on cooling, but C. Tubandt and E. Lorenz's work make it probable that the effect is due to the presence of impurities. R. Lorenz and W. Eitel did not get optically clear crystals of thallic chloride free from "fog"—*vide* lead chloride. J. E. Willm gives the sp. gr. of the solid after fusion as 7.00; and A. Lamy as 7.02. F. A. Henglein studied the mol. vol. of thallic halides. W. Biltz found the lattice energy of thallic chloride to be 193 Cals. per mol. T. W. Richards and G. Jones gave the coeff. of compressibility as 4.7×10^{-6} per atm. S. Motylewsky found the drop-weight is $w=149$ (referred to water at $0^\circ=100$), the capillary constant $\sigma=0.076w$; and sp. cohesion $a^2=2/D$, where D is the sp. gr. at the m.p.

The reported numbers for the m.p. of thallic chloride vary from E. Korreng's³ 435° to T. Carnelley and W. C. Williams' 451°. C. Sandonnini gave 429°; H. von Wartenberg and O. Bosse, 430°; W. Hampe, 427°; and K. Mönkemeyer, 426°. The best representative value may be taken as 430°. F. A. Henglein found that the mol. vols. of the chlorides of thallium, copper, and silver gave a straight line when plotted against numbers corresponding with anions or cations. E. Carstanjen said the yellow molten chloride solidifies, on cooling, to a translucent white mass which can be cut with difficulty with a knife; and M. Heberling, to a brown crystalline mass which soon became white. The b.p. of thallic chloride, according to T. Carnelley and W. C. Williams, lies between 708° and 719° when measured with the pyrometer in the vap. and 719° to 731° when in the liquid. H. von Wartenberg and O. Bosse found the vap. press., p , at 665° to be 129.6 mm.; at 713°, 253.8 mm.; at 760°, 4425 mm.; at 791°, 653.6 mm.; and at 807°, 767.4 mm.; the results at the absolute temp., T , are represented by $\log p = -25108/4.571T + 5.093$

and the b.p. is 806°. The vap. density between 837° and 1026° was found by H. E. Roscoe to agree with that calculated for the formula $TlCl$, and E. Beckmann obtained the same mol. formula from its effect on the f.p. of mercuric chloride. G. D. Roos gave 16.5 cal. per gram for the heat of fusion. According to J. Thomsen, the heat of formation is $Tl + Cl = TlCl + 48.6$ Cals.—M. de K. Thompson calculated 43.7 Cals. from the solubility. J. O. Perrine observed no fluorescence with thallos chloride in X-rays. The fused salt was found by W. Hampe to be a good electrolyte. The photochemistry of thallos chloride has been studied by C. Renz, from which it appears that under water, hydrochloric acid, ammonia, ethylamine, ethyl alcohol, glycerol, toluene, xylene, or pyridine, a darkening occurs, and the thallos chloride passes through various shades of greyish-brown to blackish-brown. This is attributed to the formation of *thallos photochloride*, and thallosenthallic chloride. A. Benrath found thallos chloride, whether dry or under water, is changed by light to a brown substance, possibly $TlCl_3 \cdot 3TlCl$. W. W. Coblenz and J. F. Eckford measured the photoelectric sensitivity of thallos chloride. C. Sandonnini gives the electrical conductivity of fused thallium chloride at 429° as 1.224 reciprocal ohms. The eq. conductivity of soln. at 25° with a gram-molecule of the salt in v litres of water was found by E. Franke to be 139.6 reciprocal ohms for $v=128$; 143.1 for $v=256$; and 145.1 for $v=512$. G. Jones and W. C. Schumb measured the conductivity of soln. of thallos chloride. A. A. Noyes and G. Abbot calculated the degree of ionization of thallos chloride in aq. soln. at 29.75° to be 86.5 to 86.6 per cent. Lord Berkeley found the ratio of the osmotic press., P atm., and the mol. conc., C , to be 57.0 when the value calculated from the dil. soln. law is about 31. The electrical conductivity of aq. soln. has been also investigated by F. Kohlrausch and M. E. Maltby. F. Kohlrausch's value for the sp. conductivity of a sat. aq. soln. at 18° is 1514×10^{-6} reciprocal ohms per cm. cube; and at 25°, 2176×10^{-6} reciprocal ohms. J. C. Ghosh measured the sp. conductivity, μ , of fused thallos chloride and found 0.00005 at 523° K.; 0.00024 at 573° K.; 0.00090 at 623° K.; 0.00370 at 673° K.; and 0.00610 at 694° K. A. A. Noyes and K. G. Falk found the percentage ionization of soln. with 1, 5, and 10 millieq. per litre to be respectively 97.6, 94.2, and 91.5. A. A. Noyes has measured the effect of cadmium sulphate on the conductivity of aq. soln. of thallos chloride; G. N. Lewis and M. Randall measured the activity coeff.; and K. Klemensiewicz, the conductivity of soln. of thallos chloride in antimony trichloride. G. von Hevesy found the ratio of the conductivities above and below the m.p. to be 160, and he calculated that the gain of energy required to render the ions of the crystal neutral is 44 cal. The greater this energy the smaller the tendency of the lattice to be loosened with rise of temp. W. Schmidt gave 30 for the dielectric constant. G. Tammann measured the potential of fused thallos chloride with magnesium, manganese, or aluminium.

The solubility of thallos chloride in cold water is relatively small, but it rapidly increases as the temp. rises. The thallos halides, like the silver halides, are precipitated by the halogen acids, but, like the lead halides, they are appreciably soluble in water. Isolated observations on the solubility have been made by W. Crookes,⁴ A. Lamy, A. E. Hill, G. N. Lewis and C. L. von Ende, G. Jones and W. C. Schumb, M. Heberling, A. A. Noyes and G. Abbot, W. Böttger, G. Geffcken, and F. Kohlrausch; series of measurements have been made by A. A. Noyes, and the Earl of Berkeley; while A. A. Noyes and G. Abbot, and G. Geffcken have measured the influence of other salts on the solubility of thallos chloride. The best representative values by interpolation of all but the Earl of Berkeley's data give for the solubility S of thallos chloride in grams per 100 c.c. are :

	0°	10°	20°	25°	30°	40°	50°	60°	80°	100°
S	0.21	0.25	0.33	0.39	0.42	0.52	0.63	0.80	1.20	1.80

The Earl of Berkeley's values are :

S	0.17	0.24	0.34	0.40	0.46	0.60	0.80	1.02	1.60	2.41
-----	------	------	------	------	------	------	------	------	------	------

the last value refers to 99.3°. The solid phase through the whole range is the anhydrous chloride. A. Lamy, and A. Ditte found that the solubility is depressed by the presence of *hydrochloric acid*, and this the more the greater the conc. of the acid; consequently, as M. Heberling noted, the salt is precipitated from aq. soln. by the addition of hydrochloric acid; and, as A. Ditte noted, the salt is virtually insoluble in the conc. acid. A. A. Noyes found at 25°, the solubility of thalious chloride fell from 3.861 grms. per litre to 2.002 grms. when 1.032 grms. of hydrochloric acid, HCl, were present, and to 1.353 and 0.757 grms. when respectively 2.043 and 5.357 grms. of HCl were present. A. E. Hill and J. P. Simmons measured the solubility and sp. gr. of soln. of thalious chloride in *nitric acid*. Expressing the results, *S*, in grams per litre at 25°:

N-HNO ₃	. 0	0.4977	1.0046	2.0452	4.0170
<i>S</i>	. 3.951	5.937	6.882	8.143	9.925
Sp. gr.	. 0.996	1.0184	1.0359	1.0705	1.1362

For *acetic acid*, A. E. Hill gave:

N-CH ₃ COOH	. 0	0.0501	0.0958	0.263	0.524
<i>S</i>	. 3.8515	3.8375	3.8326	3.7503	3.6539

A. Lamy reported that thalious chloride is insoluble in *alcohol*; A. Naumann, that it is sparingly soluble in *acetone*; and A. Naumann and J. Schröder, that it is insoluble in *pyridine*.

Remembering that a litre of water dissolves $S=0.01612$ mol of thalious chloride at 25°, and expressing solubilities and proportions of salt in mols per litre at 25°, and selecting extreme terms of particular series of measurements, G. Geffcken found that with 0.5 and 2.0 mols of *ammonium nitrate* per litre the solubility, *S*, changed to 0.0258 and to 0.03966 respectively; with 0.5 and 3.0 mols of *lithium nitrate*, *S* changed to 0.0242 and 0.04438; with 0.5 mol of *potassium chloride*, *S* changed to 0.0237; with 0.5 and 2.0 mols of *potassium nitrate*, *S* changed to 0.0257 and 0.0390; with 0.5 and 4.0 mols of *sodium nitrate*, *S* changed to 0.02564 and 0.05128; and with 0.5 and 4.0 mols of *sodium chloride*, *S* changed to 0.02320 and 0.03850. A. A. Noyes found with 0.0283 and 0.1468 mol of *barium chloride*, *S* changed to 0.00857 and 0.00323; with 0.030 and 0.1574 mol of *cadmium sulphate*, *S* changed to 0.0206 and 0.0309; with 0.015 and 0.1574 mol of *sodium acetate*, *S* changed to 0.0168 and 0.0196; with 0.0283 and 0.1468 mol of *thallous nitrate*, *S* changed to 0.0083 and 0.00332; with 0.0283 and 0.0560 mol of *thallous sulphate*, *S* changed to 0.00886 and 0.00624; with a sat. soln. of *thallous thiocyanate*, *S* changed to 0.0119; with 0.025 and 0.2 mol of *ammonium or hydrogen chloride*, *S* changed to 0.00873 and to 0.00262; with 0.025 and 0.20 mol of *cupric or calcium chloride*, *S* changed to 0.00902 and 0.00287; with 0.025 and 0.20 mol of *manganous or magnesium chloride*, *S* changed to 0.00901 and 0.00278; with 0.025 and 0.20 mol of *potassium or sodium chloride*, *S* changed to 0.00871 and 0.00268; with 0.025 and 0.10 mol of *thallous chlorate or nitrate*, *S* changed to 0.00889 and 0.00423; with 0.25 and 0.20 mol of *zinc chloride*, *S* changed to 0.00899 and 0.00281; and with 0.025 and 0.20 mol of *cadmium chloride*, *S* changed to 0.0104 and 0.00427 respectively. A. A. Noyes and G. Abbot, working at 39.75°, found that with 0.01567 mol of *thallous bromate*, *S* changed to 0.01959; and with 0.02149 mol of *thallous thiocyanate*, *S* changed to 0.01807. W. C. Bray and W. J. Winninghoff found that with 20 and 300 millieq. of *potassium sulphate* per litre, the solubility rose from 0.01607 for water to 0.01779 and to 0.02600 respectively. J. F. Spencer and M. le Pla found that the presence of *potassium carbonate* also augmented the solubility of thalious chloride—at 25° water alone dissolves 3.86 grms. of thalious chloride per litre, but with a 5*N*-soln. of potassium carbonate, 21.84 grms. of thalious chloride are dissolved.

According to V. Thomas,⁵ dried liquid chlorine has virtually no action on dry thalious chloride; but if this salt be heated in a stream of dry chlorine, A. Lamy found that Tl_2Cl_4 , or $TlCl_2$, is formed; and if the thalious chloride be suspended in water, Tl_2Cl_3 is first formed, and later $TlCl_3$ is produced. G. Werther found that aqua regia converts thalious chloride into Tl_2Cl_3 , or Tl_2Cl_4 , but J. E. Willm added that with a very prolonged action, thallium trichloride is formed. According to J. E. Willm, a hydrochloric acid soln. of thalious chloride is oxidized to thallic chloride by potassium permanganate. V. Thomas also found that bromine converts thalious chloride into a series of bromochlorides. A. Lamy found that hot sulphuric acid converts thalious chloride into thalious sulphate, and fused sodium hydrosulphate

effects the same conversion very readily, and J. Krause made the same remarks concerning a boiling soln. of sodium sulphate of sp. gr. 1.02 to 1.04, but R. Nietzki contested the accuracy of J. Krause's statement. A. Lamy says thalious chloride is virtually insoluble in aq. ammonia, and that hot potash-lye partially decomposes thalious chloride, but on cooling, the salt is for the most part re-formed. Thalious chloride does not absorb ammonia at ordinary temp., but in liquid ammonia, W. Biltz and W. Stollenwerk found that **thalious triamminochloride**, $\text{TlCl} \cdot 3\text{NH}_3$, is formed. Similarly also with thalious bromide and iodide. The vap. press. of all three salts are very near that of ammonia itself. The solubility of the triamines in liquid ammonia increases with rise of temp., and with the at. wt. of the halogen. The heat of formation for the ammine is about 7.1 Cals. for each mol of ammonia; and it dissociates at -63° under 100 mm. press. No lower ammine was observed. W. Biltz, and J. Clark made some observations on this subject.

A. Cossa found aluminium precipitates metallic thallium from soln. of thalious chloride at 90° ; magnesium acts similarly, and a mixture of dry thalious chloride with magnesium powder at a red heat was found by K. Seubert and A. Schmidt to form magnesium chloride, and metallic thallium without becoming incandescent. A. G. Page, and V. Thomas used the thallium chlorides as catalytic agents for stimulating the chlorination of organic compounds. C. Benrath found that thalious chloride is reduced to metal by oxalic, tartaric, and citric acids; more easily than the bromide, and still more easily than the iodide. Thallic halides are more easily reduced than thalious salts.

Thalious chloride forms a number of double salts with other metal chlorides,⁶ but no definite compounds of thalious chloride and the alkali chlorides have been prepared. C. Sandonnini and P. C. Aureggi found that *lithium and thalious chlorides* are completely miscible when fused; there is a eutectic at 342° corresponding with 62 molar per cent. of thalious chloride and no mixed crystals are formed. There is a eutectic at 412° in the system: *sodium and thallium chlorides*, corresponding with about 85 molar per cent. of the latter component. The two chlorides are probably not miscible in the solid state. *Potassium and thalious chlorides* are miscible in all proportions in the solid and liquid states; and *rubidium and thalious chlorides* are completely miscible within very wide limits; *cæsium and thalious chlorides* behave similarly. E. H. Ducloux said that a double salt is formed with cæsium chloride.

E. Korreng found that the f.p. curve of the binary system $\text{CuCl}-\text{TlCl}$ gave indications of the formation of a double salt of **thalious cuprous chloride**. According to C. Sandonnini and P. C. Aureggi, the f.p. curve of thalious and silver chlorides indicates the existence of **silver thalious chloride**, $2\text{AgCl} \cdot \text{TlCl}$, which is shown by a break in the curve at 252° —the compound decomposes on melting and there is a eutectic at 210° corresponding with 41 molar per cent. of thalious chloride. C. Sandonnini has studied the electrical conductivities of solidified mixtures of these two salts, and he found the isotherm at 200° gives a maximum corresponding with the eutectic mixture. E. Carstanjen, and W. Crookes obtained lustrous yellow crystals of **thalious chloroaurate**, TlAuCl_4 , by adding gold chloride to a hot aq. soln. of thalious chloride. The crystals are but slightly soluble in water, and when calcined give an alloy of thallium and gold.

In the thermal study of the binary system—*barium and thalious chlorides*—T. Liebisch and E. Korreng found no sign of the formation of a compound; while with the systems $\text{TlCl}-\text{CaCl}_2$ and $\text{TlCl}-\text{SrCl}_2$, E. Korreng found that double salts were formed, namely, **thalious calcium chloride**, $\text{TlCl} \cdot \text{CaCl}_2$, melting at 683° ; and **thalious strontium chloride**, $\text{TlCl} \cdot \text{SrCl}_2$, melting at 569° . Similarly, with magnesium, zinc, and cadmium chlorides, T. Liebisch and E. Korreng found that thalious chloride formed compounds: **thalious magnesium chloride**, $\text{TlCl} \cdot \text{MgCl}_2$, melting at 499° ; **thalious zinc chlorides**, $2\text{TlCl} \cdot \text{ZnCl}_2$, melting at 352° , and $\text{TlCl} \cdot 2\text{ZnCl}_2$, melting at 226° ; and **thalious cadmium chloride**, $\text{TlCl} \cdot \text{CdCl}_2$, melting at 436° —C. Sandonnini gives 426° —there are here eutectics at 259° and 400° with respectively 27 and 66

molar per cent. of cadmium chloride. He also studied the electrical conductivities of the mixed salts at different temp. C. Sandonnini found that binary mixtures of thalious and mercuric chlorides gave a f.p. curve indicating the formation of two **thalious mercuric chlorides**, namely, TlCl.HgCl_2 , melting at 224° , and 4TlCl.HgCl_2 , which probably decomposes when fused, and is formed at about 250° . Both compounds form solid soln. with each other and with the simple salts between wide limits. The eutectics at 183° and 205° correspond respectively with 64 and 32 molar per cent. of mercuric chloride. The first-named mercuric compound, TlCl.HgCl_2 , was obtained by E. Carstanjen in long needles by cooling a hot soln. of thalious and mercuric chlorides. The compound is volatilized more easily than thalious chloride, and it colours the flame intensely green. The air-dried salt was found by S. M. Jørgensen to be anhydrous, and it loses traces of mercuric chloride at 120° – 130° , and within two days, at 200° , all the mercury salt is lost. When boiled with water and zinc all the thallium and mercury are precipitated. J. Kendall and co-workers made **thalious tetrachloroaluminate**, TlCl.ACl_3 , melting at 297° , and **thalious heptachloroaluminate**, $\text{TlCl}_2.2\text{AlCl}_3$.

According to J. E. Willm,⁷ an aq. soln. of **thallic chloride** or **thallium trichloride**, TlCl_3 , can be prepared by treating an aq. soln. of thalious chloride with chlorine. G. Werther treated thalious chloride suspended in water with chlorine until all had dissolved. A soln. of thallic chloride is also made by treating thalious chloride with aqua regia; or by dissolving in water the product of the action of chlorine on heated thalious chloride and precipitating thallic hydroxide by the addition of potassium hydroxide. The washed precipitate is then dissolved in cold hydrochloric acid. C. Renz obtained thallic hydroxide by warming thalious hydroxide or carbonate with sodium hypochlorite, and also dissolved the washed product in cold hydrochloric acid.

G. Werther passed chlorine into water with thallium or thalious chloride in suspension until the soln. no longer gave a turbidity with hydrochloroplatinic acid; the excess of chlorine was removed by a current of carbon dioxide; and the soln. evaporated in vacuo. Colourless prisms of **monohydrated thallic chloride**, $\text{TlCl}_3 \cdot \text{H}_2\text{O}$, were formed. A. S. Cushman could not establish R. J. Meyer's and G. Werther's claims to have made monohydrated thallic chloride. A. S. Cushman, however, does agree that one of the four mols. of water in tetrahydrated thallic chloride is differently related to thallic chloride from the other three, and he expresses his hypothesis by the symbols:

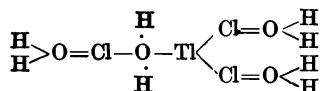

The full saturation value of mols. of the type MCl_3 for water is six, as exemplified by aluminium, iron, etc. No thallic chloride with six mols. of water has been isolated. G. Werther also reported $\text{TlCl}_3 \cdot 7\frac{1}{2}\text{H}_2\text{O}$, but this has not been confirmed. According to R. J. Meyer, the monohydrated salt is obtained only when the soln., not too conc., is evaporated in the desiccator; if the soln. be in the least super-saturated or undercooled the tetrahydrated salt is formed. The monohydrated salt is also formed by the hydration of the tetrahydrated salt at 55° . If the tetrahydrated salt be confined in a desiccator over potassium hydroxide, sulphuric acid, or phosphoric oxide, it loses water and liquefies; the liquid deposits long hexagonal crystals of the monohydrated salt, and finally the anhydrous chloride. According to R. J. Meyer and A. S. Cushman, **tetrahydrated thallic chloride**, $\text{TlCl}_3 \cdot 4\text{H}_2\text{O}$, is prepared in the following manner:

Thalious chloride suspended in a little water is treated with chlorine while slowly heated up to its b.p.; the action is continued until all is in soln. The liquid is evaporated between 60° and 80° and repeatedly sat. with chlorine, until it has a syrupy consistency. On cooling the syrupy liquid slowly by a freezing mixture, prismatic crystals separate out; but on cooling rapidly, white needles appear. The crystals belong to the rhombic system.

Tetrahydrated thallic chloride is hygroscopic, according to R. J. Meyer, and not hygroscopic, according to A. S. Cushman, while V. Thomas showed that at 17° in air, the salt deliquesces only when the moisture content of the air exceeds 63 per cent. corresponding with a dissociation press. of about 23 mm. of mercury, so that the tetrahydrated chloride is stable in air sat. with water vapour. A. S. Cushman gives the vapour tension of the tetrahydrated chloride as 9.5 mm. at 17°, and he adds that if this salt be fitted to an instrument for recording variations in weight, the curve is a record of the hygroscopic state of the atmosphere. According to R. J. Meyer, the tetrahydrated salt melts at 45° and freezes at 33°. V. Thomas gives the m.p. between 36° and 37°. Thallic chloride, anhydrous or hydrated, is very soluble in water; according to V. Thomas, 100 parts of water at 17° dissolve 86.2 parts of the tetrahydrated salt, and the sp. gr. of the soln. is 1.85 and the heat of the soln. of the tetrahydrated salt in water is -2.12 Cals. The aq. soln. reacts acid, and the hydrolysis is emphasized by the rise in the eq. conductivity, λ , which occurs on dilution as determined by R. J. Meyer, with soln. containing a gram-eq. of the salt in v litres of water, $\lambda=34.8$ when $v=2$; $\lambda=40.8$ when $v=4$; $\lambda=48.2$ when $v=8$; $\lambda=58.6$ when $v=16$; $\lambda=74.2$ when $v=32$; $\lambda=102.7$ when $v=64$; and $\lambda=145.7$ when $v=128$. With dilution, a stage is reached when the soln. becomes turbid through the separation of the brown hydroxide, $Tl(OH)_3$. Thallic chloride, however, is stable in dil. soln. if sufficient hydrochloric acid be present. A. Voigt and W. Biltz made some measurements of the electrical conductivity of the fused salt.

Silver nitrate precipitates the chlorine quantitatively as silver chloride from a soln. of thallic chloride acidified with nitric acid; but from a neutral soln., in addition to silver chloride, a brown precipitate of thallic hydroxide is formed. R. J. Meyer stated that silver nitrate precipitated only two-thirds of the chlorine from soln. of thallium trichloride, but after A. S. Cushman had shown that this statement is inaccurate, R. J. Meyer showed that the precipitation of silver chloride is hindered by the solubility of silver chloride in the thallium nitrate which is formed. The constitutional formula for thallic chloride, $TlCl_3$, based on the different properties possessed by one of the three chlorine atoms in thallic chloride is therefore invalidated. One of the peculiarities of thallic chloride and its water complex is the ease with which they dissolve in most solvents including ether and alcohol. J. Nicklès passed chlorine into a suspension of thallic chloride in dry ether, $(C_2H_5)_2O$, and obtained what he thought to be $(C_2H_5)_2O.TlCl_3.HCl.H_2O$, but R. J. Meyer could not verify this. R. J. Meyer did prepare the compound $(C_2H_5)_2O.TlCl_3$ by the action of ether on tetrahydrated thallic chloride; A. S. Cushman questioned the existence of R. J. Meyer's compound, but the objection could not be maintained, for if the ethereal soln. be evaporated in vacuo, crystals of the compound melting at 30° are produced. R. J. Meyer also prepared an analogous compound with alcohol, $TlCl_3.C_2H_5(OH)$. Several other compounds of thallic chloride with organic bases—pyridine, aniline, etc.—have been prepared.

According to F. M. McClenahan, tetrahydrated thallic chloride loses all its water when heated for an hour at 100° and there is very little loss of chlorine, and he traces the loss of water through the following stages: $TlCl_3.4H_2O \rightarrow TlCl_3.2H_2O \rightarrow TlCl_3.H_2O \rightarrow TlCl_3$. The evidence for the existence of *dihydrated thallic chloride*, $TlCl_3.2H_2O$, has not yet been established. If the dehydration be conducted in a stream of hydrogen chloride, a hydrochloride is formed: $TlCl_3.4H_2O \rightarrow TlCl_3.3H_2O.HCl \rightarrow TlCl_3.H_2O \rightarrow TlCl_3$. According to A. S. Cushman, if the tetrahydrated salt be confined over phosphorus pentoxide in a desiccator, the anhydrous chloride is formed, but if certain impurities are present, the chloride is reduced to the dichloride with the evolution of hydrogen chloride or chlorine; but even under the best conditions, A. S. Cushman found that the hydrated salt cannot be freed from water without undergoing a slight reduction. R. J. Meyer prepared anhydrous thallic chloride by dehydrating the tetrahydrated salt at 55°. R. J. Meyer also prepared anhydrous thallic chloride by keeping the hydrate with

ether, $TlCl_3(C_2H_5)_2O$, for about 10 days in vacuo, when the ether is all removed. The preparation of anhydrous thallic chloride by heating one of the lower chlorides in a stream of chlorine is not satisfactory, because a mixture with a variable amount of chlorine is formed; but V. Thomas made it by sealing some liquid chlorine in one leg of a A-tube, with thallic chloride in the other leg. The tube was surrounded by a metal cloth, and the leg with the solid heated by a Bunsen's burner. In about 48 hrs. a small quantity of white crystals of thallic chloride was found to have sublimed in the atm. of chlorine. V. Thomas found the product melted at 60° to 70° while confined in the sealed tube at 7-8 atm. press. The small six-sided crystalline plates, obtained by dehydrating the tetrahydrated salt, melt at 24° but, according to W. Hampe, they cannot be melted without decomposition under atm. press. According to V. Thomas, the decomposition is slow at 40° and rapid at 100° —the lower chlorides are simultaneously formed. The anhydrous chloride is very hygroscopic, and soluble in water; and, according to R. J. Meyer, in ether and alcohol; and, according to C. Renz, in acetone. It is also soluble in other organic solvents. According to V. Thomas, the heat of formation is $Tl + 3Cl_{gas} = 80.82$ Cals.; or $TlCl_{solid} + 2Cl_{gas} = 32.2$ Cals.; and $TlCl_{3solid} + 4H_2O_{liquid} = TlCl_3 \cdot 4H_2O_{solid} + 10.55$ Cals.; and the heat of soln. of the tetrahydrated chloride in water is -2.12 Cals.; and the heat of soln. of the anhydrous chloride is 8.43 Cals. According to J. Nicklès, colourless thallic chloride is changed by exposure to sunlight, forming brown thallium sesquioxide. Soln. of ammonia, alkali hydroxides, alkali or alkaline earth carbonates, form brown thallium sesquioxide. Ammonia does not react in this way in the presence of an excess of ammonium chloride, for the soln. remains clear and colourless; it, however, turns brown if water be added, but the original colour is restored if more ammonium chloride be added. Thallic salts in general were shown by A. J. Berry to be quantitatively reduced by ferrous sulphate: $Tl_2(SO_4)_3 + 4FeSO_4 = Tl_2SO_4 + 2Fe_2(SO_4)_3$, and by sodium arsenite: $Tl_2O_3 + As_2O_3 = Tl_2O + As_2O_5$; he also examined the reducing effect of copper, and hydroxylamine: $Tl_2O_3 + 2NH_2OH = Tl_2O + 3H_2O + N_2O$. Bismuth nitrate gives a white precipitate—nearly quantitative; the precipitate is soluble in a soln. of ammonium chloride.

Thallium trichloride combines with ammonia producing white crystals of **thallium triamminotrichloride**, $TlCl_3 \cdot 3NH_3$, which was prepared by J. E. Willm by mixing an alcoholic soln. of the chloride with an alcoholic soln. of ammonia; by mixing a conc. aq. soln. of thallic chloride with ammonia; by boiling thallic hydroxide with a conc. aq. soln. of ammonium chloride until it begins to give off ammonia, and then treating the colourless soln. with ammonia. The white crystalline precipitate is washed with aqua ammonia, then with alcohol made feebly ammoniacal; then with absolute alcohol; and finally dried in vacuo. J. E. Willm also said that thallium triamminotrichloride is formed by the action of dry ammonia on anhydrous thallic chloride, but D. Gauthier found that **thallium pentamminotrichloride**, $TlCl_3 \cdot 5NH_3$, is produced by the action of an excess of ammonia on the anhydrous trichloride at ordinary temp. W. Biltz measured the vap. press. of the triamminotrichloride at -50° , -60° , and -79° , and obtained the values 39 (38) mm., 156 (165) mm., and 290 (307) mm. respectively. The numbers in brackets refer to the vap. press. of liquid ammonia at these temp. J. E. Willm found that thallic triamminochloride is decomposed by water with the separation of bluish-black thallium sesquioxide; it dissolves in hydrochloric acid, forming ammonium chlorothallate, and when heated it gives off ammonia, and ammonium chloride, and leaves behind a residue of thallic chloride. R. J. Meyer found that tetrahydrated thallium chloride readily absorbs one molar proportion of hydrogen chloride, forming a liquid which, on standing over phosphorous pentoxide, furnishes needle-like crystals of **hydrotetrachlorothallic acid**, $H \cdot TlCl_4 \cdot 3H_2O$, or $TlCl_3 \cdot HCl \cdot 3H_2O$; the same compound was obtained by evaporating a soln. of thallic chloride in conc. hydrochloric acid; and by evaporating on a water-bath a soln. of thallic chloride sat. with chlorine, and maintained sat. during the evaporation. The evaporation is completed over

sulphuric acid, and potassium hydroxide contained in a desiccator. The crystals rapidly deliquesce in air, and chlorine and hydrogen chloride are evolved simultaneously with the reduction of some of the thallic salt. The crystals are stable in dry air. V. Thomas gives the heat of formation: $\text{TlCl}_{3\text{soln.}} + \text{HCl}_{\text{soln.}} = \text{TlCl}_3 \cdot \text{HCl} - 0.2 \text{ Cal.}$ When a soln. of the salt is neutralized with potassium hydroxide, R. J. Meyer found that the salt $2\text{KCl} \cdot \text{TlCl}_3 \cdot 2\text{H}_2\text{O}$ is obtained, and not, as anticipated, $\text{KTlCl}_4 \cdot n\text{H}_2\text{O}$; the reaction is represented by: $2\text{HTlCl}_4 + 2\text{KOH} = \text{K}_2\text{TlCl}_5 + \text{TlCl}_3 + 2\text{H}_2\text{O}$; and A. S. Cushman represents the transformation by the symbols:

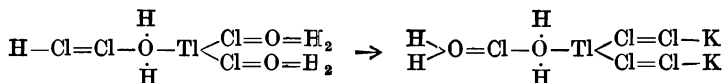

where the linkage of $\text{H}-\text{Cl}=\text{O}$ to the complex is not strong enough to attach the heavier and more basic $\text{K}-\text{Cl}=\text{O}$; in consequence, a redistribution of the atoms in the mol. occurs so as to produce the most stable configuration which is possible under the circumstances. R. J. Meyer drew attention to the analogy between hydrochlorothallic acid, $\text{HTlCl}_4 \cdot 3\text{H}_2\text{O}$, and hydrochloroauric acid, $\text{HAuCl}_4 \cdot 3\text{H}_2\text{O}$.

Three types of double salts with thallic chloride and alkali or ammonium chloride are known: $2\text{TlCl}_3 \cdot 3\text{MCl} \cdot n\text{H}_2\text{O}$; $\text{TlCl}_3 \cdot 3\text{MCl} \cdot n\text{H}_2\text{O}$; and $3\text{TlCl}_3 \cdot \text{MCl} \cdot n\text{H}_2\text{O}$. Thallic and ammonium chlorides can be fused and crystallized together in all proportions, the thallic salt suffers reduction during fusion, and this prevents the construction of f.p. curves like those obtained with thallic chloride. **Ammonium hexachlorothallate**, $3\text{NH}_4\text{Cl} \cdot \text{TlCl}_3$, or $(\text{NH}_4)_3\text{TlCl}_6$, is formed, according to J. E. Willm,⁸ when a soln. of thallic triamminotrichloride in hydrochloric acid is evaporated to the point of crystallization; and G. Neumann prepared it by treating a soln. of thallic chloride in conc. hydrochloric acid with a conc. soln. of ammonium chloride. According to R. J. Meyer, the hexagonal plates so formed gradually become yellow owing to the reduction of the salt. J. Nicklès obtained **dihydrated ammonium hexachlorothallate**, $3\text{NH}_4\text{Cl} \cdot \text{TlCl}_3 \cdot 2\text{H}_2\text{O}$, by treating the ether or alcohol compound of thallic chloride with ammonium chloride; C. F. Rammelsberg obtained the same product by evaporating a mixture of ammonium chloride with a soln. of thallic hydroxide in hydrochloric acid; and G. Neumann, by saturating with chlorine a warm soln. of thallium sesquioxide and potassium chloride in conc. hydrochloric acid. The liquid, filtered through glass-wool, is evaporated either in a desiccator or on a water-bath while chlorine is being passed through the soln. According to C. F. Rammelsberg, the tetragonal bipyramidal crystals have the axial ratio $a : c = 1 : 0.7954$. J. Nicklès noted that the crystals gradually become yellow with red spots due to the formation of thallic hydroxide. The salt is soluble in water and in alcohol, and it loses all its water at 100° . When a soln. of the salt is treated with alkali hydroxide, carbonate, or with water containing calcium hydrocarbonate in soln., thallic hydroxide is precipitated.

J. H. Pratt prepared sparingly-soluble, deliquescent crystals of **octohydrated lithium hexachlorothallate**, $3\text{LiCl} \cdot \text{TlCl}_3 \cdot 8\text{H}_2\text{O}$, or $\text{Li}_3\text{TlCl}_6 \cdot 8\text{H}_2\text{O}$, from mixtures of soln. of the component salts; and likewise also, **dodecahydrated sodium hexachlorothallate**, $3\text{NaCl} \cdot \text{TlCl}_3 \cdot 12\text{H}_2\text{O}$, or $\text{Na}_3\text{TlCl}_6 \cdot 12\text{H}_2\text{O}$. C. F. Rammelsberg, and G. Neumann prepared **dihydrated potassium hexachlorothallate**, $3\text{KCl} \cdot \text{TlCl}_3 \cdot 2\text{H}_2\text{O}$, or $\text{K}_3\text{TlCl}_6 \cdot 2\text{H}_2\text{O}$, by methods similar to those which they respectively employed for the corresponding ammonium salt. R. J. Meyer made it from a mixed soln. of the component salts containing three or more mols of potassium chloride for one of thallium trichloride. J. Nicklès also investigated this salt. According to A. Fock, the tetragonal bipyramidal plates have the axial ratio $a : c = 1.017913$, and they are feebly double-refracting. According to A. Fock, and R. C. Wallace, the salts $\text{K}_3\text{TlCl}_6 \cdot 2\text{H}_2\text{O}$, $(\text{NH}_4)_3\text{TlCl}_6 \cdot 2\text{H}_2\text{O}$, $\text{K}_3\text{InCl}_6 \cdot 2\text{H}_2\text{O}$, are isomorphous with one another and with the corresponding bromides. The crystals can be kept in air for some time, but they gradually become matte and turbid; and between 50° or 60° , or in vacuo, they lose their water of crystallization. At higher temp.,

they decompose with reduction. A soln. of the salt in hydrochloric acid becomes brown on exposure to light. A. Fock found that the salts $3\text{KCl} \cdot \text{InCl}_3 \cdot 1\frac{1}{2}\text{H}_2\text{O}$ and $3\text{KCl} \cdot \text{TlCl}_3 \cdot 1\frac{1}{2}\text{H}_2\text{O}$ form isomorphous mixtures. The salt **potassium pentachlorothallate**, $2\text{KCl} \cdot \text{TlCl}_3 \cdot 2(\text{or } 3)\text{H}_2\text{O}$, is formed by methods analogous to those employed for the hexachlorothallate, from soln. with less than three mols of potassium chloride to one of thallic chloride. G. Neumann failed in his attempt to make the salt. According to R. J. Meyer, this salt is formed by neutralizing hydrochlorothallic acid. According to C. F. Rammelsberg, it forms transparent, colourless, monoclinic, prismatic crystals with axial ratios $a : b : c = 0.7050 : 1 : 0.9576$, and $\beta = 98^\circ 18'$. According to R. J. Meyer, when dried in vacuo, or when heated between 50° and 60° , a mol of water is lost. According to C. F. Rammelsberg, two mols of water are lost over sulphuric acid. It is decomposed when heated above 60° , and is partially reduced. J. H. Pratt prepared rhombic crystals of **monohydrated rubidium pentachlorothallate**, $2\text{RbCl} \cdot \text{TlCl}_3 \cdot \text{H}_2\text{O}$, by adding between 1.25 and 18 grms. of rubidium chloride to a conc. soln. of 30 grms. of thallic chloride. The axial ratios are $a : b : c = 0.6792 : 1 : 0.7002$; R. C. Wallace gives for the axial ratios $a : b : c = 0.9770 : 1 : 1.4388$, and the sp. gr. 3.513 at 20° . The crystals are not decomposed by recrystallization. G. Neumann made **rubidium hexachlorothallate**, $3\text{RbCl} \cdot \text{TlCl}_3$, by dissolving thallium sesquioxide and rubidium chloride in conc. hydrochloric acid, and oxidizing the hot soln. with chlorine. The hot filtered soln. deposits thin rhombic plates which are readily soluble in water with decomposition, and gradually become matte and turbid in air. J. H. Pratt prepared monoclinic crystals of **monohydrated rubidium hexachlorothallate**, $3\text{RbCl} \cdot \text{TlCl}_3 \cdot \text{H}_2\text{O}$, from a soln. containing 1.5 to 25 grms. of thallic chloride to 40 grms. of rubidium chloride. F. Godeffroy obtained colourless, quadratic crystals of **dihydrated rubidium hexachlorothallate**, $3\text{RbCl} \cdot \text{TlCl}_3 \cdot 2\text{H}_2\text{O}$, by evaporating a mixed soln. of the component salts, and he says that 100 parts of water at 18° dissolve 13.3 parts of the salt and at 100° , 62 parts of salt. J. H. Pratt obtained pale green crystals of **cæsium pentachlorothallate**, $2\text{CsCl} \cdot \text{TlCl}_3$, from soln. with 5 to 8 grms. of thallic chloride and 50 grms. of cæsium chloride. He also prepared rhombic crystals of **monohydrated cæsium pentachlorothallate**, $2\text{CsCl} \cdot \text{TlCl}_3 \cdot \text{H}_2\text{O}$, from dil. soln. of 8 to 15 grms. of thallic chloride and 100 grms. of cæsium chloride. The axial ratios are $a : b : c = 0.6762 : 1 : 0.6954$; R. C. Wallace gives for the axial ratios $a : b : c = 0.9690 : 1 : 1.4321$, and the sp. gr. 3.879 at 20° . The salt is isomorphous with the corresponding rubidium salt, with the corresponding indium chlorides and bromides, and with $\text{K}_2\text{FeCl}_5 \cdot \text{H}_2\text{O}$ and $(\text{NH}_4)_2\text{FeCl}_5 \cdot \text{H}_2\text{O}$. When the pentachlorothallate is recrystallized from water, or when soln. of 40 grms. of thallic chloride and 0.5 to 20 grms. of cæsium chloride are mixed, crystals of **cæsium enneachlorodithallate**, $3\text{CsCl} \cdot 2\text{TlCl}_3$, are formed. If the soln. contains 50.30 grms. of cæsium chloride to 0.5 gm. of thallic chloride, the crystals are hexagonal plates; if crystallized from water, hexagonal prisms. The axial ratios are $a : c = 1 : 0.8257$. The crystals have a feeble negative double refraction; and the indices of refraction for the Li-, Na-, and Tl-lines are respectively $\omega = 1.772$, 1.784, and 1.792, and $\epsilon = 1.762$, 1.774, and 1.786. J. H. Pratt prepared a mass of hair-like crystals of **monohydrated cæsium hexachlorothallate**, $3\text{CsCl} \cdot \text{TlCl}_3 \cdot \text{H}_2\text{O}$, by adding a soln. of 0.25 gm. of thallic chloride to one with 50 grms. of cæsium chloride. F. Godeffroy claimed to have made *dihydrated cæsium hexachlorothallate*, $3\text{CsCl} \cdot \text{TlCl}_3 \cdot 2\text{H}_2\text{O}$, from a mixture of the component salts; and he says 100 grms. of water at 17° dissolve 2.747 grms. of the salt, and at 100° , 33.3 grms. E. H. Ducloux recommended cæsium chloride as a microchemical test for thallium. C. Sandonini and P. C. Aureggi found that binary mixtures of silver and thallic chlorides form a compound $\text{Ag}_2\text{Tl}_3\text{Cl}_6$, **silver pentachlorotrithallate**, which decomposes on melting, and is revealed by an arrest at 252° . There is a eutectic at 210° with 41 molar per cent. of thallic chloride.

J. Gewecke prepared double salts of many of the bivalent metal chlorides of the type $\text{MCl}_2 \cdot 2\text{TlCl}_3 \cdot 6\text{H}_2\text{O}$, by allowing a soln. of the component salts in water

acidified with hydrochloric acid to evaporate in vacuo over sulphuric acid. For example, **hexahydrated calcium octochlorodithallate**, $\text{CaCl}_2 \cdot 2\text{TlCl}_3 \cdot 5\text{H}_2\text{O}$, forms large, colourless, transparent crystals; **hexahydrated strontium octochlorodithallate**, $\text{SrCl}_2 \cdot 2\text{TlCl}_3 \cdot 6\text{H}_2\text{O}$, was also prepared; the corresponding **hexahydrated barium octochlorodithallate** could not be obtained in the pure state, since the needle-like crystals were so hygroscopic they could not be analyzed. G. Neumann prepared thin rhombic plates of **beryllium dodecachlorodithallate**, $3\text{BeCl}_2 \cdot 2\text{TlCl}_3$, a method similar to that he used for the potassium salt. The crystals are dissolved by water, but are simultaneously decomposed; and they are not stable in air. J. Gewecke obtained transparent, colourless, hygroscopic crystals of **hexahydrated magnesium octochlorodithallate**, $\text{MgCl}_2 \cdot 2\text{TlCl}_3 \cdot 6\text{H}_2\text{O}$; colourless prisms of **hexahydrated zinc octochlorodithallate**, $\text{ZnCl}_2 \cdot 2\text{TlCl}_3 \cdot 6\text{H}_2\text{O}$; and large pale blue crystals of **hexahydrated cupric octochlorodithallate**, $\text{CuCl}_2 \cdot 2\text{TlCl}_3 \cdot 6\text{H}_2\text{O}$, from neutral aq. soln. J. E. Willm also prepared green matte crystals of **cupric octochlorodithallate**, $\text{CuCl}_2 \cdot 2\text{TlCl}_3$, by evaporating mixed soln. of the component salts.

Colourless, hygroscopic, needle-like crystals of **trihydrated thallic fluodichloride**, $\text{TlFCl}_2 \cdot 3\text{H}_2\text{O}$, were made by J. Gewecke by the action of chlorine upon a soln. of 30 grms. of thallic fluoride in 120 c.c. of 40 per cent. hydrofluoric acid, at 30° to 40° , until the white precipitate first formed is redissolved. Without stopping the current of chlorine, the soln. is evaporated at as low a temp. as possible. The crystals are pressed between filter-paper and dried for two hours in a desiccator over phosphorus pentoxide and potassium hydroxide. The salt becomes anhydrous **thallic fluodichloride**, TlFCl_2 , if it be allowed to stand some time in a desiccator over phosphorus pentoxide and potassium hydroxide. The salt is very hygroscopic, and is rapidly decomposed by moist air; it is soluble in absolute alcohol, forming a pale yellow soln.; aqueous alcohol gives a deep yellow soln. and soon deposits thallic hydroxide. Thoroughly dried ammonia is absorbed by anhydrous and dry thallic fluochloride, cooled by a freezing mixture, forming white **thallic tetramminofluodichloride**, $\text{TlFCl}_2 \cdot 4\text{NH}_3$. It is immediately decomposed by water. Thallic fluochloride forms white needles of a double salt with pyridine, $\text{TlFCl}_2 \cdot 2\text{C}_5\text{H}_5\text{N}$. J. Gewecke also prepared colourless crystals of **potassium difluopentachlorodithallate**, $\text{KCl} \cdot 2\text{TlFCl}_2$, or $\text{KTl}_2\text{F}_2\text{Cl}_5$, by evaporating a mixed soln. of 4 grms. of potassium chloride and 24 grms. of thallic fluochloride in dilute hydrofluoric acid, recrystallizing from dil. hydrofluoric acid, and drying the product in a desiccator.

In 1863, W. Crookes and A. H. Church reported the formation of **thallium sesquichloride**, Tl_2Cl_3 , **thallosic chloride**, or **thallic chlorothallate**, $3\text{TlCl} \cdot \text{TlCl}_3$, by the evaporation of a soln. of thallic chloride in aqua regia until the evolution of chlorine has ceased—A. Lamy⁹ used metallic thallium in place of thallic chloride—the product can be recrystallized from water acidified with nitric or hydrochloric acid. G. Werther says that the product of this reaction has not a constant composition since his analyses gave numbers ranging from $\text{Tl} : \text{Cl} = 2 : 3$ to nearly $1 : 3$. A. Lamy also prepared this compound by the action of chlorine on heated thallium. Thallic chloride is scarcely attacked by dry liquid chlorine at -15° , and no method of chlorinating dry thallic chloride to thallium sesquichloride is known which does not at the same time form still higher chlorides. Gaseous chlorine converts dry thallic chloride into Tl_2Cl_3 , Tl_2Cl_4 , and Tl_2Cl_6 . According to R. J. Meyer, there is a continuous series of mixtures of thallic and thallic chlorides. The so-called compound Tl_2Cl_3 —that is, $3\text{TlCl} \cdot \text{TlCl}_3$ —corresponds with a sat. soln. of thallic chloride in thallic chloride because no complex with a higher proportion of thallic chloride has been prepared. The colour of the complex deepens with increasing proportions of thallic chloride, and the solubility also decreases in the same proportion. A. S. Cushman passed chlorine into water with thallic chloride in suspension until the latter has all acquired a lemon-yellow colour. If the current of chlorine be continued, the yellow colour disappears and soluble thallic chloride is formed. According to A. S. Cushman, the low solubility of thallium sesquichloride in cold water enables a definite stage in the chlorination to be reached before

the thallium trichloride is formed. Although G. Neumann has stated that the dichloride, as well as the sesquichloride, is formed in the action of chlorine on thallos chloride suspended in water, J. E. Willm, A. Lamy, and A. S. Cushman never succeeded in preparing thallium dichloride in the presence of water. Analyses of the yellow products agree closely with the theoretical values for the sesquichloride. G. Neumann prepared thallium sesquichloride by dissolving thallium sesquioxide in hydrochloric acid; R. J. Meyer, by reducing thallic chloride by oxalic acid or hydrogen peroxide; and J. E. Willm, by precipitating a mixture of thallos and thallic chlorides with hydrogen chloride. According to R. J. Meyer, the best way of making Tl_2Cl_3 —that is, $3TlCl \cdot TlCl_3$ —is to saturate with freshly precipitated thallos chloride a boiling soln. of thallic chloride in dil. nitric acid. The required salt separates out on cooling.

On cooling a soln. in hot water, thallium sesquichloride crystallizes in yellow six-sided plates—W. Crookes and A. H. Church compared the colour with that of lead iodide. The crystals are stable in air; and, according to A. Lamy, the salt melts between 400° and 500° to a dark brown liquid which contracts during solidification, forming a yellowish-brown solid of sp. gr. 5.9. The solubility in water is low; the data are somewhat divergent; according to W. Crookes, 100 grms. of water at 15° dissolve 0.26 grm. of the salt. According to M. Heberling, 0.29 grm. at 17° ; according to R. Abegg and J. F. Spencer, 0.00333 mols or 0.343 grm. at 25° ; according to A. Lamy, 4 to 5 grms. at 100° ; and, according to W. Crookes, 1.9 grms. of salt at the same temp. The aq. soln. is colourless; according to A. Lamy, there is a small decomposition of the salt in aq. soln., and this is prevented by a few drops of hydrochloric or nitric acid; and R. J. Meyer showed that by recrystallization from dil. soln. a mixture of Tl_2Cl_3 and $TlCl$ first forms, succeeding fractions are paler and richer in chlorine, until finally thallic chloride remains in soln. M. Heberling emphasized the fact that aq. soln. give reactions characteristic of both thallic and thallos salts. W. Crookes and A. H. Church found that when exposed to dry ammonia, the colour is deepened, and when heated, ammonium chloride and nitrogen are evolved while thallos chloride remains: $6Tl_2Cl_3 + 8NH_3 = 12TlCl + 6NH_4Cl + N_2$. The aq. soln. gives with alkali hydroxides a precipitate of thallic hydroxide, while potassium and thallos chlorides remain in soln. A. S. Cushman states that the prolonged action of chlorine in the presence of water converts the salt into thallos chloride, and J. F. Spencer and R. Abegg explain this by the small dissociation press. of chlorine in the complex $3TlCl \cdot TlCl_3$.

According to A. Lamy, when thallium or thallos chloride is heated in a slow current of chlorine, so long as the product remains liquid, a yellowish-grey liquid is obtained which solidifies to a crystalline mass with about 26.15 per cent. of chlorine and 73.85 per cent. of thallium—approximately $Tl : Cl = 1 : 2$ —**thallium dichloride**, $TlCl_2$, or Tl_2Cl_4 . According to V. Thomas, this product represents the highest stage in the chlorination of thallos chloride by chlorine in the presence of methyl chloride, or carbon tetrachloride. If chloroform be used there is a slight decomposition of the solvent and a little carbon tetrachloride is formed. G. Neumann claims to have made it by dissolving thallium sesquioxide in hydrochloric acid. Thallium dichloride is a pale yellow deliquescent solid which is more fusible than the sesquichloride, and which is transformed into the sesquichloride when heated. It is decomposed by water into thallic chloride and thallium sesquichloride. J. J. Sudborough prepared a double compound with nitrosyl chloride— $TlCl \cdot TlCl_3 \cdot 2NOCl$ —and V. Cuttica and co-workers, **thallosic trinitrosyl chloride**, $TlCl_2 \cdot 3NOCl$.

R. J. Meyer regards thallium dichloride as a solid soln. of thallos in thallic chloride. In 1865, J. E. Willm summed up reasons for believing that the intermediate chlorides of the types $TlCl_2$ and Tl_2Cl_3 respectively called the tetra- and sesqui-chlorides should be regarded as double salts and formulated $TlCl_3 \cdot TlCl$, and $TlCl_3 \cdot 3TlCl$, because (i) they resemble in their general behaviour well-defined double salts of the types $TlCl_3 \cdot CuCl$; $TlCl_3 \cdot 3KCl$; $TlCl_3 \cdot 3NH_4Cl$; etc.; (ii) they can be made by mixing the thallic and thallos halides in the proper proportions; (iii) no

oxides are known corresponding with these intermediate halides; and (iv) if the intermediate halides are treated with alkali they form the alkali halide and precipitate insoluble thallic and thallose oxides. G. Neumann also favours this hypothesis. The double salts which thallium can form with itself can be represented, according to C. W. Blomstrand's views:



but this does not show why no pentahalide of thallium has been observed— $\text{TICl}_5 \cdot 2\text{TI} \text{Cl}$ should be as capable of existing as $\text{TICl}_5 \cdot \text{TI} \text{Cl}$ and $\text{TICl}_5 \cdot 3\text{TI} \text{Cl}$. According to A. Werner, there is a dominant thallium atom of the centre of an octahedron as indicated in the appended diagram—Fig. 16, A; and in the cases of the so-called sesquichloride, and of the tetra-salt the dominant thallium atom is at the centre of a tetrahedron, Fig. 17, B; or the configuration of the molecule, is in a plane, and one axis is unsaturated—Fig. 18, C. In symbols $[\text{TI} \text{Cl}_6] \text{TI}_3'$ and

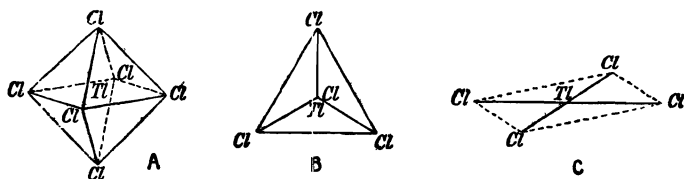

FIGS. 16-18.—A. Werner's Nuclei for $[\text{TI} \text{Cl}_6] \text{TI}_3'$ and $[\text{TI} \text{Cl}_4] \text{TI}'$.

$[\text{TI} \text{Cl}_4] \text{TI}'$ respectively. This view makes thallium sesquichloride to be **thallose hexachlorothallate**, $\text{TI}_3 \text{TI} \text{Cl}_6$; and thallium dichloride to be **thallose tetrachlorothallate**, $\text{TI} \text{TI} \text{Cl}_4$.

REFERENCES.

¹ A. Lamy, *Ann. Chim. Phys.*, (3), **67**, 385, 1863; M. Heberling, *Liebig's Ann.*, **134**, 11, 1865; E. Carstanjen, *Journ. prakt. Chem.*, (1), **102**, 65, 129, 1867; J. Hausmann, *Zeit. anorg. Chem.*, **40**, 110, 1904; F. A. Henglein, *ib.*, **120**, 77, 1921; F. Ephraim and P. Barteczko, *ib.*, **61**, 245, 1909; W. P. Davey, *Phys. Rev.*, (2), **17**, 402, 1921; W. P. Davey and F. G. Wick, *ib.*, (2), **17**, 403, 1921.

² F. A. Henglein, *Zeit. anorg. Chem.*, **120**, 77, 1921; W. P. Davey and F. G. Wick, *Phys. Rev.*, (2), **17**, 402, 1921; W. Biltz, *Zeit. Elektrochem.*, **29**, 373, 1923; B. Gossner, *Zeit. Kryst.*, **36**, 130, 1902; F. W. Clarke, *Amer. Chem. Journ.*, **5**, 240, 1883; A. Lamy, *Ann. Chim. Phys.*, (3), **67**, 385, 1863; J. E. Willm, *ib.*, (4), **5**, 5, 1865; E. Carstanjen, *Journ. prakt. Chem.*, (1), **102**, 65, 129, 1867; W. Stortenbeker, *Rec. Trav. Chim. Pays-Bas.*, **24**, 53, 1905; T. W. Richards and G. Jones, *Journ. Amer. Chem. Soc.*, **31**, 158, 1909; S. Motylewsky, *Zeit. anorg. Chem.*, **38**, 410, 1904; M. Heberling, *Liebig's Ann.*, **134**, 11, 1865; H. Stoltzenberg and M. E. Huth, *Zeit. phys. Chem.*, **71**, 641, 1910; C. Tubandt and E. Lorenz, *ib.*, **87**, 527, 1914; R. Lorenz and W. Eitel, *ib.*, **91**, 46, 57, 1915.

³ K. Mönkemeyer, *Neues Jahrb. Min.*, **22**, 1, 1906; T. Carnelley, *Journ. Chem. Soc.*, **29**, 489, 1876; **33**, 273, 1878; T. Carnelley and W. C. Williams, *ib.*, **35**, 563, 1879; **33**, 281, 1878; W. Hampe, *Chem. Ztg.*, **11**, 1109, 1887; E. Carstanjen, *Journ. prakt. Chem.*, (1), **102**, 65, 129, 1867; J. Thomsen, *ib.*, (2), **12**, 98, 1875; M. Heberling, *Liebig's Ann.*, **134**, 11, 1865; H. E. Roscoe, *Proc. Roy. Soc.*, **27**, 426, 1878; E. Beckmann, *Zeit. anorg. Chem.*, **55**, 175, 1907; F. A. Henglein, *ib.*, **120**, 77, 1921; E. Franke, *Zeit. phys. Chem.*, **16**, 463, 1895; G. von Hevesy, *ib.*, **101**, 337, 1922; E. Kohlräusch, *ib.*, **44**, 197, 1903; **64**, 129, 1908; A. A. Noyes and G. Abbot, *ib.*, **16**, 132, 1895; A. A. Noyes, *ib.*, **6**, 249, 1890; M. de K. Thompson, *Journ. Amer. Chem. Soc.*, **28**, 731, 1906; K. Klemensiewicz, *Anz. Akad. Krakau*, 485, 1908; F. Kohlräusch and M. E. Maltby, *Sitzber. Akad. Berlin*, 665, 1899; W. Schmidt, *Ann. Physik*, (4), **11**, 114, 1903; C. Sandonni, *Atti Accad. Lincei*, (5), **24**, i, 616, 1915; A. E. Hill, *Journ. Amer. Chem. Soc.*, **32**, 1189, 1910; G. N. Lewis and C. L. von Ende, *ib.*, **32**, 732, 1910; G. N. Lewis and M. Randall, *ib.*, **43**, 1112, 1921; G. Jones and W. C. Schumb, *Proc. Amer. Acad.*, **56**, 199, 1921; W. W. Coblenz and J. F. Eckford, *Scient. Papers Bur. Standards*, **18**, 489, 1922; G. D. Roos, *Ueber die Schmelzwärme und die Bildungswärme von Metallverbindungen und über das Zustandsdiagramm der Hg-Tl-Legierungen*, Leipzig, 1916; C. Renz, *Helvetica Chim. Acta*, **2**, 704, 1919; **4**, 950, 1921; Lord Berkeley, *Phil. Trans.*, **203**, A, 189, 1904; C. Tubandt and E. Lorenz, *Zeit. phys. Chem.*, **87**, 527, 1914; H. von Wartenberg and O. Bosse, *Zeit. Elektrochem.*, **28**, 384, 1922; E. Korreng, *Neues Jahrb. Min. B.B.*, **37**, 58, 1913;

J. C. Ghosh, *Journ. Chem. Soc.*, **117**, 823, 1920; A. A. Noyes and K. G. Falk, *Journ. Amer. Chem. Soc.*, **34**, 454, 1912; C. Benrath, *Zeit. wiss. Photochem.*, **14**, 217, 1915; G. Tammann, *Zeit. anorg. Chem.*, **133**, 267, 1924; J. O. Perrine, *Phys. Rev.*, (2), **22**, 48, 1923.

⁴ Earl of Berkeley, *Phil. Trans.*, **203**, A, 208, 1904; F. Kohlrausch, *Zeit. phys. Chem.*, **64**, 129, 1908; **44**, 197, 1903; **54**, 355, 1904; W. Böttger, *ib.*, **46**, 569, 1903; A. A. Noyes, *ib.*, **9**, 603, 1892; **6**, 249, 1890; A. A. Noyes and G. Abbot, *ib.*, **16**, 132, 1895; G. Geffcken, *ib.*, **49**, 296, 1904; H. M. Goodwin, *ib.*, **13**, 577, 1894; M. Heberling, *Liebig's Ann.*, **134**, 11, 1881; A. Lamy, *Ann. Chim. Phys.*, (3), **67**, 386, 1863; A. Ditte, *ib.*, (5), **22**, 551, 1881; A. E. Hill and J. P. Simmons, *Journ. Amer. Chem. Soc.*, **31**, 821, 1909; A. E. Hill, *ib.*, **59**, 218, 1917; G. N. Lewis and M. Randall, *ib.*, **43**, 1112, 1921; W. C. Bray and W. J. Winninghoff, *ib.*, **33**, 1663, 1911; W. Crookes, *Chem. News*, **3**, 1, 1860; **9**, 37, 1864; J. F. Spencer and M. le Pla, *Proc. Chem. Soc.*, **24**, 75, 1908; A. Naumann, *Ber.*, **37**, 4328, 1904; A. Naumann and J. Schröder, *ib.*, **37**, 4610, 1904; G. Jones and W. C. Schumb, *Proc. Amer. Acad.*, **56**, 199, 1921; G. N. Lewis and C. L. von Ende, *Journ. Amer. Chem. Soc.*, **32**, 732, 1910; W. Crookes, *Phil. Trans.*, **153**, 173, 1863.

⁵ A. Lamy, *Ann. Chim. Phys.*, (3), **67**, 385, 1863; V. Thomas, *ib.*, (8), **11**, 204, 1907; J. E. Willm, *ib.*, (4), **5**, 5, 1865; G. Werther, *Journ. prakt. Chem.*, (1), **91**, 385, 1864; J. Krause, *Dingler's Journ.*, **217**, 323, 1875; R. Nietzki, *ib.*, **219**, 262, 1876; A. Cossa, *Nuovo Cimento*, (2), **3**, 75, 1870; K. Seubert and A. Schmidt, *Liebig's Ann.*, **267**, 234, 1892; A. G. Page, *ib.*, **225**, 201, 1884; W. Biltz and W. Stollenwerk, *Zeit. anorg. Chem.*, **119**, 97, 1921; W. Biltz, *ib.*, **130**, 93, 1923; G. L. Clark, *Amer. Journ. Science*, (4), **7**, 1, 1923; C. Benrath, *Zeit. wiss. Photochem.*, **14**, 217, 1915.

⁶ C. Sandonini, *Gazz. Chim. Ital.*, **50**, i, 289, 1920; *Atti Accad. Lincei*, (5), **22**, ii, 20, 1913; (5), **24**, i, 616, 1915; C. Sandonini and P. C. Aureggi, *ib.*, (5), **20**, ii, 588, 1911; J. Kendall, E. D. Crittenden, and H. K. Miller, *Journ. Amer. Chem. Soc.*, **45**, 963, 1923; E. H. Ducloux, *Anal. Asoc. Quim. Argentina*, **9**, 215, 1921; T. Liebisch and E. Korreng, *Sitzber. Akad. Berlin*, **192**, 1914; E. Korreng, *Neues Jahrb. Min. B.E.*, **37**, 51, 1913; E. Carstanjen, *Journ. prakt. Chem.*, (1), **102**, 65, 129, 1867; S. M. Jörgensen, *ib.*, (2), **6**, 82, 1872; F. Wöhler and W. Ahrens, *Liebig's Ann.*, **144**, 250, 1867; A. Neumann, *ib.*, **244**, 342, 1888; E. von Biron, *Journ. Russ. Phys. Chem. Soc.*, **36**, 489, 1904; W. Crookes, *Phil. Trans.*, **153**, 173, 1863.

⁷ J. E. Willm, *Ann. Chim. Phys.*, (4), **5**, 5, 1865; G. Werther, *Journ. prakt. Chem.*, (1), **91**, 385, 1864; A. J. Berry, *Journ. Chem. Soc.*, **121**, 395, 1922; **123**, 1109, 1923; C. Renz, *Ber.*, **35**, 27, 68, 1902; R. J. Meyer, *Zeit. anorg. Chem.*, **24**, 335, 1900; **32**, 72, 1902; W. Biltz, *ib.*, **119**, 97, 1921; V. Thomas, *Ann. Chim. Phys.*, **11**, 204, 1907; *Compt. Rend.*, **134**, 545, 1902; **135**, 1051, 1902; **142**, 838, 1906; J. Nicklès, *ib.*, **58**, 357, 1864; *Journ. Pharm. Chim.*, (4), **1**, 27, 1865; (4), **2**, 219, 1865; A. S. Cushman, *Amer. Chem. Journ.*, **24**, 222, 1901; **26**, 505, 1902; F. M. McClenahan, *Amer. Journ. Science*, (4), **13**, 104, 1904; W. Hampe, *Chem. Ztg.*, **11**, 1109, 1888; D. Gauthier, in H. Moissan, *Traité de chimie minérale*, Paris, **4**, 922, 1905; A. Voigt and W. Biltz, *Zeit. anorg. Chem.*, **133**, 277, 1924.

⁸ J. E. Willm, *Ann. Chim. Phys.*, (4), **5**, 5, 1865; G. Neumann, *Liebig's Ann.*, **244**, 346, 1888; J. Gewecke, *ib.*, **366**, 217, 1909; R. J. Meyer, *Zeit. anorg. Chem.*, **24**, 343, 1900; J. Nicklès, *Journ. Pharm. Chim.*, (4), **1**, 28, 1865; (4), **2**, 219, 1865; C. F. Rammelsberg, *Ber.*, **3**, 362, 1870; *Pogg. Ann.*, **146**, 597, 1872; *Wied. Ann.*, **16**, 709, 1882; J. H. Pratt, *Amer. Journ. Science*, (3), **49**, 397, 1896; *Zeit. anorg. Chem.*, **9**, 19, 1895; A. Fock, *Zeit. Kryst.*, **6**, 171, 1882; R. C. Wallace, *ib.*, **49**, 417, 1911; F. Godeffroy, *Zeit. allgem. oesterr. Ver.*, **9**, 1880; E. H. Ducloux, *Anal. Asoc. Quim. Argentina*, **9**, 215, 1921; C. Sandonini and P. C. Aureggi, *Atti Accad. Lincei*, (5), **20**, ii, 588, 1911; W. Crookes and A. H. Church, *Chem. News*, **8**, i, 1863.

⁹ A. Lamy, *Ann. Chim. Phys.*, (3), **67**, 385, 1863; J. E. Willm, *ib.*, (4), **5**, 5, 1865; V. Thomas, *ib.*, (8), **11**, 204, 1907; *Compt. Rend.*, **142**, 840, 1906; W. Crookes and A. H. Church, *Chem. News*, **8**, 1, 1863; W. Crookes, *Phil. Trans.*, **153**, 173, 1863; G. Werther, *Journ. prakt. Chem.*, (1), **91**, 385, 1864; G. Neumann, *Liebig's Ann.*, **244**, 342, 1888; M. Heberling, *ib.*, **134**, 11, 1865; A. S. Cushman, *Amer. Chem. Journ.*, **24**, 229, 1900; R. J. Meyer, *Zeit. anorg. Chem.*, **24**, 351, 1900; J. F. Spencer and R. Abegg, *ib.*, **44**, 378, 1905; J. J. Sudborough, *Journ. Chem. Soc.*, **59**, 657, 1891; V. Cuttica, A. Jarchi, and P. Alinari, *Gazz. Chim. Ital.*, **53**, i, 189, 1923; A. Werner, *Neuere Anschauungen auf dem Gebiete der anorganischen Chemie*, Braunschweig, 1905; London, 83, 1911; C. W. Blomstrand, *Die Chemie der Jetztzeit*, Heidelberg, 1869.

§ 9. The Thallium Bromides

A. Lamy¹ found that bromine unites directly with thallium less energetically than is the case with chlorine. The attack is appreciable at ordinary temperatures only after many weeks. According to J. Nicklès, the reaction proceeds more quickly in the presence of water or alcohol. Thallium forms the bromides TlBr, and TlBr₃, with the intermediate bromides Tl₂Br₃ and Tl₂Br₄, as well as a number of chlorobromides.

Thallos bromide, TlBr, is prepared by methods analogous to those employed

in preparing thalious chloride—*e.g.* J. E. Willm made it by precipitation from a thalious salt by means of potassium bromide; and J. Nicklès, by the action of sulphur dioxide on the compound of thallic bromide with ether. The precipitated salt is white and curdy; the salt can also be obtained in pale yellow cubic crystals from hot soln. R. Lorenz and W. Eitel did not succeed in making optically clear crystals. W. Biltz represented the lattice energy of thalious bromide by 185 Cals. per mol. F. W. Clarke gives the sp. gr. of the precipitated salt as 7.540 at 21.7°, and after fusion, 7.557 at 17.3°. F. A. Henglein found that the mol. vols. of thalious, cuprous, and silver bromides give a straight line when plotted against numbers corresponding with anions or cations. T. W. Richards and G. Jones give the coeff. of compressibility as 5.2×10^{-6} per atm. T. Carnelley says the salt melts below a red heat between 458° and 463°; K. Mönkemeyer gives 450°; and H. von Wartenberg and O. Bosse, 456°. According to E. Carstanjen, thalious bromide forms a dark yellow liquid which solidifies to a pale yellow solid resembling fused thalious chloride. H. Stolzenberg and M. E. Huth give 441° for the m.p. of the iodide, and say that when the molten salt cools the liquid is anisotropic. C. Tubandt and E. Lorenz showed the phenomenon is due to the use of a badly purified salt. According to K. Mönkemeyer, fused mixtures of thalious chloride (melting at 426°) and thalious bromide (melting at 450°) give a continuous series of mixed crystals with a minimum at 413° corresponding with 60 molar per cent. of thalious chloride. H. von Wartenberg and O. Bosse found the vap. press., *p*, to be 70.8 mm. at 634°; 186.8 mm. at 695°; 396.7 mm. at 757°; 565.9 mm. at 791°; 773.6 mm. at 817°; and at the absolute temp. *T*, $\log p = -25164/4.571T + 5.059$. The b.p. is 815°. G. D. Roos gave 12.7 cal. per gram for the heat of fusion. The heat of formation, according to J. Thomsen, is $\text{Tl} + \text{Br} = \text{TlBr} + 41.3$ Cals., and M. de K. Thompson calculates, from the solubility, the heat of formation $39.7 \text{ TlOH}_{\text{aq}} + \text{HBr}_{\text{aq}} = 27.51$ Cals.; and $\text{Tl}_2\text{O} + 2\text{HBr} = 2\text{TlBr} + \text{H}_2\text{O} + 91.82$ Cals. J. O. Perrine observed no fluorescence with thalious bromide in X-rays. F. Kohlrausch gives the electrical conductivity of a soln. sat. at 18° as 192.20×10^{-6} reciprocal ohms per cm. cube. J. C. Ghosh found the sp. conductivity to be 0.00004 at 523° K.; 0.00055 at 623° K.; 0.00160 at 673° K.; and 0.00470 at 720° K. A. Benrath found the bromide is not affected by exposure to light. W. W. Coblentz and J. F. Eckford measured the photoelectric sensitivity of thalious bromide. G. von Hevesy found the ratio of the conductivities of thalious bromide above and below the m.p. is 130, and the gain of energy in rendering the ions of the crystal neutral is 73 cal.—*vide* the chloride. The chemical reactions resemble those of the chloride.

According to F. Kohlrausch, a litre of water at 18° dissolves 1.49 milligram eq., or 0.420 gm. of thalious bromide; W. Böttger gives at 20°, 0.00164 mols; and W. Biltz, 0.0013 between 16° and 18°. The solubility in 100 grms. of water is therefore 0.042 gm. at 18°, 0.048 gm. at 20°, 0.057 gm. at 25°, and 0.247 gm. at 68.5°. J. Thomsen gives for the heat of soln. in water—13.75 Cals. A. A. Noyes studied the effect of thalious nitrate on the solubility of the bromide. A. Naumann says thalious bromide is insoluble in acetone, and A. Naumann and J. Schröder, insoluble in pyridine. For **thalious triaminobromide**, $\text{TlBr} \cdot 3\text{NH}_3$, *vide* the corresponding chloride. W. Biltz found the vap. press. at -50° to be 287 (307) mm., and at -60° , 160 (165) mm., where the numbers in brackets refer to the vap. press. of liquid ammonia at the given temp. The salt dissociates at -66° under 100 atm. press., and its heat of formation is 7.1 Cals. per mol. of ammonia. G. L. Clark made some observations on this subject. J. Barlot and J. Pernot made **mercuric thalious bromide**, $\text{HgBr}_2 \cdot \text{TlBr}$, in long matted needles.

J. Nicklès stirred up thalious bromide with water to form a slurry and passed bromine through the warm liquid. The thalious bromide gradually dissolved furnishing a liquid which in vacuo formed a felted mass of deliquescent, needle-like crystals—**tetrahydrated thallic bromide**, $\text{TlBr}_3 \cdot 4\text{H}_2\text{O}$ —which contained some thalious bromide. While the soln. was found to be fairly stable, the crystals

readily decompose. V. Thomas evaporated the soln. obtained by passing bromine through water with thallous bromide in suspension, at 30° to 40°, but not higher, until the soln. crystallizes on cooling. The soln. is very liable to undercooling, and a jet of carbon dioxide from a bomb will cool the liquid and start crystallization. If the warm soln. be conc. too far, it will decompose, giving off bromine. The long, pale yellow, needle-like crystals obtained by this process are likewise tetrahydrated thallic bromide. The crystals melt at 40°, and they lose water and bromine when dried in vacuo. It has not yet been possible to prepare anhydrous *thallium tribromide*, or *thallic bromide*, $TlBr_3$, because when dehydration is attempted in vacuo, bromine and thallium dibromide are produced; the same result was obtained by V. Thomas in the attempt to dehydrate the tetrahydrated salt in a current of air at 30°, and by J. Nicklès, by confining the soln. over sulphuric acid in a desiccator—bromine was given off and Tl_2Br_4 was formed. According to V. Thomas, the heat of formation of the tribromide in aq. soln. is $Tl + 3Br_{liquid} + Aq. = TlBr_{3aq.} + 56.8$ Cals.; the heat of formation of the tetrahydrated bromide is $TlBr_{liquid} + 4H_2O_{liquid} + 2Br_{liquid} = TlBr_3.4H_2O + 59.0$ Cals.; and the heat of soln. of tetrahydrated thallic bromide is -2.45 Cals.

R. J. Meyer reported the formation of yellow hair-like crystals of **monohydrated thallic bromide**, $TlBr_3.H_2O$, by evaporating in vacuo the soln. obtained by shaking thalious bromide in the cold with bromine water. The crystals are said to be very unstable, and soluble in water, alcohol, and ether. J. E. Willm prepared **thallic triaminobromide**, $TlBr_3.3NH_3$, by mixing a conc. alcoholic soln. of thallic bromide with alcoholic ammonia. The resulting white precipitate is washed with alcohol, and dried. The colour soon becomes yellow owing to the partial decomposition of the salt. The compound is decomposed by water with the separation of a black oxide. When heated to 100°, it forms a dark yellow sticky mass, and loses ammonia and bromine to form thalious bromide. J. Nicklès prepared a compound of thallic bromide with ether, $TlBr_3.3(C_2H_5)_2O$.

R. J. Meyer found that when a soln. of thallic bromide in hydrobromic acid is evaporated, a non-crystallizable syrup is produced, but solid *hydrotetrabromothallic acid*, $HTlBr_4.3H_2O$ or $TlBr_3.HBr.3H_2O$, analogous with the corresponding hydro-tetrachlorothallic acid, has not been obtained. A similar soln. was made by the action of hydrobromic acid on hydrotetrachlorothallic acid—possibly $TlCl_3.HBr.3H_2O$ is first formed, and this reacts with more hydrobromic acid to form hydrotetrabromothallic acid. J. Nicklès prepared **ammonium tetrabromothallate**, $NH_4TlBr_4.2(4 \text{ or } 5)H_2O$, by the action of bromine on thalious and ammonium bromides, or of ammonium bromide on an ethereal soln. of thallic bromide. The former process furnishes needle-like, and the latter plate-like, crystals. The needle-like crystals lose 12.3 per cent. of water at 100°; and both forms melt in their water of crystallization. J. E. Willm made needle-like crystals by saturating with ammonia a soln. of bromine and thallium bromide suspended in alcohol. His analysis indicated that the solid contained $5H_2O$; J. Nicklès' analyses indicated $4H_2O$, and $2H_2O$. The crystals lose all their water in vacuo.

J. Nicklès made the **dihydrated potassium tetrabromothallate**, $KBr.TlBr_3.2H_2O$, or $KTlBr_4.2H_2O$, isomorphous with the ammonium salt by a similar process. R. J. Meyer made it by evaporating in vacuo a soln. of equi-molar parts of thallic and potassium bromides. The large rhombic plates are stable in air, and, according to R. C. Wallace, the crystals are cubes and octahedra belonging to the cubic system. According to J. Nicklès, the salt begins to melt at 100°, and, according to R. J. Meyer, the salt cannot be dehydrated without losing bromine—the loss of bromine occurs by exposure to air, for the crystals become covered with a crust of pale yellow thalious bromide. C. F. Rammelsberg reported yellow cubic crystals of **trihydrated potassium enneabromodithallate**, $3KBr.2TlBr_3.3H_2O$, or $K_3Tl_2Br_9.3H_2O$, but while R. J. Meyer cast doubts on the existence of this salt, the anhydrous chlorides and bromides of cesium have been made independently by J. H. Pratt. Pale yellow cubic crystals of **monohydrated rubidium tetrabromothallate**, $RbBr.TlBr_3.H_2O$,

were made by J. H. Pratt by crystallization from a soln. containing 3 to 24 grms. of rubidium bromide, and 40 grms. of thallic bromide. The salt cannot be recrystallized from water without change. J. H. Pratt also made golden-yellow tetragonal crystals of **monohydrated rubidium hexabromothallate**, $3\text{RbBr}\cdot\text{TlBr}_3\cdot\text{H}_2\text{O}$, from soln. containing 1.5 to 24 grms. of thallic bromide and 50 grms. of rubidium bromide. The axial ratios are $a:c=1:0.8073$. The crystals are feebly double refracting. The salt is sparingly soluble in water, and passes into $\text{RbTlBr}_4\cdot\text{H}_2\text{O}$ when the attempt is made to recrystallize it from water. J. H. Pratt made pale yellow cubes of **caesium tetrabromothallate**, CsTlBr_4 , or $\text{CsBr}\cdot\text{TlBr}_3$, by mixing soln. containing 40 grms. of thallic bromide with 2 to 10 grms. of caesium bromide. By recrystallization from water, he obtained yellowish-red crystals of **caesium enneabromodithallate**, $3\text{CsBr}\cdot 2\text{TlBr}_3$; and the same salt again from a mixture of 1-15 grms. of thallic bromide and 50 grms. of caesium bromide. It can be recrystallized from water.

J. Gewecke prepared sulphur-yellow plates of **thallic fluorodibromide**, TlFBr_2 , by dropping bromine into a soln. of 30 grms. of thallic fluoride in 120 c.c. of 40 per cent. hydrofluoric acid between 30° and 40° until the yellowish-white precipitate first formed has redissolved; and evaporating the soln. between 30° and 40° . The crystals are more stable than thallic bromide; they are soluble in absolute alcohol; decomposed by water; and form a yellowish-white powder of **thallic tetramminofluorodibromide**, $\text{TlFBr}_2\cdot 4\text{NH}_3$, by a process analogous to that employed for thallic tetramminofluorodichloride. This compound is decomposed by water, and is slightly soluble in absolute alcohol.

V. Thomas prepared **tetrahydrated thallic bromodichloride**, $\text{TlBrCl}_2\cdot 4\text{H}_2\text{O}$, by the action of chlorine on thallic bromide in the presence of a little water. The compound is very unstable, and it is decomposed by water and by heat. V. Thomas also prepared **tetrahydrated thallium dibromochloride**, $\text{TlBr}_2\text{Cl}\cdot 4\text{H}_2\text{O}$, by the action of a small excess of bromine on thallic chloride in the presence of cold water. The soln. on evaporation furnishes pale yellow needles which have properties recalling those of a mixture of the hydrates of thallic bromide and chloride. In vacuo, the crystals lose chlorine, bromine, and water: $6(\text{TlClBr}_2\cdot 4\text{H}_2\text{O}) = 2\text{Tl}_3\text{Cl}_2\text{Br}_4 + 24\text{H}_2\text{O} + \text{Cl}_2 + 2\text{Br}_2$. They melt at 40° , the temp. at which decomposition begins. It is not certain if these two compounds are chemical individuals or mixtures of $\text{TlCl}_3\cdot 4\text{H}_2\text{O}$ and $\text{TlBr}_3\cdot 4\text{H}_2\text{O}$.

V. Thomas found that thallic chloride at a low temp. absorbs hydrogen bromide, forming presumably **hydrobromodichlorothallic acid**, $\text{TlCl}_3\cdot\text{HBr}$, or HTlBrCl_3 ; thallic bromide under similar conditions absorbs hydrogen chloride, forming presumably **hydrotribromochlorothallic acid**, $\text{TlBr}_3\cdot\text{HCl}$ or HTlClBr_3 . In an analogous manner, the thallic bromochlorides absorb hydrogen chloride or bromide forming presumably the four compounds: $\text{TlCl}_2\text{Br}\cdot\text{HCl}$; $\text{TlClBr}_2\cdot\text{HCl}$; $\text{TlCl}_2\text{Br}\cdot\text{HBr}$; and $\text{TlClBr}_2\cdot\text{HBr}$. All these products are very soluble in water and are so unstable that they have not been isolated in the solid state.

The action of bromine on thallic bromide closely resembles that of chlorine on thallic chloride, a mixture of thallium sesqui- and di- bromides is formed. These two compounds were first prepared by J. E. Willm.² According to A. S. Cushman's modification of J. E. Willm's process, thallic bromide is suspended in a very little water and treated with bromine, a yellow compound is formed which dissolves on heating, and crystallizes on cooling in minute yellow needles which under the microscope appear as elongated square prisms of **thallium dibromide**, TlBr_2 , or Tl_2Br_4 ; if the soln. be cooled slowly the crystals are orange-red instead of red, and they are contaminated with a little bromine, but, added V. Thomas, never more than corresponds with the formula Tl_2Br_3 . When the crystals of thallium dibromide are dissolved in water and recrystallized, dark red hexagonal plates of **thallium sesquibromide**, Tl_2Br_3 , or **thallosic bromide**, $3\text{Tl}_2\text{Br}\cdot\text{TlBr}_3$, are produced. The reaction in the presence of water is symbolized: $3\text{TlBr}_2 = \text{Tl}_2\text{Br}_3 + \text{TlBr}_3$. In order to prepare the sesquibromide, V. Thomas moistened 4 to 5 grms. of thallic

bromide with a few c.c. of water, and agitated the product with 0.5 c.c. of bromine. The mixture was boiled with 50 c.c. of water, and after filtering off the undissolved thallos bromide, the soln. was cooled as rapidly as possible by immersing the containing flask in a freezing mixture when red crystals separated out. J. E. Willm precipitated thallium sesquibromide by adding potassium bromide to a mixed soln. of eq. amounts of thallos and thallic bromides; and he also agitated a soln. of thallic bromide with an eq. amount of thallos bromide. According to R. J. Meyer, the crystals of thallium sesquibromide are more easily decomposed by water than those of the corresponding chloride, and hence J. E. Willm washed them with dilute alcohol. When heated in the absence of air, J. E. Willm found the crystals become yellow, then brown, and finally melt with the evolution of bromine, and the formation of a sublimate which is brown when hot and yellow when cold. According to V. Thomas, thallium sesquibromide forms mixed crystals with thallos bromide which are orange-red or orange-yellow.

Just as the treatment of thallos chloride with thallic chloride leads to the formation of thallium sesquichloride, Tl_2Cl_3 , or thallos hexachlorothallate, $TlCl_3 \cdot 3TlCl$, or $Tl_3''Tl'''Cl_6$, so does it appear possible that the treatment of thallos bromide with thallic chloride would lead to the formation of $TlCl_3 \cdot 3TlBr$, while the treatment of thallos chloride with thallic bromide would lead to the formation of $TlBr_3 \cdot 3TlCl$. The thallium chlorobromides have been principally studied by C. Wiegand (1899), A. S. Cushman (1900), R. J. Meyer (1900), and by V. Thomas (1900-7). Bromine acts on cold thallos chloride in contact with cold water, forming a yellow powder with a composition varying between $TlCl$ and $Tl_4Cl_3Br_3$, dependent upon the proportion of bromine employed. A. S. Cushman prepared **thallos dibromotetrachlorothallate**, $Tl_3''Tl'''Br_2Cl_4$, or $TlClBr_2 \cdot 3TlCl$, belonging to the type $Tl_3[TlCl_6]$, by shaking thallos chloride with bromine in the presence of water until the white colour of the thallos salt had changed to orange-yellow; this product was washed by decantation with cold water, and finally dissolved in boiling water acidified with nitric acid; on cooling, dark orange hexagonal plates appeared which when purified by two crystallizations, washing, and drying gave analytical numbers in agreement with the indicated formula. V. Thomas employed a similar process for $Tl_4Cl_4Br_2$, and by varying the proportions of bromine up to one gram-atom, he obtained products varying in composition from $TlCl$ to $Tl_4Cl_3Br_3$. R. J. Meyer made thallium dibromotetrachlorothallate by dissolving thallos bromide in a hot soln. of thallic chloride, and cooling; and also by boiling the compound $Tl_4Br_4Cl_2$ with water.

A. S. Cushman prepared what is possibly an isomeric form of this compound and of a citron-yellow colour, by treating thallos chloride with the mother-liquid from which the complex salt was obtained, and recrystallizing from nitric acid. The physical characters of the possible isomers are very much alike, and the difference in colour may really have nothing at all to do with isomerism, but rather be an effect of crystal aggregation and impurities. According to C. W. Blomstrand's, and S. M. Jørgensen's hypotheses, these compounds may be:

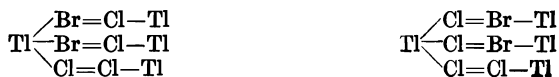

or, according to A. Werner's hypothesis:

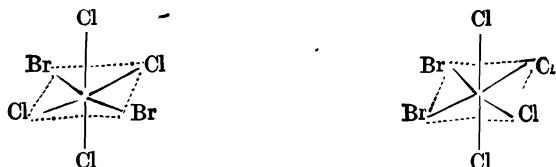

C. Wiegand and R. J. Meyer reported a compound of the composition $Tl_6Cl_5Br_2$, but A. S. Cushman regarded this product as a mixture of $Tl_4Cl_4Br_2$ with thallos

chloride. A. S. Cushman also considers C. Wiegand and R. J. Meyer's $Tl_4Cl_2Br_4$ to be $Tl_4Cl_3Br_3$. Working by analogous methods it should be possible to prepare the following series of chlorobromides of the type Tl_4Cl_6 : (i) Tl_4Cl_5Br ; (ii) $Tl_4Cl_4Br_2$; (iii) $Tl_4Cl_3Br_3$; (iv) $Tl_4Cl_2Br_4$; (v) Tl_4ClBr_5 . Of these, only the second, third, and fourth have been reported.

A. S. Cushman found that when thallos bromide, suspended in hot water, is treated with a dil. soln. of thallic chloride, an orange-coloured substance is formed which can be dissolved by boiling. Orange-coloured hexagonal plates of **thallos tribromotrichlorothallate**, or $TlCl_3 \cdot 3TlBr$, are deposited on cooling the soln. On the other hand, when thallos chloride is suspended in a considerable proportion of hot water, and treated with a soln. of thallic bromide, a dark blood-red compound is formed which dissolves on boiling, and, on rapid cooling, crystallizes out in blood-red hexagonal crystals of thallos tribromotrichlorothallate, $TlBr_3 \cdot 3TlCl$, presumably an isomeric form of the orange-coloured $TlCl_3 \cdot 3TlBr$. According to C. W. Blomstrand's, and S. M. Jørgensen's hypotheses of the tervalency of the halides, these possibly isomeric products are formulated :

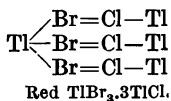
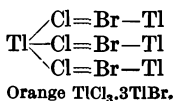

According to A. Werner's hypothesis :

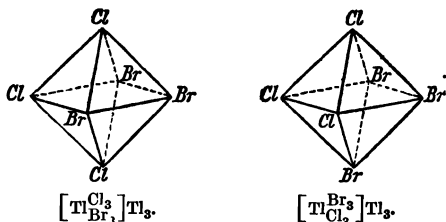

FIGS. 19-20.—Werner's Models for $[TlCl_3Br_3]Tl_3'$.

The orange-coloured salt is stable, the red-coloured salt unstable; if orange $TlCl_3 \cdot 3TlBr$ be treated with an excess of thallic chloride, lemon yellow $TlCl_3 \cdot 3TlCl$ is gradually formed; while the orange salt is transposed into the red variety by treatment with a conc. soln. of thallic bromide: $TlCl_3 \cdot 3TlBr + 3TlBr_3 = TlBr_3 \cdot 3TlCl + 3TlBr_3$. A. S. Cushman adds that the electrical conductivities of these salts show that the salt $TlBr_3 \cdot 3TlCl$ dissociates on soln. into thallic bromide and thallos chloride; and when the soln. is cooled, the particular salt which separates depends on the temp. and solubility of the products of the thallos salt and the double salts respectively. If thallic bromide and thallos chloride exist in soln. and are in turn ionized, it is difficult to see why both isomers on recrystallization retain their characteristic individuality instead of at least in part, passing into one another. By varying the conc. of the soln., A. S. Cushman found it possible to prepare yellow needles of $TlBr_3 \cdot TlCl$, or hexagonal crystals of red $TlBr_3 \cdot 3TlCl$, or orange $TlCl_3 \cdot 3TlBr$.

R. J. Meyer could not prepare a salt by dissolving thallos bromide in a soln. of thallic chloride, but he did obtain the red salt by the action of chlorine on thallos bromide suspended in water, and recrystallizing the product from hot water. V. Thomas also treated 9.6 grms. of thallos chloride, suspended in 50-100 c.c. of water, with 2 grms. of bromine, and obtained a yellow precipitate; he made the soln. up to a litre with water, and boiled the mixture till all excepting a few brown flecks of thallic oxide, the result of hydrolysis, was dissolved. On cooling the filtered soln., about 4 grms. of hexagonal plates of $Tl_4Cl_3Br_3$ separated out between 40° and 33° . The mother-liquid was conc. by evaporation, when a mixture of hexagonal plates and yellow needles separated out—the yellow needles contain

more chlorine than bromine. Both kinds of crystals when heated become orange-coloured and then blood-red; the original colour is restored on cooling; both forms melt at 240° . According to A. S. Cushman, if the crystals of the orange and yellow forms of the thalious tribromotrichlorothallates be sealed up in glass tubes separately, under their own mother liquids, and gradually heated, at about 100° , the colour changes, and as the temp. rises still higher white precipitates resembling thalious halides gradually appear. On cooling, the double salts reform in well-defined crystals without any sign of the white thalious salts. The double salts do not exist in soln. above certain temp., for the state of equilibrium is quite different at higher temp. from what it is at the lower temp. This does not invalidate A. Werner's theory, for the fact that ammonium chloride dissociates into NH_3 and HCl above a certain temp. does not affect belief in the existence of the complex $[\text{NH}_4]\text{Cl}$ at lower temp.

R. J. Meyer sat. a boiling soln. of thallic bromide with thalious chloride, and on cooling the filtered soln. obtained dark red plates of tetrathallium tetrabromodichloride, $\text{Tl}_4\text{Cl}_2\text{Br}_4$, i.e. $\text{TlBrCl}_2 \cdot 3\text{TlBr}$, or **thalious tetrabromodichlorothallate**, $\text{Tl}_3[\text{TlBr}_4\text{Cl}_2]$; and he also obtained a dark red powder of the same composition by the chlorination of thalious bromide in the presence of a little water. These crystals are very easily decomposed by water. When recrystallized from hot soln., the character of the product depends on the rapidity of the cooling. V. Thomas considers the existence of the compound $\text{Tl}_4\text{Cl}_2\text{Br}_4$ as doubtful. As A. S. Cushman has said:

The ease with which the sesquihalogen compounds of thallium undergo hydrolysis or decomposition, their hygroscopic nature, their mixed equilibria in relation to water of crystallization and state of oxidation, and their generally complex nature, present dangerous pitfalls to the investigator.

The end-product of the action of bromine on thalious bromide is **thallium dibromide**, TlBr_2 ; V. Thomas heated these two components in a sealed tube at 100° when the reaction proceeds very quickly, but it occupies about 5 hrs. at ordinary temp. The excess of bromine can be driven off by heating the product to 100° . J. E. Willm prepared thallium dibromide by the process indicated above; by mixing an aq. soln. of thallic bromide with an eq. amount of thalious bromide; or by partially reducing a soln. of thallic bromide. Yellow needles of the dibromide separate out as the soln. cools. R. J. Meyer could not make thallium dibromide by J. E. Willm's process, but he evaporated a soln. of thalious bromide in bromine-water in vacuo until bromine was no longer given off. J. E. Willm's process gives good results for thallium dibromide, but it is best made in the dry way on account of the hydrolytic action of water; it is conveniently made by the prolonged action of bromine on thalious bromide suspended in chloroform or carbon tetrachloride. Thallium dibromide forms yellow rhombic prisms which, according to R. J. Meyer, have a peculiar smell; they do not lose in weight when heated to 100° . The salt is slightly soluble in water, and it is gradually decomposed by that menstruum, forming thallium tribromide and a lower bromide. V. Thomas says thallium dibromide is somewhat soluble in bromine.

According to R. J. Meyer, if freshly precipitated thalious chloride be suspended in water, and heated with an excess of bromine, the salt dissolves; and on evaporation of the soln. in vacuo, bromine is evolved and pale yellow crystals of thallium dibromochloride, TlClBr_2 , are formed. A little thallic oxide, the result of hydrolysis, also separates out. If the evaporation be continued in vacuo over sulphuric acid, yellow rhombic prisms of a compound of the type TlX_2 , or Tl_2X_4 , namely, **trithallium tetrabromodichloride**, $\text{Tl}_3\text{Cl}_2\text{Br}_4$, are formed. R. J. Meyer, and C. Wiegand made the same compound by treating thalious chloride with a quantity of bromine insufficient to transform all the thalious into thallic salt. V. Thomas prepared this compound by frequently shaking 4.8 grms. of thalious chloride with a soln. of 2.8 grms. of bromine in chloroform; in about a week, the crystals are washed with

chloroform. The product with carbon tetrachloride as solvent is not so pure, and still less so with carbon disulphide; in both cases thallium dibromide, $\text{TlBr} \cdot \text{TlBr}_3$, is formed. The sulphur-yellow rhombic prisms of this salt become matte on exposure to air; they are rapidly decomposed by water, particularly when warm, the colour of the salt becomes dark yellow, and a part passes into soln. R. J. Meyer supposes that thallium dibromotetrachloride, $\text{Tl}_4\text{Cl}_4\text{Br}_2$, is formed; and V. Thomas represents the reactions by the equations: $4\text{Tl}_3\text{Cl}_2\text{Br}_4 = \text{Tl}_4\text{Cl}_3\text{Br}_3 + 3\text{TlBr} + 5\text{TlClBr}_2$; and $2\text{Tl}_3\text{Cl}_2\text{Br}_4 = \text{Tl}_4\text{Cl}_3\text{Br}_3 + [\text{Tl}_2\text{ClBr}_5]$ in soln. According to V. Thomas, hydrochloric acid acts like water, forming a salt of the type Tl_2X_3 , or Tl_4X_6 ; hydrobromic acid displaces part of the chlorine; sulphuric and nitric acids decompose the compound, particularly if heated, liberating large proportions of the halogen; and bromine dissolves the salt in the presence of a little water, forming a thallic salt. When heated to about 150° , this salt deepens in colour, it melts to a yellow liquid at about 165° , and begins to decompose at a higher temperature giving off bromine, and leaving behind an orange-coloured crystalline mass of a compound of the type Tl_4X_6 , or Tl_2X_3 . By passing bromine vapour over thallic chloride, or by heating bromine with thallic chloride in a sealed tube at 100° – 120° , V. Thomas prepared a product of the Tl_2X_4 type, namely, **trithallium tribromotrichloride**, $\text{Tl}_3\text{Cl}_3\text{Br}_3$. The salt is not very stable, and is decomposed by water to form a compound of the type Tl_2X_3 . R. J. Meyer claims to have obtained an intermediate product, **trithallium tetrachloro-dibromide**, $\text{Tl}_3\text{Cl}_4\text{Br}_2$, by the chlorination of thallic bromide in the presence of a little water, and the same product was obtained by the action of water on bromochlorides of the type Tl_2X_4 . When this substance is boiled with water, it passes into $\text{Tl}_4\text{Cl}_3\text{Br}_3$. J. Kendall and co-workers made **thallic tetrabromoaluminate**, $\text{TlBr} \cdot \text{AlBr}_3$, melting at 210° ; and **thallic heptabromoaluminate**, $3\text{TlBr} \cdot 2\text{AlBr}_2$, melting at 112° .

REFERENCES.

- ¹ A. Lamy, *Ann. Chim. Phys.*, (3), 67, 385, 1863; J. E. Willm, *Bull. Soc. Chim.*, (1), 5, 354, 1863; J. Nicklès, *Journ. Pharm. Chim.*, (4), 1, 26, 1865; F. W. Clarke, *Amer. Chem. Journ.*, 5, 240, 1883; M. de K. Thompson, *ib.*, 28, 731, 1906; T. W. Richards and G. Jones, *Journ. Amer. Chem. Soc.*, 31, 158, 1909; T. Carnelley, *Journ. Chem. Soc.*, 29, 489, 1876; T. Carnelley and W. C. Williams, *ib.*, 33, 281, 1878; E. Carstanjen, *Journ. prakt. Chem.*, (1), 102, 65, 129, 1867; J. Thomsen, *ib.*, (2), 12, 98, 1875; (2), 19, 13, 1878; J. Gewecke, *Liebig's Ann.*, 366, 234, 1909; F. Kohlrusch, *Zeit. phys. Chem.*, 44, 197, 1903; 50, 355, 1905; 64, 129, 1908; W. Böttger, *ib.*, 46, 602, 1903; W. Biltz, *ib.*, 58, 288, 1907; A. A. Noyes, *ib.*, 6, 248, 1890; A. Naumann, *Ber.*, 37, 4328, 1904; A. Naumann and J. Schröder, *ib.*, 37, 4610, 1904; C. F. Rammelsberg, *Ber.*, 3, 360, 1870; R. J. Meyer, *Zeit. anorg. Chem.*, 24, 353, 1900; K. Mönkemeyer, *Neues Jahrb. Min.*, 22, 1, 1906; J. H. Pratt, *Amer. Journ. Science*, (3), 49, 397, 1895; *Zeit. anorg. Chem.*, 9, 19, 1895; F. A. Henglein, *ib.*, 120, 77, 1921; G. D. Roos, *Über die Schmelzwärme und die Bildungswärme von Metallverbindungen und über das Zustandsdiagramm der Hg-Tl-Legierungen*, Leipzig, 1916; J. Barlot and J. Pernot, *Compt. Rend.*, 173, 232, 1921; W. W. Coblentz and J. F. Eckford, *Scient. Papers Bur. Standards*, 18, 489, 1922; W. Biltz, *Zeit. Elektrochem.*, 29, 348, 1923; C. Tubandt and E. Lorenz, *Zeit. phys. Chem.*, 87, 527, 1914; G. von Hefvesy, *ib.*, 101, 337, 1922; H. Stolzenberg and M. E. Huth, *ib.*, 71, 641, 1910; H. von Wartenberg and O. Bosse, *Zeit. Elektrochem.*, 28, 384, 1922; W. Biltz, *Zeit. anorg. Chem.*, 119, 97, 1921; *ib.*, 130, 93, 1923; R. Lorenz and W. Eitel, *ib.*, 91, 46, 57, 1915; J. C. Ghosh, *Journ. Chem. Soc.*, 117, 823, 1920; V. Thomas, *Ann. Chim. Phys.*, (8), 11, 204, 1907; *Compt. Rend.*, 142, 840, 1906; R. C. Wallace, *Zeit. Kryst.*, 49, 417, 1911; G. L. Clark, *Amer. Journ. Science*, (5), 7, 1, 1924; A. Benrath, *Zeit. wiss. Photochem.*, 14, 217, 1915; J. O. Perrine, *Phys. Rev.*, (2), 23, 48, 1923.
- ² J. E. Willm, *Bull. Soc. Chim.*, (2), 2, 89, 1864; *Ann. Chim. Phys.*, (4), 5, 5, 1865; V. Thomas, *ib.*, (8), 11, 232, 1907; *Compt. Rend.*, 130, 1316, 1900; 131, 892, 1208, 1900; 132, 80, 1847, 1901; 133, 735, 1901; 134, 545, 655, 1902; *Bull. Soc. Chim.*, (3), 27, 471, 1902; R. J. Meyer, *Zeit. anorg. Chem.*, 24, 354, 1900; A. S. Cushman, *Amer. Chem. Journ.*, 34, 222, 1900; 26, 505, 1901; C. Wiegand, *Ueber Halogenverbindungen des Thalliums*, Berlin, 1899; J. Kendall, E. D. Crittenden, and H. K. Miller, *Journ. Amer. Chem. Soc.*, 35, 963, 1923; A. Werner, *Neuere Anschauungen auf dem Gebiete anorganischen Chemie*, Braunschweig, 1905; London, 83, 1911; C. W. Blomstrand, *Die Chemie der Jetztzeit*, Heidelberg, 333, 1869; S. M. Jørgensen, *Das Thallium*, Heidelberg, 1871; *Journ. prakt. Chem.*, (2), 6, 82, 1873.

§ 10. Thallium Iodides

Thallium was shown by W. Crookes¹ to unite with iodine; it forms thalious and thallic iodides, TlI and TlI_3 , and the intermediate iodides, Tl_2I_3 and Tl_3I_4 . **Thalious iodide**, TlI , can be prepared by processes analogous to those employed for the chlorides and bromides. W. Crookes made it as a citron-yellow precipitate by adding potassium iodide to thalious salt soln. It exists in many differently coloured forms—green, yellow, and red. For example, M. Hebberling obtained the red variety by adding potassium iodide to a warm conc. soln. of a thalious salt, and G. Werther found it separated as a dark orange-yellow precipitate, from hot and conc. soln.; while the colour is pale citron-yellow from cold and from dil. soln.; and hot soln. of potassium acetate furnish minute orange-yellow cubes or octahedra. J. E. Willm found hot soln. of potash-lye gave red crystal plates which after a time become yellow. Yellow thalious iodide crystallizes in the rhombic system, the red variety in the cubic system. F. A. Henglein found the mol. vols. of thallium, silver, and cuprous chlorides give a straight line when plotted against numbers corresponding with anions or cations. According to M. Hebberling, the transition temp. from the yellow to the red variety is 190° , but this is probably too high. D. Gernez places it near 168° ; B. Gossner at 150° ; and K. Mönkemeyer at 174.5° . The conversion from one form to the other is often very slow. A hot filtered aq. soln. of thalious iodide deposits red crystals when rapidly cooled, but yellow crystals if slowly cooled in presence of the yellow form. According to C. van Eyk, the transition temp. is lowered by the addition of thalious nitrate. According to T. Knösel, when freshly precipitated yellow thalious iodide is exposed to the sun's rays, it becomes green and crystalline without changing its composition; the green form is somewhat more soluble in hot water than the yellow form, and it crystallizes from hot water in minute green crystals which have a high refractory power. The green form gradually changes to the yellow form, and the change is accelerated by heating it with aq. iodine or potassium iodide, but not by heating it with water. The green variety becomes red when strongly heated. According to R. E. Liesegang, of all the thallium compounds thalious iodide is the most sensitive to light; and if prepared by double decomposition on gelatine paper, it becomes dark brown by half an hour's exposure to diffuse daylight.

According to F. W. Clarke, the sp. gr. of yellow precipitated thalious iodide is 7.072 at 15.5° , and of red fused thalious iodide, 7.0975 at 14.7° ; A. Lamy gave for the latter, 7.056. W. Biltz calculated the lattice energy of thalious iodide to be 180 Cals. The compressibility coeff., according to T. W. Richards and G. Jones, is 6.8×10^{-6} per atm. S. Motylewsky found the weight of a drop of thalious iodide at its m.p. is 137 when that of water at 0° is 100; the capillary constant is $\sigma = 0.076w$; and the sp. cohesion $a^2 = 2\sigma/D$, where D is the sp. gr. at the m.p. According to M. Hebberling, when thalious iodide is heated it melts to a black liquid which freezes on cooling to a crystalline mass which is first red and then yellow. T. Carnelley first gave 446° for the m.p., and later 439° ; K. Mönkemeyer, 431° ; H. Stolzenberg and M. E. Huth, and C. van Eyk, 422° ; and H. von Wartenberg and O. Bosse gave 440° . H. Stolzenberg and M. E. Huth say that when the molten salt is cooled, the liquid becomes anisotropic; C. Tubandt and E. Lorenz say that the phenomenon is due to the use of an impure salt. W. Crookes, and G. Werther noted that when strongly heated, thalious iodide sublimes with partial decomposition; A. Lamy and A. des Cloizeaux say that the salt is volatile at a red heat; and T. Carnelley and W. C. Williams, that it boils between 800° and 806° . H. von Wartenberg and O. Bosse found the vap. press., p , to be 159.2 mm. at 693° ; 385.8 mm. at 763° ; 591.4 mm. at 801° ; 748.6 mm. at 822° ; and, at the absolute temp., $T \log p = -25168/4.571T + 5.021$. The b.p. is 824° . K. Mönkemeyer obtained unbroken series of mixed crystals of thallium iodide with thallium bromide. The rounded curve of the f.p. of mixed crystals of these two components has a minimum at 411°

with 42 molar per cent. of thallous bromide. With thallium chloride and iodide there is a V-shaped f.p. curve with the eutectic at 316° and 52 molar per cent. of thalious iodide. Thalious chloride can take up only a little thalious iodide, but thalious iodide can take up 18 per cent. of the chloride in the form of mixed crystals. J. Thomsen gives for the heat of formation $Tl + I = TlI + 30.2$ Cals.; M. de K. Thompson, 29.7 Cals. J. Thomsen gives for the heat of soln. $TlI + Aq. = -17.85$ Cals. G. Jones and W. C. Schumb gave 122.11 kj. for the heat of formation, *U*, at 25°, and 125.79 kj. for the free energy of formation at 25°, and 125.48 kj. at 0°. A. Benrath found that the iodide is not affected by exposure to light. W. W. Coblentz and J. F. Eckford measured the photoelectric sensitivity of thalious iodide. The specific conductivity of the sat. aq. soln. at 18° is 22.3×10^{-6} reciprocal ohms per cm. cube. J. C. Ghosh found the sp. conductivity at 523° K. to be 0.0001; at 623° K., 0.0010; at 673° K., 0.0027; and at 702°, 0.0048. G. von Hevesy found the ratio of the conductivities above and below the m.p. is 100; and the gain of energy in rendering the ions of the crystal neutral, 81 cal.—*vide* the chloride. G. Jones and W. C. Schumb measured the electrical conductivity of aq. soln. of thalious iodide. The reactions resemble those of the chloride.

The solubility of thalious iodide in water has been measured for about two temp. by W. Crookes, G. Werther, M. Heberling, A. Lamy, G. Jones and W. C. Schumb, F. Kohlrausch, and W. Böttger. The best representative values for the solubility, *S*, at θ° in grams per 100 c.c. are :

Solubility	0°	20°	40°	60°	80°	100°
.	0.002	0.006	0.015	0.035	0.070	0.120 gm.

W. Crookes says that thalious iodide is more soluble in the presence of an excess of *potassium iodide* than in water. A. Lamy, and M. Heberling say it is less soluble. A. A. Noyes found that the solubility is depressed in the presence of thalious nitrate such that a soln. with 0, 4.336, 7.820, and 25.400 grms. of thalious nitrate per litre dissolve respectively 2.469, 1.164, 0.820, and 0.420 grms. per litre of thalious bromide at 25°. According to J. H. Long, 100 c.c. of 2.5 per cent. aq. ammonia dissolve 0.0761 gm. of thalious iodide, and of 6.5 per cent. ammonia, 0.0758 gm.—for **thalious triamminiodide**, $TlI.3NH_3$, see the corresponding chloride. W. Biltz found the vap. press. of the triammine at -50° to be 274 (307) mm.; at -60° , 159 (165) mm.; and at -79° , 38 (39) mm., when the values for liquid ammonia are indicated in brackets. The temp. of decomposition at 100 mm. press. is -70° , and the heat of formation 7.1 Cals. per mol of ammonia. G. L. Clark made some observations on this subject.

E. Carstanjen says that thalious iodide is less soluble in *acetic acid* than in water, and he, M. Heberling, G. Werther, and J. H. Long have found the solubility to be diminished in alcoholic soln. According to J. H. Long, 100 c.c. of 90 per cent. alcohol dissolve 0.00038 gm. of thalious iodide, and of 50 per cent. alcohol, 0.0027 gm. A. Neumann reports thalious iodide to be insoluble in *acetone*; A. Neumann and J. Schröder, insoluble in *pyridine*. M. Heberling says that dil. sulphuric acid, hydrochloric acid, and alkali hydroxides do not decompose thalious iodide; and that boiling dil. nitric acid, and the conc. cold acid, liberate iodine; J. E. Willm, that chlorine water and aqua regia dissolve the salt without liberating iodine—and suggests that a *thallic chloroiodide* is formed; G. Werther, that thalious iodide is completely decomposed by zinc and alkali hydroxide soln., and also by boiling soln. of ammonia and silver nitrate; thalious iodide is reduced to thallium by fusion with potassium cyanide; and A. Lamy and A. des Cloizeaux, that it is partially reduced when heated with carbon. J. Barlot and J. Pernot prepared brown elongated crystals of **mercuric thalious iodide**, $TlI.HgI_2$.

A thallium iodide intermediate between thallium mono- and tri-iodides was prepared by W. Strecker, in 1865, by adding potassium iodide to an ammoniacal soln. of a thallic salt in tartaric acid. The black precipitate contains no free iodine or nitrogen iodide; the precipitate obtained from dil. soln. occurs in minute crystalline

rhombic plates, and S. M. Jörgensen says that while the analyses agreed with Tl_7I_9 , they can be better represented by Tl_4I_3 or Tl_3I_4 . T. Knösel treated thallos iodide with iodine in aq. soln., and obtained a black precipitate which he supposed to be **thallosic iodide**, or *thallium sesquiodide*, Tl_2I_3 , but S. M. Jörgensen considers the assumption that the product is **trithallium tetraiodide**, Tl_3I_4 , or $TlI_3 \cdot 5TlI$, agrees better with T. Knösel's analysis. S. M. Jörgensen obtained a similar product by warming thallos iodide with a conc. soln. of iodine in hydriodic acid, and evaporating to dryness at about 70° ; he prepared a less pure product by precipitation from a soluble thallic salt, by adding potassium iodothallate; and by digesting thallos iodide with an ethereal or alcoholic soln. of iodine. According to W. Maitland and R. Abegg, at 25° thallos iodide is stable in soln. with less than 0.0019 grm. or 0.76×10^{-5} mol. of iodine, I_2 , per litre of water, and if this conc. be exceeded, thallos iodide passes into trithallium tetraiodide, Tl_3I_4 , i.e. Tl_6I_8 ; this iodide is stable in soln. with between 0.0019 grm. or 0.76×10^{-5} and 0.082 grm. or 3.3×10^{-4} mol. of iodide, I_2 , per litre, and with greater conc. than this, the salt is converted into thallium tri-iodide, TlI_3 . According to S. M. Jörgensen, trithallium tetraiodide is sparingly soluble in water and organic liquids with partial decomposition; when trithallium tri-iodide is boiled with alcohol, it loses iodine and becomes yellow and the iodide is reduced to thallos iodide; when kept over sulphuric acid in a desiccator at 110° , it behaves similarly. When warmed with zinc and dil. ammonia, the thallium separates out in a metallic form.

J. Nicklès first prepared **thallic iodide** or **thallium tri-iodide**, TlI_3 , by evaporating an ethereal soln. of thallos iodide and iodine. He stated that he did not obtain it in a pure condition because his product was always contaminated with a little free iodine. H. L. Wells and S. L. Penfield say that they modified J. Nicklès' method by using alcohol as solvent, and encountered no difficulty in preparing the pure product. The amount of iodine used was slightly in excess of the theoretical amount, and the soln., produced after a long digestion, was evaporated over sulphuric acid until crystallization occurred. The crystals obtained were often large, and quite black; and the bright lustre was slowly lost on exposure. The crystals belong

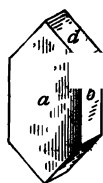

FIGS. 21-23.—Habits of Crystals of Thallium Tri-iodide.

to the rhombic system and are isomorphous with the rhombic alkali trihalides. The crystal habits are illustrated in Figs. 21 to 23. The axial ratios of thallic iodide agree closely with those of rubidium and caesium tri-iodides. The ratios $a : b : c$ are 0.6858 : 1 : 1.234 for rubidium tri-iodide; 0.6824 : 1 : 1.1051 for

caesium tri-iodide; and 0.6828 : 1 : 1.1217 for thallium tri-iodide. The small influence of the effect of substituting thallium for rubidium is remarkable when the great difference in the atomic weights of the elements is considered.

The isomorphism between the higher iodides of thallium and the alkali metals led H. L. Wells and S. L. Penfield to conclude that the arrangements of the atoms in this series of compounds is the same, and thus in spite of the apparent tervalency of thallium in the thallic compounds. They say that this compound is therefore *thallos tri-iodide*, TlI_3 ; this does not mean that all thallic salts are similarly constituted, for thallium tri-iodide may not be a true thallic salt at all, and the thallic salts may possess quite a different kind of structure. H. L. Wells and S. L. Penfield also suggest that thallium may really belong to the alkali metal group in the periodic table occupying one of the vacancies between metals of at. wt. 170 and 220.

W. Maitland and R. Abegg say that the thallium tri-iodide, TlI_3 , may be regarded as a tautomeric substance: $Tl \cdot I_3 \rightleftharpoons Tl \cdots I_3$, since it reacts towards a soln. either as a compound of univalent thallium with the I_3^- ions or as an iodide of tervalent

thallium depending on the substances with which it is brought into contact. From its solubility relations and the fact that a change in the composition of the solid substances in equilibrium with the soln. produces only a relatively small change in the thalious iodide conc., it follows that the solid tri-iodide is to be regarded as essentially a thalious compound. J. Nicklès says that thallium tri-iodide is sparingly soluble in ether, but W. Maitland and R. Abegg say that this is an erroneous observation because iodine appears in the soln. J. Nicklès adds that at a red heat an orange-yellow sublimate—presumably thalious iodide—is formed. H. L. Wells and S. L. Penfeld obtained no evidence of the formation of *thalious penta-iodide*, analogous with the cæsium pentahalides, by mixing increasing proportions of iodine with thallium tri-iodide in alcoholic soln.

Thallium tri-iodide forms a number of double salts with the metal iodides. J. Nicklès prepared red plates of **ammonium tetraiodothallate**, $\text{NH}_4\text{I}\cdot\text{TlI}_3$, similar to the corresponding bromothallate. When treated with water, iodine separates from this salt; at 100° , it blackens, and loses about 34 per cent. of iodine, leaving a yellow powder of presumably thalious iodide mixed with some black substance. J. E. Willm boiled thalious iodide with an alcoholic soln. of potassium iodide and iodine in the calculated proportions until all was dissolved. The conc. soln. furnishes large black cubic crystals of **potassium tetraiodothallate**, $\text{KI}\cdot\text{TlI}_3$, or KTlI_4 , which in transmitted light appear garnet-red. According to G. S. Johnson, the salt prepared by J. E. Willm's process is $\text{KI}\cdot\text{TlI}_3\cdot 2\text{H}_2\text{O}$. The crystals are stable in dry air nor is any weight lost in vacuo. This salt can be recrystallized from alcohol; it is decomposed by water with the separation of iodine. Iodine vapours are evolved when this salt is heated to 50° – 60° , leaving a residue of potassium and thalious iodides; the decomposition is complete at 100° . C. F. Rammelsberg reported the formation of black octahedral crystals of **trihydrated potassium ennéaiodothallate**, $3\text{KI}\cdot 2\text{TlI}_3\cdot 3\text{H}_2\text{O}$, from a soln. of thalious iodide in aq. potassium iodide. The crystals are said to be decomposed by water with the separation of thalious iodide. G. S. Johnson could not confirm C. F. Rammelsberg's work on this salt. J. H. Pratt prepared **dihydrated rubidium tetraiodothallate**, $\text{RbI}\cdot\text{TlI}_3\cdot 2\text{H}_2\text{O}$, or $\text{RbTlI}_4\cdot 2\text{H}_2\text{O}$, from soln. of thallic and rubidium iodides. The ruby-red crystals become matte on exposure to air, and are decomposed by water. J. H. Pratt made similar crystals of **cæsium tetraiodothallate**, $\text{CsI}\cdot\text{TlI}_3$, or CsTlI_4 . S. M. Jörgensen sat. a soln. of thalious iodide in hydriodic acid mixed with a little iodine, with ammonia, and added the product to a warm dil. soln. of cupric tetramino-sulphate; the reddish-brown needles which formed were washed rapidly with cold water, pressed between filter-paper, and dried in a desiccator over calcium chloride. The analysis of the product agrees with **cupric tetramino-octoiiodothallate**, $\text{CuI}_2\cdot 2\text{TlI}_3\cdot 4\text{NH}_3$. On heating to 120° , iodine and ammonia are lost, and cuprous and thalious iodides remain. This compound is decomposed by a prolonged washing; and it is decomposed by aq. ammonia in which it is partially soluble. It dissolves in alcohol. When digested with zinc and water, the metals thallium and copper separate out.

REFERENCES.

- ¹ W. Crookes, *Chem. News*, 6, 1, 1862; 9, 37, 1864; J. E. Willm, *Bull. Soc. Chim.*, (2), 2, 89, 1864; M. Heberling, *Liebig's Ann.*, 134, 11, 1865; W. Strecker, *ib.*, 135, 216, 1865; J. Nicklès, *Journ. Pharm. Chim.*, (4), 1, 25, 1864; G. Werther, *Journ. prakt. Chem.*, (1), 91, 385, 1864; J. Thomsen, *ib.*, (2), 12, 98, 1875; (2), 19, 13, 1878; E. Carstanjen, *ib.*, (1), 102, 65, 1867; S. M. Jörgensen, *ib.*, (2), 6, 82, 1872; D. Gernez, *Compt. Rend.*, 139, 1695, 1904; 139, 278, 1904; 148, 1015, 1909; *Ann. Chim. Phys.*, (8), 17, 290, 1909; A. Lamy, *ib.*, (3), 67, 385, 1863; A. Lamy and A. des Cloizeaux, *ib.*, (4), 17, 512, 1869; R. E. Liesegang, *Phot. Archiv.*, 34, 225, 1893; W. Biltz, *Zeit. Elektrochem.*, 29, 348, 1923; J. C. Ghosh, *Journ. Chem. Soc.*, 117, 823, 1920; H. von Wartenberg and O. Bosse, *Zeit. Elektrochem.*, 28, 384, 1922; W. W. Coblentz and J. F. Eckford, *Scient. Papers Bur. Standards*, 18, 489, 1922; G. Jones and W. C. Schumb, *Proc. Amer. Acad.*, 56, 199, 1921; T. Knösel, *Ber.*, 7, 576, 1874; A. Naumann, *ib.*, 87, 4328, 1904; A. Naumann and J. Schröder, *ib.*, 37, 4610, 1904; C. F. Rammelsberg, *ib.*, 3, 360, 1870; *Pogg. Ann.*, 146, 592, 1872; C. van Eyk, *Proc. Akad. Amsterdam*, 3, 98, 1900; B. Gossner, *Zeit. Kryst.*,

38. 130, 1902; K. Mönkemeyer, *Neues Jahrb. Min. B.B.*, 22. 40, 1906; F. W. Clarke, *Amer. Chem. Journ.*, 5. 240, 1883; T. W. Richards and G. Jones, *Journ. Amer. Chem. Soc.*, 31. 158, 1909; T. Carnelley, *Journ. Chem. Soc.*, 29. 489, 1876; 33. 273, 1878; T. Carnelley and W. C. Williams, *ib.*, 33. 281, 1878; G. S. Johnson, *ib.*, 33. 183, 1878; H. Stolzenberg and M. E. Huth, *Zeit. phys. Chem.*, 71. 641, 1910; C. Tubandt and E. Lorenz, *ib.*, 87. 527, 1914; G. von Hevesy, *ib.*, 101. 337, 1922; F. Kohlrausch, *ib.*, 50. 355, 1904; 44. 197, 1903; W. Böttger, *ib.*, 42. 602, 1903; S. Motylewsky, *Zeit. anorg. Chem.*, 38. 410, 1904; J. W. Retgers, *ib.*, 3. 346, 1893; F. A. Henglein, *ib.*, 120. 77, 1921; W. Biltz, *ib.*, 119. 97, 1921; 130. 93, 1923; W. Maitland and R. Aegg, *ib.*, 49. 341, 1906; M. de K. Thompson, *Journ. Amer. Chem. Soc.*, 28. 731, 1906; J. H. Long, *Journ. analyt. Chem.*, 2. 243, 1888; H. L. Wells and S. L. Penfield, *Amer. Journ. Science*, (3), 47. 463, 1894; J. H. Pratt, *ib.*, (3), 49. 397, 1895; J. Barlot and J. Pernot, *Compt. Rend.*, 173. 232, 1921; A. A. Noyes, *Zeit. phys. Chem.*, 6. 248, 1890; J. Schröder, *Chemisches und physikalisch-chemisches Verhalten des Pyridins und von Metallsalzen zu und en Pyridin*, Giessen, 1904; G. L. Clark, *Amer. Journ. Science*, (5), 7. 1, 1924; A. Benrath, *Zeit. wiss. Photochem.*, 14. 217, 1915.

§ 11. Thallium Sulphides

Thallium unites directly with sulphur when the two elements are fused together. According to H. Pelabon,¹ when fused mixtures containing more than 2 gram-

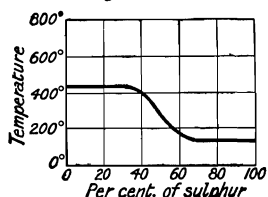

FIG. 24. — Melting-point Curve of Binary Mixtures of Sulphur and Thallium.

atoms of thallium for one gram-atom of sulphur form two layers, the upper layer consists of thallium sulphide, Tl_2S , containing 7.26 per cent. of sulphur, and solidifying at 448° , whilst the lower is pure thallium, solidifying at 302° . The portion of the m.p. curve corresponding with such mixtures is horizontal, Fig. 24.

The curve for mixtures containing 7.26 per cent. to 28.2 per cent. of sulphur corresponds with the separation of Tl_8S_7 , m.p. 295° . The m.p. curve becomes again horizontal for mixtures containing a greater proportion of sulphur; these, on fusion, form two layers, the lower consisting of the pentasulphide, Tl_2S_5 , m.p. 127° , and the upper of sulphur.

According to W. Crookes, and A. Lamy, thallos sulphide, Tl_2S , is precipitated when hydrogen sulphide or ammonium sulphide is added to an alkaline or acetic acid soln. of a thallos salt; but A. Lamy obtained a crystalline mass by melting the amorphous precipitate. M. Hebberling obtained crystalline thallos sulphide by passing hydrogen sulphide on a cold, not too dil., soln. of thallos sulphate acidified with only a trace of sulphuric acid. V. Stanek also obtained crystals by heating a mixture of amorphous sulphide with colourless ammonium sulphide, $(NH_4)_2S$, in a sealed tube at 150° – 200° ; if ammonium polysulphide is used no crystals are obtained. In a cold moderately conc. soln. of thallos sulphate acidified by a trace of sulphuric acid, E. Carstanjen obtained the crystalline sulphide by boiling an alkaline soln. of a thallos salt with sodium thiosulphate. O. Brunck obtained an incomplete precipitation of the amorphous sulphide by adding sodium hyposulphite to a thallium salt soln. The precipitate appears first reddish-brown, then violet, and finally black. No precipitation occurs in the presence of many acids. E. Carstanjen obtained a crystalline mass by melting together eq. proportions of the two elements—*vide supra*. W. Crookes obtained the crystalline sulphide by melting thallos sulphate with potassium cyanide; K. Brückner, by melting it with sulphur; and W. R. Hodgkinson and C. C. French, by the action of dry ammonia at a red heat. C. Winssinger prepared a chocolate-brown **colloidal solution of thallos sulphide** by treating a very dil. soln. of thallos sulphate with hydrogen sulphide, and dialyzing the product.

W. Crookes, and A. Lamy found the dark brown or black precipitate flocculates when boiled with the mother-liquid. E. Carstanjen said the crystals are six-sided plates or needles; and M. Hebberling said that the plates are tetrahedral with twinned forms. E. Carstanjen showed that the thallos sulphides prepared by fusing the two elements and by precipitation with ammonium sulphide are the same. A. Lamy said that the sp. gr. is about 8. According to W. Crookes, and A. Lamy,

when heated out of contact with air, thallos sulphide melts and volatilizes; and the cold mass has a crystalline fracture. The m.p. is 448° . H. von Wartenberg and O. Bosse studied the volatilization of thallium sulphide. H. Pelabon found the partial press., p , of the hydrogen sulphide at 625° , starting with hydrogen in contact with a mixture of sulphur and thallium, are 1.90 and 99.14 cms., when the amounts of sulphur in at. per cent. are, respectively, 33.33 and 60.00. The intermediate values give a straight line. J. Thomsen gave for the heat of formation ($2\text{Tl}_2\text{S}$) $=27.7$ Cals. H. Pelabon measured the electrical conductivity of thallos sulphide and found it to be influenced by the temp. and by the mode of preparation. O. Weigel measured the solubility of the sulphide.

A. Lamy said that thallos sulphide oxidizes readily to the sulphate when exposed to air; and, added M. Heberling, the amorphous sulphide oxidizes more readily than the crystalline form. The last-named also said that when heated on the water-bath, thallos sulphide slowly burns. According to W. Böttger, thallos sulphide is very sparingly soluble in water—a litre of water at 19.9° dissolves 0.0215 mol. A. Classen and O. Bauer found thallos sulphide to be readily oxidized and completely dissolved by an ammoniacal soln. of hydrogen peroxide. E. Carstanjen stated that thallos sulphide is reduced when heated in a current of hydrogen. W. Crookes, and A. Lamy found thallos sulphide to be virtually insoluble in aq. soln. of ammonia, potassium cyanide, ammonium sulphide, and alkali hydroxides and carbonates. W. Crookes, and M. Heberling found it to be sparingly soluble in an aq. soln. of oxalic acid, and in acetic acid; W. Crookes found it to be sparingly soluble in hydrochloric acid, and readily soluble in nitric acid; while J. E. Willm found it dissolves readily in sulphuric acid. E. Schürmann found that thallos sulphide is dissolved by soln. of salts of cobalt, nickel, and iron, but not by salts of manganese—manganese sulphide is converted into nitrate by a soln. of thallos nitrate.

Thallos sulphide was shown by J. W. Gunning, and L. F. Hawley to form complexes with the sulphides of arsenic, antimony, and tin, and they are precipitated from soln. of the mixed salts. L. Bruner and J. Zawadsky showed that the value of the constant $K = [\text{Tl}^+][\text{H}_2\text{S}]/[\text{H}^+]^2$ alters when the sulphides of other metals are precipitated along with thallium; they found that copper and thallos sulphides form **thallos pentasulphocuprate**, $\text{Tl}_2\text{S}_4\text{CuS}$, or $\text{Tl}_2\text{Cu}_2\text{S}_5$, over the interval 20–36 molar per cent. of thallium sulphide. The salt forms a series of solid soln. which are best explained as being soln. of **thallos trisulphocuprate**, $\text{Tl}_2\text{S}_2\text{CuS}$ in $\text{Tl}_2\text{S}_4\text{CuS}$, and of Tl_2S in $\text{Tl}_2\text{S}_2\text{CuS}$. At conc. of more than 36 molar per cent. normal values of the equilibrium constant are obtained; there are then two solid phases, consisting of thallium sulphide and probably a soln. of thallium sulphide in the compound $\text{Tl}_2\text{S}_2\text{CuS}$. H. Huber measured the equilibrium conditions in the system $\text{Ag}_2\text{S}-\text{Tl}_2\text{S}$ by the thermal method. The results are summarized in Fig. 25. There is a eutectic point at 306° with 55 per cent. of thallos sulphide; and with less than 31 per cent. of thallos sulphide there is an arrest in the cooling curve due to the formation of crystalline **thallos silver sulphide**, $4\text{Ag}_2\text{S}.\text{Tl}_2\text{S}$. The break at 175° is due to the transformation of silver sulphide.

A. Strecker showed that **thallic sulphide**, Tl_2S_3 , cannot be obtained by the action of hydrogen sulphide on an aq. soln. of a thallic salt, for the thallic sulphide, if formed, is instantly reduced to thallos sulphide and free sulphur; but if ammoniacal soln. of thallic oxide in the presence of phosphoric or tartaric acid be treated with hydrogen sulphide, the precipitate is probably thallic sulphide. E. Carstanjen made thallic sulphide by melting thallium with an excess of sulphur and distilling

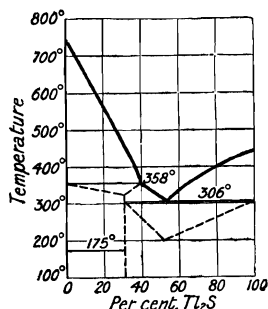

Fig. 25.—Equilibrium Diagram of the Binary System, $\text{Ag}_2\text{S}-\text{Tl}_2\text{S}$.

off the free sulphur. The amorphous black mass becomes soft and plastic at temp. exceeding 12° . Thallic sulphide gives off hydrogen sulphide and dissolves when treated with dil. mineral acids; no sulphur separates in E. Carstanjen's process, but, with A. Strecker's process, sulphur does separate. According to E. Carstanjen, no sulphide is dissolved by carbon disulphide, and it is reduced to the metal when heated in hydrogen. According to J. W. Gunning, the sulphide reported by R. Böttger to be produced by boiling flue-dust with sodium thiosulphate soln. is really thallium sulphoarsenide. R. Schneider prepared **potassium tetra-sulphothallate**, $K_2S.Tl_2S_3$, or $KTlS_2$, by fusing together one part of thalious sulphate or chloride, 6 parts each of potassium carbonate and sulphur, and extracting the cold mass with water. The dark red crystalline powder has a sp. gr. 4.263-4.60. When heated in hydrogen, sulphur is given off and a mixture of thalious and potassium sulphides remains; G. Krüss and H. Solleder found thallium and potassium sulphides are formed. According to R. Schneider, the double sulphide is stable in air at ordinary temp. It melts without decomposition when heated out of contact with air, but if heated while exposed to air, the sulphur is oxidized. With hot nitric acid, sulphur separates. If the powder is treated with silver nitrate, some thallium and potassium are replaced by silver.

R. Schneider prepared **thallium pentasulphide**, Tl_2S_5 , by heating thalious sulphate with sodium thiosulphate, or sodium carbonate and sulphur. It is a brick-red powder which rapidly turns brown on exposure to air. The pentasulphide prepared by H. Pelabon—*vide supra*—melts at 127° . K. A. Hofmann and F. Höchtlen saturated a conc. aq. soln. of ammonium polysulphide with thalious chloride, and obtained glistening black opaque prisms of the pentasulphide by allowing the soln. to stand for a few days. L. F. Hawley doubts if the pentasulphide is a chemical individual.

E. Carstanjen reported a number of intermediate sulphides—thallosic sulphides. He obtained $Tl_2S : Tl_2S_3 = 5 : 3$ by the action of ammonium sulphide on thallosic chloride, Tl_2Cl_4 ; and 1 : 1 by fusing thallium with rather less than an eq. proportion of sulphur. R. Schneider also obtained 1 : 2 by melting one part of thalious sulphate with six parts each of sodium carbonate and sulphur, and extracting the mass with water. According to L. F. Hawley, the highest sulphide corresponds with Tl_2S_5 , and a complete series of solid soln. exists between Tl_2S and Tl_2S_5 . By treating thalious sulphide with sodium sulphide soln. in which varying amounts of sulphur have been dissolved and afterwards saturating with hydrogen sulphide, products are obtained containing from 90.49 per cent. of thallium (corresponding with Tl_2S) to about 70 per cent. of thallium. By adding acid soln. of a thallium salt to a slight excess of sodium polysulphide, precipitates can be obtained containing from 25 per cent. to nearly 100 per cent. of sulphur. It is found that between pure thalious sulphide and the product containing about 81 per cent. of thallium, the solid is homogeneous; from 81 per cent. to 76 per cent. of thallium, phases are distinguishable, whilst from 76 per cent. of thallium to pure sulphur the solid is again homogeneous.

REFERENCES.

- ¹ W. Crookes, *Chem. News*, **3**, 193, 1861; **7**, 290, 1863; **8**, 159, 219, 231, 243, 255, 279, 1863; **9**, 1, 37, 54, 1864; *Journ. Chem. Soc.*, **17**, 112, 1864; *Proc. Roy. Soc.*, **12**, 150, 1862; *Phil. Trans.*, **163**, 277, 1874; *Researches on the Atomic Weight of Thallium*, London, 1874; A. Lamy, *Compt. Rend.*, **54**, 1255, 1862; **57**, 442, 1863; *Ann. Chim. Phys.*, (3), **67**, 385, 1862; (4), **5**, 410, 421, 1865; *Bull. Soc. Chim.*, (2), **11**, 210, 1869; *De l'existence d'un nouveau métal, le thallium*, Lille, 1862; *Leçon sur le thallium*, Paris, 1863; H. Pelabon, *Compt. Rend.*, **145**, 118, 1907; **173**, 142, 1921; *Ann. Chim. Phys.*, (3), **17**, 526, 1907; A. Mourlot, *ib.*, (7), **17**, 564, 1899; J. E. Willm, *ib.*, (4), **5**, 5, 1865; O. Brunek, *Liebig's Ann.*, **336**, 282, 1904; M. Heberling, *ib.*, **134**, 11, 1865; A. Strecker, *ib.*, **185**, 207, 1865; E. Schürmann, *ib.*, **249**, 337, 1888; R. Böttger, *ib.*, **128**, 250, 1863; E. Carstanjen, *Journ. prakt. Chem.*, (1), **101**, 55, 1867; (1), **102**, 65, 129, 1867; R. Schneider, *ib.*, (2), **1**, 164, 1870; (2), **9**, 209, 1874; (2), **10**, 55, 1874; (2), **42**, 305, 1890; *Fogg. Ann.*, **139**, 661, 1870; **153**, 588, 1875; J. Thomsen, *ib.*, (2), **19**, 1, 1879; *Thermochemische Untersuchungen*, Leipzig, **3**, 354, 1883; V. Stanek, *Zeit. anorg. Chem.*, **17**, 117, 1898; C. Winssinger, *Bull. Acad. Belg.*, (3), **15**, 390, 1888; *Bull. Soc. Chim.*, (2), **49**, 452, 1888; L. F. Hawley, *Journ. Phys. Chem.*, **10**, 654, 1906; *Journ. Amer. Chem. Soc.*, **29**, 300, 1011, 1907; W. Böttger, *Zeit. phys. Chem.*, **46**, 603, 1903; J. W. Gunning, *Arch. Néerl.*, **3**, 86, 1868; *Chem. News*, **17**, 138, 1868; W. R. Hodgkinson and C. C. French, *ib.*, **66**, 223, 1892; L. Bruner and J. Zawadzky, *Bull. Acad. Cracow*,

312, 1909; K. A. Hofmann and F. Höchtler, *Ber.*, **35**, 3000, 1903; G. Krüss and H. Solereder, *ib.*, **19**, 2736, 1886; A. Classen and O. Bauer, *ib.*, **16**, 1063, 1883; F. Faktor, *Pharm. Post*, **38**, 529, 1905; K. Brückner, *Monatsh.*, **27**, 53, 1906; H. Huber, *Zeit. anorg. Chem.*, **116**, 139, 1921; H. von Wartenberg and O. Bosse, *Zeit. Elektrochem.*, **28**, 384, 1922; O. Weigel, *Sitzber. Ges. Naturwiss. Marburg*, **2**, 1921.

§ 12. Thallium Sulphates

The early workers on thallium—W. Crookes,¹ and A. Lamy—prepared both thallose and thallic sulphates. When thallium, thallose hydroxide, or carbonate dissolves in sulphuric acid, a soln. of thallose sulphate, Tl_2SO_4 , is formed. W. O. Rabe covered the metal with water and added enough conc. acid to dissolve the metal. The dissolution is best conducted on a water-bath when hydrogen is rapidly evolved; the attack with dil. sulphuric acid, sp. gr. 1.17, is comparatively slow. The filtered soln. gives colourless needle-like crystals on cooling. The salt is also obtained by evaporating thallose chloride or nitrate soln. with an excess of sulphuric acid. The excess sulphuric acid must be driven off at a red heat or the hydrosulphate may be obtained. J. Kräuse converted thallose chloride to sulphate by fusion with sodium hydrosulphate.

The colourless prismatic crystals were measured by L. Pasteur, V. von Lang, G. Werther, and A. Lamy and A. des Cloizeaux and found to be isomorphous with potassium and ammonium sulphates. W. Stortenbeker prepared mixed crystals of the type $(K, Tl)_2SO_4$; and he obtained good crystals of thallose sulphate by crystallization from a soln. slightly acidified with sulphuric acid. According to A. E. H. Tutton, the bipyramidal rhombic crystals have the axial ratios $a : b : c = 0.5555 : 1 : 0.7328$; and the sp. gr. is 6.765 at $20^\circ/4^\circ$. A. Lamy gave 6.603 for the crystals, and he found that the salt melts at a red heat and freezes to a transparent glass of sp. gr. 6.77. T. Carnelley gave 632° for the m.p. of the salt. R. von Sahmen and G. Tammann found that the coeff. of expansion between 400° and 450° is three to six times smaller than that below or above this interval. W. Crookes found that thallose sulphate could be heated for a long time in a covered crucible without loss of weight; and E. Carstanjen added that over the gas blowpipe, or in air, sulphur dioxide is evolved and thallic oxide formed. J. B. J. D. Boussingault found 0.321 grm. of thallose sulphate volatilizes completely when heated in an open platinum crucible over the gas blowpipe flame. The observations of C. F. Rammelsberg, G. Werther, R. J. Meyer, W. Stortenbeker, and P. E. Browning show that thallose sulphate is stable enough to be ignited and weighed in this form for gravimetric analysis; but if too strongly heated, it rapidly loses weight. A. E. H. Tutton found the three refractive indices to be:

	Li-	C	Na-	Tl	F-line
α . . .	1.8493	1.8509	1.8600	1.8704	1.8859
β . . .	1.8563	1.8579	1.8671	1.8776	1.8935
γ . . .	1.8739	1.8755	1.8853	1.8964	1.9126

The double refraction is positive. K. A. Hofmann and co-workers found that thallose sulphate fluoresces when exposed to the cathode rays; but does not act in darkness on a photographic plate. E. Franke measured the eq. electrical conductivity, λ , in reciprocal ohms, at 25° , and found that for a mol of the salt in v litres of water:

v . . .	16	32	64	128	256	512	1024
λ . . .	101.3	113.1	129.9	131.2	138.3	143.1	146.4

A. Heydweiller investigated the sp. gr. and electrical conductivity of soln. of thallose sulphate. A. A. Noyes and K. G. Falk found the percentage ionization of soln. with 1, 5, 20, and 200 millieq. of salt per litre to be respectively 94.8, 88.2, 78.0, and 56.1. C. Drucker found that the depression of the f.p., and the conc. potentials of aq. soln. of thallose sulphate agree with the assumption that during ionization some Tl^{++} -ions

are formed. The law of mass action applies for dil. soln., and also for conc. soln. when due allowance is made for the oxidation—*vide* thalious nitrate. C. Drucker found the first ionization constant of thalious sulphate to be 0.23, and the second ionization constant, 0.014. G. N. Lewis and M. Randall measured the activity coeff. W. Schmidt found the dielectric constant to be 28.

W. Crookes, A. Lamy, and G. Wyruboff made some observations on the solubility of thalious sulphate in water. The Earl of Berkeley found the following percentage solubilities, S grms. Tl_2SO_4 per 100 grms. of soln.:

	0°	10°	20°	30°	50°	70°	90°	99.7°
S	2.63	3.57	4.64	5.80	8.44	11.31	14.19	15.57

Observations were also made by A. E. H. Tutton, A. A. Noyes, F. S. Farrel, and M. A. Stewart. E. Cohen and co-workers represented the effect of press., p atm., on the solubility, S , of thalious sulphate in grms. per 100 grms. of sat. soln., at 30°, by $S=5.831+0.003377p-0.06175p^2$, or by $S=5.831+0.003295p-0.06109p^2$; they observed for the solubility at 30°, 5.831 at 1 atm.; 7.48 at 500 atm.; 9.03 at 1000 atm.; and 10.50 at 1050 atm. W. Stortenbeker found that thalious sulphate dissolves more readily in dil. sulphuric acid than in water. F. Ishikawa studied the vol. change which occurs when thalious sulphate is dissolved in water, and found -0.05407 c.c. per gram by the sp. vol. method, and -0.04906 c.c. per gram by the e.m.f. method; he also found the heat of soln. to be -14.58 to -14.75 cal. per gram. A. A. Noyes and M. A. Stewart found that, at 25°, soln. with 4.878 and 9.747 grms. of sulphuric acid per litre dissolved respectively 59.09 and 62.95 grms. of thalious sulphate per litre. According to W. O. Rabe, 100 grms. of water dissolve 4.74 grms. of thalious sulphate and 10.3 grms. of potassium sulphate at 15°; 11.5 grms. Tl_2SO_4 and 16.4 grms. K_2SO_4 at 62°; and 18.52 grms. Tl_2SO_4 and 26.2 grms. K_2SO_4 at 100°. A. A. Noyes and M. A. Stewart found that, at 25°, soln. with 26.51 grms. of thalious nitrate per litre dissolved 42.17 grms. of thalious sulphate; soln. with 7.062 and 28.25 grms. of sodium sulphate per litre dissolved respectively 56.44 and 59.13 grms. of thalious sulphate per litre; and soln. with 12.12 grms. of sodium hydrosulphate per litre dissolved 58.53 grms. of thalious sulphate per litre. A. Lamy said the aq. soln. has a neutral reaction; while M. C. Lea said the soln. reacts acid to litmus, but he obtained no other evidence of the existence of free sulphuric acid in the soln. The aq. soln. exhibits the characteristic reactions of thalious salts. E. Carstanjen found that hydrogen; W. R. Hodgkinson and C. C. French, that ammonia; and W. Crookes, that fused potassium cyanide, reduced thalious sulphate to the sulphide, etc. A. J. Berry studied the oxidation of thalious sulphate in alkaline soln. by hydrogen dioxide; and P. E. Browning and H. E. Palmer, by potassium ferricyanide. A. Benrath found the sulphate, unlike the halides, is not reduced by oxalic, tartaric, or citric acid. R. Weber obtained **thalious heptasulphatosulphate**, $Tl_2SO_4 \cdot 7SO_3$, by melting below 100° a mixture of the constituents, and purifying by heating in a sealed tube at 100°. L. Meyer observed no sign of thalious sulphate acting as a catalytic agent in promoting the union of a mixture of sulphur dioxide and oxygen passing through an aq. soln. of the salt. H. Erdmann, and P. Köthner found that cold and hot soln. of thalious sulphate give no precipitate when treated with acetylene; not even when the soln. is also mixed with sodium acetate and hydroxide.

Thalious sulphate forms a number of complex salts with the sulphates of the magnesium series. The general formula is $TlSO_4 \cdot MSO_4 \cdot 6H_2O$, where M denotes bivalent iron, nickel, cobalt, copper, manganese, zinc, or magnesium; these salts are isomorphous with the corresponding potassium, ammonium, rubidium, and caesium salts. J. d'Ans could not make *thalious calcium disulphate* analogous to $K_2Ca(SO_4)_2 \cdot H_2O$. J. E. Willm obtained pale greenish-blue, monoclinic crystals of hexahydrated **thalious cupric sulphate**, $Tl_2SO_4 \cdot CuSO_4 \cdot 6H_2O$, which lose nearly 4 mols of water at 100°, and all at 185°. G. Canneri prepared blue crystals of the same salt. J. Locke found the solubility per litre of water at 25° to be 81 grms. of the anhydrous

salt; and a litre of the soln. contains 0.122 mol of the salt. The salt decomposes when recrystallized from aq. soln. J. E. Willm also prepared monoclinic crystals of hexahydrated **thallous magnesium sulphate**, $Tl_2Mg(SO_4)_2 \cdot 6H_2O$, by the spontaneous evaporation of a soln. of the component salts. According to G. Werther, and C. F. Rammelsberg, the axial ratios are $a : b : c = 0.742 : 1 : 0.5$, and $\beta = 106^\circ 24'$. G. Werther said that the salt melts below a red heat; it is more readily soluble in water than the corresponding zinc salt; and it is scarcely affected when recrystallized from water by slow evaporation. F. R. Mallet prepared optically anisotropic crystals of **thallous dimagnesium sulphate**, $2MgSO_4 \cdot Tl_2SO_4$, by fusing together the constituent salts. J. E. Willm, and G. Werther likewise obtained hexahydrated **thallous zinc sulphate**, $Tl_2Zn(SO_4)_2 \cdot 6H_2O$, by a process analogous to that employed for the magnesium salt. The axial ratios of the monoclinic crystals were shown by G. Werther to be $a : b : c = 0.7406 : 1 : 0.4956$, and $\beta = 106^\circ 21'$. A. Lamy and A. des Cloizeaux gave $0.7388 : 1 : 0.5010$, and $\beta = 196^\circ 10'$. The sp. gr. is 3.720 at 20° . The mean refractive index for the *D*-line is 1.6064. The crystals have a negative double refraction. According to J. Locke, a litre of water dissolves 86 grms. or 0.129 mol of the anhydrous salt. G. Werther found that the salt loses its water at 120° ; but does not decompose at 300° ; it melts below a red heat, and decomposes at a bright red heat.

Univalent thallous sulphate may also take the place of the alkali metals in the alums. A mixed soln. of the component salts was found by A. Lamy, L. Pasteur, J. E. Willm, and A. Cossa to give regular octahedra of *thallic alum*, $Tl_2SO_4 \cdot Al_2(SO_4)_3 \cdot 24H_2O$, or **thallous aluminium disulphate**, $TlAl(SO_4)_2 \cdot 12H_2O$. A. Lamy prepared a complex $3K_2SO_4 \cdot 4Al_2(SO_4)_3 \cdot Tl_2SO_4 \cdot 96H_2O$, *i.e.* $3\{KAl(SO_4)_2 \cdot 12H_2O\} \cdot TlAl(SO_4)_2 \cdot 12H_2O$, by crystallization from a soln. of the component salts. J. W. Retgers showed that the product is a soln. of the two alums. C. Soret and L. Duparc gave 2.329 for the sp. gr. of the crystals of thallic alum; J. W. Retgers, 2.318 at 15° ; W. Spring, 2.3256 at 0° ; 2.3250 at 20° ; 2.3212 at 50° ; and 2.3159 at 70° . After compressing the crystals for three weeks at 20,000 atm., the sp. gr. was 2.320 at 22° , and 2.314 at 16° . The coeff. of thermal expansion corresponds with a change from unit vol. at 0° to 1.00267 at 20° , 1.00188 at 50° , and 1.004178 at 70° . J. Locke gave 91° for the m.p. J. H. Gladstone found the refraction eq. to be 278.34. C. Soret found the indices of refraction, μ , between 10° - 23° to be:

	G-	F-	b-	E-	D-	C-	B-	α -line
λ	4310	4860	5170	5260	5890	6560	6860	7180
μ	1.51076	1.50463	1.50209	1.50128	1.49748	1.49443	1.49317	1.49226

Observations were also made by C. Soret and L. Duparc, A. Fock, and M. le Blanc and P. Rohland. F. Klocke discussed the strong abnormal double refraction of thallic alum. L. de Boisbaudran prepared *thallous gallic alum*, $Tl_2SO_4 \cdot Ga_2(SO_4)_3 \cdot 24H_2O$, or **thallous gallium disulphate**, $TlGa(SO_4)_2 \cdot 12H_2O$, from a soln. of the component salts. C. Soret gave for the indices of refraction, between 10° - 20° :

	G-	F-	b-	E-	D-	C-	B-	α -line
λ	4310	4860	5170	5260	5890	6560	6860	7180
μ	1.52007	1.51387	1.51131	1.51057	1.50665	1.50349	1.52228	1.50112

W. Crookes evaporated thallous sulphate with fuming sulphuric acid, or treated thallous chloride with an excess of sulphuric acid, and obtained **thallous hydro-sulphate**, $TlHSO_4$. A. Lamy prepared it by heating hydrated thallic sulphate to 400° . P. E. Browning, and W. Stortenbeker found that if heated to 220° - 240° , the composition is so constant, $TlHSO_4$, that in gravimetric analysis thallium could be weighed in this form; at a higher temp., thallous sulphate is produced. P. S. Oettinger reported a trihydrate, $TlHSO_4 \cdot 3H_2O$, to be formed in short thick prisms by allowing the acid salt to stand in contact with very acid mother-liquor for some months. According to W. Stortenbeker, if a sulphuric acid soln. of thallous sulphate be conc. on the water-bath, a crop of monoclinic plates is obtained and

afterwards a crop of rhombic needles. The composition of both forms is the same. A third modification exists so that the crystals are isotrimorphous with potassium hydrosulphate, and he made mixed crystals of the type $(K, Tl)HSO_4$. The crystals of thalious hydrosulphate melt at 115° – 120° , and the molten mass is at first quiescent, but it suddenly develops vapours of sulphuric acid and passes to the normal sulphate. W. Stortenbeker prepared crystals of $Tl_2SO_4 \cdot 6TlHSO_4$, like the corresponding potash salt; and also hexagonal plates of $Tl_2SO_4 \cdot TlHSO_4$, i.e. **trithallium hydrodisulphate**, $Tl_3H(SO_4)_2$. J. d'Ans and O. Fritsche showed that the solubility curves at 25° of thalious sulphate in mixtures of water and sulphuric acid consist of two straight lines with the solubility increasing continuously with the conc. of the acid. Representing conc. in mols per 1000 grms. of sat. soln.:

H_2SO_4	· 0	4.55	4.79	4.89	4.92	4.78	4.26	4.03
Tl_2SO_4	· 0.103	0.56	0.55	0.59	0.66	0.75	1.01	1.08
Tl_2SO_4					$TlHSO_4$			

There are transition points with $2.999H_2SO_4$ and $0.66Tl_2SO_4$, the solid phases are Tl_2SO_4 and $Tl_3H(SO_4)_2$; and with $4.25H_2SO_4$ and $0.61Tl_2SO_4$, the solid phases are $Tl_3H(SO_4)_2$ and $TlHSO_4$. B. Gossner found the trigonal crystals of trithallium hydrosulphate to have the axial ratio $a : c = 1 : 3.717$, and $\alpha = 42^\circ 55'$; the crystals have a medium negative double refraction. There are probably two modifications of $Tl_3H(SO_4)_2$, since the salt is isodimorphous with the corresponding potassium compound. W. Stortenbeker prepared mixed crystals of the type $(K, Tl)_3H(SO_4)_2$.

W. Crookes, and A. Lamy dissolved thallic hydroxide in warm dil. sulphuric acid and obtained crystals of **heptahydrated thallic sulphate**, $Tl_2(SO_4)_3 \cdot 7H_2O$; A. Strecker recommended removing the mother liquid by press. since, as W. Crookes showed, the salt is decomposed by water, forming the brown hydroxide. J. E. Willm prepared thallic sulphate by boiling an aq. soln. of thalious sulphate with barium or lead dioxide, and conc. the filtered soln. for crystallization. Neither H. Marshall nor R. J. Meyer and E. Goldschmidt succeeded in preparing this salt. A. Strecker, and W. Crookes said that at 220° the salt loses between 6 and 7 mols of water, and forms a small proportion of thalious sulphate; at a higher temp. it forms thalious sulphate, and loses sulphur trioxide, sulphuric acid, and oxygen. R. J. Meyer and E. Goldschmidt said that thallic hydrosulphate at 220° is completely converted into anhydrous **thallic sulphate**, $Tl_2(SO_4)_3$. G. Grube and A. Hermann found the oxidation potential of thalious to thallic sulphate in sulphuric acid soln. to be 1.211 volt; R. Abegg and J. F. Spencer's value 1.156 is too low.

Reports by the early workers on the preparation of thallic sulphate are not in agreement; this probably arises from the instability of the salt in aq. soln. In the first place, the salt is partially reduced to thalious sulphate, and the mixed products explain the series of products described in literature as *thallosothallic sulphates*, or *thallosic sulphates*.

J. E. Willm obtained prismatic crystals of a product $Tl_2SO_4 : Tl_2(SO_4)_3 : H_2O = 2 : 3 : 22$, which, according to R. J. Meyer and E. Goldschmidt, is obtained best by dissolving thallic hydroxide in moderately conc. sulphuric acid, and evaporating the soln. A basic product was found at the same time. J. E. Willm represented the composition of the first-named salt by $Tl_2SO_4 \cdot 2TlHSO_4 \cdot 3Tl_2(SO_4)_3 \cdot 24H_2O$. H. Marshall obtained yellow crystals of 5 : 3 : 0, by the electrolysis of a sat. acid soln. of thalious sulphate, or by allowing thalious sulphate to stand in air for a long time; if allowed to crystallize from a nitric acid soln., H. Marshall obtained 2 : 3 : 0. R. J. Meyer and E. Goldschmidt made crystals of 7 : 1 : 6 by partially reducing thallic sulphate with nitric acid. B. Lepsius reported octahedral crystals belonging to the cubic system of the 1 : 1 : 0 salt to be obtained by crystallization from a soln. containing eq. proportions of the component salts. H. Marshall said the crystals are rhombic. R. J. Meyer and E. Goldschmidt regarded this compound as the thalious salt of thallic sulphuric acid, $H_2Tl_2(SO_4)_4$, or $HTl(SO_4)_3$ —viz. *thalious thallic sulphate*, or *thalious sulphatothallate*. The acid is also the parent of the complex sulphates $M_2(SO_4 \cdot Tl_2(SO_4)_3)$. H. Benrath and H. Espenschied could prepare only the 1 : 1 : 0 and the 5 : 1 : 0 salts. The former is stable above 48° , and the latter between 23.5° and 30° . Between 30° and 48° , there is a state of transition, and mixtures of various compositions are formed.

In the second place, thallic sulphate is so readily hydrolyzed that it can be obtained only from acid soln. Even in moist air, the salt becomes brown owing to the formation of the hydroxide. If the soln. are not strongly acid, they are decomposed by heat, or when diluted with water. Hence, **basic sulphates** have been reported. As a consequence of the neglect to control the temp. and acidity of the soln., what appear to be similar processes furnished A. Strecker with the normal sulphate; J. E. Willm, and H. Marshall, a basic sulphate; and R. J. Meyer and E. Goldschmidt an acid sulphate. J. E. Willm, and H. Marshall reported fine needle-like crystals of dihydrated basic sulphate, $\text{Tl}(\text{OH})\text{SO}_4 \cdot 2\text{H}_2\text{O}$, or *thallic oxyhydrosulphate*, $\text{O} : \text{Tl} \cdot \text{HSO}_4 \cdot 2\text{H}_2\text{O}$, or *thallic hydroxysulphate*, $\text{HO} : \text{Tl} : \text{SO}_4 \cdot 2\text{H}_2\text{O}$, to be formed by dissolving thallic hydroxide in warm, moderately conc. sulphuric acid, and cooling the soln.; after some days large crystals of the thallic sulphate 2 : 3 : 22 appeared, and finally the monohydrate $\text{TlOHSO}_4 \cdot \text{H}_2\text{O}$. According to J. Meyer, the solubility diagrams of thallic oxide, the hydrosulphate, $\text{TlH}(\text{SO}_4)_2 \cdot 4\text{H}_2\text{O}$, and the basic sulphate, $\text{Tl}(\text{OH})\text{SO}_4 \cdot 2\text{H}_2\text{O}$, in sulphuric acid show the presence of no other thallic sulphate than the two just indicated, and hence the other sulphates which have been described in literature are mixtures which appear owing to the slowness of the change from one salt to another. The transition point of the two sulphates just indicated is 45° .

R. J. Meyer and E. Goldschmidt reported tetrahydrated **thallic hydrosulphate**, $\text{TlH}(\text{SO}_4)_2 \cdot 4\text{H}_2\text{O}$, or $\text{HSO}_4 \cdot \text{Tl} : \text{SO}_4 \cdot 4\text{H}_2\text{O}$, to be formed by saturating boiling dil. sulphuric acid with thallic sulphate, and evaporating the strongly acidified filtrate on a water-bath. If the soln. be allowed to crystallize at a low temp., the hexahydrate, $\text{TlH}(\text{SO}_4)_2 \cdot 6\text{H}_2\text{O}$, is formed. They regard this salt as *thallic sulphuric acid*—or *hydrosulphatothallic acid*—from which the alkali complexes $\text{MTl}(\text{SO}_4)_2 \cdot 4\text{H}_2\text{O}$ are derived. For the thallic salt of this acid, *vide supra*.

Thallic sulphate forms a series of **complex thallic sulphates** which are of special interest because trivalent thallium is the end-member of the Al, Ga, In, Tl-family, and it might therefore be expected to form a series of alums, $\text{MAl}(\text{SO}_4)_2 \cdot 12\text{H}_2\text{O}$. However, J. Locke,² A. Piccini and V. Fortini, H. Marshall, R. J. Meyer and E. Goldschmidt, etc., failed in the quest. It was, however, shown that the faculty of forming alums in this family of trivalent elements decreases as the at. wt. increases, so that indium has but a slight tendency to form alums, and thallium none at all. The nearest approach to alum-formation with trivalent thallium is the series of mixed crystals between ammonia alum and ammonium thallic sulphate obtained by A. Piccini and V. Fortini.

H. Marshall prepared **ammonium thallic trisulphate**, $(\text{NH}_4)_3\text{Tl}(\text{SO}_4)_3$, from a soln. obtained by saturating an acid soln. of thallic sulphate with ammonium sulphate; when recrystallized from dil. sulphuric acid, it forms tetrahydrated **ammonium thallic disulphate**, $\text{NH}_4\text{Tl}(\text{SO}_4)_2 \cdot 4\text{H}_2\text{O}$. V. Fortini obtained the tetrahydrate by dissolving thallic sulphate in a conc. aq. soln. of chlorine, adding ammonia, and washing and drying the precipitate. The latter was then dissolved in the right proportion of sulphuric acid, and mixed with ammonium sulphate. The soln., on evaporation between 0° and 20° in vacuo, furnished monoclinic prisms of the tetrahydrate. The axial ratios are $a : b : c = 0.9559 : 1 : 0.6836$, and $\beta = 125^\circ 38'$. The crystals effloresce in air at 20° – 25° ; and lose all their water of crystallization at 100° . The salt is easily soluble in acids, and is hydrolyzed by water. H. Marshall made small needle-like crystals of the anhydrous salt, $\text{NH}_4\text{Tl}(\text{SO}_4)_2$, by crystallization from a warm soln. of the component salts. G. L. Clark gave 293° for the temp. at which **thallic decaminosulphate**, $\text{Tl}_2(\text{SO}_4)_3 \cdot 10\text{NH}_3$, dissociates at 100 mm. press.

R. J. Meyer and E. Goldschmidt obtained fine needle-like crystals of trihydrated **lithium thallic disulphate**, $\text{LiTl}(\text{SO}_4)_2 \cdot 3\text{H}_2\text{O}$, from a soln. of the component salts; they also made a similar **sodium thallic disulphate**, $\text{NaTl}(\text{SO}_4)_2 \cdot 2\frac{1}{2}\text{H}_2\text{O}$. A. Strecker made the last-named salt in an anhydrous form, $\text{NaTl}(\text{SO}_4)_2$, by adding a sat. soln. of sodium sulphate to a soln. of thallic sulphate in dil. sulphuric acid. The crystals were washed with cold water, pressed between filter-paper, and dried

over conc. sulphuric acid. H. Marshall prepared tetrahydrated **potassium thallic disulphate**, $\text{KTI}(\text{SO}_4)_2 \cdot 4\text{H}_2\text{O}$, by crystallization from a nitric acid soln. of the basic salt; R. J. Meyer and E. Goldschmidt obtained it by boiling a soln. of the basic salt in sulphuric acid; and V. Fortini, by crystallization, at 0° – 20° , from a soln. of the component salts. This salt is less stable than the corresponding ammonium salt. A. Strecker prepared **potassium thallic hydroxydisulphate**, $\text{K}_2\text{SO}_4 \cdot \text{TI}(\text{OH})\text{SO}_4$ (H. Marshall), or $2\text{K}_2\text{SO}_4 \cdot \text{TI}_2\text{O}(\text{SO}_4)_2$ (A. Strecker), by mixing a dil. sulphuric acid soln. of thallic oxide with an aq. soln. of potassium hydrosulphate; on standing for some time, colourless crystals of the basic salt appear. They are coloured superficially brown by cold water owing to hydrolysis, and they dissolve with difficulty in warm dil. sulphuric acid. H. Marshall made the same salt, which he obtained by warming an aq. soln. of thalious sulphate, potassium sulphate, and carbonate. H. Marshall, and R. J. Meyer and E. Goldschmidt prepared anhydrous **rubidium thallic disulphate**, $\text{RbTI}(\text{SO}_4)_2$, by a process similar to that used for the ammonium salt. The aq. soln. furnishes crystals of the tetrahydrate, $\text{RbTI}(\text{SO}_4)_2 \cdot 4\text{H}_2\text{O}$, when cooled. V. Fortini found the crystals to be so efflorescent that he could not get crystallographic data. J. Locke obtained rhombic crystals of trihydrated **caesium thallic disulphate**, $\text{CsTI}(\text{SO}_4)_2 \cdot 3\text{H}_2\text{O}$, from a soln. of the component salts. They are sparingly soluble in cold water, copiously soluble in hot water. The further conc. of the mother liquid gave rhombic crystals of the sesquihydrate, $\text{CsTI}(\text{SO}_4)_2 \cdot 1\frac{1}{2}\text{H}_2\text{O}$. V. Fortini could not prepare a complex salt of constant composition.

R. J. Meyer and E. Goldschmidt reported a **mixed salt** to be formed by treating an aq. soln. of thalious sulphate with bromine, and evaporating the liquid over conc. sulphuric acid. The straw-yellow, needle-like crystals of **thalious bromosulphathalate**, $\text{TI}_2\text{Br}_2\text{SO}_4$, are represented as a thalious salt of a *Thallobromschwefelsäure*, $\text{TI}'\text{SO}_4 \cdot \text{T}'''' : \text{Br}_2$. The salt is sparingly soluble in water, and is hydrolyzed by a large proportion of water; ammonia gives a pale brown precipitate which when heated forms brown thallic oxide; and hydrochloric acid precipitates a crystalline chlorobromide.

REFERENCES.

- ¹ W. Crookes, *Chem. News*, 3. 193, 1861; 7. 290, 1863; 8. 159, 219, 231, 243, 255, 279, 1863; 9. 1, 37, 54, 1864; *Journ. Chem. Soc.*, 17. 112, 1864; *Proc. Roy. Soc.*, 12. 150, 1862; *Phil. Trans.*, 163. 277, 1874; *Researches on Atomic Weight of Thallium*, London, 1874; A. Lamy, *Compt. Rend.*, 54. 1255, 1862; 57. 442, 1863; *Ann. Chim. Phys.*, (3), 67. 385, 1862; (4), 5. 410, 421, 1865; *Bull. Soc. Chim.*, (2), 11. 210, 1869; *De l'existence d'un nouveau métal, le thallium*, Lille, 1862; *Leçon sur le thallium*, Paris, 1863; J. Krause, *Dingler's Journ.*, 217. 323, 1875; W. O. Rabe, *Zeit. anorg. Chem.*, 31. 156, 1902; *Zeit. phys. Chem.*, 38. 175, 1901; E. Franke, *ib.*, 16. 463, 1902; J. W. Retgers, *ib.*, 3. 289, 1889; M. le Blanc and P. Rohland, *ib.*, 19. 278, 1896; W. R. Hodgkinson and C. C. French, *Chem. News*, 66. 223, 1892; B. Gossner, *Zeit. Kryst.*, 38. 162, 1903; A. Fock, *ib.*, 4. 592, 1880; L. Meyer, *Ber.*, 20. 3058, 1887; C. F. Rammelsberg, *ib.*, 15. 2229, 1882; K. A. Hofmann, A. Korn, and E. Strauss, *ib.*, 34. 408, 1901; R. Weber, *ib.*, 17. 2502, 1884; *Pogg. Ann.*, 146. 606, 1872; W. Stortenbeker, *Rec. Trav. Chim. Pays-Bas*, 21. 87, 1902; 24. 53, 1905; 26. 248, 1907; L. de Boisbaudran, *Ann. Chim. Phys.*, (5), 10. 126, 1877; G. Grube and A. Hermann, *Zeit. Elektrochem.*, 26. 291, 1920; C. Drucker, *ib.*, 26. 364, 1920; J. Thomsen, *Journ. prakt. Chem.*, (2), 12. 98, 1875; E. Carstanjen, *ib.*, (1), 101. 55, 1867; (1), 102. 65, 129, 1867; L. Pasteur, *Ann. Chim. Phys.*, (3), 67. 408, 1863; A. E. H. Tutton, *Proc. Roy. Soc.*, 79. A, 351, 1907; 83. A, 211, 1910; Earl of Berkeley, *Phil. Trans.*, 203. A, 211, 1904; J. B. J. D. Boussingault, *Compt. Rend.*, 64. 1159, 1867; T. Carnelley, *Journ. Chem. Soc.*, 35. 563, 1879; F. R. Mallet, *ib.*, 77. 216, 1900; M. C. Lea, *Amer. Journ. Science*, (3), 45. 478, 1893; P. E. Browning, *ib.*, (4), 9. 137, 1900; P. S. Oettinger, *On the Combinations of Thallium*, Berlin, 26, 1864; R. J. Meyer, *Zeit. anorg. Chem.*, 24. 363, 1900; A. Heydweiller, *ib.*, 116. 42, 1921; H. Erdmann and P. Köthner, *ib.*, 18. 63, 1898; J. d'Ans and O. Fritsche, *ib.*, 65. 231, 1909; J. d'Ans, *Ber.*, 41. 1777, 1908; A. Lamy and A. des Cloizeaux, *Compt. Rend.*, 66. 1146, 1868; *Ann. Chim. Phys.*, (4), 17. 310, 1869; J. E. Willm, *ib.*, (4), 5. 5, 1865; H. Benrath and H. Espenschied, *Zeit. anorg. Chem.*, 121. 361, 1922; R. Abegg and J. F. Spencer, *ib.*, 44. 379, 1905; A. A. Noyes and F. S. Farrel, *Journ. Amer. Chem. Soc.*, 33. 1654, 1911; A. A. Noyes and M. A. Stewart, *ib.*, 33. 1658, 1911; B. Lepsius, *Verh. deut. Naturf. Aertze*, 63. 103, 1901; R. J. Meyer and E. Goldschmidt, *Ber.*, 36. 241, 1903; A. Strecker, *Liebig's Ann.*, 135. 207, 1865; H. Marshall, *Proc. Roy. Soc. Edin.*, 24. 305, 1902; G. Wyrouboff, *Bull. Soc. Min.*, 7. 141, 1884; C. Drucker, *Zeit. phys. Chem.*, 96. 381, 1920; G. Canneri, *Gazz. Chim. Ital.*, 52. ii, 266, 1922; F. Ishikawa, *Journ. Soc. Chem. Ind. Japan*, 43. 560, 576, 1922; 44. 220, 1923; A. J. Berry, *Journ. Chem. Soc.*,

123. 1109, 1923; P. E. Browning and H. E. Palmer, *Amer. Journ. Science*, (4), 27, 379, 1909; E. Cohen, D. H. P. Voller, and A. L. T. Moesveld, *Zeit. phys. Chem.*, 104, 323, 1923; G. N. Lewis and M. Randall, *Journ. Amer. Chem. Soc.*, 43, 1112, 1921; A. A. Noyes and K. G. Falk, *ib.*, 34, 454, 1912; P. Köthner, *Ueber Rubidium*, Halle, 1896; W. Schmidt, *Ann. Phys.*, (4), 11, 114, 1903; R. von Sahmen and G. Tammann, *ib.*, (4), 10, 879, 1903; G. Werther, *Zeit. anal. Chem.*, 3, 1, 1864; *Journ. prakt. Chem.*, (1), 92, 135, 1864; F. Klocke, *Neues Jahrb. Min.*, 1, 158, 1880; J. Locke, *Amer. Chem. Journ.*, 26, 166, 1901; 27, 459, 1902; A. Cossa, *Nuovo Cimento*, (2), 3, 75, 1870; C. Soret and L. Duparc, *Arch. Sciences Genève*, (3), 21, 90, 1889; C. Soret, *ib.*, (3), 20, 162, 517, 1885; J. H. Gladstone, *Phil. Mag.*, (5), 20, 162, 1885; V. von Lang, *ib.*, (4), 25, 248, 1863; W. Spring, *Ber.*, 17, 408, 1884; *Bull. Acad. Belg.*, (3), 6, 507, 1883; A. Benrath, *Zeit. wis. Photochem.*, 14, 217, 1915; J. Meyer, *Rec. Trav. Chim. Pays-Bas*, 42, 614, 1923; J. Meyer and H. Wilk, *Zeit. anorg. Chem.*, 132, 239, 1923.

² J. Locke, *Amer. Chem. Journ.*, 27, 280, 1902; H. Marshall, *Proc. Roy. Soc. Edin.*, 24, 305, 1902; R. J. Meyer and E. Goldschmidt, *Ber.*, 36, 239, 1903; A. Piccini and V. Fortini, *Zeit. anorg. Chem.*, 31, 451, 1902; *Gazz. Chim. Ital.*, 35, ii, 459, 1905; V. Fortini, *ib.*, 35, ii, 450, 1905; G. Canneri, *ib.*, 52, ii, 266, 1922; A. Strecker, *Liebig's Ann.*, 135, 207, 1865; G. L. Clark, *Amer. Journ. Science*, (5), 7, 1, 1924.

§ 13. Thallium Carbonates

A. Lamy¹ observed that thallos oxide or hydroxide readily absorbs carbon dioxide from the atm. W. Crookes stated that when the moist metal is exposed to the air, it is soon covered by a film of the carbonate. R. Böttger obtained a soln. of the carbonate by allowing the finely divided metal to stand in contact with water and carbon dioxide. A. Lamy, and F. Kuhlmann prepared **thallos carbonate**, Tl_2CO_3 , by saturating a soln. of thallos hydroxide with carbon dioxide, and allowing the conc. soln. to crystallize. A. Lamy also obtained crystals of the carbonate by exposing a soln. of thallium hydroxide in thallium ethoxide to carbon dioxide. G. Streit, and E. Carstanjen made a soln. of the carbonate by the action of barium carbonate on a soln. of thallos sulphate. According to E. Carstanjen, if the crystals have a yellow colour, due to the presence of organic matter, they can be purified by adding alcohol to the aq. soln. when the salt is precipitated as a white crystalline powder; or by filtering the aq. soln. through animal charcoal.

The white crystals are monoclinic prisms which, according to A. Lamy and A. des Cloizeaux, have the axial ratios $a : b : c = 1.3956 : 1 : 1.9586$, and $\beta = 94^\circ 47'$. They have a strong negative double refraction. The sp. gr. is 7.164. T. Carnelley and W. C. Williams found the m.p. to be $272^\circ - 273^\circ$. The molten liquid is reddish-brown, and A. Lamy, and G. Werther said that a slight decomposition occurs during the fusion. E. Carstanjen obtained thallos oxide as a residue when the carbonate is heated in a glass tube; if heated while exposed to air, a mixture of thallos and thallic oxide is formed. According to A. Lamy, 100 parts of water dissolve 5.23 parts of the carbonate at 18° ; 12.85 parts at 62° ; and 22.4 parts at 100.8° ; while W. Crookes found 100 parts of water dissolve 4.2 parts of the carbonate at 15.5° ; and 27.2 parts at 100° . A. Lamy said the salt is insoluble in *alcohol*; E. Carstanjen, in *ether*; A. Naumann, in *acetone*; and A. Naumann and J. Schröder, in *pyridine*. The aq. soln. has an alkaline reaction. According to W. Crookes, the soln. supersaturated with carbon dioxide has an alkaline reaction; but, according to O. L. Erdmann, this is not the case. G. Wyruboff said that prismatic crystals of thallos oxycarbonate, $Tl_2O.Tl_2CO_3$, were formed in a vessel containing thallium and water which had been standing some years. E. Franke gave for the eq. electrical conductivity, λ , of aq. soln. of thallos carbonate, at 25° , expressed in reciprocal ohms, for soln. with a mol of the salt in v litres:

v	.	.	.	32	64	128	256	572	1024	.
λ	.	.	.	93.5	107.3	119.2	129.9	137.1	143.4	.

W. Schmidt gave 17 for the dielectric constant. C. Winkler observed that the reduction of thallium carbonate, mixed with magnesium powder, proceeds explosively. Thallos carbonate dissolves in many organic and inorganic acids, and is a convenient starting-point for the preparation of many salts of thallium.

E. Carstanjen claimed to have made **thallium hydrocarbonate** by supersaturating a cold soln. of thalious carbonate with carbon dioxide, and adding alcohol; the precipitated thalious carbonate is filtered off; and the soln. furnishes crystals approximating in composition to $Tl_2CO_3 \cdot 2TiHCO_3$. Neither A. Lamy nor G. Werther could obtain the hydrocarbonate from soln. of the hydroxide sat. with an excess of carbon dioxide—acicular crystals of the normal carbonate were always obtained. G. Giorgis said that the hydrocarbonate is obtained in needle-like crystals by slowly evaporating a moderately conc. cold soln. of thalious hydroxide in an atm. of carbon dioxide; if the soln. be heated or rapidly evaporated a mixture with the normal carbonate is obtained. G. Bollmann made **thalious magnesium carbonate**, $Tl_2CO_3 \cdot MgCO_3 \cdot 4H_2O$, by allowing a mixed soln. of magnesium carbonate in carbonated water and one of thalious carbonate to stand for some time, when crystals of the compound are deposited.

REFERENCES.

- ¹ A. Lamy, *Compt. Rend.*, **54**, 1255, 1862; **57**, 442, 1863; *Ann. Chim. Phys.*, (3), **67**, 385, 1862; (4), **5**, 410, 421, 1865; *Bull. Soc. Chim.*, (2), **11**, 210, 1869; *De l'existence d'un nouveau métal, le thallium*, Lille, 1862; *Leçon sur le thallium*, Paris, 1863; W. Crookes, *Chem. News*, **3**, 193, 1861; **7**, 290, 1863; **8**, 159, 219, 231, 243, 255, 279, 1863; **9**, 1, 37, 54, 1864; *Journ. Chem. Soc.*, **17**, 112, 1864; *Proc. Roy. Soc.*, **12**, 150, 1862; *Phil. Trans.*, **163**, 277, 1874; *Researches on the Atomic Weight of Thallium*, London, 1874; F. Kuhlmann, *Ann. Chim. Phys.*, (3), **67**, 341, 1863; A. Lamy and A. des Cloizeaux, *ib.*, (4), **17**, 319, 1869; E. Carstanjen, *Journ. prakt. Chem.*, (1), **101**, 55, 1867; (1), **102**, 65, 129, 1867; G. Streit, *ib.*, (1), **100**, 191, 1866; O. L. Erdmann, *ib.*, (1), **91**, 317, 1864; G. Werther, *ib.*, (1), **89**, 189, 1864; (1), **91**, 385, 1864; (1), **92**, 135, 1864; S. M. Jörgensen, *ib.*, (2), **6**, 82, 1873; *Das Thallium*, Heidelberg, 1871; G. Bollmann, *Beiträge zur Kenntnis der Magnesiumverbindungen*, Berlin, 1905; R. Böttger, *Liebig's Ann.*, **128**, 250, 1863; T. Carnelley and W. C. Williams, *Journ. Chem. Soc.*, **33**, 281, 1878; G. Wyruboff, *Bull. Soc. Min.*, **12**, 536, 1890; C. Winkler, *Ber.*, **23**, 789, 1890; A. Naumann and J. Schröder, *ib.*, **37**, 4610, 1904; A. Naumann, *ib.*, **37**, 4328, 1904; J. Schröder, *Chemisches und physikalisch-chemisches Verhalten des Pyridins und von Metallsalzen zu und in Pyridin*, Giessen, 1904; E. Franke, *Zeit. phys. Chem.*, **16**, 463, 1895; G. Giorgis, *Atti Accad. Lincet*, (5), **3**, ii, 104, 1894; W. Schmidt, *Ann. Physik*, (4), **11**, 114, 1903; C. F. Rammelsberg, *Handbuch der kristallographisch-physikalischen Chemie*, Leipzig, **1**, 553, 1881.

§ 14. Thallium Nitrates

The early workers on thallium prepared **thalious nitrate**, $TlNO_3$, by the action of nitric acid on normal thalious hydroxide, or thalious carbonate. According to E. Carstanjen,¹ nitric acid is the best solvent for the metal (*q.v.*). W. Crookes stated that the soln. obtained by using an excess of nitric acid contains a little thallic salt, which appears as thallic hydroxide when the ammonia precipitation is made. The white prismatic crystals belong to the rhombic system, and, according to W. H. Miller, they have axial ratios $a : b : c = 0.5109 : 1 : 0.6507$. V. von Lang, C. F. Rammelsberg, and F. Wallerant made observations on the properties of the crystals. A. Lamy and A. des Cloizeaux found the sp. gr. at ordinary temp. to be 5.50, and after fusion, 5.8; J. W. Retgers gave 5.3 for the sp. gr. of the molten nitrate at 205°. F. M. Jäger gave 4.892 for the sp. gr. at 214°; 4.824 at 254°; and 4.744 at 290°; or, at θ° , the sp. gr. 4.917—0.00175(θ —200), between 206° and 430°. A. J. Rabinowitsch measured the sp. gr. and viscosity of aq. soln. of thalious nitrate.

W. Herz found the coeff. of expansion of molten thalious nitrate to be 0.0003981; the sp. gr. at 214° is 4.892, and at 290°, 4.744. J. W. Wagner found the viscosity of N^- , $\frac{1}{2}N^-$, and $\frac{1}{3}N^-$ soln., at 25°, to be respectively 0.9471, 0.9865, and 0.9932. J. Hausmann measured the capillary rise of soln. with 10 per cent. of gelatine. F. M. Jäger, and R. Lorenz and W. Herz gave 99.5 for the surface tension of the salt at the b.p. (430°), and 117.3 at the m.p. (210°); and for the mol. surface energy 1681.9 ergs. per sq. cm. at 210°, and 1506.5 ergs. per sq. cm. at 430°.

When heated to between 70° and 80°, the rhombic crystals of ordinary thalious nitrate, γ - $TlNO_3$, or III- $TlNO_3$, change into a rhombohedral form β - $TlNO_3$ or

II-TlNO₃; and the latter, between 125° and 151°, changes into a cubic modification, α-TlNO₃ or I-TlNO₃. Somewhat discordant values have been given for the reversible transition temp. Thus, for the change γ-TlNO₃ ⇌ β-TlNO₃, F. Wallerant, and B. Gossner gave 80°; P. W. Bridgman, 75°; C. van Eyk, 72.8°; and A. G. Bergmann, 78.5°; and for the change, β-TlNO₃ ⇌ α-TlNO₃, F. Wallerant gave 125°; C. van Eyk, 142.5°; A. G. Bergmann, 142.5°; P. W. Bridgman, 144.6°; and B. Gossner, 151°. C. van Eyk found the transition temp. of thalious nitrate at 142° is lowered by admixture with the iodide; and the transition temp. of thalious iodide at 169° is lowered by the addition of nitrate. P. W. Bridgman's observations on the effect of press. between 1 kgrm. and 12,000 kgrms. per sq. cm. on the two transition temp. are shown in Table I, and graphed in Fig. 26. The slopes of the curves are represented by dT/dp . The volume changes are small and sluggish; they are represented by δv in c.c. per gram; C. van Eyk found 0.0004 c.c. per gram for the II→III transition. There was evidence of a change from the thalious to the thallic form at the

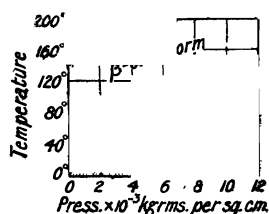

FIG. 26.—Effect of Pressure on the Transition Temperatures of Thalious Nitrate.

TABLE I.—THE EFFECT OF PRESSURE ON THALIOUS NITRATE AT DIFFERENT TEMPERATURES.

Press.	II→III.				I→II.			
	Temp.	δv c.c. per gram.	$\frac{dT}{dp}$	Latent heat kgrm.-metres per gram.	Temp.	δv c.c. per gram.	$\frac{dT}{dp}$	Latent heat kgrm.-metres per gram.
1	75.0°	0.00073	0.00668	0.38	144.6°	0.00244	0.00830	1.22
1,000	81.6°	0.00070	0.00655	0.38	152.9	0.00242	0.00825	1.25
3,000	94.5°	0.00065	0.00632	0.38	169.2	0.00239	0.00810	1.305
5,000	107.0°	0.00060	0.00616	0.37	185.3	0.00235	0.00790	1.37
7,000	119.2°	0.00055	0.00606	0.355	200.7	0.00232	0.00745	1.48
9,000	131.3	0.000495	0.00600	0.335	—	—	—	—
11,000	143.2	0.000445	0.00592	0.313	—	—	—	—
12,000	149.1	0.00042	0.00587	0.302	—	—	—	—

higher press., but no transitions were observed other than those just indicated. The difference in the compressibility or the phases, computed from the difference in the slope of the isothermals above and below the transition, show that at 75°, the compressibility of III-TlNO₃ in c.c. per gram per kgrm. per sq. cm. is 0.005 greater than II-TlNO₃; at 105°, 0.003 greater; and at 140°, 0.0015 greater. The difference in expansion, computed from the difference of compressibility and the slope of the change of volume along the transition line, shows that III-TlNO₃ is more expansible, the average difference being 0.00005 c.c. per gram per degree. W. Crookes said that the m.p. of thalious nitrate is about 205°, and that a little thallic salt may be formed, but no decomposition occurs. J. W. Retgers gave 205°; A. G. Bergmann, 207°; F. M. Jäger, 206°; and C. van Eyk, 205.0°–206.1°. The presence of the silver or mercury (ous or ic) nitrate depresses the m.p., and molten mixtures of these salts and thalious nitrate alone were recommended as heavy liquids for mineral separations; with equimolar parts of thalious nitrate and silver, mercurous or mercuric nitrate the sp. gr. at the m.p. are respectively 4.8 (70°), 5.3 (76°), and 5.0 (110°). The approximate b.p. is 430°. R. Lorenz and W. Herz found the ratio of absolute temp. of the m.p. and b.p. of many inorganic salts to be nearly constant. The effects of various nitrates on the m.p. are indicated in Figs. 26 to 30. According to P. W. Bridgman, the latent heats of the transition are indicated in Table I, where they are expressed in kilogrammetres per gram. V. Thomas

noted that the nitrate is slowly decomposed at 300°, and the reaction is rapid at 450°—oxygen, nitrogen, and nitrogen oxides are given off, and crystalline thallic oxide remains; a little thallic nitrate may be volatilized unchanged. W. Crookes said that a little thallic nitrite also accompanies the thallic oxide.

M. P. Appleby and W. Hughes found the vap. press. p mm., of sat. soln. of thallium nitrate at different temp. as determined by the b.p. method, to be:

	93.55°	99.99°	103.79°	105.12°	106.00°	107.54°	108.84°
p	547.1	659.8	740.5	773.0	795.1	827.6	859.1

The value of $dp/dT=22.3$ mm. per degree; the Earl of Berkeley found $dp/dT=16.1$ mm. per degree at 762 mm. The low b.p. of the sat. soln. is probably due to the mol. association of the salt, and is not due to the volatility of the salt, for at 104° the salt is non-volatile whether solid or in soln. The osmotic press., P , in atm. for soln. of mol. conc. C , is:

	94°	96°	98°	100°	102°	104°	106°	108°
P	147.1	173.3	195.9	217.8	237.0	254.6	268.8	288.4
C	6.230	6.760	7.323	7.990	8.775	9.816	11.257	(13.44)
P/C	23.61	25.64	26.75	27.26	27.01	25.93	23.88	(21.46)

The value of P/C thus attains a maximum. The curve is probably the resultant of two effects: (i) the normal increase of P/C with conc.; and (ii) a factor due to the association of the salt, which diminishes the osmotic press. per mol with increasing conc. C. Drucker measured the lowering of the f.p. of water by thallic nitrate.

Aq. soln. of thallic nitrate were found by W. N. Hartley to give an absorption band between $\lambda=3240-2740$; and with a dilution 0.001*N*, rays to $\lambda=2420$ are absorbed. The double refraction of crystals of γ -thallic nitrate is negative; that of β -thallic nitrate is positive; and that of α -thallic nitrate is negative. W. H. Miller gave 1.817 for the mean refractive index. A. A. Noyes, G. Jones and W. C. Schumb, and E. Franke measured the eq. electrical conductivity, λ , at 25°, for soln with a mol in v litres. The former gave:

v	4	16	32	64	128	256	512	1024	∞
λ	95.7	114.3	121.0	125.4	129.0	130.9	132.2	133.5	138.2

and for the degree of ionization of 0.0204*N*-soln. 0.906 and 0.910 at respectively 25° and 68°; and of 0.0970*N*-soln., 0.735 and 0.687. The ionization constants at 25°, calculated from solubility and conductivity determinations, are respectively 5.45 and 7.11 for 0.0161*N*-soln., and 4.81 and 2.90 for 0.1500*N*-soln. C. Drucker's observations on the f.p. and conductivity of soln. of thallic nitrate led him to infer that complex ions, corresponding with $2\text{Tl}^+=\text{Tl}_2^{2+}$, are formed, and that the ionization then follows the law of mass action. A. J. Rabinowitsch studied the anomalous ionization of soln. of thallium nitrate. A. A. Noyes and K. G. Falk found the percentage ionization of soln. with 1, 5, and 100 millieq. of salt per litre to be respectively 97.7, 94.8, and 78.8. G. N. Lewis and M. Randall measured the activity coeff. W. Schmidt gave 16.5 for the dielectric constant. H. Greinacher found that in the electrolysis of a flame charged with the vapour of thallic nitrate, using spark electrodes, the metal ions migrated to the negative pole.

Observations on the solubility of thallic nitrate were made by W. Crookes, A. Lamy, and A. Étard. Expressing the solubility, S , in grams of thallic nitrate per 100 grms. of water, the Earl of Berkeley found:

	0°	10°	20°	30°	40°	60°	80°	100°	105°
S	3.91	6.22	9.55	14.3	20.9	46.2	111	414	594

A. Lamy found thallic nitrate to be insoluble in alcohol; and W. Eidmann, soluble in acetone. The aq. soln. has a neutral reaction. P. Schottländer found thallic nitrate reduces a soln. of auric nitrate: $3\text{TlNO}_3+2\text{Au}(\text{NO}_3)_3=2\text{Au}+3\text{Tl}(\text{NO}_3)_3$. C. van Eyk obtained the f.p. curve, Fig. 27, for binary mixtures of thallic iodide and nitrate. The m.p. curve belongs to H. W. B. Roozeboom's fourth

type (1. 10, 2); it rises immediately from the f.p. of the nitrate showing that mixed crystals are deposited from the melt. The white mixed crystals contain 0-8 molar per cent. of iodide, and the red mixed crystals 65-100 molar per cent. of iodide. Mixtures with 18-65 molar per cent. of iodide solidify at 215° to a conglomerate of the limiting mixed crystals.

A. Ditte assumed that in aq. soln., nitric acid forms a complex **thallous trihydro-nitrate**, $TlNO_3 \cdot 3HNO_3$, but it could not be isolated; H. L. Wells and F. J. Metzger saturated nitric acid, sp. gr. 1.5, with thallous nitrate, and at 0°, obtained crystals of **thallous dihydronitrate**, $TlNO_3 \cdot 2HNO_3$. The salt loses nitric acid rapidly on exposure to air. If the thallous nitrate be dissolved in hot nitric acid of sp. gr. 1.5, H. L. Wells and F. J. Metzger found some thallic nitrate is formed, for the soln. deposits colourless prismatic crystals of **thallosic nitrate**, $2TlNO_3 \cdot Tl(NO_3)_3$, which are stable in dry air, but rapidly blacken in moist air.

According to F. Wallerant, ammonium and thallous nitrates form a continuous series of mixed crystals; the transformation temp. of cubic ammonium nitrate is lowered from 125° to 104° by 32 per cent. thallous nitrate, and the transformation temp. of cubic to rhombohedral thallous nitrate is lowered to 104° with 32 per cent.

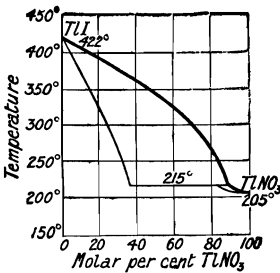

FIG. 27.—Freezing-point Curve of Thallous Iodide and Nitrate.

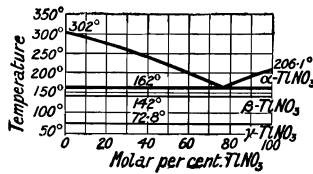

FIG. 28.—Freezing-point Curve of Mixtures of Thallous and Sodium Nitrates.

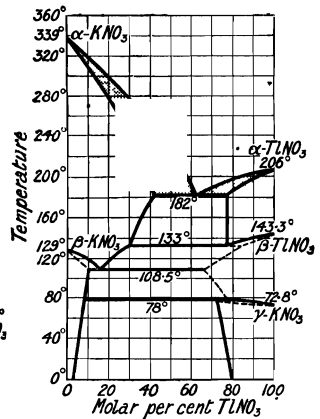

FIG. 29.—Equilibrium Curves of Mixtures of Thallous and Potassium Nitrates.

of thallous nitrate by the addition of ammonium nitrate. Likewise the transformation temp. of rhombohedral to rhombic thallous nitrate is lowered to 68° with 32 per cent. of ammonium nitrate. A. J. Boks found the f.p. curve has the V-shape with a eutectic at 109° and 19.62 per cent. of thallous nitrate. C. van Eyk found that the f.p. curve of thallous and sodium nitrates is of the simple V-type with a eutectic at 162°, Fig. 28. There is no evidence of the formation of a double salt; and since the transition temp. of thallous nitrate, 142° and 72.8°, are not affected by additions of sodium nitrate, it follows that no mixed crystals are formed. The m.p. and f.p. curves of mixtures of potassium and thallous nitrates have been studied by A. Fock, B. Gossner, F. Wallerant, W. Stortenbeker, and C. van Eyk.

The two salts are isodimorphous. Two series of solid soln. are formed, Fig. 29. There is a continuous series of rhombohedra with up to 20 per cent., and a continuous series of cubic crystals with 50-100 per cent. of potassium nitrate. With intermediate values, a conglomerate of mixed crystals is formed. Continuous transition curves are obtained for the mixed crystals from 144° to 133° on the thallium side, and 129° to 108.5° on the potassium side. The conglomerate has, however, two transition temp., the first at 133°, at which temp. it changes to a mixture of rhombohedra and rhombic crystals, and the second at 108.5°, where the remaining

rhombohedra change to the rhombic form. Although no transition in the conglomerate occurs above 133° , the composition of the two sets of mixed crystals changes with the temp., the percentage of potassium nitrate being 20 and 50 per cent. at 182° , 20 and 69 per cent. at 133° , and 35 and 84 per cent. at 108.5° . The other changes will appear from Fig. 29. F. Wallerant found thallos nitrate with rubidium or caesium nitrate forms a continuous series of cubic crystals. The cubic crystals become rhombohedral with a positive double refraction at lower temp., Fig. 30; and those with a high thallium content become rhombic at still lower temp. The fused mixtures furnish cubic crystals except those rich in rubidium, which furnish rhombohedral crystals with a negative double refraction. The continuous curves in Fig. 30 refer to the mixtures with rubidium, the dotted lines to those with caesium nitrate.

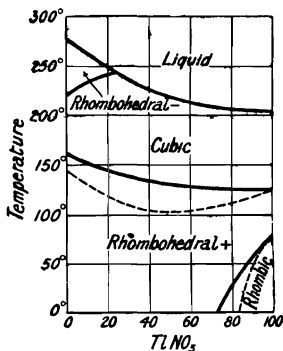

FIG. 30.—Transformations with Thallous and Rubidium or Caesium Nitrates.

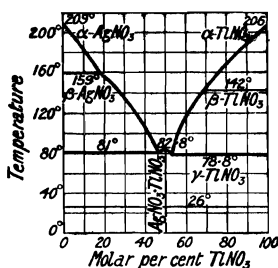

FIG. 31.—Freezing-point Curves of Mixtures of Thallous and Silver Nitrates.

C. van Eyk obtained the f.p. curves, Fig. 31, for mixtures of thallos and silver nitrates. A compound, **silver thallos nitrate**, $\text{AgNO}_3 \cdot \text{TlNO}_3$, appears as a maximum on the curve. J. W. Retgers also prepared the double salt in what were regarded as monoclinic crystals with m.p. 76° ; C. van Eyk gave 82.8° for the m.p. The complex salt separates on cooling fused mixtures with 47–53 molar per cent. of silver nitrate down to 80° – 85° . C. Sandonini studied the electrical conductivities of the mixed salts fused and solid. There is no evidence of the formation of appreciable quantities of mixed crystals; and there are only solidified conglomerates of the double salt with excess of silver or thallos nitrate. There is a slowly progressing transformation of the double salt at 26° , but the nature of the change is not understood. The change is attended by a decrease in the volume of the double salt, while that of the admixed silver or thallos nitrate remains unchanged. A. J. Rabinowitsch measured the sp. gr., viscosity, electrical conductivity, and ionization of aq. soln. of thallos silver nitrate. G. Schulze studied the electrolytic valve action of the eutectic mixture. P. Schottländer prepared **thallos auric nitrate**, $\text{TlAu}(\text{NO}_3)_4$, by mixing a sat. soln. of one mol. of thallos nitrate with a soln. of 1 to 3 mols. of auric nitrate in nitric acid. J. W. Retgers prepared **mercurous thallos nitrate**, $\text{TlNO}_3 \cdot \text{HgNO}_3$, of sp. gr. 5.3, and m.p. 70° ; and likewise **mercuric thallos nitrate**, $\text{TlNO}_3 \cdot \text{Hg}(\text{NO}_3)_2$, of sp. gr. 5.0, and m.p. 110° . A. G. Bergmann and co-workers found that thallos nitrate forms two compounds with mercuric chloride. There is a eutectic at 176° and 12.8 per cent. of mercuric chloride; a maximum at 195° , **thallos mercuric dichlorodinitrate**, $2\text{TlNO}_3 \cdot \text{HgCl}_2$; a eutectic at 192° and 37 per cent. of mercuric chloride; a maximum at 202.5° , **thallos mercuric dichloronitrate**, $\text{TlNO}_3 \cdot \text{HgCl}_2$; and a eutectic at 197° . With mercuric bromide, there is a maximum at 152° , **thallos mercuric dibromonitrate**, $\text{TlNO}_3 \cdot \text{HgBr}_2$, and a eutectic at 146° and 30 per cent. of mercuric bromide. A. G. Bergmann found the fusion curve of mixtures of thallos nitrate and mercuric iodide is

of the simple V-type with a eutectic at 192°, and a flat portion in the region 33–75 molar per cent. of mercuric iodide indicating the formation of solid soln. There is no indication of chemical combination.

J. E. Willm, A. Strecker, and R. J. Meyer dissolved thallic oxide or hydroxide in nitric acid of sp. gr. 1.4, and found that the conc. soln. deposited colourless deliquescent crystals of **thallic nitrate**, $Tl(NO_3)_3 \cdot 3H_2O$. C. F. Rammelsberg said that the crystals are rhombohedral. The salt is hydrolyzed in the presence of much water and thallic oxide is formed; it is also decomposed, according to J. E. Willm, if heated even below 100°. When exposed to air, the crystals lose nitric acid. R. J. Meyer found that the soln. of thallic nitrate in nitric acid is a strong oxidizing agent—with mercurous nitrate, mercuric and thallic nitrates are formed. He could not prepare *thallic hydronitrate*; even with thallic anhydride in fuming nitric acid, $Tl(NO_3)_3 \cdot 3H_2O$ is formed. R. J. Meyer found that thallic nitrate unites with potassium nitrate, furnishing crystals of **potassium pentanitratothallate**, $2KNO_3 \cdot Tl(NO_3)_5 \cdot H_2O$, or $K_2Tl(NO_3)_5 \cdot H_2O$. When heated, nitric acid is given off, and when treated with water, thallic oxide is formed.

REFERENCES.

- ¹ W. Crookes, *Chem. News*, **3**, 193, 1861; **7**, 290, 1863; **8**, 159, 219, 231, 243, 255, 279, 1863; **9**, 1, 37, 54, 1864; *Journ. Chem. Soc.*, **17**, 112, 1864; *Proc. Roy. Soc.*, **12**, 150, 1862; *Phil. Trans.*, **163**, 277, 1874; *Researches on the Atomic Weight of Thallium*, London, 1874; A. Lamy, *Compt. Rend.*, **54**, 1255, 1862; **57**, 442, 1863; *Ann. Chim. Phys.*, (3), **67**, 385, 1862; (4), **5**, 410, 421, 1865; *Bull. Soc. Chim.*, (2), **11**, 210, 1869; *De l'existence d'un nouveau métal, le thallium*, Lille, 1862; *Léçon sur le thallium*, Paris, 1863; E. Carstanjen, *Journ. prakt. Chem.*, (1), **101**, 55, 1867; (1), **102**, 65, 129, 1867; J. Thomsen, *ib.*, (2), **12**, 98, 1875; *Ber.*, 2065, 1879; R. J. Meyer and F. Wendel, *ib.*, **36**, 4055, 1903; R. J. Meyer, *Zeit. anorg. Chem.*, **24**, 321, 1900; R. Lorenz and W. Herz, *ib.*, **117**, 103, 1921; **120**, 320, 1922; F. M. Jäger, *ib.*, **101**, 1, 1917; C. Sandonnini, *Gazz. Chim. Ital.*, **50**, i, 289, 1920; A. G. Bergmann, *Journ. Russ. Phys. Chem. Soc.*, **54**, 200, 1922; A. G. Bergmann, T. A. Henke, and F. M. Isaikin, *ib.*, **54**, 466, 1923; J. W. Retgers, *Neues Jahrb. Min.*, i, 90, 1893; ii, 183, 1896; *Zeit. phys. Chem.*, **4**, 593, 1889; M. Bellate and S. Lussana, *ib.*, **9**, 378, 1892; C. van Eyk, *Proc. Akad. Amsterdam*, **2**, 480, 1900; **3**, 98, 1901; *Zeit. phys. Chem.*, **30**, 430, 1899; **51**, 721, 1905; J. W. Wagner, *ib.*, **5**, 31, 1900; A. A. Noyes, *ib.*, **6**, 241, 1890; E. Franke, *ib.*, **16**, 463, 1895; W. Stortenbeker, *ib.*, **43**, 629, 1903; *Rec. Trav. Chim. Pays-Bas*, **24**, 64, 1905; W. Herz, *Zeit. phys. Chem.*, **98**, 98, 1921; A. Fock, *Zeit. Kryst.*, **4**, 583, 1890; **28**, 337, 1897; B. Gossner, *ib.*, **38**, 110, 1903; W. Schmidt, *Ann. Physik*, (4), **11**, 114, 1903; W. H. Miller, *Phil. Mag.*, (4), **31**, 153, 1866; *Proc. Roy. Soc.*, **14**, 555, 1865; W. N. Hartley, *Journ. Chem. Soc.*, **81**, 556, 1902; A. Lamy and A. des Cloizeaux, *Ann. Chim. Phys.*, (4), **17**, 317, 1869; A. Étard, *ib.*, (7), **2**, 527, 1894; J. E. Willm, *ib.*, (4), **5**, 5, 1865; G. Schulze, *Zeit. Elektrochem.*, **17**, 513, 1911; P. W. Bridgman, *Proc. Amer. Acad.*, **51**, 581, 1916; V. von Lang, *Sitzber. Akad. Wien*, **55**, 416, 1867; F. Wallerant, *Bull. Soc. Min.*, **28**, 311, 1905; *Compt. Rend.*, **140**, 1045, 1905; A. Ditte, *ib.*, **39**, 576, 641, 1879; V. Thomas, *ib.*, **138**, 1697, 1904; C. F. Rammelsberg, *Handbuch der kristallographisch-physikalischen Chemie*, Leipzig, **1**, 348, 1881; H. L. Wells and F. J. Metzger, *Amer. Chem. Journ.*, **26**, 271, 1901; H. L. Wells and H. P. Beardsley, G. S. Jamieson, and F. J. Metzger, *ib.*, **26**, 275, 1901; S. L. Penfield and D. A. Kreider, *Amer. Journ. Science*, (3), **46**, 141, 1894; Lord Berkeley, *Phil. Trans.*, **203**, A, 189, 1904; Lord Berkeley and M. P. Appleby, *Proc. Roy. Soc.*, **85**, A, 489, 1911; A. Strecker, *Liebig's Ann.*, **135**, 207, 1865; W. Eidmann, *Ein Beitrag zur Erkenntnis des Verhaltens chemischer Verbindungen in nichtwässrigen Lösungen*, Giessen, 1899; G. N. Lewis and M. Randall, *Journ. Amer. Chem. Soc.*, **43**, 1112, 1921; A. A. Noyes and K. G. Falk, *ib.*, **34**, 454, 1912; H. Greinacher, *Phys. Zeit.*, **23**, 65, 1922; C. Drucker, *Zeit. Elektrochem.*, **28**, 463, 1922; G. Jones and W. C. Schumb, *Proc. Amer. Acad.*, **56**, 199, 1921; M. P. Appleby and W. Hughes, *Journ. Chem. Soc.*, **197**, 1798, 1915; P. Schottländer, *Ueber das Salpetersäure-Goldnitrat und einige neue Derivate desselben*, Würzburg, 1884; J. Hausmann, *Zeit. anorg. Chem.*, **40**, 132, 1904; A. J. Rabinowitch, *Zeit. phys. Chem.*, **99**, 338, 417, 434, 1921; A. J. Boks, *Mengkrystallen von Ammoniumnitrat en Thalliumnitrat*, Amsterdam, 1902.

§ 15. Thallium Phosphates

W. Crookes¹ found that normal **thallous orthophosphate**, Tl_3PO_4 , is obtained as a crystalline precipitate when an excess of phosphoric acid and ammonia is added to a soln. of thallic nitrate. A. Lamy mixed conc. soln. of sodium hydrophosphate and thallic sulphate; about one-third of the thallium was precipitated

as orthophosphate, and two-thirds remain in soln. as a complex salt; he also made it by melting equi-molar proportions of thalious metaphosphate and thalious carbonate; and by adding alkali hydroxide to soln. of thalious hydrophosphate—alkali carbonate will not do in place of the hydroxide. C. F. Rammelsberg made it by saturating a soln. of phosphoric acid with thalious carbonate; and by adding an excess of ammonia to a soln. of one of the acid phosphates. The salt appears in white, silky, acicular crystals. C. F. Rammelsberg said that normal thalious and lithium orthophosphates resemble one another closely. A. Lamy gave 6.89 (10°) for the sp. gr. of the molten salt. W. Crookes found that the salt melts to a brown liquid, and on cooling it appears orange, then white, and finally as a crystalline mass. He also found that 100 parts of water at 15° dissolve 0.497 part of salt, and boiling water 0.673 part of the salt. A. Lamy found that thalious phosphate is quite insoluble in alcohol; E. Carstanjen, that it is sparingly soluble in soln. of ammonium salts; and C. F. Rammelsberg, that it is soluble in soln. of thalious hydrophosphate. The aq. soln. has a neutral reaction, and when boiled with silver nitrate, yellow silver phosphate is formed without the soln. losing its neutrality.

A. Lamy regarded the sparingly soluble crystals which he obtained by saturating phosphoric acid with thalious carbonate as anhydrous **thalious hydrophosphate**, Ti_2HPO_4 ; but, according to C. F. Rammelsberg's analysis, this salt is not a hydrophosphate, but, rather normal thalious phosphate with one to two per cent. of adsorbed water. A. Lamy also said that a hemihydrate, $\text{Ti}_2\text{HPO}_4 \cdot \frac{1}{2}\text{H}_2\text{O}$, separates when the syrupy soln. obtained by evaporation is allowed to cool, but C. F. Rammelsberg's analysis shows that the product is more probably a complex *thalium pentahydrotriphosphate*, $\text{Ti}_2\text{HPO}_4 \cdot 2\text{TiH}_2\text{PO}_4$. According to A. Lamy and A. des Cloizeaux, the rhombic crystals have the axial ratios $a : b : c = 0.9314 : 1 : 0.7818$; and they are positively doubly refracting. C. F. Rammelsberg said that they are isomorphous with the corresponding ammonium hydrophosphate and arsenate. A. Lamy said that half a mol of water is lost at 200°, and at a dark red heat, vitreous pyrophosphate is formed, while C. F. Rammelsberg said a mixture of pyro- and meta-phosphates is produced. A. Lamy said the salt is sparingly soluble in water; insoluble in alcohol; the aq. soln. reacts alkaline, but does not coagulate the white of egg; the aq. soln. gives a yellow precipitate with silver nitrate, and at the same time becomes acid. C. F. Rammelsberg found that when the salt dissolves in water, some normal phosphate is precipitated.

A. Lamy, and C. F. Rammelsberg prepared **thalious dihydrophosphate**, TiH_2PO_4 , by adding phosphoric acid to a soln. of the preceding salt, or by saturating a boiling soln. of phosphoric acid with thalious carbonate. A. Lamy and A. des Cloizeaux found the monoclinic crystals have the axial ratios $a : b : c = 3.1750 : 1 : 1.4577$, and $\beta = 91^\circ 44'$; the double refraction is negative; the sp. gr. is 4.723; the m.p. about 190°; it loses water at 240°, and forms thalious dihydropyrophosphate; at a red heat, it forms the sparingly soluble metaphosphate. The salt is sparingly soluble in water, and insoluble in alcohol. The aq. soln. has a feebly acid reaction. A. Lamy prepared an **ammonium thalious phosphate** by adding ammonia to a soln. of thalious hydrophosphate, and evaporating the liquid filtered from the precipitated thalious phosphate. According to A. Lamy and A. des Cloizeaux, the anhydrous crystals are tetragonal and have the axial ratio $a : c = 1.07107$; they are optically negative, and isomorphous with ammonium phosphate. The salt is sparingly soluble in water. A. Lamy's analysis corresponds with $(\text{NH}_4)_3\text{PO}_4 \cdot (\text{NH}_4)_2\text{TiPO}_4$; and C. F. Rammelsberg regards it as an isomorphous mixture of $(\text{NH}_4)_2\text{H}_2\text{PO}_4$ and Ti_2HPO_4 in the molar proportions 5 : 1. G. Bollmann made **thalious magnesium orthophosphate**, $\text{TiMgPO}_4 \cdot 6\text{H}_2\text{O}$, by dropping a soln. containing equimolar proportions of thalious and magnesium sulphates into one of sodium hydrophosphate. The filtered soln. after some hours deposits crystals of this salt.

A. Lamy prepared normal **thalious pyrophosphate**, $\text{Ti}_4\text{P}_2\text{O}_7$, by heating his hemihydrated thalious hydrophosphate. A syrupy soln. of the sparingly soluble salt crystallizes with difficulty. C. F. Rammelsberg made this salt by adding thalious

carbonate to the mother liquid remaining after the preparation of thallos dihydrophosphate. P. Glühmann obtained the anhydrous salt by allowing a soln. of sodium triphosphate and thallos sulphate to stand in air for some time. The salt dried at 100° has 0.21 per cent. of water. A. Lamy and A. des Cloiseaux found the monoclinic prisms have the axial ratios $a : b : c = 1.4274 : 1 : 1.2921$, and $\beta = 114^{\circ}$. The sp. gr. is 6.786; the double refraction is negative. A. Lamy found that the salt softens near 120° , and melts at a higher temp. The glassy mass obtained on cooling the molten salt is non-hygroscopic. 100 parts of water dissolve about 40 parts of the salt; at the same time some of the salt is hydrolyzed, and an insoluble white mass separates—possibly thallos dihydrophosphate. Silver nitrate gives a white precipitate and the mother liquid is neutral. According to A. Lamy, the spontaneous evaporation of the mother liquid remaining after the deposition of the crystals of the anhydrous salt furnishes the **dihydrated thallos pyrophosphate**, $Tl_4P_2O_7 \cdot 2H_2O$. A. Lamy and A. des Cloiseaux found the monoclinic crystals have the axial ratios $a : b : c = 2.1022 : 1 : 1.9217$, and $\beta = 114^{\circ} 57'$; the double refraction is negative. When exposed to air, the salt becomes superficially moist and sticky. When heated, the salt loses two mols of water below a red heat. It dissolves in water more quickly than the anhydrous salt. A. Lamy prepared **thallos dihydrophosphate**, $Tl_2H_2P_2O_7$, by heating thallos dihydrophosphate to 240° , or, according to C. F. Rammelsberg, to 275° . A. Lamy reported that the salt is sparingly soluble in water, and the acid soln. yields short prismatic crystals which melt at 270° , and lose 2.85 per cent. of water at a red heat.

According to A. Lamy, **thallos metaphosphate**, $TlPO_3$, exists in two forms. One is an opaque glass made by calcining thallos dihydrophosphate. The product dissolves with difficulty in water, and it does not coagulate white-of-egg directly, but only after the addition of a few drops of phosphoric acid. The second form is obtained by calcining ammonium thallos orthophosphate; it is a glassy mass readily soluble in water, and the soln. coagulates white-of-egg directly. If the sparingly soluble form be fused with a few drops of phosphoric acid it passes into the soluble form.

J. E. Willm prepared normal **thallic orthophosphate**, $TlPO_4 \cdot 2H_2O$, by mixing a syrupy soln. of thallic nitrate with phosphoric acid; the white gelatinous mass is insoluble in water. When boiled with water, a basic salt and some thallic hydroxide are formed. A. Strecker noted the white slimy precipitate formed when a soln. of sodium hydrophosphate is mixed with one of thallic sulphate; and C. F. Rammelsberg's analysis of the product corresponds with $Tl_3P_2O_7 \cdot 13H_2O$. J. E. Willm made the *basic phosphate*, $2Tl_2O_3 \cdot P_2O_5 \cdot 5H_2O$, by adding ammonia to a hydrochloric acid soln. of the normal phosphate; if too much ammonia is added brown thallic hydroxide is formed.

REFERENCES.

- ¹ W. Crookes, *Chem. News*, 3, 193, 1861; 7, 290, 1863; 8, 159, 219, 231, 243, 255, 279, 1863; 9, 1, 37, 54, 1864; *Journ. Chem. Soc.*, 17, 112, 1864; *Proc. Roy. Soc.*, 12, 150, 1862; *Phil. Trans.*, 163, 277, 1874; *Researches on the Atomic Weight of Thallium*, London, 1874; A. Lamy, *Compt. Rend.*, 54, 1255, 1862; 57, 442, 1863; *Ann. Chim. Phys.*, (3), 67, 385, 1862; (4), 5, 410, 421, 1865; *Bull. Soc. Chim.*, (2), 11, 210, 1869; *De l'existence d'un nouveau métal, le thallium*, Lille, 1862; *Leçon sur le thallium*, Paris, 1863; C. F. Rammelsberg, *Pogg. Ann.*, 146, 604, 1872; *Wied. Ann.*, 16, 695, 1882; *Ber.*, 3, 279, 1876; *Sitzber. Akad. Berlin*, 21, 1883; *Handbuch der krystallographisch-physikalischen Chemie*, Leipzig, 1, 348, 1881; A. Lamy and A. des Cloiseaux, *Ann. Chim. Phys.*, (4), 17, 322, 1869; J. E. Willm, *ib.*, (4), 5, 5, 1865; E. Carstanjen, *Journ. prakt. Chem.*, (1), 101, 55, 1867; (1), 102, 65, 219, 1867; A. Strecker, *Liebig's Ann.*, 135, 207, 1865; P. Glühmann, *Beitrag zur Kenntnis der Triphosphorsäure und ihrer Salze*, Berlin, 1899; G. Bollmann, *Beiträge zur Kenntnis der Magnesiumverbindungen*, Berlin, 1905.

CHAPTER XXXVII

SCANDIUM

§ 1. The History and Occurrence of Scandium

THERE are differences of opinion as to whether scandium should or should not be included in the rare earth family of elements. In any case, it is always associated with the rare earths for, in 1879, while studying the ytterbia derived from gadolinite and euxenite, L. F. Nilson¹ obtained 0.3 grm. of a new earth which was characterized by its spark spectrum, its low chemical eq., and feeble basicity. He called the element **scandium** in honour of his country, the Scandinavian peninsula where the minerals containing the earth were originally found. Shortly afterwards, P. T. Cleve obtained 0.8 grm. of scandia from 4 kgrms. of gadolinite, and 1.2 grm. from 3 kgrms. of keilhauite. G. Urbain and H. Lacombe believe that scandium should not be included in the rare earths in spite of the fact that it forms a cyanoplatinate resembling those of the ceria earths, and another, which resembles those of the yttrium earths. Unlike the yttrium earths, it forms a sparingly soluble double alkali sulphate, and in this it resembles more the cerium earths. In its low basicity, however, scandia more resembles the yttrium earths. Scandium sulphate is hexahydrated and very soluble in water. R. J. Meyer emphasized that in this and in other qualities, it resembles beryllium. Scandium fits very well into the place assigned by D. I. Mendeléeff to *ekaboron*. P. T. Cleve emphasized the analogies between the prediction and verification, as shown in Table I.

TABLE I.—COMPARISON OF THE PREDICTED AND OBSERVED PROPERTIES OF SCANDIUM.

Ekaboron, Eb.	Scandium, Sc.
<p>At. wt. 44</p> <p>It will form one oxide, Eb_2O_3, of sp. gr. 3.5 ; more basic than alumina, less basic than yttria or magnesia; not soluble in alkalies; and it is doubtful if it will decompose ammonium chloride.</p> <p>The salts will be colourless, and give gelatinous precipitates with potassium hydroxide, and sodium carbonate. The salts will not crystallize well.</p> <p>The carbonate will be insoluble in water; and probably precipitated as a basic salt. The double alkali sulphates will probably not be alums.</p> <p>The anhydrous chloride, $EbCl_3$, should be less volatile than aluminium chloride, and its aq. soln. should hydrolyze more readily than that of magnesium chloride. Ekaboron will probably not be discovered spectroscopically.</p>	<p>At. wt. 44</p> <p>Scandium oxide, Sc_2O_3, has a sp. gr. 3.86 ; it is more basic than alumina, and less basic than yttria or magnesia. It is not soluble in alkalies; and does not decompose ammonium chloride.</p> <p>Scandium salts are colourless, and give gelatinous precipitates with potassium hydroxide and sodium carbonate. The sulphate crystallizes with difficulty.</p> <p>Scandium carbonate is insoluble in water, and readily loses carbon dioxide.</p> <p>The double alkali sulphates are not alums.</p> <p>Scandium chloride, $ScCl_3$, begins to sublime at 850°—aluminium chloride begins to sublime above 100°. In aq. soln. the salt is hydrolyzed.</p> <p>Scandium was not recognized by spectrum analysis.</p>

Scandium is sparsely but widely distributed. J. H. L. Vogt estimated that the ten-mile crust, the hydrosphere, and lithosphere of the earth contained 0.00000000z

per cent. of scandium; F. W. Clarke and H. S. Washington, 0·0000x per cent. From spectroscopic observations it is inferred that scandium occurs relatively abundantly in the sun and stars. M. N. Saha² observed evidence of it in the high-level solar chromospheric spectrum. Since the lines of the scandium spectrum are observed in the spectra of stars in diverse stages of development—for example, in α -Persei, which is younger than our sun, and in the red stars α -Orionis and α -Herculis, which are older than our sun—G. Eberhard argued that scandium must be universally distributed on the earth. Consonant therewith, he found that the arc spectra of 459 minerals and rocks showed that small quantities of scandium are present in 204; the evidence with 74 was doubtful; and the element was absent in 181. He finally concluded that scandium in small quantities is one of the most widely distributed of the elements on the earth's crust. It was found to occur most frequently in the zirconium minerals, in beryls, in titanates, columbites, titanocolumbites of the rare earths, in micas, and in specimens of wolframite and cassiterite. R. J. Meyer, and W. Crookes verified these conclusions, and found that scandium can be detected in most of the rocks forming the earth's crust. Even the rocks and, with a couple of exceptions, the minerals richest in scandium contain very small proportions—less than two per cent. G. Eberhard, and W. Vernadsky say that these rocks are all derived from granites and pegmatites. Most of the yttrium minerals contain scandium, but the yttrium always predominates. Scandium is found in keilhauite, euxenite, auelrite, cerite, cryptolite, koppite, mosandrite, orangite, orthite, pyrochlore, thorianite, thorite, widite, etc. T. Uemura detected scandium in a Japanese beryl. R. J. Meyer found that the wolframite from Zinnwald contains 0·15 per cent. R. J. Meyer and A. H. Winter's analyses of wolframite from Zinnwald and Sadisdorf are respectively:

WO ₃	FeO	MnO	TiO ₂ ; Ta ₂ O ₅	PbO; SnO ₂	CaO	Rare earths
75·41	9·34	14·00	0·50	0·18	0·55	0·15
73·47	15·13	9·81	0·63	0·47	0·54	0·20

Scandium constitutes 56·4 per cent. of the total rare earths present. H. S. Lukens found scandium in American wolframite; and C. James in Brazilian zirconite. J. Sterba-Böhm said that after tungsten has been removed from the wolframite, in the manufacture of sodium tungstate, the separation of the scandium is easy and could be profitable if there were any demand.

G. Urbain said that he found no scandium in his fractions of the rare earths. W. B. Hicks did not detect this element in the minerals fergusonite, æschynite, euxenite, and samarskite. R. J. Meyer found a Finnish orthite containing about one per cent. of scandia; and W. Crookes and R. J. Meyer obtained a similar amount from the mineral *wiikite*, which occurs with the monazite from a felspar quarry near Impilaks, Finland, in black masses which show no signs of a crystalline structure or action on polarized light. The mineral is so complex that a definite formula has not been obtained. W. Crookes' analysis is:

Ta ₂ O ₅ , Cb ₂ O ₅	TiO ₂ , ZrO ₂	Ce ₂ O ₃	Y ₂ O ₃	Sc ₂ O ₃	ThO ₂	FeO	UO ₃	SiO ₂
15·91	23·36	2·55	7·64	1·17	5·51	15·52	3·56	16·93

The volatiles—helium, neon, hydrogen sulphide and water—amounted to 5·83 per cent. Traces of lime, magnesia, stannic oxide, and sulphur were also present. L. H. Borgström has discussed and analyzed the mineral, and suggested the idealized formula FeTiSiO₅. The type rich in uranium is called *wiikite*, and one rich in yttrium, *loranscrite*. The sp. gr. is 4·85, and the hardness 6. The mineral is feebly radioactive. The evolution of gas which attends the heating of the mineral is almost explosive, and is accompanied by a curious fracture. *Wiikite* is partially attacked by acids, and readily by fused potassium hydrosulphate.

Scandium occurs as an essential constituent of only one mineral, namely, **thortveitite**. This was analyzed and recognized as a new mineral by J. Schetelig; it was found in a pegmatite vein in granite in Iceland, and in the felspar quarries at Sætersdalen, Norway. A. Lacroix found it at Befanamo, Madagascar. The

composition, according to J. Schetelig and R. J. Meyer, corresponds with that required for a silicate of the yttria earths and scandia approximating to **scandium orthodisilicate**, $R_2O_3 \cdot 2SiO_2$, or $R_2S_3O_7$, where R represents Sc, Y, . . . The scandia forms about 37 per cent. of the whole; this with yttria and small quantities of other yttria bases make up 54.5 per cent.; the members of the ceria group are almost absent; traces of thoria are present; and ferric oxide with traces of manganic oxide and alumina make up nearly 3 per cent. The mineral occurs in radial aggregates. The colour is white, greyish-green, or reddish-grey; it appears yellowish-green by transmitted light. The refraction is strong, and the birefringence strongly negative. The crystals are rhombic with axial ratios $a : b : c = 0.7456 : 1 : 1.4912$. The sp. gr. is 3.571, and the hardness 6 to 7. The mineral fuses with difficulty, and it is only partially attacked by hydrochloric acid. C. Boulanger and G. Urbain analyzed thortveitite from Madagascar.

REFERENCES.

- ¹ L. F. Nilson, *Compt. Rend.*, **88**, 645, 1879; **91**, 56, 118, 1880; *Cefners. Akad. Förh.*, **3**, 1879; **6**, 1880; P. T. Cleve, *ib.*, **7**, 1879; *Compt. Rend.*, **89**, 419, 1879; *Bull. Soc. Chim.*, (2), **31**, 486, 1879; *Chem. News*, **40**, 159, 1879; D. I. Mendéléeff, *ib.*, **40**, 243, 1879; **41**, 2, 1880; *Journ. Russ. Phys. Chem. Soc.*, **1**, 60, 1869; **3**, 47, 1871; G. Urbain and H. Lacombe, *Chem. News*, **90**, 319, 1905; J. H. L. Vogt, *Zeit. prakt. Geol.*, **6**, 225, 314, 377, 413, 1898; **7**, 10, 274, 1899; F. W. Clarke and H. S. Washington, *Proc. Nat. Acad. Sciences*, **8**, 108, 1922; R. J. Meyer, *Sitzber. Akad. Berlin*, 379, 1911.
- ² G. Eberhard, *Sitzber. Akad. Berlin*, 851, 1908; 404, 1910; *Zeit. anorg. Chem.*, **45**, 374, 1905; *Chem. News*, **99**, 30, 1909; **102**, 2.11, 1910; W. Crookes, *ib.*, **98**, 274, 1908; *Proc. Roy. Soc.*, **80**, A, 516, 1908; *Phil. Trans.*, **209**, A, 15, 1908; **210**, A, 359, 1910; R. J. Meyer, *Sitzber. Akad. Berlin*, 379, 1911; R. J. Meyer and A. H. Winter, *Zeit. anorg. Chem.*, **67**, 398, 1910; J. Schetelig, *Centr. Min.*, 721, 1911; *Danske Vid. Seisk. Skr.*, **6**, 233, 1922; *Norsk. Geol. Tids.*, **6**, 233, 1922; M. N. Saha, *Phil. Mag.*, (6), **40**, 472, 1920; L. H. Borgström, *Geol. För. Förh. Stockholm*, **32**, 1525, 1910; C. Boulanger and G. Urbain, *Compt. Rend.*, **174**, 1442, 1922; A. Lacroix, *ib.*, **171**, 421, 1920; O. Hauser and F. Wirth, *Ber.*, **42**, 4445, 1909; W. Vernadsky, *Bull. Acad. St. Petersburg*, (6), **2**, 1273, 1908; W. B. Hicks, *Journ. Amer. Chem. Soc.*, **33**, 1422, 1911; C. James, *ib.*, **40**, 1674, 1918; H. S. Lukens, *ib.*, **35**, 1470, 1913; G. Urbain, *Journ. Chim. Phys.*, **4**, 64, 1906; J. Sterba-Böhm, *Zeit. Elektrochem.*, **20**, 289, 1914; A. H. Winter, *Ueber Vorkommen und Reindarstellung des Scandiums*, Berlin, 1911; T. Uemura, *Journ. Chem. Soc. Japan*, **44**, 296, 1923

§ 2. The Extraction of Scandium

R. J. Meyer,¹ and C. R. J. Sterba-Böhm have described the extraction of scandium from wolframite or tin-stone residues; and the separation of scandia from the contained rare earths depends (i) on the formation of a sparingly soluble fluoride when the soln. is treated with hydrofluoric acid or sodium fluosilicate; or (ii) on the formation of the hydroxide when boiled with sodium thiosulphate. If thorium be present it will accompany the scandia. Traces of yttria earths can be removed by repetitions of the process. The raw scandia prepared by R. J. Meyer's process was found by W. Crookes still to contain yttria and ytterbia—particularly when the fluosilicate method was used. P. and G. Urbain extracted scandia from thortveitite of Madagascar by the following process:

The mineral is easily attacked when fused with soda and the silica contained in it is eliminated when the residue is taken up with water. The insoluble residue is then treated with sulphuric acid, and the soln. of sulphates is precipitated with hydrofluoric acid. The fluorides of scandium and the rare earths are washed and then decomposed with sulphuric acid in excess. The scandium can be precipitated in a very pure state by means of potassium sulphate, after the sulphates have been transformed into nitrates. Ammonia never precipitates all the scandium from liquids containing it, but the precipitation of scandium phosphate is quantitative in an ammoniacal medium, provided that ammonium carbonate is absent. The latter appears to dissolve all scandium precipitates, and the soln. obtained are decomposed by heat, hydroxycarbonates being usually precipitated. The yttria earths containing scandium which have been concentrated in the mother liquors of the precipitates of the double potassium sulphates are transformed by ammonia into hydroxides. These are finally treated with a slight excess of acetylacetone. Only a trace of scandium is found

in the mother liquors and the rest of the earths are converted into the crystalline acetylacetonates. When these are treated with chloroform all the scandium is dissolved and a residue of yttric acetylacetonates is left. The final separation is effected by sublimation in vacuo at about 200°, the scandium compound only being volatile.

To extract the crude scandia from wolframite, R. J. Meyer employed the following process :

The residues remaining after the extraction of tin are fused with sodium carbonate, and the cold product extracted with water. Sodium tungstate passes into soln. The washed residue is dissolved in hydrochloric acid, and the rare earths precipitated by either oxalic or hydrofluoric acid. An excess of the precipitant is required so as to keep the iron and manganese in soln. The precipitate of rare earths contains 90–95 per cent. of scandium ; and it is ignited for the oxide, which is then dissolved in hydrochloric acid, and the soln. boiled for half an hour with sodium fluosilicate, when the scandium is precipitated as fluoride. Traces of the yttria earths may be removed from this by reprecipitation with sodium thiosulphate. The scandia is dissolved in hydrochloric acid. The excess of acid is removed by evaporation, and basic scandium thiosulphate precipitated at 100°. The washed precipitate is decomposed by hydrochloric acid, and the process repeated. The washed precipitate is thus freed from yttria earths, decomposed by hydrochloric acid, and reprecipitated as oxalate, and ignited for the oxide. The scandia so obtained is contaminated with thoria.

R. J. Meyer and co-workers found that 0.5 per cent. of thoria is difficult to remove from scandia—the oxalate process gives but an incomplete separation ; the thoria cannot be precipitated by the hydrogen peroxide process ; it cannot be detected spectroscopically ; and the ignited oxides dissolve in hydrochloric acid, even though the thoria alone would be insoluble. R. J. Meyer and H. Goldenberg showed that the most convenient method of detecting traces of thoria in scandia is the magnetic susceptibility test.

Thoria can be separated by the following methods : (i) R. J. Meyer and A. Gumperz, and A. H. Winter separated thorium from scandium by the fractional sublimation of the anhydrous chlorides—scandium chloride is the more volatile ; (ii) by boiling a neutral soln. of the chlorides with a large excess of a 20 per cent. soln. of sodium carbonate. Scandium sodium carbonate is precipitated while most of the thorium remains in soln. This process was found by R. J. Meyer and co-workers to yield a product so free from thoria that no radioactivity could be detected.

The conc. chloride soln. is poured into one of sodium carbonate containing 20 per cent. of anhydrous carbonate. One litre of sodium carbonate soln. is used for every 10 grms. of scandium oxide. The scandium dissolves entirely on stirring and warming. It is then boiled rapidly for half an hour, when the double carbonate is precipitated as a powder. The vol. of the soln. should be kept constant during the boiling. After the crystalline powder has settled, the liquid is poured off, and the precipitate washed by boiling with 20 per cent. sodium carbonate soln. for 15 mins.—this is repeated three times. The double carbonate is dissolved in two litres of cold water—4 hrs. and constant stirring are required for this purpose. The liquid is then filtered, acidified with hydrochloric acid, and the hydroxide precipitated by ammonium hydroxide while boiling. The scandium hydroxide is filtered off and well washed with boiling water until free from alkali. If necessary, the operation is repeated. Finally, the chloride soln. is precipitated with oxalic acid.

(iii) Another method used by R. J. Meyer and H. Goldenberg is to drop slowly a neutral soln. of the scandium salt into a 10–20 per cent. neutral soln. of sodium tartrate, and to boil the clear soln. with ammonia. The precipitated ammonium scandium tartrate is then washed with a dil. soln. of ammonium tartrate. (iv) According to R. J. Meyer and M. Speter, and B. Schweig, most of the thoria can be removed by the iodate process. An excess of potassium iodate sufficiently great to precipitate some of the scandia is added to a nitric acid soln. of the nitrates. The thorium iodate precipitate is separated from the soln., and the scandia precipitated in the usual way. (v) R. J. Meyer separated thoria from scandia by fractional crystallization of scandium ammonium fluoride. In this process, a neutral soln. of the chloride is mixed with an excess of aq. ammonium fluoride contained in a platinum dish, and vigorously stirred. A gram of scandia requires 8 grms. of ammonium fluoride.

On evaporating at 100°, insoluble thorium fluoride separates. Any scandium ammonium fluoride which crystallizes out can be redissolved by warming with more water. The soln. of scandium salt is then filtered off. R. J. Meyer and A. H. Winter also fractionally crystallized the acetylacetonates; W. Crookes, the metanitrobenzoates; R. J. Meyer, the hydrazine sulphates; and C. R. J. Sterba-Böhm, the formates. It is claimed that the last traces of ytterbia can be removed from scandia by the fractional crystallization of the formates. The various methods were examined by B. Schweig.

W. Crookes employed the following process for extracting scandia from wilkite. He did not consider a sample of scandia to be satisfactory if it had an at. wt. higher than 44.1, and if it showed the least trace of the dominant ytterbia spectral line $\lambda=36944.344$.

The ground mineral is passed through an 80-mesh sieve, then mixed with five times its weight of powdered potassium bisulphate and fused in a clay crucible. At first much frothing occurs, due to the escape of permanent gases and aq. vap. This ebullition can be abated by stirring with an iron rod. When in quiet fusion, the heat is raised to full redness for 10 mins. and the liquid mass poured on an iron plate. When cold, the melt is finely ground, mixed with water in the proportion of 1 kilo. to 5 litres, and mechanically agitated for about 12 hrs. It is then thrown on a linen filter and well washed. This treatment extracts most of the rare earths, together with a little titanitic, niobic, and tantalitic acids, and zirconia, but the bulk of these bodies is left behind. The soln. is supersaturated with ammonia and well boiled; this treatment precipitates all the earths, together with iron, titanitic acid, zirconia, etc. The precipitate of crude earths is filtered and well washed. The precipitated crude earths are converted into oxalates by heating the pasty precipitate in a dish with crystals of oxalic acid added gradually, excess being avoided as much as possible. When cold, the oxalates are filtered off, and the iron etc., in the filtrate is precipitated with ammonia. As scandium oxalate is slightly soluble in water, the iron precipitate will contain a certain proportion, which must be kept for subsequent working up. The washed oxalates are dried and ignited; the resulting earths form about 17 per cent. of the mineral and contain about 7 per cent. of scandia. The crude oxides are converted into sulphates by heating with sulphuric acid, the excess of acid being driven off by heat—not using too high a temp. The dry sulphates are agitated with plenty of water, and filtered from a little insoluble residue of the so-called metallic acids. Ammonia in excess is then added to the filtrate, and the precipitated oxides are washed, once more converted into oxalates in the manner already described, and the oxalates again washed, dried, and ignited. The ignited oxides are boiled in dil. nitric acid, filtered from a little insoluble matter, and evaporated to dryness. These somewhat complicated operations are to insure the removal of sulphuric and metallic acids, the presence of which interferes with subsequent fractionation. The earthy nitrates rich in scandium are mixed with an equal bulk of potassium nitrate and fused in large porcelain crucibles with constant stirring until the mass has the appearance of cream—fluid when hot, solidifying on cooling to a white enamel-like mass. On boiling this mass in water, a dense white basic nitrate separates and undecomposed nitrates are left in soln. Scandium and ytterbium, forming easily decomposed nitrates, concentrate in the insoluble end, while the yttrium and cerium earths, whose nitrates are less easily decomposed by heat, are left in the soluble end. Fractionation on these lines is now continued until spectrum photographs show the scandium to be pure. It is not difficult to obtain scandia free from all earths present except ytterbia and yttria; but the final elimination of pure scandia from these earths is a matter demanding much time and patience.

REFERENCES.

- ¹ C. R. J. Sterba-Böhm, *Zeit. Elektrochem.*, **20**, 289, 1914; P. and G. Urbain, *Compt. Rend.*, **174**, 1310, 1922; R. J. Meyer, *Zeit. anorg. Chem.*, **60**, 134, 1908; **86**, 266, 1914; *Chem. News*, **99**, 85, 97, 1909; *German Pat.*, *D.R.P.P.* 202523, 208355, 1908; R. J. Meyer and A. Wassjuchnow, *Zeit. anorg. Chem.*, **86**, 257, 1914; R. J. Meyer and A. H. Winter, *ib.*, **67**, 398, 1910; *Chem. News*, **102**, 163, 1910; R. J. Meyer and H. Goldenberg, *ib.*, **106**, 13, 1912; *Nernst's Festschrift*, 306, 1912; *Zeit. anorg. Chem.*, **102**, 13, 1912; R. J. Meyer and M. Speter, *ib.*, **41**, 97, 1904; **71**, 65, 1912; M. Speter, *German Pat.*, *D.R.P.P.* 282657, 1911; 292257, 1912; *Chem. Ztg.*, **33**, 306, 1910; A. H. Winter, *Ueber Vorkommen und Reindarstellung des Scandiums*, Berlin, 1911; R. J. Meyer and A. Gumperz, *Ber.*, **38**, 817, 1905; B. Schweig, *Zur Reindarstellung des Scandiums; Vorarbeiten zur Bestimmung des Atomgewichtes*, Berlin, 1917; W. Crookes, *Phil. Trans.*, **209**, A, 15, 1908; **210**, A, 359, 1910; C. James, *Journ. Amer. Chem. Soc.*, **34**, 757, 1912.

§ 3. The Properties of Scandium

W. R. Mott¹ gave 1200° for the m.p. of the metal, and calculated 2400° for the b.p. Scandium acts as a trivalent element and furnishes a basic oxide which is stronger than alumina, but weaker than that of any of the rare earths of the type R_2O_3 . The salts are distinctly hydrolyzed in aq. soln. They have a sweet astringent taste, and are colourless.

Many organic salts of scandium have been prepared—*e.g.* the formate, acetate, acetyl-acetate, propionate, butyrate, isobutyrate, isovalerate, oxalate, succinate, picrate, benzoate, *o*- and *m*-toluates, phenylacetate, pyromellitate, camphorate, mono-chloroacetate, malonate, malate, fumarate, tartrate, racemate, mesotartrate, $\alpha\beta$ -dibromopropionate, citrate, phthalate, tetrachlorophthalate, 2-nitrophenyl-4'-tolylamine-4-sulphonate, octomethyltetraminodihydroxyparadixanthylbenzenetetracarboxylate, and metanitrobenzoate.

Scandium gives no absorption spectrum in the visible region; and P. T. Cleve² observed no flame spectrum.

In preparing the rare earths for spectroscopic examination G. Eberhard recommended that the part which could be extracted with acids was first separated from the non-extractible part, and the former was then further separated by treatment with oxalic acid into a part which was precipitated by this acid, and a part which was not precipitated by oxalic acid, but gave a precipitate with ammonia. This precipitation of the remaining liquors with ammonia was always necessary, as scandium oxalate is exceedingly soluble even in weak mineral acids, such as the extraction always contains, and thus a part of the scandium remains in the liquid after precipitation with oxalic acid. The preparation of other minerals and rocks was essentially simpler. They were first finely powdered and then heated to a bright red heat for some time in a porcelain crucible to remove the gases and water contained in them. If this preliminary treatment is neglected unpowdered particles spurt with little explosions, and powdered pieces crumble up as soon as the arc is started. Since vaporization in the arc is a kind of fractional distillation, the material should be all completely vaporized until the spectral lines disappear. In the early stages the more volatile constituents—*e.g.* the alkalis—vaporize first, and scandium, zirconium, thorium, tantalum, etc., do not appear.

The list of lines in the spark spectrum of scandium given by L. F. Nilson includes some lines derived from impurities; R. Thalen worked with a better purified material, and H. A. Rowland identified a few of these lines with the Fraunhofer lines in the solar spectrum. The more intense of the numerous lines in the spark spectrum are 6305, 6080, 6038 in the orange-yellow; 5527 and 5031 in the green; and 4415, 4400, 4374, 4325, 4320, 4314, and 4240 in the blue and violet. Measurements have been made by F. Exner and E. Haschek, J. N. Lockyer and F. E. Baxendall, and W. Crookes. The arc spectrum has been examined by A. Fowler, S. P. de Rubies, A. S. King, J. M. Eder and E. Valenta, and F. Exner and E. Haschek. The more intense lines are 3353·90, 3372·33, 3558·69, 3567·89, 3572·73, 3576·53, 3614·00, 3630·93, 3642·99, 3907·69, 3912·03, 4020·60, 4023·88, 4247·02, 4314·31, 4320·98, 4325·22, 4374·69, 4400·63, 4415·78, and 6305·94. According to A. Fowler, the arc spectrum of scandium consists of two distinct sets of lines, which behave very differently in solar spectra. Each set includes both strong and faint lines. Lines belonging to one set correspond with the enhanced lines of other elements, notwithstanding that they appear strongly in the ordinary arc spectrum. (a) These lines are very feeble or missing from the arc-flame spectrum, and are strengthened in passing to the arc in hydrogen, or the spark. (b) They occur as relatively strong lines in the Fraunhofer spectrum. (c) They are weakened in the sun-spot spectrum. (d) They occur as high-level lines in the chromosphere. The remaining lines show a great contrast when compared with the first group. (a) They are relatively strong lines in the arc-flame. (b) They are very feebly represented in the Fraunhofer spectrum. (c) The stronger lines are prominent in sun-spot spectra. (d) They have not been recorded in the spectrum of the chromosphere. The special development of the enhanced lines in the Fraunhofer spectrum, together with their presence

in the upper chromosphere, indicates that the greater part of the scandium absorption in the solar spectrum originates at a higher level than that at which the greater part of the iron absorption is produced. The flutings which occur in the arc and arc-flame spectra do not appear when the arc is passed in an atm. of hydrogen. As suggested by R. Thalen, they are probably due to scandium oxide. W. J. Humphreys studied the effect of press. on the spectral lines. M. A. Catalan, W. M. Hicks, and E. Paulson studied the regularities in the structure of the scandium line spectrum; A. S. King, the Zeeman effect. J. M. Eder and E. Valenta gave drawings of typical spectra of the arc and spark spectra, Figs. 1 and 2. G. Eberhard showed spectroscopically the wide distribution of scandium. F. W. Dyson, G. Hofbauer, A. Fowler, and W. S. Adams studied the scandium lines in the solar spectrum, and the last-named identified 45 scandium lines in that spectrum.

H. G. J. Moseley, E. Hjalmar, and E. Friman studied the high-frequency or X-ray spectrum; and W. M. Hicks found that the high-frequency spectra of scandium, yttrium, lanthanum, and ytterbium show doublet series. V. Dolejssek, H. Fricke, E. Hjalmar, M. Siegbahn, and H. Stenstrom gave for the K-series $\alpha_2\alpha' = 3.02863$; $\alpha_1\alpha = 3.02526$ A.; α_3 and $\alpha_4 = 3.006$ A.; $\beta_1\beta = 2.77366$ A.; and $\beta_2\gamma = 2.7555$ A. The atomic structure and the paramagnetic properties observed by B. Cabrera were discussed by A. Dauvillier.

Reactions of scandium salts of analytical interest.—According to P. T. Cleve, a soln. of a scandium salt gives no precipitate with hydrochloric acid or with hydrogen sulphide. **Alkali hydroxides or ammonia** give a voluminous precipitate insoluble in an excess of the reagent; tartaric acid hinders the precipitation in the cold, but when heated, an abundant precipitation occurs. **Alkali or ammonium carbonate** gives a voluminous precipitate fairly soluble in an excess of the reagent. **Ammonium sulphide** gives a precipitate of the hydroxide. An excess of a sat. soln. of **potassium or sodium sulphate** with conc. soln. of the scandium salt precipitates the double alkali sulphate. **Sodium phosphate** gives a gelatinous precipitate; **sodium thiosulphate** with a boiling soln. gives an incomplete precipitation of a basic thio-sulphate. **Hydrogen peroxide** in neutral or slightly acid soln. gives no precipitate. **Iodic acid** readily precipitates scandium iodate which is readily soluble in nitric acid. **Hydrofluoric acid** precipitates a fluoride which is soluble in alkali fluorides, but much less soluble in acids than are ceric or yttrium salts. Hydrofluosilicic acid or **sodium fluosilicate** gives a white precipitate of scandium fluoride. Thorium fluoride is similarly precipitated. **Tartaric acid** gives no precipitate, but if ammonia be present, the double tartrate is precipitated.

A curdy precipitate is produced when **oxalic acid** is added to a soln. of scandium chloride. This is speedily transformed into a crystalline powder; the precipitate is sparingly soluble in acids, but readily soluble in ammonium oxalate. The precipitation is incomplete in acid soln. Scandium oxalate is slightly but distinctly soluble in water; it is less soluble than the oxalates of the rare earths in dil. acids, and unlike the rare earth oxalates, it is more soluble in dil. sulphuric acid than in dil. hydrochloric acid. In these respects it resembles thorium oxalate. Scandium oxalate forms sparingly soluble potassium, and sodium oxalates, and readily soluble ammonium oxalate. Although *scandium oxalate*, $\text{Sc}_2(\text{C}_2\text{O}_4)_3 \cdot 5\text{H}_2\text{O}$, appears to be more soluble than the oxalates of the rare earths, it is found in the first fractions when a mixture of ytterbium and scandium salts is fractionally precipitated. F. Wirth found at 25°, 100 grms. of a sat. soln. of scandium oxalate, in presence of 1.624, 2.4, and 4.478 grms. of ammonium oxalate, contain respectively 0.3019, 0.4012, and 0.7108 gm. of scandia. The solid phase with the first two soln. is the pentahydrate, and with the last-named soln. a mixture of the pentahydrate and ammonium oxalate. F. Wirth, and R. J. Meyer measured the solubility of scandium oxalate in hydrochloric and sulphuric acids, and, expressing the results in grams of scandium oxalate in 100 grms. of soln., with acids of normality N -, the solubilities at 25° and 50°, found by R. J. Meyer, are :

Normality	0.1	0.5	1.0	2.0	5.0
HCl { 25°	0.0299	0.0650	0.1020	0.1716	0.4170
50°	0.0420	0.0870	0.1435	0.2556	0.6533
H ₂ SO ₄ { 25°	0.0385	0.0997	0.1663	0.3176	0.7761
50°	0.0562	0.1481	0.2493	0.4429	1.1280

The results are plotted in Fig. 1. In quantitative analyses scandium is precipitated as oxalate, ignited and weighed as scandia, Sc₂O₃. Acid potassium oxalate precipitates a crystalline double salt.

The atomic weight of scandium.—The relations between ekaboron—*vide* Table I—and scandium agree with the assumption that scandium is a trivalent element. The X-ray spectrum fits in with the atomic number, 21. This was confirmed by the observations of R. J. Meyer and co-workers,³ A. H. Winter, and G. T. Morgan and H. W. Moss on scandium acetylacetonate. Mol. wt. determinations from its action on the f.p. of benzene, and on the b.p. of benzene, chloroform, and carbon disulphide, show that the formula is Sc[CH(COCH₃)₂]₃, and not Sc[CH(COCH₂)₂] or Sc[CH(COCH₃)₂]₄. F. M. Jäger's observations on the isomorphism of the scandium and indium acetylacetonates and ethylsulphates; and L. F. Nilson and O. Pettersson's observations on the sp. ht. of the oxides and sulphates of alumina, gallia, india, scandia, and yttria also agree with the trivalency of scandium. The difficulty in eliminating the rare earth elements from scandium salts explains the high results obtained by the early workers on the at. wt. of scandium. P. T. Cleve ignited the anhydrous sulphate, and from the ratio Sc₂(SO₄)₃:Sc₂O₃ obtained 44.96; from the synthesis of the sulphate, P. T. Cleve obtained from the ratio Sc₂O₃:Sc₂(SO₄)₃, 45.20; L. F. Nilson, 44.13; and R. J. Meyer and H. Goldenberg, 44.09. J. Meyer and B. Schweig obtained 45.23; R. J. Meyer and A. H. Winter, 45.0; and O. Hönigschmid, 45.099 ± 0.014. The International Committee on at. wt. determinations gives 44.1 as the best representative value. The **atomic number** of scandium is 21. F. W. Aston found scandium is a simple element without **isotopes**. G. Kirsch and H. Pettersson found that when bombarded with long-range α -rays, scandium does not give long-range particles in evidence of **atomic disintegration**. L. F. Bates and J. S. Rogers made observations on this subject.

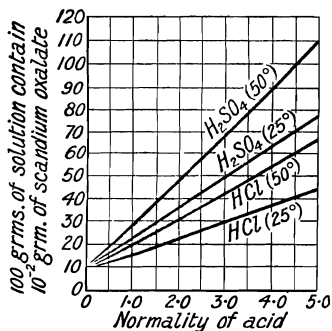

FIG. 1.—Solubility of Scandium Oxalates in Hydrochloric and Sulphuric Acids.

REFERENCES.

- W. R. Mott, *Trans. Amer. Electrochem. Soc.*, **34**, 555, 1918.
- L. F. Nilson, *Öfvers. Akad. Förh.*, **35**, 47, 1879; *Ber.*, **12**, 554, 1879; *Compt. Rend.*, **88**, 645, 1879; R. Thalen, *ib.*, **91**, 45, 1880; *Bihang. Svenska. Akad. Handl.*, **6**, 13, 1881; *Chem. News*, **47**, 217, 1883; W. N. Hartley, *Phil. Trans.*, **185**, A, 161, 1894; F. W. Dyson, *ib.*, **206**, A, 403, 1906; A. Fowler, *ib.*, **209**, A, 47, 1908; W. Crookes, *ib.*, **209**, A, 15, 1908; W. J. Humphreys, *Astrophys. Journ.*, **6**, 169, 1897; W. S. Adams, *ib.*, **30**, 86, 1909; A. S. King, *ib.*, **54**, 28, 1921; *Chem. News*, **123**, 179, 1921; H. A. Rowland, *Preliminary Tables of Solar Spectra*, Chicago, 1898; J. M. Eder and E. Valenta, *Atlas typischer Spectren*, Wien, 1911; *Sitzber. Akad. Wien*, **119**, 519, 1910; G. Hofbauer, *ib.*, **116**, 267, 1907; F. Exner and E. Haschek, *ib.*, **109**, 103, 1900; *Wellenlängentabellen für spectralanalytische Untersuchungen auf Grund der ultravioletten Funkenspectren der Elemente*, Leipzig, 1904; *Wellenlängentabellen für spectralanalytische Untersuchungen auf Grund der ultravioletten Bogenspectren der Elemente*, Leipzig, 1904; *Die Spectren der Elemente bei normalen Druck*, Leipzig, 1912; J. N. Lockyer and F. E. Baxendall, *Proc. Roy. Soc.*, **74**, 338, 1905; G. Eberhard, *Sitzber. Akad. Berlin*, **851**, 1908; **404**, 1910; *Chem. News*, **99**, 30, 1909; **102**, 211, 1910; P. T. Cleve, *Compt. Rend.*, **89**, 419, 1879; *Bull. Soc. Chim.*, (2), **31**, 486, 1879; *Chem. News*, **40**, 159, 1879; H. Kayser, *Handbuch der Spectroscopie*, Leipzig, **6**, 444, 1912; F. Wirth, *Zeit. anorg. Chem.*, **87**, 1, 1914; R. J. Meyer, *ib.*, **88**, 285, 1914; E. Paulson, *Ann. Physik*, (4), **45**, 419, 1914; (4), **45**, 1203, 1914; W. M. Hicks, *Phil. Trans.*, **212**, A, 33, 1912; **213**, A, 323, 1913; *Phil. Mag.*, (6), **28**, 139, 1914; H. G. J. Moseley, *ib.*, (6), **26**, 1024, 1914; (6), **27**, 703, 1914; E. Friman, *ib.*, (6), **32**, 497, 1916; E. Hjalmar, *Zeit. Physik*, **1**, 439, 1920; **7**, 341, 1921; *Phil.*

Mag., (6), **41**. 675, 1921; M. A. Catalan, *Anal. Fis. Quim.*, **20**. 606, 1922; **21**. 464, 1923; W. Grotrian, *Zeit. Physik*, **18**. 169, 1923; V. Dolejšek, *Compt. Rend.*, **174**. 421, 1922; H. Fricke, *Phys. Rev.*, (2), **16**. 202, 1920; N. Stenstrom, *Zeit. Physik*, **3**. 60, 1920; M. Siegbahn, *Jahrb. Rad. Elektron.*, **13**. 296, 1916; *Phil. Mag.*, (6), **37**. 601, 1919; A. Dauvillier, *Compt. Rend.*, **176**. 1802, 1923; B. Cabrera, *Anal. Fis. Quim.*, **20**. 92, 1922; G. Kirsch and H. Pettersson, *Nature*, **112**. 394, 1923; L. F. Bates and J. S. Rogers, *ib.*, **112**. 435, 1923; F. W. Aston, *ib.*, **112**. 449, 1923; *Journ. Soc. Chem. Ind.*—*Chem. Ind.*, **42**. 935, 1923; S. P. de Rubies, *Anal. Fis. Quim.*, **22**. 49, 1924.

³ R. J. Meyer and A. H. Winter, *Chem. News*, **102**. 163, 1910; *Zeit. anorg. Chem.*, **67**. 398, 1910; R. J. Meyer and A. Wassjuchnof, *ib.*, **86**. 257, 1914; R. J. Meyer and H. Goldenberg, *ib.*, **102**. 12, 1912; *Nernst's Festschrift*, 306, 1912; R. J. Meyer, *Zeit. anorg. Chem.*, **86**. 238, 1914; G. T. Morgan and H. W. Moss, *Journ. Chem. Soc.*, **105**. 196, 1914; A. H. Winter, *Ueber Vorkommen und Reindarstellung des Scandiums*, Berlin, 1911; J. Meyer and B. Schweig, *Zeit. anorg. Chem.*, **108**. 303, 1919; E. Wedekind and P. Hausknecht, *Eer.*, **54**. B, 253, 1921; B. Schweig, *Zur Reindarstellung des Scandiums; Vorarbeiten zur Bestimmung des Atomgewichtes*, Berlin, 1917; L. F. Nilson and O. Pettersson, *Compt. Rend.*, **91**. 232, 1880; *Ber.*, **73**. 1459, 1880; F. M. Jäger, *Proc. Acad. Amsterdam*, **16**. 1095, 1914; *Rec. Trav. Chim. Pays-Bas.*, **33**. 342, 1914; P. T. Cleve, *Compt. Rend.*, **89**. 419, 1879; *Bull. Soc. Chim.*, (2), **31**. 486, 1879; L. F. Nilson, *Compt. Rend.*, **91**. 56, 118, 1880; *Ber.*, **13**. 1430, 1880; O. Hönigschmid, *Zeit. Elektrochem.*, **25**. 91, 1919; G. Kirsch and O. Pettersson, *Nature*, **112**. 394, 1923; F. W. Aston, *Journ. Soc. Chem. Ind.*—*Chem. Ind.*, **42**. 935, 1923; *Phil. Mag.*, (6), **47**. 385, 1924.

§ 4. Scandium Oxide and Hydroxide

When scandium hydroxide, carbonate, oxalate, sulphate, or nitrate is ignited, **scandium oxide**, Sc_2O_3 —scandium sesquioxide, or scandia—is formed as a fine white powder. According to L. F. Nilson and O. Pettersson,¹ the sp. gr. is 3.864, and the sp. ht. 0.1530 between 0° and 100°. R. J. Meyer and co-workers found the magnetic susceptibility to be -0.05×10^{-6} electromagnetic mass units. E. Wedekind and P. Hausknecht found the mol. magnetism of scandium oxide to be -1.2×10^{-6} . According to L. F. Nilson, scandia dissolves slowly in cold acids and rapidly in hot acids, forming scandium salts. According to W. Crookes, ignited scandia dissolves with difficulty in dil. cold acids, but readily, in warm acids, and particularly so in conc. acids. Conc. sulphuric acid dissolves ignited scandia with the evolution of much heat. When alkali hydroxide or ammonia is added to a soln. of a scandium salt, a white voluminous gelatinous precipitate of **scandium hydroxide**, $\text{Sc}(\text{OH})_3$, is formed. It is insoluble in an excess of the precipitant. When dried in air, at ordinary temp., it forms a hard horny mass which, according to W. Crookes' analysis, has the composition $\text{Sc}(\text{OH})_3$. W. Crookes added that the hydroxide is a weak base with a marked tendency to form basic salts. It dissolves readily in dil. acids, forming, as in the case of the oxide, scandium salts. J. Böhm and H. Niclassen studied the X-radiograms of the sol and gel hydroxide.

REFERENCES.

¹ R. J. Meyer and H. Goldenburg, *Chem. News*, **106**. 13, 1912; *Nernst's Festschrift*, 306, 1912; R. J. Meyer and J. Wuorinen, *Zeit. anorg. Chem.*, **80**. 7, 1913; W. Crookes, *Phil. Trans.*, **209**, A, 15, 1908; L. F. Nilson, *Bihang. Svenska Akad. Förh.*, **47**. 6, 1880; *Ber.*, **13**. 1430, 1439, 1880; *Compt. Rend.*, **91**. 56, 118, 1880; L. F. Nilson and O. Pettersson, *Compt. Rend.*, **91**. 232, 1880; *Ber.*, **73**. 1459, 1914; E. Wedekind and P. Hausknecht, *ib.*, **54**. B, 253, 1921; J. Böhm and H. Niclassen, *Zeit. anorg. Chem.*, **132**. 1, 1923.

§ 5. Scandium Halides

W. Crookes¹ prepared **scandium fluoride**, ScF_3 , by heating scandia with aq. hydrofluoric acid; the semi-transparent gum-like mass changes on boiling to a white mass difficult to filter. When hydrofluoric acid is added to a soln. of scandium nitrate or sulphate, a white precipitate is formed, which on boiling resembles the preceding one. R. J. Meyer also precipitated scandium fluoride from warm—not cold—neutral or acid soln. by means of hydrofluosilicic acid. This behaviour is attributed to the ready hydrolysis of the fluosilicate in hot soln.: $\text{Sc}_2(\text{SiF}_6)_3 + 6\text{H}_2\text{O} = 2\text{ScF}_3 + 3\text{SiO}_2 + 12\text{HF}$, and the reaction is utilized in separating scandium from other rare earths. C. R. J. Sterba-Böhm said that W. Crookes' process does not

give a pure fluoride because of its great adsorptive power for salts in the mother-liquor; a pure preparation is obtained by the action of hydrofluoric acid on the oxide, and drying at 150°–180°. When dried over sulphuric acid, scandium fluoride is anhydrous, ScF_3 ; it loses a little weight at a red heat; at a higher temp. it sinters together; and fuses before the blowpipe flame. The salt is very stable, for it is but imperfectly decomposed by conc. sulphuric acid; it is completely decomposed by fusion with potassium bisulphate; the melt dissolves in acidulated water; and the soln. gives a precipitate of scandium hydroxide with ammonia. Unlike the fluorides of thorium and the rare earths, the solubility of the fluoride in mineral acids is less than that of the other rare earth fluorides, and approaches that of thorium fluoride. Scandium fluorides are very sparingly soluble in hydrochloric acid. R. J. Meyer found that unlike all the other earths—excepting zirconium—scandium fluoride is readily soluble in soln. of the alkali fluorides when acids are absent. According to C. R. J. Sterba-Böhm, fuoscandic acids do not exist in the free state, and of the fuoscandiates those of the type R_3ScF_3 are limiting forms. In its fluoride, scandium resembles calcium more than titanium, and in its property of forming complex fluorides, it resembles titanium and zirconium, and differs from the rare earths. Its co-ordination number is 6, that of boron 4.

R. J. Meyer prepared **ammonium fuoscandate**, $(\text{NH}_4)_3\text{ScF}_6$, or $3\text{NH}_4\text{F} \cdot \text{ScF}_3$, by treating a neutral or feebly acid soln. of a scandium salt with ammonium fluoride and evaporating the clear soln. in a platinum dish on a water-bath. The clear octahedral crystals are very soluble in water; the aq. soln. is not decomposed by boiling; hydrochloric acid precipitates scandium fluoride; and with dil. sulphuric acid, ammonium scandium sulphate is precipitated. It is assumed that the aq. soln. has the ions 3NH_4^+ and ScF_6^{3-} because it does not give any precipitate—hot or cold—with ammonia; sodium or potassium hydroxide, however, does precipitate scandium hydroxide from hot soln. When freshly precipitated scandium fluoride dissolves in conc. soln. of the alkali fluorides; and, when conc., the soln. deposit crystals of the double fluorides. When a soln. of scandium chloride is treated with potassium fluoride, the liquid becomes turbid; the turbidity clears up on dilution or boiling. C. R. J. Sterba-Böhm found that on hydrolysis: $(\text{NH}_4)_3\text{ScF}_6 \rightarrow (\text{NH}_4)_2\text{ScF}_5 \rightarrow (\text{NH}_4)\text{ScF}_4$, the solubility decreases progressively as ammonium fluoride is removed. Clear octahedral crystals of **potassium fuoscandate**, K_3ScF_6 , are obtained on evaporating the soln. The salt is less soluble than the ammonium salt in water; and it behaves like the ammonium salt with dil. acids, but when boiled with ammonia, scandium hydroxide is precipitated. The corresponding **sodium fuoscandate**, Na_3ScF_6 , is less soluble than the potassium salt, for it dissolves but sparingly in hot water. The microscopic crystals are easily soluble in dil. acids.

R. J. Meyer and H. Winter prepared anhydrous **scandium chloride**, ScCl_3 , by C. Matignon and F. Bourion's process, namely, by the action of a mixture of the vapour of sulphur chloride, S_2Cl_2 , and chlorine on the heated oxide. The reaction begins about 500°, and is soon completed, and the chloride begins to sublime between 800° and 850°—rather higher than thorium chloride. W. Biltz and W. Klemm found that molten scandium chloride freezes at 939°, and that the electrical resistance runs from 3 ohms at about 933° to nearly 10 ohms at 935°, and on melting it rises abruptly becoming nearly 70 ohms at 950°. Scandium chloride is a white solid which deliquesces rapidly in air; and dissolves in water with a hissing sound, and the development of much heat; the aq. soln. reacts acid owing to hydrolysis. The hydrolysis is more marked than with lanthanum and yttrium. R. J. Meyer found the eq. conductivity rose with dilution. Thus, for soln. with a mol of scandium chloride in *v* litres of water at 25°:

<i>v</i>	.	.	32	64	128	256	512	1024	$\lambda_{1024}-\lambda_{32}$
$\lambda(\text{ScCl}_3)$.	.	104.7	111.7	119.0	126.2	133.6	142.5	37.8
$\lambda(\text{AlCl}_3)$.	.	99.9	106.9	114.1	123.8	131.0	138.0	38.1

H. Ley found for the chlorides of the strongly basic earths—*e.g.* yttrium and cerium earths—a difference in the eq. conductivity of approximately $\lambda_{1024-32}=26$ units. This constant is fairly general for normally ionized and unhydrolyzed chlorides of the trivalent metals. Scandium chloride is considerably hydrolyzed in aq. soln. and it has a higher value, 37.8, than the normal one, 26, for $\lambda_{1024-32}$. Scandium chloride is insoluble in dry alcohol. When heated in air it forms an oxychloride which resists the action of acids and alkalis. P. T. Cleve obtained a mass of felted needle-like crystals by crystallization from a conc. soln. of the earth in hydrochloric acid. According to W. Crookes, the crystals can be dried by press. between filter-paper followed by a few hours in a desiccator—the composition corresponds with **hexahydrated scandium chloride**, $\text{ScCl}_3 \cdot 6\text{H}_2\text{O}$. The crystals are deliquescent, but not so much as the nitrate; and they are readily soluble in alcohol. When heated for 6 hrs. at 100° , water is given off, and the oily liquid solidifies to a white crystalline mass of **sesquihydrated scandium chloride**, $2\text{ScCl}_3 \cdot 3\text{H}_2\text{O}$; when heated to redness, water and hydrogen chloride are given off, and scandia, Sc_2O_3 , remains.

R. J. Meyer failed to prepare double compounds of scandium chloride with sodium, potassium, ammonium, and rubidium chlorides in acid or alkaline soln., but he did make **cæsium chloroscandate**, probably Cs_3ScCl_6 , which had so great a solubility that it was not obtained pure enough to justify analysis. The corresponding salts of praseodymium, neodymium, and samarium have the formula $\text{Cs}_3\text{MCl}_6 \cdot 5\text{H}_2\text{O}$, and lanthanum, $\text{Cs}_3\text{LaCl}_6 \cdot 4$ or $5\text{H}_2\text{O}$. Thorium forms two cæsium salts. In general, the tendency of the chlorides of the rare earths to form double salts is small; this is possibly due to the relatively strongly positive characteristics of the metals because the tendency to form double salts is most marked with the chlorides of the feebly positive metals—platinum, gold, bismuth, antimony, tin, etc. W. Crookes prepared a mass of felted yellow deliquescent needle-like crystals of **henicosihydrated auric chloroscandate**, $3\text{ScCl}_3 \cdot 2\text{AuCl}_3 \cdot 21\text{H}_2\text{O}$, by slowly evaporating over sulphuric acid in vacuo a mixture of conc. soln. of the component chlorides. When these crystals are allowed to stand about a fortnight in a desiccator over sulphuric acid, the weight rapidly diminishes, and remains constant when the composition corresponds with **octohydrated auric chloroscandate**, $3\text{ScCl}_3 \cdot 2\text{AuCl}_3 \cdot 8\text{H}_2\text{O}$; and when heated at 100° , for about six days, there are indications of an arrest in the rate of dehydration when the composition corresponds with **dihydrated auric chloroscandate**, $3\text{ScCl}_3 \cdot 2\text{AuCl}_3 \cdot 2\text{H}_2\text{O}$; but by continuously drying anhydrous **auric chloroscandate**, $3\text{ScCl}_3 \cdot 2\text{AuCl}_3$, is finally obtained.

W. Crookes prepared deliquescent rhombic crystals of **hexahydrated scandium bromide**, $\text{ScBr}_2 \cdot 6\text{H}_2\text{O}$, by evaporating on the water-bath a soln. of scandium hydroxide or carbonate in hydrobromic acid. When these crystals are heated in an air-bath to 120° , **sesquihydrated scandium bromide**, $2\text{ScBr}_3 \cdot 3\text{H}_2\text{O}$, is formed. O. Hönigschmid obtained the bromide, ScBr_3 , by heating a mixture of the oxide and carbon in a stream of bromine, and resubliming in vacuo. It sublimes above 1000° . Its sp. gr. is 3.910–3.913. It slightly attacks quartz at a high temperature: $4\text{ScBr}_3 + 3\text{SiO}_2 = 3\text{SiBr}_4 + 2\text{Sc}_2\text{O}_3$.

REFERENCES.

- ¹ P. T. Cleve, *Bull. Soc. Chim.*, (2), **31**, 486, 1879; R. J. Meyer and H. Winter, *Zeit. anorg. Chem.*, **67**, 398, 1910; R. J. Meyer and A. Wassjuchnoff, *ib.*, **86**, 271, 1914; C. R. J. Sterba-Böhm, *Bull. Soc. Chim.*, (4), **27**, 185, 1920; R. J. Meyer, *Zeit. anorg. Chem.*, **86**, 257, 1914; W. Crookes, *Phil. Trans.*, **209**, A, 15, 1908; **210**, A, 359, 1910; *Chem. News*, **98**, 274, 1908; **102**, 85, 1910; C. Matignon and F. Bourion, *Compt. Rend.*, **138**, 631, 1904; H. Ley, *Zeit. phys. Chem.*, **30**, 193, 1899; O. Hönigschmid, *Zeit. Elektrochem.*, **25**, 91, 1919; W. Biltz and W. Klemm, *Zeit. anorg. Chem.*, **131**, 22, 1923; W. Biltz, *ib.*, **133**, 306, 1924.

§ 6. Scandium Sulphide and Sulphate

F. Wirth¹ prepared **scandium sulphide**, Sc_2S_3 , by heating scandium sulphate in hydrogen sulphide. The yellow solid is stable in air even at 100° , but it is decomposed by boiling water and by dil. acids with the evolution of hydrogen sulphide. L. F. Nilson, and P. T. Cleve made a soln. of **scandium sulphate**, $\text{Sc}_2(\text{SO}_4)_3$, by dissolving the oxide, hydroxide, or carbonate in dil. sulphuric acid. E. Wedekind and P. Hausknecht found the mol. magnetism to be -62.5×10^{-6} . The ignited oxide dissolves with difficulty in the dil. acid, but readily in the conc. acid with the evolution of heat. Unlike most of the sulphates of the rare earths, P. T. Cleve showed that when a conc. soln. is heated, it does not deposit crystals, for it may be evaporated to a supersaturated syrup which L. F. Nilson found to deposit, on standing, globular aggregates of crystals of the *hexahydrate*, $\text{Sc}_2(\text{SO}_4)_3 \cdot 6\text{H}_2\text{O}$. W. Crookes found 100 parts of a sat. soln., at 12° , contains 44.5 parts of the anhydrous salt. F. Wirth found that the pentahydrate is the stable phase in contact with the soln. at 25° , for he said that at this temp. 100 grms. of the sat. soln. contain 28.52 grms. of the anhydrous sulphate, and added that, unlike the rare earth sulphates, the solubility of scandium sulphate does not decrease with a rise of temp. The hexahydrate, said W. Crookes, is not deliquescent in the ordinary air of a room even in damp weather, but it effloresces in dry air, loses one mol of water, and forms the *pentahydrate*, $\text{Sc}_2(\text{SO}_4)_3 \cdot 5\text{H}_2\text{O}$, which appears to be the most stable hydrate at ordinary temp. Scandium sulphate, said W. Crookes, is insoluble in alcohol so that the addition of alcohol renders turbid a conc. aq. soln. of scandium sulphate, and a heavy oily liquid separates out. This may be separated by filtration through paper moistened with alcohol, when the residue is left as a viscid liquid with the composition of the hexahydrate. The oily liquid becomes more viscid on exposure to air. When a mol of the hexahydrate is heated to 100° for 3 hrs., W. Crookes found that four mols of water are expelled and a *dihydrate* is formed; and when kept in a desiccator over conc. sulphuric acid for 170 hrs., two mols of water are expelled and a *tetrahydrate* is produced. W. Crookes found that a mol of the pentahydrate loses nearly five mols of water or about 20 per cent. at 150° ; and at about 500° , it loses weight corresponding with a little more than the theoretical amount of water because a little basic sulphate is formed. At 250° , the hydrated sulphate loses all its water, and becomes anhydrous $\text{Sc}_2(\text{SO}_4)_3$. The anhydrous sulphate is obtained by evaporating the acid soln. of the sulphate to dryness so as to get rid of the excess of sulphuric acid. At dull redness, say 550° , W. Crookes said that a mol of the sulphate loses a mol of sulphur trioxide, forming **scandium oxysulphate**, $\text{Sc}_2\text{O}(\text{SO}_4)_2$. At a higher temp. all the sulphuric acid is expelled and white powdered scandia, Sc_2O_3 , is formed. L. F. Nilson and O. Pettersson give 2.579 for the sp. gr., and 0.1639 for the sp. ht. between 0° and 100° . It is difficult to expel the last traces of sulphur trioxide by ignition, and therefore W. Crookes recommends moistening the ignited sulphate with water, adding a little ammonium carbonate, drying and igniting again. L. F. Nilson said that when the anhydrous sulphate is treated with water, a turbid liquid is produced. The anhydrous salt is hydrated very slowly with water before it dissolves. When heated with water, a clear soln. is produced.

F. Wirth found the solubility of scandium sulphate is at first increased and then diminished by the addition of sulphuric acid, thus:

Grms. H_2SO_4 per litre	0	24.5	49.0	121.5	243.3
Grms. $\text{Sc}_2(\text{SO}_4)_3$ in 100 grms. soln.	28.52	29.5	19.87	8.36	1.32
Solid phases		$\text{Sc}_2(\text{SO}_4)_3 \cdot 5\text{H}_2\text{O}$			$\text{Sc}_2(\text{SO}_4)_3 \cdot 3\text{H}_2\text{O}$

The pentahydrate dissolves in sulphuric acid of sp. gr. 1.6, and crystals of an acid sulphate, **scandium trihydrosulphate**, $\text{Sc}_2(\text{SO}_4)_3 \cdot 3\text{H}_2\text{SO}_4$, or **scandium sulphuric acid**, $\text{H}_3\text{Sc}(\text{SO}_4)_3$, separate out. The scandium is slowly and incompletely precipitated from aq. soln. of the sulphate by the addition of oxalic acid, or sodium thiosulphate.

The eq. conductivity, λ , of the soln. is such that $\lambda_{1024} - \lambda_{32}$, is less than would be anticipated; thus contrasting scandium and aluminium sulphates for soln. containing a mol of the salt in v litres of water:

v	32	64	128	256	512	1024	$\lambda_{1024} - \lambda_{32}$
$\text{Sc}_2(\text{SO}_4)_3$	28.3	33.8	40.1	47.7	75.6	72.1	43.8
$\text{Al}_2(\text{SO}_4)_3$	51.1	60.6	71.2	83.1	95.3	107.2	56.1

R. J. Meyer and co-workers assume that scandium sulphate is really the scandium salt, $\text{Sc}[\text{Sc}(\text{SO}_4)_3]$, of the complex acid $\text{H}_3\text{Sc}(\text{SO}_4)_3$, for in migration experiments, nothing abnormal occurs with scandium nitrate or chloride, but with the sulphate much scandium migrates to the anode. R. J. Meyer, and N. Drapier found that **sodium scandium sulphate**, $\text{Sc}_2(\text{SO}_4)_3 \cdot 3\text{Na}_2\text{SO}_4 \cdot 10\text{H}_2\text{O}$, or $\text{Na}_3\text{Sc}(\text{SO}_4)_3 \cdot 5\text{H}_2\text{O}$, can be prepared only in the presence of a large excess of sulphuric acid. It is readily soluble in water, and, like sodium thorium sulphate, in a conc. soln. of sodium sulphate. L. F. Nilson, and P. T. Cleve prepared **potassium scandium sulphate**, $\text{Sc}_2(\text{SO}_4)_3 \cdot 2\text{K}_2\text{SO}_4$, or $\text{K}_3\text{Sc}(\text{SO}_4)_3$, by adding an excess of a sat. soln. of potassium sulphate to one of scandium sulphate. He noted that the salt dissolves with difficulty even in boiling water, and not at all in a sat. soln. of potassium sulphate. He continued: "The composition of the double salt shows that scandium belongs to the group of gadolinite and cerite metals since all these metals give salts of the same typical composition." On the other hand, P. T. Cleve gave $\text{Sc}_2(\text{SO}_4)_3 \cdot 2\text{K}_2\text{SO}_4$ for the composition of the double salt, and he said that the salt is soluble in a sat. soln. of potassium sulphate. W. Crookes' analyses of the salt agree with L. F. Nilson's results, and he found that for every 100 c.c. of a cold sat. soln. of potassium sulphate the eq. of 1.473 grms. of scandium sulphate remained in soln. R. J. Meyer and A. H. Winter made **ammonium scandium sulphate**, $\text{Sc}_2(\text{SO}_4)_3 \cdot 3(\text{NH}_4)_2\text{SO}_4$, or $(\text{NH}_4)_3\text{Sc}(\text{SO}_4)_3$, like the potassium salt; and R. J. Meyer and co-workers found that when boiled with water the sparingly soluble double salt $\text{Sc}_2(\text{SO}_4)_3 \cdot 2(\text{NH}_4)_2\text{SO}_4$ separated out. R. J. Meyer obtained **hydrazine scandium sulphate**, $\text{Sc}_2(\text{SO}_4)_3 \cdot 3(\text{N}_2\text{H}_4)_2\text{SO}_4 \cdot \text{H}_2\text{O}$, in a similar manner, and found it to be fairly soluble in water.

REFERENCES.

¹ F. Wirth, *Zeit. anorg. Chem.*, **87**, 5, 1914; L. F. Nilson and O. Pettersson, *Compt. Rend.*, **91**, 232, 1880; *Ber.*, **13**, 1459, 1880; L. F. Nilson, *ib.*, **12**, 550, 1879; **13**, 1349, 1430, 1880; *Compt. Rend.*, **88**, 645, 1879; **91**, 56, 118, 1880; P. T. Cleve, *ib.*, **89**, 419, 1879; *Bull. Soc. Chim.*, (2), **31**, 486, 1879; *Chim. News*, **40**, 159, 1879; W. Crookes, *ib.*, **98**, 274, 1908; **102**, 73, 1908; *Phil. Trans.*, **209**, A, 15, 1908; **210**, A, 359, 1908; *Proc. Roy. Soc.*, **80**, A, 516, 1908; **84**, A, 79, 1910; R. J. Meyer and A. H. Winter, *Chem. News*, **102**, 163, 1910; *Zeit. anorg. Chem.*, **67**, 398, 1910; R. J. Meyer, A. Wassjuchnoff, N. Drapier, and E. Bodländer, *ib.*, **86**, 257, 1914; R. J. Meyer and O. Müller, *ib.*, **109**, 1, 1919; E. Wedekind and P. Hausknecht, *Ber.*, **54**, B, 253, 1921; H. Winter, *Ueber Vorkommen und Reindarstellung des Scandiums*, Berlin, 1911; B. Schweig, *Zur Reindarstellung des Skandiums; Vorarbeiten zur Bestimmung des Atomgewichtes*, Berlin, 1917.

§ 7. Scandium Carbonate, Nitrate, and Phosphate

According to W. Crookes,¹ **scandium carbonate**, $\text{Sc}_2(\text{CO}_3)_3 \cdot 12\text{H}_2\text{O}$, is formed as a bulky white precipitate when a soluble carbonate is added to a soluble scandium salt. When air-dried it appears to be dodecahydrated. The salt is inclined to decompose, and when dried at 100° , it loses a little carbon dioxide. Scandium carbonate is very sparingly soluble in cold aq. soln. of sodium or ammonium carbonate, but readily soluble in hot soln. Since under the same circumstances yttrium carbonate is sparingly soluble, the difference can be utilized as a basis for the fractional separation of yttrium and scandium. When these soln. are boiled, crystalline precipitates of sparingly soluble **sodium scandium carbonate**, $\text{Sc}_2(\text{CO}_3)_3 \cdot 4\text{Na}_2\text{CO}_3 \cdot 6\text{H}_2\text{O}$, or **ammonium scandium carbonate**.

$2\text{Sc}_2(\text{CO}_3)_3 \cdot (\text{NH}_4)_2\text{CO}_3 \cdot 6\text{H}_2\text{O}$, are formed. R. J. Meyer and H. Winter stated that these complex carbonates are less soluble in cold than in hot conc. soln. of alkali carbonate, showing that at a lower temp. more easily soluble double salts, possibly containing more water, are stable; the double carbonates dissolve in a large volume of cold water, but even in a 2 per cent. soln. the appearance of turbidity owing to hydrolysis can be observed after standing 16 hrs., and when the soln. are boiled, a basic carbonate or the hydroxide is precipitated.

P. T. Cleve, and W. Crookes prepared **scandium nitrate**, $\text{Sc}(\text{NO}_3)_3 \cdot 4\text{H}_2\text{O}$. Scandium hydroxide easily dissolves in dil. nitric acid, and ignited scandia dissolves in the hot conc. acid. The acid soln. over sulphuric acid dries to a gummy mass in which groups of stellate crystals appear; while a neutral aq. soln. when conc. on the water-bath and cooled furnishes prismatic, colourless crystals of the tetrahydrate. The salt is very deliquescent, and readily dissolves in water and in alcohol. When heated scandium nitrate decomposes more readily than any of the rare earth nitrates; the crystals get pasty at 100° , but do not melt; in vacuo, at 100° , the crystals give off water, and frit together, without melting, forming the anhydrous salt, $\text{Sc}(\text{NO}_3)_3$. The dried crystals show signs of melting at 125° , but melt to an opaque white liquid at 150° .

The hydrated nitrate, gradually heated in a silica crucible, fuses and boils, becomes opaque and evolves much water. If the heating be stopped at the proper time, the anhydrous nitrate is left, the whole of the water having been driven off. On continuing the heat nitrous vapours come off and the liquid becomes clear and liquid like water. Increasing the heat turns the liquid brown and drives off more nitrous vapours, ebullition becomes sluggish, the fused mass gets white and opaque, and finally there remains a white residue of scandia. When partially decomposed by heat, and the molten mass extracted with hot water, and the soln. well boiled, a basic nitrate, **scandium hydroxynitrate**, $\text{Sc}(\text{OH})(\text{NO}_3)_2 \cdot \text{H}_2\text{O}$, difficult to filter, is formed. When scandium nitrate is heated for 12 hrs. in a hot-air oven at 120° , **scandium oxynitrate**, $\text{Sc}_2\text{O}(\text{NO}_3)_4$, is formed. P. T. Cleve noted that a white gelatinous precipitate, presumably **scandium phosphate**, is formed when sodium phosphate is added to a soln. of a scandium salt.

REFERENCES.

- ¹ R. J. Meyer and H. Winter, *Zeit. anorg. Chem.*, **67**, 398, 1910; *Chem. News*, **102**, 163, 175, 1910; W. Crookes, *Phil. Trans.*, **209**, A, 15, 1908; **210**, A, 359, 1910; *Proc. Roy. Soc.*, **80**, A, 516, 1908; **84**, A, 79, 1910; *Chem. News*, **98**, 274, 1908; **102**, 73, 1910; P. T. Cleve, *ib.*, **40**, 159, 1879; *Bull. Soc. Chim.*, (2), **31**, 486, 1879; *Compt. Rend.*, **89**, 419, 1879.

CHAPTER XXXVIII

THE RARE EARTHS

§ 1. The Rare Earths

La terre est une des quatre substances simples, qu'on nomme élémens ou principes primitifs, parcequ'elles sont en effet les plus simples de celles qui entrent dans la combinaison des corps composés.—P. J. MACQUER

As indicated in the first chapter, the term *earth* was in common use by the early chemists; and, up to near the end of the eighteenth century, the earths were considered to be elemental.¹ The different kinds of earth were regarded as mixtures of the elemental earth with calcareous, argillaceous, arenaceous, and other matters; lime thus becomes calcareous earth; clay, argillaceous matter; etc. The term was then gradually restricted to substances with alkaline qualities which do not melt or change when heated; do not effervesce with acids; and are almost insoluble in water. Thus, near the end of the eighteenth century J. W. Nicholson wrote:

Chemists sometimes in a gross and inaccurate way call those substances earths which remain after the volatile products of distillation have arisen, and which are not soluble in water. This is not, however, sufficiently exact, though it is difficult to exhibit a good positive definition. Earths are bodies simple with respect to the present powers of chemical analysis, brittle, incombustible, infusible by the heat of furnaces, not soluble in many hundred times their weight of water, and destitute of that opaque brilliancy which characterizes metals. There are few earthy substances which may not be reduced by analysis to one of the five following primitive earths; the siliceous, argillaceous, calcareous, ponderous, and magnesian earths; or otherwise, taken substantively, they are called *silex*, *clay*, *lime*, *barytes*, and *magnesia*.

A. L. Lavoisier gave reasons for supposing that these earths are not themselves elements, but rather oxides of the elements. This was demonstrated by H. Davy in 1808. The term *alkaline earths* still persists for the oxides of calcium, strontium, and barium oxides derived from certain minerals. In 1794, J. Gadolin obtained yttria; and in 1804, M. H. Klaproth, and J. J. Berzelius and W. Hisinger independently obtained ceria from some comparatively scarce Swedish minerals. These products came to be called the **rare earths**.

A closer study of the rare earths first prepared has shown them to be remarkably complex, and the rare earth group now includes about sixteen elements, which have been generally recognized, and a number of others whose existence has not been satisfactorily established. The term "rare earth" is interpreted in different ways. For example, beryllia, thoria, zirconia, scandia, etc., are sometimes included with the rare earths, but the general tendency is to restrict the term to the sesquioxide components of the original ceria and yttria earths. Thoria and scandia, although closely associated with the rare earths, are often considered to be outside the group of rare earths proper. The rare earths thus comprise a curious group of basic oxides of elements which resemble one another so very closely that they appear to form a series of compounds with properties which change but slightly in passing from member to member. In many of their reactions they resemble aluminium and chromium, in others they resemble bismuth, and the alkaline earths. The group of rare earths is easily isolated, along with thoria and scandia, by adding oxalic acid to the sulphuric acid soln. remaining after the removal of the elements whose sulphides are precipitated by hydrogen sulphide. According to G. Urbain, the

precipitate containing the oxalates of the rare earths is then separated into three main groups according to the solubility of their complex salts in a sat. soln. of potassium sulphate. Thus :

TABLE I.—SUB-GROUPS OF THE RARE EARTHS.

Insoluble oxalate (Rare earth)	{	Insoluble potassium sulphates (Cerium family)	}	(Thorium, Th)
		Moderately soluble K sulphates (Terbium family)		(Scandium, Sc)
				Lanthanum, La
Readily soluble K sulphates (Yttrium family)	{	Cerium, Ce	}	Praseodymium, Pr
Erbium family		Neodymium, Nd		
	Ytterbium family	{	}	Samarium, Sa
Europium, Eu				
				Gadolinium, Gd
				Terbium, Tb
				Dysprosium, Dy
				Holmium, Ho
				Erbium, Er
				Thulium, Tm
				Yttrium, Y
				Ytterbium, Yb
				Lutecium, Lu

The separation of the group into these families is not so clean and sharply defined as can usually be obtained with other elements; because, added W. Crookes, as ordinarily understood **insolubility is a fiction**, and separation by precipitants is impossible. With our present knowledge it is extraordinarily difficult and in some cases impossible to separate the members of these series one from the other, and there is even the uncomfortable uncertainty that some of the so-called elements are not really homogeneous chemical individuals. The rare earths are in many cases so closely related that they can be separated into parts which give evidence of chemical individuality only by very special and laborious methods. The fractionation of the rare earths is described later.

In 1886, W. Crookes argued very ingeniously that the closeness of the relationship between the metals of the rare earths makes it probable that these elements are modifications of one common element. For example, by a laborious process of fractionation, W. Crookes subdivided yttria into some eight components with different phosphorescent spectra, but the difference in the *chemical properties* of the fractions was so slight that, if it were not for a slight difference in the solubilities of the different fractions in ammonia, they could not have been separated from one another. W. Crookes points out that the original yttrium passes muster as an element. It has a definite at. wt., it enters into combination with other elements, and it can be separated from them as a whole; but, the searching process of fractionation sorts the atoms of yttrium into groups with different phosphorescent spectra, and presumably with different at. wt., though, from the usual chemical point of view, all the groups behave alike. W. Crookes added: "Here, then, is a so-called element whose spectrum does not emanate equally from all its atoms; but some atoms furnish some, other atoms others, of the lines and bands of the compound spectrum of the element. Hence, the atoms of this element differ probably in weight, and certainly in the internal motions they undergo. Assuming that the principle is of general application to all the elements, and is limited only by our knowledge of tests delicate enough to recognize the simpler constituent groups of the different elements, it is inferred that there are definite differences in the internal motions of the several groups of the atoms of these chemical elements. The seven series of bands in the absorption spectrum of iodine, for instance, may prove not to emanate from every molecule, but "some of these molecules may emit some of the series, others others, and in the jumble of all these molecules, to which is given the name 'iodine vapour,' the whole seven series are contributors." W. Crookes thus introduced the conception of what he called **meta-elements** for those fractional parts of

an element which resemble one another much more closely than one ordinary element resembles any other. The properties of the ordinary elements are supposed to be an average of the properties of aggregates of several meta-elements. The hypothesis did not survive a closer study of the cathodic phosphorescent spectra (*vide infra*), but was resuscitated as the so-called theory of isotopic elements (4. 25, 9).

The following monographs deal with the rare earths: C. R. Böhm, *Die Verwendung der seltenen Erden*, Leipzig, 1913; *Die Darstellung der seltenen Erden*, Leipzig, 1905; *Die Fabrikation der Glühkörper für Gasglühlicht*, Halle a. S., 1910; S. J. Johnstone, *The Rare Earth Industry*, London, 1915; P. Nicolardet, *Industrie des métaux secondaires et des terres rares*, Paris, 1908; J. Schilling, *Das Vorkommen der seltenen Erde im Mineralreiche*, Stuttgart, 1904; J. F. Spencer, *The Metals of the Rare Earths*, London, 1919; S. I. Levy, *The Rare Earths—Their Occurrence, Chemistry, and Technology*, London, 1915; J. von Panayeff, *Verhalten der Wichtigsten seltenen Erden zu Reagentien*, Halle a. S., 1909; J. Herzfeld and O. Korn, *Chemie der seltenen Erden*, Berlin, 1901; P. Truchot, *Les terres rares—minéralogie, propriétés, analyse*, Paris, 1898; E. Cahen and W. O. Wooton, *The Mineralogy of the Rarer Metals*, London, 1912; P. E. Browning, *Introduction to the Rarer Elements*, New York, 1917; J. Ohly, *Analysis, Detection, and Commercial Value of the Rare Metals*, Denver, 1903; G. Wyruboff and A. Verneuil, *La chimie des terres rares*, Paris, 1903; P. T. Cleve, *Métaux terreux*, Paris, 1884; R. J. Meyer, *Bibliographie der seltenen Erden*, Hamburg, 1905; W. H. Magee, *Indexes to the Literatures of Cerium and Lanthanum*, Washington, 1895; A. C. Langmuir, *Index to the Literature of Didymium*, 1842–1893, Washington, 1894; C. H. Joliet, *Index to the Literature of Thorium*, 1817–1902, Washington, 1903; J. Koppel, *Die Chemie des Thoriums*, Stuttgart, 1901; R. J. Meyer and O. Hauser, *Die Analyse der seltenen Erden und der Erdsäuren*, Stuttgart, 1912; E. White, *Thorium and its Compounds*, London, 1912; H. Kellermann, *Die Ceritmetalle und ihre pyrophoren Legierungen*, Halle a. S., 1912.

REFERENCES.

¹ P. J. Macquer, *Dictionnaire de chimie*, Paris, 4. 53, 1778; J. W. Nicholson, *A Dictionary of Chemistry*, London, 1. 298, 1795; A. L. Lavoisier, *Traité de chimie*, Paris, 2. 194, 1801; H. Davy, *Phil. Trans.*, 98. 1, 333, 1808; W. Crookes, *B.A. Rep.*, 558, 1886; G. Urbain, *Ann. Chim. Phys.*, (7), 19. 184, 1900; J. Gadolin, *Crell's Ann.*, i, 313, 1796; *Svenska Akad. Handl.*, 15. 137, 1794; J. J. Berzelius and W. Hisinger, *Gehlen's Journ.*, 2. 303, 397, 1804; M. H. Klaproth, *ib.*, 2. 303, 1804; *Crell's Ann.*, i, 307, 1801; *Sitzber. Akad. Berlin.*, 155, 1804; *Beiträge zur chemischen Kenntniss der Mineralkörper*, Berlin, 1. 227, 1795; 3. 52, 1802; 4. 142, 1807. *Vide* 1. 1, 15; 1. 8, 10; 2. 20, 1 and 6.

§ 2. The History of the Rare Earths

The false may be true through ignorance, and the true may be false in the light of new knowledge.—C. BASKERVILLE.

Sein und das nicht Sein sind nämliche.—G. W. F. HEGEL.

In 1752, A. J. Cronstedt¹ described a new mineral—*ferrum calciforme, terra quadam incognita intime mixtum*—which he found associated with copper pyrites in a quarry near Ryddarhyttan, Sweden; he called the mineral *Tungstein*, or heavy stone. C. W. Scheele examined a specimen of J. C. Wallerius' *lapides stanniferi spathacei*, or Tennspath, *i.e.* heavy stone, from Bohemia, and found it contained lime and tungstic oxide. A. J. Cronstedt's tungstein did not contain tungstic oxide, and it was regarded as a false variety of tungstein. T. Bergman (1780), and J. J. y Don Fausto d'Elhuyar (1784) showed that the two minerals are distinct, and that while the Bohemian mineral is a calcium tungstate, scheelite, the Ryddarhyttan mineral, is a silicate of calcium and iron. The analysis of M. H. Klaproth, who called the mineral *ochroite*, and J. J. Berzelius and W. Hisinger, who called it *cerite*, showed that T. Bergman, and J. J. y Don Fausto d'Elhuyar had mistaken the rare earths for lime.

In 1794, J. Gadolin² discovered the first of the rare earths in a heavy black mineral which had been found at Ytterby. He obtained about 38 per cent. of the new oxide from the mineral, and noted that it resembled in some ways calcium oxide and in other ways alumina. J. Gadolin proposed to call the oxide *ytterbia*, and the mineral *ytterbite*. A. G. Ekeberg (1797) verified J. Gadolin's observations and

proposed to call the earth **yttria**, after the locality Ytterby, where the mineral was found, and the mineral from which ytterbia was obtained was termed *yttria-stone*, but later, the name was changed to *gadolinite*, after J. Gadolin; a few years later, he discovered tantalum in a sample of yttria-stone, and hence named it *yttriotantalite*. The discovery of yttria was confirmed by M. H. Klaproth and L. N. Vauquelin, who analyzed gadolinite and described some properties of yttria. Both J. J. Berzelius, and N. J. Berlin studied yttria, and they considered it to be homogeneous, and a chemical individual; but T. Scheerer noticed that when yttria was heated in an open vessel, it became yellow; and when re-heated in a reducing atm., the yellow colour disappeared. He therefore inferred that yttria contains another earth which forms a yellow powder when heated in air. In 1842, in a paper entitled *Nagot om Cer och Lanthan*, C. G. Mosander described how by the fractional precipitation of the oxalates by oxalic acid from acid soln., and of the hydroxides by dil. aq. ammonia, the old yttria could be separated into three new earths. In both processes, erbia separated first, terbia next, and yttria last. He called the most basic one **yttria**; the least basic one **erbia**; and the intermediate one **terbia**. The names erbia and terbia were formed from the letters of the word Ytterby, the name of the locality where gadolinite was found. Yttria was white and gave colourless salts; erbia was orange-yellow and gave colourless salts; while terbia was white and gave rose-coloured salts. C. G. Mosander's results were confirmed by several other chemists—J. J. Berzelius, L. Svanberg, and T. Scheerer. The fractional decomposition of yttrium nitrate by heat furnished N. J. Berlin two of C. G. Mosander's earths—white yttria, and white terbia. J. J. Berzelius and subsequent writers called C. G. Mosander's terbia, erbia. He could not find C. G. Mosander's erbia, now called terbia. O. Popp in 1864 repeated the work, and failed to find either erbia or terbia, and he suggested that the so-called erbia is a mixture of cerite earths, and terbia a mixture of erbia and yttria. M. Delafontaine, however, maintained that both C. G. Mosander's erbia and terbia were chemical individuals, and he obtained the former by fractional precipitation with potassium oxalate and removed the yttria and terbia with potassium sulphate; the remaining terbia and yttria were separated by fractionating the oxalates and dissolving out the yttria by repeated treatment with dil. acids. In 1866, J. F. Bahr and R. Bunsen, and in 1872, P. T. Cleve and M. Höglund, corroborated N. J. Berlin's observations, and succeeded in preparing white yttria, and N. J. Berlin's erbia, *i.e.* C. G. Mosander's terbia. N. J. Berlin, O. Popp, J. F. Bahr and R. Bunsen, and P. T. Cleve and M. Höglund failed to get terbia, *i.e.* C. G. Mosander's erbia. The doubts as to the existence of terbia were removed when M. Delafontaine, and J. C. G. de Marignac each succeeded in preparing specimens. In 1905, G. Urbain prepared terbia of a high degree of purity; and C. James, G. Urbain, and K. A. Hofmann have prepared moderately pure erbia.

M. Delafontaine treated a soln. of yttria with a sat. soln. of sodium sulphate containing crystals of the salt, and fractionated the nitric acid soln. of the precipitate as oxalate; the first fractions were treated with formic acid when crystals of terbiium formate separated from the conc. soln. The portion soluble in the sodium sulphate soln. contained an earth not so deeply coloured as terbia, and it also gave a base of lower mol. wt. It was therefore concluded that a new element was present which was named *philippium*—at. wt. 121 to 123; and characterized by an absorption band in the violet, $\lambda=450$. The existence of M. Delafontaine's philippium was disputed. J. L. Soret considered it to be identical with an earth-X, which he regarded as the source of a series of absorption bands in his examination of the spectrum of J. C. G. de Marignac's terbia and erbia preparations. M. Delafontaine maintained his philippium to be identical with P. T. Cleve's holmia, and J. L. Soret's earth-X, but P. T. Cleve denied this. H. E. Roscoe fractionated the sulphates of terbia with potassium sulphate and refractionated the first portions with formic acid, but obtained nothing more than a mixture of yttria and terbia. W. Crookes also denied the individuality of philippia. M. Delafontaine indicated methods by which he considered philippia could be obtained, but G. Urbain showed that M. Delafontaine was mistaken.

J. C. G. de Marignac fractionated the nitrates from yttria earth, and obtained yttria at one end of the series and erbia at the other. K. A. Hofmann and G. Krüss

also fractionally precipitated a soln. of terbia with aniline hydrochloride and obtained what appeared to be two new earths with elements of at. wt. 148–150, and 160 on the assumption that they were trivalent. They also showed that erbia is complex when fractionated with aniline hydrochloride. G. Krüss also doubted the individuality of erbia; for, by fractionating an alcoholic soln. with aniline, and treating the middle portions with ammonia, he could not obtain an earth with a constant mol. wt. J. F. Bahr discovered the beautiful spectrum of erbia, and W. Crookes mapped the spectral lines. In 1886, L. de Boisbaudran showed that after terbia had been freed from gadolinia and dysprosia, it still appeared complex on fractionation. In 1895, L. de Boisbaudran called attention to an absorption band $\lambda=4877$ in his preparation of terbia; he could not assign this band to any known element, and he provisionally assumed the existence of a new element which he termed Z_6 . W. Crookes found characteristic phosphorescent spectra in the ultraviolet in terbia, and he attributed the results to the presence of two new rare earth elements which he named *incognitum* and *ionium*. C. A. von Welsbach expressed the view that terbia is a complex with at least three different components; C. James and D. W. Bissel fractionated terbia by the bromate process, and found it to be homogeneous—a chemical individual.

J. C. G. de Marignac tried to isolate M. Delafontaine's philippia by the fractionation of the nitrates, and he isolated a colourless earth which he called **ytterbia**. It had no absorption spectrum, and assuming the element to be trivalent, its at. wt. was 172. The spark spectrum of ytterbia was studied by R. Thalen and by L. de Boisbaudran. L. F. Nilson verified the existence of ytterbia, and gave 173 for the at. wt. In 1907 G. Urbain, and in 1908 C. A. von Welsbach independently found ytterbium is really complex. The latter termed the components aldebaranium and cassiopëium; the former, **neoytterbium** and **lutecium**. The latter terms have been adopted by the International Committee on at. wt. C. A. von Welsbach also expressed the opinion that ytterbia contains yet a third element characterized by lines which are not present either in neoytterbium or lutecium; and G. Urbain, in 1911, announced that the lutecium which he obtained by the fractional crystallization of the nitrates from gadolinite furnishes another earth which he named **celtium**, and which is characterized by its arc spectrum and low magnetic susceptibility, but all the evidence adduced proved to be worthless. In the spring of 1922, A. Dauvillier found that a trace of an element with an X-ray spectrum corresponding with that of an unknown element, No. 72 in the periodic table, was contained in these residues, and it was proposed to call it by the very name previously employed for an element which did not exist—*vide* hafnium. J. M. Eder found that two fractions from C. A. von Welsbach's preparations of aldebaranium, showed lines characteristic of two elements which he named *denebium* and *dubhium*.

During his work on ytterbia, L. F. Nilson obtained a white oxide with a lower eq. wt. than ytterbia, and, suspecting the presence of a new element, he isolated an earth which he named **scandia**. The at. wt. of the element, 44, and the properties of the compound corresponded with those predicted by D. I. Mendeléeff for ekaboron. P. T. Cleve verified the individuality of scandium, and placed the at. wt. a little higher than L. F. Nilson. The spark spectrum of scandium was studied by R. Thalen.

P. T. Cleve showed that the fractional crystallization of J. C. G. de Marignac's erbia and terbia materials furnished three earths each of which is characterized by an absorption spectrum; and each spectrum is a portion of that which had been ascribed to erbia. The corresponding elements were called erbium, at. wt. about 166; and **holmium** and **thulium**, with at. wt. between 170 and 171. J. L. Soret, and P. T. Cleve believed that the earth-X was identical with holmia, and M. Delafontaine, that his philippia was identical with both holmia and the earth-X; but P. T. Cleve showed that holmia gave an absorption spectrum while philippia gave none. L. de Boisbaudran fractionated holmia and resolved it into two portions—one had absorption bands $\lambda=640.4$ and $\lambda=536.3$, while the other had absorption bands $\lambda=451.5$ and

$\lambda=753.0$. The first two bands were those attributed by P. T. Cleve, and J. L. Soret to holmia, and hence the same name was reserved for this fraction. The other bands were attributed to a new earth which was named **dysprosia**. In 1906, G. Urbain obtained dysprosia of a high degree of purity. W. Crookes stated that he had isolated an earth with an absorption band $\lambda=451.0$, and therefore inferred that dysprosia is itself complex. L. de Boisbaudran agreed with this conclusion. G. Krüss and L. F. Nilson found that the absorption spectra of thulia indicates that the earth is a complex of two components; dysprosia, three; and holmia, four. K. A. Hofmann and G. Krüss also concluded that holmia is a complex earth. In 1911, O. Holmberg obtained holmia of a high degree of purity. The absorption and spark spectrum of thulia has been studied by R. Thalen. In 1911, C. James obtained thulia of a high degree of purity.

L. de Boisbaudran examined the spark spectra of soln. of terbia, and he concluded that two bands, at $\lambda=573.0$ and $\lambda=543.2$, are caused by two elements which he called respectively Z_{α} , and Z_{β} , and later, another band corresponding with a third element, Z_{γ} . Soln. of yttria showed no such spectrum. By the method of fractional precipitation with ammonia, W. Crookes claimed to have separated the original yttria into nine new earths or oxides of what he called meta-elements, for he showed that all the nine differed from each other and from the original earth. He provisionally posited these supposed elements:



Some, not all, of these earths when sealed up in exhausted tubes and subjected to the induction discharge, phosphoresce. Their phosphorescent spectra are to a certain extent different, and this the more the further the earths were removed from one another in respect of their basicity. The extreme fractions showed considerable differences in their phosphorescent spectra, but the only chemical property in which they appear to differ is a slight difference of basicity among themselves. There are no perceptible differences in the at. wt. of the fractionated earths; spark-spectra of the original yttria, the earth G_{η} and the earth G_{δ} were exactly the same. G. Krüss and L. F. Nilson assumed that each absorption band in the spectrum of a rare earth corresponds with a different element, and hence inferred that the absorption bands of erbia, holmia, didymia, samaria, and thulia showed that these earths are really composed of twenty different elements. There is, however, no foundation for the assumption. W. Crookes made the extraordinary suggestion that only the lines due to the impurity could be observed in the spectrum of an earth and none due to the earth itself. He said:

The nine earths are chemical elements differing in basic powers and several other chemical and physical properties, but not sufficiently, to enable us to effect any but a partial separation. Thus, G_{δ} , for instance, gives a certain spectrum under the influence of the electric spark; the other earths, G_{ϵ} , G_{η} , . . . are contaminated with a certain quantity of this G_{δ} ; and so the spectra of these other earths G_{ϵ} , G_{η} . . . is that of G_{δ} and G_{δ} only, they themselves presumably not having any spectra at all, or what they do have is masked by the greater intensity of that of G_{δ} .

W. Crookes then argued that the fractionated earths are to be regarded as isomorphous bodies composed of the same atoms arranged in different ways within the molecule. He said:

Elements are not so simple as we suppose. Our notions of a chemical element have expanded. Hitherto the molecule has been regarded as an aggregate of two or more atoms, and no account has been taken of the architectural design on which the atoms have been joined. We may consider that the structure of a chemical element is more complicated than has hitherto been supposed. Between the molecules we are accustomed to deal with in chemical reactions, and ultimate atoms as first created, come smaller molecules or aggregates of physical atoms; these submolecules differ one from the other according to the position they occupy in the yttrium edifice. We may consider them similar to the carbon atoms in the benzene ring which have the impress of their position, 1, 2, 3, 4, 5, stamped on them.

The sole ground upon which this argument is based is the difference in the phosphorescent spectra of the fractionated earth. Although W. Crookes stated that the

more this method is used the more reliable it appears, yet he also showed that a bright orange line $\lambda=269.3$ is found in the spectrum of a mixture of samaria and yttria earths which has been treated with sulphuric acid and ignited. If the two earths are mechanically mixed without the acid treatment, no orange line is obtained; nor is the orange line obtained either with the earth alone, or with either earth mixed with but a small proportion of the other. As H. M. Vernon showed, this makes it appear as if the bright orange line is due to a combination of the two earths in agreement with the fact that the spectra of salts which are not decomposed into their constituents by heat are often very different from the spectra of the constituent elements. Hence also it follows as an alternative to W. Crookes' hypothesis that the phosphorescent spectra of the Crookes' nine earths G_a, G_b, \dots are produced by combinations of two or three simple earths. This view is further supported by W. Crookes' observation that when his new earths are mixed with varying proportions of lime or baryta and ignited, different phosphorescent spectra are again obtained. The nature of the spectrum is dependent on the nature and proportion of the admixed base. W. Crookes has emphasized the fact that the merest trace of a certain earth, unable to be detected by chemical means, can cause great variations in the spectrum of another earth. He said:

One important lesson taught by the many anomalies unearthed in these researches is that inferences drawn from spectrum analysis *per se* are liable to grave doubt, unless at every step the spectroscopist goes hand in hand with the chemist. Spectroscopy may give valuable indications, but chemistry must after all be the final court of appeal.

The argument that an element can be decomposed into meta-elements by fractional precipitation is based on the power of phosphorescent spectra to distinguish between the unequivocally different elemental forms of matter. The spectral evidence, however, is considerably weakened by the fact that the spectrum of an earth can be greatly altered by admixture or combination with another earth. The difficulty is enhanced by the fact that it is almost if not quite impossible to obtain by fractionation, earths which are quite free from other earths present as impurities, and this the more because the earth under consideration may have properties very like those of half a dozen other earths. There is a large number of these earths with very similar properties, and the resemblance is the closer the larger the at. wt. of the elements under consideration. The fact that yttria obtained from different minerals gave phosphorescent spectra of varying intensity was taken by W. Crookes to mean that a partial separation had occurred in nature. L. de Boisbaudran, and E. Demarçay also opposed W. Crookes' hypothesis and conclusions. The former showed that pure yttria gave no phosphorescent phenomena; and the fluorescent bands obtained by W. Crookes were attributed to the presence of foreign earths— Z_a and Z_b , in fact—very difficult to remove from yttria. W. Muthmann and E. Baur, E. Baur and R. Marc, G. H. Bailey, P. Schottländer, etc., showed that the intensity and nature of the phosphorescent spectrum and absorption bands can be varied in a marked way by the addition of traces of foreign substances; and G. Urbain demonstrated that the phosphorescent spectrum of varying mixtures of gadolinium and terbium sulphates contain the very bands which W. Crookes attributed to meta-elements G_a, G_b , *ionium* and *incognitum*.

In 1896, P. Barrière announced the existence of a new metal which he named *lucium*. The earth from which it was derived occurred in the yttria earths separated from monazite. The at. wt. 104 was assigned to it. W. Crookes, however, showed that lucia is really yttria mixed with didymia, erbia, and terbia. This was confirmed by W. Shapleigh, who found that a sample of lucia contained 94 per cent. of yttria earths, 3.7 per cent. of ceria earths, 1.1 per cent. of thoria, and 1.2 per cent. of other oxides. P. Schützenberger and O. Boudouard fractionated yttria earths from monazite sands, and at the lower limit of fractionation they obtained an earth with a trivalent metal of at. wt. 95 to 102. G. P. Drossbach also obtained a similar earth from monazite, and E. Boudischowsky fractionated the yttria earths with acetyl

acetone, and also obtained a lower limit. G. Urbain showed that by fractionation with ethyl sulphate this hypothetical earth could be resolved into, terbia, at. wt. 151.4, at one end, and yttria, at. wt. 89, at the other; he then concluded that the hypothetical earth is principally yttria mixed with some erbia and terbia. The separation of a base with a constant mol. wt. as the lower limit of a series of fractions is a phenomenon which does not establish the existence of a new element, for A. E. Nordenskjöld made a rare earth mixture which he knew contained yttria, erbia, and terbia, and yet, under these conditions, gave a constant at. wt. 107. In 1898, W. Crookes announced the existence of a new element which he called *monium*, as a result of fractionating the yttria earths. The principal lines in the spectrum were $\lambda=3120$ and 3117 . W. Crookes later changed the name to *victorium*, at. wt. 117. G. Urbain showed that the spectrum and at. wt. of a mixture of 58 parts of yttria and 226 parts of gadolinia is the same as that of W. Crookes' victorium. E. Baur and R. Marc came to a similar conclusion.

In 1803, soon after the discovery of yttria in 1794, M. H. Klaproth, and J. J. Berzelius and W. Hisinger simultaneously found another new earth, termed **ceria**, in the minerals cerite, and tungstein or ochroïte. Ceria resembled yttria in many respects, but unlike yttria was insoluble in ammonium carbonate, and acquired a light brown colour on ignition, and hence M. H. Klaproth suggested the name *ochroïte* for the earth. In 1814, J. J. Berzelius showed that yttria derived from orthite contained considerable quantities of ceria. B. Brauner expressed the belief that what is now recognized as ceria is mixed with another element which he termed *metaceria*. The former is white, the latter rose-brown. G. P. Drossbach could not confirm the existence of metacerium; nor did B. Brauner mention its existence in his later work. P. Schützenberger and O. Boudouard doubted the individuality of ceria, but G. Wyrouboff and A. Verneuil showed that they worked with impure specimens. In 1817, J. J. Berzelius isolated an earth which he called *thorine*, but in 1824, he showed that thorine is a phosphate of impure yttria. In 1828, J. J. Berzelius isolated the **thoria** from the mineral thorite; and in 1851, C. Bergemann, after extracting thoria from the mineral orangeite, obtained a fraction which he stated contained an unknown element to which he gave the name *donarium*. A. Damour, N. J. Berlin, and M. Delafontaine stated that donarium is really a mixture of thorium, lead, and uranium, and about the same time C. Bergemann was convinced that his report was premature.

In 1839, C. G. Mosander showed that ceria is really a complex earth. He was able to separate from it a white earth, **lanthana**, and later he obtained *didymia* from the same source. The means of detecting the element didymium found by C. G. Mosander (1842) in ceria and lanthana, were so imperfect that R. Hermann argued against its very existence. J. H. Gladstone, however, demonstrated that soln. of its salts possess a peculiar absorption spectrum; and this was soon followed by the application of the spectroscope to detecting small quantities of the rare earths and guided chemists in the better purification of ceria, lanthana, and yttria. J. H. Gladstone mentioned two absorption bands; O. L. Erdmann, seven; O. N. Rood, twelve; and J. F. Bahr and R. Bunsen, eleven. L. de Boisbaudran showed that some of the bands formerly attributed to didymium really belonged to samarium. G. Krüss and L. F. Nilson in a paper: *Was bedeutet Dym?* showed that didymia derived from different localities gave an absorption spectrum with bands of varying intensity, and hence concluded that the so-called didymium is probably complex; and P. T. Cleve, C. M. Thompson, and H. Becquerel came to a similar conclusion. In 1882, B. Brauner also expressed the opinion that didymia, from which all known earths have been removed, is a mixture, and in 1885 C. A. von Welsbach discovered that didymium when freed from samarium is a mixture of two elements which he named *praseodidymium* and *neodidymium*, terms which were soon abbreviated to **praseodymium** and **neodymium**. The salts of the former were green, and of the latter, rose-red. G. Krüss and L. F. Nilson examined praseodymia and neodymia spectroscopically, and concluded that at least eight elements are

present; C. M. Thompson also assumed that at least five elements are present. W. Crookes added: Neodymium and praseodymium are not to be considered to be the names of actual elements, but rather the names of complex groups of molecules with which the complex molecule didymium splits up by one particular method of fractionation; other methods of fractionation would probably split didymium into different products. W. Muthmann and L. Stützel, and C. R. Böhm denied the elementary nature of praseodymium. No confirmation of the complexity of praseodymia has been obtained, although K. von Christchoff claimed to have obtained a third constituent which he called *glaucodidymia* or *glaucodymia*, and which furnished blue salts.

While analyzing the rare earth mineral samarskite, from North Carolina, J. L. Smith isolated an earth which he called *mosandra*; he considered the earth to be new because of the insolubility of its double potassium sulphate in a sat. soln. of potassium sulphate. J. C. G. de Marignac showed that solubility is only a relative quality, and considered mosandra to be identical with terbia; this view was shared by M. Delafontaine. Some years later, L. de Boisbaudran found a sample of mosandra to contain didymia, samaria, gadolinia, and terbia. In 1878, M. Delafontaine described a new oxide *decipia* which he had extracted from impure didymia derived from samarskite. The element, assumed trivalent, was stated to have an at. wt. 159, and to be characterized by absorption bands $\lambda=416.0$ and 478.0 . L. de Boisbaudran observed some new lines in the spectrum of impure didymia from samarskite. The absorption spectrum showed two strong bands in the blue— $\lambda=4800$ and 4635 —and three faint ones, one of which coincided with $\lambda=416$ of M. Delafontaine's decipia. Finally, he separated from decipia a new earth which he called **samaria**, and which exhibited three of these absorption bands. Meanwhile, in 1880, J. C. G. de Marignac isolated two new earths from samarskite, one he called γ_a and the other γ_b . The mixed earths were fractionated by partial decomposition of the nitrates, and by precipitation with a sat. soln. of potassium sulphate. The three fractions were (i) soluble in less than 100 vols. of the potassium sulphate soln.; (ii) soluble in 100 to 200 vols. of potassium sulphate soln.; and (iii) still less soluble. The fraction (i) was termed γ_a , and fraction (iii), γ_b . J. L. Soret showed that spectroscopically γ_b and samaria are identical, and that decipia resembles neither γ_b nor γ_a , but was probably a mixture of both γ_a and γ_b . The residue remaining after the separation of samaria from decipia was found to be a mixture of γ_a and samaria. In his memoir: *Sur les terres de la samarskite*, J. C. G. de Marignac, speaking of γ_a , said:

L'existence de cette base comme terre distincte est rendue évidente par le fait que son équivalent est un maximum entre celles qui l'avoisinent par leur solubilité dans le sulfate de potasse. . . . Elle ne saurait être confondue avec aucune de celles qui ont été signalées jusqu'ici.

In 1886, L. de Boisbaudran obtained a purified form of γ_a , and named it **gadolinia**. In 1905, G. Urbain obtained gadolinia of a high degree of purity. Thus did decipia disappear from the list of rare earths. Still further, W. Crookes showed that J. C. G. de Marignac's earth, provisionally named γ_a , possessed a spectrum analogous to that of a mixture of samaria 39, and yttria 61, which had been ignited with sulphuric acid, except that a citron band present in the artificial mixture is absent from the spectrum of the γ_a earth. Hence, added W. Crookes:

The earth γ_a is shown to consist of samaria with the greenish-blue band of yttria, and some of the other yttria bands added to it. It proves further that the citron band, which was hitherto regarded as one of the essential bands of the yttria spectrum can be entirely removed, whilst another characteristic yttrium group, the green double band, can remain with heightened brilliancy. If, now, it were possible to remove the citron-band-forming body from this mixture, the earth γ_a would be left behind; in fact, the earth γ_a would have been recomposed from its elements.

Consequently, as H. M. Vernon has pointed out, the spectral test is unreliable, whether the earth γ_a is identical with or distinct from the yttria-samaria earth.

L. de Boisbaudran did not accept W. Crookes' conclusion. A. Bettendorff separated gadolinia from samaria, but could get it to yield no spark spectrum. The spectra assigned by W. Crookes to the meta-elements, G_α , G_β , and G_ζ , are duplicated by mixtures of terbium and gadolinium. E. Demarçay reported four elements were revealed by the spectroscopic examination of gadolinia, terbia, erbia, and yttria earths; these elements were provisionally designated Γ , Δ , Ω , and Θ . The spark spectrum of the brown oxide obtained from the most soluble portions of *déjà assez pur* gadolinium magnesium nitrate furnished the lines $\lambda=3704\cdot3$, $3703\cdot2$, $3676\cdot7$, $3568\cdot4$, $3561\cdot7$, $3540\cdot2$, $3523\cdot4$, $3508\cdot5$, which possibly belong to pure terbium, but since the purity of the material used was indeterminate, they are attributed provisionally to an element denoted by Γ . In some less coloured oxides, the following lines were observed, possibly belonging to the earth Z_γ of L. de Boisbaudran: $4212\cdot6$, $4195\cdot5$, $4187\cdot3$, $3978\cdot6$, $3945\cdot0$, $3595\cdot0$, $3550\cdot0$, $3531\cdot3$. The element producing these lines is denoted by Δ . In some yttrium, containing fractions intermediate in solubility between holmium and erbium, two intense lines, $3967\cdot9$ and $3930\cdot9$, were recorded, belonging to the hypothetical element Ω . In the spectra of the slightly basic earths, intermediate between ercium and ytterbium, the two lines $4008\cdot2$ and $3906\cdot5$ are very intense; these are attributed to an element Θ .

In 1883, P. T. Cleve made an extended examination of samarium. He considered it to be a chemical individual, and described many of the salts. Three years afterwards E. Demarçay separated a new element from P. T. Cleve's samaria, and designated it S_1 . A. Bettendorff could not confirm E. Demarçay's result, but in 1892, L. de Boisbaudran found that samaria is really complex, for, when fractionated with ammonia, the least basic fractions differed from the other fractions in showing a spark spectrum with three new blue lines, and a *reversion spectrum* with a new band between $\lambda=6110$ and 4593 .

In the reversion spectrum, an induction spark is taken between the surfaces of a conc. acid soln. of the chloride and a clean platinum wire a few millimetres apart. The wire is kept negative, the soln. positive. A thin fluorescent light appears at the surface of the liquid. This layer gives a spectrum of nebulous bands. L. de Boisbaudran called such spectra *les spectres de renversement* because the direction of the spark is the reverse of that commonly employed.

He attributed the new spark lines to an element which he provisionally called Z_ϵ , and the band likewise to an element Z_ζ . He expressed no opinion as to the identity of the two elements. In 1893, he showed that Z_ζ is closely related with W. Crookes' S_8 , which exhibited an anomalous band in the phosphorescent spectrum of the rare earths. In 1896, E. Demarçay fractionally crystallized samarium nitrate, and obtained a new earth which he designated Σ , in addition to gadolinia and samaria. The third component was readily soluble in nitric acid, its double potassium sulphate was readily soluble, and the base was feebly basic. C. Benedicks could find no signs of E. Demarçay's Σ . In 1906, E. Demarçay fractionally crystallized the double magnesium nitrate, and obtained the new earth fairly pure. He identified it with the S_8 of W. Crookes and the Z_ϵ and Z_ζ of L. de Boisbaudran, all of which were shown to be the same earth which was called **europia**. In 1917, J. M. Eder considered that the spectra of fractions of samaria show the presence of another element which he named *eurosamarium*; and four years later, he gave spectroscopic evidence of a new element lying between terbium and dysprosium, and named it *welsium* in honour of C. A. von Welsbach.

In addition to thorine, donarium, mosandrum, philippium, decipium, lucium, victorium or monium, incognitium, and ionium, many other elements have been reported, but when tested have been found wanting; there are others—metacerium, glaucodymium, E. Demarçay's Ω and Θ , denebium, dubhium, eurosamarium—which have been reported, but whose claims have not been established. Lists have been compiled by F. P. Venable, C. Winkler, P. T. Cleve, H. C. Bolton, and C. Baskerville.

In 1811, T. Thomson prepared what he called *junonium* from the mineral allanite, but T. Scheerer and T. Thomson himself later showed that the report was based on an error in the analytical work. L. W. Gilbert, in 1818, announced *vestium* or *sirium*. E. Linnemann, in 1886, announced *austrium* in orthite, but L. de Boisbaudran, and R. Pribram showed it to be impure gallium. J. F. Bahr, in 1862, obtained what he called *wasmium* from orthite and gadolinite, but M. Delafontaine, H. P. Stevens, and O. Popp regarded it as impure cerium; J. Nicklès, as mixture of yttria, terbia, and didymia; and J. F. Bahr himself later identified *wasmium* with thorium. J. L. Sraith, in 1884, reported two new elements in samarskite, these he called *columbium* (not niobium) and *rogerium*. K. von Chrustchoff, in 1887, detected spectroscopically what he thought to be a new element in monazite, etc.; he called it *russium*, this was later regarded as being similar to P. Barrière's lucium—*vide supra*—L. Wenghöffer said it is a mixture of thorium and cerium. K. Lauer and P. Antsch, in 1890, announced *damarium*; and H. D. Richmond and H. Off, in 1892, *masrium* in a fibrous alum from Egypt. C. Baskerville, in 1901, reported two radioactive elements, *carolinium* and *berzelium*, in thorium; K. A. Hofmann and W. A. A. Prandtl, in 1901, *euxenium*, in Norwegian euxenite; but O. Hauser and F. Wirth failed to find any signs of the new element in any of the known zirconia minerals. B. Kosmann, in 1896, announced two new elements, *kosmium* and *neokosmium*, which C. Winkler found to resemble lucium. The use of the last two mythical elements for gas-mantles was patented. F. Exner and E. Haschek announced the existence of a new element *E* with a definite spectrum; but J. M. Eder showed that the spectrum was produced by the blending of the gadolinium and terbium of nearly the same wave-length.

A large proportion of unconfirmed discoveries of elements belongs to the rare earth series, and this may be taken as a tribute to the difficulties attending their isolation. There is no adequate test to decide whether a mixture is involved; it is difficult to get definite results; fractionation may give mixtures which cannot be resolved into their constituents; and spectroscopic results are modified by the presence of traces of impurities which cannot be removed. A chronological summary of the announcements of discoveries of new elements derived from the rare earth minerals is summarized in Table II, together with an indication of the fate of the supposed discovery.

TABLE II.—CHRONOLOGICAL VIEW OF REPORTED ELEMENTS OF THE RARE EARTHS.

Year.	Reported Element.	Source.	Discoverer.	Remarks.
1794	Yttrium	Gadolinite	J. Gadolin	Impure yttria.
1804	Cerium	Cerite	J. J. Berzelius, etc.	Impure ceria.
1811	Junonium	Allanite	T. Thomson	Erroneous analysis.
1817	Thorine	Cerite	J. J. Berzelius	Yttrium phosphate.
1818	Vestium	Allanite	L. W. Gilbert	Unverified.
1828	Thorium	Thorite	J. J. Berzelius	Element.
1839	Lanthanum	Ceria	C. G. Mosander	Element.
1842	Didymium	Ceria	C. G. Mosander	Mixture.
1843	Terbium	Yttria	C. G. Mosander	Erbium since 1860.
1843	Erbium	Yttria	C. G. Mosander	Terbium since 1877
1851	Donarium	Orangsite	C. Bergemann	Mixture.
1862	Wasmium	Orthite	J. F. Bahr	Mixture.
1878	Mosandium	Samarskite	J. L. Smith	Mixture.
1878	Philippium	Yttria	M. Delafontaine	Mixture.
1878	Decipium	Samarskite	M. Delafontaine	Mixture.
1878	Ytterbium	Erbia	J. C. G. de Marignac	Mixture.
1878	X	Erbia	J. L. Soret	Holmium.
1879	Scandium	Ytterbia	L. F. Nilson	Element.
1879	Samarium	Didymia	L. de Boisbaudran	Element.
1879	Thulium	Erbia	P. T. Cleve	Element.
1879	Holmium	Erbia	P. T. Cleve	Element.
1880	γ_a	Samarskite	J. C. G. de Marignac	Gadolinium after 1886.
1880	γ_b	Samarskite	J. C. G. de Marignac	Samarium.
1884	Co'umbium	Samarskite	J. L. Smith	Mixture (not niobium).
1884	Rogierium	Samarskite	J. L. Smith	Mixture.
1885	Neodymium	Didymia	C. A. von Welsbach	Element.

Year.	Reported Element.	Source.	Discoverer.	Remarks.
1885	Praseodymium	Didymia	C. A. von Welsbach	Element.
1885	Z _α	Terbia	L. de Boisbaudran	Dysprosium.
1885	Z _β	Terbia	L. de Boisbaudran	Terbium.
1886	Z _γ	Terbia	L. de Boisbaudran	Dysprosium.
1886	Z	Terbia	L. de Boisbaudran	Terbium.
1886	S ₁	Samaria	E. Demarçay	Possibly \approx below.
1886	Dysprosium	Holmia	L. de Boisbaudran	Element.
1886	Austrium	Orthite	E. Linnemann	Impure gallium.
1886	Meta-elements	Various	W. Crookes	<i>Vide supra.</i>
1887	Meta-elements	Various	G. Krüss, etc.	<i>Vide supra.</i>
1887	Russium	Monazite	K. von Chrustchoff	Mixture.
1892	Masrium	Egyptian alum	H. D. Richmond, etc.	Unverified.
1892	Z _c	Samaria	L. de Boisbaudran	Europium.
1892	Z _ζ	Samaria	L. de Boisbaudran	Europium.
1894	Demonium	Yttria	H. E. Rowland	Dysprosium.
1895	Metacerium	Cerite	E. Brauner	Unverified.
1896	Damarium	Monazite	K. Lauer and P. Antsch	Unverified.
1896	Σ	Yttria	E. Demarçay	Europium.
1896	Lucium	Yttria	P. Barrière	Mixture.
1896	Kosmium	Yttria	B. Kosmann	Mixture.
1896	Neokosmium	Yttria	B. Kosmann	Mixture.
1897	Glaucodymium	Didymia	K. von Chrustchoff	Unverified.
1898	Monium	Yttria	W. Crookes	Victorium.
1899	Victorium	Yttria	W. Crookes	Mixture.
1900	r	Terbia	E. Demarçay	Terbium.
1900	Δ	Terbia	E. Demarçay	Dysprosium.
1900	Ω	Yttria	E. Demarçay	Unconfirmed.
1900	ϑ	Yttria	E. Demarçay	Unconfirmed.
1901	Euxenium	Euxenite	K. A. Hotmann, etc.	Unverified.
1904	Carolinium	Thorite	C. Baskerville	Unverified.
1904	Berzelium	Thorite	C. Baskerville	Unverified.
1905	Incognitum	Yttria	W. Crookes	Terbia-gadolinita.
1905	Ionium	Yttria	W. Crookes	Terbia-gadolinita.
1905	Neoytterbium	Ytterbia	G. Urbain	Element.
1905	Lutecium	Ytterbia	G. Urbain	Element.
1907	Aldebaranium	Ytterbia	C. A. von Welsbach	Neoytterbium.
1907	Cassiopëium	Ytterbia	C. A. von Welsbach	Lutecium.
1910	E	Terbia	F. Exner and E. Haschek	Mixture.
1911	Celtium	Gadolinite	G. Urbain	Lutecium.
1912	Tb ₁ , Tb ₂ , Tb ₃	Terbia	C. A. von Welsbach	Unconfirmed.
1916	Denebium	Ytterbia	J. M. Eder	Unconfirmed.
1916	Dubhium	Ytterbia	J. M. Eder	Unconfirmed.
1917	Eurosamarium	Samarskite	J. M. Eder	Unconfirmed.
1920	Welsium	Terbia	J. M. Eder	Unconfirmed.

REFERENCES.

- ¹ A. J. Cronstedt, *Mineralogie*, Stockholm, 183, 1758; *Svenska Akad. Handl.*, 235, 1751; C. W. Scheele, *ib.*, 91, 1781; J. G. Wallerius, *Mineralogia*, Stockholm, 303, 1747; J. J. y Don Fausto d'Elhuyar, *Svenska Akad. Handl.*, 5, 121, 1784; T. Bergman, *Opuscula physica et chemica*, Lipsiæ, 6, 108, 1780; J. J. Berzelius and W. Hisinger, *Gehlen's Journ.*, 2, 303, 397, 1804.
- ² J. Gadolin, *Crell's Ann.*, i, 313, 1796; *Svenska Akad. Handl.*, 15, 137, 1794; A. G. Ekeberg, *ib.*, 18, 156, 1797; 23, 68, 1802; *Crell's Ann.*, ii, 63, 1799; *Scheerer's Journ.*, 9, 597, 1802; H. M. Vernon, *Phil. Mag.*, (5), 31, 108, 1891; D. I. Mendeléeff, *Bull. Acad. St. Petersburg*, (4), 16, 45, 1871; *Journ. Russ. Phys. Chem. Soc.*, 5, 119, 1873; *Liebig's Ann.*, 168, 45, 1873; L. N. Vauquelin, *Ann. Chim. Phys.*, (1), 22, 179, 1797; (1), 36, 143, 1801; (1), 54, 28, 1805; M. H. Klaproth, *Beiträge zur chemischen Kenntniss der Mineralkörper*, Berlin, 1, 227, 1795; 3, 52, 1802; 4, 142, 1807; *Sitzber. Akad. Berlin*, 155, 1804; *Crell's Ann.*, i, 307, 1801; *Gehlen's Ann.*, 2, 303, 1804; J. J. Berzelius and W. Hisinger, *ib.*, 2, 303, 397, 1804; W. Hisinger, *Svenska Akad. Handl.*, 32, 209, 1811; J. J. Berzelius, *ib.*, 50, 1, 1829; *Afhand. Fysik Kemi Min.*, 4, 148, 217, 289, 319, 1814; 5, 25, 39, 42, 1815; 5, 56, 1817; *Schweigger's Journ.*, 21, 25, 1817; *Gilbert's Ann.*, 12, 50, 1812; L. W. Gilbert, *ib.*, 59, 107, 1818; T. Scheerer, *ib.*, 29, 99, 1818; *Pogg. Ann.*, 51, 409, 1840; 56, 482, 1842; L. Svanberg, *ib.*, 65, 317, 1845; N. J. Berlin, *ib.*,

85. 555, 1852; *Forh. Skand. Nat. Kopenhagen*, 8. 448, 1860; M. Faraday, *Quart. Journ. Science*, 6. 112, 1819; C. Bergemann, *Ann. Chim. Phys.*, (3), 35. 235, 1852; *Pogg. Ann.*, 82. 561, 1851; 85. 558, 1852; *Phil. Mag.*, (4), 1. 583, 1851; O. N. Rood, *Amer. Journ. Science*, (2), 34. 129, 1862; O. L. Erdmann, *Journ. prakt. Chem.*, (1), 85. 394, 1862; H. Bequerel, *Compt. Rend.*, 104. 165, 777, 1691, 1887; A. Damour, *ib.*, 34. 685, 1852; *Ann. Chim. Phys.*, (3), 35. 241, 1852; J. F. Bahr, *Pogg. Ann.*, 119. 572, 1862; *Chem. News*, 8. 175, 185, 1862; *Liebigs Ann.*, 132. 227, 1864; J. F. Bahr and R. Bunsen, *ib.*, 137. 1, 1866; O. Popp, *ib.*, 131. 179, 364, 1864; *Chem. News*, 11. 205, 1864; R. Pribram, *Monatsh.*, 21. 148, 1900; E. Demarcay, *Compt. Rend.*, 102. 1551, 1886; 104. 580, 1887; 105. 276, 1887; 117. 163, 1893; 122. 728, 1896; 126. 1039, 1898; 130. 1019, 1185, 1469, 1900; 131. 387, 389, 1900; 132. 1484, 1901; *Chem. News*, 82. 127, 1900; J. H. Gladstone, *Journ. Chem. Soc.*, 10. 219, 1858; 11. 36, 1859; G. Krüss and L. F. Nilson, *Ber.*, 20. 2134, 1887; *Chem. News*, 56. 74, 85, 135, 145, 154, 165, 172, 1887; P. Kiesewetter and G. Krüss, *Ber.*, 21. 2310, 1888; *Chem. News*, 58. 75, 91, 1888; G. Krüss, *ib.*, 64. 65, 75, 100, 120, 1891; *Liebigs Ann.*, 265. 1, 1891; *Zeit. anorg. Chem.*, 3. 352, 1893; K. A. Hofmann and G. Krüss, *ib.*, 3. 407, 1893; K. A. Hofmann, *Ueber die Terbineride*, München, 1893; K. A. Hofmann and W. A. A. Prandtl, *Ber.*, 34. 1064, 1901; O. Hauser and F. Wirth, *ib.*, 42. 4443, 1909; W. A. A. Prandtl, *Ueber einiger neue Bestandteile des Euzenits*, München, 1901; O. Holmberg, *Arkiv. Fysik Kemi Min.*, 4. 2, 10, 1911; G. Urbain, *Ann. Chim. Phys.*, (7), 19. 184, 1900; *Compt. Rend.*, 126. 835, 1898; 140. 583, 1905; 141. 521, 1905; 142. 785, 1906; 152. 141, 1911; *Journ. Chim. Phys.*, 4. 334, 356, 1906; *Bull. Soc. Chim.*, (3), 17. 98, 1897; (3), 19. 376, 1898; *Compt. Rend.*, 174. 1349, 1922; A. Dauvillier, *ib.*, 174. 1347, 1922; G. and E. Urbain, *ib.*, 132. 136, 1901; G. Urbain and E. Boudschowsky, *Compt. Rend.*, 124. 618, 1897; C. Baskerville, *Chem. News*, 84. 179, 187, 1901; 89. 109, 121, 135, 150, 1904; *Journ. Amer. Chem. Soc.*, 23. 761, 1901; C. James, *ib.*, 33. 1332, 1911; C. James and D. W. Bissel, *ib.*, 38. 893, 1916; W. Shapleigh, *Chem. News*, 76. 41, 1897; P. Barrière, *ib.*, 74. 159, 212, 259, 1896; H. A. Rowland, *ib.*, 70. 68, 1894; H. D. Richmond and H. Off, *Journ. Chem. Soc.*, 61. 491, 1892; *Chem. News*, 65. 257, 1892; K. Lauer and P. Antsch, *Chem. Ztg.*, 14. 435, 1890; J. M. Eder, *Sitzber. Akad. Wien*, 124. 124, 1916; 125. 1467, 1916; 126. 473, 1917; 129. 421, 1920; G. H. Bailey, *Ber.*, 20. 2769, 3325, 1887; 21. 1520, 1888; C. G. Mosander, *Pogg. Ann.*, 11. 406, 827; 46. 648, 1839; 56. 503, 1842; *Svenska Akad. Handl.*, 27. 299, 1826; *Skand. Naturfor. Förh.*, 3. 387, 1842; *Compt. Rend.*, 8. 356, 1839; *Liebigs Ann.*, 44. 125, 1842; 46. 210, 1842; *Phil. Mag.*, (3), 23. 241, 1843; J. C. G. de Marignac, *Ann. Chim. Phys.*, (3), 38. 148, 1853; (3), 60. 257, 1860; (4), 30. 56, 1873; (5), 14. 247, 1878; *Arch. Sciences Genève*, (1), 24. 278, 1853; (2), 8. 121, 1860; (2), 61. 283, 1878; (2), 63. 172, 1878; (2), 64. 87, 1378; (3), 3. 413, 1880; *Phil. Mag.*, (4), 20. 87, 1860; *Compt. Rend.*, 50. 952, 1860; 87. 281, 578, 1878; 90. 899, 1880; *Chem. News*, 38. 213, 1878; 41. 250, 1880; M. Delafontaine, *Arch. Sciences Genève*, (2), 18. 343, 1863; (2), 21. 97, 1864; (2), 22. 30, 1865; (2), 25. 105, 112, 1866; (2), 51. 48, 1874; (2), 61. 273, 1878; (3), 3. 350, 1880; *Ann. Chim. Phys.*, (5), 14. 238, 1878; *Chem. News*, 11. 241, 253, 1865; 38. 202, 253, 1878; 44. 67, 1881; *Compt. Rend.*, 87. 559, 600, 654, 933, 1878; 90. 221, 1880; 93. 63, 1881; P. T. Cleve and M. Höglund, *Bihang. Svenska Akad. Handl.*, 1. 8, 1873; 2. 7, 8, 12, 1874; *Bull. Soc. Chim.*, (2), 18. 193, 239, 1873; P. T. Cleve, *ib.*, (2), 21. 246, 344, 1874; (2), 31. 195, 1879; *Cheffers. Akad. Förh.*, 36. 7, 1879; *Chem. News*, 40. 125, 159, 224, 1879; 42. 182, 199, 1880; 45. 273, 1882; *Compt. Rend.*, 89. 419, 478, 708, 1879; 91. 328, 381, 1880; 94. 1528, 1882; 95. 33, 1882; T. Dahll, *ib.*, 89. 47, 1879; *Chem. News*, 40. 25, 1879; C. M. Thompson, *ib.*, 55. 227, 1887; 64. 167, 1891; *B.A. Rep.*, 611, 1891; E. Baur and R. Marc, *Ber.*, 34. 2460, 1901; R. Marc, *Die Kathodoluminescenz-Spektren der seltenen Erden und Untersuchungen über die Erden der Yttergruppe*, München, 1902; W. Muthmann and L. Stützel, *Ber.*, 32. 2654, 1899; L. Stützel, *Zur Kenntnis der seltenen Erden des Cerits*, München, 1899; C. R. Böhm, *Die Zerlegbarkeit des Praseodyms*, Halle a. S., 1900; W. Muthmann and C. R. Böhm, *Ber.*, 33. 48, 1900; W. Muthmann and E. Baur, *ib.*, 33. 1748, 1900; L. de Boisbaudran, *Compt. Rend.*, 88. 322, 1342, 1879; 89. 212, 516, 1879; 100. 1437, 1885; 101. 552, 588, 1885; 102. 153, 395, 647, 899, 1003, 1005, 1436, 1536, 1886; 103. 113, 627, 1886; 105. 258, 301, 343, 784, 1887; 108. 165, 1889; 110. 67, 1890; 111. 393, 409, 474, 1890; 114. 575, 1892; 116. 611, 674, 1893; 121. 709, 1895; *Chem. News*, 39. 115, 1879; 40. 99, 167, 1879; 52. 4, 290, 299, 1885; 53. 53, 217, 1886; *Arch. Sciences Genève*, (3), 2. 119, 1879; *Bull. Soc. Chim.*, (3), 3. 53, 1890; H. E. Roscoe, *Ber.*, 15. 1274, 1882; *Chem. News*, 45. 184, 1882; *Journ. Chem. Soc.*, 41. 277, 1882; W. Crookes, *Proc. Roy. Soc.*, 32. 206, 1881; 35. 262, 1883; 38. 414, 1883; 40. 236, 502, 1886; 42. 111, 1887; 65. 237, 1899; *Phil. Trans.*, 174. 891, 1882; *Compt. Rend.*, 100. 1495, 1885; 102. 506, 646, 1464, 1886; *Chem. News*, 43. 237, 1881; 47. 261, 1884; 49. 159, 169, 181, 194, 205, 1884; 51. 301, 1885; 53. 75, 133, 1886; 54. 13, 27, 39, 40, 54, 63, 76, 1886; 55. 83, 95, 107, 119, 131, 1887; 56. 62, 81, 1887; 60. 27, 39, 51, 63, 1889; 74. 259, 1897; 79. 212, 1899; 80. 49, 1899; *Journ. Chem. Soc.*, 55. 250, 1889; J. L. Smith, *Amer. Journ. Science*, (3), 13. 359, 1877; (3), 14. 509, 1877; *Amer. Chem. Journ.*, 5. 44, 73, 1883; *Chem. News*, 38. 61, 100, 1878; *Nature*, 21. 146, 1879; *Compt. Rend.*, 87. 145, 148, 831, 1878; 89. 480, 1879; J. L. Soret, *ib.*, 86. 1062, 1878; 88. 422, 521, 1879; 89. 521, 1879; 91. 378, 1880; *Chem. News*, 42. 198, 1880; *Arch. Sciences Genève*, (2), 63. 89, 1878; R. Thalen, *ib.*, 42. 197, 1880; *Compt. Rend.*, 91. 376, 1881; L. F. Nilson, *ib.*, 88. 645, 1879; 91. 56, 118, 1880; *Bull. Soc. Chim.*, (2), 23. 260, 353, 494, 1875; *Chem. News*, 40. 76, 1879; 42. 61, 83, 1880; *Ber.*, 12. 554, 1879; J. Nicklès, *Compt. Rend.*, 57. 740, 1863; B. Brauner, *Tagbl. Nat. Vers. Salzburg*, 48, 1881; *Compt. Rend.*, 94. 1718, 1882; *Monatsh.*, 3. 486, 1882; *Chem. News*, 46. 16, 1882; 47. 175, 1883; 71. 283, 1895; *Journ. Chem. Soc.*, 43. 278, 1883; *Proc. Chem. Soc.*, 11.

96, 1895; 17. 67, 1901; *Zeit. anorg. Chem.*, 34. 207, 1903; B. Brauner and A. Batek, *ib.*, 34. 103, 1903; C. A. von Welsbach, *Sitzber. Akad. Wien*, 92. 318, 1885; 112. 1037, 1903; 113. 507, 1909; *Monatsh.*, 5. 1, 508, 1884; 6. 477, 1885; 27. 935, 1906; 29. 181, 1908; 30. 695, 1909; *Liebig's Ann.*, 351. 464, 1907; *Chem. Ztg.*, 35. 658, 1912; *Chem. News*, 52. 49. 1885; P. Schottländer, *Ber.*, 25. 378, 1892; *Chem. News*, 95. 205, 219, 233, 243, 255, 1892; G. P. Drossbach, *Ber.*, 29. 2452, 1896; 33. 3506, 1900; B. Kosmann, *Zeit. Elektrochem.*, 3. 279, 1896; *German Pat.*, D.R.P. 90652, 1896; *Ber.*, 30. 13, 1897; P. Schützenberger, *Compt. Rend.*, 120. 663, 962, 1896; P. Schützenberger and O. Boudouard, *ib.*, 122. 697, 1096, 1897; O. Boudouard, *ib.*, 125. 772, 1096, 1897; T. Thomson, *Trans. Roy. Soc. Edin.*, 6. 386, 1811; *Phil. Mag.*, (1), 37. 278, 1811; G. Wyruboff and A. Verneuil, *Compt. Rend.*, 125. 950, 1180, 1897; A. Bettendorff, *Liebig's Ann.*, 263. 164, 1891; E. Linnemann, *Monatsh.*, 7. 121, 1886; *Nature*, 34. 59, 1886; L. Wenghöffer, *Ber. deut. pharm. Ges.*, 7. 85, 1897; K. von Chrutchoff, *Journ. Russ. Phys. Chem. Soc.*, 29. 206, 1897; *Berg. Hütt. Ztg.*, 48. 329, 1887; C. Benedicks, *Internat. Zeit. Metallog.*, 7. 225, 1916; F. P. Venable, *Journ. Elisha Mitchell Scient. Soc.*, 4. 36, 1887; C. Winkler, *Ber.*, 30. 13, 1897; H. C. Bolton, *Chem. News*, 58. 188, 1888; A. E. Nordenskjöld, *Øfvers. Akad. Förh.*, 27. 551, 1870; 30. 13, 1873; F. Exner and E. Haschek, *Sitzber. Akad. Wien*, 119. 771, 1910; R. Hermann, *Journ. prakt. Chem.*, (1), 34. 182, 1845; B. Kosman, *Zeit. Elektrochem.*, 3. 279, 1897; H. P. Stevens, *Zeit. anorg. Chem.*, 27. 41, 1901; 31. 368, 1902.

§ 3. The Occurrence of the Rare Earths

The rare earths are widely distributed, but in minute quantities. F. W. Clarke and H. S. Washington¹ estimated that the ten-mile crust, the hydrosphere, and lithosphere contained 0.019 per cent. of yttrium and cerium earths. The history of the rare earth minerals begins with the discovery of *tungstein*, or *tungsten*, and the confusion of that mineral with the Bohemian *tennspar* heralded the greater confusion which was destined to follow when the composition of the mineral was minutely examined. The early history of this mineral has been previously described. M. H. Klaproth² proposed to call it *ochröite*— $\omega\chi\rho\acute{o}\varsigma$, brownish-yellow—on account of its colour; and J. J. Berzelius *cerite*, in honour of the discovery of the minor planet Ceres in 1801. M. H. Klaproth accepted J. J. Berzelius' term, but suggested adding another syllable—*cererite*—so that it would not be supposed that the term was derived from *κηρός*, wax. The proposal was not accepted. M. H. Klaproth reported 34.5 per cent. of silica in the mineral; L. N. Vauquelin, 17.0 per cent.; and R. Hermann, 18.0 per cent. M. H. Klaproth included with the silica in his analysis all the material not decomposed by the method he employed. R. Hermann assumed that two different minerals were in question; and, since appreciable quantities of lanthanum as well as cerium are contained in the mineral, he suggested calling the mineral with a high proportion of lanthanum and a smaller proportion of cerium, *lanthanocerite*. G. A. Kennigott said that lanthanocerite owes its lanthanum to admixed *lanthanite*. R. J. Haüy's term for the mineral was *cérium oxydé siliceux rouge*, in contrast with *cérium oxydé siliceux noir* employed for allanite. Analyses of the Swedish mineral from Bastnaes were reported by W. Hisinger and J. J. Berzelius, M. H. Klaproth, W. Hisinger, J. F. John, A. Arche, R. Hermann, T. Kjerulf, C. F. Rammelsberg, G. Nordström, F. Stolba, W. Muthmann, and L. Stützel. Analyses made after 1843 show the presence of didymium and lanthanum:

SiO ₂	Ce ₂ O ₃	Di ₂ O ₃	La ₂ O ₃	Al ₂ O ₃	FeO	CaO	MgO	CO ₂	H ₂ O
16.06	26.55	18.05	16.33	1.68	3.17	1.23	1.25	4.62	8.10
21.35	60.99	3.90	3.51	—	1.46	1.65	—	0.38	6.31

The idealized mineral is usually regarded as a basic cerium silicate, H₃(Ca, Fe)Ce₃Si₃O₁₃, with 50.7–71.8 per cent. cerium. P. Groth interprets this formula as representing a basic metasilicate, (Ca, Fe)(CeO)Ce₂(OH)₃(SiO₃)₃, a derivative of the acid H₆Si₃O₉. C. F. Rammelsberg gave (Ce, La, Di)₂SiO₄.H₂O. Numerous other constituents have been reported—*e.g.* bismuth, manganese, copper, phosphoric and sulphuric oxides, etc. H. St. C. Deville found traces of vanadium and titanium oxides. G. Tschermak found 11.7 per cent. of zirconium in a sample from Batoum, and he also found 7.6 per cent. of yttria. W. Crookes, G. Krüss and L. F. Nilson,

etc., have discussed the complexity of the rare earths contained in cerite; but the mineral is too scarce to serve generally for the extraction of rare earths. G. Tschermak, W. Ramsay and M. W. Travers, and R. J. Strutt found a considerable proportion of helium occluded in the mineral. R. J. Strutt found 1.36×10^{-8} grm. of radium; G. Bardet found the mineral radioactive. It is rather unusual to find thorium and uranium both absent in the rare earth minerals; G. Tschermak found traces of thorium in a sample from Batoum; but this element is not represented in analyses of the mineral. The mineral occurs massive or granular. A. E. Norden-skjöld and W. Haidinger have discussed the crystalline form. The brown to red translucent or opaque crystals are rhombic with axial ratios $a:b:c=0.9988:1.08127$. The hardness is 5 to 6. L. N. Vauquelin gave 4.530 for the sp. gr.; M. H. Klaproth, 4.660; and G. Nordström, 4.86. G. Spezia showed that cerite turns yellow in the oxidizing flame, and melts to a brown enamel in the reducing flame. A. L. Fletcher found cerite softened at about 1230° , and melted about 1350° . It is readily attacked by sulphuric acid, and with hydrochloric acid it forms a gelatinous silica. From the different proportions of the mineral attacked by the acid, and left in the silica, C. F. Rammelsberg inferred that "cerite is a mixture of silicates which are not all attacked with the same ease by hydrochloric acid." C. A. von Welsbach made a similar observation. J. Schilling compiled a bibliography on cerite.

Cerite and **gadolinite** are two of the most interesting minerals in connection with the discovery of the rare earths. The mineral which J. Gadolin named *ytterbite*, and in which he discovered yttria earth, was afterwards named gadolinite. B. R. Geijer described it in 1788 as a black zeolite. This mineral occurs at Ytterby near Stockholm and at Fahlun, Taberg, and Carlberg in Sweden; it occurs also in Hitterö and Malö in Norway; in the Riesengebirge and the Harz in Germany; in the trapp rock of Galway, and in the granulite of Down County, Ireland; on the Zdjar Mountains in Austria; in the granite of Baveno, Italy; in the granite of Ceylon; and at Disko, Greenland. There is a remarkable deposit at Baringer Hill, Llano Cg., near Bluffton in Texas; and near Devil's Head in Colorado.

The giant pegmatite of Texas furnishes large crystals of gadolinite associated with thorogummite, nivenite, fergusonite, allanite, tenerite, cyrtolite, rowlandite, mackintoshite, and yttracrasite. This deposit has been studied by W. E. Hidden and co-workers. There is here a decomposition product of gadolinite which they named green gadolinite or *yttrialite*. It contains no beryllia, and twice as much silica as the parent mineral, for it approximates to $R_2O_3 \cdot 2SiO_2$, where R_2O_3 represents the yttria oxides.

The analysis of J. Gadolin was confirmed by A. G. Ekeberg, M. H. Klaproth, and L. N. Vauquelin. In 1802, A. G. Ekeberg showed that the earth reported as alumina was really beryllia, and amounts up to 11.60 per cent. of beryllia were reported by N. J. Berlin, A. Connell, T. Scheerer, etc. From these results it is considered that beryllia is of secondary origin. Amounts of ceria up to 20.28 per cent. were reported by J. J. Berzelius, J. S. Humpidge and W. Burney, T. Thomson, etc. In addition to analyses by those just mentioned, others have been reported by C. F. Rammelsberg, N. Lindström, C. W. Blomstrand, T. Thomson and A. Steel, B. F. Davis and A. G. Maitland, W. Petersson, B. Szilard, J. Fromme, W. C. Brögger and co-workers, J. F. Bahr and R. Bunsen, G. P. Tschernik, G. A. König, M. Websky, L. G. Eakins, A. des Cloizeaux, etc. The silica ranges from 21.86 to 29.20 per cent.; the yttria earths, from 9.50 to 51.46 per cent.; the ceria earths, from 1.80 to 16.69 per cent.; the ferrous oxide, from 7.47 to 16.04 per cent.; the beryllia up to 11.60 per cent.; the lime, 0.23 to 3.47 per cent.; the loss on ignition, up to 5.2 per cent. In addition, ferric oxide, alumina, thoria (0.81–0.89 per cent.), magnesia, manganese oxide, and the alkalis have been reported. The complex character of the rare earths in this mineral is indicated in the preceding section. C. F. Rammelsberg, G. Tschermak, and A. Himmelbauer have discussed the constitution of the mineral. The formula of the idealized mineral is sometimes written $FeBe_2Y_2Si_2O_{10}$, or $2BeO \cdot FeO \cdot Y_2O_3 \cdot 2SiO_2$; and P. Groth regards it as a basic orthosilicate, $Be_2Fe(YO)_2(SiO_4)_2$, derived from the acid $H_3Si_2O_8$. B. R. Geijer has described the

cerium ore of Bastnaes, and microscopically it appears as a fine grained aggregate of cerite, bastnäsite, orthite, lanthanite, fluocerite, and törnebohmitite.

Gadolinite occurs in subtranslucent or opaque masses, black, or greenish- or brownish-black in colour. It also occurs in crystals belonging to the monoclinic system with axial ratios $a : b : c = 0.62726 : 1 : 1.32149$, and $\beta = 89^\circ 26' 30''$. The crystals have also been examined by N. S. Maskelyne and V. von Lang, P. Waage, R. J. Haüy, W. Phillips, A. Lévy, T. Scheerer, A. T. Kupffer, G. vom Rath, A. des Cloizeaux, and H. Sjögren. A. Hadding, and H. Küstner studied the X-radiogram of gadolinite. The latter found that the isotropic crystals are truly isotropic, and no colloidal or subcolloidal anisotropic crystals are present. Both the natural anisotropic crystals and the anisotropic crystals formed by heating the isotropic crystals to 1000° furnish characteristic X-radiograms. The sp. gr. is between 4.0 and 4.5, and the hardness 6.5–7.0. E. D. Clarke fused gadolinite in the oxy-hydrogen blowpipe flame to form a black glass; and A. L. Fletcher found the mineral showed signs of melting between 1395° and 1450° . The crystals have a strong positive birefringence. The brown variety is distinctly pleochroic, the green varieties have a weaker pleochroism. According to W. H. Wollaston, T. Liebisch, and K. A. Hofmann and F. Zerban, gadolinite is calorescent at about 430° . W. C. Brögger, W. Petersson, and G. T. Prior examined the hypotheses that on calcination the crystalline mineral becomes amorphous. The heating curve of the crystalline mineral, obtained by T. Liebisch, gives no ground for the assumption; the curve is quite regular. W. Petersson, G. Tschermak, W. Ramsay and M. W. Travers, T. Scheerer, and J. J. Berzelius showed that the sp. gr. of the calcined mineral is greater, and H. Rose, that its sp. ht. about one-fourteenth less, than the original mineral. J. Schilling compiled a bibliography on gadolinite.

According to C. C. von Leonhard,³ and F. von Kobell, in 1808, H. L. Giesecke sent a package of minerals from Greenland to Copenhagen; the vessel was captured by an English privateer, and brought to Leith. The minerals were purchased by T. Allan; he mistook one mineral for gadolinite and sent it to T. Thomson for analysis. The latter recognized it as a new mineral and called it **allanite**. Judging from the many names which have been assigned to what appear to be varieties of the same mineral, it might almost be called polyonymite—*πολυώνυμος*, having many names.

W. Hisinger called a variety from Ridrarhyttan, Sweden, *cerine*, and R. J. Haüy designated the mineral *cérium oxydé siliceux noir* in contrast with *cérium oxydé siliceux rouge* employed for the mineral cerite. J. J. Berzelius named a mineral from Finbo, Fahlun, orthite—*ὀρθίτις*, straight—in reference to the form of its crystals, and another mineral from Kararfvet, Fahlun, *pyrorthite*—*πύρ*, fire—in reference to its colour. F. Stromeyer, and T. Scheerer showed that allanite, cerine, and orthite are varieties of the same mineral. A. Lévy described a black mineral from Näskil, Arendal, as *bucklandite*. A. Lévy, G. Rose, and R. Hermann showed that bucklandite is closely related to orthite. R. Hermann, C. F. Rammelsberg, and J. Auerbach called a sample from Miask, Urals, *uralorthite*, and N. von Kokscharoff showed that it is related to orthite. A. Breithaupt called a sample from the trachyte of Laach, *tautolite*—*ταυτόν*, the same; *λίθος*, stone—and G. vom Rath showed its relationship to orthite. A specimen from Eriksberge, near Stockholm, was called *xanorthite* or *xanthorthite*—*ξανθός*, yellow—by R. Hermann and described as a yellow orthite. N. von Kokscharoff, and R. Hermann described *bagrationite*—named after P. R. Bagration—from Achmatovsk. R. Hermann regarded it as a variety of orthite. A. Breithaupt, C. Kersten, and T. Kerndt reported *bodenite* from the soil at Mauersberg, Saxony; T. Kerndt, *muromonite*—Latinized name of Mauersberg—from Mauersberg; *vasite* or *wasite* obtained by J. F. Bahr from Rönsholm, Stockholm, and studied by B. Szilard, and N. Engström; *michaelsonite* found by C. A. Michaelson and E. Nobel near Brevig; and N. J. Berlin, the *erdmannite*—named after O. L. Erdmann—was obtained from Stökö near Brevig. All these are more or less impure varieties of orthite or allanite. Pale green crystals of a mineral named **törnebohmitite** were found by P. Geijer to be associated with the cerite of Bastnäas. The analysis is:

SiO ₂	Ce ₂ O ₃	(La, D) ₂ O ₃	Al ₂ O ₃	FeO	MnO	MgO	CaO	F	Ignition
22.05	27.52	34.85	8.55	1.91	0.05	0.49	0.23	0.29	1.70

The formula $R_2(\text{ROH})(\text{SiO}_4)_2$ approximates to andalusite or topaz; but the mineral is more closely allied to cerite from which it differs in containing more aluminium and calcium. The optical properties differ from those of cerite; the sp. gr. is 4.94.

Allanite or orthite is fairly widely distributed in relatively small quantities. For example, it is found in Greenland, Riddarhyttan, Ytterby, and Tunaberg in Sweden; at Kragerø, Hitterø, and Fille Fjeld in Norway; at Impilaks near the border of Finland; at Miask in the Urals; at Plauensche Grund near Dresden; in the Laacher See near Coblenz, and near Sahl in the Thüringerwald; at Criffel in Scotland; in Canada; and in Colorado, Virginia, and Carolina in the United States. Numerous analyses of the varieties of allanite or orthite have been reported—*e.g.* by G. vom Rath, F. Stiff, H. Credner, F. Zschau, T. Kerndt, T. Scheerer, N. Engström and P. T. Cleve, K. A. von Zittel, D. Forbes, C. W. Blomstrand, N. J. Berlin and J. F. Bahr, F. W. Clarke, W. Hisinger, J. J. Berzelius, B. Szilard, M. Schubin, C. F. Rammelsberg, A. Stromeyer, J. Torrey, D. M. Balch, C. Bergemann, D. I. Mendeléeff, P. Keyser, J. W. Mallet, J. A. Cabell, F. P. Dunnington, G. A. König, F. A. Genth, C. Memminger, L. G. Eakins, W. C. Brögger and co-workers, E. P. Valentine, A. Strecker, T. L. Walker and A. L. Parsons, T. S. Hunt, etc. The composition varies very much because the bases can be replaced vicariously. A selection of analyses is shown in Table III. The first three analyses are by N. Engström and P. T. Cleve; the fourth and fifth are by N. Engström; and the last is by F. P. Dunnington.

TABLE III.—ANALYSES OF ALLANITE OR ORTHITE.

	Hitterø.	Naskilen.	Ytterby.	Miask.	Greenland.	Amelia Co.
SiO ₂	31·63	32·01	32·07	30·81	33·29	32·35
Al ₂ O ₃	13·21	17·54	16·52	16·25	19·35	16·42
Fe ₂ O ₃	8·39	5·20	2·53	6·29	3·31	4·49
Ce ₂ O ₃	8·67	6·21	5·90	10·13	9·26	11·14
Di ₂ O ₃	5·60	10·78	7·57	3·43	6·97	6·91
La ₂ O ₃	5·46	0·24	5·16	6·35	1·04	3·47
Y ₂ O ₃	0·87	1·38	2·74	1·24	—	—
Er ₂ O ₃	0·52	1·53	2·00	—	—	—
FeO	7·86	9·92	11·89	8·14	10·67	10·48
MnO	1·66	0·47	2·34	2·25	—	1·12
CaO	10·48	12·03	6·75	10·43	11·04	11·47
MgO	0·08	—	0·45	0·13	0·40	—
K ₂ O	0·28	0·15	0·29	0·53	1·27	0·46
Na ₂ O	—	—	—	—	0·37	—
H ₂ O	3·49	1·79	3·23	2·79	1·54	2·31
ThO ₂	0·87	1·14	trace	—	1·17	—

Allanite or orthite appears to belong to the epidote family of silicates. This has been emphasized by A. Michel-Lévy, G. Rose, R. Hermann, N. von Kokscharoff, etc.; and P. Geijer's analysis gives 4·29RO; 2·61R₂O₃; 5·93SiO₂:H₂O. The mineral has accordingly been called *cerium-epidote*. V. M. Goldschmidt found what he called *epidote-orthites*, which he regarded as isomorphous mixtures of orthite with iron epidote; and most of the orthites may be regarded as solid soln. The general formula for epidote is H₂O·4RO·3R₂O₃·6SiO₂, where R is trivalent and R'' bivalent, and may be represented by vicarious metals. With allanite, R'' is (Fe'', Ca), and R is (Al, Fe'', Ce), where Ce stands for elements of the cerium and yttrium families. N. Engström said that some orthites agree in composition with the epidotes H₂R''₄R₆Si₆O₂₆, but some others agree with H₄R''₄R₆Si₆O₂₇; and, in the latter case, it is not clear whether the extra molecule of water is of secondary importance, or whether it represents a special class of orthites. P. Groth regarded allanite as a basic salt, R₃(OH)R''₂Si₃O₁₂, of the acid H₁₂Si₃O₁₂. The idealized mineral with the epidote formula is (Ca, Fe)₂(AlOH)(Al, Ce, Fe)₂(SiO₄)₃, and it may be a solid soln. of isomorphous epidote, ferric-epidote, and cerium-epidote, Ca₂(AlOH)Ce₂(SiO₄)₃, or *calcium dicerium aluminohydroxy-triorthosilicate*—*vide* epidote.

The rare earths in allanite range from 3·6 to 5·1 per cent., and the components indicated in Table III no doubt give the impression of having been more accurately determined than the methods of analysis allow. Yttria ranges up to 4·7 per cent., and thoria up to 3·5 per cent. R. J. Meyer found scandia up to 1 per cent. Traces of uranium are often present. W. Ramsay, J. N. Collie, and M. W. Travers found no helium, but R. J. Strutt found some radium to be present in some samples, and therefore the presence of occluded helium is highly probable. T. Kerndt reported 5·52 per cent. of beryllia in a specimen from Mauersberg; J. W. Mallet, 0·52 per cent. in a specimen from Norfolk, Virginia; J. A. Cabell, 0·24 per cent. in a specimen from Amherst; L. G. Eakins, 0·27 per cent. in a specimen from Douglas Co., Colorado; and J. Fromme also reported small quantities of beryllia in some specimens of allanite. R. Hermann reported the presence of some titanite. Carbon dioxide is found in some samples, and the amount of water ranges from zero up to 17 per cent.

Allanite or orthite occurs as an accessory constituent in granite, syenite, diorite, gneiss, limestone, etc. It appears either in compact masses, or as crystals. The colour may be reddish-brown, greyish-green, or even black. The crystals are sometimes broad and tabular, at other times long and slender. A. des Cloizeaux and A. Damour found some well-formed crystals without double refraction. W. Haidinger, G. Rose, A. Sjögren, L. H. Borgström, A. Michel-Lévy and A. Lacroix, N. von Kokscharoff, A. E. Nordenskjöld, R. Hermann, J. Auerbach, etc., have studied the crystals. According to G. vom Rath, the crystals belong to the monoclinic system, and have the axial ratios $a : b : c = 1.55070 : 1 : 1.76838$, and $\beta = 64^\circ 59'$. The hardness and sp. gr. vary with the amount of water in the mineral, and with other conditions. The sp. gr. ranges from 2·53 to 4·32—the average is about 3·5. G. vom Rath found a sample with a sp. gr. 3·983; T. Kerndt, 4·263; C. Kersten, 3·523; T. Scheerer, 3·546; N. J. Berlin and J. F. Bahr, 2·78; R. Hermann, 3·48–3·66; T. S. Hunt, 3·84; C. Bergemann, 3·4917; F. A. Genth, 3·782; L. G. Eakins, 3·52; J. W. Mallet, 4·32, etc. The hardness is between 5 and 6. A. L. Fletcher found that the mineral melted between 1220° and 1265° . Most varieties gelatinize when treated with hydrochloric acid; but if previously ignited, they are not decomposed by the acid.

A complex silicate of the rare earths metals, calcium, iron, etc., with a high proportion of zirconia was found by T. Scheerer at Kangerdluarsuk, Greenland, and on the islands of the Langesund Fiord, Norway. C. U. Shepard,⁴ and F. A. Genth have reported it in Arkansas. F. Stromeyer named it from $\epsilon\acute{\iota}$, easily, and $\delta\iota\alpha\lambda\acute{\upsilon}\omega$, to dissolve, in reference to its easy solubility in acids; **eudialyte** is a corrupted form of this term; T. Scheerer called a Norwegian variety **eucolite**—from $\epsilon\acute{\upsilon}\kappa\omicron\lambda\omicron\varsigma$, not difficult to satisfy—in allusion to the alleged replacement of iron oxide for zirconia in wöhlerite. Analyses have been made by C. H. Pfaff, F. Stromeyer, C. F. Rammelsberg, A. Damour, T. Scheerer, L. Gruner, O. B. Böggild, F. A. Genth, J. Lorenzen, etc. P. T. Cleve's analysis of a sample from Barkevik is:

Na ₂ O	K ₂ O	CaO	MnO	FeO	Y ₂ O ₃	(Ce, Di, La) ₂ O ₃	SiO ₂	ZrO ₂	Os ₂ O ₃
11·17	0·11	12·11	3·60	3·90	0·32	4·80	45·15	12·51	3·52

and 0·55 per cent. of chlorine, and 2·11 per cent. of water. The constitution has been discussed by C. W. Blomstrand, P. Groth, F. W. Clarke, C. F. Rammelsberg, L. Colomba, etc. J. D. Dana gives the empirical formula $\text{Na}_{13}(\text{Ca}, \text{Fe})_6\text{Cl}(\text{Si}, \text{Zr})_{20}\text{O}_{52}$; while W. C. Brögger considers it to be a metasilicate, $(\text{Na}, \text{K}, \text{H})_4\text{R}_3\text{Zr}(\text{SiO}_3)_7$, where R may represent Ca, Fe, Mn, and CeOH; and ZrOCl may act as an acidic radicle in place of silica—*vide* zirconium silicates. G. Hevesy and V. T. Jantzen found 0·7 per cent. of hafnia in Greenland eudialyte, and 0·7 per cent. in Norwegian eucolite. J. Thomsen found that eudialyte contained 0·4 c.c. of occluded gas—CO₂, 10; H₂, 75; CO, 3; N₂, 7—per kgrm. of mineral. The fact that such a complex silicate may occur in well-defined crystals shows what intricate problems in inorganic chemistry are awaiting solution. The crimson, purple, or brown trigonal crystals were studied by W. H. Miller, and

V. von Lang; the axial ratio is $a : c = 1 : 2.1116$. Observations by F. Stromeyer, A. Damour, J. Lorenzen, C. F. Rammelsberg, A. Lévy, J. F. Williams, T. Scheerer, and P. T. Cleve show that the reddish-brown crystals have a sp. gr. ranging from 2.624 to 3.104. The hardness is 5 to 6. Eudialyte is optically positive, eucolite negative. W. Ramsay found the zones of positive and negative birefringence as well as isotopic zones can occur on the same minerals, and he suggested that the mineral is really composed of two isomorphous compounds. The optical behaviour of the eudialyte is sometimes anomalous, possibly an effect of repeated twinning, and the lamellar intergrowth of two varieties with slightly different optical properties. E. Jannettaz measured the thermal conductivity. J. Schilling has given a bibliography of eudialyte.

The *eucolitic titanite* of W. C. Brögger⁵ from Langesund Fiord, Norway, contains 2.57 per cent. of ceria, 0.59 per cent. of yttria, and 0.18 per cent. of thoria earths. The sp. gr. is 3.59. C. W. Blomstrand's *alshedite*, from Alsheda, Småland, is a variety of titanite with 2.57–2.78 per cent. of yttria earths, the sp. gr. is 3.36. For *alvite*, *anderbergite*, *cataplevite*, and *cyrtolite*, see zirconium silicate. W. C. Brögger and co-workers, and C. B. Benedicks described a monoclinic mineral *thalenite* from a quartz quarry in Oesterby; and T. Vogt, from the pegmatite at Hundholmen. The crystals are reddish-violet. The former had axial ratios $a : b : c = 1.541 : 1 : 0.602$, and $\beta = 80^\circ 12'$, the latter 0.9190 : 1 : 0.6480, and $\beta = 82^\circ 54\frac{1}{2}'$; hardness 6 to 6.5; sp. gr. 3.945 to 4.454; indices of refraction $\alpha = 1.7312$, $\beta = 1.7375$, $\gamma = 1.7436$ for sodium light. Analyses correspond with $H_2Y_2Si_2O_{15}$, or, according to W. C. Brögger and co-workers, *yttrium orthodisilicate*, $Y_2Si_2O_7$. R. Mauzelius and H. Sjögren's analysis is:

Na ₂ O	MgO	CaO	Fe ₂ O ₃	SiO ₂	SnO ₂	ThO ₂	Y ₂ O ₃	(La, D) ₂ O ₃	Ce ₂ O ₃
0.08	0.05	0.11	0.45	28.88	0.22	0.18	61.84	4.15	0.83

with loss on ignition 3.33, which includes 1.73 per cent. of water. W. E. Hidden and J. B. Mackintosh found an orange-yellow to orange-green mineral *yttrialite*, or green gadolinite, in the granite of Llano Co., Texas. W. F. Hillebrand's analysis is:

MgO	CaO	MnO	FeO	PbO	Fe ₂ O ₃	SiO ₂	TiO ₂	Cl	P ₂ O ₅
0.16	0.67	0.88	1.96	0.80	0.76	29.63	0.05	0.11	0.12

with water over 105°, 0.32, and water below 105°, 0.04; undetermined nitrogen, helium, fluorine, and alkalis about 0.31; and

Y ₂ O ₃	La ₂ O ₃	Ce ₂ O ₃	ThO ₂	UO ₂
43.45	5.18	3.07	10.85	1.64

The formula approximates to $(Fe, Mn)(Y, La)_2ThSi_6O_{24}$, or simplified, $RThSi_2O_7 \cdot 4Y_2Si_2O_7$. The mineral is regarded as a kind of weathered gadolinite. The sp. gr. is 4.575; the hardness 5 to 5.5. It is readily soluble in hydrochloric acid; but not if it has been calcined. F. W. Clarke has also studied the mineral. A kind of dark reddish-brown garnet, *yttrio-garnet*, occurs at Stockö, Norway, and Schreiberhau, Germany, with yttria earths 1.0 to 6.7 per cent., and zirconia, 0 to 3 per cent. It has been investigated by L. Gruner, C. Bergemann, M. Websky, W. C. Brögger, A. T. C. Soltmann, and M. Piners. L. A. Aars', and W. C. Brögger's analysis of brownish-red *hellandite* from Lindvikskollan near Kragerö, Norway, is:

Na ₂ O	K ₂ O	MgO	CaO	Al ₂ O ₃	Mn ₂ O ₃	Fe ₂ O ₃	SiO ₂	H ₂ O
0.23	0.06	0.10	9.81	10.12	5.91	2.56	23.66	11.75

with Y₂O₃, 19.29; Er₂O₃, 15.43; Ce₂O₃, 1.01; and ThO₂, 0.62. A possible formula is $Ca_2(R''OH)_4(SiO_4)_4$ or $2R''O \cdot 3R'''O_3 \cdot 4SiO_2 \cdot 3H_2O$, where R'' stands for Ca, Mg, or $\frac{1}{2}$ Th; and R''' for trivalent Al, Fe, Mn, or the rare earth metals. The mineral may thus be regarded as a basic salt of the orthosilicate $H_4Si_2O_{16}$. The monoclinic prisms have the axial ratios $a : b : c = 2.0646 : 1 : 2.507$, and $\beta = 109^\circ 45'$; the sp. gr. is 3.41 to 3.70; the hardness, 5.5. The mineral readily fuses. It dissolves readily in hydrochloric acid with the evolution of chlorine; it does not dissolve as easily in nitric or sulphuric acid. B. Szilard also studied the mineral.

F. Zambonini⁶ found a complex titanate of the rare earths in the pegmatite of Craveggia, Italy, and named it *delorenzite*. The analysis is:

FeO	Y ₂ O ₃	TiO ₂	SnO ₂	UO ₂
4.25	14.63	66.03	4.33	9.87

The yttria earth is almost free from ceria. There are traces of columbic oxide. The formula is $2\text{FeO}\cdot\text{UO}_2\cdot 2\text{Y}_2\text{O}_3\cdot 24\text{TiO}_2$, with a little tin replacing titanium. The mineral is strongly radioactive. The rhombic crystals have the axial ratios $a : b : c = 0.3375 : 1 : 0.3412$. The sp. gr. is 4.7, and the hardness 5.5–6.0. Its closest chemical relation is yttracrasite, but in appearance and angles it resembles polycrase. W. E. Hidden and C. H. Warren analyzed a black mineral from Burnet Co., Texas, which was called **yttracrasite**. It contains 25.7 per cent. of yttria earths; 2.9 per cent. of ceria earths; 8.7 per cent. of thoria; and 49.7 per cent. titanic oxide. The formula approximates $(\text{Ca}, \text{Pb})\text{O}\cdot(\text{Th}, \text{U})\text{O}_2\cdot 3\text{R}_2\text{O}_3\cdot 16\text{TiO}_2\cdot 6\text{H}_2\text{O}$. The prismatic crystals are rhombic, the axial ratios are unknown. The sp. gr. is 4.80, and the hardness 5.5–6.0. It was also studied by B. Szilard.

P. J. Holmquist described a brown mineral in pseudo-cubic crystals from Alnö, Sweden, which he named **knopite**. It is regarded as a variety of perowskite—*vide* titanium. It contains 26.84–33.32 per cent. of calcium oxide; 3.23 to 5.15 per cent. ferrous oxide; 0.06 per cent. of yttria earths; 4.42 to 6.81 per cent. of ceria earths; and 54.12 to 58.74 per cent. of titanic oxide. C. F. Rammelsberg, and P. Groth have described the formula. The sp. gr. is 4.11 to 4.29; and the hardness, 5 to 6. The black mineral is in rounded crystal grains belonging to the cubic system found at O'Cary, South Australia, was named **dauidite**. It was described by D. Mawson, and E. E. H. Rennie and W. C. Cook, and appears to be a titanate of iron, uranium, vanadium, chromium, and the rare earths. It contains over 50 per cent. of titanic oxide, and 5 to 10 per cent. of the rare earths. The sp. gr. is about 4.

A brown mineral from Arendal, Buö, Arkerö, Alve, Narrestö in Norway was named **yttrotitanite** by T. Scheerer,⁷ and **keilhavite** by A. Erdmann. It is a titanosilicate of calcium, aluminium, iron, and yttria earths; it is monoclinic, and isomorphous with titanite, and it is considered to be a mixture of titanite $\text{CaO}\cdot\text{TiO}_2\cdot\text{SiO}_2$, with the silicate $(\text{Y}, \text{Al}, \text{Fe})_2\text{SiO}_3$. The sp. gr. is 3.52 to 3.77; and its hardness, 6.5. The double refraction is positive and feeble. Analyses were made by A. Erdmann, D. Forbes, C. F. Rammelsberg, and T. Scheerer. The constitution has been discussed by H. Rose, J. J. Berzelius, C. W. Blomstrand, F. Zambonini, P. Groth, and O. Hauser—*vide* titanosilicates.

In 1841, A. Erdmann described a brown mineral which he found in the syenite near Brevig, Norway, and named **mosandrite**, after C. G. Mosander. It was analyzed by W. C. Brögger, and B. Szilard. In 1890, W. C. Brögger described a brown mineral, from the islands of Langesund Fiord, Norway, which he called **johnstrupite**, after F. Johnstrup. N. J. Berlin analyzed mosandrite. The composition and general properties are so much alike that W. C. Brögger regards them as belonging to the same mineral species. Both are titanosilicates of the rare earth metals, aluminium, calcium, magnesium, sodium, etc. There is about 13.5 per cent. of ceria earths; 1.1 of yttria earths; 7 to 8 per cent. of titanic oxide; and 3.6 per cent. of thoria and zirconia. The crystals are monoclinic with axial ratios $a : b : c = 1.6229 : 1 : 1.3911$, and $\beta = 93^\circ 4' 15''$ —very close to those of epidote. The sp. gr. of johnstrupite is just over 3, that of mosandrite just below 3. The hardness is 4–5. J. Lorenzen investigated a yellow titanosilicate from the syenites of Kangerdluarsuk, Greenland, and found:

Na_2O	CaO	FeO	Y_2O_3	$(\text{Ce}, \text{La}, \text{Di})_2\text{O}_3$	SiO_2	TiO_2	F
8.93	23.26	0.44	0.92	21.25	29.08	13.36	5.82

The formula has been discussed by W. C. Brögger, and P. Groth—*vide* titanosilicates. The mineral closely resembles johnstrupite. The monoclinic crystals have the axial ratios $a : b : c = 0.7844 : 1 : 1.4610$, and $\beta = 91^\circ 12' 45''$. Their sp. gr. is 3.46, and hardness 5. It is pleochroic. J. Lorenzen found a mineral which he called **rinkite** in the syenite of Kangerdluarsuk, Greenland. Analyses were made by J. Lorenzen, and W. C. Brögger gave the formula $(\text{F}_3\text{Ti}_4)\text{Na}_2\text{Ca}_{11}\text{Ce}_2(\text{SiO}_4)_{12}$; and P. Groth, $\text{Na}_2\text{Ca}_4\text{Ce}_2(\text{Si}, \text{Ti})_6\text{O}_{19}\text{F}_3$ —*vide* titanosilicates. The flattened crystals are yellowish-brown or straw-yellow. They belong to the monoclinic system with the axial ratios $a : b : c = 1.5688 : 1 : 0.2922$, and $\beta = 88^\circ 47\frac{1}{2}'$. The (100) cleavage is distinct; the sp. gr. is 3.46; and the hardness 5. The pleochroic crystals are optically positive. The mineral is easily decomposed by dil. acids with the separation of silica and some titania. A complex silicate called **steenstrupine** was obtained by J. Lorenzen from Steenstrup, Greenland; it contains 14.40 to 35.18 per cent. of ceria earths; 0.36 to 15.90 per cent. of yttria earths; and 2.13 to 7.09 per cent. of thoria. The mineral has been studied by W. C. Brögger, J. Lorenzen, O. B. Böggild, and J. C. Moberg. The brown crystals belong to the rhombohedral system. The sp. gr. is 3.19 to 3.51, and the

hardness 4. The orange-grey mineral *rosenbuschite* was obtained by W. C. Brögger from the islands of Langesund Fiord, Norway. P. T. Cleve's analysis gives:

Na ₂ O	CaO	MnO	Fe ₂ O ₃	Ce ₂ O ₃	SiO ₂	TiO ₂	ZrO ₂	F
9.93	24.87	1.39	1.00	0.33	31.36	6.85	20.10	5.83

The crystals are monoclinic with axial ratios $a : b : c = 1.1687 : 1 : 0.9776$ and $\beta = 101^\circ 47'$; the sp. gr. is 3.30–3.31; and the hardness 5–6—*vide* titanosilicates. The mineral *tseffkinite* was obtained by G. Rose from the Ilmen mountains in the Urals, and it has also been found on the coast of Coromandel, in Madagascar, in Virginia, etc. It has been analyzed by H. Rose, R. Hermann, A. Damour, F. S. Beudant, F. W. Clarke, W. R. Dunstan, B. Szilard, F. Pisani, L. G. Eakins, and R. C. Price. It is a titanosilicate of the rare earth elements, thorium, iron, calcium, etc., and contains 23–47 per cent. of ceria earths; up to 3.4 per cent. of yttria earths; 0 to 20 per cent. of thoria and zirconia; and 16–21 per cent. of titanic oxide. R. C. Price's analysis corresponds with $(Ca, Fe)_2(Di, Ce, La, Fe)_2(Si, Ti)_3O_{15}$. The constitution has been discussed by C. F. Rammelsberg, A. des Cloizeaux, R. C. Price, J. D. Dana, and R. Hermann—*vide* titanosilicates. The mineral is velvety-black and amorphous. Its sp. gr. is 4.26–4.55; and its hardness 5.0–5.5. Under the microscope, the mineral is not homogeneous. The mineral is attacked by hydrochloric or nitric acid with the separation of gelatinous silica.

G. P. Tschernik⁸ described a kind of titanium zirconosilicate which he obtained from Batum, and called *titanocerite*. The sp. gr. was 5.08 and the hardness 5 to 6. The composition was:

CaO	FeO	CuO	SiO ₂	TiO ₂	ZrO ₂	P ₂ O ₅	SO ₃	H ₂ O
2.33	3.70	0.67	6.57	14.73	11.67	3.30	0.97	3.43

together with

Y ₂ O ₃	La ₂ O ₃	Di ₂ O ₃	Ce ₂ O ₃	Er ₂ O ₃	ThO ₂	UO ₂
6.97	6.73	2.27	34.20	0.67	0.73	trace

The brown, transparent zirconosilicate of calcium and the rare earth metals occurring near the Sea of Azoff, Russia, called *beckelite*, has, according to J. Morozewicz, the composition:

Na ₂ O	K ₂ O	CaO	Mn ₂ O ₃	SiC ₂	Al ₂ O ₃	ZrO ₃	Loss on ignition
0.78	0.39	15.46	0.07	17.13	0.30	2.50	0.99

with traces of magnesia and ferric oxide; 2.80, $(Y, Er)_2O_3$; 13.60, La_2O_3 ; 18.0, Di_2O_3 ; 28.10, Ce_2O_3 . The formula may be $Ca_3(Y, Ce, La, Di)_4(Si, Zr)_3O_{15}$. The crystals are octahedral belonging to the cubic system; the sp. gr. is 4.15; and the hardness, 5. It is soluble in hot hydrochloric acid, even after ignition.

W. C. Brögger's analyses⁹ of the three borosilicates, *melanocerite*, *caryocerite*, *cappelenite*, and N. Engström's analysis of *tritomite*, are shown in Table IV. These minerals were also studied by B. Szilard. The formula of *cappelenite* approximates $(Y, La, Di)BO_3(Ba, Ca, Na_2, K_2)SiO_3$. *Melanocerite* dissolves in hydrochloric acid with the separation of silica; *cappelenite* is likewise decomposed by that acid; and *tritomite* dissolves with the separation of gelatinous silica and the evolution of chlorine. T. Liebisch noted the thermoluminescence of *tritomite*. E. S. Larsen studied the optical properties of *caryocerite*, *tritomite*, and *homilite*. S. R. Paijkull analyzed a borosilicate of the rare earth metals, calcium, and iron which occurs near Brevig, Norway. It is accompanied by *erdmannite* and *melophanite*, and is named *homilite*— $\delta\mu\lambda\acute{\epsilon}\omega$, to occur together—*vide* borosilicates. The mineral was also studied by A. des Cloizeaux and A. Damour. It contains up to 2.6 per cent. of ceria earths, and the formula approximates $(Ca, Fe)_2(BO_2(SiO_4))_2$. The crystals are monoclinic and isomorphous with *gadolinite*. The sp. gr. is 3.34–3.38; its hardness is 4.5 to 5.0; and it is pleochroic. W. C. Brögger found the borosilicate *cappelenite* in the islands of Langesund Fiord, Norway, in 1885. It contains 4.20 per cent. of ceria earths, 52.55 per cent. of yttria earths, and 0.79 per cent. of thoria, as well as silica, boric oxide, etc. The greenish-brown mineral approximates $BaSiO_3 \cdot YBO_3$ in composition. According to B. Szilard, the prismatic crystals are hexagonal. The sp. gr. is 4.407; and the hardness 6.0–6.5. H. Sjögren, and A. E. Nordenskjöld analyzed the yellowish-brown mineral *cainosite* or *cenosite* from Hitterøe, and found

Na ₂ O	MgO	CaO	FeO	Y ₂ O ₃	(Ce, La, Di) ₂ O ₃	SiO ₂	CO ₂	H ₂ O
3.6	1.4	16.5	2.9	35.9	trace	31.7	5.1	2.9

corresponding with the carbonatosilicate, $Ca_2Y_2(Si, C)_3O_{15} \cdot 2H_2O$; or, according to C. F. Rammelsberg, $CaCO_3 \cdot CaY_2Si_4O_{12} \cdot 2H_2O$. W. C. Brögger and co-workers made observations on the mineral. According to H. Sjögren, the rhombic crystals have the axial ratios $a : b : c = 0.9517 : 1 : 0.8832$. The sp. gr. is 3.38–3.413, and the hardness 5 to 6. It is easily decomposed by hydrochloric acid, and carbon dioxide is evolved. There are some decomposition products of *thorite* and *orangite*—*vide* thorium—which contain rare earths. *Thorite* has up to about 5 per cent. of rare earths. The *calciorthorite* of W. C. Brögger¹⁰

TABLE IV—COMPOSITION OF SOME RARE EARTH BOROSILICATES.

	Melanocerite.	Caryocerite.	Cappelenite.	Tritomite.
K ₂ O	—	—	0.22	0.71
Na ₂ O	1.45	1.42	0.53	—
MgO	0.14	0.17	—	—
CaO	8.62	7.37	0.67	6.97
BaO	—	—	8.29	—
B ₂ O ₃	3.19	4.70	16.98	8.37
Al ₂ O ₃	0.83	0.87	—	0.88
Mn ₂ O ₃	1.22	0.66	—	0.34
Fe ₂ O ₃	2.09	1.36	—	1.55
Y ₂ O ₃	9.17	2.21	52.62	2.58
La ₂ O ₃	12.94	14.34	2.97	21.56
Di ₂ O ₃	7.67	6.75	—	4.76
Ce ₂ O ₃	20.76	14.83	1.29	8.14
CO ₂	1.75	0.35	—	—
SiO ₂	13.07	12.97	14.66	13.59
ZrO ₂	0.46	0.47	—	1.03
CeO ₂	3.68	5.89	—	11.26
ThO ₂	1.66	13.64	0.80	8.58
P ₂ O ₅	1.29	0.86	—	—
UO ₂	—	trace	—	—
Ta ₂ O ₅	3.65	3.11	—	1.11
H ₂ O	3.01	4.77	0.61	6.48
F	5.78	5.63	—	3.15
Trigonal axial ratio .	1 : 1.25537	1 : 1.2903	1 : 1.1845	1 : 1.114
Sp. gr.	4.113—4.148	4.286—4.305	—	4.15—4.25
Hardness	5 to 6	5 to 6	—	5 to 6

approximates 59.3 per cent. of thorium; 0.23 per cent. of yttria earths; and 0.39 per cent. of ceria earths—5ThSiO₄·2Ca₂SiO₄·10H₂O. It is a red amorphous mass of sp. gr. 4.114, and hardness 4.5, found on the islands of Langesund Fiord, Norway. The amorphous silicate of the rare earth metals, thorium, aluminium, iron, manganese and sodium, found near Brevig, Norway, and called *freyalite*, has 31.1 per cent. ceria earths; 28.4 per cent. thorium; and 6.3 per cent. zirconia. Its sp. gr. is 4.06–4.17, and its hardness 6. It was studied by W. C. Brögger, and A. Damcur. W. E. Hidden and J. B. Mackintosh found *auerlite*, approximating ThO₂· $\frac{1}{3}$ P₂O₅·SiO₂·2H₂O, as a yellow or brownish-red tetragonal mineral in North Carolina. Its sp. gr. is 4.422 to 4.766; B. Szilard found 8 to 10 mols of water. The brownish-black mineral *eucasite* from Brevig, Norway, is likewise an altered thorite; it was studied by W. C. Brögger, and S. R. Paijkull. It contains 14 per cent. ceria earths; 5.9 per cent. yttria earths; 36.0 per cent. of thorium; and 0.6 per cent. of zirconia; in addition, the oxides of calcium, iron, manganese, sodium, and titanium; and water. W. C. Brögger's sample was isotropic and amorphous, S. R. Paijkull's sample was in rhombic crystals. The sp. gr. is 4.39, and the hardness 4.5–5.0. The black opaque mineral *mackintoshite* is found at Bluffton, Llano Co., Texas. It was studied by W. E. Hidden, B. Szilard, F. W. Clarke, and W. F. Hillebrand. It is a complex mixture of silica and oxides of the rare earth metals, thorium, uranium, iron, calcium, magnesium, lead, sodium, boron, tantalum, etc. The thorium amounts to 45.3 per cent., the uranium oxide, UO₂, 22.4 per cent.; the rare earths, 1.9 per cent.; and the zirconia, 1.0 per cent. The tetragonal crystals resemble those of thorite. The sp. gr. is 5.42, and the hardness 5.5. W. E. Hidden and J. B. Mackintosh obtained a silicate of thorium, uranium, etc., with 6.7 per cent. of rare earths. The approximate formula is UO₂·3ThO₂·3SiO₂·6H₂O. The mineral was called *thorogummite*, and it is regarded as an altered mackintoshite. The crystals resemble zircon, but it usually occurs massive. The sp. gr. is 4.43 to 4.54, and the hardness 4.0–4.5. The yellowish-brown tetragonal mineral *yttrougummite* was found by W. E. Hidden and co-workers in Llano Co., Texas. It contains 6.7 per cent. of rare earths, and 41.4 per cent. of thorium. The formula approximates UO₂·2ThO₂·3SiO₂·3H₂O. Its sp. gr. is 4.43–4.54, and its hardness 4.0–4.5. The bright yellow amorphous mineral *pilbarite* from Pilbara, West Australia, was found by E. S. Simpson to contain traces of ceria and yttria earths. It has 31 per cent. of thorium, and approximates PbO·UO₂·ThO₂·2SiO₂·2H₂O. Its sp. gr. is 4.4–4.7, and the hardness 2.5–3.0.

A. G. Ekeberg¹¹ found black and yellow tantalates of yttrium, iron, and calcium with some uranium in the red felspar at Ytterby, Sweden, and he called them

yttrotantalite. The mineral was found also at Finbö and Broddbö near Fahlun; R. J. Haüy called it *tantale oxidé yttrifère*; and R. Hermann, *yttrölmennite*. A similar mineral was described by B. Szilard. A tantalocolumbate of the rare earth metals, iron, calcium, and uranium, was discovered in the Urals and analyzed by G. Rose in 1839, and called *uranotantalite*, he also called it *uranoniobite*. H. Rose in 1847 renamed it **samarskite** after a Russian engineer who obtained him the specimen for analysis. The mineral is also called *eytlandrite*. Samarskite and yttrotantalite are now considered to be the same mineral species. The prismatic crystals of the opaque, velvety-black or yellowish-brown mineral belong to the rhombic system. E. S. Dana gave for the axial ratios of samarskite $a:b:c = 0.5456:1:0.5178$; and W. C. Brögger, for yttrotantalite $0.5566:1:0.5173$. Samarskite and yttrotantalite are isomorphous. K. von Chrustchoff's analysis of a specimen of samarskite from Miask, Urals, gave:

Na ₂ O	K ₂ O	MgO	CaO	MnO	FeO	ZnO	PbO	Fe ₂ O ₃	Al ₂ O ₃	SnO ₂	ZrO ₂	WO ₃
0.28	0.21	0.41	0.51	0.69	11.15	0.17	0.15	2.13	0.19	0.79	1.03	1.73
SiO ₂	TiO ₂	Cb ₂ O ₅	Ta ₂ O ₅	H ₂ O	ThO ₂	UO ₃	Y ₂ O ₃	Er ₂ O ₃	Ce ₂ O ₃	La ₂ O ₃	Di ₂ O ₃	
0.12	0.68	32.02	11.18	1.22	1.73	11.23	7.83	13.37	0.25	0.37	1.56	

Analyses of samarskite have been made by O. D. Allen, J. L. Smith, B. Szilard, M. Delafontaine, R. Hermann, H. Rose, R. J. Strutt, G. H. Williams, T. S. Hunt, C. F. Rammelsberg, G. C. Hoffmann, Y. Shibata and K. Kimura, W. F. Hillebrand, W. C. Brögger and co-workers, G. P. Tschernik, and A. Lacroix; and analyses of yttrotantalite by C. F. Rammelsberg, W. C. Brögger, and G. P. Tschernik. Yttrotantalite usually contains rather more tantalum than samarskite. C. F. Rammelsberg gave the formula $(Fe'', Ca, UO_2)_3R_2(Cb, Ta)_6O_{20}$, where R represents the elements of the rare earths; P. Groth regards samarskite as a *pyrocolumbate* or *pyrotantalate*, $R_4[(Cb, Ta)_2O_7]_3$, where iron, calcium, and uranium are regarded as accessory constituents. A. des Cloizeaux considers the formula indefinite. Germanium was reported in samarskite by K. von Chrustchoff; and the rare earth samaria is also found therein. The sp. gr. is 5.6–5.8, and the hardness 5 to 6. A. L. Fletcher gave 1330° for the m.p. of samarskite.

The *nohlite* of A. E. Nordenskjöld is a brownish-black massive variety of samarskite, containing about 4.6 per cent. of water, and found near Nohl, Sweden. Its sp. gr. is 5.04, and hardness 4.5 to 5.0. The *loranscite* from Imbilax, Finland, analyzed by P. Nikolaëff; the *plumboniobite* from Morogoro, West Africa, analyzed by O. Hauser; the *rogersite* of J. L. Smith from North Carolina; the *annerödite* of W. C. Brögger from Anneröd, Norway; the rhombic crystals of *hjelmit* or *hielmite* of sp. gr. 5.82, from Kararfvet, Sweden, and analyzed by C. F. Rammelsberg and M. Weibull; and the *ampangabeite* of A. Lacroix from Ampangabé, Madagascar, are all closely related to samarskite, or to weathered products of that mineral. The dark brown or black crystals of plumboniobite are isotropic; the formula is $(Fe, Pb, Ca, UO_2)_2Cb_2O_7R_4(Cb_2O_7)_3$, where R denotes aluminium, the yttria earth elements. The yttria earths are rich in gadolite and samaria, the ceria earths are almost absent. The sp. gr. is 4.80–4.81, and the hardness 5.0 to 5.5. Unlike samarskite, it does not glow when heated. O. Hauser found the mineral to be radioactive and to give much occluded gas, including helium, when heated with sulphuric acid. Y. Shibata and K. Kimura found a mineral at Ishikawa, Japan, which they called *ishikawaite*. It occurs in black crystals carrying 8.40 per cent. rare earths; 21.88 per cent. UO₂; 36 per cent. Cb₂O₅; 15 per cent. Ta₂O₅; etc. The axial ratios of the rhombic crystals are $a:b:c = 0.9451:1:1.147$, the sp. gr. 6.2–6.4, hardness 5–6.

H. L. Giesecke¹² found a mineral in the quartz near Cape Farewell, Greenland, in 1806, and later, W. Haidinger named it **fergusonite**; the same mineral was found at Ytterby, Sweden. D. Forbes and T. Dahll found a similar mineral at Hampemyr and Helle near Arendal, Norway, and called it *tyrite*; and D. Forbes found a similar mineral at Helle, Narestö, Aloe, and Askerö, Norway, which they called *bragite*. J. A. Michälson and others have shown that these minerals are probably fergusonite. In addition to the occurrences in Norway and Sweden, and Greenland, the mineral has been reported at Rockfort, Massachusetts; Burke Co. and Amherst Co., North Carolina; Llano Co., Texas; Durayakanda, Kuriwita, and

Rakivana, Ceylon; Terek, Caucasus; between Tamatave and Beforona, Madagascar; Cooglegong, West Australia. Analyses have been made by B. Szilard, V. Hartwall, H. Weber, A. E. Nordenskjöld, J. J. Berzelius, D. Forbes and T. Dahll, J. Potyka, J. A. Michäelson, C. F. Rammelsberg, J. L. Smith, W. H. Seamon, W. E. Hidden and J. B. Mackintosh. G. T. Prior, G. Tschermak, W. C. Brögger, G. S. Blake, A. Lacroix, and E. S. Simpson. The following analysis is by W. C. Brögger of a sample from Rade, Norway:

BeO	MgO	CaO	MnO	FeO	SiO ₂	SnO ₂	Cb ₂ O ₅	Ta ₂ O ₅	H ₂ O
0·40	0·05	1·23	0·15	0·73	1·44	0·98	39·30	6·25	4·00

and traces of zirconia, together with

(Y, Er) ₂ O ₃	Ce ₂ O ₃	(La, Di) ₂ O ₃	ThO ₂	UO ₂
35·03	0·72	2·25	2·15	4·68

The mineral may be regarded as a columbate and tantalate of the rare earth metals with uranium, iron, calcium, etc. The idealized formula is $R(\text{Cb}, \text{Ta})\text{O}_4$, where R denotes the metals of the rare earth group—chiefly yttria earths. W. C. Brögger gives the more complex formula $(\text{Th}, \text{U})(\text{Si}, \text{Sn})\text{O}_4 \cdot 12R(\text{Cb}, \text{Ta})\text{O}_4$. G. Hevesy and V. T. Jantzen found no hafnia in fergusonite. M. S. Curie, and R. J. Strutt studied the radioactivity of the mineral.

The brownish-black pyramidal crystals belong to the tetragonal system with the axial ratio $a:c=1.4643$. The sp. gr. is 5.84, which is smaller with the more hydrated specimens; the hardness is 5 to 6. A. L. Fletcher gave 1300° for the m.p. of fergusonite. W. Ramsay and M. W. Travers found the mineral contains 1.3 to 1.5 c.c. of helium per gram; and when heated to 500°–600°, it glows suddenly, giving off its helium, and decreasing in sp. gr. from 5.617 to 5.375; at the same time 8.92 Cals. per gram are evolved.

The **rutherfordite** obtained by C. U. Shepard from the gold mines of Rutherford, North Carolina; the **kochelite** obtained by M. Websky, and B. Szilard from the Kochelweise, Silesia; and the **adelpholite** obtained by N. Nordenskjöld from Finland, were probably all more or less altered fergusonites. The **sipyllite**, found by J. W. Mallet in Amherst Co., Virginia, in 1877, and named after Sipyllus, one of the sons of Niobe in allusion to the contained niobium (columbium), is closely related to fergusonite. The idealized formula given by J. W. Mallet is $R_2\text{O}_3(\text{Cb}, \text{Ta})_2\text{O}_5$, where the basic elements include, besides the rare earths, iron, calcium, etc. Some tungstic oxide is also present. R. J. Strutt found the mineral also contained 4.9 per cent. of thoria, and some uranium, radium, and occluded helium. The yellowish or greenish-brown mineral **risörite**, found in the granite of Risör, Norway, is considered by O. Hauser to be an orthocolumbate, $R(\text{Cb}, \text{Ta})\text{O}_4$, with admixed isomorphous metatitanate, $R_2(\text{TiO}_3)_3$. It differs from fergusonite chiefly in the higher proportions of titanic oxide, in a higher loss on ignition, and in the almost complete absence of uranium. The rare earths are chiefly yttria with some erbia, and a little terbia; ceria, lanthana, and didymia are also present. The mineral is radioactive, and contains much occluded helium, which is unusual with minerals containing so little uranium and thorium. It was investigated by W. C. Brögger and co-workers. The mineral is isotropic in polarized light, but no good crystals have been obtained. The hardness is 5.5; and the sp. gr. 4.179 rises to 4.678 on ignition. A. L. Fletcher gave 1720° for the m.p. of the mineral.

J. J. Berzelius¹³ discovered a black mineral at Miask, Urals, which appeared to be a columbate and titanate of rare earths, and other bases; he called it **aeschnyite**—*αἰσχύνη*, shame—in allusion to the inability of chemists, at the time of its discovery, to separate titanium and zirconium oxides. It also occurs at Hitterøe, Norway; and a variety described by J. J. Berzelius was called **polymignite**. This mineral occurs at Fredriksværn, Norway, and at Beverley, Massachusetts. Polymignite was shown by H. Rose to be probably identical with aeschnyite. When the ceria earths are replaced by yttria earths, a similar variety is obtained resembling polycrase in composition, but W. C. Brögger named it **blomstrandine**—*vide infra*. Analyses of aeschnyite were made by V. Hartwall, W. C. Brögger, R. Hermann, J. C. G. de Marignac, R. J. Strutt, L. Schmeleck, G. P. Drossbach, G. F. Rammelsberg, and G. Tschermak. The results show that

it approximates to $2R(\text{CbO}_3)_3 \cdot 2\text{ThTiO}_4 \cdot \text{TiO}_2$, where R represents the rare earth metals partially replaced by iron (ous), and thorium by iron (ous) and calcium. R. J. Strutt found it contained uranium, radium, and helium. The rhombic crystals were examined by G. Rose, H. J. Brooke, and A. des Cloizeaux. N. von Kokscharoff gave $a : b : c = 0.48665 : 1 : 0.67366$ for the axial ratios. The sp. gr. is 4.93–5.17, and the hardness 5 to 6. A. L. Fletcher found the mineral melted between 1245° and 1330°.

T. Scheerer,¹⁴ in 1839, discovered a rare mineral which he named **euxenite**—*εὐξενος*, a stranger—in allusion to its scarcity. It was found at Jølster, Norway; and it has since been found in various places in Scandinavia, North Carolina, South Australia, etc. Analyses have been made by C. F. Rammelsberg, L. Schmelz, H. Lange, W. A. A. Prandtl, D. Forbes and T. Dahll, A. Strecker, J. J. Chydenius, J. C. G. de Marignac, C. J. Jehn, C. W. Blomstrand, L. A. Aars, B. Szilard, R. J. Strutt, O. B. Böggild, W. C. Brögger, E. S. Simpson, O. Hauser and F. Wirth, G. T. Prior, H. Lange, A. Lacroix, K. A. Hofmann, etc. G. Tschermak gave for a sample from Caucasus :

CaO	Fe ₂ O ₃	(Y, Er) ₂ O ₃	Ce ₂ O ₃	La ₂ O ₃	Di ₂ O ₃	SiO ₂	TiO ₂	U ₂ O ₃	Cb ₂ O ₅
0.44	3.24	11.20	8.53	0.55	0.48	7.03	33.31	11.11	22.20

with a trace of thoria, and 0.93 per cent. of water. This makes the mineral a titanocolumbate of uranium and the rare earths, $\text{Y}_2\text{Ti}_4\text{O}_{11} \cdot 2(\text{Ca}, \text{Fe})\text{Cb}_2\text{O}_5 \cdot (\text{UO}_2)\text{Cb}_2\text{O}_5$, or $\text{Y}_2\text{Ti}_4\text{O}_{11} \cdot \text{R}''\text{Cb}_2\text{O}_6$. J. J. Chydenius also found thoria in a sample of the mineral, but only traces of ceria. G. Hevesy and V. T. Jantzen found no hafnia in euxenite. According to B. B. Boltwood, euxenite is usually radioactive, and contains helium. G. Krüss reported germanium in euxenite, but G. Lincio could find none. K. A. Hofmann and W. A. A. Prandtl believed that they had discovered a new element in euxenite, and named it euxenium, but O. Hauser and F. Wirth showed that in all probability some mistake had been made. The rhombic crystals, according to W. C. Brögger, have the axial ratios $a : b : c = 0.3789 : 1 : 0.3527$; the sp. gr. is 4.6–5.4; the hardness, 5.0–6.5. A. L. Fletcher found the mineral melted at about 1375°. T. Scheerer discovered a related mineral in the granite of Hitterö, Norway, and near Dresden. He named it **polycrase**—*πολύς*, many; *κρᾶσις*, mixture. Analyses were made by T. Scheerer, C. F. Rammelsberg, W. E. Hidden and J. B. Mackintosh, and C. W. Blomstrand. Polycrase and euxenite are isomorphous. According to W. C. Brögger, the ratio of the acidic oxides $\text{Cb}_2\text{O}_5 : \text{TiO}_2$ is nearly 1 : 2 in euxenite, but in the analyses of euxenite and polycrase this ratio ranges from 1 : 2 to 1 : 5, or, according to H. Lange, from 1 : 2 to 1 : 6. There is a continuous variation in composition between these limits, and the members of the isomorphous series are regarded as solid soln. with the unknown metacolumbate and metatitanate as end-terms of the series. W. C. Brögger suggests that the name euxenite be reserved for the minerals with the ratio $\text{Cb}_2\text{O}_5 : \text{TiO}_2$ between 1 : 2 and 1 : 3, and polycrase for those with the ratio less than 1 : 4. A. L. Fletcher gave 1420° for the m.p. of polycrase. The isomorphous euxenite-polycrase series is dimorphous; and there is a parallel series of similar composition with **priorite** analogous with euxenite and **blomstrandine** analogous with polycrase. These two types were discussed by W. C. Brögger and co-workers; they belong to the rhombic system and have axial ratios $a : b : c = 0.4746 : 1 : 0.6673$; the sp. gr. ranges from 4.82 to 5.00. Analyses have been made by G. T. Prior, O. Hauser and H. Herzfeld, B. Szilard, and W. C. Brögger. A bibliography has been compiled by J. Schilling.

F. Wöhler¹⁵ found a columbate of calcium, cerium, etc., in the syenite at Fredriksværn and Laurvig, Norway; it also occurs near Brevig, Alnö, and Sundsvall, Sweden; Tscheroch, Caucasus; and near Miask, Urals. It was named **pyrochlore**—*πύρ*, fire; *χλωρός*, green—in allusion to its colour before the blowpipe flame. Analyses have been made by C. F. Rammelsberg, R. Hermann, F. Wöhler, B. Szilard, J. J. Chydenius, G. Tschermak, P. J. Holmquist, and K. von Chrutchoff. A sample from the Urals furnished the last-named with the analysis :

Na ₂ O	K ₂ O	CaO	FeO	TiO ₂	(Cb, Ta) ₂ O ₅	F
3.35	0.87	14.05	2.52	8.32	56.01	2.77

with traces of zirconia and magnesia, and the rare earths:

(Y, Er) ₂ O ₃	Ce ₂ O ₃	Di ₂ O ₃	La ₂ O ₃	UO	ThO ₂
0.56	2.16	1.94	1.23	2.63	4.28

The presence of water is probably due to a secondary action. A. L. Fletcher gave 1340° for the m.p. of pyrochlore. R. Hermann called the varieties containing water **hydrochlore**, and those containing fluorine **fluochlore**. The brown octahedral crystals belong to the cubic system. The sp. gr. is 4.2 to 4.4; and the hardness 5.0–5.5. The thermoluminescence has been studied by W. Ramsay and T. Liebisch. P. J. Holmquist synthesized the mineral by melting together calcium chloride, columbic acid, and sodium fluoride. The crystals had the composition NaCaCb₂O₆F.

S. Weidman and V. Lenher found brown octahedral crystals of a mineral in the pegmatite near Wausau, Wisconsin. The mineral was named **marignacite**. The sp. gr. was 4.13; and hardness 5.0–5.5. Analysis gave:

Cb ₂ O ₅	Ta ₂ O ₅	SiO ₂	TiO ₂	Fe ₂ O ₃	FeO	CaO	MgO	Na ₂ O	K ₂ O
55.22	5.86	3.10	2.88	0.50	0.02	4.10	0.16	2.52	0.57

Water above 110°, 5.95, and below 110°, 0.45 per cent. The rare earth contents were Ce₂O₃, 13.33; Y₂O₃, 5.07; and ThO₂, 0.20 per cent. Traces of alumina, manganese, tin, tungsten, didymia, lanthana, and erbia are reported. **Marignacite** thus differs from other members of the pyrochlore group in containing more cerium and yttrium and less calcium and iron; also in the presence of a little silica, suggesting a relation to the titanosilicates. The water, no doubt, represents hydroxyl, isomorphously replacing fluorine, which is here absent. It was also studied by B. Szilard. It is insoluble in acids. The **loranscite** of M. P. Meinikoff and P. D. Nikolajeff, found near Imbilax, Finland, is closely related to euxenite; it contains 3.0 per cent. of ceria, 10.0 per cent. of yttria, 20.0 per cent. of thoria earths. Its sp. gr. is 3.8 to 4.8; and the hardness 6. W. Ramsay and A. Zilliacus, L. J. Spencer, and W. Crookes referred to a mineral which H. Börgström considered as belonging to a group of minerals containing loranscite, and he called the group **wilkitite**. It is a columbatotitanosilicate of iron and the rare earths. According to H. Börgström, the rhombic crystals have the axial ratios $a : b : c = 0.5317 : 1 : 0.5046$. A. L. Fletcher gave 1250° for the m.p. of wilkitite.

The minerals **blomstrandite**, **betafite**, and **samiresite** closely resemble pyrochlore. They occur in octahedra. **Blomstrandite** occurs massive at Nohl, Sweden, and in crystals at Tongafeno, Madagascar—G. Lindström analyzed the former, A. Lacroix the latter; **betafite**, from Ambolotora, Madagascar; and **samiresite**, from Samirey, Madagascar, were analyzed by A. Lacroix. They contain more uranium and less alkalis than pyrochlore: otherwise their properties are similar. They contain from 0.2 to 3.0 per cent. of rare earths; up to 1.30 per cent. thoria; 18.1 to 26.6 per cent. U₂O₄; bismuth oxide, up to 0.4 per cent.; lead oxide, up to 7.35 per cent.; nearly 50 per cent. of tantalic and columbic oxides; 6.7 to 13.3 per cent. titanic oxide; up to 0.3 per cent. stannic oxide; etc. O. Hauser and H. Herzfeld, and B. Szilard studied blomstrandite. C. U. Shepard found yellow octahedral crystals of calcium tantalate and columbate in the albite at Chesterfield, Mass., and called the mineral **microlite**—*μικρός*, small—in allusion to the size of the crystals. **Micromerite** also occurs at Utö, Sweden; **Amelia**, Virginia; **Igaliko**, Greenland; and West Australia. It is a kind of pyrochlore with a high proportion of tantalic acid. It was analyzed by C. U. Shepard, A. A. Hayes, F. P. Dunnington, A. E. and G. Nordenskjöld, and E. S. Simpson. The sp. gr. is 5.405 to 5.656; and the hardness 5.5. The Virginia sample analyzed by F. P. Dunnington gave:

Na ₂ O	K ₂ O	BeO	MgO	CaO	Fe ₂ O ₃	Al ₂ O ₃	WO ₃	SnO	(Cb, Ta) ₂ O ₅
2.86	0.29	0.34	1.01	11.80	0.29	0.13	0.30	1.05	76.17

and 1.17 of water; 2.83 of fluorine; 1.59 of UO₃; 0.23 of yttria earth; and 0.17 of ceria earth. J. L. Smith, and O. D. Allen found octahedral crystals of a calcium columbate and tantalate in the mica mine, Mitchell Co., North Carolina. They called the mineral **hatchetolite**. It is closely related to pyrochlore. Its sp. gr. is 4.77–4.90; and its hardness, 5. Analyses showed 0.86 per cent. yttria earths; 7.09, calcium oxide; 15.63, uranic oxide; 1.61, titanic oxide; 67.86, of columbic and tantalic oxides; etc. A. Knop found a mineral in the limestone near Schelingen, Baden, which resembled pyrochlore but contained no titanic oxide, and little or no fluorine. He called it **koppite**. Analyses have been made by A. Knop, and G. H. Bailey. It contains 6.89–10.10 per cent. of ceria earths; 61.64–61.90, tantalic and columbic oxides; 16.00–16.61, calcium oxide; etc. The sp. gr. is 4.45–4.56. The **neotantalite** of P. Termier obtained from Allier, France, occurs in octahedral crystals and appears to be closely related to the above. The **pyrrhite**—*πυρρός*, yellowish-red-like fire—of G. Rose, found as octahedral crystals at Alabaschka in

the Urals, is considered to be closely related with microlite. Likewise also with the orange-red octahedral crystals—called by J. D. Dana, *azorite*—found by G. vom Rath, J. E. Teschemacher, A. Osann, and A. Corsi in the albite rock at San Miguel, Azores; by L. L. Hubbard, at Laacher See; and by W. C. Brögger at Moss and Kragerø, Norway—*vide* the zirconatosilicates.

A red silicotantalate of yttrium metals with cerium, aluminium, iron, calcium, beryllium, etc., which occurs at Ytterby, Sweden, is an amorphous decomposition product. It has been called *arrhenite*, and was investigated by A. E. Nordenskjöld, and N. Engström. It contains yttria earths, 33·2 per cent.; ceria earths, 2·6; tantalum oxide, 21·28; columbic oxide, 2·67; alumina, 3·88; ferric oxide, 1·87; silica, 17·65; zirconia, 3·42; beryllia, 0·74; calcium oxide, 5·22; and water, 6·87 per cent. Its sp. gr. is 3·68. G. Flink, and O. B. Böggild and C. Winther found in the same locality a mineral which was called *endelolite*, it contains 4·43 of the rare earths, and 3·78 per cent. of zirconia. Its approximate formula is $\text{RCb}_2\text{O}_6(\text{OH})_2 \cdot \text{RSiO}_3$ —*vide* the columbatosilicates.

Fluorine is the only halogen which occurs in nature in combination with the rare earths. The chlorine in eudialite is probably of secondary origin, and is possibly part of the zirconyl radicle, ZrOCl . T. Scheerer¹⁶ emphasized the fact that except in a few cases the rare earth minerals occur in igneous rocks, particularly the granites, which have undergone metamorphosis. In a few cases where erosion has occurred, the secondary formation has in all probability been derived from plutonic rocks of great age. G. Eberhard has found that the age and nature of the common rocks has no influence on the traces of the contained scandia and yttria earths; but rare earth minerals are usually very stable and have been formed by the metamorphosis of granites. The occurrence of fluorine in the rare earth minerals is also in agreement with the assumption that they have formed during the pneumatolytic metamorphism of plutonic rocks.

The mineral *yttrocerite* was discovered by J. J. Berzelius and J. G. Gahn.¹⁷ It is found massive or granular, and coloured white, violet-blue, or reddish-brown; and it occurs sparingly in different parts of Scandinavia. G. Gibbs found it in New Jersey; C. T. Jackson in Massachusetts; and W. F. Pettard in Tasmania. Its composition corresponds with a mixture of ceria and yttria earth fluorides with calcium fluoride approximating $2\text{CeF}_3 \cdot 4\text{YF}_3 \cdot 9\text{CaF}_2 \cdot 2\text{H}_2\text{O}$; or $5\text{RF}_3 \cdot 9\text{CaF}_2 \cdot 2\text{H}_2\text{O}$. Analyses were also made by C. F. Rammelsberg, and C. T. Jackson. G. Tschermak's analysis of violet-blue crystals of ytthrocerite from Colorado gave:

Ce_2O_3	Y_2O_3	CaO	H_2O	F
18·19	29·36	27·61	1·96	37·69

with traces of $\text{Al}_2\text{O}_3 \cdot \text{SiO}_2$. The proportions of ceria earths range from 9·3 to 18·19, and the yttria earths from 8·1 to 29·36 per cent. Hence ytthrocerite has been regarded as fluorspar in which part of the calcium has been replaced by the ceric or yttria earth metals. E. F. Glocker called it *ytthrocalcite*. The hardness is about 4·5, and the sp. gr. 3·45. A. L. Fletcher found ytthrocerite infusible below 1510°. The powdered mineral readily dissolves in boiling hydrochloric acid and more readily still in hot sulphuric acid. T. Vogt discovered a mineral in the pegmatite vein of Northern Norway; it is related to ytthrocerite, but contains less cerium and more yttrium. Hence he called it *ytthrofluorite*. It also contains less water than ytthrocerite. His analysis is:

Ce_2O_3	Y_2O_3	CaO	Alkalies	H_2O	F
1·68	17·35	54·89	0·15	0·67	45·54

T. Vogt regards the mineral as an isomorphous mixture of calcium fluoride with yttrium fluoride together with cerium fluoride, where the terms yttrium and cerium represent the corresponding groups of rare earths metal. This hypothesis explains the frequency in the occurrence of the rare earths in fluorspar. The crystals belong to the cubic system. The sp. gr. is 3·5356 to 3·5572, the hardness 4·5; the index of refraction for Na-light, 1·4522–1·4572. E. Dittler also studied the mineral.

J. J. Berzelius¹⁸ found a basic fluoride of ceria and yttria earths at Finbö and Broddbö, Sweden; and called it *basisk flussopatsyradt cerium*. W. Haidinger's term *fluocerite*

is now generally employed. It contains from 81.43 to 82.64 per cent. of ceria earths, and 1.12 to 4.30 per cent. of yttria earths. M. Weibull gave the formula $(Ce, La, Di)_2OF_4$. The mineral is very scarce. It occurs in hexagonal crystals of sp. gr. 5.7–5.9, and hardness 4. A. Hadding studied the X-radiogram of fluocerite. The yellow *hydrofluorite* from Finbø is probably a weathered product containing cerium hydroxide and fluoride. F. W. Clarke,¹⁹ and W. F. Hillebrand and W. E. Hidden described a mineral from the pegmatite of Llano Co., Texas, which they called **rowlandite**.

(Na, K) ₂ O	MgO	CaO	MnO	FeO	Fe ₂ O ₃	SiO ₂	H ₂ O	F	CO ₂
0.28	1.62	0.50	0.67	4.39	0.09	26.04	0.24	3.87	0.34

with a trace of phosphoric oxide, uranium and titanium oxides, 0.39 per cent. of matter undetermined; and

Y-group	La-group	Ce ₂ O ₃	ThO ₂
47.70	9.34	5.06	0.59

They gave the formula $R''R_4Si_4O_{14}F_2$, where R is trivalent and R'' bivalent. W. C. Brögger gave $R''(RF)_2R_2(Si_2O_7)_2$; and P. Groth, $(Fe, Mg)(Y, Ce, La)(YF)_2(Si_2O_7)_2$.

J. J. Berzelius²⁰ found greyish-white, pink, or yellow crystals of *kohlensaures Cereroxydul* coating some cerite at Bastnäs, Sweden. W. Hisinger, and F. S. Beudant made some observations on the mineral; the latter called it *carbocérine*. W. Haidinger called the mineral **lanthanite**. It has also been found at Bethlehem, Pennsylvania; and at Moriah, Essex Co., New York. The mineral is essentially a carbonate of the ceria earths, chiefly lanthana. Analyses have been made by G. Lindström, J. L. Smith, F. A. Genth, and C. F. Rammelsberg. The first-named gave for the Bastnäs mineral:

Y ₂ O ₃	(La, Di) ₂ O ₃	Ce ₂ O ₃	CO ₂	H ₂ O
0.79	28.34	25.52	21.95	23.40

The analyses correspond with the enneahydrated carbonate, $(La, Di, Ce)_2(CO_3)_3 \cdot 9H_2O$, but since P. T. Cleve, and C. Morton made the isomorphous octohydrated didymium salt, he concluded that lanthanite is octohydrated. R. Hermann, and F. A. Genth synthesized lanthanum carbonate. K. F. A. Hartmann called the mineral **hydrocerite**, and E. F. Glocker, **hydrolanthanite**. Lanthanite is usually amorphous; but tabular crystals have been examined by V. von Lang, and W. P. Blake; they are rhombic, with axial ratios $a : b : c = 0.9528 : 1 : 0.9023$. The sp. gr. is 2.6–2.7, and the hardness 2. It is readily soluble in acids.

A. F. Svanberg obtained a chalk-like alteration product, which he regarded as *kolsgrad Ytterjord*, as a thin film on gadolinite at Ytterby. J. D. Dana called it *tengerite*; it has also been called yttria spar. F. A. Genth's analysis of a sample from Llano Co., Texas, sp. gr. 3.592, is:

CaO	MnO	BeO	Fe ₂ O ₃	(Ce, Di, La, Y, Er) ₂ O ₃	SiO ₂	Loss on ignition
5.58	0.22	6.03	14.53	39.20	1.03	9.30

G. Flink found crystals of a hydrated carbonate of cerium and strontium at Narsaruk, Greenland, and called it **ancylite**—*ἀγκύλις*, sinuous—in reference to the sinuous surface of the crystals. The analysis is:

CaO	FeO	SrO	(La, Di) ₂ O ₃	Ce ₂ O ₃	CO ₂	ThO ₂	H ₂ O
1.50	0.35	21.03	24.04	22.22	23.28	0.20	6.52

with insoluble matters, 0.60; and there are traces of fluorine. The corresponding formula is $4R(OH)CO_3 \cdot 3H_2O$. The brown octahedral crystals belong to the rhombic system, and have the axial ratios $a : b : c = 0.916 : 1 : 0.9174$. The sp. gr. is 3.95, and the hardness 4.5.

A brownish-yellow or red crystalline mineral found in 1835 in the emerald mines of Muso or Muzo Valley, New Granada, and in the collection of L. de Medici-Spada, was analyzed by R. Bunsen²¹ in 1845. The mineral was at first called *musite* or *mussite*, but since a variety of amphibole had the same name, the mineral was designated **parisite**, from J. J. Paris, the proprietor of the mine. W. C. Brögger found it at Langesund, Norway; G. Nordenskjöld, at Narsaruk, Greenland; S. L. Penfield, and C. H. Warren, in Ravalli Co., Montana; C. Palache, and C. H. Warren, at Quincy, Massachusetts; and G. P. Tschernik, at Mukden, Manchuria. Analyses have also

been made by A. Damour and H. St. C. Deville, S. L. Penfield and C. H. Warren, T. Korovaeff, etc. The analysis by C. H. Warren of a specimen from Quincy, Massachusetts, is:

Na ₂ O	K ₂ O	CaO	Fe ₂ O ₃	La ₂ O	Ce ₂ O ₃	CO ₂	F	Gangue
0.30	0.20	11.40	0.32	27.31	30.94	24.16	6.56	102

C. F. Rammelsberg said in 1875 that the available data do not suffice to deduce the constitution of this rare mineral. The best analyses make the mineral a fluorcarbonate of calcium and the metals of the ceria earths, CaR₂F₂(CO₃)₃. S. L. Penfield and C. H. Warren gave the formula 2RF₂CO₃.CaCO₃, or (RF)₂Ca(CO₃)₃, which is given graphically:

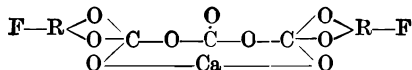

P. Groth gave (CaF)(RF)R(CO₃)₃; and J. Schilling, Ce₂(CO₃)₃.CaF₂. R. Bunsen stated that the crystals belong to the hexagonal system, and have the axial ratio $a : c = 1 : 3.2808$; A. des Cloizeaux gave $1 : 3.289057$; and K. Vrba, $1 : 3.36456$. The crystals are now considered to belong to the trigonal system which makes the axial ratios $a : c = 1 : 1.9425$. G. Aminoff found that the spots of the X-radiogram did not change in position after the expulsion of carbon dioxide by ignition, and he therefore inferred that there is no displacement of the atoms or distortion of the structure. The symmetry is dihexagonal, and the at. distance in the direction of the c -axis is 11.9×10^{-8} cms. The sp. gr. of the specimens analyzed by the different investigations range from 4.129 to 4.358. K. Vrba obtained 4.364; the hardness is 4 to 5. The double refraction, according to A. des Cloizeaux, is strongly positive, $\omega = 1.676$, $\epsilon = 1.757$, and $\epsilon - \omega = 0.081$. With the spectromicroscope, crystals of parisite give the characteristic absorption bands of didymium—*vide infra*—illustrated by Fig. 2.

G. Nordenskjöld described as parisite a mineral from Narsarsuk, Greenland, but G. Flink regarded it as a new species with the composition R₂F₂Ca₂(CO₃)₄, *i.e.* the same as parisite plus another mol of calcium carbonate; he named it *synchisite*—*σύνχισσις*, confusion—in allusion to its having been confused with parisite. C. Palache, and C. H. Warren noted the extraordinarily close resemblance between the physical and crystallographic properties of parisite and synchisite, and suggested that G. Flink's material must have been parisite mixed with some calcium carbonate. This mineral was investigated by G. Flink, R. Mauzelius, O. B. Bøggild, etc. G. Aminoff made similar observations on the X-radiograms of synchisite as those made on parisite. E. Quercigh concluded that the sp. gr., the optical properties, and the composition of the two minerals make their identity practically certain.

G. Flink discovered at Narsarsuk, Greenland, a barium-parisite which closely resembled ordinary parisite excepting that barium replaced the calcium. It was called **cordylite**—*κορδύλιτη*, a club—in allusion to the shape of the crystals. The analysis of the yellow crystals is:

CaO	FeO	BaO	(La, Di) ₂ O ₃	C ₂ O ₃	CO ₂	ThO ₂	F	H ₂ O	Gangue
1.91	1.43	17.30	25.67	23.72	23.47	0.30	4.37	0.80	2.58

and the formula (RF)₂Ba(CO₃)₃. The axial ratio of the hexagonal crystals is $a : b : c = 1 : 1 : 1.1288$, and they are isomorphous with those of parisite. The sp. gr. is 4.31; the hardness, 4 to 5; and, according to O. B. Bøggild, the indices of refraction are $\omega = 1.7640$, and $\epsilon = 1.5762$. B. Szilard examined this mineral.

In 1838, W. Hisinger found that a mineral from Bastnäs, Sweden, corresponded in composition with a hydrated fluoride of the cerium metals, and J. J. N. Huot named it **bastnäsite**—this mineral also shows the didymium absorption bands, Fig. 1. T. Karawajeff obtained a mineral—named *kischtimite*—from the alluvial sands of the Barsorka River, near Kischtim, Urals, which he named *Kischtim-parisite* because it contained carbon dioxide in place of water given in W. Hisinger's analysis. G. Nordenskjöld showed that the loss on ignition assumed by W. Hisinger to be water was really carbon dioxide, and hence, in ignorance of J. J. N. Huot's term, he proposed to call the mineral *hamartite*—*ἡμάρτις*, I deceive myself. O. D. Allen and W. J. Comstock found a sample—which they called *tysonite*,

after the discoverer S. T. Tyson—at Pike's Peak, Colorado. This mineral was afterwards identified with bastnäsite by W. F. Hillebrand, and F. W. Clarke. G. Nordenskjöld's analysis of a sample from Bastnäs is :

Ce_2O_3	$(La, Di)_2O_3$	CO_2	F
29.94	45.77	19.50	7.42

This agrees with the formula $RFCO_3$. Analyses made by T. Karawajeff, W. Hisinger, F. Radominsky, B. Szilard, W. E. Hidden, W. F. Hillebrand, and O. D. Allen and W. J. Constock are in general agreement; though the ceria earths range from 64.0 to 93.5 per cent., and thoria from 0 to 10 per cent. According to A. des Cloizeaux, the prismatic crystals

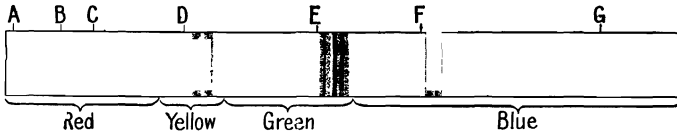

FIG. 1.—Absorption Spectrum of Monazite.

are hexagonal. The sp. gr. ranges from 4.784 for the sample from Kischtim; to 4.93 for the sample from Bastnäs; to 5.20 for the sample from Colorado. The hardness is 4 to 5. The double refraction is strongly positive. W. C. Brögger found on Oevre Arø of Lange-sund Fiord, Norway, a very small specimen of a mineral which he named *weibylite*—after P. C. Weibye. The imperfect analysis shows it to be a fluocarbonate of the rare earth metals with calcium, and strontium. It contains 66.96 per cent. of ceria earths. The mineral is allied to parisite and bastnäsite, and the pyramidal crystals belong to the rhombic system with axial ratios $a : b : c = 0.9999 : 1 : 0.64$.

Prior to the invention of the rare earth gas-mantle in 1885, there was practically no demand for **monazite**; the small quantity required was obtained at a high price from the deposits of Scandinavia, and the Urals. With the advent of C. A. von Welsbach's gas-mantle, there was a great demand for ceria and thoria earths, and a systematic search was made for sources of the rare earths, and it was found that these earths are not at all so rare as the name implies. From the commercial point of view, the most important source of the rare earths is monazite— $\mu\nu\nu\acute{\alpha}\zeta\omega$, to be solitary—so named because, when first discovered, it was considered to be of extremely rare occurrence. Although monazite is essentially an orthophosphate of the ceria earths, RPO_4 , yet its commercial value depends upon the percentage of thoria present. The amount of thoria ranges up to about 20 per cent. There is some confusion in the early history of monazite because a number of minerals which were given different names were not recognized as belonging to the same mineral species.

The spelling *monacite* is but a corruption of the original. A. Lévy²² first described a specimen from E. Turner's collection and it was labelled as a variety of sphene from Dauphiné; A. Lévy named it *turnerite*. J. D. Dana noted the resemblances between turnerite and the mineral afterwards named monazite, and said that "they may be the same species." This hypothesis was established by F. Pisani in 1877. Meanwhile, in 1826, A. Breithaupt applied the term monazite to a mineral accompanying the zircon in a granite of Miask, Urals. The same mineral was described as *mengite* by H. J. Brooke in 1831. In 1837, C. U. Shepard described a basic sesquiphosphate of the protoxide of cerium from South Carolina, and gave it the name *edwardsite*, and another variety from Connecticut he called *eremite*— $\epsilon\rho\eta\mu\iota$, solitude—in allusion to the isolated occurrence of the crystals. He found the specimens were accompanied by zirconia, alumina, and silica as impurities. G. Rose, in 1840, showed that the American minerals were the same as monazite. In 1846, F. Wöhler found acicular crystals and grains of a wine-yellow mineral in the apatite of Arendal, Norway, from which it could be separated by dissolving the latter in dil. nitric acid. The mineral was called *cryptolite*— $\kappa\rho\upsilon\pi\tau\acute{\iota}\tau\epsilon$, concealed. E. Mallard found the physical properties of cryptolite and monazite to be identical. A variety from Kärarfvet, Sweden, was called *kärarfvetite*. R. Hermann, 1847, called the brown mineral he obtained from the Ilem Mountains, *monazitoid*; H. Watts, 1849, called the greyish-yellow crystalline powder which he found in the cobalt ore of Tunaberg, *phosphocerite*; and D. Forbes and T. Dahl, 1855, called the crystalline mineral which they obtained near Nöterø, Norway, *urdite*.

J. Schilling said that monazite is one of the most widely disseminated minerals

in the earth's crust. Comparatively large crystals of monazite are found embedded in the felspar of the veins of pegmatite in the Ilmen Mountains, Urals; and in several places in South Scandinavia; in the gneiss of Carolina and Georgia; etc. Small crystals occur in the crevices of some rocks. It occurs massive and granular in veins in granite associated with wolframite, cassiterite, and molybdenite on the Walsh and Tinaroo mineral fields of Queensland. Massive and granular monazite were found by F. Freise in the pegmatite veins of the granite of the Aymore Mountains, Espirito Santo, Brazil. More usually, monazite occurs in small proportions as an accessory constituent of the older crystalline rocks—granites, diorites, gneisses, etc.—belonging to the Archæan or pre-Cambrian Age, and in no rocks younger than the Mesozoic Age. The monazite may occur in the veins of crystalline matter in these rocks, or it may occur in small crystals disseminated through the whole mass of rocks. Monazite is found among the débris formed by the disintegration of the monazite-bearing rocks owing to the action of weathering and eroding agents. The unweathered fragments may have been washed away by the rivers and streams, or by the waters of the ocean. The water-borne fragments have been re-deposited so that the heavier particles with a high sp. gr. have been separated from the lighter particles of less sp. gr. The monazite grains of high sp. gr. have thus been concentrated by nature in deposits from which the water may have since receded. The grains of monazite are thus collected by nature along with the heavier constituents of the parent rock to form monazite sands which are found in the alluvial deposits of rivers, and on the sea-shore exactly like the concentration of platinum

and gold in alluvial sands, or of precious stone in the so-called gem-gravels. The monazite in these sands may be in angular fragments, but it is more usually present in rounded grains—Fig. 2—showing that the grains have previously been rolled to and fro in streams of water. Monazite sands therefore represent nature's attempt to concentrate the heavier accessory constituents of the parent rock. Hence, monazite sands contain grains of zircon, rutile, ilmenite, sphere, and apatite. There are also present grains of garnet, epidote, sillimanite, tourmaline; and a number of rare earth minerals—xenotime, fergusonite, samarskite, gadolinite, and allanite. There are also present grains of ferric oxide; tin oxide; and much quartz. Often, too, the parent



FIG. 2.—Water-worn Grains of Monazite Sand.

rocks are auriferous, and the particles of gold then accumulate with the heavier minerals. Monazite is thus almost universally present in the auriferous and gem-bearing sands and gravels.

Monazite sands occur near Arendal, Moss, Lönneby, Dillingsö, Hvalö, etc., in Norway; Holma, Kärarfvet, etc., in Sweden; Imilaks in Finland; Miask and Batoum in the Urals; Pisel in Bohemia; Travancore in India; in the gem-gravels of Bentota, and Kudremalai in Ceylon; Mindarivo and Antyabé in Madagascar; in the beach sands, Queensland; Emmaville and Vegetable Creek in New South Wales; Victoria; in the beach sands, the diamond-bearing sands, and the auriferous sands of Minas Geraes, Bahia, and Espirito Santo in Brazil; in the sands derived from the gneiss rocks of Carolina, and Georgia; in the auriferous sands of Idaho, Oregon, Portland in Connecticut, Amelia Co. in Virginia, and in many of the Pacific States; in the stanniferous sands of Embabaan, Swaziland; in the alluvial tinstone of Pahang, Puchong Babi, Kulim Kedah, and Kelantan, Federated Malay States; the river sands near Chiromo, Nyasaland; the river sands of Ekole, Kadera, Naraguta, Iboboto River, and Ebara River, Nigeria; Ottawa, Canada; Transvaal in South Africa; etc. The deposits of monazite sand on the coast of Brazil, North and South Carolina, and Travancore have been worked. So also have other deposits. According to E. H. Pascoe, the total production of monazite commenced in Ceylon

in 1918 to 1922, when the works closed down, was 235 tons. The exports from Brazil in 1920 was 1153 metric tons; the United States production was very small (34·7 metric tons in 1917); Travancore commenced producing in 1911, when it furnished 819 metric tons, and in 1921, 1280 tons. A great many factors determine whether a deposit can be worked profitably—transport, cost of labour, selling price of finished product, the manipulation of prices by competing syndicates, etc.

The monazite in the sands is not sufficiently concentrated for them to be used directly as a source of thorium. The sands are therefore subjected to a further washing, and magnetic or electrostatic concentration processes are applied before the chemical treatment. In some of the best of these processes, the concentrate contains 97–99 per cent. monazite. This subject has been discussed by J. H. Pratt and D. B. Sterrett. In the magnetic concentration, the sand traverses, say, four magnetic fields of increasing intensity—the first removes the magnetite, larger fragments of ilmenite and garnet; the second removes the remaining ilmenite and garnet; the third removes the coarser; and the fourth, the finer monazite; while the tailings, containing zircon, rutile, and quartz, pass on. The tailings from the Travancore sands are used in the preparation of zirconia. Efforts have been made to supersede nature's preliminary concentration of monazite, by crushing the gneiss rocks of Carolina; but even with the richest rock—containing 0·2 per cent. of monazite—the working costs are too high to compete with processes based on the concentration of the monazite sands.

Analyses of monazite have been made by C. Kersten, R. Hermann, A. Damour, C. F. Rammsberg, C. W. Blomstrand, F. Radominsky, W. Ramsay and A. Zilliacus, K. Preis, A. Lacroix, L. A. Aars, P. Wenger and P. Christin, L. Schmelck, W. Prinz, R. J. Strutt, W. R. Dunstan, B. Szilard, F. Katzer, W. Lindgren, L. Duparc, R. Sabot and M. Wunder, E. Hussak and J. Reitinger, H. Gorceix, S. L. Penfield, F. P. Dunnington, A. Thorpe, F. A. Genth, G. P. Tschernik, A. Liversidge, J. C. H. Mingaye, C. Anderson, S. J. Johnstone, J. Bjelussoff and S. Kusnezoff, H. B. C. Nitzé, C. Glaser, A. H. Church, E. S. Sperry, G. C. Hoffmann, G. P. Drossbach, R. J. Gray, O. Boudouard, O. Kress and J. F. Metzger, etc. The maximum and minimum values are calcium oxide, 0·10–1·58 per cent.; magnesium oxide, 0–0·40; manganese oxide, 0–4·89; lead oxide, 0–0·34; ferrous oxide, 0–1·10; ferric oxide, 0–5·58; alumina, 0–3·11; yttria earths, 0–7·69; lanthana earths, 6·56–40·79; ceria earths, 16·30–45·40; silica, 0·32–6·68; stannic oxide, 0–9·03; zirconia, 0–15·44; thorium, 0·46–28·20; uranium oxide, 0–1·0; phosphoric oxide, 18·89–29·92; tantalum and columbium oxides, 0–6·39; fluorine, 0–4·35; loss on ignition, 0·09–2·76 per cent. A selection of particular samples is given in Table V.

TABLE V.—ANALYSES OF MONAZITE.

Source.	Thoria.	Ceria earths.	Lanthana earths.	Yttria earths.	Ferric oxide.	Alumina.	Calcium oxide.	Silica.	Phosphoric oxide.	Loss on ignition.
Travancore, India	9·43	31·90	28·00	0·46	1·29	0·14	0·16	1·00	26·82	0·46
Niriellagange, Ceylon	10·75	26·71	30·06	1·46	1·09	0·70	0·85	2·47	24·61	0·93
Pahang, Malay	8·38	25·46	32·72	2·80	0·84	2·78	0·61	0·92	23·92	1·28
Ekole, Nigeria	5·00	30·72	30·02	2·74	3·00	0·35	0·15	1·20	26·29	0·25
Kadera, Nigeria	3·20	36·53	30·00	0·39	1·20	0·10	0·21	0·63	28·29	0·20
Villeneuve, Canada	12·60	24·80	26·41	4·76	1·07	—	1·54	0·91	26·86	0·78
Lønneby, Norway	9·34	28·06	29·60	1·82	0·66	0·16	0·53	1·65	28·27	0·21
Carolina	1·01	36·17	21·29	7·62	—	1·84	0·36	1·02	29·39	0·26
Espirito Santo, Brazil	6·06	62·12		0·80	0·97	0·10	0·21	0·75	28·50	0·38
Bahia, Brazil	6·50	61·40		0·70	1·50	0·08	0·30	0·64	28·46	0·64
Richmond River, N.S.W.	0·46	22·42	22·95	0·16	2·08	0·14	1·32	6·68	18·89	0·10
Amelia Co., Virginia	18·60	16·30	34·70	1·10	0·90	0·04	2·70	2·70	24·04	—
Antyabie, Madagascar	11·23	26·95	32·60	0·30	0·60	0·15	—	2·87	25·90	0·56
Transvaal, Africa	3·51	34·58	27·25	2·14	0·44	0·86	0·31	1·52	27·38	2·21
Pisek, Bohemia	5·85	31·05	26·64	4·02	1·32	—	0·41	1·46	27·57	0·42
Miask, Urals	5·55	31·31	31·86	0·52	0·26	0·13	0·55	1·37	27·32	0·41

The analyses can be regarded as representing only monazite plus more or less foreign inclusions. The ratio of the isomorphous ceria and lanthana earths is not constant. The idealized mineral, as first suggested by C. U. Shepard, is considered to be an orthophosphate of ceria earths, RPO_4 . O. Mann represents the formula by $mTh_3(PO_4)_4.n(Ce, La, Pr, Nd)_4(PO_4)_4$, where the first component is regarded as the primary constituent from which thoria is formed by weathering. F. Radominsky synthesized cerium orthophosphate, and obtained large yellow prisms; the analysis corresponded with RPO_4 ; if yttria and didymia be absent, the crystals are colourless. C. James has applied the bromate method to the fractionation of the rare earths derived from the monazite sands of Carolina, and found that in addition to lanthanum, cerium, praseodymium, and neodymium, these sands contain considerable quantities of samarium, gadolinium, and yttrium; small amounts of dysprosium, holmium, and erbium; and minute amounts of europium, terbium, thulium, and ytterbium. Erbium occurs in much smaller quantities than holmium and dysprosium, and this fact probably accounts for the anomalous behaviour of certain fractions which has been observed by some workers.

There has been some discussion as to the relation of thoria to monazite. F. P. Dunnington suggested that orangite, $ThSiO_4$, was mechanically mixed with the monazite, and that thoria is not an essential constituent. S. L. Penfield supported this conclusion, and claimed (i) to have detected particles of thoria or orangite microscopically, and (ii) found that the ratio $R_2O_3 : P_2O_5$ is unity—R denoted the rare earth metals—and also (iii) that the ratio of $ThO_2 : SiO_2$ is also unity. K. Preis supported S. L. Penfield's hypothesis; but C. W. Blomstrand objected. He found that silica is never absent, but its amount does not depend on the amount of thoria which is present, but rather on the amount of phosphorus pentoxide; the thoria present is combined partly with the silica and partly with the phosphorus pentoxide; and finally, the rare earths alone are not sufficient to satisfy the ratio $R_2O_3 : P_2O_5 = 1$. The thoria is therefore regarded as a primary constituent of monazite occurring as phosphate in isomorphous admixture with the cerium phosphate; the presence of silica is attributed to alteration by siliceous waters. O. Kress and F. J. Metzger also found that silica is always present, and although it usually increases with the amount of thoria, the increase is not regular; in the majority of cases, the amount of silica is quite insufficient to combine with the thoria present. They concluded that the silica which is present belongs to some unidentified silicate other than normal thorium silicate and possibly felspar. No biaxial thoria could be observed microscopically in the monazite, nor was there any evidence of a dark resinous constituent mentioned by S. L. Penfield. S. J. Johnstone showed that analyses of monazite from monazite sands are not valid in the argument owing to the risk of inclusions, and only analyses on massive monazites such as those from Ceylon can be considered; and these analyses do not support S. L. Penfield's hypothesis. There is not always sufficient phosphoric oxide to combine with the thoria and rare earths, and this does not favour O. Kress and F. J. Metzger's hypothesis. C. F. Rammelsberg, and S. J. Johnstone concluded that there is in monazite a thorium constituent which is more rapidly dissolved by nitric or hydrochloric acid than is the cerium earth constituent. For example:

	Ratio $ThO_2 : R_2O_3$ in mineral.	Ratio $ThO_2 : R_2O_3$ extracted by acid.
Nitric acid	14.03	19.7 per cent.
Hydrochloric acid	14.03	17.7 „

B. B. Boltwood found uranium is contained in monazite, and regarded it as an essential constituent, while F. Zerban considered it to be an impurity. R. J. Strutt also found uranium in what was regarded as pure monazite, and he represented his observations by Table VI. L. Haitinger and K. Peters, J. Schetelig, B. B. Boltwood, D. O. Wood, and C. Doelter and H. Sirk also investigated the radioactivity of monazite. W. A. Tilden, and W. Ramsay, J. N. Collie and M. W. Travers observed the presence of occluded helium in monazite.

TABLE VI.—THE RADIUM, URANIUM, AND HELIUM CONTENTS OF MONAZITE.

Source.	Radium 10 ⁻⁶ per cent.	U ₃ O ₈ per cent.	ThO ₂ per cent.	Helium c.c. per gram.
Norway	2.35	1.0	0.65	1.54
Norway	0.275	—	1.21	2.41
Fahlun	0.323	—	0.80	1.40
Johannesburg	1.03	—	5.94	—
North Carolina	0.53	—	3.79	—
Amelia Co.	0.806	0.1	2.43	1.57
Brazil	0.238	—	1.54	0.81
Nigeria	3.73	—	2.98	—
Malay States	4.02	—	1.53	—

The crystals of monazite are coloured dark brown, red, yellow, or greenish-brown. Some samples, assumed pure, are transparent, other samples are translucent to opaque. The crystals belong to the monoclinic system, and have the axial ratios $a : b : c = 0.96933 : 1 : 0.92558$, and $\beta = 76^\circ 20'$; these values vary a little with variations in the composition of the specimens. The crystal habit is tabular, prismatic, or acicular. A. Hadding studied the X-radiogram of monazite. R. Scharizer has collected a bibliography of the crystallographical, optical, and chemical data. The fracture of monazite is conchoidal. The sp. gr. ranges from C. W. Blomstrand's 4.64 for a sample from Moss, Norway, to L. Duparc and co-workers' 2.2735 for a sample from Madagascar. The values for some samples from Ceylon approach 5.5; thus, S. J. Johnstone gave 5.47 for the sp. gr. of a sample from Ratnapura, Ceylon. The hardness is 5.0 to 5.5. A. L. Fletcher gave 1140° for the m.p. of monazite. H. Rosenbusch and A. E. Wülfing give for the indices of refraction of a sample from Arendal, $\alpha = 1.7957$; $\beta = 1.7965$; $\gamma = 1.8411$, and for the strong positive double refraction $\gamma - \alpha = 0.0454$ to 0.0510. J. Schetelig gave:

	Li-ray	Na-ray	Tl-ray	Sr-ray
α	1.7822	1.7938	1.7997	1.8144
β	1.8388	1.8452	1.8522	1.8658

W. W. Coblentz found the ultra-red transmission spectrum of monazite shows a large band extending from 3.4μ to 5.5μ , and the mineral was opaque beyond 6.5μ . Monazite dissolves very slowly in acids. According to K. Haushofer, and H. Behrens, if a crystal be warmed with conc. sulphuric acid; the soln. evaporated to a small bulk; and a drop be mixed with a drop of a conc. soln. of sodium acetate; under the microscope, minute pointed oval crystals of sodium cerium sulphate will be observed. With the spectro-microscope, crystals of monazite give the characteristic absorption bands of didymium—*vide infra*—illustrated by Fig. 2. J. Schilling, R. Scharizer, and H. L. Bowmann have compiled bibliographies of monazite.

J. J. Berzelius²³ obtained a mineral from Hitterö and Ytterby which he regarded as yttrium phosphate—*phosphorsyrad ytterjord*—E. F. Glocker called it *yttria spar*; A. Damour, *castelnaudite*; G. S. Kenngott, *wiserine*. The present term *xenotime* appears to be the result of a misprint. F. S. Beudant apparently intended to call it *kenotime* since he gives the derivation: “*κενός*, vain, et *τιμή*, honneur.” The irony is, that F. S. Beudant stated the name was intended to recall the fact that in 1815 J. J. Berzelius made a mistake in supposing the mineral to contain a new metal *thorine*—afterwards found to be a yttrium phosphate. The term *xenotime* may be derived from *ξένος*, stranger to; *τιμή*, honour, in allusion to the fact that the small crystals were for a long time unnoticed. In addition to its occurrence in Scandinavia, xenotime has been observed in Switzerland, Bohemia, Germany, Austria, Italy, France, Brazil, Canada, etc. It is also found in various monazite sands—*e.g.* those of Caroline, Georgia, etc. Xenotime is not so widely distributed as monazite, but it is not uncommon; it often occurs associated with

zircon in granite rocks. Zircon is closely allied to xenotime in crystalline form, and, according to E. Hussak, in many reports of xenotime in rocks that mineral has been confused with zircon. Analyses have been reported by J. J. Berzelius, E. Zschau, W. Wartha, A. Damour, O. E. Schlötz, B. Szilard, J. L. Smith, H. Gorceix, C. W. Blomstrand, W. C. Brögger, S. L. Penfield, C. F. Rammelsberg, etc. For a sample from Narestö, Arendal, C. W. Blomstrand gave :

ThO ₂	UO ₂	Ce ₂ O ₃	Y ₂ O ₃	Fe ₂ O ₃	Al ₂ O ₃	CaO	SiO ₂	P ₂ O ₅	H ₂ O
2·43	3·48	0·96	54·57	2·01	0·28	1·09	2·36	29·23	1·77

together with MgO, 0·26; PbO, 0·68; ZrO₂, 1·11; SnO₂, 0·08 per cent. The terms yttria and ceria here refer to the corresponding groups of rare earths. The composition of xenotime closely resembles that of monazite, and it can be regarded as an orthophosphate of the yttria and erbia earths, YPO₄, just as monazite is regarded as the corresponding salt of the ceria earths, CePO₄. The formula has been discussed by C. F. Rammelsberg, E. H. Kraus and J. Reitingger, and W. C. Brögger. In xenotime, the ceria earths range from 0·32 to 11·03 per cent.; in monazite, 16·30 to 45·40 per cent. In xenotime, the yttria earths range from 54·13 to 59·70 per cent.; and in monazite from 0 to 7·69 per cent. W. Ramsay, J. N. Collie, and M. W. Travers found helium occluded in xenotime. B. B. Boltwood, and R. J. Strutt discussed the uranium and radium content of the mineral. Samples of xenotime with 0·75 to 2·74 per cent. of sulphur trioxide have been reported—sulphato-xenotimes. For instance, the xenotime from Bandeira de Mello, Brazil, analyzed by E. H. Kraus and J. Reitingger; from Brindletown, Burke Co., by W. E. Hidden; and from Idaho, by G. Tschermak.

In 1901, E. H. Kraus and J. Reitingger announced the discovery of a new mineral, a kind of *sulphato-xenotime* which they named *hussakite*. A sample from Sao Paulo, Brazil, contained 6·3 per cent. of sulphur, and they assigned to it the formula 3R₂O₃·3P₂O₅·SO₂ or 6RPO₄·SO₃. They found that the sulphur trioxide could be easily removed by the action of dil. alkalis, and inferred that xenotime is really a pseudomorph after hussakite. The sulphur trioxide was assumed to have been removed from hussakite by the alkaline water of the earth's crust. W. C. Brögger found fresh xenotime from Arö, Norway, to be quite free from sulphur trioxide, and suggested that hussakite is an independent species with the formula 5YPO₄(YSO₄)PO₃. H. Rössler said that hussakite is common in igneous rocks and resembles zircon in appearance and properties. E. Hussak, however, showed that hussakite is not a distinct mineral species, but that it is a xenotime of prismatic habit. The report of E. H. Kraus and J. Reitingger is based on faulty analyses. The precipitate obtained by the addition of barium chloride to the acid soln. of the mineral after fusion with alkali carbonate, was assumed to be barium sulphate, whereas barium phosphate is precipitated as well. He added that the name hussakite is unnecessary and undesirable.

F. Radominsky obtained needle-like prisms of artificial xenotime by fusing yttrium phosphate and chloride. The colour of xenotime is yellow or brown. Xenotime and hussakite crystallize in the tetragonal system, and the former has the axial ratio $a : c :: 1 : 0·61867$, and the latter 1 : 6208. The crystals have been studied by A. des Cloizeaux, J. D. Dana, E. Hussak, H. Rössler, and E. H. Kraus and J. Reitingger. Since tetragonal xenotime is largely yttrium phosphate, and monoclinic monazite largely cerium phosphate, and since monazite contains yttrium phosphates and xenotime cerium phosphates, it is assumed that the minerals represent the end-terms of an isodimorphous series of mixed crystals. W. C. Brögger considers that the following minerals furnish a series of the general formula (RO)RO₃ : mossite, Fe(CbO₃)₂; tapiolite, Fe(TaO₃)₂; rutile, TiO(TiO₃), or Ti(TiO₃)₂; xenotime, (YO)PO₃; and monazite, (CeO)PO₃, where the last three minerals are homomorphous. L. Vegard obtained X-radiograms of xenotime, and the structure appears to resemble that of rutile and other tetragonal minerals. M. L. Huggins also found the structure to resemble that of rutile (*q.v.*). The sp. gr. of the samples of xenotime which have been analyzed range from 4·40 to 5·106—the average is about 4·5; and of hussakite, 4·45 to 4·59. The hardness of xenotime is 4 to 5, and of hussakite, 5. According to H. Rosenbusch and A. E. Wülfing, the indices of refraction and the double refraction

of hussakite or xenotime are positive and like that of zircon. E. H. Kraus and J. Reitinger found the following indices of refraction for hussakite :

	Li-ray	Na-ray	Tl-ray
ω	1.7166	1.7207	1.7244
ϵ	1.8113	1.8155	1.8196
$\epsilon - \omega$	0.0947	0.0948	0.0952

H. Rössler noted the feeble pleochroism of the crystals; J. Becquerel, W. Prinz, W. Voigt, and W. M. Page examined the magnetic rotation of the ray of polarized light, and the effect of the magnetic field on the absorption spectrum.

W. G. Lettsom²⁴ found some samples labelled Cornish blende and described by A. Lévy as *zinc sulfuré, mameloné de Cornouailles* showed the absorption spectrum of didymium, Fig. 1; and, on analysis, gave

Fe ₂ O ₃	Y ₂ O ₃	(Ce, La, Di) ₂ O ₃	P ₂ O ₅	H ₂ O
0.25	9.93	52.82	29.10	6.86

He named the mineral *rhabdophane*. Samples from Scoville, Connecticut, named *scovillite*, were found to have a similar composition by G. J. Brush and S. L. Penfield, and W. N. Hartley; and G. J. Brush and S. L. Penfield later established the identity of the two minerals. L. de Boisbaudran found the absorption spectrum gave didymium and erbium bands. Rhabdophane is regarded as a hydrated phosphate of the rare earths, iron, aluminium, etc., with 53.8 to 57.0 per cent. of ceria earths and 2.1 to 10 per cent. of yttria earths. The idealized formula is R₂O₃.P₂O₅.2H₂O, or RPO₄.H₂O. It occurs massive, yellow or brown in colour; the sp. gr. is 3.94–4.01, and the hardness 3.5. E. Bertrand found rhabdophane is optically uniaxial. F. Henrich and G. Hiller reported a hydrated phosphate of yttrium, erbium, etc. (Er, Y, etc.)PO₄.2H₂O, which they termed *weinschenkite*, in the Bavarian Oberpfalz. It occurs as a white, matted, globular mass of radiating needles on brown hæmatite. Sufficient has not yet been obtained for an accurate analysis. The so-called *pseudo-wavellite* of F. Henrich is a wavellite containing 13 per cent. CaO, about 1 per cent. BaO and SrO, and 2–3 per cent. of rare earths. A. H. Church reported a hydrated calcium cerium phosphate from Cornwall which he called *churchite*. The composition approximates CaO : Ce₂O₃ : P₂O₅ : H₂O = 1 : 1.65 : 2 : 8.5; and C. F. Rammelsberg represents it by 3Ca₃(PO₄)₂.10CePO₄.48H₂O. The colour is smoky-grey, or flesh-red. The doubly refracting crystals are monoclinic prisms; the sp. gr. 3.14; and the hardness 3.0–3.5. A brown, opaque, basic phosphosilicate of cerium, calcium, magnesium, etc., occurring in the pegmatite at Nauyasakik, Greenland, was named *britholite*—from *βριθος*, heavy. C. Winther gives the analysis:

Na ₂ O	MgO	CaO	Fe ₂ O ₃	(La, Di, Ce) ₂ O ₃	SiO ₂	P ₂ O ₅	F	H ₂ O
1.85	0.13	11.28	0.43	60.54	16.77	6.48	1.33	1.27

According to O. B. Bøggild, the crystals are hexagonal; C. Winther said rhombic with axial ratios $a : b : c = 0.620 : 1 : 0.423$. The sp. gr. is 4.446; the hardness, 5.5; and the negative double refraction weak, 0.004. O. B. Bøggild obtained brown crystals of a mineral from Julianehaab, Greenland, which was named *erikite*—after Eric the Red, after whom the adjoining fiord was formerly named—with the composition:

Na ₂ O	CaO	Al ₂ O ₃	(Ce, La, Di) ₂ O ₃	SiO ₂	ThO ₂	P ₂ O ₅	H ₂ O
5.63	1.81	9.28	40.51	15.12	3.26	17.78	6.28

The rhombic crystals have the axial ratios $a : b : c = 0.5755 : 1 : 1.5780$; the sp. gr. is 3.493, and the hardness 5.5 to 5.0. The mineral dissolves in acids without gelatinization of the silica. W. C. Brøgger described the fluosilicate *melanocerite*, obtained from the islands of Langesund Fiord, Norway. It contains 45.05 per cent. of ceria earths; 9.17 of yttria earths; 1.66 of thoria; and 0.46 of zirconia. The tabular crystals belong to the rhombohedral system; the sp. gr. is 4.13, and hardness 5 to 6.

The mineral *fluorenite* is a cerium aluminophosphate occurring in the diamond mines at Mina Graës, Brazil. G. T. Prior's analysis is:

CaO	Al ₂ O ₃	Fe ₂ O ₃	Ce ₂ O ₃	SiO ₂	P ₂ O ₅	H ₂ O
1.31	32.38	0.76	28.00	0.48	25.56	10.87

The presence of fluorine is doubtful. The composition approximates AlPO₄.CePO₄.2Al(OH)₃, or 3Al₂O₃.Ce₂O₃.2P₂O₅.6H₂O. The spectroscope shows only a trace of didymium. E. Hussak found that the trigonal crystals have the axial ratio $a : c = 1 : 1.1901$; the sp. gr. is 3.586, and the hardness about 3. The mineral resembles hamlinite. The isomorphism of cerium, calcium, and strontium salts has been discussed by A. Cossa, and G. Wyrouboff. The microcrystalline *gorcelxite* is a barium aluminophosphate occurring in the diamond sands of Brazil. According to the analyses of E. Hussak, B. Jezek,

H. Gorceix, and A. Damour, it contains 1.55–2.57 per cent. of cerous oxide. Its composition approximates $(\text{Ba}, \text{Ca}, \text{Sr}, \text{Ce})\text{O} \cdot 2\text{Al}_2\text{O}_3 \cdot \text{P}_2\text{O}_5 \cdot 5\text{H}_2\text{O}$. The sp. gr. is 3.036–3.123, and the hardness 6. It has also been discussed by E. Boutan.

H. Sjögren reported a rare earth arsenate from Moss, Norway, of the composition :

MgO	CaO	MnO	FeO	PbO	R ₂ O ₃	As ₂ O ₅	SiO ₂	H ₂ O	Gangue
2.7	19.2	30.2	1.7	0.2	10.3	24.4	0.5	8.4	4.3

which he called *retzian*. The brownish-red to wine-red mineral is pleochroic. The prismatic crystals belong to the rhombic system; the sp. gr. is 4.15; and the hardness about 4. They are readily dissolved by hydrochloric acid.

The inseparable companionship of elements of like affinities such as nickel and cobalt, and the platinum metals, is very marked with the rare earths. This does not refer to such associations as calcium sulphate or carbonate, and sodium as chloride, but rather to co-mixtures of elements with little affinity for one another. No well-defined regularities have been observed in the nature and quantities of the members of the rare groups present in minerals, although it has been noticed that they are virtually absent from minerals which contain other elements. O. Hauser and F. Wirth²⁵ made some observations of the effects of titanitic and tantalic acids on the occurrence of the rare earths in euxenite, samarskite, and polycrase. They found that in these minerals (i) one-third to three-sevenths of the rare earths are yttria earths containing erbia earths; (ii) as the titanitic acid increases, the proportion of holmium and dysprosium increases at the expense of the erbia earths, although these earths are generally present only in small proportions; on the other hand, (iii) the proportions of scandia and yttria are relatively greater with increasing proportions of titanitic acid. The relationships are more marked with the ceria earths, (iv) euxenite poor in tantalic acid, and rich in titanitic acid, is free from samarium and praseodymium, but as the tantalic acid increases and titanitic acid decreases, samaria makes its appearance—e.g. a euxenite from South Carolina, poor in titanitic acid, but rich in tantalic acid, contained 2 per cent. of samaria, whilst the proportion of gadolinia was less than usual. (v) The presence of thoria in columbates also seems to depend on the presence of titanitic acid, since if titanitic acid is absent or present in small proportions, thoria is also absent.

G. Eberhard reported that minute traces of scandia and the rare earths are present in many of the commoner rocks and minerals. W. P. Headden found that up to 0.03 per cent. of rare earths were present in the yellow phosphorescent variety of *calcite* from Colorado; and W. Crookes observed yttria in *calcite*. J. Humphreys found up to 0.5 per cent. in one or two phosphorescent varieties of *fluorspar*, and traces of yttria are usually contained in *fluorspar*. G. Eberhard observed quite appreciable quantities of rare earths in *cassiterite*, and in *wolframite*. Thus, a specimen of *wolframite* from the Erzgebirge contained over 0.4 per cent. of rare earths, over half of which was scandia.

G. Woitschach reported traces of ceria and 3.47 per cent. of yttria earths in *zircon* from Schwalbenberg; H. S. Washington, 2.67 per cent. of ceria in *aegirite* from Rockall; T. Scheerer, 0.34 per cent. of yttria in *malacone* from Hitterö; and W. J. Knowlton, 1.40–2.24 per cent. of rare earths in *malacone* from Rockport, Massachusetts. A. E. Nordenskjöld found 1.39 per cent. of rare earths in *thorite* from Arendal; W. E. Hidden, and J. B. Mackintosh, 6.69 per cent. in *thorite* from Bluffton, Texas; and W. E. Hidden, 1.0 per cent. of yttria in *thorite* from Landbø, Norway. Up to 2.70 per cent. of ceria earths, and 10.22 per cent. of yttria earths were reported in *uraninite* and *pitchblende* by G. Lindström, C. W. Blomstrand, W. E. Hidden, and W. F. Hillebrand; 2.95 per cent. of ceria and 10.34 per cent. of yttria earths in *cleveite* were reported by A. E. Nordenskjöld, up to 0.45 per cent. of ceria, and 4.27 per cent. of yttria earths in *bröggerite* were reported by W. C. Blomstrand, W. F. Hillebrand, and K. A. Hofmann and W. Heidepriem; and 11.22 per cent. of yttria earths in *nivenite* were reported by W. E. Hidden. Up to 0.48 per cent. of ceria, and 4.483 per cent. of yttria earths in *columbite* were reported by R. Hermann, T. Bromeis and H. Rose, F. P. Dunnington, and F. A. Genth. 0.66 per cent. of ceria earths were found in *wöhlerite* by W. C. Brögger. The *zirkelite* of Sao Paulo was found by G. T. Prior to have 2.52 per cent. of ceria, and 0.21 per cent. of yttria earths. T. Scheerer found 5.0 per cent. of ceria earths in *apatite* from Snarum, Norway, and R. Weber and G. Rose, 1.79 per cent. T. L. Phipson reported 0.10 per cent. of yttria in *pyrolusite*; C. U. Shepard, 0.85

per cent. of yttria earths in *danburite* from Danbury, Connecticut; T. Thomson, 3·57 per cent. of ceria earths in *deweyhite* or *gymnite* from Emmons; W. F. Hillebrand, 0·89 per cent. of ceria, and 1·52 per cent. of yttria earths in a manganese *epidote* from South Mountain, Pennsylvania; R. Hermann, and C. Bergemann, 2·0–5·08 per cent. of ceria earths in felspar from Arendal; O. Rebuffat, 3·45 per cent. ceria and 1·23 per cent. yttria earths in *guarinite* from Vesuvius; R. Hermann, 2·0 per cent. of ceria earth in *hyposclerite* (albite) from Arendal; H. Trenkler, 0·03 per cent. of ceria earths in *phonolites*, from Spitzberg, Bohemia; L. P. Lych-nell, 1·25–2·24 per cent. of ceria earths in *serpentine* from Norberg, Sweden; J. R. Strohecker, 12·8 to 14·28 per cent. of ceria and 1·7 per cent. of yttria earths in *clay* from Hainstadt; T. Thomson, 25·95 per cent. of ceria earths from Suland, Norway; C. G. Mosander, 0·58 per cent. of rare earths in *itanite* from Egersund, and A. Cossa, 2·30 per cent. in titanite from Biellese; J. Renwick, 12·32 per cent. of ceria earths in *torrelite* (probably allanite) from Sussex Co., New Jersey; G. Bodenbender, 0·54 per cent. ceria earths in the *bismuth-spar* from the Argentine; W. F. Hillebrand, 0·30 per cent. ceria in *wyomingite*, and 0·11 per cent. in *madupite*; and F. A. Genth and S. L. Penfield, 2·48 per cent. of ceria and 47·58 per cent. of yttria earths in a *calcium fluoride* from El Paso, Colorado.

Many of the rare earths are present in the sun and stars; thus, J. Lunt identified the spectral lines of europium in solar and stellar spectra; and H. A. Rowland mentioned the occurrence of the spectral lines of yttrium, lanthanum, neodymium (but not praseodymium), cerium, and erbium in the solar spectrum—*vide* the spectra of the individual earths. In view of the very wide distribution of the rare earths in the mineral kingdom, it would be natural to look for evidence of the occurrence of these elements in the vegetable and animal kingdoms. G. Tschermak found 10 per cent. of rare earths in the ash of a coal from Kutais, Caucasus; and smaller quantities, in the ashes of many plants. W. Crookes, and A. Cossa detected the rare earths in the ashes of rice, and tobacco. These earths also occur in the human body as shown by the fact that W. Crookes, and A. Cossa detected the rare earths in bones; and, added W. Crookes, “gorgoniae of the species *melithæa* and *mussa sinuosa* undoubtedly remove from sea-water not merely lime, but also yttria; and other recent corals, *pocillopora damicornis* and a *symphyllia* close to the yttria-secreting *mussa*, separate samaria from sea-water.”

REFERENCES.

- ¹ F. W. Clarke and H. S. Washington, *Proc. Nat. Acad. Sciences*, 8, 108, 1922; J. H. L. Vogt, *Zeit. prakt. Geol.*, 6, 225, 314, 377, 413, 1898; 7, 10, 274, 1899; G. Tammann, *Zeit. anorg. Chem.*, 131, 96, 1923.
- ² J. F. John, *Chemische Untersuchungen*, Berlin, 2, 247, 1810; G. A. Kenngott, *Uebersicht der Resultate mineralogischer Forschungen*, Leipzig, 98, 1861; M. H. Klaproth, *Beiträge zur chemischen Kenntniss der Mineralkörper*, Berlin, 1, 203, 227, 1795; 3, 52, 1802; 4, 147, 1807; *Gehlen's Journ.*, 2, 309, 1804; *Sitzber. Akad. Berlin*, 147, 1789; *Crell's Ann.*, i, 307, 1801; B. R. Geijer, *ib.*, i, 229, 1788; L. N. Vauquelin, *Ann. Muséum*, 5, 412, 1807; *Ann. Chim. Phys.*, (1), 36, 143, 1801; (1), 54, 28, 1805; H. St. C. Deville, *ib.*, (3), 61, 344, 1861; J. Schilling, *Das Vorkommen der seltenen Erden im Mineralreiche*, München, 60, 84, 1904; W. Hisinger and J. J. Berzelius, *Gehlen's Journ.*, 2, 303, 397, 1804; W. Hisinger, *Journ. Phys.*, 75, 239, 1811; R. Hermann, *Journ. prakt. Chem.*, (1), 30, 193, 1843; (1), 82, 406, 1861; T. Kjerulf, *Liebig's Ann.*, 87, 12, 1853; G. Nordström, *Öfvers. Akad. Förh.*, 30, 16, 1873; N. Lindström, *Geol. För. Förh. Stockholm*, 2, 218, 1874; G. Krüss and L. F. Nilson, *ib.*, 44, 371, 1887; A. E. Nordenskjöld, *ib.*, 27, 561, 1870; 30, 13, 1873; *Öfvers. Akad. Förh. Stockholm*, 16, 287, 1859; H. Sjögren, *ib.*, 39, 7, 1882; F. Stolba, *Böhm. Ges. Wiss.*, 372, 1879; W. Crookes, *Chem. News*, 54, 40, 1886; C. A. von Welsbach, *Monatsh.*, 5, 512, 1884; B. F. Davis and A. G. Maitland, *Bull. Geol. Soc. West. Australia*, 23, 1906; G. Spezia, *Zeit. Kryst.*, 14, 504, 1888; *Atti Accad. Torino*, 22, 419, 1887; G. P. Tschernik, *Journ. Russ. Phys. Chem. Soc.*, 28, 345, 1896; 29, 291, 1897; W. Haidinger, *Handbuch der bestimmenden Mineralogie*, Wien, 550, 1845; P. Groth, *Tabellarische Uebersicht der Mineralien*, Braunschweig, 1898; J. Gadolin, *Crell's Ann.*, i, 313, 1796; *Svenska Vet. Akad. Handl.*, 15, 137, 1794; A. G. Ekeberg, *ib.*, 18, 156, 1797; 23, 68, 1802; *Crell's Ann.*, ii, 63, 1799; *Scheerer's Journ.*, 9, 597, 1802; *Gilbert's Ann.*, 14, 247, 1803; A. Arche, *Monatsh.*, 4, 913, 1883; G. Bardet, *Bull. Soc. Min.*, 27, 65, 1904; A. L. Fletcher, *Scient. Proc. Roy. Dublin Soc.*, (2), 13, 443, 1913; L. Stützel, *Zur Kenntnis der seltenen Erden des Cerits*, München, 1899; W. Muthmann and L. Stützel, *Ber.*, 3, 2667, 1899; C. F. Rammelsberg, *Sitzber. Akad. Berlin*, 549, 1886; *Handbuch der Mineralchemie*, Leipzig, 108, 1886; *Pogg. Ann.*, 107, 632, 1861; T. Scheerer, *ib.*, 41, 407, 1837; 51, 474, 1840; 56, 479, 1842; *De fossilium Allanit, Orthit, Cerin, Gadolimit que natura et indole*, Berolini, 1840; L. G. Eakins, *Proc. Colorado Scient. Soc.*, 2, 32, 1886; *Chem. News*, 53, 282, 1886; M. Websky, *Zeit. deut. geol. Ges.*, 17, 566, 1865; A. Connell, *Edin. New Phil. Journ.*, 20, 300, 1836; T. Thomson, *Phil. Mag.*, (3), 7, 430, 1835; J. S. Humpidge and W. Burney,

Journ. Chem. Soc., 35, 111, 1879; A. des Cloizeaux, *Manuel de minéralogie*, Paris, 2, 13, 1874; N. J. Berlin, *Öfvers. Akad. Stockholm*, 2, 86, 1845; *Dissertatio chemica analyse Gadolinitorum et Ytterbiensium*, Upsala, 1834; C. W. Blomstrand, *Geol. För. Förh. Stockholm*, 9, 442, 1887; J. F. Bahr and R. Bunsen, *Liebig's Ann.*, 137, 33, 1866; G. Tschermak, *Journ. Russ. Phys. Chem. Soc.*, 32, 252, 1900; *Proc. Russ. Min. Soc.*, 23, 34, 653, 1902; 36, 25, 1904; 43, 451, 467, 1905; *Neues Jahrb. Min.*, ii, 192, 1903; ii, 367, 1907; F. Eichstädt, *Bihang Svenska Akad. Handl.*, 10, 18, 1885; N. S. Maskelyne and V. von Lang, *Phil. Mag.*, (4), 23, 145, 1864; P. Waage, *Christiania Vid. Förh. Selsk.*, 1, 1864; R. J. Haüy, *Traité de minéralogie*, Paris, 2, 443, 1822; 4, 393, 1822; W. Phillips, *Elementary Introduction to Mineralogy*, London, 1823; A. Lévy, *Description d'une collection de minéraux formée par H. Heuland*, Londres, 2, 46, 1838; G. vom Rath, *Pogg. Ann.*, 144, 576, 1871; R. J. Strutt, *Proc. Roy. Soc.*, 76, A, 88, 312, 1905; W. Ramsay and M. W. Travers, *ib.*, 64, 62, 1898; A. T. Kupffer, *Ueber genaue Messung der Winkel an Krystallen*, Berlin, 1825; H. Rose, *Journ. prakt. Chem.*, (1), 73, 391, 1858; J. J. Berzelius, *Schweigger's Journ.*, 16, 405, 1816; W. H. Wollaston, in C. C. von Leonhard, *Handbuch der Oryktognosie*, Heidelberg, 482, 1826; K. A. Hofmann and F. Zerban, *Ber.*, 36, 3095, 1903; W. E. Hidden and J. B. Mackintosh, *Amer. Journ. Science*, (3), 38, 474, 1889; F. A. Genth, *ib.*, (3), 38, 198, 1889; W. E. Hidden and C. H. Warren, *ib.*, (4), 22, 515, 1906; W. E. Hidden and W. F. Hillebrand, *ib.*, (3), 46, 98, 208, 1893; W. F. Hillebrand, *ib.*, (4), 13, 145, 1902; W. E. Hidden, *ib.*, (3), 42, 430, 1891; (4), 19, 425, 1905; W. Petersson, *Geol. För. Förh. Stockholm*, 10, 181, 1888; *Studier öfver Gadolinii*, Upsala, 1890; A. Himmelbauer, *Sitzber. Akad. Wien*, 115, 1147, 1906; T. Liebisch, *Sitzber. Akad. Berlin*, 351, 1910; W. C. Brögger, *Zeit. Kryst.*, 16, 110, 174, 495, 1892; 25, 427, 1890; V. M. Goldschmidt, *ib.*, 45, 494, 1908; G. T. Prior, *Min. Mag.*, 10, 234, 1894; T. Thomson and A. Steel, *Thomson's Records*, 1, 403, 1835; P. Geijer, *Sveriges-Geol. Undersökning*, 14, 6, 1921; B. Szilard, *Le Radium*, 6, 233, 1909; H. Küstner, *Zeit. Physik*, 10, 41, 1922; A. Hadding, *Zeit. anorg. Chem.*, 122, 195, 1922; J. Fromme, *Centr. Min.*, 305, 1917; E. D. Clarke, *The Gas Blowpipe*, London, 65, 1819; W. C. Brögger, T. Vogt, and J. Schetelig, *Danske Vid. Selsk. Skr.*, 1, 1922; G. A. König, *Liebig's Ann.*, 137, 33, 1865.

³ H. L. Giesecke, *Bericht ein mineralogische Reise in Grönland—1806—1813*, Kjöbenhavn, 1878; F. von Kobell, *Geschichte der Mineralogie*, München, 679, 1864; C. C. von Leonhard, *Handbuch der Oryktognosie*, Heidelberg, 390, 1821; T. Allan, *Trans. Roy. Soc. Edin.*, 6, 345, 1810; T. Thomson, *ib.*, 6, 371, 1810; *Phil. Mag.*, (1), 36, 278, 1811; R. J. Haüy, *Traité de minéralogie*, Paris, 4, 398, 1822; W. Hisinger, *Ahand. Physik Kemi Min.*, 4, 327, 1815; J. J. Berzelius, *ib.*, 5, 23, 1818; W. Haidinger, *Pogg. Ann.*, 5, 157, 1825; T. Scheerer, *ib.*, 51, 407, 465, 1840; 54, 479, 1841; 56, 479, 1842; 61, 636, 1844; *De fossilium Alaniit, Orthit, Cerin, Gadolinii que natura et indole*, Berolini, 1840; G. Rose, *Elemente der Krystallographie*, Berlin, 170, 1833; *Mineralogisch-geognostische Reise nach Ural dem Altai, und dem kaspischen Meere*, Berlin, 1, 432, 1837; R. Hermann, *Bull. Soc. Nat. Moscou*, 3, 248, 1862; *Journ. prakt. Chem.*, (1), 23, 273, 1841; (1), 43, 35, 99, 106, 112, 1848; T. Kerndt, *ib.*, (1), 43, 228, 1848; A. Breithaupt, *Schweigger's Journ.*, 50, 321, 1827; *Pogg. Ann.*, 62, 273, 1844; J. F. Bahr, *ib.*, 119, 572, 1863; N. von Kokscharoff, *ib.*, 73, 182, 1848; M. Schubn, *Russ. Min. Journ.*, 1, 434, 1847; *Materialen zur Mineralogie Russlands*, St. Petersburg, 3, 357, 1858; A. Lévy, *Ann. Phil.*, 7, 134, 1824; J. Auerbach, *Journ. prakt. Chem.*, (1), 23, 273, 1841; F. Stromeyer, *Pogg. Ann.*, 32, 288, 1834; N. J. Berlin, *ib.*, 88, 162, 1853; H. Credner, *ib.*, 79, 414, 1850; C. Karsten, *ib.*, 63, 135, 1844; G. vom Rath, *ib.*, 113, 281, 1861; 119, 273, 1863; 138, 492, 1869; 144, 576, 1871; C. Bergemann, *ib.*, 84, 485, 1851; C. F. Rammelsberg, *ib.*, 76, 96, 1849; 80, 285, 1850; *Zeit. deut. geol. Ges.*, 24, 64, 1872; *Handbuch der Mineralchemie*, Leipzig, 596, 1875; R. J. Strutt, *Proc. Roy. Soc.*, 76, 88, 312, 1905; W. Ramsay, J. N. Collie, M. W. Travers, *Journ. Chem. Soc.*, 67, 684, 1895; D. I. Mendeléeff, *Proc. Russ. Min. Soc.*, 234, 1854; D. Forbes and T. Dahll, *Edin. Phil. Journ.*, (2), 2, 112, 1855; (2), 3, 59, 1856; (2), 6, 112, 1857; F. Zschau, *Jahrb. Min.*, 652, 1852; F. Stiff, *ib.*, 395, 1856; P. Keyser, *Amer. Journ. Science*, (2), 19, 20, 1855; D. M. Balch, *ib.*, (2), 33, 348, 1862; J. Torrey, *ib.*, (3), 27, 412, 1884; F. W. Clarke, *ib.*, (3), 23, 20, 1884; T. S. Hunt, *ib.*, (2), 34, 264, 1862; *Proc. Nat. Hist. Soc. Boston*, 8, 57, 1862; K. A. von Zittel, *Liebig's Ann.*, 112, 85, 1859; P. T. Cleve, *Journ. prakt. Chem.*, (1), 64, 386, 1854; *Öfvers. Akad. Förh.*, 19, 425, 1862; C. W. Blomstrand, *ib.*, 11, 296, 1854; *Journ. prakt. Chem.*, (1), 66, 156, 1855; A. Strecker, *ib.*, (1), 64, 386, 1854; V. M. Goldschmidt, *Centr. Min.*, 4, 1911; J. Fromme, *Tschermak's Mitt.*, (2), 28, 305, 1909; J. Schilling, *Das Vorkommen der seltenen Erden im Mineralreiche*, München, 1904; R. J. Meyer, *Sitzber. Akad. Berlin*, 375, 1911; P. Groth, *Tabellarische Uebersicht der Mineralien*, Braunschweig, 1898; A. Michel-Lévy and A. Lacroix, *Bull. Soc. Min.*, 11, 66, 1888; A. Sjögren, *Geol. För. Förh. Stockholm*, 3, 258, 1876; A. des Cloizeaux and A. Damour, *Ann. Chim. Phys.*, (3), 59, 365, 1860; N. Engström and P. T. Cleve, *Zeit. Kryst.*, 3, 194, 1879; N. Engström, *Undersökning af några mineral som innehålla sällsynta jordarter*, Upsala, 1877; J. W. Mallet, *Amer. Journ. Science*, (3), 14, 397, 1877; *Chem. News*, 38, 94, 109, 1878; 44, 215, 1881; 46, 195, 1882; J. A. Cabell, *ib.*, 30, 141, 1874; G. A. König, *Proc. Amer. Acad.*, 103, 1882; C. Memminger, *Amer. Chem. Journ.*, 6, 172, 1885; F. P. Dunnington, *ib.*, 4, 138, 1883; E. P. Valentine, *ib.*, 6, 172, 1885; A. E. Nordenskjöld, *Pogg. Ann.*, 101, 635, 1857; N. J. Berlin, *Dissertatio chemica analyse Gadolinitorum et Ytterbiensium*, Upsala, 1834; N. J. Berlin and J. F. Bahr, *Öfvers. Akad. Förh.*, 2, 86, 1845; F. A. Genth, *Amer. Journ. Science*, (2), 19, 20, 1855; (3), 40, 114, 1890; *Proc. Amer. Phil. Soc.*, 18, 1882; 18, 1887; L. G. Eakins, *Proc. Colorado Scient. Soc.*, (2), 1, 32, 1886; *Chem. News*, 53, 282, 1885; P. Geijer, *Sveriges Geol. Undersökning, Arsbok*, 14, 6, 1921; *Amer. Min.*, 6, 118, 1921; B. Szilard, *Le Radium*, 6, 233, 1909; L. H. Borgström, *Bull. Geol. Finlande*, 41, 1914; A. L. Fletcher, *Scient. Proc. Roy. Dublin Soc.*, (2), 13, 443,

1913; W. C. Brögger, T. Vogt, and J. Schetelig, *Danske Vid. Selsk. Skr.*, 1, 1922; C. A. Michaelson and E. Nobel, *Chefvers. Akad. Stockholm*, 505, 1862; T. L. Walker and A. L. Parsons, *Univ. Toronto Geol. Series*, 16, 1923.

⁴ F. Stromeyer, *Gött. Anz.*, 998, 1819; J. B. Trommsdorff, *Crell's Ann.*, 433, 1801; L. Gruner, *Gilbert's Ann.*, 13, 491, 1803; C. H. Pfaff, *Schweigger's Journ.*, 28, 97, 1820; 29, 1, 1820; W. H. Miller, *Phil. Mag.*, (3), 16, 477, 1820; A. Damour, *ib.*, (4), 13, 391, 1867; *Compt. Rend.*, 43, 1197, 1853; J. Lorenzen, *Min. Mag.*, 5, 63, 1882; C. F. Rammelsberg, *Handbuch der Mineralchemie*, Leipzig, 447, 1895; *Zeit. deut. geol. Ges.*, 38, 500, 1886; *Pogg. Ann.*, 63, 142, 1844; O. B. Böggild, *Mineralogia Grönlandica*, Kjöbenhavn, 495, 1905; T. Vogt, *Danske Vid. Selsk. Skr.*, 1, 17, 1922; F. A. Genth, *Amer. Journ. Science*, (3), 41, 397, 1891; J. F. Williams, *ib.*, (3), 40, 457, 1890; P. T. Cleve, *Zeit. Kryst.*, 16, 503, 1890; W. C. Brögger, *ib.*, 16, 504, 1890; T. Scheerer, *Pogg. Ann.*, 72, 561, 1847; L. Colomba, *Rivista Ital. Min.*, 38, 75, 1909; F. W. Clarke, *The Constitution of the Natural Silicates*, Washington, 116, 1914; W. Ramsay, *Bull. Soc. Geol. Finland*, 3, 43, 1890; J. D. Dana, *A System of Mineralogy*, London, 248, 1868; V. von Lang, *Phil. Mag.*, (4), 25, 436, 1863; E. Jannettaz, *Bull. Soc. Min.*, 15, 136, 1892; J. Thomsen, *Bull. Acad. Denmark*, 53, 1904; C. W. Blomstrand, *Bihang. Svenska Akad. Handl.*, 12, 1, 1886; *Denks. physig. Ges. Lund*, 3, 7, 1878; P. Groth, *Tabellarische Uebersicht der Mineralien*, Braunschweig, 143, 1889; A. Lévy, *Description d'une collection de minéraux formés par H. Heuland*, Londres, 1, 412, 1838; J. Schilling, *Das Vonkommen der seltenen Erde im Mineralreiche*, München, 98, 1904; C. U. Shepard, *Amer. Journ. Science*, (2), 37, 407, 1864; G. Hevesy and V. T. Jantzen, *Journ. Chem. Soc.*, 123, 1218, 1923.

⁵ C. B. Benedicks, *Geol. För. Förh. Stockholm*, 20, 308, 1898; R. Mauzelius and H. Sjögren, *ib.*, 28, 93, 1906; W. C. Brögger, *ib.*, 9, 253, 1887; *Zeit. Kryst.*, 16, 468, 1890; 42, 438, 1907; W. E. Hidden and J. B. Mackintosh, *Amer. Journ. Science*, (3), 38, 474, 1889; W. F. Hillebrand, *ib.*, (4), 13, 145, 1903; *Bull. U.S. Geol. Sur.*, 262, 65, 1905; F. W. Clarke, *ib.*, 419, 275, 1910; L. A. Aars, *Ueber die analytische Bestimmung von Beryllium und den sogenannten seltenen Erden*, Kristiania, 1905; L. Gruner, *Gilbert's Ann.*, 13, 497, 1803; C. Bergemann, *Pogg. Ann.*, 84, 486, 1851; *Ber. Niederrhein. Ges. Nat. Bonn.*, 12, 1, 1854; M. Websky, *Zeit. deut. geol. Ges.*, 29, 257, 1868; A. T. C. Soltmann, *ib.*, 18, 628, 1890; M. Piners, *ib.*, 22, 481, 1893; B. Szilard, *Le Radium*, 6, 233, 1909; T. Vogt, *Danske Vid. Selsk. Skr.*, 1, 17, 1922.

⁶ F. Zambonini, *Zeit. Kryst.*, 46, 76, 1908; W. E. Hidden and C. H. Warren, *Amer. Journ. Science*, (4), 22, 515, 1906; P. J. Holmquist, *Geol. För. Förh. Stockholm*, 16, 73, 1894; C. F. Rammelsberg, *Handbuch der Mineralchemie*, Leipzig, 171, 1895; P. Groth, *Chemische Krystallographie*, Leipzig, 2, 233, 1908; D. Mawson, *Trans. Roy. Soc. South Australia*, 30, 188, 1916; E. E. H. Rennie and W. C. Cook, *ib.*, 30, 193, 1916; B. Szilard, *Le Radium*, 6, 233, 1909.

⁷ A. Erdmann, *Chefvers. Akad. Stockholm*, 191, 1840; 355, 1844; T. Scheerer, *Pogg. Ann.*, 63, 459, 1844; H. Rose, *ib.*, 62, 253, 591, 1844; G. Rose, *ib.*, 48, 551, 1839; N. J. Berlin, *ib.*, 88, 156, 1833; C. F. Rammelsberg, *ib.*, 106, 296, 1859; *Handbuch der Mineralchemie*, Leipzig, 269, 1886; D. Forbes and T. Dahl, *Edin. Phil. Journ.*, (2), 1, 62, 1855; (2), 3, 59, 1856; (2), 6, 112, 1857; J. J. Berzelius, *Arsber. Fysik Kemi*, (2), 5, 275, 1845; C. W. Blomstrand, *Denks. phys. För. Lund*, 24, 1878; P. Groth, *Tabellarische Uebersicht der Mineralien*, Braunschweig, 188, 1882; 160, 1904; F. Pisani, *Compt. Rend.*, 155, 672, 1912; W. R. Dunstan, *Journ. Gaslight*, 96, 518, 1906; F. W. Clarke, *Bull. U.S. Geol. Sur.*, 419, 299, 1910; A. L. Fletcher, *Scient. Proc. Roy. Dublin Soc.*, (2), 13, 433, 1913; O. Hauser, *Zeit. anorg. Chem.*, 63, 340, 1909; F. Zambonini, *Atti Accad. Lincei*, (5), 15, i, 291, 1906; W. C. Brögger, *Geol. För. Förh. Stockholm*, 9, 251, 1887; *Zeit. Kryst.*, 16, 87, 378, 468, 1890; P. T. Cleve, *ib.*, 16, 382, 1890; J. Lorenzen, *ib.*, 9, 248, 1884; *Med. Grönland*, 2, 73, 1881; O. B. Böggild, *ib.*, 25, 181, 1899; J. C. Moberg, *Zeit. Kryst.*, 29, 386, 1898; B. Szilard, *Le Radium*, 6, 233, 1909; R. Hermann, *Journ. prakt. Chem.*, (1), 105, 332, 1868; R. C. Price, *Amer. Chem. Journ.*, 10, 38, 1888; L. G. Eakins, *Amer. Journ. Science*, (3), 42, 37, 1891; J. D. Dana, *ib.*, (2), 18, 253, 1854; A. des Cloizeaux, *Manuel de minéralogie*, Paris, 1, 153, 1862; F. S. Beudant, *Traité élémentaire de minéralogie*, Paris, 2, 652, 1832.

⁸ G. P. Tschernik, *Journ. Russ. Phys. Chem. Soc.*, 28, 345, 1896; W. F. Hillebrand and W. E. Hidden, *Amer. Journ. Science*, (3), 45, 208, 1893; W. F. Hillebrand, *ib.*, (4), 13, 145, 1902; W. E. Hidden and J. B. Mackintosh, *ib.*, (3), 38, 474, 1889; E. S. Larsen, *Bull. U.S. Geol. Sur.*, 679, 1921; W. C. Brögger, *Zeit. Kryst.*, 16, 468, 1890; 42, 439, 1907; *Geol. För. Förh. Stockholm*, 9, 256, 1887; P. Groth, *Tabellarische Uebersicht der Mineralien*, Braunschweig, 1898; O. B. Böggild, *Zeit. Kryst.*, 41, 426, 1906; 50, 435, 1912; *Medd. Grönland*, 26, 93, 1903; C. Wintner, *ib.*, 24, 181, 1899; J. Morozewicz, *Tschermak's Mitt.*, (2), 24, 120, 1905; B. Szilard, *Le Radium*, 6, 233, 1909.

⁹ S. R. Pajjkull, *Geol. För. Förh. Stockholm*, 3, 229, 1876; A. E. Nordenskiöld, *ib.*, 8, 143, 1886; H. Sjögren, *ib.*, 19, 63, 1897; A. des Cloizeaux and A. Damour, *ib.*, 3, 385, 1876; *Ann. Chim. Phys.*, (5), 12, 405, 1877; W. C. Brögger, T. Vogt, and J. Schetelig, *Danske Vid. Selsk. Skr.*, 1, 1, 1922; W. C. Brögger, *Zeit. Kryst.*, 16, 478, 1890; *Geol. För. Förh. Stockholm*, 7, 599, 1885; N. Engström, *ib.*, 3, 200, 1879; *Undersökning af några mineral, som minnehålla sällsyntha jordarter*, Upsala, 1877; F. P. Möller, *Amer. Journ. Science*, (2), 34, 222, 1861; T. Liebisch, *Sitzber. Akad. Berlin*, 22, 357, 1910; C. F. Rammelsberg, *Handbuch der Mineralchemie*, Leipzig, 462, 1895; B. Szilard, *Le Radium*, 6, 233, 1909; E. S. Larsen, *Bull. U.S. Geol. Sur.*, 679, 1921.

¹⁰ W. C. Brögger, *Zeit. Kryst.*, 16, 127, 1890; A. Damour, *Bull. Soc. Min.*, 1, 32, 1880; S. R. Pajjkull, *Geol. För. Förh. Stockholm*, 3, 350, 1876; A. L. Fletcher, *Scient. Proc. Roy. Dublin Soc.*, (2), 13, 433, 1913; W. E. Hidden and J. B. Mackintosh, *Amer. Journ. Science*, (3), 38, 479,

1889; W. E. Hidden and W. F. Hillebrand, *ib.*, (3), 46. 98, 1893; W. E. Hidden, *ib.*, (3), 42. 430, 1891; (4), 19. 425, 1905; W. F. Hillebrand, *ib.*, (4), 13. 145, 1902; W. E. Hidden and C. H. Warren, *ib.*, (4), 22. 515, 1906; B. Szilard, *Le Radium*, 6. 233, 1909; F. W. Clarke, *Bull. U.S. Geol. Sur.*, 419. 276, 1910; E. S. Simpson, *Chem. News*, 102. 283, 1910.

¹¹ G. Rose, *Pogg. Ann.*, 48. 555, 1839; 71. 166, 1847; H. Rose, *ib.*, 71. 157, 1847; 73. 449, 1848; 103. 311, 1858; 118. 497, 1863; *Journ. prakt. Chem.*, (1), 88. 201, 1863; R. Hermann, *ib.*, (1), 33. 87, 1844; (1), 38. 119, 1846; (1), 40. 474, 1847; (1), 42. 119, 1847; (1), 95. 114, 198, 1865; (1), 107. 150, 1869; (2), 1. 123, 1870; (2), 4. 191, 1871; (1), 50. 178, 1850; *Bull. Soc. Nat., Moscow*, 38. 358, 1865; T. S. Hunt, *Amer. Journ. Science*, (2), 14. 341, 1877; O. D. Allen, *ib.*, (3), 14. 131, 1877; J. L. Smith, *Amer. Chem. Journ.*, 5. 44, 73, 1883; *Chem. News*, 48. 13, 29, 1883; *Amer. Journ. Science*, (3), 13. 362, 1877; G. C. Hoffmann, *ib.*, (3), 24. 476, 1882; J. Potyka, *Pogg. Ann.*, 107. 590, 1859; *Untersuchungen über einige Mineralien*, Berlin, 1859; R. J. Haiy, *Traité de minéralogie*, Paris, 1822; C. F. Chandler, *Miscellaneous Chemical Researches*, Albany, 1837; *Pogg. Ann.*, 118. 498, 1863; A. G. Ekeberg, *Svenska Akad. Handl.*, 80, 1802; J. J. Berzelius, *Afhand. Fysik Kemi Min.*, 4. 268, 272, 1815; *Schweigger's Journ.*, 16. 451, 1816; A. E. Nordenskjöld, *Öfvers. Akad. Förh.*, 28, 1860; *Geol. För. Förh. Stockholm*, 1. 7, 1872; *Pogg. Ann.*, 111. 280, 1860; J. J. Chydenius, *ib.*, 111. 284, 1860; W. Ramsay and M. W. Travers, *Proc. Roy. Soc.*, 60. 442, 1897; R. J. Strutt, *ib.*, 76. A, 95, 1905; Y. Shibata and K. Kimura, *Journ. Chem. Soc. Japan*, 42. 301, 648, 1922; A. L. Fletcher, *Scient. Proc. Roy. Dublin Soc.*, (2), 13, 433, 1913; A. des Cloizeaux, *Manuel de minéralogie*, Paris, 1862; C. F. Rammelsberg, *Zeit. deut. geol. Ges.*, 29. 817, 1877; *Handbuch der Mineralchemie*, Berlin, 360, 1875; *Ber.*, 3. 926, 1870; O. Hauser and L. Finckh, *ib.*, 42. 2270, 1909; O. Hauser, *ib.*, 43. 417, 1910; G. H. Williams, *Neues Jahrb. Min.*, ii, 19, 1888; W. F. Hillebrand, *Proc. Colorado Scient. Soc.*, 3. 38, 1888; K. von Chruschhoff, *Proc. Russ. Min. Soc.*, 31. 412, 1894; P. Nikolaëff, *ib.*, 35. 11, 1897; G. P. Tschernik, *ib.*, 45. 276, 1907; *Journ. Russ. Phys. Chem. Soc.*, 34. 684, 1902; A. Lacroix, *Compt. Rend.*, 152. 559, 1911; *Bull. Soc. Min.*, 35. 180, 1912; M. Duparc, R. Sabot, and M. Wunder, *ib.*, 36. 11, 1913; W. C. Brögger, T. Vogt, and J. Schetelig, *Danske Vid. Selsk. Skr.*, 1, 1922; W. C. Brögger, *Die Mineralen der süd-norwegischen Granitpegmatitgänge*, Kristiania, 142, 1906; *Geol. För. Förh. Stockholm*, 5. 354, 1881; M. Weibull, *ib.*, 9. 371, 1887; P. Groth, *Tabellarische Uebersicht der Mineralien*, Braunschweig, 1898; V. Lomonosoff, *Bull. Acad. St. Petersburg*, 23. 463, 1877; B. Szilard, *Le Radium*, 6. 233, 1909; E. S. Dana, *Amer. Journ. Science*, (3), 11. 201, 1876; M. Delafontaine, *Compt. Rend.*, 87. 933, 1878.

¹² H. L. Giesecke, *Bericht ein mineralogische Reise in Grönland—1806—1813*, Kopenhagen, 1878; W. Haidinger, *Phil. Trans.*, 116. 274, 1826; D. Forbes and T. Dahll, *Phil. Mag.*, (4), 13. 91, 1856; *Edin. Phil. Journ.*, (2), 1. 67, 1855; (2), 3. 59, 1856; (2), 6. 112, 1857; V. Hartwall, *Svenska Akad. Handl.*, 167, 1828; J. J. Berzelius, *Afhand. Fysik Kemi Min.*, 4. 281, 1815; J. Potyka, *Pogg. Ann.*, 107. 590, 1859; J. A. Michäson, *Journ. prakt. Chem.*, (2), 110. 108, 1870; A. E. Nordenskjöld, *ib.*, (1), 81. 200, 1860; *Geol. För. Förh. Stockholm*, 3. 226, 1876; 4. 28, 1879; 7. 121, 1885; N. Nordenskjöld, *Pogg. Ann.*, 122. 615, 1864; H. Weber, *ib.*, 137. 190, 1869; C. F. Rammelsberg, *Sitzber. Akad. Berlin*, 406, 1871; W. C. Brögger, T. Vogt, and J. Schetelig, *Danske Vid. Selsk. Skr.*, 1, 1922; W. C. Brögger, *Die Mineralien der süd-norwegischen Granitpegmatitgänge*, Kristiania, 36, 1906; G. S. Blake, *Colonial Rep.*, 37. 36, 1906; G. Tschermak, *Ann. Geol. Min. Russ.*, 5. 221, 1902; A. L. Fletcher, *Scient. Proc. Roy. Dublin Soc.*, (2), 13. 433, 1913; G. T. Prior, *Min. Mag.*, 10. 234, 1893; W. E. Hidden and J. B. Mackintosh, *Amer. Journ. Science*, (3), 38. 482, 1889; J. W. Mallet, *ib.*, (3), 14. 397, 1877; (3), 22. 52, 1881; J. L. Smith, *ib.*, (3), 13. 367, 1877; C. U. Shepard, *ib.*, (2), 12. 209, 1851; (2), 14. 344, 1852; (3), 20. 57, 1880; W. H. Seamon, *ib.*, (3), 24. 372, 1882; *Chem. News*, 46. 204, 1882; A. Lacroix, *Bull. Soc. Min.*, 31. 312, 1908; E. S. Simpson, *Australian Assoc. Rep.*, 310, 1909; O. Hauser, *Zeit. anorg. Chem.*, 60. 230, 1908; *Ber.*, 40. 3118, 1907; J. H. L. Vogt, *Centr. Min.*, 373, 1911; M. Websky, *Zeit. deut. geol. Ges.*, 17. 566, 1865; 20. 250, 1868; C. A. Kenngott, *Pogg. Ann.*, 97. 622, 1856; W. H. Miller, *Introduction to Mineralogy*, London, 465, 1852; W. Ramsay and M. W. Travers, *Proc. Roy. Soc.*, 60. 442, 1897; R. J. Strutt, *ib.*, 76. 88, 312, 1905; M. S. Curie, *Recherches sur les substances radioactives*, Paris, 1903; R. J. Strutt, *Jahrb. Radioaktivitat*, 1. 14, 1904; B. Szilard, *Le Radium*, 6. 233, 1909; G. Hevesy and V. T. Jantzen, *Journ. Chem. Soc.*, 123. 3218, 1923.

¹³ J. J. Berzelius, *Svenska Akad. Handl.*, 338, 1824; *Pogg. Ann.*, 3. 205, 1825; V. Hartwall, *Pogg. Ann.*, 17. 483, 1829; R. Hermann, *Journ. prakt. Chem.*, (1), 31. 89, 1844; (1), 37. 116, 1846; 50. 170, 1860; 65. 77, 1855; 68. 97, 1856; *Journ. prakt. Chem.*, (1), 95. 78, 123, 1865; (1), 97. 342, 1866; (1), 99. 288, 1866; (1), 105. 321, 1868; (1), 109. 288, 1869; (2), 4. 191, 1871; *Bull. Soc. Nat. Moscow*, 38. 472, 1865; 39. 55, 1866; H. J. Brooke, *Phil. Mag.*, (3), 10. 188, 1837; A. des Cloizeaux, *Ann. Mines*, (4), 2. 349, 1842; G. Rose, *Mineralogisch-geognostische Reise nach dem Ural, dem Altai, und dem kaspischen Meere*, Berlin, 2. 70, 1842; H. Rose, *Pogg. Ann.*, 69. 139, 1846; N. von Kokscharoff, *Materialien zur Mineralogie Russlands*, St. Petersburg, 3. 384, 1858; 4. 53, 190, 1866; J. C. G. de Marignac, *Bibl. Univ. Geneva*, 29. 282, 1867; C. F. Rammelsberg, *Zeit. deut. geol. Ges.*, 29. 815, 1877; *Pogg. Ann.*, 150. 214, 1873; *Sitzber. Akad. Berlin*, 656, 1877; G. P. Drossbach, *Zeit. angew. Chem.*, *Journ. Gasbeleucht.*, 38. 481, 1895; L. Schmelck, *Zeit. angew. Chem.*, 8. 543, 1895; B. Szilard, *Le Radium*, 6. 233, 1909; A. L. Fletcher, *Scient. Proc. Roy. Dublin Soc.*, (2), 13. 433, 1913; G. Tschermak, *Bull. Acad. St. Petersburg*, (6), 2. 389, 1908; W. C. Brögger, *Die Mineralien der süd-norwegischen Granitpegmatitgänge*, Kristiania, 103, 1906; G. Woitschack, *Abhand. Nat. Ges. Görlitz*, 17. 182, 1881; R. J. Strutt, *Proc. Roy. Soc.*, 76. 88, 312, 1905.

¹⁴ W. C. Brögger, *Die Mineralien der süd-norwegischen Granitpegmatitgänge*, Kristiania, 1906; W. C. Brögger, T. Vogt, and J. Schetelig, *Danske Vid. Selsk. Skr.*, 1, 1922; J. C. G. de Marignac, *Bibl. Univ. Genève*, 25, 29, 1866; C. F. Rammelsberg, *Sitzber. Akad. Berlin*, 425, 1871; C. J. Jehn, *Ueber Babingtonit und Euzenite*, Jena, 1871; C. W. Blomstrand, *Minnesskrift Fys. Sällsk. Lund.*, 3, 1878; W. E. Hidden and J. B. Mackintosh, *Amer. Journ. Science*, (3), 41, 423, 1891; B. B. Boltwood, *ib.*, (4), 23, 77, 1907; W. A. A. Prandtl, *Ueber einiger neue Bestandteile des Euzenits*, München, 1901; G. Tschermak, *Ann. Geol. Min. Russ.*, 5, 196, 1902; O. B. Böggild, *Mineralogia Groenlandica*, Kjöbenhavn, 15, 1905; B. Szilard, *Le Radium*, 6, 233, 1909; R. J. Strutt, *Proc. Roy. Soc.*, 76, A, 95, 1905; L. Schmelck, *Zeit. angew. Chem.*, 8, 543, 1895; G. Lincio, *Centr. Min.*, 142, 1904; O. Hauser and H. Herzfeld, *ib.*, 756, 1910; E. S. Simpson, *Australian Assoc. Rep.*, 310, 1909; O. Hauser and F. Wirth, *Ber.*, 42, 4443, 1909; 43, 1807, 1910; K. A. Hofmann and W. A. A. Prandtl, *ib.*, 34, 1064, 1901; G. Krüss, *ib.*, 21, 131, 1888; K. A. Hofmann, *ib.*, 43, 2631, 1910; G. T. Prior, *Min. Mag.*, 12, 97, 1899; A. Lacroix, *Bull. Soc. Min.*, 33, 321, 1910; 35, 91, 1912; H. Lange, *Zeit. Naturwiss.*, 82, 1, 1910; T. Scheerer, *Berg. Hütt. Ztg.*, 17, 22, 1858; *Pogg. Ann.*, 50, 149, 1840; 62, 430, 1844; 72, 566, 1847; J. J. Chydenius, *Bull. Soc. Chim.*, (2), 6, 434, 1866; A. Strecker, *Journ. prakt. Chem.*, (1), 64, 384, 1855; N. B. Moller, *ib.*, (1), 69, 318, 1856; D. Forbes and T. Dahll, *Edin. New Phil. Journ.*, (2), 1, 62, 1855; (2), 3, 59, 1856; (2), 6, 112, 1857; L. A. Aars, *Ueber die analytische Bestimmung von Beryllium und den sogenannten seltenen Erden*, Kristiania, 1905; J. Schilling, *Das Vorkommen der selten Erden im Mineralreiche*, München, 107, 1904; M. P. Melnikoff and P. D. Nikolajeff, *Proc. Russ. Min. Soc.*, 35, 11, 1897; A. L. Fletcher, *Scient. Proc. Roy. Dublin Soc.*, (2), 13, 433, 1913; G. Hevesy and V. T. Jantzen, *Journ. Chem. Soc.*, 123, 3218, 1923.

¹⁵ S. Weidman and V. Lenher, *Amer. Journ. Science*, (4), 23, 287, 1907; R. Hermann, *Bull. Soc. Nat. Moscou*, 38, 366, 1866; *Journ. prakt. Chem.*, (1), 31, 94, 1844; (1), 50, 188, 1850; F. Wöhler, *Pogg. Ann.*, 7, 417, 1826; 48, 83, 1839; A. L. Fletcher, *Scient. Proc. Roy. Dublin Soc.*, (2), 13, 433, 1913; C. F. Rammelsberg, *Sitzber. Akad. Berlin*, 183, 1871; T. Liebisch, *ib.*, 350, 1910; K. von Christoch, *Proc. Russ. Min. Soc.*, 31, 415, 1894; P. J. Holmquist, *Geol. För. Förh. Stockholm*, 15, 588, 1893; *Bull. Geol. Inst. Upsala*, 3, 253, 1896; G. Tschermak, *Ann. Geol. Min. Russ.*, 5, 196, 1902; *Journ. Russ. Phys. Chem. Soc.*, 36, 457, 712, 1904; W. C. Brögger, *Die Mineralien der süd-norwegischen Granitpegmatitgänge*, Kristiania, 102, 1906; W. Ramsay, *Proc. Roy. Soc.*, 62, 325, 1898; G. Lindström, *Geol. För. Förh. Stockholm*, 4, 162, 1874; H. Bögström, *ib.*, 32, 1525, 1911; A. E. Nordenskjöld, *ib.*, 3, 282, 1872; G. Nordenskjöld, *ib.*, 16, 336, 1894; A. Lacroix, *Bull. Soc. Min.*, 35, 87, 1912; C. U. Shepard, *Amer. Journ. Science*, (1), 27, 361, 1835; (1), 32, 338, 1837; (1), 43, 116, 1842; A. A. Hayes, *ib.*, (1), 43, 33, 1842; (1), 46, 158, 338, 1844; (2), 9, 423, 1850; F. P. Dunnington, *ib.*, (3), 3, 130, 1881; J. L. Smith, *ib.*, (3), 13, 365, 1877; O. D. Allen, *ib.*, (3), 14, 128, 1877; O. Hauser and H. Herzfeld, *Centr. Min.*, 756, 1910; B. Szilard, *Le Radium*, 6, 233, 1909; W. Ramsay and A. Zilliacus, *Öfvers. Finsk. Vet. Förh.*, 39, 58, 1897; L. J. Spencer, *Min. Mag.*, 13, 379, 1903; W. Crookes, *Proc. Roy. Soc.*, 80, A, 516, 1908; J. D. Dana, *A System of Mineralogy*, London, 396, 681, 1850; E. S. Simpson, *Australian Assoc. Rep.*, 310, 1919; A. Knop, *Neues Jahrb. Min.*, 67, 1875; *Zeit. deut. geol. Ges.*, 23, 656, 1871; G. vom Rath, *ib.*, 22, 672, 1870; G. H. Bailey, *Journ. Chem. Soc.*, 49, 153, 1886; P. Termier, *Bull. Soc. Min.*, 25, 34, 1902; G. Flink, *Mémoires Grönland*, 16, 234, 1898; G. Flink, O. B. Böggild, and C. Winther, *ib.*, 16, 24, 1898; G. Rose, *Pogg. Ann.*, 48, 562, 1840; A. Corsi, *Boll. Com. Geol.*, 564, 1881; L. L. Hubbard, *Ber. Niederrhein Ges. Nat.*, Bonn, 1886; J. E. Teschemacher, *Amer. Journ. Science*, (2), 3, 32, 1874; *Journ. Nat. Hist. Soc. Boston*, 4, 499, 1844; A. Osann, *Neues Jahrb. Min.*, i, 115, 1886; i, 117, 1888; J. J. Chydenius, *Pogg. Ann.*, 119, 43, 1863; *Kemisk Undersökning af Thorjord och Thorsalter*, Helsingfors, 1861; M. P. Meini-koff and P. D. Nikolajeff, *Proc. Russ. Min. Soc.*, 35, 11, 1897.

¹⁶ T. Scheerer, *Pogg. Ann.*, 51, 412, 1840; G. Eberhard, *Sitzber. Akad. Berlin*, 851, 1908; 404, 1910; *Chem. News*, 99, 30, 1909; 102, 211, 1910.

¹⁷ J. J. Berzelius and J. G. Gahn, *Schweigger's Journ.*, 16, 244, 1816; C. T. Jackson, *Proc. Boston Nat. Hist. Soc.*, 166, 1844; C. F. Rammelsberg, *Ber.*, 3, 858, 1870; W. F. Pettard, *A Catalogue of the Minerals of Tasmania*, Launceston, 1896; T. Vogt, *Centr. Min.*, 373, 1911; 673, 1923; G. Tschermak, *Proc. Russ. Min. Soc.*, 42, 51, 1905; E. F. Glocker, *Generum et specierum mineralium secundum ordines naturales digestorum synopsis*, Halle, 283, 1847; G. Gibbs, *Amer. Journ. Science*, (1), 1, 346, 1818; A. L. Fletcher, *Scient. Proc. Roy. Dublin Soc.*, (2), 13, 433, 1913; E. Dittler, *Centr. Min.*, 673, 1923.

¹⁸ J. J. Berzelius, *Afhand. Fysik. Kemi Min.*, 6, 56, 1818; *Pogg. Ann.*, 1, 29, 1824; W. Haidinger, *Handbuch der bestimmenden Mineralogie*, Wien, 500, 1845; M. Weibull, *Zeit. Kryst.*, 18, 619, 1891; *Geol. För. Förh. Stockholm*, 8, 478, 1886; A. Hadding, *Zeit. anorg. Chem.*, 122, 195, 1922.

¹⁹ W. F. Hillebrand and W. E. Hidden, *Amer. Journ. Science*, (3), 46, 208, 1893; W. C. Brögger, *Zeit. Kryst.*, 16, 468, 1890; 42, 438, 1907; P. Groth, *Tabellerische Uebersicht der Mineralien*, Braunschweig, 1898; F. W. Clarke, *Bull. U.S. Geol. Sur.*, 419, 276, 1910.

²⁰ W. Haidinger, *Handbuch der bestimmenden Mineralien*, Wien, 500, 1845; E. F. Glocker, *Generum et specierum mineralium secundum ordines naturales digestorum synopsis*, Halle, 248, 1847; J. J. Berzelius, *Svenska Akad. Handl.*, 134, 1824; W. Hisinger, *Versuch einer Mineralogie und Geographie von Sweden*, Leipzig, 144, 1820; F. S. Beudant, *Traité élémentaire de minéralogie*, Paris, 2, 354, 1832; K. F. A. Hartmann, *Handbuch der Mineralogie*, Weimar, 2, 816, 1843; G. Lindström, *Geol. För. Förh. Stockholm*, 32, 206, 1910; C. G. Mosander, *Journ. prakt. Chem.*, (1),

30. 276, 1843; R. Hermann, *ib.*, (1), 82. 400, 1861; P. T. Cleve, *Bihang Svenska Akad. Handl.*, 2. 20, 1874; C. Morton, *Cfvers. Akad. Förh.*, 42. 192, 1885; V. von Lang, *Phil. Mag.*, (4), 25. 43, 1863; W. P. Blake, *Amer. Journ. Science*, (2) 16. 228, 1853; F. A. Genth, *ib.*, (2), 23. 425, 1857; (2), 38. 198, 1889; J. L. Smith, *ib.*, (2), 16. 230, 1853; (2), 18. 378, 1854; C. F. Rammelsberg, *Ber.*, 9. 1582, 1876; A. F. Svanborg and C. Tenger, *Arsber. Phys. Chem.*, (1), 18. 206, 1838; J. D. Dana, *A System of Mineralogy*, London, 710, 1868; G. Flink, *Medd. Grönland*, 24. 49, 1899.

²¹ C. F. Rammelsberg, *Handbuch der Mineralchemie*, Leipzig, 1875; K. Vrba, *Zeit. Kryst.*, 5. 211, 1881; W. C. Brögger, *ib.*, 16. 651, 1890; C. H. Warren, *ib.*, 49. 343, 1911; *Amer. Journ. Science*, (4), 28. 450, 1909; O. D. Allen and W. J. Constock, *ib.*, (3), 19. 390, 1880; S. L. Penfield and C. H. Warren, *ib.*, (4), 8. 21, 1899; C. Palache and W. F. Hillebrand, *ib.*, (4), 7. 51, 1899; W. E. Hidden, *ib.*, (3), 41. 439, 1891; C. H. Warren, *ib.*, (4), 31. 533, 1911; W. F. Hillebrand, *ib.*, (4), 7. 51, 1899; *Bull. U.S. Geol. Sur.*, 167. 1, 1899; F. W. Clarke, *ib.*, 419. 251, 1910; A. des Cloizeaux, *Manuel de minéralogie*, Paris, 2. 163, 1893; R. Bunsen, *Liebig's Ann.*, 53. 147, 1845; A. Damour and H. St. C. Deville, *Compt. Rend.*, 59. 270, 1864; G. Nordenskjöld, *Geol. För. Förh. Stockholm*, 16. 336, 1894; *Cfvers. Akad. Förh.*, 25. 399, 1868; G. Flink, *Medd. Grönland*, 24. 29, 1890; O. B. Böggild, *ib.*, 33. 99, 1906; *Bull. Geol. Inst. Upsala*, 5. 81, 1902; R. Mauzelius, *ib.*, 5. 86, 1902; B. Szilard, *Le Radium*, 6. 233, 1909; G. Aminoff, *Geol. För. Förh. Stockholm*, 42. 291, 1920; G. P. Tschernik, *Proc. Russ. Min. Soc.*, 24. 507, 1906; P. Groth, *Tabellarische Uebersicht der Mineralien*, Braunschweig, 1898; J. Schilling, *Das Vorkommen der seltenen Erde im mineralreiche*, München, 23, 1904; T. Korovaëff, *Journ. prakt. Chem.*, (1), 85. 442, 1862; E. Quercigh, *Atti Accad. Lincei*, (5), 21. i, 581, 1912; W. Hisinger, *Svenska Akad. Handl.*, 187, 1838; J. J. N. Huot, *Manuel de minéralogie*, Paris, 1. 249, 1841; T. Karawajeff, *Bull. Acad. St. Petersburg*, (4), 4. 401, 1862; N. von Kokscheroff, *Materialien zur Mineralogie Russlands*, St. Petersburg, 4. 40, 1862; F. Radominsky, *Ber.*, 7. 483, 1874.

²² A. Lévy, *Ann. Phil.*, 21. 241, 1823; *Description d'une collection de minéraux formée par H. Heuland*, Londres, 3. 423, 1837; J. D. Dana, *A System of Mineralogy*, London, 540, 1868; *Amer. Journ. Science*, (1), 33. 70, 1838; (2), 42. 420, 1866; F. Pisani, *Compt. Rend.*, 84. 462, 1877; A. Breithaupt, *Schweigger's Journ.*, 55. 301, 1829; H. J. Brooke, *Phil. Mag.*, (2), 10. 139, 1831; B. B. Boltwood, *ib.*, (6), 9. 599, 1905; *Amer. Journ. Science*, (4), 18. 97, 1904; (4), 20. 253, 1905; (4), 21. 415, 1906; (4), 25. 269, 1908; C. U. Shepard, *ib.*, (1), 32. 162, 341, 1837; F. A. Genth, *ib.*, (3), 38. 203, 1889; S. L. Penfield, (3), 24. 250, 1882; (3), 36. 317, 1888; H. L. Bowmann, *Zeit. Kryst.*, 33. 113, 1900; R. Scharizer, *ib.*, 12. 265, 1887; F. P. Dunnington, *Amer. Chem. Journ.*, 4. 138, 1882; *Amer. Journ. Science*, (3), 24. 168, 1882; G. C. Hoffmann, *ib.*, (3), 34. 73, 1887; W. E. Hidden and J. H. Pratt, *ib.*, (4), 6. 463, 1898; W. Lindgren, *ib.*, (4), 43. 63, 1897; E. S. Sperry, *ib.*, (3), 36. 317, 1888; G. Rose, *Pogg. Ann.*, 49. 223, 1840; F. Wöhler, *ib.*, 67. 424, 1846; *Gött. Anz.*, 19, 1846; C. Kersten, *Pogg. Ann.*, 47. 385, 1839; O. Boudouard, *Bull. Soc. Min.*, (3), 19. 10, 1898; J. Schilling, *Das Vorkommen der seltenen Erde im Mineralreiche*, München, 38, 1904; H. Watts, *Journ. Chem. Soc.*, 2. 131, 1849; A. H. Church, *ib.*, 18. 259, 1865; W. Ramsay, J. N. Collie, and M. W. Travers, *ib.*, 67. 684, 1895; A. Dieseldorff, *Chem. Ind.*, 29. 411, 1906; C. R. Böhm, *ib.*, 29. 3, 1906; P. Truchot, *Chem. News*, 77. 134, 145, 1898; F. Katzer, *Öster. Zeit. Berg. Hüt.*, 53. 231, 1905; J. F. Kemp, *Trans. New York Acad.*, 13. 76, 1893; W. R. Dunstan, *Journ. Gaslight*, 96. 518, 1906; O. Boudouard, *Bull. Soc. Chim.*, (3), 19. 10, 1898; E. Mallard, *Bull. Soc. Min.*, 10. 236, 1887; R. Hermann, *Journ. prakt. Chem.*, (1), 33. 90, 1844; (1), 40. 21, 1847; (1), 93. 109, 1864; *Heteromeres Mineralsystem*, Moscow, 196, 1860; D. Forbes and T. Dahll, *Nyt Mag. Natur.*, 8. 213, 1855; 9. 14, 1857; *Edin. Phil. Journ.*, (2), 1. 62, 1855; (2), 3. 59, 1856; (2), 6. 112, 1857; F. Freise, *Zeit. prakt. Geol.*, 17. 514, 1909; 18. 143, 1910; J. H. Pratt and D. B. Sterrett, *Trans. Amer. Inst. Min. Eng.*, 40. 313, 1909; A. Damour, *Ann. Chim. Phys.*, (3), 51. 445, 1857; C. Glaser, *Chem. Ztg.*, 20. 612, 1896; R. J. Gray, *ib.*, 19. 706, 1895; H. B. C. Nitze, *Journ. Franklin Inst.*, 143. 279, 1897; J. Bjelusoff and S. Kusnezoff, *Bull. Acad. St. Petersburg*, (6), 6. 361, 1912; G. P. Tschernik, *ib.*, (6), 2. 243, 1908; *Proc. Russ. Min. Soc.*, 41. 115, 1903; 42. 9, 1905; G. P. Drossbach, *Ber.*, 29. 2452, 1896; F. Zerban, *ib.*, 38. 557, 1905; S. J. Johnstone, *Journ. Soc. Chem. Ind.*, 33. 55, 1914; 37. 373, R., 1918; A. Thorpe, *Chem. News*, 72. 32, 1896; A. Liversidge, *The Mineralogy of New South Wales*, Sydney, 1882; J. C. H. Mingaye, *Rep. Geol. Sur. N.S.W.*, 7. 222, 1903; C. Anderson, *Rep. Australian Mus.*, 5. 258, 1904; E. Hussak and J. Reitingner, *Zeit. Kryst.*, 37. 559, 1903; P. Christin, *Désagrégation de la monazite et séparation des terres rares comme oxalates*, Genève, 1922; A. Hadding, *Zeit. anorg. Chem.*, 122. 195, 1921; J. Reitingner, *Ueber Monazit, Xenotim, Senait und natürlich Zirkonoxyd aus Brasilien*, München, 1902; F. Giesel, *Ber.*, 38. 2334, 1905; L. Schmelck, *Zeit. angew. Chem.*, 8. 543, 1895; W. Prinz, *Bull. Acad. Belg.*, 313, 1904; B. Szilard, *Le Radium*, 6. 233, 1909; H. Gorceix, *Compt. Rend.*, 100. 356, 1885; *Bull. Soc. Min.*, 8. 32, 1885; L. Duparc, R. Sabot, and M. Wunder, *ib.*, 36. 8, 1913; A. Le Croix, *ib.*, 35. 199, 1912; K. Haushofer, *Mikroskopische Reaktionen*, Braunschweig, 1885; H. Behrens, *Anleitung zu mikrochemischen Analyse*, Hamburg, 1899; L. A. Aars, *Ueber die analytische Bestimmung von Beryllium und den sogenannten seltenen Erden*, Kristiania, 1905; K. Preis, *Sitzer. Böhm. Ges.*, 19, 1897; W. Ramsay and A. Zilliaceus, *Cfvers. Finska Vet. Soc.*, 39, 1879; C. W. Blomstrand, *Geol. För. Förh. Stockholm*, 9. 160, 1887; 11. 171, 379, 1889; *Zeit. Kryst.*, 6. 160, 1887; 20. 367, 1892; F. Radominsky, *Ber.*, 7. 483, 1874; *Compt. Rend.*, 80. 309, 1895; C. F. Rammelsberg, *Zeit. deut. geol. Ges.*, 29. 79, 1877; *Handbuch der Mineralchemie*, Leipzig, 1894; O. Kress and F. J. Metzger, *Journ. Amer. Chem. Soc.*, 31. 640, 1909; C. James, *ib.*, 35. 235, 1913; *Chem. News*, 107. 110, 1913; O. Mann,

Beiträge zur Kenntnis Verscheidener Mineralien, Leipzig, 1904; A. L. Fletcher, *Scient. Proc. Roy. Dublin Soc.*, (2), 13. 433, 1913; P. Wenger and P. Christin, *Ann. Chim. Anal.*, 4. 231, 1922; K. Busz, *Centr. Min.*, 169, 1917; W. W. Coblenz, *Investigations of Infra-red Spectra*, Washington, 3. 58, 1906; L. Haitinger and K. Peters, *Vorkommen von Radium im Monazit*, Wien, 1904; *Sitzber. Akad. Wien*, 113. 569, 1904; J. Schetelig, *Norsk. Geol. Tidsskr.*, 2. 3, 1913; R. J. Strutt, *Chem. News*, 91. 299, 1905; *Proc. Roy. Soc.*, 73. 191, 1904; 76. A, 312, 1905; 80. A, 56, 572, 1908; D. O. Wood, *ib.*, 84. A, 70, 1910; W. A. Tilden, *ib.*, 59. 218, 1896; C. Doelter and H. Sirk, *Sitzber. Akad. Wien*, 119. 159, 1910; H. Rosenbusch and A. E. Wulffing, *Mikroskopische Physiographie der Mineralien und Gesteine*, Stuttgart, 60, 1905; H. E. Pascoe, *Nature*, 113. 238, 1924; V. Kritsky, *Mem. Radium Expedition. Acad. St. Petersburg*, 5, 1916.

²³ J. J. Berzelius, *Afhand. Fysik Kemi Min.*, 5. 76, 1817; *Svenska Akad. Handl.*, 334, 1824; *Pogg. Ann.*, 3. 203, 1824; E. F. Glocker, *Handbuch der Mineralogie*, Nürnberg, 959, 1831; G. S. Kennigott, *Neues Jahrb. Min.*, 454, 1864; O. E. Schlötz, *ib.*, 306, 1876; A. Damour, *L'Inst.*, 78, 1853; *Bull. Geol. Soc.*, (2), 13. 542, 1853; F. S. Beudant, *Traité élémentaire de minéralogie*, Paris, 2. 552, 1832; E. Zschau, *Neues Jahrb. Min.*, 513, 1855; *Amer. Journ. Science*, (2), 20. 273, 1855; J. L. Smith, *ib.*, (2), 18. 377, 1854; W. E. Hidden, *ib.*, (3), 46. 254, 1893; S. L. Penfield, *ib.*, (3), 45. 498, 1893; W. Wartha, *Pogg. Ann.*, 128. 166, 1866; H. Gorceix, *Compt. Rend.*, 102. 1024, 1886; C. W. Blomstrand, *Geol. För. Förh. Stockholm*, 9. 185, 1887; W. C. Brögger, *Nyt Mag. Naturvid.*, 42. 1, 1904; *Zeit. Kryst.*, 16. 68, 1890; 45. 93, 1908; E. H. Kraus and J. Reitinger, *ib.*, 34. 275, 1901; E. Hussak and J. Reitinger, *ib.*, 37. 565, 1903; C. F. Rammelsberg, *Handbuch der Mineralchemie*, Leipzig, 137, 1894; F. W. Clarke, *Bull. U.S. Geol. Sur.*, 419. 302, 1910; L. Vegard, *Phil. Mag.*, (6), 32. 505, 1916; (6), 33. 395, 1917; M. L. Huggins, *Phys. Rev.*, (2), 21. 719, 1923; G. Tschermak, *Proc. Russ. Min. Soc.*, 42. 9, 1905; 45. 425, 1907; E. Hussak, *Tschermak's Mitt.*, (2), 12. 457, 1891; *Centr. Min.*, 533, 1907; J. D. Dana, *A System of Mineralogy*, New York, 748, 1892; H. Rosenbusch and A. E. Wulffing, *Mikroskopische Physiographie der Mineralien und Gesteine*, Stuttgart, 60, 1905; H. Rössler, *Neues Jahrb. Min. B.B.*, 15. 231, 1902; *Zeit. Kryst.*, 36. 258, 1902; J. Becquerel, *Phys. Zeit.*, 8. 632, 1907; W. M. Page, *Trans. Cambridge Phil. Soc.*, 20. 291, 1908; W. Prinz, *Bull. Acad. Belg.*, 305, 1913, 1904; W. Voigt, *Lehrbuch der Kristallphysik*, Leipzig, 1910; *Gött. Nachr.*, 1, 1901; 305, 1902; F. Radominsky, *Compt. Rend.*, 80. 304, 1875; B. B. Boltwood, *Amer. Journ. Science*, (4), 18. 97, 1904; (4), 20. 253, 1905; (4), 21. 415, 1906; (4), 25. 269, 1908; *Phil. Mag.*, (6), 9. 599, 1905; W. Ramsay, J. N. Collie, and M. W. Travers, *Journ. Chem. Soc.*, 67. 684, 1895; R. J. Strutt, *Proc. Roy. Soc.*, 73. 191, 1904; 76. A, 88, 312, 1905; 80. A, 56, 572, 1907; A. des Cloizeaux, *Ann. Chim. Phys.*, (6), 8. 226, 1886; B. Szilard, *Le Radium*, 6. 233, 1909.

²⁴ W. G. Lettson, *Phil. Mag.*, (5), 13. 527, 1882; W. N. Hartley, *ib.*, (5), 13. 527, 1882; *Chem. News*, 45. 27, 1882; *Journ. Chem. Soc.*, 41. 210, 1882; L. de Boisbaudran, *Compt. Rend.*, 86. 1028, 1878; E. Bertrand, *Bull. Soc. Min.*, 3. 58, 1880; G. T. Prior, *Min. Mag.*, 12. 246, 1900; E. Hussak, *ib.*, 12. 245, 1900; *Ann. Hofmeseums Wien*, 19. 85, 1904; A. Cossa, *Compt. Rend.*, 98. 990, 1884; G. Wyruboff, *Bull. Soc. Min.*, 19. 281, 1896; E. Boutan, *Le diamant*, Paris, 128, 1886; H. Gorceix, *Ann. Mines*, (3), 3. 197, 1884; A. Damour, *Bull. Geol. Soc.*, 2. 542, 1866; B. Jezek, *Mitt. Akad. Prag.*, 17. 2, 1908; C. Winther, *Meddelelser om Grönland*, 24. 181, 1899; O. B. Böggild, *Zeit. Kryst.*, 50. 435, 1912; F. Henrich and G. Hiller, *Ber.*, 55. B, 3013, 1922; G. J. Brush and S. L. Penfield, *Chem. News*, 48. 15, 1883; *Amer. Journ. Science*, (3), 27. 200, 1883; *Zeit. Kryst.*, 10. 83, 1885; A. Lévy, *Description d'une collection de minéraux formée par H. Heuland*, Londres, 1837; A. H. Church, *Chem. News*, 12. 121, 1865; C. F. Rammelsberg, *Handbuch der Mineralchemie*, Leipzig, 2. 138, 1894; H. Sjögren, *Bull. Geol. Inst. Upsala*, 2. 39, 1894; W. C. Brögger, *Zeit. Kryst.*, 16. 472, 1890.

²⁵ W. Crookes, *Phil. Trans.*, 174. 891, 1863; 209. A, 15, 1908; 210. A, 359, 1910; *Proc. Roy. Soc.*, 80. A, 516, 1908; 84. A, 79, 1910; B. A. Rep., 558, 1886; *Chem. News*, 49. 159, 1891, 194, 205, 1884; 98. 274, 1908; 102. 73, 1910; G. Eberhard, *ib.*, 99. 30, 1909; 102. 211, 1910; *Sitzber. Akad. Berlin*, 861, 1908; 404, 1910; W. P. Headen, *Amer. Journ. Science*, (4), 21. 301, 1906; C. U. Shepard, *ib.*, (2), 35. 137, 1889; *A Treatise on Mineralogy*, New Haven, 1857; F. A. Genth and S. L. Penfield, *Amer. Journ. Science*, (3), 44. 381, 1892; O. Hauser and F. Wirth, *Ber.*, 42. 4443, 1909; J. Humphreys, *Astrophys. Journ.*, 20. 266, 1904; A. Cossa, *Gazz. Chim. Ital.*, 9. 118, 1879; 10. 465, 1880; *Atti Accad. Lincei*, (3), 7. 34, 1883; G. Tschermak, *Journ. Russ. Phys. Chem. Soc.*, 28. 345, 1896; W. C. Brögger, *Zeit. Kryst.*, 16. 360, 1890; J. Lunt, *Proc. Roy. Soc.*, 79. A, 118, 1907; H. A. Rowland, *Amer. Journ. Science*, (3), 41. 243, 1891; *Chem. News*, 63. 133, 1891; G. Woitschach, *Verh. Nat. Ges. Görlitz*, 17. 141, 1882; G. Bodenbender, *Zeit. prakt. Geol.*, 7. 322, 1899; T. Scheerer, *Pogg. Ann.*, 62. 436, 1844; *Nyt Mag. Naturvid.*, 5. 308, 1848; W. J. Knowlton, *Amer. Journ. Science*, (2), 43. 217, 1869; (2), 44. 224, 1867; W. E. Hidden, and J. B. Mackintosh, *ib.*, (3), 38. 474, 1889; W. E. Hidden, *ib.*, (3), 38. 494, 1889; (3), 41. 440, 1891; W. F. Hillebrand, *ib.*, (3), 40. 384, 1890; (3), 46. 50, 1893; (5), 4. 115, 1897; *Bull. U.S. Geol. Sur.*, 78. 43, 1891; F. A. Genth, *Proc. Acad. Philadelphia*, 50, 1889; F. P. Dunnington, *ib.*, 100, 1882; *Amer. Chem. Journ.*, 4. 138, 1882; A. E. Nordenskjöld, *Geol. För. Förh. Stockholm*, 3. 226, 1876; 4. 28, 1878; C. W. Blomstrand, *Journ. prakt. Chem.*, (2), 30. 191, 1884; *Geol. För. Förh. Stockholm*, 7. 59, 1883; G. Lindström, *ib.*, 4. 28, 1878; H. S. Washington, *Journ. Geol. Soc.*, 70. 300, 1914; L. P. Lychnell, *Svenka Akad. Handl.*, 175, 1826; W. G. Mosander, *ib.*, 220, 1829; *Pogg. Ann.*, 19. 219, 1829; H. Trenkler, *Tschermak's Mitt.*, (2), 20. 129, 1901; K. A. Hofmann and W. Heidepriem, *Ber.*, 34. 914, 1901; T. Bromeis and H. Rose, *Pogg. Ann.*, 71. 168, 1846; C. Bergemann, *ib.*, 105. 121, 1858; R. Hermann, *Journ. prakt. Chem.*, (1), 38. 128, 1846;

(1), 46. 396, 1849; R. Weber and G. Rose, *ib.*, (1), 53. 150, 1899; J. R. Strohecker, *ib.*, (2), 33. 132, 1886; G. T. Prior, *Min. Mag.*, 11, 180, 1897; T. Thomson, *Thomson's Records*, 3. 332, 1836; T. L. Phipson, *Bull. Soc. Chim.*, (2), 26. 9, 1876; O. Rebuffat, *Rend. Soc. Ing. Napoli*, 1, 1894; T. Thomson, *Outlines of Mineralogy*, London, 1836; J. Renwick, *Amer. Journ. Science*, (1), 8. 192, 1824; *Ann. New York Lyceum*, 1. 37, 1824.

§ 4. Fractional Precipitation, and Fractional Crystallization

When an acid is allowed to act upon a mixture of two bases, or a base upon a mixture of two acids, the ratio in which the acid divides itself between the two bases, or the base between two acids, depends not only upon the relative masses of the substances taking part in the reaction, but also upon the specific affinities acting between the different substances. It is assumed that the amount of single base (or single acid) is not sufficient to precipitate the two acids (or two bases) present in the system. In the same way, when a substance is added to a mixture of two or more salts of different metals, the relative amounts of salts decomposed depends upon the relative masses and specific affinities acting between the components of the system. Let only sufficient C be added partially to precipitate A and B, and let the soln. originally contain a mols of A, and b of B; let x and y denote the amounts of A and of B precipitated at the end of a certain time t , then, $a-x$ of A, and $b-y$ of B, will remain in soln.; further, let z denote the amount of C required for the precipitation of x of A, and y of B, and let c denote the amount of C added to the soln. at first. The velocity of precipitation of A and B will be $dx/dt=k_1(a-x)(c-z)$; and $dy/dt=k_2(b-y)(c-z)$, respectively. By division, and integration in the usual way:

$$\frac{k_1}{k_2} = \frac{\log a - \log(a-x)}{\log b - \log(b-y)}, \quad \text{or} \quad \left(1 - \frac{x}{a}\right)^{k_2} = \left(1 - \frac{y}{b}\right)^{k_1}$$

which gives the relative amounts of precipitates formed in terms of their affinity coefficients.

E. J. Mills¹ and co-workers have studied the fractional precipitation of a mixture of sulphates of different metals by means of sodium hydroxide and sodium carbonate. When sodium carbonate is added to a soln. containing mixtures of nickel and manganese sulphates, the value of k_1/k_2 is 0.34, or $k_2=2.94k_1$. This means that manganese sulphate "resists the decomposing action of sodium carbonate with a force 2.94 times greater than nickel sulphate, when both salts are simultaneously subjected to the action of the same agent." If the original soln. contains $\text{MnSO}_4 : \text{NiSO}_4 = 2.94 : 1$, and a very small fraction be precipitated, the precipitate will contain equal weights of the eq. of the two sulphates; or, if the soln. contain equal weights of the two salts, the precipitate will contain the eq. of $\text{MnSO}_4 : \text{NiSO}_4 = 1 : 2.94$. It is therefore concluded that the more k_2 exceeds k_1 , the less will A tend to accumulate in the precipitate; and the more k_1 exceeds k_2 , the more will A tend to accumulate in the precipitate. In the fractional precipitation of salts, a process commonly employed in the separation of the rare earths, the mixed metallic salts may be precipitated as nitrates, oxalates, etc. The mixed precipitate is redissolved, and again partially precipitated. By many repetitions of the process, it will be obvious that the element with the greater value of k will tend to accumulate in the precipitate, and the other element in the filtrate. In this way C. G. Mosander² separated the constituents of the gadolinite earths; C. A. von Welsbach, praseodymium and neodymium from the cerite earths; W. Crookes, the constituents of the yttria earths; etc.

When k_1 is nearly equal to k_2 , the ratio of the quantities of A and B in the precipitate will be nearly the same as in the soln., and the process of fractionation will be a prolonged operation. This would be the case with the precipitation of a mixture of nickel and cobalt sulphates by means of sodium hydroxide, for E. J. Mills and J. J. Smith find that $k_2 : k_1 = 0.97 : 1$. Hence, the precipitate from a soln. containing equal weights would contain the eq. of $\text{CoSO}_4 : \text{NiSO}_4 = 1 : 0.97$.

In the limiting case, when $k_1 = k_2$, the ratio of A to B in the precipitate will be the same as in the soln., and the constituents of the soln. could no more be separated by fractional precipitation than two liquids boiling at the same temp. could be separated by fractional distillation. J. C. G. de Marignac tried to prove that some common substances were homogeneous compounds by showing that fractional precipitation gave no indication of heterogeneity; but no separation would occur if the substance really did contain two components for which $k_1 = k_2$, very nearly.

A little work has been done upon the subject by H. Debus on the fractional precipitation of mixtures of barium and calcium hydroxide by a soluble carbonate; by A. Chizynsky, upon the precipitation of mixtures of magnesium and calcium chlorides by ammonium phosphate; by K. von Chroustchoff, upon the composition of the precipitate from a mixture of strontium and barium chlorides after the addition of potassium sulphate, or mixtures of soluble sulphates and chromates, and soluble iodates and sulphate, by means of barium chloride; and by F. W. Küster and A. Thiel, of the precipitate from a mixture of potassium bromide and potassium thiocyanate by the addition of silver nitrate. A. Findlay studied the distribution of lead between sulphuric and hydriodic acids; R. Salvadori, lead between sulphuric and carbonic acids. The experiments of T. Paul, F. W. Küster and A. Thiel, and of A. Heintz furnish studies in the separation of the non-volatile organic acids.

In the chemical fractionation of a mixture of earths, W. Crookes separated the different components, more or less incompletely, by performing a chemical operation in an incomplete manner so that only a certain fraction of the bases was separated. As a result, he obtained part of the material in the insoluble and the rest in the soluble state. Suppose that two earths are present differing almost imperceptibly in their basicity.

Add to the very dil. soln. dil. ammonia in such amount that it can precipitate only half the bases present. The dilution must be such that a considerable time elapses before the liquid begins to show turbidity, and several hours will have to elapse before the full effect of the ammonia is complete. On filtering we have the earths divided into two parts, and we can easily imagine that now there is a slight difference in the basic value of the two portions of the earth; the portion in soln. being, by an almost imperceptible amount, more basic than that which the ammonia has precipitated. This minute difference is made to accumulate by a systematic process until it becomes perceptible by a chemical or physical test.

Other means may be employed—*e.g.* fractional precipitation with oxalic acid, formic acid, nitric acid, etc. The operations are analogous to the separation of members of a homologous series of hydrocarbons by fractional distillation. When the earths appear in the same proportion in the soln. and in the precipitate thrown down by ammonia, the precipitated earths are worked up by some other process so as to alter the ratio between them, when the previous operation can be again employed. According to W. Crookes, there are three methods of operating.

(i) In one process, one-third the eq. quantity of ammonia is added; then, after the precipitate has quite settled, it is filtered, to the filtrate one-third more ammonia is added, and the precipitate is again filtered off. The remainder of the bases present are then fully precipitated. In this way the earths are divided into three parts, which may be designated -1 , 0 , and $+1$. Each of these lots is then treated as just described, and the thirds are added to the vessel on each side. This plan is rapid in the actual separations, but probably more time is spent in the extra filterings and washings than is saved in the lessened number of operations.

(ii) C. G. Stokes recommended the following process: "Suppose the filtrate to travel to the right and the precipitate to the left. Taking the contents of any bottle, precipitate two-thirds of the whole, and advance the filtrate two places to the right and the precipitate one place to the left, and so on. Theoretically, this is the best way to operate, and I have carried on several long series with much success by its means. There is, however, a disadvantage, in that the precipitate is twice as much as the earth in soln.; and the largest part of the operation is the feeding of the filters. The reason for the selection of the two-thirds proportion is as follows:

"Suppose two earths, a mols. of A and b mols. of B, are in soln. The tendency at any moment to precipitation under given conditions is such that the proportion of the number

of mols. of A to that of B, which goes down, is that of $ak_1 : bk_2$, where k_1 and k_2 are constants whose reciprocals may be considered as representing the specific affinities of the earths for the acid. Then if x and y are the numbers of the A and B mols. which have been precipitated at a given instant

$$\frac{-dx}{k_1(a-x)} = \frac{-dy}{k_2(b-y)}; \text{ or } \left(1 - \frac{x}{a}\right)^{k_1} = \left(1 - \frac{y}{b}\right)^{k_2}$$

by integration. When the difference between the proportions of the two earths that are precipitated is a maximum, $dx/a = dy/b$ or $x/a = y/b$. The ratio of the number of mols. of both kinds left in the soln., $a-x+b-y$, to the total number of mols., $a+b$, then reduces to

$$\frac{ak_2 + bk_1 \left(\frac{k_1 k_1}{k_2 k_2}\right)^{\frac{1}{k_1 - k_2}}}{a+b}$$

When k_1 and k_2 are nearly equal, the earths have nearly the same affinity for the acid, and the ratio becomes $e^{-1} = 2.718 \dots$. This means that nearly two-thirds of the whole would be precipitated."

(iii) W. Crookes modified C. G. Stokes' plan in order to avoid as much as possible the extended manipulation by the sacrifice of a little speed: Add half the eq. amount of precipitant to the liquid, and after full settlement, filter. Starting with say 1000 grms. in the zero bottle, transfer 500 to bottle -1 and 500 to bottle +1. Then add another 1000 grms. to the 0 bottle, and repeat the operations as in the following table:

NUMBERS OF THE BOTTLES.												
-6	-5	-4	-3	-2	-1	0	1	2	3	4	5	6
						1000						
					500	1000	500					
				250	500	500	500	250				
			125	250	375	500	375	250	125			
		63	125	250	375	375	375	250	125	63		
	31	63	156	250	312	375	312	250	156	63	31	
15	31	94	156	234	312	312	312	234	156	94	31	15

After the seventh fractionation the 2000 grms. of earth are spread out amongst 13 bottles in the proportions represented in the bottom line. The separation of *two* earths by either of these plans is comparatively easy. The precipitation by ammonia depends not directly on the affinities of the earths for the acid, but rather on the excess of affinity of the precipitating ammonia. For if the affinities of the two earths are represented by 100 and 101, and that of ammonia by 150, the affinities on which the precipitation depends would be represented by $150-100=50$, and $150-101=49$, the difference of which is 2 per cent. of the larger.

If more than two earths are present, the above processes fail, in any reasonable time, to yield practically pure specimens of more than two out of a group of closely allied earths. Thus, if there are as many as three earths, say, A, B, and C, whose positions in reference to the chemical process employed are in the order of sequence in which they are written, we may get a specimen of A as nearly as we please free from B and C, and a specimen of C as nearly as we please free from A and B, but we cannot get a specimen of B practically free from A and C. The law seems to be that *to obtain practically pure specimens of three closely allied earths, it is essential to have recourse to at least two different chemical processes.* The mere continued repetition of the same process will not do, unless indeed the operations are repeated such a vast number of times as to make the approximate expressions no longer applicable, even though the substances are chemically very close. With a greater number of earths the same law holds good; thus with n closely allied earths to be separated, we must have recourse to $n-1$ different chemical processes. C. G. Stokes added that the number of chemical processes to be employed is not necessarily $n-1$ when one process divides the n earths into groups, and another into sub-groups, for then the earths need not necessarily be separated one at a time.

Fractional crystallization with a separating element.—Fractional crystallization has been discussed in connection with the isolation of radium. An ingenious

modification was devised by G. Urbain and H. Lacombe³ for separating two salts of the rare earths, A and C, by means of a foreign salt, B, which is isomorphous with A and C, under conditions where the binary mixture A and C separates only slowly, and where crystallization occurs with difficulty. For example, in the separation of the europium-samarium fraction, it is an advantage to introduce bismuth nitrate as the intermediary B. The solubility of the bismuth salt, B, is intermediate between the solubilities of europium and samarium nitrates, A and C. Fractionation of the mixture gives virtually pure B in several consecutive intermediate fractions; the least soluble fractions consist of AB, free from C, and the most soluble fractions consist of BC free from A. It is then possible to eliminate the bismuth by ordinary analytical processes. The separation of A from C has then been accomplished by the aid of B, so that G. Urbain and H. Lacombe called B, *l'élément séparateur*—the **separating element**.

In the mixtures of the double magnesium nitrates of samarium and europium containing neodymium, praseodymium, cerium, and lanthanum, the samarium and bismuth salts are to a large extent miscible in the solid state, whereas the neodymium salt is taken up but slightly by the bismuth salt, and the praseodymium, lanthanum, and cerium salts not at all. Hence, after the removal of the bulk of neodymium, praseodymium, lanthanum, and cerium, by ordinary methods, the use of bismuth as *un élément séparateur* rapidly eliminates these elements from samarium, and reduces the intermediate neodymium-samarium fractions to a small amount. The separation of europium and gadolinium is greatly facilitated by the use of bismuth, although here each salt is readily miscible with the separating element. G. Eberhard reported that in the separation of samarium, europium, and gadolinium by G. Urbain and H. Lacombe's process, the separation of samarium and europium is quantitative; europium may be obtained pure; samarium may be freed from europium; and gadolinium may be freed from samarium but still containing traces of europium. The process has been successfully used in separating gadolinium from terbium in mixtures containing the elements between gadolinium and celtium; and in separating the simple nitrates of gadolinium, terbium, dysprosium, etc.

Outside the rare earths themselves bismuth is the only element which has hitherto been found suitable for the purpose. One of the rare earths may act as *l'élément séparateur*. Thus, in the fractional crystallization of lanthanum, praseodymium, and neodymium double ammonium nitrates from nitric acid, the lanthanum separates fairly readily at one end before the other two elements have separated to any marked extent. When the lanthanum has separated, the other two elements crystallize very slowly and with difficulty. Hence, C. A. von Welsbach, and P. Schottländer recommended returning part of the separated lanthanum to the mother liquor and again crystallizing it out through a series of fractions. Here the lanthanum acts as a separating element. C. von Scheele found the double ammonium nitrate process gave better results with cerium as separating element. C. James used praseodymium as *l'élément séparateur* in mixtures of thulium and erbium bromates; and W. Feit and C. Przibylla, and H. Erdmann and F. Wirth used cerous magnesium nitrate as separating element with mixtures of the double magnesium nitrates of lanthanum, praseodymium, and neodymium. C. James and D. W. Bissel found neodymium acted as a separating element with mixtures of gadolinium and terbium bromates—each of the binary mixtures—gadolinium and neodymium and terbium bromates so obtained were then separated by the bismuth process.

G. Urbain and H. Lacombe found that a mixture of rare earths rich in samarium and gadolinium with much of the yttrium group does not crystallize when the magnesium nitrate process is used. The yttrium elements do not form double magnesium nitrates. By adding bismuth salts from time to time to the soluble fractions, it is possible to make the bismuth salt accumulate at the less soluble end, and carry with it practically all the samarium and gadolinium.

The controlling of the progress of fractionations.—In fractional operations it is necessary to find how the separation is proceeding, and when a direct element test is not available, as is usually the case in rare earth separations, a method dependent on some physical property is employed. Prior to the introduction of the spectro-scope, about 1860, the determination of the *mean equivalent weight* was the sole

method available for controlling the fractions of the rare earths. This is effected by converting the oxide into sulphate as employed by J. F. Bahr and R. Bunsen,⁴ etc., by converting the sulphate into oxide as employed by G. Urbain, by converting the oxalate into oxide as employed by B. Brauner; and by volumetric methods, say by dissolving a known weight of oxide in an excess of sulphuric acid, neutralizing the excess of acid, precipitating the earth with an excess of a standard soln. of oxalic acid, and titrating the excess of oxalic acid with standard permanganate. This process was used by G. Krüss and A. Loose, W. Feit and C. Przibylla. In the calculations the oxide is assumed to be R_2O_3 except in the case of mixtures containing ceria, thoria, terbia, and praseodymia when the method breaks down.

The *absorption spectra* of soln. with a fixed acid radicle are useful. The reflected light from oxides furnishes a characteristic absorption spectrum called a *reflection spectrum*.⁵ K. A. Hofmann and G. Bugge, A. Wägner, and G. Urbain obtained good results by this method. The *spark spectra*; ⁶ the *arc spectra*; and the *phosphorescent spectra*, produced by a stream of cathode rays, are employed.⁷ The phosphorescent spectra have been studied by W. Crookes, G. Urbain, etc.; they are of limited application in following the course of a fractionation, but this spectrum furnishes a delicate test of the purity of a substance. The measurement of the *magnetic susceptibility* of a mixture of rare earths by means of the magnetic balance of, say, P. Curie and C. Cheveneau,⁸ occupies a few minutes, and the property being strictly additive, has been employed to control fractionations by G. Urbain, R. J. Meyer and H. Goldenberg, etc.

REFERENCES.

¹ E. J. Mills and J. H. Bicket, *Phil. Mag.*, (5), **13**, 169, 1882; E. J. Mills and B. Hunt, *ib.*, (5), **13**, 177, 1882; E. J. Mills and J. J. Smith, *Proc. Roy. Soc.*, (5), **29**, 181, 1879; *Chem. News*, **40**, 15, 1879; E. J. Mills and D. Wilson, *Journ. Chem. Soc.*, **33**, 360, 1878; E. J. Mills and J. W. Pratt, *ib.*, **35**, 336, 1879; E. J. Mills and C. W. Meanwell, *ib.*, **39**, 533, 1881; E. J. Mills and G. Donald, *ib.*, **41**, 18, 1882; E. J. Mills and R. L. Barr, *ib.*, **41**, 341, 1882; J. J. Hood, *Phil. Mag.*, (5), **21**, 119, 1886.

² C. G. Mosander, *Compt. Rend.*, **8**, 356, 1839; *Journ. prakt. Chem.*, (1), **16**, 513, 1839; *Phil. Mag.*, (3), **23**, 241, 1843; C. A. von Welsbach, *Monatsh.*, **5**, 508, 1884; W. Crookes, *Phil. Trans.*, **174**, 891, 1883; **176**, 691, 1885; *Chem. News*, **54**, 131, 155, 1886; *B.A. Rep.*, 583, 586, 1886; C. G. Stokes, *Chem. News*, **54**, 131, 1886; *Mathematical and Physical Papers*, Cambridge, **5**, 288, 1905; M. S. Curie, *Recherches sur les substances radioactives*, Paris, 1903; *Chem. News*, **88**, 146, 1903; J. C. G. de Marignac, *Ann. Chim. Phys.*, (6), **1**, 289, 1884; H. Debus, *Liebig's Ann.*, **85**, 103, 1853; **86**, 156, 1853; **87**, 238, 1853; W. Ostwald, *Zeit. phys. Chem.*, **1**, 419, 1887; A. Chizynsky, *Liebig's Ann. Suppl.*, **4**, 226, 1866; K. von Chroustchoff and A. Martinoff, *Compt. Rend.*, **104**, 571, 1887; K. von Chroustchoff, *ib.*, **104**, 1711, 1887; T. Paul, *Zeit. phys. Chem.*, **14**, 105, 1894; A. Heintz, *Journ. prakt. Chem.*, (2), **66**, 1, 1902; F. W. Küster and A. Thiel, *Zeit. anorg. Chem.*, **19**, 81, 1899; **23**, 25, 1900; **24**, 1, 1900; **33**, 129, 1903; R. Salvadori, *Gazz. Chim. Ital.*, **34**, i, 87, 1904; A. Findlay, *Zeit. phys. Chem.*, **34**, 409, 1900; E. J. Mills and J. J. Smith, *Proc. Roy. Soc.*, (5), **29**, 181, 1879.

³ G. Urbain and H. Lacombe, *Chem. News*, **88**, 295, 1903; **52**, 277, 1904; *Compt. Rend.*, **137**, 792, 1903; **138**, 84, 627, 1166, 1904; G. Urbain, *ib.*, **149**, 37, 1909; *Journ. Chim. Phys.*, **4**, 121, 1906; G. Eberhard, *Zeit. anorg. Chem.*, **45**, 374, 1905; C. von Scheele, *ib.*, **17**, 310, 1898; W. Feit and C. Przibylla, *ib.*, **43**, 202, 1905; H. Erdmann and F. Wirth, *Liebig's Ann.*, **361**, 190, 1908; C. A. von Welsbach, *Monatsh.*, **6**, 477, 1885; P. Schottländer, *Ber.*, **25**, 378, 569, 1892; C. James, *Journ. Amer. Chem. Soc.*, **33**, 1311, 1911; C. James and D. W. Bissel, *ib.*, **36**, 2060, 1914.

⁴ J. F. Bahr and R. Bunsen, *Liebig's Ann.* **137**, 1, 1886; G. Krüss, *Zeit. anorg. Chem.*, **3**, 44, 1893; O. Brill, *ib.*, **47**, 464, 1905; G. Krüss and A. Loose, *ib.*, **4**, 161, 1893; W. Feit and C. Przibylla, *ib.*, **43**, 202, 1905; **50**, 249, 1906; B. Brauner and F. Pavlicek, *Journ. Chem. Soc.*, **81**, 1243, 1902; B. Brauner, *ib.*, **47**, 879, 1885; *Zeit. anorg. Chem.*, **34**, 103, 207, 1903; *Sitzber. Akad. Wien*, **92**, 814, 1885; *Monatsh.*, **6**, 785, 1885; G. Urbain, *Ann. Chim. Phys.*, (7), **19**, 184, 1900.

⁵ G. Urbain, *Ann. Chim. Phys.*, (7), **19**, 184, 1900; K. A. Hofmann and G. Bugge, *Ber.*, **41**, 3783, 1908; **43**, 2631, 1910; A. Wägner, *Zeit. anorg. Chem.*, **42**, 118, 1904.

⁶ W. Crookes, *Proc. Roy. Soc.*, **72**, 295, 1903; J. H. Pollok, *Proc. Roy. Soc. Dublin*, (2), **11**, 184, 1907.

⁷ W. Crookes, *Journ. Chem. Soc.*, **55**, 255, 1889; *Phil. Trans.*, **174**, 891, 1883; *Proc. Roy. Soc.*, **32**, 206, 1881; **35**, 262, 1883; **38**, 414, 1883; **40**, 77, 1886; **42**, 111, 1887; **65**, 237, 1899; *Chem. News*, **43**, 237, 1881; **47**, 261, 1884; **49**, 159, 169, 181, 194, 205, 1884; **51**, 301, 1885; **53**, 75, 133, 1886; **54**, 13, 27, 39, 54, 63, 76, 1886; **55**, 83, 95, 107, 119, 131, 1887; **60**, 27, 39, 51, 63, 1889; **79**, 212, 1899; **80**, 49, 1899; L. de Boisbaudran, *ib.*, **52**, 4, 290, 299, 1885; **53**, 63, 217,

1886; **54**. 15, 1886; *Compt. Rend.*, **100**. 1437, 1885; **101**. 552, 588, 1885; **102**. 153, 899, 1536, 1886; **103**. 113, 1886; **103**. 627, 1886; **105**. 258, 301, 343, 784, 1887; *Bull. Soc. Chim.*, (3), **3**. 53, 1890; E. Baur and R. Marc, *Ber.*, **34**. 2460, 1900; G. Urbain, *Ann. Chim. Phys.*, (8), **18**. 222, 1909; *Introduction à l'étude de la spectrochimie*, Paris, 145, 1911.

⁸ G. Urbain, *Compt. Rend.*, **145**. 752, 1907; **146**. 406, 1908; **149**. 127, 1909; **150**. 913, 1910; **159**. 323, 1914; G. Urbain and G. Jantsch, *ib.*, **147**. 1286, 1908; S. Meyer, *Monatsh.*, **20**. 369, 793, 1899; **29**. 1017, 1900; *Sitzber. Akad. Wien*, **108**. 171, 861, 1899; **110**. 541, 1901; *Wied. Ann.*, **68**. 324, 1899; *Ber.*, **33**. 320, 1900; H. E. J. G. du Bois and O. Liebknecht, *ib.*, **32**. 3244, 1899; **33**. 975, 1900; A. P. Wills and O. Liebknecht, *Verh. deut. phys. Ges.*, **1**. 170, 236, 1899; R. J. Meyer and H. Goldenberg, *Chem. News*, **106**. 13, 1912; P. Curie and C. Cheveneau, *Journ. Phys.*, (4), **2**. 796, 1903; *Phil. Mag.*, (6), **20**. 357, 1910.

§ 5. The General Separation of the Rare Earth Group into Chemical Individuals

The rare earths form a group to themselves; chemically, they are so much alike that it taxes the utmost skill of the chemist to effect even a partial separation, and their history is so obscure that we do not yet know the number of them.—W. CROOKES.

The extraction of most of the individual members of the rare earth elements from minerals is a very laborious operation, but the separation of the group from foreign elements is comparatively easy. The particular mineral selected for treatment is determined by the element which is in quest. When the proportion of the desired earth contained in the available mineral is small, it is of course necessary to treat with rather large quantities of raw material. Thorium for gas mantles is extracted on a large scale from monazite sand, and cerium for pyrophoric alloys is extracted from the residual salts. The residues were worked up by C. James¹ for yttria earths, and they furnished samarium, gadolinium, europium, terbium, dysprosium, and holmium. Monazite sand is also a convenient source of cerium, lanthanum, praseodymium, and neodymium. According to C. R. Böhm, commercial cerium oxalate, and *cerium oxalicum medicinale* are monazite residues, and when calcined, give mixtures containing about 50 per cent. of cerium. Terbia is best obtained from xenotime, euxenite, samarskite, and some columbates; and gadolinite is rich in yttria and ytterbia.

The first operation is to open up the mineral so that the desired constituents can be brought into soln. The elements so far as the hydrogen sulphide precipitates are removed in the usual manner. The rare earths are separated from the other elements by taking advantage of the insolubility of their oxalates in dil. mineral acids. E. Rimbach and A. Schubert, and B. Brauner have studied the solubilities of some of the rare earth oxalates. Table VII represents the solubilities in water, in soln. of ammonium oxalate, and in *N*-sulphuric acid.

TABLE VII.—SOLUBILITIES OF THE RARE EARTH OXALATES.

Oxalate.	Water grm. per litre.	Ammonium oxalate One gram of oxalate in 38 grms. of water dissolves grm.	Normal sulphuric acid. Grms. of anhydrous oxalate per litre.
Lanthanum . . .	0·00062	0·00023	2·56
Praseodymium . . .	0·00074	0·00026	1·23
Neodymium . . .	0·00049	0·00034	1·00
Cerium . . .	0·00041	0·00042	1·64
Yttrium . . .	0·00100	0·00256	—
Ytterbium . . .	0·00334	0·02437	—
Thorium . . .	—	0·62000	0·190

Other determinations have been made by R. J. Meyer and O. Hauser. The oxalates are slightly soluble in dil. mineral acids, and the solubility increases with the conc. of the acid and with temp. Observations have been made by O. Hauser and F. Wirth, R. J. Meyer and A. Wassjuchnoff, and B. Brauner. The results of

F. Wirth are illustrated in Figs. 3 and 4. In Table VIII, the solubility represents grams of anhydrous oxalate in 100 grms. of sat. soln. at 25°. Excluding the erbium

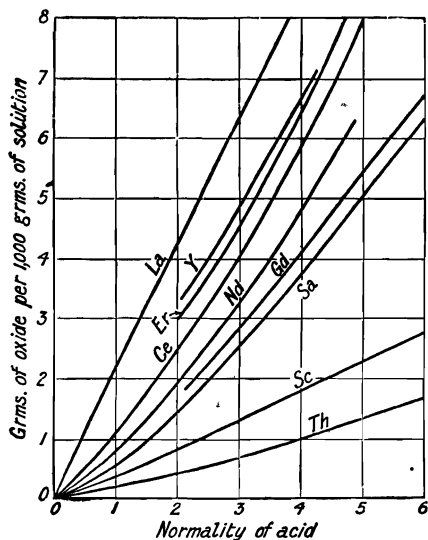

FIG. 3.—Solubilities of Some Rare Earth Oxalates in Sulphuric Acid at 25°.

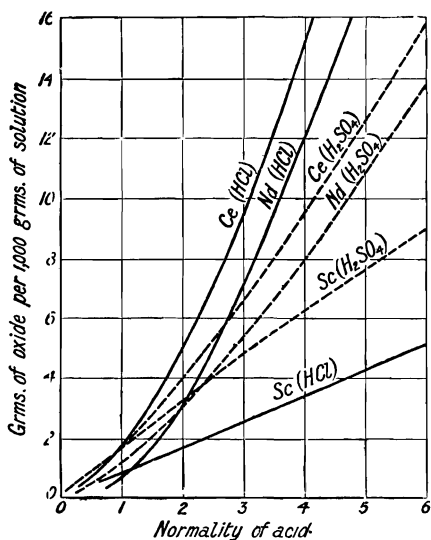

FIG. 4.—Solubilities of Cerium, Neodymium, and Scandium Oxalates in Sulphuric and Hydrochloric Acids at 25°.

TABLE VIII.—SOLUBILITY OF THE RARE EARTH OXALATES IN SULPHURIC ACID.

$R_2(C_2O_4)_3 \cdot nH_2O$							
$N-H_2SO_4$	R=La $n=10$	R=Ce $n=10$	R=Nd $n=10$	E.=Sa $\gamma=10$	R=Gd $n=10$	R=Y $n=9$	R=Er $n=15$
0.10	0.0208	0.0136	—	0.0058	—	—	—
0.50	0.0979	0.0524	0.0336	0.0313	—	—	—
1.00	0.2383	0.1140	—	0.0627	—	—	—
1.445	—	0.1764	—	0.1114	—	—	—
1.50	0.3190	—	—	—	—	—	—
2.00	0.4417	—	0.1872	—	—	—	—
2.16	—	—	—	—	0.1883	0.352	0.329
2.39	—	0.3083	—	0.1914	—	—	—
3.11	—	—	—	—	0.3010	—	0.493
3.20	0.7632	—	—	—	—	—	—
3.90	—	0.6300	—	—	—	—	—
4.32	—	—	—	0.4359	0.4359	0.7236	0.704
5.00	—	—	0.6603	—	—	—	—

oxalate curve, the more basic the rare earth, the greater is the solubility of the corresponding oxalate in the acid. The solubility in hydrochloric acid is greater than in sulphuric acid. Thus, R. J. Meyer and O. Hauser give for the number of grams of anhydrous oxalate per 100 grms. of soln. with *N*-hydrochloric acid at 25°:

N.	0.125	0.25	0.5	1.0	1.5	2.0	3.0	4.0	5.0
Ce.	0.0151	0.0343	0.0812	0.1974	0.355	0.532	0.977	1.555	—
Nd.	—	—	0.0270	0.0732	—	0.333	—	—	1.721

Scandium oxalate is more soluble in aq. sulphuric acid than in aq. hydrochloric acid. The results are shown in Fig. 4. Like thorium and scandium oxalates, but unlike zirconium oxalate, the oxalates of the rare earths are but very sparingly soluble in aq. soln. of oxalic acid, and the addition of oxalic acid reduces the solubilities of

these oxalates in the mineral acids. O. Hauser and F. Wirth give for the solubilities of the oxalates in a mixture of sulphuric and oxalic acids, expressed in grams of anhydrous oxalate per 100 grms. of soln., at 25°, the results shown in Table IX.

TABLE IX.—SOLUBILITIES OF SOME RARE EARTH OXALATES IN MIXTURES OF SULPHURIC AND OXALIC ACIDS.

$N-H_2SO_4$	$N-H_2C_2O_4$	La. oxalate	Ce oxalate	Sm oxalate
0.05	0.05	—	0.0030	—
0.05	0.05	0.0039	(0.0025)	0.0009
0.25	0.25	0.0099	0.0046	—
0.25	0.50	0.0069	—	—
0.50	0.05	0.0334	0.0105	—
0.50	0.50	0.0090	(0.0010)	0.0010
0.96	0.50	0.0138	—	0.0032
1.19	0.50	0.0203	—	0.0042
1.44	0.50	0.0293	—	0.0057
1.70	0.50	0.0369	—	0.0080

With more conc. acids, the solid phase changes and, as A. Job has shown, mixed oxalates—oxalato-chlorides, oxalato-nitrates, oxalato-sulphates, etc.—may be formed; or the oxalate may be converted into chloride, nitrate, sulphate, etc. The oxalates of the ceria earths are almost insoluble in soln. of the alkali oxalates, those of the yttria earths are perceptibly soluble. The order of increasing solubility of the rare earth oxalates in soln. of ammonium oxalate—Table VII.—is approximately in the order of the decreasing basicity of the corresponding oxide. Soln. of ammonium and potassium oxalates are better solvents than soln. of sodium oxalate for the yttria earth oxalates. The solubility of the rare earth oxalates is connected with the formation of complex oxalates several of which have been isolated. The whole of the third analytical group of elements, including the rare earths, can be removed from the soln. filtered from the hydrogen sulphide precipitate by treatment with ammonia; or, the rare earth group can be separated from the filtrate of the hydrogen sulphide precipitate, or from the acid soln. of the ammonia precipitate by treatment with oxalic acid. Zirconium oxalate is fairly soluble in oxalic acid and in mineral acids, so that it remains in soln. The thorium is then to be separated from the residual rare earths, and the rare earths fractionated.

The opening up of the mineral.—The mineral is very finely powdered. It may or may not be soluble in hot hydrochloric acid or in hot sulphuric acid. For example, cerite, allanite, gadolinite, thorite, and yttrialite are decomposed by treatment with hydrochloric acid; and cerite, allanite, æschynite, gadolinite, xenotime, yttrotitanite, thorianite, and monazite are decomposed by sulphuric acid. With æschynite, G. Urbain² recommended heating the finely powdered mineral until the excess of acid was eliminated, and after treatment with ice-cold water, allowing the liquid to stand for 24 hrs., and decanting the clear liquid from the residual titanate, columbic, and tantalate acids. The liquid was treated with ammonia, and the washed precipitate boiled with conc. nitric acid for some days, adding more acid from time to time to make good the loss by evaporation. The liquid was allowed to stand for several days, and the clear portion decanted from the last traces of titanate, columbic, and tantalate acids. With monazite sand, the excess of sulphuric acid should not be expelled so as to keep the phosphates in soln. when water is added. G. Urbain recommended decomposing monazite by fusion with sodium carbonate. In the case of fergusonite, euxenite, polycrase, samarskite, and yttrioantalite, the mineral is to be fused with sodium hydrosulphate, or sodium pyrosulphate, and the cold cake taken up with acid. L. F. Nilson and G. Krüss used the potassium salt, but it is better to use the sodium salt, because the former gives sparingly soluble complex salts under conditions where the salts given by the

latter are freely soluble. The temp. is raised gradually to avoid loss by spurting. The fusion temp. is kept as low as possible in order to avoid the formation of sparingly soluble basic sulphates. C. James decomposed euxenite by heating it with an excess of sulphuric acid. Some of the columbates—*e.g.* sipylite—the tantalates, and the titanates are best decomposed by fusion with sodium hydroxide, and the cold cake taken up with acid.

H. E. Roscoe, J. L. Smith, and W. Gibbs found that it is possible to decompose minerals like fergusonite, euxenite, polycrase, samarskite, and yttriotantalite by treatment with hydrofluoric acid. The rare earths then remain as insoluble fluorides which can be brought into soln. by decomposition with sulphuric acid. If the fluorides be washed with dil. hydrofluoric acid, M. Delafontaine showed that columbium, tantalum, tungsten, and zirconium fluorides pass into soln. W. B. Hicks found that the mineral columbates, tantalates, titanates, etc., are decomposed by heating in a stream of sulphur chloride, S_2Cl_2 ; the chlorides of columbium, tantalum, titanium, tungsten, etc., are volatilized, while the chlorides of the rare earth metals remain. Good results were obtained with samarskite, fergusonite, æschynite, and euxenite. J. Barlot and E. Chauvenet also obtained good results by using carbonyl chloride in place of sulphur chloride.

The isolation of the rare earth group.—The acid soln. of the mineral or cold cake resulting from the fusion is taken up with water or dil. acid, and evaporated to dryness. The residue is digested in acid, and the soln. boiled for a couple of hours. Most of the zirconia and ferric oxide dissolves, while silica, stannic, tungstic, titanic, columbic, and tantallic oxides, and lead and barium sulphates remain undissolved. The soln. is allowed to stand for some hours, and filtered. The filtrate contains the rare earth oxides, uranium and thorium oxides, alumina, part of the zirconium and ferric oxides, magnesia, the alkaline earths, and alkalis. The hot acid soln. is saturated with hydrogen sulphide, and again saturated when cold. The liquid is filtered and boiled to expel hydrogen sulphide. Simplifications can be introduced when the composition of the rare earth material permits. The soln. containing the rare earths, aluminium, zirconium, uranium, etc., hydroxides or phosphates is treated with a slight excess of oxalic acid. The precipitated oxalates separate in a colloidal form, which includes some of the mother liquor. One portion of the oxalic acid should be added first, and before adding the remainder of the acid, the precipitate should be vigorously shaken until it assumes the crystalline form. The crystalline precipitate can be easily filtered and washed. The yttrium, cerium, and thorium oxalates are precipitated, while zirconium, aluminium, iron, and uranium remain in soln. According to O. Hauser,³ the presence of uranyl salts makes the cerium oxalates very soluble, unless a great excess of oxalic acid is added. The chief source of difficulty is a fact that the acidity of the soln. requires careful adjustment, or appreciable quantities of the cerium, yttrium, and thorium oxalates will pass into soln., or else the precipitate may be contaminated with zirconium oxalate. The conditions for successful work with ceria have been investigated, but not for yttria. The best results are obtained when the ammonia precipitate is dissolved in $\frac{1}{2}N$ to $\frac{1}{4}N$ -hydrochloric acid—about 50 c.c. of acid are required per gram of the earths. Add 40–50 c.c. of a 10 per cent. soln. of oxalic acid, and keep the soln. at about 60° for about 12 hrs. The precipitate is washed with warm water. The precipitate can be calcined to convert the oxalates into oxides. The precipitated oxalates are usually contaminated with small quantities of iron, aluminium, and calcium oxalates and phosphates. The precipitate is then digested with fuming hydrochloric acid, on a water-bath, and a reprecipitation made with oxalic acid.

The removal of thoria from the rare earths.—The washed precipitate of the mixed oxalates is digested on a water-bath with conc. nitric acid (sp. gr. 1.4) and one drop of $\frac{1}{10}N$ -potassium permanganate, which accelerates the rate of dissolution by the nitric acid is added. The dish should be covered with a clock-glass to prevent loss by spurting. The oxalates will be decomposed in a short time. The excess of acid is removed by evaporation. The mixed oxalates can also be converted into carbonates

by heating them with a 10 per cent. soln. of sodium carbonate, and a little sodium hydroxide to precipitate any of the thorium which might pass into soln. The washed precipitate is then dissolved in hydrochloric acid. Several methods are now available for removing the thoria. (1) *The hydrogen peroxide process*, studied by G. Wyruboff and A. Verneuil,⁴ P. T. Cleve, L. de Boisbaudran, etc., is based on the fact that all the thorium separates as peroxyhydroxide, $\text{Th}(\text{OH})_4(\text{O.OH})$, a white voluminous precipitate, when a soln. of the nitrate is treated with hydrogen peroxide. The procedure recommended by G. Wyruboff and A. Verneuil is as follows :

Barium peroxide is stirred into a conc. acid soln. of the rare earths a little at a time until the clear liquor no longer gives a precipitate with conc. hydrogen peroxide. The filtrate contains rare earths free from thorium, the precipitate contains thorium mixed with 20-30 per cent. of the rare earths. The washed precipitate is dissolved in cold hydrochloric acid, and the barium removed by adding a slight excess of sulphuric acid so that the filtered soln. does not contain over 15 per cent. of free acid. Oxalic acid is added, and the precipitated oxalates are washed and treated with a very conc. ammoniacal soln. of ammonium carbonate. Thorium oxalate passes into soln. together with about 7 per cent. of the rare earths. The precipitate of rare earth oxalates is free from thorium. The cold filtrate is treated with sodium hydroxide, and the washed precipitate dissolved in the minimum quantity of nitric acid, and the thorium precipitated by adding an excess of hydrogen peroxide. The filtrates containing rare earths are united and precipitated with oxalic acid in a slightly acid soln. ; the precipitates of the rare earth oxalates are collected together.

Among other methods for separating thoria from the rare earths there is (2) J. J. Chydenius' *thiosulphate process*,⁵ in which a boiling dil. soln. of the chlorides is treated with an excess of a conc. soln. of sodium thiosulphate. Basic thorium thiosulphate is precipitated in a flocculent mass which, after standing about 12 hrs., is easily filtered and washed. The precipitate with its filter-paper is digested in conc. hydrochloric acid, and again treated with the thiosulphate so as to get rid of all but a trace of ceria which contaminated the first precipitate. (3) J. F. Bahr's *ammonium oxalate process*,⁶ Thorium oxalate is somewhat soluble in nearly neutral soln., of ammonium oxalate, and if a large excess of ammonium oxalate be used, thorium may not be precipitated at all ; but an excess is necessary to keep the zirconium oxalate in soln. Hence, some thorium may escape precipitation, and, if not separated, will, later on, appear with the zirconium precipitate. C. Glaser, therefore, recommended adding conc. hydrochloric acid to the boiling filtrate. On cooling, insoluble thorium oxalate is precipitated. The zirconium oxalate is soluble in the oxalic acid liberated by the action of the hydrochloric acid. The process may have to be repeated several times, because even with C. Glaser's improvement the separation is not sharp, for notable quantities of the rare earths—particularly the yttrium oxalates—pass into soln. As previously stated, O. Hauser added that should uranium be present the solubility of the cerium and lanthanum oxalates is increased, and the precipitation will be imperfect unless a very large excess of oxalic acid is present.

T. O. Smith and C. James,⁷ and O. Knöfler recommended sebacic acid as a precipitating agent for thorium ; W. B. Giles, lead carbonate—ceric salt is also precipitated, and to prevent this, the ceric salts should be reduced to cerous salts by sulphur dioxide ; L. M. Dennis and F. L. Kortright, T. Curtius and A. Darapsky, and G. Wyruboff and A. Verneuil, sodium azide ; F. J. Metzger, fumaric acid ; A. C. Neish, and A. Kolb and H. Ahrle, metanitrobenzoic acid ; T. O. Smith and C. James, pyrotartaric acid ; R. J. Meyer and M. Speter, iodic acid ; R. J. Carney and E. D. Campbell, pyrophosphoric acid ; M. Koss, A. Rosenheim, and F. Wirth, sodium hypophosphate ; F. Garelli and G. A. Barbieri, and C. R. Böhm, salicylic acid ; W. Muthmann and E. Baur, potassium chromate ; L. de Boisbaudran, copper and cuprous oxide ; C. R. Böhm, acetic acid ; R. Chavastelon, H. Grossmann, and A. Batek, sodium sulphite ; and F. J. Metzger and F. W. Zons, ammonium molybdate. B. L. Hartwell, and A. McM. Jefferson studied the precipitation of thorium in the presence of the rare earths by quinoline, aniline, and other aromatic bases.

After the above treatment the rare earth oxalates are supposed to have been freed from thoria, zirconia, etc. Scandia still remains. Should any thoria have escaped the extraction, and still pollute the rare earths, it will appear in one of the subsequent fractions, and if the sodium sulphate process be employed, the thoria

will be found in the more soluble yttria fractions. Similarly, if traces of other elements still contaminate the rare earths, they may introduce complications in later fractions, and lead to the premature announcement of a new element. Quite a long list of pseudo-discoveries has been made both in connection with the rare earths and in connection with other elements. The *deceptio visus* is the more likely to lead one astray because **the characteristic properties of one element may be suppressed or masked in the presence of another element, so that reactions which readily occur when the element is alone do not necessarily occur when the two elements are mixed together.** For instance, W. Crookes⁸ showed that titanium hydroxide is completely precipitated when a dil. soln. of titanium sulphate is boiled for some time; but if zirconium be present, there may be either an incomplete precipitation or none at all. The phenomenon is by no means uncommon. Thus, C. A. Joy found that aluminium hydroxide is dissolved by ammonium carbonate soln. in appreciable quantities when beryllium hydroxide is present, but alone, the alumina is scarcely affected. Columbium hydroxide is completely precipitated if a dil. acid soln. of the chloride be boiled, but, according to L. Weiss and M. Landecker, some columbium escapes precipitation if much titanium be present, for "it seems as if a soluble double chloride of titanium and columbium is formed and part only of the columbium separates as hydroxide." These facts also show that tables of solubilities like Table VII must be used with caution.

The resolution of the rare earths into ceria and yttria earths.—J. J. Berzelius and J. G. Gahn⁹ employed potassium sulphate as a group reagent—*vide* Table I—for separating the rare earths contained in yttrocerite into the yttria and ceria groups according as they are soluble or insoluble in a cold sat. soln. of that salt. The process was employed by many of the early workers, J. J. Berzelius and W. Hisinger, J. C. G. de Marignac, C. G. Mosander, N. J. Berlin, M. H. Klaproth, etc. Most of the terbia group accompanies the sparingly soluble ceria group. The separation is not clean. The precipitate containing the double sulphates of the ceria earths is tainted with some of the members of the yttria earths; while the filtrate contains a considerable proportion of the terbia and ceria earths—more particularly with neodymia and samaria because, according to O. Boudouard, and G. Urbain, samarium and neodymium double sulphates are appreciably soluble in the presence of much yttrium sulphate, and in addition to the augmentation of the solubilities of the double sulphates of the terbium family, these salts are formed somewhat slowly. The potassium sulphate process is therefore to be regarded as a method of fractionation. C. James showed that if much of the neodymium be left in soln. only traces of the terbium and yttrium groups are precipitated. The yttrium and terbium earths in the filtrate are converted into double magnesium nitrates and fractionated. The crystals contain the cerium group up to neodymium; the mother liquor contains samarium, terbium, and yttrium.

The separation is conducted by gradually adding finely divided potassium sulphate to a soln. of the rare earth sulphates, chlorides, or nitrates. R. J. Meyer worked with a soln. which had just been raised to the b.p., and kept the soln. vigorously stirred by a jet of steam. The addition of potassium sulphate is continued until a test portion of the clear soln. shows but the faintest absorption spectrum of didymium, Fig. 1. The crystals of the cerium earth double sulphates are allowed to settle, and the soln. of yttrium earths is decanted off, and the crystals washed with a cold sat. soln. of potassium sulphate. If the potassium sulphate be added until the didymium absorption spectrum has vanished, some double sulphate yttria earths will be precipitated with the ceria earths. Many modifications have been proposed by K. A. Hofmann, L. M. Dennis and E. M. Chamot, A. Bettendorff, W. Muthmann and H. Rölig, L. de Boisbaudran, J. C. G. de Marignac, etc.

M. H. Klaproth used sodium sulphate in place of potassium sulphate in his work on ochroite, and this salt has been employed by W. Gibbs, J. L. Smith, C. James, M. Delafontaine, G. P. Drossbach, L. de Boisbaudran, C. Erk, etc. Solid sodium sulphate is stirred into a 10 per cent. soln. of the rare earth chlorides, nitrates, or sulphates until the didymium bands disappear. Special care must be taken not to use an undue excess of the sodium salt because of the formation of a sparingly soluble

yttrium sodium sulphate—Fig. 25. The double sulphates of the cerium group are filtered off and washed with sodium sulphate soln. as described below. The filtrate is treated for the yttrium group—*vide infra*.

C. James found that the sodium sulphate process does not give such good results if the cerium group predominates much in excess of the yttrium group. In that case, (1) the potassium sulphate method can be used; (2) an excess of sulphuric acid can be added; the liquid warmed so as to precipitate the bulk of the cerium group as sulphates, and the filtrate treated by the sodium sulphate process (G. P. Drossbach); (3) the bulk of the cerium group can be precipitated as double carbonates by adding potassium carbonate, and the filtrate treated by the sodium sulphate process (G. P. Drossbach); or (4) the material can be fractionated by the double magnesium nitrate process of E. Demarçay, whereby the terbium and yttrium groups collect in the more soluble portions (C. James). C. James recommended four different methods of treatment dependent upon the composition of the crude oxalates:

(a) If the mixture is chiefly composed of lanthanum, much cerium, praseodymium, neodymium, samarium, europium, and gadolinium, it should be converted into the neutral nitrates and boiled with potassium bromate and marble, as required for the separation of cerium—*vide infra*. (b) If only a little cerium is present, the oxides should be converted into double magnesium nitrates, which are then fractionated, the cerium being separated from the fractions in which it is found to occur. (c) Should the mixture be composed of gadolinium, terbium, dysprosium, holmium, erbium, thulium, ytterbium, lutecium, yttrium, and scandium, it is best to commence with the fractional crystallization of the bromates. (d) When the cerium and yttrium metals occur together, one must commence with the sodium sulphate treatment.

C. James' process for separating the ceria earths.—The precipitate obtained by the sodium sulphate process contains cerium, lanthanum, praseodymium, neodymium, samarium, europium, gadolinium, and traces of terbium, dysprosium, etc., belonging to the yttrium family. An outline of the scheme is indicated in Table X.

TABLE X.—RESOLUTION OF THE RARE EARTH SULPHATES INSOLUBLE IN A SATURATED SOLUTION OF SODIUM SULPHATE.

Treat chlorides of rare earth with sodium sulphate

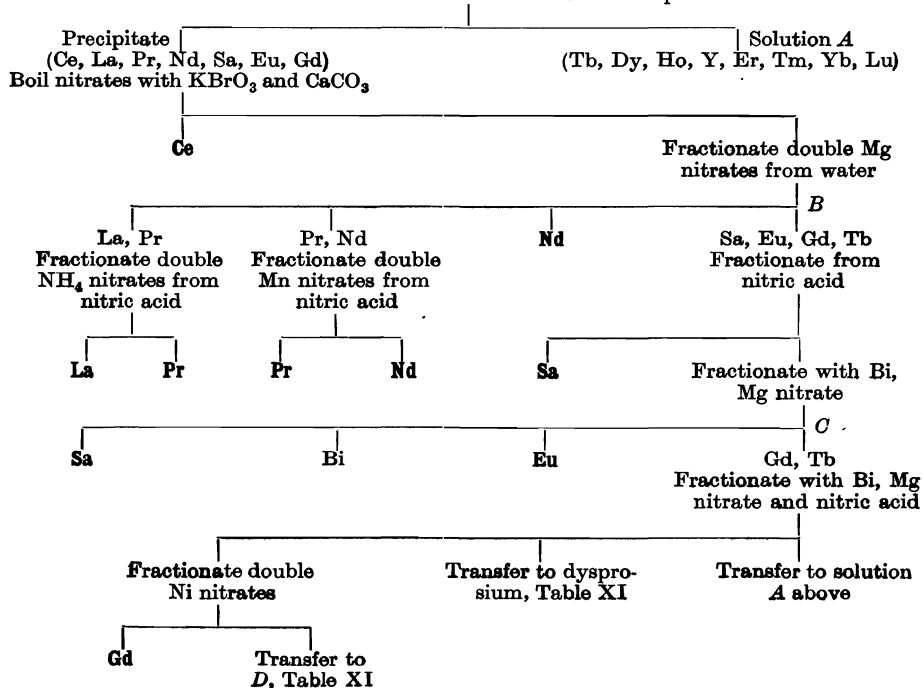

The separation of ceria.—The double sodium sulphates are decomposed by boiling with a conc. soln. of sodium hydroxide. Water is added, and the hydroxides filtered and washed until free from sulphates. The hydroxides are dissolved in nitric acid, and the soln. nearly neutralized. Potassium bromate is added to the boiling soln. as recommended by C. James and A. L. Pratt¹⁰ until red fumes of bromine appear, a few lumps of marble are then added to keep the liquid nearly neutral. The liquid is boiled until a few drops of the filtered liquid fail to give the reaction for cerium with hydrogen peroxide. The lump marble is removed and the precipitate allowed to settle. The basic ceric salts are filtered, and washed with dil. nitric acid.

The precipitate of basic ceric nitrate can be purified by a repetition of the process; or it can be dissolved in conc. nitric acid by the aid of a little alcohol. The orange-red liquid is boiled with lump marble for a short time so that it does not become too alkaline. The precipitate is filtered off, and the soln. treated with potassium bromate to remove the remaining cerium. The basic salts can be further purified by dissolving the precipitate in hydrochloric acid, adding a slight excess of sulphuric acid, and heating. The crystalline cerium sulphate which separates is washed with alcohol.

The preliminary separation into four fractions.—The filtrates from the basic cerium salts can be precipitated either in the cold, with oxalic acid; or boiling, with sodium hydroxide. If a large excess of bromate has been used, much oxalic acid is consumed in reducing the bromate to bromine, etc. The oxalates are converted into oxides by ignition, and E. Demarçay's magnesium nitrate fractionation process is applied.

The oxides are dissolved in a known amount of nitric acid, an equal weight of nitric acid is neutralized with magnesia, and the two soln. are mixed. The soln. is evaporated until crystals begin to form when the surface is blown. Water is sprayed on the surface, and the whole is allowed to crystallize for about 24 hrs. The mother liquid is poured off, and further evaporated, while the crystals are dissolved by heating them with a little water. The two soln. are allowed to crystallize so that about half the solid separates on cooling. The process is now arranged so that the more soluble portions move in one direction, the less soluble fraction in the opposite direction. When the crystallization of the second series is complete, the liquid from the more soluble portion is poured off and again evaporated, while the liquid from the first fraction is used as solvent for the second fraction—adding or evaporating water as may be necessary. The least soluble portion of the first fraction is again dissolved by heating it with water. The process is repeated many times. When the fractions at either end become too small to work they should miss one series of operations and be added to the next lot. After a few series of crystallizations, the least soluble portion becomes very light coloured, later growing nearly colourless, and finally takes a faint green tinge. When the fractions at this end no longer show the characteristic absorption bands of neodymium, they should be placed aside and mixed together according to the amount of praseodymium contained therein; in other words, fractions of the same colour are united. If the liquid refuses to crystallize or a precipitate forms, it is best to dil. with water and precipitate with oxalic acid in order to separate the impurities that have accumulated and interfere with the crystallization. The insoluble oxalates are converted back to the double magnesium nitrates. The crystals are inclined to carry much mother liquid.

During the fractionation the more soluble portion changes rapidly, acquiring a yellow tint, and showing the spectra of samarium, dysprosium, holmium, and erbium. The neodymium finally becomes very weak in the mother liquor of the most soluble fraction. The soln. is then set aside to be treated for samarium, europium, and gadolinium. The more soluble portion of the remaining fractions soon becomes an amethyst-blue colour, and it is set aside as crude neodymium. After fractionating for some time longer, the material will have been resolved into the following four groups of double magnesium nitrates—commencing with the least soluble: (i) Lanthanum and praseodymium; (ii) Praseodymium and neodymium; (iii) Neodymium; and (iv) Samarium, europium, and gadolinium together with the simple nitrates of terbium, dysprosium, holmium, yttrium, etc.

(i) *Isolation of lanthanum.*—The fraction containing lanthanum and praseodymium can be treated by the metanitrobenzenesulphonate or the bromate process. C. James recommends C. A. von Welsbach's process involving the fractional crystallization of the double ammonium nitrates.

The rare earths are separated from the double magnesium nitrates, by adding oxalic acid to the aq. soln. of the magnesium double salts, and igniting the washed and dried oxalates. The resulting oxides are dissolved in the required amount of nitric acid, and for every three parts of acid required by the oxides, two additional parts are neutralized by ammonia. The resulting soln. are mixed, filtered if necessary, and evaporated until small crystals appear when the surface is blown. A little water is sprayed on the surface of the hot soln. and the whole is allowed to crystallize for 24 hrs. The process of fractional crystallization is allowed to proceed as in the case of the double magnesium nitrates.

(ii) *Isolation of praseodymium.*—Praseodymium is obtained from the mother liquor remaining after the separation of lanthanum, and from the second fraction of the double magnesium nitrate process. The fractionation of the double ammonium nitrates is continued until no more lanthanum ammonium nitrate separates at the less soluble end of the series. The praseodymium accumulates at the more soluble end of the series. The mixture of praseodymium and neodymium magnesium nitrates is then treated by H. Lacombe's process involving the fractional crystallization of the double manganese nitrates from dil. nitric acid.

The rare earth oxides are extracted from the magnesium double nitrates as indicated above. The oxides are dissolved in nitric acid, and an equal amount of nitric acid is neutralized by manganese carbonate. Any peroxide remaining undissolved can be brought into soln. by the addition of a few drops of dil. oxalic acid soln. to the hot double nitrates. The manganese double salts are crystallized from nitric acid having a sp. gr. 1.3.

The fractionation is continued until the spectrum of neodymium disappears, even when a conc. soln. is examined in thick layers. The double ammonium or manganese nitrate is then dissolved in water and precipitated with oxalic acid. The oxalate is free from the other rare earth metals excepting perhaps a trace of cerium. The cerium can be removed by C. James and A. L. Pratt's process—*vide supra*—or by means of the potassium permanganate process—*vide infra*.

(iii) *Isolation of neodymium.*—Neodymium is obtained from the mother liquors of the double manganese nitrate and the third fraction from the double magnesium nitrate process. The fractional crystallization of the respective mixtures can be continued until the most soluble fraction assumes a lilac-blue colour, with marked absorption bands in the blue. The pure oxide is blue.

(iv) *Isolation of samarium and europium.*—The fourth fraction from the double magnesium nitrate process contains samarium and europium as well as large quantities of gadolinium, yttrium, dysprosium, and erbium. The double magnesium salts are fractionally crystallized from 30 per cent. nitric acid. The least soluble fractions soon acquire a yellow tint as the samarium accumulates, while the most soluble fractions begin to crystallize badly as the yttrium earths accumulate. G. Urbain and H. Lacombe's *l'élément séparateur* in the form of bismuth magnesium nitrate may now be advantageously employed. This rapidly removes all the europium from the yttrium earth nitrates. After many crystallizations, the mother liquor shows a strong spectrum of dysprosium, holmium, and erbium, and it is put on one side. The series is allowed to expand to about 20 fractions. After a large number of crystallizations, samarium is removed from the least soluble end, when it is considered certain that all the europium has passed along the series. As soon as the gadolinium fractions, next to the samarium, show a fine sharp absorption band in the blue, due to europium, 50 per cent. nitric acid is used as solvent. Most of the samarium of a high degree of purity will now have been removed, and in addition, nearly all the yttrium, dysprosium, and erbium earths, together with quantities of gadolinium from the opposite end. As the work proceeds, the europium band grows stronger in the fractions between samarium and gadolinium; later two green bands appear. The fractions become smaller and smaller since all the mother liquors beyond one or two that give no europium spectrum, have been removed. Only traces of samarium are left. Finally, the samarium bands disappear and the remaining fractions contain only bismuth magnesium nitrate. The fractions containing no gadolinium are mixed, diluted, and the bismuth precipitated with hydrogen

sulphide; the clear filtrate is treated with oxalic acid, and the europium oxalate is collected, washed, and dried.

(v) *Isolation of gadolinium.*—All the more soluble portions of the preceding operations consisting of gadolinium, yttrium, etc., are collected together; converted into oxalates; ignited to oxides; and dissolved in nitric acid. The simple nitrates are then fractionated from conc. nitric acid. The first crystals contain gadolinium and terbium; the intermediate crystals contain dysprosium, holmium, and yttrium; and yttrium, erbium, etc., collect in the mother liquor. The last is added to soln. of yttria earths derived from the first sodium sulphate precipitation. The middle fraction containing dysprosium, holmium, and yttrium is added to a later fraction employed for dysprosium. The least soluble nitrates of gadolinium and terbium cannot be purified by the fractional crystallization of the double magnesium nitrates, likewise the simple nitrates fractionate very slowly, but G. Urbain fractionated the double nickel nitrates and obtained a white gadolinium salt which readily crystallizes from nitric acid of sp. gr. 1.3. Terbium collects in the more soluble crystals.

C. James' process for separating the yttria earths.—The fraction of the rare earths soluble in a sat. soln. of sodium sulphate, consists of dysprosium, holmium, yttrium, erbium, thulium, ytterbium, lutecium, celtium, and small quantities of gadolinium, terbium, and scandium. The soln. is acidified, and the rare earths are precipitated by oxalic acid. The oxalates are heated with conc. sulphuric acid until fumes of sulphuric acid cease to be evolved. An outline of the scheme of separation is indicated in Table XI.

TABLE XI.—RESOLUTION OF THE RARE EARTH SULPHATES SOLUBLE IN A SATURATED SOLUTION OF SODIUM SULPHATE.

Solution A (Tb, Dy, Ho, Y, Er, Tm, Yb, Lu)
Fractionate the bromates from water

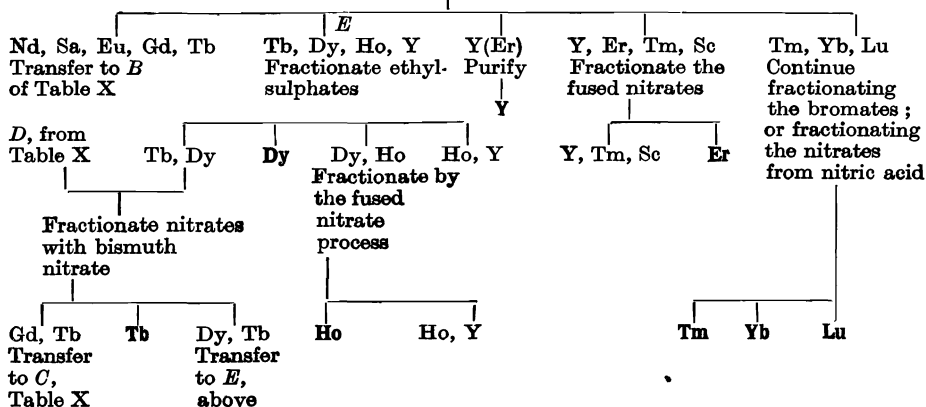

The preliminary separation into five fractions.—The sulphates are dissolved in cold water, and the conc. soln. gradually added to finely divided barium bromate covered with a layer of water; the mixture is heated and stirred until decomposition is complete. This is shown by the absence of a precipitate when a little of the clear liquor is diluted and boiled with a soln. of barium bromate. The mixture is filtered, and the barium sulphate well washed. The clear filtrate is evaporated until a drop removed on the end of a glass rod nearly solidifies when rubbed on a watch-glass. A little water is then sprayed on the surface, and the contents allowed to crystallize. The mother liquor and crystals are fractionally crystallized. The absorption spectrum soon shows that a change rapidly occurs. The products (i) samarium, gadolinium, terbium, neodymium, and europium which collect at the less soluble end. This mixture is fractionated as indicated in connection with Table X for the more soluble earths derived from the samarium-europium fraction (iv). (ii) The second

fraction is yellow, and contains dysprosium, holmium, and yttrium, with small quantities of terbium. (iii) The third fraction consists almost entirely of yttrium contaminated with small quantities of dysprosium, holmium, and erbium. (iv) Practically the whole of the erbium is contained in the fractions more soluble than yttrium; the erbium spectrum is very marked, and the soln. is rose-red. (v) The mother liquor is nearly colourless or it has a faint pink colour. The absorption spectrum shows a feeble erbium spectrum and an intense thulium spectrum. This fraction consists almost entirely of ytterbium, lutecium, and celtium.

Traces of scandium in the mineral are usually lost in the oxalate precipitations, owing to the slight solubility of scandium oxalate, particularly in the presence of free acid. During the fractional crystallizations, the scandium accumulates in the mother liquid and in the erbium, and dysprosium fractions.

(i) *Isolation of terbium.*—The mother liquor from the gadolinium nickel nitrate fractionation contains terbium, as well as dysprosium, and gadolinium. The less soluble portion of the next fractionation also contains terbium and dysprosium. The collected mixture can be fractionated by crystallization of the simple nitrates, as the ethyl sulphates, or it may be fractionally precipitated by ammonia which concentrates the terbium in the portions more basic than dysprosium. The simple nitrates are fractionally crystallized using bismuth nitrate as a separating element. (i) Bismuth nitrate accompanied by terbium collects in the middle fraction; (ii) gadolinium collects with the least soluble fraction; and (iii) the dysprosium in the mother liquor is passed on to the dysprosium fraction. The bismuth is removed from the middle fractions by hydrogen sulphide, and the terbium precipitated by oxalic acid; and the oxalate ignited for terbium oxide which appears as a black powder. In the ethyl sulphate fractionation, terbium comes between gadolinium and dysprosium.

(ii) *Isolation of dysprosium.*—Most of the dysprosium in the original material collects in the intermediate fraction from the gadolinium nitrate fractionation, the second fraction from the preliminary separation of the yttria fraction, and the mother liquor from the terbium fractionation. The earths in this fraction are separated by the ethyl sulphate process advocated by G. Urbain. The earths are first converted into ethylsulphates either by the action of the rare earth sulphates on barium ethylsulphate or by mixing alcoholic soln. of the rare earth chlorides with sodium ethylsulphate. In the former process, there is a loss of rare earth sulphates entrained with the barium sulphate, and the filtration is difficult; the latter process gives the best results when hot conc. soln. are used. The collected fractions are treated with oxalic acid, the oxalates converted to oxides, and the oxides dissolved in hydrochloric acid, adding a slight excess of oxide so as to keep the soln. slightly basic. The soln. is evaporated until it solidifies on cooling. Before the soln. has cooled sufficiently to solidify it is poured into 95 per cent. alcohol, and the turbid soln. cleared by adding hydrochloric acid drop by drop. A hot conc. alcoholic soln. of sodium ethylsulphate is then added, with vigorous stirring. The mixture is heated on the water-bath for a short time, filtered, washed with hot alcohol, and the filtrate allowed to crystallize. The mother liquid is poured off and the crystals well drained. Liquid and crystals are then fractionally crystallized for a long time. (i) Terbium with a little dysprosium collects in the first few fractions; (ii) dysprosium alone comes next; (iii) then follows dysprosium and holmium; and (iv) the most soluble portion contains holmium and yttrium.

(iii) *Isolation of holmium.*—Holmium has not been prepared of a high degree of purity. The small quantities available may be freed from dysprosium, but the fractions so obtained are rich in yttrium, and carry a little erbium. Fractionation by the fusion of the nitrates as described in connection with yttrium should give a basic holmium nitrate, but too little holmium is usually available.

(iv) *Isolation of yttrium.*—The best sources of yttrium are the third fraction of the preliminary fractionation of the yttria earths soluble in sodium sulphate, and also the less soluble fraction after the separation of erbium. Several methods are

available for the purification of the crude yttrium. The chromate process of W. Muthmann and C. R. Böhm gives good results, particularly if terbium is present, and not much material is available.

The oxides are dissolved in a soln. of chromic acid so that about 40 grms. of the rare earth sesquioxide is contained in a litre. C. James said that the soln. obtained by adding potassium dichromate to a soln. of the rare earth nitrates can also be used. The liquid is treated with a 10 per cent. soln. of potassium chromate until it becomes cloudy, and heated in a retort while agitated by a current of steam. The retort is fitted with a cork and separating funnel so that potassium chromate can be added from time to time to keep the vol. of soln. in the retort constant. The precipitate is collected in a series of fractions. The first and second fractions are obtained by using 10 per cent. potassium chromate, and about four fractions by using a 5 per cent. soln. The best fraction is virtually pure yttrium chromate in the form of minute deep-red prisms.

C. James recommends the fused nitrate process of A. Damour and H. St. C. Deville for purifying large quantities of yttrium material. If terbium be present, pure white yttria cannot be obtained. The result of the operation furnishes yttrium nitrate of a high degree of purity, and a less basic portion which is worked up for erbia. He said:

When working on a large scale, porcelain dishes are used, while casseroles are found very convenient for smaller amounts. During the decomposition, the evolution of red fumes is allowed to proceed until the surface assumes a glazed appearance. This point is easily ascertained by experience. The decomposition should never be allowed to advance so that the mass becomes of a thick creamy nature. The best method for obtaining a soln. of the melt is to pour the fused mass into a sufficient quantity of cold water. Great care, however, is required and stirring usually aids the operation very much. A large amount of cold water must be avoided, since it is desired that the soln. should be concentrated after about five minutes' boiling. As the fused nitrate is gradually added to the water, the temp. rapidly rises and the whole suddenly begins to boil violently. When the dish, which contained the melted salt, has cooled sufficiently, a little water is added and the whole heated until the glassy mass has disintegrated, after which it is added to the main bulk. The latter is then boiled for five minutes and set aside to cool. Under the best conditions the entire mass goes into soln.; especially is this true of the yttrium end of the series. Upon cooling, it will be found that the basic nitrate separates in a crystalline form. At the opposite end, the least basic portion of the fractions, there always remains an insoluble basic nitrate, unless the decomposition is stopped at an earlier stage, *i.e.* when there is a copious evolution of red fumes. In case a precipitate remains, it is highly important that it be well agitated by thoroughly boiling. After cooling, the precipitate (fraction B) is filtered off, redissolved in nitric acid, and again fused. The filtrate (fraction A) is also boiled down and fused. The second series gives two filtrates and two precipitates. The filtrate from fraction B is mixed with the precipitate from fraction A, with the result that the second series contains three fractions, etc.

(v) *Isolation of erbium.*—The less basic fraction obtained from the purification of the yttria by the fused nitrate process, and the fourth fraction in the preliminary separation of the rare earth sulphates which are soluble in a sat. soln. of sodium sulphate, contain practically the whole of the erbia present in the raw material. Some yttrium is present along with traces of scandium, thulium, and holmium. According to C. James, yttrium is best separated by fractionally decomposing the nitrate by fusion. Since erbium nitrate decomposes easily, the temp. is not raised quite so high as in the case of nearly pure yttrium. The least basic portion obtained after a large number of series, consists of erbium basic nitrate. During conc., the material rapidly becomes less, the erbium soln. becomes more rose coloured, and the absorption spectrum appears very intense. The yttrium concentrates in more basic fractions, which, when united, are worked up for yttria as described above. The best method for removing scandium is to crystallize the nitrates from nitric acid (fairly strong). Holmium and thulium are separated, if still found contaminating the material, by converting back to the bromate and employing fractional crystallization from water. This last method also causes yttrium to pass into the less soluble crystals.

(vi) *Isolation of thulium.*—Thulium is so scarce that only small quantities can be obtained from large quantities of material. The most soluble portion obtained

in the preliminary fractionation of the yttria earths soluble in a sat. soln. of sodium sulphate is employed. This fraction contains thulium, ytterbium, lutecium, and celtium, it shows the absorption bands of thulium, and mere traces of those of erbium. As a rule ytterbia largely predominates in this fraction. The thulium is separated by continuing the fractionation of the bromates at a temp. of about 16°; at higher temp., the soln. employed are so conc. that they solidify on cooling. The soln. are very liable to supersaturation, and crystallization has to be started by seeding. C. James found that during the first few series, erbium rapidly separates in the least soluble portion, after which the other fractions become coloured greenish. As soon as the mother liquors fail to give any thulium absorption bands, when examined in a sat. soln. of about 10 cms., they are placed aside for the separation of ytterbium, etc. Thulium is found to collect in the fractions between erbium and ytterbium. The soln. become coloured a faint bluish-green and show a very intense absorption spectrum consisting of three bands. If very great care be taken, dil. alcohol can be used as solvent for a short time—best towards the end of the work. However, it soon shows signs of being attacked by the bromate.

(vii) *Isolation of ytterbium and lutecium.*—These three elements are contained in the mother liquor remaining after the separation of thulium. This can be fractionated by continuing the bromate process, provided the soln. do not become basic. G. Urbain fractionated the nitrates from nitric acid. Lutecium is more soluble than ytterbium. Lutecium salts have not yet been obtained of even a moderate degree of purity.

REFERENCES.

- ¹ E. Rimbach and A. Schubert, *Zeit. phys. Chem.*, **67**, 183, 1909; B. Brauner, *Journ. Chem. Soc.*, **73**, 951, 1898; O. Hauser and F. Wirth, *Zeit. anal. Chem.*, **47**, 389, 1908; R. J. Meyer and O. Hauser, *Die Analyse der seltenen Erden und Erdsäuren*, Stuttgart, 61, 1912; R. J. Meyer and A. Wassjuchnow, *Zeit. anorg. Chem.*, **86**, 257, 1914; F. Wirth, *ib.*, **58**, 213, 1908; **76**, 174, 1912; **79**, 357, 1913; **87**, 1, 1914; A. Job, *Compt. Rend.*, **126**, 246, 1898; C. James, *Journ. Amer. Chem. Soc.*, **34**, 757, 1912; C. R. Böhm, *Die Verwendung der seltenen Erden*, Leipzig, 5, 1913; *Pharm. Ztg.*, **47**, 737, 1902.
- ² M. Delafontaine, *Chem. News*, **75**, 229, 1897; C. James, *Journ. Amer. Chem. Soc.*, **33**, 1332, 1911; **35**, 235, 1913; W. B. Hicks, *ib.*, **33**, 1492, 1911; C. James and A. J. Grant, *ib.*, **38**, 41, 1916; G. Urbain, *Compt. Rend.*, **152**, 141, 1911; *Ann. Chim. Phys.*, (7), **19**, 202, 1900; L. F. Nilson, *Ber.*, **13**, 1430, 1880; G. Krüss and L. F. Nilson, *ib.*, **20**, 1676, 1887; H. E. Roscoe, *ib.*, **15**, 1274, 1882; J. L. Smith, *Chem. News*, **48**, 13, 29, 1883; **51**, 289, 304, 1885; W. Gibbs, *Amer. Journ. Science*, (2), **37**, 355, 1864; J. Barlot and E. Chauvenet, *Compt. Rend.*, **157**, 1153, 1913; C. R. Böhm, *Zeit. angew. Chem.*, **15**, 372, 1902; the opening up and analysis of these minerals is discussed by J. W. Mellor, *A Treatise on Quantitative Inorganic Analysis*, London, 160, 503, 1913.
- ³ E. Hintz and H. Weber, *Zeit. anal. Chem.*, **36**, 213, 1897; P. Drossbach, *Zeit. angew. Chem.*, **14**, 655, 1901; E. Benz, *ib.*, **15**, 297, 1902; O. Hauser and F. Wirth, *ib.*, **22**, 484, 1909; C. Glaser, *Zeit. anal. Chem.*, **36**, 213, 1897; R. Finkener, *ib.*, **3**, 369, 1864; N. Engström, *Zeit. Kryst.*, **3**, 191, 1879; W. Blomstrand, *ib.*, **15**, 99, 1889; H. Bäckström, *ib.*, **16**, 83, 1890; C. Jones, *Amer. Chem. Journ.*, **20**, 345, 1898; H. Gorceux, *Compt. Rend.*, **100**, 357, 1885; M. Holzmann, *Journ. prakt. Chem.*, (1), **75**, 321, 1858; R. Rueter, *Zeit. anorg. Chem.*, **42**, 87, 1904; R. J. Meyer and R. Jacoby, *ib.*, **27**, 364, 1901; L. F. Nilson, *Ber.*, **13**, 1437, 1880; P. T. Cleve and M. Höglund, *ib.*, **6**, 1468, 1873; N. J. Berlin, *Pogg. Ann.*, **43**, 111, 1838; O. Hauser, *Zeit. anal. Chem.*, **47**, 677, 1908; H. C. Kremers, *School Science*, **17**, 622, 1917.
- ⁴ P. T. Cleve, *Bull. Soc. Chim.*, (2), **43**, 53, 1885; G. Wyruboff and A. Verneuil, *ib.*, (3), **19**, 219, 1898; *Chem. News*, **77**, 245, 1898; *Compt. Rend.*, **126**, 340, 1898; **127**, 412, 1898; **128**, 1331, 1899; L. de Boisbaudran, *ib.*, **100**, 605, 1864; E. Benz, *Zeit. angew. Chem.*, **15**, 297, 1902.
- ⁵ J. J. Chydenius, *Pogg. Ann.*, **119**, 46, 1863; R. Hermann, *Journ. prakt. Chem.*, (1), **93**, 106, 1864; G. P. Drossbach, *Zeit. angew. Chem.*, **14**, 655, 1901; O. Hauser and F. Wirth, *ib.*, **22**, 484, 1909; E. Hintz and H. Weber, *Zeit. anal. Chem.*, **36**, 27, 213, 617, 1897; C. Glaser, *Journ. Amer. Chem. Soc.*, **18**, 782, 1896; *Chem. Ztg.*, **20**, 612, 1896; *Chem. News*, **75**, 145, 157, 1897; S. J. Johnstone, *Journ. Soc. Chem. Ind.*, **33**, 55, 1914.
- ⁶ J. F. Bahr, *Liebig's Ann.*, **132**, 231, 1864; E. Hintz and H. Weber, *Zeit. anal. Chem.*, **36**, 27, 1897; P. Drossbach, *Zeit. angew. Chem.*, **14**, 655, 1901; E. Benz, *ib.*, **15**, 297, 1902; T. Scheerer, *Pogg. Ann.*, **56**, 498, 1842; **51**, 470, 1840; C. F. Rammelsberg, *ib.*, **108**, 48, 1859; H. Rose, *ib.*, **118**, 502, 1863; T. Thomson, *Trans. Roy. Soc. Edin.*, **6**, 371, 1811; A. Connell, *Edin. Phil. Journ.*, **20**, 300, 1842; R. Hermann, *Journ. prakt. Chem.*, (1), **82**, 387, 1861; M. Holzmann, *ib.*, (1), **84**, 78, 1861; T. Lange, *ib.*, (1), **82**, 135, 1861; M. Delafontaine, *Liebig's Ann.*, **131**,

105, 1864; J. Brush and S. L. Penfield, *Amer. Journ. Science*, (3), **25**, 459, 1883; G. Bodmann, *Zeit. anal. Chem.*, **27**, 251, 1901; H. du Bois and O. Liebknecht, *Ber.*, **32**, 3346, 1899; C. Glaser, *Journ. Amer. Chem. Soc.*, **13**, 782, 1896; *Chem. Ztg.*, **20**, 612, 1896; *Chem. News*, **75**, 145, 157, 1914; O. Hauser, *Zeit. anal. Chem.*, **47**, 665, 1908.

⁷ T. O. Smith and C. James, *Journ. Amer. Chem. Soc.*, **34**, 281, 1912; F. J. Metzger, *ib.*, **24**, 906, 1902; A. C. Neish, *ib.*, **26**, 780, 1904; R. J. Carney and E. D. Campbell, *ib.*, **36**, 1134, 1914; A. McM. Jefferson, *ib.*, **24**, 540, 1902; B. L. Hartwell, *ib.*, **25**, 1128, 1903; L. M. Dennis, *ib.*, **18**, 947, 1896; L. M. Dennis and F. L. Kortright, *Amer. Chem. Journ.*, **16**, 79, 1894; G. Urbain, *Ann. Chim. Phys.*, (7), **19**, 184, 1900; *Bull. Soc. Chim.*, (3), **15**, 338, 347, 1896; G. Wyruboff and A. Verneuil, *ib.*, (3), **7**, 679, 1887; (3), **19**, 219, 1898; *Ann. Chim. Phys.*, (8), **6**, 484, 1905; *Compt. Rend.*, **126**, 340, 1898; **127**, 412, 1898; R. Chavastelon, *ib.*, **130**, 781, 1900; O. Knöfler, *German Pat.*, *D.R.P.* 266459, 1912; W. B. Giles, *Chem. News*, **92**, 1, 1905; A. Kolb and H. Ahrlé, *Zeit. angew. Chem.*, **18**, 92, 1905; R. J. Meyer and M. Speter, *Chem. Ztg.*, **34**, 306, 1910; R. J. Meyer, *Zeit. anorg. Chem.*, **71**, 65, 1911; A. Batek, *ib.*, **45**, 87, 1905; H. Grossmann, *ib.*, **44**, 229, 1905; F. J. Metzger and F. W. Zons, *Journ. Ind. Eng. Chem.*, **4**, 493, 1912; M. Koss, *Chem. Ztg.*, **36**, 686, 1912; A. Rosenheim, *ib.*, **36**, 821, 1912; F. Wirth, *ib.*, **37**, 773, 1913; *German Pat.*, *D.R.P.* 268866, 1913; L. de Boisbaudran, *Compt. Rend.*, **99**, 525, 1884; F. Garelli and G. A. Barbieri, *Zeit. angew. Chem.*, **19**, 895, 1906; *Chem. Ztg.*, **30**, 433, 1906; C. R. Böhm, *Chem. Ind.*, **29**, 452, 1906; W. Muthmann and E. Baur, *Ber.*, **33**, 2029, 1900; E. Baur, *German Pat.*, *D.R.P.* 120013, 1900; *Zeit. angew. Chem.*, **14**, 476, 1901; O. N. Witt, *Chem. Ind.*, **17**, 161, 1894; *Ueber den Cergehalt der Thorsalze*, Berlin, 1897; T. Curtius and A. Darapsky, *Journ. prakt. Chem.*, (2), **61**, 408, 1900.

⁸ W. Crookes, *Select Methods in Chemical Analysis*, London, 139, 1905; C. A. Joy, *Amer. Journ. Science*, (2), **36**, 83, 1863; *Chem. News*, **8**, 183, 197, 1863; L. Weiss and M. Landecker, *Zeit. anorg. Chem.*, **64**, 65, 1909; *Chem. News*, **101**, 2, 13, 26, 1910.

⁹ J. J. Berzelius and J. G. Gahn, *Schweigger's Journ.*, **16**, 244, 1816; O. Boudouard, *Compt. Rend.*, **126**, 900, 1898; *Bull. Soc. Chim.*, (3), **19**, 382, 1898; G. Urbain, *ib.*, (3), **19**, 331, 1898; *Ann. Chim. Phys.*, (7), **19**, 251, 1900; J. C. G. de Marignac, *ib.*, (5), **20**, 535, 1880; M. H. Klaproth, *ib.*, (1), **49**, 256, 1803; *Gehlen's Ann.*, **2**, 312, 1804; J. J. Berzelius and W. Hisinger, *ib.*, **2**, 407, 1804; *Ann. Chim. Phys.*, (1), **50**, 245, 1803; K. A. Hofmann, *Ueber die Terbinerde*, München, 1893; L. M. Dennis and E. M. Chamot, *Journ. Amer. Chem. Soc.*, **19**, 799, 1897; C. James, *ib.*, **34**, 757, 1912; **35**, 235, 1913; A. Bettendorff, *Liebigs Ann.*, **263**, 164, 1891; W. Muthmann and H. Rölig, *Ber.*, **31**, 1718, 1898; G. P. Drossbach, *ib.*, **29**, 2452, 1896; **33**, 3506, 1900; *Chem. News*, **74**, 274, 1896; L. de Boisbaudran, *Compt. Rend.*, **102**, 902, 1003, 1886; M. Delafontaine, *ib.*, **93**, 63, 1881; E. Demarçay, *ib.*, **130**, 1019, 1185, 1900; N. J. Berlin, *Pogg. Ann.*, **43**, 105, 1834; J. J. Berzelius, *ib.*, **3**, 209, 1825; **4**, 135, 1825; C. G. Mosander, *Phil. Mag.*, (3), **25**, 241, 1843; C. Erk, *Zeit. Chem.*, (2), **7**, 109, 1871; *Zeit. anal. Chem.*, **10**, 477, 1871; W. Gibbs, *Amer. Journ. Science*, (2), **37**, 354, 1864; J. L. Smith, *Amer. Chem. Journ.*, **5**, 44, 53, 1883; *Chem. News*, **48**, 29, 1883; R. J. Meyer, *Zeit. anorg. Chem.*, **71**, 65, 1911.

¹⁰ C. James, *Journ. Amer. Chem. Soc.*, **30**, 182, 1908; **34**, 757, 1912; C. James and A. L. Pratt, *ib.*, **33**, 1326, 1911; E. Demarçay, *Compt. Rend.*, **122**, 728, 1896; **130**, 1019, 1185, 1900; G. Urbain, *ib.*, **138**, 84, 1904; **140**, 583, 1905; C. A. von Welsbach, *Monatsh.*, **6**, 477, 1885; H. Lacombe, *Bull. Soc. Chim.*, (3), **31**, 570, 1904; *Chem. News*, **89**, 277, 1904; W. Muthmann and C. R. Böhm, *Ber.*, **33**, 12, 1900; A. Damour and H. St. C. Deville, *Compt. Rend.*, **59**, 270, 1864; *Bull. Soc. Chim.*, (2), **2**, 339, 1864.

§ 6. The Processes Employed in Resolving the Rare Earths into their Component Earths

C. R. Böhm, in his *Die Darstellung der seltenen Erden* (Leipzig, 1905), reviews the methods which have been employed in resolving the rare earths into their components. He classifies these methods: I. Separation by fractional crystallization—*A*, simple salts; *B*, complex salts. II. Separation by fractional precipitation—*A*, basic salts; *B*, hydroxides and salts. III. Separation by oxidation processes—*A*, in the dry way; *B*, in the wet way. IV. Separation by physical methods. The following outline is based on that of C. R. Böhm.

Since fractional crystallization or precipitation usually involves the frequent repetition of the same operations, it is important to reduce the necessary operations to a minimum; not only because of the need for economizing time, but also to lessen the risk of accidents and the frittering away of the material by small losses. Large quantities of materials have usually to be handled in the initial operations in order to get relatively small amounts of the finished product. Expensive materials are often ruled out. Except in very special cases, it is well to avoid methods where troublesome precipitates have to be washed and ignited, or where tedious

evaporations have to be made. As C. James¹ has said: "Fractional operations to be of value, must be very rapid."

I. Fractional crystallization.—Processes for the fractional crystallization of the rare earths are mainly dependent upon the fact that corresponding salts can form isomorphous or mixed crystals. The fractional crystallization of salts which are not isomorphous usually results in the separation of the least soluble or the most abundant component of the mixture; but the members of an isomorphous series of salts can usually be separated in the order of their solubilities. According to G. Urbain and H. Lacombe,² the usual order of separation is: La, Ce, Pr, Nd, Sa, Eu, Gd, Tb, Dy, Ho, Y, Er, Tm, Yb, Lu, *i.e.* with the exception of yttrium in the order of increasing at. wt. This is generally assumed to be the order of the solubilities. C. James, however, has shown that this does not always follow, because praseodymium bromate is rather more soluble in water than yttrium bromate, and yet when the mixed bromates of yttrium, praseodymium, erbium, and thulium are fractionated, praseodymium bromate accumulates in advance of the yttrium salt. Usually lanthanum furnishes the least soluble salt of the series, but in some cases the order is changed and lanthanum furnishes the most soluble salt. If the salts be not all isomorphous and of the same type, it is easy to understand how fractional crystallization may alter the order of separation. Thus, the bromonitrobenzenesulphonates studied by S. H. Katz and

C. James, fall into three groups with different degrees of hydration, and each group has its own order of solubility as illustrated by Fig. 5. The order may be modified even in cases where the salts are isomorphous. Water is the most convenient solvent. The salts should have a high solubility in the hot solvent, and separate on cooling in compact crystalline masses so that the only operations involved are the dissolution of the crystals, the concentration of the soln., and the decantation of the mother liquors. The operations involved are outlined in connection with the extraction of radium chloride—3. 26, 2. It is a matter of opinion whether some processes should be classed with fractional crystallization or with fractional precipitation.

1. *Fractional crystallization of the halides.*—The action of alkali fluorides is described in connection with fractional precipitation—*vide infra*. C. Baskerville and R. Stevenson³ also fractionally precipitated the chlorides by saturating a soln. of the chlorides with hydrogen chloride. P. H. M. P. Brinton and C. James obtained good results in the fractional crystallization of the rare earth chlorides from hydrochloric acid (1 : 1).

2. *Fractional crystallization of the bromates.*—C. James⁴ and co-workers introduced a method for the separation of the yttria earths by the fractional crystallization of the bromates. The following method was recommended by C. James:

The rare earth material, generally in the form of the oxalates, is mixed into a paste with sulphuric acid and the temp. raised until the fumes of sulphuric acid cease to be evolved. The residue is then finely powdered, dissolved in ice-cold water, and the resulting soln. poured over an excess of barium bromate. This operation is best carried out in a large evaporating dish placed on the water-bath, care being taken to keep the mass well stirred. After a time the precipitate is allowed to settle and some of the clear liquid taken up by means of a pipette and added to a warm soln. of barium bromate; if no precipitate is obtained the liquid is filtered off. Sometimes, however, a precipitate is formed which consists of barium bromate: and, therefore, it is best to dilute with water and boil. If the precipitate persists, either more stirring or more barium bromate may be required. When the double decomposition is complete a little bromine is often liberated. This is evidently due to the fact that a small amount of bromic acid is formed by the action of a trace of free sulphuric acid accompanying the rare earth sulphates. The latter should, therefore, be

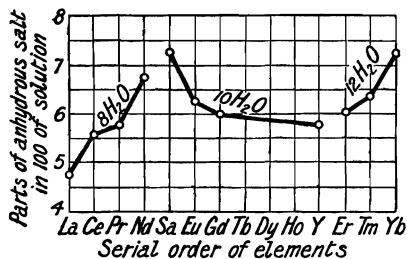

FIG. 5.—Solubilities of the Rare Earth Bromonitrobenzenesulphonates.

well ignited. The filtered liquid is evaporated until a drop, removed on the end of a glass rod, nearly solidifies when stirred on a watch-glass. Under these conditions just about half of the substance in soln. crystallizes out on cooling. After a little experience there is absolutely no difficulty in judging the most convenient concentration. If the fractionation is carried out in porcelain dishes a little water should be sprayed on the surface so as to prevent the top from solidifying to a crystalline mass. Very often, but usually when working with small quantities, the liquid refuses to crystallize or else the crystals separate out as a fine feathery mass, so that it is quite impossible to pour off the mother liquor. If it does not crystallize, the best procedure is to add a trace of the solid, when the whole immediately solidifies, forming the feathery type of crystals as mentioned above. The mass is then carefully heated so as to dissolve all but a very little, which will start the crystallization as the liquid cools. An even better plan is to commence the operation by the addition of a crystal while the liquid is still quite hot. After about twenty crystallizations, the least soluble fraction is colourless and consists of the desired bromate with traces of dysprosium, samarium, holmium, and terbium; the next fractions are yellow, and show the spectral lines of dysprosium and holmium; the next fractions are pink, and they show the erbium lines; there is one fraction mainly thulium; and finally, a very soluble fraction, chiefly yttrium.

The solubilities of the bromates increase in the following order: Sa, (Eu, Gd), Tb, Y, Dy, Ho, Er, Tm, Yb, similar to the order of the solubilities of the oxalates in ammonium oxalate. The order of separation with the bromates decreases with increasing at. wt. from lanthanum to europium, and thereafter increases with increasing at. wt.—*confer* Fig. 6 for the analogous behaviour of the nitrates. By the bromate process, C. James obtained thulium and yttrium bromates of a high degree of purity; L. Jordan and B. S. Hopkins separated terbium from samarium and europium; and H. C. Kremers and C. W. Balke, dysprosium and holmium from yttria earths.

3. *Fractional crystallization of the simple sulphates.*—The method depends on the fact that the sulphates of the rare earths are less soluble in hot water than in cold water, but to varying extents with the different earths. Consequently a sat. soln. of the dihydrated sulphate, made in ice-cold water, furnishes crystals of one or more of the hydrates, $M_2(SO_4)_3 \cdot nH_2O$, as the temp. is raised to 30°–40°. C. G. Mosander⁵ used the process to separate lanthana and ceria, and didymia from lanthana, and it was used by J. C. G. de Marignac, M. Holzmann, C. Czudnowicz, R. Bunsen, C. Wolf, H. Robinson, P. Schützenberger, O. Boudouard, R. H. F. Manaske, etc. W. Muthmann and H. Rölig employed it to separate praseodymium and neodymium. Thorium is easily freed from the rare earths by this method, although the ceria earths are not so readily freed from thorium.

4. *Fractional crystallization of the double sulphates.*—The use of potassium and sodium sulphates as grouping agents for the rare earths has been described in previous sections. Nearly all investigators⁶ on the rare earths have employed one or other of these agents; for cerium, thorium, and zirconium salts give precipitates with potassium sulphate, and the different solubilities of the double potassium sulphates is after used as a means of separating the rare earths from one another. The use of potassium sulphate in separating the ceria and yttria earths dates from M. H. Klaproth's work on ochroite; W. Hisinger and J. J. Berzelius worked simultaneously and independently on the same subject, and J. J. Berzelius later made observations on zirconia and thoria. The rare earths form double sulphates with sodium sulphate, and those formed with the ceria earths are very sparingly soluble in a sat. soln. of alkali sulphate. As indicated in the preceding section, sodium sulphate has been used by M. H. Klaproth, C. Erk, and many others. W. Gibbs, and C. H. Wing tried a number of sulphates other than those of the alkalies, and obtained the best results with luteocobaltic and roseocobaltic ammoniosulphates. The double sulphates are less soluble and crystallize better than those formed with the alkali sulphates. W. Gibbs found that the sulphates of the alkaloids offer no advantages. T. Scheerer, F. Wöhler, R. Hermann, N. Engström, L. F. Nilson, C. Schmidt, H. Rose, W. Gibbs, H. Bührig, J. L. Smith, A. Loöse, F. M. Stapff, R. Fresenius and E. Hintz, etc., utilized the solubility of the double alkali sulphates in dil. acids; W. Hisinger and J. J. Berzelius, and R. J. Meyer and E. Marckwald,

in conc. nitric acid; G. Urbain, L. M. Dennis and E. M. Chamot, W. Muthmann, H. Rölig, and L. Stützel, in soln. of ammonium acetate.

5. *Fractional crystallization of the ethylsulphates.*—In 1898, G. Urbain⁷ described a method for the separation of the yttria earths by the fractional crystallization of the ethyl sulphates. The earths separate in the order terbia, yttria, holmia, dysprosia, erbia, and ytterbia. No free acid should be present, for ethylsulphuric acid is then readily hydrolyzed. The solubilities of the ethylsulphates of the rare earths decrease with increasing at. wt. from lanthanum to neodymium and thereafter increase—confer Fig. 6 for the analogous behaviour of the nitrates. The application of the process has been described in the previous section. By its means, G. Urbain separated dysprosium from a mixture of yttrium, terbium, and dysprosium. C. von Scheele separated lanthanum and praseodymium. K. A. Hofmann and O. Burger obtained erbium from an admixture of thulium, holmium, dysprosium, and erbium; and H. C. Kremers, C. W. Hopkins, and E. W. Engle, dysprosium from a mixture of neodymium, praseodymium, and terbium, but it did not separate satisfactorily holmium and dysprosium. W. Muthmann and E. Baur employed the process for fractionating yttria earths. G. Urbain recommended separating the rare earths into three groups—ceria, terbia, and yttria earths—by means of the ethylsulphate process in preference to the potassium sulphate process.

6. *Fractional crystallization of the nitrates.*—In 1896, E. Demarçay⁸ separated gadolinium and samarium by crystallization of the nitrates from conc. nitric acid of sp. gr. 1.30 to 1.54. The method gives good results with earths of at. wt. less than that of dysprosium (162.5). This is due to the fact that the solubilities of the nitrates in nitric acid decrease with increasing at. wt. as shown diagrammatically in Fig. 6, until gadolinium nitrate is reached, when after that, the solubilities increase with increasing at. wt. up to a maximum with ytterbium nitrate. E. Baur and R. Marc obtained good results with gadolinium and ytterbium; J. Blumenfeld and G. Urbain obtained ytterbium of a high degree of purity after 4000 fractionations; and with 15,000 fractionations of the ytterbium nitrate, G. Urbain separated it into lutecium and ytterbium, and from the mother liquor he obtained celtium. K. Bröckelmann obtained a didymium preparation which could not be fractionally crystallized by the usual methods, but with alcohol as solvent furnished scandium and yttrium. O. L. Barnebey fractionated the basic nitrates from acetone soln. and obtained cerium in the first fraction, didymium in the last one.

7. *Fractional crystallization of the double nitrates.*—(i) *The double ammonium nitrates*, $R(\text{NO}_3)_3 \cdot 2\text{NH}_4\text{NO}_3 \cdot 4\text{H}_2\text{O}$, were first used by D. I. Mendeléeff for the separation of lanthanum and didymium; and C. A. von Welsbach subsequently modified the process by crystallizing from nitric acid instead of from aq. soln. The method has been outlined in the previous section, and it has been extensively employed. C. James and others have used it in separating lanthanum and praseodymium; M. Esposito, lanthanum, praseodymium, and neodymium, etc. C. von Scheele modified the process by using ceria as *l'élément séparateur*.

(ii) C. A. von Welsbach, and C. von Scheele tried substituting sodium nitrate for ammonium nitrate, for separating lanthanum and praseodymium from neodymium, but the *double sodium nitrate* method was not economical or efficient, since the separation is too slow.

(iii) E. Demarçay employed a process based on the fractional crystallization of the *double magnesium nitrates*, $2R(\text{NO}_3)_3 \cdot 3\text{Mg}(\text{NO}_3)_2 \cdot 24\text{H}_2\text{O}$, from nitric acid of sp. gr. 1.3. The process has been described in the preceding section. According to W. Muthmann and L. Weiss,⁹ with the yttria earths the separation from water is in the order: La, Pr Nd, Sa, Eu, Er, Gd, Y, and the remaining yttria earths.

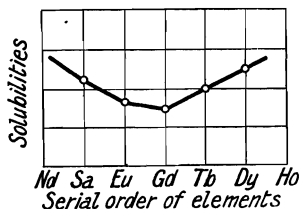

FIG. 6.—Solubilities of the Rare Earth Nitrates (Diagrammatic).

G. P. Drossbach used the process for the separation of neodymium and praseodymium; W. Feit, for the separation of terbium from monazite; and C. James, for the initial separation of the ceria earths.

(iv) G. Urbain and H. Lacombe¹⁰ employed a process based on the fractional crystallization of the *double bismuth nitrates*. The bismuth also acts as *l'élément séparateur*. The process has been outlined in the preceding section. G. Urbain and H. Lacombe applied the process to the separation of gadolinium from the yttria earths; G. Urbain, to the separation of lanthanum and cerium from a mixture of ytterbium, lanthanum, lutecium, and cerium; G. Urbain and H. Lacombe, C. James and J. E. Robinson, and G. Eberhard, to the preparation of europium; and G. Urbain to the separation of terbium and gadolinium.

(v) G. Urbain¹¹ fractionally crystallized the *double nickel nitrates*, $2R(NO_3)_3 \cdot 3Ni(NO_3)_2 \cdot 24H_2O$, in order to separate traces of europium and terbium from gadolinium as indicated in the preceding section. When the soln. of the mixed earths is treated with nickel nitrate, the nickel gadolinium salt separates in a high degree of purity. The continued fractionation of the mother liquid furnishes terbium also of a high degree of purity.

(vi) H. Lacombe,¹² and C. James found that when the *double manganese nitrates*, $2R(NO_3)_3 \cdot 3Mn(NO_3)_2 \cdot 24H_2O$, are fractionally crystallized a good separation of neodymium and praseodymium from each other, and from lanthanum and samarium, is obtained, and this more quickly than with E. Demarçay's process—*vide supra*. The fractionation is best carried out in nitric acid of sp. gr. 1.3; the volume of the mother liquid should be maintained almost constant, and be very small in comparison with the bulk of crystalline matter separated. The formation of crystals may be initiated by a nucleus of the isomorphous bismuth manganese nitrate. C. James also recommended the process for the separation of neodymium and praseodymium.

8. *Fractional crystallization of the formates*.—Like the double potassium sulphates, the formates serve for separating the terbia earths. The formates of the ceria earths are much less soluble than those of the yttria earths. P. T. Cleve¹³ gave 1 : 421 for the solubility of lanthanum formate in water; 1 : 360 for cerium formate; and 1 : 220 for didymium formate—J. C. G. de Marignac gave between 1 : 128 and 1 : 160 for the latter. According to B. Brauner, when a soln. of the rare earth formates is evaporated, the formates of the ceria earths separate first, then follow those of the terbia earths, while those of the yttria earths remain in soln. M. Delafontaine applied the method to the terbia earths and obtained *philippia* from the mother liquor. G. Urbain separated neodymium and praseodymium formates; A. Bettendorff separated the yttria earths into three groups; and J. Sterba-Böhm removed the last traces of ytterbium from scandium by the fractional crystallization of the formates. G. Urbain showed that *philippia* is a mixture of terbia and yttria which cannot be completely separated as formates—*vide* fractional precipitation.

9. *Fractional crystallization of the acetates*.—N. J. Berlin¹⁴ observed that by the repeated crystallization of the so-called yttrium acetate, the rose-coloured crystals became colourless. J. F. Bahr and R. Bunsen also found that by the fractional crystallization of the acetates of erbium and yttrium the first crop of crystals was richer in erbium than the later crops. O. Popp, M. Delafontaine, C. Benedicks, and others made observations on this subject. The yttrium acetates are less soluble than those of the cerium group. K. T. Postius separated mixtures of yttria and terbia earths by the fractional crystallization of the acetates.

10. *Fractional crystallization of the acetylacetonates*.—G. Urbain¹⁵ showed that the acetylacetonates of the rare earths, $R[CH(COOCH_3)_2]_3$, crystallize well, and he applied the fact to the purification of thoria. The mixed hydroxides were first dissolved in nitric acid, and the soln. evaporated to dryness on a water-bath, the residue was dissolved in water, and treated with sodium acetylacetonate, and again evaporated to dryness. The residue, crystallized from its soln. in chloroform, furnished thoria of a high degree of purity. G. Urbain also fractionated the rare

earths from monazite by this process using absolute alcohol as solvent. K. A. Hofmann likewise separated erbium from holmium and dysprosium; and R. J. Meyer and A. H. Winter, scandium from the rare earths in wolframite.

11. *Fractional crystallization of the dimethylphosphates.*—J. C. Morgan and C. James¹⁶ found that with dimethylphosphoric acid the rate of separation of the rare earths is vastly greater than with that of practically all the methods given up to the present time. Lanthanum, cerium, praseodymium, neodymium are left at once in the mother liquor. Samarium, europium, and gadolinium are much less soluble than those previously mentioned, while they are more soluble than terbium, dysprosium, and holmium. Erbium, thulium, yttrium, ytterbium, etc., collect in the least soluble portions. Since the solubilities of these compounds are the reverse of the usual type, they may be used for the rapid purification of many of the rare earths. For instance, we can easily remove traces of neodymium from samarium by this means, as the samarium dimethyl phosphate separates before the neodymium compound. It is necessary to state that there is some inconvenience when working with the salts of dimethyl phosphoric acid, since they undergo a very gradual decomposition. A gelatinous precipitate is formed, very slowly, in the case of the rare earths, which filters with difficulty.

12. *Fractional crystallization of the picrates.*—L. M. Dennis¹⁷ and co-workers recommend crystallization from a hot soln. of the hydroxides in picric acid for separating erbia and holmia from the didymia and yttria earths previously freed from ceria and thoria. It is also said to be an "excellent means of effecting a rapid concentration of praseodymium and neodymium practically free from erbium and holmium, and the concentration of erbium and holmium with but a relatively small amount of the members of the didymium group." P. S. Willand and C. James found that for the separation of erbia from yttria, the method does not compare favourably with other processes.

13. *Fractional crystallization of the m-nitrobenzenesulphonates.*—O. Holmberg¹⁸ found that the *m*-nitrobenzenesulphonates of the cerium earths crystallize very well, and he successfully separated and purified neodymium as *m*-nitrobenzenesulphonate. C. Garnier also found this a speedy method for separating neodymium from mixtures with samarium and praseodymium. P. S. Willand and C. James tried the diphenylmonosulphonates for separating erbia from yttria, but no special advantages were observed.

14. *Fractional crystallization of sulphanilates.*—L. Stützel¹⁹ separated neodymium from praseodymium by the fractional crystallization of soln. of the oxides in sulphanilic acid. K. T. Postius also removed the last traces of didymia from erbia by this means. This method has nothing to recommend it in preference to other more efficacious processes.

II. Separation by fractional precipitation.—In these methods the mixed earths are dissolved and then gradually concentrated by precipitation in stages as indicated in the preceding section.

1. *Fractional precipitation by ammonia.*—The method was employed by J. J. Berzelius,²⁰ C. G. Mosander, M. Delafontaine, O. Popp, P. T. Cleve, W. Crookes, B. Brauner, L. de Boisbaudran, etc.—*vide supra*. K. A. Hofmann and O. Burger used the same method for removing traces of thulium, holmium, and dysprosium from erbium. Ammonia effects a separation strictly in the order of the basicity of the bases. Starting with the weakest, *i.e.* the base first to be precipitated, the order is Zr, Th, Ce (ous), Sc, Yb, Tm, Er, Ho, Dy, Tb, Y, Sa, Gd, Nd, Pr, Ce (ic), La. There are, however, considerable differences of opinion in detail. R. Marc, P. Truchot, L. de Boisbaudran, A. Bettendorff, C. Benedicks, K. T. Postius, C. G. Mosander, G. Krüss and K. A. Hofmann, A. Loose, R. Hermann, G. Urbain, and W. Muthmann and co-workers give a different order. W. A. A. Prandtl and J. Rauchenberger show that the reaction $RCl_3 + 3NH_3 + 3H_2O \rightleftharpoons R(OH)_3 + 3NH_4Cl$ is reversible. W. A. A. Prandtl and co-workers examined the effect of cadmium and cobalt on the basic precipitation.

2. *Fractional precipitation by alkali hydroxides.*—The main features of the process are the same as those with the ammonia precipitation. A dil. soln. of sodium hydroxide was found by G. P. Drossbach²¹ to give good results in separating didymium from lanthanum, and in fractionating a mixture of the erbia earths which had been previously treated by the magnesia process. B. Brauner and F. Pavlicek used it for purifying lanthanum earths, and H. Behrens, for cerium earths.

3. *Fractional precipitation by organic bases.*—In this connection *aniline* has been used more than the other organic bases. In applying the process, a neutral soln. of the chlorides in 50 per cent. alcohol, at say 90°, is treated with a 2 per cent. soln. of aniline in 50 per cent. alcohol. The method was used by K. A. Hofmann and O. Burger²² for separating holmium, thulium, and dysprosium from erbium; by G. Krüss for fractionating holmia earths; and by A. Kolb for purifying thoria. A. Loose tested didymium for homogeneity by fractional precipitation with aniline. A number of other bases—*o-toluidine, xylidine, dimethylaniline, diethylaniline, benzylamine, pyridine, quinoline, piperidine, phenylhydrazine, dimethylamine, triethylamine, diphenylamine, naphthylamine, m-chloro-aniline, benzidine, picoline*, etc.—have been tried by A. McM. Jefferson, B. L. Hartwell, G. Krüss and co-workers, and K. A. Hofmann. Some might give good results in special separations.

With respect to cerium, lanthanum, neodymium, praseodymium, thorium and zirconium, B. L. Hartwell found (i) *benzylaniline, dimethylnitrosamine, dipropylnitrosamine, o-, m- and p-nitroaniline, p-nitrophenylhydrazine, o-chloro-aniline, piperidine, succinimide, and tetranitromethylamine* precipitated none of the six bases from their soln.; (ii) *Allylamine, benzylmethylamine, bornylamine, camphylamine, diamylamine, dibenzylamine, diethylamine, dimethylamine, dipropylamine, ethylenediamine, heptylamine, hexylamine, isobutylamine, isotributylamine, isodibutylamine, monoamylamine, monoethylamine, monomethylamine, monopropylamine, neurine, normal butylamine, normal dibutylamine, propylenediamine, tetraethylammonium hydroxide, tetramethylammonium hydroxide, triethylamine, trimethylamine, tripropylamine*, give precipitates with salts of all six earths; and *benzidine, m-bromo-aniline, p-bromo-aniline, p-bromo-phenylhydrazine, p-chloro-aniline, isoquinoline, a-picoline, p-toluidine, m-tolylenediamine, tribenzylamine*, give precipitates only with thorium and zirconium salts. The chloro-anilines and hexamethylene-tetramine appeared the most suitable of the bases tried for the separation of thorium from zirconium, whilst *p-toluidine* gave promising results in the separation of zirconium and thorium from lanthanum, neodymium, and praseodymium. J. Köppel²³ dissolved a mixture of rare earths in a soln. of hydrogen chloride in methyl alcohol, and added pyridine. Crystals of cerium pyridine chloride, $(C_5H_5NH)_2CeCl_6$, separate, and they can be purified by recrystallization from a mixture of alcohol and ether.

4. *Fractional precipitation by magnesia.*—C. Czudnowicz²⁴ tried to fractionate the ceria earths by boiling the nitrate with magnesia. G. P. Drossbach suggested using magnesia in place of ammonia or alkali hydroxide, and he found that the earths are precipitated in the order of their different basicities. Magnesia is gradually added to a boiling soln. of the nitrates, until the filtrate no longer shows the spectral bands of didymium. W. Muthmann and H. Rölzig thus separated lanthanum from didymium in a single operation, but the yield was poor. The precipitation can be conducted in a series of stages whereby the least basic element will be found in the first fractions, and the most basic element in the last fraction. G. P. Drossbach separated yttria from the yttria earths by this process.

5. *Fractional precipitation by cuprous oxide.*—L. de Boisbaudran²⁵ claimed to separate thoria from the other rare earths by the following process:

Boil for a few minutes the soln. mixed with copper turnings and acidified with a few drops of hydrochloric acid, so as to reduce the weakly basic ceric salt to the strongly basic cerous salt. Add a slight excess of finely powdered cuprous oxide, and boil the mixture for an hour.

The precipitated thoria contains a little ceria which can be removed by two or three repetitions of the process. The copper is removed by hydrogen sulphide.

G. P. Drossbach, P. Schützenberger and O. Boudouard, and G. Urbain examined the process. The latter found that cuprous oxide does not precipitate all the thoria from the soln.

6. *Fractional precipitation by basic oxides.*—C. A. von Welsbach²⁶ devised an important process—*Welsbach's basic oxide process*—in which the oxides of the rare earths themselves act as basic oxide, like the magnesia in the above-described process, and so hasten the formation of sparingly soluble basic salts of elements of weakened basicity. The process differs in details according to the particular mixture employed. For the mixed ceria and yttria earths, the process is conducted as follows :

Dissolve, say, 100 grms. of the mixed ceria and yttria earth oxides in the minimum quantity of nitric acid for dissolution ; and add gradually a paste made from another 100 grms. of the same oxides. Care must be taken that at no point is all the oxide dissolved. The soln. should have a syrupy consistency and contain some undissolved oxide ; it also becomes hot owing to chemical action. On cooling, most of the yttrium and erbium will be found as basic nitrate in the crys'alline precipitate. Enough nitric acid is added to change the colour of the soln. red, and to dissolve all the residual oxide and carbonate. The basic nitrates are insoluble. A rose-coloured precipitate forms in a few hours, and sets to a hard mass. The mother liquid is decanted off, and the residue extracted with alcohol to remove normal nitrates from the basic nitrates containing the erbia group, some scandia, and some ytterbia ; the soln. contains nitrates of yttrium and ceria earths. The ceria can be removed by the basic nitrate process. The separation of the yttria earths can be continued by repeating the process.

G. P. Drossbach used the process for the yttria earths ; P. Schottländer for the ceria earths ; and G. P. Drossbach, H. Behrens, W. Muthmann and L. Weiss, P. Schottländer, and C. R. Böhm for separating lanthana and didymia. It has also been described in the preceding section.

7. *Fractional precipitation by alkali azides.*—L. M. Dennis²⁷ and co-workers added a 0.3 per cent. soln. of potassium or sodium azide to a cold soln. of earth containing thoria, and on boiling found thoria to be precipitated as hydroxide : $\text{Th}(\text{NO}_3)_4 + 4\text{NaN}_3 + 4\text{H}_2\text{O} = \text{Th}(\text{OH})_4 + 4\text{NaNO}_3 + 4\text{HN}_3$; but G. N. Wyrouboff and A. Verneuil did not get the same results.

8. *Fractional precipitation by sulphurous acid or sulphites.*—M. H. Klaproth,²⁸ and N. J. Berlin utilized the fact in analytical work that sulphurous acid or soluble sulphites give precipitates with some metal salt soln., and P. Berthier first applied the reaction to salts of the rare earths. When a sat. soln. of sodium sulphite is added to neutral soln. of rare earths and thoria, the ceria and yttria earths are precipitated, but thoria remains in soln. ; on the contrary, sodium hydrosulphite precipitates thoria from a cold soln., but does not precipitate the ceria earths. J. P. Bonardi and C. James precipitated the yttria earths from boiling soln. mixed with potassium sulphite. The reactions have been utilized by H. Grossmann, and A. Batek for purifying thoria, and separating thoria from ceria earths. The reaction has also been applied by R. Hermann, W. Henneberg, C. Erk, C. Baskerville, W. Buddäus and co-workers, H. Geisow and P. Horkheimer, and R. Chavastelon.

9. *Fractional precipitation by sodium thiosulphate.*—N. J. Berlin²⁹ found that the yttria earths are not precipitated from their soln. by sodium thiosulphate ; F. Chancel, R. Hermann, F. Stromeyer, M. Weibull, K. Rördam, and P. T. Cleve found that zirconia is precipitated under these conditions ; and W. C. Brögger, and O. Boudouard used the process to separate zirconium from titanium. J. J. Chydenius found that when a soln. of sodium thiosulphate is added to a soln. of the rare earths, thorium thiosulphate is precipitated when the soln. is boiled, while the rare earths remain in soln. W. Crookes noted that some yttria is carried down with the precipitate. P. T. Cleve found that scandia is readily but not completely precipitated under these conditions ; samaria is not precipitated. R. Bunsen, and G. Urbain have utilized the reaction to separate thoria from the rare earths—*vide supra*. P. H. M. P. Brinton and C. James did not recommend the basic thiosulphate process for the separation of the erbia earths.

10. *Fractional precipitation as fluorides or fluosilicates.*—J. J. Berzelius,³⁰ and J. J. Chydenius noted that the addition of hydrofluoric acid or of normal or acid alkali fluorides to thorium salts gives a gelatinous precipitate of thorium fluoride.

The precipitation is almost quantitative. J. J. Chydenius, and A. Rosenheim and co-workers studied zirconium fluoride. While the rare earth fluorides are insoluble in an excess of hydrofluoric acid or soln. of alkali fluorides, zirconium fluoride is readily soluble under these conditions. When hydrofluoric acid or potassium fluoride is added to a soln. of salts of the rare earths containing zirconium and titanium the fluorides of these elements are all precipitated; and when fused with potassium hydrofluoride, and the cold cake extracted with water, the zirconium and titanium are dissolved while the rare earth fluorides remain as a residue. The solubility of the rare earth fluorides in a large excess of conc. acid increases with the electropositive character of this metal, the fluorides of the more negative elements being least soluble. Hence, thoria and scandia may be conc. to a large extent by repeated precipitation with hydrofluoric acid in acid soln. As shown by F. Stolba, the fluosilicates of the rare earths form gelatinous precipitates when hydrofluosilicic acid or alkali fluosilicate is added to a boiling neutral soln. of the rare earth salt. In the presence of mineral acids, the precipitation does not occur in the cold. The cerium fluosilicate is hydrolyzed to the fluoride; the yttrium elements are held in soln. by the mineral acid; the scandium salt is precipitated. R. J. Meyer used this process for separating scandia from the rare earths—*vide* scandium. J. Sterba-Böhm used ammonium fluoride to separate scandia from the hydrochloric acid soln. of wolframite residues.

11. *Fractional precipitation of the chlorides and oxychlorides.*—J. J. Berzelius³¹ noted the hydrolysis of a soln. of zirconium chloride, and on boiling a basic chloride was precipitated. G. H. Bailey separated iron from zirconium by boiling the mixed chlorides; zirconium oxychloride is precipitated and the iron remains in soln. G. Krüss and L. F. Nilson, F. P. Venable, O. Hauser, and J. M. Matthews also studied the reaction with zirconium. G. P. Drossbach dissolved the mixed erbia and yttria earths in hydrochloric acid, and added more of the mixed oxides until the soln. showed no more erbium spectral bands. The mixture was heated some hours on a water-bath, mixed with a large proportion of boiling water, and allowed to settle. The precipitate contained all the erbia, and it was repeatedly boiled with a soln. of ammonium chloride to remove traces of entrained yttrium. The same method was used for separating praseodymium and neodymium. J. C. G. de Marignac found that when a mixture of the lanthanum, didymium, etc., chlorides is heated some of the earths form oxychlorides, others not. When the residue is treated with water, the earths can be separated. P. H. M. P. Brinton and C. James did not recommend the *basic chloride process* for the separation of the erbia earths. M. Fronstein and J. Mai used the process for the initial separation of the monazite earths. The process has been modified by H. Behrens, F. Frerichs, etc. C. James and co-workers tried the process for the separation of erbia from yttria earths. C. Baskerville and R. Stevenson fractionally precipitated neodymium and lanthanum by passing hydrogen chloride into the soln. W. Gibbs tried *bromides* in place of chlorides.

12. *Fractional precipitation with iodates.*—N. J. Berlin³² observed that yttria earths are precipitated as an amorphous white powder by alkali iodates; and P. T. Cleve noted that zirconium and thorium are likewise precipitated quantitatively as iodates under similar conditions. When calcined, the iodates pass into oxides. R. J. Meyer and J. Wuorinen, and H. C. Holden and C. James found that on the addition of a soln. of potassium iodate, drop by drop, to a hot soln. of the nitrates, acidified with nitric acid, yttrium iodate is precipitated last; and when iodic acid is added to a soln. of scandium and thorium salts, most of the thorium is precipitated, while the scandium remains in soln.

13. *Fractional precipitation by ammonium or alkali carbonates.*—In 1802, M. H. Klaproth³³ showed that white yttria earths are precipitated from soln. of their salts by potassium, sodium, or ammonium carbonate, and the precipitate is soluble in an excess of the reagent. The precipitate with dil. soln. of carbonate is a simple rare earth carbonate, but with a conc. soln., a double carbonate is produced:

in the preliminary fractionation of the yttria earths soluble in a sat. soln. of sodium sulphate is employed. This fraction contains thulium, ytterbium, lutecium, and celtium, it shows the absorption bands of thulium, and mere traces of those of erbium. As a rule ytterbia largely predominates in this fraction. The thulium is separated by continuing the fractionation of the bromates at a temp. of about 16°; at higher temp., the soln. employed are so conc. that they solidify on cooling. The soln. are very liable to supersaturation, and crystallization has to be started by seeding. C. James found that during the first few series, erbium rapidly separates in the least soluble portion, after which the other fractions become coloured greenish. As soon as the mother liquors fail to give any thulium absorption bands, when examined in a sat. soln. of about 10 cms., they are placed aside for the separation of ytterbium, etc. Thulium is found to collect in the fractions between erbium and ytterbium. The soln. become coloured a faint bluish-green and show a very intense absorption spectrum consisting of three bands. If very great care be taken, dil. alcohol can be used as solvent for a short time—best towards the end of the work. However, it soon shows signs of being attacked by the bromate.

(vii) *Isolation of ytterbium and lutecium.*—These three elements are contained in the mother liquor remaining after the separation of thulium. This can be fractionated by continuing the bromate process, provided the soln. do not become basic. G. Urbain fractionated the nitrates from nitric acid. Lutecium is more soluble than ytterbium. Lutecium salts have not yet been obtained of even a moderate degree of purity.

REFERENCES.

- ¹ E. Rimbach and A. Schubert, *Zeit. phys. Chem.*, **67**, 183, 1909; B. Brauner, *Journ. Chem. Soc.*, **73**, 951, 1898; O. Hauser and F. Wirth, *Zeit. anal. Chem.*, **47**, 389, 1908; R. J. Meyer and O. Hauser, *Die Analyse der seltenen Erden und Erdsäuren*, Stuttgart, 61, 1912; R. J. Meyer and A. Wassjuchnof, *Zeit. anorg. Chem.*, **86**, 257, 1914; F. Wirth, *ib.*, **58**, 213, 1908; **76**, 174, 1912; **79**, 357, 1913; **87**, 1, 1914; A. Job, *Compt. Rend.*, **126**, 246, 1898; C. James, *Journ. Amer. Chem. Soc.*, **34**, 757, 1912; C. R. Böhm, *Die Verwendung der seltenen Erden*, Leipzig, 5, 1913; *Pharm. Zig.*, **47**, 737, 1902.
- ² M. Delafontaine, *Chem. News*, **75**, 229, 1897; C. James, *Journ. Amer. Chem. Soc.*, **33**, 1332, 1911; **35**, 235, 1913; W. B. Hicks, *ib.*, **33**, 1492, 1911; C. James and A. J. Grant, *ib.*, **38**, 41, 1916; G. Urbain, *Compt. Rend.*, **152**, 141, 1911; *Ann. Chim. Phys.*, (7), **19**, 202, 1900; L. F. Nilson, *Ber.*, **13**, 1430, 1880; G. Krüss and L. F. Nilson, *ib.*, **20**, 1676, 1887; H. E. Roscoe, *ib.*, **15**, 1274, 1882; J. L. Smith, *Chem. News*, **48**, 13, 29, 1883; **51**, 289, 304, 1885; W. Gibbs, *Amer. Journ. Science*, (2), **37**, 355, 1864; J. Barlot and E. Chauvenet, *Compt. Rend.*, **157**, 1153, 1913; C. R. Böhm, *Zeit. angew. Chem.*, **15**, 372, 1902; the opening up and analysis of these minerals is discussed by J. W. Mellor, *A Treatise on Quantitative Inorganic Analysis*, London, 160, 503, 1913.
- ³ E. Hintz and H. Weber, *Zeit. anal. Chem.*, **36**, 213, 1897; P. Drossbach, *Zeit. angew. Chem.*, **14**, 655, 1901; E. Benz, *ib.*, **15**, 297, 1902; O. Hauser and F. Wirth, *ib.*, **22**, 484, 1909; C. Glaser, *Zeit. anal. Chem.*, **36**, 213, 1897; R. Finkener, *ib.*, **3**, 369, 1864; N. Engström, *Zeit. Kryst.*, **3**, 191, 1879; W. Blomstrand, *ib.*, **15**, 99, 1889; H. Bäckström, *ib.*, **16**, 83, 1890; C. Jones, *Amer. Chem. Journ.*, **20**, 345, 1898; H. Gorceix, *Compt. Rend.*, **100**, 357, 1885; M. Holzmann, *Journ. prakt. Chem.*, (1), **75**, 321, 1858; R. Ruer, *Zeit. anorg. Chem.*, **42**, 87, 1904; R. J. Meyer and R. Jacoby, *ib.*, **27**, 364, 1901; L. F. Nilson, *Ber.*, **13**, 1437, 1880; P. T. Cleve and M. Höglund, *ib.*, **6**, 1468, 1873; N. J. Berlin, *Pogg. Ann.*, **43**, 111, 1838; O. Hauser, *Zeit. anal. Chem.*, **47**, 677, 1908; H. C. Kremers, *School Science*, **17**, 622, 1917.
- ⁴ P. T. Cleve, *Bull. Soc. Chim.*, (2), **43**, 53, 1885; G. Wyruboff and A. Verneuil, *ib.*, (3), **19**, 219, 1898; *Chem. News*, **77**, 245, 1898; *Compt. Rend.*, **126**, 340, 1898; **127**, 412, 1898; **128**, 1331, 1899; L. de Boisbaudran, *ib.*, **100**, 605, 1864; E. Benz, *Zeit. angew. Chem.*, **15**, 297, 1902.
- ⁵ J. J. Chydenius, *Pogg. Ann.*, **119**, 46, 1863; R. Hermann, *Journ. prakt. Chem.*, (1), **93**, 106, 1864; G. P. Drossbach, *Zeit. angew. Chem.*, **14**, 655, 1901; O. Hauser and F. Wirth, *ib.*, **22**, 484, 1909; E. Hintz and H. Weber, *Zeit. anal. Chem.*, **36**, 27, 213, 617, 1897; C. Glaser, *Journ. Amer. Chem. Soc.*, **18**, 782, 1896; *Chem. Zig.*, **20**, 612, 1896; *Chem. News*, **75**, 145, 157, 1897; S. J. Johnstone, *Journ. Soc. Chem. Ind.*, **33**, 56, 1914.
- ⁶ J. F. Bahr, *Liebig's Ann.*, **132**, 231, 1864; E. Hintz and H. Weber, *Zeit. anal. Chem.*, **36**, 27, 1897; P. Drossbach, *Zeit. angew. Chem.*, **14**, 655, 1901; E. Benz, *ib.*, **15**, 297, 1902; T. Scheerer, *Pogg. Ann.*, **56**, 498, 1842; **51**, 470, 1840; C. F. Rammelsberg, *ib.*, **108**, 48, 1859; H. Rose, *ib.*, **118**, 502, 1863; T. Thomson, *Trans. Roy. Soc. Edin.*, **6**, 371, 1811; A. Connell, *Edin. Phil. Journ.*, **20**, 300, 1842; R. Hermann, *Journ. prakt. Chem.*, (1), **82**, 387, 1861; M. Holzmann, *ib.*, (1), **84**, 78, 1861; T. Lange, *ib.*, (1), **82**, 135, 1861; M. Delafontaine, *Liebig's Ann.*, **131**,

105, 1864; J. Brush and S. L. Penfield, *Amer. Journ. Science*, (3), **25**, 459, 1883; G. Bodmann, *Zeit. anal. Chem.*, **27**, 251, 1901; H. du Bois and O. Liebcknecht, *Ber.*, **32**, 3346, 1899; C. Glaser, *Journ. Amer. Chem. Soc.*, **18**, 782, 1896; *Chem. Ztg.*, **20**, 612, 1896; *Chem. News*, **75**, 145, 157, 1914; O. Hauser, *Zeit. anal. Chem.*, **47**, 665, 1908.

⁷ T. O. Smith and C. James, *Journ. Amer. Chem. Soc.*, **34**, 281, 1912; F. J. Metzger, *ib.*, **24**, 906, 1902; A. C. Neish, *ib.*, **26**, 780, 1904; R. J. Carney and E. D. Campbell, *ib.*, **36**, 1134, 1914; A. McM. Jefferson, *ib.*, **24**, 540, 1902; B. L. Hartwell, *ib.*, **25**, 1128, 1903; L. M. Dennis, *ib.*, **18**, 947, 1896; L. M. Dennis and F. L. Kortright, *Amer. Chem. Journ.*, **16**, 79, 1894; G. Urbain, *Ann. Chim. Phys.*, (7), **19**, 184, 1900; *Bull. Soc. Chim.*, (3), **15**, 338, 347, 1896; G. Wyruboff and A. Verneuil, *ib.*, (3), **7**, 679, 1887; (3), **19**, 219, 1898; *Ann. Chim. Phys.*, (8), **6**, 484, 1905; *Compt. Rend.*, **126**, 340, 1898; **127**, 412, 1898; R. Chavastelon, *ib.*, **130**, 781, 1900; O. Knöfler, *German Pat.*, *D.R.P.* 266459, 1912; W. B. Giles, *Chem. News*, **92**, 1, 1905; A. Kolb and H. Ahrle, *Zeit. angew. Chem.*, **18**, 92, 1905; R. J. Meyer and M. Speter, *Chem. Ztg.*, **34**, 306, 1910; R. J. Meyer, *Zeit. anorg. Chem.*, **71**, 65, 1911; A. Batek, *ib.*, **45**, 87, 1905; H. Grossmann, *ib.*, **44**, 229, 1905; F. J. Metzger and F. W. Zons, *Journ. Ind. Eng. Chem.*, **4**, 493, 1912; M. Koss, *Chem. Ztg.*, **36**, 686, 1912; A. Rosenheim, *ib.*, **36**, 821, 1912; F. Wirth, *ib.*, **37**, 773, 1913; *German Pat.*, *D.R.P.* 268866, 1913; L. de Boisbaudran, *Compt. Rend.*, **99**, 525, 1884; F. Garelli and G. A. Barbieri, *Zeit. angew. Chem.*, **19**, 895, 1906; *Chem. Ztg.*, **30**, 433, 1906; C. R. Böhm, *Chem. Ind.*, **29**, 452, 1906; W. Muthmann and E. Baur, *Ber.*, **33**, 2029, 1900; E. Baur, *German Pat.*, *D.R.P.* 120013, 1900; *Zeit. angew. Chem.*, **14**, 476, 1901; O. N. Witt, *Chem. Ind.*, **17**, 161, 1894; *Ueber den Cergehalt der Thorsalze*, Berlin, 1897; T. Curtius and A. Darapsky, *Journ. prakt. Chem.*, (2), **61**, 408, 1900.

⁸ W. Crookes, *Select Methods in Chemical Analysis*, London, 139, 1905; C. A. Joy, *Amer. Journ. Science*, (2), **36**, 83, 1863; *Chem. News*, **8**, 183, 197, 1863; L. Weiss and M. Landecker, *Zeit. anorg. Chem.*, **64**, 65, 1909; *Chem. News*, **101**, 2, 13, 26, 1910.

⁹ J. J. Berzelius and J. G. Gahn, *Schweigger's Journ.*, **16**, 244, 1816; O. Boudouard, *Compt. Rend.*, **126**, 900, 1898; *Bull. Soc. Chim.*, (3), **19**, 332, 1898; G. Urbain, *ib.*, (3), **19**, 331, 1898; *Ann. Chim. Phys.*, (7), **19**, 251, 1900; J. C. G. de Marignac, *ib.*, (5), **20**, 535, 1880; M. H. Klaproth, *ib.*, (1), **49**, 256, 1803; *Gehlen's Ann.*, **2**, 312, 1804; J. J. Berzelius and W. Hisinger, *ib.*, **2**, 407, 1804; *Ann. Chim. Phys.*, (1), **50**, 245, 1803; K. A. Hofmann, *Ueber die Terbinerde*, München, 1893; L. M. Dennis and E. M. Chamot, *Journ. Amer. Chem. Soc.*, **19**, 799, 1897; C. James, *ib.*, **34**, 757, 1912; **35**, 235, 1913; A. Bettendorff, *Liebig's Ann.*, **263**, 164, 1891; W. Muthmann and H. Rölig, *Ber.*, **31**, 1718, 1898; G. P. Drossbach, *ib.*, **29**, 2452, 1896; **33**, 3506, 1900; *Chem. News*, **74**, 274, 1896; L. de Boisbaudran, *Compt. Rend.*, **102**, 902, 1003, 1886; M. Delafontaine, *ib.*, **93**, 63, 1881; E. Demarçay, *ib.*, **130**, 1019, 1185, 1900; N. J. Berlin, *Pogg. Ann.*, **43**, 105, 1834; J. J. Berzelius, *ib.*, **3**, 209, 1825; **4**, 135, 1825; C. G. Mosander, *Phil. Mag.*, (3), **25**, 241, 1843; C. Erk, *Zeit. Chem.*, (2), **7**, 109, 1871; *Zeit. anal. Chem.*, **10**, 477, 1871; W. Gibbs, *Amer. Journ. Science*, (2), **37**, 354, 1864; J. L. Smith, *Amer. Chem. Journ.*, **5**, 44, 53, 1883; *Chem. News*, **48**, 29, 1883; R. J. Meyer, *Zeit. anorg. Chem.*, **71**, 65, 1911.

¹⁰ C. James, *Journ. Amer. Chem. Soc.*, **30**, 182, 1908; **34**, 757, 1912; C. James and A. L. Pratt, *ib.*, **33**, 1326, 1911; E. Demarçay, *Compt. Rend.*, **122**, 728, 1896; **130**, 1019, 1185, 1900; G. Urbain, *ib.*, **138**, 84, 1904; **140**, 583, 1905; C. A. von Welsbach, *Monatsh.*, **6**, 477, 1885; H. Lacombe, *Bull. Soc. Chim.*, (3), **31**, 570, 1904; *Chem. News*, **89**, 277, 1904; W. Muthmann and C. R. Böhm, *Ber.*, **33**, 12, 1900; A. Damour and H. St. C. Deville, *Compt. Rend.*, **59**, 270, 1864; *Bull. Soc. Chim.*, (2), **2**, 339, 1864.

§ 6. The Processes Employed in Resolving the Rare Earths into their Component Earths

C. R. Böhm, in his *Die Darstellung der seltenen Erden* (Leipzig, 1905), reviews the methods which have been employed in resolving the rare earths into their components. He classifies these methods: I. Separation by fractional crystallization—*A*, simple salts; *B*, complex salts. II. Separation by fractional precipitation—*A*, basic salts; *B*, hydroxides and salts. III. Separation by oxidation processes—*A*, in the dry way; *B*, in the wet way. IV. Separation by physical methods. The following outline is based on that of C. R. Böhm.

Since fractional crystallization or precipitation usually involves the frequent repetition of the same operations, it is important to reduce the necessary operations to a minimum; not only because of the need for economizing time, but also to lessen the risk of accidents and the frittering away of the material by small losses. Large quantities of materials have usually to be handled in the initial operations in order to get relatively small amounts of the finished product. Expensive materials are often ruled out. Except in very special cases, it is well to avoid methods where troublesome precipitates have to be washed and ignited, or where tedious

to work with an equimolar mixture of sodium and potassium nitrates, fusing at 231°, and so bring the m.p. above the decomposition temp. of cerium nitrate, *viz.* 200°, and below that of didymium nitrate.

19. *Fractional precipitation with alkali nitrates.*—The alkali nitrates were found by H. Erdmann,⁴⁰ and L. Pissarjewsky to precipitate thorium hydroxide from soln. of its salts; and with neutral soln. of zirconium salts, the precipitation of zirconium hydroxide is complete. G. Krüss and A. Loose found that the reaction with the rare earths is not suited for the separation of yttria and ceria earths. C. James and co-workers found that if the yttria earths be dissolved in nitric acid, diluted, boiled, and mixed with a boiling soln. of sodium nitrite, the yttrium concentrates in the later fractions, and the isolation of yttria is effective and rapid if terbium be absent. B. S. Hopkins and C. W. Balke also found that yttria is rapidly separated from holmium and erbium earths by this process. K. A. Hofmann and O. Burger evaporated to dryness a soln. of sodium nitrite with thulmum, holmium, dysprosium, and erbium nitrates. When the dry residue was extracted with water most of the erbium oxide remained insoluble.

20. *Fractional precipitation by the acids of phosphorus, arsenic, and vanadium.*—W. Hisinger and J. J. Berzelius,⁴¹ and J. C. G. de Marignac found that phosphoric acid precipitated the ceria earth phosphates from soln. of the salts; L. N. Vauquelin, and R. Hermann, that it precipitates zirconium and thorium phosphates; but, according to L. N. Vauquelin, yttria earth phosphates are not precipitated under like conditions. P. T. Cleve, G. Wyrouboff and A. Verneuil, and C. Volck found that with thorium salts the precipitation by orthophosphoric acid is quantitative. L. N. Vauquelin showed that all the rare earths are precipitated by sodium phosphate; and, added A. Loose, secondary sodium phosphate precipitates the primary phosphate of yttrium. H. C. Holden and C. James tried fractionally precipitating the yttria earths with ammonium phosphate, monomethylphosphate, and dimethylphosphate. P. S. Willand and C. James tried sodium phosphate for the separation of erbia from yttria earths. J. C. Morgan and C. James found the solubilities of the dimethylphosphates expressed in parts of salt per 100 parts of water at 25°, to be:

La	Ce	Pr	Nd	Sa	Gd	Y	Er	Yb
103·7	79·6	64·1	56·1	35·2	23·0	2·8	1·78	1·2

The subject was also investigated by L. Jordan and B. S. Hopkins. P. T. Cleve showed that pyrophosphoric acid gives a voluminous precipitate with soln. of thorium salts. A. Rosenheim and T. Triantaphyllides found that both cerium and thorium pyrophosphates are precipitated by sodium pyrophosphate, but the former is alone dissolved by hydrochloric acid. O. Kauffmann noted that thorium salts are precipitated by *hypophosphorous acid*. F. Wirth found that when this acid or sodium hypophosphite is added to a soln. of the rare earths in hydrochloric acid, thoria is alone precipitated as hypophosphite. With soln. of the earths in sulphuric acid sodium cerium earth sulphates are precipitated as well. This is avoided by preparing the hypophosphoric acid in soln. either by the oxidation of yellow phosphorus, or by the anodic oxidation of copper phosphide. O. Kauffmann obtained a white precipitate by treating thorium salts with *phosphorus or hypophosphorous acid*. H. C. Holden and C. James tried fractionally precipitating the yttria earths with sodium phosphite, and with sodium hypophosphite.

21. *Fractional precipitation with arsenates and vanadates.*—W. Hisinger and J. J. Berzelius⁴² obtained no precipitate by adding arsenic acid to soln. of ceria earth salts, but J. C. G. de Marignac found that when arsenic acid is boiled with didymium salts a precipitate is produced which does not dissolve readily in acids. M. H. Klaproth, and N. J. Berlin found that potassium arsenate gives an insoluble gelatinous precipitate with yttria earths. J. J. Berzelius obtained a similar precipitate with thorium salts. G. Krüss and A. Loose separated samarium, lanthanum, and didymium salts from scandium, ytterbium, erbium, and terbium salts by

fractional precipitation with this reagent; and H. C. Holden and C. James tried sodium arsenate as a fractional precipitant for the yttria earths. G. Krüss and A. Loose obtained poor results with *potassium arsenite*.

J. J. Berzelius noted that neutral alkali *vanadates* give a precipitate with soln. of the yttria earths while acid vanadates give no precipitation; neither neutral nor acid vanadates give a precipitate with zirconium salts; and thorium salts behave like the yttrium salts. C. Volck found thorium salts are quantitatively precipitated by salts of metavanadic acid.

22. *Fractional precipitation with tungstates and molybdates*.—N. J. Berlin⁴³ found that sodium tungstate with soln. of yttria earths gives a white sparingly soluble precipitate; F. Frerichs and F. Smith, A. Cossa, M. Zechini, and F. R. M. Hitchcock obtained similar results with cerium, lanthanum, neodymium and praseodymium salts. J. J. Berzelius found thorium salts behave similarly, while zirconium hydroxide dissolves in a boiling soln. of potassium paratungstate. W. Gibbs stated that the precipitates given by soln. of the rare earth salts with phosphotungstic acid are probably simple tungstates. J. P. Bonardi and C. James obtained poor results in trying sodium tungstate for separating the yttria earths.

N. J. Berlin found that an alkali molybdate with soln. of yttria earths gives a curdy precipitate insoluble in water. W. Hisinger and J. J. Berzelius, and A. Cossa obtained similar results with soln. of ceria earths; and F. R. M. Hitchcock with neodymium and praseodymium. J. J. Berzelius, and J. J. Chydenius found thorium salts behave similarly. W. Gibbs also stated that phosphomolybdic acid probably precipitated simple molybdates.

23. *Fractional precipitation with formates*.—J. J. Berzelius⁴⁴ found that thorium formate which is soluble in alcohol and in hot water, is decomposed by cold water (the hot soln. does not become turbid), and M. Delafontaine could not purify the salt by recrystallization. L. Haber found that sodium formate could be used as a precipitating agent in the purification of thoria. When zirconium salt soln. are boiled, hydrated zirconia is precipitated; with cerium, sparingly soluble salts are formed in cold and hot water. H. Behrens found ammonium formate precipitated the ceria earths but not the yttria earths. K. Postius did not get good results by the fractional soln. of the finely divided earths in dil. formic acid.

24. *Fractional precipitation with acetates*.—Unlike the salts of most trivalent metals, the addition of an alkali acetate to a soln. of a rare earth salt gives no precipitate when the soln. is boiled; so that the hydrolysis of the rare earth salts under these conditions is relatively small. In this respect, too, the salts of the rare earths differ from the salts of tetravalent cerium, thorium, and zirconium for the salts of these tetravalent elements, when boiled with sodium acetate give sparingly soluble basic acetates. O. Boudouard⁴⁵ claimed to confirm P. Schützenberger's observation that ceria is complex, by fractionally precipitating thoria-free cerium sulphate as acetate, but G. Wyruboff and A. Verneuil showed that a mistake had been made. N. A. Orloff also claimed to purify ceria in the form of its acetate. Even sparingly soluble salts of the rare earths usually dissolve when digested with a soln. of ammonium acetate. G. Krüss examined L. de Boisbaudran's method of separating erbia, holmia, thulia, and ytterbia earths based on the retarding action of ammonium acetate on the precipitation of the rare earths by ammonia, but obtained unsatisfactory results. M. Delafontaine investigated the action of ammonia on yttrium acetate. The solubility of thorium oxalate in soln. of ammonium acetate was noted by R. Finkener, H. Rose, G. P. Drossbach, C. Glaser, and E. Benz; the solubility of the double potassium sulphate, by G. Urbain, L. M. Dennis and E. M. Chamot, and L. Stützel; and H. Bäckström, and P. T. Cleve noted that titanium and zirconium oxides are precipitated when soln. containing ammonium acetate are boiled. O. Popp, and R. J. Meyer and M. Koss noted the quantitative precipitation of ceric oxide from neutral soln. by sodium acetate, while didymium and lanthanum remain in soln. L. M. Dennis and B. Dales, C. G. Mosander, and G. Krüss fractionally precipitated the yttria earths by adding dil. acetic acid drop

by drop to a soln. of the hydroxides in ammonium carbonate. Terbia and yttria accumulate in the first fractions, holmium, thulium, and dysprosium in the middle fractions, and erbium and ytterbium in the last fractions.

25. *Fractionation by precipitation with stearic acid.*—C. W. Stoddart and C. W. Hill⁴⁶ found that the yttria earths can be separated from monazite, gadolinite, and samarskite by the addition, drop by drop, of a 50 per cent. hot alcoholic soln. of potassium stearate to a cold vigorously stirred soln. of the neutral nitrates and in quantity sufficient for the precipitation of a fractional portion of the earths present. The more basic earths precipitate first. It is said that the precipitate formed is easily filtered and washed, the precipitant cheap, the separation sharp and distinct. For the preparation of pure yttria from monazite it is decidedly the best method known, and yttria is one of the most difficult rare earths to separate pure. Only one reagent is necessary, and few fractionations are required, thereby saving a great amount of time, as well as of material, in a large number of manipulations.

26. *Fractional precipitation with oxalic acid or the oxalates.*—C. G. Mosander⁴⁷ introduced a method for the separation of the rare earths based on the varying solubilities of the oxalates in water. The details of the original method have undergone many modifications; and advantage has been taken of the varying solubilities of the rare earth oxalates in dil. mineral acids in oxalic acid, and in soln. of alkali or ammonium acetate and of alkali or ammonium oxalate—*vide supra*. In one method the boiling soln. of the nitrate, just acidified with nitric acid, is treated with oxalic acid added drop by drop until a slight permanent precipitate is formed; the soln. is allowed to cool, and the precipitated nitrate-oxalate filtered off. The filtrate is again treated as before. The ceria earths and thoria are precipitated in the order: Th, Sa, Nd, Pr, Ce, La; and in the case of the yttria earths, in the order: Tb, Eu, Gd, Dy, Ho, Tm, Er, Sc, Yb, and Y. In this way J. C. G. de Marignac, B. Brauner, and R. Bunsen separated lanthanum from didymium; neodymium has likewise been separated from samarium and the yttria earths, and ytterbium from erbium. The method was modified by F. Wirth by precipitating all the earths as oxalates, and fractionally dissolving the precipitate in sulphuric and oxalic acids; B. Brauner found the solubility of the oxalates in ammonium oxalate to be in the relative order: Th (2663), Yb (104), Y (10·99), Ce (1·8), Nd (1·44), Pr (1·13), and La (1·0), and he separated thoria from ceria by this means. C. A. von Welsbach separated a mixture of dysprosium, holmium, erbium, and ytterbium; and N. A. Orloff separated cerium and thorium from the other ceria earths. C. James found the elements separated from a hot ammoniacal soln. of ammonium carbonate in the order: Tb, Y, Dy, Ho, Er, Tm, Yb, Lu, and in this way rapidly separated erbium from dysprosium, holmium, and terbium. M. Esposito separated lanthanum from didymium by using nitric acid as solvent; C. G. Mosander used potassium hydroxalate for separating ceria and yttria earths; and M. Delafontaine used the method for separating the gadolinia earths. A. J. Grant and C. James tried 20 per cent. soln. of the amine oxalates as solvents, but the solubilities of the various oxalates were too close together for successful applications. P. S. Willard and C. James tried ammonium oxalate for the separation of erbia from yttria earths.

27. *Fractional precipitation with succinates.*—According to A. G. Ekeberg,⁴⁸ yttria earths are not precipitated by alkali succinates, while beryllia earth is precipitated. This does not agree with the observations of others. N. J. Berlin stated that yttria earths are not precipitated at once by sodium succinate, but after a few minutes, the liquid becomes turbid, and a fine crystalline powder is deposited, but M. H. Klaproth said no precipitate is formed and the mixture dries to a viscid mass. J. P. Bonardi and C. James precipitated yttria earths from boiling soln. mixed with sodium tartrate. T. Thomson, and H. Behrens found that, like oxalic acid, succinic acid produces a crystalline precipitate with soln. of cerium salts and the precipitate is not soluble in excess; ammonium succinate precipitates soln. of cerium chlorides or nitrates. W. Hisinger and J. J. Berzelius found that acetates are not precipitated by ammonium succinate, and hence they recommended this

agent for separating iron from these earths. J. J. Berzelius, O. Kauffmann, and J. Schilling found that thorium is quantitatively precipitated by ammonium or potassium succinate, but that only 99.5 per cent. is precipitated by sodium succinate. V. Lehner, and R. C. Benner found that if a soln. of sodium succinate be added drop by drop to a one or two per cent. soln. of the nitrates of the yttria earths, a fraction containing terbia, holmia, europia, with some yttria is precipitated, while europia, yttria, samaria, and small quantities of holmia remain in soln. P. S. Willand and C. James tried ammonium succinate for the separation of erbia from yttria earths.

28. *Fractional precipitation with tartaric acid and the tartrates.*—N. J. Berlin⁴⁹ observed the formation of an insoluble white precipitate when alkali tartrates are added to soln. of yttria earths; and H. Rose, A. Brauell, and R. Fresenius and E. Hintz found that this behaviour is characteristic of the yttria earths in contrast with the other rare earths. The precipitate obtained by adding ammonium tartrate to a neutral soln. of the rare earths is readily soluble in acids, and in an excess of the precipitant. According to W. Hisinger and J. J. Berzelius, M. H. Klaproth, A. Brauell, and T. Thomson, in the presence of tartaric acid, the precipitation of the earths by sodium hydroxide is completely inhibited; potassium hydroxide under these conditions gives a precipitate with the yttria earths when the soln. are boiled, and ammonia gives a precipitate with the yttria earths even in the cold. L. Haber, and A. Rosenheim and co-workers showed that the precipitates are double alkali tartrates. The ceria earths give no precipitates under these conditions. J. J. Chydenius, P. T. Cleve, L. Haber, and O. Kauffmann studied the precipitation of soln. of thorium salts by tartaric acid; and J. Schilling, by ammonium tartrate; M. H. Klaproth, L. N. Vauquelin, R. Hornberger, and L. Haber, the precipitation of zirconium salts by tartaric acid, and the alkali tartrates. Zirconium tartrate is soluble in soln. of potassium hydroxide, sodium tartrate, and sodium acetate. According to F. P. Venable and A. W. Belden, zirconium hydroxide is soluble in ammonium tartrate. H. Behrens said that soln. of cerium salts give a curdy precipitate with soln. of ammonium pyrotartrate, which is readily dissolved by free acids. O. L. Barneby fractionated an acetone soln. of the rare earths by a soln. of tartaric acid in the same solvent—erbiu, holmium, and dysprosium are precipitated with the first fractions, and yttrium last; cerium concentrates with the first fraction, and didymium with the yttrium. O. L. Barneby, and P. S. Willand and C. James tried the process for the separation of erbia from yttria earths, but the latter found it not suitable.

29. *Fractional precipitation with citric acid and the citrates.*—N. J. Berlin⁵⁰ and J. P. Bonardi and C. James found that alkali citrates precipitate the yttria earths from soln. of their salts; at first, the white precipitate dissolves as it is formed, but later, it remains permanent. Yttrium citrate is soluble in an excess of sodium citrate, especially when freshly precipitated, and undried; the soln. is not precipitated by alkali carbonates or hydroxides, but it is by potassium oxalate. The presence of citric acid hinders the precipitation of the rare earths by ammonia, or alkali hydroxides. M. H. Klaproth, W. Hisinger and J. J. Berzelius, and L. Haber found the ceria earths are not precipitated by citric acid, but if the oxide be treated with citric acid, insoluble compounds are formed which do not dissolve in an excess of the acid. C. Baskerville purified praseodymium by precipitation as citrate. J. J. Chydenius, L. Haber, O. Kauffmann, C. Baskerville, H. Erdmann, L. Pissarjewsky, E. Benz, and J. J. Berzelius studied the precipitation of thoria by citric acid and the citrates; and L. N. Vauquelin, L. Haber, and H. Harris, the precipitation of zirconia by the same reagents.

30. *Fractional precipitation with organic salts.*—G. Urbain⁵¹ tried a number of salts like the acetates, chloroacetates, butyrates, etc., but noticed no special advantages over the ordinary methods. A. Mandl found that salts of (i) formic, acetic, mono-, di-, and tri-chloroacetic, acetoacetic, succinic, fumaric, tricarballylic, aconitic, benzoic, m- and p-oxybenzoic, trimesic, or benzoylformic acid gives a precipitate with zirconium nitrate soln.; (ii) glycollic, ethylenelactic, glyceric, tartronic, malic, tartaric, saccharic,

muicic, trioxybenzoic (gallic), dioxybenzoic (resorcylic), citric, phenylglycollic, or quinolic acid gives a precipitate which dissolves in excess and ammonia gives no precipitation; (iii) *o-oxybenzoic (salicylic), o-phthalic, or benzalmalonic acid* gives a precipitate when warm, but no precipitation occurs with ammonia in the cold; (iv) *oxalic, malonic, maleinic, or maleic acid* gives no precipitate, but the clear soln. gives a precipitate with ammonia. H. Erdmann and T. Nieszytka obtained precipitates with soln. of cerium salts and *sodium naphthalenemonosulphonate, naphthalene disulphonate, naphthalene trisulphonate, naphthosulphonate, chromotropate, or anthraquin-sulphonate*. H. Erdmann and F. Wirth studied the action of the *hydroxynaphthalene sulphonics acids* on the rare earths.

A. Rosenheim and co-workers, and L. Haber showed that ceria earths are not precipitated, but that thoria is precipitated from soln. of their salts by malic acid; N. J. Berlin said that alkali malates precipitate the yttria earths if an excess of the precipitant be not added. H. Behrens said *ammonium malonate* gives a flocculent precipitate with soln. of cerium salts. J. B. Trommsdorff said that the zirconium salt of *valeric acid* appears to be insoluble, and L. L. Bonaparte found that if this acid be added to a mixed soln. of cerium and didymium nitrates, pure cerium valerate is precipitated, whilst didymium with a little cerium remains in soln. According to H. Behrens, *ammonium lactate* can be used in place of the double sulphate or ammonium carbonate methods of separating the ceria and yttria earths. The thoria and the ceria earths remain in soln., while zirconium and yttrium lactates are precipitated. Soln. of ceria earths in lactic acid give no precipitate with ammonia. A. Brauell noted the formation of a sparingly soluble, non-crystalline, basic ammonium cerium lactate. W. Gibbs, and P. Waage also made observations on the action of lactic acid on soln. of salts of the rare earths. O. Kauffmann found thorium salicylate is precipitated by *potassium salicylate*; and H. Behrens found that soln. of salts of cerium earths, thorium, and zirconium give precipitates with ammonium salicylate, while salts of the yttria earths are not precipitated. L. A. Pratt and C. James studied the action of salicylic acid on yttria.

C. James and co-workers⁵² found that thoria is completely precipitated from the rare earths by adding a boiling soln. of *sebacic acid* to a hot neutral soln. of the earths. The other earths are not precipitated even when the soln. is boiled for a long time. Yttrium can be separated quantitatively from the alkali metals by means of ammonium sebacate. T. O. Smith, C. F. Whittemore and C. James found that on fractionally precipitating a soln. of yttrium, holmium, and dysprosium chlorides with *sodium cacodylate*, the yttrium was conc. in the earlier fractions, while the holmium and dysprosium collected in the later ones; with the cerium group, neodymium collected in the more soluble fractions, and samarium and gadolinium in the less soluble ones. C. James and co-workers studied the action of cacodylic acid on samaria and neodymia. R. J. Meyer and J. Wuorinen found that with *phthalic acid*, the most positive elements remain longest in soln., and the weakly basic ones accumulate in the first precipitates, and they were able to separate the members of the yttria group with good results. A. Kolb and H. Ahrle showed that *m-nitrobenzoic acid* precipitates thoria and ceria salts, but not cerous salts and those of lanthanum and didymium. The precipitation of thoria is more complete in the presence of a little aniline. J. P. Bonardi and C. James did not get useful results with *sodium m-nitrobenzoate* and the yttria earths, and they also tried the *sodium phenoxyacetate, sodium camphorate, sodium azobenzene-sulphonate*, but with poor results. C. James and co-workers studied the effect of *methylsulphonic, methylenedisulphonic, methanetrisulphonic, ethylsulphonic, propylsulphonic, isobutylsulphonic, camphorsulphonic, methoxysulphonic, methanetrisulphonic, phthalic, phenylacetic, phenoxyacetic, ethylenedisulphonic, m-xylenesulphonic, citraconic, sulphoacetic, hydroxyethanesulphonic, m-sulphobenzoic, quinic, anisic, and oxanilic acids*, and *ethyl glycolate*, on yttria, samaria, and neodymia. P. S. Willand and C. James tried *malonic acid* in acetone soln., and with *sodium diphenylmonosulphonate* for the separation of erbium from yttrium, but the results were not satisfactory. H. Erdmann and

F. Wirth found that malonic acid gives no precipitates with the rare earths, but they prepared a number of rare earth malonates. P. S. Willand and C. James found that with *picric acid* the erbium accumulates at the more soluble end of the series, but the results are not good. G. Jantsch and A. Grünkraut fractionated the rare earths from xenotime by *glycollic acid*. They found that yttrium glycolate is least soluble, then follow the salts of lanthanum, cerium, praseodymium, neodymium, samarium, and gadolinium. L. Jordan and B. S. Hopkins found that sodium glycolate is useful in removing the last traces of samaria from gadolinia. C. James and co-workers also studied the action of glycollic acid on yttria, samaria, and neodymia.

N. J. Berlin⁵³ found that *alkali benzoates* do not give an immediate precipitation with soln. of the yttria earths; but one forms if the mixture is allowed to stand for some time in a warm place. H. Behrens found *ammonium benzoate* gives a precipitate with cerium salts. The action of *benzoic acid* was studied by W. Hisinger and J. J. Berzelius, T. Thomson, and A. Brauell, the acid gives no precipitate with cerium salts. O. Kauffmann found that thorium and zirconium salts give a gelatinous precipitate with alkali benzoates.

III. Separation by fractional oxidation.—These methods are mainly directed to the separation of cerium from the other rare earth elements, and they are based on the fact that, unlike the other elements of the family, cerium forms a strongly basic trioxide, $\text{Ce}(\text{OH})_3$, and a feebly basic tetrahydroxide, $\text{Ce}(\text{OH})_4$. The basicity of cerium tetroxide is very near that of thorium hydroxide, $\text{Th}(\text{OH})_4$. Mixtures of the rare earths containing over 50 per cent. of ceria are usually only partially soluble in hydrochloric or nitric acid; but if digested with an excess of sulphuric acid, ceric sulphate is produced. This is insoluble in the excess of sulphuric acid. The mixed sulphates are dissolved in cold nitric acid, and when the soln. is boiled with alkali hydroxide, the rare earth hydroxide is formed. This is readily soluble in nitric acid. G. N. Wyruboff and A. Verneuil,⁵⁴ and G. von Knorre showed that rare earths containing over 50 per cent. ceria are dissolved when heated with nitric acid if hydrogen peroxide be added from time to time. The soln. contains cerous nitrate. R. Bunsen showed that the mixture of rare earths is also dissolved by conc. hydrochloric acid if ammonium or potassium iodide be present. Iodine is liberated, and cerous chloride is formed. R. J. Meyer obtained a similar result with a mixture of hydriodic and conc. nitric acids.

1. *Fractional oxidation by roasting.*—When the rare earth carbonates, oxalates, nitrates, etc., are ignited, oxides are formed—cerium and thorium salts give dioxides, and the other rare earths, sesquioxides. When treated with dil. nitric acid, cerium dioxide is either insoluble, or very sparingly soluble dependent on the amount of lanthana or didymia which may be present. C. G. Mosander⁵⁵ used this method and separated lanthana and didymia from what was considered to be pure ceria. H. Zschiesche explained the brown colour of ceric oxide as a result of the combination of ceria and didymia. T. Kjerulf, B. Brauner, C. A. von Welsbach, P. Schottländer, P. Mengel, R. J. Meyer and M. Koss, etc., explained the great tendency of ceria to be contaminated by didymia and lanthana to the formation of compounds of ceria oxide with the trivalent earths analogous to manganites and chromites. H. Zschiesche found some cerous oxide was always dissolved by the nitric acid. C. F. Rammelsberg, and F. M. Stapff, in order to ensure the complete oxidation of the ceria, fused the earths with potassium chlorate; and F. Frerichs and F. Smith repeatedly calcined the oxide moistened with nitric acid. P. Schottländer, however, showed that cerium dioxide, like lead dioxide, manganese dioxide, etc., develops some oxygen with nitric acid, or chlorine with hydrochloric acid; and when dissolved in conc. nitric acid, a little of the ceric oxide is always reduced to cerous oxide.

2. *Fractional oxidation by chlorine or bromine.*—C. G. Mosander⁵⁶ purified cerium by suspending the mixed oxides in a soln. of potassium hydroxide, and passing in a rapid stream of chlorine for a few hours. This converts all the

rare earths except cerium into soluble chlorides. The cerium remains undissolved as a light yellow powder of hydrated ceric oxide. R. Bunsen, T. Kjerulf, S. Jolin, L. M. Dennis and co-workers, L. Haber, G. Krüss, K. Brockelmann, O. Pettersson, L. Stützel, P. Mengel, O. N. Witt, etc., found that a repetition of the process for a number of times is said to effect a complete separation of the cerium. J. L. Smith used the chlorine process for the separation of thorium which is precipitated with the cerium. L. M. Dennis and F. L. Kortright also used it for separating thorium from thorite. O. Popp, R. Fresenius and E. Hintz, and G. P. Drossbach used sodium or calcium hypochlorite in place of chlorine. P. E. Browning and E. J. Roberts found that the hydroxide of lanthanum passes into soln. more rapidly than that of didymium. P. E. Browning, L. Haber, and W. Muthmann and H. Rölig, found that bromine can be more conveniently added than chlorine. With bromine, the hydrobromic acid produced towards the end of the operation does not act on the ceric oxide the same as does the hydrochloric acid produced when chlorine is employed. Iodine was also tried in place of chlorine.

3. *Fractional oxidation by potassium permanganate.*—F. M. Stappf,⁵⁷ and W. Gibbs oxidized soln. of cerous sulphate, nitrate, and chloride with potassium permanganate; but the oxidation was incomplete. C. Winkler found that the oxidation was completed in the presence of mercuric oxide, and hence the reaction: $3\text{Ce}_2\text{O}_3 + 2\text{KMnO}_4 + \text{H}_2\text{O} = 6\text{CeO}_2 + 2\text{KOH} + 2\text{MnO}_2$, could be employed for the quantitative determination of cerium. F. Stolba substituted zinc oxide for mercuric oxide, and founded a volumetric process on the reaction; and the method was successfully employed by W. Muthmann and H. Rölig, C. James, G. P. Drossbach, P. E. Browning, etc. If zinc oxide and potassium permanganate be employed for precipitating ceric oxide from soln. of the rare earths, the zinc salt is troublesome to remove, and C. R. Böhm accordingly substituted the alkaline earths, or magnesia; and R. J. Meyer and A. Schweitzer recommended sodium carbonate which is now generally employed. E. J. Roberts recommends the following procedure:

The rare earth soln., which should not contain salts other than nitrates, is heated to boiling in a large porcelain dish, and, if not already neutral, is neutralized with the sodium carbonate soln. The soln. of permanganate is added in small quantities until the red colour begins to be permanent, and the mixed soln. of permanganate and alkali is then added very slowly, with constant stirring, the liquid being kept nearly at the b.p. during the whole process. A faint colour of permanganate is maintained all the time in the liquid, a little of the pure permanganate soln. being added if at any time the colour be entirely bleached. This is important, as the constant acidity of the liquid is thereby insured. When the cerium is nearly all precipitated, the colour is bleached more slowly after each addition of the precipitant, and the effervescence is less noticeable. The acidity of the liquid should now be tested from time to time, which may be done with litmus-paper if only a slight excess of permanganate be present. Small amounts of the mixed soln. or of sodium carbonate are added, until the liquid is nearly neutral to litmus, but still is faintly coloured with permanganate. The whole is heated, and stirred for about ten minutes, and filtered hot. The precipitate is washed with boiling water till the washings give no precipitate with ammonia. If the liquid at the end of the precipitation be faintly acid, the filtrate usually contains a trace of cerium giving a faint yellow colour with ammonia and hydrogen peroxide, while from the precipitate a preparation of cerium chloride may readily be obtained which shows no absorption bands in a thickness of 15 cms. of very conc. soln. The presence of a little cerium in the filtrate, where the earths in the latter are to be subjected to fractional crystallization, is usually not objectionable.

4. *Fractional oxidation by lead dioxide or bismuth tetroxide.*—In 1864, W. Gibbs⁵⁸ introduced a method of separating ceria from the rare earths which was based on the oxidation of cerous salts by boiling them with lead dioxide and nitric acid; H. Zschiesche used red lead in place of the dioxide; and in 1894, W. Gibbs suggested using bismuth tetroxide in place of lead dioxide. W. Gibbs' lead dioxide process is as follows:

Boil a mixture of the rare earth sulphates, with lead dioxide and nitric acid until a drop of the clear liquid gives no precipitate with lead acetate. Small quantities of lead dioxide and nitric acid are added from time to time as the reaction proceeds. The soln. is boiled for an hour and a half longer, adding nitric acid from time to time to replace that

lost by evaporation. After cooling and settling, the clear soln. is decanted off, and the lead sulphate is digested several times with hot nitric acid so as to remove any rare earths entrained with the precipitate. The main soln. and washings are concentrated to a syrupy liquid, on a water-bath, and poured into ten times its vol. of water, when basic ceric nitrate is precipitated. This is well washed with water, treated with conc. sulphuric acid, and heated to remove the excess of acid. The mass, digested in ice-cold water, gives a soln. of cerous sulphate of a high degree of purity.

The process was used by H. Bührig, P. Mengel, H. Robinson, etc.; and the reaction was applied to the detection of small quantities of cerium by W. Gibbs, L. M. Dennis and W. H. Magee, G. Krüss and L. F. Nilson, G. von Knorre, R. Fresenius and E. Hintz, etc. G. von Knorre tried oxidizing cerous salts by boiling them with manganese dioxide and nitric acid, but the result was not satisfactory. C. H. Wing treated a soln. of a cerous salt with lead dioxide and sulphuric acid, so as to form the ceric salt. This was mixed with luteocobaltic sulphate, *i.e.* luteocobaltic tetramminotrisulphate, when crystals of the double salt, $[\text{Co}(\text{NH}_3)_6](\text{SO}_4)_3 \cdot \text{H}_2\text{O}$, are formed. The product contains a little didymium.

5. *Fractional oxidation by hydrogen, sodium, or barium dioxide.*—G. H. Bailey⁵⁹ found that a soln. of zirconium sulphate or acetate gave with hydrogen dioxide a precipitate of zirconium peroxide, Zr_2O_5 , under conditions where titanium, columbium, iron, and aluminium salts gave no precipitation. The reaction was investigated by H. Geisow and P. Horkheimer, who found that in dil. soln. in the presence of hydrogen peroxide, iron hydroxide but not zirconium hydroxide is precipitated by alkali hydroxide. P. T. Cleve, and L. de Boisbaudran then found that in the presence of ammonia or the hydroxides of the alkaline earths, a thorium persulphate is precipitated. This reaction was studied by G. Wyruboff and A. Verneuil as a method of separating thoria from the rare earths. In applying the process, it is advisable to remove most of the ceria and yttria earths before applying the hydrogen dioxide process to avoid the entraining of these earths with the precipitated thoria. It is also necessary to use hydrogen dioxide free from phosphoric acid. E. Wedekind found that the presence of tartaric acid hinders the precipitation. G. Wyruboff and A. Verneuil use the process in the following manner:

To obtain thorium free from cerium, the soln. of the nitrates is mixed with an excess of ammonium carbonate, and a small quantity of ammonium hydroxide added; all the thorium remains in soln. whilst the greater part of the other metals is precipitated. The soln. is neutralized as exactly as possible with nitric acid, mixed with excess of hydrogen peroxide, and heated to 60°; all the thorium is precipitated, and if the precipitate be dissolved in nitric acid, evaporated to dryness, redissolved in water, and the treatment with hydrogen peroxide repeated, very pure thorium is obtained. In the presence of large quantities of cerite earths, three or four precipitations may be necessary. The formation of the compound, $\text{Th}_4\text{O}_7 \cdot \text{N}_2\text{O}_5$, by the action of hydrogen peroxide constitutes a delicate and characteristic test for thorium, and can be used for its quantitative estimation. The oxynitrate cannot, however, be heated or dissolved in acids without loss, and the following method is recommended. The soln. of nitrates containing not more than 0.5 gm. of oxide is evaporated to dryness, mixed with 100 c.c. of water and 10 c.c. of hydrogen peroxide, heated for a short time, and filtered. The precipitate, after washing, is transferred to a flask and dissolved in hot water containing ammonium iodide and hydrochloric acid, the soln. is precipitated with ammonium hydroxide, and the precipitate dried and heated. If the precipitate of oxynitrate be not white, it must be redissolved in nitric acid, evaporated to dryness, and the process repeated.

G. and E. Urbain used the method to separate thoria from ytterbia. If a boiling soln. of lanthanum and didymium in the presence of sodium acetate be treated with hydrogen peroxide, a peroxidized didymium acetate is precipitated which redissolves on cooling; this reaction enables didymium to be separated rapidly from lanthanum, which is not precipitated. The basic ceric acetate is less soluble than the didymium salt.

P. Mengel found that an ice-cold soln. of sodium peroxide added to a soln. of the rare earths, oxidizes and completely precipitates the cerium as hydrated ceric

oxide. The precipitate is well washed with cold water, dried at 120°–130°, redissolved, and again precipitated. The product has a high degree of purity. H. Geisow and P. Horkheimer studied the process. G. Wyruboff, and C. G. Mosander noted that *barium dioxide* gave a precipitate with soln. of cerium salts, and A. Verneuil used this reagent for the approximate separation of thoria from the monazite earths.

6. *Fractional oxidation by ammonium or potassium persulphate.*—G. von Knorre⁶⁰ oxidized the cerous salts in a boiling neutral soln. of the rare earths by the addition of potassium or ammonium persulphate: $K_2S_2O_8 + H_2O = K_2SO_4 + H_2SO_4 + O$. The soln. must be kept neutral during the reaction, and this was done by allowing the reaction to proceed in the presence of barium or calcium carbonate. G. Wyruboff and A. Verneuil removed the last traces of cerium from ceria earths by this reaction, but instead of using an alkaline earth carbonate to keep the soln. neutral, they boiled the soln. with a mixture of sodium acetate and ammonium persulphate. If thorium be present, the soln. should be dil. enough to prevent the precipitation of thorium sulphate. O. N. Witt and W. Theel replaced the sodium acetate by precipitated calcium carbonate.

7. *Fractional oxidation with potassium bromate.*—C. James⁶¹ used potassium bromate for removing cerium from the rare earths. He boiled a neutral soln. of the nitrates mixed with potassium bromate, in the presence of some marble. The cerium was precipitated as basic ceric nitrate as described in the previous section. Ceria can thus be obtained free from other earths.

IV. Separation by physical processes.—In a rigid system of classification, some of the basic salt processes would be more correctly described as cases of fractional dissolution or decomposition by heat. K. A. Hofmann and G. Krüss⁶² suggested a possible means of fractionating the rare earths by shaking a soln. of one of their salts with charcoal free from phosphates because he found that the charcoal adsorbs the weaker bases first. About 0.5 grm. is adsorbed by 8 grms. of charcoal from 2 grms. of the mixture.

1. *Fractional distillation, or sublimation.*—J. J. Berzelius and W. Hisinger⁶³ separated iron chloride from cerium chloride by *fractional sublimation*, the iron chloride volatilizes while cerium chloride remains. G. P. Drossbach passed a current of chlorine gas over a heated mixture of the rare earths from monazite sand and charcoal. Thorium chloride volatilizes, and the less readily volatile chlorides of the ceria earths remain. O. Pettersson studied the volatility of the rare earth chlorides, but his attempt at the fractional distillation of the anhydrous chlorides gave negative results. R. J. Meyer and A. H. Winter showed that scandium can be freed from thorium by the fractional sublimation of the anhydrous chlorides. G. T. Morgan and H. W. Moss showed that scandium and thorium can be separated by the distillation of their acetylacetonates, for, at 8–10 mm. press., thorium acetylacetonate begins to sublime at 160°, while the scandium salt sublimes at a lower temp., and, at atm. press., scandium acetylacetonate sublimes undecomposed between 210° and 260°, while at 260° the thorium salt decomposes into a brown charred mass. G. Urbain and co-workers found the method to be of use in separating small quantities of lutecium chloride from the less volatile neoytterbium chloride. Scandium and thorium chlorides are also more volatile than lutecium chloride.

2. *Fractional electrolysis.*—In 1879, L. de Boisbaudran⁶⁴ separated didymium from the samarskite earths by electrolysis. G. Krüss stated that when a soln. of a chloride of a rare earth behaves upon electrolysis like a soln. of an hydroxide in dil. hydrochloric acid, chlorine and hydrogen are set free at the electrodes, the soln. loses more and more hydrochloric acid, and as the amount of the solvent diminishes, the hydroxide of the earth is precipitated in increasing amount. In this manner the rare earths can be removed from chloride soln. of mixtures of the earths, the amounts thus precipitated depending upon the strength of the current and the duration of the electrolysis. It is to be expected that those bases which are the weakest toward hydrochloric acid will first be precipitated as hydroxides as

soon as a part of the hydrochloric acid is decomposed by the electrolysis. The stronger bases will remain in soln. as the more stable chlorides. In order to remove the hydrochloric acid uniformly from all parts of the soln. of the chlorides of the rare earths, electrodes of large surface were employed. E. F. Smith found that on electrolysis didymium is not precipitated either as nitrate or acetate although a partial precipitation takes place at the positive pole. B. Brauner, in the course of his study of peroxides, electrolyzed a soln. of didymium acetate with platinum electrodes and obtained on the negative pole a pale red crystalline crust containing didymium and acetic acid; while soln. of the nitrate and sulphate gave similar products. He observed no peroxide formation. G. Bricout, J. Sterba, and G. von Knorre studied the anodic oxidation of cerous salts. A. Classen separated iron from zirconium by the electrolysis of a soln. of ammonium zirconium oxalate. L. M. Dennis and B. J. Lemon electrolyzed neutral soln. of the rare earth nitrates using a mercury cathode and platinum anode, without a diaphragm, and found that with a neutral soln. of the nitrates of neodymium, praseodymium, lanthanum, and samarium, the lanthanum collects in the last fractions, and can thus be separated from the other earths of the didymium group. Lanthanum can be satisfactorily separated from praseodymium by this method. On the fractional electrolysis of the earths from xenotime, erbium collects in the early fractions and yttrium in the later fractions. In order to test if the fractional precipitation were caused by the ammonia formed in the cathodic reduction of the nitric acid, L. M. Dennis and P. A. van der Meulen employed a diaphragm cell, and fractionally electrolyzed a soln. of the chlorides and the nitrates of yttria earths from which nearly all the ceria and didymia had been removed. They found that the coloured earths concentrated in the earlier fractions, yttrium in the last fractions. The rate of separation is about four times as great with the nitrates as with the chlorides. No ammonium salts were produced. L. M. Dennis and A. B. Ray found that a vigorous stirring of the liquid about the cathode accelerates the segregation of earths of higher at. wt. in the early fractions and gives a better conc. of the earths of lower at. wt. in the last fractions. In the fractional electrolysis of mixtures of thorium and the rare earth nitrates, thoria concentrates in the early fractions.

REFERENCES.

- ¹ C. James, *Journ. Amer. Chem. Soc.*, **30**, 182, 1908.
- ² C. James, *Journ. Amer. Chem. Soc.*, **33**, 1341, 1911; S. H. Katz and C. James, *ib.*, **35**, 872, 1913; G. Urbain, *Journ. Chim. Phys.*, **4**, 64, 1906; *Chem. News*, **100**, 73, 1909; G. Urbain and H. Lacombe, *ib.*, **90**, 319, 1904.
- ³ C. Baskerville and R. Stevenson, *Journ. Amer. Chem. Soc.*, **26**, 54, 1904; P. H. M. P. Brinton and C. James, *ib.*, **43**, 1397, 1921.
- ⁴ C. James, *Chem. News*, **97**, 61, 1908; *Journ. Amer. Chem. Soc.*, **30**, 182, 979, 1908; **31**, 913, 1909; **32**, 517, 1910; **33**, 1332, 1911; **34**, 757, 1912; C. James and J. E. Robinson, *ib.*, **33**, 1363, 1911; C. James and L. A. Pratt, *ib.*, **32**, 873, 1910; H. C. Holden and C. James, *ib.*, **36**, 643, 1914; L. Jordan and B. S. Hopkins, *ib.*, **39**, 2614, 1917; H. C. Kremers and C. W. Balke, *ib.*, **40**, 593, 1918.
- ⁵ C. G. Mosander, *Phil. Mag.*, (3), **23**, 241, 1843; *Liebig's Ann.*, **48**, 217, 1843; O. Popp, *ib.*, **131**, 191, 1864; J. F. Bahr and R. Bunsen, *ib.*, **137**, 10, 1866; F. Frerichs and F. Smith, *ib.*, **191**, 398, 1878; G. Krüss, *ib.*, **265**, 15, 1891; W. Muthmann, H. Hofer, and L. Weiss, *ib.*, **320**, 268, 1902; M. Delafontaine, *ib.*, **131**, 101, 1864; **134**, 106, 1865; **135**, 191, 1865; *Arch. Sciences Genève*, (2), **18**, 343, 1863; R. Hermann, *Journ. prakt. Chem.*, (1), **30**, 187, 1843; (1), **31**, 85, 1844; (1), **82**, 385, 1861; (1), **93**, 113, 1864; (1), **107**, 129, 139, 1869; J. C. G. de Marignac, *ib.*, (1), **48**, 408, 1849; M. Holzmann, *ib.*, (1), **75**, 346, 1858; C. Czudnowicz, *ib.*, (1), **80**, 32, 1860; C. Winkler, *ib.*, (1), **95**, 410, 1865; H. Zschiesche, *ib.*, (1), **107**, 70, 1869; H. Bührig, (2), **12**, 222, 240, 1875; H. Endemann, *ib.*, (2), **11**, 220, 1875; J. J. Chydenius, *Kemisk undersökning af Thorjord och Thorsalter*, Helsingfors, 1861; K. Bröckelmann, *Beiträge zur Kenntnis der Elemente der Yttrium und Cer-gruppe*, Erlangen, 1891; J. Lesingis, *Zur Kenntnis der Thoriumverbindungen. Ueber quantitative Metalltrennungen durch Wasserstoffsperoxyd*, Bern, 1898; H. Rölzig, *Beiträge zur Kenntnis der seltenen Erden des Cerits*, München, 1898; L. Stützel, *Zur Kenntnis der seltenen Erden des Cerits*, München, 1899; C. R. Böhm, *Die Zerlegbarkeit des Praseodyms und Darstellung seltener Erden mit Hilfe einer neuen Trennungsmethode*, Halle a. S., 1900; L. Weiss, *Ueber die Darstellung der Metalle der Cergruppe durch Schmelzelektrolyse*, München, 1902; J. J. Berzelius,

Pogg. Ann., 4. 138, 1825; 15. 633, 1829; 16. 395, 1829; F. J. Otto, *ib.*, 40. 404, 1837; N. J. Berlin, *ib.*, 43. 109, 1838; C. Kersten, *ib.*, 47. 385, 1839; F. Wöhler, *ib.*, 48. 85, 1839; 67. 427, 1846; H. Rose, *ib.*, 118. 503, 1863; R. Bunsen, *ib.*, 155. 377, 1875; W. F. Hillebrand and A. Norton, *ib.*, 155. 613, 1875; 156. 467, 1875; T. Hiortdahl, *Compt. Rend.*, 61. 175, 1866; P. T. Cleve, *ib.*, 89. 419, 1879; *Bull. Soc. Chim.*, (2), 39. 151, 1883; *Chem. News*, 53. 30, 1886; H. Robinson, *ib.*, 54. 229, 1886; G. H. Bailey, *ib.*, 60. 6, 1889; P. T. Cleve and O. M. Höglund, *Bihang. Svenska Akad. Handl.*, 1. 8, 1873; 2. 6, 1874; H. Watts, *Journ. Chem. Soc.*, 2. 140, 1850; C. Wolf, *Amer. Journ. Science*, (2), 45. 53, 1868; F. Frerichs, *Ber.*, 7. 798, 1874; J. Thomsen, *ib.*, 7. 31, 1874; W. Muthmann, *ib.*, 31. 1832, 1898; W. Muthmann and H. Rölig, *ib.*, 31. 1718, 1898; *Zeit. anorg. Chem.*, 16. 450, 1898; C. Benedicks, *ib.*, 22. 409, 1900; A. Cleve, *ib.*, 32. 142, 1902; C. von Scheele, *Ber.*, 32. 417, 1899; W. Muthmann and E. Baur, *ib.*, 33. 1751, 1900; H. Brauner, *Proc. Chem. Soc.*, 13. 69, 1897; *Sitzber. Akad. Wien*, 92. 827, 1886; *Monatsh.*, 3. 12, 28, 490, 1882; *Journ. Chem. Soc.*, 53. 357, 1888; 73. 952, 1898; *Zeit. anorg. Chem.*, 34. 207, 1903; B. Brauner and A. Batek, *ib.*, 34. 207, 1903; J. Koppel, *ib.*, 41. 377, 1904; L. F. Nilson, *Compt. Rend.*, 91. 118, 1879; 95. 784, 1882; *Ann. Chim. Phys.*, (5), 30. 563, 1882; *Öfvers. Akad. Förh.*, 7, 1882; G. Krüss and L. F. Nilson, *ib.*, 5, 1887; R. H. F. Manasse, *Canadian Chem. Met.*, 6. 83, 1922; E. Demarçay, *Compt. Rend.*, 96. 1859, 1883; *Chem. News*, 48. 49, 1883; J. F. Smith, *ib.*, 48. 29, 1883; *Amer. Chem. Journ.*, 5. 73, 1883; H. W. B. Roozeboom, *Zeit. phys. Chem.*, 5. 198, 1890; W. Palmaer, *ib.*, 14. 362, 1897; P. Schützenberger, *Compt. Rend.*, 120. 664, 962, 1895; P. Schützenberger and O. Boudouard, *ib.*, 122. 697, 1896; 124. 482, 1897; O. Boudouard, *ib.*, 125. 774, 1898; G. P. Drossbach, *Ber.*, 29. 2454, 1896; B. Kosmann, *German Pat.*, D.R.P. 90652, 1897; G. Wyruboff and A. Verneuil, *Compt. Rend.*, 123. 1331, 1899; *Bull. Soc. Chim.*, (3), 17. 679, 1897; G. Wyruboff, *ib.*, (3), 25. 105, 1901; G. Urbain, *Ann. Chim. Phys.*, (7), 19. 184, 1900; H. Behrens, *Arch. Néerl.*, (2), 6. 83, 1901; M. H. Klaproth, *Gehlen's Ann.*, 2. 303, 1804; *Chemische Wörterbuch*, Berlin, 1. 572, 1807; *Ann. Chim. Phys.*, (1), 37. 86, 1801, L. N. Vauquelin, *ib.*, (1), 36. 143, 1801; W. Hisinger and J. J. Berzelius, *Gehlen's Ann.*, 2. 397, 1804; T. Thomson, *Amer. Phil.*, 8. 356, 1816; C. M. Marx, *Schweigger's Journ.*, 52. 481, 1828; C. Wolf, *Amer. Journ. Science*, (2) 45. 53, 1868.

* J. J. Berzelius and J. G. Gahn, *Schweigger's Journ.*, 16. 244, 1816; M. H. Klaproth, *Gehlen's Ann.*, 2. 312, 1904; W. Hisinger and J. J. Berzelius, *ib.*, 2. 407, 1804; J. J. Berzelius, *Gilbert's Ann.*, 59. 248, 1818; *Pogg. Ann.*, 3. 209, 1825; 4. 135, 1825; 15. 634, 1829; 16. 385, 390, 402, 410, 1829; *Svenska Akad. Handl.*, 1. 8, 1829; N. J. Berlin, *ib.*, 209, 212, 1835; *Pogg. Ann.*, 43. 106, 109, 1835; 88. 157, 1853; V. Hartwall, *ib.*, 16. 481, 1829; *Svenska Akad. Handl.*, 167, 1828; G. Krüss and L. F. Nilson, *ib.*, 5, 1887; F. Wöhler, *Pogg. Ann.*, 7. 426, 1826; 48. 85, 1839; 67. 425, 1846; T. Scheerer, *ib.*, 51. 467, 473, 1840; 56. 497, 1842; H. Rose, *ib.*, 59. 101, 1843; 118. 508, 1863; C. Kersten, *ib.*, 47. 392, 1839; 63. 139, 1844; C. G. Mosander, *Phil. Mag.*, (3), 23. 241, 1843; *Pogg. Ann.*, 46. 649, 1839; 47. 209, 1839; 60. 298, 306, 1843; L. Svanberg, *ib.*, 66. 311, 1845; *Öfvers. Akad. Förh.*, 1. 3, 1845; C. F. H. Credner, *Pogg. Ann.*, 79. 151, 1850; C. Bergemann, *ib.*, 85. 558, 1852; C. M. Warren, *ib.*, 102. 449, 1857; A. E. Nordenskjöld and J. J. Chydenius, *ib.*, 110. 642, 1860; *Öfvers. Akad. Förh.*, 1. 3, 1860; J. J. Chydenius, *Kemisk undersökning af Thorjord och Thorsalter*, Helsingfors, 1861; *Pogg. Ann.*, 119. 43, 1863; A. Beringer, *Liebig's Ann.*, 42. 135, 142, 1842; O. Popp, *ib.*, 131. 182, 1864; C. Schmidt, *ib.*, 83. 329, 1862; J. F. Bahr and R. Bunsen, *ib.*, 137. 1, 13, 1866; A. Knop, *ib.*, 159. 55, 1871; R. Hornberger, *ib.*, 181. 233, 1876; F. Frerichs and F. Smith, *ib.*, 191. 337, 1878; A. Bettendorff, *ib.*, 256. 160, 1890; 263. 165, 1891; 270. 378, 1892; O. W. Muthmann, H. Hofer, and L. Weiss, *ib.*, 320. 268, 1902; G. Krüss, *ib.*, 265. 7, 1391; *Zeit. anorg. Chem.*, 3. 366, 1893; G. Krüss and A. Loose, *ib.*, 3. 93, 1893; K. A. Hofmann and G. Krüss, *ib.*, 3. 413, 1893; 4. 34, 1893; C. Böttinger, *ib.*, 6. 1, 1894; G. Bodmann, *ib.*, 27. 254, 1901; C. Benedicks, *ib.*, 22. 394, 1900; L. Pissarijewsky, *ib.*, 25. 388, 1900; A. Cleve, *ib.*, 32. 131, 1902; R. Marc, *ib.*, 38. 121, 1904; *Ber.*, 35. 2387, 1902; *Die Kathodoluminescenz-Spektren der seltenen Erden und Untersuchungen über die Erden der Yttergruppe*, München, 1902; *Ber.*, 35. 2382, 1902; L. Weiss, *Ueber die Darstellung der Metalle der Cergruppe durch Schmelzelektrolyse*, München, 1902; C. R. Böhm, *Die Zerlegbarkeit des Praseodyms und Darstellung seltener Erden mit Hilfe einer neuen Trennungsmethode*, Halle a. S., 1900; J. Lesinsky, *Zur Kenntnis der Thoriumverbindungen. Ueber quantitative Metalltrennungen durch Wasserstoffperoxyd*, Bern, 1898; L. Stützel, *Zur Kenntnis der seltenen Erden des Cerits*, München, 1899; H. Rölig, *Beiträge zur Kenntnis der seltenen Erden des Cerits*, München, 1898; K. Hofmann, *Ueber die Terbinerde*, Hamburg, 1893; A. Loose, *Studien über die seltenen Erden aus der Cer- und Yttergruppe*, München, 1892; K. Bröckelmann, *Beiträge zur Kenntnis der Elemente der Yttrium- und Cergruppe*, Erlangen, 1891; N. Engström, *Undersökning af några mineral, som innehålla sällsynta jordarter*, Upsala, 1877; A. Connell, *Edin. Phil. Journ.*, (2), 20. 300, 1842; R. Hermann, *Journ. prakt. Chem.*, (1), 30. 1888, 1843; (1), 38. 88, 1844; (1), 93. 107, 1864; T. Kerndt, *ib.*, (1), 43. 221, 1848; M. Holzmann, *ib.*, (1), 75. 356, 1858; C. Czudnowicz, *ib.*, (1), 80. 23, 1860; F. M. Staff, *ib.*, (1), 79. 257, 1860; R. Korovaeff, *ib.*, (1), 85. 443, 1862; G. Streit and B. Franz, *ib.*, (1), 108. 75, 1869; H. Bührig, *ib.*, (2), 12. 235, 1875; D. M. Balch, *Amer. Journ. Science*, (2), 23. 348, 1857; C. H. Wing, (2), 49. 358, 1870; W. Gibbs, *ib.*, (2), 37. 252, 1864; *Amer. Chem. Journ.*, 15. 546, 1893; L. M. Dennis and E. M. Chamot, *Journ. Amer. Chem. Soc.*, 19. 799, 1897; L. M. Dennis and B. Dales, *ib.*, 24. 400, 1902; C. Baskerville and H. Holland, *ib.*, 26. 71, 1904; C. Baskerville and E. G. Moss, *ib.*, 26. 67, 1904; M. Delafontaine, *Arch. Sciences Genève*, (2), 18. 343, 1863; *Journ. prakt. Chem.*, (1), 94. 198, 298, 1865; *Liebig's Ann.*, 131. 100, 1863; 134. 104, 1864; 135. 188, 1865; *Compt. Rend.*, 87. 633, 1878;

93. 63, 1881; F. Pisani, *ib.*, 59. 301, 1864; J. L. Smith, *Chem. News*, 48. 29, 1886; *Compt. Rend.*, 87. 145, 831, 1873; 89. 480, 1879; L. de Boisbaudran, *ib.*, 88. 323, 1879; 102. 153, 395, 483, 899, 1886; 102. 395, 398, 1004, 1886; J. L. Soret, *ib.*, 88. 422, 1879; P. T. Cleve, *ib.*, 91. 382, 1880; 94. 1529, 1882; 95. 33, 1225, 1882; 97. 94, 1883; *Chem. News*, 53. 31, 1886; B. Brauner, *ib.*, 47. 175, 1882; *Compt. Rend.*, 94. 1718, 1882; *Journ. Chem. Soc.*, 43. 281, 1883; 73. 952, 1898; *Monatsh.*, 3. 487, 498, 1882; C. A. von Welsbach, *ib.*, 4. 631, 1883; E. Linnemann, *ib.*, 6. 335, 1885; C. Erk, *Zeit. Chem.*, (2), 7. 109, 1871; *Zeit. anal. Chem.*, 10. 477, 1871; C. Winkler, *ib.*, 4. 418, 1865; J. C. G. de Marignac, *Ann. Chim. Phys.*, (5), 14. 247, 1878; (6), 20. 535, 1880; *Arch. Sciences Genève*, (3), 3. 113, 1880; *Compt. Rend.*, 87. 580, 1878; 90. 900, 1880; J. Lorenzen, *Mendeleefser om Grönland*, 2. 75. 1881; L. F. Nilson, *Ber.*, 13. 1440, 1880; 15. 2525, 1882; H. E. Roscoe, *ib.*, 15. 1275, 1882; *Journ. Chem. Soc.*, 41. 277, 1882; *Chem. News*, 45. 184, 1882; P. Barrière, *ib.*, 74. 159, 1896; W. Shapleigh, *ib.*, 76. 41, 1897; A. E. Nordenskjöld, *Compt. Rend.*, 103. 797, 1886; J. Sterba, *ib.*, 133. 221, 1901; O. Boudouard, *ib.*, 121. 274, 1895; 126. 1648, 1898; 125. 774, 1897; *Bull. Soc. Chim.*, (3), 19. 11, 1898; G. Urbain, *ib.*, (3), 15. 349, 1896; *Ann. Chim. Phys.*, (7), 19. 184, 1900; P. Schützenberger and O. Boudouard, *Compt. Rend.*, 122. 697, 1896; 124. 482, 1897; P. Schützenberger, *ib.*, 120. 962, 1895; C. W. Blomstrand; *Geol. För. Förh. Stockholm*, 9. 160, 1887; W. C. Brögger, *Zeit. Kryst.*, 16. 85, 1890; J. W. Ling, *Chem. Ztg.*, 19. 1468, 1895; C. Glaser, *ib.*, 20. 612, 1896; G. P. Drossbach, *Journ. Gasbeleucht.*, 38. 582, 1895; *Ber.*, 29. 2452, 1896; 34. 3508, 1901; 35. 2837, 1902; *Zeit. angew. Chem.*, 14. 656, 1901; W. Muthmann and H. Rölig, *ib.*, 31. 1721, 1898; C. von Scheele, *ib.*, 32. 412, 1899; R. J. Meyer and E. Marckwald, *ib.*, 33. 3009, 1900; K. A. Hofmann and F. Zerban, *ib.*, 35. 331, 1902; H. Behrens, *Arch. Néerl.*, (2), 6. 68, 1901; R. Fresenius and E. Hintz, *Zeit. anal. Chem.*, 35. 530, 1896.
- ⁷ G. Urbain, *Bull. Soc. Chim.*, (3), 19. 381, 1898; *Compt. Rend.*, 126. 835, 1898; 127. 107, 1898; 132. 136, 1901; *Ann. Chim. Phys.*, (7), 19. 184, 1900; (8), 13. 274, 1900; *Journ. Chim. Phys.*, 4. 55, 1906; C. von Scheele, *Ber.*, 32. 412, 1899; W. Muthmann and E. Baur, *ib.*, 33. 1754, 1900; K. A. Hofmann and O. Burger, *ib.*, 41. 308, 1908; H. C. Kremers, C. W. Hopkins, and E. W. Engle, *Journ. Amer. Chem. Soc.*, 40. 598, 1918.
- ⁸ D. I. Mendeleef, *Liebig's Ann.*, 168. 45, 1873; A. Bettendorff, *ib.*, 256. 163, 1890; W. Muthmann, H. Hofer, and L. Weiss, *ib.*, 320. 268, 1902; W. Muthmann and L. Weiss, *ib.*, 331. 3, 1903; C. A. von Welsbach, *Sitzber. Akad. Wien*, 92. 318, 1885; 112. 1037, 1903; *Brit. Pat. No.* 9806, 1886; *Monatsh.*, 4. 630, 1884; 5. 508, 1884; 6. 477, 1885; P. Kiesewetter and G. Krüss, *Ber.*, 21. 2311, 1888; P. Schottlander, *ib.*, 25. 379, 1892; H. du Bois and O. Liebknecht, *ib.*, 32. 3345, 1899; W. Muthmann and L. Stützel, *ib.*, 32. 2657, 1899; C. von Scheele, *ib.*, 32. 410, 1899; *Zeit. anorg. Chem.*, 17. 316, 1898; 18. 356, 1898; *Om Praseodym och några af dess Föreninger*, Upsala, 1900; G. Kölle, *Beiträge zur Kenntnis der Cers*, Zürich, 1898; M. Koss, *Beiträge zur Abcheidung und Bestimmung des Cers*, Berlin, 1904; H. Rölig, *Beiträge zur Kenntnis der seltenen Erden des Cers*, München, 1898; R. Jacoby, *Die Doppelnitrate des vierwertigen Ceriums und des Thoriums*, Berlin, 1901; L. Weiss, *Ueber die Darstellung der Metalle der Cergruppe durch Schmelzelektrolyse*, München, 1902; W. Hiller, *Beiträge zur Kenntniss der Certerden*, Berlin, 1904; G. P. Drossbach, *Journ. Gasbeleucht.*, 38. 582, 1896; 41. 352, 1898; *Ber.*, 29. 2452, 1896; 33. 3506, 1900; C. R. Böhm, *Zeit. angew. Chem.*, 15. 372, 1902; *Die Zerlegbarkeit des Praseodyms und Darstellung seltener Erden mit Hilfe einer neuen Trennungsmethode*, Halle a. S., 1900; R. H. Meyer and E. Marckwald, *Ber.*, 33. 3006, 1900; W. Muthmann and E. Baur, *ib.*, 33. 1751, 1900; R. J. Meyer and M. Koss, *ib.*, 35. 672, 1902; R. J. Meyer and R. Jacoby, *Zeit. anorg. Chem.*, 27. 361, 1901; R. J. Meyer, *ib.*, 33. 113, 1902; 37. 380, 1903; P. Mengel, *ib.*, 19. 70, 1899; L. Pissarjewsky, *ib.*, 25. 382, 1900; C. Benedicks, *ib.*, 22. 407, 1900; F. Melikoff and L. Pissarjewsky, *ib.*, 21. 70, 1899; W. Muthmann and H. Rölig, *ib.*, 16. 451, 1898; B. Brauner and A. Batek, *ib.*, 34. 120, 1903; B. Brauner and F. Pavlicek, *Journ. Chem. Soc.*, 81. 1246, 1902; B. Brauner, *Proc. Chem. Soc.*, 14. 70, 1898; *Chem. News*, 71. 283, 1895; O. N. Witt, *Chem. Ind.*, 19. 156, 1896; O. N. Witt and W. Theel, *Ber.*, 33. 1315, 1900; H. Behrens, *Arch. Néerl.*, (2), 6. 81, 1901; L. M. Dennis and E. M. Chamot, *Journ. Amer. Chem. Soc.*, 19. 799, 1897; C. Baskerville and H. Holland, *ib.*, 26. 71, 1904; C. Baskerville and E. G. Moss, *ib.*, 26. 67, 1904; G. P. Baxter and H. C. Chapin, *ib.*, 33. 1, 1911; G. P. Baxter and O. J. Stewart, *ib.*, 37. 516, 1915; C. James, *Chem. News*, 97. 205, 1908; H. C. Jones, *Amer. Chem. Journ.*, 20. 348, 1898; E. Demarçay, *Compt. Rend.*, 126. 1040, 1898; G. Urbain and H. Lacombe, *ib.*, 138. 84, 1904; *Chem. News*, 89. 52, 1904; G. Urbain, *Ann. Chim. Phys.*, (7), 19. 184, 1900; M. Esposito, *Proc. Chem. Soc.*, 22. 20, 1906; 23. 64, 1907.
- ⁹ R. Bunsen, *Liebig's Ann.*, 105. 43, 1858; W. Muthmann and L. Weiss, *ib.*, 331. 3, 1903; E. Demarçay, *Compt. Rend.*, 130. 1020, 1185, 1469, 1900; 132. 1484, 1901; G. P. Drossbach, *Ber.*, 35. 2827, 1902; W. Hiller, *Beiträge zur Kenntniss der Certerden*, Berlin, 1904; W. Feit and C. Prazibyla, *Zeit. anorg. Chem.*, 43. 202, 1905; W. Feit, *ib.*, 43. 267, 1905; C. James, *Chem. News*, 97. 205, 1908; O. Holmberg, *Bihang Svenska Akad. Handl.*, 28. 5, 1903; *Zeit. anorg. Chem.*, 53. 83, 1907; G. Urbain and H. Lacombe, *Compt. Rend.*, 137. 792, 1903; 138. 84, 627, 1166, 1904; G. Urbain, *Journ. Chim. Phys.*, 4. 31, 105, 1906.
- ¹⁰ G. Urbain and H. Lacombe, *Compt. Rend.*, 137. 792, 1903; 138. 84, 627, 1166, 1904; *Chem. News*, 88. 295, 1903; 89. 52, 277, 1904; G. Urbain, *Journ. Chim. Phys.*, 4. 40, 105, 1906; G. Eberhard, *Zeit. anorg. Chem.*, 45. 374, 1905; C. James and J. E. Robinson, *Journ. Amer. Chem. Soc.*, 33. 1363, 1911; 35. 754, 1913.
- ¹¹ G. Urbain, *Compt. Rend.*, 139. 736, 1904; 140. 583, 1905; 141. 521, 1905; *Journ. Chim. Phys.*, 4. 324, 1906.

- ¹² H. Lacombe, *Bull. Soc. Chim.*, (3), 31. 570, 1904; *Chem. News*, 89. 277, 1904; C. James, *Journ. Amer. Chem. Soc.*, 34. 757, 1912.
- ¹³ M. Delafontaine, *Arch. Sciences Genève*, (3), 3. 246, 1880; *Compt. Rend.*, 87. 560, 1878; 90. 222, 1880; *Ann. Chim. Phys.*, (5), 14. 238, 1878; G. Urbain, *ib.*, (7), 19. 184, 1900; J. C. G. de Marignac, *ib.*, (5), 14. 247, 1878; *Compt. Rend.*, 87. 580, 1878; 90. 899, 1880; P. T. Cleve, *ib.*, 91. 382, 1880; *Bull. Soc. Chim.*, (2), 21. 246, 1874; (2), 30. 2, 1878; *Chem. News*, 53. 30, 1886; A. Bettendorff, *Liebig's Ann.*, 352. 88, 1907; J. Sterba-Böhm, *Zeit. Elektrochem.*, 20. 289, 1907; B. Brauner, *Monatsh.*, 3. 487, 498, 1882; *Chem. News*, 47. 175, 1883; H. E. Roscoe, *ib.*, 45. 184, 1882; *Ber.*, 15. 1274, 1882; W. Muthmann and E. Baur, *ib.*, 33. 1753, 1900; H. Behrens, *Arch. Néerl.*, (2), 6. 72, 83, 1901; K. A. Hofmann and G. Krüss, *Zeit. anorg. Chem.*, 4. 34, 41, 43, 1893; K. A. Hofmann, *Ueber die Terbinerde*, München, 1893.
- ¹⁴ J. J. Berzelius, *Pogg. Ann.*, 16. 413, 1829; N. J. Berlin, *ib.*, 43. 112, 1838; *Svenska Akad. Handl.*, 212, 1835; R. Finkener, *Pogg. Ann.*, 118. 503, 1863; H. Rose, *ib.*, 118. 503, 1863; O. Popp, *Liebig's Ann.*, 131. 195, 1864; J. P. Bahr and R. Bunsen, *ib.*, 137. 2, 1866; M. Delafontaine, *ib.*, 131. 110, 1864; *Arch. Sciences Genève*, (2), 18. 343, 1864; *Compt. Rend.*, 87. 633, 639, 1878; *Chem. News*, 73. 284, 1896; C. Benedicks, *Zeit. anorg. Chem.*, 22. 419, 1900; K. T. Postius, *Untersuchungen in der Yttergruppe*, München, 1902.
- ¹⁵ G. Urbain, *Bull. Soc. Chim.*, (3), 15. 347, 1896; *Ann. Chim. Phys.*, (7), 19. 184, 1900; G. Urbain and E. Budischowsky, *Compt. Rend.*, 124. 618, 1897; G. and E. Urbain, *ib.*, 132. 136, 1901; A. Hantzsch and C. H. Desch, *Liebig's Ann.*, 323. 26, 1902; W. Biltz, *ib.*, 331. 334, 1904; K. A. Hofmann, *Ber.*, 43. 2631, 1910; R. J. Meyer and A. H. Winter, *Zeit. anorg. Chem.*, 67. 398, 1910.
- ¹⁶ J. C. Morgan and C. James, *Journ. Amer. Chem. Soc.*, 36. 10, 1914.
- ¹⁷ L. M. Dennis and C. W. Bennett, *Journ. Amer. Chem. Soc.*, 34. 7, 1912; L. M. Dennis and F. H. Rhodes, *ib.*, 37. 807, 1915; P. S. Willard and C. James, *ib.*, 38. 1198, 1916.
- ¹⁸ O. Holmberg, *Bihang. Svenska Akad. Handl.*, 28. 5, 1903; *Zeit. anorg. Chem.*, 53. 83, 1907; O. Holmberg and C. von Scheele, *Chem. Ztg.*, 18. 344, 1903; C. Garnier, *Arch. Sciences Genève*, (6), 40. 93, 199, 1915; P. S. Willard and C. James, *Journ. Amer. Chem. Soc.*, 38. 1198, 1916.
- ¹⁹ L. Stützel, *Zur Kenntnis der seltenen Erden des Cerits*, München, 1899; K. T. Postius, *Untersuchungen in der Yttergruppe*, München, 1902.
- ²⁰ A. Loose, *Studien über die seltenen Erden aus der Cer- und Yttergruppe*, München, 1892; H. Rölig, *Beiträge zur Kenntnis der seltenen Erden des Cerits*, München, 1898; K. T. Postius, *Untersuchungen in der Yttergruppe*, München, 1902; L. Weiss, *Ueber die Darstellung der Metalle der Cergruppe durch Schmelzelektrolyse*, München, 1902; C. R. Böhm, *Die Zerlegbarkeit des Praseodyms und Darstellung seltener Erden mit Hilfe einer neuen Trennungsmethode*, Halle a. S., 1900; R. Marc, *Die Kathodoluminescenz-Spektren der seltenen Erden und Untersuchungen über die Erden der Yttergruppe*, München, 1902; *Ber.*, 35. 2382, 1902; K. de Boisbaudran, *Chem. News*, 54. 225, 1886; *Compt. Rend.*, 88. 323, 516, 1879; 89. 212, 1879; 102. 153, 395, 483, 647, 899, 1004, 1536, 1886; 103. 627, 1886; 111. 393, 397, 1890; 114. 575, 1892; 116. 611, 1893; P. T. Cleve, *ib.*, 89. 478, 1879; 91. 328, 1880; 95. 33, 1882; *Ber.*, 8. 129, 1875; *Bull. Soc. Chim.*, (2), 21. 196, 246, 1874; (2), 39. 289, 1883; *Chem. News*, 53. 30, 1886; M. Delafontaine, *ib.*, 73. 284, 1896; *Journ. prakt. Chem.*, (1), 94. 298, 1865; *Liebig's Ann.*, 134. 105, 1865; B. Brauner, *Ber.*, 24. 1329, 1891; *Sitzber. Akad. Wien*, 92. 826, 1886; *Journ. Chem. Soc.*, 41. 68, 1882; 43. 278, 1883; *Chem. News*, 47. 175, 1883; *Monatsh.*, 3. 14, 487, 495, 498, 1882; J. J. Berzelius, *Pogg. Ann.*, 4. 140, 1825; C. G. Mosander, *ib.*, 60. 303, 314, 1843; *Phil. Mag.*, (3), 23. 341, 1843; J. C. G. de Marignac, *Ann. Chim. Phys.*, (3), 38. 148, 1853; G. Urbain, *ib.*, (7), 19. 184, 1900; R. Hermann, *Journ. prakt. Chem.*, (1), 82. 386, 1861; (1), 93. 113, 1864; O. Popp, *Liebig's Ann.*, 131. 180, 1864; F. Frerichs and F. Smith, *ib.*, 191. 338, 1878; G. Krüss, *Zeit. anorg. Chem.*, 3. 353, 1893; *Liebig's Ann.*, 265. 8, 1891; A. Bettendorff, *ib.*, 270. 378, 1892; W. Muthmann, H. Hofer, and L. Weiss, *ib.*, 320. 268, 1902; G. Krüss and A. Loose, *Zeit. anorg. Chem.*, 3. 93, 1893; K. A. Hofmann and G. Krüss, *ib.*, 4. 27, 1893; C. Benedicks, *ib.*, 22. 396, 1900; P. Truchot, *Les terres rares*, Paris, 1898; C. Erk, *Zeit. Chem.*, (2), 7. 104, 1871; *Zeit. anal. Chem.*, 10. 479, 1871; J. L. Smith, *Chem. News*, 48. 29, 1883; *Amer. Chem. Journ.*, 5. 73, 1883; W. A. A. Prandtl and J. Rauchenberger, *Ber.*, 53. 843, 1920; *Zeit. anorg. Chem.*, 120. 120, 1921; 122. 311, 1922; 129. 176, 1923; W. A. A. Prandtl and J. Losch, *ib.*, 122. 159, 1922; 127. 209, 1923; E. Demarcay, *Compt. Rend.*, 100. 740, 1885; 117. 163, 1893; W. Crookes, *Chem. News*, 54. 42, 1886; *Proc. Roy. Soc.*, 40. 236, 1886; G. P. Drossbach, *Ber.*, 29. 2454, 1896; W. Muthmann and H. Rölig, *ib.*, 1. 1722, 1898; W. Muthmann and E. Baur, *ib.*, 33. 1753, 1900; W. Muthmann and C. R. Böhm, *ib.*, 33. 42, 1900; K. A. Hofmann and O. Burger, *ib.*, 41. 308, 1908; C. von Scheele, *ib.*, 32. 411, 1899; O. N. Witt and W. Theel, *ib.*, 33. 1318, 1900; C. Glaser, *Chem. Ztg.*, 11. 612, 1869; H. Behrens, *Arch. Néerl.*, (2), 6. 83, 1901.
- ²¹ G. P. Drossbach, *Ber.*, 29. 2453, 1896; H. Behrens, *Arch. Néerl.*, (2), 6. 86, 1901; B. Brauner and F. Pavlicek, *Journ. Chem. Soc.*, 81. 1243, 1902; *Proc. Chem. Soc.*, 17. 63, 1901.
- ²² A. Loose, *Studien über die seltenen Erden aus der Cer- und Yttergruppe*, München, 1892; K. A. Hofmann, *Ueber die Terbinerde*, München, 1893; K. A. Hofmann and O. Burger, *Ber.*, 41. 308, 1900; K. A. Hofmann and G. Krüss, *Zeit. anorg. Chem.*, 3. 410, 1893; 4. 27, 1893; G. Krüss, *ib.*, 3. 108, 354, 1893; *Liebig's Ann.*, 265. 18, 1891; A. McMe. Jefferson, *Journ. Amer. Chem. Soc.*, 24. 540, 1902; B. L. Hartwell, *ib.*, 25. 1128, 1903; A. Kolb, *Journ. prakt. Chem.*, (2), 66. 59, 1902.

- ²³ J. Köppel, *Zeit. anorg. Chem.*, **18**, 305, 1898.
- ²⁴ C. Czudnowicz, *Journ. prakt. Chem.*, (1), **80**, 17, 1860; G. P. Drossbach, *Zeit. angew. Chem.*, **14**, 658, 1901; *Ber.*, **29**, 2454, 1896; R. J. Meyer and E. Marckwald, *ib.*, **33**, 3010, 1900; W. Muthmann and H. Rölig, *ib.*, **31**, 1721, 1725, 1898; H. Rölig, *Beiträge zur Kenntnis der Cerits*, München, 1899; H. Behrens, *Arch. Néerl.*, (2), **6**, 86, 1901; W. Hiller, *Beiträge zur Kenntniss der Ceriterden*, Berlin, 1904.
- ²⁵ L. de Boisbaudran, *Compt. Rend.*, **99**, 525, 1884; P. Schützenberger and O. Boudouard, *ib.*, **124**, 481, 1897; G. P. Drossbach, *Journ. Gasbeleucht.*, **38**, 582, 1895; G. Urbain, *Ann. Chim. Phys.*, (7), **19**, 184, 1900.
- ²⁶ C. A. von Welsbach, *Monatsh.*, **4**, 630, 1883; **5**, 508, 1884; *Brit. Pat. No.* 9806, 1886; P. Schottländer, *Ber.*, **25**, 382, 1892; G. P. Drossbach, *ib.*, **29**, 2453, 1896; **35**, 1486, 2826, 1902; *Zeit. angew. Chem.*, **14**, 658, 1901; W. Muthmann and H. Rölig, *Ber.*, **31**, 1721, 1898; C. R. Böhm, *ib.*, **15**, 372, 1902; *Die Zerlegbarkeit des Praseodyms und Darstellung seltener Erden mit Hilfe einer neuen Trennungsmethode*, Halle a. S., 1900; H. Behrens, *Arch. Néerl.*, (2), **6**, 85, 1901; W. Muthmann and L. Weiss, *Liebig's Ann.*, **331**, 3, 1903; H. Rölig, *Beiträge zur Kenntnis der seltenen Erden des Cerits*, München, 1898.
- ²⁷ L. M. Dennis, *Journ. Amer. Chem. Soc.*, **18**, 947, 1896; L. M. Dennis and B. Dales, *ib.*, **24**, 401, 1902; L. M. Dennis and W. H. Magee, *Zeit. anorg. Chem.*, **7**, 250, 1894; L. M. Dennis and F. L. Kortright, *ib.*, **6**, 35, 1894; *Amer. Chem. Journ.*, **16**, 79, 1894; G. N. Wyruboff and A. Verneuil, *Compt. Rend.*, **126**, 340, 342, 1898; **127**, 412, 1898; *Bull. Soc. Chim.*, (3), **19**, 219, 1898.
- ²⁸ M. H. Klaproth, *Gehlen's Ann.*, **2**, 303, 1804; N. J. Berlin, *Svenska Akad. Handl.*, **212**, 1835; P. Berthier, *Ann. Chim. Phys.*, (3), **7**, 74, 1843; R. Hermann, *Journ. prakt. Chem.*, (1), **31**, 85, 1844; W. Henneberg, *ib.*, (1), **38**, 609, 1846; C. Erk, *Zeit. Chem.*, (2), **7**, 104, 1871; *Zeit. anal. Chem.*, **10**, 479, 1871; C. Baskerville, *Journ. Amer. Chem. Soc.*, **16**, 475, 1894; **17**, 448, 1895; **23**, 761, 1901; H. Geisow and P. Horkheimer, *Zeit. anorg. Chem.*, **32**, 372, 1902; A. Batek, *ib.*, **45**, 87, 1905; H. Grossmann, *ib.*, **44**, 299, 1905; H. L. Wells and H. W. Foote, *ib.*, **10**, 434, 1895; *Amer. Journ. Science*, (4), **1**, 18, 1896; R. Chavastelon, *Compt. Rend.*, **130**, 781, 1900; W. Buddäus, L. Preussner, H. Itzig, and C. Oppenheimer, *German Pat.*, *D.R.P.* 95061, 1897; J. P. Bonardi and C. James, *Journ. Amer. Chem. Soc.*, **37**, 2642, 1915.
- ²⁹ J. J. Chydenius, *Kemisk undersökning af Thorjord och Thorsalter*, Helsingfors, 1861; *Pogg. Ann.*, **119**, 45, 1863; R. Bunsen, *ib.*, **155**, 366, 1875; N. J. Berlin, *ib.*, **43**, 109, 1838; *Svenska Akad. Handl.*, **212**, 1835; N. Engström, *Undersökning af några mineral, som innehålla sällsynta jordarter*, Upsala, 1877; M. Weibull, *Om Zirkonium och vers föreningar*, Lund, 1883; P. Truchot, *Les terres rares*, Paris, 1898; F. Chancel, *Compt. Rend.*, **46**, 987, 1858; *Journ. prakt. Chem.*, (1), **74**, 471, 1858; R. Hermann, *ib.*, (1), **93**, 107, 1864; (1), **97**, 330, 1866; F. Stromeyer, *Liebig's Ann.*, **113**, 127, 1860; P. H. M. P. Brinton and C. James, *Journ. Amer. Chem. Soc.*, **43**, 1397, 1921; J. C. G. de Marignac, *Compt. Rend.*, **87**, 580, 1378; *Chem. News*, **53**, 30, 1886; *Zeit. Kryst.*, **16**, 362, 1890; W. C. Brögger, *ib.*, **16**, 83, 1890; K. Rördam, *Medd. Grönland*, **7**, 49, 1888; C. W. Blomstrand, *Geol. Förh. Stockholm*, **9**, 160, 1887; S. L. Penfield, *Amer. Journ. Science*, (3), **25**, 459, 1883; G. Krüss and L. F. Nilson, *Öfvers. Akad. Förh.*, **267**, 1887; *Ber.*, **20**, 1696, 1887; W. Crookes, *Chem. News*, **74**, 259, 1896; R. Fresenius and E. Hintz, *Zeit. anal. Chem.*, **35**, 530, 1896; E. Hintz and H. Weber, *ib.*, **35**, 543, 1896; **36**, 30, 678, 1897; C. Glaser, *Chem. Ztg.*, **11**, 612, 1896; G. Urbain, *Bull. Soc. Chim.*, (3), **15**, 347, 1896; *Ann. Chim. Phys.*, (7), **19**, 184, 1900; O. Boudouard, *Compt. Rend.*, **126**, 1649, 1898; G. P. Drossbach, *Zeit. angew. Chem.*, **14**, 656, 1901; E. Benz, *ib.*, **15**, 302, 1902; K. A. Hofmann and F. Zerban, *Ber.*, **35**, 531, 1902; P. T. Cleve, *Zeit. Kryst.*, **16**, 362, 1890.
- ³⁰ J. J. Berzelius, *Pogg. Ann.*, **16**, 385, 1829; *Svenska Akad. Handl.*, **1**, 1829; M. Delafontaine, *Chem. News*, **75**, 229, 1897; L. Pissarjevsky, *Zeit. anorg. Chem.*, **25**, 379, 1900; J. J. Chydenius, *Kemisk undersökning af Thorjord och Thorsalter*, Helsingfors, 1861; *Pogg. Ann.*, **119**, 45, 1863; V. Samter, *Ueber Thoriumdoppelsalze*, Berlin, 1901; I. Davidsohn, *Beiträge zur Chemie des Thoriums*, Berlin, 1902; A. Rosenheim, V. Samter, and I. Davidsohn, *Zeit. anorg. Chem.*, **35**, 424, 1903; J. Sterba-Böhm, *Zeit. Elektrochem.*, **20**, 289, 1914; R. J. Meyer, *Zeit. anorg. Chem.*, **60**, 134, 1908; *German Pat.*, *D.R.P.P.* 202253, 203355, 1908; F. Stolba, *Zeit. anal. Chem.*, **13**, 59, 1874; J. C. G. de Marignac, *Ann. Chim. Phys.*, (3), **60**, 257, 1860; *Journ. prakt. Chem.*, (1), **83**, 201, 1861; B. Franz, *Ber.*, **3**, 59, 1870; R. Hornberger, *Liebig's Ann.*, **181**, 332, 1876; H. Wade, *Brit. Pat. No.* 164581, 1920.
- ³¹ L. N. Vauquelin, *Ann. Chim. Phys.*, (1), **36**, 143, 1801; J. C. G. de Marignac, *ib.*, (3), **38**, 148, 1853; W. Hisinger and J. J. Berzelius, *Gehlen's Ann.*, **2**, 387, 1804; M. H. Klaproth, *Chemische Wörterbuch*, Berlin, **4**, 477, 1809; F. Frerichs, *Ber.*, **7**, 798, 1874; O. Hauser, *ib.*, **37**, 2024, 1904; G. Krüss and L. F. Nilson, *ib.*, **20**, 2146, 1887; G. P. Drossbach, *ib.*, **35**, 2826, 1902; *Journ. Gasbeleucht.*, **38**, 582, 1895; R. Hornberger, *Liebig's Ann.*, **181**, 235, 1876; B. Brauner, *Monatsh.*, **3**, 487, 1882; P. T. Cleve, *Compt. Rend.*, **94**, 1528, 1882; C. Matignon, *ib.*, **133**, 289, 1901; G. Urbain, F. Bourin, and P. Mallard, *ib.*, **149**, 127, 1909; G. H. Bailey, *Chem. News*, **60**, 6, 17, 32, 1889; W. Gibbs, *Amer. Chem. Journ.*, **15**, 546, 1893; O. Pettersson, *Zeit. anorg. Chem.*, **4**, 1, 1893; W. Palmer, *ib.*, **14**, 366, 1897; M. Fronstein and J. Mai, *German Pat.*, *D.R.P.* 93940, 1897; H. Behrens, *Arch. Néerl.*, (2), **6**, 89, 1901; F. P. Venable, *Journ. Amer. Chem. Soc.*, **20**, 119, 1898; J. M. Matthews, *ib.*, **20**, 846, 1898; C. Baskerville and R. Stevenson, *ib.*, **26**, 54, 1904; P. H. M. P. Brinton and C. James, *ib.*, **43**, 1397, 1921; C. James and P. S. Williams, *ib.*, **38**, 1497, 1916; J. P. Bonardi and C. James, *ib.*, **37**, 2642, 1915.
- ³² H. C. Holden and C. James, *Journ. Amer. Chem. Soc.*, **36**, 638, 1914; R. J. Meyer and

- J. Wuorinen, *Zeit. anorg. Chem.*, **80**, 7, 1913; N. J. Berlin, *Svenska Akad. Handl.*, **212**, 1835; *Pogg. Ann.*, **43**, 108, 1835; P. T. Cleve, *Bull. Soc. Chim.*, (2), **21**, 116, 1874.
- ³³ M. H. Klaproth, *Beiträge zur chemischen Kenntniss der Mineral Körper*, Berlin, **3**, 66, 1802; W. Gruner, *Gilbert's Ann.*, **13**, 495, 1803; J. J. Berzelius, *Pogg. Ann.*, **41**, 141, 1835; T. Scheerer, *ib.*, **59**, 333, 1843; N. J. Berlin, *ib.*, **43**, 108, 1838; *Svenska Akad. Handl.*, **209**, 1835; A. Damour, *Ann. Mines*, (5), **1**, 587, 1852; R. Hermann, *Journ. prakt. Chem.*, (1), **82**, 401, 1861; C. Erk, *Zeit. Chem.*, (2), **7**, 104, 1871; *Zeit. anal. Chem.*, **10**, 479, 1871; P. T. Cleve, *Bull. Soc. Chim.*, (2), **21**, 252, 345, 1874; (2), **43**, 168, 364, 1885; S. Jolin, *ib.*, (2), **21**, 639, 1874; G. Krüss, *Liebig's Ann.*, **265**, 20, 1891; C. Schmidt, *ib.*, **83**, 329, 1852; O. Popp, *ib.*, **131**, 188, 1864; G. N. Witt, *Die chemische Industrie auf der Weltausstellung zu Chicago*, Berlin, **122**, 1894; P. S. Willand and C. James, *Journ. Amer. Chem. Soc.*, **38**, 1198, 1916; G. Wyrnoff and A. Verneuil, *Compt. Rend.*, **124**, 1302, 1897; **127**, 412, 1898; O. Job, *ib.*, **126**, 247, 1898; **128**, 179, 1098, 1899; R. Chavastelon, *ib.*, **130**, 781, 1900; C. von Scheele, *Zeit. anorg. Chem.*, **18**, 319, 362, 1898; H. Geisow and P. Horkheimer, *ib.*, **32**, 372, 1902; R. J. Meyer and A. H. Winter, *ib.*, **67**, 398, 1910; E. Baur, *ib.*, **30**, 256, 1902; R. J. Meyer, *ib.*, **41**, 97, 1904; A. Hiller, *Beiträge zur Kenntniss der Ceriterden*, Berlin, 1904; V. Samter, *Ueber Thoriumdoppelsalze*, Berlin, 1901; I. Davidsohn, *Beiträge zur chemie des Thoriums*, Berlin, 1902; A. Rosenheim, V. Samter, and I. Davidsohn, *Zeit. anorg. Chem.*, **35**, 424, 1903; L. Stützel, *Zur Kenntniss der seltenen Erden des Cerits*, München, 1899; W. Muthmann and L. Stützel, *Ber.*, **32**, 2659, 1899; G. P. Drossbach, *ib.*, **33**, 3508, 1900; **34**, 3508, 1901; **35**, 2828, 1902; G. Possetto, *Giorn. Farm. Chim.*, **48**, 49, 1898; J. C. G. de Marignac, *Ann. Chim. Phys.*, (3), **38**, 148, 1853; *Arch. Sciences Genève*, (1), **24**, 278, 1853.
- ³⁴ N. J. Berlin, *Svenska Akad. Handl.*, **212**, 1835; A. Brauell, *Beiträge zur Kenntniss des Cerium*, Jena, 1875; J. J. Chydenius, *Kemisk undersökning af Thorjord och Thorsalter*, Helsingfors, 1861; *Pogg. Ann.*, **119**, 45, 1863; C. R. Böhm, *Die Zerlegbarkeit des Praseodyms und Darstellung seltener Erden mit Hilfe einer neuen Trennungsmethode*, Halle a. S., 1900; *Zeit. angew. Chem.*, **15**, 372, 1282, 1902; *Pharm. Ztg.*, **47**, 297, 1902; R. Marc, *Die Kathodoluminescenz-Spectren der seltenen Erden und Untersuchungen über die Erden der Yttergruppe*, München, 1902; *Ber.*, **35**, 2382, 1902; A. Loose, *Studien über die seltenen Erden aus der Cer- und Yttergruppe*, München, 1892; K. Postius, *Untersuchungen in der Yttergruppe* München, 1902; L. Weiss, *Ueber die Darstellung der Metalle der Cergruppe durch Schmelzelektrolyse*, München, 1902; M. M. Pattinson and J. Clark, *Chem. News*, **16**, 259, 1867; G. Krüss and A. Loose, *Zeit. anorg. Chem.*, **3**, 103, 1893; R. J. Meyer and J. Wuorinen, *ib.*, **80**, 7, 1913; G. Bricout, *Compt. Rend.*, **118**, 145, 1894; E. Pozzi-Escot and H. C. Couquett, *ib.*, **130**, 1136, 1900; H. Moissan and A. Étard, *ib.*, **122**, 573, 1896; L. Haber, *Monatsh.*, **18**, 688, 1897; W. Muthmann and L. Stützel, *Ber.*, **32**, 2660, 1899; W. Muthmann and C. R. Böhm, *ib.*, **33**, 42, 1900; W. Muthmann and E. Baur, *ib.*, **33**, 1756, 2028, 1900; W. Muthmann, H. Hofer, and L. Weiss, *Liebig's Ann.*, **320**, 268, 1902; E. Baur, *German Pat.*, *D.R.P.* 120013, 1901; K. A. Hofmann and F. Zerban, *Ber.*, **35**, 531, 1902; R. Marc and E. Baur, *ib.*, **34**, 12, 1901; L. M. Dennis and B. Dales, *Journ. Amer. Chem. Soc.*, **24**, 400, 1902; J. E. Egan and C. W. Balke, *ib.*, **35**, 365, 1913; H. C. Holden and C. James, *ib.*, **36**, 638, 1914; B. S. Hopkins and C. W. Balke, *ib.*, **38**, 2332, 1916; C. James, *ib.*, **34**, 757, 1912.
- ³⁵ H. Moissan, *Compt. Rend.*, **124**, 1233, 1897; H. Moissan and F. Lengfeld, *ib.*, **122**, 651, 1896; B. Brauner, *Zeit. anorg. Chem.*, **34**, 224, 1903; W. Muthmann, H. Hofer, and L. Weiss, *Liebig's Ann.*, **320**, 260, 1901; L. Weiss, *German Pat.*, *D.R.P.* 129416, 1901.
- ³⁶ N. J. Berlin, *Svenska Akad. Handl.*, **212**, 1835; *Pogg. Ann.*, **43**, 108, 1838; J. J. Berzelius, *ib.*, **385**, 1829; *Svenska Akad. Handl.*, **1**, 1829; J. P. Bonardi and C. James, *Journ. Amer. Chem. Soc.*, **37**, 2642, 1915; P. S. Willand and C. James, *ib.*, **38**, 1198, 1916; L. T. Lange, *Journ. prakt. Chem.*, (1), **82**, 135, 1861; R. Hermann, *ib.*, (1), **93**, 113, 1864; A. Brauell, *Beiträge zur Kenntniss des Cerium*, Jena, 1875; P. T. Cleve, *Chem. News*, **53**, 30, 1886; H. A. Rowland, *ib.*, **70**, 68, 1894; *Johns Hopkins Univ. Circular*, **112**, 73, 1894; J. J. Chydenius, *Pogg. Ann.*, **119**, 45, 1861; *Kemisk undersökning af Thorjord och Thorsalter*, Helsingfors, 1861; H. Rose, *Pogg. Ann.*, **59**, 102, 1843; H. Sjögren, *Journ. prakt. Chem.*, (1), **55**, 298, 1852; R. J. Meyer and J. Wuorinen, *Zeit. anorg. Chem.*, **80**, 7, 1913; R. Hornberger, *Liebig's Ann.*, **181**, 232, 1876; A. Bettendorff, *ib.*, **352**, 88, 1907; W. Crookes, *Chem. News*, **70**, 81, 1894; H. C. Jones, *Amer. Chem. Journ.*, **17**, 154, 1895; H. Behrens, *Arch. Néerl.*, (2), **5**, 72, 1901.
- ³⁷ J. J. Berzelius, *Pogg. Ann.*, **41**, 138, 1825; C. F. Rammelsberg, *ib.*, **108**, 41, 52, 1849; R. Bunsen, *Liebig's Ann.*, **105**, 42, 1858; *Pogg. Ann.*, **155**, 375, 1875; C. G. Mosander, *ib.*, **60**, 305, 1843; *Phil. Mag.*, (3), **23**, 251, 1843; J. C. G. de Marignac, *Ann. Chim. Phys.*, (3), **8**, 262, 1843; G. Urbain, *ib.*, (7), **19**, 184, 1900; J. Sterba, *ib.*, (8), **2**, 193, 1904; M. Holzmann, *Journ. prakt. Chem.*, (1), **75**, 322, 345, 1858; C. Czudnowicz, *ib.*, (1), **80**, 17, 1860; R. Hermann, *ib.*, (1), **82**, 385, 1861; (1), **92**, 122, 1864; T. Lange, *ib.*, (1), **82**, 129, 1861; H. Zschiesche, *ib.*, (1), **107**, 70, 1869; H. Bührig, *ib.*, (2), **12**, 217, 1878; H. Endemann, *ib.*, (2), **11**, 220, 1875; C. Wolf, *Amer. Journ. Science*, (2), **46**, 53, 1868; C. H. Wing, *ib.*, (2), **40**, 358, 1870; C. Erk, *Zeit. Chem.*, (2), **7**, 103, 1871; *Zeit. anal. Chem.*, **10**, 478, 1871; S. R. Paykull, *Ber.*, **12**, 1719, 1879; G. P. Drossbach, *ib.*, **33**, 3507, 1901; *Journ. Gasbeleucht.*, **41**, 352, 1898; B. Brauner and J. Picck, *Zeit. anorg. Chem.*, **38**, 322, 1904; B. Brauner and A. Batek, *ib.*, **34**, 206, 103, 1903; B. Brauner, *ib.*, **34**, 206, 1903; *Monatsh.*, **3**, 497, 1882; **6**, 792, 1885; *Sitzber. Akad. Wien*, **92**, 821, 1886; *Ber.*, **15**, 110, 1882; *Chem. News*, **71**, 283, 1895; W. Crookes, *ib.*, **54**, 41, 1886; H. Robinson, *ib.*, **54**, 229, 1886; *Proc. Roy. Soc.*, **37**, 150, 1886; G. Krüss and L. F. Nilson, *Öfvers. Akad. Förh.*, **5**, 1887; *Ber.*, **20**, 1678,

1887; O. Hauser, *ib.*, **37**. 2024, 1904; G. N. Wyrouboff and A. Verneuil, *Bull. Soc. Chim.*, (3), **13**. 756, 1895; (3), **17**. 679, 1897; (3), **19**. 219, 1898; *Compt. Rend.*, **124**. 1230, 1897; **129**. 1231, 1899; H. C. Jones, *Amer. Chem. Journ.*, **20**. 345, 1898; H. Behrens, *Arch. Néerl.*, (2), **6**. 82, 1901; R. J. Meyer, *Zeit. anorg. Chem.*, **37**. 383, 1903; R. J. Meyer and A. Aufrecht, *Ber.*, **37**. 140, 1904; W. Muthmann and H. Rölig, *ib.*, **31**. 1720, 1898; G. Kolle, *Beiträge zur Kenntnis der Cers*, Zürich, 1898; M. Koss, *Beiträge zur Abscheidung und Bestimmung des Cers*, Berlin, 1904; W. N. Hartley, *Journ. Chem. Soc.*, **41**. 202, 1882; P. H. M. P. Brinton and C. James, *Journ. Amer. Chem. Soc.*, **43**. 1397, 1921.

³⁸ C. G. Mosander, *Phil. Mag.*, (3), **23**. 241, 1843; *Pogg. Ann.*, **60**. 303, 1843; J. C. G. de Marignac, *Ann. Chim. Phys.*, (3), **38**. 148, 1853; (5), **14**. 247, 1878; *Compt. Rend.*, **87**. 578, 1878; **90**. 900, 1880; *Arch. Sciences Genève*, (3), **3**. 113, 1880; A. Damour and H. St. C. Deville, *Bull. Soc. Chim.*, (2), **2**. 339, 1864; *Compt. Rend.*, **59**. 272, 1864; P. T. Cleve, *ib.*, **89**. 422, 1879; **91**. 381, 1880; **95**. 1225, 1882; P. T. Cleve and O. M. Höglund, *Bihang. Akad. Handl.*, **8**. 1873; *Ber.*, **6**. 1467, 1873; L. F. Nilson, *ib.*, **12**. 550, 555, 1879; **13**. 1430, 1435, 1439, 1444, 1880; **15**. 2526, 1882; *Compt. Rend.*, **88**. 642, 1879; **91**. 57, 1880; M. Delafontaine, *ib.*, **87**. 561, 933, 1878; **90**. 223, 1880; *Chem. News*, **75**. 229, 1897; *Liebigs Ann.*, **135**. 189, 1865; J. F. B. Parr and R. Bunsen, *ib.*, **137**. 2, 1866; W. Muthmann, H. Hofer, and L. Weiss, *ib.*, **320**. 268, 1902; O. Popp, *ib.*, **131**. 193, 1864; A. Bettendorff, *ib.*, **256**. 161, 1889; **263**. 164, 1891; G. Krüss, *ib.*, **265**. 3, 8, 16, 1891; *Zeit. anorg. Chem.*, **3**. 354. 1893; G. Krüss and L. F. Nilson, *Öfvers. Akad. Förh.*, **5**, 1887; *Ber.*, **20**. 1677, 1887; P. Kieseewetter and G. Krüss, *ib.*, **21**. 2311, 1888; K. A. Hofmann and G. Krüss, *Zeit. anorg. Chem.*, **3**. 413, 1896; G. Krüss and A. Loose, *ib.*, **3**. 93, 1893; A. Loose, *Studien über die seltenen Erden aus der Cer- und Ytter-gruppe*, München, 1892; R. Marc, *Die Kathodoluminescenz-Spektren der seltenen Erden und Untersuchungen über die Erden der Yttergruppe*, München, 1902; *Ber.*, **35**. 2382, 1902; K. A. Hofmann, *Ueber die Terbinerde*, Hamburg, 1893; L. Weiss, *Über die Darstellung der Metalle der Cergruppe durch Schmelzelektrolyse*, München, 1902; P. H. M. P. Brinton and C. James, *Journ. Amer. Chem. Soc.*, **43**. 1397, 1921; J. L. Soret, *Compt. Rend.*, **88**. 422, 1879; O. Boudouard, *ib.*, **121**. 273, 1895; **126**. 1648, 1898; P. Schützenberger and O. Boudouard, *ib.*, **123**. 782, 1897; G. and E. Urbain, *ib.*, **132**, 137, 1901; H. E. Roscoe, *Ber.*, **15**. 1275, 1882; C. A. von Welsbach, *Monatsh.*, **4**. 635, 1883; *Sitzber. Akad. Wien*, **88**. 1237, 1883; H. Robinson, *Chem. News*, **54**. 229, 1886; W. Crookes, *ib.*, **54**. 42, 1886; *Proc. Roy. Soc.*, **65**. 237, 1899; C. von Scheele, *Ber.*, **32**. 411, 1899; *Zeit. anorg. Chem.*, **17**. 315, 1897; C. Benedicks, *ib.*, **22**. 397, 1900; H. Behrens, *Arch. Néerl.*, (2), **6**. 86, 1901; H. C. Kremers and C. W. Balke, *Journ. Amer. Chem. Soc.*, **40**. 593, 1918; N. J. Berlin, *Svenska Akad. Handl.*, **212**, 1835; *Pogg. Ann.*, **43**. 108, 1838.

³⁹ L. M. Dennis and W. H. Magee, *Zeit. anorg. Chem.*, **7**. 250, 1894; R. J. Meyer, *ib.*, **37**. 384, 1903; H. Debray, *Compt. Rend.*, **96**. 828, 1883; H. Goreceix, *ib.*, **100**. 357, 1885; J. Sterba, *ib.*, **133**. 221, 1901; P. Didier, *ib.*, **100**. 1461, 1885; P. Schützenberger, *ib.*, **120**. 663, 693, 1143, 1895; P. Schützenberger and O. Boudouard, *ib.*, **122**. 697, 1896; **124**. 481, 1897; *Bull. Soc. Chim.*, (3), **19**. 10, 1889; G. Wyrouboff and A. Verneuil, *ib.*, (3), **17**. 679, 1897; G. Urbain, *Ann. Chim. Phys.*, (7), **19**. 184, 1900; W. Crookes, *Chem. News*, **54**. 41, 1885; B. Brauner, *ib.*, **71**. 283, 1894; B. Brauner and F. Pavlicek, *Journ. Chem. Soc.*, **81**. 1243, 1902; A. Bettendorff, *Liebigs Ann.*, **256**. 160, 1890; C. von Scheele, *Ber.*, **32**. 411, 1899; P. H. M. P. Brinton and C. James, *Journ. Amer. Chem. Soc.*, **43**. 1397, 1921.

⁴⁰ H. Erdmann, *Lehrbuch der anorganischen Chemie*, Braunschweig, 1898; L. Pissarjewsky, *Zeit. anorg. Chem.*, **25**. 390, 1900; G. Krüss and A. Loose, *ib.*, **3**. 92, 1893; H. C. Holden and C. James, *Journ. Amer. Chem. Soc.*, **35**. 148, 1914; P. S. Willand and C. James, *ib.*, **38**. 1198, 1916; B. S. Hopkins and C. W. Balke, *ib.*, **38**. 2332, 1916; K. A. Hofmann and O. Burger, *Ber.*, **41**. 308, 1908.

⁴¹ W. Hisinger and J. J. Berzelius, *Gehlen's Ann.*, **2**. 397, 1804; J. C. G. de Marignac, *Ann. Chim. Phys.*, (3), **38**. 148, 1853; L. N. Vauquelin, *ib.*, (1), **21**. 201, 1797; (1), **36**. 143, 1801; (1), **54**. 26, 1805; R. Hermann, *Journ. prakt. Chem.*, (2), **31**. 81, 1844; P. T. Cleve, *Bull. Soc. Chim.*, (2), **21**. 116, 1874; A. Loose, *Studien über die seltenen Erden aus der Cer- und Ytter-gruppe*, München, 1892; O. Kauffmann, *Zur Kenntnis einiger neuer Thoriumsalze*, Bostock, 1899; C. Volck, *Zeit. anorg. Chem.*, **6**. 161, 1894; G. Wyrouboff and A. Verneuil, *Compt. Rend.*, **126**. 340, 1898; H. C. Holden and C. James, *Journ. Amer. Chem. Soc.*, **36**. 638, 1914; L. Jordan and B. S. Hopkins, *ib.*, **39**. 3614, 1917; J. C. Morgan and C. James, *ib.*, **36**. 10, 1914; P. S. Willand and C. James, *ib.*, **38**. 1198, 1916; A. Rosenheim and T. Triantaphylides, *Ber.*, **48**. 582, 1915; F. Wirth, *Chem. Ztg.*, **37**. 773, 1913; *German Pat.*, *D.R.P.* 268866, 1914.

⁴² W. Hisinger and J. J. Berzelius, *Gehlen's Ann.*, **2**. 397, 1804; J. J. Berzelius, *Svenska Akad. Handl.*, **1**, 1829; *Pogg. Ann.*, **16**. 385, 1829; **22**. 68, 1831; J. C. G. de Marignac, *Ann. Chim. Phys.*, (3), **38**. 148, 1853; M. H. Klaproth, *Beiträge zur chemischen Kenntniss der Mineralkörper*, Berlin, **3**. 66, 1802; N. J. Berlin, *Svenska Akad. Handl.*, **212**, 1835; *Pogg. Ann.*, **43**. 108, 1838; G. Krüss and A. Loose, *Zeit. anorg. Chem.*, **3**. 92, 1893; A. Loose, *Studien über die seltenen Erden aus der Cer- und Ytter-gruppe*, München, 1892; H. C. Holden and C. James, *Journ. Amer. Chem. Soc.*, **36**. 638, 1914; C. Volck, *Zeit. anorg. Chem.*, **6**. 161, 1894.

⁴³ N. J. Berlin, *Svenska Akad. Handl.*, **212**, 1835; *Pogg. Ann.*, **43**. 108, 1838; J. J. Berzelius, *ib.*, **16**. 385, 1829; *Svenska Akad. Handl.*, **1**, 1829; J. J. Chydenius, *Kemisk undersökning af Thorjord och Thorsalter*, Helsingfors, 1861; *Pogg. Ann.*, **119**. 45, 1863; W. Gibbs, *Amer. Chem. Journ.*, **15**. 546, 1893; W. Hisinger and J. J. Berzelius, *Gehlen's Ann.*, **2**. 397, 1804; A. Cossa, *Compt. Rend.*, **98**. 900, 1884; *Gazz. Chim. Ital.*, **10**. 467, 1881; A. Cossa and M. Zechini, *ib.*, **10**.

225, 1881; F. R. M. Hitchcock, *Journ. Amer. Chem., Soc.* 17. 520, 1895; J. P. Bonardi and C. James, *ib.*, 37. 2642, 1915; F. Frerichs and F. Smith, *Liebig's Ann.*, 191, 331, 1878.

⁴⁴ J. J. Berzelius, *Pogg. Ann.*, 16. 414, 1829; M. Delafontaine, *Liebig's Ann.*, 131. 110, 1864; 135. 197, 1865; H. Behrens, *Arch. Néerl.*, (2), 6. 72, 83, 1901; K. Postius, *Untersuchungen in der Yttergruppe*, München, 1902; L. Haber, *Monatsh.*, 18. 692, 1897; A. Mandl, *Zeit. anorg. Chem.*, 37. 252, 1903.

⁴⁵ O. Boudouard, *Compt. Rend.*, 125. 772, 1096, 1897; P. Schützenberger, *ib.*, 120. 962, 1895; G. Wyruboff and A. Verneuil, *ib.*, 125. 950, 1897; 128. 1331, 1898; *Bull. Soc. Chim.*, (3), 19. 219, 1898; C. Glaser, *Zeit. anal. Chem.*, 36. 213, 1897; G. P. Drossbach, *Zeit. angew. Chem.*, 14. 656, 1901; E. Benz, *ib.*, 15. 302, 1902; C. Benedicks, *Zeit. anorg. Chem.*, 22. 419, 1900; A. Mandl, *ib.*, 37. 252, 1903; R. J. Meyer and M. Koss, *Ber.*, 35. 673, 1902; K. Postius, *Untersuchungen in der Yttergruppe*, München, 1902; G. Urbain, *Ann. Chim. Phys.*, (7), 19. 184, 1900; *Bull. Soc. Chim.*, (3), 15. 349, 1896; G. Krüss, *Liebig's Ann.*, 265. 8, 1891; O. Popp, *ib.*, 131. 195, 1864; C. G. Mosander, *ib.*, 48. 219, 1843; *Phil. Mag.*, (3), 23. 25, 1843; M. Delafontaine, *Chem. News*, 73. 284, 1896; L. de Boisbaudran, *Compt. Rend.*, 111. 394, 1890; H. Bäckström, *Zeit. Kryst.*, 16. 83, 1890; P. T. Cleve, *ib.*, 16. 362, 1890; N. A. Orloff, *Russ. Pharm. Journ.*, 42. 5, 1903; L. M. Dennis and E. M. Chamot, *Journ. Amer. Chem. Soc.*, 19. 799, 1897; L. M. Dennis and B. Dales, *ib.*, 24. 401, 1902; L. Stützel, *Zur Kenntnis der seltenen Erden des Cerits*, München, 1899; H. Rose, *Pogg. Ann.*, 118. 503, 1863; R. Finkoner, *ib.*, 118. 503, 1863.

⁴⁶ C. W. Stoddard and C. W. Hill, *Journ. Amer. Chem. Soc.*, 35. 1076, 1911.

⁴⁷ H. Rölig, *Beiträge zur Kenntnis der seltenen Erden des Cerits*, München, 1898; L. Weiss, *Ueber die Darstellung der Metalle der Cergruppe durch Schmelzelektrolyse*, München, 1902; R. Marc, *Die Kathodluminescenz-Spektren der seltenen Erden und Untersuchungen über die Erden der Yttergruppe*, München, 1902; *Ber.*, 35. 2832, 1901; W. Muthmann and H. Rölig, *ib.*, 31. 1722, 1898; W. Muthmann and L. Weiss, *Liebig's Ann.*, 331. 16, 1903; W. Muthmann, H. Hofer, and L. Weiss, *ib.*, 320. 268, 1902; L. Svanberg, *ib.*, 56. 223, 1845; *Öfvers. Svenska Akad. Förh.*, 37. 1845; C. G. Mosander, *Phil. Mag.*, (3), 23. 241, 1843; *Liebig's Ann.*, 48. 222, 1843; O. Popp, *ib.*, 131. 180, 1864; H. Sjögren, *Pogg. Ann. Ergbd.*, 3. 469, 1852; J. C. G. de Marignac, *Ann. Chim. Phys.*, (3), 27. 209, 1849; (3), 38. 148, 1853; (5), 14. 247, 1878; M. Delafontaine, *Arch. Sciences Genève*, (2), 21. 97, 1864; (2), 22. 30, 1865; *Ann. Chim. Phys.*, (5), 14. 238, 1878; G. Urbain, *ib.*, (7), 19. 184, 1900; *Compt. Rend.*, 127. 107, 1898; A. Job, *ib.*, 126. 246, 1898; E. Demarçay, *ib.*, 117. 163, 1893; N. J. Berlin, *Journ. prakt. Chem.*, (1), 58. 145, 1853; R. Hermann, *ib.*, (1), 97. 321, 1866; H. Zschiesche, *ib.*, (1), 107. 71, 1869; H. Bührig, (2), 12. 222, 1875; M. Holzmann, *Zeit. Chem.*, (1), 5. 668, 1862; H. Rose, *Pogg. Ann.*, 118. 503, 1863; R. Finkener, *ib.*, 118. 503, 1863; R. Bunsen, *ib.*, 155. 230, 366, 1873; P. T. Cleve, *Bull. Soc. Chim.*, (2), 31. 486, 1879; (2), 39. 290, 1883; *Compt. Rend.*, 89. 421, 1879; 95. 1225, 1882; P. T. Cleve and O. M. Höglund, *Bihang. Akad. Handl.*, 1. 3, 1873; B. Brauner, *Ber.*, 24. 232, 1891; *Monatsh.*, 3. 491, 498, 1882; *Chem. News*, 71. 283, 1895; *German Pat.*, D.R.P. 97689, 1897; *Journ. Chem. Soc.*, 73. 951, 1898; *Rozprawy Ceské Akad.*, 5. 6, 1896; P. Christin, *Désagrégation de la monazite et séparation des terres rares comme oxalates*, Genève, 1922; W. Crookes, *Proc. Roy. Soc.*, 65. 237, 1899; *Chem. News*, 54. 41, 1886; L. de Boisbaudran, *ib.*, 54. 225, 1886; *Compt. Rend.*, 103. 627, 1886; 116. 611, 1893; W. Gibbs, *Journ. Amer. Chem. Soc.*, 15. 546, 1893; A. J. Grant and C. James, *ib.*, 38. 41, 1916; C. James, *ib.*, 29. 495, 1907; *Chem. News*, 95. 181, 1907; P. S. Willand and C. James, *ib.*, 38. 1198, 1916; K. A. Hofmann and G. Krüss, *Zeit. anorg. Chem.*, 4. 27, 1893; C. von Scheele, *Ber.*, 32. 409, 1899; *Zeit. anorg. Chem.*, 17. 318, 1898; 18. 352, 1898; P. Melikoff and L. Pissarjewsky, *ib.*, 21. 70, 1899; C. Benedicks, *ib.*, 22. 418, 1900; F. Wirth, *ib.*, 76. 174, 1912; H. Stevens, *ib.*, 37. 42, 1901; R. J. Meyer and E. Marckwald, *Ber.*, 33. 3006, 1900; R. Marc, *ib.*, 35. 2382, 1902; H. Behrens, *Arch. Néerl.*, (2), 6. 73, 82, 88, 1901; G. P. Drossbach, *Zeit. angew. Chem.*, 14. 657, 1901; C. A. von Welsbach, *Monatsh.*, 27. 935, 1906; 29. 181, 1908; N. A. Orloff, *Chem. Ztg.*, 30. 733, 1906; M. Esposito, *Proc. Chem. Soc.*, 22. 20, 1906; 23. 64, 1907.

⁴⁸ V. Lehner, *Journ. Amer. Chem. Soc.*, 30. 572, 1908; R. C. Benner, *ib.*, 33. 50, 1911; A. G. Ekeberg, *Gilbert's Ann.*, 14. 247, 1803; *Svenska Akad. Handl.*, 1. 68, 1802; J. J. Berzelius, *ib.*, 1, 1829; *Pogg. Ann.*, 16. 385, 1829; W. Hisinger and J. J. Berzelius, *Gehlen's Ann.*, 2. 397, 1804; M. H. Klaproth, *Chemische Wörterbuch*, Berlin, 1. 572, 1807; *Gehlen's Ann.*, 2. 303, 1804; T. Thomson, *Ann. Phil.*, 356, 1816; O. Kauffmann, *Zur Kenntnis einiger neuer Thoriumsalze*, Rostock, 1899; J. Schilling, *Beiträge zur Chemie des Thoriums*, Heidelberg, 1902; H. Behrens, *Arch. Néerl.*, (2), 5. 72, 1901; P. T. Cleve and O. M. Höglund, *Bihang. Svenska Akad. Handl.*, 1. 8, 1873; *Ber.*, 6. 1467, 1873; N. J. Berlin, *Svenska Akad. Handl.*, 212, 1835; *Pogg. Ann.*, 43. 108, 1838; P. S. Willand and C. James, *Journ. Amer. Chem. Soc.*, 38. 1198, 1916; J. P. Bonardi and C. James, *ib.*, 37. 2642, 1915.

⁴⁹ A. Brauell, *Beiträge zur Kenntnis der Cerium*, Jena, 1875; J. J. Chydenius, *Kemisk undersökning af Thorjord och Thorsalter*, Helsingfors, 1861; *Pogg. Ann.*, 119. 45, 1863; O. Kauffmann, *Zur Kenntnis einiger neuer Thoriumsalze*, Rostock, 1899; J. Schilling, *Beiträge zur Chemie des Thoriums*, Heidelberg, 1902; V. Samter, *Ueber Thoriumdoppelsalze*, Berlin, 1901; I. Davidsohn, *Beiträge zur Chemie des Thoriums*, Berlin, 1902; A. Rosenheim, V. Samter, and I. Davidsohn, *Zeit. anorg. Chem.*, 35. 424, 1903; A. Rosenheim and P. Itzig, *Ber.*, 32. 3424, 1899; 83. 707, 1900; N. J. Berlin, *Svenska Akad. Handl.*, 212, 1835; *Pogg. Ann.*, 43. 108, 1838; W. Hisinger and J. J. Berzelius, *Gehlen's Ann.*, 2. 397, 1804; M. H. Klaproth, *Chemische Wörterbuch*, Berlin, 1. 572, 1807; *Beiträge zur chemischen Kenntniss der Mineralkörper*, Berlin, 1. 216, 1795;

L. N. Vauquelin, *Ann. Chim. Phys.*, (1), 22, 201, 1797; T. Thomson, *Phil. Mag.*, 37, 278, 1811; *Trans. Roy. Soc. Edin.*, 6, 371, 1812; H. Behrens, *Arch. Néerl.*, (2), 5, 72, 1901; P. T. Cleve, *Bull. Soc. Chim.*, (2), 21, 116, 1874; *Chem. News*, 53, 30, 1886; L. Haber, *Monatsh.*, 18, 687, 698, 1897; R. Hornberger, *Liebig's Ann.*, 181, 232, 1876; F. P. Venable and A. W. Belden, *Journ. Amer. Chem. Soc.*, 20, 273, 1898; O. L. Barneby, *ib.*, 34, 1174, 1912; J. P. Bonardi and C. Jones, *ib.*, 37, 2642, 1915; P. S. Willand and C. James, *ib.*, 38, 1198, 1916; H. Rose, *Pogg. Ann.*, 59, 102, 1843; R. Fresenius and E. Hintz, *Zeit. anal. Chem.*, 35, 531, 1896.

⁶⁰ N. J. Berlin, *Svenska Akad. Handl.*, 212, 1835; *Pogg. Ann.*, 43, 108, 1838; O. Kauffmann, *Zur Kenntnis einiger neuer Thoriumsalze*, Rostock, 1899; J. Schilling, *Beiträge zur Chemie des Thoriums*, Heidelberg, 1902; J. J. Chydenius, *Kemisk undersökning af Thorjord och Thorsalter*, Helsingfors, 1861; L. Haber, *Monatsh.*, 18, 687, 698, 1897; L. N. Vauquelin, *Ann. Chim. Phys.*, (1), 22, 201, 1897; W. Hisinger and J. J. Berzelius, *Gehlen's Ann.*, 2, 397, 1804; M. H. Klaproth, *Beiträge zur chemischen Kenntnis der Mineralkörper*, Berlin, 3, 66, 1802; *Chemische Wörterbuch*, Berlin, 1, 572, 1807; J. J. Berzelius, *Svenska Akad. Handl.*, 1, 1829; *Pogg. Ann.*, 16, 385, 1829; 22, 58, 1831; C. Baskerville, *Journ. Amer. Chem. Soc.*, 23, 761, 1901; C. Baskerville and J. W. Turrentine, *ib.*, 26, 46, 1904; J. P. Bonardi and C. James, *ib.*, 37, 2642, 1915; L. Pissarjewsky, *Zeit. anorg. Chem.*, 25, 390, 1900; H. Erdmann, *Lehrbuch der anorganischen Chemie*, Braunschweig, 601, 1898; E. Benz, *Zeit. angew. Chem.*, 15, 300, 1902; H. Harris, *Amer. Chem. Journ.*, 20, 871, 1898.

⁶¹ G. Urbain, *Ann. Chim. Phys.*, (7), 19, 184, 1900; A. Mandl, *Zeit. anorg. Chem.*, 37, 252, 1903; T. Nieszytka, *Naphtalinsulfosäure Salze der Cers*, Halle, 1904; H. Erdmann and T. Nieszytka, *Liebig's Ann.*, 361, 166, 1908; H. Erdmann and F. Wirth, *ib.*, 361, 190, 1908; L. Haber, *Monatsh.*, 18, 687, 698, 1898; H. Behrens, *Arch. Néerl.*, (2), 5, 72, 1901; N. J. Berlin, *Svenska Akad. Handl.*, 212, 1835; *Pogg. Ann.*, 43, 108, 1838; J. B. Trommsdorff, *ib.*, 26, 159, 1838; L. L. Bonaparte, *Compt. Rend.*, 16, 1008, 1843; *Chem. News*, 63, 263, 1891; A. Rosenheim, V. Samter, and J. Davidsohn, *Zeit. anorg. Chem.*, 35, 424, 1903; V. Samter, *Ueber Thoriumdoppelsalze*, Berlin, 1901; J. Davidsohn, *Beiträge zur Chemie des Thoriums*, Berlin, 1902; A. Brauell, *Beiträge zur Kenntnis des Cerium*, Jena, 1875; W. Gibbs, *Amer. Chem. Journ.*, 15, 546, 1893; P. Waage, *Chem. Ztg.*, 19, 1072, 1895; O. Kauffmann, *Zur Kenntnis einiger neuer Thoriumsalze*, Rostock, 1899; L. A. Pratt and C. James, *Journ. Amer. Chem. Soc.*, 33, 1330, 1911.

⁶² T. O. Smith and C. James, *Journ. Amer. Chem. Soc.*, 34, 281, 1912; H. S. Holden and C. James, *ib.*, 36, 638, 1914; J. P. Bonardi and C. James, *ib.*, 37, 2642, 1915; P. S. Willand and C. James, *ib.*, 38, 1198, 1916; L. Jordan and B. S. Hopkins, *ib.*, 39, 2614, 1917; L. A. Pratt and C. James, *ib.*, 33, 1331, 1911; C. James, F. M. Hoben, and C. H. Robinson, *ib.*, 34, 276, 1912; C. F. Whittemore and C. James, *ib.*, 35, 127, 1913; *Chem. News*, 107, 75, 1913; A. Kolb and H. Ahrlé, *Zeit. angew. Chem.*, 18, 92, 1905; R. J. Meyer and J. Wuorinen, *Zeit. anorg. Chem.*, 80, 7, 1913; G. Jantsch and A. Grünkraut, *ib.*, 79, 305, 1913; H. Erdmann and F. Wirth, *Liebig's Ann.*, 361, 190, 1908.

⁶³ H. Behrens, *Arch. Néerl.*, (2), 5, 72, 1901; N. J. Berlin, *Svenska Akad. Handl.*, 212, 1835; W. Hisinger and J. J. Berzelius, *Gehlen's Ann.*, 2, 397, 1804; A. Brauell, *Beiträge zur Kenntnis des Cerium*, Jena, 1875; T. Thomson, *Phil. Mag.*, 37, 278, 1811; *Trans. Roy. Soc. Edin.*, 6, 371, 1812; O. Kauffmann, *Zur Kenntnis einiger neuer Thoriumsalze*, Rostock, 1899.

⁶⁴ G. Wyrzouboff and A. Verneuil, *Bull. Soc. Chim.*, (3), 17, 679, 1897; (3), 19, 219, 1898; *Compt. Rend.*, 124, 1230, 1897; 127, 950, 1897; 123, 1331, 1899; *Ann. Chim. Phys.*, (8), 9, 333, 1906; G. von Knorre, *Zeit. angew. Chem.*, 11, 723, 1897; R. Bunsen, *Liebig's Ann.*, 105, 40, 45, 1858; R. J. Meyer, *Zeit. anorg. Chem.*, 33, 113, 1902.

⁶⁵ N. J. Berlin, *Svenska Akad. Handl.*, 209, 1835; *Pogg. Ann.*, 43, 106, 1838; C. Kersten, *ib.*, 47, 385, 1839; 63, 138, 1844; T. Scheerer, *ib.*, 51, 468, 476, 1840; 56, 498, 504, 1842; C. F. Rammelsberg, *ib.*, 55, 65, 1842; 107, 631, 1859; 108, 45, 62, 435, 1860; F. Wohler, *ib.*, 67, 426, 1846; C. G. Mosander, *ib.*, 46, 649, 1838; 47, 207, 1839; 60, 307, 1843; *Phil. Mag.*, (3), 23, 241, 1843; *Liebig's Ann.*, 48, 212, 1843; T. Kjerulf, *ib.*, 87, 12, 1853; R. Bunsen, *ib.*, 105, 40, 1858; F. Frerichs and F. Smith, *ib.*, 191, 337, 1878; R. Hermann, *Journ. prakt. Chem.*, (1), 30, 198, 1843; (1), 82, 385, 1861; M. Holzmann, *ib.*, (1), 75, 345, 1858; F. M. Stapff, *ib.*, (1), 79, 273, 1860; C. Czudnowicz, *ib.*, (1), 80, 17, 1860; T. Lange, *ib.*, (1), 82, 130, 1861; H. Zschiesche, *ib.*, (1), 107, 68, 1869; H. Bührig, *ib.*, (2), 12, 216, 1875; J. R. Strohecker, *ib.*, (2), 33, 134, 1886; J. C. G. de Marignac, *Arch. Sciences Genève*, (1), 8, 267, 1848; *Liebig's Ann.*, 63, 213, 1848; 71, 306, 1848; E. Berliën, *Ueber die Trennung der Ceritoxyde*, Göttingen, 1864; J. B. Mackay, *Brit. Pat. No. 1275*, 1880; W. Buddäus, L. Preussner, P. Itzig, and G. Oppenheimer, *German Pat.*, D.R.P. 95061, 1897; A. Damour and H. St. C. Deville, *Compt. Rend.*, 59, 270, 1864; G. Wyrzouboff and A. Verneuil, *ib.*, 124, 1230, 1897; C. Erk, *Zeit. Chem.*, (2), 7, 103, 1871; *Zeit. anal. Chem.*, 10, 476, 1871; C. A. von Welsbach, *Monatsh.*, 5, 508, 1884; B. Brauner, *ib.*, 3, 21, 492, 1882; *Ber.*, 24, 1239, 1891; P. Schottländer, *ib.*, 25, 378, 1892; W. Muthmann, *ib.*, 31, 1832, 1898; R. J. Meyer and E. Marckwald, *ib.*, 33, 3005, 1900; R. J. Meyer and M. Koss, *ib.*, 35, 672, 1902; R. J. Meyer, *Zeit. anorg. Chem.*, 33, 113, 1902; 37, 385, 1903; F. Mengel, *ib.*, 19, 67, 1899; C. von Scheele, *ib.*, 17, 317, 1898; L. M. Dennis and W. H. Magee, *ib.*, 7, 251, 1894; A. Piccini, *ib.*, 12, 169, 1896; H. Behrens, *Arch. Néerl.*, (2), 6, 82, 1901; R. Jacoby, *Die Doppelnitrate des Vierwertigen Ceriums und des Thoriums*, Berlin, 1901; G. von Knorre, *Zeit. angew. Chem.*, 10, 723, 1897.

⁶⁶ C. G. Mosander, *Phil. Mag.*, (3), 23, 241, 1843; *Liebig's Ann.*, 44, 125, 1842; *Pogg. Ann.*, 60, 297, 1843; C. F. Rammelsberg, *ib.*, 108, 40, 1859; R. Bunsen, *Liebig's Ann.*, 86, 286, 1853;

T. Kjerulf, *ib.*, 87. 15, 1853; O. Popp, *ib.*, 131. 359, 1864; A. Bettendorff, *ib.*, 256. 160, 1889; G. Krüss, *ib.*, 265. 13, 1891; C. Erk, *Zeit. Chem.*, (2), 7. 101, 1871; *Zeit. anal. Chem.*, 10. 476, 1871; R. Fresenius and E. Hintz, *ib.*, 35. 530, 1896; A. Damour and H. St. C. Deville, *Compt. Rend.*, 59. 272, 1864; J. Sterba, *ib.*, 133. 221, 1901; S. Jolin, *Bull. Soc. Chim.*, (2), 21. 533, 1874; H. Bührig, *Journ. prakt. Chem.*, (2), 12. 218, 1875; B. Brauner, *Zeit. anorg. Chem.*, 34. 227, 1903; *Sitzber. Akad. Wien*, 92. 328, 1885; *Monatsh.*, 3. 6, 1882; L. Haber, *ib.*, 18. 693, 1897; W. N. Hartley, *Chem. News*, 45. 40, 1882; *Journ. Chem. Soc.*, 41. 202, 1882; J. L. Smith, *Amer. Chem. Journ.*, 5. 73, 1883; K. Bockelmann, *Beiträge zur Kenntnis der Elemente der Yttrium- und Cer-gruppe*, Erlangen, 1891; O. Pettersson, *Zeit. anorg. Chem.*, 4. 1, 1893; L. M. Dennis and F. L. Kortright, *ib.*, 6. 37, 1894; L. M. Dennis and W. H. Magee, *ib.*, 7. 252, 1894; *Journ. Amer. Chem. Soc.*, 16. 649, 1894; P. E. Browning, *Compt. Rend.*, 158. 1679, 1914; *Chem. News*, 110. 49, 1914; P. E. Browning and E. J. Roberts, *Journ. Amer. Chem. Soc.*, (4), 29. 45, 1910; *Zeit. anorg. Chem.*, 22. 298, 1900; P. Mengel, *ib.*, 19. 70, 1899; L. Pissarjewsky, *ib.*, 31. 364, 1902; G. P. Drossbach, *Gasbeleucht.*, 38. 582, 1895; *Ber.*, 34. 3506, 1901; O. N. Witt, *Chem. Ind.*, 19. 186, 1896; L. M. Dennis and C. M. Chamot, *Journ. Amer. Chem. Soc.*, 19. 799, 1897; W. Muthmann and H. Rölig, *Ber.*, 32. 1720, 1898; R. J. Meyer and M. Koss, *ib.*, 35. 673, 1902; H. Behrens, *Arch. Néerl.*, (2), 6. 84, 1901; L. Stützel, *Zur Kenntnis der seltenen Erden des Cerits*, München, 1898; H. Rölig, *Beiträge zur Kenntnis der seltenen Erden des Cerits*, München, 1898; H. Watts, *Journ. Chem. Soc.*, 2. 140, 1850; J. H. Pollok and A. G. Leonard, *Proc. Roy. Soc. Dublin*, 11. 257, 1908; O. Hauser and F. Wirth, *Zeit. anal. Chem.*, 48. 679, 1909; A. C. Neish, *Journ. Amer. Chem. Soc.*, 31. 517, 1909.

⁵⁷ F. M. Stappf, *Journ. prakt. Chem.*, (1), 79. 258, 1860; C. Winkler, *ib.*, (1), 95. 410, 1865; W. Gibbs, *Amer. Journ. Science*, (2), 37. 352, 1864; *Proc. Amer. Acad.*, 28. 260, 1893; F. Stolba, *Chem. News*, 41. 31, 1880; B. Brauner, *ib.*, 71. 285, 1895; B. Brauner and F. Pavlicek, *Journ. Chem. Soc.*, 81. 1264, 1902; *Zeit. anorg. Chem.*, 34. 209, 1903; B. Brauner and A. Batek, *Zeit. anorg. Chem.*, 34. 114, 1903; G. P. Drossbach, *German Pat.*, D.R.P. 143106, 1896; *Ber.*, 35. 2830, 1902; *Zeit. angew. Chem.*, 14. 657, 1901; C. R. Böhm, *ib.*, 16. 1129, 1903; *Die Zerlegbarkeit des Praseodyms und Darstellung seltener Erden mit Hilfe einer neuen Trennungsmethode*, Halle a. S., 1900; C. von Scheele, *Zeit. anorg. Chem.*, 17. 320, 1898; P. E. Browning, *ib.*, 22. 297, 1899; R. J. Meyer, *ib.*, 37. 383, 1903; W. Muthmann and L. Weiss, *Liebig's Ann.*, 331. 9, 1903; W. Muthmann and H. Rölig, *Ber.*, 31. 1719, 1898; L. Stützel, *Zur Kenntnis der seltenen Erden des Cerits*, München, 1899; H. Rölig, *Beiträge zur Kenntniss der seltenen Erden des Cerits*, München, 1898; C. James, *Journ. Amer. Chem. Soc.*, 30. 182, 1908; E. J. Roberts, *Amer. Journ. Science*, (5), 31. 350, 1911; *Chem. News*, 103. 303, 1911; R. J. Meyer and A. Schweitzer, *Zeit. anorg. Chem.*, 54. 104, 1907; M. Esposito, *Proc. Chem. Soc.*, 23. 64, 1907.

⁵⁸ W. Gibbs, *Amer. Journ. Science*, (2), 37. 352, 1864; *Amer. Chem. Journ.*, 15. 546, 1894; H. Zacheische, *Journ. prakt. Chem.*, (1), 107. 68, 1869; H. Bührig, *ib.*, (2), 12. 219, 236, 1875; R. Fresenius and E. Hintz, *Zeit. anal. Chem.*, 35. 531, 1896; G. von Knorre, *Zeit. angew. Chem.*, 10. 718, 1897; *Ber.*, 33. 1926, 1900; C. H. Wing, *Amer. Journ. Science*, (2), 49. 358, 1870; H. Robinson, *Proc. Roy. Soc.*, 37. 150, 1885; G. Krüss and L. F. Nilson, *Øfvers. Akad. Förh.*, 5, 1887; L. M. Dennis and W. H. Magee, *Journ. Amer. Chem. Soc.*, 16. 694, 1894; *Zeit. anorg. Chem.*, 7. 252, 1894; P. Mengel, *ib.*, 19. 67, 1899; A. Job, *Compt. Rend.*, 128. 101, 1899.

⁵⁹ G. H. Bailey, *Chem. News*, 53. 55, 1886; 60. 6, 1889; *Journ. Chem. Soc.*, 49. 149, 481, 1886; P. T. Cleve, *Bull. Soc. Chim.*, (2), 43. 359, 1885; G. Wyruboff and A. Verneuil, *ib.*, (3), 17. 679, 1896; (3), 19. 219, 1898; *Compt. Rend.*, 126. 340, 1898; 127. 412, 1898; 128. 1331, 1899; L. de Boisboudran, *ib.*, 100. 605, 1885; R. Chavastelon, *ib.*, 130. 78, 1900; G. and E. Urbain, *ib.*, 132. 136, 1901; G. Urbain, *Ann. Chim. Phys.*, (7), 19. 184, 1900; A. Piccini, *Gazz. Chim. Ital.*, 17. 479, 1887; B. Kosmann, *German Pat.*, D.R.P. 90652, 1896; G. P. Drossbach, *ib.*, 117755, 1901; *Ber.*, 29. 2453, 1896; R. J. Meyer and M. Koss, *ib.*, 35. 673, 1902; R. Marc, *ib.*, 35. 2372, 1902; K. A. Hofmann and F. Zerban, *ib.*, 35. 531, 1902; R. J. Meyer and E. Marckwald, *ib.*, 33. 3005, 1900; G. von Knorre, *ib.*, 33. 1924, 1900; *Zeit. angew. Chem.*, 10. 685, 717, 1897; E. Benz, *ib.*, 15. 303, 1902; W. Muthmann and H. Rölig, *Ber.*, 31. 1720, 1898; P. Schottländer, *ib.*, 25. 379, 1892; H. Rölig, *Beiträge zur Kenntnis der seltenen Erden des Cerits*, München, 1898; H. Behrens, *Arch. Néerl.*, (2), 6. 88, 1901; L. Pissarjewsky, *Zeit. anorg. Chem.*, 25. 378, 1900; 31. 359, 1902; H. Geisow and P. Horkheimer, *ib.*, 32. 375, 1902; B. Brauner and A. Batek, *ib.*, 34. 117, 1903; R. J. Meyer, *ib.*, 37. 379, 1903; P. Mengel, *ib.*, 19. 67, 1899; E. Wedekind, *ib.*, 33. 85, 1903; C. G. Mosander, *Pogg. Ann.*, 47. 210, 1839; W. Hiller, *Beiträge zur Kenntniss der Certerden*, Berlin, 1904; L. M. Dennis and W. H. Magee, *Journ. Amer. Chem. Soc.*, 16. 694, 1894; *Zeit. anorg. Chem.*, 7. 252, 1894.

⁶⁰ G. von Knorre, *Zeit. angew. Chem.*, 10. 717, 1897; *Ber.*, 33. 1926, 1900; O. N. Witt and W. Theel, *ib.*, 33. 1315, 1900; R. J. Meyer and E. Marckwald, *ib.*, 33. 3007, 1900; R. J. Meyer and M. Koss, *ib.*, 35. 672, 1902; M. Koss, *Beiträge zur Abscheidung und Bestimmung des Cers*, Berlin, 1904; H. Behrens, *Arch. Néerl.*, (2), 6. 84, 1901; G. Wyruboff and A. Verneuil, *Compt. Rend.*, 128. 1331, 1898; *Bull. Soc. Chim.*, (3), 19. 219, 1898.

⁶¹ C. James, *Journ. Amer. Chem. Soc.*, 30. 182, 1908; 34. 757, 1912; C. James and L. A. Pratt, *ib.*, 33. 1326, 1911.

⁶² K. A. Hofmann and G. Krüss, *Zeit. anorg. Chem.*, 3. 89, 1893; K. A. Hofmann, *Ueber die Terbinde*, München, 1893.

⁶³ J. J. Berzelius and W. Hisinger, *Gehlen's Ann.*, 2. 397, 1804; O. Pettersson, *Zeit. anorg. Chem.*, 4. 1, 1893; R. J. Meyer and A. H. Winter, *ib.*, 67. 398, 1910; G. P. Drossbach, *Journ.*

Gasbeleucht., **38**, 582, 1895; W. Muthmann, H. Hofer, and L. Weiss, *Liebig's Ann.*, **320**, 231, 1902; G. T. Morgan and H. W. Moss, *Journ. Chem. Soc.*, **105**, 189, 1914; G. Urbain, F. Bourion, and P. Mallard, *Compt. Rend.*, **149**, 127, 1909.

⁶⁴ L. M. Dennis, *U.S. Pat. No.* 115513, 1914; L. M. Dennis and B. J. Lemon, *Journ. Amer. Chem. Soc.*, **37**, 131, 1915; L. M. Dennis and P. A. van der Meulen, *ib.*, **37**, 1963, 1915; L. M. Dennis and A. B. Ray, *ib.*, **40**, 174, 1918; L. de Boisbaudran, *Compt. Rend.*, **88**, 322, 1879; L. Troost, *ib.*, **116**, 1428, 1893; G. Bricout, *ib.*, **118**, 146, 1894; J. Sterba, *ib.*, **133**, 222, 1901; E. F. Smith, *Ber.*, **13**, 754, 1880; A. Classen, *ib.*, **14**, 2771, 1881; W. Muthmann, *ib.*, **31**, 1835, 1898; B. Brauner, *Monatsh.*, **3**, 15, 1882; G. Krüss, *Zeit. anorg. Chem.*, **3**, 60, 1893; G. von Knorre, *Zeit. angew. Chem.*, **10**, 685, 717, 1897.

§ 7. The Occurrence and Isolation of the Cerium Family of Rare Earths

The cerium family of elements is arbitrarily taken to include: cerium, Ce; lanthanum, La; neodymium, Nd; praseodymium, Pr; and samarium, Sa or Sm. As previously indicated, the criterion of this classification is the sparing solubility of the double sodium or potassium sulphates. The oxides are strongly electro-positive, and form a series of sesquioxides of the type R_2O_3 , in which the element R is trivalent. The strongly basic oxides form a series of well-defined salts. Cerium furnishes a well-defined dioxide, CeO_2 , which is also basic, forming a series of ceric salts. Praseodymium forms an analogous oxide, PrO_2 , and neodymium an unstable dioxide. The basicity of ceric oxide, CeO_2 , is much less than that of the sesquioxide cerous oxide, Ce_2O_3 . A number of intermediate cerosceric oxides have been prepared. Still higher oxides of the different members of the family have also been reported. Samarium forms a series of salts of the type SaX_2 which correspond with the unknown monoxide, SaO . The high basicity of the rare earth sesquioxides is illustrated by the relatively large heats of dissociation of the sulphates as calculated by L. Wöhler and M. Grunzweig,¹ indeed, these values are the greatest hitherto observed for trivalent sulphates, and indicate that the rare earths belong to the strongest bases. These values ranged in the order of decreasing basicity furnish the series: La, Pr, Nd, Sa, Ce, while the series:

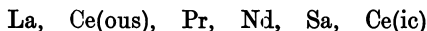

is derived from (i) the order in which the hydroxides are precipitated from soln. by alkali hydroxides or aq. ammonia; or from (ii) the order in which the nitrates are decomposed by heat; or from (iii) the electrical conductivity of aq. soln. of the chlorides.

The occurrence of the ceria earths.—Cerium occurs in a large number of widely distributed minerals, orthite or allanite, cerite, æschynite, yttrocerite, parisite, lanthanite, and a number of others which have been previously described. Monazite is almost exclusively the source of cerium products on a commercial scale. The cerium earths are really a by-product remaining after the extraction of thorium from monazite. Allanite and cerite are used to a very small extent on a manufacturing scale. It is not alone the relative richness of the minerals in the cerium earths that determines its availability as raw material for the manufacture of cerium, but rather its relative abundance. Allanite and cerite are comparatively scarce minerals. Only a small proportion of the ceria earth by-products obtained in the manufacture of thoria from monazite are manufactured into pure cerium salts.

Lanthanum is found in all the minerals containing cerium, and it occurs to the largest extent in lanthanite and beckelite; it is also in moderate proportions in allanite, cerite, and samarskite. Praseodymium and neodymium occur in all the minerals which contain cerium and lanthanum, but to a smaller extent. The term *didymium* is often used as a grouping term to include both neodymium and praseodymium; the group was formerly supposed to be one element. It is curious that the ratio of Pr: Nd in minerals is very nearly constant 1:2, so that neodymium appears to be twice as abundant as praseodymium. Samarium also accompanies cerium, in the cerium earths; and when samarium itself is desired, the usual sources

are cerite, allanite, samarskite, and euxenite. For the occurrence of these elements in the sun and stars, *vide infra*, spectrum.

The preparation of ceria.—Among the rare earth elements cerium is unique in readily forming a series of quadrivalent ceric compounds which are easily hydrolyzed, forming sparingly soluble hydrated oxides or basic salts. In the ceric form, cerium behaves in many respects like thorium and zirconium, and as if it did not belong to the rare earth family; and in this form cerium can be isolated without the need for elaborate processes of fractionation. Ceria is obtained by the extraction of the roasted mixture of salts with very dil. mineral acids or a boiling soln. of ammonium chloride; by the extraction of the partially roasted nitrates or chromates; with acids by the oxidation of cerium salts with chlorine, lead dioxide, potassium bromate, potassium permanganate, hydrogen dioxide, sodium dioxide, and potassium or ammonium persulphate; by anodic oxidation; by the hydrolysis of oxidized soln.; by treating the carbides with dil. acid; by precipitation with *o*-toluidine, pyridine, or quinoline hydrochloride; by a sulphate, chromate, acetate, or valerate; by precipitation as potassium cerium sulphate or ceric ammonium nitrate; and by the partial solubility of the oxalate. These methods have been described in the preceding section. The most expeditious and efficient methods are the basic nitrate process, the bromate process, the permanganate process, and the pyridine hydrochloride process—*vide thoria*. W. Prandtl² described a process based on the use of cadmium nitrate as separating element.

The purification of ceria has been discussed by J. Sterba, G. Wyruboff and A. Verneuil, G. P. Drossbach, R. J. Meyer, B. Brauner, A. Batek, C. C. Kiess and co-workers, A. C. Neish, etc.—*vide at. wt. of cerium*. Conc. aq. soln. of cerous salts should show no signs of the didymium spectrum, Fig. 1, when viewed in layers 10–12 cms. thick. The colour of the ignited oxide should be pale yellow when cold, and show no signs of a salmon, red, or brown tint. H. Bührig showed that the methods published prior to 1875 did not give pure ceria. W. Gibbs first purified cerium to pass the spectroscopic test. Ceria can be purified by dissolving the impure oxide in conc. nitric acid, and evaporating the soln. to a syrupy consistency. The cold mass is then dissolved in cold water, and boiled for 10–15 mins. so as to precipitate the basic nitrate according to the process previously described. J. Sterba found that four precipitations as basic nitrate suffice to eliminate the last traces of other rare earths from ceria. Another method is to apply the ammonium ceric nitrate process four or five times, but this does not get rid of the other rare earths. The salt can also be freed from thoria by the recrystallization of cerous sulphate a number of times. The thoria can also be removed by adding hydrogen dioxide to a hot, neutral, or feebly acid soln.

The preparation of lanthana.—According to H. Zschiesche,³ prior to W. Gibbs' discovery of the lead dioxide test for ceria in 1864, and the application of spectroscopic tests, the methods of detecting ceria in the rare earths were so inadequate that it is almost certain that all the preparations were more or less ceriferous. The preparation of highly purified lanthana is a far more serious undertaking than is the case with ceria. Lanthana has been obtained from the ceria earths, after the removal of cerium, by fractionation with ammonia, alkali hydroxide, magnesia, and aromatic bases; by extracting the roasted oxides with mineral acids; by the extraction of the partially roasted nitrates or chlorides with acids; by precipitation as oxalates or chromates; by the action of sodium acetate and hydrogen peroxide; by electrolysis; by the fractional crystallization of the nitrates, the double ammonium, sodium, magnesium, or manganese nitrates, double potassium carbonates, the sulphates, the ethylsulphates, the chlorides, the bromates, *m*-nitrobenzene sulphonates, and the picrates. These methods have been described in the preceding section. The order of separation with the nitrates, ethylsulphates, bromates, and oxalates is Nd, Pr, La; with the double nitrates, double carbonates, and *m*-nitrobenzene sulphonates, La, Pr, Nd; and with the sulphates, La, Nd, Pr. The more expeditious methods for the purification of lanthana are the fractional crystallization of the double

magnesium nitrate, and the double carbonate processes as recommended by R. J. Meyer. W. Prandtl and J. Rauchenberger used the basic ammonia process. The last traces of praseodymia are retained very tenaciously. C. James' process of purification has been previously described. Purified lanthana is white, and a thick layer of an aq. soln. of the chloride or nitrate should not show the praseodymium absorption bands.

The preparation of neodymia.—Although didymium no longer appears in the list of elements, it is often convenient to prepare first what was formerly regarded as didymia before proceeding to separate it into its components neodymia and praseodymia. The fractionation methods employed for the preparation of crude lanthana also yield didymia. The separation of didymia into its components is more difficult than the preparation of lanthana; and neodymia is more difficult to purify than is the case with praseodymia. The fractionation of the double ammonium nitrates from nitric acid for the separation of neodymium has been previously described, and it was the method employed by C. A. von Welsbach⁴ in his demonstration of the complex nature of didymia. W. Muthmann and L. Weiss recommend the double magnesium nitrate process, and W. Feit and C. Przibylla say that better results are obtained by using cerium as *l'élément séparateur*. According to E. Demarçay, samarium can be eliminated from neodymium by the double magnesium nitrate process continued for four days' working with four fractions; it can also be removed by the double ammonium nitrate process; or perhaps, best of all, by the double manganese nitrate process. The elimination of praseodymium is tedious. After ignition, purified neodymia has a blue colour which is not affected by a few tenths of one per cent. of praseodymia. If samaria and praseodymia be present, the blue absorption bands are less sharply defined than when these impurities are absent. G. P. Baxter and co-workers separated samaria and praseodymia by the fractional crystallization of the nitrate from conc. nitric acid. The bromate fractionation also collects the praseodymium in the more soluble fractions. C. Baskerville and R. Stevenson recommended fractional precipitation by passing hydrogen chloride into a soln. of the chlorides. O. Holmberg, and C. Garnier purified neodymia by fractionating the *m*-nitrobenzene sulphonates. The subject has been discussed by C. C. Kiess and co-workers.

The preparation of praseodymia.—The preparation of praseodymia naturally follows as a sequel to the preparation of its congener neodymia by the double ammonium nitrate or the double magnesium nitrate process. The product may contain lanthana and neodymia. W. Feit and C. Przibylla⁵ eliminate the last traces of lanthana by crystallization of the ethylsulphates, bromates, or simple nitrates from nitric acid. G. P. Baxter and O. J. Stewart used the double ammonium nitrate process in their work on the at. wt. of praseodymium. M. Esposito crystallized the oxalates from nitric acid. B. Brauner found that pure praseodymium dioxide, PrO_2 , separates when the nitrate is fused at 440° . N. A. Orloff purified praseodymia from lanthana by boiling it with a soln. of potassium permanganate and mercuric oxide, to which a soln. of cerium chloride is then gradually added. The precipitate obtained consists of the higher oxides of cerium and praseodymium, whilst the lanthanum remains in soln. The praseodymium is then separated from the cerium by any of the usual methods. C. Baskerville and J. W. Turrentine said that praseodymia containing not more than 10 per cent. of lanthana, can be purified in one operation by precipitating the hydroxides with ammonia, washing the precipitate free from ammonia, dissolving it in a sat. soln. of citric acid, and filtering the soln. When heated to 100° , normal praseodymium citrate separates as an amorphous green powder which can be washed with water. R. J. Meyer could not support this claim. The last traces of neodymia can be removed from praseodymia by the fractional crystallization of the double potassium carbonate, or the double ammonium, magnesium, or manganese nitrate.

The preparation of samaria.—The samaria will be found in the mother liquors from the didymia extractions, and it will also be found with the less soluble portion

of the earths which are not insoluble in a sat. soln. of sodium sulphate. The more soluble fractions from the double ammonium nitrate, the ethylsulphate, or the bromate process, are converted into double magnesium nitrates, and again fractionated from nitric acid of sp. gr. 1.3 as recommended by G. Urbain,⁶ E. Demarçay, and C. James and co-workers. The fractionation should be continued until the samarium has been eliminated from the more soluble fractions, and the less soluble fractions do not show the europium absorption bands. Crystals of magnesium nitrate are apt to separate during this fractionation since the single nitrate is less soluble than the double salt, it is therefore considered best to seed the supersaturated soln. with small crystals of bismuth magnesium nitrate. G. Urbain and H. Lacombe recommended the fractional crystallization of the double magnesium nitrates to which a little bismuth nitrate has been employed as separating element.

REFERENCES.

- ¹ L. Wöhler and M. Grunzweig, *Ber.*, **46**, 1726, 1913.
² J. Sterba, *Ann. Chim. Phys.*, (7), **2**, 193, 1904; G. Wyruboff and A. Verneuil, *ib.*, (8), **9**, 333, 1906; G. P. Drossbach, *Ber.*, **33**, 3506, 1900; R. J. Meyer, *Zeit. anorg. Chem.*, **37**, 378, 1903; J. Koppel, *ib.*, **18**, 305, 1898; B. Brauner, *ib.*, **34**, 207, 1903; B. Brauner and A. Batek, *ib.*, **34**, 103, 1903; W. Prandtl and J. Rauchenberger, *Ber.*, **53**, 843, 1920; *Zeit. anorg. Chem.*, **120**, 120, 1921; **122**, 311, 1922; W. Prandtl and J. Lösch, *ib.*, **127**, 209, 1923; A. C. Neish, *Journ. Amer. Chem. Soc.*, **31**, 517, 1909; H. Bührig, *Journ. prakt. Chem.*, (2), **12**, 222, 240, 1874; W. Gibbs, *Amer. Journ. Science*, (2), **27**, 352, 1864; *Amer. Chem. Journ.*, **15**, 546, 1894; C. C. Kiess, B. S. Hopkins, and H. C. Kremers, *Scient. Papers Bur. Standards*, 421, 1921.
³ H. Zschiesche, *Journ. prakt. Chem.*, (1), **107**, 68, 1896; R. J. Meyer, *Zeit. anorg. Chem.*, **41**, 97, 1904; C. James, *Journ. Amer. Chem. Soc.*, **30**, 979, 1908; **34**, 757, 1912; C. C. Kiess, B. S. Hopkins, and H. C. Kremers, *Scient. Papers Bur. Standards*, 421, 1921; W. Prandtl and J. Rauchenberger, *Ber.*, **53**, 843, 1920; *Zeit. anorg. Chem.*, **120**, 120, 1922; W. Gibbs, *Amer. Journ. Science*, (2), **37**, 352, 1864.
⁴ C. A. von Welsbach, *Monatsh.*, **6**, 477, 1885; *Sitzber. Akad. Wien*, **112**, 1037, 1903; W. Muthmann and L. Weiss, *Liebig's Ann.*, **331**, 1, 1904; W. Feit and C. Przibylla, *Zeit. anorg. Chem.*, **43**, 202, 1905; E. Demarçay, *Compt. Rend.*, **130**, 1019, 1185, 1900; G. P. Baxter and H. C. Chapin, *Journ. Amer. Chem. Soc.*, **33**, 1, 1911; G. P. Baxter, W. H. Whitcomb, O. J. Stewart, and H. C. Chapin, *ib.*, **38**, 302, 1916; C. Baskerville and R. Stevenson, *ib.*, **26**, 54, 1904; O. Holmberg, *Zeit. anorg. Chem.*, **53**, 83, 1907; *Bihang. Svenska Akad. Handl.*, **28**, 5, 1903; C. Garnier, *Arch. Sciences Genève*, (6), **40**, 93, 199, 1915; C. C. Kiess, B. S. Hopkins, and H. C. Kremers, *Scient. Papers Bur. Standards*, 421, 1921.
⁵ N. A. Orloff, *Chem. Zig.*, **30**, 733, 1906; **31**, 115, 1907; B. Brauner, *ib.*, **14**, 70, 1898; **17**, 66, 1901; M. Esposito, *Proc. Chem. Soc.*, **22**, 20, 1906; **23**, 64, 1907; W. Feit and C. Przibylla, *Zeit. anorg. Chem.*, **43**, 202, 1905; C. Baskerville and J. W. Turrentine, *Journ. Amer. Chem. Soc.*, **26**, 46, 1904; G. P. Baxter and O. J. Stewart, *ib.*, **37**, 516, 1915; C. Baskerville, *Zeit. anorg. Chem.*, **45**, 86, 1905; R. J. Meyer, *ib.*, **41**, 97, 1904.
⁶ G. Urbain, *Journ. Chim. Phys.*, **4**, 31, 105, 1905; *Compt. Rend.*, **149**, 37, 1909; G. Urbain and H. Lacombe, *ib.*, **137**, 792, 1903; **138**, 84, 1904; E. Demarçay, *ib.*, **130**, 1019, 1900; C. James, *Chem. News*, **97**, 61, 1908; *Journ. Amer. Chem. Soc.*, **30**, 979, 1908; **34**, 757, 1912; O. J. Stewart and C. James, *ib.*, **39**, 2605, 1917; C. C. Kiess, B. S. Hopkins, and H. C. Kremers, *Scient. Papers Bur. Standards*, 421, 1921.

§ 8. The Preparation of the Metals of the Cerium Family

A few of the metals of the rare earths have been isolated, but usually in an impure state. All the metals of the cerium family of earths have been obtained more or less impure.

The preparation of the cerium metals.—C. G. Mosander¹ obtained cerium, lanthanum, and didymium by reducing the anhydrous chloride with heated sodium or potassium; A. Beringer, and F. Wöhler also made cerium in this way; J. C. G. de Marignac, didymium; and C. A. Matignon, and M. A. Hunter, neodymium. The yield is poor. The metal appears in the form of a large number of fine globules which give it the appearance of a powder. It is difficult to remove the alkali chloride which is produced; and the metal is liable to be alloyed with a little sodium or potassium. M. Moldenhauer reduced cerium fluoride by heating

it with an excess of calcium, or aluminium. The cerium was always alloyed with the reducing agent. Thus, the product with calcium contained 12 per cent. of calcium, and 86 per cent. of cerium. It is necessary to cover the contents of the crucible with a layer of calcium fluoride in order to prevent oxidation during the reaction. If the cerium fluoride be mixed with ferric oxide, a cerium-iron alloy is produced. M. Moldenhauer said that cerium oxide is not reduced by applying the thermite process, using aluminium, magnesium, or calcium as a reducing agent. C. A. Winkler reduced lanthana and ceria by means of magnesium; and H. Holm, and C. A. Matignon reduced the ceria by the same agent. C. A. Matignon, E. C. Schiffer, W. Muthmann and L. Weiss, and A. Hirsch reduced cerium oxide with aluminium; K. A. Kühne used the thermite process; and A. Hirsch used calcium, carbon, or silicon. The last-named found that with carbon, and silicon, the products are carbides or silicides, and with the other three metals, alloys are produced. C. A. Matignon made praseodymium by reducing the oxide with magnesium. E. W. von Siemens and J. G. Halske obtained cerium by heating the nitride or other compound of cerium with the elements of the nitrogen family, in the absence of air. G. Siebert and E. Korten obtained the metal by heating the halides at a high temp. in the presence of a reducing agent—*e.g.* carbon.

W. F. Hillebrand and T. H. Norton² prepared the metals cerium, lanthanum, and didymium in a coherent form by the electrolysis of the fused chlorides covered by a layer of ammonium chloride, and contained in a porous cell surrounded by a mixture of molten sodium and potassium chlorides, contained in a porcelain crucible. The anode was thin sheet iron, and the cathode iron wire. W. Muthmann and co-workers electrolyzed a fused mixture of 90 per cent. of cerous chloride, and 10 per cent. of potassium and sodium chlorides in a water-cooled copper vessel. A current of 30–40 amps. and 12–15 volts was used, and the electrodes were carbon. They also electrolyzed a soln. of cerium oxide in molten cerous fluoride using a current density of 8–10 amps. per sq. cm. at the cathode, and 3 amps. per sq. cm. at the anode. The yield of metal corresponded with 57 per cent. of the current used. They showed that the materials employed should be free from silica or the metal will be contaminated with silicide; potassium fluoride, calcium fluoride, or cryolite cannot be employed with success in place of cerium fluoride. The electrolysis of a molten soln. of ceric oxide in cryolite yields an alloy of cerium and aluminium. If the electrolysis be conducted in the presence of carbon, cerium carbide is formed. According to A. Hirsch, cerium is best prepared by dehydrating ceric chloride in an atm. of hydrogen chloride, and electrolyzing the fused chloride in an iron crucible, which serves as cathode, with a graphite anode. Sodium chloride, potassium fluoride, and barium chloride are added in small quantities to the electrolyte to increase the resistance of the bath and check decomposition. The cerium thus obtained contains about 2 per cent. of impurities, consisting of iron and of cerium oxide and carbide. It may be purified by amalgamating with boiling mercury, skimming off the undissolved impurities, and distilling in a vacuum in a quartz vessel lined with magnesia.

W. Muthmann and co-workers found that since lanthanum, neodymium, and praseodymium melt at a higher temp. than cerium, while their chlorides melt at a lower temp., a higher temp. about the electrodes is required for the preparation of these metals by the electrolysis of the anhydrous chlorides in order to avoid the formation of a neutral regulus. This was secured by using very slender carbon electrodes, or by using an iron rod to which sticks of carbon were fastened. Lanthanum was obtained by using a current of 50 amps. at 10–15 volts; while with neodymium a current of 90–100 amps. at 16–22 volts was employed. In the case of praseodymium, it was necessary to avoid the formation of the dioxide and consequently a maximum current of 70 amps. was used. The metals were purified by remelting them in crucibles made from purified magnesia, and covered by a layer of barium chloride. Ordinary crucibles must not be used since lanthanum, neodymium, and praseodymium attack the silicates. Metallic samarium was

obtained with difficulty by the electrolysis of the fused anhydrous chloride mixed with one-third its weight of barium chloride, using a current of 100 amps. and a small carbon cathode. The metal is deposited on the carbon from which it is separated by a layer of golden-yellow carbide. H. C. Kremers and R. G. Stevens prepared lanthanum by the electrolysis of the fused chloride mixed with variable amounts of potassium fluoride and sodium chloride. The metal prepared by the use of a tungsten cathode did not contain tungsten; metal prepared in iron cells was always contaminated with iron.

REFERENCES.

¹ C. G. Mosander, *Svenska Akad. Handl.*, 299, 1826; *Pogg. Ann.*, 11, 406, 1826; 46, 648, 1839; 47, 207, 1839; 56, 504, 1843; *Phil. Mag.*, (3), 23, 241, 1843; *Liebig's Ann.*, 32, 235, 1839; 48, 210, 1843; A. Beringer, *ib.*, 42, 134, 1842; F. Wöhler, *ib.*, 144, 251, 1867; J. C. G. de Marignac, *Ann. Chim. Phys.*, (3), 38, 148, 1853; C. A. Matignon, *ib.*, (8), 8, 282, 1906; *Compt. Rend.*, 131, 837, 891, 1900; K. A. Kühne, *U.S. Pat. No.* 910394, 1909; *German Pat.*, D.R.P. 179403, 1904; M. A. Hunter, *Internat. Cong. App. Chem.*, 8, ii, 125, 1912; M. Moldenhauer, *Chem. Ztg.*, 38, 147, 1914; H. Holm, *Beiträge zur Kenntnis des Cer*, München, 1902; A. Hirsch, *Trans. Amer. Electrochem. Soc.*, 20, 57, 1911; *Journ. Ind. Eng. Chem.*, 3, 880, 1911; 4, 65, 1912; C. A. Winkler, *Ber.*, 23, 772, 1890; 24, 873, 1891; E. C. Schiffer, *Das Verhalten der Cerit-oxide gegen Aluminium bei hohen Temperaturen*, München, 1900; H. Kellermann, *Ueber die Darstellung des metallischen Cers und seine Verbindungen mit Arsen und Antimon*, Berlin, 1910; E. W. von Siemens and J. G. Halske, *Brit. Pat. No.* 10867, 1900; W. Muthmann and L. Weiss, *Liebig's Ann.*, 331, 1, 1904; G. Siebert and E. Korten, *German Patent, D.R.P.* 355485, 1920.

² W. F. Hillebrand and T. H. Norton, *Pogg. Ann.*, 155, 631, 1875; 156, 466, 1875; W. F. Hillebrand, *ib.*, 158, 71, 1876; H. C. Kremers and R. G. Stevens, *Journ. Amer. Chem. Soc.*, 45, 614, 1923; W. Muthmann, H. Hofer, and L. Weiss, *Liebig's Ann.*, 320, 231, 1902; 331, 1, 1904; W. Muthmann, L. Weiss, and J. Scheidemandel, *ib.*, 355, 116, 1907; W. Muthmann and K. Kraft, *ib.*, 325, 279, 1902; A. Hirsch, *Trans. Amer. Electrochem. Soc.*, 20, 57, 1911.

§ 9. The Physical Properties of the Cerium Family of Metals

According to W. Muthmann and L. Weiss,¹ polished surfaces of cerium, lanthanum, neodymium, and praseodymium are very similar, but exhibit minute differences in colour. Lanthanum has the whiteness of tin, cerium that of iron; neodymium has a yellow tinge, which is still more marked in the case of praseodymium. Samarium is a pale grey lustrous metal. The interior of a bar of cerium is highly crystalline, but attempts by A. Hirsch to make definite crystals by fusion below molten lithium chloride were not successful. According to A. W. Hull, the **X-radiogram** of cerium corresponds either with a hexagonal close-packing with side 3.65 Å., and the closest approach of the atoms, 3.64 Å.; or with a face-centred cube with side 5.12 Å., and the closest approach of the atoms as before; while E. E. Schumacher and F. F. Lucas found that the metal crystallizes in the cubic system. A. Hirsch gives 6.920 for the **specific gravity** of cerium; and J. F. Bahr and R. Bunsen give 6.628. W. Muthmann and L. Weiss

give for the sp. gr. of cerium, 7.0424; lanthanum, 6.1545; neodymium, 6.9563; praseodymium, 6.4754; and samarium, 7.7 to 7.8. The **atomic volumes** are cerium, 19.917; lanthanum, 22.547; neodymium, 20.765; praseodymium, 21.709; and samarium, 19.36. On plotting the at. vol. against the at. wt., Fig. 7, cerium, not lanthanum, occupies an exceptional position. H. C. Kremers and R. G. Stevens gave 6.1598 for the sp. gr. of lanthanum at 15°. The **hardness** is in the order: Pb, Sn, Ce, La, Zn, Nd, Pr, Sa, so that while cerium is nearly as soft as lead, and can be cut with a knife, samarium has the hardness of steel. H. C. Kremers gave 37 for Brinell's hardness (599 kgrms.); F. Hanaman gave 28. Samarium is very brittle, while, according to A. Hirsch, the **ductility** and **malleability** of cerium resemble those of lead; lanthanum is malleable, and it

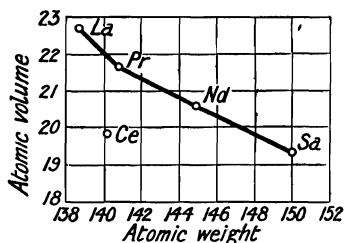

FIG. 7.—Atomic Volumes of the Cerium Metals.

is ductile enough to be hammered into foil, or drawn into wire. Cerium can be machined fairly well although it has a tendency to buckle. The **tensile strength** is 9 kgrms. per sq. mm. According to P. W. Bridgman, the **compressibility** of cerium represented by $\delta v/v$, where v denotes the vol. of cerium at θ° and atm. press., and the change in vol. δv , given by $\delta v/v \times 10^7$ at 30° is $-35.74p + 19.0 \times 10^{-5}p^2$; and at 75° , $-35.80p + 19.7 \times 10^{-5}p^2$.

The **melting point** of cerium given by W. Muthmann and L. Weiss is 623° ; lanthanum, 810° ; neodymium, 840° ; praseodymium, 940° ; while samarium melts at 1300° – 1400° . F. Hanaman estimates the m.p. of cerium to be 720° . W. Guertler and M. Pirani gave for cerium 700° ; lanthanum, 810° ; praseodymium, 940° ; neodymium, 840° ; samarium, 1300° . H. C. Kremers and R. G. Stevens gave 826° for lanthanum. W. R. Mott gave 645° for the m.p. and 1400° for the **boiling point** of cerium; and 810° for the m.p. and 1800° for the b.p. of lanthanum. J. J. von Laar estimated the **critical temperature** to be 3580° , and the **critical pressure**, 560 atm. D. I. Mendeléeff gave for **specific heat** of cerium, 0.05; W. F. Hillebrand, 0.0448 between 0° and 100° ; and A. Hirsch, 0.05112 between 20° and 100° ; the average at. ht. is 6.82, an unusually high value. J. Dewar gave 0.0330 for the sp. ht. of cerium and 0.0322 for that of lanthanum at a temp. between the b.p. of hydrogen and oxygen. W. F. Hillebrand gave 0.449 for the sp. ht., and 6.23 for the at. ht. of lanthanum. G. W. Lewis and co-workers, and E. D. Eastman found the **entropies** of lanthanum and cerium to be respectively 13.7 and 13.8 at 25° and atm. press. A. Hirsch found qualitatively that the **thermal conductivity** of cerium is high, and that the latent **heat of fusion** is high. R. Pohl and P. Pringsheim prepared mirrors by condensing the vapour of cerium on glass plates. W. Muthmann and L. Weiss gave 1603.15 cal. for the **heat of combustion** of a gram of cerium burning to ceric oxide; and the **heat of formation** of the oxide given by A. Hirsch is $\frac{1}{4}\text{CeO}_2 = 56.1$ Cals. W. Muthmann and L. Weiss give for the heats of combustion of a gram of metal to the sesquioxide—lanthanum, 1602.1 cal.; neodymium, 1506.0 cal.; and praseodymium, 1476.8 cal. The high values of the heats of combustion suggest that since a mixture of the cerium and yttrium metals can be easily obtained, the alloy might be useful as a reducing agent. The heat of formation of lanthana, $\frac{1}{3}\text{La}_2\text{O}_3 = 74.1$ Cals., is greater than that of alumina; this makes it doubtful if lanthana can be reduced by aluminium, unless the heats of combustion alter at higher temp. The heat of formation of praseodymia, $\frac{1}{3}\text{Pr}_2\text{O}_3 = 68.7$ Cals.; and of neodymia, $\frac{1}{3}\text{Nd}_2\text{O}_3 = 72.5$ Cals. H. C. Kremers and R. G. Stevens gave 1645 cal. per gram for the heat of combustion of lanthanum.

It will be observed that praseodymium and neodymium present an exception to the rule that there is a regular change in the properties of a sequence of elements in a given family with change in the at. wt. Thus:

	La	Pr	Nd	Sa
At. wt.	139	140.9	144.3	150.4
M.p.	810°	940°	840°	1300° – 1400°
Heat of formation, cal. per eq.	74.1	68.9	72.5	—
Heat of combustion, cal.	1602.1	1466.8	1506	—

There are therefore four pairs of such anomalies presented by argon and potassium, tellurium and iodine, cobalt and nickel, and praseodymium and neodymium, and, as A. Werner pointed out, these anomalies occur in periods in which six to seven elements occur between the first and last pairs.

The lines in the **spark spectrum** of cerium were first measured by G. Kirchhoff,² and compared with Fraunhofer's lines of the solar spectrum. Many observers—R. Thalén, J. H. Pollok and A. G. G. Leonard, B. Brauner, F. Exner and E. Haschek, O. Lohse, F. L. Cooper, R. Bunsen, A. Hagenbach and H. Konen, etc.—have studied

the spark spectrum. G. Meyer and M. Greulich found that with a soln. containing 0.01 mgrm. of cerium per c.c. the lines $\lambda=3940.89$ and 4166.75 are visible. They also examined the influence of various other salts when admixed with the cerium salt. A. Bakowsky, F. L. Cooper, J. M. Eder and E. Valenta, C. C. Kiess and co-workers, F. Exner and E. Haschek, etc., studied the lines in the **arc spectrum** of cerium. The spectrum of this element is one of the richest in lines; A. Bakowsky measured between 2800 and 2900 of them. The most intense lines in the arc spectrum are 4150.11 , 4186.78 , 4222.78 , 4296.88 , 4337.96 , 4382.32 , 4386.95 , **4460.40** , 4479.52 , 4487.06 , 4527.51 , 4528.64 , in the violet; 4539.90 , 4562.52 , 4572.45 , 4594.11 , 4628.33 , in the blue; and 5512.27 in the green. W. J. Humphreys measured the effect of press. on the lines; H. Geisler studied the anomalous dispersion; and P. G. Nutting, the structure of the lines. R. Bunsen observed no spectrum in the Bunsen flame. W. Huggins obtained a continuous spectrum with the oxide in the oxyhydrogen flame, but J. N. Lockyer observed the lines 5273 and 5160 . W. N. Hartley noted that special spectra are furnished by cerium oxide and salts under these conditions. G. Kirchhoff, and J. N. Lockyer observed two of Fraunhofer's lines corresponded with the spectral lines of cerium; H. A. Rowland found 33 coincidences; and A. Bakowsky, several hundreds.

The lines in the spark spectrum obtained from aq. soln. of salts of the rare earths gradually weaken and vanish at different rates as the conc. of the soln. is diminished. J. H. Pollok, A. G. G. Leonard,³ W. N. Hartley, and A. de Gramont have studied this question in the case of cerium, lanthanum, and yttrium. The most persistent lines—*i.e.* those which remain longest when the soln. is diluted—are called ultimate or residual lines. The lines which show in a 0.001 per cent. soln. are called the ω -lines; with a 0.01 but not in a 0.001 per cent. soln., the ψ -lines; those in a 0.1 per cent. but not in a 0.01 per cent. soln., the χ -lines; those in a 1.0 per cent. but not in a 0.1 per cent. soln., the ϕ -lines; and those in a more conc. soln. σ -lines. Lines given by sparks from the solid but not by an aq. soln., are called the τ -lines. Assuming that with the same conditions, the same lines disappear at the same dilutions, the observations become quantitative. G. Meyer found 0.01 mgrm. per c.c. to be the minimum conc. for the spectroscopic detection of cerium, lanthanum, and didymium.

G. Kirchhoff,⁴ R. Thalén, P. T. Cleve, J. H. Pollok and A. G. G. Leonard, B. Brauner, A. Bettendorff, E. Demarçay, O. Lohse, F. Exner and E. Haschek, S. Forsling, J. M. Eder and E. Valenta, A. Hagenbach and H. Konen, etc., have studied the spark spectrum of lanthanum. G. Meyer and M. Greulich found that with a soln. containing 0.006 mgrm. of lanthanum per c.c., the line $\lambda=3949.22$ can be detected. They also examined the effect of various other salts admixed with the lanthanum salt soln. H. A. Rowland and C. N. Harrison, R. J. Meyer, C. C. Kiess and co-workers, F. Exner and E. Haschek, A. Hagenbach and H. Konen, J. Kellner, E. Wolff, M. Bertram, etc., have investigated the arc spectrum. The most intense lines in the arc spectrum are 3949.27 , 3988.69 , and 4238.55 in the violet; 4333.98 in the blue; and 6250.14 , 6262.52 , and 6394.46 in the red. There are also bands in the arc spectrum studied by J. Kellner, J. Okubo, E. Wolff, and A. Hagenbach and H. Konen. R. Bunsen found lanthanum salts do not show a spectrum in Bunsen's flame. W. N. Hartley and H. Ramage observed that the spectrum of the oxide in the oxyhydrogen flame exhibits a number of bands. W. J. Humphreys studied the effect of press.; H. Ebert; the anomalous dispersion; J. N. Lockyer, the enhanced lines; and W. M. Hicks, and E. Paulsen, their regularities in the spectral lines. H. A. Rowland observed lines of lanthanum in the solar spectrum.

C. A. von Welsbach,⁵ the discoverer of neodymium and praseodymium, made some observations on the spark spectra of these elements; and further observations were made by S. Forsling, O. Lohse, F. Exner and E. Haschek, A. Hagenbach and H. Konen, C. C. Kiess, J. M. Eder and E. Valenta, etc. G. Meyer and M. Greulich found that with soln. containing 0.01 mgrm. per c.c. the Nd-lines $\lambda=4061.27$ and 4325.80 or the Pr-lines $\lambda=4206.81$ and 4429.41 , could be detected; and they

examined the effect of other salts admixed with the neodymium or praseodymium salt soln. The arc spectra were examined by A. Hagenbach and H. Konen, J. M. Eder and E. Valenta, etc. F. Exner and E. Haschek observed 2014 lines in the spark spectrum and 1294 in the arc spectrum of neodymium, and 2490 lines in the spark spectrum of praseodymium; and M. Bertram reported 1954 lines in the arc spectrum of neodymium, and 1500 lines in that of praseodymium. The most intense lines in the arc spectrum of neodymium are 3863·52, 3951·32, 4061·32, 4274·54, 4282·67, 4325·87, 4375·11, 4385·81, 4400·96, 4446·51, 4451·71, 4463·09, 4920·84, 5293·35, 5319·98, 5594·58, 5620·75, 6310·69, 6314·69, and 6385·32; while with praseodymium, the most intense lines are: 4100·91, 4118·70, 4143·33, 4179·60, 4189·70, 4206·88, 4223·18, 4225·80, 4241·20, 4305·99, 4429·28, 4496·60, and 4510·32. H. Auerbach observed no spectrum with praseodymium salts in Bunsen's flame, or in the oxyhydrogen flame; W. N. Hartley and H. Ramage said that in the oxyhydrogen flame neodymium gives a band spectrum. L. Haitinger noted a flame spectrum with praseodymium, and C. A. von Welsbach, L. Haitinger, K. Schaum and H. Wüstenfeld, and C. Anderson noted the flame spectrum of neodymium. The flame spectra are of little or no help in the detection of these earths. The flame spectra vary with temp., and C. Anderson found that the bands occupy the same position in the flame and **reflection spectra** of neodymium when examined at the same temp., and W. Muthmann and co-workers and P. Joye examined the reflection spectra of neodymium and praseodymium; and K. A. Hofmann and K. Höschele, the reflection spectrum of the same two elements. Neodymium mixed with alumina was found by L. Haitinger to give a discontinuous spectrum in Bunsen's flame, and this spectrum is almost identical with the reversed absorption spectrum. H. A. Rowland attributed a number of Fraunhofer's lines in the solar spectrum to neodymium and to praseodymium. G. Hofbauer noted that 140 neodymium lines and 110 praseodymium lines corresponded with lines in the solar spectrum.

The spark spectrum of samarium was examined by R. Thalén,⁶ A. Bettendorff, F. Exner and E. Haschek, A. Hagenbach and H. Konen, C. C. Kiess, E. Demarçay, J. M. Eder and E. Valenta, etc.; and the arc spectrum by F. Exner and E. Haschek, J. M. Eder and E. Valenta, A. Hagenbach and H. Konen, C. Rütten, etc. The most intense lines in the spark spectrum are: 3739·30, 4152·38, 4203·18, 4225·48, 4229·83, 4236·88, 4256·54, 4319·12, 4329·21, 4334·32, 4347·95, 4391·03, 4420·72, 4421·32, 4424·55, 4434·07, 4434·52, 4452·92, 4454·84, 4458·70, 4467·50, 4519·80, 4524·08, 4544·12, 4566·38, 4577·88, 4642·41, and 4674·79. The flame spectrum of samarium was examined by L. de Boisbaudran, and A. Bettendorff; and the reflection spectrum, by K. A. Hofmann and K. Höschele. Samarium chloride or nitrate was found by E. Demarçay, and L. de Boisbaudran, to give a yellow phosphorescent *spectre de reversion* or **reversion spectrum**; there are three bands with maxima of wave-length 6440, 6000, 5640. H. A. Rowland could identify no samarium lines in the solar spectrum, but G. Hofbauer reported that 125 lines of the samarium spectrum probably coincided with lines in the solar spectrum.

Unlike the salts of a great number of elements with a colourless acid, soln. of the salts of many of the rare earths show a characteristic **absorption spectrum** which exhibit a number of bands some of them remarkably narrow and intense. The aq. soln. of cerous and lanthanum salts are devoid of absorption spectra in the visible region, but soln. of praseodymium, neodymium, and samarium have well-defined absorption spectra. The blue and red ceric salts also show absorption bands at the violet end of the spectrum. The width of the bands is increased by augmenting the conc. of the soln. or the depth of the soln. through which the light passes; the edges of the bands are also more or less hazy, hence, it is usual to state the position of maximum absorption, *i.e.* the so-called head of the band, than to state the limits of the region included by the band. The head of a band is usually independent of the conc., but one band may have two or more maxima. The intensity of the absorption is increased by increasing the conc. of the soln., or the depth of the liquid through which the light passes; and, as H. C. Jones⁷ and

co-workers have shown, in accord with Beer's law. With a constant depth of soln., broad bands shown in conc. soln. may be resolved by dilution into two or more narrower bands; and eventually as dilution proceeds, the bands disappear—*cf.* Fig. 8. The conc. at which the bands cease to be visible is different for different

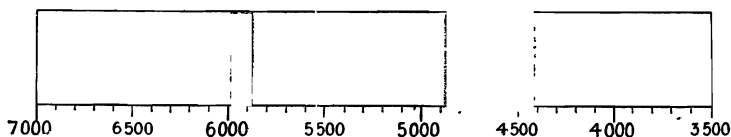

FIG. 8.—The Absorption Spectrum of Aqueous Solutions of Praseodymium Chloride.

bands. As in the case of the arc and spark spectra, estimates of the conc. of a soln. can sometimes be made from the bands which are present or absent. J. Becquerel, R. W. Wood, and G. J. Elias found that in the vicinity of the absorption bands, aq. soln. exhibit anomalous magnetic rotatory dispersion. Absorption spectra are assumed to be produced by molecules of the solute, or by combinations of the molecules of the solute with those of the solvent. The absorption spectrum may therefore be considerably modified by variations in the nature of the solvent. This subject has been discussed by H. C. Jones and co-workers. W. N. Hartley, G. D. Liveing, and H. C. Jones, etc., have studied the effect of temp. on the absorption bands. Usually, a rise of temp. intensifies the absorption, and broadens some of the bands, while lowering the temp. narrows the bands. H. C. Jones and W. W. Strong showed that in the presence of calcium chloride, the absorption bands of aq. soln. of neodymium chloride decrease in intensity with rise of temp., and the heads of the bands are slightly displaced.

Thin slices of crystals of minerals and salts may also show absorption bands which are not the same as those obtained with soln. although a certain family likeness can often be detected. R. Bunsen⁸ noted that the crystals of didymium sulphate are pleochroic. H. Becquerel, H. Dufet, G. H. Bailey, etc., have also studied the phenomenon with a number of minerals containing the rare earths, and found that the bands may differ in relative intensities, but not in position. J. Becquerel showed that the bands become narrower and more intense as the temp. is lowered, and in the vicinity of the absorption bands, the crystals exhibit an anomalous magnetic rotatory dispersion. F. Weidert studied the absorption spectrum of glasses stained with didymium compounds.

The absorption spectrum of aq. soln. of praseodymium salts have been investigated by S. Forsling,⁹ A. Langlet, W. Rech, A. Aufrecht, L. F. Yntema, P. Schottländer, G. P. Baxter and O. J. Stewart, J. E. Purvis, H. C. Jones and co-workers, B. Brauner, A. Bettendorff, C. R. Böhm, B. Stahl, W. C. Ball, etc. According to W. Rech, there are five well-defined bands in the visible spectrum of praseodymium chloride, or nitrate, with weak maxima in the yellow at 5964 and 5882; an intense maximum in the blue at 4813, and one at 4683, which is coincident with a neodymium band; and a broad intense band in the violet with a maximum at 4442—Fig. 8. The maxima given by different observers usually differ by a few units; thus, for the above bands B. Brauner gives 5963, 5895, 4812, 4693, and 4447 respectively. The absorption in the yellow can be seen only with conc. soln. F. G. Wick found that the effect of press. produces the same changes as those produced by lowering the temp., or decreasing the conc. Measurements of the absorption spectrum in organic solvents were made by H. Schäffer, and H. C. Jones and J. A. Anderson. The results show that the bands change their position owing to the formation of complexes between solute and solvent. F. Weidert studied the absorption spectra of glasses containing didymium oxides.

The absorption spectrum of aq. soln. of neodymium is complex, and very rich in bands; it has been measured by E. Demarçay, W. W. Strong, S. Forsling, C. A. von Welsbach, J. E. Purvis, L. F. Yntema, B. Brauner, O. Boudouard, W. Rech,

B. Holmberg, B. Stahl, F. Exner, G. Dimmer, G. P. Drossbach, W. Muthmann and L. Stützel, C. Garnier, G. P. Baxter and co-workers, etc. According to W. Rech, intense maxima occur at 7324, 5800, 5780, 5750, 5740, 5210, 5200, 5120, 5090, 4274, 3556, 3540, 3507, 3465, 3288, and 2983; while less intense bands have maxima at 6890, 6790, 6730, 6360, 6280, 6250, 6220, 5870, 5830, 5710, 5470, 5310, 5250, 4870, 4800, 4750, 4690, 4610, 4327, 4290, 4180, 3801, 3399, 3231, 3144, 3067, 3047, 3080, 3015, 2998, 2937, 2913, and 2902. The band at 4690 coincides with one due to praseodymium, so that in a mixed soln. the two bands overlap and so intensify one another. The two bands 4610 and 4750 partially overlap the 4632 and 4761 bands of samarium. They also clash with europium bands, and since these two elements constantly occur with samarium, the absorption spectrum is not of much use as a test. The two bands, 5800 and 5470, which appear in the absorption spectrum of the nitrate are not shown in the spectrum of the chloride. L. Isakoff found soln. of neodymium chloride show an anomalous dispersion. W. Rech's photograph is shown in Fig. 9. H. Schäffer, and H. C. Jones with J. A. Anderson, with

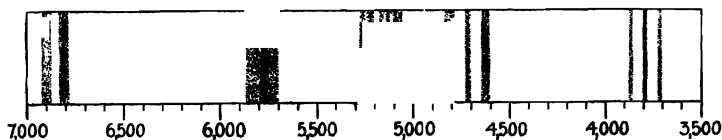

FIG. 9.—The Absorption Spectrum of Aqueous Solutions of Neodymium Chloride.

W. W. Strong, and with J. S. Guy, have measured the absorption spectra in non-aq. soln. There is a marked resemblance between the absorption spectrum of neodymium chloride in glycerol and that of the same substance in water, but the former are rather closer to the red end; the absorption spectrum in ethyl chloride is very different from that in water. The absorption spectra of aq. soln. of neodymium acetate are less intense, wider, and nearer the red end than with aq. soln. of the chloride. A. G. Wick found a press. of 3500 atm. had the same influence on the absorption spectrum of neodymium nitrate as cooling to -60° .

The absorption spectra of aq. soln. of samarium salts are not very intense, but are characteristic; the bands have been measured by C. Demarçay,¹⁰ C. R. Böhm, J. L. Soret, L. J. Yntema, L. de Boisbaudran, A. Bettendorff, S. Forsling, G. Krüss and L. F. Nilson, W. Prandtl, R. Thalén, W. Muthmann and co-workers, etc. The strongest absorption is in the blue and violet regions. E. Demarçay reported that a 20 per cent. soln. of the nitrate in conc. nitric acid, with a soln. 13 mm. thick, has some complex bands: 5590, 5290, 4980, 4760, 4630, 4530, 4430, 4170, 4070, 4020, 3900, 3750, and 3620. The bands 5290, 4530, 4070, and 3900 are very feeble, being visible only with thick layers of soln., or in conc. soln. According to S. Forsling, maxima in the bands of the absorption spectrum of an aq. soln. of the chloride, are 5600, 5001, 4804–4783, 4761–4727, 4632, 4443–4383, 4177, 4157, 4083, 4077, 4035–

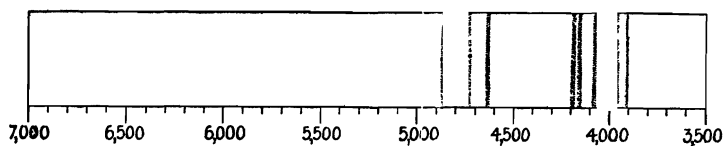

FIG. 10.—Absorption Spectrum of Samarium Chloride.

4030, 4016–4007, 3942–3932, 3906, 3752–3742, 3738–3732, and 3630–3615—*vide* Fig. 10. The two samarium bands at 4632 and 4761 overlap the neodymium bands at 4610 and 4750. J. Becquerel measured the influence of the magnetic field and low temp. on the absorption spectra. H. C. Jones and W. W. Strong measured the absorption spectrum of samarium in non-aq. solvents.

In 1881, W. Crookes¹¹ showed that many substances bombarded by cathode rays

emit a phosphorescent light which generally gives a continuous spectrum; but less frequently, the spectrum is discontinuous—**cathodic phosphorescent spectrum**. In studying the yttria earths he was attracted by a pair of orange bands of wavelength 5970 and 6030, which he attributed to an element X. He found that compounds of X are sensibly phosphorescent only when very intimately mixed with certain other substances—*e.g.* compounds of calcium. He finally identified the element X with samarium. He assumed that samarium is a complex of four meta-elements. L. de Boisbaudran showed that purified substances are not sensibly phosphorescent when exposed to the cathode rays. The addition of another substance may produce cathodic phosphorescence which increases in intensity as the proportion of the foreign matter increases until it reaches a maximum, and any further increase reduces the intensity of the effect by dilution. The optimum addition for the maximum effect is independent of the intensity of the cathodic rays, or of the temp., although the latter may modify the spectrum. A similar result obtains with each band in the phosphorescent spectrum, although the effect on any band varies independently of the effect on other bands. The foreign material which induces the phosphorescent effect is called the *phosphorogen*. These substances have been studied by G. Urbain, L. Brünighaus, etc.—*vide* phosphorescent zinc sulphide. Purified lanthana gives no cathodic phosphorescent spectrum, and the reports by W. Muthmann and E. Baur, E. Baur and R. Marc, W. Crookes, and A. Bettendorff are based on materials tainted with impurities. Praseodymium gives a red cathodic phosphorescence, when diluted with lime, with maxima at 6780, 6700, 6340, 6265, 6200, 6065, 6045, 5790, 5570, 5527, 5405, 5355, 5255, 5170, and 5110. Praseodymium sulphate also gives a red phosphorescence when diluted with calcium sulphate; the maxima in the spectrum are at 6100, 6000, and 5876. Neodymia, diluted with lime, gives a cathodic phosphorescent spectrum with maxima at 5045, 4690, 4660, 4610, 4575, 4515, 4400, 4295, 4270, 4230, 4220, 4190, 3980, and 3920; while neodymium sulphate diluted with calcium sulphate gives a broad band between 5770 and 5010. Samarium gives an orange-yellow, orange, or orange-red cathodic phosphorescence. The maxima in the system samaria-lime are at 6740, 6605, 6470, 6265, 6150, 6052, 5865, 5762, 5683, 5561, and 5486, the system samarium sulphate and calcium sulphate has maxima at 6425, 6180, 6040, 5950, 5855, 5630, 5560, and 5300; the system samarium fluoride and calcium fluoride has the maxima 6530, 6220, 6190, 6042, 5725, 5713, 5675, 5580, and 5540; the system samaria diluted with gadolinia has maxima 6670, 6550, 6450, 6295, 6165, 6075, 5985, 5840, 5765, 5695, and 5655; and the system samarium sulphate diluted with gadolinium sulphate has maxima at 6455, 6355, 6035, 5980, 5885, 5610, and 5545.

The **X-ray spectrum** of lanthanum has been measured by M. de Broglie,¹² and G. Kettmann; the X-ray spectra of lanthanum and cerium by I. Malmer, and D. Coster and co-workers; and those of lanthanum, cerium, praseodymium, neodymium, and samarium by H. G. J. Moseley, G. Hertz, E. Friman, J. R. Rydberg, A. Dauvillier, and E. Hjalmar. In general, the spectra are simple with 4 or 5 lines at the most—*vide* X-ray spectra. The K-series for lanthanum was measured by F. C. Blake and W. Duane, and M. Siegbahn and E. Jönsson, who found for a_2a' = 0·376; a_1a = 0·372; and $\beta_1\beta$ = 0·329; while for the L-series, D. Coster, G. Hertz, E. Hjalmar, G. Kettmann, and M. Siegbahn gave a_2a' = 2·66893; a_1a = 2·65968; $\beta_1\beta$ = 2·45330; $\beta_2\gamma$ = 2·298; $\gamma_1\delta$ = 1·87382; β_4v = 2·44426, and $\beta_3\phi$ = 2·40531. For the K-series of cerium, F. C. Blake and W. Duane, and M. Siegbahn and E. Jönsson gave a_2a' = 0·360; a_1a = 0·355; and $\beta_1\beta$ = 0·314; and for the L-series, D. Coster, G. Hertz, E. Hjalmar, and M. Siegbahn gave a_2a' = 2·56511; a_1a = 2·55600; $\beta_1\beta$ = 2·35100; $\beta_2\gamma$ = 2·20380; $\gamma_1\delta$ = 2·04433; $\beta_5\zeta$ = 2·19600; β_4v = 2·34480; and $\beta_3\phi$ = 2·40531. For the K-series of praseodymium, M. Siegbahn and E. Jönsson, gave a_2a' = 0·347; a_1a = 0·355; $\beta_1\beta$ = 0·314; and for the L-series, D. Coster, G. Hertz, E. Hjalmar, and M. Siegbahn gave a_2a' = 2·46763; a_1a = 2·45770; $\beta_1\beta$ = 2·25390; $\beta_2\gamma$ = 2·11468; $\gamma_1\delta$ = 1·95681; β_4v = 2·254; and $\beta_3\phi$ = 2·21237. For the K-series of neodymium, W. Duane and T. Shimizu, and M. Siegbahn and

E. Jönsson gave $\alpha_2\alpha' = 0.335$; $\alpha_1\alpha = 0.330$; and $\beta_1\beta = 0.292$; and for the L-series, D. Coster, G. Hertz, E. Hjalmar, and M. Siegbahn gave $\alpha_2\alpha' = 2.37563$; $\alpha_1\alpha = 2.36531$; $\beta_1\beta = 2.16221$; $\beta_2\gamma = 2.031$; $\gamma_1\delta = 1.87383$; $\gamma_2\theta = 1.801$; $\beta_4\nu = 2.162$; and $\beta_3\phi = 2.12230$. For the L-series of samarium, D. Coster, E. Hjalmar, and M. Siegbahn gave $\alpha_2\alpha' = 2.20568$; $\alpha_1\alpha = 2.19501$; $\beta_1\beta = 1.99357$; $\beta_2\gamma = 1.877$; $\gamma_1\delta = 1.72309$; $\gamma_2\theta = 1.657$; and $\beta_3\phi = 1.958$. W. M. Hicks found that the line spectra of scandium, lanthanum, yttrium, and ytterbium show a doublet series. W. Duane measured the absorption frequencies of the X-rays for cerium. J. Carrera gave for the absorption coeff. for X-rays: La, 53.48; Ce, 53.53; Pr, 55.56; Nd, 56.58; and Sm, 58.71. R. Pohl and P. Pringsheim studied the **photoelectric effect** with cerium.

Cerium is a poor conductor of electricity. According to C. Benedicks,¹³ the **electrical conductivity** is 0.0128×10^6 reciprocal ohms, at 18°, and for praseodymium, 0.0114×10^6 , and for neodymium, 0.0130×10^6 reciprocal ohms. According to C. Benedicks, the sp. **electrical resistance** of cerium is 78×10^{-6} ohms per cm. cube at ordinary temp., while A. Hirsch gave 71.6×10^{-6} ohms. P. W. Bridgman found 0.001476 for the temp. coeff. of the resistance of an impure lanthanum between 0° and 100°, and for the press. coeff. in kgrms. per sq. cm.:

Temp.	Resistance.	Pressure coefficient.		
		0 kgrm.	12,000 kgrms.	Average.
0°	1.000	-0.0 ₅ 39	-0.0 ₅ 25	-0.0 ₅ 331
50°	1.0750	-0.0 ₅ 39	-0.0 ₅ 36	-0.0 ₅ 377
100°	1.1476	—	—	—

C. Benedicks gave 79–88 microhms per cm. cube for praseodymium. P. W. Bridgman gave 0.000799 for the temp. coeff. of the resistance of neodymium, between 0° and 95°, and for the press. coeff. in kgrms. per sq. cm.:

Temp.	Resistance.	Pressure coefficient.		
		0 kgrms.	12,000 kgrms.	Average.
0°	1.0000	-0.0 ₅ 238	-0.0 ₅ 183	-0.0 ₅ 213
50°	1.0400	-0.0 ₅ 250	-0.0 ₅ 197	-0.0 ₅ 226

According to A. Hirsch, the **electrode potential** of cerium could not be successfully measured in alcoholic soln. of cerium chloride, because of the rapid formation of films on the metal; but from the decomposition potential of normal cerium chloride, and the heats of formation and soln. of that chloride, the single potential of cerium in a *N*-soln. of its chloride, measured against a normal calomel electrode, is -3.16 volts. C. Erk, E. F. Smith, G. Bricoat, etc., have shown that the electrolysis of soln. of cerous salts with platinum electrodes is attended by the anodic oxidation of the cerium, so that in neutral or feebly acid soln., ceric hydroxide or basic ceric salts are deposited on the anode, and in strongly acid soln., ceric salts pass into soln. J. Sterba found most of the cerous salt is oxidized. G. von Knorre thus oxidized 91 per cent. of a soln. of ammonium cerous nitrate, and A. Job oxidized it all. G. Kolle found that a large anode surface, small cathode density, and an optimum temp. of 50° favour the oxidation. W. Krilitschewsky, and E. Mühlbach also studied the conditions of oxidation. E. Baur and A. Glässner, and E. Mühlbach have studied the **oxidation potential**; and C. A. von Welsbach, and W. Krilitschewsky, the possibility of using cerium accumulators with an electrolyte of zinc, cerous, and ceric sulphates, a cathode of zinc amalgam, and an anode of carbon. The results are not satisfactory. A. Heydweiller found the **ionic velocity** at infinite dilution to be $\frac{1}{3}\text{La} = 50$; and $\frac{1}{3}\text{Sa} = 53.5$ at 18°; and A. Noyes and K. G. Falk, $\frac{1}{3}\text{La} = 72$ at 25°.

A. Hirsch measured the **thermoelectric force** of cerium against copper with the cold junction at 30°, and the hot junction at 49.2°, and found 0.000075 volt; 100°, 0.000250 volt; 151°, 0.000387 volt; and at 200.5°, 0.000502 volt. Cerium is paramagnetic; the **magnetic susceptibility**, according to S. Meyer, is 12×10^{-6}

C.G.S. units per gram; M. Owen gives 15×10^{-6} at 18° . The latter also found that a sample of lanthanum of doubtful purity was paramagnetic; praseodymium and neodymium are paramagnetic; M. Owen found at 18° , 25×10^{-6} C.G.S. units for praseodymium; and 36×10^{-6} C.G.S. units for neodymium. B. Cabrera, and A. Dauvillier have discussed the magnetic properties of these elements.

REFERENCES.

¹ W. Muthmann and L. Weiss, *Liebig's Ann.*, **331**, 1, 1904; J. F. Bahr and R. Bunsen, *ib.*, **137**, 1, 1886; W. Muthmann and K. Kraft, *ib.*, **325**, 261, 1902; A. W. Hull, *Phys. Rev.*, (2), **18**, 88, 1921; W. Guertler and M. Pirani, *Zeit. Metallkunde*, **11**, 1, 1919; G. W. Lewis and G. E. Gibson, *Journ. Amer. Chem. Soc.*, **39**, 2554, 1917; G. W. Lewis, G. E. Gibson, and H. M. Latimer, *ib.*, **44**, 1008, 1922; E. D. Eastman, *ib.*, **45**, 80, 1923; H. C. Kremers and R. G. Stevens, *ib.*, **45**, 614, 1923; E. E. Schumacher and F. F. Lucas, *ib.*, **46**, 1167, 1924; P. W. Bridgman, *Proc. Amer. Acad.*, **58**, 166, 1922; J. J. van Laar, *Proc. Acad. Amsterdam*, **18**, 1220, 1916; **20**, 138, 492, 1918; W. R. Mott, *Trans. Amer. Electrochem. Soc.*, **34**, 555, 1918; W. F. Hillebrand, *Pogg. Ann.*, **158**, 71, 1876; W. F. Hillebrand and T. H. Norton, *ib.*, **155**, 631, 1875; **156**, 466, 1875; A. Hirsch, *Trans. Amer. Electrochem. Soc.*, **20**, 57, 1911; *Journ. In². Eng. Chem.*, **3**, 880, 1911; **4**, 65, 1912; D. I. Mendeléeff, *Bull. Acad. St. Petersburg*, (4), **16**, 445, 1870; J. Dewar, *Proc. Roy. Soc.*, **89**, A, 158, 1913; F. Hanaman, *Internat. Zeit. Metallog.*, **7**, 174, 1915; A. Werner, *Ber.*, **38**, 914, 1905; R. Pohl and P. Pringsheim, *Ber. deut. phys. Ges.*, **14**, 506, 546, 1912.

² G. Kirchhoff, *Sitzber. Akad. Berlin*, **63**, 1861; **227**, 1863; O. Lohse, *ib.*, **179**, 1897; *Pub. Astrophys. Obs. Potsdam*, **12**, 109, 1902; R. Thalén, *Om spectralanalyse*, Upsala, 1866; *Nova Acta Upsala*, (3), **6**, 9, 1868; W. Huggins, *Proc. Roy. Soc.*, **18**, 546, 1870; J. N. Lockyer, *ib.*, **27**, 279, 1878; **43**, 117, 1887; W. N. Hartley, *ib.*, **54**, 5, 1893; *Phil. Trans.*, **185**, A, 161, 1894; R. Bunsen, *Pogg. Ann.*, **155**, 230, 366, 1875; B. Brauner, *Monatsh.*, **3**, 1, 1882; W. J. Humphreys, *Astrophys. Journ.*, **6**, 169, 1897; F. L. Cooper, *ib.*, **29**, 329, 1909; P. G. Nutting, *ib.*, **23**, 64, 1906; H. Geisler, *Zeit. wiss. Phot.*, **7**, 89, 1909; A. Bakowsky, *ib.*, **6**, 73, 1908; *Das Bogenspectrum des Cer*, Bonn, 1907; J. H. Pollok and A. G. G. Leonard, *Proc. Roy. Soc. Dublin*, (2), **11**, 257, 1908; H. Ebert, *Astron. Nachr.*, **162**, 193, 1903; J. M. Eder and E. Valenta, *Sitzber. Akad. Wien*, **119**, 519, 1910; J. M. Eder, *ib.*, **123**, 2289, 1914; C. C. Kiess, B. S. Hopkins, and H. C. Kremers, *Scient. Papers Bur. Standards*, **421**, 1921; F. Exner and E. Haschek, *ib.*, **108**, 1071, 1899; *Tabelle der Funkenspectra*, Wien, 1902; *Tabelle der Bogenspectra*, Wien, 1904; A. Hagenbach and H. Konen, *Atlas der Emissionsspectra*, Jena, 1905; H. Kayser, *Handbuch der Spectroscopie*, Leipzig, **5**, 285, 1910; H. A. Rowland, *Amer. Journ. Science*, (3), **41**, 243, 1891; *Chem. News*, **63**, 133, 1891; G. Meyer and M. Greulich, *Phys. Zeit.*, **22**, 583, 1921.

³ J. H. Pollok, *Proc. Roy. Soc. Dublin*, (2), **11**, 184, 331, 1908; J. H. Pollok and A. G. G. Leonard, *ib.*, (2), **11**, 217, 229, 257, 1908; A. G. G. Leonard, *ib.*, (2), **11**, 270, 1908; A. de Gramont, *Ann. Chim. Phys.*, (8), **17**, 437, 1909; *Compt. Rend.*, **144**, 1101, 1907; **145**, 1101, 1907; **146**, 1260, 1908; **147**, 239, 307, 1908; **149**, 263, 1909; **150**, 1236, 1910; **151**, 308, 1910; **159**, 5, 1914; G. Meyer, *Phys. Zeit.*, **22**, 583, 1921; W. N. Hartley, *Phil. Trans.*, **175**, 325, 1884.

⁴ J. Okubo, *Science Rep. Tokoku Univ.*, **11**, 95, 1922; S. Forsling, *Bihang. Svenska Akad. Handl.*, **23**, 5, 1898; E. Paulsen, *Ann. Physik*, (4), **45**, 1203, 1914; G. Kirchhoff, *Sitzber. Akad. Berlin*, **63**, 1861; **227**, 1863; H. A. Rowland, *Amer. Journ. Science*, (3), **41**, 243, 1891; *Chem. News*, **63**, 133, 1891; R. Thalén, *Om spectralanalyse*, Upsala, 1866; *Svenska Akad. Handl.*, **12**, 4, 1874; *Nova Acta Upsala*, (3), **6**, 9, 1868; R. Bunsen, *Pogg. Ann.*, **155**, 230, 366, 1875; J. N. Lockyer, *Solar Physics Committee*, London, 1906; *Proc. Roy. Soc.*, **27**, 279, 1878; *Compt. Rend.*, **86**, 317, 1878; P. T. Cleve, *ib.*, **95**, 33, 1882; B. Brauner, *Monatsh.*, **3**, 1, 1882; A. Bettendorff, *Liebig's Ann.*, **256**, 159, 1890; E. Demarçay, *Spectres électriques*, Paris, 1895; W. J. Humphreys, *Astrophys. Journ.*, **6**, 169, 1897; **26**, 18, 1907; H. A. Rowland and C. N. Harrison, *ib.*, **7**, 373, 1898; O. Lohse, *ib.*, **6**, 95, 1897; *Sitzber. Akad. Berlin*, **179**, 1897; *Pub. Astrophys. Obs. Potsdam*, **12**, 109, 1902; W. N. Hartley and H. Ramage, *Trans. Roy. Soc. Dublin*, (2), **7**, 339, 1901; J. H. Pollok and A. G. G. Leonard, *Proc. Roy. Soc. Dublin*, (2), **11**, 257, 1908; J. M. Eder and E. Valenta, *Sitzber. Akad. Wien*, **118**, 511, 1909; **123**, 2289, 1914; F. Exner and E. Haschek, *ib.*, **108**, 1071, 1899; *Tabelle der Funkenspectra*, Wien, 1902; *Tabelle der Bogenspectra*, Wien, 1904; R. J. Meyer, *Zeit. anorg. Chem.*, **41**, 97, 1904; A. Hagenbach and H. Konen, *Atlas der Emissionsspectra*, Jena, 1905; M. Bertram, *Zeit. wiss. Phot.*, **4**, 16, 1906; E. Wolff, *ib.*, **3**, 395, 1905; *Das Lanthanspectrum*, Bonn, 1905; J. Kellner, *Das Lanthanspectrum*, Bonn, 1904; H. Ebert, *Astron. Nachr.*, **162**, 193, 1903; H. Kayser, *Handbuch der Spectroscopie*, Leipzig, **5**, 655, 1910; W. M. Hicks, *Phil. Trans.*, **212**, A, 33, 1912; **213**, A, 323, 1913; G. Meyer and M. Greulich, *Phys. Zeit.*, **22**, 583, 1921; C. C. Kiess, B. S. Hopkins, and H. C. Kremers, *Scient. Papers Bur. Standards*, **421**, 1921; C. C. Kiess, *ib.*, **442**, 1922.

⁵ C. A. von Welsbach, *Monatsh.*, **6**, 477, 1885; *Sitzber. Akad. Wien*, **92**, 317, 1885; **112**, 1037, 1903; F. Exner and E. Haschek, *ib.*, **108**, 1071, 1899; *Tabelle der Funkenspectra*, Wien, 1902; *Tabelle der Bogenspectra*, Wien, 1904; *Spectren der Elemente bei normal Druck*, Leipzig, 1911; A. Hagenbach and H. Konen, *Atlas der Emissionsspectra*, Jena, 1905; J. M. Eder and E. Valenta, *Atlas typischer Spectren*, Wien, 1911; *Sitzber. Akad. Wien*, **119**, 519, 1910;

G. Hofbauer, *ib.*, 116. 267, 1907; S. Forsling, *Bihang. Svenska Akad. Handl.*, 23. 1, 1898; O. Lohse, *Sitzber. Akad. Berlin*, 179, 1897; *Pub. Astrophys. Potsdam*, 12. 109, 1902; H. A. Rowland, *Astron. Astrophys.*, 12. 321, 1893; *Amer. Journ. Science*, (3), 41. 243, 1891; *Chem. News*, 63. 133, 1891; W. N. Hartley and H. Ramage, *Trans. Roy. Soc. Dublin*, (2), 7. 339, 1901; M. Bertram, *Die Bogenspectra von Neodym und Praseodym*, Bonn, 1905; *Zeit. wiss. Phot.*, 4. 16, 1906; H. Auerbach, *ib.*, 7. 30, 41, 1909; H. Kayser, *Handbuch der Spectroscopie*, Leipzig, 6. 145, 290, 1912; P. Joye, *Arch. Sciences Genève*, (4), 36. 41, 431, 1913; K. A. Hofmann and K. Höschele, *Ber.*, 47. 240, 1914; L. Haitinger, *Monatsh.*, 12. 362, 1891; K. Schaum and H. Wüstenfeld, *Zeit. wiss. Phot.*, 10. 226, 1911; C. Anderson, *Astrophys. Journ.*, 27. 93, 1907; W. Muthmann, H. Hofer, and H. Heramhoff, *Liebig's Ann.*, 355. 165, 1907; G. Meyer and M. Greulich, *Phys. Zeit.*, 22. 583, 1921; C. C. Kiess, *Scient. Papers Bur. Standards*, 442, 1922; J. M. Eder, *Ann. Physik*, (4), 71. 12, 1923.

⁶ H. A. Rowland, *Amer. Journ. Science*, (3), 41. 243, 1891; *Chem. News*, 43. 133, 1891; G. Hofbauer, *Sitzber. Akad. Wien*, 116. 267, 1907; F. Exner and E. Haschek, *ib.*, 109. 103, 1900; 110. 557, 1901; *Die Spectren der Elemente bei normalen Druck*, Leipzig, 1912; *Wellenlängentabellen für spectralanalytische Untersuchungen auf Grund der ultravioletten Bogenspectren der Elemente*, Leipzig, 1904; *Wellenlängentabellen für spectralanalytische Untersuchungen auf Grund der ultravioletten Funkenspectren der Elemente*, Leipzig, 1902; E. Demarcay, *Compt. Rend.*, 130. 1185, 1900; 131. 995, 1900; R. Thalén, *Öfvers. Akad. Förh.*, 40. 3, 1883; *Journ. Phys.*, (2), 2. 446, 1883; A. Bettendorff, *Liebig's Ann.*, 263. 164, 1891; A. Hagenbach and H. Koenen, *Atlas der Emissionsspectra*, Jena, 1905; C. Rütten, *Das Bogenspectrum von Samarium*, Bonn, 1905; *Zeit. wiss. Phot.*, 3. 181, 1905; J. M. Eder and E. Valenta, *Atlas typischer Spectren*, Wien, 1911; *Sitzber. Akad. Wien*, 116. 267, 1907; H. Kayser, *Handbuch der Spectroscopie*, Leipzig, 6. 494, 1912; K. A. Hofmann and K. Höschele, *Ber.*, 47. 240, 1914; L. de Boisbaudran, *Compt. Rend.*, 88. 322, 1879; 89. 212, 1879; 114. 575, 1892; 116. 611, 1893; C. C. Kiess, *Scient. Papers Bur. Standards*, 442, 1922.

⁷ H. C. Jones and J. A. Anderson, *The Absorption Spectra of Solutions*, Washington, 1909; *Proc. Amer. Phil. Soc.*, 47. 276, 1908; *Amer. Chem. Journ.*, 41. 276, 1909; H. C. Jones and W. W. Strong, *ib.*, 43. 37, 97, 1910; 45. 1, 1911; 47. 27, 126, 1912; *A Study of Absorption Spectra*, Washington, 1910; *The Absorption Spectra of Solutions*, Washington, 1911; *Proc. Amer. Phil. Soc.*, 48. 194, 1909; H. C. Jones and J. S. Guy, *Amer. Chem. Journ.*, 49. 1, 1913; 50. 257, 1913; *Phys. Zeit.*, 13. 649, 1912; *The Absorption Spectra of Solutions as affected by Temperature and by Dilution*, Washington, 1915; H. C. Jones, *Amer. Chem. Journ.*, 41. 19, 1910; *Phil. Mag.*, (6), 23. 730, 1912; *Zeit. Elektrochem.*, 20. 552, 1914; J. F. Bahr and R. Bunsen, *Liebig's Ann.*, 137. 1, 1866; A. Bettendorff, *ib.*, 256. 159, 1890; 263. 164, 1891; R. Bunsen, *Pogg. Ann.*, 128. 100, 1866; *Phil. Mag.*, (6), 32. 177, 1866; G. H. Bailey, *B.A. Rep.*, 654, 1887; 773, 1890; H. Becquerel, *Compt. Rend.*, 102. 106, 1886; 103. 198, 1886; 104. 165, 777, 1691, 1887; *Ann. Chim. Phys.*, (6), 14. 170, 257, 1888; G. D. Liveing, *Trans. Cambridge Phil. Soc.*, 18. 298, 1900; J. E. Purvis, *Proc. Cambridge Phil. Soc.*, 12. 202, 206, 1903; A. Langlet, *Zeit. phys. Chem.*, 56. 624, 1906; W. C. Ball, *Proc. Roy. Soc.*, 87. A, 121, 1912; A. Aufrecht, *Die Lichtabsorption von Praseodymsalz-Lösungen im Zusammenhang mit ihrem Dissoziationszustande in Lösung*, Berlin, 1904; G. Rudorff, *Zeit. wiss. Photochem.*, 5. 24, 1907; H. Schäffer, *Phys. Zeit.*, 7. 822, 1906; W. W. Strong, *ib.*, 11. 668, 1910; G. J. Elias, *ib.*, 7. 931, 1906; L. de Boisbaudran and J. L. Smith, *Compt. Rend.*, 88. 1167, 1879; J. L. Soret, *ib.*, 91. 378, 1880; E. Demarcay, *ib.*, 126. 1039, 1898; B. Brauner, *Journ. Chem. Soc.*, 43. 278, 1883; C. A. von Welsbach, *Sitzber. Akad. Wien*, 92. 317, 1885; 112. 1037, 1903; W. N. Hartley, *Trans. Roy. Soc. Dublin*, (2), 7. 253, 1900; W. Muthmann and L. Stützel, *Ber.*, 32. 2653, 1899; A. Wäagner, *ib.*, 36. 3055, 1903; W. Muthmann and H. Heramhoff, *Liebig's Ann.*, 355. 165, 1907; R. W. Wood, *Phil. Mag.*, (6), 15, 270, 1908.

⁸ R. Bunsen, *Pogg. Ann.*, 128. 100, 1866; *Phil. Mag.*, (4), 32. 177, 1866; J. Becquerel, *ib.*, (6), 16. 153, 1908; H. Becquerel, *Compt. Rend.*, 102. 106, 1886; 103. 198, 1887; 104. 165, 777, 1691, 1887; *Ann. Chim. Phys.*, (6), 14. 170, 257, 1888; G. H. Bailey, *B.A. Rep.*, 654, 1887; 773, 1890; H. Dufet, *Bull. Soc. Min.*, 24. 373, 1901; F. Weidert, *Zeit. wiss. Phot.*, 21. 254, 1922.

⁹ H. C. Jones, *Amer. Chem. Journ.*, 41. 19, 1910; *Phil. Mag.*, (6), 23. 730, 1912; *Zeit. Electrochem.*, 20. 552, 1914; H. C. Jones and J. A. Anderson, *The Absorption Spectra of Solutions*, Washington, 1909; *Proc. Amer. Phil. Soc.*, 47. 276, 1908; *Amer. Chem. Journ.*, 41. 276, 1909; H. C. Jones and W. W. Strong, *ib.*, 43. 37, 97, 1910; 45. 1, 1911; 47. 27, 126, 1912; *A Study of Absorption Spectra*, Washington, 1910; *The Absorption Spectra of Solutions*, Washington, 1911; *Proc. Amer. Phil. Soc.*, 48. 194, 1909; H. C. Jones and J. S. Guy, *Amer. Chem. Journ.*, 49. 1, 1913; 50. 257, 1913; *Phys. Zeit.*, 13. 649, 1912; *The Absorption Spectra of Solutions as affected by Temperature and by Dilution*, Washington, 1915; L. F. Yntema, *Journ. Amer. Chem. Soc.*, 45. 907, 1923; A. Bettendorff, *Liebig's Ann.*, 256. 159, 1890; 263. 164, 1891; W. C. Ball, *Proc. Roy. Soc.*, 87. A, 121, 1912; H. Schäffer, *Phys. Zeit.*, 7. 822, 1906; A. Aufrecht, *Die Lichtabsorption von Praseodymsalz-Lösungen im Zusammenhang mit ihrem Dissoziationszustande in Lösung*, Berlin, 1904; S. Forsling, *Bihang. Svenska Akad. Handl.*, 18. 4, 10, 1893; 23. 5, 1898; A. Langlet, *ib.*, 26. 2, 1901; W. Rech, *Zeit. wiss. Photochem.*, 3. 411, 1905; G. P. Baxter and O. J. Stewart, *Journ. Amer. Chem. Soc.*, 37. 516, 1915; G. P. Baxter and H. C. Chapin, *ib.*, 33. 1, 1911; G. P. Baxter and T. S. Woodward, *ib.*, 33. 270, 1911; P. Schottländer, *Ber.*, 25. 378, 569, 1892; W. Muthmann and L. Stützel, *ib.*, 32. 2653, 1899; B. Stahl, *Le Radium*, 6. 215, 1909; C. Garnier, *Arch. Sciences, Genève*, (4), 40.

93, 199, 1915; W. W. Strong, *Phys. Zeit.*, **11**, 688, 1910; B. Holmberg, *Zeit. anorg. Chem.*, **53**, 116, 1907; E. Demarçay, *Compt. Rend.*, **126**, 1039, 1898; C. A. von Welsbach, *Monatsh.*, **6**, 477, 1885; *Sitzber. Akad. Wien*, **92**, 317, 1885; **112**, 1037, 1903; F. Exner, *ib.*, **103**, 1259, 1899; G. Dimmer, *ib.*, **106**, 1087, 1897; B. Brauner, *Proc. Chem. Soc.*, **14**, 71, 1898; O. Boudouard, *Bull. Soc. Chim.*, (3), **19**, 382, 1898; C. R. Böhm, *Die Zerlegbarkeit des Praseodyms und Darstellung seltener Erden mit Hilfe einer neuen Trennungsmethode*, Halle a. S., 1900; *Zeit. angew. Chem.*, **15**, 372, 1282, 1902; W. Muthmann and C. R. Böhm, *Ber.*, **33**, 42, 1900; L. Isakoff, *Journ. Russ. Phys. Chem. Soc.*, **42**, 236, 1910; G. P. Drossbach, *Ber.*, **29**, 2452, 1896; **35**, 1486, 1902; F. Weidert, *Zeit. wiss. Photochem.*, **21**, 254, 1922; F. G. Wick, *Proc. Amer. Acad.*, **58**, 557, 1923; J. E. Purvis, *Proc. Cambridge Phil. Soc.*, **21**, 781, 1923.

¹⁰ C. Demarçay, *Compt. Rend.*, **102**, 1551, 1886; **130**, 1185, 1900; J. L. Soret, *ib.*, **91**, 378, 1880; L. de Boisbaudran, *ib.*, **89**, 212, 521, 1879; **83**, 322, 1879; J. Becquerel, *ib.*, **145**, 1150, 1907; W. Prandtl, *Zeit. anorg. Chem.*, **116**, 96, 1921; C. R. Böhm, *Zeit. angew. Chem.*, **15**, 372, 1282, 1902; A. Bettendorff, *Liebig's Ann.*, **263**, 164, 1891; S. Forsling, *Bihang. Svenska Akad. Handl.*, **18**, 10, 1893; **23**, 5, 1898; G. Kriess and L. F. Nilson, *Öfvers. Svenska Akad. Handl.*, **44**, 6, 1887; R. Thalén, *ib.*, **40**, 7, 1883; W. Muthmann, L. Weiss, and H. Heramhoff, *Liebig's Ann.*, **355**, 165, 1907; H. C. Jones and W. W. Strong, *Amer. Chem. Journ.*, **47**, 27, 1912; L. F. Yntema, *Journ. Amer. Chem. Soc.*, **45**, 907, 1923.

¹¹ W. Muthmann and E. Baur, *Ber.*, **33**, 1748, 1900; E. Baur and R. Marc, *ib.*, **34**, 2460, 1901; R. Marc, *ib.*, **39**, 1392, 1906; A. Bettendorff, *Liebig's Ann.*, **256**, 159, 1890; **263**, 164, 1891; **270**, 376, 1892; W. Crookes, *Phil. Trans.*, **170**, 641, 1879; **174**, 891, 1883; **176**, 691, 1885; *Proc. Roy. Soc.*, **30**, 469, 1880; **32**, 256, 1881; **35**, 262, 1883; **38**, 414, 1885; **40**, 77, 236, 602, 1886; **42**, 111, 1887; *Chem. News*, **43**, 237, 1881; **47**, 261, 1883; **49**, 159, 169, 181, 194, 205, 1884; **51**, 301, 1885; **53**, 75, 133, 1886; **54**, 13, 29, 38, 40, 54, 63, 76, 155, 1886; **60**, 27, 39, 51, 63, 77, 89, 112, 98, 1889; *B. A. Rep.*, **558**, 1886; *Journ. Chem. Soc.*, **53**, 487, 1888; **55**, 250, 1889; *Proc. Roy. Inst.*, **12**, 37, 1889; *Journ. Inst. Elect. Eng.*, **20**, 4, 1892; *Compt. Rend.*, **88**, 283, 1879; **92**, 1281, 1881; **100**, 1380, 1495, 1885; **102**, 606, 646, 1464, 1886; L. de Boisbaudran, *ib.*, **101**, 552, 588, 1886; **102**, 153, 1536, 1886; **103**, 113, 468, 627, 629, 1064, 1107, 1886; **104**, 330, 478, 554, 824, 1584, 1680, 1887; **105**, 45, 206, 258, 261, 301, 304, 343, 347, 784, 1228, 1887; **106**, 452, 1386, 1781, 1888; **107**, 311, 468, 490, 1888; **110**, 24, 67, 1890; E. Demarçay, *ib.*, **130**, 1185, 1469, 1900; G. Urbain, *ib.*, **142**, 205, 1518, 1906; **143**, 229, 1906; **145**, 1335, 1907; *Journ. Chem. Phys.*, **4**, 233, 1906; *Ann. Chim. Phys.*, (8), **18**, 222, 1909; L. Brüninghaus, *ib.*, (8), **20**, 519, 1910; (8), **21**, 210, 1910; G. Urbain and C. Seul, *Compt. Rend.*, **144**, 1363, 1907; J. de Kowalsky and C. Garnier, *ib.*, **144**, 836, 1907; E. Wiedemann and G. C. Schmidt, *Zeit. phys. Chem.*, **18**, 529, 1895; G. Hertz, *Phys. Zeit.*, **21**, 630, 1920; E. Goldstein, *Sitzber. Akad. Berlin*, 824, 1900; A. A. C. Swinton, *Proc. Roy. Soc.*, **65**, 115, 1899; E. L. Nichols and H. L. Howes, *Phys. Rev.*, (2), **19**, 300, 1922; H. L. Howes, *ib.*, (2), **17**, 60, 1921; *Chem. News*, **122**, 55, 1921.

¹² H. G. J. Moseley, *Phil. Mag.*, (6), **26**, 1024, 1913; (6), **27**, 703, 1914; I. Malmér, *ib.*, (6), **28**, 787, 1914; J. R. Rydberg, *ib.*, (6), **28**, 144, 1914; M. de Broglie, *Compt. Rend.*, **159**, 304, 1914; E. Hjalmar, *Zeit. Physik*, **15**, 65, 1923; **7**, 341, 1921; **3**, 282, 1920; J. Carrera, *Compt. Rend.*, **176**, 740, 1923; A. Dauvillier, *ib.*, **176**, 1874, 1923; W. M. Hicks, *Phil. Trans.*, **212**, A, 58, 1912; *Phil. Mag.*, (6), **28**, 139, 1914; E. Friman, *ib.*, (6), **39**, 497, 1916; W. Duane, *Proc. Nat. Acad. Sciences*, **7**, 260, 267, 1921; G. Hertz, *Zeit. Physik*, **21**, 630, 1920; G. Kettmann, *ib.*, **18**, 359, 1923; D. Coster, Y. Nishina, and S. Werner, *ib.*, **18**, 207, 1923; R. Pohl and P. Pringsheim, *Ber. deut. phys. Ges.*, **14**, 506, 546, 1912; G. Kettmann, *Zeit. Physik*, **18**, 359, 1923; F. C. Blake and W. Duane, *Phys. Rev.*, (2), **10**, 98, 697, 1917; W. Duane and T. Shimizu, *ib.*, (2), **14**, 522, 1919; D. Coster, *Compt. Rend.*, **174**, 378, 1922; M. Siegbahn and E. Jönsson, *Phys. Zeit.*, **20**, 251, 1919; M. Siegbahn, *Jahrb. Rad. Elektron.*, **13**, 296, 1916.

¹³ S. Meyer, *Wied. Ann.*, **68**, 324, 1899; *Ber.*, **33**, 320, 1900; *Monatsh.*, **20**, 369, 793, 1899; *Sitzber. Akad. Wien*, **108**, 171, 861, 1899; **110**, 541, 1901; M. Owen, *Ann. Physik*, (4), **37**, 657, 1912; **14**, 637, 1911; C. Benedicks, *Internat. Zeit. Metallog.*, **7**, 225, 1915; A. Hirsch, *Trans. Amer. Electrochem. Soc.*, **20**, 57, 1911; *Journ. Ind. Eng. Chem.*, **3**, 880, 1911; **4**, 65, 1912; P. W. Bridgman, *Proc. Amer. Acad.*, **56**, 61, 1921; C. A. von Welsbach, *Brit. Pat. No.* 21566, 1900; *Zeit. Elektrochem.*, **8**, 298, 1902; E. Baur and A. Glässner, *ib.*, **9**, 634, 1903; G. Kolle, *Beiträge zur Kenntnis des Cers*, Zürich, 1898; W. Kriitshewsky, *Zur Kenntnis des Cersulfat Akkumulators*, Halle a. S., 1904; E. Mühlbach, *Ueber die Elektrolyse von Cersalzen*, München, 1903; J. Sterba, *Compt. Rend.*, **133**, 221, 1901; A. Job, *ib.*, **128**, 101, 1098, 1899; G. Bricout, *ib.*, **118**, 145, 1894; G. von Knorke, *Zeit. angew. Chem.*, **10**, 685, 717, 1897; E. F. Smith, *Ber.*, **13**, 754, 1879; C. Erk, *Jena Zeit.*, **6**, 299, 1870; *Zeit. Chem.*, (2), **7**, 100, 1871; A. Heydweiller, *Zeit. phys. Chem.*, **89**, 281, 1915; A. A. Noyes and K. G. Falk, *Journ. Amer. Chem. Soc.*, **33**, 1436, 1911; **34**, 479, 1912; A. Dauvillier, *Compt. Rend.*, **176**, 1802, 1923; B. Labrera, *Anal. Fis. Quim.*, **20**, 92, 1922.

§ 10. The Chemical Properties of the Cerium Family of Metals

C. A. Matignon¹ found that cerium, lanthanum, neodymium, praseodymium, and samarium readily adsorb hydrogen. C. Winkler heated ceric oxide with magnesium at a high temp. in an atm. of hydrogen and obtained cerium hydride mixed

with magnesia; lanthanum behaved in a similar manner, furnishing **lanthanum hydride**, LaH_3 . According to W. Muthmann and K. Kraft, cerium hydride is best obtained by passing purified hydrogen over cerium turnings at $250^\circ\text{--}270^\circ$; the metal burns with a brilliant flame, producing cerium hydride whose composition, represented by some not very concordant analyses, corresponds with a mixture of cerium trihydride, CeH_3 , and of cerium dihydride, CeH_2 . A. Hirsch, and A. Sieverts and G. M. Goldegg, studied the action of hydrogen on cerium and lanthanum resulting in the formation of the trihydrides. Lanthanum behaves similarly; here the reaction begins at 240° , and the metal burns with a reddish-yellow light. F. Kellenberger and K. Kraft found the sp. ht. of cerium hydride to be 0.088915 and the mol. ht. 12.715, whence the at. ht. of hydrogen is 2.15, and that of cerium 6.27. The sp. ht. of lanthanum hydride is 0.087335, and the mol. ht. 12.34, which gives 2.06 for the at. ht. of hydrogen if the at. ht. of lanthanum be 6.189. The hydrides were found by C. A. Matignon to be readily dissociated by heat. According to G. I. Tschukoff, the dissociation press. of cerium hydride at 450° does not exceed one mm. W. Muthmann and E. Baur found the dissociation press. of cerium and lanthanum hydrides at various temp. In each case, the press. did not remain constant at any given temp., but slowly changed. This was attributed to the hydrides undergoing a slow molecular change which is accompanied by a change in the dissociation press. When cerous hydride is shaken in a closed glass tube, it emits light. W. Muthmann and H. Beck prepared **neodymium hydride**, NdH_3 , by the action of hydrogen on strips of the metal at 220° ; **praseodymium hydride**, PrH_3 , was obtained in a similar way. C. Matignon prepared the two last-named hydrides, and also **samarium hydride**, SaH_3 , by heating the oxides with magnesium in an atm. of hydrogen. W. Muthmann and co-workers state that the hydrides of cerium, lanthanum, neodymium, and praseodymium are brittle amorphous solids, the cerium and lanthanum compounds are bluish-black, the neodymium compound is indigo-blue, and the praseodymium compound is green. W. Muthmann and K. Kraft said that cerium hydride is stable in dry air, but rapidly decomposes in moist air, often igniting spontaneously. When heated in dry air, hydrogen is evolved and a mixture of cerium dioxide and nitride is formed. When purified cerium hydride is treated with a slow stream of moist air, F. W. Dafert and R. Miklauz say that no ammonia is formed, but when allowed to take fire spontaneously, the cerium formed by the dissociation of the hydride partly combines with nitrogen from the air, and then gives ammonia with moisture. Cerium often contains traces of nitrogen, with the result that the hydride then smells of ammonia on exposure to the air. J. Lipski found that when dry, purified nitrogen is passed over the freshly prepared hydride in the cold, ammonia is formed rapidly—about one-half the possible quantity in three and a half hours; the reaction, however, soon becomes slower, probably owing to superficial formation of nitride. The reaction is $\text{CeH}_3 + \text{N}_2 = \text{CeN} + \text{NH}_3$. Raising the temp. to 200° increases the rate of reaction very little. F. W. Dafert and R. Miklauz observed no signs of the formation of an imide or other compound containing hydrogen or nitrogen. According to W. Muthmann and K. Kraft, cerium hydride dissolves in acids, evolving hydrogen and forming cerous salts, and it is decomposed by moist air and alkali soln. with the liberation of hydrogen. Lanthanum, praseodymium, and neodymium hydrides behave in a similar manner.

According to W. Muthmann and L. Weiss, cerium, praseodymium, and neodymium, preserve their lustre in dry air, but are tarnished in moist air. Lanthanum tarnishes rapidly, even in dry air. When cerium is exposed to air it very slowly acquires a yellow film which slowly turns bluish-green, and probably contains some cerium dioxide; samarium tarnishes quickly in air and becomes coated with a yellow deposit. A. Hirsch found that cerium burns with luminescence when heated in air to 160° ; and if a lump of cerium, sealed in a glass bottle, be kept warm for some time, a black powder is formed on the surface of the cerium, and when the bottle is opened the powder ignites at the temp. of the room. He added that the

phenomenon is probably due to the formation of a highly pyrophoric *cerium suboxide*. When cerium is scratched with a steel needle, when filed, or when struck with a piece of flint, it emits showers of sparks. Cerium wire burns in Bunsen's flame with a more intense light than does magnesium wire. Lanthanum wire burns brilliantly under similar conditions. The products of the combustion of cerium and lanthanum in air contain oxide and nitride. W. Muthmann and K. Kraft give 150°–180° for the ignition temp. of cerium in **oxygen**, and 440°–460° for that of lanthanum—under similar conditions, magnesium ignites at 540°, and aluminium at 580°. G. Tamman investigated the velocity of attack by oxygen on cerium, and lanthanum. H. C. Kremers and R. G. Stevens gave 445° for the ignition temp. of lanthanum. They found the metal is not pyrophoric; but it is easily corroded even in dry air. N. N. Mittra and N. R. Dhar studied the induced oxidation of nickelous oxide during the primary oxidation of cerous hydroxide.

A. Hirsch said that 98 per cent. cerium is very slightly attacked by cold **water**, but in boiling water there is a slow evolution of hydrogen, and the metal is tarnished black. Lanthanum slowly forms the hydroxide with cold water, and rapidly with hot water; in both cases hydrogen is evolved. Praseodymium is also slowly attacked by cold, and rapidly by hot water. According to A. Hirsch, at room temp., a conc. soln. of **sodium hydroxide** has no action on the metal, but a boiling soln. has a slight action; at the room temp., a soln. of **ammonium chloride**, or of **potassium chloride**, has a moderate action on the metal. This is explained by assuming that by the action of the water on the metal a small amount of cerium hydroxide is formed which is soluble in soln. of the salts in question; a fresh surface of the metal is exposed to attack by the solvent, and the cycle of actions is repeated. The action is more pronounced with boiling soln. At room temp., a 3 per cent. and a 30 per cent. soln. of **hydrogen peroxide** have a slight action on the metal. Dil. nitric acid, ammonium chloride, potassium chloride, and 3 per cent. hydrogen peroxide at boiling temp. gave moderate action; dil. sulphuric acid, conc. and dil. hydrochloric acid, conc. nitric acid and 30 per cent. hydrogen peroxide, gave vigorous evolution of gas at boiling temp.

According to A. Hirsch, when cerium filings are heated in a stream of **chlorine**, they emit a bright light at 210°–215°, forming anhydrous *cerous chloride*; the action with **bromine** at 215°–220° is similar to that with chlorine, but it is not quite so vigorous. No light is emitted when **iodine** vapour acts on the metal at 300°, but some *cerous iodide* is formed. Lanthanum behaves similarly. Dil. and conc. **hydrochloric acid** in the cold act vigorously on cerium. When cerium filings are heated in the vapour of **sulphur**, some *cerium sulphide* is probably formed, since the product gives off hydrogen sulphide when treated with an acid. Both **selenium** and **tellurium** react vigorously when added to molten cerium. With selenium, the product forms a powder which is impure *cerium selenide*, and a pyrophoric alloy which is a soln. of the selenide in an excess of cerium; with tellurium, a brown pulverulent telluride is formed, and this gives off hydrogen telluride when treated with acids. At room temp., dil. **sulphuric acid** acts vigorously on cerium, but the conc. acid has no perceptible action on cerium either in the cold or at the b.p. Cold conc. sulphuric acid has but little action on lanthanum, although the dil. acid attacks it rapidly.

A. Sieverts and G. M. Goldegg found the absorption of nitrogen to be very slow. According to A. Hirsch, when cerium is heated to about 1000° in a stream of **nitrogen**, no luminescence occurs, but some nitride is formed; and, according to C. A. Matignon, when a mixture of the oxides of one of the five cerium metals is heated with magnesium in a stream of nitrogen, the corresponding nitride is formed. Conc. aq. **ammonia** has no visible action on cerium, neither at room temp. nor at the b.p. The action of dil. or conc. **nitric acid** is moderately vigorous in the cold, and a brown crust of the dioxide is formed. Nitric acid oxidizes lanthanum violently. H. Beck found that heated cerium readily reacts with **phosphorus**, forming a series of phosphides. A. K. Goard and E. K. Rideal investigated the catalytic oxidation

of **arsenites** from the point of view of the oxidation potentials. A. Hirsch found that when cerium is heated with **arsenic**, an endothermal reaction ensues and a soft somewhat pyrophoric alloy is formed, which does not decompose when kept; with **antimony**, much heat is evolved, and when freshly made, the alloy is pyrophoric; it disintegrates to a powder when kept for a few months in air. J. Kellermann studied the alloys of cerium with arsenic and antimony. H. Kunheim patented the use of arsenic or antimony with the cerite metals for the preparation of pyrophoric alloys; and J. Kellermann, alloys with **bismuth**. According to R. Vogel, cerium and bismuth combine with great development of heat. Porcelain tubes are rapidly corroded, but carbon tubes may be used, and the alloys are not seriously contaminated with carbide. The thermal effects are often small, and the micro-structure has been largely employed in determining the form of the diagram. The sections must be polished with wet alumina, but they oxidize very rapidly, and the polished surfaces cannot be preserved. Four compounds are formed: **cerium tritribismuthide**, Bi_3Ce_3 , **cerium tritetritabismuthide**, Bi_3Ce_4 , **cerium bismuthide**, BiCe , and **cerium dibismuthide**, Bi_2Ce . Cerium tritetritabismuthide, Bi_3Ce_4 , melts at 1630° , and appears as a maximum on the f.p. curve. It crystallizes in polygonal grains. Cerium tritribismuthide, Bi_3Ce_3 , is formed at 1400° , and is softer than cerium tritetritabismuthide, Bi_3Ce_4 . It forms a eutectic with cerium at 757° . Cerium bismuthide, BiCe , is formed at 1525° , and cerium dibismuthide, Bi_2Ce , at 882° , whilst the second eutectic point practically coincides with the m.p. of bismuth. All the alloys are more readily attacked by water than is cerium alone; the action of water on alloys with between 25 and 75 per cent. of bismuth may even raise them to incandescence.

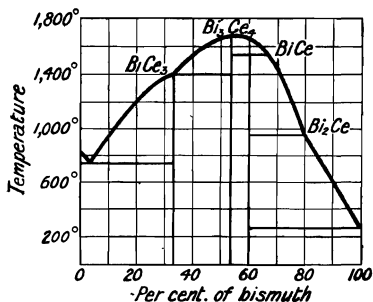

FIG. 11.—Freezing-point Curve of Alloys of Bismuth and Cerium.

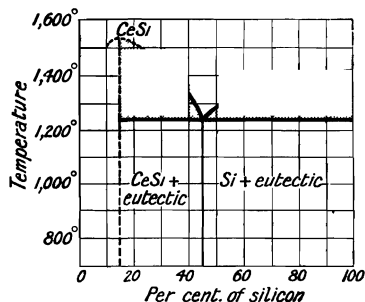

FIG. 12.—Freezing-point Curve of Alloys of Silicon and Cerium.

A. Hirsch found that when cerium is heated with **carbon**, the two elements readily react, forming a carbide; and when the metal is heated to 500° in an atm. of **carbon monoxide**, there is no visible reaction, although part of the cerium is oxidized. W. Muthmann and K. Kraft found that both lanthanum and cerium reduce **carbon dioxide** and carbon monoxide, forming ceric oxide, and both **ethylene** and **acetylene** react with lanthanum, furnishing the hydride and carbon. S. Medsforth investigated the effect of cerium oxide in promoting the activity of nickel in reducing the carbon oxides by hydrogen. A. Hirsch found that at room temp., **ethyl alcohol**, **amyl alcohol**, **chloroform**, and **carbon tetrachloride** have no visible action on cerium; and ethyl ether has but a slight action; at the b.p., chloroform and carbon tetrachloride have no action on cerium, while the action with ethyl or amyl alcohol or ethyl ether is but slight. W. Muthmann and K. Kraft found that **methyl chloride** reacts with cerium between 500° – 600° giving a mixture of carbon and cerium chloride and hydride: $3\text{CH}_3\text{Cl} + 4\text{Ce} = \text{CeCl}_3 + 3\text{CeH}_3 + 3\text{C}$. A. K. Goard and E. K. Rideal studied the catalytic oxidation of **sugars** by cerous salts from the standpoint of the oxidation potentials. A. Hirsch found that cerium reacts with **silicon**, forming **cerium silicide**, CeSi ; the same com-

found is obtained by heating cerium oxide with silicon. According to R. Vogel, the fact that cerium combines with lead and tin with development of heat, forming several compounds, indicates that it does not belong to the same chemical family of the fourth group. It is now found that it combines with silicon at high temp. with great violence. It has not been found possible to prepare alloys containing more than 70 per cent. of cerium, as combination does not take place until 1400° , and the heat developed brings about the destruction of the containing vessel, or, if carbon crucibles be used, there is a considerable production of cerium carbide, in which case the alloys rapidly disintegrate in air. Solid silicon floats on molten cerium, and at a sufficiently high temp. combines explosively. Between 0 and 70 per cent. Ce the f.p. curve has two branches, intersecting at 1240° and 53 per cent. Ce. The eutectic times indicate that the maximum on the curve must be at 83 per cent. Ce, corresponding with a compound, cerium silicide, CeSi , melting above 1500° . This compound forms yellow, rounded crystallites, and the eutectic has a distinct lamellar structure. Free silicon crystallizes in needles, which are harder than the compound. The alloys are brittle, very stable in air, and are not pyrophoric. Molten cerium attacks silicates; porcelain crucibles are attacked, and a layer of cerium silicide is formed which protects the material from further attack; and the silicide does not appear to dissolve in the metal. Magnesia crucibles are best used for melting the metal. The reducing action of cerium, or of a mixture of the cerium group of metals—with or without aluminium or magnesium—on the metal oxides, was proposed by R. Escales, in place of that of magnesium or of aluminium in the thermite process.

The alloys of the cerium metals.—The cerium metals, so far as they have been examined, readily form alloys with other metals. The alloys are usually

brittle, and can be readily pulverized. Various alloys were described by L. Guillet. The following deals with the alloys of those metals which have already been discussed in this treatise. According to A. Hirsch,² sodium dissolves quietly in cerium, forming a hard, slightly pyrophoric alloy, which is somewhat oxidized on exposure to air. He also found that when cerium and copper are melted together under a layer of sodium chloride in a magnesia crucible, there is formed a hard and brittle alloy, although the two components are soft and malleable. The alloy disintegrated to a powder on exposure to air. The copper-cerium alloys were mentioned by W. Borchers, H. Kellermann, and F. Fattinger as illustrations of the

great faculty possessed by cerium of alloying with the metals. L. Stockem prepared some copper-cerium alloys by melting in an electric arc furnace a mixture of carbon with cerium and copper oxides, and also by applying the thermite aluminium process to a mixture of cerium and copper oxides. A. Hirsch, and F. Hanaman melted the two metals under a layer of fused alkali chloride by adding the cerium to molten copper, or *vice versa* for alloys with over 80 per cent. of cerium. The f.p. curve, Fig. 13, has two well-marked maxima, corresponding with cerium hexacupride, Cu_6Ce , which melts at 935° , and cerium dicupride, Cu_2Ce , melting at 820° . There are also two compounds which are formed by reactions between solid and liquid, thus giving rise to breaks in the f.p. curve; cerium tetracupride, Cu_4Ce , at 780° , and cerium cupride, CuCe , at 514° . There are three eutectic points, at 875° , 757° , and 415° , occurring at 17 per cent., 44 per cent., and 84 per cent. of cerium respectively. Solid soln. are not formed. The hardness curve of the alloys has two pronounced maxima, corresponding with the compounds Cu_6Ce and Cu_2Ce , the former being nearly four times as hard as copper. The colour of the alloys

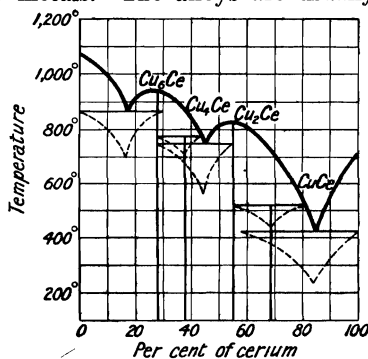

FIG. 13.—Freezing-point Curve of Copper-Cerium Alloys.

resembles that of copper as far as the first eutectic; from that point to the third eutectic it resembles that of bronze, and then becomes steel-grey. Only those alloys which lie between 55 per cent. and 85 per cent. Ce are pyrophoric. Those containing less than 30 per cent. Ce are stable and retain their colour in air; richer alloys soon disintegrate. G. Tammann studied the electrode potential and chemical behaviour of the Ce—Cu alloys. A. Hirsch observed that **silver** forms alloys with cerium with but a small thermal change. The alloy has a silvery white lustre, and is hard and brittle. A compound is probably formed. When **gold** is added to molten cerium, there is a slight flash from the crucible, but the reaction is not violent. The alloy is fairly soft, and has a reddish colour. It disintegrates to a very dark purple powder when allowed to stand in air.

M. Moldenhauer obtained alloys of cerium and **calcium** by reducing cerous fluoride with calcium; and A. Hirsch, by melting the two metals under a layer of alkali chloride. The combination occurs quietly without the evolution of much heat; the alloys are white and harder than either constituent. When scratched with a file, the alloy emits a shower of bright sparks. It is stable in air, oxidizes very slowly, and does not disintegrate. W. Muthmann and H. Beck, A. Hirsch, and R. Vogel also prepared alloys of **magnesium** and cerium—A. Hirsch by a process like that used for calcium-cerium alloys, and R. Vogel by melting an intimate mixture of the two elements in a carbon crucible at a temp. not exceeding 900°. The f.p. curve has maxima at 738° and 780°, corresponding with the compounds **cerium magneside**, CeMg, and **cerium trimagneside**, CeMg₃, and a break at 620°, corresponding with **cerium enneamagneside**, CeMg₉. A minute maximum at 632° is also inferred, due to **cerium tetriramagneside** or **quadrantomagneside**, Ce₄Mg. Solid soln. are only formed between **cerium magneside** and **cerium trimagneside**, whilst **cerium quadrantomagneside** breaks up into cerium and cerium magneside at 497°. This is inferred from the microscopic structure, which is developed by heat-tinting.

Alloys corresponding with the compounds cerium quadrantomagneside and cerium magneside are pyrophoric. Cerium magneside is hard (5 on Mohs' scale), and oxidizes rapidly on heating. When containing magnesium in solid soln. the compound explodes violently in Bunsen's flame, the magnesium vapour being enclosed in a crust of oxide. Moist air at the ordinary temp. has very little action. Cerium trimagneside is still more stable towards air and acids, and is not pyrophoric. Cerium enneamagneside is softer, and brittle. It falls spontaneously into fragments, which retain their silvery lustre, indicating some polymorphic change. According to A. Hirsch, most of the alloys are brittle and can be pulverized, but those with 75 to 85 per cent. of cerium are so highly pyrophoric that it is difficult to pulverize them without ignition. The alloys with the higher proportions of cerium furnish excellent flash-light powders; and they are also splendid reducing agents, as the combination of cerium and magnesium is an endothermic reaction, and when the alloy is oxidized, more heat is emitted than from an eq. mechanical mixture of the two constituents. The fact that the alloys of from 60 to 75 per cent. cerium content may be easily pulverized in a mortar to a fineness of 200 mesh should render these alloys valuable for thermal reductions. The optical constants of cerium metal could not be obtained because of the formation of a film of oxide on the surface, but the indices of refraction and the coeff. of absorption for magnesium-cerium alloys were:

Per cent. cerium	.	.	.	0	26	61	83
Refractive index	.	.	.	0.32	0.73	1.43	1.60
Absorption coeff.	.	.	.	1.74	2.30	4.79	12.0

W. Muthmann and H. Beck state that 84.9 cal. are absorbed in the formation of a gram of the alloy with 46.94 per cent. of cerium; and the heat of combustion is 3952.4 cal. per gram. The sp. gr. of the alloy is 2.744; it is silver-white, and very brittle; it does not change in air, but burns with an intensely bright flame; it is readily attacked by dil. acids, with the evolution of hydrogen; at 200°–400° in

hydrogen, cerium hydride is formed; and at 900° in air, nitrides of the two metals are formed.

A. Hirsch, and W. Muthmann and H. Beck found that **zinc** unites with molten cerium with explosive violence, and a large amount of heat is evolved. A. Hirsch said the alloy he prepared was hard, brittle, pyrophoric, and remained unoxidized on exposure to air, but W. Muthmann and H. Beck found the alloy with 32.75 per cent. of cerium is bluish-white, and very brittle; its m.p. is high; its heat of formation is 94.48 cal. per gram; its heat of combustion is 1305.5 cal. per gram; it oxidizes readily on exposure to air; dissolves in dil. acids; and forms cerium hydride when heated to 200° – 400° in hydrogen. F. Clotofsky found that the electromotive behaviour of cerium-zinc alloys show the existence of two compounds, **cerium quadrantzincide, or tetrizincide**, Ce_4Zn , and **cerium hemizincide**, Ce_2Zn . The velocity constants of the formation of the former was computed to be 4×10^{77} , and of the latter 10^{67} . A. Hirsch found that **cadmium** unites vigorously with cerium, and much heat is evolved. The alloy is hard, brittle, and pyrophoric. On exposure to air, a film of oxide is formed, but the alloy does not disintegrate. C. Winkler noted that cerium dissolves in **mercury**, and by this solvent he extracted the metal from the products of the reduction of ceric oxide with magnesium. W. Kettmeil found that it is not possible to prepare amalgams of cerium and of praseodymium or neodymium by the electrolysis of salts of these elements using a mercury cathode. A. Hirsch also found that cerium readily forms amalgams; those with up to 2 per cent. of cerium are liquid; the others are solid. The amalgams readily oxidize in air; and those with 8–10 per cent. of cerium fire spontaneously on exposure to air. According to H. Beck, amalgams containing between 10 and 16 per cent. of cerium, possess the property of igniting spontaneously in the air; with a content greater than 40 per cent. Ce, they ignite rapidly in these conditions and throw out intense sparks which give an exceedingly bright light. The intensity of production of the sparks increases with the proportion of cerium up to a content of 80 per cent., after which the pyrophoric power considerably decreases. The alloys can be obtained by heating the finely divided rare metal in a closed vessel in contact with mercury vapour at a temp. of 500° – 600° C., the intensity and duration of the heating being adjusted according to the amount of mercury it is desired to absorb. W. Muthmann and H. Beck found that a liquid amalgam of cerium, containing 2.74 per cent. of the metal, and a solid amalgam, containing 10.41 per cent., can be prepared by adding cerium to boiling mercury in an atm. of carbon dioxide. The amalgams react with water with the evolution of hydrogen, and become covered with a very voluminous coat of ceric hydroxide in moist air; spontaneous combustion frequently takes place.

A. Hirsch found **aluminium** unites with molten cerium quietly, forming a hard, brittle alloy which disintegrates without oxidation. O. Barth, and W. Borchers made cerium-aluminium alloys by adding cerium fluoride to the electrolyte employed in the manufacture of aluminium, and it is claimed that it improved the tensile strength and elongation of aluminium without interfering with its working qualities. The alloys have been studied by J. Schulte, and by H. W. Gillett and V. H. Schnee; the latter reported that the use of cerium in aluminium alloys is "an expense not attended by any benefit." According to R. Vogel, cerium and aluminium may be melted together at 1100° , when combination occurs and the temp. rises to 1600° – 1700° . Repeated remelting is necessary in order to obtain a homogeneous mixture. The development of heat is a maximum at the composition of **cerium tetraluminide**,

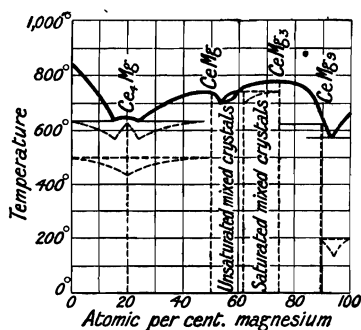

FIG. 14.—Freezing-point Curve of Magnesium-Cerium Alloys.

$CeAl_4$. Alloys rich in aluminium are fused in carbon tubes, and the remainder in porcelain tubes, which are very little attacked at 1100° . Many of the thermal changes in the system are indistinct, and the diagram has been completed from microscopic observations. The f.p. curve, Fig. 15, has two maxima, at 614° , corresponding with the compound **cerium tritaluminide**, Ce_3Al , and at 1460° , corresponding with **cerium dialuminide**, $CeAl_2$. There are also breaks at 595° , 780° , and 1250° , corresponding with the formation of the compounds **cerium hemialuminide**, Ce_2Al , **cerium aluminide**, $CeAl$, and cerium tetraluminide, $CeAl_4$, respectively. The last compound undergoes a transformation at 1005° . There are three eutectic points, and solid soln. are not formed. L. Guillet also obtained these five aluminides. The alloys, with the exception of those containing more than 75 per cent. Ce, are stable towards air and water. Cerium dialuminide is hardly attacked by conc. hydrochloric, nitric, or sulphuric acid, but burns vigorously when heated in Bunsen's flame. Only the alloys richest in cerium

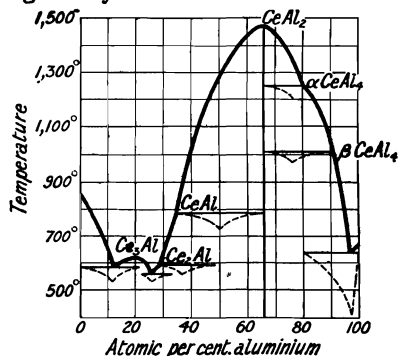

FIG. 15.—Freezing-point Curve of Aluminium-Cerium Alloys.

give sparks when filed. The maximum hardness, 6 on Mohs' scale, is given by cerium dialuminide, $CeAl_2$. W. Muthmann and H. Beck found needles or prisms of cerium tetraluminide remain when an alloy of the two metals is treated with a soln. of alkali hydroxide. The alloy is brittle. The crystals are rhombic or monoclinic with the axial ratio $a : b = 0.7706 : 1$. The sp. gr. is 4.183; the heat of combustion is 3441.19 cal. per gram when the calculated value is 3940.5 cal. per gram; and the heat of formation is 499.3 cal. Lanthanum was found by W. Muthmann and H. Beck to furnish **lanthanum tetraluminide**, $LaAl_4$, in crystals isomorphous with those of the cerium compound. The monoclinic or rhombic crystals have the axial ratios $a : b : c = 0.7517 : 1 : -$; the sp. gr. is 3.923; the heat of combustion, 3481.6 cal. per gram; and the heat of formation 395.4 cal. The aluminium alloys of cerium and lanthanum are very stable; are not affected by exposure to air; are not attacked by nitric acid, and are dissolved by hydrochloric acid and aq. potassium hydroxide, but less readily than their components. The alloy known as *Mischmetall*, *Cermischmetall*, or *Ceritemetall*, is obtained by the electrolysis of a mixture of the chlorides of the cerium earths from monazite sand—containing roughly 45 per cent. Ce_2O_3 ; 25 per cent. La_2O_3 ; 15 per cent. Nd_2O_3 ; and the remainder contains the sesquioxides of praseodymium, samarium, and yttrium metals. Consequently, the **mischmetall** is a mixture of the rare earth metals—cerium, lanthanum, neodymium, praseodymium, and samarium—with more or less of the yttria earth metals. A. Sieverts and G. M. Goldegg studied the action of hydrogen and nitrogen on the mischmetals.

Reactions of analytical interest.—As previously indicated, the rare earths are isolated by removing silica by evaporation with hydrochloric acid, and precipitating the hydrogen sulphide group. The gas is expelled from the filtrate by boiling, and treated with a boiling soln. of oxalic acid added slowly with constant stirring. The washed and ignited precipitate is dissolved in the minimum quantity of acid, a little alcohol is added to reduce the ceric to cerous salts, and an excess of potassium sulphate is added. After standing a few hours, the precipitate is washed with a soln. of potassium sulphate. The filtrate contains the yttrium and terbium earths; the precipitate, the cerium earths as sparingly soluble double sulphates. The precipitate is dissolved in dil. hydrochloric acid, precipitated with oxalic acid, washed, dried, and ignited. The oxides can be dissolved in hydrochloric acid and the components separated as previously described.

The general reactions of soln. of cerous, lanthanum, praseodymium, neodymium,

and samarium salts are as follows: A precipitate of the hydroxide, $R(OH)_3$, is produced by **ammonium hydroxide** or **ammonium sulphide**; the precipitate is not soluble in an excess of the reagent, but is readily soluble in acids. The precipitation does not occur if much citric or tartaric acid be present. The colour of the precipitate with cerous and lanthanum hydroxides is white; with samarium hydroxide, faintly yellow; with praseodymium hydroxide, green; and with neodymium hydroxide, blue. Cerous hydroxide gradually oxidizes and becomes yellow on exposure to air. W. Biltz³ showed that lanthanum hydroxide is peculiar in adsorbing iodine and acquiring a blue colour like starch. The blue colour is destroyed by acids and alkalis. The hydroxides are also precipitated by soln. of **potassium or sodium hydroxide**. According to R. J. Meyer and co-workers, with sufficient tartaric acid, the precipitation by sodium hydroxide is completely prevented; potassium hydroxide precipitates double potassium tartrates with the members of the yttrium group provided the soln. is boiling; and ammonium hydroxide precipitates double ammonium tartrates of the members of the yttrium group from cold soln. and the precipitates become crystalline when warmed. Precipitates of the carbonates or basic carbonates are produced by soln. of **potassium, sodium, or ammonium carbonate**; the precipitate is very sparingly soluble in an excess of the reagent. Precipitated lead carbonate gives no precipitation, but barium carbonate slowly precipitates all the ceria earth from cold soln. With **oxalic acid, or ammonium oxalate**, a precipitate of the oxalate is obtained which is almost insoluble in oxalic acid, but slightly soluble in a soln. of ammonium oxalate. A crystalline double salt is precipitated by **potassium, sodium, or ammonium sulphate**, the double salt is sparingly soluble in cold water, fairly soluble in hot water, and almost insoluble in a sat. soln. of the alkali sulphate. A boiling soln. of **sodium acetate** or of **sodium thiosulphate** gives no precipitation. Neutral or slightly acid soln. give no precipitate with **hydrogen dioxide**. With **tartaric acid**, no precipitation occurs. With **hydrofluoric acid**, the sparingly soluble fluoride is precipitated and the salt is insoluble in soln. of alkali fluorides, but appreciably soluble in hot mineral acids. With **iodic acid**, the iodates are precipitated, and they are readily soluble in nitric acid.

Cerous salts are readily oxidized in acid soln. by the action of lead dioxide and nitric acid; by persulphates; by anodic oxidation; etc., as previously described. Ceric salts are readily reduced to cerous salts by the usual reducing agents—alcohol, hydriodic acid, hydrogen sulphide, sulphurous acid, hydrogen dioxide, nitrous acid, ferrous sulphate, etc. Ceric salts give a precipitate of ceric hydroxide when treated with ammonium hydroxide or sulphide, or an alkali hydroxide. Sodium or potassium carbonate gives a precipitate, almost insoluble in an excess of the reagent; with ammonium carbonate the precipitate dissolves in a large excess of the reagent, but is reprecipitated on boiling the soln. Lead carbonate precipitates ceric hydroxide; barium carbonate precipitates all the cerium from cold soln. Oxalic acid, ammonium oxalate, and tartaric acid reduce ceric to cerous salts—*q.v.* Ceric salts give a precipitate with potassium sulphate, but not with sodium or ammonium sulphate. Sodium acetate precipitates a basic acetate from a boiling soln. Sodium thiosulphate gives a precipitate of ceric hydroxide. Iodic acid precipitates ceric iodate sparingly soluble in nitric acid.

W. Gibbs⁴ proposed the lead dioxide test for ceria in 1864. It is based on the more intense coloration exerted by ceric salts, when cerous salts are oxidized. A soln. of cerium sulphate with the eq. of 0.00025 grm. of ceria, when boiled with lead dioxide and nitric acid (1 : 2), gives a faint yellow colour under conditions where the untreated soln. gives no coloration. W. Gibbs later replaced lead dioxide by bismuth tetroxide, and detected 0.000017 grm. of ceria under similar conditions. W. N. Hartley claimed that 0.00001 grm. of ceria can be detected by the action of ammonium acetate and hydrogen dioxide, although L. de Boisbaudran, and P. T. Cleve found ammonium hydroxide and hydrogen dioxide is far more sensitive. P. C. Plugge added a drop of a soln. of one part of strychnine in 1000 of sulphuric

acid to the dry mass obtained by evaporating an alkaline soln. He found that 0.0001 part of ceria gave a blue or violet tint which changed to a reddish colour; 0.00001 grm. of ceria gave a faint blue which rapidly faded. The strychnine test does not work if oxalic acid be present.

The uses of the cerium earths.—According to E. Stern,⁵ in 1913, about 3300 tons of monazite were consumed annually in producing the 300 tons of thorium nitrate used in making incandescent mantles; about 315 million mantles were made in that year. About 100 tons of ceria were obtained as a by-product. Of this, about 3 tons were used in making gas mantles; 200 tons in making pyrophoric alloys; and 300 tons of cerium fluoride in impregnating arc-light carbons. C. R. Böhm has discussed the applications of the rare earths in his *Die Verwendung der seltenen Erden* (Leipzig, 1913). For *gas mantles*—*vide* the uses of thorium. A mixture of 100 grms. of thorium nitrate; 0.8 to 0.1 grm. cerium nitrate; 0.2–0.5 grm. beryllium nitrate; and 0.10 to 0.25 grm. of magnesium nitrate is employed for impregnating the mantles. Mantles for high-press. gas may have 2.8 per cent. of ceria. For stamping the mantles before burning off, a soln. containing didymium nitrate is used. A little yttria earth, along with thoria and zirconia, is employed in making the filaments for Nernst's lamps. The pyrophoric alloys are used in the manufacture of modern automatic gas lighters petrol lighters, cigarette lighters, for indicating the path of projectiles in the so-called tracer shells and tracer bullets, etc. Here, the "flint and steel" of our forefathers is revived; the steel is replaced by the so-called pyrophoric alloys. It has been known for a long time that metals other than steel give pyrophoric sparks when struck. Thus, G. Chesneau observed that sparks can be detached from uranium by friction with hard steel, and these sparks instantly ignite mixtures of methane and air, and alcohol, benzene, or light petroleum poured on cotton. The estimated temp. is over 1000°. The sparks detached from steel have not so high a temp. since they ignite none of these gases and vapours. The term **pyrophoric alloy** is applied to those brittle metals or alloys which, when struck with hard steel, furnish a shower of small particles which are heated sufficiently to allow them to ignite. The cerium family of metals also gives sparks, but the metals are too soft to be useful. C. A. von Welsbach found that cerium, or mischmetall, when alloyed with iron, cobalt, or nickel, becomes brittle enough to enable the alloys to be employed for the purpose. The alloy with 35 per cent. of iron and 65 per cent. of mischmetall is called *auer-metal*. Numerous other alloys with cerium or mischmetall have been patented. The so-called *kunheim-metal* was patented by H. Kunheim. It contains hydrides of some of these metals. Its composition approximates: mischmetall, 85 per cent.; magnesium, 10; aluminium, 1.0; iron, 0.5; hydrogen, 1.3; and silicon, 0.5. H. Kunheim patented alloys with particles of carborundum, boron, silicon, metals, oxides, peroxides, salts, phosphorus, sulphur, arsenic, and antimony. H. Kellermann, R. Grimshaw, R. Kremann and co-workers, J. F. G. Hicks, B. Simmersbach, J. Camillo, and G. Olsen have described many others. H. Beck found that alloys of mercury with mischmetall or cerium can be made to ignite spontaneously in air and then give off bright sparks, provided the amalgam is mixed with an oxidizing agent such as a chlorate. B. Simmersbach has reviewed the history of the cerium-alloy industry. A. Hirsch suggested the use of magnesium-cerium alloys as flash-light powders. G. Senftner proposed utilizing the pyrophoric alloys as arc-lamp electrodes either mixed with the carbon, or alone. The incorporation of salts of cerium, particularly the fluoride, in carbons used for arc-lamp electrodes, has been patented. C. W. von Siemens used cerium, lanthanum, and didymium tungstates or molybdates. It is claimed that the arc then gives a more intense light, and burns easily and quietly. The use of cerium fluotitanate was patented by the General Electric Co. Cerium nitride and carbide have been tried as a filament for incandescent electric lamps by the General Electric Co.—but with no commercial success.

Glasses for railway carriages in hot countries have been mixed with a little nickel and manganese oxides with the idea of cutting off the heat rays of the sun

without interfering appreciably with the transparency to luminous rays. W. Crookes suggested introducing ceria with the same object, and for making glare-reducing spectacles, etc. O. Schott discusses the use of ceria for tinting glass yellow; and of didymia for making blue optical glass. W. Muthmann and co-workers discuss the use of neodymium phosphate for producing an amethyst-red porcelain colour; and of praseodymium phosphate for producing a bright green—mixtures produce intermediate tints. Cerium titanate produces a bright yellow colour; cerium molybdate, a bright blue; cerium tungstate, a bluish-green; cerium manganititanate, an orange-yellow; and neodymium tungstate, a bluish-red. R. Rickmann and E. Rappe discussed the use of cerium dioxide as a yellow opacifying agent for glass and enamel. O. N. Witt, G. Matschak, C. Baskerville and T. B. Foust, and R. Gnehm discuss the use of cerium salts as a mordant in dyeing cotton, etc.; E. Stern, the weighting of silk; and F. Garelli, W. Eitner, and M. Parenzo, the dyeing and tanning of leather; and A. and L. Lumière, and A. Seyewetz and J. T. Gateau, in photography. There is a patent by C. A. von Welsbach for the use of cerium sulphate for accumulators, and W. Krilitschewsky found that such accumulators had some advantages over those made of lead. W. Plüddemann, and V. Hölbling and H. Ditz discuss the use of cerium earths as catalysts in the oxidation of sulphur dioxide to sulphur trioxide—but the suggestion does not appear to be of any industrial use; and H. Ditz and B. M. Margosches, the production of chlorine by passing a mixture of hydrogen chloride and air over cerium chlorides heated to 350°–480°. H. Kunheim and N. Whitehouse found that cerium hydride and nitride serve as catalysts in the union of hydrogen and nitrogen to form ammonia, but the catalyst does not retain its activity very long. J. Bekk, and M. Reimer tried cerium dioxide in place of platinum as catalyst for rapid organic combustions. K. Kruis, H. Bührig, and O. N. Witt discuss the use of alkali cerium sulphates as catalysts in the production of aniline black by the action of alkali chlorate or chromate on aniline. While alloys of the cerium earth metals are very strong reducing agents and reduce columbium, tantalum, zirconium, cobalt, nickel, chromium, manganese, vanadium, tungsten, uranium, boron, silicon, etc., from their oxides on a small scale. Acid soln. of ceric salts are strong oxidizing agents, and A. Meister and co-workers claim that they are more efficient than chromates for the production of aldehydes and quinones from aromatic hydrocarbons.

Cerium salts are used to a very limited extent in therapeutics. Like bismuth, they act as a sedative. Mixed cerium earth oxalates in small doses have been recommended to prevent nausea in cases of stomach catarrh, pregnancy-sickness, mal de mer, etc.; didymium salicylate is sold under the trade-name *dymal* as a non-irritant antiseptic dressing for wounds; double ceric sulphates have been sold under the trade-name *ceriform* for the same purpose. E. Schering recommended cerium phenolate as a less toxic disinfectant than phenol, but with the same efficiency. The chlorides of the rare earths are said to act like ferric chloride in stopping bleeding; and proposals have been made to use cerous bromide in place of alkali bromides.

REFERENCES.

- ¹ A. Hirsch, *Journ. Ind. Eng. Chem.*, 3, 880, 1911; 4, 65, 1912; *Trans. Amer. Electrochem. Soc.*, 29, 57, 1911; W. Muthmann and L. Weiss, *Liebigs Ann.*, 331, 1, 1904; W. Muthmann and K. Kraft, *ib.*, 325, 261, 1902; W. Muthmann and E. Baur, *ib.*, 325, 281, 1902; F. Kellenberger and K. Kraft, *ib.*, 325, 279, 1902; W. Muthmann and H. Beck, *ib.*, 331, 58, 1904; W. Muthmann, *ib.*, 331, 60, 1904; W. F. Hillebrand, *Pogg. Ann.*, 158, 71, 1876; W. F. Hillebrand and T. H. Norton, *ib.*, 155, 633, 1875; 156, 466, 1875; H. C. Kremers and R. G. Stevens, *Journ. Amer. Chem. Soc.*, 45, 614, 1923; C. A. Matignon, *Compt. Rend.*, 131, 837, 891, 1900; C. Winkler, *Ber.*, 24, 873, 1891; G. I. Tschukoff, *Journ. Russ. Phys. Chem. Soc.*, 45, 2073, 1913; F. W. Dafert and R. Miklausz, *Monatsh.*, 33, 911, 1912; J. Lipski, *Zeit. Elektrochem.*, 15, 189, 1909; R. Escales, *German Pat.*, D.R.P. 145820, 1903; H. Kunheim, *ib.*, 38762, 1909; J. Kellermann, *ib.*, 39488, 1908; H. Kellermann, *Ueber die Darstellung des metallischen Cers und seine Verbindungen mit Arsen und Antimon*, Berlin, 1910; H. Beck, *Beiträge zur Kenntnis der Metalle der Cerggruppe*, München, 1907; R. Vogel, *Zeit. anorg. Chem.*, 84, 323, 1913; N. N. Mittra and N. R. Dhar, *ib.*,

122. 146, 1922; A. Sieverts and G. M. Goldegg, *Zeit. anorg. Chem.*, **131**, 65, 1923; A. K. Goard and E. K. Rideal, *Proc. Roy. Soc.*, **105**, A, 135, 1924; S. Medaforth, *Journ. Chem. Soc.*, **123**, 1452, 1923; G. Tammann, *Rec. Trav. Chim. Pays-Bas*, **42**, 547, 1923.

² A. Hirsch, *Trans. Amer. Electrochem. Soc.*, **29**, 57, 1911; *Journ. Ind. Eng. Chem.*, **3**, 880, 1911; **4**, 65, 1912; H. Kellermann, *Die Cerimetalle und ihre pyrophoren Legierungen*, Halle a. S., 1912; F. Hanaman, *Internat. Zeit. Metallg.*, **7**, 174, 1915; W. Muthmann and H. Beck, *Liebig's Ann.*, **331**, 46, 1904; R. Vogel, *Zeit. anorg. Chem.*, **75**, 41, 1904; **91**, 277, 1915; F. Clotofsky, *ib.*, **114**, 1, 1920; W. Kettnebel, *ib.*, **38**, 213, 1904; *Studien über elektrolytische Amalgambildung und Versuche zur Metalltrennung durch Amalgambildung*, Göttingen, 1903; M. Moldenhauer, *Chem. Ztg.*, **38**, 147, 1914; F. Fattinger, *ib.*, **33**, 1113, 1909; **34**, 469, 1910; C. R. Böhm, *ib.*, **34**, 361, 387, 1910; L. Guillet, *Rev. Mét.*, **18**, 681, 1921; L. Stockem, *Zeit. Elektrochem.*, **8**, 39, 744, 1902; W. Borchers, *Elektrometallurgie*, Braunschweig, 155, 1896; W. Borchers and O. Barth, *German Pat.*, *D.R.P.* 246484, 1912; O. Barth, *Met.*, **9**, 261, 1911; C. Winkler, *Ber.*, **24**, 1883, 1891; J. Schulte, *Metall Erz.*, **18**, 236, 1921; *Metal Ind.*, **20**, 142, 1922; H. W. Gillett and V. H. Sohnee, *Journ. Ind. Eng. Chem.*, **15**, 709, 1923; H. Beck, *Brit. Pat. Nos.* 2876, 1910; 15507, 1910; A. Sieverts and G. M. Goldegg, *Zeit. anorg. Chem.*, **131**, 65, 1923; G. Tammann, *ib.*, **118**, 93, 1921; L. Guillet, *Rev. Mét.*, **19**, 352, 1922.

³ W. Biltz, *Ber.*, **37**, 719, 1904; R. J. Meyer and H. Goldenberg, *Chem. News*, **106**, 13, 1912; R. J. Meyer and O. Hauser, *Die Analyse der seltenen Erden und der Erdsäuren*, Stuttgart, 43, 1912.

⁴ W. Gibbs, *Amer. Journ. Science*, (2), **37**, 352, 1864; *Amer. Chem. Journ.*, **15**, 546, 1894; W. N. Hartley, *Journ. Chem. Soc.*, **41**, 203, 1882; L. de Boisbaudran, *Compt. Rend.*, **100**, 605, 1885; P. T. Cleve, *Bull. Soc. Chim.*, (2), **43**, 57, 1885; P. C. Plugge, *Arch. Pharm.*, **229**, 558, 1891.

⁵ E. Stern, *Zeit. angew. Chem.*, **26**, 806, 1913; B. Simmersbach, *Chem. Ztg.*, **45**, 577, 1921; G. Chesneau, *Compt. Rend.*, **122**, 471, 1896; C. A. von Welsbach, *Brit. Pat. Nos.* 16853, 1903; 27341, 1908; H. Beck, *ib.*, 2876, 1910; 15507, 1910; G. Senftner, *ib.*, 8150, 8151, 1909; General Electric Co., *ib.*, 929, 1906; 13988, 1912; H. Kunheim, *ib.*, 16210, 16211, 1909; *German Pat.*, *D.R.P.P.* 238127, 238128, 1909; 276986, 1913; H. Kellermann, *Die Cerimetalle und ihre pyrophoren Legierungen*, Halle a. S., 1912; G. Olsen, *Polyt. Eng.*, **14**, 24, 1914; A. Hirsch, *Journ. Ind. Eng. Chem.*, **3**, 880, 1911; *Trans. Amer. Electrochem. Soc.*, **29**, 57, 1911; W. Crookes, *Chem. News*, **109**, 265, 289, 301, 1914; *Phil. Trans.*, **214**, A, 1, 1914; O. Schott, *Jahres. Fortschr.*, **42**, 2685, 1889; *German Pat.*, *D.R.P.* 103441, 1889; W. Muthmann, L. Weiss, and H. Heramhof, *Liebig's Ann.*, **355**, 144, 1907; O. N. Witt, *Chem. Ind.*, **19**, 153, 1896; R. Gnehm, *ib.*, **17**, 577, 1894; G. Matschak, *ib.*, **17**, 150, 1898; W. Eitner, *Gerber.*, **37**, 199, 213, 1911; F. Garelli, *Collegium*, **418**, 1912; M. Parenzo, *ib.*, **121**, 1910; N. Whitehouse, *Journ. Soc. Chem. Ind.*, **26**, 738, 1907; C. Baskerville and T. B. Foust, *ib.*, **23**, 104, 1904; W. Plüddemann, *Beitrag zur Aufklärung des Schwefelsäurekontaktprozesses*, Berlin, 1907; J. Bekk, *Ber.*, **46**, 2574, 1913; M. Reimer, *Journ. Amer. Chem. Soc.*, **37**, 1636, 1915; W. Krilitschewsky, *Zur Kenntnis des Cersulfat Akkumulators*, Halle a. S., 1904; L. Gräfenberg, *Zeit. Elektrochem.*, **8**, 297, 1902; R. Grimshaw, *Metal Ind.*, **3**, 197, 1911; C. A. von Welsbach, *Brit. Pat. No.* 21566, 1900; J. T. Gateau, *ib.*, 20740, 1907; A. and L. Lumière, *Compt. Rend.*, **116**, 574, 1893; *Bull. Soc. Phot.*, **16**, 103, 1900; A. and L. Lumière and A. Seyewetz, *Monit. Scient.*, (5), **15**, 169, 1901; *Brit. Pat. No.* 470, 1900; H. Bührig, *Dingler's Journ.*, **231**, 77, 1897; K. Kruijs, *ib.*, **212**, 347, 1874; C. W. von Siemens, *ib.*, 216800, 1909; E. Scherng, *ib.*, 214782, 1909; A. Lumière, *ib.*, 123017, 1901; R. Rickmann and E. Rappe, *ib.*, 203773, 1908; V. Höbbling and H. Ditz, *ib.*, 142144, 1903; 149677, 1904; H. Ditz and B. M. Margosches, *ib.*, 150266, 1904; A. Meister, R. Lucius, and H. W. Brüning, *ib.*, 158609, 1902; 241469, 1911; *Brit. Pat. No.* 1385, 1901; R. Kremann, R. Schädinger, and R. Kropsch, *Monatsh.*, **38**, 91, 1917; J. F. G. Hicks, *Journ. Amer. Chem. Soc.*, **40**, 1619, 1918; B. Simmersbach, *Chem. Ztg.*, **45**, 577, 1921; J. Camillo, *Metal Ind.*, **15**, 84, 1919; J. Escard, *L'Ind. Chim.*, **5**, 182, 1918.

§ 11. The Valency of the Rare Earth Metals, and their Position in the Periodic System

At the beginning of the nineteenth century, J. J. Berzelius¹ regarded ceria and yttria as dioxides, assigning to them the formulæ respectively CeO₂ and YO₂; and he gave ceric oxide the formula CeO₃. Influenced by the applications of P. L. Dulong and A. P. Petit's rule, and the law of isomorphism, J. J. Berzelius admitted the existence of sesquioxides, and in 1826, he altered the formulæ of ceria and yttria to CeO and YO respectively, and that of ceric oxide to Ce₂O₃. Up to 1870, the formulæ of the rare earths, lanthana, didymia, yttria, erbia, and terbia were written RO because their strong basic characters were considered to be analogous with those of the alkaline earths. Ceria was given the formula Ce₃O₄, and H. Zschiesche supposed it to be a mixture of the oxides CeO and CeO₂ analogous with red-lead. This explanation could neither be proved nor disproved with the then state of

knowledge of the ceric salts. In 1870, D. I. Mendeléeff proposed to change the fashionable formulæ of the rare earth oxides into the sesquioxide form R_2O_3 ; with the R-element trivalent, cerous oxide was also taken to be a sesquioxide, Ce_2O_3 , of trivalent cerium, and ceric oxide, a dioxide, CeO_2 , of quadrivalent cerium. P. T. Cleve, and S. Jolin supported D. I. Mendeléeff's suggestion for yttria, erbia, didymia, and ceria(ous), but they thought lanthana to be different, forming not La_2O_3 but LaO_2 . L. F. Nilson's work on the selenites and chloroplatinates further strengthened the idea that the rare earths, lanthana included, are sesquioxides. In 1873, C. F. Rammelsberg raised some objections to D. I. Mendeléeff's hypothesis, but he accepted it three years later.

The rare earths have been likened to alumina, but the feeble basicity of aluminium hydroxide, coupled with its tendency to form basic salts, and the tendency of aluminium to form complex compounds with organic acids, are the reverse of those properties which characterize the rare earths. The highly basic properties of these earths appear to hinder the formation of complex derivatives; a like contrast occurs with cupric and barium salts. C. Winkler argued in favour of the assumption that these elements are quadrivalent, but B. Brauner showed that the hypothesis is inadequate. From his measurements of the sp. ht. of cerous and didymium tungstates, A. Cossa concluded that the rare earth elements are bivalent, G. Wyruboff and A. Verneuil decline to accept the arguments based upon sp. ht., isomorphism, and the periodic law, and state that there is a close relationship between the chemical properties of the rare earth elements and the bivalent metals; but G. Urbain has shown that if this plan be rigidly followed, the rare earths can just as well be classed with trivalent bismuth. P. T. Cleve and M. Höglund showed that D. I. Mendeléeff's assumption furnishes simpler formulæ for the complex salts of yttrium and erbium than when the rare earth metals are assumed to be bivalent. For example, $3YSO_4 \cdot 8H_2O$ becomes $Y_2(SO_4)_3 \cdot 8H_2O$; $Y_3H_2(C_4H_4O_6)_4 \cdot 6H_2O$ becomes $YH(C_4H_4O_6)_4 \cdot 6H_2O$; etc. The amino-chlorides also give simpler formulæ with a triadic than with a dyadic base. The chloroplatinates of the uni- and bivalent metals are built on the type $2KCl \cdot PtCl_4$, and $MgCl_2 \cdot PtCl_4$, while the salts of the rare earths are built on the type $RCl_3 \cdot PtCl_4 \cdot nH_2O$. The corresponding salts of yttrium and indium are anomalous in that the former has the composition $4YCl_3 \cdot 5PtCl_4 \cdot 52H_2O$, and the latter, $2InCl_3 \cdot 5PtCl_4 \cdot 36H_2O$. P. T. Cleve found that the chloroplatinates and the selenites also agree better with the rare earths trivalent.

No volatile compounds of the rare earths have been prepared which allow the vapour density to be determined. Tervalent scandium does furnish compounds which can be volatilized without decomposition, and, in view of the very close relationship between scandium and the rare earths, it is inferred that the rare earth metals are trivalent. This is confirmed by mol. wt. determinations of the rare earths in soln. W. Muthmann, and B. Brauner showed that the raising of the b.p. of alcohol by anhydrous cerium, lanthanum, praseodymium, neodymium, and yttrium is in accord with the trivalency of these elements RCl_3 , although, as C. A. Matignon has shown, these chlorides form complexes with the solvent. C. A. Matignon found the f.p. of aq. soln. neodymium, samarium, and ytterbium chlorides. The results are in accord with the trivalency of these elements when compared with F. M. Raoult's values for aluminium and chromium chlorides which are admittedly trivalent. Thus, the mol. depression of the f.p.:

$NdCl_3$	$SaCl_3$	$YbCl$	$AlCl_3$	$CrCl_3$
68.0	65.6	66.0	64.5	64.0

W. Biltz found that the f.p. of soln. of acetylacetonates of cerium and didymium in carbon tetrachloride; of praseodymium and samarium in carbon disulphide; and of neodymium in ethyl sulphide, are in accord with the view that in conc. soln., these compounds are present in doubled molecules $[R\{(CH_3 \cdot CO)_2CH_3\}_3]_2$, which break down on dilution. The electrical conductivities of lanthanum and yttrium

chlorides by H. Ley; of cerium, praseodymium, neodymium, and samarium chlorides, and of lanthanum, cerium, and samarium sulphates by A. Aufrecht; of lanthanum nitrate by W. Muthmann; and of lanthanum, cerium, praseodymium, neodymium, samarium, gadolinium, yttrium, erbium, and ytterbium sulphates by B. Brauner, are in accord with the tervalency of the rare earth elements when tested by W. Ostwald's rule—1, 15, 13.

The sp. ht. of cerium, lanthanum, and didymium, measured by W. F. Hillebrand, favour the view that these elements are trivalent; similarly also does L. F. Nilson and O. Pettersson's work on the mol. ht. of the oxides and sulphates of aluminium, scandium, gallium, indium, and the metals of the rare earths; but, as indicated above, A. Cossa's work on the sp. ht. of the silicotungstates does rather favour the bivalency of these elements. The evidence from the isomorphism of the compounds of the rare earths is conflicting in that some favour the assumption that the earths are bivalent, and some that they are trivalent. It must also be added that G. Wyrouboff found that silicotungstates of cerium, lanthanum, and didymium are isomorphous with the corresponding salts of thorium, a quadrivalent element. The same evidence would favour the assumption that univalent lithium is bivalent. This shows that the nature of the basic element in the silicotungstates has but a minor influence on the crystalline form. Many of the salts of the rare earths are isomorphous with one another so that arguments which apply to the one apply to all. The value of the evidence from isomorphism is usually feeble since, as T. V. Barker has emphasized, there are cases of apparent isomorphism among unrelated salts.

(i) *Isomorphism with salts of bivalent elements.*—M. Delafontaine found that cadmium, didymium, and yttrium sulphates are isomorphous and crystallize like salts of the magnesium series of metal sulphates. T. Vogt showed that isomorphous mixtures of the fluorides of the alkaline earths and the rare earths occur in many minerals—ytrocerite, yttrifluorite, parisite, cordylite, etc.; A. Cossa and M. Zecchini, P. Didier, and A. Högbom showed that cerous and didymium tungstates and molybdates form mixed crystals with calcium tungstate and lead molybdate; and G. Wyrouboff showed that the silicotungstates of the alkaline earths form mixed crystals with the corresponding salts of cerium, lanthanum, and didymium.

(ii) *Isomorphism with salts of trivalent elements.*—G. Bodman has shown that the stable pentahydrated bismuth nitrate, $\text{Bi}(\text{NO}_3)_3 \cdot 5\text{H}_2\text{O}$, is isomorphous with the labile pentahydrates of lanthanum and didymium; and labile hexahydrated bismuth nitrate, $\text{Bi}(\text{NO}_3)_3 \cdot 6\text{H}_2\text{O}$, is isomorphous with the stable hexahydrates of the same two elements. G. Urbain, J. Blumenfeld, and H. Lacombe also showed that the yttria and terbia earths form mixed crystals with pentahydrated bismuth nitrate; that ammonium bismuth nitrate, $\text{Bi}(\text{NO}_3)_3 \cdot 2\text{NH}_4\text{NO}_3 \cdot 4\text{H}_2\text{O}$, is isomorphous with the lanthanum salt, $\text{La}(\text{NO}_3)_3 \cdot 2\text{NH}_4\text{NO}_3 \cdot 4\text{H}_2\text{O}$, and that the double salts of the type $2\text{Bi}(\text{NO}_3)_3 \cdot 3\text{M}(\text{NO}_3)_2 \cdot 24\text{H}_2\text{O}$, are isomorphous with the corresponding salts of cerium, lanthanum, praseodymium, neodymium, samarium, europium, and gadolinium, when M represents an atom of bivalent magnesium, manganese, zinc, nickel, or cobalt. G. Bodman also found that pentahydrated, octohydrated, and enneahydrated bismuth sulphates are isomorphous with the corresponding hydrated sulphates of the rare earths. P. T. Cleve, and L. F. Nilson found that yttrium selenite and chloroplatinate are isomorphous with the corresponding salts of trivalent chromium, aluminium, indium, and iron.

L. Benoist and H. Copaux found that cerium fits well into the curve where the at. wt. is plotted against the transparency to the X-rays on the assumption that in cerous salts cerium is trivalent. Similarly also the order of increasing at. number is nearly the same as that of increasing at. wt., and H. G. J. Moseley has shown that when the at. number is plotted with the sq. root of the frequency, the rare earth metals, with the exception of yttrium, come between barium and tantalum in accord with the tervalency of these elements. H. Freundlich and H. Schucht found that the action of salts of the rare earths on colloidal arsenic sulphide resembled that of salts of other trivalent metals.

At the time D. I. Mendeléeff published the periodic law,² the problem was to find places in the periodic table for the elements; at the present day fifteen vacant places in the table want filling. D. I. Mendeléeff was quite definite about the position of cerium; he placed it after tin in the fourth group and eighth series, and showed

that this element was then in conformity with the sp. ht. rule. He was also satisfied with the position of yttrium between gallium and indium in the third group, and sixth series, but rather doubtful about erbium, didymium, and lanthanum, which he placed :

Groups	II.	III.	IV.	V.
4	Ca	(Sc)	Ti	V
5	Zn	Ga	Ge	As
6	Sr	Y	Zr	Cb
7	Cd	In	Sn	Sb
8	Ba	Di	Ce	—
9	—	—	—	—
10	—	Er	La	Ta

D. I. Mendeléeff was of the general opinion that we are too ignorant of the rare earths to justify the attempt to instal them in the table. D. I. Mendeléeff's erbium and didymium were afterwards shown to be complex, and with increasing knowledge lanthanum was assigned to the place occupied by didymium. The allocation of places in the table for the fifteen or sixteen rare earth elements has not been successfully accomplished, whether these elements be regarded as dyads or triads. The assumption that these elements are dyads leaves the table in a hopeless position ; there is no suitable place for many members of the series—*e.g.* yttrium—and there are three candidates for one vacancy between molybdenum and ruthenium. If these elements be triads, yttrium falls in the place indicated above, the space between molybdenum remains vacant, and there are fourteen candidates for the vacant places between barium and tantalum. On the other hand, if these vacant places be filled by the elements ranged in the order of their at. wt. the majority occupy positions not in accord with their properties. Cerium remains in the position assigned to it by D. I. Mendeléeff ; and this harmonizes with the properties of ceric compounds, and with their relations with titanium, zirconium, and thorium—*q.v.* Scandium, yttrium, and lanthanum then form a sub-group of the third group. At one time, B. Brauner considered that the rare earths from cerium to ytterbium form a zone of elements in the fourth group, so that Ce in the above scheme is replaced by ΣCe , where

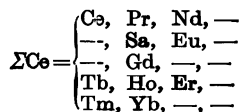

and the nine empty spaces of the ninth series of the table disappear. This forms the so-called **asteroid theory of the rare earths**. The scheme also assumes that there are nine undiscovered elements—*vide* 1. 6, 6. C. Benedicks emphasized the slow change in the at. vol. of the rare earth elements in passing from lanthanum to ytterbium, and he assembled them all in the third and fourth groups of the periodic table, and, like B. Brauner, he omitted the ninth series. J. W. Retgers places lanthanum, cerium, didymium, samarium, erbium, and ytterbium in the eighth series of the third group. G. Rudorf placed the rare earths in a special group.

R. J. Meyer believes that cerium should remain in the place assigned to it by D. I. Mendeléeff, and he instalts the other elements as an assemblage in the place assigned to lanthanum. Cerium thus falls out of the atomic order. R. J. Meyer then arranges the rare earth elements in the form of three sub-groups, with five elements each, two of which have not yet been found.

Group III.		
(I)	(II)	(III)
La	Gd	Tm
Pr	Tb	—
Nd	Dy	—
Sa	Ho	Yb
Eu	Er	Lu

arranged the elements with the rare earth metals as an intermediate group between barium and tantalum. B. Brauner in 1908 revived and modified a suggestion he made twenty-seven years earlier, by allocating the rare earths to various positions in the eighth, ninth, and tenth series of the third to the eighth groups :

Groups	II.	III.	IV.	V.	VI.	VII.	VIII.
6	Sr	Y	Zr	Cb	Mo	—	Ra, Rh, Pd
7	Cd	In	Sn	Sb	Te	I	
8	Ba	La	Ce	Pr	Nd	Sa	Eu, —, —
9	—	Gd	Tb	Dy	Ho	Er	Tm, Yb, —
10	—	Lu	Hf	Ta	W	—	Os, Ir, Pt

As the at. wt. of the elements of the eighth series increase, there is a decrease in basicity and in the tendency to form complexes; while those in the ninth series increase in the tendency to form complexes, but decrease in basicity as the at. wt. increases. B. Brauner assigned the positions from the valencies of the elements deduced from the hydrides :

I.	II.	III.	IV.	V.	VI.	VII.	VIII.
CsH	BaH ₂	LaH ₃	CeH ₄	PrH ₃	NdH ₂	(SaH)	(EuH ₀)

He also said that some of the rare earth elements can form higher oxides than the sesquioxide in the presence of oxygen carriers.

The general result of this discussion is to show that scandium, yttrium, lanthanum, and cerium fit very well into the periodic table, but when the remaining rare earths are installed, the simplicity and regularity of the scheme are destroyed. The discontinuity may be masked, but it cannot be removed by the use of geometrical devices—spirals, helices, lemniscates, etc. If the rare earth elements be allocated in the order of their at. wt. in the twenty spaces in the periodic table between barium and tantalum, then it can no longer be said that the properties of the elements are periodic functions of their at. wt., Table XII, and the periodic law breaks down.

TABLE XII.—ALLOCATION OF THE RARE EARTHS IN D. I. MENDELÉEFF'S TABLE.

Groups	I.	II.	III.	IV.	V.	VI.	VII.	VIII.
6	Rb	Sr	Y	Zr	Cb	Mo	—	Ru, Rh, Pd
7	Ag	Cd	In	Sn	Sb	Te	I	
8	Cs	Ba	La	Ce	Pr	Nd		
9	Sa	Eu	Gd	Tb	Dy	Ho	Er	
10	Tm	Yb	Lu	Hf	Ta	W		Os, Ir, Pt

In 1885, J. R. Rydberg introduced the use of integers in place of at. wt. since he thought the latter is not a simple quality, but has a complex nature, whereas the integers may be considered to represent a true independent variable. As with H. G. J. Moseley's at. numbers, the order chosen for J. R. Rydberg's at. numbers is that of increasing at. wt. except with four pairs of elements—argon and potassium, nickel and cobalt, iodine and tellurium, and praseodymium and neodymium. He rejected D. I. Mendeléeff's classification claiming that the system of elements does not consist of periods in the ordinary sense, but rather embodies quadratic groups, each group containing 4, 16, 36, or 64, *i.e.* $4p^2$ elements, where p is the number of the group, so that $p=1, 2, 3, \text{ or } 4$. Each element in J. R. Rydberg's Table is identified by an integral number which is two units above that chosen by H. G. J. Moseley as the atomic number, $N-4$. 25, 6. This is because the latter started his series with H, 1; He, 2, . . . , whereas J. R. Rydberg's first group with $p=1$, commencing with the hypothetical electron gas E, 0, runs on H, 1; then follow two hypothetical elements numbered 2 and 3, and the group ends with He, 4. It is suggested that the gases named *coronium* and *nebulium*, which have been revealed by the solar spectrum represent the unknowns in J. R. Rydberg's first group. This makes nebulium, 2, and coronium 3. The second group, $p=2$, contains the 16 elements from helium

TABLE XIII.—J. R. RYDBERG'S CLASSIFICATION OF THE ELEMENTS.

Valency.	0	1	2	3	4	5	6	7	8	
Group 1	[E (0)	—								
		H (1)								
	— (2)	—								
		(3)								
	He (4)	Li (5)	Be (6)	B (7)	C (8)					
Group 2		F (11)	O (10)	N (9)						
	Ne (12)	13	Mg (14)	Al (15)	Si (16)					
		Cl (19)	S (18)	P (17)						
	Ar (20)	K (21)	Ca (22)	Sc (23)	Ti (24)	V (25)	Cr (26)	Mn (27)	Fr (28)	Co (29)
Group 3		Br (37)	Se (36)	As (35)	Ge (34)	Ga (33)	Zn (32)	Cu (31)	Ni (30)	
	Kr (38)	Rb (39)	Sr (40)	Y (41)	Zr (42)	Cb (43)	Mo (44)	(45)	Ru (46)	Rh (47)
		I (55)	Te (54)	Sb (53)	Sn (52)	In (51)	Cd (50)	Ag (49)	Pd (48)	
	X (56)	Cs (57)	Ba (58)	La (59)	Ce (60)	Pr (61)	Nd (62)	(63)	Sa (64)	
Group 4		Er (70)	Ho (69)	Dy (68)	Tb (67)	Gd (66)	Eu (65)			
		Tm (71)	Yt (72)	Lu (73)	Hf (74)]	Ta (75)	W (76)	(77)	Os (78)	Ir (79)
		(87)	(86)	Bi (85)	Pb (84)	Tl (83)	Hg (82)	Au (81)	Pt (80)	
	Nt (88)	(89)	Ra (90)	(91)	Th (92)	(93)	U (94)			

to argon; the third group, $p=3$, contains the 36 elements ranging from argon to xenon; and the fourth group, $p=4$, with 64 elements, ranges from xenon to uranium. Both Tables XII and XIII are in harmony with H. G. J. Moseley's work on the high frequency spectra of the elements—3, 25, 6—according to which, the sequence of the atomic numbers of the rare earths is as indicated in both tables—remembering that *J. R. Rydberg's atomic numbers* are two units higher than those of H. G. J. Moseley. When the at. numbers, N , are plotted against the sq. roots of the frequencies, the points lie on a series of smoothed curves approximating to straight lines. This fact is not likely to be chance, and it is accordingly assumed that the order of the atomic numbers is the outward symbol of a hidden mechanism of fundamental importance. With respect to the rare earths, H. G. J. Moseley's law indicates that an element with an at. wt. between that of neodymium and samarium awaits discovery, and four elements—presumably thulium, ytterbium, lutecium, and celtium—come between erbium and tantalum; terbium and holmium are not complexes, but are chemical individuals; nor is thulium likely to be a mixture of three elements as C. A. von Welsbach argued. Hence, in the ordinary sense of the term, only one rare earth element is missing from H. G. J. Moseley's and J. R. Rydberg's series. The arrangement cannot be reconciled with the general chemical and physical characters of the rare earth elements; but it agrees with the observations of W. M. Hicks: *viz.* (i) The line spectra of cadmium, europium, and mercury exhibit triplet series of the sharp and diffuse type; where the triplet intervals are approximately proportional to the squares of the at. wts.; (ii) gadolinium exhibits doublet series similar to those of aluminium, gallium, and titanium; and (iii), scandium, yttrium, lanthanum, and ytterbium also show doublet series.

In passing from hydrogen to uranium, the majority of the elements show conspicuous differences in their chemical properties, but there is an interruption in the normal sequence, for one group of elements suddenly appears whose members are so closely related chemically that their separation offers special difficulties. N. Bohr³ showed that the nucleus theory of the atom, and the quantum theory of radiation offer a rational interpretation of the interruptions in the normal sequence of the elements by the rare earth groups. What can be called the atom's chemical properties are determined by the number and the arrangement of the electrons of the atom, but chiefly by the number and arrangement in the outermost group of electrons. When proceeding from hydrogen to uranium there are, in general, appreciable differences in the outermost group of electrons of two neighbour elements, hence the marked difference in the chemical behaviour of these elements. Furthermore, N. Bohr assumed that at a certain place in the periodic table a group of elements is encountered whose members show differences only in the constitution of the deeper lying electron groups of their atoms. Differences in the inner groups correspond with only small differences in the chemical behaviour, hence the great similarity in chemical behaviour of the group of the rare earth elements. According to N. Bohr's theory, the successive change in the inner groups of electrons occurs in the interval between lanthanum, at. wt. 57, and lutecium, at. wt. 71. He said: In the rare-earth elements there is a gradual development of the group 4-quantum electrons from a group containing 18 electrons into a group of 32 electrons, the numbers in the groups 5- and 6-quantum electrons remaining unchanged. In lutecium, the group of 4-quantum electrons is complete, and in the neutral atom of the next element hafnium, the number of electrons moving in 5- and 6-quantum orbits must exceed that of the rare earths by one. Lutecium must therefore be the last in the sequence. C. R. Bury expressed the same idea another way. He said that in general, succeeding elements differ by one electron in the outer shell, but in the rare earths, succeeding elements differ by one electron in an inner shell—probably the fourth of their kernels. Further, these elements do not show the variety of structure characteristic of other series, although some of these elements show signs of having more than one structure. Among a number of

possibilities, he suggested the following electronic structures for the rare earth elements :

At. No.		At. No.	
58	Ce (2, 8, 18, 18, 8, 4)	65	Tb (2, 8, 18, 26, 8, 3)
59	Pr (2, 8, 18, 19, 8, 4)	66	Ds (2, 8, 18, 27, 8, 3)
60	Nd (2, 8, 18, 21, 8, 3)	67	Ho (2, 8, 18, 28, 8, 3)
61	... (2, 8, 18, 22, 8, 3)	68	Er (2, 8, 18, 29, 8, 3)
62	Sa (2, 8, 18, 23, 8, 3)	69	Tm (2, 8, 18, 30, 8, 3)
63	Eu (2, 8, 18, 24, 8, 3)	70	Yb (2, 8, 18, 31, 8, 3)
64	Gd (2, 8, 18, 25, 8, 3)	71	Lu (2, 8, 18, 32, 8, 3)

H. G. J. Moseley's ⁴ arrangement of the at. numbers of the elements shows that a rare earth is missing for No. 61. J. M. Eder postulated the existence of *euro-samarium* from spectroscopic data. C. C. Kiess found lines common to neodymium and samarium, and suggested they may belong to the missing element. L. F. Yntema examined the monazite and gadolinite earths by X-ray analysis and spectroscopically, and considered it probable that an element of this number may be present in the fraction containing neodymium and samarium.

REFERENCES.

¹ H. G. J. Moseley, *Phil. Mag.*, (6), 27. 709, 1914; J. J. Berzelius, *Lärbok i Kemien*, Upsala, 1818; *Lehrbuch der Chemie*, Dresden, 1825; D. I. Mendeleëff, *Bull. Acad. St. Petersburg*, (4), 14. 445, 1870; *Liebig's Ann. Suppl.*, 8. 133, 1872; *Chem. News*, 40. 231, 243, 255, 267, 279, 291, 303, 1879; 41. 2, 27, 39, 49, 61, 71, 83, 93, 106, 113, 125, 1880; *Liebig's Ann.*, 168. 45, 1873; W. Biltz, *ib.*, 331. 334, 1904; M. Delafontaine, *Arch. Sciences Genève*, (2), 51. 45, 1874; S. M. Tanatar and I. Voljansky, *Journ. Russ. Phys. Chem. Soc.*, 42. 96, 1910; P. T. Cleve and M. Höglund, *Bull. Soc. Chim.*, (2), 18. 193, 289, 1872; P. T. Cleve, *ib.*, (2), 21. 196, 246, 344, 1874; S. Jolin, *ib.*, (2), 21. 115, 196, 246, 344, 533, 1874; A. Högbom, *ib.*, (2), 42. 2, 1884; G. Wyruboff and A. Verneuil, *ib.*, (3), 21. 118, 1899; *Ann. Chim. Phys.*, (8), 6. 465, 1905; G. Wyruboff, *Bull. Soc. Min.*, 19. 219, 1896; 23. 201, 1905; W. F. Hillsbrand, *Pogg. Ann.*, 158. 71, 1876; H. Zschiesche, *Journ. prakt. Chem.*, (1), 104. 174, 1868; C. F. Rammelsberg, *Ber.*, 6. 84, 1873; 9. 1580, 1876; C. Winkler, *ib.*, 24. 873, 1966, 1891; W. Muthmann, *ib.*, 21. 1829, 1898; L. F. Nilson, *ib.*, 9. 1056, 1142, 1876; B. Brauner, *ib.*, 24. 1328, 1891; *Proc. Chem. Soc.*, 17. 65, 1901; A. Hirsch, *Journ. Ind. Eng. Chem.*, 3. 880, 1911; 4. 65, 1912; *Trans. Amer. Electrochem. Soc.*, 29. 57, 1911; G. Urbain, *Journ. Chim. Phys.*, 4. 195, 342, 1906; *Compt. Rend.*, 139. 736, 1904; 149. 37, 1909; G. Urbain and H. Lacombe, *ib.*, 137. 568, 792, 820, 1903; J. Blumenfeld and G. Urbain, *ib.*, 159. 323, 1914; L. F. Nilson and O. Petterson, *ib.*, 91. 232, 1880; L. Benoist and H. Copaux, *ib.*, 158. 689, 1914; P. Didier, *ib.*, 102. 823, 1886; A. Cosca, *ib.*, 98. 990, 1884; 102. 1315, 1886; *Gazz. Chim. Ital.*, 10. 225, 1880; A. Cosca and M. Zecchini, *ib.*, 10. 225, 1880; T. Vogt, *Neues Jahrb. Min.*, ii, 9, 1914; G. Bodman, *Bihang Svenska Akad. Handl.*, 26. 3, 1900; *Zeit. anorg. Chem.*, 27. 254, 1901; *Zeit. Kryst.*, 32. 613, 1900; 36. 192, 1902; *Ber.*, 31. 1237, 1898; T. V. Barker, *Journ. Chem. Soc.*, 101. 2484, 1912; C. Matignon, *Ann. Chim. Phys.*, (3), 8. 273, 435, 1906; F. M. Raoult, *ib.*, (6), 4. 411, 1885; A. Aufrecht, *Die Lichtabsorption von Praseodymsalz-Lösungen im Zusammenhang mit ihrem Dissoziationszustande in Lösung*, Berlin, 1904; H. Ley, *Zeit. phys. Chem.*, 30. 193, 1899; H. Freundlich and H. Schucht, *ib.*, 80. 564, 1912; H. C. Jones and C. R. Allen, *Amer. Chem. Journ.*, 18. 321, 1896; H. C. Jones and H. M. Reese, *ib.*, 20. 606, 1898; A. A. Noyes and J. Johnston, *Journ. Amer. Chem. Soc.*, 31. 987, 1909.

² D. I. Mendeleëff, *Liebig's Ann.*, 168. 45, 1873; *Liebig's Ann. Suppl.*, 8. 133, 1872; *Bull. Acad. St. Petersburg*, (4), 14. 445, 1870; *Chem. News*, 40. 231, 243, 255, 267, 291, 303, 1879; 41. 27, 39, 49, 61, 71, 83, 93, 106, 113, 125, 1880; C. R. Nodder, *ib.*, 121. 269, 1920; J. R. Partington, *ib.*, 121. 304, 1920; L. B. Tansley, *ib.*, 122. 121, 1921; B. Brauner, *Journ. Chem. Soc.*, 41. 68, 1882; *Zeit. anorg. Chem.*, 32. 1, 1902; *Zeit. Elektrochem.*, 14. 525, 1908; L. W. D. Hackh, *Scient. Amer. Suppl.*, 87. 146, 1919; *Amer. Journ. Science*, (4), 46. 481, 1918; C. Benedicks, *Zeit. anorg. Chem.*, 39. 41, 1904; R. Vogel, *ib.*, 102. 177, 1918; J. Thomsen, *ib.*, 9. 190, 1895; C. A. von Welsbach, *ib.*, 71. 439, 1911; *Monatsh.*, 32. 373, 1911; H. Biltz, *Ber.*, 35. 562, 1902; A. Werner, *ib.*, 38. 914, 1905; J. W. Retgers, *Zeit. phys. Chem.*, 16. 644, 1895; E. Baur, *ib.*, 76. 569, 1911; R. J. Meyer, *Naturwiss.*, 2. 781, 1914; S. Meyer, *Phys. Zeit.*, 19. 178, 1918; T. Bayley, *Phil. Mag.*, (5), 13. 26, 1882; I. D. Margary, *ib.*, (6), 42. 287, 1921; B. D. Steele, *Chem. News*, 84. 245, 1901; J. E. Reynolds, *ib.*, 54. 1, 1886; W. Crookes, *ib.*, 55. 83, 95, 1886; F. Soddy, *The Chemistry of the Radio-elements*, London, 2. 11, 1914; G. Rudorf, *Das periodisches System*, Leipzig, 247, 1904; W. D. Harkins and R. E. Hall, *Journ. Amer. Chem. Soc.*, 38. 169, 1916; H. Baumhauer, *Die Beziehungen zwischen dem Atomgewichte und der Natur chemische Elemente*, Braunschweig, 1870; E. Huth, *Das periodische Gesetz der Atomgewichte und das natürliche System der Elemente*, Frankfurt a. O., 1884; W. M. Hicks, *Phil. Trans.*, 212. A, 58, 1912; *Phil. Mag.*, (6), 23. 139, 1914; H. G. J. Moseley, *ib.*, (6), 26. 1024, 1914; (6), 27. 703, 1914; J. R. Rydberg, *ib.*, (6), 23. 144,

1914; *Bihang. Svenska Akad. Handl.*, 11. 13, 1886; *Lund Univ. Arsskrift*, 2. 9, 18, 1913; *Zeit. anorg. Chem.*, 14. 66, 1897; *Rev. Gen. Sciences*, 25. 734, 1914; *Journ. Chim. Phys.*, 12. 585, 1914; C. Renz, *Zeit. anorg. Chem.*, 122. 135, 1922; W. D. Harkins, *Journ. Amer. Chem. Soc.*, 59. 856, 1917; F. W. Aston, *Nature*, 113. 393, 1924.

³ C. R. Bury, *Journ. Amer. Chem. Soc.*, 43. 1602, 1921; N. Bohr, *Danske Vid. Selsk. Skr.*, (8), 4. 1918; *The Theory of Spectra and Atomic Constitution*, Cambridge, 114, 1922; *vide* 4. 27, 4.

⁴ H. G. J. Moseley, *Phil. Mag.*, (6), 26. 1024, 1913; (6), 27. 703, 1914; J. M. Eder, *Sitzber. Akad. Wien*, 126. 473, 1917; C. C. Kiess, *Scient. Paper Bur. Standards*, 18. 201, 1922; L. F. Yntema, *Journ. Amer. Chem. Soc.*, 46. 37, 1924.

§ 12. The Atomic Weights of the Cerium Family of Metals

The earlier determinations of the at. wt. of cerium must have been made on ceria contaminated with other earths, since later observations have shown that unknown and unsuspected rare earths accompany the raw materials, and these could not have been all removed by the methods of purification employed. In 1868, C. Wolf¹ showed reasons for suspecting the homogeneity or the chemical individuality of ordinary cerium, but he died before completing his work. B. Brauner, in 1885, suspected that cerium may be a mixture, and he claimed that (i) by the fractional soln. of ceria in sulphuric acid; (ii) by the extraction of partially reduced ceric oxide; (iii) by fractional precipitation with oxalic acid; (iv) by fractional crystallization of the sulphate; (v) by fractional crystallization of ceric ammonium nitrate or of cerous ammonium nitrate; and by the fractionation of basic nitrate or sulphate, ceria can be separated into two forms, one of which is insoluble in cold hydrochloric acid, and the other dissolves in hydrochloric acid. The one form gives a white oxide, and the other a dark salmon-coloured oxide of an element which he designated *metacerium*. The spark spectra of both forms had some lines in common, whereas other lines are characteristic of each. P. Schützenberger also claimed to have separated cerium by the basic nitrate process into (i) *cerium-1*, which gave a white oxide with an at. wt. 139.5; and (ii) *cerium-2*, with an oxide-coloured rouge, *rosé ou brun rose clair*; and, in conjunction with O. Boudouard, they declared that cerium from cerite is different from that from monazite. G. Wyrouboff and A. Verneuil showed that the methods employed by P. Schützenberger and O. Boudouard were not sufficient to separate ceria from thoria and the yttria earths; and that cerium from cerite and monazite is the same element. G. P. Drossbach failed to confirm B. Brauner's results, and in 1906, the last-named said that his *metacerium* was mainly terbium. It is, therefore, inferred that when adequately purified by known methods cerium is a homogeneous individual.

In 1882, B. Brauner² claimed to have obtained from lanthana an earth with an at. wt. and basicity intermediate between lanthana and didymia; and P. T. Cleve obtained an analogous earth which he named provisionally β -Di; but later found that the spark spectrum agreed with that of lanthana when an incorrect measurement of one of the lanthanum spectral lines by R. Thalén was rectified. He then expressed the opinion that there is no intermediate between lanthanum and didymium. P. Schützenberger likewise claimed to have resolved lanthana, but B. Brauner and F. Pavlicek claimed that he had not eliminated yttria from his lanthana; the last-named also confirmed the previous work of B. Brauner on the existence of an intermediate element which imparts to lanthana a pale buff tint. This inference has not been confirmed, and it meets with no support from H. G. J. Moseley's³ observations on the high-frequency spectra.

The homogeneity of praseodymium, neodymium, and samarium has been denied by G. Krüss and L. F. Nilson, W. Crookes, H. Becquerel, A. Bettendorff, C. M. Thompson, L. M. Dennis and E. M. Chamot, C. R. Böhm, C. Baskerville and co-workers, and B. Brauner. In most cases the opinions have been founded on the absorption spectra. The high-frequency or X-ray spectra are in accord with the assumption that an earth remains to be discovered, and its at. wt. lies between those of neodymium (144.3) and samarium (150.4), but no clear evidence of the nature of

the alleged companion elements has been adduced. E. Demarçay failed to find any difference in neodymia derived from cerite, samarskite, and mosandrite by different methods of fractionation; and no difference could be detected in neodymia after repeated fractionation; nor could he find any evidence of complexity after the repeated fractionation of samaria. It was therefore inferred that samarium and neodymium are homogeneous. This conclusion was confirmed by W. Muthmann and L. Weiss, W. Feit and C. Przibylla, C. A. von Welsbach, G. Eberhard, O. Holmberg, G. P. Baxter and H. C. Chapin, W. Rech, C. Baskerville and R. Stevenson, G. Urbain, and H. Lacombe. The homogeneity of praseodymium has been tested by C. von Scheele, C. A. von Welsbach, W. Muthmann and L. Weiss, W. Feit and C. Przibylla, W. Rech, G. P. Baxter and O. J. Stewart, and H. Lacombe, but there is no clear evidence of complexity, nor, indeed, of the existence of an element with an at. wt. intermediate between those of praseodymium and neodymium. The X-ray spectra fit with the assumption that the **atomic numbers** are La, 57; Ce, 58; Pr, 59; Nd, 60; Sa, 62, with an unknown element between neodymium and samarium.

Considering the designation rare element, a remarkable number of determinations of the at. wt. of some of these elements has been made. The unusual chemical and physical properties of these substances, and their relations to the periodic system, have been the magnet. The at. wt. of cerium has attracted more attention than that of a common element like iron; similarly also with the at. wt. of lanthanum. Nevertheless, owing to the extraordinary difficulties attending the purification of the materials, and the difficulties attending the analytical operations, the degree of accuracy of the results is of a lower order than that of the common elements. J. J. Berzelius⁴ in his at. wt. tables of 1814–18 gave 137.9 as the value of this constant for **cerium** on the assumption that the element is trivalent; W. Hisinger apparently made the determination. In 1840, F. J. Otto gave the value 138.91.

A. Beringer obtained 142.06 by converting the carbonate into chloride and 142.29 by analyzing the sulphate: $2\text{CeO}_2 : 3\text{BaSO}_4$. C. F. Rammelsberg obtained 135.59, and R. Bunsen and J. Jögel, 138.29, from the same ratio. R. Hermann obtained 138.52, and J. C. G. de Marignac, 142.05, from the ratio $\text{Ce}_2(\text{SO}_4)_3 : 3\text{BaSO}_4$; the last-named also obtained 142.43 from the ratio $\text{Ce}_2(\text{SO}_4)_3 : 3\text{BaCl}_2$; T. Kjerulf obtained 174.6—a worthless value—and C. F. Rammelsberg, 138.19 from the ratio $\text{Ce}_2(\text{C}_2\text{O}_4)_3 : 6\text{CO}_2$; and R. Bunsen and J. Jögel, 140.25, from the ratio $\text{Ce}_2(\text{C}_2\text{O}_4)_3 : 2\text{CeO}_2$.

It is not likely that results obtained prior to the discovery of lanthanum (1839) and didymium (1843) can have much value, since the ceria was virtually certain to have been contaminated with these elements. Not until about 1860 were the materials tested for the presence of foreign earths by spectrum analysis. Prior to that year, the ceria employed was of an uncertain degree of purity. From the ratio $\text{Ce}_2(\text{SO}_4)_3 : 2\text{CeO}_2$, C. Wolf computed the at. wt. 138.75; C. H. Wing (1870), 137.88; B. Brauner (1885), 140.22; G. Wyrouboff and A. Verneuil (1897), 139.52; G. Kölle (1898), 138.81; and B. Brauner and A. Batek, 140.21; B. Brauner (1885) obtained 140.24 from the ratio $\text{Ce}_2(\text{SO}_4)_3 : \text{Ce}_2\text{O}_3$. From the ratio $\text{Ce}_2(\text{SO}_4)_3 \cdot 8\text{H}_2\text{O} : 8\text{H}_2\text{O}$, G. Wyrouboff and A. Verneuil (1897) obtained 139.21; and from the ratio $\text{Ce}_2(\text{SO}_4)_3 \cdot 8\text{H}_2\text{O} : 2\text{CeO}_2$, 139.43; and from the same ratio, B. Brauner obtained 140.25. From the ratio $\text{Ce}_2(\text{SO}_4)_3 : 3\text{BaSO}_4$, P. Schützenberger obtained 139.45. From the ratio $\text{Ce}_2(\text{C}_2\text{O}_4)_3 : 2\text{CeO}_2$, H. Bührig obtained 141.43; and from the ratio $\text{Ce}_2(\text{C}_2\text{O}_4)_3 : 6\text{CO}_2$, 141.59. From the ratio $2\text{CeO}_2 : 3\text{C}_2\text{O}_3$ (*i.e.* loss on ignition of oxalate), B. Brauner obtained 140.01 in 1895, and 140.25 in 1903; while B. Brauner and A. Batek obtained 140.27. From the ratio $\text{CeCl}_3 : 3\text{Ag}$, H. Robinson (1884) obtained 140.19. B. Brauner computed 140.25 for the best representative value; and F. W. Clarke, 140.197 ± 0.0038 . The International Table, 1920, gives 140.25.

The at. wt. of **lanthanum** was stated by its discoverer, C. G. Mosander,⁵ to be 680 when oxygen is 100; *i.e.* 139.2 when oxygen is 16. This value is much nearer

the mark than many later determinations. Determinations by M. Choubine (1842), C. F. Rammelsberg (1842), and R. Hermann (1843) gave values which were inaccurate because the lanthana must have been contaminated with didymia. From the ratio $\text{La}_2(\text{SO}_4)_3 : 3\text{BaSO}_4$, J. C. G. de Marignac obtained 139.5 and 148.3; C. Czudnowicz, 133.0; C. Erk, 135.82. From the ratio $\text{La}_2(\text{SO}_4)_3 : 3\text{BaCl}_2$, J. C. G. de Marignac obtained 141.3. From the ratio $\text{La}_2\text{O}_3 : \text{La}_2(\text{SO}_4)_3$, M. Holzmann obtained 139.2; C. Czudnowicz, 146.5; R. Hermann, 139.50; H. Zschiesche, 135.33; C. Erk, 135.63; J. C. G. de Marignac, 138.80; P. T. Cleve, 139.27 and 138.34; B. Brauner, 138.86, 138.34, and 138.21; G. Bodmann, 138.94; O. Brill, 139.79; F. A. Bauer, 138.75; A. Bettendorff, 138.69; W. Gibbs, 139.70; P. Schützenberger, 138.0 and 135.0; B. Brauner and F. Pavlicek, 139.03; and H. C. Jones, 138.77 and 138.80. From the ratio $\text{La}_2\text{O}_3 : 3\text{BaSO}_4$, M. Holzmann obtained 139.46; from the ratio $\text{La}_2(\text{IO}_3)_6 \cdot 3\text{H}_2\text{O} : \text{La}_2\text{O}_3$, 137.59; and from the ratio $\text{La}_2\text{Mg}_3(\text{NO}_3)_{12} \cdot 24\text{H}_2\text{O} : \text{La}_2\text{O}_3$, 138.68. From the ratio $\text{LaCl}_3 : 3\text{AgCl}$, R. Hermann obtained 139.25; G. P. Baxter and co-workers, 138.89; and B. S. Hopkins and F. S. Driggs, 138.91. R. Hermann obtained from the ratio $\text{La}_2\text{O}_3 : 3\text{CO}_2$, 139.36. From the ratio $\text{La}_2\text{O}_3 : 3\text{C}_2\text{O}_3$, W. Gibbs obtained 139.70, and H. C. Jones, 139.07. From the ratio $\text{La}_2\text{O}_3 : 3\text{H}_2\text{SO}_4$, W. Feit and C. Przibylla obtained 139.09. B. Brauner gives 139.0 for the best representative value; F. W. Clarke, 138.8. The International Atomic Weight Commission for 1921 gave 139.0.

The at. wt. of **didymium** determined by J. C. G. de Marignac⁶ and others, lost interest when C. A. von Welsbach⁷ demonstrated that it is compounded of praseodymium and neodymium of at. wt. approximately 143.6 and 140.8 respectively; more accurate determinations give more nearly 141 for the former, and 144 for the latter. It therefore appears as if C. A. von Welsbach had somehow got the labels of his materials crossed. B. Brauner calculated 141.09 for the at. wt. of **praseodymium** from the ratio $\text{Pr}_2(\text{SO}_4)_3 \cdot 8\text{H}_2\text{O} : \text{Pr}_2\text{O}_3$; and from the ratio $\text{Pr}_2(\text{SO}_4)_3 : \text{Pr}_2\text{O}_3$, 140.95 and 140.96; H. C. Jones from the same ratio obtained 140.46, and C. von Scheele, 140.53. From the ratio $\text{Pr}_2\text{O}_3 : 3\text{C}_2\text{O}_3$, B. Brauner obtained 140.98, and C. von Scheele, from the ratios $\text{Pr}_2\text{O}_3 : 3\text{C}_2\text{O}_3 : \text{Pr}_2(\text{SO}_4)_3$, 139.72 to 140.15. W. Feit and C. Przibylla obtained 140.62 from the ratio $\text{Pr}_2\text{O}_3 : 3\text{H}_2\text{SO}_4$; and G. P. Baxter and O. J. Stewart, 140.93 from the ratio $\text{PrCl}_3 : 3\text{AgCl}$, and for the ratio $\text{PrCl}_3 : 3\text{Ag}$, 140.92. B. Brauner estimates the best representative value to be 140.97; and F. W. Clarke, 140.619 ± 0.0033 . The International Atomic Weight Commission for 1920 gives 140.9.

For the at. wt. of **neodymium** B. Brauner obtained 143.63 and 143.89 from the ratio $\text{Nd}_2\text{O}_3 : \text{Nd}_2(\text{SO}_4)_3$; O. Boudouard, 143.05; H. C. Jones, 143.6; O. Holmberg, 144.10; O. Brill, 142.46; and C. A. von Welsbach, 144.54. W. Feit and C. Przibylla obtained 144.5 from the ratio $\text{Nd}_2\text{O}_3 : 3\text{H}_2\text{SO}_4$. G. P. Baxter and H. C. Chapin obtained 144.272 from the ratio $\text{NdCl}_3 : 3\text{AgCl}$, and 144.268 from the ratio $\text{NdCl}_3 : 3\text{Ag}$. G. P. Baxter and co-workers (1916) from the last-named ratio obtained 144.261. B. Brauner gave 143.9 for the best representative value; and F. W. Clarke, 143.910 ± 0.0051 . The International Atomic Weight Commission for 1920 gives 144.3.

M. Delafontaine's⁸ **decipium**, L. de Boisbaudran's **samarium**, and J. C. G. de Marignac's Y_β gave an at. wt. approximating to 159.171. The determinations by J. C. G. de Marignac, B. Brauner, P. T. Cleve, A. Bettendorff, and W. Muthmann and L. Weiss must have been made with impure material. It was not until 1900-1904 that E. Demarçay, and G. Urbain and H. Lacombe prepared material of a high degree of purity and free from europium; samaria prepared before that probably contained europium. Nevertheless, the earlier determinations do not differ very much from more recent values. From the ratio $\text{Sa}_2(\text{SO}_4)_3 : \text{Sa}_2\text{O}_3$, J. C. G. de Marignac obtained 149.4 and 149.87; B. Brauner, 150.7 and 150.66; P. T. Cleve, 150.15; A. Bettendorff, 150.44; W. Muthmann and L. Weiss, 151.39; E. Demarçay, 147.2-148.0; and G. Urbain and H. Lacombe, 150.53. From the ratio $\text{Sa}_2\text{O}_3 : \text{Sa}_2(\text{SO}_4)_3 \cdot 8\text{H}_2\text{O}$, J. C. G. de Marignac obtained 150.01; B. Brauner,

150.76; and G. Urbain and H. Lacombe, 150.48. From the ratio $\text{Sa}_2(\text{SO}_4)_3 \cdot 8\text{H}_2\text{O} : \text{Sa}_2(\text{SO}_4)_3$, the last-named obtained 150.31. From the ratio $\text{Sa}_2\text{O}_2(\text{SO}_4) : \text{SaO}(\text{SO}_4)_2$, C. Matignon obtained 150.6, and W. Feit and C. Przibylla, 150.56 from the ratio $\text{Sa}_2\text{O}_3 : 3\text{H}_2\text{SO}_4$. O. J. Stewart and C. James obtained 150.43 from the ratio $\text{SaCl}_3 : 3\text{Ag}$. A. W. Owens and co-workers found from the ratio $\text{SaCl}_3 : 3\text{Ag}$, an at. wt. 150.43, the range being 150.40 to 150.49. For the best representative value, B. Brauner gave 150.44; F. W. Clarke, 150.390 ± 0.0071 . The International Atomic Weight Commission for 1920 gave 150.4.

REFERENCES.

- ¹ B. Brauner, in R. Abegg, *Handbuch der anorganischen Chemie*, Leipzig, 3. i, 308, 1906; *Monatsh.*, 6. 785, 1885; *Chem. News*, 71. 283, 1895. *Journ. Chem. Soc.*, 47. 879, 1885; *Proc. Chem. Soc.*, 14. 69, 1898; *Zeit. anorg. Chem.*, 34. 207, 1903; B. Brauner and A. Batek, *ib.*, 34. 103, 1903; P. Schützenberger, *Chem. News*, 71. 188, 1895; *Compt. Rend.*, 120. 663, 962, 1895; P. Schützenberger and O. Boudouard, *ib.*, 124. 481, 1897; O. Boudouard, *ib.*, 125. 772, 1096, 1897; G. Wyruboff and A. Verneuil, *ib.*, 124. 1230, 1897; 125. 950, 1180, 1897; G. P. Drossbach, *Ber.*, 33. 3506, 1900; C. Wolf, *Amer. Journ. Science*, (2), 45. 53, 1868.
- ² B. Brauner, *Monatsh.*, 3. 436, 1882; B. Brauner and F. Pavlicek, *Journ. Chem. Soc.*, 81. 1243, 1902; P. T. Cleve, *Bull. Soc. Chim.*, (2), 39. 151, 285, 1883; *Compt. Rend.*, 94. 1528, 1882; 95. 33, 1882; *Chem. News*, 53. 30, 45, 67, 80, 91, 100, 1886; P. Schützenberger, *ib.*, 120. 1143, 1895; R. Thalén, *Om spectralanalyse*, Upsala, 1866; *Nova Acta Soc. Upsala*, (3), 6. 9, 1868; *Svenska Akad. Handl.*, 12. 4, 1874; *Journ. Phys.*, 4. 33, 1875.
- ³ W. Crookes, *Chem. News*, 54. 27, 1886; C. M. Thompson, *ib.*, 55. 227, 1887; G. Krüss and L. F. Nilson, *Ber.*, 20. 1676, 2134, 3067, 1887; 21. 585, 2019, 1888; A. Bettendorff, *Liebig's Ann.*, 256. 159, 1890; 263. 164, 1891; W. Muthmann and L. Weiss, *ib.*, 331. 1, 1904; B. Brauner, *Proc. Chem. Soc.*, 14. 71, 1898; L. M. Dennis and E. M. Chamot, *Journ. Amer. Chem. Soc.*, 19. 799, 1897; C. Baskerville and J. W. Turrentine, *ib.*, 26. 46, 1904; C. Baskerville and R. Stevenson, *ib.*, 28. 54, 1904; G. P. Baxter and H. C. Chapin, *ib.*, 33. 1, 1911; G. P. Baxter and O. J. Stewart, *ib.*, 37. 516, 1915; B. Stahl, *Le Radium*, 6. 215, 1909; E. Demarcay, *Compt. Rend.*, 126. 1039, 1898; 130. 1185, 1900; G. Urbain and H. Lacombe, *ib.*, 138. 1166, 1904; G. Urbain, *Journ. Chim. Phys.*, 4. 119, 1906; H. Lacombe, *Bull. Soc. Chim.*, (3), 31. 570, 1904; *Chem. News*, 89. 277, 1904; H. Becquerel, *Ann. Chim. Phys.*, (6), 14. 170, 257, 1888; H. G. J. Moseley, *Phil. Mag.*, (6), 26. 1024, 1914; (6), 27. 703, 1914; W. Feit and C. Przibylla, *Zeit. anorg. Chem.*, 43. 202, 1905; 50. 249, 1906; G. Eberhard, *ib.*, 45. 374, 1905; O. Holmberg, *ib.*, 53. 83, 1907; C. von Scheele, *ib.*, 17. 310, 1898; *Ber.*, 32. 409, 1899; W. Rech, *Zeit. wiss. Photochem.*, 3. 411, 1905; C. A. von Welsbach, *Sitzber. Akad. Wien*, 112. 1037, 1903; C. K. Böhm, *Zeit. angew. Chem.*, 16. 1220, 1903; *Die Zerlegbarkeit der Praseodyms und Durstellung seltener Erden mit Hilfe einer neuen Trennungsmethode*, Berlin, 1900.
- ⁴ J. J. Berzelius, *Lärbok i Kemien*, Upsala, 1814; W. Hisinger, *Afhandl. Fys. Kemi Min.*, 3. 283, 1814; 4. 378, 1814; *Schweigger's Journ.*, 17. 424, 1814; *Pogg. Ann.*, 8. 186, 1826; F. J. Otto, *ib.*, 40. 404, 1837; *Lehrbuch der Chemie*, Braunschweig, 1. 222, 1840; A. Beringer, *Liebig's Ann.*, 42. 138, 1842; R. Bunsen and J. J. Jögel, *ib.*, 105. 45, 1858; T. Kjerulf, *ib.*, 87. 12, 1853; C. F. Rammelsberg, *Pogg. Ann.*, 55. 482, 1842; 108. 44, 1859; R. Hermann, *Journ. prakt. Chem.*, (1), 30. 184, 1843; H. Bührig, *ib.*, (2), 12. 231, 1875; C. Wolf, *Amer. Journ. Science*, (2), 46. 53, 1868; C. H. Wing, *ib.*, (2), 49. 358, 1870; H. Robinson, *Proc. Roy. Soc.*, 37. 150, 1884; *Chem. News*, 50. 251, 1884; 54. 229, 1886; B. Brauner, in R. Abegg's *Handbuch der anorganischen Chemie*, Leipzig, 3. i, 184, 1906; *Monatsh.*, 6. 785, 1885; *Journ. Chem. Soc.*, 47. 879, 1885; *Chem. News*, 71. 283, 1895; *Sitzber. Akad. Wien*, 92. 814, 1886; *Proc. Chem. Soc.*, 14. 69, 1898; *Zeit. anorg. Chem.*, 34. 207, 1903; B. Brauner and A. Batek, *ib.*, 34. 103, 1903; G. Wyruboff and A. Verneuil, *Bull. Soc. Chim.*, (3), 17. 679, 1897; *Compt. Rend.*, 124. 1300, 1897; O. Boudouard, *ib.*, 125. 772, 1097, 1898; P. Schützenberger and O. Boudouard, *ib.*, 122. 697, 1896; 124. 481, 1897; P. Schützenberger, *ib.*, 120. 663, 962, 1895; M. Delafontaine, *Chem. News*, 92. 5, 1905; G. Kölle, *Beiträge zur Kenntnis des Cers*, Zürich, 1898; J. C. G. de Marignac. *Arch. Sciences Genève*, (1), 8. 273, 1848; *Ann. Chim. Phys.*, (3), 38. 148, 1853; F. W. Clarke, *A Recalculation of the Atomic Weights*, Washington, 505, 1910.
- ⁵ C. G. Mosander, *Pogg. Ann.*, 60. 301, 1843; C. F. Rammelsberg, *ib.*, 55. 65, 1842; J. C. G. de Marignac, *Arch. Sciences Genève*, (1), 11. 29, 1849; (2), 46. 193, 1873; *Ann. Chim. Phys.*, (3), 27. 209, 1849; (4), 30. 68, 1873; M. Holzmann, *Journ. prakt. Chem.*, (1), 75. 343, 1858; G. P. Baxter, P. Tani, and H. C. Chapin, *Journ. Amer. Chem. Soc.*, 43. 1080, 1921; G. P. Baxter, *ib.*, 44. 328, 1922; B. S. Hopkins and F. S. Driggs, *ib.*, 44. 1927, 1922; C. Czudnowicz, *ib.*, (1), 80. 31, 1860; R. Hermann, *ib.*, (1), 30. 199, 1843; (1), 82. 395, 1861; H. Zschiesche, *ib.*, (1), 104. 174, 1868; M. Choubine, *Russ. Ann. Mines*, 348, 1842; *Journ. prakt. Chem.*, (1), 26. 443, 1842; C. Erk, *Jena. Zeit.*, 6. 306, 1871; *Zeit. Chem.*, (2), 7. 106, 1871; P. T. Cleve, *Bull. Soc. Chim.*, (2), 21. 196, 1874; (2), 39. 151, 1883; *Bihang Svenska Akad. Handl.*, 2. 7, 1874; 11. 2, 1883; G. Bodmann, *ib.*, 26. 3, 1901; B. Brauner, in R. Abegg, *Handbuch der anorganischen Chemie*, Leipzig, 3. i, 236, 1906; *Monatsh.*, 3. 486, 1882; *Journ. Chem. Soc.*, 41. 68, 1882; *Ber.*, 24. 1328, 1891; *Zeit. anorg. Chem.*, 33. 317, 1903; B. Brauner and F. Pavlicek, *Proc. Chem.*

Soc., 17. 63, 1901; *Journ. Chem. Soc.*, 81. 1243, 1902; *Chem. News*, 88. 13, 1903; O. Brill, *ib.*, *anorg. Chem.*, 47. 464, 1905; W. Feit and C. Przibylla, *ib.*, 43. 213, 1905; 50. 248, 1906; H. C. Jones, *ib.*, 36. 92, 1903; *Amer. Chem. Journ.*, 28. 23, 1902; *Chem. News*, 77. 280, 292, 1898; A. Bettendorff, *Liebig's Ann.*, 256. 159, 1890; W. Gibbs, *Proc. Amer. Acad.*, 18. 260, 1893; *Amer. Chem. Journ.*, 15. 546, 1893; F. A. Bauer, *Beiträge zur Chemie der Ceritmetalle*, Freiburg, 1884; P. Schützenberger, *Compt. Rend.*, 120. 1143, 1895; F. W. Clarke, *A Recalculation of the Atomic Weights*, Washington, 493, 1910; J. C. G. de Marignac, *Arch. Sciences Genève*, (1), 8. 273, 1848; *Ann. Chim. Phys.*, (3), 38. 148, 1853.

* J. C. G. de Marignac, *Arch. Sciences Genève*, (1), 11. 21, 1849; (2), 24. 278, 1865; R. Hermann, *Journ. prakt. Chem.*, (1), 82. 367, 1861; H. Zschiesche, *ib.*, (1), 107. 65, 1869; C. Erk, *Jena Zeit.*, 6. 299, 1871; *Zeit. Chem.*, (2), 7. 106, 1871; P. T. Cleve, *Bull. Soc. Chim.*, (2), 39. 287, 1883; *Bihang. Svenska Akad. Handl.*, 2. 7, 1874; *Öfvers. Akad. Förh.*, 40. 23, 1883; B. Brauner, *Monatsh.*, 3. 486, 1882; *Journ. Chem. Soc.*, 43. 278, 1883; P. Schützenberger, *Compt. Rend.*, 120. 1143, 1895; G. Krüss and A. Loose, *Zeit. anorg. Chem.*, 3. 92, 1893; A. Loose, *Studien über die seltener Erden aus der Cer- und Ytter-gruppe*, München, 1893; F. A. Bauer, *Beiträge zur Chemie der Ceritmetalle*, Freiburg, 1884.

† C. A. von Welsbach, *Monatsh.*, 6. 477, 1885; *Sitzber. Akad. Wien*, 112. 1037, 1903; B. Brauner, in R. Abegg, *Handbuch der anorganischen Chemie*, Leipzig, 3. i, 261, 275, 1906; *Proc. Chem. Soc.*, 14. 72, 1898; 17. 65, 1901; *Chem. News*, 77. 161, 1898; H. C. Jones, *Amer. Chem. Journ.*, 20. 345, 1898; *Zeit. anorg. Chem.*, 19. 329, 1899; O. Brill, *ib.*, 47. 464, 1905; O. Homberg, *ib.*, 53. 124, 1907; W. Feit and C. Przibylla, *ib.*, 43. 202, 1905; C. von Scheele, *ib.*, 17. 310, 1898; O. Boudouard, *Compt. Rend.*, 126. 900, 1039, 1898; *Bull. Soc. Chim.*, (3), 19. 383, 1898; G. P. Baxter and H. C. Chapin, *Journ. Amer. Chem. Soc.*, 33. 1, 1911; G. P. Baxter, W. H. Whitcomb, O. J. Stewart, and H. C. Chapin, *ib.*, 33. 302, 1916; G. P. Baxter and O. J. Stewart, *ib.*, 37. 516, 1915; F. W. Clarke, *ib.*, 21. 209, 1899; *A Recalculation of the Atomic Weights*, Washington, 518, 522, 1910.

‡ J. C. G. de Marignac, *Arch. Sciences Genève*, (3), 3. 413, 1880; *Compt. Rend.*, 90. 899, 1880; B. Brauner, in R. Abegg, *Handbuch der anorganischen Chemie*, Leipzig, 3. i, 283, 1906; *Sitzber. Akad. Wien*, 86. 168, 1882; *Journ. Chem. Soc.*, 43. 278, 1883; P. T. Cleve, *ib.*, 43. 362, 1883; *Chem. News*, 48. 39, 1883; *Öfvers. Akad. Förh.*, 40. 7, 1883; A. Bettendorff, *Liebig's Ann.*, 263, 164, 1891; W. Muthmann and L. Weiss, *ib.*, 331. 16, 1904; L. de Boisbaudran, *Compt. Rend.*, 88. 322, 1879; 89. 212, 1879; 114. 575, 1892; C. Matignon, *ib.*, 141. 1230, 1905; E. Demarçay, *ib.*, 122. 728, 1896; 130. 1019, 1185, 1469, 1900; 132. 1484, 1901; G. Urbain and H. Lacombe, *ib.*, 138. 1166, 1904; M. Delafontaine, *ib.*, 87. 682, 1878; 93. 63, 1881; *Chem. News*, 44. 67, 1881; W. Feit and C. Przibylla, *Zeit. anorg. Chem.*, 50. 259, 1906; J. Koppel, *ib.*, 41. 377, 1904; O. J. Stewart and C. James, *Journ. Amer. Chem. Soc.*, 39. 2605, 1917; A. W. Owens, C. W. Balke, and H. C. Kremers, *ib.*, 42. 515, 1920; F. W. Clarke, *A Recalculation of the Atomic Weights*, Washington, 525, 1910; F. W. Aston, *Phil. Mag.*, (6), 39. 449, 611, 1920.

§ 13. The Oxides of the Cerium Family of Earths

Each of the rare earths forms a basic sesquioxide in which the metal is trivalent. The sesquioxides are all stable, and constitute the rare earths properly so called. The sesquioxides of the rare earth metals other than those of terbium, praseodymium, and cerium are stable in air, even at a bright red heat. The three rare earths just named pass into higher oxides when heated in air, and in the case of ceria, oxidation occurs at a comparatively low temp. In some cases higher oxides or hydroperoxides are formed by the action of hydrogen dioxide. According to C. Winkler,¹ there is no sign of the formation of cerium monoxide, CeO, when ceric oxide is reduced by magnesium. The ignition of the hydroxides, carbonates, nitrates, sulphates, oxalates, and of the salts of many other oxy-acids furnishes lanthana, or lanthanum sesquioxide, La₂O₃; neodymia, or neodymium sesquioxide, Nd₂O₃; and samaria, or samarium sesquioxide, Sa₂O₃. It is generally difficult—particularly with the lanthanum salt—to get rid of the last trace of sulphate by ignition. The sesquioxides of these elements were also formed by W. Muthmann and L. Weiss, etc., by the combustion of the metals. In the case of praseodymia, or praseodymium sesquioxide, Pr₂O₃, the higher oxide obtained by ignition is to be reduced to the sesquioxide by heating it in a stream of hydrogen at a red heat, say 900°. The preparation of cerium sesquioxide offers some difficulty because of the great stability of ceric oxide which is the product obtained by calcining the oxy-salts, etc., of cerium. The higher oxide of cerium is not reduced to the sesquioxide so readily as is the case with praseodymium dioxide; the reduction of the red-hot oxide by

hydrogen, as J. Sterba has shown, is incomplete at atm. press.; but, according to E. Newbery and J. N. Pring, *ceria*, or **cerium sesquioxide**, or **cerous oxide**, Ce_2O_3 , can be obtained by reducing ceric oxide by heating it to 2000° in hydrogen at 150 atm. press. W. Guertler found ceric oxide is reduced to the sesquioxide by heating it white hot in the reducing atm. of a petroleum injector furnace. C. F. Rammelsberg said that it is obtained by calcining cerous carbonate in hydrogen free from ozone. If cerous oxalate be calcined in *vacuo*, or in a stream of hydrogen, a mixture of ceric and cerous oxides and carbon is obtained. C. G. Mosander, and A. Beringer said that cerous oxide is formed by calcining ceric oxide to a high temp. in a carbon crucible, or in a stream of hydrogen. This is doubtful, for, according to R. J. Meyer, P. Didier, and J. Sterba, when the hydroxide, carbonate, nitrate, or oxalate is heated in hydrogen or in the absence of air, the dark blue product has a composition approximating Ce_4O_7 . L. M. Dennis and W. H. Magee say that a white cerous oxide can be obtained by calcining the hydroxide in an inert atm.; but later observations have shown that in the dehydration of the dried hydroxide, water is decomposed and the cerous oxide is oxidized. C. Winkler found that some cerous oxide is obtained when ceric oxide is heated with magnesium, or, according to J. Sterba, with zinc; it is, however, not practicable to separate the cerous oxide from the other products of the reaction. A. Burger obtained cerous oxide by reducing ceric oxide with an excess of calcium, and washing out the other products of the reaction with a soln. of ammonium chloride at -10° , or with a soln. of sugar at 0° .

Owing to the difficulty of removing didymia from ceria, and to the ignorance of the early workers as to the complexity of what they considered to be pure ceria, there are some conflicting statements as to the colour of cerous oxide. C. F. Rammelsberg said that it is a bluish-grey powder; A. Burger, yellowish-green; and O. Popp, and L. M. Dennis and W. H. Magee, white. Lanthana is white; praseodymia, yellowish-green or greenish-yellow; neodymia, sky-blue; and samaria, white with a faint yellow tinge. There are some differences of opinion as to the colour of neodymia described by C. A. von Welsbach as being blue; A. Wagner, sky-blue with a violet tint; B. Brauner, pink with an amethyst tint; W. Muthmann and L. Weiss greyish-blue without any yellow or brown tinge; E. Demarçay, violet; H. C. Jones, when hot, "a marked bluish colour, which, however, disappears on cooling"; C. Baskerville and R. Stevenson, brown, rose, black, and violet; and H. Lacombe, sky-blue. The varying statements, said A. Wagner, are probably due to the oxide under investigation having been in many cases contaminated with other rare earths, and particularly with praseodymia. E. T. Wherry attributed the reddish-violet colour of certain minerals to the presence of neodymium compounds. When ceria is exposed to air, oxygen is absorbed and the dioxide is formed, the product usually acquires a yellow tinge; praseodymia likewise absorbs oxygen, forming a brown powder which is probably a mixture of praseodymous and praseodymic oxides. Lanthana resembles quicklime in that it rapidly absorbs water and carbon dioxide when exposed to air; neodymia and samaria are not appreciably oxidized or carbonated on exposure to air. Ceria is unstable in air, forming the dioxide, and, according to A. Burger, even at 200° , it burns to the higher oxide. When praseodymia or neodymia is heated in air a mixture of the sesquioxide with more or less of the higher oxide (*q.v.*) is formed; while lanthana and samaria are not perceptibly peroxidized.

The sesquioxides prepared by the above-described processes are generally described as amorphous. According to A. E. Nordenskjöld, prismatic rhombic crystals of lanthana are obtained by heating the oxide with fused borax. The crystals are said to have a sp. gr. 5.296 at 16° ; for the sp. gr. of amorphous lanthana, P. T. Cleve gave 6.53 at 17° ; R. Hermann, 5.94; L. F. Nilson and O. Pettersson, 6.480; B. Brauner, 6.41 at 15° ; and W. Prandtl, 6.51 at $15^\circ/4^\circ$. For the old didymia, R. Hermann gave 6.64; A. E. Nordenskjöld, 5.825 (14°); P. T. Cleve, 7.180 at 13.5° ; and L. F. Nilson and O. Pettersson, 6.950. For praseodymia,

C. von Scheele gave 6·88 at 15°; B. Brauner, 7·068; and W. Prandtl, 6·87 at 15°/4°. For samaria, P. T. Cleve gave 8·347 at 13°–15°; and W. Prandtl, 7·43 at 15°/4°. For neodymia, W. Prandtl gave 7·24 at 15°/4°. A. H. White and M. E. Müller demonstrated a loss of ceria by volatilization when thoria mantles with one per cent. of ceric oxide are heated. According to L. F. Nilson and O. Petterson, the sp. ht. of lanthana is 0·0749, and of didymia, 0·0810 between 0° and 100°. E. Tiede and E. Birnbräuer say that lanthana melts and volatilizes at about 2000°. W. R. Mott gave 4200° for the b.p. of lanthanum oxide at 760 mm. W. Muthmann and L. Weiss' observations on the heats of formation have been described in connection with the metals. H. L. Howes found the cathode ray luminescence spectrum of samarium oxide has eight short series of constant frequency intervals, and the spectrum is unchanged by heat treatment between 600° and 3000°. E. L. Nichols and H. L. Howes studied the luminescent spectra of incandescent oxides of cerium, praseodymium, neodymium, and samarium. W. W. Coblenz found the ultra-red emission spectrum has maxima at 3 μ , 4·4 μ , and 4·83 μ . The magnetic susceptibilities of the oxides have been determined by G. Urban and G. Jantsch, R. J. Meyer and J. Wuorinen, and S. Meyer. These values are: lanthana, $-0\cdot18 \times 10^{-6}$; neodymia, $+33\cdot5 \times 10^{-6}$; samaria, $+6\cdot5 \times 10^{-6}$ electromagnetic units; hence lanthana is diamagnetic and the other two oxides paramagnetic; praseodymia is also paramagnetic, but less so than neodymia. E. H. Williams measured the magnetic susceptibilities of the oxides of lanthanum, neodymium, and samarium between 20° and -140° , and found the value for samaria to be about 10 per cent. larger at -140° than at 20°. E. Wedekind and P. Hausknecht found the at. magnetism of lanthanum oxide to be $-18\cdot3 \times 10^{-6}$; praseodymium oxide, $+4740 \times 10^{-6}$; neodymium oxide, $+5100 \times 10^{-6}$; and samarium oxide, $+8300 \times 10^{-6}$. They found that if the values for the at. magnetism of the metals of the rare earths be plotted against at. wt. a graph is obtained which shows a flat maximum at yttrium, and a second maximum in the cerite group, either at neodymium or samarium, according to the value adopted; the curve then descends to europium, and subsequently rises somewhat steeply but regularly through gadolinum and terbium to a high maximum at dysprosium, after which it falls steeply and evenly through holmium, erbium, ytterbium, to lutecium.

All the sesquioxides are soluble in acids, but, as in the case of alumina (*q.v.*), and many other oxides, the reactivity of the rare earth oxides depends upon the temp. of calcination; the higher the temp. of calcination the more slowly are the oxides attacked by acids. According to A. Damour, however, lanthana, even after intense ignition, is readily soluble. Like quicklime, lanthana hisses when sprinkled with water, and forms the hydroxide, but, according to A. E. Nordenskjöld, the crystals of lanthana are not affected by water. The rare earths are fairly strong basic oxides; C. A. Matignon said that they are stronger bases than magnesia, but weaker than the alkaline earths. The rare earths readily form normal salts even with weak acids like carbonic acid, chromic acid, and numerous organic acids. The basicity has been determined qualitatively. The relative order of precipitation from their salt soln. by ammonia and the alkali hydroxides has already been discussed. There are some reversals in the order of basicity when determined by different methods, thus, by ammonia precipitation, gadolina is a stronger base than samaria, but by some other methods the reverse obtains. When tested by the thermal value of the reactions: $R_2O_3 + 6HCl = 2RCl_3 + 3H_2O + Q_1$ Cals., and by $R_2O_3 + 3H_2SO_4 = R_2(SO_4)_3 + 3H_2O + Q_2$ Cals., C. A. Matignon found the order to be:

	La	Pr	Nd	Sa
Q_1	160·6	147·8	143·1	128·4
Q_2	138·2	125·7	125·1	113·8
Hydrolysis	6·81	—	11·07	14·20

This order also agrees with S. H. Katz and C. James' observations on the degrees of hydrolysis of aq. soln. of the sulphates, expressed in arbitrary units.

L. Kahlenberg and W. J. Trautmann found cerous oxide, Ce_2O_3 , is not reduced by silicon at the temp. of the electric arc furnace.

According to C. Baskerville and G. F. Catlett, when lanthana is fused with alkali carbonates, and washed with alcohol; or when lanthana is digested for a long time with soln. of the alkali hydroxides at 100° , **lanthanates**—e.g. sodium lanthanate, $Na_2La_4O_7$; and **metalanthanates**—e.g. *dihydrated lithium enneahydropentalanthanate*, $LiH_9La_5O_{15}\cdot 2H_2O$; *tetrahydrated sodium enneahydropentalanthanate*, $NaH_9La_5O_{15}\cdot 4H_2O$; *pentadecahydrated potassium enneahydropentalanthanate*, $KH_9La_5O_{15}\cdot 15H_2O$; *barium enneahydropentalanthanate*, $Ba(H_9La_5O_{15})_2$, but not the calcium compound—are formed; but the report has not been confirmed, and in view of the very marked basic properties which are indeed comparable with those of calcium oxide, it will be extraordinary if lanthana has the acidic strength to form such compounds. According to F. Zambonini and G. Carobbi, the products reported by C. Baskerville and G. F. Catlett are only mixtures of lanthanum oxide or hydroxide with varying proportions of the hydroxides or carbonates. The alkalis and alkaline earths which were present probably represented adsorption effects by the hydroxide. Double carbonates may also be present. H. von Euler and R. Nilsson studied the adsorptive power of lanthanum and aluminium hydroxides.

When an excess of an ammonium or alkali hydroxide, or ammonium sulphide, is added to a hot dil. soln. of a salt—chloride, nitrate, sulphate, etc.—of the rare earths, the corresponding rare earth hydroxide is precipitated as a gelatinous colloid, insoluble in an excess of the precipitant. If insufficient precipitant be added for complete precipitation, or if cold soln. be used, some basic salt may also be deposited. A. Damiens found the sesquioxides are formed when water acts on the carbides. The colours of **cerous hydroxide**, $Ce(OH)_3$, and of **lanthanum hydroxide**, $La(OH)_3$, are white; the colour of **praseodymium hydroxide**, $Pr(OH)_3$, is green; that of **neodymium hydroxide**, $Nd(OH)_3$, is blue; and that of **samarium hydroxide**, $Sa(OH)_3$, is a very pale yellow. The precipitation is prevented or hindered if citric, tartaric, or other organic hydroxy-acids be present—*vide* analytical reactions; according to A. Müller, glycerol inhibits the precipitation of cerous and neodymium hydroxides; and according to L. de Boisbaudran, J. Sterba, M. Delafontaine, W. Biltz, N. A. Orloff, etc., the hydroxides are but slowly and incompletely precipitated by ammonia in the presence of ammonium acetate. This property has been utilized in separating iron from the rare earths. Cerous hydroxide oxidizes in air whereby the colour changes to violet, forming cerosoceric hydroxides, and finally yellow owing to the formation of ceric hydroxide. Lanthanum hydroxide is soluble enough in water to colour red litmus blue. L. M. Dennis and W. H. Magee, and A. Damiens found that cerous hydroxide can be dried out of contact with air and still retain its white colour, but when the dehydration is pushed further some cerous oxide is converted to ceric oxide by the decomposition of the water. According to J. F. Spencer, the oxidation of cerous to ceric oxide takes place more rapidly in the presence of alkali hydroxides, but in the presence of alkali carbonate a still higher oxide is produced. The oxidation to the peroxide in the presence of air occurs only with cerous hydroxide and not ceric hydroxide. The ready oxidation of cerous hydroxide renders it a strong reducing agent, for, as W. Biltz and F. Zimmermann, and G. A. Barbieri showed, it reduces cupric to cuprous salts; mercuric to mercurous salts, etc. This reducing action of cerous salts distinguishes them from the salts of all the other rare earths, and shows that in this respect they are more nearly allied to the manganous salts. G. A. Barbieri added that it is not quite accurate to state that ceric compounds are unstable, whilst cerous compounds are stable. What is really unstable is the ceric ion Ce^{4+} , which is readily transformed into the cerous ion Ce^{3+} . In an alkaline medium, in which ceric ions cannot exist, ceric compounds are stable, whilst cerous compounds act as reducing agents. Further, in an acid medium, when the conditions are such as to diminish the conc. of the ceric ions, the oxidation of cerous salts can be effected by nitric acid alone. When neodymium hydroxide is heated to 300° , P. Joye and C. Garnier found that

the composition corresponds with the sesquihydrate, $2\text{Nd}_2\text{O}_3 \cdot 3\text{H}_2\text{O}$; at 525° , the monohydrate, $\text{Nd}_2\text{O}_3 \cdot \text{H}_2\text{O}$; and at a bright red heat, Nd_2O_3 . The two hydrated neodymium sesquioxides have different reflection spectra. All the hydroxides are strong bases which react readily with acids to form salts. Indeed, lanthanum hydroxide is the strongest base of all the rare earth hydroxides, and approaches in strength that of calcium hydroxide; while, according to K. A. Vesterberg, its strength is comparable with that of ammonium hydroxide. All the rare earth hydroxides absorb carbon dioxide from air. Lanthanum hydroxide liberates ammonia from ammonium salts. K. C. Sen and N. R. Dhar studied the peptization of cerium hydroxide by sugars, starch, dextrine, glycerol, etc.: and H. von Euler and R. Nilsson, the action of acids and bases.

A well-defined basic oxide, namely, **ceric oxide**, or **cerium dioxide**, CeO_2 , is represented by a corresponding series of salts; but salts derived from praseodymic oxide or praseodymium dioxide, PrO_2 , have not been reported. There is some evidence of the formation of an unstable neodymium dioxide, NdO_2 ; but none at all with respect to the corresponding samarium oxide. According to H. Zschiesche,² lanthana does not absorb oxygen when heated in air, but, according to R. Marc, if an activating substance like cerium dioxide be present, oxygen is absorbed, and a higher oxide is produced. In conformity with the terms applied to the other rare earths, *ceria* should refer to the sesquioxide, but the term is sometimes applied to the dioxide possibly because zirconium and thorium dioxides are called respectively by zirconia and thoria, and cerium comes between zirconium and thorium in the periodic table. Ceric oxide is obtained as an amorphous powder when cerous or ceric hydroxide, nitrate, sulphate, or salt of a volatile oxy-acid is heated; the oxalate is most commonly used for this purpose. J. Sterba removed the last traces of nitrate by fusing ceric oxide with potassium hydroxide. It is also made by burning the metal in air.

According to H. E. Ives and co-workers, when white or brownish-white ceric oxide is heated in a quartz tube by a Bunsen burner, the colour becomes yellow or brown when the temp. has risen a few hundred degrees, and this also obtains with mixtures of thoria with a low percentage of ceric oxide. The colour change is exhibited by the commercial mantle with one per cent. of ceria, when the flame is burning low. If a fragment of a commercial mantle be heated in the inner part of the flame of Meker's burner—with less than 0.1 per cent. of oxygen—and allowed to cool in the products of combustion, the colour is dark grey; and if heated in hydrogen, the colour is black. The original colour is restored by heating the material in an oxidizing flame. The ordinary form of the oxide is ceric oxide, CeO_2 ; the yellow colour acquired in the oxidizing low temp. flame is due to *cerium trioxide*, CeO_3 ; and the grey-blue or black form is the oxide Ce_4O_7 . For the volatilization of ceric oxide, *vide ceria*.

Crystals belonging to the cubic system and exhibiting faces of the cube and octahedron, have been obtained by A. E. Nordenskjöld by fusing the oxide with borax in a porcelain oven, and extracting the cold mass with hydrochloric acid; J. Sterba, L. Grandeau, and P. Didier also prepared the crystals by melting the amorphous oxide with borax, sodium chloride, or potassium hydrosulphate, or by fusing the anhydrous chloride with borax; and in all cases extracting the cold mass with acid as before. K. A. Hofmann and K. Höschele also obtained crystals of ceric oxide by adding anhydrous cerous sulphate to molten magnesium oxide; after slowly cooling, the mass was extracted with hydrochloric acid. If small quantities of neodymium, praseodymium, or erbium sulphate be also added, the crystals have a fine colour. V. M. Goldschmidt and L. Thomassen found the crystals of cerium dioxide, thorium dioxide, and uranous oxide are isomorphous. The X-radiograms agree with a fan-centred cubic lattice of the calcium fluoride type with the edge 5.41 \AA . The mol. vol. was examined by F. A. Henglein. J. Böhm and H. Niclassen found the hydroxides of cerium, lanthanum, and neodymium as first precipitated are amorphous, and slowly crystallize.

R. J. Meyer and H. A. Winter, and B. Brauner made **praseodymium dioxide**, PrO_2 , by heating the nitrate to $400^\circ\text{--}450^\circ$. When praseodymium hydroxide, nitrate, carbonate, or oxalate is heated in air, the resulting black powder was considered by C. A. von Welsbach, and H. C. Jones to have the composition Pr_4O_7 , which was doubted by G. P. Baxter and P. C. Griffin; P. Schottländer, and R. J. Meyer gave Pr_6O_{11} ; and B. Brauner, Pr_5O_9 . C. von Scheele, however, found the composition to be dependent on the mode of preparation, for the product obtained by calcining the oxalate at as low a temp. as possible contains the most oxygen, while that similarly prepared from the nitrate contains least; and the product contains less oxygen the higher the temp. of calcination. If the product be strongly heated, it loses oxygen, but re-absorbs the gas on cooling. P. H. M. P. Brinton and H. A. Pagel found that Pr_6O_4 represented the product of the calcination of the oxalate in air at ordinary press. over a wide range of temp. B. Brauner assumed that the oxide Pr_5O_9 is a compound of the two oxides: $\text{Pr}_2\text{O}_3 + 3\text{PrO}_2 = \text{Pr}_5\text{O}_9$, but it is doubtful if the products with the composition just indicated are chemical individuals; rather do they represent intermediate stages in the conversion of praseodymium sesquioxide to the dioxide. According to F. M. Jäger, and R. Marc, if small quantities of cerium be present the product approaches nearer the limit PrO_2 because the ceria seems to act as oxygen-carrier; on the contrary, if small quantities of lanthana or neodymia be present, R. J. Meyer and M. Koss found that the formation of the dioxide is adversely affected. C. A. von Welsbach, H. C. Jones, and R. J. Meyer and M. Koss deny that an oxide of neodymium higher than the sesquioxide can be prepared by calcination, but R. Marc, and B. Brauner say that if traces of ceria or praseodymia are present, the product approximates in composition to **neodymium dioxide**, NdO_2 . A. Wagner claimed to have made an oxide of the composition Nd_4O_7 by heating the oxalate in oxygen, and he described the reflection spectrum of this product; but P. Joye and C. Garnier have shown that the spectrum is characteristic of the hydrated oxide $\text{Nd}_2\text{O}_3 \cdot \text{H}_2\text{O}$. R. Hermann, H. Zschiesche, and R. Marc obtained indications of the existence of a higher oxide—possible *lanthanum dioxide*. P. T. Cleve said that *samarium dioxide* has not been made and that this earth forms no oxide higher than Sm_2O_3 when heated in oxygen.

There have been some arguments as to the colour of cerium dioxide. From the position of cerium between zirconium and thorium in the periodic table, it might be anticipated that cerium dioxide, like thorium and zirconium dioxides, would be white. This is the opinion of G. Wyruboff and A. Verneuil, J. Sterba, C. Wolf, H. Moissan, and J. F. Spencer. B. Brauner attributed the white colour to the presence of silica, but J. F. Spencer prepared the white dioxide free from silica. The presence of other elements of the cerium group—praseodymium and neodymium—impart a salmon-colour, reddish-brown, or brown tint to the oxide, which becomes deeper the larger the amount of these substances present, and the higher the temp. of calcination. J. F. Spencer found that if the white oxide be calcined at a red heat, it becomes pale yellow. The tint depends on the mode of preparation, and G. Wyruboff and A. Verneuil add that there are several shades of white. The oxide derived from the sulphate is lightest in colour, that derived from the hydroxide is darkest, but the tint of neither is definite enough to be described other than as a particular shade of white. J. Sterba also concluded that ceric oxide can be white or a pale citron-yellow, and that the yellow colour which cannot be attributed to iron, platinum, or other rare earth elements, but it may be due to the presence of a higher oxide than the dioxide. Praseodymium dioxide is black or brownish-black; and the neodymium compound is blue. According to V. M. Goldschmidt and L. Thomassen, the X-radiogram of ceric oxide indicates a cubic lattice with sides 5.41×10^{-8} cms. C. J. B. Karsten gave 5.6059 for the sp. gr. of cerium dioxide; R. Hermann, 6.00; A. E. Nordenskjöld, 6.935 at 15.5° , and 7.09 at 14.5° , for the crystals; L. F. Nilson and O. Pettersson, 6.739; and J. Sterba noted that the higher the temp. of formation of the crystals the greater the sp. gr.—thus, by using fused sodium chloride, borax,

and potassium sulphate, the sp. gr. were respectively 7.314, 7.415, and 7.995. W. Prandtl gave 6.71 at $15^{\circ}/4^{\circ}$ for the sp. gr. of the black oxide Pr_4O_7 . The sp. gr. of praseodymium dioxide is 5.978 at 20° . J. F. Spencer observed that the colour of the white oxide appears yellow when it is heated, but if the temp. has not been too high, the original colour is restored on cooling; praseodymium dioxide passes into the sesquioxide when strongly heated. According to E. Tiede and E. Birnbräuer, ceric oxide does not melt at 1875° , but in vacuo, it volatilizes rapidly at that temp. The oxide readily fuses in the electric arc furnace, and attacks the containing vessel. O. Ruff and co-workers found that cerium dioxide melted at 1930° . W. R. Mott gave for the order of volatility of the oxides: Al_2O_3 , Ti_2O_3 , Er_2O_3 , CeO_2 , Nd_2O_3 , La_2O_3 , ZrO_2 , and ThO_2 . W. W. Coblenz found the ultra-red emission spectrum of cerium dioxide has a strong emission between 2μ and 3μ , with possible maxima at 4.4μ and 7.5μ . Beyond 7μ , H. Rubens found the emissivity approaches that of a complete radiator. According to C. Renz, purified cerium dioxide, which has a pale yellow colour, is unaffected by light, but if mixed with a small quantity of praseodymia or terbia it becomes light-sensitive. Such a mixture, which has a slightly reddish-yellow colour, when exposed to sunlight becomes bluish-grey, but in the dark its original colour is restored. In the cerite earths, cerium is known to have an oxidizing influence on praseodymia, and apparently in sunlight this influence becomes emphasized. E. L. Nichols and H. L. Howes studied the blue glow which occurs when the oxide is heated in the oxy-hydrogen flame. L. F. Nilson and O. Petterson found the sp. ht. of ceric oxide to be 0.0877 between 0° and 100° . J. Sterba said that the refractive index of the crystals of ceric oxide is high—about 1.9. E. Wedekind and P. Hausknecht found the at. magnetism to be $+74.4 \times 10^{-6}$.

Ceric oxide is a very stable oxide, but it is weakly basic, forming a series of ceric salts. According to C. Renz, ceric oxide is reduced when exposed to light in the presence of certain organic liquids and reducing soln., particularly glycerol. Crystalline ceric oxide is not attacked by hydrochloric or nitric acid or by alkali hydroxides. According to C. F. Rammelsberg, fused alkali hydroxide has no action on ceric oxide; and L. Marino showed that the amorphous oxide after calcination is not soluble in hydrochloric or nitric acid, but if a reducing agent, like hydrogen dioxide, hydriodic acid, stannous chloride, or hydroquinone, be present, the oxide dissolves as a cerous salt. If ceria earths containing less than 50 per cent. of ceria oxide be treated with hydrochloric or nitric acid, the cerium is dissolved under conditions where ceric oxide alone is not dissolved. G. Wyruboff and A. Verneuil assume that ceric oxide is a feeble acid, forming with other bases, salts of the type $\text{R}_2\text{O}_3 \cdot 2\text{CeO}_2$ or $2\text{R}_2\text{O}_3 \cdot 3\text{CeO}_2$; these salts are assumed to be decomposed by the acid into ceric hydroxide which is soluble as a base in the excess of acid present. K. A. Hofmann and K. Höschele prepared some salts with uranic oxide— $\text{UO}_2 \cdot 2\text{CeO}_2$. According to R. Bunsen, warm conc. sulphuric acid converts ceric oxide into ceric sulphate but no dissolution occurs; moderately conc. sulphuric dissolves ceric oxide producing both ceric and cerous sulphates, and liberating a little ozonised oxygen; dil. sulphuric acid has no perceptible action on ceric oxide. Hydriodic acid converts ceric oxide into cerous iodide and iodine. Praseodymium dioxide, said B. Brauner, is not of the peroxide type, but in it, the praseodymium is quadrivalent. According to C. von Scheele, praseodymium dioxide liberates chlorine from hydrochloric acid; iodine from hydriodic acid; and ozonised oxygen from oxy-acids; it oxidizes cerous to ceric salt; manganous to manganic salts; stannous to stannic salts; and ferrous to ferric salts—part of the oxygen also escapes without oxidizing the ferrous or stannous salt. A soln. of strychnine in sulphuric acid is coloured violet by praseodymium dioxide. P. G. Melikoff and B. E. Klimenko say that praseodymium dioxide gives hydrogen dioxide but no ozone when treated with dil. sulphuric acid; with nitric acid it oxidizes manganese sulphate to a permanganate; and with hypochlorous acid it gives rise to the evolution of oxygen and the formation of chloric acid. In this reaction, which proceeds very slowly in the cold, but much more energetically at higher temp., no ozone is given off, and any which is formed must be

at once used up in oxidizing the hypochlorous acid. They add that praseodymium dioxide is not constituted like hydrogen peroxide. J. Sterba found that carbon does not reduce ceric oxide to the metal, but in the electric arc furnace cerium carbide is formed. For the reduction of ceric oxide by aluminium, magnesium, etc., *vide* metallic cerium. According to C. G. Mosander, and A. Beringer, hydrogen from zinc and an acid reduces ceric oxide to the lower state of oxidation. Ceric oxide, said W. S. Chase, readily absorbs gases.

As indicated by J. J. Berzelius and W. Hisinger,³ and C. G. Mosander, when ammonia or an alkali hydroxide is added to a soln. of a ceric salt, a yellow gelatinous precipitate of **ceric hydroxide**—possibly $\text{Ce}(\text{OH})_4$, or $\text{CeO}_2 \cdot n\text{H}_2\text{O}$ —is formed; it is insoluble in excess. Like most gelatinous precipitates, this hydroxide is liable to be contaminated with basic salt or the entrained salt, as well as adsorbed alkali hydroxide. According to G. Wyruboff and A. Verneuil, the best procedure is to add ammonia to a cold soln. of ceric ammonium nitrate, and allow the washed precipitate partially to dry at a low temp., and wash again with cold water to remove the ammonium nitrate. When dried over potassium hydroxide, the composition corresponds with $2\text{CeO}_2 \cdot 3\text{H}_2\text{O}$, or $\text{Ce}_2\text{O}(\text{OH})_6$. C. F. Rammelsberg, and C. Erk assigned to this compound a similar formula. T. Carnelley and J. Walker obtained different results. They measured the mols of water lost per mol of ceric hydroxide at different temp. They said:

The curve, Fig. 18, after rising almost perpendicularly from 200° to 600° , begins at the latter temp. to curve towards the horizontal, and this continues even up to 815° . The composition at 600° , just before this change occurs, is represented by $\text{CeO}_2 \cdot 2\text{H}_2\text{O}$. This would seem to be a definite hydrate, for the composition had previously remained nearly constant, the loss of water for 12 hrs. between 385° and 600° not having amounted to more than 0.39 per cent., or for 8 hrs. heating between 440° and 600° , to 0.23 per cent. Further, the rate of loss which commences at 600° is 20 times as great as the average rate during the previous 220° , and, moreover, at 600° the colour suddenly changes from a light yellow (presumably the colour of the hydrate $\text{CeO}_2 \cdot 2\text{H}_2\text{O}$) to salmon colour, the latter prevailing until complete dehydration. Finally, at the temp. at which the composition became practically constant (385°), and therefore presumably that at which the hydrate $\text{CeO}_2 \cdot 2\text{H}_2\text{O}$ was formed, there was a change of colour from brownish-yellow to bright yellow. It is therefore concluded that ceric oxide forms a definite hydrate, $\text{CeO}_2 \cdot 2\text{H}_2\text{O}$, or normal ortho-ceric hydroxide, H_4CeO_4 , or $\text{Ce}(\text{OH})_4$, which is very nearly stable even up to 600° , at which temp. rapid dehydration begins.

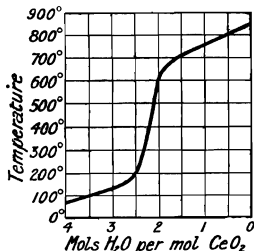

FIG. 18.—Dehydration Curve of Ceric Hydroxide.

Ceric hydroxide was made by C. Erk by the action of ammonia on basic ceric sulphate. It is also made by the oxidation of cerous hydroxide by exposure to air, but in this case the reaction is slow. C. G. Mosander, O. Popp, R. Hermann, C. F. Rammelsberg, and M. Stapff oxidized it by the action of chlorine or bromine on cerous hydroxide suspended in water, or by adding alkali hypochlorite or hypobromite to a soln. of a cerous salt. Cerous hydroxide may also be oxidized by treatment with hydrogen dioxide, and, in order to destroy the peroxides, heating the product to 120° , or boiling the product with water. When freshly prepared, or when dried at 120° , ceric hydroxide dissolves in nitric acid, forming a reddish coloured soln. of ceric nitrate; it dissolves in hydrochloric acid with the evolution of chlorine and the formation of cerous chloride; and with sulphuric acid, a mixture of cerous and ceric sulphates is formed and oxygen evolved, but, according to B. Brauner, if platinum be present ceric hydroxide prepared from ceric peroxide furnishes cerous sulphates alone, while ceric hydroxide, prepared by oxidizing cerous hydroxide with chlorine, furnishes ceric sulphate alone. According to G. A. Barbieri, ceric hydroxide obtained by either method gives with dil. sulphuric acid, 93–95 per cent. of the cerium in the quadrivalent form. J. M. Ordway found ceric hydroxide to be insoluble in alkali hydroxides, but soluble in soln. of alkali carbonates, forming, according to A. Job, a perceric carbonate.

W. Biltz prepared a colloidal soln. or **hydrosol of ceric hydroxide** by dialyzing a ten per cent. aq. soln. of ceric ammonium sulphate for four or five days. The colloid is positively charged with respect to water. The soln. is readily coagulated by a few drops of soln. of electrolytes. When the colloidal soln. is evaporated, it leaves a gum-like mass which dissolves to a clear soln. in hot water. The sol was studied by J. E. M. van der Made, H. N. Holmes, and J. Böhm and H. Niassen; the adsorption of dyes by cerium dioxide, by H. Rheinboldt and E. Wedekind; and the action of radium emanation, by A. Fernau and W. Pauli. The colloid was further investigated by H. R. Kruyt and J. E. M. van der Made.

J. J. Berzelius and W. Hisinger,⁴ A. Beringer, J. C. G. de Marignac, L. N. Vauquelin, and C. G. Mosander describe a **cerosceric oxide** as a lemon-yellow powder obtained by igniting ceric oxide in a current of hydrogen, or by igniting cerous oxalate or carbonate in a retort. A. Beringer gives the formula $Ce_2O_3 \cdot 16CeO_2$, and J. C. G. de Marignac, $3Ce_2O_3 \cdot 8CeO_2$. There appears to be something amiss with these observations because, when ceric oxide is heated to redness in a current of dry hydrogen, free from air, it is partially reduced, and it loses about two per cent. in weight. The reduction is more rapid with ceric oxide which has not been strongly ignited, than it is with an oxide which has been strongly ignited; but the former oxide is liable to retain a little water. The product is a blue or bluish-black solid which readily absorbs oxygen from the air, and is sometimes pyrophoric. The dark blue oxide is also obtained by heating ceric oxide in vacuo. It has been described by G. Wyruboff and A. Verneuil,⁵ J. Sterba, W. S. Chase, and R. J. Meyer. The two last-named gave the composition of the cerosceric oxide, Ce_4O_7 , while G. Wyruboff and A. Verneuil gave Ce_7O_{12} . W. S. Chase found this oxide readily adsorbed gases.

When white cerous hydroxide is exposed to air or to oxygen, it acquires a violet or purple tint and ultimately becomes yellow ceric hydroxide. G. Wyruboff and A. Verneuil obtained the *violet foncé* product by adding alkali hydroxide to a mixed soln. of cerous and ceric salts. The maximum intensity of tint is obtained when the ratio $CeO_2 : Ce_2O_3 = 2 : 1$. When the material is dried in vacuo, the colour is nearly black. The same product is obtained by precipitating a soln. of cerosceric sulphate with alkali hydroxide. They also described a cerosceric oxide, $6CeO_2 \cdot Ce_2O_3$, which is not stable, but if the cerous oxide be replaced by one of the other ceria or yttria earths, the product is stable; and a complex $6CeO_2 \cdot R_2O_3$ is formed. From a study of the basic ceric salts, G. Wyruboff and A. Verneuil concluded that they are derived from different polymerized forms of ceric hydroxide; these include what they call the *para-oxides*, $(CeO_2)_{40} \cdot nH_2O$; the *meta-oxides*, $(CeO_2)_{56} \cdot nH_2O$; etc. There is very little to support the mol. formulæ so ascribed to these compounds.

The colloidal soln. of ceric hydroxide, made by the dialysis of a soln. of ceric ammonium sulphate, change in a marked manner with time, the ageing being accompanied by a diminution in viscosity, a gradual loss of the faculty of gelatinization, and by a diminution in the sensitiveness towards electrolytes. The change is irreversible, and is accelerated by rise of temperature. It is supposed that the ageing is due to the gradual dehydration of the sol particles. The ageing of ceric hydroxide sols is very largely modified under the influence of β - or γ -rays from radium. The first effect consists in an accelerated rate of diminution of the viscosity, but this effect is succeeded by a second, in which the viscosity of the sol increases to a value very large in comparison with that of the freshly dialyzed sol. The progress of the second stage is not dependent on the continued exposure of the sol to the action of the active rays, for if the exposure be made intermittent, it is found that the course of the viscosity—time curve is quite unchanged. A further curious effect is observed when the source of the radiation is removed before the end of the first stage in the ageing process. Under these circumstances, the second stage in the ageing process sets in, and the viscosity of the sol increases very considerably, attains a maximum value, and subsequently decreases almost as rapidly as it increased before the

attainment of the maximum. The jelly obtained when the radiation is allowed to act sufficiently long appears to be perfectly stable. Similar changes in the viscosity are produced by the addition of electrolytes, although the effects are not readily distinguishable. The ageing of sols is supposed to be due to the gradual formation of larger colloidal particles by a process of aggregation, but it is probable that the effects described by the authors are connected with changes in the degree of hydration. It is probable that ceric hydroxide and other metallic hydroxide sols are highly hydrated, and in this way differ from hydrophobic colloids, such as the metallic and the sulphide sols. Under the influence of electrolytes or β - or γ -rays, the electrical charge of the colloidal particles is neutralized, and this is accompanied by a diminution in the degree of hydration, and results in a lowering of the viscosity, gradual when the sol is subjected to β - or γ -rays and immediate when an electrolyte is added. The increase in viscosity in the second state of the ageing process is then due to the aggregation of the electrically neutral particles, a process which takes place with a velocity comparable with that of crystallization and similar processes. The attainment of a maximum viscosity and the subsequent fall which is observed when the added electrolyte is very small in quantity or the time of exposure to the rays is comparatively brief is explained by assuming that this peptization is due to the action of electrically charged colloid particles which are enclosed by the jelly resulting from the aggregation of the electrically neutral particles. In support of this view, it has been found that ceric hydroxide jelly may be readily peptized by the addition of the corresponding sol.

According to R. Hermann,⁶ and L. de Boisbaudran, when a soln. of a cerous salt is treated with a mixture of ammonia and hydrogen dioxide, or when a soln. of, say, cerous sulphate is mixed with a slight excess of ammonia, and hydrogen peroxide added, a reddish gelatinous precipitate is obtained. The orange-red precipitate formed when a soln. of cerium acetate is treated with hydrogen dioxide does not contain such a high proportion of oxygen. Cerium compounds are sometimes recognized by mixing the soln. with an alkaline acetate, adding hydrogen dioxide, and heating gently, when an orange-red precipitate is formed. In the case of cerous salts, the precipitate not unfrequently remains white, or at most becomes pale yellow. This precipitate should be moistened with ammonia, and again treated with hydrogen peroxide, when the orange-red colour will be produced. The white precipitate formed by hydrogen peroxide in soln. of cerous acetate does not appear to be more highly oxidized than the sesquioxide. L. de Boisbaudran, and P. T. Cleve assume the orange-red precipitate is a **hydrated cerium trioxide**, $\text{CeO}_3 \cdot n\text{H}_2\text{O}$. According to L. Pissarjewsky, the mechanism of the formation of the peroxidized cerium compound is $\text{Ce}(\text{OH})_4 + \text{HO} \cdot \text{OH} = \text{Ce}(\text{OH})_3 \cdot \text{O} \cdot \text{OH} + \text{H}_2\text{O}$. The sesquioxides of didymium and samarium were found by P. T. Cleve to yield peroxides of the general formula, $\text{R}_4\text{O}_9 \cdot n\text{H}_2\text{O}$, or, according to L. Pissarjewsky, hydrated **lanthanum pentoxide**, $\text{R}_2\text{O}_5 \cdot n\text{H}_2\text{O}$, or $\text{HLaO}_3 + n\text{H}_2\text{O}$ —P. G. Melikoff and L. Pissarjewsky ascribed the formula $\text{La}(\text{OH})_2 \cdot (\text{O} \cdot \text{OH})$ to lanthanum peroxide. According to B. Brauner, if praseodymium hydroxide be precipitated in the presence of hydrogen peroxide, a hydrated **praseodymium pentoxide**, $\text{Pr}_2\text{O}_5 \cdot n\text{H}_2\text{O}$, is produced; P. G. Melikoff and B. E. Klimenko assume that the first product of the action is $\text{Pr}(\text{O} \cdot \text{OH})_3$, which then decomposes to give the product the formula $\text{Pr}(\text{OH})_2(\text{O} \cdot \text{OH})$. B. Brauner also assumes the existence of a corresponding hydrated **neodymium pentoxide**, $\text{Nd}_2\text{O}_5 \cdot n\text{H}_2\text{O}$. He also mentions the existence of $(\text{CH}_3 \cdot \text{CO})_2\text{R} \cdot \text{O} \cdot \text{O} \cdot \text{OR}(\text{OH})(\text{CO} \cdot \text{CH}_3) \cdot \text{H}_2\text{O}$, where R represents Pr or Nd., P. T. Cleve's peroxide $\text{Sa}_4\text{O}_9 \cdot n\text{H}_2\text{O}$ is probably analogous to the products just described, and in conformity therewith, the compound is called hydrated **samarium pentoxide**, $\text{Sa}_2\text{O}_5 \cdot n\text{H}_2\text{O}$. P. Mengel found that if sodium dioxide be employed instead of hydrogen dioxide, at ordinary temp., oxyhydroxides are obtained containing more oxygen than the sesquioxide, but less than the P. T. Cleve's peroxide, and the amount of oxygen varies with the conditions of the experiment, especially with the temp. When a soln. of a pure cerium salt is precipitated with sodium dioxide and boiled,

whereby a bright yellow precipitate of cerium dioxyhydroxide is obtained, and this is dried at 130° , the percentage of CeO_2 in the precipitate estimated with ferrous ammonium sulphate and permanganate, shows that the oxidation of the cerium is incomplete. If, however, the precipitate be heated over the blowpipe, the theoretical quantity of dioxide is obtained. When a mixture of lanthanum and didymium salts, free from cerium, is treated with sodium dioxide in the cold, it yields a precipitate which gives off oxygen when the mixture is warmed; the precipitate, when dried at 120° , is bluish-white, and contains much carbonic anhydride absorbed from the air, which is eliminated only at a high temp.; when heated at 400° , it becomes dark brown, and on further heating over the blowpipe assumes the characteristic grey colour of the anhydrous sesquioxide. The brown coloration is due to the formation of a higher oxide of praseodymium, and since this higher oxide cannot be obtained by the action of chlorine in alkaline soln., the praseodymium peroxide, like barium peroxide, must belong to the type H_2O_2 . The oxalates of lanthanum and didymium do not yield the brown oxide when heated; if, however, the grey oxide which is obtained be moistened with nitric acid and cautiously heated, the brown oxide is obtained.

According to A. Job, cerous salts are more soluble than ceric salts in soln. of alkali carbonates, and the solubility is still further increased if they are peroxidized. If, however, an excess of hydrogen peroxide be added, the solubility is reduced and a precipitate forms, the nature of which has not yet been ascertained. In order to obtain a conc. soln. of cerium peroxide, hydrogen peroxide and ceric ammonium nitrate, in molecular proportion, are added successively to a conc. aq. soln. of potassium carbonate, and the soln. is agitated; a limpid, deep-coloured liquid is thus obtained, and as much as 40 grms. of cerium dioxide may be added per litre if 280 grms. of alkali carbonate be also present. Potassium hydrogen carbonate may be used in place of the normal carbonate, but then the solubility of the cerium salt be less. If to the soln. prepared in the manner just described, hydrogen peroxide is added in slight excess but not in sufficient quantity to produce a precipitate, and the soln. be allowed to remain at the ordinary temp., it at first loses some oxygen, but is afterwards quite stable, the quantity of available oxygen in it corresponding exactly with that required by the formula CeO_3 . Ceric salts do not absorb oxygen from the air, but if a soln. of a cerous salt containing also an alkali carbonate be exposed to the air, it is first oxidized to a ceric salt and then continues to absorb oxygen up to a limit that depends on the strength of the soln. E. Baur confirmed the results by A. Job. Cerous sulphate soln. containing potassium carbonate, when shaken with air, are converted into cerium peroxide, and at the same time some ceric salt is formed. A slight alkalinity of the soln. increases the yield of peroxide. When arsenious oxide is used as "acceptor," the cerium is converted to a greater extent into peroxide. The salt, $Ce_2O(CO_3)_2 \cdot O_3 \cdot 4K_2CO_3 \cdot 10H_2O$, described by A. Job, gives oxygen as well as carbon dioxide when treated with dil. sulphuric acid. More oxygen is liberated than indicated by the equation $2CeO_3 + 3H_2SO_4 = Ce_2(SO_4)_3 + O_2 + H_2O_2 + 2H_2O$, and this is due to a spontaneous decomposition of the hydrogen peroxide present. According to L. Pissarjewsky, the peroxidized cerium compound is not stable; it loses oxygen fairly quickly at ordinary temp.; it is rapidly converted into ceric hydroxide when heated with boiling water, or when dried at 100° ; and, with dil. acids, it forms a cerous salt, hydrogen dioxide, and ozonized oxygen: $2\{Ce(OH)_3 \cdot O \cdot OH\} + 3H_2SO_4 = Ce_2(SO_4)_3 + H_2O_2 + O_2 + 6H_2O$. Carbonic acid also liberates hydrogen dioxide from the peroxidized compound. The peroxides like the sesquioxides have basic properties, and do not combine with the bases to form salts. L. Pissarjewsky gives for the heat of formation $CeO_{3aq.} = CeO_{2aq.} + O + 33 \cdot 576$ Cals. The higher oxide of praseodymium, say P. G. Melikoff and B. E. Klimenko, does not convert manganese salts into permanganates in the presence of nitric acid.

REFERENCES.

- ¹ C. Winkler, *Ber.*, **24**, 873, 1891; W. Biltz, *ib.*, **37**, 719, 1904; W. Biltz and F. Zimmermann, *ib.*, **40**, 4979, 1907; A. Burger, *ib.*, **40**, 1652, 1907; W. Prandtl, *ib.*, **55**, B, 692, 1922; L. F. Nilson and O. Pettersson, *Ber.*, **13**, 1459, 1880; *Compt. Rend.*, **91**, 232, 1880; P. Joye and C. Garnier, *ib.*, **154**, 510, 1912; P. Joye, *Arch. Sciences Genève*, (4), **36**, 1, 1913; C. Garnier, *ib.*, (4), **40**, 93, 1915; E. Newbery and J. N. Pring, *Proc. Roy. Soc.*, **92**, A, 276, 1916; W. Guertler, *Zeit. anorg. Chem.*, **40**, 247, 1904; K. A. Vesterberg, *ib.*, **94**, 371, 1916; G. A. Barbieri, *Atti Accad. Lincei*, (5), **16**, i, 395, 1907; C. F. Rammelsberg, *Pogg. Ann.*, **108**, 63, 1859; A. E. Nordenskjöld, *ib.*, **114**, 616, 1861; C. Matignon, *Compt. Rend.*, **142**, 276, 1906; *Ann. Chim. Phys.*, (8), **8**, 242, 364, 386, 402, 426, 433, 440, 1906; (8), **10**, 104, 1907; J. Sterba, *ib.*, (8), **2**, 199, 1904; *Compt. Rend.*, **134**, 1056, 1902; E. Demarçay, *ib.*, **126**, 1039, 1898; H. Lacombe, *Bull. Soc. Chim.*, (3), **31**, 570, 1904; P. T. Cleve, *ib.*, (2), **21**, 196, 1874; (2), **39**, 289, 1883; *Chem. News*, **53**, 30, 45, 67, 80, 91, 100, 1886; C. G. Mosander, *Phil. Mag.*, (3), **23**, 241, 1843; H. C. Jones, *Amer. Chem. Journ.*, **20**, 345, 1898; *Chem. News*, **77**, 280, 292, 1898; C. Baskerville and R. Stevenson, *Journ. Amer. Chem. Soc.*, **26**, 54, 1904; H. Bührig, *Journ. prakt. Chem.*, (2), **12**, 209, 1875; R. Hermann, *ib.*, (1), **82**, 385, 1861; N. A. Orloff, *Chem. Ztg.*, **31**, 45, 1907; O. Popp, *Liebigs Ann.*, **131**, 359, 1864; A. Beringer, *ib.*, **42**, 138, 1842; W. Muthmann and L. Weiss, *ib.*, **331**, 1, 1904; P. Didier, *Ann. École Norm.*, **65**, 1887; M. Delafontaine, *Arch. Sciences Genève*, (2), **22**, 38, 1865; *Chem. News*, **73**, 284, 1896; R. J. Meyer, *Zeit. anorg. Chem.*, **37**, 378, 1903; A. Wägner, *ib.*, **42**, 118, 1904; C. von Scheele, *ib.*, **17**, 310, 1898; **18**, 352, 1899; R. J. Meyer and J. Wuorinen, *ib.*, **80**, 7, 1913; L. M. Dennis and W. H. Mseege, *Journ. Amer. Chem. Soc.*, **16**, 649, 1894; C. Baskerville and G. F. Catlett, *ib.*, **26**, 75, 1904; S. H. Katz and C. James, *ib.*, **36**, 779, 1914; A. Damiens, *Ann. Chim. Phys.*, (9), **10**, 137, 1918; *Compt. Rend.*, **157**, 214, 1913; G. Urbain and G. Jantsch, *ib.*, **147**, 1286, 1908; A. Damour, *ib.*, **59**, 270, 1864; L. de Boisbaudran, *ib.*, **111**, 394, 1890; W. W. Coblenz, *Investigations of Infra-red Spectra*, Washington, **7**, 118, 1908; H. E. Ives, E. F. Kingsbury, and E. Karrer, *Journ. Franklin Inst.*, **186**, 401, 585, 1918; A. H. White and M. E. Müller, *Journ. Gaslight.*, **83**, 504, 1903; E. L. Nichols and H. L. Howes, *Phys. Rev.*, (2), **19**, 300, 1922; H. L. Howes, *ib.*, (2), **17**, 60, 1921; W. R. Mott, *Trans. Amer. Electrochem. Soc.*, **34**, 255, 1918; E. T. Wherry, *Journ. Washington Acad.*, **7**, 143, 1917; E. H. Williams, *Chem. News*, **119**, 287, 1919; *Phys. Rev.*, (2), **14**, 348, 1919; J. F. Spencer, *Journ. Chem. Soc.*, **107**, 1265, 1915; C. A. von Welsbach, *Monatsh.*, **6**, 477, 1885; *Sitzber. Akad. Wien*, **92**, 317, 1885; **112**, 1037, 1903; S. Meyer, *ib.*, **110**, 492, 1901; **111**, 38, 1902; *Monatsh.*, **20**, 369, 1899; **29**, 1017, 1908; *Ber.*, **33**, 320, 1918, 1900; *Ann. Physik*, (4), **1**, 664, 1900; B. Brauner, *Proc. Chem. Soc.*, **14**, 71, 1898; **17**, 66, 1901; E. Tiede and E. Birnbräuer, *Zeit. anorg. Chem.*, **87**, 129, 1914; A. Müller, *ib.*, **43**, 320, 1905; R. Marc, *ib.*, **38**, 128, 1904; *Ber.*, **35**, 2382, 1902; H. Zschiesche, *Journ. prakt. Chem.*, (1), **104**, 174, 1868; (1), **107**, 65, 1869; L. Kahlenberg and W. Trautmann, *Trans. Amer. Electrochem. Soc.*, **39**, 377, 1921; H. von Euler and R. Nilsson, *Zeit. physiol. Chem.*, **131**, 107, 1923; F. Zambonini and G. Carobbi, *Atti Accad. Lincei*, (5), **32**, ii, 53, 1923; *Gazz. Chim. Ital.*, **54**, 46, 53, 1924; K. C. Sen and N. R. Dhar, *Koll. Zeit.*, **33**, 193, 1912; N. G. Chatterji and N. R. Dhar, *Trans. Faraday Soc.*, **16**, 122, 1921; E. Wedekind and P. Hausknecht, *Ber.*, **54**, B, 253, 1921.
- ² A. E. Nordenskjöld, *Pogg. Ann.*, **114**, 612, 1861; C. G. Mosander, *Phil. Mag.*, (3), **23**, 241, 1843; P. Didier, *Ann. École Norm.*, **65**, 1887; L. Grandeau, *Compt. Rend.*, **100**, 1134, 1885; J. Sterba, *ib.*, **133**, 221, 294, 1901; *Ann. Chim. Phys.*, (8), **2**, 193, 1904; G. Wyruboff and A. Verneuil, *ib.*, (8), **9**, 356, 1906; *Compt. Rend.*, **124**, 1300, 1897; **127**, 863, 1898; **128**, 501, 1899; L. F. Nilson and O. Pettersson, *Ber.*, **13**, 1459, 1880; *Compt. Rend.*, **91**, 232, 1880; H. Moissan, *ib.*, **124**, 1233, 1897; P. Joye and C. Garnier, *ib.*, **154**, 510, 1912; P. Joye, *Arch. Sciences Genève*, (4), **36**, 41, 1913; K. A. Hofmann and K. Höschele, *Ber.*, **47**, 238, 1914; C. Wolf, *Amer. Journ. Science*, (2), **46**, 53, 1868; R. J. Meyer, *Zeit. anorg. Chem.*, **37**, 378, 1903; **41**, 97, 1904; B. Brauner, *ib.*, **32**, 1, 1902; **34**, 207, 1903; *Proc. Chem. Soc.*, **14**, 71, 1898; **17**, 66, 1901; *Versamm. deut. Naturf.*, ii, 131, 1899; *Sitzber. Akad. Wien*, **84**, 1165, 1882; *Journ. Chem. Soc.*, **41**, 68, 1882; A. C. Neish, *Journ. Amer. Chem. Soc.*, **31**, 517, 1909; V. M. Goldschmidt and L. Thomassen, *Die Kristallstruktur natürlicher und synthetischer Oxyde von Uran, Thorium, und Cerium*, Kristiania, 1923; P. H. M. P. Brinton and H. A. Pagel, *Journ. Amer. Chem. Soc.*, **45**, 1460, 1923; G. P. Baxter and P. C. Griffin, *ib.*, **28**, 1690, 1906; W. Prandtl, *Ber.*, **55**, B, 692, 1922; E. Wedekind and P. Hausknecht, *ib.*, **54**, B, 253, 1921; R. Hermann, *Journ. prakt. Chem.*, (1), **82**, 385, 1861; (1), **92**, 113, 1864; H. Zschiesche, *ib.*, (1), **107**, 65, 1869; C. J. B. Karsten, *Schweigger's Journ.*, **65**, 394, 1832; J. F. Spencer, *Journ. Chem. Soc.*, **107**, 1265, 1915; H. Watts, *ib.*, **2**, 140, 1850; D. Meneghini, *Gazz. Chim. Ital.*, **43**, 1, 81, 1913; L. Marino, *ib.*, **37**, i, 61, 1907; P. Schottländer, *Ber.*, **25**, 569, 1892; R. J. Meyer and M. Koss, *ib.*, **35**, 2622, 3740, 1902; R. Marc, *ib.*, **35**, 2382, 1902; C. von Scheele, *ib.*, **32**, 409, 1899; *Zeit. anorg. Chem.*, **17**, 310, 1898; **18**, 352, 1898; R. J. Meyer and A. H. Winter, *ib.*, **67**, 398, 1910; A. Wagner, *ib.*, **42**, 118, 1904; E. Tiede and E. Birnbräuer, *ib.*, **87**, 160, 1914; C. A. von Welsbach, *Monatsh.*, **6**, 477, 1885; *Sitzber. Akad. Wien*, **92**, 317, 1885; F. M. Jäger, *Proc. Acad. Amsterdam*, **16**, 1095, 1914; H. C. Jones, *Amer. Chem. Journ.*, **20**, 345, 1898; *Chem. News*, **77**, 280, 292, 1898; C. Renz, *Helvetica Chim. Acta*, **4**, 961, 1921; *Zeit. anorg. Chem.*, **110**, 104, 1920; R. Bunsen, *Liebigs Ann.*, **86**, 265, 1855; A. Beringer, *ib.*, **42**, 134, 1842; C. F. Rammelsberg, *Ber.*, **5**, 492, 1872; C. G. Mosander, *Svenska Akad. Handl.*, **299**, 1826; P. G. Melikoff and B. E. Klimenko, *Journ.*

Russ. Phys. Chem. Soc., **33**, 663, 739, 1901; H. Rubens, *Phys. Zeit.*, **6**, 790, 1905; W. W. Coblenz, *Investigations of Infra-red Spectra*, Washington, 7, 112, 1908; O. Ruff, H. Seiferheld, and J. Suda, *Zeit. anorg. Chem.*, **82**, 373, 1913; W. R. Mott, *Trans. Amer. Electrochem. Soc.*, **34**, 555, 1918; E. L. Nichols and H. L. Howes, *Journ. Amer. Optical Soc.*, **6**, 42, 1922; F. A. Henglein, *Zeit. Elektrochem.*, **30**, 5, 1924; *Zeit. anorg. Chem.*, **120**, 77, 1921; R. Marc, *ib.*, **38**, 128, 1904; *Ber.*, **35**, 2382, 1902; H. E. Ives, E. F. Kingsbury, and E. Karrer, *Journ. Franklin Inst.*, **186**, 401, 585, 1918; V. M. Goldschmidt and L. Thomassen, *Ved. Skr. Math. Nat.*, **5**, 1923; P. T. Cleve, *Bull. Soc. Chim.*, (2), **43**, 53, 1885; W. S. Chase, *Journ. Amer. Chem. Soc.*, **39**, 1576, 1917; J. Böhm and H. Niemann, *Zeit. anorg. Chem.*, **132**, 1, 1923.

³ J. J. Berzelius and W. Hisinger, *Gehlen's Ann.*, **397**, 1804; C. G. Mosander, *Phil. Mag.*, (3), **23**, 251, 1843; G. Wyruboff and A. Verneuil, *Ann. Chim. Phys.*, (8), **9**, 289, 1906; *Bull. Soc. Chim.*, (3), **21**, 118, 1899; *Compt. Rend.*, **127**, 863, 1898; **128**, 501, 1899; C. F. Rammelsberg, *Pogg. Ann.*, **108**, 40, 1859; C. Erk, *Zeit. Chem.*, (2), **7**, 100, 1871; O. Popp, *Liebig's Ann.*, **131**, 359, 1864; R. Hermann, *Journ. prakt. Chem.*, (1), **30**, 184, 1843; (1), **92**, 113, 1864; M. Stapff, *ib.*, (1), **79**, 257, 1860; H. Rheinboldt and E. Wedekind, *Koll. Beihefte*, **17**, 115, 1923; J. E. M. van der Made, *Over het Cerihydroxyd-Sol*, Amsterdam, 1923; H. R. Kruyt and J. E. M. van der Made, *Rec. Trav. Chim. Pays-Bas*, **42**, 277, 1923; B. Brauner, *Zeit. anorg. Chem.*, **34**, 207, 1903; **39**, 261, 1904; G. A. Barbieri, *Atti Accad. Lincei*, (5), **16**, i, 525, 1907; W. Biltz, *Ber.*, **35**, 4431, 1902; **37**, 1095, 1904; T. Carnelley and J. Walker, *Journ. Chem. Soc.*, **53**, 59, 1888; J. M. Ordway, *Amer. Journ. Science*, (2), **26**, 205, 1858; A. Job, *Compt. Rend.*, **128**, 178, 1899; A. Fermau and W. Pauli, *Koll. Zeit.*, **20**, 20, 1917; J. Böhm and H. Niemann, *Zeit. anorg. Chem.*, **132**, 1, 1923; H. N. Holmes, *Monograph Univ. Wisconsin Symposium Colloids*, **24**, 1923.

⁴ J. J. Berzelius and W. Hisinger, *Gehlen's Ann.*, **2**, 303, 1804; W. Hisinger, *Schweigger's Journ.*, **17**, 424, 1816; J. Laugier, *ib.*, **19**, 54, 1817; *Ann. Chim. Phys.*, (1), **89**, 304, 1814; L. N. Vauquelin, *ib.*, (1), **54**, 28, 1805; A. Beringer, *Liebig's Ann.*, **42**, 134, 1842; R. Bunsen, *ib.*, **105**, 40, 1858; C. G. Mosander, *Kastner's Arch.*, **10**, 470, 1827; *Pogg. Ann.*, **11**, 406, 1827; *Phil. Mag.*, (3), **23**, 241, 1843; J. C. G. de Marignac, *Arch. Sciences Genève*, (1), **8**, 266, 1860; *Ann. Chim. Phys.*, (3), **60**, 257, 1860; C. F. Rammelsberg, *Pogg. Ann.*, **108**, 40, 1859; C. Winkler, *Ber.*, **24**, 873, 1891.

⁵ G. Wyruboff and A. Verneuil, *Compt. Rend.*, **128**, 501, 1899; **128**, 501, 1899; *Bull. Soc. Chim.*, (3), **21**, 118, 1899; *Ann. Chim. Phys.*, (8), **9**, 289, 1906; J. Sterba, *ib.*, (8), **2**, 210, 1904; *Compt. Rend.*, **133**, 221, 1901; R. J. Meyer, *Zeit. anorg. Chem.*, **37**, 378, 1903; A. Fernau and W. Pauli, *Koll. Zeit.*, **20**, 20, 1917; W. S. Chase, *Journ. Amer. Chem. Soc.*, **39**, 1576, 1917.

⁶ R. Hermann, *Journ. prakt. Chem.*, (1), **30**, 184, 1843; P. T. Cleve, *Bull. Soc. Chim.*, (2), **43**, 53, 1885; *Öfvers. Svenska Akad. Förh.*, **40**, 7, 1883; **42**, 1, 1885; *Chem. News*, **48**, 39, 1883; *Compt. Rend.*, **97**, 94, 1883; *Journ. Chem. Soc.*, **43**, 362, 1883; L. de Boisbaudran, *Compt. Rend.*, **100**, 605, 1885; A. Job, *ib.*, **136**, 45, 1903; B. Brauner, *Proc. Chem. Soc.*, **14**, 72, 1898; **17**, 66, 1901; *Zeit. anorg. Chem.*, **32**, 1, 1902; G. Wyruboff and A. Verneuil, *Ann. Chim. Phys.*, (8), **9**, 313, 1906; P. Mengel, *Zeit. anorg. Chem.*, **19**, 71, 1899; P. G. Melikoff and L. Pissarjewsky, *ib.*, **21**, 70, 1899; L. Pissarjewsky, *ib.*, **31**, 359, 1902; *Journ. Russ. Phys. Chem. Soc.*, **32**, 609, 1900; P. G. Melikoff and B. E. Klimenko, *ib.*, **33**, 739, 1901; E. Bauer, *Zeit. anorg. Chem.*, **30**, 251, 1902. *Vide* the hydrogen peroxide process for the separation of cerium from the rare earths.

§ 14. The Halides of the Cerium Metals

H. Moissan¹ prepared the anhydrous fluorides of the rare earths by the action of fluorine on the carbides; and W. K. van Haagen and E. F. Smith converted yttrium, lanthanum, and cerium oxides into fluorides by heating them in a stream of hydrogen fluoride.

According to A. Hirsch, the hydrated fluorides can be made by the action of conc. hydrofluoric acid on a hot soln. of the chlorides, acidified with hydrochloric acid. The precipitated fluoride is washed with hot water, then with 95 per cent. alcohol, and the alcohol removed by the centrifuge. If the product be covered with absolute alcohol, evaporated to dryness, and the residue heated first at 100°, and then at 200°, the anhydrous fluoride is formed.

The fluorides of the rare earths crystallize in the cubic system, and they are isomorphous with calcium fluoride. The fluorides of the rare earths are practically insoluble in water and in dil. mineral acids; they are perceptibly soluble in hot conc. hydrochloric acid, and this the more with the fluorides of the cerium group than with those of the yttrium group. The fluorides of scandium and thorium are much less soluble.

Hydrated cerium tetrafluoride, $\text{CeF}_4 \cdot \text{H}_2\text{O}$, occurs with the quartz and albite at Brodö, Sweden, as the mineral *fluocerite*. B. Brauner prepared hydrated ceric

fluoride, $\text{CeF}_4 \cdot \text{H}_2\text{O}$, as a brown powder by the action of hydrofluoric acid on ceric hydroxide, and drying the product at 100° . When heated this salt gives off water, hydrogen fluoride, and possibly fluorine. B. Brauner claims to have made the salt $3\text{KF} \cdot 2\text{CeF}_4 \cdot 2\text{H}_2\text{O}$, in cubic or octahedral crystals insoluble in water, by the action of potassium hydrogen fluoride on ceric hydroxide, but E. Rimbach and H. F. C. Kilian question the accuracy of B. Brauner's statement; they did not succeed in preparing B. Brauner's salt nor the analogous salts of lithium, sodium, rubidium, caesium, or ammonium, but they did prepare a series of double salts of the type $\text{MF}_2 \cdot 2\text{CeF}_4 \cdot 7\text{H}_2\text{O}$, where M denotes Zn, Cd, Cu, Co, or Ni, by the action of a soln. of the metal oxide in an excess of hydrofluoric acid on a soln. of ceric hydroxide in hydrofluoric acid. **Heptahydrated zinc decafluodicerate**, $\text{ZnF}_2 \cdot 2\text{CeF}_4 \cdot 7\text{H}_2\text{O}$, and **heptahydrated cadmium decafluodicerate** are white, **heptahydrated copper decafluodicerate** is pale blue. These salts are decomposed more or less readily by water. T. Vogt found that fused mixtures of calcium and cerium fluorides give cubic mixed crystals with up to 55.8 per cent. of cerium fluoride; these crystals are called *cerofluorite*, and mixed with yttrifluorite they find a representative in the mineral *ytthrocerite*. According to B. Brauner, ceric fluoride is converted into **cerous fluoride**, CeF_3 , by heating it to dull redness. S. Jolin made **hemihydrated cerous fluoride**, $2\text{CeF}_3 \cdot \text{H}_2\text{O}$, by double decomposition. N. A. Puschin and A. V. Baskoff did not succeed in preparing a double compound with cerous and potassium fluorides; the two chlorides have a eutectic at 660° corresponding with 24 mol per cent. of cerous fluoride. P. R. Bassett studied the electrochemistry of the high intensity arc with the positive electrode having a core of cerous fluoride.

P. T. Cleve, and F. Frerichs and F. Smith have described **hemihydrated lanthanum fluoride**, $2\text{LaF}_3 \cdot \text{H}_2\text{O}$, prepared as a white gelatinous precipitate by adding hydrofluoric acid to a soln. of the acetate; and **lanthanum hydrofluoride**, $2\text{LaF}_3 \cdot 3\text{HF}$, prepared by adding hydrofluoric acid to a soln. of the sulphate. H. Moissan made the anhydrous fluoride by the action of fluorine on the carbide. W. F. Smith obtained a voluminous precipitate of lanthanum hydrofluoride, $2\text{LaF}_3 \cdot 3\text{HF}$. W. F. Smith also precipitated a gelatinous **didymium hydrogen fluoride**, $3\text{HF} \cdot \text{DiF}_3$; and B. Brauner reported three **potassium fluodidymates**, with the ratios $\text{KF} : \text{DiF}_3 : \text{H}_2\text{O}$ as 1 : 2 : 1; 6 : 6 : 2; and 3 : 4 : 3. J. Popovici precipitated gelatinous **praseodymium fluoride**, PrF_3 , from an aq. soln. of praseodymium sulphate by hydrofluoric acid. The gelatinous precipitate when warmed forms a mass of yellow glistening crystals which appear green by reflected light. **Neodymium fluoride**, NdF_3 , is formed in a similar manner as a pale, lilac-coloured, crystalline powder. P. T. Cleve obtained **hemihydrated samarium fluoride**, $\text{SaF}_3 \cdot \text{H}_2\text{O}$, as a gelatinous precipitate by double decomposition by adding hydrofluoric acid to a soln. of a samarium salt.

The classical process of H. C. Oersted² is of no practical value for chlorinating the oxides of the rare earths because the resulting chloride is non-volatile. C. A. Matignon and F. Bourion made the anhydrous chlorides of the rare earths by heating the oxide, sulphate or oxalate in a stream of sulphur chloride, S_2Cl_2 , followed by the fusion of the chloride in a stream of dry hydrogen chloride; E. Chauvenet heated the oxide in a stream of carbonyl chloride; P. Didier and also C. Baskerville used a mixture of carbon monoxide and chlorine; E. Demarçay, and H. Quantin used carbon tetrachloride; and C. A. Matignon, and O. Pettersson used hydrogen chloride, but in the latter case the reaction is not quantitative, although it is so if the oxalate be used in place of the oxide. F. Hillebrand and A. Norton converted the metals into chlorides by heating them in a stream of chlorine or hydrogen chloride; C. G. Mosander, and W. Muthmann and L. Stützel heated the sulphides in a stream of chlorine or hydrogen chloride; and H. Moissan heated the carbide in a stream of chlorine, O. Pettersson, in hydrogen chloride. The hydrated salts can be dehydrated by heating them to 105° – 130° in a stream of dry hydrogen chloride until no more water is evolved. The product is heated to 180° – 200° in a stream of the same gas. When water is no longer evolved, the temp.

is raised until the chloride fuses. The solid residue obtained by evaporating an aq. soln. of the chloride can also be dehydrated by heating it in a stream of dry hydrogen chloride and sulphur chloride, S_2Cl_2 . W. Heap and E. Newbery treated the oxide or the salt of a weak acid at 350° – 400° with carbonyl chloride.

Aq. soln. of the rare earth chlorides are readily made by dissolving the oxides, hydroxides, or carbonates in conc. hydrochloric acid; and when the soln. are evaporated over sulphuric acid; or when the hot sat. soln. is cooled; or when the cold aq. soln. is sat. with hydrogen chloride, crystalline hydrated chlorides are formed. The hydrated salts cannot be dehydrated without decomposition by simply heating them in air. The hydrated salts are usually of the type $MCl_3 \cdot 6H_2O$, and when heated between 105° and 130° in a stream of dry hydrogen chloride, they are partially dehydrated, forming the monohydrated salts $MCl_3 \cdot H_2O$, which are completely dehydrated between 180° – 200° in a stream of hydrogen chloride.

The chlorides are all hygroscopic and dissolve in water with the evolution of heat. The aq. soln. are neutral to methyl orange. Cæsium chloride forms double salts with the chlorides of lanthanum, praseodymium and neodymium, and samarium, but other double chlorides of the metals of groups I and II have not been prepared—excepting the chloroaurates. Double chlorides with antimony, bismuth, tin, and platinum have been made. They also form double compounds with mercuric cyanide, and with alcohol, pyridine, and many organic bases.

Crystallized oxychlorides of the rare earths were prepared by C. A. Matignon and F. Bourion by passing a slow current of air or steam along with an inert gas, over the molten anhydrous chloride, and A. Job made them by heating the hydrated or oxalo-chlorides to redness. K. A. Hofmann and K. Hörschele prepared them in a crystalline form by adding the oxides or sulphates to molten magnesium chloride; and extracting the soluble salts from the cold mass by dil. acetic or hydrochloric acid. G. Urbain prepared crystalline oxychlorides for spectroscopic examination by dissolving the oxides in hydrochloric acid, adding ammonium and alkali chlorides; the soln. is evaporated to dryness, the residue carefully heated, and, when cold, extracted with water. The residual oxychloride is practically insoluble in water, but slowly soluble in dil. acids. A prolonged ignition converts them into oxides.

According to C. G. Mosander,³ cerium burns vigorously when heated in chlorine gas, and F. Hillebrand and A. Norton prepared the chloride by igniting cerium in this gas. According to A. Beringer, if chlorine gas be passed over heated ceric oxide, cerium chloride mixed with the oxide is formed, and some oxychloride sublimes. **Cerium trichloride**, or **cerous chloride**, $CeCl_3$, was prepared by F. Wöhler, A. Beringer, and by F. Hillebrand and A. Norton by evaporating a soln. of the carbonate in hydrochloric acid to dryness and igniting the residue, mixed with ammonium chloride, at a red heat. H. Robinson ignited the oxalate in a stream of hydrogen chloride; P. Didier ignited the oxide in a stream of carbon dioxide and chlorine; L. Meyer ignited the oxide in a stream of carbon tetrachloride; and C. G. Mosander heated the sulphide in chlorine—free from oxygen; if all the air be not expelled by the chlorine before the sulphide is heated, a mixture of the chloride and oxide is formed which fuses with great difficulty. Of the general methods described above, F. Bourion's sulphur chloride process is one of the most convenient. The anhydrous chloride forms white deliquescent crystals of sp. gr. 3.92 at 0° —H. Robinson gives 3.88 at 15.5° —the crystals melt at 848° . According to P. Didier, cerium chloride is decomposed by oxygen or steam, forming cerium sesquioxide, Ce_2O_3 . The salt is very soluble in water, and, according to L. M. Dennis and W. L. Magee, the aq. soln.—generally prepared by dissolving cerous oxide or ceric hydroxide in conc. hydrochloric acid—when sat. with hydrogen chloride furnishes rhombic crystals of **heptahydrated cerous chloride**, $CeCl_3 \cdot 7H_2O$, with the axial ratios $a : b : c = 0.8083 : 1 : 1.4419$; and, according to A. S. Eakle, the rhombic bipyramidal crystals, $CeCl_3 \cdot 7\frac{1}{2}H_2O$, have the axial ratios $a : b : c = 0.6096 : 1 : 0.7857$. A. Fock also reported triclinic pinacoidal crystals of

hexahydrated cerium trichloride, $\text{CeCl}_3 \cdot 6\text{H}_2\text{O}$, with the axial ratios $a:b:c = 1.1580:1:0.8635$; and $\alpha = 91^\circ 2\frac{1}{2}'$; $\beta = 114^\circ 9'$; and $\gamma = 88^\circ 11\frac{1}{2}'$. These crystals are said to be isomorphous with hexahydrated lanthanum trichloride. According to T. Lange, cerium dioxide, CeO_2 , dissolves in hydrochloric acid only in the presence of a reducing agent—say hydroferrocyanic acid. L. N. Vauquelin's and A. Beringer's products were rose-coloured owing to the presence of impurities; the purer crystals obtained by W. Hisinger and J. J. Berzelius are colourless. According to J. J. Berzelius, when the heptahydrated chloride is heated, water is given off, then hydrogen chloride, as indicated in describing the general properties of these salts. The hydrated salt is also deliquescent, and very soluble in water. R. J. Meyer found the eq. conductivity of aq. soln. of cerium chloride rises from 107.6 with a dilution $v=32$ to 135.2 with $v=1024$, so that the difference $\lambda_{1024} - \lambda_{32} = 27.6$, very nearly the value 26 characteristic of strongly basic trivalent cations which do not hydrolyze to any marked degree. From the potential of the cell $\text{H}_2 | \text{CeCl}_3 | \text{NH}_4\text{NO}_3 | \text{Calomel}$ electrode, H. G. Denham computes that about 0.14 per cent. of the salt is hydrolyzed in a $\frac{1}{32}N$ -soln. A. B. Schiotz found that the electrolysis of soln. of cerous chloride in the presence of chloride of mercury, nickel, platinum, zinc, or aluminium gave deposits containing no cerium; the addition of potassium lactate to the soln. of cerous chloride raised the overvoltage to 0.15 volt. With soln. of cerous and ferrous chlorides in the presence of alkali lactate, iron with 62 per cent. of cerium was deposited on the cathode. J. H. Hildebrand titrated cerium, praseodymium, and neodymium chlorides with sodium hydroxide soln., and measured the e.m.f. against the normal hydrogen electrode during the operation. J. J. Berzelius found the colourless aq. soln. becomes brown on exposure to the air owing to the formation of a ceric salt. The alcoholic soln. burns with a green flame. H. Arnold electrolyzed molten cerium trichloride, and he observed a secondary reaction at about 900° so long as there is an excess of water present in the molten mass. The dark brown powder has the composition $\text{CeOCl}_2 \cdot 10\text{H}_2\text{O}$, **ceric oxychloride**, and it is hydrolyzed by water, forming ceric hydroxide and cerous chloride. It is supposed to be formed from the ceric chloride produced on the anode: $\text{CeCl}_4 + \text{H}_2\text{O} = 2\text{HCl} + \text{CeOCl}_2$. W. Biltz and E. Meinecke found cerium trichloride to be insoluble in liquid chlorine.

M. Barre has shown that cerium chloride readily forms additive compounds with ammonia. Gaseous ammonia, when introduced into a tube containing cerium chloride at -80° , combines with the development of heat, and there is a considerable increase in the volume of the mass. By a study of the dissociation pressures, this author has established the existence of five different compounds of cerium chloride with ammonia, and has prepared them in the form of white powders decomposable by water. The compounds are: **cerium icosiamminotrichloride**, $\text{CeCl}_3 \cdot 20\text{NH}_3$; **cerium dodecamminotrichloride**, $\text{CeCl}_3 \cdot 12\text{NH}_3$; **cerium octamminotrichloride**, $\text{CeCl}_3 \cdot 8\text{NH}_3$; **cerium tetramminotrichloride**, $\text{CeCl}_3 \cdot 4\text{NH}_3$; and **cerium diamminotrichloride**, $\text{CeCl}_3 \cdot 2\text{NH}_3$. G. L. Clark found the temp. of decomposition at 760 mm. press. to be -32° for the icosiamminochloride; -14° , for the dodecachloride; 18° , for the octamminochloride; 67° , for the tetramminochloride; and 98° , for the diamminochloride. E. H. Ducloux prepared crystals of **caesium tetrachlorocerate**, $\text{CsCl} \cdot \text{CeCl}_3$, of refractive index 1.58, and recommended the reaction as a microchemical test for cerium. The yellow, dichroic, deliquescent, monoclinic crystals of tridecahydrated **auric hexachlorocerate**— $\text{CeCl}_3 \cdot \text{AuCl}_3 \cdot 13\text{H}_2\text{O}$, according to S. Jolin, or $\text{CeCl}_3 \cdot \text{AuCl}_3 \cdot 10\text{H}_2\text{O}$, according to M. Holzmann—are deliquescent, and soluble in water and in alcohol. F. Zambonini found that up to 2.19 per cent. of cerous chloride, $\text{CeCl}_3 \cdot 3\text{H}_2\text{O}$, and barium chloride, $\text{BaCl}_2 \cdot 2\text{H}_2\text{O}$, form a series of mixed crystals. S. Jolin has prepared hexahedral crystals of decahydrated **mercuric henadecachlorocerate**, $\text{CeCl}_3 \cdot 4\text{HgCl}_2 \cdot 10\text{H}_2\text{O}$, soluble in water; and J. E. Ahlen, felted needle-like crystals of octohydrated **mercuric hexacyanotrichlorocerate**, $\text{CeCl}_3 \cdot 3\text{HgCy}_2 \cdot 8\text{H}_2\text{O}$, very soluble in water, by crystallization from a soln. of mercuric cyanide with an excess of cerium chloride.

The crystals lose their water of crystallization at 100° or over sulphuric acid. They crystallize only from soln. containing an excess of the chloride.

J. J. Berzelius obtained **cerium oxychloride**, CeOCl , as a residue after heating the hydrated chloride in a retort; F. Wöhler, as a by-product in the preparation of cerium from cerium chloride and sodium, when the slag is treated with dil. acid; P. Didier, by the action of water vapour diluted with nitrogen on a molten mixture of cerous and sodium chlorides; C. G. Mosander by the action of a mixture of air and chlorine on heated cerium sulphide; and C. Erk, by the electrolysis of molten cerium chloride. The silver-white, mica-like crystals become yellow when exposed to the air; they form ceric sulphate with sulphuric acid; dissolve slowly in nitric acid; and are scarcely affected by hydrochloric acid. A. Beringer found that the oxychloride forms the oxide when strongly ignited in an open vessel.

Cerium tetrachloride, or **ceric chloride**, CeCl_4 , has not been isolated. J. J. Berzelius obtained a dark red soln. of a ceric salt in cold conc. hydrochloric acid which is believed to contain the complex **hydrochloroceric acid**, H_2CeCl_6 . This soln. decomposes slowly in the cold with the evolution of chlorine, the decomposition is rapid when the soln. is heated, and in either case cerous chloride remains. I. Koppel,⁴ and A. J. Grant and C. James have prepared several double compounds of ceric chloride with the organic bases—pyridine, quinoline, etc.—by adding the base to a soln. of ceric chloride in a methyl alcohol soln. of hydrogen chloride. H. Arnold has prepared **ceric oxychloride**, CeOCl_2 , by the electrolysis of slightly hydrated molten cerous chloride.

Anhydrous **lanthanum chloride**, LaCl_3 , was prepared by C. G. Mosander⁵ by evaporating a soln. of the oxide in hydrochloric acid to dryness, and heating the product in a stream of hydrogen chloride; M. Choubine also prepared it by heating the oxide in a stream of the same gas. The same salt has been prepared by several of the general methods—by heating the oxide in a mixture of sulphur monochloride and chlorine; the sulphide, or carbide in hydrogen chloride; the carbide in chlorine; and by heating the hydrated chloride with ammonium chloride. B. S. Hopkins and F. H. Driggs described the preparation of highly purified lanthanum chloride. The anhydrous chloride forms colourless crystals which, according to F. Bourion, melt at 890°, or, according to C. A. Matignon, at 907°; and solidify to long deliquescent needles recalling aragonite, and which, according to F. Bourion, have a sp. gr. of 3.79 at 0°, or, according to C. A. Matignon, 3.947 at 18°. C. A. Matignon also gives the heat of formation $(\text{La}, 3\text{Cl}) = 263$ Cals.; $\text{La}_2\text{O}_3 + 6\text{HCl}_{\text{aq.}} = 2\text{LaCl}_{3\text{aq.}} + 3\text{H}_2\text{O} + 114.6$ Cals., or $\text{La}_2\text{O}_3 + 6\text{HCl} = 2\text{LaCl}_3 + 3\text{H}_2\text{O} + 160.6$ Cals. C. G. Mosander noted that the salt is very soluble in water with the evolution of a large amount of heat; for, according to C. A. Matignon, the heat of soln. is 31.3 Cals. W. W. Coblentz studied the ultra-red transmission spectrum. A. Voigt and W. Biltz measured the electrical conductivity of the fused chloride. According to H. Ley, the aq. soln. is very slightly hydrolyzed; the eq. conductivity rises from 105.8 for a dilution $v=32$ to 131.5 for a dilution $v=1024$, so that $\lambda_{1024} - \lambda_{32} = 25.7$. The aq. soln. was found by A. Beringer to deposit pale rose-coloured crystals, which, according to J. Watts, are white when quite pure. According to J. C. G. de Marignac, the triclinic crystals of **hexahydrated lanthanum chloride**, $\text{LaCl}_3 \cdot 6\text{H}_2\text{O}$, have the axial ratios $a:b:c = 1.1593:1:0.8659$; and $\alpha = 91^\circ 3'$; $\beta = 114^\circ 28'$; and $\gamma = 88^\circ 12'$, and are isomorphous with hexahydrated cerium chloride. C. Söderström obtained crystals of heptahydrated praseodymium chloride, $\text{PrCl}_3 \cdot 7\text{H}_2\text{O}$, of the same form as J. C. G. de Marignac's hexahydrated lanthanum chloride. There is therefore some doubt about the water content of these hydrated salts. The formula $\text{LaCl}_3 \cdot 7\frac{1}{2}\text{H}_2\text{O}$ has also been assigned to this salt. R. Hermann found that when **hydrated lanthanum chloride** is heated, it loses both water and hydrogen chloride, forming lanthanum oxychloride, $2\text{LaCl}_3 \cdot 3\text{La}_2\text{O}_3$, as a white residue insoluble in water, and sparingly soluble in hydrochloric and nitric acids, and F. Frerichs obtained the oxychloride, $\text{LaCl}_3 \cdot \text{La}_2\text{O}_3$, that is, LaOCl , by heating

lanthanum oxide to 200° in a stream of chlorine gas. The greyish-white powder yields but a trace of soluble matter when treated with water. The anhydrous and hydrated salts are both soluble in alcohol, and C. A. Matignon's value for the mol. wt. of the chloride by the b.p. method in alcoholic soln. corresponds with LaCl_3 ; according to R. J. Meyer and M. Koss, the alcoholic soln. deposits crystals of $\text{LaCl}_3 \cdot 2\text{C}_2\text{H}_5\text{OH}$. B. J. Dryfuss and C. G. L. Wolf found that dil. soln. of lanthanum chloride have little or no effect on bacteria; and 0·8 per cent. soln. coagulates the proteins in serum; and 0·1 grm. injected hypodermically in guinea-pigs causes convulsions followed by death. Lanthanum chloride unites with a number of other metal chlorides, forming double salts. R. J. Meyer prepared hydrated **cæsium hexachlorolanthanate**, $\text{LaCl}_3 \cdot 3\text{CsCl} \cdot 4(\text{or } 5)\text{H}_2\text{O}$; J. C. G. de Marignac, colourless, double refracting crystals of dodecahydrated **mercuric henadecachlorolanthanate**, $\text{LaCl}_3 \cdot 4\text{HgCl}_2 \cdot 12\text{H}_2\text{O}$, easily soluble in water; J. E. Ahlen, needle-like crystals of octohydrated **mercuric hexacyanotrichlorolanthanate**, $\text{LaCl}_3 \cdot 3\text{HgCy}_2 \cdot 8\text{H}_2\text{O}$, like the cerium salt.

The properties of *didymium chloride*, DiCl_3 , were investigated by J. C. G. de Marignac,⁶ P. T. Cleve, L. F. Nilson, F. T. Frerichs and E. F. Smith. These became of less importance when it was discovered that didymium is a complex mixture of praseodymium and neodymium. J. O. Perrine found didymium chloride shows no ultra-violet fluorescence. The general methods for the preparation of the chlorides of the rare earths apply to anhydrous **praseodymium chloride**, PrCl_3 , namely, the action of chlorine on the heated carbide; of hydrogen chloride on the heated sulphide; of a mixture of sulphur monochloride and chlorine on the heated oxide; and of hydrogen chloride on the heated hydrated chloride. Praseodymium chloride forms bluish-green, transparent, hygroscopic, needle-like crystals. The sp. gr. at 0° is given by F. Bourion as 4·07; by C. A. Matignon, at 18°, as 4·017; and by G. P. Baxter and O. J. Stewart, at 25°, as 4·020. According to F. Bourion, it melts at 810°, and, according to T. Vogt, at 818°, to form a black liquid. It is not volatile at 1000°, and, in general, it may be said that the chlorides of the cerium group—cerium, lanthanum, praseodymium, neodymium, and samarium—are less volatile than the metals of the yttrium group. A. Voigt and W. Biltz measured the electrical conductivity of the fused chloride. C. A. Matignon found that at 13·8°, 100 parts of water dissolve 103·9 parts of the anhydrous chloride. The aq. soln. of the chloride, or a soln. of the oxide in hydrochloric acid, furnishes large green crystals of **heptahydrated praseodymium chloride**, $\text{PrCl}_3 \cdot 7\text{H}_2\text{O}$, which, according to C. von Scheele, have a sp. gr. of 2·251 at 150°, and melt in their water of crystallization at 115°—G. P. Baxter and O. J. Stewart say 111°. At 13·8°, C. A. Matignon says that 100 parts of water dissolve 334·2 parts of the heptahydrated chloride, and that the soln. is in equilibrium with the same salt. According to C. A. Matignon, the heat of the reaction $\text{Pr}_2\text{O}_3 + 6\text{HCl} = 2\text{PrCl}_3 + 3\text{H}_2\text{O} + 147·8$ Cals.; and $\text{Pr}_2\text{O}_3 + 6\text{HCl}_{\text{aq.}} = 2\text{PrCl}_{3\text{aq.}} + 3\text{H}_2\text{O} + 106·2$ Cals. The anhydrous chloride is very soluble in water, and C. A. Matignon gives the heat of soln. $\text{PrCl}_3 + \text{Aq.} = 35·5$ Cals.; for the heptahydrated chloride, $\text{PrCl}_3 \cdot 7\text{H}_2\text{O} + \text{Aq.} = 5·3$ Cals.; and for the hydrated chloride, $\text{PrCl}_3 \cdot \text{H}_2\text{O} + \text{Aq.} = 28·9$ Cals. C. von Scheele says that the crystals of the heptahydrated chloride do not lose water when allowed to stand over sulphuric acid, but C. A. Matignon says that the crystals effloresce in air, forming **hexahydrated praseodymium chloride**, $\text{PrCl}_3 \cdot 6\text{H}_2\text{O}$, that this salt can be slowly dehydrated to form **trihydrated praseodymium chloride**, $\text{PrCl}_3 \cdot 3\text{H}_2\text{O}$; that when heated to 105°–130° in a stream of hydrogen chloride, it forms **monohydrated praseodymium chloride**, $\text{PrCl}_3 \cdot \text{H}_2\text{O}$; and that when heated to 180°–200° in the same gas the anhydrous chloride is formed. When heated in air to 115°, hydrogen chloride and water are given off and an oxychloride of indefinite composition remains; G. P. Baxter and O. J. Stewart formed **praseodymium oxychloride**, PrOCl , by heating the heptahydrated chloride in oxygen. F. T. Frerichs and E. F. Smith studied the properties of didymium oxychloride. K. A. Hofmann and K. Höschele obtained crystals of the oxychloride from a soln. of the oxide in fused magnesium chloride. The conc.

aq. soln. of praseodymium chloride dissolves considerable amounts of the rare earth oxalates. C. A. Matignon found that when praseodymium chloride is heated with hydrobromic or hydriodic acid the bromide or iodide respectively is formed. B. J. Dryfuss and C. G. L. Wolf find the physiological action is analogous to that of lanthanum chloride. Praseodymium chloride is very soluble in alcohol, and, according to B. Brauner, the mol. wt. in alcoholic soln. agrees with the simple formula PrCl_3 . C. A. Matignon says that 100 grms. of pyridine dissolve 21.4 grms. of praseodymium chloride at 15°. Praseodymium forms double chlorides in the same way as cerium and lanthanum chlorides.

J. C. G. de Marignac prepared the *didymium mercuric chloride* $2\text{DiCl}_3 \cdot 9\text{HgCl}_2 \cdot 24\text{H}_2\text{O}$, in deliquescent cubes; J. E. Ahlen, *didymium mercuric chlorocyanide*, $\text{DiCl}_3 \cdot 3\text{HgCy}_2 \cdot 8\text{H}_2\text{O}$; P. T. Cleve, *didymium stannic chloride*, $2\text{DiCl}_3 \cdot 2\text{SnCl}_4 \cdot 21\text{H}_2\text{O}$; L. F. Nilson, *didymium platinum chlorides*, or *didymium chloroplatinates*, $2\text{DiCl}_3 \cdot 3\text{PtCl}_2 \cdot 18\text{H}_2\text{O}$, and $\text{DiCl}_3 \cdot 2\text{PtCl}_2 \cdot 10\text{H}_2\text{O}$; P. T. Cleve, *didymium platinum chloride*, $2\text{DiCl}_3 \cdot 2\text{PtCl}_4 \cdot 21\text{H}_2\text{O}$, which F. T. Frerichs and E. F. Smith said had the composition $2\text{DiCl}_3 \cdot 3\text{PtCl}_4 \cdot 24\text{H}_2\text{O}$ of sp. gr. 2.41 at 16°; and yellow crystals of *auric hexachloropraseodymate*, *praseodymium chloroaurate*, $\text{PrCl}_3 \cdot \text{AuCl}_3 \cdot 10\text{H}_2\text{O}$, which have a sp. gr. 2.60 at 15°, and which are very soluble in water. P. T. Cleve previously had prepared didymium auric chloride, $\text{DiCl}_3 \cdot \text{AuCl}_3 \cdot 10\text{H}_2\text{O}$, and F. T. Frerichs and E. F. Smith, $2\text{DiCl}_3 \cdot 3\text{PtCl}_4 \cdot 24\text{H}_2\text{O}$. C. Söderström says the chloroplatinates of the cerium group are isomorphous crystallizing in tetragonal bipyramids—the cerium salt has the axial ratio $a:c=1:1.1272$; and the praseodymium salt, $a:c=1:1.13$. Praseodymium chloride also forms double salts with many organic compounds.

Anhydrous **neodymium chloride**, NdCl_3 , has been prepared in a similar manner to its companion praseodymium chloride. Neodymium chloride forms rose-pink, transparent, very hygroscopic crystals. F. Bourion⁷ found the sp. gr. to be 4.14 at 0°; C. A. Matignon, 4.195 at 18°; and G. P. Baxter and H. C. Chapin, 4.134 at 25°. According to F. Bourion, neodymium chloride melts at 784°, forming a red liquid, although C. A. Matignon says that the salt becomes green in colour below the m.p. A. Voigt and W. Biltz measured the electrical conductivity of the fused chloride. C. A. Matignon found at 13°, 100 parts of water dissolve 96.68 parts of the salt at 13°, and 140 parts of the salt at 100°; in both cases, the soln. is in equilibrium with the hexahydrated chloride. The aq. soln. of the chloride furnishes large, rose-pink, rhombic prisms of **hexahydrated neodymium chloride**, $\text{NdCl}_3 \cdot 6\text{H}_2\text{O}$, which have a sp. gr. 2.282 at 16.5°, and which are readily soluble in water, for 100 grms. of water at 13° dissolve 246.2 grms., and at 100°, 511.6 grms. The conc. aq. soln. dissolves neodymium oxalate on warming, and as the soln. is cooled crystals of *neodymium chloroxalate* separate out. According to C. A. Matignon, the heat of the reaction: $\text{Nd}_2\text{O}_3 + 6\text{HCl}_{\text{aq.}} = 2\text{NdCl}_{3\text{aq.}} + 3\text{H}_2\text{O}$, is +105.5 Cals.; the heat of soln. of the anhydrous chloride, 35.4 Cals.; and of the hexahydrated chloride, 7.6 Cals. When hexahydrated neodymium chloride is heated to 115° in a stream of hydrogen chloride, it forms **monohydrated neodymium chloride**, $\text{NdCl}_3 \cdot \text{H}_2\text{O}$, which loses all its water when the temp. is carried up to 160°, and the anhydrous chloride remains. By heating the hexahydrated chloride in air or steam, C. A. Matignon obtained mauve-coloured leaflets of **neodymium oxychloride**, NdOCl , which do not fuse at 1000°. K. A. Hofmann and K. Höschele obtained crystals from a soln. of the oxide in fused magnesium chloride. C. A. Matignon found that acetylene is polymerized catalytically when passed over heated neodymium chloride, graphite being simultaneously deposited. B. J. Dryfuss and C. G. L. Wolf observed that soln. of neodymium chloride have the same physiological action as the salts of praseodymium and lanthanum. Neodymium chloride is soluble in alcohol, and C. A. Matignon reports that 100 parts of this solvent at 20° dissolve 44.5 parts of the salt; the heat of soln. in alcohol is 21.5 Cals.; the mol. wt. in alcoholic soln. corresponds with the formula NdCl_3 , and the alcoholic soln. deposits crystals of $\text{NdCl}_3 \cdot 3\text{C}_2\text{H}_5\text{OH}$. Similarly, 100 parts of pyridine at 15° dissolve 1.8 parts of the salt, and the soln. deposits crystals of $\text{NdCl}_3 \cdot 3\text{C}_5\text{H}_5\text{N}$. Other compounds with organic bases have been reported.

According to C. A. Matignon and R. Trannoy, when anhydrous neodymium chloride is exposed to the action of gaseous ammonia at a low temp. or is sealed in a tube with liquefied ammonia, it is converted into the additive compound, $\text{NdCl}_3 \cdot 12\text{NH}_3$. This, on being gradually heated, dissociates, giving rise to a series of less complex additive products, the formulæ, dissociation temp., and heats of formation (in each case from the preceding compound in the list) of which are as follows: **neodymium monoamminochloride**, 360° , 20.2 Cals.; **neodymium diamminochloride**, $\text{NdCl}_3 \cdot 2\text{NH}_3$, 255° , 16.9 Cals.; **neodymium tetramminochloride**, $\text{NdCl}_3 \cdot 4\text{NH}_3$, 157° , 13.7 Cals.; **neodymium pentamminochloride**, $\text{NdCl}_3 \cdot 5\text{NH}_3$, 117° , 12.5 Cals.; **neodymium octamminochloride**, $\text{NdCl}_3 \cdot 8\text{NH}_3$, 79° , 11.2 Cals.; **neodymium henadecamminochloride**, $\text{NdCl}_3 \cdot 11\text{NH}_3$, 26° , 9.5 Cals.; and **neodymium dodecamminochloride**, $\text{NdCl}_3 \cdot 12\text{NH}_3$, -10° , 8.4 Cals. The heats of formation were calculated from the law of the constant change of entropy.⁸

Anhydrous **samarium trichloride**, or *samarium chloride*, SaCl_3 , can be prepared by the general methods for the anhydrous chlorides of the rare earths. C. A. Matignon,⁹ and F. Bourion used the sulphur chloride process. O. J. Stewart and C. James made a highly purified chloride for their at. wt. determinations. Samarium chloride forms a hygroscopic crystalline powder with a faint yellow tinge. F. Bourion gives for the sp. gr. at 0° , 4.27; and C. A. Matignon, 4.465 at 18° . According to F. Bourion, samarium chloride melts at 686° to form a dark brown liquid. C. A. Matignon found the salt dissolves readily in water with a hissing noise, and the aq. soln. deposits large yellow plates of **hexahydrated samarium chloride**, $\text{SaCl}_3 \cdot 6\text{H}_2\text{O}$, which, according to P. T. Cleve, have a sp. gr. 2.383. When the hexahydrated chloride is heated to 110° in a stream of hydrogen chloride, it forms **monohydrated samarium chloride**, $\text{SaCl}_3 \cdot \text{H}_2\text{O}$, which, under similar conditions, at 180° , forms the anhydrous salt. C. A. Matignon gives for the heat of the reaction: $\text{Sa}_2\text{O}_3 + 6\text{HCl} = 2\text{SaCl}_3 + 3\text{H}_2\text{O} + 128.4$ Cals.; for $\text{Sa}_2\text{O}_3 + 6\text{HCl}_{\text{aq.}} = 2\text{SaCl}_{3\text{aq.}} + 3\text{H}_2\text{O} + 94.63$ Cals.; and for the heat of soln. of the anhydrous chloride, 37.4 Cals. When the anhydrous chloride is heated in oxygen, it forms **samarium oxychloride**, SaOCl , of sp. gr. 7.017, and P. T. Cleve prepared the same compound by calcining the oxide in chlorine. K. A. Hofmann and K. Hörschle obtained crystals of the oxychloride from a soln. of the oxide in fused magnesium chloride. Samarium chloride is soluble in alcohol and in pyridine, and C. A. Matignon found 100 grms. of pyridine at 25° dissolve 6.38 grms. of chloride, and that when the pyridine soln. is heated, a gelatinous compound separates out, and this redissolves when the soln. is cooled. E. Fouard found that soln. of samarium chloride accelerate the oxidation of quinol more than do any of the other rare earth chlorides. C. A. Matignon and R. Trannoy found that when anhydrous samarium chloride is sealed in a tube with liquid ammonia, it is converted into a white, voluminous compound, $\text{SaCl}_3 \cdot 11.5\text{NH}_3$, which, on being progressively heated, gives off its ammonia at eight different temp., which are the dissociation temp. of the eight compounds which samarium chloride forms with ammonia; the formulæ of the compounds, their dissociation temp. at 760 mm., and heats of formation, are, respectively, as follow: **samarium monoamminochloride**, $\text{SaCl}_3 \cdot \text{NH}_3$, 375° , 20.7 Cals.; **samarium diamminochloride**, $\text{SaCl}_3 \cdot 2\text{NH}_3$, 240° , 16.4 Cals.; **samarium triamminochloride**, $\text{SaCl}_3 \cdot 3\text{NH}_3$, 200° , 15.1 Cals.; **samarium tetramminochloride**, $\text{SaCl}_3 \cdot 4\text{NH}_3$, 155° , 13.7 Cals.; **samarium pentamminochloride**, $\text{SaCl}_3 \cdot 5\text{NH}_3$, 105° , 12.1 Cals.; **samarium octamminochloride**, $\text{SaCl}_3 \cdot 8\text{NH}_3$, 76° , 11.2 Cals.; **samarium hemienneadecamminochloride**, $\text{SaCl}_3 \cdot 9\frac{1}{2}$ (or 8) NH_3 , 40° , 10.0 Cals.; and **samarium hemitricosiamminochloride**, $\text{SaCl}_3 \cdot 11\frac{1}{2}\text{NH}_3$, 15° , 9.2 Cals. G. L. Clark discussed this subject. By mixing soln. of the component chlorides, P. T. Cleve prepared deliquescent orange-red prisms of platonic heptachlorosamarate, $\text{SaCl}_3 \cdot \text{PtCl}_4 \cdot 10\frac{1}{2}\text{H}_2\text{O}$, of sp. gr. 2.712; and rhombic plates of auric hexachlorosamarate, $\text{SaCl}_3 \cdot \text{AuCl}_3 \cdot 10\text{H}_2\text{O}$, of sp. gr. 2.742.

C. A. Matignon and E. Cazes prepared **samarium dichloride**, or *samarous*

chloride, SaCl_2 , by heating anhydrous samarium chloride in a current of dry hydrogen or ammonia; and by heating samarium trichloride with powdered aluminium. This compound forms dark reddish-brown crystals of sp. gr. 3.687 at 22° . It dissolves readily in water, forming a reddish-brown soln. which gradually loses its colour as hydrogen is evolved, and samarium hydroxide is precipitated: $6\text{SaCl}_2 + 6\text{H}_2\text{O} = 4\text{SaCl}_3 + 2\text{Sa}(\text{OH})_3 + 3\text{H}_2$; the rapidity with which the colour disappears is accelerated by shaking the soln. in air: $12\text{SaCl}_2 + 6\text{H}_2\text{O} + 3\text{O}_2 = 8\text{SaCl}_3 + 4\text{Sa}(\text{OH})_3$. Samarium subchloride is insoluble in alcohol, carbon disulphide, and other organic solvents.

Anhydrous **cerium tribromide**, CeBr_3 , is white hygroscopic crystalline powder which can be made by one of the general methods—W. Muthmann and L. Stützel's,¹⁰ H. Robinson's or F. Bourion's processes. The soln. in water is slightly acid; no definite hydrates have been reported, but a number of double salts have been obtained by S. Jolin, J. Dehnicke, and by G. T. Morgan and E. Cahen: J. Dehnicke made **antimony hexabromocerate**, $\text{CeBr}_3 \cdot \text{SbBr}_3 \cdot 12\text{H}_2\text{O}$; **bismuth hencicosibromocerate**, $\text{CeBr}_3 \cdot 6\text{BiBr}_3 \cdot 20\text{H}_2\text{O}$; **bismuth hexabromocerate**, $\text{CeBr}_3 \cdot \text{BiBr}_3 \cdot 12\text{H}_2\text{O}$; **stannic heptabromocerate**, $\text{CeBr}_3 \cdot \text{SnBr}_4 \cdot 10\text{H}_2\text{O}$; and **auric hexabromocerate**, $\text{CeBr}_3 \cdot \text{AuBr}_3 \cdot 8\text{H}_2\text{O}$, was made by S. Jolin in dark brown deliquescent crystals. F. T. Frerichs and E. F. Smith made anhydrous **lanthanum bromide**, LaBr_3 , by F. Bourion's process; E. Cahen heated lanthanum oxide in bromine vapour, but F. T. Frerichs and E. F. Smith found that **lanthanum oxybromide**, LaOBr , is so formed. The resulting white fused mass dissolves in water, producing a soln. which has no action on methyl orange but colours litmus wine red, because the soln. is slightly acid through hydrolysis. The aq. soln. obtained by dissolving lanthanum oxide in hydrobromic acid furnishes colourless crystals of **heptahydrated lanthanum bromide**, $\text{LaBr}_3 \cdot 7\text{H}_2\text{O}$. These crystals are soluble in water and in alcohol, and form double salts with many metallic bromides; F. T. Frerichs and E. F. Smith made **zinc dodecabromolanthanate**, $2\text{LaBr}_3 \cdot 3\text{ZnBr}_2 \cdot 39\text{H}_2\text{O}$; and **nickel dodecabromolanthanate**, $2\text{LaBr}_3 \cdot 3\text{NiBr}_2 \cdot 18\text{H}_2\text{O}$; P. T. Cleve made **auric hexabromolanthanate**, $\text{LaBr}_3 \cdot \text{AuBr}_3 \cdot 9\text{H}_2\text{O}$; J. Dehnicke made **bismuth hexabromolanthanate**, $\text{LaBr}_3 \cdot \text{BiBr}_3 \cdot 12\text{H}_2\text{O}$; **antimony hexabromolanthanate**, $\text{LaBr}_3 \cdot \text{SbBr}_3 \cdot 12\text{H}_2\text{O}$; and **antimony dodecabromolanthanate**, $\text{LaBr}_3 \cdot 3\text{SbBr}_3 \cdot 20\text{H}_2\text{O}$. F. Bourion prepared anhydrous **praseodymium bromide**, PrBr_3 , by heating the brown oxide in the vapour of sulphur monochloride and hydrogen bromide. The green crystalline powder resembles the corresponding chloride; it dissolves slowly in water, forming a soln. which is slightly hydrolyzed. The aq. soln. of the oxide in hydrobromic acid furnishes green crystals of **hexahydrated praseodymium bromide**, $\text{PrBr}_3 \cdot 6\text{H}_2\text{O}$. P. T. Cleve made deliquescent tabular crystals of **zinc enneabromodidymate**, $\text{DiBr}_3 \cdot 3\text{ZnBr}_2 \cdot 12\text{H}_2\text{O}$, to which F. T. Frerichs and E. F. Smith assigned the formula $2\text{DiBr}_3 \cdot 3\text{ZnBr}_3 \cdot 36\text{H}_2\text{O}$, and to the corresponding **nickel dodecabromodidymate**, $2\text{DiBr}_3 \cdot 3\text{NiBr}_2 \cdot 18\text{H}_2\text{O}$. P. T. Cleve made black deliquescent crystals of **auric hexabromodidymate**, $\text{DiBr}_3 \cdot \text{AuBr}_3 \cdot 10\text{H}_2\text{O}$, of sp. gr. 3.304. Red crystals of **platinic heptabromoprasedymate**, $\text{PrBr}_3 \cdot \text{PtBr}_4 \cdot 10\text{H}_2\text{O}$, of sp. gr. 2.41 at 16° . Anhydrous **neodymium bromide**, NdBr_3 , was prepared by F. Bourion in a similar manner to the praseodymium salt. The green crystalline substance melts to a dark brown liquid. The aq. soln. is slightly hydrolyzed. Anhydrous **samarium bromide**, SaBr_3 , was made by F. Bourion by passing the vapour of sulphur bromide and hydrogen bromide over the heated oxide. The yellow fused mass dissolves slowly in water, forming a soln. which is slightly hydrolyzed. According to P. T. Cleve, the aq. soln. obtained by dissolving the oxide in hydrobromic acid forms yellow deliquescent crystals of **hexahydrated samarium bromide**, $\text{SaBr}_3 \cdot 6\text{H}_2\text{O}$, of sp. gr. 2.971; it also forms with auric bromide, **auric hexabromosamarate**, $\text{SaBr}_3 \cdot \text{AuBr}_3 \cdot 10\text{H}_2\text{O}$.

The iodides of the rare earths have been studied even less than the bromides. L. T. Lange¹¹ made colourless crystals of **enneahydrated cerium iodide**, $\text{CeI}_3 \cdot 9\text{H}_2\text{O}$, by evaporating in vacuo over sulphuric acid a soln. of cerium dioxide in hydriodic acid. The crystals turn brown when exposed to air owing to the separation of iodine.

Lanthanum iodide has been reported, and the equilibrium conditions in the presence of iodine whereby a polyiodide is produced, have been studied by R. G. van Name and W. G. Brown, but T. F. Frerichs and E. F. Smith prepared **zinc dodecaiodolanthanate**, $2\text{LaI}_3 \cdot 3\text{ZnI}_2 \cdot 27\text{H}_2\text{O}$, in hygroscopic needle-like crystals. C. A. Matignon has prepared **praseodymium iodide**, PrI_3 , and also **neodymium iodide**, NdI_3 , by the action of hydrogen iodide on the anhydrous chlorides heated just below their melting points. According to C. A. Matignon, neodymium iodide melts to a black liquid, which at a higher temp. becomes transparent owing to the formation of an allotropic modification. C. A. Matignon also made **samarium triiodide**, SaI_3 , in a similar manner to the neodymium salt. The orange-yellow crystals become deeper in colour as the temp. is raised and pass through orange, brick-red, and finally, at 800° , black. When heated to a high temp. in a stream of hydrogen iodide, yellow **samarium diiodide**, SaI_2 , is formed. This compound dissolves in water, forming a brown soln. which, on standing, loses its colour and deposits gelatinous samarium hydroxide.

REFERENCES.

¹ H. Moissan, *Compt. Rend.*, **122**, 357, 1896; **123**, 148, 1896; **131**, 595, 924, 1900; W. K. van Haagen and E. F. Smith, *Journ. Amer. Chem. Soc.*, **33**, 1504, 1911; A. Hirsch, *Journ. Ind. Eng. Chem.*, **3**, 885, 1911; B. Brauner, *Ber.*, **11**, 1944, 1881; *Journ. Chem. Soc.*, **41**, 68, 1882; E. Rimbach and H. F. C. Kilian, *Liebig's Ann.*, **368**, 101, 1909; N. A. Puschin and A. V. Baskoff, *Journ. Russ. Phys. Chem. Soc.*, **45**, 82, 1913; S. Jolin, *Bull. Soc. Chim.*, (2), **21**, 533, 1874; P. T. Cleve, *ib.*, (2), **21**, 196, 1874; (2), **29**, 492, 1878; F. Frerichs and F. Smith, *Liebig's Ann.*, **191**, 331, 1878; J. Popovici, *Ber.*, **41**, 634, 1908; T. Vogt, *Neues Jahrb. Min.*, ii, **9**, 1914; W. F. Smith, *Ueber Didymium und Lanthanum*, Göttingen, 1876; B. Brauner, *Monatsh.*, **3**, 24, 1883; P. R. Bassett, *Trans. Amer. Electrochem. Soc.*, **44**, —, 1923.

² C. A. Matignon, *Ann. Chim. Phys.*, (8), **8**, 243, 364, 402, 426, 433, 440, 1906; F. Bourion, *ib.*, (8), **20**, 547, 1910; (8), **21**, 49, 1910; G. Urbain, *ib.*, (7), **19**, 222, 1900; C. A. Matignon, *Compt. Rend.*, **133**, 289, 1901; **134**, 427, 1308, 1902; **140**, 1181, 1339, 1637, 1905; M. Barre, *ib.*, **158**, 1017, 1913; C. A. Matignon and F. Bourion, *ib.*, **138**, 631, 1904; E. Demarçay, *ib.*, **104**, 111, 1887; H. Quantin, *ib.*, **104**, 223, 1887; **106**, 1074, 1888; C. A. Matignon and M. Delépine, *ib.*, **132**, 37, 1901; H. Moissan, **122**, 357, 1896; **131**, 595, 924, 1900; H. Moissan and A. Étard, *ib.*, **122**, 573, 1895; A. Job, *ib.*, **126**, 246, 1898; E. Chauvenet, *ib.*, **152**, 87, 1911; P. Didier, *ib.*, **101**, 882, 1885; *Ann. École Norm.*, (3), **4**, 65, 1887; A. Duboin, *ib.*, (3), **5**, 416, 1888; H. C. Oersted, *Cøfvers. Danske Vid. Selsk. Førh.*, **15**, 1825; F. Zambonini, *Zeit. Kryst.*, **58**, 226, 1923; C. Baskerville, *Science*, (2), **50**, 443, 1919; H. Arnold, *Zeit. Elektrochem.*, **24**, 137, 1918; C. Erk, *Zeit. Chem.*, (2), **7**, 106, 1871; *Zeit. anal. Chem.*, **10**, 509, 1871; *Jena Zeit.*, **6**, 299, 1871; E. H. Ducloux, *Anal. Assoc. Quim. Argentina*, **9**, 215, 1921; F. Wöhler, *Liebig's Ann.*, **144**, 251, 1867; A. Beringer, *ib.*, **42**, 134, 1842; W. Hisinger and J. J. Berzelius, *Gehlen's Ann.*, **2**, 897, 1804; L. N. Vauquelin, *ib.*, **5**, 189, 1805; W. Hisinger, *Schweigger's Journ.*, **17**, 424, 1816; *Ann. Chim. Phys.*, (1), **94**, 108, 1815; C. G. Mosander, *Kastner's Arch.*, **10**, 470, 1827; *Pogg. Ann.*, **11**, 406, 1827; J. H. Hildebrand, *Journ. Amer. Chem. Soc.*, **35**, 847, 1913; A. Fock, *Zeit. Kryst.*, **22**, 32, 1894; T. Lange, *Journ. prakt. Chem.*, (1), **82**, 129, 1861; R. J. Meyer and M. Koss, *Ber.*, **35**, 3740, 1902; *Zeit. anorg. Chem.*, **86**, 271, 1914; H. G. Denham, *ib.*, **57**, 375, 1908; G. P. Baxter and H. C. Chapin, *Journ. Amer. Chem. Soc.*, **33**, 1, 1911; G. P. Baxter and O. J. Stewart, *ib.*, **37**, 516, 1915; A. M. Jefferson, *ib.*, **24**, 540, 1902; B. L. Hartwell, *ib.*, **25**, 1123, 1903; R. Hermann, *Journ. prakt. Chem.*, (2), **82**, 385, 1861; L. Meyer, *Ber.*, **20**, 681, 1887; H. Robinson, *Proc. Roy. Soc.*, **37**, 150, 1884; *Chem. News*, **50**, 251, 1884; F. Hillebrand and A. Norton, *Pogg. Ann.*, **155**, 623, 1875; O. Pettersson, *Zeit. anorg. Chem.*, **4**, 1, 1893; *Ber.*, **28**, 2419, 1895; W. Muthmann and L. Stützel, *ib.*, **32**, 3413, 1899; K. A. Hofmann and K. Höschele, *ib.*, **47**, 238, 1914; G. A. Barbieri and F. Calzolari, *Atti Accad. Lincei*, (5), **20**, i, 164, 1911; A. B. Schiötz, *Zeit. Elektrochem.*, **27**, 521, 1921; W. Heap and E. Newbery, *Brit. Pat. No.* 130626, 1918.

³ F. Wöhler, *Liebig's Ann.*, **144**, 251, 1867; A. Beringer, *ib.*, **42**, 134, 1842; W. Hisinger and J. J. Berzelius, *Gehlen's Ann.*, **2**, 897, 1804; L. N. Vauquelin, *ib.*, **5**, 189, 1805; J. J. Berzelius, *Kastner's Arch.*, **10**, 470, 1827; *Pogg. Ann.*, **11**, 406, 1827; W. Hisinger, *Schweigger's Journ.*, **17**, 424, 1816; *Ann. Chim. Phys.*, (1), **94**, 108, 1815; J. C. G. de Marignac, *ib.*, (4), **30**, 67, 1873; C. G. Mosander, *Kastner's Arch.*, **10**, 470, 1827; *Pogg. Ann.*, **11**, 406, 1827; L. M. Dennis and W. L. Magee, *Zeit. anorg. Chem.*, **7**, 250, 1894; A. S. Eakle, P. Groth's *Chemische Krystallographie*, Leipzig, **1**, 252, 1906; A. Fock, *Zeit. Kryst.*, **22**, 32, 1894; T. Lange, *Journ. prakt. Chem.*, (1), **82**, 129, 1861; M. Holzmann, *ib.*, (1), **84**, 76, 1861; S. Jolin, *Bull. Soc. Chim.*, (2), **21**, 533, 1874; J. E. Ahlen, *ib.*, (2), **27**, 365, 1876; P. T. Cleve, *ib.*, (2), **21**, 196, 1874; R. J. Meyer and M. Koss, *Ber.*, **35**, 3740, 1902; L. Meyer, *ib.*, **20**, 681, 1887; L. F. Nilson, *ib.*, **9**, 1056, 1876; F. Bourion, *Ann. Chim. Phys.*, (8), **20**, 547, 1910; (8), **21**, 49, 1910;

C. A. Matignon and F. Bourion, *Compt. Rend.*, **138**, 631, 1904; C. A. Matignon, *ib.*, **140**, 1181, 1339, 1905; C. A. Matignon and M. Delépine, *ib.*, **132**, 37, 1901; M. Barre, *ib.*, **156**, 1017, 1913; E. Demarçay, *ib.*, **104**, 223, 1887; **106**, 1074, 1888; P. Didier, *ib.*, **101**, 882, 1885; *Ann. École Norm.*, (3), **4**, 65, 1887; A. Duboin, *ib.*, (3), **5**, 416, 1888; H. Robinson, *Proc. Roy. Soc.*, **37**, 150, 1884; *Chem. News*, **50**, 251, 1884; H. Topsøe, *Bihang. Svenska Vet. Akad. Handl.*, **2**, 5, 1875; C. Söderström, *Zeit. Kryst.*, **36**, 194, 1902; R. J. Meyer, *Zeit. anorg. Chem.*, **86**, 271, 1914; H. G. Denham, *ib.*, **57**, 375, 1908; R. J. Meyer and O. Hauser, *Die chemische Analyse der seltenen Erden*, Stuttgart, **34**, 1912; A. B. Schiotz, *Zeit. Elektrochem.*, **27**, 521, 1921; *Tids. Kem.*, **17**, 213, 228, 1920; C. Erk, *Jena Zeit.*, **6**, 299, 1871; *Zeit. Chem.*, **2**, 7, 106, 1871; *Zeit. anal. Chem.*, **10**, 509, 1871; J. H. Hildebrand, *Journ. Amer. Chem. Soc.*, **35**, 847, 1913; E. H. Ducloux, *Anal. Asoc. Quim. Argentina*, **9**, 215, 1921; F. Hillebrand and A. Norton, *Pogg. Ann.*, **155**, 623, 1875; H. Arnold, *Zeit. Elektrochem.*, **24**, 137, 1918; F. Zambonini, *Journ. Chem. Soc.*, **110**, ii, 249, 1916; G. L. Clark, *Amer. Journ. Science*, (5), **7**, 6, 1924; W. Biltz and E. Meinecke, *Zeit. anorg. Chem.*, **131**, 1, 1923.

⁴ I. Koppel, *Zeit. anorg. Chem.*, **18**, 305, 1898; A. J. Grant and C. James, *Journ. Amer. Chem. Soc.*, **37**, 2652, 1915; H. Arnold, *Zeit. Elektrochem.*, **24**, 137, 1918.

⁵ C. G. Mosander, *Pogg. Ann.*, **46**, 648, 1814; **47**, 207, 1814; **56**, 504, 1817; M. Choubine, *Journ. prakt. Chem.*, (1), **26**, 443, 1842; *H. Zschiesche, ib.*, (2), **107**, 65, 1869; J. Watts, *Journ. Chem. Soc.*, **2**, 131, 1850; R. Hermann, *ib.*, (1), **82**, 385, 1861; A. Beringer, *Liebig's Ann.*, **42**, 134, 1842; H. Ley, *Zeit. phys. Chem.*, **30**, 193, 1899; J. C. G. de Marignac, *Arch. Sciences Genève*, **14**, 201, 1855; *Ann. Mines*, (5), **15**, 272, 1859; P. T. Cleve, *Bull. Soc. Chim.*, (2), **21**, 196, 1874; (2), **22**, 353, 1874; J. E. Ahlen, *ib.*, (2), **27**, 365, 1876; B. S. Hopkins and F. H. Driggs, *Journ. Amer. Chem. Soc.*, **44**, 1929, 1922; W. W. Coblenz, *Investigations of Infra-red Spectra*, Washington, **6**, 51, 1908; R. Meyer and M. Koss, *Ber.*, **35**, 2622, 1902; F. Frerichs, *ib.*, **7**, 798, 1874; C. A. Matignon, *Compt. Rend.*, **133**, 289, 1901; *Ann. Chim. Phys.*, (8), **8**, 364, 1906; F. Bourion, *ib.*, (8), **19**, 547, 1910; (8), **21**, 49, 1910; B. J. Dryfuss and C. G. L. Wolf, *Amer. Journ. Physiol.*, **16**, 314, 1906; F. Frerichs and F. Smith, *Liebig's Ann.*, **191**, 356, 1878; L. F. Nilson, *Ber.*, **9**, 1056, 1142, 1876; P. Pfeiffer and J. von Modolsky, *Zeit. physiol. Chem.*, **85**, 1, 1913; G. A. Barbieri and F. Calzolari, *Atti Accad. Lincei*, (5), **20**, i, 164, 1911; O. Pettersson, *Zeit. anorg. Chem.*, **4**, 1, 1893; A. Voigt and W. Biltz, *ib.*, **133**, 277, 1924; W. Biltz, *ib.*, **133**, 306, 1924; R. J. Meyer, *ib.*, **86**, 257, 1914; C. Söderström, *Zeit. Kryst.*, **36**, 194, 1902.

⁶ J. C. G. de Marignac, *Ann. Mines*, (5), **15**, 272, 1859; *Liebig's Ann.*, **88**, 237, 1853; F. T. Frerichs and E. F. Smith, *ib.*, **191**, 340, 1878; P. T. Cleve, *Bull. Soc. Chim.*, (2), **21**, 195, 1874; J. E. Ahlen, *ib.*, (2), **27**, 206, 1877; L. F. Nilson, *Ber.*, **9**, 1147, 1876; F. Frerichs, *ib.*, **7**, 709, 1874; C. A. Matignon, *Compt. Rend.*, **140**, 1339, 1905; **134**, 427, 1902; *Ann. Chim. Phys.*, (8), **8**, 386, 1906; F. Bourion, *ib.*, (8), **21**, 49, 1910; G. P. Baxter and O. J. Stewart, *Journ. Amer. Chem. Soc.*, **37**, 516, 1915; T. Vogt, *Neues Jahrb. Min.*, ii, **9**, 1914; B. Brauner, *Proc. Chem. Soc.*, **17**, 66, 1901; C. von Scheele, *Zeit. anorg. Chem.*, **17**, 310, 1898; R. J. Meyer and M. Koss, *Ber.*, **35**, 2622, 1902; B. J. Dryfuss and C. G. L. Wolf, *Amer. Journ. Physiol.*, **85**, 1, 1913; C. Söderström, *Zeit. Kryst.*, **36**, 194, 1902; K. A. Hofmann and K. Höschele, *Ber.*, **47**, 238, 1914; J. O. Perrine, *Phys. Rev.*, (2), **22**, 48, 1923; A. Voigt and W. Biltz, *Zeit. anorg. Chem.*, **133**, 277, 1924; W. Biltz, *ib.*, **133**, 306, 1924.

⁷ C. A. Matignon and R. Trannoy, *Compt. Rend.*, **142**, 1042, 1906; C. A. Matignon, *ib.*, **133**, 289, 1901; **140**, 1637, 1905; **141**, 53, 1905; *Ann. Chim. Phys.*, (8), **8**, 243, 1906; F. Bourion, *ib.*, (8), **21**, 49, 1910; R. F. Meyer and M. Koss, *Ber.*, **35**, 2622, 1902; K. A. Hofmann and K. Höschele, *ib.*, **47**, 238, 1914; G. P. Baxter and H. C. Chapin, *Journ. Amer. Chem. Soc.*, **33**, 1, 1911; B. J. Dryfuss and C. G. L. Wolf, *Amer. Journ. Physiol.*, **85**, 1, 1913; R. Trannoy, *Ann. Chim. Phys.*, (8), **8**, 284, 1906; G. L. Clark, *Amer. Journ. Science*, (5), **7**, 1, 1924; A. Voigt and W. Biltz, *Zeit. anorg. Chem.*, **133**, 277, 1924; W. Biltz, *ib.*, **133**, 306, 1924.

⁸ C. A. Matignon, *Compt. Rend.*, **128**, 103, 1899.

⁹ C. A. Matignon, *Compt. Rend.*, **134**, 1308, 1902; *Ann. Chim. Phys.*, (8), **8**, 402, 1906; F. Bourion, *ib.*, (8), **21**, 49, 1910; C. A. Matignon and R. Trannoy, *ib.*, (8), **8**, 407, 1906; *Compt. Rend.*, **140**, 141, 1905; C. A. Matignon and E. Cazes, *ib.*, **142**, 83, 1906; *Ann. Chim. Phys.*, (8), **8**, 417, 1906; K. A. Hofmann and K. Höschele, *Ber.*, **47**, 238, 1923; O. J. Stewart and C. James, *Journ. Amer. Chem. Soc.*, **39**, 2605, 1917; P. T. Cleve, *Bull. Soc. Chim.*, (2), **43**, 53, 1885; E. Fouard, *Compt. Rend.*, **142**, 1163, 1906; G. L. Clark, *Amer. Journ. Science*, (5), **7**, 1, 1924.

¹⁰ W. Crookes, *Phil. Trans.*, **209**, A, 15, 1908; C. A. Matignon, *Ann. Chim. Phys.*, (8), **8**, 364, 1906; F. Bourion, *Compt. Rend.*, **145**, 243, 1907; W. Muthmann and L. Stützel, *Ber.*, **32**, 3413, 1899; M. Barre, *Bull. Soc. Chim.*, (4), **11**, 433, 1912; S. Jolin, *ib.*, (2), **21**, 533, 1874; H. Robinson, *Proc. Roy. Soc.*, **37**, 150, 1884; *Chem. News*, **50**, 251, 1884; G. T. Morgan and E. Cahen, *Journ. Chem. Soc.*, **91**, 475, 1907; F. T. Frerichs and E. F. Smith, *Liebig's Ann.*, **191**, 331, 1878; P. T. Cleve, *Bull. Soc. Chim.*, (2), **43**, 53, 359, 1885; C. von Scheele, *Zeit. anorg. Chem.*, **17**, 310, 1898; **18**, 352, 1898; J. Dehnicke, *Beiträge zur Kenntnis der Verbindungen des dreiwertigen Ceriums und Lanthans*, Berlin, 1904

¹¹ L. T. Lange, *Journ. prakt. Chem.*, (1), **82**, 129, 1861; F. T. Frerichs and E. F. Smith, *Liebig's Ann.*, **191**, 331, 1878; R. G. van Name and W. G. Brown, *Amer. Journ. Science*, (4), **44**, 105, 1917; C. A. Matignon, *Compt. Rend.*, **140**, 1637, 1905; *Ann. Chim. Phys.*, (8), **8**, 402, 1906; C. A. Matignon and E. Cazes, *ib.*, (8), **8**, 417, 1906.

§ 15. The Sulphides of the Cerium Metals

The sulphides of the rare earths have not been prepared in the wet way, *i.e.* by the action of hydrogen sulphide, or of ammonium or alkali sulphide on aq. soln. of the salts. When ammonium or an alkali sulphide is added to an aq. soln. of a salt of the rare earths, the hydroxide is precipitated. Hydrogen sulphide has no perceptible action. In this respect, the rare earth metals resemble aluminium and chromium; but unlike these elements, the cerium metals furnish sulphides which are fairly stable in contact with water at ordinary temp. The normal sulphides are of the sesquisulphide type, R_2S_3 ; but they also form polysulphides, and some oxysulphides have been reported.

C. G. Mosander¹ made **cerium sulphide**, Ce_2S_3 , by heating the metal in the vapour of sulphur, and by passing the vapour of carbon disulphide over heated cerous carbonate. A. Beringer substituted ceric oxide in place of the carbonate. F. T. Frerichs and E. F. Smith also prepared cerium sulphide by this process. P. Didier prepared this sulphide by passing a current of dry hydrogen sulphide over a fused mixture of sodium chloride and anhydrous cerium chloride, and extracting the soluble salts with cold water. According to C. G. Mosander, when a mixture of ceric oxide (or cerium chloride) with three times its weight of potassium polysulphide (liver of sulphur), is strongly heated in a covered vessel for half an hour, and the potassium sulphide removed by leaching with water, small crystalline scales of cerium sulphide are formed; they have a yellow or yellowish-green colour like mosaic gold. W. Muthmann and L. Stützel did not succeed in making the gold-yellow crystalline sulphide by this process; and J. Sterba said that C. G. Mosander's crystalline sulphide was really crystalline ferric sulphide. A. Beringer claimed to have made a crystalline variety resembling C. G. Mosander's cerium sulphide by using sodium polysulphide in place of potassium polysulphide; but this is probably a similar mal-observation.

C. G. Mosander also prepared **lanthanum sulphide**, La_2S_3 , by the carbon disulphide process. T. Lange, R. Hermann, and F. T. Frerichs and E. F. Smith also prepared lanthanum sulphide by the processes employed for cerium sulphide. W. Muthmann and L. Stützel prepared it by a process similar to that employed for cerium sulphide, namely, by heating the anhydrous sulphate in a stream of hydrogen sulphide. W. Biltz showed that the disulphide, LaS_2 , is first formed, and if the temp. exceeds 650° , the latter compound is converted to the sesquisulphide. F. T. Frerichs and E. F. Smith prepared **didymium sulphide** by C. G. Mosander's carbon disulphide process. W. Muthmann and L. Stützel prepared **praseodymium sulphide**, Pr_2S_3 , and **neodymium sulphide**, Nd_2S_3 , by the same process as that employed for the lanthanum and cerium sulphides. W. Biltz observed that as in the case of lanthanum, praseodymium disulphide is formed if the temp. be not high enough. H. Moissan found that if sulphur vapour be passed over praseodymium carbide at 1000° , a mixture of the sulphide and graphite is formed. H. Erdmann and F. Wirth prepared **samarium sulphide**, Sa_2S_3 , by heating the anhydrous sulphate in a stream of dry hydrogen sulphide. H. Moissan made samarium sulphide by the action of sulphur vapour or hydrogen sulphide on samarium carbide heated to a high temp.; and C. A. Matignon made it by passing dry hydrogen sulphide on heated anhydrous samarium chloride.

Cerium sulphide, as prepared by P. Didier, was a porous mass, and vermilion or black according to the temp. of preparation; the crystals he made were red and translucent. W. Biltz said cerium sesquisulphide is red. W. Muthmann and L. Stützel's process furnishes black, or brownish-black, pulverulent cerium sulphide; yellow lanthanum sulphide; chocolate-brown praseodymium sulphide; and olive-green neodymium sulphide; H. Erdmann and F. Wirth's samarium sulphide was a yellow powder. P. Didier's cerium sulphide had a sp. gr. 5.1, and W. Muthmann and L. Stützel's, 5.020 at 11° , while the lanthanum sulphide had a sp. gr. 4.9108

at 11°; praseodymium sulphide, 5.042 at 11°; and neodymium sulphide, 5.179 at 11°; and H. Erdmann and F. Wirth's samarium sulphide, 3.7. All agree that the sulphides are fairly stable in air at ordinary temp., but if heated in air, they burn with a blue flame, forming sulphur dioxide, and a mixture of oxide and sulphate is formed, or, as C. G. Mosander expressed it with respect to cerium sulphide, the product of the combustion is a basic cerium sulphate. W. Muthmann and L. Stützel found that finely divided cerium sulphide ignites spontaneously in air at ordinary temp. J. Sterba said that the spontaneous ignition occurs only when cerium oxysulphide has been produced by using moist hydrogen sulphide. All agree that the sulphides are slowly hydrolyzed by hot water with the evolution of hydrogen sulphide; the hydrolysis is fastest with lanthanum sulphide. The sulphides are dissolved by dil. acids with the evolution of hydrogen sulphide. Cerium sulphide, said P. Didier, dissolves even in acetic acid without the separation of sulphur; and when treated with alkali sulphide it undergoes alteration, but does not become crystalline. C. G. Mosander said that a soln. of potassium hydroxide converts cerium sulphide into a green powder which appears to be an oxysulphide. W. Muthmann and L. Stützel found that dry hydrogen chloride or bromide passed over the dry sulphide furnishes the corresponding cerium, lanthanum, praseodymium, or neodymium halide. According to C. G. Mosander, when cerium sulphide is heated in chlorine gas it is resolved into cerium and sulphur chlorides, but it is not altered by heating it in the vapour of iodine, phosphorus, or potassium.

In 1826, C. G. Mosander said that cerium disulphide had not been isolated, and was known only in combination with electronegative metal sulphides. W. Biltz passed a current of hydrogen sulphide over cerium sulphide at 580°–600°, and found that in about 20 hrs., 2 to 3 grms. of the sesquisulphide were converted into **cerium disulphide**, Ce_2S_4 . The progress of the formation of the polysulphide is best followed by weighing from time to time, but since cerium oxysulphide has also been obtained, of approximately the same weight per mol, a complete analysis is necessary to characterize the compound. Cerium disulphide is a dark yellowish-brown crystalline powder, moderately stable in air and in cold water. A 17.7 per cent. soln. of hydrochloric acid dissolves the disulphide in the cold, and an odour of hydrogen persulphide is perceptible, and sulphur is afterwards deposited. This is taken to prove that the disulphide is not a true analogue of the dioxide, but is rather a polysulphide, $Ce_2S_3.S$. The conversion of the disulphide into the sesquisulphide has been examined up to 1200°. The temp. of decomposition is about 720°; the lower sulphide is stable at a red heat, and does not react with hydrogen or nitrogen at that temp., but between 1400° and 1500° it melts and decomposes. The sesquisulphide prepared at 745°, when heated in a current of hydrogen sulphide for thirty hours at 615°, did not reabsorb sulphur.¹ This irreversibility is only apparent, as by heating the disulphide in a current of hydrogen at 400° the sesquisulphide was obtained, and this product reabsorbed 4.2 per cent. sulphur. The heat of soln. of the disulphide, CeS_2 , in hydrochloric acid is 32,500 cal.; that of $CeS_{1.5}$, 37,800 cal. (39,500 cal. from the product prepared at 400°). From these figures, the equation $4CeS_2 = 2Ce_2S_3 + 2S_{(amorp.)} - 18,600$ cal. is calculated. By the use of Nernst's equation for heterogeneous equilibria, the decomposition temp. is calculated to be 793°, whereas that found was roughly 720°.

W. Biltz prepared **lanthanum disulphide**, La_2S_4 , by heating anhydrous lanthanum sulphate at 580°–600° in a current of hydrogen sulphide. The product behaves as a polysulphide, $La_2S_3.S$, and it decomposes when more strongly heated at about 650°. A comparison of the heat of soln. of the two sulphides in hydrochloric acid gives the result $4LaS_2 = 2La_2S_3 + S_{2(gas)} - 43.4$ cal. This gives a theoretical dissociation temp. of 670°, about 100° lower than that of cerium disulphide. The action of hydrogen sulphide on anhydrous praseodymium sulphate results only in the formation of **praseodymium oxysulphide**, Pr_2SO_2 . Sulphides free from oxygen are only obtained in the presence of some cerium. In the same way, cerium is known to assist the formation of praseodymium peroxide. **Praseodymium**

disulphide, PrS_2 , dissociates at a temp. near that of the lanthanum compound. J. J. Berzelius and W. Hisinger mentioned the formation of an apple-green powder of **cerium oxysulphide** by heating cerous carbonate with sulphur, or in a stream of hydrogen sulphide. A little basic sulphate is usually present. Acids decompose the oxysulphide with the evolution of hydrogen sulphide and the separation of sulphur. C. G. Mosander also mentioned cerium oxysulphide—*vide supra*—but W. Muthmann and L. Stützel could not obtain this product. W. Biltz prepared cerium oxysulphide, $\text{Ce}_2\text{S}_{24}\text{OS}$; and J. Sterba also obtained an oxysulphide by using moist instead of dry hydrogen sulphide in the preparation of cerium sulphide.

REFERENCES.

¹ C. G. Mosander, *Svenska Akad. Handl.*, **299**, 1826; *Karsten's Arch.*, **10**, 470, 1827; *Pogg. Ann.*, **11**, 406, 1826; J. J. Berzelius and W. Hisinger, *Gehlen's Ann.*, **2**, 397, 1804; A. Beringer, *Liebig's Ann.*, **42**, 134, 1842; F. T. Frerichs and E. F. Smith, *ib.*, **191**, 331, 1878; O. Popp, *ib.*, **131**, 197, 1864; H. Erdmann and F. Wirth, *ib.*, **361**, 190, 1908; P. Didier, *Compt. Rend.*, **100**, 1461, 1885; **101**, 882, 1885; H. Moissan, *ib.*, **131**, 595, 924, 1900; J. Sterba, *Ann. Chim. Phys.*, (8), **2**, 193, 1904; C. A. Matignon, *ib.*, (8), **8**, 402, 1906; W. Muthmann and L. Stützel, *Ber.*, **32**, 3413, 1899; W. Biltz, *ib.*, **41**, 3341, 1908; *Zeit. anorg. Chem.*, **71**, 427, 1911; R. Hermann, *Journ. prakt. Chem.*, (1), **82**, 385, 1861; T. Lange, *ib.*, (1), **82**, 129, 1861; H. Holm, *Beiträge zur Kenntnis des Cers*, München, 1902.

§ 16. The Sulphates of the Cerium Metals

J. J. Berzelius and W. Hisinger¹ made anhydrous **cerous sulphate**, $\text{Ce}_2(\text{SO}_4)_3$, by dissolving the carbonate in cold dil. sulphuric acid. The hydroxide or oxide can be used; if ceric oxide be used a little reducing agent like hydroquinone is added to reduce ceric to cerous sulphate. P. Berthier dissolved ceric oxide in sulphurous acid. The aq. soln. is evaporated for crystallization, and the crystals are dehydrated by heat. B. Brauner and co-workers, and G. Wyrouboff and A. Verneuil showed that the temp. of dehydration should be 400° – 450° —if it exceeds 500° , the sulphate begins to decompose. E. Löwenstein measured the vap. press. of hydrated cerium sulphate, and found evidence of the existence of the octo-, penta-, tetra-, and di-hydrates. M. Stuart found an efflorescence of cerium sulphate on some graphite from Velland, Travancore. Anhydrous cerium sulphate thus prepared is a white hygroscopic powder. **Anhydrous lanthanum sulphate**, $\text{La}_2(\text{SO}_4)_3$, is also a white hygroscopic powder, and it is prepared in a similar way. B. Brauner and F. Pavlicek, and H. C. Jones showed that the dehydration must be carried out at 600° – 650° , for if the temp. be less, the whole of the water will not be expelled, or some acid sulphate will remain undecomposed. E. Löwenstein measured the vap. press. of hydrated lanthanum sulphate, and found evidence of the existence of the ennea-, hexa-, and tri-hydrates. He also obtained the octo-, hexa-, and penta-hydrates of didymium sulphate. The sulphates of the remaining members of the family are hygroscopic powders, and are obtained in a similar manner—**anhydrous praseodymium sulphate**, $\text{Pr}_2(\text{SO}_4)_3$, is light green; **anhydrous neodymium sulphate**, $\text{Nd}_2(\text{SO}_4)_3$, is light red; and **anhydrous samarium sulphate**, $\text{Sa}_2(\text{SO}_4)_3$, is pale yellow; B. D. Keyes and C. James thus describe the preparation of samarium sulphate in the following manner:

Samarium oxalate was ignited and the oxide dissolved in hydrochloric acid. To the cool soln. there was added a little more sulphuric acid than was required to unite with the samarium present, after which the mixture was poured into a large excess of alcohol. The precipitated sulphate was filtered off, washed with alcohol and rendered anhydrous by heating. The anhydrous sulphate was dissolved in water, filtered, and the filtrate evaporated upon the steam-bath. The purified salt was then dried and very finely powdered.

The sp. gr. of anhydrous cerous, lanthanum, and praseodymium sulphates are respectively 3.91, 3.60, and 3.726 at 15.8° . L. F. Nilson and O. Petterson gave for the sp. ht. of anhydrous cerous, lanthanum, and didymium sulphates 0.1168,

0·1182, and 0·1187 between 0° and 100°; and for the corresponding mol. ht., 66·23, 66·90, and 68·96. B. Brauner represented the sp. gr. of soln. of cerous sulphate containing p parts of $Ce_2(SO_4)_3$ in 100 parts of water, at 15°:

p	.	.	2	4	6	8	10	12	14
Sp. gr.	.	.	1·01888	1·03796	1·05691	1·07572	1·09441	1·11296	1·13137

or sp. gr. = 0·999665 + 0·0096401 p + 0·0000166 p^2 . C. von Scheele gave for anhydrous praseodymium sulphate the sp. gr. 3·720. According to G. Wyruboff and A. Verneuil, and B. Brauner and A. Batek, cerous sulphate begins to decompose at 500°, and at a white heat it is completely converted into the dioxide. The other sulphates behave similarly, but lanthanum sulphate resists thermal decomposition better than any of the rare earth sulphates. L. Wöhler and M. Grünzweig measured the dissociation press. of some rare earth sulphates between 800° and 1020° with the idea of obtaining a measure of the basicity of the rare earths. The following represents the partial press., p , of the sulphur trioxide, and the heats of dissociation, Q , at 900°. The values of Q were computed from Nernst's theorem.

	La	Pr	Nd	Sa
Press. of SO ₃ at 900°	2	5·5	6·0	8·0
Heat of dissociation	59·8	57·4	57·2	56·6

E. Wedekind and C. Hausknecht found the at. magnetism of cerous (Ce^{III}) sulphate to be +2200 × 10⁻⁶; ceric (Ce^{IV}) sulphate, +37·5 × 10⁻⁶; lanthanum sulphate, -84 × 10⁻⁶; praseodymium sulphate, +5100 × 10⁻⁶; neodymium sulphate, +5270 × 10⁻⁶. The different observers agree that the rare earth sulphates are completely decomposed only at a white heat; and when heated between 900° and 1000°—L. Wöhler and M. Grünzweig said between 800° and 850°—the products are often called **basic sulphates**, or oxysulphates, and represented by the formula R₂O₃.SO₃, or R₂O₂.SO₄. C. A. Matignon said that **praseodymium dioxysulphate**, Pr₂O₂.SO₄, and **neodymium dioxysulphate**, Nd₂O₂.SO₄, are amorphous powders insoluble in water or cold dil. sulphuric acid, and stable at 1000°; the former is green, the latter pink; **samarium dioxysulphate**, Sa₂O₂.SO₄, has similar properties, and it is pale yellow. L. Wöhler and M. Grünzweig obtained **lanthanum dioxysulphate**, La₂O₂.SO₄, and **cerous dioxysulphate**, Ce₂O₂.SO₄.

L. Pissarjewsky gave for the heats of formation of some rare earth sulphates 2{Ce(OH)₃.O.OH} + 3H₂SO_{4aq.} = Ce₂(SO₄)_{3aq.} + H₂O_{2aq.} + O₂ + 29·95 Cals.; C. A. Matignon, La₂O₃ + 3H₂SO₄ = La₂(SO₄)₃ + 3H₂O + 138·2 Cals.; and La₂(SO₄)₃ + Aq. = La₂(SO₄)_{3aq.} + 34·6 Cals.; Pr₂O₃ + 3H₂SO₄ = Pr₂(SO₄)₃ + 3H₂O + 125·7 Cals.; and Pr₂(SO₄)₃ + Aq. = Pr₂(SO₄)_{3aq.} + 36·0 Cals.; 2Nd + 3S + 6O₂ = Nd₂(SO₄)₃ + 928·2 Cals.; 2Nd + 3S + 6O₂ + 8H₂O = Nd₂(SO₄)₃.8H₂O + 946·8 Cals.; Nd₂O₃ + 3H₂SO₄ = Nd₂(SO₄)₃ + 3H₂O + 125·1 Cals.; Nd₂O₃ + 3H₂SO_{4aq.} = Nd₂(SO₄)_{3aq.} + 3H₂O + 106·4 Cals.; Nd₂(SO₄)₃ + Aq. = Nd₂(SO₄)_{3aq.} + 36·5 Cals.; Nd₂(SO₄)₃.5H₂O + Aq. = Nd₂(SO₄)_{3aq.} + 8·3 Cals.; and Nd₂(SO₄)₃.8H₂O + Aq. = Nd₂(SO₄)_{3aq.} + 6·7 Cals.; Sa₂O₃ + 3H₂SO₄ = Sa₂(SO₄)₃ + 3H₂O + 113·8 Cals.; and Sa₂(SO₄)₃ + Aq. = Sa₂(SO₄)_{3aq.} + 38·8 Cals. The electrical conductivities of aq. soln. of cerous sulphate have been determined by A. Aufrecht and K. Holmberg. The eq. conductivities of soln. of a gram eq. of the salts in v litres of water at 25° are as follow:

Ce ₂ (SO ₄) ₃ { v	.	.	33	66	132	264	528	1056
	.	.	45·66	53·71	63·63	74·09	87·17	100·90
La ₂ (SO ₄) ₃ { v	.	.	33·86	67·72	135·44	270·88	541·76	1083·25
	.	.	43·58	50·30	58·49	68·89	80·93	96·26
Pr ₂ (SO ₄) ₃ { v	.	.	3·46	13·84	55·36	110·72	442·88	885·76
	.	.	26·46	36·12	49·14	58·41	67·40	92·70
Nd ₂ (SO ₄) ₃ { v	.	.	33·47	66·94	133·88	267·76	535·52	1071·04
	.	.	40·61	48·15	—	62·23	80·21	95·95
Sa ₂ (SO ₄) ₃ { v	.	.	31·35	62·70	125·40	250·80	501·60	1003·2
	.	.	31·17	43·49	51·59	61·39	72·76	89·24

Those of praseodymium sulphate were measured by H. C. Jones and H. M. Reese, C. von Scheele and A. Aufrecht; those of lanthanum sulphate, by K. Holmberg, A. A. Noyes and J. Johnston, A. Aufrecht; those of neodymium sulphates, by H. C. Jones and H. M. Reese, A. Aufrecht; and those of samarium sulphates, by A. Aufrecht, A. A. Noyes and J. J. Johnston gave for the percentage ionization of soln. of lanthanum sulphate:

v	5	10	20	80	500	∞
Percentage ionization	13.2	15.8	19.10	27.8	45.0	100

A. Aufrecht calculated the degrees of ionization of soln. of neodymium and of praseodymium sulphates from the lowering of the f.p. of aq. soln., and found for $v=2.54$ and 92.61 , the percentage ionization of praseodymium sulphate in aq. soln. was respectively 29 and 88; with soln. of neodymium sulphate, $v=4.65$ and 5.72 , the percentage degree of ionization was 40 and 72 respectively. According to S. H. Katz and C. James, aq. soln. of samarium sulphate are slightly hydrolyzed.

The hydrated forms of these sulphates are best considered in connection with the solubility curves, *i.e.* the equilibrium conditions in connection with the binary system, $R_2(SO_4)_3-H_2O$. F. J. Otto showed that when anhydrous cerous sulphate is sprinkled with water, much heat is evolved, and the mixture cools to a solid mass which dissolves with difficulty. The early observers noted that if a soln. of the salt in cold water be heated, pale red crystals of a hydrate—they thought sesquihydrate—are deposited, and the crystals redissolve as the liquid cools. The solubility of cerous sulphate in cold water is greater than that of magnesium sulphate, and it exhibits a very different behaviour from that shown by the alkaline earth sulphates. The phenomenon is related with that shown by thorium sulphate investigated by H. W. B. Roozeboom. Measurements of the solubility of cerous sulphate in water made by B. Brauner, H. Bührig, F. Wirth, W. Muthmann and H. Rölig, and by

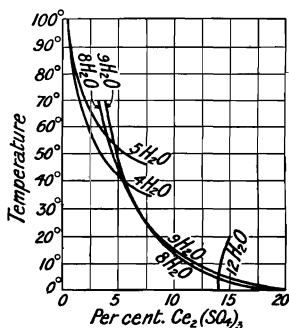

FIG. 19.—Solubility of Cerous Sulphate in Water.

G. Wyruboff, were shown by J. Koppel to be inaccurate. There are at least five definite hydrates, and the ranges of stability and transition points are indicated in Fig. 19. The *dodecahydrate*, $Ce_2(SO_4)_3 \cdot 12H_2O$, was obtained as a mass of felted needle-like crystals, by W. Muthmann and H. Rölig, G. Wyruboff, and J. Koppel, by the evaporation of a sat. soln. of the anhydrous salt, at 0° , over sulphuric acid; by S. Jolin, by evaporating a soln., at 0° , in air; or, by stirring the lower hydrates with ice-cold water. The solubilities of the dodecahydrate at 0° , 18.8° , and 19.2° are respectively 14.20, 14.91, and 15.04 grms. of $Ce_2(SO_4)_3$ per 100 grms. of soln. At 16° , the dodecahydrate slowly passes into the octohydrate, although it is stable in contact with the soln. only between 0° and 3° . The *enneahydrate*, $Ce_2(SO_4)_3 \cdot 9H_2O$, was prepared by C. M. Marx, J. J. Berzelius and W. Hisinger, L. N. Vauquelin, M. H. Klaproth, C. Czudnowitz, R. Hermann, E. H. Kraus, J. C. G. de Marignac, F. J. Otto, G. Wyruboff, etc. According to J. Koppel, the enneahydrate is obtained by the slow evaporation of a sat., but not supersat., soln. of the sulphate at 40° to 45° , and seeding with a crystal of the enneahydrate. If the soln. be not seeded, a mixture of the octo- and ennea-hydrates will be obtained. The percentage solubilities of the enneahydrate, *i.e.* the number of grams of $Ce_2(SO_4)_3$ per 100 grms. of soln., are as follow:

$Ce_2(SO_4)_3$	0°	15°	21°	31.6°	45.6°	50°	60°	65°
	17.35	10.61	8.863	6.686	4.910	4.465	3.73	3.47

The enneahydrate is stable in contact with the soln. between 33° and 41° , Fig. 19. The *octohydrate*, $Ce_2(SO_4)_3 \cdot 8H_2O$, was described by R. Hermann, J. C. G. de Marignac, A. des Cloiseaux, G. Wyruboff, etc. According to J. Koppel, the octohydrate is

obtained by crystallization from soln. between 30° and 70°. The percentage solubility of the octohydrate is :

	0°	15°	20°5'	40°	60°
Ce ₂ (SO ₄) ₃	15·95	9·95	8·69	5·613	3·88

The octohydrate is stable in contact with the soln. between 3° and 33°, Fig. 19, and at the transition point 70°, it passes spontaneously into the pentahydrate. R. Hermann, and S. Jolin reported a *hexahydrate*, but neither W. Muthmann and H. Rölig, nor J. Koppel were able to confirm this. G. Wyrouboff suggested that the alleged hexahydrate is a mixture of the octohydrate and pentahydrate. F. J. Otto, C. Czudnowitz, S. Jolin, R. Hermann, C. Wolf, C. H. Wing, J. Thomsen, W. Muthmann and H. Rölig, etc., made the *pentahydrate*, Ce₂(SO₄)₃·5H₂O, by heating an aq. soln. of cerium sulphate, and pouring off the liquid from the crystals which separate. The percentage solubility is :

	45°	60°	80°	100°5'
Ce ₂ (SO ₄) ₃	8·116	3·145	1·19	0·46

The pentahydrate is stable in contact with the soln. between 56° and 100·5°, Fig. 19. G. Wyrouboff noticed that the crystals of the octohydrate become opaque at 100° or more slowly on a summer's day, owing to the formation of a *tetrahydrate*, Ce₂(SO₄)₃·4H₂O. The crystals were obtained by J. Koppel by heating the enneahydrate with a little water at 70° or by evaporating a one per cent. soln. on the water-bath, and sowing with crystals of the tetrahydrate. The percentage solubility is :

	35°	40°	50°	65°	82°	100°5'
Ce ₂ (SO ₄) ₃	7·8	5·71	3·31	1·85	0·98	0·42

The tetrahydrate is stable in contact with a soln. between 41° and 100·5°.

According to W. Ostwald, the solubility of the different solids which a substance can form with the same solvent in corresponding soln. is inversely as their stability, so that the most stable form has the smallest solubility, and the least stable form the greatest solubility. Suppose that at a given temp., the stable octohydrate had a greater solubility than the labile pentahydrate, then a sat. soln. of the latter could still dissolve some of the former. Suppose that a soln., saturated with respect to the octohydrate, and supersaturated with the pentahydrate, be sown with the pentahydrate, that hydrate separates out until the soln. is sat. with respect to the pentahydrate. It is thus possible to convert the octohydrate into the pentahydrate without the consumption of energy. This, however, is contrary to the original assumption that the pentahydrate is the labile form, and hence the solubility of the pentahydrate must be greater than that of the octohydrate. J. Koppel has given a general demonstration of the original proposition. The solubility determinations by J. Koppel are in agreement with this rule, but this is not the case with the determinations of W. Muthmann and H. Rölig.

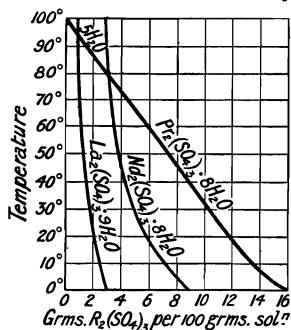

FIG. 20.—The Solubility of Lanthanum, Neodymium, and Praseodymium Sulphates.

C. F. Rammelsberg, P. A. Bolley, and C. G. Mosander prepared crystals of lanthanum sulphate. The last-named found that 100 parts of water dissolve 16·67 parts of *enneahydrated lanthanum sulphate*, La₂(SO₄)₃·9H₂O, at 2°; 2·35 parts at 23°; and 1·89 parts at 100°. W. Muthmann and H. Rölig gave for the percentage solubility :

	0°	14°	30°	50°	75°	100°
La ₂ (SO ₄) ₃	2·91	2·53	1·86	1·47	0·95	0·68

with the enneahydrate as solid phase, Fig. 20. The enneahydrate is readily made by warming a 15 per cent. ice-cold soln. of lanthanum sulphate to 30°. According

to B. Brauner and F. Pavlicek, fine needles of the *hexadecahydrate*, $\text{La}_2(\text{SO}_4)_3 \cdot 16\text{H}_2\text{O}$, separate from the ice-cold sat. soln. This hydrate is unstable and decomposes at 0° ; F. T. Frerichs and E. F. Smith said that the *hexahydrate*, $\text{La}_2(\text{SO}_4)_3 \cdot 6\text{H}_2\text{O}$, separates from a strongly acid soln. of lanthanum sulphate. According to G. Eberhard, and C. von Scheele, 100 parts of water dissolve 23.64 parts of praseodymium sulphate at 0° ; and 17.7 parts at 20° . W. Muthmann and H. Rölig found the percentage solubility to be:

	0°	18°	35°	55°	75°	85°	95°
$\text{Pr}_2(\text{SO}_4)_3$	16.5	12.3	9.4	6.6	4.1	1.5	1.0
Solid phase	$\text{Pr}_2(\text{SO}_4)_3 \cdot 3\text{H}_2\text{O}$					$\text{Pr}_2(\text{SO}_4)_3 \cdot 5\text{H}_2\text{O}$	

The results are plotted in Fig. 20. C. von Scheele found the hydrate, $\text{Pr}_2(\text{SO}_4)_3 \cdot 15\frac{1}{2}\text{H}_2\text{O}$, to be formed by the crystallization of a dil. soln. at ordinary temp., and W. Muthmann and H. Rölig, the *dodecahydrate*, $\text{Pr}_2(\text{SO}_4)_3 \cdot 12\text{H}_2\text{O}$, at temp. in the vicinity of 0° , and it resembles the corresponding cerium sulphate; at ordinary temp. it passes into the *octohydrate*, $\text{Pr}_2(\text{SO}_4)_3 \cdot 8\text{H}_2\text{O}$, which separates from aq. soln. between 0° and 75° . Near 75° , it changes to the *pentahydrate*, $\text{Pr}_2(\text{SO}_4)_3 \cdot 5\text{H}_2\text{O}$, which crystallizes from the soln. between 90° and 100° . B. Brauner mentioned a *hexahydrate*, $\text{Pr}_2(\text{SO}_4)_3 \cdot 6\text{H}_2\text{O}$, but this has not been confirmed. W. Muthmann and H. Rölig found the percentage solubility of neodymium sulphate to be:

	0°	18°	30°	50°	80°	108°
$\text{Nd}_2(\text{SO}_4)_3$	8.7	6.6	4.7	3.5	2.6	2.2

The solid phase is the *octohydrate*, $\text{Nd}_2(\text{SO}_4)_3 \cdot 8\text{H}_2\text{O}$, Fig. 20. C. A. Matignon mentioned a *pentahydrate*, $\text{Nd}_2(\text{SO}_4)_3 \cdot 5\text{H}_2\text{O}$, but this has not been confirmed. The octohydrate, $\text{Sa}_2(\text{SO}_4)_3 \cdot 8\text{H}_2\text{O}$, is the only known hydrate of samarium sulphate. F. Wirth gave for the percentage solubility of octohydrated samarium sulphate, 3.426 grms. of anhydrous sulphate in 100 grms. of liquid at 25° . F. Wirth gives for the percentage solubilities, *i.e.* the number of grams of the anhydrous sulphate in 100 grms. of soln. at 25° , the following:

$\text{La}_2(\text{SO}_4)_3 \cdot 9\text{H}_2\text{O}$ 2.483	$\text{Ce}_2(\text{SO}_4)_3 \cdot 8\text{H}_2\text{O}$ 7.600	$\text{Pr}_2(\text{SO}_4)_3 \cdot 8\text{H}_2\text{O}$ 11.110	$\text{Nd}_2(\text{SO}_4)_3 \cdot 8\text{H}_2\text{O}$ 5.30	$\text{Sa}_2(\text{SO}_4)_3 \cdot 8\text{H}_2\text{O}$ 3.426
---	---	--	--	---

The crystals of the dodecahydrates have not been obtained in a form suitable for measurement. The hexagonal bipyramidal crystals of enneahydrated cerium sulphate were measured by J. C. G. de Marignac, and E. H. Kraus; the former gave for the axial ratio $a : c = 1 : 0.73100$; and the latter, $1 : 0.72958$. The crystals of enneahydrated lanthanum sulphate were measured by J. C. G. de Marignac, H. Töpsöe, and E. H. Kraus. They are isomorphous with those of the corresponding cerium salt, and, according to the last-named, have the axial ratio $a : c = 1 : 0.7356$. E. H. Kraus examined the corrosion figures of both salts; and showed that the double refraction is feebly positive. H. Töpsöe gave 2.827 for the sp. gr. of the lanthanum salt, and E. H. Kraus, 2.821. G. Wyruboff gave 2.841 for the sp. gr. of the cerium salt, and E. H. Kraus, 2.831. P. T. Cleve gave 3.898 for the sp. gr. of the samarium salt at 18.3° .

The hydrated crystals and aq. soln. of cerous and lanthanum sulphates are colourless; those of praseodymium sulphate are green; those of neodymium sulphate are rose-red; and those of samarium sulphate are yellow. J. C. G. de Marignac regarded the crystals of octohydrated cerium sulphate as combinations of bipyramidal rhombic crystals; B. Brauner, and A. des Cloizeaux agreed with this, but G. Wyruboff showed that the crystals are pseudorhombic, and are really twinned triclinic crystals, devoid of all elements of symmetry, with axial ratios $a : b : c = 1.0650 : 1.1144$, and $\alpha = 90^\circ 52'$, $\beta = 90^\circ 40'$, and $\gamma = 91^\circ 45'$. The double refraction is strongly negative. G. Wyruboff gave 2.886 for the sp. gr. of the crystals. Octohydrated cerous sulphate is dimorphous. C. F. Rammelsberg treated a soln. of cerosceric sulphate with hot water; the filtrate from the basic ceric sulphate furnished monoclinic prismatic crystals of octohydrated cerous

sulphate with the axial ratios $a : b : c = 2.9398 : 1 : 2.0302$, and $\beta = 117^\circ 15'$. E. H. Kraus, B. Brauner, and H. Dufet examined the crystals of octohydrated praseodymium sulphate. The monoclinic prisms, said E. H. Kraus, have the axial ratios $a : b : c = 2.9863 : 1 : 1.9995$, and $\beta = 118^\circ 0'$; he also studied the corrosion figures. E. H. Kraus gave 2.819 for the sp. gr.; and C. von Scheele, 2.882. The double refraction is feebly positive, and the crystals exhibit a feeble anomalous dispersion. H. Dufet gave for the indices of refraction for Li-, Na-, and Tl-light respectively $\alpha = 1.5366, 1.5399$, and 1.5430 ; $\beta = 1.5459, 1.5494$, and 1.5525 ; and $\gamma = 1.5573, 1.5607$, and 1.5641 . He also studied the absorption spectrum of the salt. For monoclinic prismatic crystals of octohydrated neodymium sulphate H. Dufet gave the axial ratios $a : b : c = 2.9835 : 1 : 1.9968$, and $118^\circ 8.5'$. B. Brauner also studied the crystals. E. H. Kraus gave 2.850 for the sp. gr. The double refraction is positive, and it exhibits an anomalous dispersion. H. Dufet gave for the indices of refraction for Li-, Na-, and Tl-light, respectively $\alpha = 1.5379, 1.5413$, and 1.5441 ; $\beta = 1.5469, 1.5505$, and 1.5534 ; and $\gamma = 1.5583, 1.5621$, and 1.5652 . The pleochroism is weak. H. Dufet studied the absorption spectrum of the salt. H. Dufet found the axial ratios of the monoclinic prisms of octohydrated samarium sulphate to be $a : b : c = 3.0030 : 1 : 2.0022$, and $\beta = 118^\circ 16'$. A. Fock also examined the crystals. According to S. H. Katz and C. James, the sp. gr. is 2.930 at 18.3° . The double refraction is positive. H. Dufet gave for the indices of refraction for Li-, Na-, and Tl-light respectively $\alpha = 1.5395, 1.5427$, and 1.5458 ; $\beta = 1.5486, 1.5519$, and 1.5551 ; and $\gamma = 1.5594, 1.5629$, and 1.5663 . He also studied the absorption spectrum. The monoclinic crystals of the octohydrates of praseodymium, neodymium, samarium, gadolinium, yttrium, and erbium are isomorphous with one another, and also with the corresponding selenates, and with the monoclinic form of octohydrated cerous sulphate. The isomorphous crystals of octohydrated didymium sulphate were investigated by J. C. G. de Marignac, H. Becquerel, P. T. Cleve, R. Bunsen, J. Schabus, and C. F. Rammelsberg. According to G. Bodman, the hydrates of bismuth sulphate are isomorphous with those of lanthanum— $(\text{Bi}, \text{La})_2(\text{SO}_4)_3 \cdot 9\text{H}_2\text{O}$; $(\text{Bi}, \text{La})_2(\text{SO}_4)_3 \cdot 5\text{H}_2\text{O}$; $(\text{Bi}, \text{Di})_2(\text{SO}_4)_3 \cdot 8\text{H}_2\text{O}$; etc.

The crystals of pentahydrated cerous sulphate, $\text{Ce}_2(\text{SO}_4)_3 \cdot 5\text{H}_2\text{O}$, were examined by A. des Cloizeaux, G. Wyruboff,² and E. H. Kraus; the last-named found the axial ratios of the monoclinic prisms to be $a : b : c = 1.4656 : 1 : 1.1264$, and $\beta = 102^\circ 40'$. and he studied the corrosion figures. E. H. Kraus gave 3.160 for the sp. gr.; G. Wyruboff, 3.176; and L. F. Nilson and O. Pettersson, 3.220. The crystals have a negative double refraction. For the monoclinic prismatic crystals of the isomorphous pentahydrated praseodymium sulphate, E. H. Kraus gave $a : b : c = 1.4450 : 1 : 1.1157$, and $\beta = 101^\circ 16'$; and the sp. gr. 3.173. The crystals have a strong double refraction.

P. T. Cleve found the 100 c.c. of a sat. soln. of potassium sulphate dissolved 0.05 eq. of S_2O_3 ; and 100 c.c. of a sat. soln. of sodium sulphate dissolved 0.24 grm. of sodium samarium sulphate, $\text{SaNa}(\text{SO}_4)_2 \cdot n\text{H}_2\text{O}$. A. A. Noyes and F. G. Falk found the percentage ionization of soln. of lanthanum sulphate at 18° to be for soln. containing 2, 10, and 50 millieq. per litre, respectively 46.4, 28.9, and 19.8. F. Wirth measured the solubility of cerous, lanthanum, and samarium sulphates in sulphuric acid. The order of solubility is quite different from what it is in water. The results are shown in Fig. 21. Expressing the data in grams of $\text{R}_2(\text{SO}_4)_3$ per 100 grms. of sat. soln. at 25° , he found with sulphuric acid of normality N :

N	0	0.1	1.1	2.16	4.32	6.685	9.68	15.15
$\text{Ce}_2(\text{SO}_4)_3$	7.60	7.618	6.00	5.018	3.301	1.505	0.733	0.239

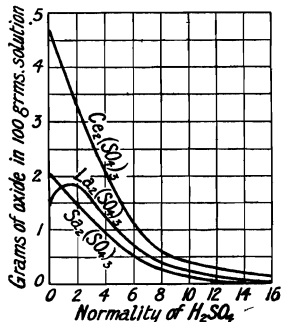

Fig. 21.—Solubility of Cerous, Lanthanum, and Samarium Sulphates in Sulphuric Acid.

where the solid phase is $Ce_2(SO_4)_3 \cdot 8H_2O$; with lanthanum sulphate:

N	.	.	.	0	0.505	1.10	2.16	4.321	6.685	9.68	15.15
$La_2(SO_4)_3$.	.	.	2.483	2.934	3.118	3.156	1.927	0.9217	0.4617	0.307

where the solid phase is $La_2(SO_4)_3 \cdot 9H_2O$; and with samarium sulphate:

N	.	.	.	0	0.1	0.505	1.1	2.16	6.175	12.6
$Sa_2(SO_4)_3$.	.	.	3.426	3.441	3.352	3.075	2.416	0.7025	0.1107

G. Wyrouboff found that the hydrated and anhydrous varieties of the lower cerium oxide dissolve in conc. sulphuric acid, and the soln. on evaporation, deposits small, brilliant, transparent needles. When the evaporation is continued until no more sulphuric anhydride is evolved, care being taken that the temperature of decomposition of the salt is not reached, a crystalline **cerous hydrosulphate**, $Ce(HSO_4)_3$, is obtained. The salt is quite stable in dry air, and is very hygroscopic. B. Brauner and J. Picek found that in the above process of preparation, some sulphuric acid adheres very tenaciously to the acid salt, but it can be separated by heating the salt under reduced press. at a temp. not sufficiently high to decompose the sulphate—say 130° , but not above 180° . They prepared this salt by dissolving normal cerium sulphate in ice-cold water and then adding an excess of sulphuric acid. The acid salt which separates may occasionally be contaminated with the hydrate of the normal salt, which is, however, readily converted into the acid salt by heating. The acid salt was freed from sulphuric acid in a Sprengel vacuum at 130° ; it forms colourless, glistening needles. The corresponding **lanthanum hydrosulphate**, $La(HSO_4)_3$, was obtained by a similar process in colourless silky needles; so also in green silky needles of **praseodymium hydrosulphate**, $Pr(HSO_4)_3$, rose-red silky needles of **neodymium hydrosulphate**, $Nd(HSO_4)_3$; and golden-yellow silky needles of **samarium hydrosulphate**, $Sa(HSO_4)_3$. C. A. Matignon prepared neodymium hydrosulphate either by evaporating down a soln. of the neodymium salt of a volatile acid with excess of sulphuric acid or by dissolving the normal sulphate in the boiling reagent and allowing the soln. to cool. It crystallizes in long, silky, deliquescent, pink needles, which have an oblique extinction inclined at 12° to the principal axis. This form, however, rapidly becomes hydrated and changes into an aggregate of small, anisotropic crystals; finally, the normal salt with $8H_2O$ is obtained mixed with excess of dil. sulphuric acid. One hundred parts of boiling conc. sulphuric acid dissolve 1.30 parts of the acid salt. The heats of dissolution of the acid and normal sulphates in water at 17° are 64.20 and 37.2 Cals. respectively, the heat of formation of the former from the latter being 26.3 Cals. Praseodymium hydrosulphate, prepared in a similar manner, is isomorphous with this substance, separating in slender needles having oblique extinction; 100 parts of boiling conc. sulphuric acid dissolve only 1.02 parts of the compound. The heats of dissolution of the acid and normal sulphates in water at 16° are 65.5 and 36.0 Cals. respectively, the heat of formation of the former from the latter being 24.2 Cals. The acid praseodymium salt is less stable than its neodymium analogue, and is more readily decomposed on heating. He also obtained samarium hydrosulphate by evaporating at 200° a sulphuric acid soln. of the normal sulphate or by allowing the boiling soln. to cool, when the salt forms thin needles, less soluble than the corresponding salts of praseodymium or neodymium. B. Brauner and J. Picek heated the hydrosulphates in the vacuum of the mercury pump, and found the percentage decomposition to be:

			Ce	La	Pr	Nd	Sa
180°	{ 3½ hrs.	.	2.5	6.0	2.8	1.3	6.6
	{ 7 hrs.	.	3.2	12.0	4.1	2.3	7.7
230°	{ 3½ hrs.	.	67.1	72.9	70.3	34.7	46.6
	{ 7 hrs.	.	75.2	85.9	83.1	76.7	62.9
280°	{ 3½ hrs.	.	91.6	94.4	92.6	76.7	85.9
	{ 7 hrs.	.	92.7	95.8	94.7	79.7	88.5

E. Kunheim studied the action of carbon on cerium sulphate in the electric arc furnace.

Complex salts.—M. Barre³ has examined the lowering of the solubility of cerous and lanthanum sulphates in water by the presence of alkali sulphates, and, expressing the results in grams of anhydrous salt in soln. per 100 grms. of water, he found with sodium sulphate :

19°	$\{Na_2SO_4$	·	·	0	0·33	1·09	1·39	1·70	3·59
	$Ce_2(SO_4)_3$	·	·	9·65	0·64	0·09	0·06	0·03	0·01
18°	$\{Na_2SO_4$	·	·	0	0·40	0·77	1·14	2·48	5·55
	$La_2(SO_4)_3$	·	·	2·13	1·00	0·30	0·13	0·04	0·02

with potassium sulphate :

16°	$\{K_2SO_4$	·	·	0	0·18	0·51	0·73	1·29	2·50
	$Ce_2(SO_4)_3$	·	·	10·75	0·96	0·43	0·25	0·04	0·00
16·5°	$\{K_2SO_4$	·	·	0	0·25	0·50	0·85	1·16	2·50
	$La_2(SO_4)_3$	·	·	2·21	0·73	0·27	0·19	0·02	0·00

and with ammonium sulphate :

16°	$\{(NH_4)_2SO_4$	·	·	0	3·46	9·32	19·24	45·62	72·84
	$Ce_2(SO_4)_3$	·	·	10·75	1·03	0·78	0·75	0·50	0·04
18°	$\{(NH_4)_2SO_4$	·	·	0	4·01	18·24	36·11	47·49	65·29
	$La_2(SO_4)_3$	·	·	2·13	0·39	0·25	0·28	0·14	0·01

The solid phase is not stated, but it is known that double or complex salts are produced. The subject is in an empirical stage ; it has not yet been illumined by the phase rule. M. Barre, for example, found that a sat. soln. of sodium sulphate precipitates **sodium dicerous sulphate**, $Na_2SO_4 \cdot Ce_2(SO_4)_3 \cdot 2H_2O$, from a soln. of cerous sulphate, and at the b.p. precipitation is virtually complete. The same complex salt is obtained if crystalline sodium sulphate is added to a soln. of cerous sulphate.

C. Czudnowicz, and S. Jolin reported **sodium dicerous hexasulphate**, $3Na_2SO_4 \cdot Ce_2(SO_4)_3 \cdot 2H_2O$; and A. Beringer, **sodium tetracerous enneasulphate**, $3Na_2SO_4 \cdot 2Ce_2(SO_4)_3$. P. T. Cleve, and M. Barre also obtained **sodium lanthanum sulphate**, $Na_2SO_4 \cdot La_2(SO_4)_3 \cdot 2H_2O$, and P. T. Cleve **sodium samarium sulphate**, $Na_2SO_4 \cdot Sa_2(SO_4)_3 \cdot 2H_2O$, in a similar way. D. B. Keyes and C. James' solubility curve, Fig. 22, shows the existence of only the complex salt, $3Na_2SO_4 \cdot 2Sa_2(SO_4)_3 \cdot 6H_2O$, at 25°.

J. J. Berzelius noted that a double salt is precipitated when a conc. soln. of a cerous salt is mixed with a soln. or with crystals of potassium sulphate. If any iron sulphate be present, T. Scheerer said that it is carried down with the double salt and imparts to it a yellow tint. The double salt which is precipitated by the solid potassium sulphate, said A. Beringer, contains a slight excess of potassium sulphate which is not entirely separated by washing and recrystallization. The double salt can be purified by washing with cold water, dissolving in boiling water, and cooling the soln. Small colourless crystals are thereby obtained. The properties of the double salt were described by J. J. Berzelius, A. Beringer, C. G. Mosander, etc. From this, it appears that the salt fuses at a red heat ; it is decomposed by fusion with alkali carbonate, and when the fused mass is extracted with water, ceric oxide remains. Cerous hydroxide is precipitated by potassium hydroxide or carbonate from a hot aq. soln. of the double salt, but some basic sulphate or other sulphate will be entrained with the precipitate unless the mixture is digested

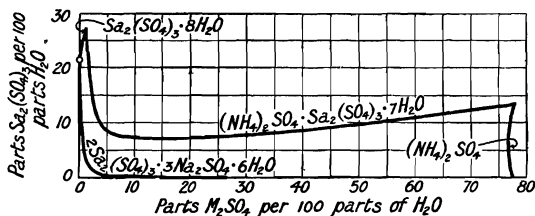
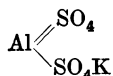
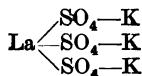

FIG. 22.—Solubility Curves of Samarium Sulphate in Solutions of Sodium and Ammonium Sulphates at 25°.

or boiled for a considerable time. Sulphuric acid dissolves the double salt, forming potassium hydrosulphate. The double salt is soluble in other acids; it is freely soluble in boiling water; sparingly soluble in cold water; and virtually insoluble in a sat. soln. of potassium carbonate. According to J. J. Berzelius and W. Hisinger, and W. Muthmann and H. Rölig, the double sulphates are very conveniently brought into soln. by heating them with conc. nitric acid, and pouring the whole into boiling water, or, according to G. Urbain, by dissolving them in a conc. soln. of ammonium acetate. C. von Scheele found that they are directly converted into hydroxides by heating them with alkali hydroxide; and C. A. von Welsbach converted them into oxalates by prolonged heating with an aq. soln. of oxalic acid. According to P. E. Browning and P. L. Blumenthal, and L. M. Dennis and F. H. Rhodes, when the double sulphates are heated for about an hour with four times their weight of powdered charcoal, they are almost completely reduced to sulphides, soluble in hydrochloric acid.

C. Czudnowicz, S. Jolin, and M. Barre obtained **potassium cerous sulphate**, $K_2SO_4 \cdot Ce_2(SO_4)_3 \cdot 2H_2O$. Crystals of potassium lanthanum sulphate were made by M. Choubine, T. Scheerer, and C. G. Mosander. M. Barre made **potassium lanthanum sulphate**, $K_2SO_4 \cdot La_2(SO_4)_3 \cdot 2H_2O$. C. Baskerville and H. Holland made **potassium praseodymium sulphate**, $Pr_2(SO_4)_3 \cdot K_2SO_4 \cdot 4H_2O$; **cæsium praseodymium sulphate**, $Pr_2(SO_4)_3 \cdot Cs_2SO_4 \cdot 2H_2O$, and $Pr_2(SO_4)_3 \cdot Cs_2SO_4 \cdot 4H_2O$; lavender blue crystals of **cæsium neodymium sulphate**, $Cs_2SO_4 \cdot Nd_2(SO_4)_3 \cdot 3H_2O$. According to S. Jolin, R. Hermann, and C. Czudnowicz, when a conc. soln. of potassium sulphate is added to one of cerous sulphate, at ordinary temp., **potassium dicerous hexasulphate**, $3K_2SO_4 \cdot Ce_2(SO_4)_3$, is precipitated; at 50° , R. Hermann obtained **potassium dicerous pentasulphate**, $2K_2SO_4 \cdot Ce_2(SO_4)_3 \cdot 2H_2O$. According to R. Hermann and C. Czudnowicz, if the soln. contains one part of potassium sulphate to two or more parts of cerous sulphate, crystals of **potassium tetracerous enneasulphate**, $3K_2SO_4 \cdot 2Ce_2(SO_4)_3$, are formed, and M. Barre obtained the octohydrate, $3K_2SO_4 \cdot 2Ce_2(SO_4)_3 \cdot 8H_2O$, as well as **potassium dicerous octosulphate**, $5K_2SO_4 \cdot Ce_2(SO_4)_3$, and **potassium dilanthanum octosulphate**, $5K_2SO_4 \cdot La_2(SO_4)_3$. R. Hermann and P. T. Cleve made **potassium dilanthanum hexasulphate**, $3K_2SO_4 \cdot La_2(SO_4)_3$. C. Baskerville and E. G. Moss made **rubidium hexalanthanum henasulphate**, $2Rb_2SO_4 \cdot 3La_2(SO_4)_3$; and **cæsium hexalanthanum henasulphate**, $2Cs_2SO_4 \cdot 3La_2(SO_4)_3$. C. von Scheele made **potassium dipraseodymium hexasulphate**, $3K_2SO_4 \cdot Pr_2(SO_4)_3 \cdot H_2O$, as a heavy crystalline precipitate of sp. gr. 3.275. P. T. Cleve prepared **potassium samarium pentadecasulphate**, $2Sa_2(SO_4)_3 \cdot 9K_2SO_4 \cdot 3H_2O$.

Lanthanum in the aluminium group might be expected to form a series of alums like those of aluminium. J. Locke stated that if an element will form an alum at all, it does so more readily with cæsium sulphate than with any other alkali sulphate. According to C. Baskerville and co-workers, when equi-mol. mixtures of lanthanum and cæsium sulphates are evaporated on a water-bath, enneahydrated lanthanum sulphate, $La_2(SO_4)_3 \cdot 9H_2O$, separates; if the evaporation is conducted under diminished press., crystals of $3La_2(SO_4)_3 \cdot 2Cs_2SO_4$ were formed. Similarly with rubidium salts, crystals corresponding with $La_2(SO_4)_3 \cdot 2R_2SO_4 \cdot 2H_2O$ were obtained by electrolysis, where R represents cæsium, rubidium, potassium, or sodium. The anhydrous salts $La_2(SO_4)_3 \cdot 2R_2SO_4$ are formed by the evaporation of soln. at about 50° . The property possessed by lanthanum sulphate of forming the enneahydrate with a slight elevation of temp., interferes with the formation of the alum. F. W. Clarke suggests that while aluminium very readily forms the alum type: $SO_4=Al-SO_4-K$, lanthanum is more inclined to give salts of the type: $La_2(SO_4)_3 \cdot 3K_2SO_4$; or, graphically,



Similar attempts to form praseodymium and neodymium alums have not been

successful. The former furnishes crystals of $\text{Pr}_2(\text{SO}_4)_3 \cdot \text{Cs}_2\text{SO}_4 \cdot 2\text{H}_2\text{O}$, resembling the gadolinium sulphate, $\text{Gd}_2(\text{SO}_4)_3 \cdot \text{K}_2\text{SO}_4 \cdot 2\text{H}_2\text{O}$. The evaporation of mixed soln. of praseodymium and caesium sulphates under reduced press., or the application of the electrolytic process for alums, furnishes crystals of $\text{Pr}_2(\text{SO}_4)_3 \cdot \text{Cs}_2\text{SO}_4 \cdot 4\text{H}_2\text{O}$. Neodymium and caesium sulphate soln. evaporated under reduced press. furnish $\text{Nd}_2(\text{SO}_4)_3 \cdot \text{Cs}_2\text{SO}_4 \cdot 3\text{H}_2\text{O}$.

According to C. Czudnowicz, and S. Jolin, when a mixed soln. of ammonium and cerous sulphates is boiled, octohydrated **ammonium cerous sulphate**, $(\text{NH}_4)_2\text{SO}_4 \cdot \text{Ce}_2(\text{SO}_4)_3 \cdot 8\text{H}_2\text{O}$, separates in monoclinic prismatic crystals, which, according to E. H. Kraus, have the axial ratios $a : b : c = 0.3598 : 1 : 0.9340$, and $\beta = 97^\circ 15'$. Observations on the crystals have been also made by G. Wyruboff and A. Verneuil; and on the corrosion figures by E. H. Kraus. The double refraction is feeble and positive; and the dispersion very weak. E. H. Kraus gave 2.523 for the sp. gr. H. Wolff found that a mol. of the salt loses 6 mols. of water at 100° , and it becomes anhydrous at 150° ; but, in contact with its sat. soln., the salt becomes anhydrous at 45° ; the solubility expressed in grams of $(\text{NH}_4)_2\text{SO}_4 \cdot \text{Ce}_2(\text{SO}_4)_3$ per 100 grms. of water is:

	22.3°	35.1°	45.2°	45°	55.3°	75.4°	82.2°
$(\text{NH}_4)_2\text{SO}_4 \cdot \text{Ce}_2(\text{SO}_4)_3$	5.331	5.184	4.993	2.994	2.240	1.482	1.184
Solid phase	Octohydrate			Anhydrous salt			

The corresponding octohydrated **ammonium lanthanum sulphate**, $(\text{NH}_4)_2\text{SO}_4 \cdot \text{La}_2(\text{SO}_4)_3 \cdot 8\text{H}_2\text{O}$, was prepared by J. C. G. de Marignac, E. H. Kraus, and G. Wyruboff and A. Verneuil. It is isomorphous with the cerous salt. The axial ratios of the monoclinic prisms are $a : b : c = 0.3509 : 1 : 0.9145$, and $\beta = 97^\circ 36'$. The corrosion figures were studied by E. H. Kraus. The double refraction is feeble; the sp. gr. 2.516. M. Barre also made the dihydrate. P. T. Cleve reported the octohydrated **ammonium samarium sulphate**, $(\text{NH}_4)_2\text{SO}_4 \cdot \text{Sa}_2(\text{SO}_4)_3 \cdot 8\text{H}_2\text{O}$, but D. B. Keyes and C. James inferred from the solubility curve at 25° , Fig. 22, that the salt is really heptahydrated. P. T. Cleve, and C. Morton, and J. C. G. de Marignac studied the corresponding didymium salt. M. Barre prepared **ammonium dicerous octosulphate**, $5(\text{NH}_4)_2\text{SO}_4 \cdot \text{Ce}_2(\text{SO}_4)_3$; **ammonium dilanthanum octosulphate**, $5(\text{NH}_4)_2\text{SO}_4 \cdot \text{La}_2(\text{SO}_4)_3$; and **ammonium tetralanthanum hexasulphate**, $5(\text{NH}_4)_2\text{SO}_4 \cdot 2\text{La}_2(\text{SO}_4)_3$. C. von Scheele made **ammonium dipraseodymium hexasulphate**, $3(\text{NH}_4)_2\text{SO}_4 \cdot \text{Pr}_2(\text{SO}_4)_3 \cdot 8\text{H}_2\text{O}$, in large crystals of sp. gr. 2.532; the crystals do not change in air or over conc. sulphuric acid, but they become anhydrous at 170° .

A. Kolb prepared **cerium pyridine sulphate**, $\text{Ce}_2(\text{C}_5\text{NH}_6)_6(\text{SO}_4)_6 \cdot 3\text{H}_2\text{O}$, in needle-like crystals; **cerium quinoline sulphate**, probably $\text{Ce}_2(\text{SO}_4)_3 \cdot 6\text{C}_9\text{NH}_7 \cdot 4\text{H}_2\text{SO}_4 \cdot 17\text{H}_2\text{O}$; **cerium hydrazine sulphate** in lustrous crystals; **cerium hydroxy ne sulphate** in microscopic leaflets; **lanthanum pyridine sulphate**, $\text{La}_2(\text{C}_5\text{NH}_6)_6(\text{SO}_4)_6 \cdot 4\text{H}_2\text{O}$, in lustrous, columnar crystals; **lanthanum quinoline sulphate** in small, columnar crystals, and **lanthanum hydrazine sulphate** in small leaflets. R. J. Meyer and U. Müller prepared lanthanum hydrazine sulphate, $\text{La}_2(\text{SO}_4)_3 \cdot (\text{N}_2\text{H}_5)_2\text{SO}_4 \cdot 3\text{H}_2\text{O}$, in sparingly soluble, colourless crystals on warming a soln. of the mixed sulphates to 75° ; and **neodymium hydrazine sulphate**, $\text{Nd}_2(\text{SO}_4)_3 \cdot (\text{N}_2\text{H}_5)_2\text{SO}_4 \cdot 3\text{H}_2\text{O}$, in reddish-violet crystals, by warming a soln. of the mixed sulphates.

According to G. Wyruboff, **cadmium cerous sulphate**, $\text{CdSO}_4 \cdot \text{Ce}_2\text{SO}_4 \cdot 6\text{H}_2\text{O}$, is obtained by mixing eq. proportions of the component salts, adding sulphuric acid which precipitates some cerium sulphate on evaporation of the soln., the double salt crystallizes in rhombic prisms with axial ratios $a : b : c = 1.1336 : 1 : 0.7535$. According to H. Zschiesche, and G. Wyruboff, **thallous cerous sulphate**, $\text{Tl}_2\text{SO}_4 \cdot \text{Ce}_2(\text{SO}_4)_3 \cdot 4\text{H}_2\text{O}$, crystallizes from a soln. of the mixed salts in monoclinic prisms with axial ratios $a : b : c = 1.309 : 1 : 0.7059$, and $\beta = 91^\circ 53'$. By mixing cold cc. or, or warm dil. soln. of thallic and cerous sulphates, the double salt $3\text{Tl}_2\text{SO}_4 \cdot \text{Ce}_2(\text{SO}_4)_3 \cdot \text{H}_2\text{O}$ is precipitated. According to F. Zambonini, didymium and barium sulphates are immiscible when crystallized from hot conc. sulphuric acid.

When a soln. of ceric oxide or hydroxide is warmed with sulphuric acid, some oxygen is evolved because part of the ceric sulphate is reduced to the cerous state; when the soln. is evaporated, orange-red or dark-red hexagonal prisms, or masses of acicular crystals are produced. Similar crystals are formed when a soln. of cerous sulphate is mixed with an excess of ceric sulphate and sulphuric acid, and evaporated. R. J. Meyer, and A. Aufrecht, and B. Brauner added a definite amount of sulphurous acid to the acid soln. of ceric sulphate and evaporated the product. The mother liquor furnished, on evaporation, pale yellow crystals of ceric sulphate. The orange-red hexagonal crystals are regarded as **cerosoceric hydrosulphate**, $[\text{Ce}^{\text{IV}}(\text{SO}_4)_4]\text{Ce}_x^{\text{III}}.44\text{H}_2\text{O}$. Many attempts have been made to find the composition of the crystals. The results are complicated by the fact that the degree of oxidation—*i.e.* the ratio $\text{Ce}(\text{ous}) : \text{Ce}(\text{ic})$ —of the salt varies with the mode of preparation—*e.g.* B. Brauner⁴ found the less the acidity of the soln., the less the sulphuric acid and the more the trivalent cerium in the product; and recrystallization from dil. acid gives still more cerous oxide, and the crystals retain an excess of sulphuric acid very tenaciously. R. J. Meyer has recalculated the different formulæ which have been proposed on the assumption that the at. wt. of cerium is 140.

One set of determinations has $3\text{Ce}(\text{SO}_4)_2.\text{Ce}_2(\text{SO}_4)_3.n\text{H}_2\text{O}$ —R. Hermann (1843), C. F. Rammelsberg (1859), and C. Czudnowicz gave $n=27$; C. F. Rammelsberg (1873) gave $n=31.5$; and S. Jolin, $n=31$. Another set of determinations has $2\text{Ce}(\text{SO}_4)_2.\text{Ce}_2(\text{SO}_4)_3.n\text{H}_2\text{O}$ —D. I. Mendelëeff and B. Brauner gave $n=24$; and W. Muthmann and L. Stützel, $n=20$. Another set of determinations has $2\text{Ce}(\text{SO}_4)_2.\text{Ce}_2(\text{SO}_4)_3.m\text{H}_2\text{SO}_4.n\text{H}_2\text{O}$ —R. Hermann (1864) gave $m=2, n=25$. Another set has $2\text{Ce}(\text{SO}_4)_2.\text{Ce}_2(\text{SO}_4)_3.m\text{H}_2\text{SO}_4.n\text{H}_2\text{O}$ —B. Brauner (1895) gave $m=1.5, n=26$; R. J. Meyer and A. Aufrecht, $m=1, n=26$; and B. Brauner, $m=1, n=24$; H. Zschiesche gave $2\text{Ce}(\text{SO}_4)_2.1\frac{1}{2}\text{Ce}_2(\text{SO}_4)_3.H_2\text{SO}_4.26\text{H}_2\text{O}$; and G. Wyruboff and A. Verneuil, $3\text{Ce}(\text{SO}_4)_2.2\text{Ce}_2(\text{SO}_4)_3.1.5\text{H}_2\text{SO}_4.42\text{H}_2\text{O}$.

G. Wyruboff and A. Verneuil showed that the actual analyses—particularly in the ratio $\text{Ce}(\text{ous}) : \text{Ce}(\text{ic})$ —often agree as well with one formula as with another. In consequence, the formula for cerosoceric sulphate is still *sub judice*. Cerosoceric sulphate thus contains both cerous and ceric sulphates, and the colour of cerosoceric sulphate is darker than that of ceric sulphate even though about half the cerium is present as cerous sulphate, a colourless salt. It is therefore inferred that the two sulphates are chemically combined as a complex. The fact that the sulphuric acid cannot be eliminated at 130° in vacuo led B. Brauner to regard cerosoceric hydrosulphate as the cerous salt of a complex acid—**cerous sulphatocerate**, $\text{Ce}_4^{\text{'''}}[\text{Ce}(\text{SO}_4)_4]_3.12\text{H}_2\text{O}$; where the **hydrosulphatoceric acid** is symbolized $\text{H}_4\text{Ce}(\text{SO}_4)_4$. This is rendered the more probable by the existence of the corresponding salts; **lanthanum sulphatocerate**, $\text{LaH}[\text{Ce}(\text{SO}_4)_4]_3.12\text{H}_2\text{O}$; **praseodymium sulphatocerate**, $\text{PrH}[\text{Ce}(\text{SO}_4)_4]_3.12\text{H}_2\text{O}$; and **neodymium sulphatocerate**, $\text{NdH}[\text{Ce}(\text{SO}_4)_4]_3.12\text{H}_2\text{O}$, which B. Brauner obtained by crystallization from an acid soln. of ceric sulphate mixed with an eq. proportion of lanthanum, praseodymium, or neodymium sulphate. It will be observed too that the rare earth hydrosulphates are symbolized, $\text{H}_3\text{R}(\text{SO}_4)_3$ —*vide supra*—so that cerous hydrosulphate becomes $\text{H}_3\text{Ce}^{\text{'''}}(\text{SO}_4)_3$, and the ceric salt of this would be $\text{Ce}_3^{\text{'''}}[\text{Ce}_3^{\text{'''}}(\text{SO}_4)_3]_4$, or $3\text{Ce}^{\text{'''}}(\text{SO}_4)_2.2\text{Ce}_2(\text{SO}_4)_3$, where the ratio of $\text{Ce}(\text{ic}) : \text{Ce}(\text{ous})$ is the same as that given by G. Wyruboff and A. Verneuil. B. Brauner has stated that the four sulphatocerates are isomorphous, crystallizing in hexagonal prisms. The axial ratio of the lanthanum salt is $a : c = 1 : 2.3349$; that of the cerous salt, $1 : 2.3081$; that of the praseodymium salt, $1 : 2.1771$; and that of the neodymium salt, $1 : 2.6669$. The double refraction is negative. The crystals of the cerous salt were examined by J. Schabus and C. F. Rammelsberg. The cerous salt is reddish-yellow and pleochroic— ω dark yellow, ϵ citron-yellow; the praseodymium salt is greenish-yellow; and the neodymium salt— ω yellowish-green, ϵ pale-green.

W. H. Magee and A. S. Eakle have described three other dicerosoceric sulphates: **dicerosoceric sulphate**, $\text{Ce}_2[\text{Ce}(\text{SO}_4)_5].16\frac{1}{2}\text{H}_2\text{O}$, is obtained from a sulphuric acid soln. of red ceric hydroxide; **dicerosotetraceric sulphate**, $\text{Ce}_2[\text{Ce}_2(\text{SO}_4)_{11}].16\text{H}_2\text{O}$, obtained

from a mixed sulphurous-sulphuric acid soln. of yellow ceric hydroxide; and **diceroso-octoceric sulphate**, $\text{Ce}_2[\text{Ce}_8(\text{SO}_4)_{19}] \cdot 45\text{H}_2\text{O}$, from a sulphuric acid soln. of ceric hydroxide. The crystals are monoclinic prisms with axial ratios and angles respectively $a : b : c = 0.7159 : 1 : 1.3296$, and $\beta = 94^\circ 1'$; $1.6023 : 1 : 1.89784$, and $\beta = 111^\circ 8'$; and $1.5122 : 1 : 1.5166$, and $\beta = 105^\circ 13'$.

Anhydrous **ceric sulphate**, $\text{Ce}(\text{SO}_4)_2$, is produced when a mixture of ceric oxide and conc. sulphuric acid is warmed on a sand-bath; the sulphate does not dissolve; and the change is quantitative. The deep yellow crystalline powder is washed with ice-cold water or glacial acetic acid, and dried over caustic alkali. Ceric sulphate can also be made by fusing ceric oxide with potassium hydrosulphate. D. I. Mendeléeff, and C. F. Rammelsberg prepared the tetrahydrate, $\text{Ce}(\text{SO}_4)_2 \cdot 4\text{H}_2\text{O}$, in yellow needles from the mother liquor remaining after the deposition of cerosoceric hydrosulphate; and from the liquid obtained by dissolving basic ceric sulphate in sulphuric acid. The soln. is concentrated over sulphuric acid. The evaporation of a conc. soln. of the anhydrous salt in dil. sulphuric acid, or, as W. Hisinger and J. J. Berzelius showed, of ceric hydroxide in the same medium, furnishes the yellow crystals. While B. Brauner represents the crystals as those of a tetrahydrate, G. Wyrouboff and A. Verneuil represent them by the formula $\text{Ce}(\text{SO}_4)_2 \cdot 3\frac{1}{2}\text{H}_2\text{O}$. According to B. Brauner, the tetrahydrate furnishes rhombic pyramids with axial ratios $a : b : c = 0.717 : 1 : 0.471$. According to J. F. Spencer, when the anhydrous salt is heated in air, there is a slight loss in weight at 155° ; and when heated at 195° until the weight is constant, the basic salt **ceric oxytetrasulphate**, $\text{Ce}_3\text{O}_2(\text{SO}_4)_4$, or $2\text{Ce}(\text{SO}_4)_2 \cdot \text{CeO}_2$, $3\text{CeO}_2 \cdot 4\text{SO}_3$, is produced; more sulphur trioxide is lost at 250° , and at 300° , sulphur trioxide is continuously lost until ceric oxide remains. L. and P. Wöhler and W. Plüddemann found that heat converts ceric into cerous sulphate with the loss of oxygen. B. Brauner showed that in the presence of slightly dil. sulphuric acid, ceric sulphate undergoes autoreduction to an appreciable extent. The ready reduction of soln. of ceric salts is explained on the ionic hypothesis by the high oxidation potential of the ceric ion, Ce^{\dots} . This has been measured by E. Baur and A. Glässner, and E. Mühlbach. The potential is greater than that of oxygen, so that acid soln. behave as if they were supersaturated with oxygen; in alkaline soln., ceric soln. are not so readily reduced to the cerous condition, but cerous salts are readily oxidized to ceric salts. According to G. A. Barbieri, in the cold, ceric sulphate, and ceric salts generally, oxidize nitrites without the evolution of gas: $2\text{Ce}(\text{SO}_4)_2 + \text{KNO}_2 + \text{H}_2\text{O} = \text{Ce}_2(\text{SO}_4)_3 + \text{KNO}_3 + \text{H}_2\text{SO}_4$. A volumetric process for the determination of nitrites has been based on the reaction. The end-point is attained when the soln. becomes yellow with the first drop of the standard ceric sulphate.

Ceric sulphate is very soluble in water, and it forms a yellowish-brown soln. The salt readily hydrolyzes so that the soln. is acidic, and when diluted or boiled, a pale yellow amorphous solid is precipitated. C. G. Mosander said that water dissolves only one part of the basic salt in 25,000. R. J. Meyer and A. Aufrecht say that basic sulphate contains some cerous salt, but J. F. Spencer could find none. The speed of the hydrolysis is increased by raising the temp. Owing to hydrolysis, the colour of an aq. soln. of the ceric salt fades perceptibly. A freshly made soln. of ceric sulphate darkens immediately when sulphuric acid is added, because the hydrolytic action is reversed; but with an old soln. the reversion takes place more slowly—possibly because the ageing of the product of the hydrolysis has made it less reactive. For a similar reason, the addition of hydrogen dioxide immediately decolorizes a freshly prepared soln. of a ceric salt, but, as R. J. Meyer and R. Jacoby showed, with an old soln. a dark red intermediate product is formed, and this is reduced more slowly. A. Benrath and K. Ruland discussed the oxidation of formic acid, methyl alcohol, acetic acid, tartaric acid and anthracene, by soln. of ceric sulphate; oxalic acid: $\text{H}_2\text{C}_2\text{O}_4 + 2\text{Ce}(\text{SO}_4)_2 = 2\text{CO}_2 + \text{Ce}_2(\text{SO}_4)_3 + \text{H}_2\text{SO}_4$; hydrazine: $2\text{N}_2\text{H}_4 + 2\text{Ce}(\text{SO}_4)_2 = \text{N}_2 + (\text{NH}_4)_2\text{SO}_4 + \text{Ce}_2(\text{SO}_4)_3$; hydroxylamine forms nitrogen and nitrous oxide; sodium thiosulphate forms the tetrathionate:

$2\text{Na}_2\text{S}_2\text{O}_3 + 2\text{Ce}(\text{SO}_4)_2 = \text{Ce}_2(\text{SO}_4)_3 + \text{Na}_2\text{SO}_4 + \text{Na}_2\text{S}_4\text{O}_6$; sulphurous acid forms sulphuric and dithionic acid; and hypophosphorous acid forms phosphorous acid.

R. Hermann reported the basic sulphates: $\text{CeO}(\text{SO}_4)\cdot\text{H}_2\text{O}$, and later $8\text{CeO}_2\cdot 7\text{SO}_3\cdot 15\text{H}_2\text{O}$, and $6\text{CeO}_2\cdot 5\text{SO}_3\cdot 5\text{H}_2\text{O}$; J. C. G. de Marignac, $8\text{CeO}_2\cdot 7\text{SO}_3\cdot 12\text{H}_2\text{O}$; C. F. Rammelsberg, $4\text{CeO}_2\cdot 3\text{SO}_3\cdot 7\text{H}_2\text{O}$, and $3\text{Ce}(\text{SO}_4)_2\cdot 5\text{Ce}(\text{OH})_4$. C. Erk made some observations on this subject; he was able to extract all the sulphuric acid from the precipitate by the action of boiling water. O. Hauser and F. Wirth have described two basic sulphates, $4\text{CeO}_2\cdot 3\text{SO}_3\cdot 12\text{H}_2\text{O}$, as a pale yellow crystalline substance obtained by keeping a dil. ice-cold soln. of ceric sulphate at 0° for 24 hrs., and $2\text{CeO}_2\cdot 3\text{SO}_3\cdot 4\text{H}_2\text{O}$, by similarly treating a sat. soln. of ceric sulphate. The latter product is readily soluble in water. J. F. Spencer varied the proportion of the acid and the conc. of the soln., and obtained only one solid phase—**ceric oxysulphate**, $\text{CeO}(\text{SO}_4)\cdot 2\text{H}_2\text{O}$ —which is a yellow amorphous powder, stable in contact with 0.02*N*- to 0.37*N*- sulphuric acid, but is further hydrolyzed by water apparently to the lithium, ceric hydroxide. The compound is sparingly soluble in water. With soln. of greater acidity it is probable that autoreduction occurs. Attempts to make ceric oxysulphate by the action of acid on ceric oxide were not successful.

Ceric sulphate forms a number of complex salts. W. Hisinger and J. J. Berzelius⁵ observed that when a little potassium hydroxide or potassium sulphate is added to a soln. of ceric sulphate, an orange-yellow precipitate is obtained which dissolves in water with difficulty. A hot, aq. soln. furnishes dark yellow crystals of **potassium ceric sulphate**, $2\text{K}_2\text{SO}_4\cdot \text{Ce}(\text{SO}_4)_2\cdot 2\text{H}_2\text{O}$. The salt was also made by C. F. Rammelsberg, R. Hermann, J. C. G. de Marignac, etc. T. Scheerer found that the sulphur-yellow double salt is precipitated when potassium sulphate is added to a soln. of ceric nitrate, but if the ceric nitrate soln. be previously boiled or mixed with hydrochloric acid, the precipitate is white. According to J. C. G. de Marignac, the monoclinic prisms have the axial ratios $a : b : c = 1.2160 : 1 : 2.0925$, and $\beta = 100^\circ 40'$. According to W. Hisinger and J. J. Berzelius, when potassium hydroxide is added to a soln. of the salt, ceric hydroxide is precipitated, while ammonia, ammonium carbonate, or potassium carbonate precipitates ceric hydroxide mixed with some sulphate. When an acid soln. of ceric and ammonium sulphates is evaporated, the soln. deposits a crop of small yellow crystals, followed by a crop of monoclinic prisms, and both salts are **ammonium ceric sulphates**. According to C. F. Rammelsberg, and D. I. Mendeléeff, the formula of the yellow salt is $3(\text{NH}_4)_2\text{SO}_4\cdot 2\text{Ce}(\text{SO}_4)_2\cdot 3\text{H}_2\text{O}$ —a recalculation of the analysis gave $2(\text{NH}_4)_2\text{SO}_4\cdot \text{Ce}(\text{SO}_4)_2\cdot 2\text{H}_2\text{O}$ —and that of the orange-yellow salt, $3(\text{NH}_4)_2\text{SO}_4\cdot \text{Ce}(\text{SO}_4)_2\cdot 4\text{H}_2\text{O}$. G. Geipel found the axial ratios of the monoclinic prisms to be $a : b : c = 0.6638 : 1 : 0.7838$, and $\beta = 96^\circ 44'$. Observations were also made by J. Schabus. The double refraction is positive. V. Cuttica made **sodium ceric sulphate**, $2\text{Na}_2\text{SO}_4\cdot \text{Ce}(\text{SO}_4)_2$, in orange-yellow prismatic crystals. No signs of a lithium salt were observed. M. E. Pozzi-Escot obtained an orange-yellow crystalline precipitate of **silver ceric sulphate**, $3\text{Ag}_2\text{SO}_4\cdot 5\text{Ce}(\text{SO}_4)_2$, by adding silver nitrate to a strongly acid soln. of ceric sulphate. The salt slowly hydrates, forming the dihydrate, and it is decomposed by boiling water. V. Cuttica obtained the same salt; also orange-red, prismatic crystals of **thallium ceric sulphate**, $2\text{Tl}_2\text{SO}_4\cdot \text{Ce}(\text{SO}_4)_2$; and a complex salt with guanidine sulphate. **Cerous ceric sulphate**, and B. Brauner's **lanthanum ceric sulphate**, **praseodymium ceric sulphate**, and **neodymium ceric sulphate**, are described above as derivatives of hydrosulphatoceric acid.

REFERENCES.

- ¹ J. J. Berzelius and W. Hisinger, *Gehlen's Ann.*, 2, 397, 1804; M. H. Klaproth, *ib.*, 2, 203, 1804; P. Berthier, *Ann. Chim. Phys.*, (3), 7, 74, 1843; H. Becquerel, *ib.*, (6), 14, 176, 1888; L. N. Vauquelin, *ib.*, (1), 36, 143, 1801; (1), 54, 26, 1805; C. A. Matignon, *ib.*, (8), 10, 110, 1907; F. J. Otto, *Pogg. Ann.*, 40, 404, 1837; C. F. Rammelsberg, *ib.*, 55, 65, 318, 445, 1842; *Handbuch der kristallographisch-physikalischen Chemie*, Leipzig, 1, 438, 1881; *Die neuesten Forschungen in der kristallographischen Chemie*, Leipzig, 38, 1857; C. G. Mosander, *Pogg. Ann.*,

48. 210, 1843; P. A. Bolley, *ib.*, 33. 126, 1840; F. T. Frerichs and E. F. Smith, *ib.*, 191. 331, 1878; R. Bunsen, *ib.*, 128. 102, 1866; J. C. G. de Marignac, *ib.*, 63. 214, 1867; *Ann. Chim. Phys.*, (4), 30. 56, 1873; *Arch. Sciences Genève*, (1), 14. 201, 1855; *Bibl. Univ.*, 46. 205, 1873; C. M. Marx, *Schweigger's Journ.*, 52. 481, 1828; R. Hermann, *Journ. prakt. Chem.*, (1), 30. 184, 1843; (1), 92. 126, 1864; C. Czudnowitz, *ib.*, (1), 80. 19, 1860; H. Bührig, *ib.*, (2), 12. 222, 240, 1875; C. Wolf, *Amer. Journ. Science*, (2), 45. 53, 1868; C. H. Wing, *ib.*, (2), 46. 356, 1870; P. T. Cleve, *Chem. News*, 53. 30, 45, 67, 80, 91, 100, 1886; M. Stuart, *Rec. Geol. Sur. India*, 51. 156, 1920; G. Bodman, *Bihang. Svenska Akad. Handl.*, 26. 3, 1900; *Zeit. anorg. Chem.*, 27. 254, 1901; *Zeit. Kryst.*, 32. 613, 1900; 36. 192, 1902; *Ber.*, 31. 1327, 1898; B. Brauner, *Sitzber. Akad. Wien*, 92. 814, 1885; *Monatsh.*, 6. 785, 1885; *Proc. Chem. Soc.*, 14. 70, 1898; *Journ. Chem. Soc.*, 47. 879, 1885; 53. 357, 1888; *Chem. News*, 57. 90, 1888; *Zeit. anorg. Chem.*, 32. 7, 1902; 34. 207, 1903; 39. 283, 1904; B. Brauner and A. Batek, *ib.*, 34. 103, 1903; B. Brauner and F. Pavlicek, *Proc. Chem. Soc.*, 17. 63, 1901; *Journ. Chem. Soc.*, 81. 1243, 1902; W. Muthmann and H. Röllig, *Zeit. anorg. Chem.*, 16. 450, 1898; *Ber.*, 31. 1728, 1898; G. Wyruboff and A. Verneuil, *Compt. Rend.*, 124. 1230, 1897; C. A. Matignon, *ib.*, 134. 657, 1902; 141. 1230, 1905; 142. 276, 1906; *Ann. Chim. Phys.*, (8), 8. 243, 386, 426, 1906; (8), 10. 104, 1907; L. Pissarjewsky, *Journ. Russ. Phys. Chem. Soc.*, 32. 609, 1900; G. Wyruboff, *Bull. Soc. Chim.*, (3), 25. 105, 1901; S. Jolin, *ib.*, (2), 533, 1874; *Bull. Soc. Min.*, 24. 105, 1901; H. Dufet, *ib.*, 24. 278, 1901; H. C. Jones, *Chem. News*, 88. 13, 1903; *Amer. Chem. Journ.*, 28. 23, 1902; H. C. Jones and H. M. Reese, *ib.*, 80. 606, 1898; J. Koppel, *Zeit. anorg. Chem.*, 41. 377, 1904; G. Eberhard, *ib.*, 45. 374, 1905; F. Wirth, *ib.*, 76. 174, 1912; C. von Scheele, *ib.*, 17. 310, 1898; 18. 352, 1898; *Om Praseodym och några af des föräningar*, Upsala, 1900; E. H. Kraus, *Zeit. Kryst.*, 34. 397, 1901; *Ueber einige Salze der seltenen Erden*, Leipzig, 1901; H. W. B. Roozboom, *Zeit. phys. Chem.*, 51. 198, 1890; A. des Cloizeaux, *Mém. Sav. Étrang.*, 18. 682, 1867; *Nouvelles recherches sur les propriétés optiques des cristaux*, Paris, 96, 172, 1867; *Ann. Mines*, (5), 14. 404, 1858; J. Thomsen, *Thermochemische Untersuchungen*, Leipzig, 3. 190, 1883; B. D. Keyes and C. James, *Journ. Amer. Chem. Soc.*, 36. 634, 1914; C. James and H. C. Holden, *ib.*, 35. 559, 1913; S. H. Katz and C. James, *ib.*, 36. 779, 1914; A. A. Noyes and K. G. Falk, *ib.*, 34. 454, 1912; A. A. Noyes and J. Johnston, *ib.*, 31. 987, 1909; W. Ostwald, *Lehrbuch der allgemeinen Chemie*, Leipzig, 2. ii, 781, 1903; E. Kunheim, *Ueber die Einwirkung des Lichtbogens auf Gemische von Sulfaten mit Kohle*, Berlin, 1900; H. Töpsöe, *Bihang. Svenska Akad. Handl.*, 2. 5, 1875; E. Wedekind and P. Hausknecht, *Ber.*, 54 B, 253, 1921; A. Fock, *Zeit. Kryst.*, 32. 251, 1900; J. Schabus, *Bestimmung der Krystallgestalten in chemischen Laboratorien erzeugter Producte*, Wien, 105, 1855; L. F. Nilson and O. Pettersson, *Compt. Rend.*, 91. 232, 1880; *Ber.*, 13. 1459, 1880; L. Wöhler and M. Grünzweig, *ib.*, 48. 1726, 1913; K. Holmberg, *Arkiv. Kemi Min. Geol.*, 1. 1, 1903; A. Aufrecht, *Die Lichtabsorption von Praseodymsalz-Lösungen im Zusammenhang mit ihrem Dissoziationszustande in Lösung*, Berlin, 1904; E. Löwenstein, *Zeit. anorg. Chem.*, 63. 69, 1909.

² G. Wyruboff, *Bull. Soc. Chim.*, (3), 2. 745, 1889; C. A. Matignon, *Compt. Rend.*, 134. 657, 1902; 141. 1230, 1905; B. Brauner and J. Picck, *Zeit. anorg. Chem.*, 38. 322, 1904; F. Wirth, *ib.*, 76. 174, 1912; E. H. Kraus, *Zeit. Kryst.*, 34. 397, 1901; *Ueber einige Salze der seltenen Erden*, Leipzig, 1901; A. A. Noyes and F. G. Falk, *Journ. Amer. Chem. Soc.*, 34. 454, 1912; L. J. Nilson and O. Pettersson, *Compt. Rend.*, 91. 232, 1880; *Ber.*, 13. 1459, 1880; P. T. Cleve, *Chem. News*, 53. 30, 45, 67, 80, 91, 100, 1886; E. Kunheim, *Ueber die Einwirkung des Lichtbogens auf Gemische von Sulfaten mit Kohle*, Berlin, 1900.

³ M. Choubine, *Journ. prakt. Chem.*, (1), 26. 443, 1842; M. Barre, *Compt. Rend.*, 151. 871, 1910; E. H. Kraus, *Zeit. Kryst.*, 34. 397, 1901; *Ueber einige Salze der seltenen Erden*, Leipzig, 1901; A. Beringer, *Liebig's Ann.*, 42. 134, 1842; W. Muthmann and H. Röllig, *Ber.*, 31. 1718, 1898; H. Wolff, *Über einige Salze des Ceriums*, Bonn, 1903; *Zeit. anorg. Chem.*, 45. 89, 1905; A. Kolb, *ib.*, 60. 123, 1908; C. von Scheele, *ib.*, 17. 310, 1898; 18. 352, 1898; E. Wolff, *Das Lanthanspektrum*, Bonn, 1905; F. Zambonini, *Zeit. Kryst.*, 58. 226, 1923; C. Czudnowicz, *Journ. prakt. Chem.*, (1), 80. 31, 1860; R. Hermann, *ib.*, (1), 80. 184, 1843; (1), 82. 385, 1861; (1), 92. 113, 1864; H. Zschiesche, *ib.*, (1), 107. 98, 1869; J. Locke, *Amer. Chem. Journ.*, 27. 281, 1902; C. A. von Welsbach, *Monatsh.*, 4. 630, 1883; S. Jolin, *Bull. Soc. Chim.*, (2), 21. 533, 1874; G. Urbain, *ib.*, (3), 15. 338, 347, 1896; C. Baskerville and H. Holland, *Journ. Amer. Chem. Soc.*, 26. 71, 1904; C. Baskerville and E. G. Moss, *ib.*, 26. 67, 1904; L. M. Dennis and F. H. Rhodes, *ib.*, 37. 809, 1915; D. B. Keyes and C. James, *ib.*, 36. 634, 1914; P. E. Browning and P. L. Blumenthal, *Amer. Journ. Science*, (4), 32. 164, 1911; F. W. Clarke, *The Constitution of the Natural Silicates*, Washington, 1914; C. G. Mosander, *Svenska Akad. Handl.*, 299, 1826; *Kästner's Arch.*, 10. 470, 1826; *Pogg. Ann.*, 11. 406, 1826; T. Scheerer, *ib.*, 66. 499, 1842; C. Morton, *Oefers. Akad. Förh.*, 6, 1885; G. Wyruboff, *Bull. Soc. Min.*, 14. 83, 1891; G. Wyruboff and A. Verneuil, *Ann. Chim. Phys.*, (8), 9. 290, 1906; J. J. Berzelius and W. Hisinger, *ib.*, (1), 50. 245, 1803; J. J. Berzelius, *Schweigger's Journ.*, 16. 248, 1816; J. C. G. de Marignac, *Arch. Sciences Genève*, (1), 14. 243, 1855; P. T. Cleve, *Bull. Soc. Chim.*, (2), 21. 196, 1874; (2), 43. 53, 1885; R. J. Meyer and U. Müller, *Zeit. anorg. Chem.*, 109. 1, 1919; R. F. Weinland and H. Kuhl, *ib.*, 54. 244, 1907; B. Brauner, 39. 261, 1904; V. Cuttica, *Gazz. Chim. Ital.*, 53. ii, 761, 1923.

⁴ R. J. Meyer in R. Abegg's *Handbuch der anorganischen Chemie*, Leipzig, 3. i, 215, 1906; A. Aufrecht, *Die Lichtabsorption von Praseodymsalz-Lösungen im Zusammenhang mit ihrem Dissoziationszustande in Lösung*, Berlin, 1904; R. J. Meyer and A. Aufrecht, *Ber.*, 37. 140,

1904; R. J. Meyer and R. Jacoby, *ib.*, **33**, 2135, 1900; *Zeit. anorg. Chem.*, **27**, 259, 1901; C. F. Rammelsberg, *Handbuch der kristallographischen Chemie*, Berlin, 1855; *Pogg. Ann.*, **108**, 40, 1859; *Ber.*, **6**, 84, 1873; **9**, 15, 81, 1876; W. Muthmann and L. Stützel, *ib.*, **33**, 1763, 1900; D. I. Mendeléeff, *ib.*, **6**, 558, 1873; *Liebig's Ann.*, **168**, 45, 1873; R. Hermann, *Journ. prakt. Chem.*, (1), **30**, 184, 1843; (1), **92**, 113, 1864; C. G. Mosander, *ib.*, (1), **30**, 283, 1843; C. Czudnowicz, *ib.*, (1), **80**, 16, 1860; H. Zschiesche, *ib.*, (1), **107**, 65, 1869; S. Jolin, *Bull. Soc. Chim.*, (2), **21**, 533, 1874; B. Brauner, *Zeit. anorg. Chem.*, **18**, 305, 1898; **39**, 261, 1904; *Chem. News*, **71**, 283, 1895; *Journ. Russ. Phys. Chem. Soc.*, **36**, 469, 1904; J. C. G. de Marignac, *Arch. Sciences Genève*, (1), **8**, 278, 1848; G. Wyruboff and A. Verneuil, *Ann. Chim. Phys.*, (8), **9**, 293, 1906; J. Schabus, *Bestimmung der Krystallgestalten in chemischen Laboratorien erzeugter Producte*, Wien, 1855; W. H. Magee and A. S. Eakle, in P. Groth, *Chemische Krystallographie*, Leipzig, **2**, 583, 1908; G. A. Barbieri, *Atti Accad. Lincei*, (5), **16**, i, 525, 1907; *Chem. Ztg.*, **29**, 668, 1905; W. Hisinger and J. J. Berzelius, *Gehlen's Ann.*, **2**, 397, 1804; J. F. Spencer, *Journ. Chem. Soc.*, **107**, 1265, 1915; O. Hauser and F. Wirth, *Zeit. anorg. Chem.*, **60**, 242, 1908; A. Benrath and K. Ruland, *ib.*, **114**, 267, 1920; C. Erk, *Zeit. Chem.*, (2), **7**, 100, 1871; *Zeit. anal. Chem.*, **10**, 476, 1871; W. Kriktshewsky, *Zur Kenntnis des Cersulfat Akkumulators*, Halle a. S., 1904; E. Mühlbach, *Ueber die Elektrolyse von Cerosalzen*, München, 1903; E. Baur and A. Glässner, *Zeit. Elektrochem.*, **9**, 534, 1903; L. and P. Wöhler and W. Plüddemann, *Ber.*, **41**, 703, 1908; V. Cuttica, *Gazz. Chim. Ital.*, **53**, ii, 761, 1923.

⁵ W. Hisinger and J. J. Berzelius, *Gehlen's Ann.*, **2**, 397, 1804; T. Scheerer, *Pogg. Ann.*, **56**, 499, 1842; C. F. Rammelsberg, *ib.*, **108**, 40, 1859; *Ber.*, **6**, 84, 1873; **9**, 1581, 1876; *Die neuesten Forschungen in der kristallographischen Chemie*, Leipzig, 109, 1857; J. Schabus, *Bestimmungen der Krystallgestalten in chemischen Laboratorien erzeugter Produkte*, Wien, 103, 1855; B. Brauner, *Zeit. anorg. Chem.*, **39**, 261, 1904; J. C. G. de Marignac, *Ann. Mines*, (5), **15**, 221, 1859; R. Hermann, *Journ. prakt. Chem.*, (1), **30**, 184, 1843; G. Geipel, *Zeit. Kryst.*, **35**, 608, 1902; D. I. Mendeléeff, *Liebig's Ann.*, **168**, 45, 1873; M. E. Pozzi-Escot, *Compt. Rend.*, **156**, 1074, 1913.

§ 17. The Carbonates of the Cerium Metals

The high basicity of the rare earths is shown by the ready formation of their carbonates. The hydroxides of the rare earths absorb carbon dioxide from the atm., and from water, thereby forming granular powders. L. N. Vauquelin¹ found that the precipitate produced in cerous salts by the addition of an alkali carbonate, is, when dried, a white voluminous powder with a silvery lustre; and A. Beringer, S. Jolin, and C. Czudnowicz showed that the white amorphous flakes, which are precipitated by ammonium carbonate, after standing in the liquid for about three days, change into shining crystalline scales. Analyses by L. N. Vauquelin, M. H. Klaproth, W. Hisinger, and A. Beringer correspond with pentahydrated **cerous carbonate**, $\text{Ce}_2(\text{CO}_3)_3 \cdot 5\text{H}_2\text{O}$. P. T. Cleve also obtained the rare earth carbonates in a crystalline form by passing a current of carbon dioxide through water in which the rare earth hydroxide is suspended. J. Preiss and A. Dussik found that the normal carbonates of this family can be obtained only by precipitation of a soln. of the salt with a soln. of alkali hydrocarbonate sat. with carbon dioxide; the normal alkali carbonates furnish basic salts. C. G. Mosander produced shining crystalline scales of **lanthanum carbonate**, $\text{La}_2(\text{CO}_3)_3 \cdot 3\text{H}_2\text{O}$, by a process similar to that employed by A. Beringer for cerium carbonate. P. A. Bolley said that crystalline scales are precipitated from a hot soln., while in the cold, a horny gelatinous mass, resembling aluminium oxide, is produced; when dried at 100° , the composition is $\text{La}_2(\text{CO}_3)_3 \cdot \text{H}_2\text{O}$. This carbonate was also obtained by R. Hermann, and P. T. Cleve. The octohydrate occurs in nature as lanthanite, $\text{La}_2(\text{CO}_3)_3 \cdot 8\text{H}_2\text{O}$, *q.v.* C. von Scheele made **praseodymium carbonate**, $\text{Pr}_2(\text{CO}_3)_3 \cdot 8\text{H}_2\text{O}$, in green silky plates, by the action of carbon dioxide on the hydroxide suspended in water, or by precipitation with ammonium carbonate. R. J. Meyer made light red **neodymium carbonate** in a similar way; and P. T. Cleve prepared yellow needle-like crystals of **samarium carbonate**, $\text{Sa}_2(\text{CO}_3)_3 \cdot 3\text{H}_2\text{O}$, by the action of carbon dioxide on the hydroxide, suspended in water; but not by the addition of alkali carbonates to a soln. of a samarium salt, because double carbonates are precipitated. Samarium carbonate is insoluble in water, and loses $2\text{H}_2\text{O}$ at 100° . J. Preiss and co-workers studied the thermal dissociation of the praseodymium, neodymium, and lanthanum carbonates, and

found a step by step dissociation from the normal carbonate, $M_2(CO_3)_3$, to the **oxydicarbonate**, $M_2O(CO_3)_2$, between 350° and 550° and to the **dioxy monocarbonate**, $M_2O_2O_3$, between 800° and 905° .

The properties of *lanthanite* have already been discussed. The mineral *bastnäsité* (*q.v.*) is regarded as **lanthanum fluocarbonate**. P. T. Cleve, and C. Morton have also discussed the preparation and properties of *didymium carbonate*, $Di_2(CO_3)_3 \cdot 8H_2O$. According to W. Hisinger and J. J. Berzelius, cerous carbonate can be gently ignited without decomposition, but at a higher temp., cerosceric oxide, carbon monoxide and dioxide are formed; and, if ignited with access of air, ceric oxide is formed. C. G. Mosander said that the carbon dioxide can be all expelled from lanthanum carbonate by long-continued ignition. L. N. Vauquelin noted that cerous carbonate is insoluble in water and in aq. carbon dioxide. P. H. M. P. Brinton and C. James measured the hydrolysis of many of the carbonates of the rare earths by boiling them with water for different periods of time, and measuring the ratio of the amount of carbon dioxide given off to the total carbon dioxide originally present in the system:

Hours boiling	0.5	1.0	1.5	2.0	2.5	3.0	3.5	4.9
$La_2(CO_3)_3$	27.9	27.9	28.0	—	—	—	—	—
$Ce_2(CO_3)_3$	28.9	28.9	29.0	—	—	—	—	—
$Pr_2(CO_3)_3$	23.2	27.4	29.5	30.9	31.9	32.6	33.3	—
$Nd_2(CO_3)_3$	26.6	30.3	32.7	34.4	35.5	36.4	37.1	—
$Sa_2(CO_3)_3$	31.8	35.4	37.8	39.5	40.8	42.4	43.2	44.2

which shows that the order of basicity is in accord with Pr, Nd, La, Ce, and Sa. Lanthanum and cerous carbonates behave abnormally. When the precipitated carbonates are allowed to stand in contact with a conc. soln. of an alkali carbonate, they are transformed into double carbonates; and the double carbonates can be precipitated by adding, drop by drop, a conc. soln. of a rare earth salt to a cold conc. soln. of an alkali carbonate.

S. Jolin described **sodium cerous carbonate**, $2Na_2CO_3 \cdot Ce_2(CO_3)_3 \cdot 2H_2O$, as an amorphous powder obtained by pouring a soln. of a cerous salt into a boiling soln. of sodium hydrocarbonate. R. J. Meyer, and W. Hiller poured a conc. soln. of cerous chloride into a cold sat. soln. of sodium carbonate, and obtained a gelatinous precipitate which, after standing in contact with the mother liquid, acquired a crystalline structure. The composition was $3Na_2CO_3 \cdot 2Ce_2(CO_3)_3 \cdot 24H_2O$. The salt decomposed in contact with a dil. soln. of sodium carbonate, and is virtually insoluble in a conc. soln. W. Hiller, R. J. Meyer, and C. Arnold showed that, in general, the double carbonates of the cerium earths are slightly soluble in conc. soln. of sodium or ammonium carbonate, but readily soluble in a conc. soln. of potassium carbonate; the order of increasing solubility is La, Pr, Ce, and Nd. R. J. Meyer prepared gelatinous **sodium lanthanum carbonate**, $3Na_2CO_3 \cdot 2La_2(CO_3)_3 \cdot 20H_2O$, by adding an aq. soln. of lanthanum chloride to one of the alkali carbonate; similarly also with amorphous **sodium praseodymium carbonate**, $3Na_2CO_3 \cdot 2Pr_2(CO_3)_3 \cdot 22H_2O$; amorphous pale red **sodium neodymium carbonate**, $3Na_2CO_3 \cdot 2Nd_2(CO_3)_3 \cdot 22H_2O$; and, according to P. T. Cleve, with hydrated **sodium samarium carbonate**, $Na_2CO_3 \cdot Sa_2(CO_3)_3 \cdot 16H_2O$. F. Zamboni and G. Carobbi found these five double carbonates are easily obtained crystalline, with the general formula $M_2(CO_3)_3 \cdot Na_2CO_3 \cdot 12H_2O$.

Owing to the solubility of the double carbonates of the rare earths in a conc. soln. of potassium carbonate, the potassium salts are best made by adding the rare earth chloride to an excess of a conc. soln. of potassium carbonate, warming to dissolve the precipitate, cooling, and diluting slightly. R. J. Meyer prepared **potassium cerous carbonate**, $K_2CO_3 \cdot Ce_2(CO_3)_3 \cdot 3H_2O$, by a somewhat similar process. S. Jolin reported needle-like crystals of the trihydrate, $K_2CO_3 \cdot Ce_2(CO_3)_3 \cdot 3H_2O$, to be formed by pouring a cerous salt soln. into a boiling soln. of potassium hydrocarbonate. R. J. Meyer said that the salt becomes pale yellow on exposure to air. He also made silky crystals of **potassium lanthanum carbonate**, $K_2CO_3 \cdot La_2(CO_3)_3 \cdot 12H_2O$; small needle-like crystals of **potassium praseodymium carbonate**, $K_2CO_3 \cdot Pr_2(CO_3)_3$.

$12\text{H}_2\text{O}$; and rosette groups of needles of **potassium neodymium carbonate**, $\text{K}_2\text{CO}_3 \cdot \text{Nd}_2(\text{CO}_3)_3 \cdot 12\text{H}_2\text{O}$, in a similar way. The potassium salts of praseodymium and neodymium carbonates were also obtained in needle-like crystals by the slow evaporation of their soln. in one of potassium carbonate. P. T. Cleve made **potassium samarium carbonate**, $\text{K}_2\text{CO}_3 \cdot \text{Sa}_2(\text{CO}_3)_3 \cdot 12\text{H}_2\text{O}$, in a similar way.

R. J. Meyer, and W. Hiller prepared **ammonium cerous carbonate**, $(\text{NH}_4)_2\text{CO}_3 \cdot \text{Ce}_2(\text{CO}_3)_3 \cdot 6\text{H}_2\text{O}$, as a voluminous precipitate, by treating a soln. of cerous chloride with an excess of a soln. of ammonium carbonate; on standing in contact with the mother liquid for some time, the salt becomes crystalline. The double salt is only slightly soluble in an excess of the precipitant; and it acquires a yellow colour on exposure to air. They also obtained crystalline **ammonium lanthanum carbonate**, $(\text{NH}_4)_2\text{CO}_3 \cdot \text{La}_2(\text{CO}_3)_3 \cdot 4\text{H}_2\text{O}$; bright green crystals of **ammonium praseodymium carbonate**, $(\text{NH}_4)_2\text{CO}_3 \cdot \text{Pr}_2(\text{CO}_3)_3 \cdot 4\text{H}_2\text{O}$; and regular prisms of **ammonium neodymium carbonate**, $(\text{NH}_4)_2\text{CO}_3 \cdot \text{Nd}_2(\text{CO}_3)_3 \cdot 4\text{H}_2\text{O}$. P. T. Cleve also obtained crystalline **ammonium samarium carbonate**, $(\text{NH}_4)_2\text{CO}_3 \cdot \text{Sa}_2(\text{CO}_3)_3 \cdot 16\text{H}_2\text{O}$, in a similar way. The mineral *parisite* (*q.v.*) can be regarded as a calcium lanthanum carbonate.

It has not yet been possible to make **ceric carbonate**. W. Hisinger obtained a yellow gelatinous precipitate of what is thought to be basic ceric carbonate, by double decomposition between a ceric salt and an alkali carbonate. The precipitate dissolves in a conc. soln. of potassium carbonate; the yellow soln. is stable in air, but, according to A. Job, may be oxidized with hydrogen dioxide. C. Engler and co-workers represent the formula graphically:

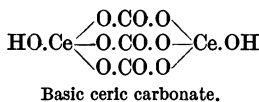
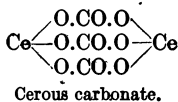

A. Job also reported that two **ceric oxycarbonates**, $2\text{CeO}_2 \cdot 3\text{CO}_2$, and $2\text{CeO}_2 \cdot \text{CO}_2$ —contaminated with potassium carbonate—are obtained by heating potassium perceric carbonate to 240° and 360° respectively. When hydrogen dioxide is added to a soln. of cerous carbonate in a conc. soln. of potassium carbonate, oxidation occurs, and a blood-red colour is developed. With increasing proportions of hydrogen dioxide, the intensity of the coloration increases to a maximum, further additions weaken the tint, and deposit an orange-yellow or reddish-brown precipitate. All the cerium may be so removed from the soln. A similar soln. can be obtained from ceric carbonate by oxidation with hydrogen peroxide. The precipitate is thought to be an unstable *cerium tetroxide*, CeO_4 , but it has not yet been studied in detail. When covered with a conc. soln. of potassium carbonate, oxygen is slowly evolved, and blood-red crystals of **perceric potassium carbonate**, $\text{Ce}_2\text{O}_3(\text{CO}_3)_3 \cdot 4\text{K}_2\text{CO}_3 \cdot 12\text{H}_2\text{O}$, are produced. E. Baur attributes the formula $\text{Ce}_2\text{O}_4(\text{CO}_3)_2 \cdot 4\text{K}_2\text{CO}_3 \cdot 10\text{H}_2\text{O}$ to the crystals.

The red soln. is supposed to contain perceric carbonate, a derivative of cerium trioxide, CeO_3 , and when the colour has acquired its maximum intensity all the cerium is thought to be in the perceric form. C. Engler and co-workers represent the formation of the perceric carbonate by the equation:

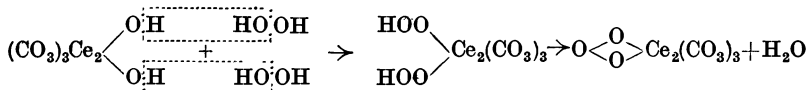

A. Job prepared the soln. by the interaction of ceric ammonium nitrate and hydrogen dioxide in a conc. soln. of potassium carbonate. He found that the soln. can be kept several months without alteration; and, by spontaneous evaporation at ordinary temp., it furnishes blood-red crystals of potassium perceric carbonate. When this substance is dissolved in dil. sulphuric acid, it yields carbon dioxide, oxygen, hydrogen dioxide, and potassium cerous sulphate. A brown liquid having

all the characteristics of a soln. of a perceric salt is obtained on dissolving the double carbonate in a dil. soln. of potassium carbonate. The crystals of the double carbonate become anhydrous when heated to 110° , but undergo no further decomposition when the temp. is raised to 200° ; at 210° , evolution of oxygen commences, and as the temp. rises, the rate of evolution increases; at 300° , carbon dioxide is liberated, and the decomposition is complete in one hour at 360° ; the residue then consists of a yellow ceric potassium carbonate having the composition $Ce_2O_3 \cdot CO_3 \cdot 4K_2CO_3$. The double perceric carbonate is also produced, together with the yellow ceric salt by agitating a soln. of cerous nitrate and potassium carbonate in the presence of atm. oxygen. C. C. Meloche modified the method of preparation. Instead of working in conc. potassium carbonate soln., he found it advantageous to pass a stream of carbon dioxide through the potassium carbonate soln. until a large part of the potassium was removed as the hydrocarbonate. The filtered liquid, when kept at 5° for 24 hrs, deposited ruby-red crystals. His analysis corresponded with $Ce_2O_4(CO_3)_2 \cdot 4K_2CO_3 \cdot 12H_2O$. This product loses part of its water when exposed to dry air; and may be almost completely dehydrated at 110° – 120° without losing available oxygen.

In alkaline soln., the potassium perceric carbonate has three gram-atoms of available oxygen for two gram-atoms of cerium, but in acid soln., only one-third this amount of oxygen is available. C. C. Meloche hence infers that it is impossible for perceric compounds to exist in soln. with free mineral acids, and he found that in contact with water the salt is rapidly hydrolyzed. He infers that in order to make the oxygen available in the nascent form when in the presence of an acid, contact is necessary as in the case of the nascent hydrogen liberated by the action of metals on dil. hydrochloric acid. The loss of oxygen by the acid treatment is explained by representing the reaction: $2CeO_3 + 3H_2SO_4 = Ce_2(SO_4)_3 + O_2 + H_2O_2 + 2H_2O$; where the production of oxygen by autoreduction is regarded as an intramolecular process, so that oxygen is evolved in the molecular, and not in the atomic state. It is inferred that there are two atoms of peroxide oxygen in perceric compounds because if three atoms were present more than one molecule of hydrogen peroxide would probably remain in soln. after treatment with cold dil. sulphuric acid. If only one atom of peroxide oxygen were present, it is improbable that any hydrogen peroxide would remain after treatment with acid, since the following reaction takes place quantitatively: $2Ce(SO_4)_2 + H_2O_2 = Ce_2(SO_4)_3 + O_2 + H_2SO_4$. The presence of peroxide oxygen is indicated qualitatively by the following reactions: When a 10 per cent. soln. of the perceric potassium carbonate in 23 per cent. potassium carbonate soln. was treated with a conc. potassium carbonate soln. of potassium ferricyanide, potassium permanganate, potassium manganate, potassium hypochlorite, or potassium hypobromite, a lively evolution of oxygen was observed. Likewise, when a 10 per cent. soln. of the same compound in sat. potassium bicarbonate soln. was treated with lead dioxide, oxygen was evolved. It is inferred that the peroxide oxygen in potassium perceric carbonate is not present as hydrogen peroxide because of the stability of the compound at 110° – 120° .

While a soln. of ceric carbonate in one of potassium carbonate is stable in air or oxygen, an aq. soln. of cerous carbonate is autoxidized, for it absorbs oxygen and forms perceric, not ceric, carbonate: $Ce_2(CO_3)_3 + 2H_2O + O_2 = Ce_2(CO_3)_3(OH)_2 + H_2O_2$. The perceric carbonate so produced reacts with the unchanged cerous carbonate, forming ceric carbonate. C. Engler and co-workers showed that by varying the conditions, the relative speeds of the two reactions can be modified. Cerous carbonate may thus act as a catalytic agent or as a carrier of oxygen in the oxidation of various substances by air. In this reaction the acceptor should be able to reduce both the perceric and ceric carbonates to the cerous states; if it can reduce only the perceric carbonate to the ceric state, the reaction ceases when all the cerous salt has been oxidized to the ceric state.

C. C. Meloche prepared ruby-red crystals of **rubidium perceric carbonate** by a method similar to that employed for the potassium salt, but the salt was not

analyzed. The rubidium salt is less readily hydrolyzed than the potassium salt; and oxygen is liberated by its soln. in contact with lead dioxide. A soln. of **ammonium perceric carbonate** was obtained by a similar process, but the salt could not be crystallized from the liquid. The soln. is less stable than that of the potassium compound, and decomposes when kept with the formation of a yellow deposit—presumably a ceric oxycarbonate. It was not possible to prepare **sodium perceric carbonate** by the method used for the potassium compound—presumably owing to the lower solubility of the sodium carbonate—but if the dark red soln. of perceric ammonium carbonate is treated with excess of solid sodium carbonate and the soln. evaporated slowly in vacuo, well-formed crystals of perceric sodium carbonate of the composition $Ce_2O_4(CO_3)_2 \cdot 4Na_2CO_3 \cdot 30H_2O$, are obtained. It is only sparingly soluble in cold water and effloresces in dry air. Contact with moisture above 0° results in hydrolysis, and with larger quantities of water the crystals are completely decomposed with the formation of a gelatinous, orange-red precipitate.

REFERENCES.

- ¹ A. Beringer, *Liebig's Ann.*, **42**, 138, 1842; S. Jolin, *Bull. Soc. Chim.*, (2), **21**, 533, 1874; P. T. Cleve, *ib.*, (2), **21**, 196, 1874; (2), **22**, 353, 1874; (2), **43**, 359, 1885; *Chem. News*, **53**, 30, 45, 67, 80, 91, 100, 1886; *Bihang. Svenska Akad. Handl.*, **2**, 7, 8, 12, 1874; C. Czudnowicz, *Journ. prakt. Chem.*, (1), **82**, 277, 1861; K. Hermann, *ib.*, (1), **82**, 395, 1861; C. G. Mosander, *Pogg. Ann.*, **46**, 648, 1839; **47**, 207, 1839; **56**, 504, 1842; P. A. Bolley, *ib.*, **33**, 126, 1834; P. H. M. P. Brinton and C. James, *Journ. Amer. Chem. Soc.*, **43**, 1446, 1921; M. H. Klaproth, *Gehlen's Ann.*, **2**, 303, 1804; W. Hisinger and J. J. Berzelius, *ib.*, **2**, 397, 1804; W. Hisinger, *Schweigger's Journ.*, **17**, 424, 1811; L. N. Vauquelin, *Ann. Chim. Phys.*, (1), **36**, 143, 1801; (1), **54**, 26, 1805; G. Eberhard, *Zeit. anorg. Chem.*, **45**, 374, 1905; R. J. Meyer, *ib.*, **41**, 97, 1904; C. von Scheele, *ib.*, **18**, 352, 1898; E. Baur, *ib.*, **30**, 251, 1902; *Ber.*, **36**, 3038, 1903; **37**, 795, 1904; C. Morton, *Cfveers. Svenska Akad. Handl.*, **6**, 189, 1885; *Zeit. Kryst.*, **12**, 518, 1885; W. Hiller, *Beiträge zur Kenntnis der Ceriterden*, Berlin, 1904; C. Arnold, *Ber.*, **35**, 1173, 1905; K. A. Hofmann and K. Höschele, *ib.*, **48**, 20, 1915; A. Job, *Compt. Rend.*, **126**, 246, 1898; **128**, 178, 1098, 1899; **134**, 1052, 1902; **135**, 45, 1903; *Ann. Chim. Phys.*, (7), **20**, 205, 1900; C. Engler, *Ber.*, **36**, 2642, 1903; **37**, 3268, 1904; C. Engler and L. Wöhler, *Zeit. anorg. Chem.*, **29**, 1, 1902; C. Engler and J. Weissberg, *Kritische Studien über die Vorgänge der Autoxydation*, Braunschweig, 1904; C. C. Meloche, *Journ. Amer. Chem. Soc.*, **37**, 2338, 2645, 1915; J. Preiss and A. Dussik, *Zeit. anorg. Chem.*, **131**, 275, 1923; J. Preiss and N. Rainer, *ib.*, **131**, 287, 1923; F. Zambonini and G. Carobbi, *Atti Acad. Lincei*, (5), **32**, ii, 125, 1923; *Gazz. Chim. Ital.*, **54**, 53, 1924.

§ 18. The Nitrates of the Cerium Metals

The nitrates of the rare earths are readily obtained in soln. by dissolving the sesquioxides, hydroxides, or carbonates in nitric acid; or by the oxidizing action of hot conc. nitric acid on the oxalates. As a rule, the evaporation of the aq. soln. furnishes the hexahydrated salt. J. J. Berzelius¹ prepared colourless tabular crystals of **cerous nitrate**, $Ce(NO_3)_3 \cdot 6H_2O$, by evaporating a soln. to a syrupy consistency; A. Beringer could not get his soln. to crystallize; and L. N. Vauquelin obtained crystals only from acidified soln. S. Jolin, and T. Lange prepared a soln. of cerous nitrate by double decomposition of cerous sulphate and barium nitrate; and if cerous oxide or oxalate and nitric acid is used, they recommend the addition of some hydrogen peroxide as reducing agent. A mol of the hexahydrate loses three mols of water at 100° , and at 200° it begins to decompose. In general, when the attempt is made to prepare the anhydrous rare earth nitrates by heat, basic nitrates are produced. E. Löwenstein measured the vap. press. of cerium nitrate crystals and found evidence of the hexa-, tetra-, and mono-hydrates. J. C. G. de Marignac and C. G. Mosander prepared large crystals of **lanthanum nitrate**, $La(NO_3)_3 \cdot 6H_2O$, by the spontaneous evaporation of the aq. soln.; a mol of the salt loses five mols of water when confined over conc. sulphuric acid. E. Löwenstein measured the vap. press. of lanthanum nitrate crystals and found evidence of the hexa-, tetra-, and mono-hydrates. By similar processes, C. von Scheele prepared

large green needles of **praseodymium nitrate**, $\text{Pr}(\text{NO}_3)_3 \cdot 6\text{H}_2\text{O}$; G. Bodman, **neodymium nitrate**, $\text{Nd}(\text{NO}_3)_3 \cdot 6\text{H}_2\text{O}$; and P. T. Cleve, **samarium nitrate**, $\text{Sa}(\text{NO}_3)_3 \cdot 6\text{H}_2\text{O}$, of sp. gr. 2.375 at 20.4° .

The hexahydrates all crystallize in the triclinic system; according to A. Fock, the axial ratios and angles of the cerous salt are $a : b : c = 0.8346 : 1 : 0.6242$, and $\alpha = 78^\circ 54'$, $\beta = 102^\circ 9'$, and $\gamma = 92^\circ 3'$; for the lanthanum salt, J. C. G. de Marignac gave $a : b : c = 0.8345 : 1 : 0.6215$, and $\alpha = 79^\circ 12'$, $\beta = 101^\circ 58'$, and $\gamma = 92^\circ 18'$; and H. Töpsöe gave for the didymium salt, $a : b : c = 2.4035 : 1 : 1.8597$, and $\alpha = 69^\circ 6'$, $\beta = 97^\circ 30'$, and $\gamma = 92^\circ 47\frac{1}{2}'$. Hexahydrated lanthanum and neodymium nitrates were shown by G. Bodmann to be isodimorphous with bismuth nitrate. J. C. G. de Marignac said that the crystals of cerous nitrate are deliquescent, but S. Jolin said this is not the case. K. Jauch found the sp. ht. of soln. of N eq. of lanthanum and samarium nitrates to be:

N	.	.	.	0.5	1.0	2.0	3.0	4.0
Sp. ht. La salt	.	.	.	0.9395	0.8880	0.8036	0.7321	0.6688
Sp. ht. Sa salt	.	.	.	0.9435	0.8960	0.8166	0.7510	—

W. W. Coblenz studied the ultra-red transmission spectra of the nitrates of lanthanum, praseodymium, and neodymium. W. Muthmann measured the electrical conductivity, λ , of soln. containing a gram-eq. of the salt, $\frac{1}{3}\text{La}(\text{NO}_3)_3$, in v litres, and found, at 25° :

v	.	.	32	64	128	256	512	1024
λ	.	.	98.6	105.4	112.8	118.1	124.1	126.5

where the value $\lambda_{1024} - \lambda_{32} = 28$. A. A. Noyes and J. Johnston found for the percentage ionization, α , at 35° :

v	.	.	5.00	10.00	20.00	80.00	500.0	α
α	.	.	58.6	64.4	70.0	80.4	90.4	100

A. A. Noyes and K. G. Falk, and G. N. Lewis and G. A. Linhardt studied the ionization of soln. of lanthanum nitrate.

A. Heydweiller gave the sp. gr. and electrical conductivities of soln. of lanthanum and samarium nitrates. G. N. Lewis and M. Randall calculated the activity coeff. of soln. of lanthanum nitrate. A. C. Neish and J. W. Burns measured the hydrogen ion conc. of $\frac{1}{100}N$ -soln. of the nitrates of some rare earths, and found the order to be thorium, cerium(ic), neodymium, praseodymium, cerium(ous), and lanthanum. J. H. Hildebrand titrated soln. of praseodymium and neodymium nitrates with soln. of sodium hydroxide, and measured the e.m.f. of the soln. during the operation against a normal hydrogen electrode. These nitrates are all readily soluble in water; according to C. James and C. F. Whittemore, 100 grms. of water at 25° dissolve 151.1 grms. of hexahydrated lanthanum nitrate, and, according to C. James and J. E. Robinson, 152.9 grms. of neodymium nitrate. According to O. L. Barneby, these nitrates are also soluble in acetone, and in alcohol; according to L. N. Vauquelin, 100 parts of alcohol dissolve 50 parts of cerous nitrate. The solubilities are usually diminished by the addition of nitric acid, and the pentahydrates usually separate from nitric acid of sp. gr. 1.4. E. Demarçay gave $78^\circ - 79^\circ$ for the m.p. of the yellow needles of hexahydrated samarium nitrate. C. James and C. F. Whittemore measured the solubility of lanthanum nitrate in aq. soln. of lanthanum oxalate; H. Freundlich and E. Löning studied its effect on a colloidal silver soln. G. L. Clark made **lanthanum hexamminonitrate**, $\text{La}(\text{NH}_3)_6(\text{NO}_3)_3$, by the action of ammonia at 43° on the hexahydrated nitrate.

According to G. Wyruboff and A. Verneuil, crystals of **cerous sulphatonitrate**, $\text{Ce}(\text{NO}_3)(\text{SO}_4) \cdot \text{H}_2\text{O}$, separate when a soln. of cerous sulphate in conc. nitric acid is evaporated on a steam-bath. C. James and C. F. Whittemore studied the ternary system, lanthanum oxalate, lanthanum nitrate, and water at 25° , and found that the hexahydrated lanthanum oxalate, $\text{La}_2(\text{C}_2\text{O}_4)_3 \cdot 11\text{H}_2\text{O}$, is not stable at this temp. in contact with the nitrate; the solubility curves show the existence of the

octohydrate, the pentahydrate, and the trihydrate, but no *lanthanum oxalatonitrate* appears to be stable at this temp. though one might exist at a higher temp. The observed results are summarized in Fig. 23. A similar examination by C. James and J. E. Robinson of the ternary system, neodymium oxalate, neodymium nitrate, and water, at 25°, shows the existence of hexahydrated neodymium oxalate, and **neodymium oxalatonitrate** with $\text{Nd}_2(\text{C}_2\text{O}_4)_3 \cdot 2$ (or $2\frac{1}{2}$) $\text{Nd}(\text{NO}_3)_3 \cdot 24\text{H}_2\text{O}$, as illustrated in Fig. 24.

The cerium family of metals forms double nitrates with many other metals. The general method of preparation is to dissolve the two nitrates in conc. nitric acid,

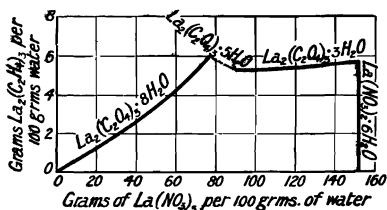

FIG. 23.—Mutual Solubility of Lanthanum Oxalate and Nitrate.

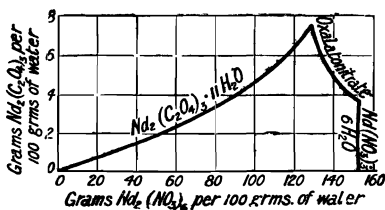

FIG. 24.—Mutual Solubility of Neodymium Oxalate and Nitrate.

and evaporate until crystals are formed. G. Wyrouboff found that with the exception of the sodium salt, if soln. of the double nitrates with the alkali metals are evaporated over 70°, the anhydrous salt is obtained, but G. Jantsch and S. Wigdoroff could not confirm this observation. According to T. Lange, when a mixed soln. of cerous and sodium nitrates is evaporated, slender needle-like crystals of **sodium cerous nitrate**, $2\text{NaNO}_3 \cdot \text{Ce}(\text{NO}_3)_3 \cdot \text{H}_2\text{O}$, are formed. G. Jantsch and S. Wigdoroff found that double salt is not completely dehydrated at 150°. The sp. gr. is 2.65 at 0°/4°. The last-named also made **sodium lanthanum nitrate**, $2\text{NaNO}_3 \cdot \text{La}(\text{NO}_3)_3 \cdot \text{H}_2\text{O}$, in white slender needles of sp. gr. 2.63 at 0°/4°; and the salt is not completely dehydrated at 150°. G. Wyrouboff said that the monoclinic crystals have the axial ratios $a : b : c = 1.9970 : 1 : 0.7678$, and $\beta = 90^\circ 32'$. C. von Scheele said that sodium praseodymium nitrate, $2\text{NaNO}_3 \cdot \text{Pr}(\text{NO}_3)_3 \cdot \text{H}_2\text{O}$, crystallizes in small deliquescent needles. T. Lange made **potassium cerous nitrate**, $2\text{KNO}_3 \cdot \text{Ce}(\text{NO}_3)_3 \cdot 2\text{H}_2\text{O}$, and found that the crystals are completely dehydrated at 180°. According to A. Fock, the formula is $2\text{KNO}_3 \cdot \text{Ce}(\text{NO}_3)_3 \cdot 1\frac{1}{2}\text{H}_2\text{O}$; and the crystals are rhombic pyramids with axial ratios $a : b : c = 0.5227 : 1 : 0.5704$. Similarly for **potassium lanthanum nitrate**, A. Fock gave $2\text{KNO}_3 \cdot \text{La}(\text{NO}_3)_3 \cdot 1\frac{1}{2}\text{H}_2\text{O}$, and found the rhombic crystals to have the axial ratios $a : b : c = 0.5220 : 1 : 0.5712$. G. Jantsch and S. Wigdoroff found the white, slender, hygroscopic needles are dihydrated; they have a sp. gr. 2.54 at 0°/4°; and are dehydrated at 60°. G. Wyrouboff, and G. Jantsch and S. Wigdoroff made **rubidium cerous nitrate**, $2\text{RbNO}_3 \cdot \text{Ce}(\text{NO}_3)_3 \cdot 4\text{H}_2\text{O}$. It forms hygroscopic, needle-like crystals belonging to the monoclinic system, with axial ratios $a : b : c = 1.2298 : 1 : 0.9910$, and $\beta = 101^\circ 16'$; the sp. gr. is 2.497 at 0°/4°; the m.p. is 70°; and the crystals are dehydrated at 60°. G. Wyrouboff, and G. Jantsch and S. Wigdoroff obtained **rubidium lanthanum nitrate**, $2\text{RbNO}_3 \cdot \text{La}(\text{NO}_3)_3 \cdot 4\text{H}_2\text{O}$, by evaporation from a soln. containing lanthanum and rubidium nitrates in the molar proportions 1 : 4. The monoclinic crystals have the axial ratios $a : b : c = 1.2349 : 1 : 0.9888$, and $\beta = 101^\circ$; the sp. gr. is 2.497 at 0°/4°; the m.p. 86°; and the crystals are dehydrated at 60°. If the lanthanum and rubidium nitrates be in the molar proportion 1 : 2, colourless plates of **rubidium lanthanum hydronitrate**, $\text{RbNO}_3 \cdot \text{La}(\text{NO}_3)_3 \cdot \text{HNO}_3 \cdot 6\text{H}_2\text{O}$, appear in colourless plates which lose their nitric acid, and five-sixths the water at 120°; the product $\text{RbNO}_3 \cdot \text{La}(\text{NO}_3)_3 \cdot \text{H}_2\text{O}$ is not dehydrated at 200°, and its sp. gr. is 2.377 at 0°/4°. C. von Scheele, and G. Jantsch and S. Wigdoroff made **rubidium praseodymium nitrate**, $\text{RbNO}_3 \cdot \text{Pr}(\text{NO}_3)_3 \cdot 4\text{H}_2\text{O}$, in green, hygroscopic, monoclinic crystals; which have a sp. gr. 2.50 at 0°/4°; and m.p. 63.5°; and are dehydrated at 60°. Similarly

rubidium neodymium nitrate, $\text{RbNO}_3 \cdot \text{Nd}(\text{NO}_3)_3 \cdot 4\text{H}_2\text{O}$, furnishes bright reddish-violet plates which, according to G. Wyrouboff, have the axial ratios $a : b : c = 1.2276 : 1 : 1.0153$, and $\beta = 100^\circ 29'$. The sp. gr. is 2.56 at $0^\circ/4^\circ$; and the m.p. 47° . The salt is dehydrated at 60° . The temp. at which the above compounds melt in their water of crystallization decrease with increasing at. wt. of the rare earth metal. According to G. Wyrouboff, the nitrates of the type $2\text{M}'\text{NO}_3 \cdot \text{R}(\text{NO}_3)_3 \cdot 4\text{H}_2\text{O}$, are isomorphous. G. Jantsch and S. Wigdoroff, and G. Wyrouboff prepared **cesium cerous nitrate**, $2\text{CsNO}_3 \cdot \text{Ce}(\text{NO}_3)_3 \cdot 2\text{H}_2\text{O}$, in monoclinic prisms, with axial ratios $a : b : c = 1.2052 : 1 : 0.9816$, and $\beta = 103^\circ 41'$; similarly, **cesium lanthanum nitrate**, $2\text{CsNO}_3 \cdot \text{La}(\text{NO}_3)_3 \cdot 2\text{H}_2\text{O}$, forms small, tabular, monoclinic crystals with axial ratios $a : b : c = 1.3052 : 1 : 0.9663$, and $\beta = 103^\circ 26'$; the sp. gr. is 2.827 at $0^\circ/4^\circ$.

H. Wolff prepared **ammonium cerous nitrate**, $2\text{NH}_4\text{NO}_3 \cdot \text{Ce}(\text{NO}_3)_3 \cdot 4\text{H}_2\text{O}$, by crystallization from a mixed soln. of ammonium and cerous nitrates. This double salt is stable in the interval of temp. between 9° and 65° , and it can be recrystallized from water with change. A. des Cloizeaux, J. C. G. de Marignac, A. Fock, and G. Wyrouboff have examined the crystals. According to A. Fock, the monoclinic crystals have the axial ratios $a : b : c = 1.2321 : 1 : 2.1695$, and $\beta = 112^\circ 45'$, and they are isomorphous with the corresponding salts of lanthanum and didymium. The double refraction is negative. The salt melts in its water of crystallization at 74° . According to H. Wolff, 100 grms. of water dissolve

	25°	45°	60°	65°06°
Grms. $2\text{NH}_4\text{NO}_3 \cdot \text{Ce}(\text{NO}_3)_3$	296.8	410.2	681.2	817.4

and if w denotes the percentage amount of the anhydrous salt, the solubility at θ° between 25° and 65° is $w = 68.7 + 172\theta + 0.002\theta^2$. M. Holzmann obtained $3\text{NH}_4\text{NO}_3 \cdot 2\text{Ce}(\text{NO}_3)_3 \cdot 12\text{H}_2\text{O}$ by crystallizing a soln. of the component salts at 0° . According to H. Wolff, when this salt is recrystallized from water, it furnishes $2\text{NH}_4\text{NO}_3 \cdot \text{Ce}(\text{NO}_3)_3 \cdot 4\text{H}_2\text{O}$. J. C. G. de Marignac, A. des Cloizeaux, H. Dufet, E. H. Kraus, and G. Wyrouboff prepared **ammonium lanthanum nitrate**, $2\text{NH}_4\text{NO}_3 \cdot \text{La}(\text{NO}_3)_3 \cdot 4\text{H}_2\text{O}$, and found the monoclinic, prismatic crystals were isomorphous with those of cerium (ous) and didymium. E. H. Kraus gave for the axial ratios $a : b : c = 1.2475 : 1 : 2.1863$, and $\beta = 112^\circ 36'$; and the sp. gr. 2.135 . The double refraction is strongly negative. O. Holmberg found that 100 grms. of water at 15° dissolve 181.14 grms. of $2\text{NH}_4\text{NO}_3 \cdot \text{La}(\text{NO}_3)_3$. C. von Scheele prepared **ammonium praseodymium nitrate**, $2\text{NH}_4\text{NO}_3 \cdot \text{Pr}(\text{NO}_3)_3 \cdot 4\text{H}_2\text{O}$, in large deliquescent crystals of sp. gr. 2.155; and C. A. von Welsbach, **ammonium neodymium nitrate**, $2\text{NH}_4\text{NO}_3 \cdot \text{Nd}(\text{NO}_3)_3 \cdot 4\text{H}_2\text{O}$.

A. Kolb and co-workers reported complex salts of cerous nitrate with pyridine, quinoline, and piperidine; and of lanthanum nitrate with pyridine, antipyrine, and quinoline. G. A. Barbieri and F. Calzolari made a complex salt of lanthanum and neodymium nitrates and hexamethylenetetramine.

G. Jantsch and S. Wigdoroff prepared **thallous cerous nitrate**, $2\text{TlNO}_3 \cdot \text{Ce}(\text{NO}_3)_3 \cdot 4\text{H}_2\text{O}$, in hygroscopic crystals of sp. gr. 3.326 at $0^\circ/4^\circ$, and m.p. 64.5° . The salt is dehydrated at 60° . They also made hygroscopic crystals of **thallous lanthanum nitrate**, $2\text{TlNO}_3 \cdot \text{La}(\text{NO}_3)_3 \cdot 4\text{H}_2\text{O}$, of sp. gr. 3.318, and m.p. 72° . The salt is dehydrated at 160° .

The magnesium, zinc, manganese, cobalt, and nickel rare earth nitrates of the general formula $3\text{M}''(\text{NO}_3)_2 \cdot 2\text{R}(\text{NO}_3)_3 \cdot 24\text{H}_2\text{O}$, have been investigated by many. They form an extended isomorphous series crystallizing in the trigonal system. They are also isomorphous with the corresponding bismuth complex salts. While the double nitrates of the alkali metals are obtained from acidified soln., these salts, with the exception of the gadolinium series, can be obtained from neutral soln. T. Lange, M. Holzmann, and C. F. Rammelsberg prepared **magnesium cerous nitrate**, $3\text{Mg}(\text{NO}_3)_2 \cdot 2\text{Ce}(\text{NO}_3)_3 \cdot 24\text{H}_2\text{O}$, in trigonal crystals with the axial ratio $a : c = 1 : 1.5378$. The crystals were also examined by A. des Cloizeaux, L. Carius,

C. F. Rammelsberg, and G. Geipel. The double refraction is feebly negative. G. Jantsch gave for the magnesium series :

	La	Ce	Pr	Nd	Sa
Sp. gr. (0°/4°)	1·988	2·002	2·019	2·020	2·088
Mol. vol.	768·3	764·2	758·0	761·2	742·4
Melting point	113·5°	111·5°	111·2°	109·0°	96·2°
Molar solubility	0·0418	0·0382	0·0503	0·0635	0·0583

where the molar solubility refers to the mols of salts dissolved by a litre of nitric acid of sp. gr. 1·325 at 16°/4°. M. Holzmann prepared **magnesium lanthanum nitrate**, $3\text{Mg}(\text{NO}_3)_2 \cdot 2\text{La}(\text{NO}_3)_3 \cdot 24\text{H}_2\text{O}$; and G. Jantsch, large leek-green crystals of **magnesium praseodymium nitrate**, $3\text{Mg}(\text{NO}_3)_2 \cdot 2\text{Pr}(\text{NO}_3)_3 \cdot 24\text{H}_2\text{O}$; E. Demarçay prepared **magnesium neodymium nitrate**, $3\text{Mg}(\text{NO}_3)_2 \cdot 2\text{Nd}(\text{NO}_3)_3 \cdot 24\text{H}_2\text{O}$; and **magnesium samarium nitrate**, $3\text{Mg}(\text{NO}_3)_2 \cdot 2\text{Sa}(\text{NO}_3)_3 \cdot 24\text{H}_2\text{O}$. T. Lange, and H. Zschiesche prepared **zinc cerous nitrate**, $3\text{Zn}(\text{NO}_3)_2 \cdot 2\text{Ce}(\text{NO}_3)_3 \cdot 24\text{H}_2\text{O}$, in deliquescent trigonal crystals which, according to A. Fock, have the axial ratio $a:c=1:1\cdot5677$. The double refraction is negative. G. Jantsch gave for the zinc series :

	La	Ce	Pr	Nd	Sa
Sp. gr. (0°/4°)	2·161	2·188	2·215	2·208	2·283
Mol. vol.	763·8	755·5	751·0	750·0	732·8
Melting point	98·0°	92·8°	91·5°	88·5°	76·5°
Molar solubility	0·0751	0·0675	0·0888	0·1066	0·2179

vide supra for the term molar solubility. A. Damour and H. St. C. Deville prepared **zinc lanthanum nitrate**, $3\text{Zn}(\text{NO}_3)_2 \cdot 2\text{La}(\text{NO}_3)_3 \cdot 24\text{H}_2\text{O}$. G. Jantsch made **zinc praseodymium nitrate**, $3\text{Zn}(\text{NO}_3)_2 \cdot 2\text{Pr}(\text{NO}_3)_3 \cdot 24\text{H}_2\text{O}$, in large, tabular, yellowish-green crystals; **zinc neodymium nitrate**, $3\text{Zn}(\text{NO}_3)_2 \cdot 2\text{Nd}(\text{NO}_3)_3 \cdot 24\text{H}_2\text{O}$, in small reddish-violet crystals; and **zinc samarium nitrate**, $3\text{Zn}(\text{NO}_3)_2 \cdot 2\text{Sa}(\text{NO}_3)_3 \cdot 24\text{H}_2\text{O}$, in large violet crystals; and another zinc samarium nitrate, $3\text{Zn}(\text{NO}_3)_2 \cdot \text{Sa}(\text{NO}_3)_3 \cdot 24\text{H}_2\text{O}$, in large topaz-yellow crystals.

Normal **ceric nitrate**, $\text{Ce}(\text{NO}_3)_4$, has not been prepared. When a soln. of ceric hydroxide in conc. nitric acid in the presence of calcium nitrate, is evaporated, V. von Lang and L. Haitinger obtained red monoclinic prisms with axial ratios $a:b:c=1\cdot7834:1:1\cdot0465$, and $\beta=90^\circ 48'$. The favourable action of calcium nitrate on the crystallization is probably due to its lowering the solubility. The composition of the red crystals corresponds with **ceric hydroxynitrate**, $\text{Ce}(\text{OH})(\text{NO}_3)_3 \cdot 4\frac{1}{2}\text{H}_2\text{O}$, or, according to R. J. Meyer and R. Jacoby, $\text{Ce}(\text{OH})(\text{NO}_3)_3 \cdot 3\text{H}_2\text{O}$. When this salt is dissolved in water, the yellow liquid has an acid reaction, and in consequence of a progressive hydrolysis, the colour gradually deepens; by adding nitric acid to a freshly prepared soln., the colour becomes dark red, but a soln. which has stood a long time at ordinary temp., or one which has been boiled, is only gradually darkened by nitric acid. When hydrogen dioxide is added to a freshly prepared soln. of ceric nitrate, the salt is immediately reduced and the soln. decolorized; but with an old soln. or one that has been boiled, the liquid first acquires a deep red colour owing to the formation of a higher oxidized salt, and it is then slowly decolorized by reduction. R. J. Meyer and R. Jacoby add that this behaviour is characteristic of ceric salts.

In the old soln. or in soln. which have been boiled, hydrolysis has presumably made considerable progress, and a hydrosol is formed which coagulates when nitric acid is added, and virtually all the cerium can be precipitated as a hydrogel by adding sufficient acid. When the hydrogel is dried over potassium hydroxide, an amber-coloured, horny, translucent mass is formed. Its composition is $4\text{CeO}_2 \cdot \text{N}_2\text{O}_5 \cdot 5\text{H}_2\text{O}$; and in contact with sufficient water, a greenish soln. is obtained; if less water is used the liquid may appear opalescent. When the hydrosol is dialyzed nitric acid is lost, but the decomposition ceases when the ratio is about $28\text{Ce}(\text{OH})_4:\text{N}_2\text{O}_5$. If hydrochloric acid be added to the hydrosol, the precipitated hydrogel has the composition $4\text{CeO}_2 \cdot 2\text{HCl} \cdot 34\text{H}_2\text{O}$; and with sulphuric acid, $4\text{CeO}_2 \cdot \text{SO}_3 \cdot 5\text{H}_2\text{O}$. The

basic chloride resembles the basic nitrate, but the basic sulphate does not form the hydrosol when treated with water, although about half the sulphuric acid is washed away. Similar colloids have been prepared with lanthanum, praseodymium, etc., in place of cerium.

When ammonia is added to the nitrate hydrosol, a hydrogel with the composition $8\text{CeO}_2 \cdot 11\text{H}_2\text{O}$ is formed. G. Wyrouboff and A. Verneuil regard these colloids as derivatives of polymerized or condensed ceric hydroxides, which they liken to metastannic acid and metatungstic acid, and called *metaceric oxide*, $\text{Ce}_{21}\text{O}_{15}(\text{OH})_{60}(\text{OH})_6$, in which only the $(\text{OH})_6$ is capable of reacting with acids. When ceric oxide is obtained by calcining cerous oxalate in air at as low a temp. as possible, it is indifferent towards conc. nitric acid, but when digested for some hours at 100° with 3 per cent. nitric acid, and separated from the liquid by decantation, the product is soluble in water. The turbid soln. contains a hydrosol which may be precipitated as a hydrogel by adding 2 per cent. nitric acid, or ammonium nitrate. When dried at 100° , it forms a horny translucent mass with the composition $20\text{CeO}_2 \cdot \text{N}_2\text{O}_5 \cdot 5\text{H}_2\text{O}$. It is soluble in water. Basic chlorides, sulphates, etc., may be similarly prepared. If cerous hydroxide, precipitated by ammonia from a cerous salt soln., is oxidized to ceric hydroxide by a current of air, the product is almost entirely insoluble in boiling conc. nitric acid, but the soluble portion is colloidal and with water forms a soln. of *paraceric oxide*.

C. F. Rammelsberg, and R. J. Meyer and R. Jacoby prepared **potassium ceric nitrate**, $\text{K}_2\text{Ce}(\text{NO}_3)_6$, by evaporating a mixed soln. of the component salts in conc. nitric acid, sp. gr. 1.25, over potassium hydroxide and conc. sulphuric acid. M. Holzmann also reported this double salt to be a sesquihydrate, but this is possibly due to contamination with the hydrated cerous salt, or with the basic nitrate. The colour of double nitrates of this type is like that of the dichromates. According to A. des Cloizeaux, the potassium salt furnishes monoclinic crystals with axial ratios $a : b : c = 1.2455 : 1 : 1.9170$, and $\beta = 91^\circ 12'$. The double refraction is negative. G. Wyrouboff said the crystals of M. Holzmann are hexagonal with the axial ratio $a : c = 1 : 1.400$, and the double refraction is negative. R. J. Meyer and R. Jacoby prepared in a similar way **rubidium ceric nitrate**, $\text{Rb}_2\text{Ce}(\text{NO}_3)_6$, readily soluble in water, sparingly soluble in nitric acid; and **cæsium ceric nitrate**, $\text{Cs}_2\text{Ce}(\text{NO}_3)_6$, which is not so readily soluble as the rubidium salt. M. Holzmann prepared **ammonium ceric nitrate**, $(\text{NH}_4)_2\text{Ce}(\text{NO}_3)_6$, and he regarded it as a sesquihydrate; W. Muthmann supposed it to be monohydrated; and P. Schottländer, anhydrous. The work of R. J. Meyer and R. Jacoby has shown that the salt is anhydrous. G. Plancher and G. A. Barbieri prepared the salt by the anodic oxidation of cerous ammonium nitrate in a compartment cell. This is one of the most important of the ceric salts, and it is employed as a means of preparing pure ceria. A. Sachs found that the monoclinic crystals have the axial ratios $a : b : c = 2.4668 : 1 : 2.3901$, and $\beta = 129^\circ 52'$. A. des Cloizeaux gave $a : b : c = 1.1690 : 1 : 1.9260$, and $\beta = 90^\circ 21'$. The double refraction is negative. The hygroscopic crystals readily dissolve in water, forming yellow soln. H. Wolff found the percentage solubility to be :

	25°	35°	45°	64°	85°	(122°)
$(\text{NH}_4)_2\text{Ce}(\text{NO}_3)_6$	58.49	62.79	64.51	66.84	69.40	(88.03)

and he represented the results at θ° between 25° and 85° by the formula $S = 52.07 + 0.314\theta - 0.0013\theta^2$; but with soln. above 60° there is a partial reduction of ceric salt to cerous salt; and at about the b.p. of the sat. soln., say 122° , after 3 hrs.' boiling about 9.8 per cent. of the salt was found to be in the cerous state. The soln. in alcohol is dark red. The salt is not very soluble in nitric acid, and it forms dark red soln., which become nearly black when heated. The salt can be recrystallized from water without decomposition. J. Koppel found the double compounds of ceric salts with the organic bases to be more stable than the inorganic double salts. C. H. G. Williams prepared a compound of ceric nitrate with quinoline.

Ceric nitrate also forms an isomorphous series of double salts of the type

$M(NO_3)_2.Ce(NO_3)_4.8H_2O$, in which M represents an atom of bivalent magnesium, zinc, nickel, cobalt, or manganese. The crystals are also isomorphous with the corresponding thorium salts. These salts are very easily reduced, and they must be prepared from conc. nitric acid; the salts are decomposed when dissolved in water, and they do not lose their water of crystallization when dried over sulphuric acid. R. Bunsen and J. Jegel, and M. Holzmann prepared **magnesium ceric nitrate**, $MgCe(NO_3)_6.8H_2O$, but H. Zschiesche, and C. F. Rammelsberg believed the product to be a mixture of ceric nitrate and magnesium cerous nitrate. R. J. Meyer and R. Jacoby prepared the salt in the presence of conc. nitric acid, and showed the idea that the salt does not exist to be based on the fact that it is very easily reduced. It is deliquescent in air; more soluble in water and nitric acid than the alkali salts; and when heated it melts in, and is decomposed by, its water of crystallization. G. Geipel found the axial ratios of the monoclinic, dark red crystals to be $a : b : c = 1.032 : 1 : 1.586$, and $\beta = 96^\circ 43'$. M. Holzmann prepared **zinc ceric nitrate**, $ZnCe(NO_3)_6.8H_2O$. C. F. Rammelsberg and H. Zschiesche denied the existence of this salt, but as in the case of the magnesium salt, R. J. Meyer and R. Jacoby showed how it can be prepared. M. Holzmann thought the salt was an enneahydrate. G. Geipel found the axial ratios of the monoclinic dark red crystals to be $a : b : c = 0.978 : 1 : 1.339$, and $\beta = 100^\circ 0'$.

REFERENCES.

- J. J. Berzelius and W. Hisinger, *Gehlen's Ann.*, 2, 397, 1804; R. Bunsen and J. Jegel, *Liebig's Ann.*, 105, 40, 1858; V. von Lang and L. Haitinger, *ib.*, 351, 450, 1907; L. N. Vauquelin, *Ann. Chim. Phys.*, (1), 35, 143, 1801; (1), 54, 26, 1805; G. Wyruboff and A. Verneuil, *ib.*, (8), 9, 289, 1906; *Bull. Soc. Chim.*, (3), 21, 118, 1899; *Compt. Rend.*, 127, 863, 1898; 128, 501, 1899; G. Wyruboff, *Bull. Soc. Min.*, 24, 112, 1901; 29, 324, 1906; 30, 299, 1907; H. Dufet, *ib.*, 11, 146, 1888; A. Beringer, *Liebig's Ann.*, 42, 134, 1842; C. G. Mosander, *ib.*, 46, 648, 1843; 47, 207, 1843; 56, 504, 1848; *Phil. Mag.*, (3), 23, 241, 1843; S. Jolin, *Bull. Soc. Chim.*, (2), 21, 533, 1874; P. T. Cleve, *ib.*, (2), 21, 196, 246, 344, 1874; *Chem. News*, 50, 30, 45, 67, 80, 91, 100, 1886; *Bihang. Svenska Akad. Handl.*, 2, 7, 8, 1874; H. Töpsöe, *ib.*, 2, 5, 1874; G. Bodman, *ib.*, 26, 3, 1900; *Zeit. anorg. Chem.*, 27, 254, 1901; *Zeit. Kryst.*, 32, 613, 1900; 36, 192, 1902; *Ber.*, 31, 1237, 1898; T. Lange, *Journ. prakt. Chem.*, (1), 82, 129, 1861; R. Hermann, *ib.*, (1), 82, 385, 1861; H. Zschiesche, *ib.*, (1), 107, 65, 1869; M. Holzmann, *ib.*, (1), 75, 321, 1858; (1), 84, 76, 1861; L. Carius, *ib.*, (1), 75, 354, 1858; J. C. G. de Marignac, *Arch. Sciences Genève*, (1), 46, 193, 1873; *Ann. Chim. Phys.*, (4), 30, 67, 1873; W. Muthmann and H. Rölig, *Zeit. anorg. Chem.*, 16, 450, 1898; W. Muthmann, *Ber.*, 31, 1829, 1898; G. Bodman, *ib.*, 31, 1237, 1898; P. Schottländer, *ib.*, 25, 381, 1892; C. F. Rammelsberg, *ib.*, 6, 86, 1873; C. H. G. Williams, *Chem. News*, 58, 199, 1888; C. von Scheele, *Zeit. anorg. Chem.*, 17, 310, 1898; 18, 352, 1898; G. Jantsch, *ib.*, 76, 303, 1912; A. Kolb, G. Melzer, A. Merckle, and C. Teufel, *ib.*, 60, 123, 1908; A. Kolb, *ib.*, 83, 143, 1913; G. Jantsch and S. Wigdoroff, *ib.*, 69, 222, 1911; O. Holmberg, *ib.*, 53, 83, 1907; H. Wolff, *ib.*, 45, 89, 1905; *Diss. Bonn*, 1903; W. Muthmann, *Ber.*, 31, 1829, 1898; R. J. Meyer and R. Jacoby, *ib.*, 33, 2135, 1900; *Zeit. anorg. Chem.*, 27, 359, 1901; J. Koppel, *ib.*, 18, 305, 1898; C. James and J. E. Robinson, *Journ. Amer. Chem. Soc.*, 35, 754, 1913; C. James and C. F. Whittemore, *ib.*, 34, 1168, 1912; J. H. Hildebrand, *ib.*, 35, 847, 1913; O. L. Barneby, *ib.*, 34, 1174, 1912; A. A. Noyes and J. Johnston, *ib.*, 31, 987, 1909; G. A. Barbieri and F. Calzolari, *Atti Accad. Lincei*, (5), 20, i, 164, 1911; G. Plancher and G. A. Barbieri, *ib.*, (5), 14, i, 119, 1904; K. Jauch, *Zeit. Physik*, 4, 441, 1920; H. Freundlich and E. Löning, *Koll. Beihefte*, 16, 1, 1922; A. Heydweiller, *Zeit. anorg. Chem.*, 116, 42, 1921; E. Löwenstein, *ib.*, 63, 69, 1909; E. Demarcay, *Compt. Rend.*, 128, 1039, 1898; 130, 1185, 1900; 131, 343, 1900; G. Urbain, *ib.*, 140, 583, 1905; A. Fock, *Zeit. Kryst.*, 22, 34, 1894; G. Geipel, *ib.*, 35, 625, 1902; A. Sachs, *ib.*, 34, 162, 1901; E. H. Kraus, *ib.*, 34, 397, 1901; *Ueber einige Salze der seltenen Erden*, Leipzig, 1901; A. C. Neish and J. W. Burns, *Journ. Canadian Inst. Chem.*, 5, 69, 1921; W. W. Coblenz, *Investigations of Infra-red Spectra*, Washington, 6, 50, 1908; G. N. Lewis and M. Randall, *Journ. Amer. Chem. Soc.*, 43, 1112, 1921; G. N. Lewis and G. A. Linhardt, *ib.*, 41, 1951, 1919; A. A. Noyes and K. G. Falk, *ib.*, 34, 454, 1912; C. F. Rammelsberg, *Pogg. Ann.*, 108, 40, 1859; *Handbuch der kristallographischphysikalischen Chemie*, Leipzig, 1, 371, 1881; A. des Cloizeaux, *L'Inst.*, 111, 1858; *Ann. Mines*, (5), 14, 352, 402, 1858; *Nouvelles recherches sur les propriétés optiques des cristaux*, Paris, 121, 1358; *Mém. Acad.*, 18, 632, 1867; C. A. von Welsbach, *Sitzber. Akad. Wien*, 92, 317, 1885; *Monatsh.*, 5, 508, 1884; 6, 477, 1885; A. Damour and H. St. C. Deville, *Compt. Rend.*, 43, 976, 1856; G. L. Clark, *Amer. Journ. Science*, (5), 7, 1, 1924.

§ 19. The Phosphates of the Cerium Metals

Several phosphates of the rare earths occur in nature. These have already been discussed. W. Hisinger and J. J. Berzelius¹ precipitated a cerium phosphate by adding phosphoric acid or an alkali phosphate to a soluble cerous salt. S. Jolin, and W. N. Hartley showed that the white powder so obtained is dihydrated **cerous orthophosphate**, $\text{CePO}_4 \cdot 2\text{H}_2\text{O}$. F. V. C. Radominsky fused the precipitated phosphate with cerous chloride, and extracted the cold mass with water and dil. nitric acid; the crystals of cerous orthophosphate, CePO_4 , resembled monazite. L. V. R. Ouvrard also obtained the anhydrous phosphate in yellow rhombic prisms by fusing ceric oxide with potassium metaphosphate; H. Grandeau obtained similar greenish-yellow, needle-like crystals. H. Holm obtained a similar product by fusing cerous sulphate with sodium metaphosphate. M. Choubine, P. T. Cleve, and R. Hermann made **lanthanum orthophosphate**, LaPO_4 , by adding phosphoric acid or disodium hydrophosphate to a soln. of lanthanum acetate or sulphate. F. T. Frerichs and E. F. Smith say that the amorphous precipitate obtained with the sulphate soln. has the composition $\text{La}_2(\text{HPO}_4)_3$. L. V. R. Ouvrard, and H. Grandeau obtained the crystalline orthophosphate by melting lanthana with potassium metaphosphate. P. T. Cleve made crystals of **samarium orthophosphate**, SaPO_4 , by fusing samaria with sodium metaphosphate, and leaching the cold mass with water.

According to H. Grandeau, the sp. gr. of the crystals of cerium orthophosphate is 5.22 at 14°; and, according to P. T. Cleve, that of samarium phosphate is 5.828 at 17.5°. W. Hisinger and J. J. Berzelius said that cerous orthophosphate is slightly soluble in nitric and hydrochloric acids; M. Choubine also noted that lanthanum orthophosphate is soluble in acids; and P. T. Cleve, that samarium orthophosphate is insoluble in water. C. G. Mosander said that when cerous phosphate is ignited in a carbon crucible, it is neither fused nor reduced, but merely sinters together. L. V. R. Ouvrard saturated molten potassium orthophosphate or pyrophosphate with ceric oxide, and, on cooling, obtained prismatic crystals of **potassium cerous orthophosphate**, $\text{K}_3\text{Ce}_2(\text{PO}_4)_3$, or $\text{K}_3\text{PO}_4 \cdot 2\text{CePO}_4$, of sp. gr. 3.8 at 20°; and similarly also with **sodium cerous orthophosphate**, $\text{Na}_3\text{Ce}_2(\text{PO}_4)_3$; and with **potassium lanthanum orthophosphate**, $\text{K}_3\text{La}_2(\text{PO}_4)_3$, of sp. gr. 3.5 at 20°. F. Zambonini obtained *cerium apatite* and *didymium apatite* by fusing and slowly cooling a mixture of calcium orthophosphate and chloride, and cerium phosphate, CePO_4 . The crystals contained up to 13 per cent. CePO_4 ; similarly, crystals with 3 per cent. of DiPO_4 were made; and also crystals of *didymium spodiosite* with up to 9 per cent. DiPO_4 .

A. Rosenheim and T. Triantaphyllides prepared **cerous pyrophosphate**, $\text{Ce}_4(\text{P}_2\text{O}_7)_3 \cdot 12\text{H}_2\text{O}$, by adding a cerous salt to an excess of a soln. of sodium pyrophosphate. It is readily soluble in mineral acids. S. Jolin made microscopic needles of **cerous hydroxyphosphate**, CeHP_2O_7 , from a sat. soln. of cerous carbonate in pyrophosphoric acid. P. T. Cleve prepared **lanthanum hydroxyphosphate**, $\text{LaHP}_2\text{O}_7 \cdot 3\text{H}_2\text{O}$, by adding a lanthanum salt to a soln. of sodium pyrophosphate until the white precipitate first formed redissolves. On allowing the soln. to stand, needle-like crystals of this salt are formed. He also made **samarium hydroxyphosphate**, $\text{SaHP}_2\text{O}_7 \cdot 3\frac{1}{2}\text{H}_2\text{O}$, from a soln. of samarium hydroxide in pyrophosphoric acid. K. A. Wallroth prepared **sodium cerous pyrophosphate**, CeNaP_2O_7 , from a soln. of the oxide in molten sodium metaphosphate or sodium ammonium phosphate; he also made in a similar way **sodium lanthanum pyrophosphate**, LaNaP_2O_7 , isomorphous with the cerous salt.

C. F. Rammelsberg obtained **cerous metaphosphate**, $\text{Ce}(\text{PO}_3)_3$, by evaporating cerous hypophosphite with nitric acid, and calcining the residue; and K. R. Johnson obtained microscopic crystals by the action of anhydrous cerous sulphate on fused metaphosphoric acid. The sp. gr. of the salt is 3.272, and it is insoluble in acids. F. T. Frerichs and E. F. Smith precipitated **lanthanum metaphosphate**,

$\text{La}(\text{PO}_3)_3$, from a soln. of sodium metaphosphate by means of lanthanum sulphate; and K. R. Johnson obtained the acid metaphosphate, $\text{La}_2\text{O}_3 \cdot 5\text{P}_2\text{O}_5$, by dissolving the sulphate in molten metaphosphoric acid, and extracting the mass with water. The monoclinic crystals had the axial ratios $a : b : c = 1.44604 : 1 : 0.95897$, $\beta = 89^\circ 28' 20''$, and sp. gr. 3.241. P. T. Cleve similarly prepared samarium metaphosphate, $\text{Sa}_2\text{O}_3 \cdot 5\text{P}_2\text{O}_5$. The crystals had a sp. gr. 3.487 at 28.8° .

According to W. N. Hartley, when sodium phosphate is added to a slightly acid soln. of a ceric salt, a yellowish precipitate is obtained, which, when dried in vacuo over sulphuric acid, has the composition of ceric hydro-orthophosphate, $2\text{Ce}_2\text{H}(\text{PO}_4)_3 \cdot 25\text{H}_2\text{O}$; R. J. Carney and E. de M. Campbell, and A. Rosenheim and T. Triantaphyllides obtained ceric pyrophosphate, $\text{CeP}_2\text{O}_7 \cdot n\text{H}_2\text{O}$, by warming a soln. of cerous pyrophosphate in hydrochloric acid mixed with bromine.

REFERENCES.

¹ W. Hisinger and J. J. Berzelius, *Gehlen's Ann.*, 2, 397, 1804; S. Jolin, *Bull. Soc. Chim.*, (2), 21, 533, 1874; K. A. Wallroth, *ib.*, (2), 39, 316, 1883; P. T. Cleve, *ib.*, (2), 21, 196, 1874; (2), 43, 53, 1885; *Chem. News*, 53, 30, 45, 67, 80, 91, 100, 1886; *Bihang. Svenska Akad. Handl.*, 2, 7, 1874; F. V. C. Radominsky, *ib.*, (2), 23, 175, 1875; *Compt. Rend.*, 80, 304, 1875; L. V. R. Ouyard, *ib.*, 107, 37, 1888; H. Grandeau, *Ann. Chim. Phys.*, (6), 8, 193, 1886; K. A. Wallroth, *Bull. Soc. Chim.*, (2), 39, 316, 1883; A. Rosenheim and T. Triantaphyllides, *Ber.*, 48, 582, 1915; K. R. Johnson, *ib.*, 22, 976, 1889; C. F. Rammelsberg, *Pogg. Ann.*, 106, 435, 1859; *Ber.*, 5, 492, 1872; *Sitzber. Akad. Berlin*, 409, 571, 1872; W. N. Hartley, *Journ. Chem. Soc.*, 41, 202, 1882; H. Holm, *Beiträge zur Kenntnis des Cers*, München, 1902; F. Zambonini, *Zeit. Kryst.*, 58, 226, 1923; M. Choubine, *Journ. prakt. Chem.*, (1), 26, 443, 1842; R. Hermann, *ib.*, (1), 82, 385, 1861; F. T. Frerichs and E. F. Smith, *Liebig's Ann.*, 191, 331, 1878; C. G. Mosander, *Phil. Mag.*, (3), 23, 241, 1843; R. J. Carney and E. de M. Campbell, *Journ. Amer. Chem. Soc.*, 36, 1134, 1914.

§ 20. Yttrium

Yttrium occurs in virtually all the rare earths, but more particularly in gadolinite, xenotime, euxenite, polycrase, samarskite, and these minerals are common enough to act as a source of this earth—gadolinite from Hittero, for example, has been reported with 46.5 per cent. of yttrium earths; that from Colorado, 9–14 per cent.; xenotime from Hittero, 58 per cent., that from Minas Geraes, 64 per cent., that from Colorado, 67.8 per cent.; samarskite from Colorado, 17 per cent., and that from Urals, 21 per cent.; polycrase from Hittero, 32 per cent.; euxenite from Arendal, 30 per cent. Monazite has but 0.4 to 4.5 per cent. of yttria earths, but the by-product remaining after the extraction of thoria and ceria earths is a convenient source of yttria earths. Minerals rich in yttrium earths are more abundant than those rich in cerium earths. The cerium minerals are poor in yttrium earths, while the yttrium minerals are poor in cerium earths. It is, however, probable that although yttrium is the most abundant of the rare earths in the yttrium family, any one of the cerium elements, excluding samarium, is more abundant than yttrium. As previously indicated, yttria was discovered by J. Gadolin¹ in 1794, and afterwards studied by A. G. Ekeberg, M. H. Klaproth, L. N. Vauquelin, J. J. Berzelius, and N. J. Berlin.

J. J. Berzelius employed the following process of extraction: Powdered gadolinite is dissolved in aqua regia; the soln. evaporated to dryness; the mass extracted with hot water acidulated with hydrochloric acid; the soln. filtered from the silica; mixed with a sufficient quantity of potassium sulphate, which must project above the surface of the liquid; and left to stand for a space of 24 hrs.; potassium cerous sulphate is then precipitated in the form of a white powder. The whole is then passed through a filter and washed two or three times with water saturated with potassium sulphate; the filtrate and washings are neutralized with ammonia; and the ferric oxide precipitated by ammonium succinate. The filtered liquid treated with ammonia yields a precipitate consisting of basic yttrium sulphate mixed with a small quantity of manganese oxide; it is repeatedly digested, while still moist, with fresh quantities of a dil. soln. of ammonium carbonate, well shaken, and

allowed to stand. The yttrium carbonate dissolved in this liquid is precipitated on boiling the filtrate, and is then ignited. If after ignition it exhibits a brown instead of a greyish-yellow colour, it contains manganese. To eliminate this impurity, the salt is dissolved in nitric acid, evaporated to dryness, and heated in a sand-bath to the m.p. of tin, by which means the manganese nitrate is decomposed. The mass is then dissolved in a very small quantity of water: the almost syrupy liquid filtered through paper; diluted; mixed with ammonia; and the resulting hydrate exposed to a red heat. The residue on the filter containing manganese, yields, by washing with more water, a brown soln., which may be again evaporated and heated to separate the manganese. T. Scheerer discussed the separation of iron oxide from yttria.

In 1842, C. G. Mosander discovered that the earth yttria is not really simple because it can be resolved into three others. The name yttria was reserved for the most basic one, and the other two received the names erbia and terbia. The following is the procedure employed by C. G. Mosander:

When ammonia is added in small quantities at a time to a soln. of ordinary yttria in hydrochloric acid, and the precipitate produced by each addition is separately collected, washed, and dried, basic salts are obtained, the last of which are colourless, and consist of pure yttria. Proceeding from these last in the reverse order, we find that the precipitates become reddish and nearly transparent, and contain a larger and larger quantity of terbia, while the precipitates first formed contain the largest quantity of erbia, mixed, however, with terbia and yttria. When a soln. of crude yttria in nitric acid is treated in the same manner, and the several precipitates separately heated, the first precipitate yields an oxide of a deep yellow colour; and the colour of those which follow becomes continually lighter, till at length a colourless oxide is obtained, consisting mainly of yttria mixed with a small quantity of terbia. In these experiments, it is important that the crude yttria should be perfectly free from iron, uranium, etc. It is better, therefore, to precipitate it from the original soln. by a dil. soln. of ammonium sulphide; and, when the precipitate ceases to exhibit a bluish-green tinge, to filter the soln., and proceed with the filtrate as above. Or, better still: to add a portion of free acid to the soln. of yttria, and then to drop it gradually into a soln. of potassium oxalate, stirring constantly, till the precipitate no longer redissolves. In a few hours a precipitate is deposited; this must be separated by filtration, and the clear liquid again treated with acid oxalate, as long as a precipitate continues to form. The filtrate, on being neutralized with an alkali, yields a small quantity of nearly pure yttrium oxalate. The precipitates first obtained are crystalline, and rapidly fall to the bottom of the vessel; whereas the last, which is pulverulent, is slowly deposited. The first contain the largest quantity of erbia mixed with terbia and yttria; the next, chiefly terbia contaminated with erbia and yttria; and the last, nearly pure yttria. The first precipitates are always reddish; the last colourless. If the mixture of the earths be precipitated by an oxalate, and the precipitate digested in very dil. sulphuric acid (1 : 49), the acid first dissolves out the yttria, properly so called; and on treating the residue with successive portions of fresh acid, the quantity dissolved becomes less and less; and at the same time, the undissolved portion becomes more and more yellow by calcination. When the yttria has been thus removed, the residual oxalate is to be washed and ignited; and the earth which remains, dissolved in nitric acid; and the soln.—which should not be too dil.—mixed to saturation with pounded potassium sulphate. By this means the erbia is precipitated in the form of a potassium erbium sulphate, which is nearly insoluble in water saturated with potassium sulphate, but dissolves easily in pure water. The potassium terbium sulphate remains in soln. The liquid having been filtered, and the precipitate washed, the potassium erbium sulphate may be dissolved in water, and the erbia precipitated by potassium hydroxide, then washed and ignited. The terbia may also be precipitated by treating the filtrate with potassium hydroxide.

Gadolinite is much more complex than the earlier chemists supposed. In the modern process of extracting yttrium, the rare earths sulphates, which have a low solubility in a sat. soln. of an alkali sulphate, are first separated; and the remaining earths are converted into bromates or ethyl sulphates and fractionated. The fraction between that with the least and that with the greatest solubility contains yttrium contaminated with dysprosium, holmium, and erbium. Various methods of fractionation have been used—e.g. fractional hydrolysis of the phthalates; fractional precipitation with potassium ferrocyanide; fractional crystallization of the double alkali sulphates; fractional precipitation of the chromates; fractional precipitation of the basic nitrates; etc. These methods have been previously described in the first purification. L. de Boisbaudran² fractionally precipitated with ammonia; P. T. Cleve fractionally crystallized the oxalate from nitric acid; R. J. Meyer and

J. Wuorinen fractionally precipitated the iodate from nitric acid, and they found that the chromate process separates yttrium from terbium and gadolinium, but is most applicable to mixtures from which the greater part of the terbium has been removed by other methods. They found that the fractional crystallization of the ethyl sulphates is tedious, but is suitable for large quantities. Precipitation with potassium ferrocyanide gives nearly pure yttria, but the yield is small, and the precipitates are not readily filtered. The crystallization of the double ammonium tartrates is unsuccessful as is also the fractional hydrolysis of these salts by water, ammonia, or magnesia. E. W. Engle and C. W. Balke purified yttria by the chromate method; C. James and L. A. Pratt, by the basic nitrate method; and B. S. Hopkins and C. W. Balke, by the sodium nitrate method. J. P. Bonardi and C. James said the most rapid method for separating yttria from the yttria earths is by fractional precipitation with potassium cyanocobaltate. E. Wickers and co-workers found the nitrate method rather more efficient than the cyanocobaltate process. The subject has been discussed by C. C. Kiess and co-workers; and by H. C. Fogg and C. James.

C. James and L. A. Pratt proceeded with the basic nitrate method as follows: The fraction containing the yttria was precipitated as the hydroxide and well washed with boiling water. The hydroxides were next converted into the nitrates, and the latter subjected to fractional decomposition. This was carried out by evaporating the soln. and fusing until a portion had decomposed. The evolution of red fumes was allowed to proceed until the surface acquired a peculiar steely appearance. This point was easily ascertained by experience. The decomposition was allowed to continue until the mass became creamy. The fused mass was then poured into cold water. Great care was required in order to prevent spattering. The result of this operation was a nicely granulated product, which rapidly disintegrated upon boiling. Under the best conditions, the entire mass went into soln.; especially was this true of the yttrium end of the series. Upon cooling, the basic nitrates separated out in a crystalline form. At the opposite end—the least basic portion—of the fractions there always remained an insoluble basic nitrate, unless the decomposition was stopped at an earlier stage, *i.e.* when there was a copious evolution of red fumes.

In case a precipitate remained, it was highly important that it should be well agitated by thorough boiling. After cooling, the precipitate was filtered off, redissolved in nitric acid and again fused. The filtrate was also boiled down, and fused. This second series gives two filtrates and two precipitates. About 40 series of operations were carried out. The nitrate was dissolved in water, heated, and precipitated by means of oxalic acid. The resulting oxalate was filtered off, well washed, dried, and ignited. Some of the yttria still contained a little erbium and holmium. It was put through a modified chromate method. This yielded a supply of yttrium oxide of such a purity that, when converted into a conc. soln. of the nitrate, it showed no absorption bands through a layer of about 5 cms.

Yttrium metal has been obtained only in a more or less impure condition. H. Davy said that the old yttria at a white heat is but imperfectly decomposed by the vapour of potassium, and J. J. Berzelius stated that potassium yttrium fluoride appears to be decomposed by potassium, but on adding water, the yttrium is re-oxidized. F. Wöhler obtained the metal by the following process:

Yttrium chloride and flattened globules of potassium are arranged in alternate layers in a platinum crucible, the quantity of potassium not being quite sufficient to decompose the whole of the yttrium chloride; the cover is then fastened down by a wire, and the crucible heated. The reduction is effected in a moment, and with such violent disengagement of heat that the crucible becomes white hot. When the whole has become perfectly cold, the cover is taken off, and the crucible thrown into a large glass of water, in which the fused potassium chloride dissolves, with evolution of a small quantity of impure hydrogen gas having a foetid odour; and the yttrium is collected on a filter, washed thoroughly, and dried.

P. T. Cleve and co-workers obtained it by the action of sodium on the anhydrous chloride; J. F. G. Hicks, by the same method, or by electrolyzing the fused chlorides; and C. Winkler, by the action of magnesium on the oxide at a high temp. E. W. von Siemens and J. G. Halske made yttrium by heating, in the absence of air, yttrium nitride, or other compound of yttrium with the elements of the nitrogen family. J. F. Bahr and R. Bunsen, and F. Wöhler obtained yttrium by the electrolysis of a molten mixture of sodium and yttrium

chlorides. F. Wöhler, and O. Popp described the metal as a shining powder consisting of small scales with a metallic lustre, and of an iron-grey colour; when burnished, the colour and lustre of the metal resemble those of iron. P. T. Cleve and O. Höglund found that the metal is readily oxidized in air, and is converted into the hydroxide by boiling with water. When burnt in air, said F. Wöhler, yttrium oxide is formed. W. Kettembeil found that when soln. of the rare earths are electrolyzed with mercury cathodes, there is no formation of amalgam at the cathode. According to W. Nernst, a complex ion, MH_2 , separates during the electrolysis of alkali salts at about 1.4 volts cathodic potential. Above this potential, with one-third of the current, the formation of amalgam should occur. Below this point to that where the metal ion itself separates, no formation of amalgam could be obtained, even in a freezing mixture, but evolution of hydrogen took place. It is supposed that the amalgam is formed, but is decomposed with such rapidity as to escape detection.

J. Missenden observed that, superficially, yttrium is iron-grey powder when freshly obtained, and is apt to assume a darkish appearance when kept for an appreciable time. This phenomenon is not to be explained by the combination of the metal with oxygen, as the oxide is white, and precisely the same effect is observed when the metal is placed in vacuo. The change is probably due to the energetic action of light, the darkening process being considerably retarded by preservation in a box from which all light has been excluded. W. Guertler and M. Pirani gave 1490° for the m.p. of the metal. W. R. Mott gave 1250° for the m.p., and 2500° for the b.p. of yttrium. The spark spectrum of yttrium has been investigated by R. Thalén,³ O. Lohse, R. Bunsen, and F. Exner and E. Haschek. The more important lines are 3600.90, 3710.44, 3774.51, 4177.68, 4375.11, and 4883.95. The arc spectrum has been studied by F. Exner and E. Haschek, C. C. Kiess and co-workers, H. Kayser, G. Eberhard, L. F. Yntema and B. S. Hopkins, and J. M. Eder and E. Valenta. The most characteristic lines are 3216.83, 3242.42, 3328.02, 3600.92, 3611.20, 3621.10, 3633.28, 3664.78, 3710.47, 3774.52, 3788.88, 3950.52, 3982.79, 4077.5, 4102.57, 4128.50, 4143.03, 4302.45, 4309.79, 4348.93, 4375.12, 4883.89, 6191.91, and 6435.27. W. J. Humphreys studied the effect of press. on the spectral lines of yttrium; and B. E. Moore, the effect of a magnetic field in producing the Zeeman effect. F. G. Wick studied the effect of press. on the absorption spectrum. H. G. J. Moseley, D. Coster, E. Hjalmar, and E. Friman studied the high frequency or X-ray spectrum of yttrium. F. C. Blake and W. Duane, and M. Siegbahn gave for the K-series, $a_2\alpha' = 0.840$; $a_1\alpha = 0.835$; $\beta_1\beta = 0.746$; and $\beta_2\gamma = 0.733$; and for the L-series, D. Coster, E. Hjalmar, and M. Siegbahn gave $a_1\alpha = 6.4349$; $a_3\alpha'' = 6.4065$; and $\beta_1\beta = 6.1984$. M. Muthmann, E. Baur, and R. Marc showed that yttrium compounds do not give the cathodic phosphorescent spectrum when highly purified; the results obtained by W. Crookes were caused by the presence of impurities. Soln. of yttrium salts give no absorption spectrum in the visible region.

The analytical reactions of yttrium.—Yttrium salts are colourless. With a soln. of yttrium nitrate as typical salt, the addition of aq. **ammonia**, or of **sodium** or **potassium hydroxide** precipitates the white hydroxide, insoluble in excess. The hydroxide precipitated from hot soln. is gelatinous, but is not difficult to filter, while that precipitated in the cold, is slimy and difficult to filter. If tartaric, citric, or other oxy-acid is present, no hydroxide is precipitated, but in the case of ammonia and tartaric acid, an ammonium yttrium tartrate is precipitated, and with alkalis, the tartrate is precipitated on boiling. The addition of **ammonium sulphide** soln. to the yttrium salt precipitates the hydroxide, insoluble in excess. The addition of **ammonium carbonate**, or an **alkali carbonate** gives a white precipitate of yttrium carbonate, soluble in excess; and the soln. after standing some time becomes turbid owing to the separation of the double salt. Unlike aluminium, thorium, and the cerium elements, **barium carbonate** gives no precipitate in the cold, and only an incomplete precipitation with hot soln. With **oxalic acid**, and **ammonium oxalate**, an amorphous oxalate is precipitated; the precipitate is almost insoluble

in water; insoluble in an excess of oxalic acid; sparingly soluble in hydrochloric acid; but appreciably soluble in ammonium oxalate. A soluble double salt is formed with **potassium sulphate**; no precipitation occurs with **sodium thiosulphate**. White amorphous yttrium fluoride is precipitated by **hydrofluoric acid**; and the precipitate becomes pulverulent when warmed. It is insoluble in water and in hydrofluoric acid. With **hydrogen peroxide** in alkaline soln., an unstable peroxide is precipitated. A soln. of **turmeric** does not change colour. With **iodic acid**, no precipitate is formed in nitric acid soln.; and with **sodium hypophosphate** no precipitation occurs in soln. strongly acidified with hydrochloric acid. W. Kettembeil could not make *yttrium amalgam* by electrolyzing an aq. soln. of a salt of yttrium using a mercury cathode.

The atomic weight of yttrium.—The individuality of yttrium is now considered to be definitely settled, and the high frequency spectrum fits the assumption that its **atomic number** is 39. In J. J. Berzelius' ⁴ at. wt. tables of old, yttrium appeared as 96.4 calculated for the trivalent element. In 1860, N. J. Berlin also gave 89.55. O. Popp analyzed yttrium sulphate, and from the ratio $Y_2(SO_4)_3 : 3BaSO_4$ calculated 102.3; and from the ratio $Y_2(SO_4)_3 : Y_2O_3$ obtained 102.0. M. Delafontaine for the same ratio obtained in 1865, 91.1 and 87.8. J. F. Bahr and R. Bunsen calculated 92.63 from the ratio 92.63; P. T. Cleve and O. Höglund (1873) obtained 89.57; P. T. Cleve (1883), 89.11; J. C. G. de Marignac, 88.95; H. C. Jones, 88.96; G. and E. Urbain, 88.6. R. J. Meyer and J. Wuorinen, 88.6; and R. J. Meyer and M. Weinheber, 88.71 to 88.76—average, 88.7. W. Feit and C. Przibylla, from the ratio $Y_2O_3 : 3H_2SO_4$, obtained 89.40. In 1913, J. E. Egan and C. W. Balke objected to the sulphate method because the value obtained varies with the time and temp. of the ignition of the yttrium oxide; and the octohydrate is too unstable for accurate work; they determined the ratio $Y_2O_3 : 2YCl_3$, and obtained 90.12; and B. S. Hopkins and C. W. Balke, 88.9. The values deviated from 88.80 to 89.06. H. C. Fogg and C. James obtained 89.03 from the ratio $YCl_3 : 3Ag$; and H. C. Kremers and B. S. Hopkins, 89.33. The International table for 1921 gives 88.7 as the best representative value for the at. wt. of yttrium. This number is probably rather low. F. W. Aston observed no **isotopes** by the positive ray analysis.

Yttrium forms white basic *yttria* or **yttrium oxide**, Y_2O_3 , by the ignition of the hydroxide, oxalate, or nitrate. A. Duboin ⁵ prepared it in a crystalline form by fusing the oxide with calcium chloride. *Yttria*, said C. G. Mosander, is a colourless earth which is milk-white after ignition; but when not quite free from other earths it may have a yellowish colour. P. T. Cleve gave 5.028 for the sp. gr.; L. F. Nilson, 5.046; S. M. Tanatar and I. Voljansky, 5.326; and W. Muthmann and C. R. Böhm, 4.84. R. J. Meyer and J. Wuorinen gave 4.48 at 15°, and they suggested that the *yttria* used previously was impure. L. F. Nilson, and O. Pettersson said the sp. ht. is 0.1026 between 0° and 100°; and S. M. Tanatar and I. Voljansky gave 0.11729. W. R. Mott gave 4300° for the b.p. of yttrium oxide at 760 mm.; O. Ruff and co-workers gave 2410° to 2415° for the m.p. of *yttria*, and they found a vigorous vaporization occurs at 2350° and 15 mm. press. *Yttria* is feebly diamagnetic. The magnetic susceptibility of yttrium oxide was found by E. H. Williams to fall slightly from 20° to -140°. The value is less than 1×10^{-6} , and the experimental error large. E. Wedekind and P. Hausknecht found the at. magnetism of yttrium oxide to be $+8.7 \times 10^{-6}$. R. J. Meyer and J. Wuorinen gave for the magnetic susceptibility, -0.14×10^{-6} units. H. von Wartenberg and co-workers found *yttria* to be reduced by hydrogen at about 2000° if another metal be present—e.g. tungsten. P. T. Cleve found that *yttria* readily absorbs ammonia from the air; and it is a strong base capable of expelling ammonia from ammonium salts. When heated with conc. acids, said C. G. Mosander, *yttria* becomes hot and dissolves, but not so quickly as in dil. acids. It dissolves rapidly in hot acids. Its neutral sols taste sweet at first, and afterwards astringent. W. W. Coblenz found that yttrium oxide had a deep red colour at temp. between 900° and 1000°. The ultra-red emission spectrum has maxima at 2μ , 2.76μ , 3μ , 3.6μ , 4.6μ , and 6.9μ . The reflecting power for light of

wave length $\lambda=0.60\mu$ is 73.8 per cent.; for $\lambda=4.4\mu$, 34.4 per cent.; for $\lambda=8.8\mu$, 11.1 per cent.; and for $\lambda=24\mu$, 10 per cent. P. T. Cleve obtained **yttrium hydroxide**, $Y(OH)_3$, as a white gelatinous precipitate by adding ammonia or alkali hydroxide to a soln. of an yttrium salt. It dries to a white powder which absorbs carbon dioxide from the air. B. Szilard described **colloidal yttrium hydroxide**—*vide* thorium hydroxide. J. Böhm and H. Niessen studied the X-radiograms of the sol and gel of the hydroxide. A. B. Schiøtz found the oxide dissolves in formic acid, and is precipitated from this soln. by acetic acid. If an yttrium salt is precipitated by ammonia in the presence of hydrogen peroxide, hydrated **yttrium peroxide**, $Y_4O_9 \cdot nH_2O$, is produced.

P. T. Cleve prepared hemihydrated **yttrium fluoride**, $YF_3 \cdot \frac{1}{2}H_2O$, as a white gelatinous precipitate, by adding hydrofluoric acid, or an alkali fluoride to a soln. of an yttrium salt. H. Moissan and A. Étard prepared the anhydrous salt by the action of fluorine on the carbide. Yttrium fluoride occurs in nature as ytrocercite (*q.v.*). C. G. Mosander prepared a radiating mass of crystals, of **yttrium chloride**, which, according to P. T. Cleve, are hexagonal prismatic crystals of the hexahydrate, $YCl_3 \cdot 6H_2O$, and are obtained by slowly concentrating the aq. soln. These crystals deliquesce in air and are readily soluble in water and in alcohol, but not in ether. According to C. A. Matignon, a mol of the salt loses five mols of water at 110° , forming the monohydrate, $YCl_3 \cdot H_2O$, which melts between 156° to 160° ; the anhydrous salt is formed at 170° – 180° , but owing to hydrolysis, some oxide is formed at the same time. P. T. Cleve made the anhydrous salt by heating an intimate mixture of ammonium chloride and the hexahydrate; C. A. Matignon, by evaporating a soln. of the oxide in hydrochloric acid to dryness, and heating the product in a mixture of hydrogen chloride and sulphur chloride; A. Duboin, by heating the oxide in a mixture of carbon dioxide and chlorine; F. V. Radominsky, by heating the hexahydrate in a stream of hydrogen chloride; and H. Moissan and A. Étard, and O. Pettersson, by heating the carbide in a stream of hydrogen chloride. H. C. Kremers and B. S. Hopkins, and H. C. Fogg and C. James have discussed the preparation of the pure salt.

According to C. A. Matignon, the sp. gr. of the anhydrous salt is 2.80 at 18° , it melts below 686° , and solidifies to shining white leaflets which volatilize at a high temp. W. W. Coblentz studied the ultra-red transmission spectrum. He also found that the heat of soln. of anhydrous yttrium chloride in water is 45.3 Cals., and that the aq. soln. is neutral to methyl orange. Further, the anhydrous salt is very soluble in alcohol, and pyridine: 100 grms. of alcohol at 15° dissolve 60.1 grms. of the chloride, and the soln. deposits crystals of the complex $YCl_3 \cdot C_2H_5OH$; and 100 grms. of pyridine at 10° dissolve 60.6 grms. of the chloride and the soln. furnishes crystals of an addition compound, $YCl_3 \cdot 3C_5H_5N$. G. A. Barbieri and F. Calzolari obtained crystals of an addition compound, $YCl_3 \cdot 2C_6H_{12}N_4 \cdot 11H_2O$, with hexamethylenetetramine. P. T. Cleve, and L. F. Nilson prepared chloroaurates, chloroplatinites, and chloroplatinates. O. Popp prepared enneahydrated **mercuric yttrium chloride**, $YCl_3 \cdot 3HgCl_2 \cdot 9H_2O$, from a soln. of the component salts. The deliquescent salt is easily soluble in water and alkalis.

According to P. T. Cleve, enneahydrated **yttrium bromide**, $YBr_3 \cdot 9H_2O$, crystallizes from an aq. soln. of the salt in deliquescent crystals easily soluble in water. A. Duboin made the anhydrous bromide, YBr_3 , by heating yttria in a mixture of bromine vapour and carbon dioxide; the crystals are said to be very deliquescent, and very fusible. P. T. Cleve similarly made deliquescent crystals of **yttrium iodide**, which are readily soluble in water and in alcohol.

P. T. Cleve made **yttrium sulphide**, Y_2S_3 , by heating the anhydrous chloride in a stream of hydrogen sulphide; and O. Popp, by melting the oxide with sulphur and sodium carbonate; or by heating the oxide in a stream of carbon disulphide. The yellow powder of the sulphide is decomposed by water. A. Duboin made **sodium yttrium sulphide**, $Na_2S \cdot Y_2S_3$, or $NaYS_2$, in greenish leaflets, by passing hydrogen sulphide over a heated mixture of yttrium oxide and sodium sulphide.

C. G. Mosander found that **yttrium sulphate** crystallizes from its aq. soln. in small, compact, colourless prisms; the salt retains its water of crystallization at 80°. The crystals are octohydrated, $Y_2(SO_4)_3 \cdot 8H_2O$; and, according to C. F. Rammelsberg, and E. H. Kraus, they form monoclinic prisms isomorphous with the corresponding salts of erbium, gadolinium, samarium, praseodymium, and neodymium; the axial ratios are $a : b : c = 3.0284 : 1 : 2.0092$, and $\beta = 118^\circ 25'$. H. Töpsöe gave 2.530 for the sp. gr., and E. H. Kraus, 2.558. According to the last-named, the double refraction is positive, and the indices of refraction for Na-light are $\alpha = 1.5433$, $\beta = 1.5490$, and $\gamma = 1.5755$. When the octohydrate is heated, it furnishes the anhydrous sulphate, $Y_2(SO_4)_3$, which, according to L. F. Nilson and co-workers, has a sp. gr. 2.52, and sp. ht. 0.1319. E. Löwenstein measured the vap. press. of the hydrated sulphates and found evidence of the octohydrate only. E. Wedekind and P. Hausknecht found the mol. magnetism of yttrium sulphate to be -5.7×10^{-6} . Both the anhydrous salt and the octohydrate are very soluble in cold water. J. Thomsen gave for the heat of soln. $Y_2(SO_4)_3 + 8.04H_2O$, 10.68 Cals. F. Wirth found the solubility of the octohydrate is 5.02 grms. of the anhydrous sulphate in 100 grms. of soln. at 25°; or 100 parts of cold water dissolve 9.3 grms. of the octohydrate, and 4.6 grms. at 100°. According to O. Brill, **yttrium dioxysulphate**, $Y_2O_2(SO_4)$, is formed when the anhydrous sulphate is heated to 700°. P. T. Cleve found that $Y_4O_5(SO_4) \cdot 10H_2O$ is formed by a partial precipitation of a soln. of the sulphate by dil. ammonia; but whether this is a chemical individual has not been demonstrated. B. Brauner and A. Picck made **yttrium hydrosulphate**, $Y(HSO_4)_3$, by crystallization from a soln. of the anhydrous sulphate in conc. sulphuric acid. P. T. Cleve prepared a white, amorphous, pulverulent **sodium yttrium sulphate**, $Na_2SO_4 \cdot Y_2(SO_4)_3 \cdot 2H_2O$, easily soluble in water. According to C. James and H. C. Holden, equilibrium in the ternary system, $Na_2SO_4 - Y_2(SO_4)_3 - H_2O$, at 25°, is attained very slowly—to be exact, 14 months. The relative solubilities, expressed in grams of anhydrous salts per 100 grms. of water, are:

Na_2SO_4	.	.	1.29	3.85	8.53	7.57	10.14	14.89	21.05	28.13
$Y_2(SO_4)_3$.	.	5.61	6.38	8.43	5.86	3.42	1.90	3.04	1.61
Solid phase	.	.	$Y_2(SO_4)_3 \cdot 8H_2O$			$Y_2(SO_4)_3 \cdot Na_2SO_4 \cdot 2H_2O$				

Hence, Fig. 25, the addition of sodium sulphate increases the solubility of yttrium sulphate up to a maximum; the solubility then diminishes rapidly and at the same time the solid phase changes from octohydrated yttrium sulphate to the double salt.

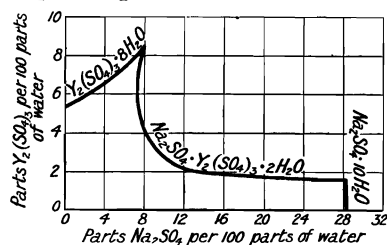

FIG. 25.—The Ternary System, $Y_2(SO_4)_3 - Na_2SO_4 - H_2O$, at 25°.

ammonium yttrium sulphate, $2(NH_4)_2SO_4 \cdot Y_2(SO_4)_3 \cdot 9H_2O$; it loses four mols of water when confined over sulphuric acid. R. J. Meyer and U. Müller made crystals of **yttrium hydrazine sulphate**, $Y_2(SO_4)_3 \cdot (N_2H_5)_2SO_4 \cdot 3H_2O$, by evaporating a soln. of the mixed sulphates. The salt is very soluble in water.

P. T. Cleve passed carbon dioxide into a soln. of yttrium hydroxide in one of sodium carbonate, and obtained white pulverulent **yttrium carbonate**, $Y_2(CO_3)_3 \cdot 3H_2O$; he obtained the same salt by adding an alkali carbonate to a soln. of an yttrium salt; the precipitate gradually crystallizes. O. Popp found that in this process the precipitate retains much sodium carbonate. P. T. Cleve and O. Höglund say that yttrium carbonate is insoluble in water, and very sparingly

soluble in carbonic acid; it loses a mol of water at 100°, and all is lost at 130°. W. H. Evans reported that yttrium carbonate acts unfavourably on the growth of plants. P. H. M. P. Brinton and C. James found that the percentage hydrolysis of yttrium carbonate—the ratio of the amount of carbon dioxide expelled by boiling to the total carbon dioxide originally present in the system—is after boiling with water for different periods of time:

Hours boiling	0.5	1.0	1.5	2.0	2.5	3.0
Hydrolysis	44.9	48.5	51.0	52.8	54.0	55.1

According to P. T. Cleve, yttrium carbonate is soluble in an excess of sodium carbonate, and, when the soln. is allowed to crystallize, needle-like crystals of **sodium yttrium carbonate**, $\text{Na}_2\text{CO}_3 \cdot \text{Y}_2(\text{CO}_3)_3 \cdot 4\text{H}_2\text{O}$, are formed; the same salt is formed as a voluminous precipitate when sodium carbonate is digested with an aq. soln. of yttrium chloride. The precipitate slowly crystallizes. A soln. of yttrium carbonate in one of ammonium carbonate likewise furnishes **ammonium yttrium carbonate**, $(\text{NH}_4)_2\text{CO}_3 \cdot \text{Y}_2(\text{CO}_3)_3 \cdot 2\text{H}_2\text{O}$; it is also obtained by adding a soln. of yttrium nitrate to an excess of a soln. of ammonium carbonate.

C. G. Mosander found that the crystallization of a soln. of **yttrium nitrate** furnishes a mass of laminated crystals. P. T. Cleve and O. Höglund evaporated the soln. over sulphuric acid, and obtained the hexahydrate, $\text{Y}(\text{NO}_3)_3 \cdot 6\text{H}_2\text{O}$, in crystals which, according to F. Zambonini, belong to the triclinic system. According to V. von Lang and L. Haitinger, the crystals are strongly doubly refracting, triclinic pinacoids, isomorphous with the gadolinium salt; and isodimorphous with bismuth nitrate. P. T. Cleve and O. Höglund found the crystals are deliquescent in moist air; and they lose three mols. of water at 100° or over conc. sulphuric acid, forming the trihydrate, $\text{Y}(\text{NO}_3)_3 \cdot 3\text{H}_2\text{O}$. E. Löwenstein measured the vap. press. of yttrium nitrate crystals and found evidence of the hexa-, penta-, and tri-hydrates. The trihydrate, according to E. Demarçay, crystallizes from conc. nitric acid. P. T. Cleve and O. Höglund found the hexahydrate to be readily soluble in water, alcohol, and ether. S. M. Tanatar and I. Voljansky also reported a dihydrate, $\text{Y}(\text{NO}_3)_3 \cdot 2\text{H}_2\text{O}$. F. Zambonini obtained a series of mixed crystals of calcium nitrate, $\text{Ca}(\text{NO}_3)_2 \cdot 4\text{H}_2\text{O}$, and up to 2.19 per cent. of yttrium nitrate, $\text{Y}(\text{NO}_3)_3 \cdot 6\text{H}_2\text{O}$; and also between strontium nitrate, $\text{Sr}(\text{NO}_3)_2 \cdot 4\text{H}_2\text{O}$, and up to 0.86 per cent. of yttrium nitrate. According to J. F. Bahr and R. Bunsen, a basic nitrate is formed when yttrium nitrate is heated until red nitrous fumes appear; and the residue passes into yttria at a still higher temp. When the basic nitrate is boiled with the smallest possible amount of water and allowed to cool, the hydrated salt $\text{Y}(\text{NO}_3)_3 \cdot \text{Y}(\text{OH})_3 \cdot 3\text{H}_2\text{O}$ appears. According to C. James and L. A. Pratt, the only basic nitrate stable at 25° in aq. soln. is **yttrium oxynitrate**, $\text{Y}(\text{NO}_3)_3 \cdot \text{YO}(\text{NO}_3) \cdot 10\text{H}_2\text{O}$, or $3\text{Y}_2\text{O}_3 \cdot 4\text{N}_2\text{O}_5 \cdot 20\text{H}_2\text{O}$. C. James and L. A. Pratt studied the ternary system, $\text{Y}(\text{NO}_3)_3 - \text{Y}(\text{OH})_3 - \text{H}_2\text{O}$, and, expressing the conc. of the compounds in grams per 100 c.c. of water at 25°, they found:

$\text{Y}(\text{NO}_3)_3$	3.13	13.97	33.02	44.35	89.06	137.10	141.6
Y_2O_3	0.014	0.034	0.160	0.114	0.074	0.083	0
Sp. gr.	1.0260	1.1106	1.2517	1.3268	1.5587	1.7440	1.744
Solid phase	$\text{Y}(\text{OH})_3$		$3\text{Y}_2\text{O}_3 \cdot 4\text{N}_2\text{O}_5 \cdot 2\text{H}_2\text{O}$			$\text{Y}(\text{NO}_3)_3$	

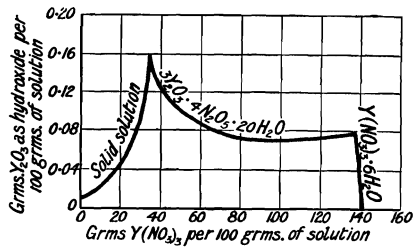

FIG. 26.—The Ternary System, $\text{Y}_2\text{O}_3 - \text{N}_2\text{O}_5 - \text{H}_2\text{O}$, at 25°.

The results are plotted in Fig. 26. This salt is stable in air, and in the presence of a soln. of yttrium nitrate containing one-fourth of its weight or more of anhydrous nitrate. It is not affected by absolute alcohol, but is decomposed by water.

The mineral xenotime (*q.v.*) is **yttrium orthophosphate**, YPO_4 ; and weinschenkite (*q.v.*) is another, $(\text{Y, Er, . . .})\text{PO}_4 \cdot 2\text{H}_2\text{O}$. According to P. T. Cleve, when an ammoniacal soln. of ammonium orthophosphate, or phosphoric acid, is added to a soln. of yttrium nitrate, the dihydrate, $\text{YPO}_4 \cdot 2\text{H}_2\text{O}$, is precipitated. F. V. Radominsky obtained crystals of the amorphous phosphate, artificial xenotime, by melting the precipitated phosphate with ten times its weight of yttrium chloride, and washing with water and acetic acid. F. Zambonini made crystals of **yttrium apatite** by fusing and slowly cooling a mixture of calcium orthophosphate and chloride, and yttrium orthophosphate. The crystals contained up to 6 per cent. YPO_4 . P. T. Cleve found that if disodium hydrophosphate is added to a soln. of an yttrium salt, amorphous **yttrium hydrophosphate**, $\text{Y}_2(\text{HPO}_4)_3$, is precipitated. According to W. Wartha, xenotime is sparingly soluble in conc. hydrochloric acid, but if it has been previously heated with a little conc. acid, dissolution readily occurs. K. R. Johnson obtained microscopic six-sided plates of **yttrium pyrophosphate**, $2\text{Y}_2\text{O}_3 \cdot 3\text{P}_2\text{O}_5$, or $\text{Y}_4(\text{P}_2\text{O}_7)_3$, by melting orthophosphoric acid with yttrium sulphate. The salt fuses with difficulty, its sp. gr. is 3.059, and it is insoluble in acids. P. T. Cleve made **yttrium hydroxyphosphate**, $\text{Y}_2(\text{H}_2\text{P}_2\text{O}_7)_3 \cdot 7\text{H}_2\text{O}$, in crystal aggregates, from a soln. of yttria in pyrophosphoric acid. The salt loses six mols of water over conc. sulphuric acid; and it does not fuse at a red heat. K. A. Wallroth heated yttria with microcosmic salt, and obtained **sodium yttrium pyrophosphate**, NaYP_2O_7 . By melting the amorphous phosphate with sodium or potassium ortho- or pyro-phosphate, A. Duboin obtained crystals of salts with the composition $\text{K}_2\text{O} \cdot \text{Y}_2\text{O}_3 \cdot 2\text{P}_2\text{O}_5$; $3\text{K}_2\text{O} \cdot \text{Y}_2\text{O}_3 \cdot 2\text{P}_2\text{O}_5$; $3\text{K}_2\text{O} \cdot 5\text{Y}_2\text{O}_3 \cdot 6\text{P}_2\text{O}_5$; and $3\text{Na}_2\text{O} \cdot \text{Y}_2\text{O}_3 \cdot 2\text{P}_2\text{O}_5$. P. T. Cleve evaporated to dryness a soln. of yttrium nitrate with an excess of orthophosphoric acid; and extracted the calcined mass with water. The resulting white crystalline **yttrium metaphosphate**, $\text{Y}(\text{PO}_3)_3$, was insoluble in water and acids.

REFERENCES.

- ¹ J. Gadolin, *Crell's Ann.*, i, 313, 1796; A. G. Ekeberg, *Scherer's Journ.*, 3, 189, 1800; 9, 597, 1803; M. H. Klaproth, *ib.*, 5, 531, 1811; J. J. Berzelius, *Schweigger's Journ.*, 16, 250, 404, 1816; N. J. Berlin, *Pogg. Ann.*, 43, 105, 1838; L. N. Vauquelin, *Ann. Chim. Phys.*, (1), 36, 143, 1801; C. G. Mosander, *Liebig's Ann.*, 48, 219, 1843; T. Scheerer, *Pogg. Ann.*, 56, 479, 1842; 61, 636, 1844; 67, 96, 1846.
- ² J. E. Egan and C. W. Balke, *Journ. Amer. Chem. Soc.*, 35, 365, 1913; C. James and L. A. Pratt, *ib.*, 32, 873, 1910; B. S. Hopkins and C. W. Balke, *ib.*, 38, 2332, 1916; J. P. Bonardi and C. James, *ib.*, 37, 2642, 1915; E. Wickers, B. S. Hopkins, and C. W. Balke, *ib.*, 40, 1615, 1918; J. F. G. Hicks, *ib.*, 40, 1619, 1918; E. W. Engle and C. W. Balke, *ib.*, 39, 53, 1917; H. C. Fogg and C. James, *ib.*, 44, 307, 1922; W. Guertler and M. Pirani, *Zeit. Metallkunde*, 11, 1, 1919; W. R. Mott, *Trans. Amer. Electrochem. Soc.*, 34, 555, 1918; C. C. Kiess, B. S. Hopkins, and H. C. Kromers, *Scient. Papers Bur. Standards*, 421, 1921; R. J. Meyer and J. Wuorinen, *Zeit. anorg. Chem.*, 80, 7, 1913; T. Scheerer, *Pogg. Ann.*, 56, 496, 1842; N. J. Berlin, *ib.*, 43, 105, 1838; F. Wöhler, *ib.*, 13, 577, 1828; J. J. Berzelius, *ib.*, 4, 117, 1825; *Schweigger's Journ.*, 16, 250, 404, 1816; M. H. Klaproth, *Scherer's Journ.*, 5, 531, 1804; A. G. Ekeberg, *ib.*, 3, 187, 1802; *Crell's Ann.*, 2, 65, 1799; J. Gadolin, *ib.*, 1, 313, 1796; *Svenska Akad. Handl.*, 15, 137, 1894; E. W. von Siemens and J. G. Halske, *Brit. Pat. No.* 10867, 1900; C. G. Mosander, *Phil. Mag.*, (3), 23, 241, 1843; *Skand. Naturför. Förh.*, 3, 387, 1842; L. N. Vauquelin, *Ann. Chim. Phys.*, (1), 22, 179, 1797; (1), 36, 143, 1801; (1), 54, 28, 1805; H. Davy, *Elements of Chemical Philosophy*, London, 1812; P. T. Cleve, *Bihang. Svenska Akad. Handl.*, 2, 7, 8, 12, 1874; *Bull. Soc. Chim.*, (2), 21, 196, 246, 1874; (2), 22, 353, 1874; P. T. Cleve and O. Höglund, *ib.*, (2), 18, 193, 1873; O. Popp, *Liebig's Ann.*, 131, 179, 1864; J. F. Bahr and R. Bunsen, *ib.*, 137, 1, 1866; C. Winkler, *Ber.*, 23, 44, 120, 772, 2642, 1890; W. Kettmeil, *Zeit. anorg. Chem.*, 38, 213, 1904; *Studien über elektrolytische Amalgambildung und Versuche zur Metalltrennung durch Amalgambildung*, Göttingen, 1903; J. Missenden, *Chem. News*, 125, 28, 1922; W. Nernst, *Ber.*, 30, 1547, 1897; L. de Boisbaudran, *Compt. Rend.*, 102, 153, 395, 483, 647, 899, 1004, 1886; 103, 627, 1886; 111, 393, 397, 1890; 114, 575, 1892; 116, 611, 1893.
- ³ R. Thalén, *Om spectralanalys*, Upsala, 1866; *Nova Acta Upsala*, (3), 6, 9, 1868; *Svenska Akad. Handl.*, 12, 4, 1874; *Journ. Phys.*, (1), 4, 33, 1875; R. Bunsen, *Pogg. Ann.*, 155, 230, 1875; J. N. Lockyer, *Proc. Roy. Soc.*, 27, 279, 1878; *Compt. Rend.*, 86, 317, 1878; *Solar Physics Committee*, London, 1906; W. N. Hartley, *Journ. Chem. Soc.*, 41, 210, 1882; H. A. Rowland, *Johns Hopkins Univ. Circ.*, 10, 41, 1891; *Astron. Astrophys.*, 12, 321, 1893; *Phil. Mag.*, (5), 36, 49, 1893; *Preliminary Table of Solar Spectrum Wave-lengths*, Chicago, 1893; E. Demarcay,

Spectres Électriques, Paris, 1895; O. Lohse, *Astrophys. Journ.*, **6**, 95, 1897; *Sitzber. Akad. Berlin*, **179**, 1897; H. Kayser, *Abhandl. Berlin Akad.*, **1**, 1903; *Handbuch der Spectroscopic*, Leipzig, **6**, 823, 1912; W. J. Humphreys, *Astrophys. Journ.*, **6**, 169, 1897; B. E. Moore, *ib.*, **28**, 1, 1908; *Phys. Rev.*, (1), **26**, 258, 1908; *Ann. Physik*, (4), **25**, 309, 1908; F. Exner and E. Haschek, *Tabellen der Funkenspectren*, Wien, 1902; *Tabellen der Bogenspectren*, Wien, 1904; *Die Spectren der Elemente bei normalen Druck*, Leipzig, 1912; *Sitzber. Akad. Wien*, **108**, 1123, 1899; G. Hofbauer, *ib.*, **116**, 267, 1907; J. M. Eder and E. Valenta, *ib.*, **119**, 9, 519, 1910; *Atlas typischer Spectren*, Wien, 1911; A. Hagenbach and H. Konen, *Atlas der Emissionsspectra*, Jena, 1905; J. Missenden, *Chem. News*, **125**, 28, 1922; L. F. Yntema and B. S. Hopkins, *Journ. Amer. Opt. Soc.*, **6**, 121, 1922; J. Becquerel, *Compt. Rend.*, **146**, 683, 1908; J. H. Pollok and A. G. G. Leonard, *Proc. Roy. Soc. Dublin*, (2), **11**, 257, 1908; G. Eberhard, *Zeit. wiss. Photochem.*, **7**, 245, 1909; *Zeit. anorg. Chem.*, **45**, 374, 1905; E. Hjalmar, *Zeit. Physik*, **3**, 262, 1920; **7**, 341, 1921; D. Coster, *Compt. Rend.*, **174**, 378, 1922; *Phil. Mag.*, (6), **43**, 1070, 1922; W. Muthmann and E. Baur, *Ber.*, **33**, 1748, 1900; E. Baur and R. Marc, *ib.*, **34**, 2460, 1901; W. Crookes, *Proc. Roy. Soc.*, **76**, A, 411, 1905; *Chem. News*, **84**, 2, 1901; **92**, 25, 1905; *Journ. Chem. Soc.*, **53**, 487, 1888; **55**, 250, 1889; *Phil. Trans.*, **176**, 691, 1885; H. G. J. Moseley, *Phil. Mag.*, (6), **26**, 1024, 1913; (6), **27**, 703, 1914; E. S. Friman, *ib.*, (6), **32**, 497, 1916; F. G. Wick, *Proc. Amer. Acad.*, **58**, 557, 1923; C. C. Kiess, B. S. Hopkins, and H. C. Kremers, *Scient. Papers U.S. Bur. Standards*, 421, 1921; W. Kettenteil, *Studien über elektrolytische Amalgambildung und Versuche zur Metalltrennung durch Amalgambildung*, Göttingen, 1903; *Zeit. anorg. Chem.*, **38**, 217, 1904; J. M. Eder, *Ann. Physik*, (4), **71**, 12, 1923; F. C. Blake and W. Duane, *Phys. Rev.*, (2), **10**, 697, 1917; M. Siegbahn, *Jahrb. Rad. Elektron.*, **13**, 296, 1916.

⁴ J. J. Berzelius, *Lärbok i Kemien*, Upsala, 1814; N. J. Berlin, *Skand. Naturfor. Förh.*, **452**, 1860; O. Popp, *Liebig's Ann.*, **121**, 179, 1864; J. F. Bahr and R. Bunsen, *ib.*, **137**, 1, 1866; M. Delafontaine, *ib.*, **134**, 108, 1865; *Arch. Sciences Genève*, (2), **25**, 119, 1866; J. C. G. de Marignac, *ib.*, (2), **64**, 87, 1873; P. T. Cleve and O. Höglund, *Bihang Svenska Akad. Handl.*, **8**, 1873; P. T. Cleve, *ib.*, **9**, 1882; *Bull. Soc. Chim.*, (2), **39**, 120, 287, 1883; *Compt. Rend.*, **95**, 1225, 1882; G. and E. Urbain, *ib.*, **132**, 136, 1901; H. C. Jones, *Amer. Chem. Journ.*, **14**, 154, 1895; *Chem. News*, **71**, 305, 1895; W. Muthmann and C. R. Böhm, *Ber.*, **33**, 42, 1900; W. Feit and C. Przibylla, *Zeit. anorg. Chem.*, **50**, 262, 1906; O. Brill, *ib.*, **47**, 464, 1905; R. J. Meyer and J. Wuorinen, *ib.*, **80**, 7, 1913; R. J. Meyer and M. Weinheber, *Ber.*, **46**, 2672, 1913; J. E. Égan and C. W. Balke, *Journ. Amer. Chem. Soc.*, **35**, 365, 1913; B. S. Hopkins and C. W. Balke, *ib.*, **38**, 2332, 1916; H. C. Fogg and C. James, *ib.*, **44**, 307, 1922; H. C. Kremers and B. S. Hopkins, *ib.*, **41**, 718, 1919; B. Brauner, in R. Abegg, *Handbuch der anorganischen Chemie*, Leipzig, **3**, i, 328, 1906; F. W. Aston, *Nature*, **112**, 449, 1923; *Phil. Mag.*, (6), **47**, 385, 1924.

⁵ A. Duboin, *Compt. Rend.*, **107**, 99, 243, 1888; L. F. Nilson and O. Pettersson, *Ber.*, **13**, 1459, 1880; *Compt. Rend.*, **91**, 232, 1880; L. F. Nilson, *Ber.*, **9**, 1056, 1142, 1876; *Öfvers. Svenska Akad. Förh.*, **37**, 1, 1880; A. B. Schiøtz, *Tids. Kem. Farm. Terapi*, **14**, 249, 1917; B. Szilard, *Journ. Chim. Phys.*, **5**, 636, 1907; W. W. Coblenz, *Investigations of Infra-red Spectra*, Washington, **6**, 51, 1908; **7**, 116, 1908; *Journ. Franklin Inst.*, **114**, 549, 1912; S. M. Tanatar and I. Völjansky, *Journ. Russ. Phys. Chem. Soc.*, **42**, 96, 1910; P. T. Cleve, *Bihang Svenska Akad. Handl.*, **2**, 7, 8, 12, 1874; *Bull. Soc. Chim.*, (2), **21**, 196, 246, 1874; (2), **22**, 353, 1874; P. T. Cleve and O. Höglund, *ib.*, (2), **18**, 193, 1873; C. G. Mosander, *Phil. Mag.*, (3), **23**, 241, 1843; *Skand. Naturfor. Förh.*, **3**, 387, 1842; O. Pettersson, *Svenska Kem. Tids.*, **6**, 176, 1895; R. J. Meyer and J. Wuorinen, *Zeit. anorg. Chem.*, **80**, 7, 1908; B. Brauner and A. Picek, *ib.*, **38**, 322, 1911; F. Wirth, *ib.*, **76**, 174, 1912; O. Brill, *ib.*, **47**, 464, 1905; W. Muthmann and C. R. Böhm, *Ber.*, **33**, 42, 1900; W. H. Evans, *Biochem. Journ.*, **7**, 349, 1913; H. Moissan and A. Étard, *Compt. Rend.*, **122**, 573, 1896; C. A. Matignon, *Ann. Chim. Phys.*, (8), **8**, 433, 1906; *Compt. Rend.*, **134**, 1308, 1902; **140**, 1637, 1905; F. V. Radominsky, *ib.*, **80**, 304, 1875; *Bull. Soc. Chim.*, (2), **23**, 178, 1875; J. Thomsen, *Thermochemische Untersuchungen*, Leipzig, **3**, 190, 1883; G. A. Barbieri and F. Calzolari, *Atti Accad. Lincei*, (5), **20**, i, 164, 1911; O. Popp, *Liebig's Ann.*, **131**, 179, 1864; J. F. Bahr and R. Bunsen, *ib.*, **137**, 1, 1866; E. H. Kraus, *Zeit. Krist.*, **34**, 307, 1901; C. F. Rammelsberg, *Pogg. Ann.*, **115**, 583, 1862; H. Töpsöe, *Bihang Svenska Akad. Handl.*, **2**, 5, 1875; H. von Wartenberg, J. Broy, and R. Reinicke, *Zeit. Elektrochem.*, **29**, 214, 1923; F. Zambonini, *Zeit. Krist.*, **58**, 226, 1923; W. R. Mott, *Trans. Amer. Electrochem. Soc.*, **34**, 555, 1918; O. Ruff, H. Seiferheld, and J. Suda, *Zeit. anorg. Chem.*, **82**, 373, 1913; R. J. Meyer and U. Müller, *ib.*, **109**, 1, 1919; O. Ruff and G. Lauschke, *ib.*, **97**, 73, 1916; E. H. Williams, *Chem. News*, **119**, 287, 1919; *Phys. Rev.*, (2), **14**, 348, 1919; E. Wedekind and P. Hausknecht, *Ber.*, **54**, B, 253, 1921; H. C. Kremers and B. S. Hopkins, *Journ. Amer. Chem. Soc.*, **41**, 718, 1919; C. James and H. C. Holden, *ib.*, **35**, 559, 1913; C. James and L. A. Pratt, *ib.*, **32**, 873, 1910; P. H. M. P. Brinton and C. James, *ib.*, **43**, 1446, 1921; J. F. G. Hicks, *ib.*, **40**, 1619, 1918; H. C. Fogg and C. James, *ib.*, **44**, 307, 1922; W. R. Mott, *Trans. Amer. Electrochem. Soc.*, **34**, 255, 1918; V. von Lang and L. Haitinger, *Liebig's Ann.*, **351**, 450, 1907; E. Demarcay, *Compt. Rend.*, **130**, 1019, 1900; A. Duboin, *ib.*, **107**, 622, 1888; W. Wartha, *Pogg. Ann.*, **139**, 237, 1866; K. R. Johnson, *Ber.*, **22**, 976, 1889; K. A. Wallroth, *Bull. Soc. Chim.*, (2), **39**, 136, 1883; E. Löwenstein, *Zeit. anorg. Chem.*, **63**, 69, 1909; R. F. Weinland and H. Kuhl, *ib.*, **54**, 244, 1907; J. Böhm and H. Niclassen, *Zeit. anorg. Chem.*, **132**, 1, 1923.

§ 21. The Terbium Family of Rare Earths

The terbium family of rare earths is arbitrarily taken to include the three elements, europium, Eu; gadolinium, Gd; and terbium, Tb. The general characters resemble those of the cerium family. The members of this family decrease in basicity in the order: . . . , Sa, Eu, Gd, Tb, Dy, . . . , so that the cerium family merges into the terbium family, and the latter into the yttrium family. There are no sharp lines of demarcation between these three families. The elements are all trivalent and yield colourless oxides of the type R_2O_3 , although terbium alone furnishes what is considered to be a higher oxide, Tb_4O_7 . The terbium elements yield salts of the type RX_3 , where X represents a univalent acidic radicle; europium alone gives rise to salts of the type EuX_2 , corresponding with the unknown oxide, EuO , where europium is bivalent. Samarium is the only other rare earth element which acts as a dyad, and it forms halides of the type SaX_2 . Soln. of the salts of terbium and europium exhibit a weak absorption spectra in the visible region; where soln. of terbium salts give an absorption spectrum only in the ultra-violet region. The salts of terbium are generally less soluble than those of gadolinium. The solubility of the double potassium or sodium sulphates is rather greater than is the case with the cerium family, and less than with the yttrium family.

The history and occurrence have already been discussed. The terbia earths are found in small amounts in the majority of the ceria and yttria minerals. They are usually extracted from gadolinite, xenotime, and samarskite, because these minerals are readily obtained, and contain a larger proportion of the terbia earths than other minerals. Probably europium is the most sparsely distributed and gadolinium the most plentiful of these elements, but in any case the actual proportion of these elements in any given mineral is very small. G. Urbain and H. Lacombe¹ say that monazite does not contain more than 0.002 per cent. of europia. The occurrence of these elements in the sun has been previously considered.

The isolation of the terbium earths.—As previously indicated, the terbium earths can be separated from the cerium and yttrium earths by fractional crystallization of the double alkali sulphates, but the separation is not clean since a large proportion crystallizes with the cerium earths, and remains in soln. with the yttrium earths. The fractional crystallization of the ethylsulphates with alcohol or water as solvent enables the terbia earths to be isolated fairly quickly, the cerium ethylsulphates crystallize first, and the yttrium sulphates last. The fractional crystallization of the formates from aq. formic acid also enables a separation to be made, although there is a loss since some of the terbia earths accompany the yttria earths and are not separable by the formate process. The general scheme for the isolation of the rare earths, previously discussed, provides for the isolation of the members of this family of earths.

The isolation of europia.—E. Demarçay² noted that in the fractional crystallization of a mixture of rare earths rich in samaria and gadolinia from conc. nitric acid, there appeared a new nitrate with a solubility greater than that of gadolinium and less than that of samarium. The element was found to have a characteristic spectrum; and he named it provisionally Σ . A year later he named it europium, and found that the crystallization of the double magnesium nitrate gave a more rapid separation. Before E. Demarçay's work, L. de Boisbaudran had noted some spectral lines in some samarium preparations which were attributed to elements Z_s and Z_r , and which were afterwards found by E. Demarçay to coincide with those given by europium; similarly, in 1885, W. Crookes noted a red band, $\lambda=6090$, in the phosphorescent spectrum of a preparation obtained by fractionating yttria earth. The band was sometimes nebulous, sometimes clear and sharp, and almost as narrow as a spark line. W. Crookes called it the *anomalous line*, and he considered it to be produced only when samaria and yttria are simultaneously present; soon afterwards, W. Crookes attributed the line to a new element which he called

*S*₈. This element was afterwards shown by E. Demarçay to have the same spectrum as europium. G. Urbain and H. Lacombe found that bismuth magnesium nitrate furnishes crystals which were isomorphous with the corresponding salts of samarium and europium, and were intermediate in solubility; and with the bismuth salt as *l'élément séparateur*, it was found possible to separate europium from samarium and gadolinium. C. James and J. E. Robinson obtained europium from monazite residues by the following process:

The crude oxides were dissolved in conc. nitric acid, taking care that the soln. did not become alkaline. An eq. amount of nitric acid was similarly treated with magnesium oxide. The two soln. were mixed, and evaporated until half the solute crystallized out on cooling. The mother liquid was poured off and evaporated further for crystallization. The double nitrates which separated were recrystallized three times, and then set aside. When the mother liquors began to crystallize badly, they were treated with oxalic acid, and the washed oxalates were ignited. The resulting mixture of oxides of lanthanum, cerium, praseodymium, neodymium, samarium, gadolinium, yttrium, etc., were again converted into double magnesium nitrates and recrystallized from 30 per cent. nitric acid. The cerium, lanthanum, praseodymium, and neodymium rapidly collected in the least soluble portion; the intermediate fraction contained the pale yellow samarium salts; and the most soluble portion contained gadolinium, erbium, and yttrium salts. As soon as crystals of yttrium nitrate appeared in the most soluble fractions, bismuth magnesium nitrate was introduced and all traces of samarium and europium were soon separated. The samarium was removed, by fractionation, from the cerium, lanthanum, praseodymium, and neodymium fraction. The samarium-gadolinium fractions were then recrystallized. The blue europium absorption band appeared in the fractions of the gadolinium next to the samarium; and the blue europium band gradually became stronger in the fractions between samarium and gadolinium. Later, the two green europium bands appeared. The fractions showing no europium absorption spectrum were removed. The fractions containing bismuth magnesium nitrate were mixed according to their absorption spectra, diluted, and treated with hydrogen sulphide. The filtrates containing europium were treated with oxalic acid; and the europium oxalate collected and washed. The oxalate from each filtrate was ignited, dissolved in nitric acid, and the soln. examined spectroscopically. The soln. of europium nearest to the samarium fraction were still contaminated with that element. The europium material was again converted to the double magnesium nitrate, and fractionally crystallized with bismuth magnesium nitrate until free from samarium. The bismuth was then removed with hydrogen sulphide, and the europium oxalate precipitated as before.

The isolation of gadolinia.—J. C. G. de Marignac³ announced the discovery of a new earth in samarskite which he designated Y_a . The impure earth was obtained by fractional precipitation with potassium sulphate. L. de Boisbaudran applied the term gadolinium to the new element which he obtained by the fractional decomposition of the nitrates, and also by fractional precipitation with ammonia. A. Bettendorff separated gadolinium from orthite. C. Benedicks obtained gadolinia by the fractional crystallization of the simple nitrates from nitric acid, and also by fractional precipitation with ammonia. E. Demarçay fractionally crystallized the double magnesium nitrates; and R. Marc fractionally crystallized the double potassium sulphates. G. Urbain and H. Lacombe used bismuth magnesium nitrate in conjunction with E. Demarçay's process, and later purified the material by recrystallization of the double nickel nitrates from conc. nitric acid. According to L. Jordan and B. S. Hopkins, the dimethyl phosphate fractionation very rapidly and completely concentrated the europium and samarium and removed them from the gadolinium. The greater part of the terbium was separated in the insoluble fractions of the series. The method did not remove the last traces of terbium which still coloured the gadolinium oxide a light yellow-brown. Gadolinium oxide of considerable purity was obtained from the middle fractions of this series. Gadolinium material giving an oxide coloured orange-brown by terbium was fractionated as the bromate in the presence of neodymium. The method was more tedious than the dimethyl phosphate method, but almost completely removed even the last traces of terbium from the gadolinium and furnished a light cream, almost colourless, oxide. This oxide still contained a small quantity of neodymium and samarium. The first method studied would seem to be an effective method for removing these

earths. C. C. Kiess and co-workers, and R. J. Meyer and U. Müller have also discussed this subject.

The isolation of terbia.—In 1842, C. G. Mosander⁴ first obtained what he called erbium from some yttria earths, but several chemists—*vide* the history of the rare earths—failed to obtain C. G. Mosander's orange-yellow erbia, and in consequence the term came to be applied to an earth which gave a rose-red oxide. In 1887, M. Delafontaine succeeded in getting C. G. Mosander's erbia from samarskite, and since the term was now generally applied to another earth, M. Delafontaine and C. G. Mosander's erbia was called terbia. J. C. G. de Marignac, and P. T. Cleve confirmed the existence of orange-yellow terbia. L. de Boisbaudran concluded that there were four terbia earths, which he designated Z_α , Z_β , Z_γ , and Z_δ . K. A. Hofmann and G. Krüss found that what was regarded as terbia could not be resolved by the fractionation of the double sulphates or formates, but could be resolved in aniline hydrochloride. R. Marc, E. Portratz, and W. Feit made some observations on this subject. G. Urbain found that a soln. of terbium oxide which he prepared gave the absorption spectrum of Z_δ , the inverse spectrum of Z_β , the spark spectrum of E. Demarcay's element Γ , and the phosphorescent spectrum of one of W. Crookes' ionium, incognitum, and his G_β . C. A. von Welsbach fractioned the double oxalates of the yttria earths, and claimed to have split terbium into three elements, but neither G. Urbain nor C. James and D. W. Bissel could confirm this.

The methods originally used for separating terbia gave preparations with only a few per cent. of that earth. These methods included the fractional decomposition of the nitrates; fractional precipitation by potassium sulphate; fractional precipitation of the oxalates from a nitric acid soln.; and the fractional precipitation of the formates. L. de Boisbaudran recommended fractional precipitation by ammonia, but G. Urbain said the process is very tedious, and recommended the fractional crystallization of the double nitrates of these earths and nickel; the fractional crystallization of the simple nitrates in the presence of bismuth nitrate; and the fractional crystallization of the ethylsulphates. C. James and D. W. Bissel used the bromate process:

The fraction, mainly containing the gadolinium, terbium, dysprosium, and holmium oxides, was warmed with bromic acid; and the resulting bromates fractionally crystallized. The order of decreasing solubility is: La, Ce, Pr, Nd, Sa, and Eu; and the solubility then increases in the order Eu, Gd, Tb, Dy, Ho, Y, Er, Tm, Yb, Lu, and Sc. The whole of the terbium and most of the holmium and dysprosium soon collected in the most soluble portions. As the work proceeded, some europium collected in the least soluble portion as shown by the blue absorption band of the soln. The gadolinium collected in the least soluble portion and gave a white oxide. Gadolinium bromate was removed as soon as it gave a white oxide; and the more soluble fractions as soon as they gave a buff-coloured oxide. The fractions which gave the darkest coloured oxides gave the absorption band of terbium alone; the more soluble portions of the fractions giving the terbium band also gave absorption bands of dysprosium; and the less soluble portions, the absorption bands of neodymium. As large amounts of gadolinium bromate were, however, rapidly removed from one end, and fair quantities of the bromates of erbium, yttrium, holmium, and dysprosium from the other, the bulk of material undergoing fractionation quickly decreased. The whole of the erbium was removed in the most soluble portion after a few crystallizations. This was followed by yttrium and holmium with some dysprosium. Finally, the holmium bands became very faint, and later dysprosium, with a little terbium, formed the most soluble fractions of the series. The crystallization of the chlorides from hydrochloric acid was used in the endeavour to separate small amounts of terbium from dysprosium. The chlorides formed very nice crystals, and the mother liquor could easily be drained off. The rate of fractionation seemed to be about the same as in the case of the nitrates. The oxide from the least soluble portion was darker than that from the most soluble. This showed that terbium chloride like terbium nitrate passed into the least soluble fractions.

The metals of the terbium family have not been isolated. The **spark spectrum** of dysprosium has been investigated by E. Demarcay,⁵ C. Benedicks, J. M. Eder and E. Valenta, W. Crookes, G. Urbain, F. Exner and E. Haschek, etc.; and the **arc spectrum** by F. Exner and E. Haschek, G. Eberhard, J. Lunt, and J. M. Eder and E. Valenta. The most prominent lines in the arc spectra have the wave-lengths:

3688·57, 3725·10, 3819·80, 3907·28, 3930·66, 3972·16, 4129·90, 4205·20, 4435·75, 4522·76, 4594·27, 4627·47, 4662·10, 6645·44. The spark spectrum of gadolinium⁶ has been measured by C. Benedicks, E. Demarçay, L. de Boisbaudran, F. Exner and E. Haschek, G. Urbain, W. Crookes, J. M. Eder, E. Baur and R. Marc, etc. The arc spectrum of gadolinium is very rich in lines which have been measured by F. Exner and E. Haschek, C. C. Kiess, G. Eberhard, and J. M. Eder and E. Valenta. The more prominent lines in the arc-spectrum characteristic of gadolinium have the wave-lengths: 3082·15, 3100·66, 3422·62, 3545·94, 3549·52, 3585·12, 3646·36, 3671·39, 3719·63, 3743·68, 3768·60, 3796·62, 3814·18, 3852·65, 3916·70, 4037·49, 4050·05, 4063·62, 4070·51, 4073·99, 4085·73, 4098·80, 4130·59, 4184·48, 4251·90, 4262·24, 4325·83, 4327·29, 4342·35, 6114·26. W. M. Hicks, and E. Paulson have sought for regularities in the spectral lines of gadolinium. The spark spectrum of terbium⁷ has been measured by E. Demarçay, G. Urbain, etc.; and the arc spectrum by G. Eberhard, J. M. Eder and E. Valenta, F. Exner and E. Haschek, etc. The more prominent lines in the arc spectrum of terbium have the wave-lengths: 3324·53, 3509·34, 3531·86, 3561·90, 3568·69, 3600·60, 3628·53, 3650·60, 3659·02, 3704·10, 3711·91, 3848·90, 3874·33, 3899·34, 3925·60, 3939·75, 3977·01, 3982·07, 4005·70, 4012·99, 4278·70, 4752·69.

The **reversion spectrum** of europium was studied by E. Demarçay,⁸ G. Urbain, and L. de Boisbaudran. There is a red phosphorescence, and a dil. acid soln. gives two bands, one between $\lambda=6160$ and $\lambda=6110$ with a maximum at $\lambda=6125$, and the other between $\lambda=5970$ and $\lambda=5920$ with a maximum at $\lambda=5890$. L. de Boisbaudran, and G. Urbain also found that terbium gives a green phosphorescence, and the chloride soln. shows four bands with maxima respectively at $\lambda=6205$, 5858, 5432, and 4870.

G. Urbain⁹ found that purified europia gives no **cathodic phosphorescent spectrum**, but if a trace of calcium sulphide or oxide be present, or if traces of other earths are present, the luminescent spectrum is very intense; it has been studied by W. Crookes, G. Urbain, and E. Demarçay. Gadolinia when pure gives no cathodic luminescent spectrum, but if slightly impure it gives a green phosphorescence whose spectrum has been studied by G. Urbain, and W. Crookes. Terbium also gives no luminescent spectrum if purified, but if a trace of alumina is present, it gives a white fluorescence. The green fluorescence of terbium chloride in the cathode rays was studied by G. Urbain. The high frequency or **X-ray spectra** of europium, gadolinium, and terbium were studied by H. G. J. Moseley, E. Friman, D. Coster and co-workers, and E. Hjalmar.

Neutral soln. of europium chloride are rose-coloured, and the **absorption spectrum** has been studied by G. Urbain,¹⁰ W. Prandtl, L. F. Yntema, and

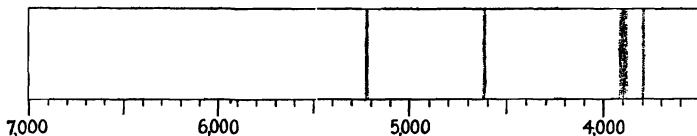

FIG. 27.—Absorption Spectrum of Europium Nitrate Solution.

E. Demarçay. The bands in the visible part of the spectrum are narrow and faint. There are maxima for $\lambda=5913$, 5882, 5790, 5337, 5251, 5234, 4656, 4645, 4000, 3950, 3853, 3836, 3800, 3760, 3746, 3663, 3615, 3207, 3192, 3178, 3168, and 2983; with a soln. of europium nitrate, Fig. 27, a band 5913 replaces 5913 and 5882 of the chloride spectrum; 5337 gives place to 5337; 5250 replaces 5251 and 5234; and 4660 replaces 4656 and 4645. Soln. of gadolinium salts are colourless if the acid radicle is colourless. The absorption bands of an aq. soln. of gadolinium chloride were studied by G. Urbain, J. L. Soret, and H. C. Jones and W. W. Strong; they are all in the ultra-violet with maxima at 3794, 3697, 3596, 3515, 3108, 3059, 3056, and 3052. H. C. Jones and W. W. Strong measured

the absorption spectrum of a soln. of gadolinium chloride in aq. alcohol, and found it very different from that in aq. soln. Soln. of terbium salts are colourless if the acid radicle is colourless. L. de Boisbaudran, and G. Urbain showed that with the exception of the feeble blue band 4880, Fig. 28, the nine absorption bands of terbium salt soln. are in the ultra-violet with maxima at 4880, 3787, 3694, 3592, 3519, 3420, 3390, 3266, 3176, 3029. J. Carrera gave for the absorption coeff. for the K-series of X-ray spectra, Eu, 59·81; Gd, 60·84; and Tb, 61·93. The K-series were examined by M. Siegbahn and E. Jönsson, and W. Duane and T. Shimizu; and for the L-series, D. Coster, E. Hjalmar, and M. Siegbahn gave for europium $\alpha\alpha'=2\cdot12733$; $\alpha_1\alpha=2\cdot11633$; $\beta_1\beta=1\cdot91631$; $\beta_2\gamma=1\cdot807$; $\gamma_1\delta=1\cdot659$; $\gamma_2\theta=1\cdot598$; $\beta_4\nu=1\cdot921$; and $\beta_3\phi=1\cdot886$; for gadolinium, $\alpha_2\alpha'=2\cdot05264$; $\alpha_1\alpha=2\cdot04193$; $\beta_1\beta=1\cdot84246$; $\beta_2\gamma=1\cdot741$; $\gamma_1\delta=1\cdot58863$; $\beta_4\nu=1\cdot848$; and $\beta_3\phi=1\cdot809$; and for terbium, $\alpha_2\alpha=1\cdot98231$; $\alpha_1\alpha=1\cdot97149$; $\beta_1\beta=1\cdot77268$; $\beta_2\gamma=1\cdot67925$; $\gamma_1\delta=1\cdot529$; $\eta=1\cdot935$; $\beta_5\zeta=1\cdot656$; $\gamma_2\theta=1\cdot474$; $\beta_4\nu=1\cdot781$; $\beta_3\phi=1\cdot74256$; $\gamma_3\chi=1\cdot468$; and $\gamma_4\psi=1\cdot437$. A. Dauvillier measured the L-series for europium and gadolinium. A. Dauvillier, and B. Cabrera have discussed the **magnetic properties** of these elements.

The atomic weights of the terbium metals.—The general reactions of salts of the terbium earths resemble those of the yttrium salts (*q.v.*). E. Demarçay¹¹ first

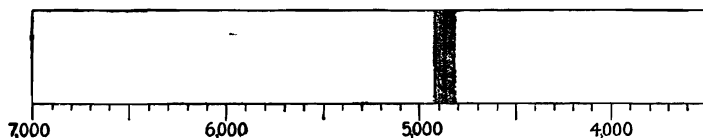

FIG. 28.—Absorption Spectrum of Terbium Nitrate Solution.

obtained europia and gadolinia of a high degree of purity, but owing to the weak absorption spectra which they exhibited, he suggested that these earths might be heterogeneous. This question was further tested by G. Urbain, who fractionated the earths in a number of ways, and tested the extreme and intermediate fractions for new elements by the spark and absorption spectra, and by at. wt. methods, but found no evidence of the resolution of these earths into simpler components. He also found that europia isolated by the bismuth nitrate method from monazite is identical with the earth isolated by the same process from gadolinite, xenotime, and pitchblende, and with europia obtained by the double magnesium nitrate process. Gadolinia was treated by G. Urbain in an analogous manner, and he failed to get any evidence of heterogeneity. The earth derived from gadolinite was identical with that obtained from xenotime or pitchblende. In the case of terbia, G. Urbain obtained no signs of complexity when the products obtained by different processes were compared. G. Eberhard also compared the arc spectra of these preparations, and concluded that there are no signs of the resolution of europia, gadolinia, or terbia into their components, and there are no signs of any intermediate elements in the terbium family. C. A. von Welsbach, however, claimed to have resolved terbia, by his double ammonium oxalate methods of fractionation, into Tb₁, Tb₂, and Tb₃; but C. James and D. W. Bissel were able to confirm G. Urbain's conclusions, and not those of C. A. von Welsbach. The conclusion that europium, gadolinium, and terbium are well-defined elements is also in harmony with J. M. Eder's work on the arc spectra, and with H. G. J. Moseley's work on the relation between the at. numbers and the frequencies of the lines in the X-ray spectra. The **atomic numbers** are Eu, 63; Gd, 64; and Tm, 65.

J. M. Eder has examined the arc spectra of C. A. von Welsbach's preparations of terbium, and he could find no evidence of a new element between gadolinium and terbium. The spectral lines of F. Exner and E. Haschek, and attributed by them to a hypothetical element, *E*, are produced by the blending of the terbium lines with those of gadolinium of nearly the same wave-length. J. M. Eder, however, affirms that the lines of the mixed fractions

lying between terbium and dysprosium correspond with the existence of a new element, which is named welsium in honour of C. A. von Welsbach. The differences in the measurements of the spectral lines by J. M. Eder and by G. Eberhard are attributed to impurities in the latter's samples.

From a comparison of the characteristics of this family of elements with those of the cerium family, it is assumed that the elements are trivalent. E. Demarçay¹² found the at. wt. of europium to be 151 from the ratio $\text{Eu}_2\text{O}_3 : \text{Eu}_2(\text{SO}_4)_3$. G. Urbain and H. Lacombe obtained 152.00 from the ratio $\text{Eu}_2(\text{SO}_4)_3 \cdot 8\text{H}_2\text{O} : \text{Eu}_2(\text{SO}_4)_3$; 151.93 from the ratio $\text{Eu}_2(\text{SO}_4)_3 : \text{Eu}_2\text{O}_3$; and 151.94 from the ratio $\text{Eu}_2(\text{SO}_4)_3 \cdot 8\text{H}_2\text{O} : \text{Eu}_2\text{O}_3$. G. Jantsch also calculated 152.05 from the results obtained by calcining the hydrosulphate; and W. Feit and C. Przibylla,^{152.66} from the ratio $\text{Eu}_2\text{O}_3 : 3\text{H}_2\text{SO}_4$. The International Table for at. wt. for 1921 gives 152 as the best representative value. J. C. G. de Marignac¹³ gave 156.75 for the at. wt. of gadolinium; and L. de Boisbaudran, 156.12. From the ratio $\text{Gd}_2\text{O}_3 : \text{Gd}_2(\text{SO}_4)_3$, A. Bettendorff calculated 156.72; C. Benedicks, 156.51; B. Brauner, 154.78; and R. Marc, 156.46. From the ratio $\text{Gd}_2(\text{SO}_4)_3 \cdot 8\text{H}_2\text{O} : \text{Gd}_2\text{O}_3$, G. Urbain calculated 157.24. From the ratio $\text{Gd}_2\text{O}_3 : \text{H}_2\text{SO}_4$, W. Feit and C. Przibylla obtained 157.39. The International Table for 1921 gives 157.3 for the best representative value of the at. wt. of gadolinium.

The early data for the at. wt. of terbium by M. Delafontaine,¹⁴ J. L. Smith, and J. C. G. de Marignac are based on determinations with very impure materials. From the ratio $\text{Tb}_2\text{O}_3 : \text{Tb}_2(\text{SO}_4)_3$, L. de Boisbaudran gave 161.4 to 163.1, and later, 159.0 to 159.95; K. A. Hofmann and G. Krüss, 148.9 to 162.2; R. Marc, 151.9 to 161.2; W. Feit, 158.6; and E. A. Potratz, 154. G. Urbain obtained 159.2 from the ratio $\text{Tb}_2(\text{SO}_4)_3 \cdot 8\text{H}_2\text{O} : 8\text{H}_2\text{O}$. The International Table for 1921 gives 159.2 as the best representative value for the at. wt. of terbium.

REFERENCES.

- ¹ G. Urbain and H. Lacombe, *Compt. Rend.*, **138**, 627, 1904.
- ² W. Crookes, *Phil. Trans.*, **176**, 691, 1885; *Proc. Roy. Soc.*, **38**, 414, 1885; E. Demarçay, *Compt. Rend.*, **122**, 728, 1896; **130**, 1019, 1469, 1900; **132**, 1484, 1901; L. de Boisbaudran, *ib.*, **114**, 675, 1892; G. Urbain and H. Lacombe, *ib.*, **138**, 628, 1904; C. James and J. E. Robinson, *Journ. Amer. Chem. Soc.*, **33**, 1363, 1911.
- ³ J. C. G. de Marignac, *Arch. Sciences Genève*, (3), **3**, 413, 1880; *Ann. Chim. Phys.*, (5), **20**, 535, 1880; L. de Boisbaudran, *Chem. News*, **53**, 225, 1886; *Compt. Rend.*, **102**, 902, 1886; E. Demarçay, *ib.*, **131**, 343, 1900; G. Urbain and H. Lacombe, *ib.*, **137**, 792, 1903; **138**, 84, 627, 1904; G. Urbain, *ib.*, **140**, 583, 1905; A. Bettendorff, *Liebig's Ann.*, **263**, 167, 1891; **270**, 376, 1892; C. Benedicks, *Zeit. anorg. Chem.*, **22**, 393, 1900; R. J. Meyer and U. Müller, *ib.*, **109**, 1, 1919; R. Marc, *ib.*, **38**, 121, 1904; L. Jordan and B. S. Hopkins, *Journ. Amer. Chem. Soc.*, **39**, 2614, 1917; C. C. Kiess, B. S. Hopkins, and H. C. Kremers, *Scient. Papers Bur. Standards*, 421, 1921.
- ⁴ C. G. Mosander, *Skand. Naturför. Förh.*, **3**, 387, 1842; *Phil. Mag.*, (3), **23**, 241, 1843; M. Delafontaine, *Ann. Chim. Phys.*, (6), **14**, 238, 1888; P. T. Cleve, *Bull. Soc. Chim.*, (2), **31**, 195, 1879; L. de Boisbaudran, *Compt. Rend.*, **102**, 153, 647, 1886; G. Urbain, *ib.*, **139**, 736, 1904; **141**, 621, 1905; **143**, 229, 825, 1906; **149**, 37, 1909; K. A. Hofmann and G. Krüss, *Zeit. anorg. Chem.*, **4**, 27, 1893; W. Feit, *ib.*, **43**, 267, 1905; R. Marc, *Ber.*, **35**, 389, 1902; E. Potratz, *Chem. News*, **92**, 3, 1903; C. James and D. W. Bissel, *Journ. Amer. Chem. Soc.*, **36**, 2060, 1914; W. Crookes, *Phil. Trans.*, **176**, 691, 1885; *Proc. Roy. Soc.*, **38**, 414, 1885; *Journ. Chem. Soc.*, **55**, 258, 1889; C. A. von Welsbach, *Chem. Ztg.*, **35**, 658, 1919; E. Demarçay, *Compt. Rend.*, **131**, 387, 1900; J. C. G. de Marignac, *ib.*, **87**, 281, 1878.
- ⁵ E. Demarçay, *Compt. Rend.*, **122**, 728, 1896; **130**, 1019, 1469, 1900; **132**, 1484, 1901; J. Carrera, *ib.*, **176**, 740, 1923; G. Urbain and H. Lacombe, *ib.*, **138**, 627, 1904; G. Urbain, *ib.*, **142**, 205, 1906; *Journ. Chim. Phys.*, **4**, 31, 105, 232, 321, 1906; C. Benedicks, *Zeit. anorg. Chem.*, **22**, 393, 1900; G. Eberhard, *ib.*, **45**, 374, 1905; W. Crookes, *Chem. News*, **84**, 2, 1901; *Proc. Roy. Soc.*, **74**, 420, 550, 1905; F. Exner and E. Haschek, *Sitzber. Akad. Wien*, **111**, 42, 1902; *Tabellen der Funkenspectra*, Wien, 1902; *Tabellen der Bogenspectra*, Wien, 1904; J. M. Eder, *Sitzber. Akad. Wien*, **126**, 473, 1917; **127**, 1100, 1918; **129**, 422, 1920; **131**, 199, 1922; J. M. Eder and E. Valenta, *Atlas typischer Spectren*, Wien, 92, 1911; J. Lunt, *Proc. Roy. Soc.*, **79**, A, 118, 1907.
- ⁶ L. de Boisbaudran, *Compt. Rend.*, **108**, 165, 1889; **111**, 472, 1890; E. Demarçay, *ib.*, **122**, 728, 1896; **131**, 343, 1900; G. Urbain, *Journ. Chim. Phys.*, **4**, 31, 105, 232, 321, 1906; F. Exner and E. Haschek, *Tabellen der Funkenspectra*, Wien, 1902; *Tabellen der Bogenspectra*, Wien, 1904;

Sitzber. Akad. Wien, **110**, 557, 1901; G. Eberhard, *Sitzber. Akad. Berlin*, 384, 1906; *Zeit. wiss. Photochem.*, **4**, 137, 1906; C. C. Kiess, *Scient. Papers Bur. Standards*, **18**, 695, 1923; J. M. Eder, *Sitzber. Akad. Wien*, **125**, 383, 1916; W. Crookes, *Proc. Roy. Soc.*, **74**, 550, 1905; E. Baur and R. Marc, *Ber.*, **34**, 2460, 1901; J. M. Eder and E. Valenta, *Sitzber. Akad. Wien*, **119**, 21, 1910; W. M. Hicks, *Phil. Trans.*, **213**, A, 323, 1913; E. Paulson, *Phys. Zeit.*, **16**, 7, 1915; C. Benedicks, *Zeit. anorg. Chem.*, **22**, 393, 1900; J. M. Eder, *Ann. Physik*, (4), **71**, 12, 1923; *Sitzber. Akad. Wien*, **129**, 421, 1920.

⁷ C. G. Mosander, *Skand. Naturför. Förh.*, **3**, 387, 1842; *Phil. Mag.*, (3), **23**, 241, 1843; H. E. Roscoe and A. Schuster, *Journ. Chem. Soc.*, **41**, 283, 1882; E. Demarçay, *Chem. News*, **82**, 127, 1900; *Compt. Rend.*, **131**, 387, 1900; G. Urbain, *ib.*, **141**, 521, 1905; **142**, 957, 1906; M. Delafontaine, *Chem. News*, **92**, 5, 1905; F. Exner and E. Haschek, *Tabellen der Funkenspectra*, Wien, 1902; *Tabellen der Bogenspectra*, Wien, 1904; *Die Spectren der Elemente bei normalem Druck*, Wien, 1911; *Sitzber. Akad. Wien*, **119**, 771, 1910; J. M. Eder, *ib.*, **125**, 1467, 1916; **129**, 421, 1920; J. M. Eder and E. Valenta, *ib.*, **119**, 9, 1910; *Atlas typischer Spectren*, Wien, 1911; G. Eberhard, *Sitzber. Akad. Berlin*, 384, 1906; *Zeit. wiss. Photochem.*, **4**, 137, 1906; E. Hjalmar, *Zeit. Physik*, **7**, 341, 1921; J. M. Eder, *Ann. Physik*, (4), **71**, 12, 1923.

⁸ E. Demarçay, *Compt. Rend.*, **130**, 1469, 1900; L. de Boisbaudran, *ib.*, **102**, 899, 1886; **114**, 575, 1892; **116**, 611, 674, 1893; G. Urbain, *Journ. Chim. Phys.*, **4**, 247, 1906.

⁹ G. Urbain, *Compt. Rend.*, **140**, 1233, 1905; **141**, 521, 1905; **142**, 205, 1518, 1906; W. Crookes, *Proc. Roy. Soc.*, **74**, 550, 1905; **76**, A, 411, 1905; *Chem. News*, **91**, 61, 1905; E. Demarçay, *Compt. Rend.*, **132**, 1484, 1901; H. G. J. Moseley, *Phil. Mag.*, (6), **26**, 1024, 1913; (6), **27**, 703, 1914; E. Friman, *ib.*, (6), **32**, 497, 1916; L. F. Yntema, *Journ. Amer. Chem. Soc.*, **45**, 907, 1923; E. Hjalmar, *Zeit. Physik*, **7**, 341, 1921; D. Coster, Y. Nishina, and S. Werner, *ib.*, **18**, 207, 1923.

¹⁰ G. Urbain, *Journ. Chim. Phys.*, **4**, 242, 323, 346, 1906; *Compt. Rend.*, **140**, 1233, 1905; E. Demarçay, *ib.*, **130**, 1469, 1900; H. C. Jones and W. W. Strong, *The Absorption Spectra of Solutions*, Washington, 43, 1911; J. L. Soret, *Arch. Sciences Genève*, (3), **4**, 261, 1880; W. Prandtl, *Zeit. anorg. Chem.*, **116**, 96, 1921; L. F. Yntema, *Journ. Amer. Chem. Soc.*, **45**, 907, 1923; L. de Boisbaudran, *Compt. Rend.*, **102**, 395, 483, 1886; **111**, 474, 1890; J. Carrera, *ib.*, **176**, 740, 1923; A. Dauvillier, *Compt. Rend.*, **176**, 1381, 1892, 1923; B. Cabrera, *Anal. Fis. Quim.*, **20**, 92, 1922; M. Siegbahn, *Jahrb. Rad. Elektron.*, **13**, 296, 1916; M. Siegbahn and E. Jönsson, *Phys. Zeit.*, **20**, 251, 1919; W. Duane and T. Shimizu, *Phys. Rev.*, (2), **14**, 522, 1919; D. Coster, *Compt. Rend.*, **174**, 378, 1922; E. Hjalmar, *Zeit. Physik*, **3**, 262, 1920.

¹¹ E. Demarçay, *Compt. Rend.*, **122**, 728, 1896; **130**, 1469, 1900; **132**, 1484, 1901; **131**, 363, 1900; G. Urbain, *ib.*, **142**, 785, 1906; **149**, 37, 1909; *Ann. Chim. Phys.*, (8), **18**, 222, 1909; *Journ. Chim. Phys.*, **4**, 31, 105, 232, 321, 1906; G. Eberhard, *Zeit. anorg. Chem.*, **45**, 374, 1905; *Sitzber. Akad. Berlin*, 384, 1906; *Zeit. wiss. Photochem.*, **4**, 137, 1906; C. A. von Welsbach, *Chem. Ztg.*, **35**, 658, 1912; C. James and D. W. Bissel, *Journ. Amer. Chem. Soc.*, **36**, 2060, 1914; H. G. J. Moseley, *Phil. Mag.*, (6), **26**, 1024, 1913; (6), **27**, 703, 1914; J. M. Eder, *Sitzber. Akad. Wien*, **129**, 421, 1920; F. Exner and E. Haschek, *ib.*, **119**, 771, 1910.

¹² E. Demarçay, *Compt. Rend.*, **132**, 1484, 1900; G. Urbain and H. Lacombe, *ib.*, **138**, 627, 1904; G. Jantsch, *ib.*, **146**, 473, 1908; W. Feit and C. Przibylla, *Zeit. anorg. Chem.*, **50**, 260, 1906.

¹³ J. C. G. de Marignac, *Ann. Chim. Phys.*, (5), **20**, 535, 1880; L. de Boisbaudran, *Compt. Rend.*, **111**, 409, 1890; A. Bettendorff, *Liebig's Ann.*, **270**, 376, 1892; C. Benedicks, *Zeit. anorg. Chem.*, **22**, 393, 1900; R. Marc, *ib.*, **38**, 128, 1904; W. Feit and C. Przibylla, *ib.*, **50**, 260, 1906; E. Demarçay, *Compt. Rend.*, **131**, 343, 1900; G. Urbain, *ib.*, **140**, 583, 1905; *Journ. Chim. Phys.*, **4**, 326, 1906; B. Brauner in R. Abegg, *Handbuch der anorganischen Chemie*, Leipzig, **3**, i, 304, 1906.

¹⁴ L. de Boisbaudran, *Compt. Rend.*, **102**, 396, 1886; **111**, 474, 1890; G. Urbain, *ib.*, **141**, 521, 1905; **142**, 727, 957, 1906; *Bull. Soc. Chim.*, (3), **33**, 403, 1905; *Journ. Chim. Phys.*, **4**, 321, 1906; W. Feit, *Zeit. anorg. Chem.*, **43**, 280, 1905; K. A. Hofmann and G. Krüss, *ib.*, **3**, 89, 407, 1893; **4**, 27, 1893; E. A. Potratz, *Chem. News*, **92**, 3, 1905; R. Marc, *Ber.*, **35**, 2370, 1902; M. Delafontaine, *Arch. Sciences Genève*, (2), **21**, 97, 1864; *ib.*, (2), **61**, 273, 1878; *Chem. News*, **38**, 202, 1878; J. L. Smith, *Compt. Rend.*, **87**, 146, 1878; J. C. G. de Marignac, *Arch. Sciences Genève*, (2), **61**, 283, 1878.

§ 22. The Compounds of the Terbium Earth Metals

According to E. Demarçay,¹ and G. Urbain and H. Lacombe, the oxides of these earths are obtained by the ignition of the hydroxide, nitrate, sulphate, oxalate, or other salts of the volatile oxyacids. *Europia*, or *europium sesquioxide*, Eu_2O_3 , is a pale pink powder. When derived from the sulphate, a very high temp. is needed—say 1600° —in order to expel the last traces of the sulphur oxides; and the colour is then rather more intense than when prepared at a lower temp. According to W. Prandtl, *europia* is white with a reddish-yellow tinge, and when obtained by

heating the oxalate at 900° , it has the sp. gr. 7.42 at $15^{\circ}/4^{\circ}$, and that obtained by heating the nitrate, 6.55 at $15^{\circ}/4^{\circ}$. White, hygroscopic *gadolinia*, or **gadolinium sesquioxide**, Gd_2O_3 , can be prepared by similar processes; and, according to G. Eberhard, if the *gadolinia* contains a trace of *terbia* it will be tinged yellow. According to W. Prandtl, white *gadolinia* has a sp. gr. 7.407 at $15^{\circ}/4^{\circ}$. E. H. Williams found the magnetic susceptibility of *gadolinium oxide* at 20° to be 129.7×10^{-6} ; at 0° , 138.2×10^{-6} ; at -40° , 160.7×10^{-6} ; at -80° , 194.2×10^{-6} ; at -100° , 217.0×10^{-6} ; at -120° , 244.6×10^{-6} ; and at -140° , 279.0×10^{-6} . E. Wedekind and P. Hausknecht found the mol. magnetism to be 9850×10^{-6} . When *terbium oxalate* is ignited, it furnishes a dark brown **terbium peroxide**, and if the sulphate is employed, at a high temp., the product is almost black. The oxygen content is rather greater than is required for the formula Tb_4O_7 , and it may be a mixture of that substance with the dioxide, TbO_2 . The peroxide is converted into *terbium salts* when treated with hot conc. acids; it loses oxygen when heated; and when heated in hydrogen, it furnishes *terbia*, or **terbium sesquioxide**, Tb_2O_3 , as a white solid.

C. Benedicks found that *gadolinia* absorbs carbon dioxide from the air, and it dissolves slowly in acids, the rate of dissolution increasing as the action proceeds. The three oxides dissolve in acids, forming the corresponding salts. According to C. Benedicks, when *gadolinia* is heated in hydrogen, it acquires a dark colour, but no reduction can be detected. The sp. gr. of *gadolinia* is 7.407 . According to D. W. Bissel and C. James, when a mixture of air and coal-gas is directed upon *terbium peroxide*, or upon *gadolinium oxide* mixed with *terbium peroxide*, heated almost to redness, the mass immediately becomes incandescent, and the gas often takes fire. E. L. Nichols and H. L. Howes studied the luminescent spectrum of incandescent *gadolinia*. All three oxides are magnetic; and G. Urbain and co-workers found the magnetic susceptibility of *erbia* to be 33.5×10^{-6} ; that of *gadolinia*, 161×10^{-6} ; and that of *terbia*, 237×10^{-6} . Gelatinous **europium hydroxide**, $Eu(OH)_3$, is obtained as in the case of the hydroxides of the cerium earths; **gadolinium hydroxide**, $Gd(OH)_3$; and **terbium hydroxide**, $Tb(OH)_3$, are obtained similarly. They rapidly absorb carbon dioxide when exposed to the atm.

The halides.—J. Popovici prepared **gadolinium fluoride**, GdF_3 , as a gelatinous precipitate by the action of hydrofluoric acid on an aq. soln. of *gadolinium sulphate*; the precipitate becomes granular when warmed. F. Bourion prepared **europium chloride**, $EuCl_3$, in yellow needles by heating the oxide, sulphate, or oxalate in a stream of sulphur chloride vapour or sulphur chloride vapour and chlorine. G. Urbain and F. Bourion found that if the oxide be employed in this process, the product is a mixture of europium di- and tri-chlorides. F. Bourion similarly prepared **gadolinium chloride**, $GdCl_3$, and **terbium chloride**, $TbCl_3$. The chlorides can be obtained in soln. by dissolving the oxides, hydroxides, or carbonates in conc. hydrochloric acid. When the soln. are evaporated over conc. sulphuric acid; or the hot soln. are cooled; or hydrogen chloride is passed into the cold aq. soln., crystals of the hexahydrates are obtained. The hydrated chlorides cannot be dehydrated by simply heating in air, since the salts are decomposed; but when heated in hydrogen chloride, at 180° to 200° , the anhydrous chloride is formed. Anhydrous *gadolinium chloride* is a white hygroscopic mass of monoclinic prisms which have a sp. gr. 4.52 at 0° ; and a m.p. of 628° ; it forms prismatic crystals of a hexahydrate, $GdCl_3 \cdot 6H_2O$, of sp. gr. 2.424 . Anhydrous *terbium chloride* gives colourless crystals which melt to a colourless liquid. The crystals at 0° have a sp. gr. 4.35 , and a m.p. of 588° . They dissolve in water without hydrolysis. The hexahydrate, $TbCl_3 \cdot 6H_2O$, forms colourless prismatic crystals. Hexahydrated *terbium chloride* is deliquescent and very soluble in water with a tendency to form supersaturated soln. If anhydrous europium trichloride be heated to 400° – 450° in a stream of hydrogen, colourless amorphous **europium dichloride**, $EuCl_2$, is formed. This salt is more stable than samarous chloride; it dissolves in cold water, forming a neutral soln., which oxidizes when boiled: $12EuCl_2 + 3O_2 + 6H_2O = 8EuCl_3$

+4Eu(OH)₃. The salt is sometimes called *europous chloride*; just as the corresponding samarium chloride is called *samarous chloride*. The notation is not good because cerous chloride is derived from the trivalent metal, and ceric chloride from the quadrivalent metal. Hence, the -ous salts of the rare earths are derived from both bivalent and trivalent metals. F. Bourion prepared **gadolinium oxychloride**, GdOCl, by passing a slow current of air or steam over the molten anhydrous chloride; similarly, when europium chloride is heated in air to 600°, **europium oxychloride**, EuOCl, is formed. Both oxychlorides are white powders insoluble in water but readily soluble in acids. G. Urbain made **terbium oxychloride**, TbOCl, in a similar manner. C. A. Matignon and F. Bourion prepared **gadolinium bromide**, GdBr₃, by heating the anhydrous chloride in a stream of dry hydrogen bromide, taking care not to fuse the material; similarly also with **terbium bromide**, TbBr₃. According to C. Benedicks, the crystallization of the aq. soln. of gadolinium bromide furnishes the hexahydrate, GdBr₃.6H₂O, in rhombic plates of sp. gr. 2.84.

The sulphides and sulphates.—H. Erdmann and F. Wirth made **gadolinium sulphide**, Gd₂S₃, as a hygroscopic yellow solid of sp. gr. 3.8. It is slowly decomposed by water and by acids. G. Urbain and H. Lacombe obtained pale pink crystals of octohydrated **europium sulphate**, Eu₂(SO₄)₃.8H₂O, from a soln. of the oxide in sulphuric acid. S. H. Katz and C. James found that the salt is slightly hydrolyzed in soln.; and the octohydrate becomes anhydrous at 375°. G. Jantsch found that it is completely decomposed at 1600°. C. Benedicks obtained octohydrated **gadolinium sulphate**, Gd₂(SO₄)₃.8H₂O, in a similar manner. The monoclinic crystals of the octohydrate have the axial ratios $a : b : c = 3.0086 : 1 : 2.0068$, and $\beta = 118^\circ 2'$. The sp. gr. of the salt is 3.01 at 14.6°. At ordinary temp., the aq. soln. deposits monoclinic crystals of the octohydrate which are isomorphous with the corresponding salts of the cerium and yttrium metals. When heated, the octohydrate becomes anhydrous, when the sp. gr. is 4.139 at 14.6°. The solubility expressed in grams of Gd₂(SO₄)₃ per 100 grms. of water, was found to be:

	0°	10°	14°	25°	34.4°
Gd ₂ (SO ₄) ₃	3.98	3.3	2.8	2.4	2.26

where the solid phase is the octohydrate, but there is an irregularity in the curve at about 10° which C. Benedicks attributed to the formation of another hydrate. F. Wirth gave for the percentage solubility of gadolinium sulphate in sulphuric acid of normality N —*i.e.* grams of Gd₂(SO₄)₃ per 100 grms. of sat. soln.—when the solid phase is the octohydrate, at 25°:

Normality H ₂ SO ₄	0	0.1	0.505	1.1	2.16	6.175	12.6
Gd ₂ (SO ₄) ₃	2.981	3.291	3.931	3.807	2.974	0.8777	0.0867

D. W. Bissel and C. James gave 2.15 for the solubility at 25° in 100 parts of water. According to S. H. Katz and C. James, gadolinium sulphates are slightly hydrolyzed in aq. soln., and, comparing the results with those obtained with the other rare earths, the tendency of the sulphates to hydrolyze in aq. soln. increases with the at. wt. of the basic element. L. Wöhler and M. Grünzweig found the partial press. of the sulphur trioxide at 900° to be 7 mm., and the heat of dissociation, 56.9 Cals. L. C. Jackson and H. K. Onnes found the octohydrate is strongly paramagnetic; and G. Breit and H. K. Onnes, and H. R. Woltjer measured the magnetic susceptibility at very low temp., *viz.*, —258°. A basic salt, **gadolinium oxysulphate**, Gd₂O₂SO₄, was made by heating the anhydrous sulphate to 800°–850°.

D. W. Bissel and C. James found the solubilities of soln. of gadolinium sulphate in soln. of sodium sulphate of different conc., expressed in grams of anhydrous salt per 100 grms. of water at 25°, to be:

Na ₂ SO ₄	0	0.42	0.44	0.66	1.26	1.94	3.01	5.71	27.40
Gd ₂ (SO ₄) ₃	2.15	2.08	2.04	0.88	0.17	0.10	0.07	0.06	0.05

The results are plotted in Fig. 29. The solid phase is **sodium gadolinium sulphate**, Na₂SO₄.Gd₂(SO₄)₃.2H₂O. This salt is readily obtained by crystallization from a

soln. containing three mols of alkali sulphate for one of gadolinium sulphate; similarly also C. Benedicks made **potassium gadolinium sulphate**, $K_2SO_4 \cdot Gd_2(SO_4)_3 \cdot 2H_2O$, which furnishes well-formed crystals which are sparingly soluble in water. The sp. gr. of the double salt is 3.503; and 100 c.c. of a sat. soln. of potassium sulphate can dissolve 0.87 to 0.77 gm. of Gd_2O_3 —A. Bettendorff said 0.77 gm. of Gd_2O_3 . R. J. Meyer and U. Müller obtained colourless, sparingly soluble crystals of **gadolinium hydrazine sulphate**, $Gd_2(SO_4)_3 \cdot (N_2H_5)_2SO_4 \cdot 3H_2O$, by boiling a soln. of the mixed sulphates for some time.

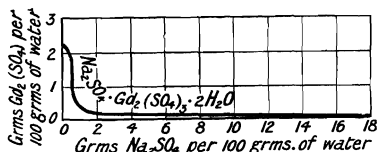

FIG. 29.—Solubility of Gadolinium Sulphate in Solutions of Sodium Sulphate.

The carbonates.—P. H. M. P. Brinton and C. James made **europium carbonate** by adding europium sulphate to an eq. amount of a soln. of sodium carbonate; **terbium carbonate** was made in the same way. According to C. Benedicks, if carbon dioxide be passed through cold water in which gadolinium hydroxide is suspended, no crystalline carbonate is formed, but microscopic, needle-like crystals appear if the liquid is warm. The crystals, dried at 100° , correspond with **gadolinium hydroxycarbonate**, $Gd(OH)CO_3 \cdot H_2O$. If the carbon dioxide be passed through the liquid for a very long time, say 12 days, the acicular crystals of the basic carbonate disappear, and larger crystals appear. When dried at 100° , the composition corresponds with **gadolinium carbonate**, $Gd_2(CO_3)_3 \cdot 13H_2O$, where there is a little doubt about the exact proportion of water. According to P. H. M. P. Brinton and C. James, the hydrolysis—represented by the ratio of the amount of carbon dioxide evolved, when the carbonates are boiled with water to the original quantity of carbon dioxide present in the system—is:

Time boiling .	0.5	1.0	1.5	2.0	2.5	3.0	3.5	4.9
$Eu_2(CO_3)_3$.	33.4	37.4	39.9	41.9	43.6	45.1	46.3	47.0
$Gd_2(CO_3)_3$.	34.8	38.9	41.3	43.1	44.4	45.6	46.7	47.6
$Tb_2(CO_3)_3$.	37.6	42.5	45.7	48.1	—	—	—	—

On comparing these results with those for the cerium metals the order of basicity is . . . Pr, Nd, Sa, Eu, Gd, Tb, . . .

The nitrates.—These salts are prepared as in the case of the nitrates of the cerium metals. E. Demarçay, V. von Lang and L. Haitinger, and C. Benedicks found that hexahydrated **gadolinium nitrate**, $Gd(NO_3)_3 \cdot 6H_2O$, separates from aq. soln. in triclinic crystals of sp. gr. 2.332, and which melt at 91° . V. von Lang and L. Haitinger gave for the axial ratios of the triclinic crystals $a : b : c = 1 : 1.795 : 1.367$, and $\alpha = 90^\circ 6'$, $\beta = 109^\circ 55'$, and $\gamma = 109^\circ 48'$. C. Benedicks gave $Gd(NO_3)_3 \cdot 6\frac{1}{2}H_2O$ for the composition of the preceding salt, and he obtained the pentahydrate, $Gd(NO_3)_3 \cdot 5H_2O$, from conc. nitric acid soln. in prismatic crystals of sp. gr. 2.406, and m.p. 92° . This salt is less soluble in conc. nitric acid than any of the other rare earth nitrates which have been tried. C. Benedicks obtained long, hair-like, deliquescent crystals of **ammonium gadolinium nitrate**, $Gd(NO_3)_3 \cdot NH_4NO_3 \cdot nH_2O$, from soln. which contained the component salts in the molar proportion, $Gd(NO_3)_3 : NH_4NO_3 = 1 : 2$. E. Demarçay prepared **magnesium gadolinium nitrate**, $3Mg(NO_3)_2 \cdot 2Gd(NO_3)_3 \cdot 24H_2O$. A. Ries found the trigonal crystals have the axial ratio $a : c = 1 : 1.5786$. G. Jantsch found the sp. gr. 2.163 at $0^\circ/4^\circ$; the mol. vol. 723.0; the m.p., 77.5° ; and the molar solubility 0.2252 gm. per litre of nitric acid of sp. gr. 1.325 at $16^\circ/4^\circ$. G. Jantsch prepared **zinc gadolinium nitrate**, $3Zn(NO_3)_2 \cdot 2Gd(NO_3)_3 \cdot 24H_2O$, with sp. gr. 2.351 at $0^\circ/4^\circ$; mol. vol., 717.5; m.p., 56.5° ; and molar solubility, 0.2801 gm. per litre of nitric acid of sp. gr. 1.325 at $16^\circ/4^\circ$. G. Urbain and co-workers prepared hexahydrated **terbium nitrate**, $Tb(NO_3)_3 \cdot 6H_2O$, in monoclinic needles from nitric acid soln. The salt melts at 89.3° .

REFERENCES.

¹ E. Demarçay, *Compt. Rend.*, **130**, 1185, 1469, 1900; **131**, 343, 1900; G. Jantsch, *Zeit. anorg. Chem.*, **76**, 303, 1912; *Compt. Rend.*, **146**, 473, 1908; G. Urbain and H. Lacombe, *ib.*, **138**, 627, 1904; G. Urbain and G. Jantsch, *ib.*, **146**, 127, 1908; G. Urbain and F. Bourion, *ib.*, **153**, 1155, 1911; G. Urbain, *ib.*, **139**, 736, 1904; **141**, 521, 1905; **149**, 37, 1909; E. H. Williams, *Phys. Rev.*, (2), **14**, 348, 1919; *Chem. News*, **119**, 287, 1919; E. Wedekind and P. Hausknecht, *Ber.*, **54**, B, 253, 1921; G. Eberhard, *Zeit. anorg. Chem.*, **45**, 374, 1905; C. Benedicks, *ib.*, **22**, 398, 1900; F. Wirth, *ib.*, **76**, 174, 1912; J. Popovic, *Ber.*, **41**, 634, 1908; F. Bourion, *Ann. Chim. Phys.*, (8), **20**, 547, 1910; (8), **21**, 49, 1910; C. A. Matignon and F. Bourion, *Compt. Rend.*, **138**, 631, 1904; C. A. Matignon, *ib.*, **140**, 1181, 1339, 1905; E. L. Nichols and H. L. Howes, *Phys. Rev.*, (2), **19**, 300, 1922; W. Prandtl, *Ber.*, **55**, B, 692, 1922; S. H. Katz and C. James, *Journ. Amer. Chem. Soc.*, **36**, 779, 1914; D. W. Bissel and C. James, *ib.*, **38**, 873, 1916; C. James and H. C. Holden, *ib.*, **35**, 559, 1913; P. H. M. P. Brinton and C. James, *ib.*, **43**, 1446, 1921; L. Wöhler and M. Grünzweig, *Ber.*, **46**, 1726, 1913; H. Erdmann and F. Wirth, *Liebig's Ann.*, **381**, 190, 1908; V. von Lang and L. Haitinger, *ib.*, **351**, 450, 1907; F. Wirth, *Zeit. anorg. Chem.*, **76**, 147, 1912; R. J. Meyer and U. Müller, *ib.*, **109**, 1, 1919; A. Bettendorff, *Liebig's Ann.*, **270**, 376, 1892; A. Ries in P. Groth, *Chemische Kristallographie*, Leipzig, **2**, 159, 1908; L. C. Jackson and H. K. Onnes, *Compt. Rend.*, **177**, 154, 1923; H. R. Woltjer and H. K. Onnes, *Proc. Akad. Amsterdam*, **26**, 626, 1923; H. R. Woltjer, *ib.*, **26**, 613, 1923; G. Breit and H. K. Onnes, *ib.*, **26**, 840, 1923.

§ 23. The Erbium Family of Rare Earths

For convenience, the four rare earth elements—dysprosium, Dy; holmium, Ho; erbium, Er; and thulium, Tm—are considered as a family or sub-group of the yttrium elements. The history of these earths has already been discussed. The earth terbia, discovered by C. G. Mosander¹ in 1842, as previously indicated, was later designated erbia. All the members of this family have been separated from C. G. Mosander's terbia. They are characterized by their absorption spectra, and by furnishing highly coloured salts. They form basic oxides of the type M_2O_3 ; of these dysprosia is the strongest base, then follow in order holmia, erbia, and thulia. The chemistry of these earths is very incomplete; erbium has been investigated more than the others.

Erbia is one of the least abundant of the yttrium earths; some estimate it to be next to yttria in abundance; the erbia earths occur in virtually all the rare earth minerals, but usually to a very small extent. According to N. Engström and P. T. Cleve, orthite from Hitterö has 0.52 per cent. of erbia earths, and that from Ytterby, 2.00 per cent.; and, according to L. G. Eakins, gadolinite from Colorado has 12.74–15.80 per cent. of erbia earths. The most convenient sources of these earths are xenotime, fergusonite, gadolinite, euxenite, polycrase, and blomstrandine.

The isolation of the erbium earths.—The individual earths of this family are derived from the mother liquids remaining after the separation of the cerium earths by the alkali sulphate process. The mixture of yttrium earths so obtained can be fractioned by precipitation by bases; by the fractional decomposition of the nitrates; by the oxalate, chromate, acetylacetonate, or ethylsulphate processes previously described. C. James² recommended the bromate process; and G. Urbain the ethyl sulphate process. In either case, three main fractions are obtained: (i) the least soluble fraction with terbium, dysprosium, holmium, and yttrium; (ii) an intermediate fraction with yttrium, dysprosium, holmium, and erbium; and (iii) the most soluble fraction with erbium, thulium, ytterbium, lutecium, and celtium—*vide* general method of resolving a mixture of the rare earths into its components.

The isolation of dysprosia.—Dysprosia was first isolated by L. de Boisbaudran from J. L. Soret's X-earth which P. T. Cleve considered to be holmium. Dysprosia was supposed by G. Krüss and L. F. Nilson, W. Crookes, and S. Forsling to be a mixture of elements. In 1885, W. Crookes, in studying the cathodic phosphorescent spectra, was attracted by a citron band with wave-length $\lambda=5740$. He assumed that the brightness of the citron band would increase as the proportion of the element responsible for it increased in his preparations. He traced the element to the yttrium

group, and finally identified it with yttrium; but G. Urbain showed that this is a wrong inference, for the band is generated by dysprosium. In order to isolate dysprosia the terbium is eliminated in the less soluble fractions during fractional crystallization with the ethyl sulphates. The holmium is eliminated by fractional crystallization of the nitrates from conc. nitric acid. The purification of dysprosium nitrate by the last operation is facilitated if bismuth nitrate be introduced as *l'élément séparateur*. The subject has also been discussed by C. C. Kiess and co-workers; and by H. C. Kremers and co-workers.

The isolation of holmia.—The fractional crystallization of the ethyl sulphates enables holmia to be separated from erbia, thulia, etc., and to be partially separated from dysprosia; the remaining dysprosia can be removed by the crystallization of the nitrates as indicated in connection with dysprosia. Yttria, however, was shown by G. Urbain to remain with the dysprosia, and he suggested removing yttria by the fractional decomposition of the nitrates, or by fractional precipitation with ammonia. P. H. M. P. Brinton and C. James highly recommend the basic nitrate method in the two forms herein outlined for the separation of erbium, holmium, dysprosium, and the less basic earths from yttrium; and the crystallization of the chlorides from 1 : 1 hydrochloric acid for the separation of holmium and dysprosium from yttrium. L. F. Yntema and B. S. Hopkins preferred the sodium nitrite method to the phthalate process. H. C. Kremers and C. W. Balke tried fractional precipitation with lactic acid, and ammonium carbonate; and the fused nitrate process. The earlier samples of holmia contained much dysprosia, and the later, less impure specimens have been called *neo-holmia*. O. Holmberg employed the following process, and obtained holmia containing traces of erbia and dysprosia:

Twenty-nine kgrms. of finely powdered euxenite were decomposed in small portions at a time with hot conc. sulphuric acid, and the excess of acid finally expelled. After cooling, the resulting mass was powdered and gradually added to cold water, whereby the ytterbium earths, oxides of cerium, iron, uranium, and some of the acidic oxides were dissolved. The soln. was completely precipitated with ammonia, the washed precipitate dissolved in conc. nitric acid, and the soln. heated to boiling; the filtrate from the precipitate so formed was precipitated with oxalic acid, and the oxalate collected and ignited. The resulting oxide amounted to 5.5 kgrms., and contained the holmium present in the original euxenite. The oxide was transformed into oxalate and separated into two fractions by repeated treatment with a hot sat. soln. of ammonium oxalate, the oxalates of scandium, thorium, and of the ytterbium earths with the highest at. wt. being much more soluble than the oxalates of yttrium, terbium, etc. The less soluble oxalates gave 4773 grms. of oxides, and were treated for holmium by converting them into the *m*-nitrobenzenesulphonates and submitting them to a long series of fractional crystallizations. The five least soluble fractions consisted of a mixture of yttrium, erbium, holmium, dysprosium, terbium, gadolinium, europium, and samarium; they were converted into the nitrates and fractionally crystallized in the presence of bismuth nitrate, whereby gadolinium is eliminated. The fourteen chief fractions consisted mainly of holmium, dysprosium, terbium, and yttrium, but europium, samarium, and erbium were also present. The holmium in these fractions was further conc. by the ammonium oxalate method; the nitrate soln. of the three most soluble fractions showed a strong holmium spectrum, but also a weak erbium and dysprosium spectrum. The oxide was yellow in colour, showing the presence of terbium, and the at. wt. 144 showed that it contained a considerable content of yttrium. It was converted into the nitrate and again submitted to 160 fractionations, and the fractions richest in holmium submitted to spectral examination; they were found to be practically free from erbium, but contained a trace of terbium, a small quantity of dysprosium, and some yttrium (about 19 per cent.), the at. wt. determination giving the value 150. Two partial precipitations with aniline raised the at. wt. from 150 to 156.

The isolation of erbia.—Erbia of a high degree of purity has probably not been obtained; the erbia of the earlier chemists undoubtedly contained much ytterbium, holmium, dysprosium, and thulium. The later, less impure, preparations have been called *neo-erbia*. The fractions from the preceding operations containing yttrium, erbium, thulium, ytterbium, lutecium, and celtium are fractionally crystallized either by the bromate process, or by the nitrate process: (i) the least soluble fractions contain neodymia, samaria, and gadolinia; (ii) the next fractions contain terbia, dysprosia, yttria, and holmia; (iii) the next contain dysprosia, holmia, yttria, and

scandia; (iv) the next, yttria, erbia, and thulia; and (v) the last contain thulia, ytterbia, erbia, lutecia, and celtia. The erbium bromate is less soluble than thulium bromate, so that the erbia and thulia can be separated by the bromate process, but the yttria is not eliminated from the erbia. C. James said that this can be effected by the fractional decomposition of the nitrates, or by fractional precipitation with ammonia. P. H. M. P. Brinton and C. James strongly recommend the basic nitrate process for the separation of erbium, holmium, and dysprosium from yttrium. The subject was also discussed by L. Hermann, and C. C. Kiess and co-workers.

The isolation of thulia.—C. James has described processes for the extraction of thulia from ytterspar (Norwegian xenotime), euxenite, and a Norwegian columbate resembling sipylite. The liquors containing the yttria earths were converted into bromates, and fractionally crystallized. The thulium collected in the fractions between erbium and ytterbium. The fractions in which the thulium bands were intense were finally submitted to a long series of recrystallizations, as they consisted mainly of ytterbium and lutecium, with some erbium and traces of scandium. The thulium was gradually conc. in the fractions next to the least soluble erbium, and when free from erbium, the soln. possessed a bluish-green colour. The presence of a little erbium turns the colour yellowish-green, a little more renders it colourless, and further addition changes it to pink. The various colours so obtained were made use of in collecting the fractions. It was found that the thulium fractions did not change in colour, always retaining a greenish tint when in soln. Other methods of fractionation were tried, but none could be compared with the bromate method. Spectroscopic examination of the purest thulium fraction obtained showed it to contain a trace of ytterbium and a very faint trace of calcium.

The metals of the four erbia earths have not been examined. S. Meyer³ described the metal erbium as a dark grey metallic powder of sp. gr. 4.77 at 15°. Dysprosium salts are yellow or greenish-yellow; holmium salts are yellow or orange; erbium salts are rose-red; and thulium salts are green. The **flame spectrum** of erbia has been examined by J. F. Bahr,⁴ R. Bunsen, L. de Boisbaudran, R. Thalén, W. Crookes, K. A. Hofmann and co-workers, W. B. Anderson, and K. Schaum and H. Wüstenfeld; while that of thulia has been examined by R. Thalén. The lines in the discontinuous flame spectrum of erbia are approximately in the position of the absorption bands—*vide infra*. The **spark spectrum** of dysprosium has been studied by G. Urbain,⁵ by L. de Boisbaudran, etc. The five lines in the visible spectrum are 5835, 5750, 5700, 5269, and 5259. There is a large number of lines in the ultra-violet. The **arc spectrum** has been studied by G. Eberhard, J. M. Eder and E. Valenta, C. C. Kiess, G. Urbain, F. Exner and E. Haschek, etc. The more prominent lines have wave-lengths 3385.16, 3531.86, 3645.54, 3898.69, 3944.83, 4000.59, 4078.11, 4187.00, 4211.82.

The **spark spectrum** of holmium has been studied by L. de Boisbaudran,⁶ G. Eberhard, and F. Exner and E. Haschek; and the **arc spectrum** by G. Eberhard, J. M. Eder and E. Valenta, and F. Exner and E. Haschek. The older observations were made on a mixture of at least two elements; the element prepared of a higher degree of purity is called for distinguishing purposes *neo-holmium*. F. Exner and E. Haschek record about 2300 lines in the arc spectrum, and 1900 in the spark spectrum. The more important lines in the arc spectrum are 3399.12, 3425.49, 3429.27, 3456.15, 3474.40, 3484.98, 3515.73, 3598.92, 3748.32, 3757.41, 3889.10, 3891.17, 4045.58, and 4254.59.

The **spark spectrum** of erbium has been measured by F. Exner and E. Haschek,⁷ R. Thalén, G. Eberhard, etc. The most prominent and persistent lines are 3230.72, 3264.91, 3312.56, 3372.92, 3499.28, 3692.85, 3896.40, 3906.47, and 3938.79. The **arc spectrum** of erbium has been measured by F. Exner and E. Haschek, J. M. Eder and E. Valenta, G. Eberhard, etc. The most intense lines are 3230.73, 3264.91, 3312.56, 3372.92, 3499.28, 3692.85, 3896.10, 3906.47, 3938.79, 3973.26, 3973.78, 4008.12, 4020.69, 4059.98, 4087.80, 4143.11, 4419.78, 4563.45, 4631.10, 4675.77, 4759.83, 5827.01, and 6221.22.

The **spark spectrum** of thulium has been investigated by F. Exner and E. Haschek,⁸ and the **arc spectrum** by F. Exner and E. Haschek, J. M. Eder and E. Valenta, C. A. von Welsbach, etc. The most intense lines in the arc spectrum are 3131·40, 3134·00, 3362·78, 3425·27, 3462·37, 3441·71, 3453·82, 3608·92, 3700·41, 3701·54, 3718·07, 3734·29, 3744·22, 3761·49, 3762·09, 3795·90, 3848·13, 4094·33, 4105·99, 4187·79, and 4481·44. E. Paulson has described some regularities in the spectrum of thulium.

L. de Boisbaudran,⁹ and G. Urbain have studied the **reversion spectrum** of dysprosia; it shows a yellow phosphorescence; and the chloride exhibits two bands with maxima at $\lambda=5730$ and 4765 . The **cathodic phosphorescent spectrum** of dysprosium has been investigated by G. Urbain;¹⁰ it is yellow or greenish-yellow. The **X-ray spectra** of dysprosia, holmia, and erbia have been studied by H. G. J. Moseley,¹¹ and E. Friman, and W. Duane measured the absorption frequencies of the X-rays for dysprosium. J. Carrera gave for the absorption coeff. for the K-series of X-ray spectra, Dy, 62·93; Ho, 64·09; Er, 64·99; and Tu, 66·11. The K-series of dysprosium were measured by W. Duane and T. Shimizu, and M. Siegbahn and E. Jönsson; and that of holmium by M. Siegbahn and E. Jönsson. The L-series were examined by D. Coster and co-workers, E. Hjalmar, and M. Siegbahn, who gave for dysprosium, $a_2a'=1.91564$; $a_1a'=1.90460$; $\beta_1\beta=1.70658$; $\beta_2\gamma=1.61975$; $\gamma_1\delta=1.467$; $\gamma_2\theta=1.419$; $\beta_4\nu=1.718$; $\beta_3\phi=1.680$; $\gamma_3\chi=1.468$; and $\gamma_4\psi=1.437$; for holmium, $a_2a'=1.85206$; $a_1a'=1.84098$; $\beta_1\beta=1.64352$; $\beta_2\gamma=1.56365$; $\gamma_1\delta=1.412$; $\gamma_2\theta=1.366$; $\beta_4\nu=1.653$; $\beta_3\phi=1.61677$; and $\gamma_3\chi=1.415$; for erbium, $a_2a'=1.79140$; $a_1a'=1.78040$; $\beta_1\beta=1.58344$; $\beta_2\gamma=1.5142$; $\gamma_1\delta=1.363$; $\eta=1.725$; $\gamma_2\theta=1.320$; $\beta_4\nu=1.596$; $\beta_3\phi=1.556$; and $\gamma_3\chi=1.313$. For the M-series, E. Hjalmar, and G. Wentzel gave for dysprosium, $\alpha=9.509$, $\beta=9.313$; for holmium, $\alpha=9.123$, $\beta=8.930$; and for erbium, $\alpha=8.770$, $\beta=8.561$. J. O. Perrine found erbium oxide showed no ultra-violet fluorescence.

The **absorption spectra** of dysprosium salts exhibit four bands in the visible region, measured by L. de Boisbaudran,¹² and seven in the ultra-violet, measured by G. Urbain. H. C. Jones and W. W. Strong, and L. F. Yntema, have also studied the absorption bands of dysprosium salt soln. The heads of the absorption bands with didymium chloride soln. are at 7530, 4750, 4515, 4275, 3970, 3865, 3795, 3650, 3510, 3380, and 3225. The absorption spectrum of holmium salts was originally characterized by two bands, $\lambda=6400$ and 5360 . There are, however, 15 bands which have been measured by O. Holmberg, G. Urbain, L. F. Yntema, and S. Forsling. These bands are $\lambda=6577-6551$, $6538-6518$, $6446-6418$, $6414-6384$, 5491 , $5438-5427$, $5411-5401$, $5385-5349$, 4910 , $4860-4346$, 4830 , $4683-4672$, $4554-4459$, $4223-4216$, $4179-4152$ when a 2*N*-soln. of a holmium salt is used. The absorption spectra of erbium salts have sharp red, green, and blue bands which have been measured by R. Bunsen, P. T. Cleve, J. L. Soret, S. Forsling, L. F. Yntema, K. A. Hofmann and co-workers, F. Exner, etc. The data are not concordant, presumably because of the presence of impurities in the specimens, and it is not at all certain if all the bands are really due to erbium. S. Forsling gives the following: 6665, 6530-6515, 6483, 5490, 5412, 5231, 5202-5188, 4908, 4871, 4845-4534, 4497, 4427, 4084, 4069, 4058, 4050, 3792, 3644, 3637, 3588, and 3561. K. A. Hofmann and O. Burger could not locate the bands 6483, 5490, and 4534. A. H. Pfund observed the bands 0.649μ , 0.687μ , 0.797μ , and 0.980μ in the infra-red region. H. C. Jones and W. W. Strong investigated the effect of temp. on the bands; and F. Wick, the effect of press. R. du Bois found that at the temp. of liquid air, and under the influence of a magnetic field, new absorption bands appear. The absorption spectra of thulium salts were investigated by P. T. Cleve, R. Thalén, L. F. Yntema, etc. S. Forsling found characteristic bands at 7015, 6845-6825, 6593-6585, 4643, 3604, and 3604-3595. A. Dauvillier, G. Wistrand, and B. Cabrera have discussed the **magnetic properties** of these elements.

The atomic weights of the erbium metals.—The general reactions of the

salts of the erbium family are similar to those of yttrium salts. G. Urbain¹³ observed no signs of the complexity of dysprosia in fractionating the ethyl sulphate and the nitrate. Forty consecutive fractions of the purified earth were practically identical. S. Forsling denied the elementary nature of holmium; and G. Krüss and L. F. Nilson, and K. A. Hofmann stated that holmia is a mixture; but O. Holmberg, and A. Langlet have shown that holmium can be obtained showing but the merest traces of erbia and dysprosia. J. L. Soret, and P. T. Cleve showed that the old erbia was complex, and holmia and thulia were separated from it. C. A. von Welsbach, G. Krüss and L. F. Nilson, C. James, and W. Muthmann and L. Weiss stated that erbia is complex, but the later work of K. A. Hofmann, and C. James and co-workers shows that erbium is homogeneous and elementary. R. Marc denied the elementary nature of thulium; and C. A. von Welsbach stated that he has fractionated thulium into three elements which he named provisionally Tm₁, Tm₂, and Tm₃. *Au contraire*, C. James failed to effect any separation of thulium into dissimilar parts by 15,000 crystallizations of the bromate. According to H. G. J. Moseley's relation between the vibration frequencies of the X-ray spectral lines and the atomic numbers dysprosium, holmium and erbium are probably elemental, and if thulium be elemental, the four places between erbium and tantalum are filled by thulium, ytterbium, lutecium, and celtium. The atomic numbers are Dy, 66; Ho, 67; Er, 68; Tm, 69. F. W. Aston found that erbium has a series of isotopes from 164 to 176.

In 1905, G. Urbain¹⁴ obtained values between 162.64 and 162.28 for the at. wt. of dysprosium; and in 1906, as a mean of six determinations, G. Urbain and M. Dementroux obtained 162.29 to 162.75—mean 162.52—from the ratio $Dy_2(SO_4)_3 \cdot 8H_2O : Dy_2O_3$; after a further purification of the same material, values between 162.36 and 162.63—mean 162.54—were obtained; another determination gave 162.49. G. D. Hinrichs recalculated G. Urbain's results and obtained 162.5. E. W. Engle and C. W. Balke obtained 164.228 for the ratio $Dy_2O_3 : 2DyCl_3$; and H. C. Kremers, B. S. Hopkins, and E. W. Engle showed that the ratio $Dy_2(SO_4)_3 \cdot 8H_2O : Dy_2O_3$ is not constant because the octohydrate is not constant in composition when dried over conc. sulphuric acid. They obtained 163.83 from the ratio $2DyCl_3 : Dy_2O_3$; and 162.52 from the ratio $DyCl_3 : 3Ag$. The International Table for 1921 gives 162.5 as the best representative value for the at. wt. of dysprosium.

In 1879, P. T. Cleve¹⁵ obtained 160–161 for the at. wt. of holmium, but the material contained traces of erbium and dysprosium. K. A. Hofmann and G. Krüss found for various holmium fractions at. wt. between 158.5 and 169.4. G. Urbain believes the at. wt. lies between 162.5 and 167. O. Holmberg obtained 156; and later still, 163.5. The International Table of at. wt. for 1921 gives 163.5 for the best representative value of the at. wt. of holmium.

In 1864, M. Delafontaine¹⁶ obtained 118.7 for the at. wt. of erbium from the ratio $Er_2(SO_4)_3 : Er_2O_3$, but he was working with very impure material. J. F. Bahr and R. Bunsen, working with a more highly purified material, obtained 16908 from the ratio $Er_2O_3 : Er_2(SO_4)_3$. From the same ratio P. T. Cleve and O. M. Höglund obtained 170.59; J. S. Humpidge and W. Burney, 171.62; P. T. Cleve, 166.25; K. A. Hofmann and G. Krüss, 165.4–172.4; B. Brauner, 167.14; W. Nernst and E. H. Riesenfeld, 161.0–163.3; K. A. Hofmann and O. Burger, 167.4; O. Brill, 166.76. The results are unsatisfactory because of the difficulties attending the separation of yttria, etc. The International Table for 1921 gives 167.7 as the best representative value for the at. wt. of erbium. The at. wt. of thulium has not been accurately determined. P. T. Cleve¹⁷ gave 170.7 without describing the procedure. G. Urbain said that the at. wt. is below 168.5. The International Table for 1921 gives 168.5 as the best representative value for the at. wt. of thulium.

REFERENCES.

- ¹ C. G. Mosander, *Skand. Naturför. Förh.*, 3, 387, 1842; *Phil. Mag.*, (3), 23, 241, 1843; N. Engström and P. T. Cleve, *Zeit. Kryst.*, 3, 194, 1879; L. G. Eakins, *Proc. Colorado Scient. Soc.*, 2, 32, 1885.
- ² G. Urbain, *Ann. Chim. Phys.*, (7), 18, 278, 1899; (7), 19, 184, 1900; *Journ. Chim. Phys.*, 4, 61, 1906; *Compt. Rend.*, 142, 785, 1906; 149, 37, 1909; L. de Boisbaudran, *ib.*, 102, 1003, 1005, 1886; J. L. Soret, *ib.*, 86, 1062, 1878; 89, 521, 1879; P. T. Cleve, *ib.*, 89, 478, 1879; C. James, *Journ. Amer. Chem. Soc.*, 32, 517, 1910; 33, 1332, 1911; 34, 757, 1912; E. W. Engle and C. W. Balke, *ib.*, 39, 53, 1917; L. F. Yntema and B. S. Hopkins, *ib.*, 40, 1163, 1918; H. C. Kremers and C. W. Balke, *ib.*, 40, 593, 1918; H. C. Kremers, B. S. Hopkins, and E. W. Engle, *ib.*, 40, 598, 1918; P. H. M. P. Brinton and C. James, *ib.*, 43, 1397, 1921; C. C. Kiess, B. S. Hopkins, and H. C. Kremers, *Scient. Papers Bur. Standards*, 421, 1921; O. Holmberg, *Arkiv. Kemi Min. Geol.*, 4, 2, 10, 1911; *Zeit. anorg. Chem.*, 71, 226, 1911; L. Hermann, *Ueber die Trennung der Ytter- und Erbinderden*, München, 1905; G. Krüss and L. F. Nilson, *Ber.*, 20, 2134, 3067, 1887; 21, 585, 1888; W. Crookes, *Proc. Roy. Soc.*, 40, 502, 1887; S. Forsling, *Bihang Svenska Akad. Handl.*, 29, 1, 1903.
- ³ S. Meyer, *Monatsh.*, 20, 793, 1899.
- ⁴ J. F. Bahr, *Liebig's Ann.*, 135, 376, 1865; J. F. Bahr and R. Bunsen, *ib.*, 137, 1, 1866; W. B. Anderson, *Astrophys. Journ.*, 26, 75, 1907; K. Schaum and H. Wüstenfeld, *Zeit. wiss. Photochem.*, 10, 226, 1911; L. de Boisbaudran, *Spectres lumineux*, Paris, 1874; *Compt. Rend.*, 76, 1080, 1873; R. Thalén, *ib.*, 91, 326, 1880; W. Crookes, *ib.*, 102, 506, 1886; K. A. Hofmann and G. Bugge, *Ber.*, 41, 3783, 1908; K. A. Hofmann and H. Kirmreuther, *Zeit. phys. Chem.*, 71, 312, 1910.
- ⁵ L. de Boisbaudran, *Compt. Rend.*, 102, 153, 1003, 1005, 1886; E. Demarçay, *ib.*, 131, 387, 1900; G. Urbain, *ib.*, 142, 785, 1906; 143, 229, 1906; 146, 922, 1908; *Ann. Chim. Phys.*, (7), 19, 184, 1900; *Chem. News*, 94, 79, 1906; *Journ. Chim. Phys.*, 4, 31, 105, 232, 321, 1906; W. Crookes, *Proc. Roy. Soc.*, 40, 502, 1883; G. Eberhard, *Pub. Astrophys. Obs. Potsdam*, 20, 3, 1909; *Zeit. wiss. Photochem.*, 4, 137, 1906; *Astrophys. Journ.*, 24, 309, 1906; *Sitzber. Akad. Berlin*, 384, 1906; J. M. Eder and E. Valenta, *Sitzber. Akad. Wien*, 119, 9, 1910; F. Exner and E. Haschek, *Die Spektren der Elemente bei normalen Druck*, Wien, 1911; C. C. Kiess, *Scient. Papers Bur. Standards*, 18, 695, 1923; J. M. Eder, *Ann. Physik*, (4), 71, 12, 1923.
- ⁶ F. Exner and E. Haschek, *Sitzber. Akad. Wien*, 110, 557, 1901; 119, 771, 1910; *Tabellen der Funkenspectra*, Wien, 1902; *Tabellen der Bogenspectra*, Wien, 1904; G. Eberhard, *Pub. Astrophys. Obs. Potsdam*, 20, 3, 1909; *Sitzber. Akad. Berlin*, 384, 1906; *Zeit. wiss. Photochem.*, 4, 137, 1906; L. de Boisbaudran, *Compt. Rend.*, 102, 1003, 1005, 1886; A. Hagenbach and H. Konen, *Atlas der Emissionsspectren*, Jena, 1905; J. M. Eder and E. Valenta, *Sitzber. Akad. Wien*, 119, 9, 1910; J. M. Eder, *Ann. Physik*, (4), 71, 12, 1923.
- ⁷ R. Thalén, *Om Spectralanalys*, Upsala, 1866; *Nova Acta Upsala*, (3), 6, 9, 1868; *Svenska Akad. Handl.*, 12, 4, 1874; *Compt. Rend.*, 91, 326, 1880; *Öfvers. Akad. Förh.*, 6, 13, 1881; R. Bunsen, *Pogg. Ann.*, 155, 230, 1875; W. J. Humphreys, *Astrophys. Journ.*, 6, 169, 1897; O. Lohse, *Sitzber. Akad. Berlin*, 179, 1898; F. Exner and E. Haschek, *Sitzber. Akad. Wien*, 108, 1123, 1899; *Tabellen der Funkenspectra*, Wien, 1902; *Tabellen der Bogenspectra*, Wien, 1904; A. Hagenbach and H. Konen, *Atlas der Emissionsspectren*, Jena, 1905; W. Crookes, *Proc. Roy. Soc.*, 78, A, 154, 1907; H. Geisler, *Zur anomalen Dispersion des Lichtes in Metalledämpfen*, Bonn, 1909; *Zeit. wiss. Photochem.*, 7, 89, 1909; G. Eberhard, *ib.*, 4, 137, 1906; *Pub. Astrophys. Obs. Potsdam*, 20, 3, 1909; *Sitzber. Akad. Berlin*, 384, 1906; J. M. Eder and E. Valenta, *Sitzber. Akad. Wien*, 119, 9, 1910; J. M. Eder, *Ann. Physik*, (4), 71, 12, 1923.
- ⁸ E. Paulson, *Phys. Zeit.*, 16, 352, 1915; P. T. Cleve, *Compt. Rend.*, 89, 478, 1879; 91, 376, 1880; *Öfvers. Svenska Akad. Handl.*, 6, 11, 1879; R. Thalén, *ib.*, 6, 13, 1881; F. Exner and E. Haschek, *Tabellen der Funkenspectra*, Wien, 1902; *Tabellen der Bogenspectra*, Wien, 1904; *Sitzber. Akad. Wien*, 110, 964, 1901; 119, 771, 1910; *Die Spektren der Elemente bei normalen Druck*, Wien, 1912; A. Crookes, *Proc. Roy. Soc.*, 78, A, 154, 1906; *Chem. News*, 94, 37, 1906; G. Urbain, *Compt. Rend.*, 145, 759, 1907; C. A. von Welsbach, *Monatsh.*, 32, 373, 1911; *Zeit. anorg. Chem.*, 71, 439, 1911; *Sitzber. Akad. Wien*, 119, 193, 1911; J. Hofbauer, *ib.*, 116, 267, 1907; J. M. Eder, *ib.*, 124, 124, 1916; J. M. Eder and E. Valenta, *ib.*, 119, 103, 1910; *Atlas typischer Spectren*, Wien, 1911; J. M. Eder, *Ann. Physik*, (4), 71, 12, 1923.
- ⁹ L. de Boisbaudran, *Compt. Rend.*, (2), 82, 899, 1886; G. Urbain, *ib.*, 142, 785, 1906; *Ann. Chim. Phys.*, (8), 18, 222, 1909.
- ¹⁰ G. Urbain, *Compt. Rend.*, 143, 229, 1906; G. and E. Urbain, *ib.*, 142, 785, 1906.
- ¹¹ H. G. J. Moseley, *Phil. Mag.*, (6), 26, 1024, 1913; (6), 27, 703, 1914; E. Friman, *ib.*, (6), 32, 497, 1916; W. Duane, *Proc. Nat. Acad. Sciences*, 7, 260, 267, 1921; J. Carrera, *Compt. Rend.*, 176, 740, 1923; E. Hjalmar, *Zeit. Physik*, 3, 262, 1920; 15, 65, 1923; D. Coster, *Phil. Mag.*, (6), 46, 956, 1923; *Compt. Rend.*, 174, 378, 1922; D. Coster, Y. Nishina, and S. Werner, *Zeit. Physik*, 18, 207, 1923; J. O. Perrine, *Phys. Rev.*, (2), 22, 48, 1923; G. Wentzel, *Naturwiss.*, 10, 369, 1922; M. Siegbahn, *Jahrb. Rad. Elektrcn.*, 13, 296, 1916.
- ¹² G. Urbain, *Journ. Chim. Phys.*, 4, 31, 1906; *Compt. Rend.*, 142, 785, 1906; L. de Boisbaudran, *ib.*, 102, 1003, 1005, 1886; J. L. Soret, *ib.*, 89, 52, 1879; P. T. Cleve, *ib.*, 89, 478, 708, 1879; 91, 381, 1880; R. Thalén, *ib.*, 91, 45, 326, 376, 1880; A. Langlet, *Zeit. phys. Chem.*,

56. 624, 1906; *Arkiv. Kemi Min. Geol.*, **2**, 32, 1907; O. Holmberg, *ib.*, **4**, 2, 10, 1911; *Zeit. anorg. Chem.*, **71**, 226, 1911; S. Forsling, *Bihang. Svenska Akad. Handl.*, **2A**, 1, 7, 1899; **28**, 1, 1902; K. A. Hofmann, *Ber.*, **43**, 2631, 1910; K. A. Hofmann and O. Burger, *ib.*, **41**, 308, 1908; K. A. Hofmann and G. Bugge, *ib.*, **41**, 3783, 1908; **43**, 2631, 1910; J. E. Purvis, *Proc. Cambridge Phil. Soc.*, **12**, 202, 206, 1903; H. C. Jones and W. W. Strong, *A Study of Absorption Spectra*, Washington, 1910; F. Exner, *Sitzber. Akad. Wien*, **108**, 1259, 1899; R. du Bois, *Phys. Zeit.*, **13**, 128, 1912; A. H. Pfund, *Zeit. wiss. Photochem.*, **12**, 341, 1913; L. F. Yntema, *Journ. Amer. Chem. Soc.*, **45**, 907, 1923; R. Bunsen, *Pogg. Ann.*, **155**, 230, 356, 1875; F. Wiek, *Proc. Amer. Acad.*, **58**, 557, 1923; A. Dauvillier, *Compt. Rend.*, **176**, 1802, 1923; B. Cabrera, *Anal. Fis. Quim.*, **20**, 92, 1922; G. Wistrand, *Magnesiaska susceptibiliteten hos Kvarts, Tellur, och några Holmium-föreningar*, Upsala, 1916; F. W. Aston, *Phil. Mag.*, (6), **39**, 449, 611, 1920.

¹³ G. Urbain, *Journ. Chim. Phys.*, **4**, 31, 105, 232, 321, 1907; *Ann. Chim. Phys.*, (8), **18**, 222, 1909; *Compt. Rend.*, **142**, 785, 1906; **149**, 47, 1909; J. L. Soret, *ib.*, **89**, 521, 1879; L. de Boisbaudran, *ib.*, **89**, 516, 1879; **102**, 1003, 1886; P. T. Cleve, *ib.*, **89**, 478, 708, 1879; S. Forsling, *Bihang. Svenska Akad. Handl.*, **28**, 1, 1903; W. Muthmann and L. Weiss, *Liebig's Ann.*, **331**, 1, 1904; C. A. von Welsbach, *Monatsh.*, **27**, 935, 1906; **32**, 373, 1911; *Zeit. anorg. Chem.*, **71**, 439, 1911; G. Krüss and L. F. Nilson, *Ber.*, **20**, 2134, 1887; K. A. Hofmann, *ib.*, **41**, 308, 1908; **43**, 2631, 1910; R. Marc, *ib.*, **35**, 2382, 1902; *Chem. News*, **86**, 73, 1902; A. Langlet, *Arkiv. Kemi Min. Geol.*, **2**, 32, 1907; C. James, *Journ. Amer. Chem. Soc.*, **29**, 498, 1907; **33**, 1332, 1911; P. H. M. P. Brinton and C. James, *ib.*, **43**, 1397, 1921; O. Holmberg, *Zeit. anorg. Chem.*, **71**, 226, 1911; H. G. J. Moseley, *Phil. Mag.*, (6), **28**, 1024, 1913; (6), **27**, 703, 1914.

¹⁴ G. Urbain, *Compt. Rend.*, **141**, 521, 1905; **142**, 785, 1906; G. Urbain and M. Dementroux, *ib.*, **143**, 598, 1906; G. D. Hinrichs, *ib.*, **143**, 1143, 1906; H. C. Kremers, B. S. Hopkins, and E. W. Engle, *Journ. Amer. Chem. Soc.*, **40**, 598, 1918; E. W. Engle and C. W. Balke, *ib.*, **39**, 53, 1917.

¹⁵ P. T. Cleve, *Compt. Rend.*, **89**, 478, 708, 1879; G. Urbain, *Bull. Soc. Chim.*, (4), **5**, 133, 1909; K. A. Hofmann and G. Krüss, *Zeit. anorg. Chem.*, **3**, 407, 1893; O. Holmberg, *Arkiv. Kemi Min. Geol.*, **4**, 2, 4, 1911; *Zeit. anorg. Chem.*, **71**, 226, 1912.

¹⁶ M. Delafontaine, *Arch. Sciences Genève*, (2), **25**, 112, 1866; P. T. Cleve and O. M. Höglund, *Bull. Soc. Chim.*, (2), **18**, 193, 289, 1873; *Bihang. Svenska Akad. Handl.*, 1, 6, 8, 1873; P. T. Cleve, *ib.*, **2**, 12, 1874; *Compt. Rend.*, **89**, 478, 708, 1879; **91**, 381, 1880; L. de Boisbaudran, *ib.*, **102**, 1003, 1886; G. Urbain, *ib.*, **141**, 521, 1905; **142**, 785, 1906; J. L. Soret, *ib.*, **86**, 1062, 1878; **89**, 521, 1879; **91**, 328, 1880; *Arch. Sciences Genève*, (2), **63**, 90, 1878; J. C. G. de Marignac, *ib.*, (2), **64**, 87, 1878; J. S. Humpidge and W. Burney, *Journ. Chem. Soc.*, **35**, 111, 1879; K. A. Hofmann and O. Burger, *Ber.*, **41**, 308, 1908; K. A. Hofmann, *ib.*, **43**, 2635, 1910; W. Nernst and E. H. Riesenfeld, *ib.*, **36**, 2091, 1903; K. A. Hofmann and G. Krüss, *Zeit. anorg. Chem.*, **3**, 353, 1893; O. Brill, *ib.*, **47**, 464, 1905; W. Crookes, *Chem. News*, **54**, **13**, 1886; B. Brauner in R. Aebeg, *Handbuch der anorganischen Chemie*, Leipzig, **3**, i, 318, 1906; J. F. Bahr and R. Bunsen, *Liebig's Ann.*, **137**, 1, 1866.

¹⁷ P. T. Cleve, *Compt. Rend.*, **145**, 759, 1907; G. Urbain, *Bull. Acad. Chim.*, (2), **33**, 403, 1905.

§ 24. Compounds of the Erbium Earth Metals

The oxides of these earths are obtained by igniting the oxalates or the salts of the volatile oxy-acids. According to G. Urbain,¹ **dysprosium oxide**, Dy₂O₃, or **dysprosia**, is white, and does not form a peroxide, nor absorb oxygen when heated in that gas, and it is not affected by heating in hydrogen. It dissolves in acids to produce green or yellow salts. E. W. Engle and C. W. Balke gave 7.81 for the sp. gr. of dysprosia at 27°/4°. O. Holmberg found that purified **holmia** or **holmium oxide**, Ho₂O₃, has a pale yellow colour, and dissolves in acids to produce yellow or orange salts. According to P. T. Cleve, erbium furnishes rose-red **erbia** or **erbium oxide**, Er₂O₃, which dissolves in acids to give intensely red salts. The colour of erbia remains unchanged after strong ignition. W. W. Coblentz examined the ultra-red emission spectrum and found maxima at 2μ, 2.85μ, 3.2μ, 4.1μ, 5μ, and 7.5μ. W. S. Mallory investigated the distribution of energy in the spectrum of erbium oxide. C. James prepared **thulia** or **thulium oxide**, Tm₂O₃, as a dense white powder with a greenish tinge; it emits a carmine-red glow when heated, and as the temp. is raised the glow becomes yellow, and then almost white, C. A. von Welsbach's thulium-II was also stated to give a white sesquioxide which when heated in the flame gave a purple light quickly succeeded by a brilliant glow. Thulia dissolves in acids to form green soln. The colours of erbium and thulium salts are almost complementary, so that traces of the one have a marked influence

on the other. The salts of thulium-II were said to be pale yellowish-green by daylight and emerald-green by artificial light.

According to L. F. Nilson and O. Pettersson, erbia has a sp. gr. 8.64, and a sp. ht. of 0.065 between 0° and 100°. W. R. Mott gave 3000° for the b.p. of erbium oxide. W. W. Strong said that the salts of erbia are feebly radioactive when tested by the photographic method. W. S. Mallory, and E. L. Nichols and H. L. Howes found the emissivity of erbium oxide is greater at 1000° than that of an ideal black body; this is attributed to the luminescence of the oxide. E. L. Nichols and H. L. Howes studied the luminescent spectrum of the incandescent oxide. E. H. Williams found the magnetic susceptibility of erbium oxide to be 188.6×10^{-6} at 20°; 201.7×10^{-6} at 0°; 234.8×10^{-6} at -40°; 282.3×10^{-6} at -80°; 314.8×10^{-6} at -100°; 355.0×10^{-6} at -120°; and 402.8×10^{-6} at -140°. According to G. Urbain, dysprosia is the most strongly paramagnetic oxide known; its magnetic susceptibility is 290×10^{-6} , a number 12.8 times as large as that of ferric oxide. E. H. Williams gave for the magnetic susceptibility 233.3×10^{-6} at 20°; 250.0×10^{-6} at 0°; 291.3×10^{-6} at -40°; 291.3×10^{-6} at -80°; 384.2×10^{-6} at 100°; 430.2×10^{-6} at -120°; and 490.0×10^{-6} at -140°. E. Wedekind and P. Hausknecht found the mol. magnetism to be $+40600 \times 10^{-6}$. Erbium oxide does not unite directly with water; **dysprosium hydroxide**, $\text{Dy}(\text{OH})_3$, is obtained by treating soln. of the salts of dysprosium with ammonia; **holmium hydroxide**, $\text{Ho}(\text{OH})_3$; **erbium hydroxide**, $\text{Er}(\text{OH})_3$; and **thulium hydroxide**, $\text{Tm}(\text{OH})_3$, are produced in a similar manner. The addition of hydrogen dioxide and ammonia to soln. of erbium salts furnishes hydrated **erbium peroxide**.

F. Bourion obtained anhydrous **dysprosium chloride**, DyCl_3 , by passing a mixture of chlorine and sulphur chloride over the heated oxide. E. W. Engle and C. W. Balke prepared the highly purified chloride for their at. wt. determination. The yellow shining crystals are said to have a sp. gr. of 3.67, and melt at 680°. According to E. W. Engle and C. W. Balke, anhydrous dysprosium chloride dissolves slowly and completely in water developing much heat, and forming a soln. which is almost neutral to litmus, quite neutral to methyl orange, and faintly acid to phenolphthalein and methyl red. G. Urbain and G. Jantsch found that the aq. soln. furnishes bright yellow crystals of the hexahydrate, $\text{DyCl}_3 \cdot 6\text{H}_2\text{O}$, which resemble the corresponding terbium salt but are less deliquescent. C. James obtained green crystals of heptahydrated **thulium chloride**, $\text{TmCl}_3 \cdot 7\text{H}_2\text{O}$, by crystallization from a soln. of the oxide in hydrochloric acid. The salt is very soluble in water and in alcohol. F. Bourion showed that when anhydrous dysprosium chloride is heated in oxygen, it furnishes yellowish-green leaflets of **dysprosium oxychloride**, DyOCl , which is insoluble in water, but dissolves slowly in nitric or hydrochloric acid. K. A. Hofmann and K. Höschele made crystals of **erbium oxychloride**, ErOCl , from a soln. of the oxide in fused magnesium chloride. G. Wistrand found the magnetic susceptibility of **holmium chloride** is 172.0×10^{-6} , when the value for water is -0.7260×10^{-6} . F. Bourion made anhydrous **dysprosium bromide**, DyBr_3 , by heating the oxides in a stream of sulphur chloride vapour mixed with an excess of hydrogen bromide.

G. Urbain and M. Dementroux found that a soln. of dysprosia in sulphuric acid furnishes pale yellow crystals of octohydrated **dysprosium sulphate**, $\text{Dy}_2(\text{SO}_4)_3 \cdot 8\text{H}_2\text{O}$, which are stable in air at 110°, and are dehydrated at 360°. The anhydrous sulphate furnishes the oxide at a white heat. The sulphate dissolves in water giving a faintly acid soln. O. Holmberg made **holmium sulphate**. P. T. Cleve showed that a soln. of erbia in sulphuric acid furnishes red monoclinic crystals of octohydrated **erbium sulphate**, $\text{Er}_2(\text{SO}_4)_3 \cdot 8\text{H}_2\text{O}$, when slowly conc. at 20°-25°. According to E. H. Kraus, the axial ratios are $a : b : c = 3.0120 : 1 : 2.0043$, and $\beta = 118^\circ 27'$. There is a feeble double refraction. H. Töpsöe gave 3.217 for the sp. gr.; L. F. Nilson and O. Pettersson gave 3.18; and E. H. Kraus, 2.731. The crystals are said to be isomorphous with the corresponding salts of praseodymium, neodymium, and yttrium. According to F. Wirth, 100 grms. of aq. soln. at 25° contain 11.94 grms. of $\text{Er}_2(\text{SO}_4)_3$, when

the solid phase is the octohydrate. F. Wirth gave for the percentage solubility in sulphuric acid—*i.e.* grams of $\text{Er}_2(\text{SO}_4)_3$ per 1.00 grms. of sat. soln.—with the octohydrate as the solid phase :

Normality of H_2SO_4	0	0.1	0.505	1.1	2.16	6.175	12.6
$\text{Er}_2(\text{SO}_4)_3$	11.94	12.02	10.164	8.549	6.473	1.521	0.1386

S. H. Katz and C. James said that the salt is slightly hydrolyzed in aq. soln. According to O. Brill, and K. A. Hofmann and co-workers, anhydrous erbium sulphate, $\text{Er}_2(\text{SO}_4)_3$, is formed when the octohydrate is heated to 400° for a long time; the sp. gr. is 3.68. E. Wedekind and P. Hausknecht found the mol. magnetism of erbium sulphate to be $+36700 \times 10^{-6}$. The salt commences to decompose at 630°, and white acicular crystals of **erbium dioxysulphate**, $\text{Er}_2\text{O}_3 \cdot \text{SO}_3$, or $\text{Er}_2\text{O}_2(\text{SO}_4)$, are formed at 845°; and this compound begins to decompose at 950°, and is completely converted into the oxide at 1055°. The double salts, **potassium erbium sulphate**, $\text{K}_2\text{SO}_4 \cdot \text{Er}_2(\text{SO}_4)_3 \cdot 4\text{H}_2\text{O}$, and **ammonium erbium sulphate**, $(\text{NH}_4)_2\text{SO}_4 \cdot \text{Er}_2(\text{SO}_4)_3 \cdot 4\text{H}_2\text{O}$, are formed by crystallization from an aq. soln. of the component salts. They are readily soluble in water. C. James prepared green crystals of octohydrated **thulium sulphate**, $\text{Tm}_2(\text{SO}_4)_3 \cdot 8\text{H}_2\text{O}$, by adding an excess of alcohol to a soln. of the chloride in dil. sulphuric acid. The salt is dehydrated at a red heat.

According to G. Jantsch and A. Ohl, **dysprosium carbonate**, $\text{Dy}_2(\text{CO}_3)_3 \cdot 4\text{H}_2\text{O}$, is formed as an insoluble powder when an aq. suspension of the hydroxide is sat. with carbon dioxide. At 15°, it loses $3\text{H}_2\text{O}$. When added to a conc. soln. of ammonium carbonate, it gradually changes into the white, crystalline, and sparingly soluble **dysprosium ammonium carbonate**, $\text{NH}_4\text{Dy}(\text{CO}_3)_3 \cdot \text{H}_2\text{O}$, which loses ammonia at 60°. C. James also prepared **thulium carbonate**. P. H. M. P. Brinton and C. James found the percentage hydrolysis of dysprosium and thulium carbonates, expressed as a ratio of carbon dioxide given off on boiling with water to the total carbon dioxide originally present.

Hrs. boiling	0.5	1.0	1.5	2.0	2.5	3.0
$\text{Dy}_2(\text{CO}_3)_3$	40.0	44.4	47.6	49.9	51.4	52.8
$\text{Tm}_2(\text{CO}_3)_3$	49.0	53.1	55.5	57.5	59.3	—

G. Urbain and G. Jantsch prepared yellow crystals of pentahydrated **dysprosium nitrate**, $\text{Dy}(\text{NO}_3)_3 \cdot 5\text{H}_2\text{O}$, more resembling the bismuth salt than the terbium salt. This salt loses its water of crystallization in a dry atm. The pentahydrate melts at 88.6° in its water of crystallization. It dissolves in water giving a neutral soln. P. T. Cleve obtained red crystals of pentahydrated **erbium nitrate**, $\text{Er}(\text{NO}_3)_3 \cdot 5\text{H}_2\text{O}$, by concentrating a soln. of the oxide in nitric acid. The crystals are stable in air at ordinary temp. G. A. Barbieri and F. Calzolari made a complex with hexamethylenetetramine, and T. H. Behrens, one with antipyrine. C. James prepared green deliquescent crystals of tetrahydrated **thulium nitrate**, $\text{Tm}(\text{NO}_3)_3 \cdot 4\text{H}_2\text{O}$, by crystallization from nitric acid. The salt is very soluble in water. The amount of water of crystallization in the salt corresponds with that in paleo-ytterbium—*παλαιός*, ancient. G. Wistrand found the magnetic susceptibility of **holmium nitrate** is 132.6×10^{-6} when the value for water is -0.7260×10^{-6} .

According to G. Jantsch and A. Ohl, **dysprosium phosphate**, $\text{DyPO}_4 \cdot 5\text{H}_2\text{O}$, forms first as a gelatinous precipitate on mixing a soln. of the nitrate with ammoniacal sodium phosphate soln.; on keeping for three or four days it becomes crystalline, and then forms a white powder with a yellow tinge. A mol. of the salt loses five mols. of water above 200°. K. A. Wallroth made rose-red rhombic prisms of **sodium erbium pyrophosphate**, NaErP_2O_7 , by fusing microcosmic salt with erbia. The salt is soluble in dil. acids.

REFERENCES.

- ¹ G. Urbain, *Compt. Rend.*, **142**, 785, 1906; **146**, 922, 1908; G. Urbain and M. Dementroux, *ib.*, **143**, 598, 1906; G. Urbain and G. Jantsch, *ib.*, **146**, 127, 1908; F. Bourion, *ib.*, **145**, 62, 243, 1907; *Ann. Chim. Phys.*, (8), **20**, 547, 1910; G. Jantsch and A. Ohl, *Ber.*, **44**, 1274, 1911;

O. Holmberg, *Arkiv. Kemi Min. Geol.*, **4**, 2, 10, 1911; *Zeit. anorg. Chem.*, **71**, 226, 1911; O. Brill, *ib.*, **47**, 464, 1905; F. Wirth, *ib.*, **76**, 174, 1912; L. F. Nilson and O. Pettersson, *Ber.*, **13**, 1459, 1880; *Compt. Rend.*, **91**, 232, 1880; W. W. Strong, *Amer. Chem. Journ.*, **42**, 147, 1909; W. S. Mallory, *Phys. Rev.*, (2), **14**, 54, 1919; E. L. Nichols and H. L. Howes, *Science*, (2), **55**, 53, 1922; *Phys. Rev.*, (2), **19**, 300, 1922; W. R. Mott, *Trans. Amer. Electrochem. Soc.*, **34**, 255, 1918; C. James, *Journ. Amer. Chem. Soc.*, **33**, 1332, 1911; E. W. Engle and C. W. Balke, *ib.*, **39**, 53, 1917; S. H. Katz and C. James, *ib.*, **36**, 779, 1914; C. James and H. C. Holden, *ib.*, **35**, 559, 1913; P. H. M. P. Brinton and C. James, *ib.*, **43**, 1446, 1921; C. A. von Welsbach, *Zeit. anorg. Chem.*, **71**, 439, 1911; E. H. Kraus, *Zeit. Kryst.*, **34**, 307, 1901; K. A. Hofmann and O. Burger, *Ber.*, **41**, 308, 1908; K. A. Hofmann, *ib.*, **43**, 2631, 1910; H. Töpsäe, *Bihang. Svenska Akad. Handl.*, **2**, 5, 9, 10, 32, 33, 1874; W. W. Coblenz, *Investigations of Infra-red Spectra*, Washington, **7**, 117, 1908; G. Wistrand, *Magnetiska susceptibiliteten hos Kvarter, Tellur, och några Holmiumforeningar*, Upsala, 1916; K. A. Hofmann and K. Höschele, *Ber.*, **47**, 238, 1914; E. H. Williams, *Phys. Rev.*, (2), **14**, 348, 1919; *Chem. News*, **119**, 287, 1919; E. Wedekind and P. Hausknecht, *Ber.*, **54**, B, 253, 1921; G. A. Barbieri and F. Calzolari, *Atti Accad. Lincei*, (5), **20**, i, 164, 1911; T. H. Behrens, *Rec. Trav. Chim. Pays-Bas*, **23**, 413, 1904; P. T. Cleve, *Compt. Rend.*, **91**, 381, 1880; K. A. Wallroth, *Bull. Soc. Chim.*, (2), **39**, 316, 1883.

§ 25. The Ytterbium Family of Earths

The ytterbium family of earths includes two little-known elements—ytterbium, Yb; and lutecium, Lu, which have been obtained from the ytterbium separated by J. C. G. de Marignac¹ from the erbium earths in 1878. J. Gadolin's yttria was resolved by C. G. Mosander in 1842 into yttria, terbia, and erbia; the erbia was resolved by J. C. G. de Marignac into rose-coloured erbia and colourless ytterbia. The properties of ytterbia were investigated by L. F. Nilson, A. Cleve, etc. Ytterbium was considered to be an element until 1905, when C. A. von Welsbach stated that the spectroscopic evidence showed that it is probably complex. In 1907, G. Urbain, and in 1908, C. A. von Welsbach, described how ytterbium could be resolved into two elemental forms. The latter suggested the name *aldebaranium* and *cassiopëium* for the components of the old ytterbium; but G. Urbain is considered to be the discoverer of these two elements, and his terms neo-ytterbium, or simply **ytterbium**, and **lutecium** are now generally adopted. The source of G. Urbain's paleo-ytterbium was xenotime. The lines $\lambda=5104.6$, 5067.4 , and 5009.7 do not appear in the arc spectrum of lutecium, or neo-ytterbium, the components of ytterbia; but they appear in the spectrum of paleo-ytterbium. Hence, it is inferred that ytterbium must contain yet another element, different from the three known components.

The elements neo-ytterbium and lutecium occur in virtually all the minerals which contain yttrium; but the amounts are small. G. Urbain regards gadolinite, xenotime, polycrase, and blomstrandine as the most convenient sources of these earths. C. A. von Welsbach estimated that about 80 or 90 per cent. of the paleo-ytterbium consisted of neo-ytterbium.

The isolation of paleo-ytterbia.—The starting-point is the soluble double alkali sulphates of the yttria earths. Various methods of fractionation can be employed—*e.g.* precipitation by alkali hydroxide, ammonia, or aniline; the oxide process; decomposition of nitrates; fractional precipitation by oxalic or chromic acids; fractional crystallization of the acetylacetonates, ethylsulphates, or bromates; etc. These methods have been described. The ytterbium accumulates in the most soluble fractions, and remains after the separation of thulium and erbium (*q.v.*).

The separation of neo-ytterbia and lutecia.—G. Urbain fractionally crystallized the simple nitrates from nitric acid of sp. gr. 1.3, and found the separation of erbium, thulium, neo-ytterbium, and lutecium to be slow but otherwise satisfactory. He made 15,000 fractional crystallizations in order to separate the two elements. C. A. von Welsbach fractionated the double ammonium oxalates from a soln. of ammonium oxalate. He stated that the separation proceeds slowly for about 200 operations, when there is a marked increase in the rate of separation. He said that this is due to the presence of a third element between neo-ytterbium

and lutecium, but he could obtain no spectroscopic indication of such an element. C. James fractionated the mixed bromates for ytterbium. At the end of a long series of fractional crystallizations of ytterbium nitrate derived from gadolinite using conc. nitric acid as solvent, G. Urbain obtained a non-crystallizable mother liquor which, with ammonia, furnished what he called *celtia*. The new earth was afterwards shown to be a mixture of known earths.

The **spark spectrum** of neo-ytterbium has been investigated by C. A. von Welsbach,² and F. Exner and E. Haschek. The arc lines have been measured by F. Exner and E. Haschek, J. M. Eder and E. Valenta, etc. J. Blumenfeld and G. Urbain found the more intense arc lines of purified neo-ytterbia are 2398·1, 2464·5, 2512·1, 2538·7, 2653·9, 2776·4, 2784·8, 2831·1, 2891·5, 2970·7, 3005·9, 3031·3, 3107·9, and 3298·4. They found about 500 lines in the region between 2300 and 3500. They also examined the ultra-violet spectra. The **cathodic phosphorescent spectrum** has been examined by G. Urbain. E. Friman measured the high frequency **X-ray spectrum** of ytterbium; and E. Hjalmar the M-series of the X-ray spectrum.

The **spark spectrum** of lutecium has been examined by C. A. von Welsbach, G. Urbain, and J. M. Eder and E. Valenta. The **arc spectrum** of lutecium has also been investigated by J. M. Eder and E. Valenta, and by F. Exner and E. Haschek, etc. The more intense lines are 2615·50, 2911·53, 3077·75, 3198·27, 3254·45, 3281·89, 3312·30, 3359·74, 3376·69, 3397·21, 3472·65, 3507·57, 3508·55, 3554·58, 3568·00, 3624·10, 3636·41, 3876·80, 4124·87, 4184·40, 4518·74, 5476·88, 5983·92, 5984·32, 6222·10, and 6463·40. The high frequency or **X-ray spectrum** of lutecium has been studied by E. Friman. The L-series of the **X-ray spectra** of ytterbium and lutecium were measured by D. Coster and co-workers, E. Hjalmar, and M. Siegbahn, who gave for ytterbium, $a_2\alpha' = 1.6789$; $a_1\alpha = 1.66779$; $\beta_1\beta = 1.472$; $\beta_2\gamma = 1.412$; $\gamma_1\delta = 1.221$; $l_c = 1.892$; $\eta = 1.618$; $\gamma_2\theta = 1.225$; $\beta_{4v} = 1.488$; $\beta_3\phi = 1.448$; and $\gamma_3\chi = 1.221$; and for lutecium, $a_2\alpha' = 1.6236$; $a_1\alpha = 1.61151$; $\beta_1\beta = 1.417$; $\beta_2\gamma = 1.366$; $\gamma_1\delta = 1.220$; $l_c = 1.834$; $\gamma_2\theta = 1.184$; $\beta_{4v} = 1.434$; $\beta_3\phi = 1.395$; and $\gamma_3\chi = 1.180$. For the M-series, E. Hjalmar, and G. Wentzel gave for ytterbium, $\alpha = 8.123$, $\beta = 7.895$; and for lutecium, $\alpha = 7.818$, $\beta = 7.587$. The **cathodic phosphorescent spectrum** has been examined by G. Urbain. M. de Broglie and J. Carrera gave for the absorption coeff. of the K-series of X-ray spectra, Yb, 67·23; and Lu, 68·34. A. Dauvillier, and B. Cabrera have discussed the **magnetic properties** of those elements.

J. Blumenfeld and G. Urbain sought a new element between thulium and ytterbium, and considered it very unlikely that such a one exists. The individuality of ytterbium, and lutecium fits in with H. G. J. Moseley's work on the X-ray spectra, and with the assumption that these elements have the **atomic numbers**, Yb, 70; and Lu, 71—*vide infra*. The **atomic weight** of paleo-ytterbium was found to be 172·5 by J. C. G. de Marignac;³ L. F. Nilson gave 173·16; A. Cleve, 173·11; and B. Brauner, 173·08. In each case the at. wt. was computed from the ratio $\text{Yb}_2\text{O}_3 : \text{Yb}_2(\text{SO}_4)_3$. For neo-ytterbium, G. Urbain first obtained 170·1 and 173·4 for lutecium; later, from the analysis of the octohydrated sulphates, he obtained 170·66 for neo-ytterbium and 174·04 for lutecium. C. A. von Welsbach obtained 172·9 for neo-ytterbium and 174·25 for lutecium from the ratio $\text{R}_2(\text{SO}_4)_3 : \text{R}_2\text{O}_3$; and still later, he obtained neo-ytterbium 173·0 and lutecium 175·0. J. Blumenfeld and G. Urbain obtained 173·54 for the at. wt. of neo-ytterbium. The International Table of at. wt. gives 173·5 as the best representative value for the at. wt. of ytterbium, and 175·0 for that of lutecium.

A. Cleve found paleo-ytterbium oxide, or *ytterbia*, Yb_2O_3 , to be colourless, but if it contains a trace of thulium, it assumes a brown or yellow tint. According to L. F. Nilson, the oxide has a sp. gr. 9·175, while L. F. Nilson and O. Pettersson found 0·0646 for the sp. ht. G. Urbain found neo-ytterbia was likewise white; and is more paramagnetic than lutecium. S. Meyer gave 18.3×10^{-6} for the magnetic susceptibility; and J. Blumenfeld and G. Urbain, 33.6×10^{-6} . L. F. Nilson, and J. C. G. de Marignac said that paleo-ytterbia fuses with difficulty; and it dissolves

slowly in dil. acids in the cold, and rapidly when heated. J. C. G. de Marignac described paleo-ytterbium as a gelatinous precipitate, **ytterbium hydroxide**, $\text{Yb}(\text{OH})_3$, obtained by adding ammonia to a soln. of the salt. C. A. von Welsbach obtained colourless *lutecia*, or **lutecium oxide**, Lu_2O_3 ; G. Urbain said that it is four to five times less paramagnetic than neo-ytterbium. All these oxides and hydroxides react with acids to form colourless salts with no visible absorption spectrum.

According to A. Cleve, a soln. of paleo-ytterbia in hydrochloric acid furnishes crystals of hexahydrated **ytterbium chloride**, $\text{YbCl}_3 \cdot 6\text{H}_2\text{O}$; and the same salt is obtained by saturating the aq. soln. with hydrogen chloride. The salt is readily soluble in water, and is deliquescent. W. W. Coblentz studied the ultra-red transmission spectrum. Ytterbium chloride furnishes a chloroplatinate and chloroaurate. When the chloride is heated in a stream of hydrogen chloride it furnishes **ytterbium oxychloride**, YbOCl , as a white deliquescent mass. G. Urbain found anhydrous **lutecium chloride**, LuCl_3 , to be more volatile than anhydrous neo-ytterbium chloride, YbCl_3 ; but less so than scandium chloride. A. Cleve similarly made paleo-**ytterbium bromide**, $\text{YbBr}_3 \cdot 8\text{H}_2\text{O}$, which is more deliquescent than the chloride. She also made the bromoplatinate.

L. F. Nilson, and A. Cleve found that a boiling soln. of paleo-ytterbia in sulphuric acid furnishes crystals of octohydrated **ytterbium sulphate**, $\text{Yb}_2(\text{SO}_4)_3 \cdot 8\text{H}_2\text{O}$, and similar crystals are obtained by spontaneous evaporation at ordinary temp. The sp. gr. of the crystals at 20° is 3.3; and L. F. Nilson gave 3.286. L. F. Nilson and O. Pettersson gave for the sp. ht. 0.1788. When heated, the octohydrate furnishes crystals of the anhydrous sulphate, $\text{Yb}_2(\text{SO}_4)_3$, which has a sp. gr. 3.62 according to A. Cleve; L. F. Nilson gave 3.793, and for the sp. ht. 0.1039. The solubility, like that of other rare earth sulphates, decreases with rise of temp. Expressing the results in grams of $\text{Yb}_2(\text{SO}_4)_3$ in 100 grms. of water, A. Cleve found:

	15°	35°	55'	60°	70°	80°	90°	100°
$\text{Yb}_2(\text{SO}_4)_3$	34.6	19.6	11.5	10.4	7.22	6.93	5.83	4.67

At 18° , she gave for the eq. electrical conductivity, λ , for soln. with a mol of the salt in v litres of water at 18° :

v	.	.	.	3.33	6.67	33.33	333.3	666.7	3333	6667
λ	.	.	.	20.7	24.7	35.3	61.6	74	98	105

It is therefore inferred that the salt is much hydrolyzed in dil. aq. soln. Neo-ytterbium sulphate was found by G. Urbain, and C. A. von Welsbach to furnish a similar octohydrate; likewise also with **lutecium sulphate**, $\text{Lu}_2(\text{SO}_4)_3 \cdot 8\text{H}_2\text{O}$.

According to A. Cleve, when ammonium carbonate is added to a soln. of paleo-ytterbium nitrate, a gelatinous precipitate of normal **ytterbium carbonate**, $\text{Yb}_2(\text{CO}_3)_3 \cdot 4\text{H}_2\text{O}$, is obtained; if an alkali carbonate is employed, the precipitate retains alkali very tenaciously. The basic **ytterbium hydroxycarbonate**, $\text{Yb}(\text{OH})\text{CO}_3 \cdot \text{H}_2\text{O}$, is formed by passing carbon dioxide into water holding the hydroxide in suspension. P. H. M. P. Brinton and C. James found that the percentage hydrolysis—*i.e.* the ratio of the amount of carbon dioxide evolved to the total carbon dioxide originally present—after boiling with water, is:

Hrs. boiling	0.5	1.0	1.5	2.0	2.5	3.0	3.5	4.9
Hydrolysis	52.6	57.3	60.4	62.4	64.4	66.1	67.3	68.5

On comparison with analogous results from the other rare earth carbonates, it follows that ytterbium carbonate is more rapidly hydrolyzed than any of the other carbonates so far examined.

By evaporating over sulphuric acid a soln. of paleo-ytterbia in nitric acid, L. F. Nilson, and A. Cleve obtained deliquescent plates of trihydrated **ytterbium nitrate**, $\text{Yb}(\text{NO}_3)_3 \cdot 3\text{H}_2\text{O}$; while deliquescent prisms of the tetrahydrate, $\text{Yb}(\text{NO}_3)_3 \cdot 4\text{H}_2\text{O}$, crystallize from a conc. soln. in nitric acid. The sp. gr. is 2.682. The water

content of the crystals is smaller than is usually the case with the rare earth nitrates. A. Cleve made **ytterbium orthophosphate**, $\text{YbPO}_4 \cdot 4\frac{1}{2}\text{H}_2\text{O}$, as a gelatinous precipitate by adding disodium hydrophosphate to a soln. of paleo-ytterbium nitrate. When the anhydrous sulphate is fused with metaphosphoric acid, and boiled with water, **ytterbium metaphosphate**, $\text{Yb}(\text{PO}_3)_3$, is formed as a crystalline powder. On evaporation of the soln., a salt, $\text{Yb}_2\text{O}_3 \cdot 2\text{P}_2\text{O}_5 \cdot 5\text{H}_2\text{O}$, separates out. K. A. Wallroth made paleo-ytterbium **sodium pyrophosphate**, NaYbP_2O_7 , in microscopic prisms by fusing ytterbia with molten microcosmic salt.

G. Urbain reported *celtia* or *celtium oxide*, Ct_2O_3 , to be a white earth with a magnetic susceptibility about one-quarter the value of that of lutecia derived from xenotime. G. Urbain said that *celtium hydroxide*, $\text{Ct}(\text{OH})_3$, is a weaker base than *lutecium hydroxide*, $\text{Lu}(\text{OH})_3$, but is stronger than scandium hydroxide, $\text{Sc}(\text{OH})_3$. In other respects the properties of celtium compounds were said to be intermediate between those of lutecium and scandium compounds. After the discovery of hafnium, G. Urbain and fellow-workers revised the previous work on celtium and stated that celtium is probably the same element as hafnium, and is not a rare earth at all—*vide* hafnium. The only enduring fact is that A. Dauvillier found in these preparations, before the discovery of hafnium, the X-ray spectrum of a new element to which the old name was assigned. There are therefore two celtiums. G. Urbain's evidence in favour of *celtium-I* proved to be worthless; and the evidence for *celtium-II* was based on A. Dauvillier's discovery of two feeble lines with wave-length $\alpha_1 = 1561 \cdot 8$, and $\beta_2 = 1319 \cdot 4$, in the L-series of the X-ray spectrum of celtium. G. Urbain considered that these lines are in agreement with the at. number 72; and establish the right of celtium-II to a place in the periodic system. D. Coster and G. Hevesy claim that the element hafnium isolated by them fits the lacuna in the periodic table for an element with an at. number 72, better than G. Urbain's celtium-I. The element occupying the gap in the periodic table corresponding with at. number 72 should be a homologue of titanium and zirconium, and be quadrivalent, and not a trivalent rare earth. The main reasons offered by D. Coster and G. Hevesy for assuming that celtium-II is not the same as hafnium, at. number 72, are: (i) There is no difficulty in purifying hafnia from the rare earths, but celtia is exceedingly difficult to isolate. (ii) Preparations of hafnium do not show the optical spectrum ascribed by G. Urbain to celtium. (iii) The X-ray spectrum of a preparation of an element sufficiently conc. to measure its magnetic properties should show very intense X-ray lines, not the weak ones found by A. Dauvillier. These lines, moreover, do not coincide within the error of measurement with the lines found by D. Coster and G. Hevesy; and (iv) Hafnium occurs more abundantly than celtium—*vide* hafnium (6. 43, 2).

REFERENCES.

- ¹ L. F. Nilson, *Cefvers. Akad. Förh. Stockholm*, 3, 1879; 6, 1881; *Compt. Rend.*, 91. 56, 118, 1880; 88. 642, 1879; G. Urbain, *Compt. Rend.*, 145. 759, 1907; 146. 406, 1908; 152. 141, 1911; 159. 323, 1914; *Zeit. anorg. Chem.*, 68. 236, 1910; F. Wenzel, *ib.*, 64. 119, 1909; A. Cleve, *ib.*, 32. 129, 1902; C. A. von Welsbach, *Monatsh.*, 27. 935, 1906; 29. 181, 1908; 30. 695, 1909; 32. 373, 1911; 34. 1713, 1913; *Sitzber. Akad. Wien*, 115. 737, 1906; 116. 1425, 1907; 118. 507, 1909; C. G. Mosander, *Skand. Naturför. Förh.*, 3. 387, 1842; *Phil. Mag.*, (3), 23. 241, 1843; J. C. G. de Marignac, *Arch. Sciences Genève*, (2), 64. 87, 1878; G. Urbain, F. Bourion, and P. Maillard, *Compt. Rend.*, 149. 127, 1909; J. Blumenfeld and G. Urbain, *ib.*, 159. 323, 1914; C. James, *Journ. Amer. Chem. Soc.*, 34. 757, 1912; J. Gadolin, *Orell's Ann.*, 1. 313, 1796.
- ² J. C. G. de Marignac, *Compt. Rend.*, 87. 578, 1878; L. de Boisbaudran, *ib.*, 88. 1342, 1879; G. Urbain, *Le Radium*, 6. 166, 9109; *Chem. News*, 100. 73, 1909; *Compt. Rend.*, 145. 759, 1907; 146. 406, 1908; 152. 141, 1911; 174. 1349, 1922; A. Dauvillier, *ib.*, 174. 1347, 1922; *Nature*, 109. 781, 1922; L. F. Nilson, *Compt. Rend.*, 88. 642, 1879; *Cefvers. Akad. Förh.*, 3. 41, 1879; R. Thalén, *ib.*, 6. 13, 1881; *Compt. Rend.*, 91. 326, 1880; J. Carrera, *ib.*, 176. 740, 1923; M. de Broglie and J. Carrera, *ib.*, 176. 453, 1923; J. Barlet, *ib.*, 176. 1711, 1923; J. L. Soret, *Arch. Sciences Genève*, (3), 4. 261, 1880; L. M. Dennis and B. Dales, *Journ. Amer. Chem. Soc.*, 24. 401, 1902; *Chem. News*, 85. 256, 265, 291, 302, 1902; C. A. von Welsbach, *ib.*, 98. 223, 297, 1908; *Sitzber. Akad. Wien*, 116. 1425, 1907; 118. 507, 1909; J. M. Eder, *ib.*, 124. 124, 1916; J. M. Eder and E. Valenta, *ib.*, 119. 1, 519, 1910; *Atlas typischer Spectren*, Wien, 1911; F. Exner, *Sitzber.*

Akad. Wien, **108**. 1252, 1899; F. Exner and E. Haschek, *ib.*, **108**. 1123, 1899; **119**. 771, 1910; *Tabellen der Funkenspectren*, Wien, 1902; *Tabellen der Bogenspectren*, Wien, 1904; *Die Spectren der Elemente bei normalem Druck*, Wien, 1911; A. Hagenbach and H. Konen, *Atlas der Emissions-spectra*, Jena, 1905; H. Kayser, *Abhandl. Berlin Akad.*, **1**, 1903; *Handbuch der Spectroscopie*, Leipzig, **6**. 192, 1912; J. Blumenfeld and G. Urbain, *Compt. Rend.*, **159**. 401, 1914; E. Froman, *Phil. Mag.*, (6), **32**. 497, 1916; E. Hjalmar, *Zeit. Physik*, **3**. 262, 1920; **15**. 65, 1923; M. Siegbahn, *Jahrb. Rad. Elektron.*, **13**. 296, 1916; G. Wentzel, *Naturwiss.*, **10**. 369, 1922; H. G. J. Moseley, *Phil. Mag.*, (6), **26**. 1024, 1913; (6), **27**. 703, 1914; D. Coster, Y. Nishina, and S. Werner, *Zeit. Physik*, **18**. 207, 1923; D. Coster, *Compt. Rend.*, **174**. 378, 1922; J. M. Eder, *Ann. Physik*, (4), **71**. 12, 1923; A. Dauvillier, *Compt. Rend.*, **176**. 1802, 1923; B. Cabrera, *Anal. Fis. Quim.*, **20**. 92, 1922.

³ J. C. G. de Marignac, *Arch. Sciences Genève*, (2), **64**. 87, 1878; *Compt. Rend.*, **87**. 578, 1878; L. F. Nilson, *Ber.*, **13**. 1439, 1880; L. F. Nilson and O. Pettersson, *ib.*, **13**. 1459, 1880; A. Cleve, *Efvers. Svenska Akad. Förh.*, **58**. 573, 1902; *Zeit. anorg. Chem.*, **32**. 129, 1902; O. Brill, *ib.*, **47**. 464, 1905; W. Feit and C. Przibylla, *ib.*, **50**. 261, 1906; G. and E. Urbain, *Compt. Rend.*, **132**. 136, 1901; G. Urbain, *ib.*, **145**. 759, 1907; **146**. 406, 1908; **149**. 127, 1909; **159**. 323, 1914; **174**. 1349, 1922; **176**. 469, 1923; *Nature*, **109**. 781, 1922; *Journ. Soc. Chem. Ind.-Chem. Ind.*, **42**. 764, 1923; *Anon.*, **42**. 784, 1923; *Zeit. anorg. Chem.*, **68**. 236, 1910; J. Blumenfeld and G. Urbain, *Compt. Rend.*, **159**. 323, 1914; A. Dauvillier, *ib.*, **174**. 1347, 1922; **176**. 676, 1923; G. Urbain and A. Dauvillier, *ib.*, **176**. 622, 1923; *Nature*, **111**. 218, 1923; D. Coster and G. Hevesy, *ib.*, **111**. 252, 1923; C. A. von Welsbach, *Monatsh.*, **29**. 181, 1908; **30**. 695, 1909; **34**. 1713, 1913; *Sitzber. Akad. Wien*, **116**. 1425, 1907; B. Brauner, in R. Abegg, *Handbuch der anorganischen Chemie*, Leipzig, **3**. i, 334, 1906; F. Bourion, *Ann. Chim. Phys.*, (8), **20**. 547, 1910; S. Meyer, *Monatsh.*, **28**. 1017, 1908; P. H. M. P. Brinton and C. James, *Journ. Amer. Chem. Soc.*, **43**. 1446, 1921; K. A. Wallroth, *Bull. Soc. Chim.*, (2), **39**. 316, 1883; W. W. Coblenz, *Investigations of Infra-red Spectra*, Washington, **6**. 51, 1908.

CHAPTER XXXIX

CARBON

§ 1. The History of Carbon

What have been the sources of that fascination which precious stones have from time immemorial exercised over the minds of men? It is because they have acquired by tradition a prestige which fashion perpetuates; a prestige rooted on strange attributes and mystic powers wherewith the fancies of five thousand years have endowed such stones; a fashion that has been ever pandered to by a harpy host of money-making parasites, and has been fostered by that human weakness which, while endeavouring to associate what is pretty with what is costly in the materials chosen for personal ornament, is apt to attach more importance to their price than to their real beauty, in proportion as cupidity is a passion more common than refinement and taste.—ANON. (1866).

THE diamond has long been prized as a precious stone on account of its beauty, rarity, and permanence. As a gem-stone, it is altogether unique, for it is distinguished from all other precious stones by peculiar qualities. The diamond has been known to the Hindus from the remotest antiquity. The scholars tell us that the Hindu *Vedas*, 1100 to 1200 B.C., and the two epic poems *Ramayana* and *Mahabharata* frequently refer to the marvellous light of the diamond. Many properties of the diamond are described in the *Puranas*, and still more particulars in the *Brhatsanhita* of the sixth century. Some Hindu proverbs relate to the hardness of the diamond—"Diamond cuts diamond;" "The heart of a magnate is harder than the diamond;" etc. No precise data concerning the diamond have been gleaned from Hindu sources. Consonant with their mystic temperament, and glowing imagination, the Hindus consecrated the diamond to their chief gods, and attributed to it sovereign virtues. Even in the seventeenth century, A. B. de Boot¹ gravely discussed whether the power of the diamond to discriminate between right and wrong, or between legal and illegal conjugal affection, be a natural quality of the stone, or belongs to a spirit dwelling in the gem.

According to *Exodus* (28. 18), the diamond was the sixth in order in the second row of the twelve precious stones on which the names of the children of Israel were engraved. These stones were jewels of the breast-plate of judgment worn by the High Priest. The diamond is also mentioned by the prophets Jeremiah and Ezekiel. Many scholars, however, are not satisfied with these translations, and say that the words rendered diamond really signify a stone hard to break, or a stone used in breaking others. It is therefore considered to be very doubtful if the diamond was really known in the time of Moses.

The *adámas*, the indomitable, of the Greeks, mentioned in the fourth century B.C., in the *Περὶ τῶν Λίθων Βιβλίον* of Theophrastus, is often translated diamond. The term is supposed to be derived from *a*, privative, and *δαμάω*, to subdue, in reference, said Pliny, "to its unspeakable hardness, to its unconquerable fire-resisting qualities, and to the fact that it is incapable of being heated." The Persian term *almas* refers to the diamond. The scholars tell us it is probable that both the Greek and Persian terms are derived from the Hebrew word *achlamah*, or *chalam*, implying in one of its senses to be hard, and compact. The term *adamas* was at first used by the Greeks for some very hard metal, sometimes apparently for steel itself; and subsequently the term came to be used for some precious stone of great hardness. Homer mentions the *adamas* in his description of the toilet of Juno.

If Homer's *adamas* referred to the true diamond, E. Boutan said that it is very difficult to explain how a knowledge of this very precious stone was lost among a people whose sense of beauty was so well developed; for, at the time of Plato, it is doubtful if the Greeks had any knowledge of its properties, or even of its existence. In his *Historiæ naturalis* (37. 15), about 77 A.D., Pliny has a strange jumble of truth and fable in his description of the *adamas*, and this in spite of his introductory claim:

We shall refute the infamous lies that have been promulgated by the magicians about precious stones; for it is more particularly about these stones that most of their fabulous stories have been circulated. Under the guise of ascertaining remedial virtues, they have stepped beyond all bounds, and entered the region of the phantasy.

It could be argued from his narration that the diamond, as we know it, was outside his ken. He applied the term *adamas* to several minerals—e.g. quartz, specular iron ore, corundum, emery, and other hard substances which cannot now be identified—and even hard metal. It is, however, possible that the Arabian and Indian varieties of *adamas* which he describes were truly diamonds. The description of the all-resplendent and brilliant *adamas* in Dionysius' *Periegesis* (5. 318, 1119), written some time after Pliny's work, agrees better with crystals of quartz than with the true diamond. M. Manilius, in his astrological poem *Astronomica* (4. 926), made the earliest unequivocal mention of the true diamond—*adamas, pretiosior auro*—near the first century of our era.

According to Pliny, the engravers of his time used fine particles of *adamas* for cutting the hardest substances known; several other writers likewise mention this custom—e.g. P. J. Mariette, C. J. Solinus, St. Isidorus, Albertus Magnus, etc. According to J. Beckmann, however, there is no evidence to show that the ancients used diamond-dust for cutting the diamond into facets, etc., to render it brilliant; nor is there any definite evidence that diamond pencils were used for engraving on diamonds. P. J. Mariette believed that they were not, C. A. Klotz believed that they were, but L. Natter was doubtful. According to J. Beckmann, and A. Brongniart, the method of polishing diamonds was developed in 1456 by Ludwig von Berquem. According to C. W. King, the cutting of diamonds must have been practised much earlier in India, because the faceting of the famous *Koh-i-noor*, or mountain of light, dates back into uncertain time. It was formerly owned by the Rajah of Lahore, and is now included amongst the English crown jewels.

The *Cullinan* is the largest known diamond. It was found near Pretoria (South Africa), January, 1905, and weighed $3025\frac{1}{2}$ carats or over $1\frac{1}{4}$ lbs. It measured $4 \times 2\frac{1}{2} \times 2$ ins. After cutting, it weighed about 800 carats, and was valued at about £100,000. It was presented to the King of England by Cape Colony in 1909. The *Regent* or *Pitt* diamond shown in the Louvre with the French crown jewels, is the purest and finest stone known. It weighs $136\frac{1}{2}$ carats, and is valued at £480,000. The *Orloff* diamond was the largest diamond of the Russian crown jewels; it has the appearance of an irregular rosette, and weighed $194\frac{1}{2}$ carats. The *Florentine* of the State treasury at Vienna weighs $133\frac{1}{2}$ carats; it is pale yellow and is cut like a double rosette or briolette. The *Sancy* diamond weighs $53\frac{1}{2}$ carats and is the property of an Indian prince. The Brazilian diamond *Star of the South*, weighing 125 carats, is also the property of an Indian prince. The *Grand Mogul* is also an Indian diamond weighing $279\frac{3}{16}$ carats. The *Star of South Africa* weighs $46\frac{1}{2}$ carats and was sold for £25,000. The *Victoria* diamond of South Africa weighed $457\frac{1}{2}$ carats uncut, and 180 carats when cut. The *Excelsior* diamond, also from South Africa, weighed $971\frac{1}{2}$ carats uncut. There are numerous other historic and celebrated diamonds. Stones over an ounce in weight are comparatively rare.

Diamonds occur in their natural state as more or less rounded, rough-looking pebbles, not unlike pieces of gum arabic in appearance. The natural diamond must be cut and polished to bring out its lustre and sparkle. The diamond-cutting industry has developed largely in Amsterdam and Antwerp. The shape of the so-called *crystal* as it leaves the diamond-cutter has no relation to the natural crystalline shape. About half the mass of the diamond is lost in the cutting. The object of the apidarist is to get the maximum reflection of light from the interior of the stone. The *rose* and *brilliant*, for instance are standard shapes; the latter has a rather

large flat face which is really the base of a pyramid with many sides (facets). The high reflecting and refracting power of the diamond are the particular qualities which make it supreme above other gems. In virtue of these qualities, the light falling on, say, the front face of a brilliant passes into the diamond, and is reflected from the interior surface of the facets. The reflected light is refracted into a wonderful play of "lightning flashes, and sparkling scintillations" as it passes into the air.

Diamonds are sold by the **carat**. The term carat is derived from the carob bean, formerly used as a small weight by the diamond merchants of India. The carat represents the Roman *siliqua* or Greek *κεράτιον*. It was $\frac{1}{4}$ th of the golden solidus of Constantine which was $\frac{1}{4}$ th oz. The carat used for diamonds and other precious stones was originally $\frac{1}{4}$ th oz., or $3\frac{1}{2}$ grains; but now, one carat corresponds with 0.207 gram of $3\frac{1}{2}$ grains troy. Expressing the weights in milligrams, the carat at London is 205.409 mgrms.; Paris, 205.500; Amsterdam, 205.700; Berlin, 205.440; Vienna, 206.130; Madras, 207.353; Batavia, 205.000; Florence, 197.200; etc. There are so many different countries with different values of the carat, that those interested are adopting the *International carat* of 200 mgrms., or 3.08647 grains troy. The carat is also used as a proportional measure, $\frac{1}{2}$ th, in stating the fineness of gold (*q.v.*).

In the fourth century, St. Epiphany wrote a brochure on the diamond and other precious stones; in the seventh century, St. Isidorus reproduced much of what Pliny and St. Epiphany had previously stated; in the eleventh century, G. Marbodius wrote a small work on the subject, and M. C. Psellus described the medicinal virtues of the precious stones; in the twelfth century, Abd Al-Malik ibn Muhammad ibn Ismail treated the subject systematically, and collected data on the properties of the gem-stones; and in the sixteenth century appeared G. Agricola's work which was compiled largely from that of Pliny. In the sixteenth century there also appeared the works of J. de Mandevil, and of Garcia da Orta. The nature of the diamond did not attract special attention until the seventeenth century. About this time appeared the treatise of A. B. de Boot. In studying the action of heat on the diamond, it will be shown how it was demonstrated that the diamond is a form of carbon; or, as J. Dalton expressed it, carbon and the diamond are the same element in different states of aggregation.

Many monographs have been published on the diamond and precious stones; e.g., in addition to some mentioned in the references, there are, among others, E. Boutan, *Le diamant*, Paris, 1886; Ibn Abi Bakr Abd Al-Rahman, *De proprietatibus ac virtutibus medicis animalium, plantarum, ac gemmarum*, Paris, 1647; A. Bacci, *De gemmis ac lapidibus pretiosis*, Roma, 1577; J. W. Baumer, *Historia naturalis lapidum pretiosorum*, Francofurti, 1771; R. Belleau, *Les amours et nouveaux échanges des pierres précieuses*, Paris, 1576; C. P. Brard, *Traité des pierres précieuses*, Paris, 1808; U. F. B. Brückmann, *Abhandlung von Edelsteinen*, Braunschweig, 1757; L. Dutens, *Des pierres précieuses et des pierres fines*, Paris, 1776; H. Engelhardt, *Die Lagenstätte der Diamanten in Ural Gebirge*, Riga, 1830; W. von Eschwege, *Plute Brasiliensis*, Berlin, 1833; J. A. F. Fladung, *Versuch über die Kennzeichen der Edelsteine und deren vortheilhaftesten Schnitt*, Pesth, 1819; Wien, 1828; L. Feuchwanger, *A Treatise on Gems*, New York, 1838; G. Gimma, *Della storia naturale delle gemme*, Napoli, 1730; W. Haidinger, *Beschreibendes Verzeichniss einer Sammlung von Diamanten*, Wien, 1852; H. de Blancourt, *Traité des pierres précieuses*, Paris, 1718; E. Jannetaz, E. Fontenay, E. Vanderheyem, and A. Coutance, *Diamant et pierres précieuses*, Paris, 1881; M. Bauer, *Edelsteinkunde*, Leipzig, 1896; P. Groth, *Handbuch der Edelsteinkunde*, Leipzig, 1887; D. Jeffries, *A Treatise on Diamonds*, London, 1750; W. Jones, *History and Mystery of Precious Stones*, London, 1880; M. Kähler, *De chrysalorum generatione*, Upsalæ, 1747; C. W. King, *The Natural History, Ancient and Modern, of precious Stones and Gems*, London, 1865; C. F. Kunz, *Gems and Precious Stones of North America*, New York, 1890; A. Schrauf, *Handbuch der Edelsteinkunde*, Wien, 1869; S. M. Burnham, *Precious Stones*, Boston, 1886; J. de Laet, *De gemmis et lapidibus*, Paris, 1648; C. von Linné, *De crystallorum generatione*, Upsalæ, 1747; J. Mawe, *A Treatise on Diamonds and Precious Stones*, London, 1823; R. Naldi, *Delle gemme e delle regole per valutarle*, Bologna, 1791; F. Küspert, *Ueber den Diamant*, Leipzig, 1904; M. Pinder, *De adamante*, Berlin, 1829; M. D. Rothschild, *Handbook of Precious Stones*, New York, 1890; F. de la Rue, *De gemmis*, Paris, 1547; M. T. Sourindro, *Mani Mala, or a Treatise on Gems*, Calcutta, 1879; A. H. Church, *Precious Stones*, London, 1883; W. R. Cattelle, *Precious Stones*, Philadelphia, 1903; E. W. Streeter, *The Great Diamonds of the World*, London, 1882; *Precious Stones and Gems*, London, 1882; A. Castellani, *Delle gemme*, Firenze, 1870; K. E. Kluge, *Handbuch der Edelsteinkunde*, Leipzig, 1860; N. Venette, *Traité des pierres*, Amsterdam, 1701; W. Rau, *Edelsteinkunde*,

Leipzig, 1907; K. Zerrenner, *Anleitung zum Diamanten*, Leipzig, 1851; V. von Zepharovich, *Der Diamant, ein populärer Vortrag*, Gratz, 1862; J. Tennant, *On Gems and Precious Stones*, London, 1851; H. Emanuel, *Diamonds and Precious Stones*, London, 1867; M. de Barrera, *Gems and Jewels*, London, 1860; L. Dieulefait, *Diamonds and Precious Stones*, London, 1874; J. E. Middlebrook, *Illustrations of the Diamond Industry*, Kimberley, 1892; L. de Launay, *Les diamants du Cap*, Paris, 1897; C. F. Williams, *The Diamond Mines of South Africa*, New York, 1902; J. R. Blum, *Taschenbuch der Edelsteinkunde*, Stuttgart, 1832; C. Barbot, *Traité complète des pierres précieuses*, Paris, 1858; W. Crookes, *Diamonds*, London, 1909.

As indicated in connection with the history of tin, lead, molybdenum, and galena, Aristotle,² Dioscorides, Pliny, and Gahlen used the terms *molybdæna* and *galena* in no very precise way for the sulphide and for oxidized ores and other products. Pliny used the term *plumbago* for a mineral product—a kind of litharge also denoted by the words *molybdæna* and *galena*; as well as for the name of a plant, and for a lead-like colour. In some sixteenth-century translations of Dioscorides—H. Barbarus, J. Ruellinus, and M. Virgilius—the term *plumbago* is used as the Latin equivalent of *μολύβδαινα*. In the sixteenth century, G. Agricola, C. Entzelt of Saalfeld, and J. Mathesius regarded *plumbago*, *galena*, and *molybdæna* as identical with *Glantz* or the modern *galena*. The *galena sterilis* of G. Agricola was probably graphite; and his *galena inanis*, zinc blende. According to J. W. Evans, one of the earliest references to graphite and its use for pencils occurs in C. Gesner's *De rerum fossilium, lapidum, et gemmarum* (Zürich, 104, 1565), where a drawing occurs showing the black-lead fixed into a handle. He added, on the authority of G. Agricola, J. H. G. von Justi, and J. Beckmann,

The flaky graphite of Bavaria has been worked from prehistoric times for mixing with clay to form pottery, and the Passau or Ips crucibles, in which this material was employed, were widely used, but it does not seem to have been employed for writing so early as that from the Borrowdale mine, near Keswick, in Cumberland, which was for some three centuries the principal source of supply of the mineral for this purpose. Metallic lead and silver were used in both ancient and mediæval times for drawing lines. Subsequently in the early renaissance an alloy of two parts of lead and one of tin, known as *lo stile del piombo* or *lapis piombino*, was employed for drawing. These terms were probably transferred to graphite when it came into use.

A. Cæsalpinus, and F. Imperato, in 1599, also made observations on the use of graphite for crucibles. J. Mathesius referred to *einem newem und Selbwachssenen Metall* used for writing which J. W. Evans said must have been graphite, and H. Platte, W. Camden, and others refer to graphite under the name *black-lead*, although as a translation of Pliny's *plumbum nigrum* the term was used by B. Anglicus, J. Marplet, and others in the sense of metallic lead. At the end of the sixteenth century, F. Imperator referred to the use of *grafio piombino* for writing, and the Italian *grafio* is derived from the Latin *graphium*, a style for writing, and the Greek *γραφειον*, a style for writing. In 1627, J. C. Boulanger referred to *plumbea graphis*, and *galena pictoris*, which J. W. Evans considers to be represented by the French *crayon de mine*, and *plomb de mer*, terms used for graphite. C. Merrett, and W. Charleton used the term *nigrica fabilis* for graphite; and in 1671, J. Webster wrote concerning graphite:

It cannot be amiss to say something of that which we commonly call *Black-Lead*, because it discoloureth the hands far more than common Lead, and is that whereof pencils are made for Painters and Scriveners, and many other such like uses. In the North we call it *Kellow*, and some call it *Watt*. . . . All that we can say here concerning *galena*, *plumbago*, *lapis plumbarius*, and *molybdæna* is that there is much said to no little purpose, and that in some respects they may be taken for all one.

In his posthumous *Minerali* (Hamburg, 1689), J. Junge applied the term *pseudo-galena* to *galena inanis* or *galena sterilis*, and for a time this usage was followed by J. G. Wallerius, G. Hoffmann and J. B. Boehmer, A. G. Monnet and others. J. Junge also referred to *plumbago scriptoria* and *plumbago anglica*, meaning graphite. In the English translation of P. Pomet's *Histoire général des drogues* (Paris, 1694), *mine de plomb noire* or *mine de plomb* is rendered *black-lead*;

and *plombagine* and *plomb de mer* are rendered respectively *plumbago* and *sea-lead*. All these terms refer to graphite. R. Plot suggested calling graphite *ochra nigra* or *black ochre*. During the seventeenth and eighteenth centuries, *lapis plumbarius*, *plumbago*, *galena*, and sometimes *molybdæna* were employed for graphite, and the mineral called molybdenite. It was soon found that graphite (and molybdenite) do not contain lead. In a paper on graphite entitled: *Examen chymicum plumbi scriptorii vulgo plumbaginis*, J. H. Pott, in 1740, gave a long list of synonyms which had been used by different peoples for graphite. He showed that this substance does not contain sulphur or zinc; and that it is decomposed by fused potassium nitrate. He probably worked with a graphite containing some pyrites, for he concluded that it is a *terra talcosa, igni et menstruis indomita, pauco martiali et pauciore acido vitriolico*. J. W. Baumer first showed that the minerals referred to by *molybdæna* and its numerous synonyms contained two different substances, one of which, containing some iron, was combustible. The confusion between graphite and molybdenite, then called *plumbago* or *molybdæna*, was cleared when C. W. Scheele demonstrated that when *plumbago* is heated with saltpetre, it is transformed into carbon dioxide. Hence, he concluded: "plumbago is a kind of mineral charcoal the constituent parts of which are aerial acid (carbon dioxide) and a considerable quantity of phlogiston." He further demonstrated that *molybdæna* is a compound of sulphur with a peculiar acid of a metallic nature. There does not appear any definite reason, other than chance, why C. W. Scheele applied the term *molybdæna* to molybdenite, and *blyerts* or *plumbago* to graphite, because previously the term *molybdæna* had been more frequently applied to graphite. C. W. Scheele's application of the terms decided subsequent usage. In order to prevent further confusion, A. G. Werner, and D. L. G. Karsten proposed the term **graphite** for *plumbago* as distinct from *molybdæna*.

Although C. W. Scheele showed that the small amount of iron oxide which occurs associated with graphite "can hardly be taken into account, for it seems to be mixed with it only mechanically," yet several later observers assumed that the iron is an essential part of graphite. R. J. Haüy called it *carbure de fer* because of the analysis of C. A. Vandermonde, G. Monge, and C. L. Berthollet—carbon, 90.9 per cent.; iron, 9.1 per cent. L. B. Guyton de Morveau regarded the graphite he obtained from cast-iron as an iron carbide; but C. J. B. Karsten showed that the iron in this product is mechanically mixed with the graphite; and this view was also demonstrated by N. G. Sefström. L. Vanuxem also showed that the iron exists in the mineral graphite as oxide and that it is an accidental impurity, and not an essential constituent; and B. Pelletier demonstrated that *plumbago* is *une substance particulière . . . les substances dans lesquelles l'air fixe ne paroît pas entrer, donnent après leur décomposition des indices de cet être*. The name *Graphit* is used in Germany where the term *Reisblei* still survives; in France, the terms *mine de plomb*, *plombagine*, and *graphite* are used; in England, *black-lead*, *plumbago*, and *graphite*; in Italy, *grafite*, and *piombaggine*; and in Spain, according to E. Halse, *grafite*, *plombagina*, *lápiz*, *lápiz plomo*, *alquifol*, *carbon*, *chacal*, *mine de plomo*, and *pedra mineral de plomo*. Soot must have been used from the earliest times as a colouring agent, and in the making of a kind of ink. A further contribution to the history of the diamond, graphite, etc., is indicated in connection with the action of heat on these substances.

The deposits of graphite at Borrowdale (Cumberland) were worked about 1550. According to C. A. Mitchell, W. W. F. Petrie discovered a lump of impure graphite with 39.4 per cent. of carbon, at Ghorub, and this must have dated back to a period between 1500 and 1200 B.C. There is, however, no evidence of the use of graphite as a pigment in ancient Egypt. C. T. Schönemann said that lines in black lead (*Reisblei*) are found on some eleventh- or twelfth-century works in the Wolfenbüttel and Göttingen libraries, but C. A. Mitchell considers that graphite was here mistaken for ordinary lead. He also examined the markings in the British Museum and Bodleian Libraries, but found none earlier than 1640.

REFERENCES.

¹ C. J. Solinus, *De situ et memorabilibus orbis capitula*, Venetiis, 1473; St. Isidorus, *Origines*, Leipzig, 15. 8, 1832; Albertus Magnus, *De rebus metallicis et mineralibus*, Rouen, 2. 2, 1476; P. J. Mariotte, *Traité des pierres gravées*, Paris, 1. 90, 156, 1750; L. Natter, *Traité de la méthode antique de graver en pierres fines, comparée avec la méthode moderne, et expliquée en diverses planches*, London, 15, 1754; C. A. Klotz, *Ueber den Nutzen und Gebrauch der Alten geschnittenen Steine und ihrer Abdrücke*, Altenbrücke, 42, 1768; J. Beckmann, *Beiträge zur Geschichte der Erfindungen*, Leipzig, 1805; London, 2. 87, 1846; J. Dalton, *A New System of Chemical Philosophy*, London, 2. 236, 1810; C. W. King, *The Natural History, Ancient and Modern, of Precious Stones and Gems, and of Precious Metals*, London, 1865; A. Brongniart, *Traité de minéralogie*, Paris, 2. 61, 1807; G. Marbodius, *De gemmarum lapidumque pretiosorum formis naturis atque viribus opusculum*, Rennes, 1070; Cologne, 1539; J. de Mandeville, *Le lapidaire en français*, Lyon, 1561; K. K. Kluge, *Handbuch der Edelsteinkunde*, Leipzig, 1860; H. Emmanuel, *Diamonds and Precious Stones*, London, 1865; M. de Barrera, *Gems and Jewels, their History, Geography, Chemistry, and Analysis, from the Earliest Years down to the Present Time*, London, 1860; C. Leonardus, *Speculum lapidum*, Venetiis, 1516; A. B. de Boot, *Gemmarum et lapidum historia*, Jena, 2. 4, 1609; 2. 117, 1636; S. F. Ravius, *Specimen Arabicum continens descriptionem et excerpta libri Achmedis Teifaschii de gemmis et lapidibus pretiosis*, Utrecht, 1784; G. Agricola, *De lapidibus*, Basileæ, 1555; A. Schrauf, *Sitzber. Akad. Wien*, 54. 1, 1866; *Handbuch der Edelsteinkunde*, Wien, 83, 1869; Garcia da Orta, *Aromatum et simplicium aliquot medicamentorum apud Indos nascentium historia*, Antverpia, 1565; E. Boutan, *Le diamant*, Paris, 1886; M. C. Psellus, *Περὶ Ἰθῶν Διάγμων*, Tolosa, 1615; *De lapidum virtutibus*, Lugduni Batavorum, 1745; St. Epiphany, *De duodecim gemmis quæ erant in veste Aaronis*, Romæ, 1565; Abd Al-Malik ibn Muhammad ibn Ismail, *Yatimat al-dahr*, Damascus, 1185.

² C. Gessner, *De omni rerum fossilium figuris*, Tiguri, 1565; A. Cæsalpinus, *De metallicis*, Romæ, 211, 1596; F. Imperato, *Dell' historia naturale*, Napoli, 4. 122, 1599; M. von Bromell, *Mineralogia*, Stockholm, 58, 1739; J. G. Wallerius, *Mineralogia, eller Mineralriket*, Stockholm, 131, 249, 1747; 238, 1889; J. H. Pott, *Dissertationes chymiques*, Paris, 4. 1, 1759; *Miscellanea Berolinensis*, 6. 29, 1740; A. G. Werner, *Berg. Journ.*, 1. 380, 1789; D. L. G. Karsten, *Museum Leskeanum*, Leipzig, 2. 339, 1789; C. J. B. Karsten, *Arch. Berg. Hütt.*, 12. 91, 1826; R. J. Haiy, *Traité de minéralogie*, Paris, 4. 98, 1801; C. A. Vandermonde, G. Monge, and C. L. Berthollet, *Mém. Acad.*, 132, 1786; L. B. Guyton de Morveau, *Ann. Chim. Phys.*, (1), 31. 72, 328, 1799; (1), 84. 241, 1812; *Gilbert's Ann.*, 2. 396, 475, 1799; N. G. Sefström, *Jerncontoret's Ann.*, 12. 145, 1829; *Pogg. Ann.*, 16. 168, 1829; L. Vanuxem, *Journ. Acad. Philadelphia*, 5. 21, 1825; *Amer. Journ. Science*, (1), 10. 102, 1826; C. A. Mitchell, *Nature*, 105. 12, 1920; 109. 615, 1922; *Journ. Soc. Chem. Ind.*, 38. 382, T, 1919; C. T. Schönemann, *Versuch eines Systems der Diplomatie*, Leipzig, 2. 108, 1818; C. W. Scheele, *Svenska Acad. Handl.*, 39. 247, 1778; 40. 238, 1779; *Journ. Phys.*, 19. 162, 1782; 20. 342, 1782; B. Pelletier, *ib.*, 27. 343, 434, 1785; Aristotle, *De generatione animalium*, 2. 2, c. 300 B.C.; Dioscorides, *De materia medica*, 5. 100, c. 50 A.D.; H. Barbarus' trans., Venice, 1516; J. Ruellinus' trans., Paris, 1516; M. Virgilius' trans., Cologne, 1529; Pliny, *Historia naturalis*, 25. 97; 29. 26; 33. 31; 34. 47; 37. 18, c. 50 A.D.; Gahlen, *De simplicium medicamentorum temperaments*, 9. 22, c. 200 A.D.; *De compositione medicamentorum per genera*, 1. 11, c. 200 A.D.; *De succedaneis*, c. 200 A.D.; G. Agricola, *Bermannus sive de re metallica*, Basle, 1530; *De natura fossilium*, Basle, 366, 1546; *Rerum metallicarum interpretatio*, Basle, 1546; C. Entzelt, *De re metallica*, Frankfurt, 66, 1551; J. Mathesius, *Sarepta*, Nuremberg, 1562; J. W. Evans, *The Meanings and Synonyms of Plumbago*, Hertford, 1908; *Trans. Philol. Soc.*, 133, 1908 (many of the references here given are from this paper); J. Beckmann, *Beyträge zur Geschichte der Erfindungen*, Leipzig, 4. 353, 1799; 5. 245, 1803; J. H. G. von Justi, *Grundriss des gesammten Mineralreichs*, Göttingen, 213, 1757; B. Anglious, *De proprietatibus rerum*, 1495; J. Marplet, *A greene Forest, or a Natural History*, London, 1567; H. Platte, *Jewell House of Art and Nature containing divers rare and profitable inventions*, London, 1594; J. C. Boulanger, *De pictura plasticæ statuaria*, Leyden, 103, 1627; J. Webster, *Metallographia, or an History of Metals*, London, 1671; W. Charleton, *De variis fossilium generibus*, Oxonia, 1668; C. Merret, *Pinax rerum naturalium Britannicum*, London, 1666; J. G. Hoffmann and J. B. Boehmer, *De matricibus metallorum*, Leipzig, 68, 1738; A. G. Moynet, *Système de minéralogie*, Bouillin, 180, 1779; R. Plot, *Phil. Trans.*, 20. 183, 1698; J. W. Baumer, *Naturgeschichte des Mineralreichs*, Gotha, 1. 151, 217, 1763; W. Camden, *Britannia*, London, 523, 1587; E. Halse, *A Dictionary of Spanish and Spanish-American Mining, Metallurgical, and Allied Terms*, London, 1908.

§ 2. The Occurrence of Carbon

Carbon occurs in nature in many forms. It occurs crystallized as the diamond and as graphite. It is the dominant element in organic matter. It is the principal element in coal. Natural gas, petroleum, and bitumen are essentially hydrocarbons. Carbon dioxide is a normal constituent of the atm.; and carbonic

acid and carbonates occur in most natural waters. The carbonates of calcium, magnesium, and iron form great masses of rock. Carbon is also present in a few naturally occurring silicates.

Reviewing the known analyses of terrestrial matters, F. W. Clarke¹ placed carbon 12th in the series showing the relative abundance of the different elements. It is less abundant than chlorine, titanium, and hydrogen, and more abundant than phosphorus, sulphur, and barium. The averages in the following excerpts include the atm. :

	O	Si . . .	Ti	Cl	C	P	S	Ba . . .
Lithosphere . . .	47·33	27·74	0·46	0·06	0·19	0·12	0·12	0·08
Hydrosphere . . .	85·79	—	—	2·07	0·002	—	0·09	—
Average . . .	50·02	25·80	0·43	0·20	0·18	0·11	0·11	0·08

F. W. Clarke and H. S. Washington place carbon 13th in the list, with 0·13 per cent. For the lithosphere, the carbonates occur 11th in the series :

	Igneous rocks.	Shales.	Sandstones.	Limestones.	Weighted Average.
SiO ₂ . . .	59·83	58·10	78·33	5·19	59·77
H ₂ O . . .	1·90	5·00	1·63	0·77	2·02
TiO ₂ . . .	0·79	0·65	0·25	0·06	0·77
ZrO ₂ . . .	0·023	—	—	—	0·02
CO ₂ . . .	0·49	2·63	5·03	41·54	0·70
P ₂ O ₅ . . .	0·29	0·17	0·08	0·04	0·28

The occurrence of carbon in the sun has been investigated spectroscopically by J. N. Lockyer,² J. Dewar, J. Trowbridge and C. C. Hutchins, H. A. Rowland, etc. The fainter red stars like Schjellerup are characterized by shaded bands which are attributed to carbon; the bands are darkest on the red side of the spectrum, and fade away towards the blue. W. Huggins, and B. Hasselberg also stated that the spectra of various comets all show the hydrocarbon spectrum. A. Fowler has examined the spectrum of Morehouse's comet.

Diamonds are sparsely distributed in different parts of the world; they sometimes occur like alluvial gold in the beds of rivers and streams, and the river stones are usually the most highly prized, and valuable. The diamonds which are not alluvial, are found in a heterogeneous mixture of fragments of various rocks and minerals³ cemented together with a bluish-green indurated clay known as *blue earth*, or *blue clay*. The diamonds are found imbedded in the blue earth. The mines in India⁴ are the oldest; and they yielded the finest and most prized diamonds. Diamonds occur in Nisam near the river Kistna; in Sambalpur near the rivers Godavari and Mahanadi; and in Bundelkhand, near Panna. There are mines in the west and south-east of Borneo. The region of Minas Geraes (Diamantina, near Abaété, Bagagem, Grao Mogul, Bahia, etc.) in Brazil has long been famed for its diamond mines. Diamonds have been reported in British Guiana, Columbia, and Mexico; and in the United States—California, Oregon, Idaho, Montana, Arizona, Indiana, Kentucky, Tennessee, Georgia, North and South Carolina, Virginia, Wisconsin, and Michigan. Diamonds were discovered in the Urals about 1829; and in Australia about 1852. The diamond fields of South Africa—Jagersfontein, Koffyfontein, Kimberley, etc.—have been the most prolific source of diamonds in recent years.

The blue earth is mined, and exposed to the weather on the veld. The earth may with advantage be frequently harrowed and occasionally watered. In about a year, the blue earth becomes friable and disintegrates. The stuff is then conveyed to the crushing machinery and washers, where the clay is separated into earth and gravel. The diamantiferous gravel is then conveyed to sifters, where it is graded. Each grade drops on to pulsator tables, where it is sorted into materials of different sp. gr. The higher portion is washed by water to the end of the trough and conveyed to the heap of tailings: the heavier portions fall through a grating and are conveyed to percussion or shaking tables smeared with grease. The diamonds adhere to the grease, and the other constituents flow as tailings over the end of the percussion tables. The tailings may be dribbled on to a second shaking table; and the reject from this may be examined and any diamonds picked out. The grease is scraped from the tables, and is placed in a pot which is immersed in a cauldron of boiling water. The grease is recovered to be used again, and the diamonds are then examined on a

sorting table, where the true diamonds are separated from pyrites, barytes, etc., by hand-picking.

J. Thoulet discussed the occurrence of diamonds on the bed of the sea in the Gulf of Gascogne. Diamonds have been found in meteorites by E. Mallard,⁵ H. Moissan, G. F. Kunz and O. W. Huntington, F. von Sandberger, A. Daubr e, C. Friedel, etc. G. A. K nig and A. E. Foote described the Canyon Diablo meteorite (Arizona, U.S.A.), which contained both black and transparent diamonds; W. Will and J. Pinnow, the meteoritic stone of Carcote (Chile); and M. Jerof eff and P. Latschinoff, that of Novo-Urei (Russia).

Graphite is very widely distributed over the surface of the globe,⁶ but most graphites are so impure by intimate admixture with other minerals—quartz and mica—and the cost of transport is so great, that only a few deposits are of commercial importance. The bulk of the world's supply of graphite is obtained chiefly from Ceylon, Austria, Bavaria, Siberia, the United States, and Canada. There are, however, workable deposits in many other places. It occurs (i) in veins running through cracks in gneiss, limestones, pegmatite, and eruptive rocks—e.g. the deposits at Ceylon, Borrowdale (Cumberland), and Batugal (Siberia); (ii) bedded masses—e.g. in Ontario (Canada), Passau (Bavaria), Madagascar, Schwarzbach-Kruman (Bavaria), and Styrian Alps; and (iii) it is also found disseminated through many rocks in scattered scales or plates. Graphitic granite, gneiss, mica schist, quartzite, pegmatite, and felspar are well known in various localities. The Laurentian limestones of Canada are graphitic.

Graphite has been reported from extra-terrestrial sources. Thus, it has been found in some of the most famous meteorites—e.g. Lenarto (Hungary) in 1815; Benedego (Bahia) in 1816; Bohumilitz (Bohemia) in 1829; Sevier (Crosly Creek) in 1840; Congford (Tennessee) in 1845; Chartago (Tennessee) in 1846; Seelasgen (Brandenburg) in 1847; Chesterville (South Carolina) in 1847; Kaba (Hungary) in 1857; etc. The subject has been discussed by C. Reichenbach,⁷ M. Berthelot, A. Daubr e, H. Moissan, J. L. Smith, W. Tassin, R. Brauns, S. Meunier, L. Troost, W. Flight, G. Ansdell and J. Dewar, etc. Some of the largest and best-developed crystals of graphite have been obtained from meteorites.

The chief monographs on graphite are; E. Wienschenk, *Der Graphite, seine wichtigsten Vorkommnisse und seine technische Verwendung*, Leipzig, 1904; *Zur Kenntniss der Graphitlagerst tten*, M nchen, 1900; F. Muck, *Die Steinkohlen Chemie*, Bonn, 1881; E. Donath, *Der Graphit*, Leipzig, 1904; F. Cirkel, *Graphite, its Properties, Occurrence, Refining, and Uses*, Ottawa, 1907; H. Weger, *Der Graphit*, Berlin, 1872; A. Hasnig, *Der Graphit*, Wien, 1910; H. S. Spence, *Graphite*, Ottawa, 1920.

REFERENCES.

¹ F. W. Clarke, *The Data of Geochemistry*, Washington, 1920; F. W. Clarke and G. Steiger, *Journ. Washington Acad.*, 4, 57, 1914; F. W. Clarke and H. S. Washington, *Proc. Nat. Acad. Sciences*, 6, 108, 1922; J. H. L. Vogt, *Zeit. prakt. Geol.*, 6, 225, 314, 377, 413, 1898; 7, 10, 274, 1899; J. F. Kemp, *Econ. Geol.*, 1, 207, 1905.

² J. Dewar, *Proc. Roy. Soc.*, 30, 85, 1880; J. N. Lockyer, *ib.*, 27, 279, 308, 1878; *Compt. Rend.*, 86, 317, 1878; J. Trowbridge, *Phil. Mag.*, (5), 41, 450, 1896; J. Trowbridge and C. C. Hutchins, *ib.*, (5), 24, 302, 1887; *Amer. Journ. Science*, (3), 34, 345, 1887; A. Fowler, *Astrophys. Journ.*, 35, 85, 1912; H. A. Rowland, *ib.*, (3), 41, 243, 1891; *Chem. News*, 63, 133, 1891; *Johns Hopkins Univ. Circ.*, 85, 41, 1891; W. Huggins, *Proc. Roy. Soc.*, 16, 236, 1868; 23, 154, 1875; *Phil. Trans.*, 158, 555, 1868; B. Hasselberg, *M m. Acad. St. Petersburg*, (7), 28, 2, 1880.

³ A. L. de Toit, *Zeit. Kryst.*, 45, 309, 1908; H. S. Harger, *ib.*, 43, 615, 1907; E. C hen, *Neues Jahrb. Min.*, 857, 1872; 52, 150, 1873; i, 318, 1884; H. B. Geinitz, *ib.*, 767, 1871; A. Knop, *ib.*, ii, 97, 1890; A. Kennigott, *ib.*, i, 187, 1884; P. Jermejeff, *ib.*, i, 388, 1896; T. B. Stone, T. G. Bonney, and C. A. Raisin, *Geol. Mag.*, 492, 1895; A. Daubr e, *Compt. Rend.*, 84, 1124, 1876; 110, 18, 1890; S. Meunier, *ib.*, 84, 250, 1877; T. L. Phipson, *ib.*, 64, 187, 1867; H. Gorceix, *ib.*, 93, 981, 1881; 98, 1010, 1446, 1884; M. Chaper, *ib.*, 98, 113, 1884; *Ann. Chim. Phys.*, (6), 2, 284, 1884; J. Shaw, *Amer. Journ. Science*, (3), 1, 69, 1871; B. Silliman, *ib.*, (3), 5, 384, 1873; (3), 6, 132, 1873; G. F. Kunz, *ib.*, (3), 38, 72, 1889; *Neues Jahrb. Min.*, ii, 497, 1892; G. F. Kunz and H. S. Washington, *ib.*, (4), 24, 275, 1907; F. von Hochstetter, *Verh. Geol. Reichsanst. Wien*, 21, 353, 1871; F. Groger, *ib.*, 25, 310, 1875; J. A. R. Smit, *Arch. N er.*, 15, 61, 1880; G. W. Stow and J. Shaw, *Phil. Mag.*, (4), 43, 235, 1872; A. Lacroix, *Bull. Soc. Min.*, 21, 21, 1898; C. Friedel,

ib., 9. 64, 1886; A. L. Hall, *Zeit. prakt. Geol.*, 12. 193, 1904; F. R. Voit, *ib.*, 14. 382, 1906; A. Damour, *L'Institut.*, 21. 77, 1853; *Bull. Soc. Geol.*, (2), 13. 542, 1857; H. C. Lewis, *Chem. News*, 56. 153, 1887; E. Hussak, *Tschermak's Mitt.*, (1), 18. 334, 1899; *Zeit. prakt. Geol.*, 14. 318, 1906; J. R. Sutton, *Nature*, 75. 488, 1908; S. H. Ball, *Eng. Min. Journ.*, 109. 1202, 1920; C. J. Mitchell, *ib.*, 116. 285, 1923; F. C. Correll, *Chem. News*, 122. 88, 1921; S. Noda, *Beiträge Min. Japan*, 5. 260, 1915; A. B. Conklin, *Amer. Chem. Age*, 29. 191, 1921; L. de Launey, *Compt. Rend.*, 145. 1188, 1907; F. Fouqué and A. M. Lévy, *ib.*, 89. 1125, 1879; F. Küsspert, *Natur. Schule*, 3. 239, 292, 1904; G. Rose, *Ber.*, 3. 88, 1870; V. von Zepharovich, *Pogg. Ann.*, 140. 652, 1870; A. Schafarik, *ib.*, 139. 188, 1870; *Chem. News*, 21. 57, 119, 1870; N. von Kokscharoff, *Bull. Soc. St. Petersburg*, (2), 6. 414, 1863.

⁴ C. Hintze (*Handbuch der Mineralogie*, Leipzig, 1. 17, 1904) has an extended bibliography on the occurrence of the diamond.

⁵ E. Mallard, *Compt. Rend.*, 114. 812, 1892; C. Friedel, *ib.*, 115. 1037, 1893; J. Thoulet, *ib.*, 146. 351, 1908; H. Moissan, *ib.*, 116. 288, 1893; 139. 773, 1904; A. Daubrée, *ib.*, 110. 18, 1890; M. Jerokéeff and P. A. Latschinoff, *ib.*, 106. 1679, 1888; *Journ. Russ. Phys. Chem. Soc.*, 20. 185, 1888; W. Will and J. Pinnow, *Ber.*, 23. 345, 1890; G. A. König and A. E. Foote, *Amer. Journ. Science*, (3), 42. 413, 1892; G. F. Kunz and O. W. Huntington, *ib.*, (3), 46, 470, 1893; O. W. Huntington, *Proc. Amer. Acad.*, 29. 204, 1893; F. von Sandberger, *Neues Jahrb. Min.*, ii, 171, 1889; W. Will and J. Pinnow, *Ber.*, 23. 345, 1890.

⁶ Anon., *Bull. Imp. Inst.*, 20. 61, 1922; E. H. Schultz, *Elektrotech. Zeit.*, 43. 820, 1922; *Giesserei Ztg.*, 10. 155, 1923; T. Kato, *Journ. Geol. Soc. Tokyo*, 22. 18, 1915; C. Heintz (*Handbuch der Mineralogie*, Leipzig, 1. 52, 1904) gives a summary of the various occurrences of graphite. The subject is discussed by F. Cirkel, *Graphite*, Ottawa, 1907; M. Debeaupuis, *Bull. Soc. Min.*, 46. 49, 1923.

⁷ C. Reichenbach, *Pogg. Ann.*, 116. 580, 1862; M. Berthelot, *Bull. Soc. Chim.*, (2), 16. 237, 1871; *Compt. Rend.*, 73. 494, 1871; A. Daubrée, *ib.*, 110. 18, 1890; H. Moissan, *ib.*, 116. 292, 1893; 123. 277, 1896; J. L. Smith, *ib.*, 82. 1042, 1876; *Ann. Chim. Phys.*, (5), 9. 295, 1876; *Chem. News*, 33. 196, 204, 215, 1876; *Amer. Journ. Science*, (3), 11. 388, 433, 1876; L. Troost, *ib.*, (2), 38. 254, 1840; W. Tassin, *Neues Jahrb. Min.*, ii, 9, 1908; R. Brauns, *Centr. Min.*, 97, 1908; S. Meunier, *Ann. Chim. Phys.*, (4), 17. 48, 1869; W. Flight, *Phil. Trans.*, 173. 885, 1883; *Proc. Roy. Soc.*, 33. 343, 1882; G. Ansdell and J. Dewar, *Proc. Roy. Soc.*, 40. 556, 1886; L. Dietrich, *Giesserei Ztg*, 10. 453, 1923.

§ 3. The Different Forms of Carbon—Allotropy

What are allotropic states? Curious states which chemists frequently dispose of by calling them allotropic, a term frequently used when they are puzzled to know what has happened.—W. S. JEVONS.

It matters much with what others, and in what positions, the same atoms are held together. . . . When the configuration of the atoms is changed, the properties of the body which is formed from them must also change.—LUCRETIVS (B.C. 60).

Near the beginning of the nineteenth century, chemists—*e.g.* H. Davy¹—recognized that carbon occurs in three different forms which they called diamond, graphite, and amorphous carbon. H. C. Sorby proposed four classes: diamond—octahedral crystals, sp. gr. 3.52; graphite—hexagonal crystals, sp. gr. 2.18; hard coke—cubic crystals, sp. gr. 1.89; and anthracite—quadratic crystals, sp. gr. 1.76. H. F. Weber said that the sp. hts. give no evidence of the existence of three intrinsically different forms of carbon, and he considers that there are only two forms of carbon, one transparent and the other opaque. This fits P. Debye and P. Scherrer's observations on the X-ray spectra of graphite and amorphous carbon, since both have the same internal crystalline structure—*vide infra*. The physical properties of graphite are usually intermediate between those of the diamond and of amorphous carbon—*vide* Table I. The electrical conductivity is exceptional because, according to G. Wiedemann and R. Franz's rule (3. 21, 5), the ratio of the thermal and electrical conductivities of the metals is approximately constant; the thermal conductivity of graphite is normal, while the electrical conductivity is abnormal. The explanation is not known.

A. Breithaupt found a mineral in the clay shales of Singbhom, near Calcutta; its sp. gr. was 1.9; and he considered it to be a special variety of carbon. A. von Inostranzeff found a black lustrous variety of what he called *schungite*, near Schunga (Russia). The sp. gr. of dried *schungite* is 1.981. A. Sauer found a variety of carbon in the gneiss, mica schists, and quartzite formations near Wiesenthal (Saxony). He called it *graphitoid*. E. Weinschenk considered it to be graphite. W. Luzy regarded *graphitoid* as a variety of carbon with over 95 per cent. carbon, and falling between anthracite and

graphite. P. and L. Schützenberger stated that the carbon obtained from cyanogen is different from other forms of this element. According to C. de Douhet, the so-called *anthracitic diamond* of Brazil contains 97 per cent. of carbon. It occurs in spherical masses, and its sp. gr. is 1.66. As G. B. Trener pointed out, it is not clear if many of these substances are graphite, amorphous carbon, or a mixture of the two.

TABLE I.—A COMPARISON OF SOME PROPERTIES OF DIFFERENT FORMS OF CARBON.

Physical property.	Diamond.	Graphite.	Amorphous carbon.
Specific gravity	3.5	2.10–2.52	1.30–2.00
Heat of combustion (Cals.)	94.31	94.81	97.65
Ignition temp. in oxygen	800°–875°	650°–700°	300°–500°
Coeff. vol. expansion	0.00000375	0.0000104	0.0000162
Thermal conductivity	0.33	0.0117	0.000405
Specific heat	0.1128	0.1604	0.1653
Electrical conductivity	2.1×10^{-15}	0.082×10^4	0.25

In his *Recherches sur les états du carbone* (Paris, 1870), M. Berthelot showed that graphite could not be characterized as *une espèce définie*. Before that time all varieties of carbon leaving a grey mark on paper were called graphite. There appears to be continuous series ranging from those varieties of carbon with a sp. gr. just below that of the diamond, to that of amorphous carbon, 1.6. Well-defined graphite, and amorphous carbon were supposed to differ in the degree of polymerization, and L. Staudenmaier showed that free carbon atoms have a marked tendency to associate into complexes to a higher and higher degree as the temp. rises, furnishing a series of modifications of carbon. M. Berthelot applied B. C. Brodie's nitric acid reaction as a criterion for distinguishing graphites from other forms of carbon. He arbitrarily defined a graphite to be *any variety of carbon which furnishes graphitic acid on oxidation* with a hot mixture of potassium chlorate and nitric acid—*vide infra*, action of nitric acid on graphite. Neither diamond nor charcoal yield graphitic acid, and B. C. Brodie believed that graphite may accordingly be regarded as a peculiar radicle to which he gave the name *graphon*. H. Moissan accepted this definition of a graphite, and, in his *Recherches sur les différentes variétés du carbone* (Paris, 1896), showed that the complete oxidation of some graphites by M. Berthelot's method requires six to eight successive treatments, but when the process is applied in the following manner, with nitric acid prepared by distillation from recently fused nitre with a large excess of boiling sulphuric acid, the application is simplified :

Dry graphite is added to conc. nitric acid, and then small amounts of dry chlorate; the oxidation is far more rapid and, in the case of natural graphites, the result is apparent at the end of the first treatment. Far more chlorate than graphite must be used, weight for weight. The oxidation must last some twelve hours and finish at 60°. Care must be taken at the outset not to bring the mixture of chlorate, nitric acid, and carbon up to 60°, or rather violent explosions may take place. The admixture of the smallest amount of organic matter must also be avoided. At the end of these oxidations, the graphitic oxide, obtained in more or less well-defined crystals, has always the same greasy appearance and the same light yellow colour.

P. Schafhäutl, R. F. Marchand, and B. C. Brodie further showed that some natural graphites after having been heated in the presence of sulphuric acid, or a mixture of that acid with potassium chlorate or nitric acid, increase largely in volume when subsequently heated on a platinum foil; and W. Luzi further showed that it is sufficient to moisten the graphite with a small amount of nitric acid to cause it to swell when heated, and to produce vermiform or dendritic projections—illustrated Fig. 1—

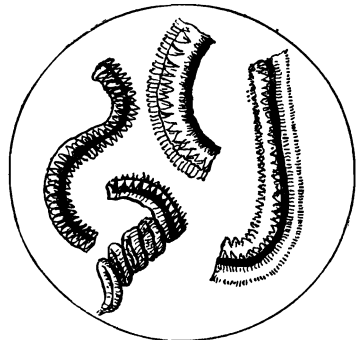

FIG. 1.—Vermiculites from Swelling Graphites.

with a circumference from a quarter to half an inch, and a length extending up to several inches, and bent or twisted in regular curves. The vermiculites consist of a number of oblong cells densely grouped together, and exhibiting on the outer surface long parallel folds and wrinkles. These forms always rise to the surface when placed in alcohol or water, and behave thus even when thoroughly soaked with liquid. The vermiculites can be readily pressed into different forms, and compressed between the fingers. The internal structure exhibits planes of highly metallic lustre which, according to E. Donath, are supposed to represent crystallization. W. Luzzi, O. Lüdecke, H. Moissan, and F. Sestini then proposed to divide the graphites into two classes: (i) Those which swell after treatment with nitric acid were called **graphites**.

To this group belong graphites from Ceylon, Ticonderoga, Amity (New York State), Grenville, and Buckingham, Province of Quebec; Borrowdale, England; Monte Rosa, Calabria; Bamle Skütterød, Norway; Marbac, Lower Austria; Pfaffenreuth, near Passau, Bavaria; and Spain.

(ii) Those which do not swell under these conditions were called **graphitites**.

To this group belong graphites from Alstadt (Moravia); Krumau, Schwarzbach, Mugrau (Bohemia); Passau (Bavaria); Saxonian graphite; Irkutsk, Tunguska (Siberia); Storgard, (Finland); Karsock and Omesnack (Greenland); Colfax County (New Mexico); South Australia; Takaschimiza (Japan); and Lerigliani, Monte Pisano, Italy. Also all artificial graphites made by electric processes.

H. Moissan found that all the graphites obtained solely by the help of a very high temp. on any variety of carbon—diamond or lampblack—or by the condensation of carbon vap., showed no tendency to swell under the action of conc. nitric acid. On the contrary, all graphites prepared at a high temp. by dissolving carbon in a metal—zirconium, vanadium, molybdenum, tungsten, uranium, chromium, iron, and aluminium—swelled readily. Graphite from low temp. iron did not swell, but that from iron which had been heated to a high temp. swelled abundantly.

E. Weinschenk attributed the different behaviour of various kinds of graphites in nitric acid to a difference in their structure. The graphites which expand so much in volume by the nitric acid treatment usually consist of very thin, minute scales or plates, which, on account of their capillary structure, suck up the acid, and swell up through the gases produced during the action of heat on the acid. Graphite and graphitite, said he, differ only in their state of division, but are otherwise strictly identical. L. Jaczewsky has opposed this statement.

According to E. Weinschenk, the term *amorphous graphite* is a misnomer because it refers to varieties characterized by a compact dense structure, but which otherwise, like the larger lamellar aggregates, really consist of minute crystals. Graphite may be in so fine a state of subdivision that it is difficult to recognize its crystalline structure, "in all cases, the limit between crystalline and amorphous carbon is so sharp and distinct that a transition from one to the other is out of the question." L. Forquignon stated that the carbon of malleable cast iron is wholly combined with the iron. The metal is softened at a temp. below the m.p., and there is a segregation of graphite throughout the whole mass. This graphite furnishes graphitic acid, but it is "absolutely amorphous even when magnified $\times 400$." This test for crystallinity is inadequate; since internal structure not external form is the only test that can now be recognized when dealing with pulverulent substances.

Some diamonds are dark grey and even black. They exhibit a more or less imperfect crystalline structure, and are known as **black diamonds**, *bort*, or *boart*, or **carbonado**. Boart is an imperfectly crystallized, translucent, dark-coloured diamond which has various colours, but no clear portions, and is therefore useless as a gem; boart is used in the drilling of rocks, and in cutting and polishing other stones. Carbonado is the Brazilian term for a still less perfectly crystallized black diamond. It is as hard as boart, and has similar uses. Boart and carbonado are

usually regarded as forms intermediate between diamonds and graphite. They occur in the diamond fields, and were synthesized by H. Moissan² who, in his *Recherches sur les différentes variétés de carbone*, showed that if silver be substituted for iron, only black diamonds are produced.

Amorphous carbon is often taken to include coke, gas carbon, anthracite, soot, lampblack, animal charcoal, wood charcoal, and the forms of carbon which separate during the decomposition of many chemical compounds—*vide infra*. M. Berthelot obtained a product which he called *benzene carbon*, by heating benzene, naphthalene, etc., with a quantity of hydriodic acid insufficient for complete saturation. C. F. Cross and E. J. Bevan obtained what they called *pseudo-carbon*, by the dry distillation of cellulose, or by heating it with a dehydrating agent. It is probable that bituminous coals are hydrocarbons.

The work of J. L. Proust discussed in the first volume (1. 2, 10) led to the idea that substances containing the same elements united in the same proportions must of necessity have the same chemical properties. In the early part of the nineteenth century this conception was regarded as axiomatic; but facts began to accumulate which rendered a revision necessary. Referring to M. Faraday's discovery³ of two hydrocarbons with the same elements united in the same proportion but with very different properties, J. J. Berzelius said in 1827:

Definite knowledge concerning this phenomenon is of such significance in the theory of the composition of animal and vegetable substances, and has such an important bearing in organic chemistry, that it must not be accepted as demonstrated until its truth has been subjected to the most severe proof.

The discovery that racemic and tartaric acids; cyanic and fulminic acids; and α - and β -stannic oxides have the same percentage composition, but different properties, led J. J. Berzelius (1832) to adopt the implication; and suggest that the simple atoms of which substances are composed may unite with each other in different ways. He added:

E. Mitscherlich's remarkable discovery that substances composed of different elements, but containing these in the same atomic ratio and arranged in the same manner, crystallize in the same form or are isomorphous, as we now say, has thus received its complement; and this complement consists in the discovery that bodies exist composed of an equal number of atoms of the same elements, arranged, however, in an unlike manner, and possessing therefore different chemical properties and crystalline forms, *i.e.* that they are heteromorphous. If further investigation should confirm this view, an important step would have been taken in the advancement of our theoretical knowledge concerning the composition of substances. But since it is requisite that we should be able to express our conceptions by definite and appropriately chosen terms, I have proposed to call substances of the same composition and of different properties "isomeric," from the Greek *ισομερής* (composed of equal parts).

Related phenomena were quickly discovered, and it became necessary to define more accurately the meaning of the term isomerism. Freely translating J. J. Berzelius' further remarks (1833):

The cases where bodies like the two stannic oxides have the same absolute and relative number of the same elements, and the same mol. wt., must not be confounded with others in which the relative number of atoms is the same, but not the absolute number. Thus the relative number of carbon and hydrogen atoms in ethylene, C_2H_4 , and in the hydrocarbon oil, C_4H_8 , is identically the same (*i.e.* the number of atoms of hydrogen is twice that of carbon), but one atom of the gaseous substance contains only two atoms of carbon and four of hydrogen, $=C_2H_4$, whilst one atom of the hydrocarbon oil contains four atoms of carbon and eight atoms of hydrogen, $=C_4H_8$. For the designation of this type of similarity in composition combined with dissimilarity in properties, I would suggest the term *polymeric* (from *πολύς*, many). But there are yet other relations in which substances appear isomeric in the true sense of the word without actually being so. Such a case arises when substances consist of two compound atoms of the first order, which are related to one another in different ways and which in consequence can form dissimilar combinations, *e.g.* stannous sulphate, $SnSO_4$, and stannic oxysulphite, contain the same absolute and relative number of atoms of the same elements and have the same at. wt., but (in case the latter salt should exist) they could not be considered as one and the same

even when the mol. wt. are the same, as is probably the case with some of the different forms of sulphur, the atoms of the mol. are arranged differently. The idea is sometimes expressed in this way: Just as the bricks of the same kind in the hands of a builder be fashioned into various structures, so Nature, from the same kind of atoms, builds up mol. structures with widely different properties. Lucretius illustrated a similar idea when he stated that the same letters differently arranged may produce words with an entirely different meaning. M. Berthelot thus regarded the different forms of carbon not as substances containing different carbon atoms, but rather as complexes with different proportions of carbon atoms per mol.—polymerized states of carbon. M. Copisarow discussed the allotropy of carbon on the assumption that allotropy is a function of valency and that the different allotropic forms are produced by differences in the mode of intramolecular linking.

2. *Energy theory.*—There is a change in the internal energy of an element when one allotropic modification is transformed into another. For example, ozone is formed from ordinary oxygen by an endothermal reaction. The heat absorbed in the production of one mol. of ozone is 34.1 Cals. Hence, $3\text{O}_2 = 2\text{O}_3 - 68.2$ Cals.; or $3\text{O}_2 + 68.2$ Cals. = 2O_3 . Accordingly, ozone is supposed to have more available energy than ordinary oxygen. Similar remarks might be applied to the different forms of carbon and of phosphorus. In the case of sulphur, $\alpha\text{-S} + \text{O}_2 = \text{SO}_2 + 71.08$ Cals.; $\beta\text{-S} + \text{O}_2 = \text{SO}_2 + 71.72$ Cals. This means that the conversion of 32 parts by weight of rhombic sulphur into the monoclinic form is attended by the absorption of 0.64 Cal. There is a difference in the energy content of the two forms of sulphur as was the case with oxygen. W. von Siemens also regarded the allotropes of carbon as combinations of a hypothetical metal *carbonium* with *latente Wärme*. Hence the definition: **the allotropic modifications of an element are composed of one element associated with different proportions of available or potential energy, and consequently they exhibit different physical and chemical properties.** A definition of this kind describes the facts and no more. That is, of course, the function of a good definition. But there is a plausible finality about it not altogether pleasing. Energetics may tell us when reactions can occur, but they do not tell us if they will occur, or how they occur. Energy definitions in general are strictly non-committal and less likely to stimulate the imagination than, perhaps, the more hypothetical views. This indicates one great objection to the energy method of dealing with chemical reactions. The atomic, mol., and kinetic methods are far more likely to prompt new and fruitful investigations. However, if we accept J. C. Maxwell's view,

The potential energy of a mol. depends essentially on the relative positions of the parts of the system in which it exists, and that potential energy cannot be transformed in any way without some change in the relative position of these parts,

it follows that the energy theory of allotropy is quite in harmony with the position theory, and that the one supplements the other, for changes in the internal energy are dependent on changes in the configuration of the system.

The transition of ordinary $\alpha\text{-S}$ to $\beta\text{-S}$ is reversible. There is a definite transition temp. below or above which only one of the forms is stable, and the other form unstable. This is a case of **enantiotropic allotropy**—from the Greek *ἐναντίος* (enantios), opposite; *τρόπος* (tropos), habit. The transformation of $\lambda\text{-S}$ to $\mu\text{-S}$ is also reversible, but there is not a definite transition temp., for the amount of each form present when the system is in equilibrium is determined by the temp. The phenomenon is called **dynamic allotropy**, to distinguish it from that which precedes. In yet a third type of allotropy, the change is irreversible, one form is in a metastable condition at all temp. This is called **monotropic allotropy**, to distinguish it from the two phenomena which precede—example, diamond and graphite.

REFERENCES.

- ¹ H. Davy, *Phil. Trans.*, **99**, 73, 1809; **104**, 557, 1814; P. Debye and P. Scherrer, *Phys. Zeit.*, **18**, 291, 1917; H. F. Weber, *Programm Akad. Hohenheim*, **56**, 1, 1874; H. C. Sorby, *Edin. Phil. Journ.*, **50**, 149, 1851; O. Lüdecke, *Tonind. Ztg.*, **19**, 115, 1895; A. Breithaupt, *Berg. Hütt. Ztg.*, **18**, 348, 1859; W. Luzzi, *ib.*, **52**, 11, 1893; *Ber.*, **24**, 4085, 1891; **25**, 216, 1384, 1892; **26**, 890, 1412, 1893; A. von Inostranzeff, *Russ. Min. Journ.*, **117**, 1877; **64**, 1878; **314**, 1879; *Neues Jahrb. Min.*, **i**, 97, 1880; **i**, 92, 1886; W. Bormann, *ib.*, **i**, 116, 1880; F. von Sandberger, *ib.*, **i**, 202, 1888; A. Sauer, *Zeit. deut. geol. Ges.*, **37**, 441, 1884; G. B. Trener, *Jahrb. Geol. Reichsanst. Wien*, 405, 1906; C. F. Cross and E. J. Bevan, *Phil. Mag.*, **(5)**, **13**, 325, 1882; *Chem. News*, **44**, 185, 1881; F. Sestini, *Gazz. Chim. Ital.*, **25**, 1, 216, 1895; M. Berthelot, *Bull. Soc. Chim.*, **(2)**, **12**, 4, 1869; *Ann. Chim. Phys.*, **(4)**, **19**, 399, 1870; E. Donath, *Der Graphite*, Leipzig, 1904; H. Moissan, *Compt. Rend.*, **116**, 608, 1893; *Bull. Soc. Chim.*, **(3)**, **9**, 948, 1893; *Rev. Gen. Chim. Pure App.*, **(7)**, **8**, 157, 1905; E. Weinschenk, *Zeit. Kryst.*, **23**, 291, 1897; L. Jaczewsky, *ib.*, **38**, 197, 1903; R. F. Marchand, *Journ. prakt. Chem.*, **(1)**, **35**, 320, 1845; P. Schafhäütl, *ib.*, **(1)**, **21**, 155, 1840; P. and L. Schützenberger, *Compt. Rend.*, **111**, 774, 1890; L. Forquignon, *ib.*, **91**, 817, 1880; L. Staudenmaier, *Ber.*, **31**, 1481, 1898; **32**, 2824, 1899; *Verh. Ges. Naturfor. Leipzig*, **ii**, 186, 1899; B. C. Brodie, *Phil. Trans.*, **149**, 249, 1859; C. de Douhet, *Les Mondes*, **13**, 531, 1867.
- ² L. E. Rivot, *Ann. Mines*, **(4)**, **14**, 417, 1848; A. des Cloizeaux, *ib.*, **(5)**, **8**, 504, 1855; *Manuel de minéralogie*, Paris, **2**, 23, 1874; J. B. A. Dumas, *Compt. Rend.*, **28**, 317, 1849; A. Daubrée, *ib.*, **84**, 1128, 1277, 1877; H. Moissan, *ib.*, **116**, 276, 1893; **121**, 449, 1895; **123**, 210, 1896; *Bull. Soc. Chim.*, **(3)**, **9**, 957, 1893; A. Damour, *L'Institut*, **21**, 77, 1853; *Bull. Soc. Géol.*, **(2)**, **13**, 542, 1856; F. Tamnau, *Zeit. deut. geol. Ges.*, **6**, 250, 1854; G. Rose, *ib.*, **6**, 255, 1854; A. Kenngott, *Uebersicht der Resultate mineralogischer Forschungen*, Wien, **81**, 1859; H. R. Goepfert, *Neues Jahrb. Min.*, **199**, 1864; C. E. Kluge, *Handbuch der Edelsteinkunde*, Leipzig, **254**, 1860; E. H. von Baumhauer, *Arch. Néerl.*, **(1)**, **8**, 97, 1873; H. Jacobs and N. Chatrian, *Le Diamant*, Paris, **334**, 1884; H. W. Fourniss, *Eng. Min. Journ.*, **66**, 608, 1898; C. F. Kunz, *Ann. Rep. U.S. Geol. Surv.*, **566**, 1898; **816**, 1902; C. F. Cross and E. J. Bevan, *Phil. Mag.*, **(5)**, **13**, 325, 1882.
- ³ M. Berthelot, *Bull. Soc. Chim.*, **(2)**, **12**, 4, 1869; M. Faraday, *Phil. Mag.*, **(1)**, **66**, 180, 1825; *Phil. Trans.*, **115**, 440, 1825; J. J. Berzelius, *Jahresb.*, **11**, 44, 1832; **12**, 63, 1833; **20**, 13, 1841; **23**, 51, 1844; **24**, 32, 1845; W. von Siemens, *Pogg. Ann.*, **10**, 560, 1880; A. Kekulé, *Lehrbuch der organischen Chemie*, Erlangen, 1866; E. Frémy, *Encyclopédie chimique*, Paris, 1882; A. Ladenburg, *Handwörterbuch der Chemie*, Breslau, 1887; H. von Fehling, *Neues Handwörterbuch der Chemie*, Braunschweig, 1878; L. Meyer, *Outlines of Theoretical Chemistry*, London, 1892; W. Nernst, *Theoretical Chemistry*, London, 1900; H. E. Roscoe and C. Schorlemmer, *A Treatise on Chemistry*, London, 1894; V. von Richter, *Chemie der Kohlenstoffverbindungen*, Bonn, 1894; A. Bernthsen, *Kurzes Lehrbuch der organischen Chemie*, Braunschweig, 1887; H. E. Armstrong in H. Watts, *A Dictionary of Chemistry*, London, **3**, 79, 1892; A. Naquet, *De l'allotropie et de l'isomerie*, Paris, 1860; M. Berthelot, *De l'allotropie des corps simples*, Paris, 1894; J. Meyer, *Die Allotropie der chemischen Elemente*, Stuttgart, 1910; A. Smits, *Die Theorie der Allotropie*, Leipzig, 1921; M. Copisarow, *Journ. Amer. Chem. Soc.*, **43**, 1870, 1921; *Chem. News*, **118**, 301, 1919; J. C. Maxwell, *Encyc. Brit.*, **6**, 310, 1877.

§ 4. The Action of Heat on the Diamond and Graphite

In 1694-5, G. Averani and C. A. Targioni,¹ of the Accademia del Cimento, showed that when heated in the focus of a large burning glass, diamonds disappeared. It was concluded that the diamond evaporated, or volatilized under the influence of heat. After comparing the high refractive indices of camphor, olive oil, amber, etc., "which are fat, sulphureous, unctuous bodies," with the high refractive index of the diamond, Isaac Newton, in 1704, inferred that "a diamond is probably an unctuous substance coagulated." Later observations showed that this hazardous guess happened to be near the mark, but, as G. Delafosse has pointed out, had the same argument been applied to anatase, or to greenockite, the analogy would have broken down. It is interesting to note that Isaac Newton's guess was anticipated a century before by A. B. de Boot. R. Boyle (1672) heated diamonds in a crucible, but with no definite results. J. Kunckel said that the diamond is not altered by fire. The subject was discussed by J. F. Henckel in 1725. T. Bergman (1777) proved by means of the blowpipe that the diamond does not contain silica, and he assumed it to be a special earth, *terra nobilis*. "Urged by intense heat, the diamond contracts a kind of soot on its surface." Five years afterwards he verified the observation that the diamond is combustible. In 1766 J. d'Arcet

repeated the experiments of G. Averani and C. A. Targioni; he heated diamonds in a crucible and found that they were *complètement volatilisés*. After heating a diamond in a luted crucible in a pottery oven, he found the interior of the crucible contained a kind of *fumée noire*, without sensible loss of weight. P. J. Macquer observed that *une espèce d'auréole ou de flamme* played about the diamond during its destruction by fire. A. L. Lavoisier inquired if the apparent destruction is truly a volatilization or a combustion. He proved that the volatilization of the diamond is *en réalité un phénomène de combustion*, and that the diamond burns only in contact with air. It resists the action of the most violent heat if air be rigorously excluded. In answer to the question: *Qu'est-ce que le diamant?* A. L. Lavoisier replied:

It is still impossible to answer this question in a satisfactory manner, and perhaps it will never be possible to do so. Nevertheless, in summarizing our knowledge on this subject we can regard as proved: (i) The diamond is a combustible substance which burns at a temp. near the m.p. of silver; (ii) Like most combustible bodies it gives a surface film of a black substance resembling carbon; (iii) When the conditions are unfavourable for combustion it is converted into carbon; (iv) When heated to a very high temp. exceeding that of the porcelain oven, it is partly converted into a *vapour incoercible* and into a gas which gives a precipitate with lime-water, and which resembles very closely *le gaz dégagé des effervescences, des fermentations, et des réductions métalliques*.

A. L. Lavoisier thus demonstrated the close analogy between the diamond and carbon, but he did not prove that these two substances have the same chemical composition. In 1797, S. Tennant burnt the diamond by fusing it with nitre, and collected the carbon dioxide which was formed. He demonstrated that equal weights of carbon and diamond furnish the same quantity of carbon dioxide, and concluded that the diamond is composed exclusively of carbon. G. S. Mackenzie, and W. Allen and W. H. Pepys concluded that different varieties of charcoal and graphite furnish the same amount of carbon dioxide as the diamond; and added that "the diamond differs from charcoal solely in the firmness of its aggregation which is generally known to be an obstacle to every chemical change." L. B. Guyton de Morveau (1799) came to the same conclusion from an experiment in which the diamond was heated with iron whereby the latter was converted into steel, just as occurs when iron is similarly treated with carbon. The general conclusion, as summarized by R. J. Haty, is that *le diamant a passé dans la classe des substances inflammables, comme étant uniquement composé de charbon*.

In 1808, J. B. Biot and F. J. Arago ascribed the high refractive index of the diamond to the presence of at least 25 per cent. of hydrogen. L. B. Guyton de Morveau also regarded the diamond as pure carbonaceous matter containing possibly some water of crystallization, but the experiments of H. Davy on the combustion of the diamond showed that no substance other than carbon dioxide is produced by the combustion of the diamond in oxygen; there is no evidence of the formation of moisture, and the assumption that the diamond contains hydrogen or water must be abandoned. J. B. A. Dumas and J. S. Stas have shown that the diamond cannot contain more than $\frac{1}{120}$ th per cent. of hydrogen. H. Davy suggested that possibly the diamond contains oxygen, and A. Caire-Morant also said in 1826 that *on n'est pas bien assuré encore s'il est pur ou combiné avec l'oxygène*. The various determinations of the at. wt. of carbon (*q.v.*) on the form of the diamond show that this assumption is also untenable.

In 1890, A. Krause raised the question whether the diamond is chemically the same as carbon since all the preceding work may be interpreted that twin elements—like cobalt and nickel—are in question. Diamond splinters were burnt in a current of oxygen, the products of combustion absorbed by ammonia, and the ammoniacal soln. decomposed with pure sodium hydroxide. A comparison of the crystals obtained on evaporation with those of pure sodium carbonate, showed that they had the same percentage of water of crystallization, and that they were identical in crystalline form, optical properties, m.p., electrical conductivity, and solubility

in water. He concluded that the diamond must be chemically identical with carbon, since not only is the at. wt. the same, but on oxidation they both yield exactly the same product.

According to J. B. A. Dumas and J. S. Stas,² only the clear and colourless diamonds leave no ash when burnt; with other samples they obtained 0.05 to 0.20 per cent. of straw-yellow to reddish-yellow ash; O. L. Erdmann and R. F. Marchand obtained 0.08 to 0.15 per cent. of reddish ash from the clearest diamonds; and L. E. Rivot, 0.24 to 2.03 per cent. of yellowish ash. A. Petzholdt found the ash contained microcrystalline plates. Some of the crystals, said C. Friedel, are active towards polarized light. A. Petzholdt said that the ash contains silica and iron oxide; L. E. Rivot, ferruginous clay; and H. Moissan, iron oxide as the principal constituent of the ash, along with silica and lime. According to G. Halphen, a diamond possessing a brownish tinge became rose-red when heated, and the colour vanished after heating 8-10 days. W. Flight and N. S. Maskelyne found that a dirty-yellow diamond was decolorized by heating it in hydrogen or chlorine gas; and a diamond which lost its rose-red colour on exposure to light, acquired the original tint when heated. C. Friedel found a green Brazilian diamond acquired a brown colour when heated to about 230° in the absence of air. H. Moissan also noted the colour of some diamonds becomes less marked after they have been heated in hydrogen.

A. F. de Fourcroy, L. B. Guyton de Morveau, P. J. Macquer, etc., have mentioned the blackening of the diamond when heated. B. Silliman noted that when the diamond is heated in the flame of the oxy-hydrogen blowpipe, and partially burnt, the edges appear rounded as if there has been superficial fusion, but it was not established whether fusion really did occur. W. Allen and W. H. Pepys, J. Murray, and C. M. Marx made a similar observation and noted that a blackening occurs. A. Morren found that when diamonds are heated in the coal-gas flame, they acquire a surface film of graphitic carbon. G. Rose noted that when some diamonds are heated, they shatter with a loud noise; but neither he nor E. H. von Baumhauer ever observed the slightest sign of blackening when the diamond is burnt in air. G. Rose attributed the blackening to the formation of graphite. E. D. Clarke's results with the oxy-hydrogen blowpipe were rather indefinite. V. A. Jacquelin, however, stated that no fusion occurs in the oxy-hydrogen or oxy-carbon monoxide flame. According to M. de K. Thompson and co-workers, diamonds darken at 1000°, due to numerous cracks causing absorption of light from total reflection. These cracks are probably produced by small black spots, which mark the beginnings of the change to graphite. At 1650°, diamonds change slowly to a substance which gives B. C. Brodie's reaction for graphite. By increasing the temp. to 1750°, the rate of transformation is increased 26 times.

G. Friedel and G. Ribaud studied the effect of heat on the diamond. When observed between nicol prisms, crystals from all sources show black lines which appear to be due to deformations of a substance originally isotropic. The uneven cooling of the original magma in which the crystals were formed, and external mechanical action, are not sufficient to account for the magnitude of the double refraction observed; and it is considered necessary to assume that a polymorphic transformation, accompanied by a change of volume, has taken place at a temp. when the plasticity was sufficient to allow the crystal to retain permanent deformations. The conversion of diamonds into graphite takes place near this point. Above 1500°, the surface of a diamond began to blacken, but only a thin skin was affected. This skin is translucent, and consists of diamond containing a small proportion of graphite; it is hard and brilliant; it is not affected by chemical reagents which oxidize graphite; but in a Bunsen burner it is burnt away leaving colourless diamond. A few minutes' heating at 1800° causes a more rapid production of graphite along the edges of the crystal. Up to between 1850° and 1865° the bands, between nicol prisms, show no alteration when re-observed after cooling; but towards 1875° or 1880°, they show some deformation in places indicating a certain plasticity at this temp. When 1885° ± 5° is exceeded the crystal breaks into

fragments, bounded by octahedral planes of cleavage, and the bands due to double refraction undergo a complete change. It is possible to observe this only if the temp. is exceeded for a few seconds, otherwise the whole of the diamond is very rapidly converted into graphite. G. Friedel and G. Ribaud suggest that above this temp. a new form of crystal is produced, which is converted into graphite more rapidly than ordinary diamond.

H. Moissan found that if heated to 2000° in a crucible packed with powdered carbon, the diamond becomes covered with a black film which is not graphite. In the electric arc, at a somewhat high temp., the diamond becomes incandescent, swells up without melting, and becomes covered with black masses, consisting entirely of hexagonal lamellæ of graphite, which is easily converted into graphitic oxide. If the diamond is placed in a small carbon crucible in the electric arc furnace, the crystals first break up into small fragments along the planes of cleavage, and then at a higher temp. swell up and are completely converted into graphite, which yields yellow graphitic oxide. It follows that at the temp. of even a moderately intense electric arc, the stable form of carbon is graphite. L. von Schrötter observed that when a diamond resting on a platinum plate is heated to a high temp., some carbide is formed. By heating the diamond in the electric arc between carbon poles, the mineral softens and changes into a mass resembling coke; and C. Despretz likewise found the diamond is converted into graphite and melts to small spheres; but H. Moissan said that the diamond swells and is graphitized without melting. J. P. Gassiot also made some inconclusive experiments on this subject. W. Crookes found that during the bombardment of diamonds in the cathode rays, not only is there a brilliant phosphorescence, but the diamond becomes discoloured and in time becomes black on the surface. Some blacken in a few minutes, others require an hour or more. C. Doelter found that diamonds were browned or blackened superficially in some cases at 1300°, in others at 1500°, and in still other cases at 2000° and 2500° in an inert atm. H. Vogel and G. Tammann observed the superficial blackening at 1500°–1700°. The black film is removed by polishing powder; it is not ordinary amorphous carbon, but probably graphite. C. A. Parsons and A. A. C. Swinton found that when heated in the focus of a cathode-ray discharge, at a temp. of 1890°, the diamond is converted into black carbon.

C. Mène has analyzed a number of samples of graphite, and his results are shown in Table II. Other analyses have been made by W. Luzi, E. Weinschenk, H. V. Regnault, etc.

TABLE II.—ANALYSES OF GRAPHITE.

	Analyses of graphite.			Analyses of ash.				
	C	Volatiles.	Ash.	SiO ₂	Al ₂ O ₃	FeO	MgO + CaO	Alkalies and loss.
Alibert, Urals . . .	94.03	0.72	5.25	64.2	24.7	10.0	0.8	0.3
Cumberland . . .	91.55	1.10	7.35	52.5	28.3	12.0	6.0	1.2
Mugrau, Bohemia . . .	91.05	4.10	4.85	61.8	28.5	8.0	0.7	1.0
Schwarzbach, do. . .	88.05	1.05	10.90	62.0	28.5	6.3	1.5	1.7
Cumberland . . .	84.38	2.62	13.00	62.0	25.0	10.0	2.6	0.4
Passau . . .	81.08	7.30	11.62	53.7	35.6	6.8	1.7	2.2
Fagerita, Sweden . . .	87.65	1.55	10.80	58.6	31.5	7.2	0.5	2.2
Ceara, Brazil . . .	77.15	2.55	20.30	79.0	11.7	7.8	1.5	—
Madagascar . . .	70.69	5.18	24.13	59.6	31.8	6.8	1.2	0.6
Ceylon . . .	68.30	5.20	26.50	50.3	41.5	8.2	—	—
Buckingham, Canada. . .	78.48	1.82	19.70	65.0	25.1	6.2	0.5	1.2
Pissie, Hautes-Alpes . . .	59.67	3.20	37.13	68.7	20.8	8.1	1.5	0.9

L. Elsner thought that graphite is volatilized in the porcelain oven because the containing vessel is blackened above the graphite, but H. V. Regnault showed that

the blackening is probably due to the volatilization of a hydrocarbon in the graphite. M. Berthelot attributed the sublimation of some graphite from a mixture of boriferous graphite heated white hot in a stream of chlorine, to the formation of a volatile compound of the three elements. C. F. Rammelsberg thought that a loss which he observed on heating some purified graphite might be due to volatilization. R. Hare, and B. Silliman passed an electric current through a graphite or a charcoal rod, and observed that the surface became covered with fused carbon, which has the character of graphite; but L. Vanuxen claimed that the fused globules are nothing but the fused ash of charcoal or graphite and consist mainly of iron oxide and silica. R. Hare defended his statement that the carbon was actually fused, but L. Vanuxen's claim was probably right. According to F. Braun, if the discharge from a Leyden jar be passed through carbon between two glass plates, the carbon gives a continuous spectrum, and microscopic spheres of fused carbon can be detected. There has been some discussion as to whether or not the carbon is really fused.

H. Davy, and N. T. de Saussure observed that amorphous carbon is one of the most difficult substances to melt or vaporize. When heated to a high temp. it becomes hard enough to scratch glass. C. Despretz, and A. Bettendorff found that when heated intensely in vacuo by an electric current, amorphous carbon is converted into graphite. A. Schuller heated a carbon rod in vacuo and noted that a grey film appears on the glass walls; this is attributed to organic matter as an impurity in the carbon because the film does not get any thicker with subsequent heating. He could detect no evidence of fusion, but there were signs of the volatilization of the carbon. M. Berthelot noted the volatilization of carbon from the filaments of an electric incandescent lamp run with the smallest possible heating of the graphite filament. The temp. is probably 1200° – 1500° . The sublimate is solely amorphous carbon. The formation of a sublimate in incandescent lamps under these conditions indicates that carbon exerts an appreciable vap. press. at temp. about 2000° below its b.p. 3600° . This unusually large interval is regarded as further evidence of the highly complex character of the mols. of solid carbon. R. Hare, and B. Silliman thought that they had established the volatilization of heated carbon:

When two mahogany-charcoal electrodes connected with an electric machine are brought into contact, they become incandescent, and if the points are separated a short distance, they glow vividly, forming a bright luminous arc, and send up a white smoke having a peculiar odour. The negative pole decreases in width, and a quantity of additional matter is deposited on the point; this grows a length of about half an inch and is then replaced by a new growth. On the contrary, the charcoal of the positive pole soon loses its point, and a cup-like cavity is formed in it, whilst at the same time it suffers but little diminution on the sides. To whichever part of the positive charcoal the point of the negative piece is directed, there the excavation is produced. If the two pieces of charcoal come in contact, they stick together. If the positive charcoal be replaced by a piece of metal, the negative piece receives no increase, but is gradually shortened during the combustion. In nitrogen gas, the two pieces of charcoal exhibit as brilliant a light, and the same growth of the negative point, as in air. Hence it appears that carbon, in the state of vap., is transferred from the positive to the negative pole. If the eyes are protected by a pair of green spectacles, small particles of carbon may even be seen passing along the luminous arc from the copper pole to the zinc pole. The matter which accumulates on the negative point sometimes forms a cylinder, sometimes a round knob with a stem. When examined by a magnifying-glass, it exhibits a fused, warty or botryoidal, smooth, metallic-shining, greyish-black surface, and a non-fibrous structure; sinks rapidly in oil of vitriol; does not conduct electricity (hence its presence makes the charcoal less brightly incandescent—but on the removal of the fused portion, the brightness is restored); burns very slowly at a red heat, without visible flame, producing carbonic acid, and leaving, sometimes a yellowish-grey ash, sometimes none at all. It is not attacked by sulphuric acid, and very little by hot nitric acid. No sign of fusion ever appears on the positive charcoal.

Similar results were obtained by J. Griscom, and even with an ordinary battery by W. West. C. A. Parsons, and R. Threlfall have discussed the effect of high temp. and high press. on carbon—*vide infra*, synthesis of diamonds. According to H. Moissan. when a carbon tube of about 1 cm. diameter is heated in an electric

arc furnace, a light black cloud forms in the interior, in consequence of the condensation of carbon vap. If a dish containing crystallized silicon is placed in the tube, the silicon melts and then boils, and its vap., coming into contact with the vap. of the carbon, forms slender needles of carbon silicide. No evidence of the fusion of carbon was obtained, although the temp. was sufficiently high rapidly to volatilize calcium and magnesium oxides. In all cases, the carbon subjected to these high temp. is converted into graphite. The black deposit formed on the internal surface of incandescent lamps consists of amorphous graphite mixed with crystals of carbon silicide and some other crystals that seem to be silica. The carbon vap., whether condensed in a carbon tube, or on the exterior of a copper tube kept cool by internal circulation of water, or on the electrodes themselves, condenses always in the form of graphite, and the deposits show no traces of fusion. When the filament of an incandescent lamp breaks, the fractured ends show no traces of fusion, but are covered with small crystals of graphite. It follows that carbon, like arsenic, volatilizes under ordinary press. without previously fusing. It is probable, however, that under a sufficiently high press. fusion would take place.

The effect of press. on a solid which evaporates under atm. press. without melting is illustrated by placing solid acetylene in a test-tube closed by the finger. It will liquefy under its own press., and on opening the tube, the liquid at once solidifies. The experiment can be repeated many times with a small quantity of liquid.

REFERENCES.

¹ R. Boyle, *An Essay about the origin and virtues of gems*, London, 1672; Isaac Newton, *Opticks: or a Treatise of the Reflexions, Refractions, Inflexions, and Colours of Light*, London, 1704; G. Delafosse, *Nouveau cours de mineralogie*, Paris, 1862; G. Averani and C. A. Targioni, *Giornale Letterati d'Italia*, 8. 221, 1711; J. d'Arcet, *Mémoire sur le diamant et quelques autres pierres précieuses traitées au feu*, Paris, 1771; *Mémoire sur l'action d'un feu égal, violent et continué plusieurs jours sur un grand nombre des terres, de pierres et de chaux métalliques essayées pour la plupart telles qu'elles sortent du sein de la terre*, Paris, 1766; Paris, 1771; *Hist. Acad. Paris*, 75, 164, 1766; 119, 1770; J. F. Henckel, *Pyritologia oder Kiess-Historie*, Leipzig, 1725; A. B. de Boot, *Gemmarum et lapidum historia*, Jena, 1609; T. Bergman, *De terra gemmarum*, Upsala, 1777; *De tubo ferruminatoria*, Vienna, 1779; *Sciagraphia regni mineralis*, Lipsiæ, 1782; H. M. Rouelle, *Rozier's Obs. Phys.*, 3. 17, 1773; J. d'Arcet and H. M. Rouelle, *ib.*, 1. 17, 480, 1772; P. J. Macquer, L. C. Cadet, and A. L. Lavoisier, *ib.*, 2. 108, 1772; J. Kunckel, *Laboratorium chymicum*, Berlin, 1745; A. L. Lavoisier, *Mém. Acad.*, 564, 591, 1772; P. J. Macquer, *ib.*, 298, 1767; *Dictionnaire de chymie*, Paris, 1. 504, 1879; S. Tennant, *Phil. Trans.*, 87. 123, 1797; W. Allen and W. H. Pepys, *ib.*, 97. 267, 1807; H. Davy, *ib.*, 99. 69, 1809; 104. 557, 1814; L. B. Guyton de Morveau, *Ann. Chim. Phys.*, (1), 31. 72, 328, 1799; (1), 32. 62, 1799; (1), 84. 20, 233, 1812; G. S. Mackenzie, *Nicholson's Journ.*, 4. 103, 1801; R. J. Haiiy, *Traité des caractères physiques des pierres précieuses*, Paris, 1817; A. Caire-Morant, *La Science des pierres précieuses appliquée aux arts*, Paris, 1826; J. B. Biot and F. J. Arago, *Mém. Instit.*, 7. 301, 1806; J. B. A. Dumas and J. S. Stas, *Compt. Rend.*, 11. 991, 1840; *Ann. Chim. Phys.*, (3), 1. 1, 1841; A. Krause, *Ber.*, 23. 2409, 1890.

² J. B. A. Dumas and J. S. Stas, *Ann. Chim. Phys.*, (3), 1. 1, 1841; *Compt. Rend.*, 11. 991, 1840; L. E. Rivot, *ib.*, 23. 317, 1849; H. Moissan, *Ann. Chim. Phys.*, (7), 9. 133, 1896; *Compt. Rend.*, 116. 458, 1429, 1893; 117. 423, 1893; 119. 776, 1894; G. Halphen, *ib.*, 62. 1036, 1866; A. Morren, *ib.*, 70. 990, 1870; *Chem. News*, 21. 225, 1870; *Bull. Soc. Chim.*, (2), 14. 192, 1870; C. Friedel, *ib.*, (2), 41. 100, 1884; M. Berthelot, *ib.*, (2), 12. 4, 1869; *Ann. Chim. Phys.*, (8), 2. 185, 1904; *Compt. Rend.*, 137. 589, 1903; O. L. Erdmann and R. F. Marchand, *Journ. prakt. Chem.*, (1), 23. 159, 1841; A. Petzholdt, *Beiträge zur Naturgeschichte der Diamanten*, Dresden, 11, 1842; *Journ. prakt. Chem.*, (1), 23. 475, 1841; L. Elsner, *ib.*, (1), 99. 257, 1866; J. N. Fuchs, *ib.*, (1), 7. 353, 1836; J. Fritzsche, *Berg. Hüt. Ztg.*, 13. 323, 1854; A. Bettendorff, *Arch. Pharm.*, (2), 144. 79, 1870; W. Flight and N. S. Maskelyne, *Ber.*, 6. 1413, 1873; A. Schuller, *Wied. Ann.*, 18. 317, 1883; *Naturwiss. Ber. Ungarn*, 1. 64, 1884; W. Luzzi, *Zeit. Naturwiss.*, 64. 255, 1891; *Ber.*, 24. 4091, 1891; C. F. Rammelsberg, *ib.*, 6. 187, 1873; L. B. Guyton de Morveau, *Ann. Chim. Phys.*, (1), 31. 72, 1799; (1), 84. 30, 233, 1812; A. F. de Fourcroy, *ib.*, (1), 32. 208, 1800; G. Rose, *Sitzber. Akad. Berlin*, 516, 1872; *Pogg. Ann.*, 148. 497, 1873; E. D. Clarke, *Ann. Phil.*, 9. 89, 163, 193, 326, 1817; 10. 373, 1817; M. de K. Thompson, P. K. Frölich, and J. L. Gibson, *Trans. Amer. Electrochem. Soc.*, 43. 115, 1923; W. Allen and W. H. Pepys, *Phil. Trans.*, 97. 267, 1807; H. V. Regnault, *Ann. Chim. Phys.*, (2), 1. 202, 1838; (4), 7. 450, 1866; V. A. Jacquelin, *ib.*, (3), 20. 459, 1847; *Compt. Rend.*, 24. 1050, 1847; C. Mène, *ib.*, 64. 1091, 1867; C. Despretz, *ib.*, 37. 369, 433, 1853; J. B. A. Dumas, *ib.*, 74. 128, 137, 1872; *Ann. Chim. Phys.*, (4), 25. 94, 1872; N. T. de Saussure, *ib.*, (1), 71. 254, 1809; J. Murray, *Ann. Phil.*, 22. 463, 1823; J. Griscom, *ib.*,

22. 73, 1823; W. West, *ib.*, 21. 314, 1823; F. Braun, *Ann. Phys.*, (4), 17. 359, 1905; E. H. von Baumhauer, *Wied. Ann.*, 1. 476, 1877; L. von Schrötter, *Sitzber. Akad. Wien*, 63. 462, 1871; C. Doelter, *ib.*, 120. 61, 1911; B. Silliman, *Amer. Journ. Science*, (1), 5. 361, 1822; (1), 6. 341, 1823; (1), 10. 119, 1826; R. Hare, *Phil. Mag.*, 65. 65, 1825; *Amer. Journ. Science*, (1), 10. 110, 1826; L. Vanuxem, *ib.*, (1), 10. 102, 1826; H. Vogel and G. Tammann, *Zeit. phys. Chem.*, 69. 600, 1910; J. P. Gassiot, *Chem. Gaz.*, 8. 338, 1850; *B.A. Rep.*, 53, 1850; W. Crookes, *Chem. News*, 74. 39, 1896; *Phil. Trans.*, 168. 658, 1879; F. Davy, *ib.*, 99. 73, 1809; 104. 557, 1814; C. A. Parsons and A. A. C. Swinton, *Proc. Roy. Soc.*, 80. A, 184, 1908; C. A. Parsons, *ib.*, 57. 253, 1888; 79. A, 532, 1907; *Chem. News*, 57. 253, 1888; R. Threlfall, *Journ. Chem. Soc.*, 93. 1333, 1908; E. Weinschenk, *Zeit. Kryst.*, 28. 300, 1897; C. M. Marx, *Schweigger's Journ.*, 47. 324, 1826; C. J. Woodward, *Chem. News*, 25. 127, 1872; *Amer. Chemist*, 2. 454, 1872; E. Prime, *ib.*, 3. 64, 1872; P. J. Macquer, *Dictionnaire de chymie*, Paris, 1. 504, 1789; G. Friedel and G. Ribaud, *Compt. Rend.*, 178, 1126, 1924.

§ 5. The Synthesis and Genesis of Diamonds .

La reproduction du diamant est un problème pour les chimistes modernes le pendant de la pierre philosophale pour les alchimistes.—H. LE CHATELIER (1908).

Many attempts have been made to synthesize diamonds, *i.e.* to enhance the commercial value of carbon by transforming it from its ordinary opaque black condition to limpid crystals of diamond. In 1828, C. Cagniard de la Tour¹ reported that he had succeeded in making artificial diamonds, but L. J. Thénard showed that the product was charcoal mixed intimately with a hard crystalline slag containing alumina, ferric oxide, silica, and manganese oxide. In 1828, J. N. Gannal announced that by keeping a soln. of phosphorus in carbon disulphide under a layer of water for three months, he readily obtained crystals of carbon, some of which attained the size of *un grain de millet*. Both G. Gore, and H. Moissan failed to confirm this report. The latter obtained nothing but small grains of silica, completely soluble in hydrofluoric acid, even after five years; nor were any better results obtained with antimony in place of phosphorus. H. Moissan said that if purified carbon disulphide be used, no deposit appears during five years, but if moisture be present, small glistening drops of water appear on the glass as soon as the temp. is lowered, and these may have been mistaken for crystals.

C. Despretz caused an electric arc to play between a carbon electrode and a bunch of platinum wires, and obtained a crystalline dust which scratched rubies. H. Moissan said that the crystals may have been carbon silicide or boride, but the action of the electric arc on carbon has never yielded crystallized carbon other than graphite. M. Berthelot examined C. Despretz's electrodes and found graphite but no diamonds. J. Mactear claimed to have synthesized diamonds by an undescribed process, the crystals were examined by W. Crookes, and shown by N. S. Maskelyne to be a crystalline silicate. The synthesis of diamonds has been discussed by E. B. de Chancourtois, D. Rossi, A. Favre, E. J. Maumené, etc. A. Ludwig experimented in an atm. of hydrogen at 1500 to 3000 atm. press. Carbon rods, with their ends in contact with each other, were heated by an electric current; after a few seconds, the current-strength sank to nothing, soon increasing again to its former value. This went on for some minutes. The author assumes that the carbon points fuse to the transparent modification of carbon, which, like other transparent substances, is a non-conductor of electricity. Owing to the interruption of the current, the temp. falls and the transparent carbon changes into graphite, whereupon the process is repeated. In order to obtain the transparent fused carbon in the solid form, it appears necessary to cool it so quickly that the transformation into graphite cannot take place. Attempts to obtain rapid cooling by means of hydrogen gas and by dropping the fused carbon into water were unsuccessful owing to the difficulty of obtaining a sufficiently rapid flow of gas in the first case and to the occurrence of Leidenfrost's phenomenon in the second. In 1828, B. Silliman claimed to have demonstrated the fusion and volatilization of carbon by an electric current; O. Lummer, M. la Rosa, and F. Braun claimed to have obtained evidence of the

fusion of sugar carbon in the electric arc. O. P. Watts and C. E. Mendenhall found that with a rising temp., deformation takes place with graphite rods between 1800° and 2150°, and it is concluded that the deformation is due to a gradually increasing plasticity of the carbon and not to the commencement of fusion. The alleged changes of structure are attributed to volatilization and subsequent condensation. S. Münch, and E. Ryschkewitsch agree that graphite becomes plastic before melting, and with a sufficiently high amperage the latter said that small graphite rods can be welded. J. G. Pammer found that the bending of carbon rods at high temp. is due to the presence of impurities. F. Sauerwald believed that E. Ryschkewitsch's fused globules of graphite were really beads of impurities distilled from the hot to the cooler parts of the graphite. A. Thiel and A. Ritter concluded that the presence of apparently solidified drops of graphite in the crater of the carbon electrode allowed to cool after forming the arc, is not a result of the fusion of the graphite.

According to A. König, graphite is the stable modification of carbon at temp. exceeding 1000°, and it is uncertain whether at lower temp. there is a transformation point for graphite or diamond, or whether the diamond is unstable at all temp. The sp. vol. of the diamond is smaller than that of graphite, so that the transition point will be raised by an increased press.—approximately 1° per 35.07 atm.—but the formation of the diamond at low temp. and high press. is very improbable because of the slowness of the reaction. The diamond can be produced at a high temp. only by accelerating the formation of the labile form before the stable form. The possible modes of formation are by crystallization from a molten flux; by condensation of the vap.; and by separation from soln. R. Threlfall, however, suggested that under suitable conditions, the formation of the diamond is not so much a transformation of carbon from one form to another, but is rather the result of a decomposition of a carbide in the presence of substances which accelerate the crystallization. The temp. must be sufficiently low to ensure that the velocity of the transformation from diamond to graphite is small. E. de Boismenu claimed to have made diamonds up to 2 mm. in diameter by the electrolysis of molten calcium carbide. The diamonds formed about the anode. A kilogram of calcium carbide is said to have furnished 1.75 carats of true diamonds. The claim yet remains unconfirmed.

Molten solids, on cooling, generally crystallize. Carbon, however, at atm. press. volatilizes at about 3600°, without passing through the intermediate liquid state. Its b.p. appears to be below its m.p. Carbon dioxide, acetylene, silicon tetrafluoride,

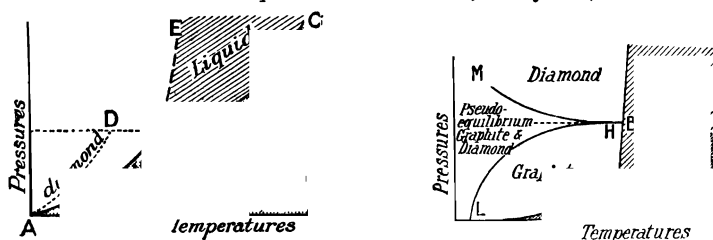

FIGS. 2, 3.—Equilibrium Conditions of Carbon at Different Temperatures and Pressures.

and arsenic also volatilize without liquefaction at atm. press., but arsenic is easily liquefied if it be heated under press. It is therefore inferred that if sufficient press. could be applied, carbon would melt to a liquid and crystallize on cooling. C. A. Parsons attempted to melt carbon at press. up to 15,000 atm., and obtained soft graphite. As indicated above, the diamond at ordinary temp. is supposed to be the unstable form of carbon, and graphite the stable form. If one form can pass into the other at ordinary temp., the speed of the transformation must be exceedingly slow. The views of H. W. B. Roozeboom, and A. Smits on the equilibrium diagram of the allotropic forms of carbon are summarized in Fig. 2, and of G. Tammann in Fig. 3. It is estimated that if the press. were great enough, graphite would

melt at about 3000° , and the liquid would have a vap. press. curve represented diagrammatically by BC , Fig. 2; and the vap. press. of solid graphite would be represented by AB . The vap. press. of the diamond would be represented by the curve AD . The m.p. of the diamond under great press. is represented by the point D ; and B represents the m.p. of graphite. The curve BE shows how the m.p. of graphite changes with press. If molten graphite be under-cooled, the soln. would become more and more viscous with a falling temp., and finally appear as amorphous carbon. G. Tammann modified the hypothetical diagram as indicated in Fig. 3. He postulates a region MBL , where the diamond is in a state of pseudo-equilibrium. The curve MB represents the temp. and press. where graphite changes into the diamond, and LB the conditions for the reverse change. When carbon is in soln., in iron, silver, or molten silicates, he assumes that the diamond and graphite are in equilibrium. Hence, diamonds may be produced with fast cooling, while with slow cooling graphite alone separates. The question whether the diamond and graphite can form solid soln. is an open one. Other observations have been made by O. Lummer, K. Fajans, E. Grüneisen, H. Kohn, J. A. M. van Liempt, J. J. van Laar, etc.

J. B. Hannay started from the fact that when the hydrocarbons are heated to a high temp. in the presence of the alkali metals, a hard, lustrous form of carbon is produced. He did not observe any signs of the formation of the diamond by working at high temp. and press. with the hydrocarbons—*e.g.* distilled paraffin—and lithium. He then heated bone oil in a sealed iron tube, and claimed that in some cases black or transparent crystals having the properties of the diamond were found in the carbonaceous mixture of iron and lithium at the bottom of the tube. He added :

From the fact that the diamond was obtained only in the presence of nitrogenous matter, and that the product contained a little nitrogen, I am led to conclude that the diamond is produced in this reaction by the decomposition of some nitrogenous compound, and not by that of a hydrocarbon.

J. B. Hannay constantly mentioned the presence of silica; and H. Moissan added that if the diamond was really obtained, it was formed under press. owing to the solubility of carbon in a fairly fusible alloy of iron and lithium, and not from the nitrogenous compounds contained in the bone oil. H. Moissan did not succeed when following J. B. Hannay's directions. C. Combes took a view different from that of H. Moissan. The special feature of H. Moissan's experiment is the crystallization of the carbon from its soln. in molten iron under the great press. generated by the contraction of the cooled and solidified outer shell.

The maximum hydrostatic pressure in the interior of a sphere of liquid metal surrounded by a shell of solid metal. According to R. Threlfall, neglecting the rigidity and modulus of incompressibility of the metal, it follows from L. J. G. Vieille's formula that if P denotes the hydrostatic press. per unit area; τ , the tensile stress of the metal; r_1 the radius of the liquid portion; and r_2 the radius of the sphere; then the relation between the maximum hydrostatic press. which can be produced before the metal ruptures is given by $P = \{2\tau(r_2^3 - r_1^3)\} / (r_2^3 - 2r_1^3)$. When τ is known, the press. corresponding with different values of r_1 and r_2 can be computed. If the breaking strength of iron under a tensile stress be 10 tons per sq. in., the hydrostatic press. might rise to 20 tons per sq. in., although R. Threlfall considers 8 or 9 tons per sq. in. would be nearer the mark.

According to G. Rousseau, crystals of the diamond, accompanied by graphite, are formed at ordinary press. when acetylene, generated from calcium carbide, is decomposed at 3000° by an electric current. C. A. Parsons heated a carbon rod electrically while immersed in liquids—benzene, paraffin, treacle, and carbon tetrachloride and disulphide—at press. up to 2200 atm., and found deposits of an amorphous carbon were obtained in all cases. Similar results were obtained at 4400 atm. press. The distillation of carbon in an atm. of carbon monoxide or dioxide also gave amorphous carbon. O. Ruff observed that no increase in size occurs when diamonds were heated at 790° for 14 days in acetylene, coal gas, methane, or carbon monoxide.

On the other hand, a carbon arc in liquid air gives a minute residue of crystals fluorescing like diamonds. A carbon arc through which a spray of water passes continuously gives a minute residue, the fluorescence of which is very faint. Organic vap. mixed with carbon monoxide yield amorphous carbon and graphite, and mixtures of molten organic solids with catalytic agents give entirely negative results. W. von Bolton, however, claimed to have recrystallized diamond dust by heating it in mercury vapour derived from sodium amalgam.

In 1880, R. S. Marsden, heated up to the m.p. of steel, silver, or an alloy of silver and platinum in a crucible lined with sugar charcoal, when the silver dissolved a small quantity of carbon, and gave it up again on cooling. When the metal was removed by nitric acid, the residue consisted of amorphous carbon, graphite, and some small black or transparent crystals with properties like the diamond. H. Moissan said that he obtained more or less well crystallized black diamonds by this process, especially when the crucible is heated in a wind furnace with retort carbon. K. Christchhoff also obtained diamonds from a soln. of carbon in molten silver. He added that molten silver can dissolve about 6 per cent. of carbon. C. V. Burton



FIG. 4.—Moissan's Electric Arc Furnace.

claims to have obtained diamonds from a soln. of carbon in molten lead alloyed with about one per cent. of calcium. Iron also dissolves carbon and gives it up again on cooling. The solubility increases with the temp. H. Moissan packed a piece of iron, as pure as practicable, in a carbon crucible with sugar charcoal. The crucible was heated between the poles of an electric arc furnace (700 amps., 120 volts)—Fig. 4. Under these conditions the iron melted and dissolved much carbon. When the temp. had reached approximately 4000° , and the iron was volatilizing in clouds, H. Moissan plunged the crucible in cold water, Fig. 5. The sudden cooling solidified the outer layer of iron. The expansion which the inner liquid core underwent on solidifying must have produced an enormous press. Hence, the carbon separated from the iron under a very great press. After dissolving away the iron, etc., some of the carbon which remained was in the form of boart—black diamonds—some as graphite, and some in the form of transparent diamonds—microscopic it is true. H. Moissan separated as many as 10 to 15 minute transparent diamonds from a single ingot treated in this way. The largest was about $\frac{3}{4}$ mm. long. He later found that the addition of a little ferrous sulphide, or silicon or iron silicide

favoured the formation of the diamonds. The method is thus described by H. Moissan:

Swedish iron (150 grms.) was cut in fragments, and melted in the electric furnace in the presence of sugar carbon. The saturation of the iron by the carbon at the temp. of the electric furnace is finished in two or three minutes with a current of 400 amperes at 120 volts. The crucible containing the fused metal is removed from the furnace, and we add a solid piece of iron monosulphide (about 5 grms.) which melts at once and mixes with the mass. The metal swells up and abundant gases are given off. After cooling, the metallic mass is treated by acids. The graphite is transformed into graphitic oxide, then into pyrographitic oxide, and the latter is destroyed by a mixture of boiling sulphuric acid into which are thrown about 50 grms. of nitrate of potash in small portions. After several alternate treatments of this residue by hydrofluoric and sulphuric acids, then by fusion with potassium hydrofluoride, it is washed, dried, and placed in methylene iodide having a density



Fig. 5.—Cooling the Solution of Carbon in Iron.

of 3.4. The part which falls to the bottom is collected. By the above process no diamonds were obtained, but the result is quite different if the crucible containing the liquid iron with the added iron sulphide is cooled suddenly in a mass of cold water. After the first phenomena of calefaction, the porous graphite crucible is rapidly penetrated by the water. The metallic mass is cooled on the exterior and a solid crust is formed. As we showed before, an internal press. is thus formed and the carbon which deposits in the inner liquid part takes the form of the diamond. The appearance of the metallic masses to which sulphur has been added is sometimes different from ordinary cast iron cooled in water. An external resistant portion is still formed, but the surface of the metal, in the case of sudden cooling, is covered with a black, spongy, and solid layer, which comes from the rapid solidification of the metal while in an emulsion form, the latter being due to the sudden disengagement of gas. If the gases have had the time to come out before the immersion in water, the metal has the ordinary appearance.

H. Moissan did not get such good results by cooling in a current of coal gas as in water. Modifications were suggested by W. Borchers, C. Friedel, W. Staedel, C. Combes, etc. O. Ruff used alloys of iron with titanium, vanadium, tungsten, and molybdenum. C. Friedel obtained black crystals which scratched glass by heating carboniferous iron with sulphur in a sealed tube at 400°–500°; and M. Berthelot obtained similar crystals by dissolving in iron phosphide. F. Fischer said that the separation of carbon in the form of the diamond can occur only below

700°, otherwise it appears as graphite. In H. Moissan's experiments, the iron containing the carbon in soln. had already solidified so that the carbon could separate only in the form of tiny crystals. Larger diamonds would probably be produced if a substance in which carbon is readily soluble were still molten at 700°.

C. A. Parsons heated a carbon crucible containing iron in an electric furnace, and quickly transferred it to a compression machine, where it was subjected, while still molten and during cooling, to a press. of 11,200 atm. Less crystals were obtained than if the crucible had been cooled in water, although the press. of 11,200 atm. must have been greatly in excess of that of the spheroidal mass of iron in H. Moissan's experiment. He inferred that press. *per se* is not a necessary condition for the production of the diamond in the cooling soln. of carbon in iron. On the other hand, W. Crookes detected diamonds in the carbonaceous residue obtained when cordite is exploded in closed steel cylinders where the press. is estimated to be as high as 8000 atm. and the temp. over 4000°; and Q. Majorana heated amorphous carbon in an apparatus arranged to produce a press. of 5000 atm. by the explosion of gunpowder, and obtained some diamonds. C. A. Parsons concluded that the diamonds in H. Moissan's experiment are formed at about 690°, and that they are derived from the occluded gases of which carbon monoxide is the most important. When the melted mass is slowly cooled no diamonds are produced because the occluded gases escape, but with almost instantaneous cooling, the gases are retained, and diamonds are formed. He believed that high pressures, except in so far as they are developed during the cooling of the melt, and within it, are not essential to success. It is further suggested that carbides like carborundum are first formed, and that the actual reaction is between the carbide, iron, sulphur, and carbon monoxide.

According to A. Rossel, and C. Friedel, small diamonds were found in hard steels which had been produced at high temp., and cooled under great press. L. Franck also claimed to have isolated diamonds from hardened steel. B. Neumann obtained no diamonds from slowly cooled iron, but graphite, carborundum, and corundum crystals were present. According to A. Ludwig, diamond crystals are formed when an electric current is passed through an iron spiral embedded in powdered gas carbon and surrounded by an atm. of hydrogen under great press. The same transformation occurs in the absence of iron, but a much higher temp. is required. H. Hoyer-mann observed the production of diamond by reducing a mixture of iron oxide with sugar charcoal by means of aluminium. A mixture of iron oxide, sugar charcoal, lithia, and aluminium gave very good results. The crystals are separated from the iron as in H. Moissan's process. No diamonds were obtained with alloys of titanium and iron, calcium, barium, and manganese; but diamonds were obtained from silver-titanium alloys. M. Houdard obtained diamonds and graphite by fusing manganese sulphide with carbon.

J. Morris claimed to have made diamonds by the following process:

Pure alumina was dissolved in pure hydrochloric acid, and a mixture of lampblack and charcoal was added to the soln. The mass was evaporated, and the alumina was precipitated in the pores of the carbon. The mixture contained by weight rather more carbon than alumina. After further treatment to expel all the hydrochloric acid, the mixture was subjected to the action of carbon dioxide gas at a red heat.

The claim has not been established. F. Göbel stated that some diamonds are present in the carbon formed when carbon dioxide is decomposed at a high temp. by many metals—sodium, calcium, magnesium, aluminium, iron, and silicon—and R. T. Simmler ascribed the action to the dissolution of carbon by the metal at a high temp. and press., and its subsequent separation as diamond. C. Doelter has discussed the reaction.

C. A. Parsons obtained diamonds by heating carbon rods embedded in a mixture of quartz and calcium oxide under high press. H. Fleissner, and B. Neumann found diamonds embedded in some blast-furnace slags. O. Johannsen found some alleged diamonds in blast-furnace slags to be alumina crystals. J. Friedlander

dissolved graphite in olivine, $(Mg,Fe)_2SiO_4$, fused in the oxy-hydrogen flame, or in the electric furnace. R. von Hasslinger also obtained diamonds from soln. of amorphous carbon in artificial magnesium silicate magma; and in conjunction with J. Wolf, the most favourable composition of the magmas was studied.

Many guesses have been made in the attempt to explain how diamonds have been formed in nature. In one set of hypotheses, the diamond is considered to be of organic origin and formed at temp. relatively low; in another set of hypotheses, the mineral is supposed to have been formed at relatively a high temp., and possibly also a high press. Thus, D. Brewster² supposed that the diamond is a vegetable secretion like gum. Modifications of this hypothesis were suggested by H. R. Göppert, J. Murray, R. Jameson, A. Petzholdt, F. Wöhler, J. D. Dana, etc. G. Wilson, and J. A. R. Smit also assumed that diamonds are of organic origin. R. T. Simmler supposed that diamonds are obtained by the crystallization of carbon from liquid carbon dioxide, because inclusions of this liquid are found in the crystals; but C. Doelter could find no evidence of the alleged solubility of the diamond in that menstruum. From analogous reasons, C. Friedel inferred that the temp. could not have been above the critical temp. of carbon dioxide. E. Lionnet supposed diamonds have been formed by the slow decomposition of carbon disulphide; A. E. B. deChancourtois, and D. Rossi, by the incomplete oxidation of hydrocarbons in the same way that sulphur is derived from hydrogen sulphide. J. von Liebig assumed that the diamond is formed as the end-term of a successive series of reactions in which the hydrocarbons are de-hydrogenized and polymerized. M. Berthelot has said:

The action of an elevated temp. on benzene is to form a successive series of hydrocarbons richer and richer in carbon, less and less volatile, and with a higher and higher mol. wt. Carbon is not comparable to a real elementary substance, but it can be better likened to a very condensed hydrocarbon, poor in hydrogen, and possessing a very high eq. Carbon itself represents a limiting state which can be attained only with difficulty and at the highest temp. As known to us, *le carbone est le terme extrême des condensations moléculaires*, that is, of a state as far removed as possible from that of the element carbon, brought into the state of *un gaz parfait* comparable with hydrogen. This explains why carbon is never liberated in a natural state in low temp. reactions, and in this respect it differs from hydrogen and most of the chemical elements.

A. B. Griffiths suggested that carbon possibly dissolves in water at a high temp. and press., and separates in crystals with a fall of temp. and press. F. Göbel supposed that the diamonds have been formed by the action of metals like calcium, aluminium, magnesium, iron, etc., on calcium carbonate. M. Parrot believed that the diamond is of volcanic origin, and is produced by the fusion of carbon at a high temp. followed by a sudden cooling of the liquid; C. C. von Leonhard assumed that sublimation, not fusion, occurred; and J. F. L. Hausmann suggested that a flux has promoted the action. A. Favre inferred that because many of the minerals which accompany the diamond can be formed artificially from chlorides at a high temp., the diamond has been formed by the decomposition of carbon tetrachloride.

The discussion on the synthesis of diamonds—*vide supra*—by the crystallization of carbon from its soln. in fused silicate magmas, and the character of the material which accompanies diamonds, makes it very probable that the diamond has been formed in nature by an analogous process. In the South African mines, for example, the diamonds occur in or near volcanic pipes embedded in a decomposed rock which E. Cohen³ described as peridotitic tuffa or breccia. H. C. Lewis ascribed the origin of the diamonds to the solvent action of the molten peridotitic magma upon the carbonaceous shales as suggested by E. J. Dunn. In some cases, however, these shales are absent. In support of this hypothesis, W. Luzi showed that at about 1770°, molten blue earth is a solvent of diamonds, and the carbon in soln. in the molten magma might just as well have come from below upwards as have been formed by the attack on carbonaceous matter near the surface. T. G. Bonney, C. F. Williams, D. Draper and W. H. Goodchild, E. Cohen, A. L. du Toit, and G. S. Costorphine have discussed the hypothesis that eclogite is the matrix from which the Cape

diamonds have separated. G. F. Kunz and H. S. Washington, and H. D. Miser found diamonds in Arkansas associated with peridotitic rock. H. S. Harger said that the Vaal River diamonds are derived from andesitic lava; and H. Merensky, from pegmatite and diabase. M. Chaper found diamonds in the pegmatite of Bellary, Madras; O. A. Derby, and J. C. Branner in the hydromicaceous schists and itacolomite (quartzite) of Brazil; E. Poitevin and R. P. D. Graham, in the chromite of Coleraine, Canada; T. W. E. David, in the hornblende diabase of Inverell, New South Wales; and J. A. Thompson, and L. A. Cotton, in the dolerite of Copeton, New South Wales. Hence it is concluded that **diamonds are formed by the crystallization of carbon from its solution in fused magmas of different kinds.** Many others⁴ have written on the genesis of natural diamonds.

REFERENCES.

- ¹ A. Favre, *Arch. Sciences Genève*, (1), 31, 136, 1856; *Bull. Soc. Géol.*, (2), 13, 307, 1856; J. Mactear, *Chem. News*, 40, 306, 1879; N. S. Maskelyne, *ib.*, 41, 4, 1880; W. Crookes, *ib.*, 41, 13, 1880; J. N. Gannal, *Observations sur l'action du phosphore mis en contact avec le carbone de soufre pur*, Paris, 1828; *Schweigger's Journ.*, 53, 468, 1828; *Monit. Scient.*, (3), 8, 1137, 1878; *Journ. Chim. Méd.*, 4, 582, 1828; L. J. Thénard, *ib.*, 5, 38, 1829; J. C. Poggendorff, *Pogg. Ann.*, 15, 311, 1829; G. Gore, *Chem. News*, 4, 160, 1862; 50, 126, 1884; C. Cagniard de la Tour, *Compt. Rend.*, 25, 81, 1847; M. Houdard, *ib.*, 143, 1230, 1906; H. Fleissner, *Oester. Zeit. Berg. Hütt.*, 58, 521, 539, 570, 1910; C. Despretz, *Bibl. Univ. Genève*, 24, 281, 1853; *Compt. Rend.*, 28, 755, 1849; 29, 48, 545, 709, 1849; 30, 367, 1850; 37, 369, 443, 1853; E. Lionnet, *ib.*, 63, 213, 1866; G. Rousseau, *ib.*, 117, 164, 1893; M. Berthelot, *ib.*, 116, 226, 1893; A. Rossel, *ib.*, 123, 113, 1896; E. J. Maumené, *ib.*, 59, 1089, 1864; D. Rossi, *ib.*, 63, 408, 1866; E. B. de Chancourtois, *ib.*, 63, 22, 1866; *Journ. Pharm. Chim.*, (4), 4, 189, 1866; B. Silliman, *Amer. Journ. Science*, (1), 6, 341, 1823; R. T. Simmler, *Pogg. Ann.*, 105, 466, 1858; M. Berthelot, *Ann. Chim. Phys.*, (4), 19, 392, 1870; J. P. J. d'Arcet, *ib.*, (1), 88, 207, 1813; H. Moissan, *ib.*, (7), 8, 466, 1896; (8), 5, 174, 1905; *Le four électrique*, Paris, 1897; London, 1904; *Compt. Rend.*, 116, 218, 320, 1893; 123, 206, 1896; 140, 185, 1905; M. Thoma, *Berg. Hütt. Ztg.*, 4, 687, 1845; A. König, *Zeit. Elektrochem.*, 12, 441, 1906; W. Borchers, *ib.*, 3, 393, 1897; W. von Bolton, *ib.*, 17, 971, 1911; P. Neumann, *ib.*, 15, 817, 1909; R. Threlfall, *Journ. Chem. Soc.*, 93, 1333, 1908; C. Doelter, *Edelsteinkunde*, Leipzig, 82, 1893; E. de BoisMENU, *Fabrication synthétique du diamant*, Paris, 1912; *French Pat. No. 4566*, 1907; J. Smithson, *Ann. Phil.*, 1, 271, 1821; H. W. B. Roozeboom, *Die heterogenen Gleichgewichte*, Braunschweig, 1, 180, 1901; A. Smits, *Ber.*, 38, 4027, 1905; R. Schenck and W. Heller, *ib.*, 38, 2139, 1905; S. Münch, *Zeit. Elektrochem.*, 27, 367, 1921; E. Ryschkewitsch, *ib.*, 27, 57, 445, 1921; 28, 185, 1922; F. Sauerwald, *ib.*, 28, 185, 1922; K. Fajans, *Ber.*, 53, 655, 1920; 55, 2826, 1922; *Zeit. Physik*, 1, 101, 1920; E. Grüneisen, *Verh. deut. Phys. Ges.*, 14, 324, 1912; *Ann. Physik*, (4), 55, 377, 1918; H. Kohn, *Zeit. Physik*, 1, 143, 1920; F. Fischer, *Brennstoff Chem.*, 2, 9, 1921; A. Thiel and F. Ritter, *Zeit. anorg. Chem.*, 132, 125, 153, 1923; C. V. Burton, *Nature*, 72, 397, 1905; *Proc. Roy. Soc.*, 76, A, 458, 1905; W. Crookes, *ib.*, 76, A, 458, 1905; J. B. Hannay, *ib.*, 30, 188, 450, 1880; *Chem. News*, 41, 106, 1880; N. S. Maskelyne, *ib.*, 41, 97, 1880; J. Morris, *ib.*, 66, 71, 309, 1892; F. Göbel, *Schweigger's Journ.*, 61, 435, 1831; *Kastner's Arch.*, 5, 131, 1832; *Pogg. Ann.*, 20, 539, 1830; C. Combes, *Monit. Scient.*, (4), 17, 785, 1903; (4), 19, 492, 1905; C. Friedel, *ib.*, (4), 15, 236, 1901; *Compt. Rend.*, 116, 224, 1893; 123, 113, 1896; O. Lummer, *Verfüssigung der Kohle und Herstellung der Sonnen Temperatur*, Braunschweig, 1914; R. S. Marsden, *Proc. Roy. Soc., Edin.*, 11, 20, 37, 1881; K. Chrutshoff, *Zeit. anorg. Chem.*, 4, 472, 1893; O. Ruff, *ib.*, 99, 73, 1917; L. J. G. Violle, *Cours de physique*, Paris, 1, 399, 1883; L. Franck, *Stahl Eisen*, 17, 1063, 1897; O. Johannsen, *ib.*, 29, 348, 1909; A. Ludwig, *Zeit. Elektrochem.*, 8, 273, 1902; *Chem. Ztg.*, 25, 979, 1901; 26, 677, 1902; H. Hoyer-mann, *ib.*, 26, 481, 1902; C. A. Parsons, *Scient. Amer. Suppl.*, 86, 125, 1918; *Journ. Inst. Metals*, 20, 5, 1918; *Phil. Mag.*, (5), 36, 304, 1893; *Proc. Roy. Soc.*, 79, A, 532, 1907; *Phil. Trans.*, 220, A, 67, 1919; *Engg.*, 105, 485, 1918; B. Neumann, *Stahl Eisen*, 29, 906, 1909; *Zeit. Elektrochem.*, 15, 817, 1909; J. Friedlander, *Naturwiss. Rund.*, 13, 279, 1898; R. von Hasslinger, *Monatsh.*, 23, 817, 1902; R. von Hasslinger and J. Wolf, *ib.*, 24, 633, 1903; Q. Majorana, *Atti Accad. Lincei*, (5), 6, 141, 1897; O. P. Watts and C. E. Mendenhall, *Ann. Physik*, (4), 35, 783, 1911; F. Braun, *ib.*, (4), 17, 359, 1905; M. la Rosa, *ib.*, (4), 30, 369, 1909; (4), 34, 95, 1911; (4), 36, 841, 1911; *Gazz. Chim. Ital.*, 47, ii, 19, 1917; *Trans. Faraday Soc.*, 5, 288, 1910; *Compt. Rend.*, 148, 475, 616, 1909; W. Staedel, *Apoth. Ztg.*, 23, 854, 865, 1908; G. Tammann, *Zeit. phys. Chem.*, 69, 569, 1909; *Kristallisieren und Schmelzen*, Leipzig, 114, 1903; *Zeit. anorg. Chem.*, 115, 145, 1921; J. A. M. van Liempt, *ib.*, 115, 218, 1921; J. J. van Laar, *Rec. Trav. Chim. Pays-Bas*, 39, 215, 647, 1920; W. Herapath, *Quart. Journ. Science*, 16, 162, 1823; *Tilloch's Phil. Mag.*, 61, 423, 1823; J. G. Pammer, *Monatsh.*, 41, 467, 1920. I am indebted to Messrs. Masson et Cie. for permission to reproduce Figs. 4 and 5.

² R. Jameson, *Mem. Werner Soc. Edin.*, 4, 556, 1822; D. Brewster, *Trans. Roy. Soc. Edin.*, 10, 1, 1823; 23, 39, 1864; *Journ. Geol. Soc.*, 3, 466, 1833; *Phil. Mag.*, (3), 7, 245, 1835; B. A.

Rep., 41, 1853; J. D. Dana, *A System of Mineralogy*, London, 23, 1868; C. C. von Leonhard, *Populäre Vorlesungen über Geologie*, Heidelberg, 3, 498, 1836; Baltimore, 1839; *Neues Jahrb. Min.*, 200, 1835; 398, 1856; A. Knop, *ib.*, ii, 97, 1890; *Ber. Vers. Oberrh. Geol. Ver.*, 11, 1889; J. von Liebig, *Die organische Chemie in ihrer Anwendung auf Agricultur und Physiologie*, Braunschweig, 285, 1840; H. R. Göppert, *Verh. Geol. Reichsanst. Wien*, 19, 252, 1869; *Neues Jahrb. Min.*, 198, 1864; *Abhand. Schles. Ges. Breslau*, 61, 1869; *Pogg. Ann.*, 92, 623, 1854; R. T. Simmler, *ib.*, 105, 406, 1858; F. Göbel, *ib.*, 20, 539, 1830; G. Wilson, *Proc. Roy. Soc. Edin.*, 2, 301, 1850; *Edin. Phil. Journ.*, 48, 337, 1850; F. Wöhler, *Liebig's Ann.*, 41, 346, 1842; A. Petzholdt, *Journ. prakt. Chem.*, (1), 23, 475, 1841; *Beiträge zur Naturgeschichte der Diamanten*, Dresden, 1842; M. Parrot, *Mém. Acad. St. Petersburg*, (6), 3, 21, 1835; J. A. R. Smit, *Arch. Neerl.*, 15, 61, 1880; A. Favre, *Arch. Sciences Genève*, (1), 31, 136, 1856; *Bull. Soc. Géol.*, (2), 13, 307, 1856; E. Lionnet, *Compt. Rend.*, 63, 123, 1866; D. Rossi, *ib.*, 63, 498, 1866; A. E. B. de Chancourtois, *ib.*, 63, 22, 1866; *Journ. Pharm. Chim.*, (4), 4, 189, 1866; C. Friedel, *Bull. Soc. Chim.*, (2), 41, 100, 1850; A. B. Griffiths, *Chem. News*, 46, 105, 1882; C. Doelber, *Edelsteinkunde*, Leipzig, 1893; A. König, *Zeit. Elektrochem.*, 12, 441, 1906; J. Murray, *A Memoir on the Diamond*, London, 1851; *Phil. Mag.*, (2), 58, 386, 1821; J. F. L. Haussmann, *Gött. Nachr.*, 109, 1858; A. Daubrée, *Compt. Rend.*, 106, 1681, 1881; 110, 18, 1890; 111, 766, 1890; *Bull. Soc. Géol.*, (3), 19, 313, 1891; M. Berthelot, *Ann. Chim. Phys.*, (4), 19, 342, 1870; *Compt. Rend.* 116, 226, 1893; 140, 905, 1905.

³ E. Cohen, *Jahresb. Ver. Erdkunde*, 5, 129, 1882; *Neues Jahrb. Min.*, 857, 1872; 864, 1879; H. C. Lewis, *Papers and Notes on the Genesis and Matrix of the Diamond*, London, 1897; *B.A. Rep.*, 667, 1886; 720, 1887; E. J. Dunn, *Journ. Geol. Soc.*, 37, 609, 1881; W. Luzi, *Ber.*, 25, 2470, 1892; T. G. Bonney, *Proc. Roy. Soc.*, 65, 223, 1899; *Amer. Journ. Science*, (4), 5, 76, 1898; G. S. Costorphine, *Trans. Geol. Soc. South Africa*, 10, 65, 1907; H. S. Harger, *ib.*, 12, 139, 1910; A. L. du Toit, *Ann. Rep. Geol. Commission, Cape of Good Hope*, 11, 135, 1907; C. F. Williams, *Trans. Amer. Inst. Min. Eng.*, 35, 440, 1905; *The Diamond Mines of South Africa*, New York, 1905; D. Draper and W. H. Goodchild, *Min. Journ.*, 113, 357, 1916; H. Merensky, *Zeit. prakt. Geol.*, 16, 155, 1908; G. F. Kunz and H. S. Washington, *Amer. Journ. Science*, (4), 24, 275, 1907; J. C. Branner, *ib.*, (4), 31, 480, 1911; O. A. Derby, *ib.*, (3), 24, 34, 1882; *Journ. Geol.*, 6, 121, 1898; H. D. Miser, *Bull. U.S. Geol. Sur.*, 540, 1914; M. Chaper, *Compt. Rend.*, 98, 113, 1884; *Bull. Soc. Géol.*, (3), 14, 330, 1886; T. W. E. David, *B.A. Rep.*, 562, 1906; *Chem. News*, 96, 146, 1907; J. A. Thompson, *Geol. Mag.*, 492, 1909; L. A. Cotton, *Proc. Linn. Soc. New South Wales*, 38, 803, 1914; É. Poitevin and R. P. D. Graham, *Museum Bull. Canada Dept. Mines*, 27, 13, 1918.

⁴ W. Crookes, *Diamonds*, New York, 1900; E. Boutan, *Le Diamant*, Paris, 1886; A. König, *Zeit. Elektrochem.*, 12, 441, 1906; J. A. Thomson, *Econ. Geol.*, 5, 64, 1910; R. Beck, *Zeit. deut. geol. Ges.*, 59, 275, 1907; C. Heusser and G. Glaraz, *ib.*, 11, 448, 1859; P. A. Wagner, *Die diamantführenden Gesteine Südafrikas*, Berlin, 1909; London, 1914; H. W. Turner, *Amer. Geol.*, 23, 182, 1899; O. A. Derby, *Journ. Geol.*, 19, 627, 1911; 20, 451, 1912; E. Kaiser, *Zeit. Kryst.*, 51, 399, 1912; F. H. Hatch, *Nature*, 77, 224, 1908; W. B. Clarke, *Chem. News*, 24, 16, 40, 64, 78, 1871; J. C. Johnson, *Trans. Inst. Min. Met.*, 17, 277, 1908; F. W. Voit, *Eng. Min. Journ.*, 87, 789, 1909; *Zeit. prakt. Geol.*, 13, 382, 1906; 14, 382, 1907; 16, 18, 1908; *Trans. Geol. Soc. South Africa*, 10, 69, 75, 101, 1907; E. J. Maumené, *Compt. Rend.*, 59, 1089, 1864; J. Werth, *ib.*, 116, 323, 1893; H. Gorceix, *ib.*, 98, 1010, 1446, 1884; A. Daubrée, *ib.*, 106, 1681, 1888; L. de Launay, *ib.*, 145, 1188, 1907; R. von Hasslinger, *Monatsh.*, 23, 817, 1902; C. A. Parsons, *Phil. Mag.*, (6), 36, 304, 1893; H. C. Lewis, *Proc. Amer. Acad.*, 22, 81, 1886; *Geol. Mag.*, (3), 4, 367, 1897; J. Friedländer, *Naturwiss. Rund.*, 13, 279, 1898; H. Moissan, *Ann. Chim. Phys.*, (7), 8, 466, 1896; *Compt. Rend.*, 116, 460, 1893; B. Foote, *Rec. Geol. Sur. India*, 22, 39, 1889; A. W. Stelzner, *Sitzber. Ges. Isis Dresden*, 85, 1893; *Die Erlagerstätten*, Leipzig, 1, 72, 1904; F. P. Mennel, *Geol. Mag.*, (5), 3, 459, 1907; E. H. L. Schwarz, *Causal Geology*, London, 192, 1910; F. Fouqué and A. M. Lévy, *Synthèse des minéraux et des roches*, Paris, 197, 1882; *Compt. Rend.*, 89, 1125, 1879; C. Heintz, *Handbuch der Mineralogie*, Leipzig, 1, 1, 1904; F. W. Clarke, *The Data of Geochemistry*, Washington, 317, 1920.

§ 6. The Genesis of Graphite

Allein dennoch bleibt noch Natur unsere Lehrmeisterin.—F. A. QUENSTEDT (1877).

G. Rose¹ showed that a diamond bedded in charcoal at the temp. of molten cast iron, becomes coated with a film of graphite; while V. A. Jacquelin, and M. la Rosa found that the diamond passes into graphite when heated in the electric arc; and, added H. L. Fizeau and L. Foucault, F. Fouqué and A. M. Levy, and H. Moissan, at a high enough temp. all the different modifications of carbon pass into graphite. The graphitization of the diamonds and of carbon has been discussed by W. Skey, C. Street, W. Crookes, A. Bettendorff, J. Rudolphs and J. Hörden, etc. N. G. Sefström noted the formation of graphite scales in carbon crucibles which had been

heated for some time. J. N. Pring and W. Fielding showed that at 2000° boron accelerates the conversion of carbon to graphite. H. Moissan examined the sublimed carbon which collects on the positive electrode of the electric arc, and the distilled carbon obtained by heating a carbon tube about 2 cms. in diameter in a powerful arc furnace. The interior of the tube soon filled with a very light deposit produced by the condensation of carbon vap. Carbon vapour condensed on a cold or on a hot surface furnishes, in all cases, graphite. Hence, *when carbon vapour returns to the solid state it always appears as graphite*. W. Luzi obtained well-defined hexagonal plates of graphite by heating carbon in a silicate magma (finely-ground alkali glass, and fluorspar).

Graphite is formed when carbon is dissolved in a metal at a high temp., and the metal is allowed to cool. Much of the carbon separates in the form of graphite as the soln. cools. Thus, carbon which separates from soln. in cast iron, appears as tabular crystals possessing a metallic lustre; or from iron, iron silicate slags, or iron alloys which have been melted in contact with carbon. This subject has been discussed by G. Charpy, B. Osann, R. von Wagner, P. Schafhäutl, C. C. von Leonhard, etc.

Graphite is obtained by dissolving carbon in a molten metal, the carbon separating as graphite when another element is added. Thus, H. Moissan found the displacement of graphite from cast iron is favoured by silicon, and boron. He further showed that

(i) At ordinary press., the graphite is purer the higher the temp. of formation; (ii) The higher the temp. of formation, the more the graphite resists the action of nitric acid and potassium chlorate; (iii) Under the influence of press., the crystals and mass of graphite have the appearance of a fused substance; (iv) The small quantity of hydrogen, always found in graphites, diminishes as their purity increases; and (v) Compounds containing hydrogen and oxygen are formed by the action of acids on cast iron; these compounds are not decomposed at a dull red heat, but, like graphite, are destroyed on combustion.

J. W. Döbereiner obtained the crystals of graphite by heating a mixture of iron filings, manganese oxide, and soot; and M. Houdard, by melting manganese sulphide with carbon. H. St. C. Deville passed carbon tetrachloride over molten cast iron; the gas decomposed, the iron dissolved the separated carbon, and, on cooling, furnished hexagonal plates of graphite. He obtained only amorphous carbon when using sodium, zinc, and aluminium in place of iron. H. Moissan found that aluminium does take up carbon at a high temp. and gives graphite crystals on cooling. M. Berthelot obtained only amorphous carbon from molten manganese, but if the temp. be high enough, crystals of graphite are formed. Silver, even at its b.p., dissolves but little carbon, although ingots of silver slowly cooled in the electric furnace are covered with a film of graphite. He found that a number of molten metals were able to dissolve carbon, and give it up again as graphite when the metals cooled—for instance, zirconium, vanadium, molybdenum, tungsten, uranium, chromium, nickel, silicon, titanium, platinum, iridium, and palladium. The graphite crystals can be isolated by dissolving out the metal with aqua regia, or other suitable acid. K. Iokibe found that the optical properties of the graphite and the so-called *temper carbon* from cast iron are the same, so that the latter is really very finely divided graphite.

Graphite is formed by the decomposition of carbides at a high temp. In 1896, E. G. Acheson showed that amorphous carbon can be converted into graphite by heating it to a high temp. In the presence of metallic or other oxides, etc.—*e.g.* silica, clay, alumina, ferric oxide, manganese oxide—capable of forming carbides, the yield is enormously increased. Much less metal oxide is needed than would be required to convert the carbon to graphite, and it is assumed that the carbide acts catalytically. The metal oxide first forms a carbide which is then decomposed into graphite and metal, the latter reacts with the amorphous carbon re-forming a carbide, and so the cycle continues. W. Borchers confirmed these results in 1897; he said:

All substances which are capable of entering into a chemical combination with carbon, more or less easily dissociable, are also in a condition to further the crystallization of carbon.

I name especially boron, silicon, titanium, zirconium, vanadium, aluminium, cerite metals, chromium, molybdenum, tungsten, uranium, manganese, iron, nickel, etc.; it appears to me, however, that it is not thoroughly determined that combination of carbon, in the form of gases and vap., with hydrogen, oxygen, sulphur, etc., can also bring about crystallization.

Observations on this subject were made by F. A. J. Fitzgerald, K. Iokibe, H. Ditz, O. Mühlhäuser, E. Pietrusky, T. F. Bailey, etc. A. Frank obtained graphite by heating the carbides of the alkaline earth metals, etc., in a stream of carbon dioxide or monoxide, the halogens, or hydrogen halides, nitrogen, phosphorus, arsenic, hydrogen sulphide, ammonia, arsine, phosphine, organic halides, sulphides, or nitrides. A. Remelé and B. Rassow found small quantities of graphite remaining after the decomposition of calcium cyanamide by water, and it appeared to have been formed in the reaction between calcium carbide and nitrogen.

E. L. Grüner obtained graphite in the reduction of ferruginous minerals by carbon monoxide, and M. Jungck, likewise, nickel ores. M. Berthelot showed that graphite may be formed when carbon separates from its combinations with the halogens, sulphur, boron, and possibly oxygen. According to R. Schenck and W. Heller, E. Baur, and A. Smits, the carbon derived from carbon dioxide is finely divided graphite. M. Berthelot also obtained a mixture of graphite and amorphous carbon by the action of phosphorus on sodium carbonate; or by passing ethyl iodide or carbon disulphide through a red-hot tube. G. Dragendorff also studied the liberation of carbon by the action of phosphorus on sodium carbonate; and G. Gore, by the action of phosphorus, arsenic, or antimony on potassium cyanide. H. R. Ellis found that in the action of powdered magnesium on the carbonates of ammonium, calcium, magnesium, strontium, barium, and cadmium, or on carbon dioxide, some graphite always accompanies the carbon which is formed. E. Lionnet decomposed carbon disulphide by a couple—the so-called J. Smithson's pile—formed by wrapping a sheet of tin-foil about one of gold-leaf, and obtained a deposit of crystalline carbon (graphite).

G. Rousseau obtained graphite and diamonds by passing acetylene through the electric arc. F. J. Bergmann made graphite by heating acetylene with hydrogen dioxide to 150° under 5 atm. press., $C_2H_2 + H_2O_2 \rightarrow 2C + 2H_2O$. Acetylene decomposes at about 780°: $C_2H_2 \rightarrow 2C + H_2$, and the carbon is in the graphitic state; and H. Erdmann and P. Köthner showed that in the presence of finely divided copper, the decomposition temp. is reduced to 400°–500°. H. Erdmann noted the formation of graphite crystals in the process of making amido-derivatives of naphthalene when the hydroxyl-derivatives and ammonia are heated in an iron autoclave at 250°–300°. According to P. and L. Schützenberger, when pure and dry cyanogen is passed through a porcelain tube at a cherry-red heat, it is only partially decomposed, and even at a bright-red heat the decomposition is very limited, the interior of the tube being covered with a thin, brilliant, blackish-grey coating, with a sub-metallic lustre resembling that of polished graphite. If, however, there is placed in the hot part of the tube some gas carbon with powdered cryolite sprinkled over the surface, the cyanogen decomposes completely into carbon and nitrogen, even at a cherry-red heat. The carbon separates in a bulky mass of very slender filaments, and, after a time, chokes up the tube. Those portions in contact with the walls of the tube are more compact and somewhat elastic. The carbon is friable, and leaves on paper a mark resembling that made by graphite, but not so bright. When a piece of aluminium was placed along with the gas-carbon, the carbon separated round it in non-elastic filaments, which could be compressed between the fingers into a mass resembling graphite. The filamentous carbon obtained by the decomposition of cyanogen is not identical with any of the established forms of graphite or carbon, and may be taken as a new modification. R. von Wagner also stated that the black azulmic acid obtained by the slow decomposition of hydrocyanic acid contains some graphite. H. N. Warren said that if induction sparks are passed between platinum electrodes in coal gas, graphite is formed. A. Roedel described the extraction of graphite from gas-carbon. P. Pauli found that in the evaporation of the waste-

liquors in the preparation of soda, the cyanogen compounds are converted into ammonia and graphite. The reactions were discussed by J. Stingl, and W. Thalheim. The preparation of graphite was described by E. Ryschkewitsch, and K. P. Gregarovitch; and V. Kohlschütter and A. Nägeli studied the deposition of graphitic carbon, $2\text{CO}=\text{C}+\text{CO}_2$, in cobalt, nickel, iron, and silver. K. A. Hofmann and C. Röchling found a hard, lustrous, crystalline form of carbon was deposited when the flame of some of the aliphatic hydrocarbons comes in contact with chemically inert surfaces at a temp. exceeding 650° . A steel surface, probably owing to the intermediate formation of metallic carbides, gives only a deposit of graphitic carbon, whilst flames of burning benzene and naphthalene gave only amorphous, sooty carbon, or, at higher temp., graphitic carbon. The vitreous form of carbon has a sp. gr. at $4^\circ=2.07$, is very pure (C= 99.06 per cent., H= 0.48 per cent.), and has a low electrical conductivity ($\frac{1}{15}$ th to $\frac{1}{15}$ th of that of Singalese graphite, and $\frac{1}{3}$ rd to $\frac{1}{4}$ th of that of Acheson graphite). It is also very hard—that prepared at 900° having a hardness equal to that of quartz, that at 1100° having a hardness equal to that of topaz, whilst that prepared at 1300° is harder than carborundum. It is considered to be a form intermediate between graphite and diamond, and its X-ray spectrum shows characteristic lines of both these forms.

The problems connected with our views as to the genesis of graphite in nature have not been solved except with reference to particular districts. Its occurrence in meteorites shows that it is not necessarily of organic origin. The various methods of synthesizing graphite—*vide supra*—show that it could be formed by contact metamorphism. T. S. Hunt² assumed:

The graphite of bedded rocks has been formed by the alteration of coal and similar matters, at temp. below redness; while its subsequent translation into the veins, and its deposition in a crystalline form, together with various other minerals, has been effected under conditions which, although imperfectly understood, probably included aq. soln. at a temp. not far below redness.

J. S. Newberry showed that the trap dykes of the Sonora coalfield (South Mexico) have everywhere metamorphosed the coal into anthracite, and in extreme cases into graphite. L. Jaczewsky supposes the Siberian mineral to have been formed by the transformation of coaly matter in eruptive magmas. M. Diersche supposed graphite is formed by the infiltration of liquid hydrocarbons and their decomposition by the hot lava. It is doubtful if the formation of graphite by the action of the vap. of carbon disulphide, carbon tetrachloride, etc., on heated iron has any geological importance, though possibly the conditions might occasionally be favourable when volcanic emanations contain these gases. E. Weinschenk assumed that metallic carbonyls might yield graphite by their decomposition, but there is no evidence that nature produces these gases. H. I. Jensen postulates thiocarbonyls, $\text{Fe}(\text{CS})_4$, analogous to the carbonyls, and assumes that they decompose $\text{Fe}(\text{CS})_4=\text{FeS}_4+4\text{C}$, or $\text{Fe}(\text{CS})_4=\text{FeS}_2+\text{CS}_2+3\text{C}$. Like E. Weinschenk, A. Osann ascribed the graphite in the Canadian limestones to their penetration by gases and vap. from neighbouring eruptive magma. F. Cirkel said there can be little doubt that the carbon of these limestones was originally present, and was probably of organic origin; the same process of metamorphism which converted the limestone into marble, converted the carbon into graphite. J. Walther believed that the Cingalese graphite was formed by the decomposition of carbonaceous gases rising from great depths.

The mechanical separation of graphite from the ore is effected by a system involving crushing, screening, washing and levigation, grinding, and grading. The flow-sheets of the process differ according to the nature of the ore and other local conditions. The reduction of the ash of the washed graphite can be effected by chemical treatment. Numerous methods have been proposed, but the cost of many is too great for the processes to be of industrial value. E. Donath³ said that treatment with hydrochloric acid, sodium hydroxide, and finally hot water will reduce the percentage ash from 30 or 40 per cent. to 2 or 3 per cent. J. Stingl fused the graphite with sodium carbonate, and treated the washed product with aqua

regia, and hydrofluoric acid. Gebr. Bessel mixed the graphite with one to ten per cent. of animal or vegetable fat, ethereal oils, resinous matter, petroleum, paraffin, benzene, fusel oil, or ozokerite. The mixture was heated with water until boiling began. The graphite rises to the surface of the liquid, and can be skimmed off; the gangue remains at the bottom. They have also devised some modifications of the process. E. B. Kirby, H. Putz, J. D. Darling, M. F. R. Glogner, C. Winkler, and F. Gottschalk, also modified the process. A. Lang objected to the use of molten alkali hydroxides in the purification because of the possibility of changes in composition. W. Luzi recommended the following process :

The ore is moistened with conc. nitric acid and then heated. During heating the mass swells considerably in developing peculiar wormlike forms. These forms are chemically unaltered graphite, but in consequence of their fine, delicate structure they are extraordinarily light in weight, so that by washing in water they remain afloat and are carried away, while the constituents of the gangue, which have been completely separated from the graphite by the swelling up of the latter, sink to the bottom by continued agitation of the mass. It appears that graphite, according to this method, can be purified quickly and cheaply ; because first, the graphite is not powdered before being moistened with nitric acid, nor is it mechanically cleaned ; and secondly, the mass is heated immediately after moistening ; and further, the swelling is instantaneous. The washing process afterwards takes little time, while little of the nitric acid is lost, as the process is performed in closed retorts. It is noteworthy that the graphite obtained by this method is plastic, in a very high degree, so that it can be pressed with ease into plates, etc.

H. le Chatelier and S. Wologdine treated the graphite with fuming nitric acid ; then fused the washed and dried mass with potassium hydroxide for 30 minutes at a dark red heat ; the washed product was boiled with hydrochloric acid, sp. gr. 1.12 ; and finally washed with water and dried at a dull red heat. H. Langbein heated the graphite first with sulphuric acid ; and treated the washed product with sodium hydroxide. According to B. C. Brodie, graphite is conveniently purified on a small scale by the following process :

The roughly powdered graphite, freed as much as possible from its impurities, is mixed with one-fourteenth part of its weight of chlorate of potash. This mixture is placed in an iron vessel ; conc. sulphuric acid (sp. gr. 1.8) of double the weight of the graphite is added and the whole thoroughly stirred and heated in a water-bath, until no more gases escape ; after cooling, the mass is put into water and thoroughly washed. The dry graphite is then exposed in a crucible to a red heat ; it swells up considerably and is converted into an exceedingly fine powder. In order to clean the graphite thoroughly, the powder is then subjected to washing and settling in water. If the graphite contains silicates and is to be made applicable to the manufacture of pencils, it is necessary to add a little sodium fluoride to the mixture of sulphuric acid, chlorate of potash and graphite ; the silicic acid escapes then as fluoride of silicon. According to F. Gottschalk, if the graphite is heated with a mixture of sulphuric acid and an oxidizing agent it is liable to become oxidized.

J. Löwe, and O. G. Pritchard have modified the process somewhat as follows :

Eighteen parts by weight of graphite, one part by weight of chlorate of potash are treated with 36 parts of sulphuric acid (sp. gr. 1.8). The whole is gently heated until no more chlorine escapes, the surplus of sulphuric acid is poured off, and a small quantity of sodium fluoride is added to the graphite paste. Finally the mass is thoroughly washed and the graphite exposed to a red heat, when it forms a red spongy mass.

J. B. A. Dumas and J. S. Stas heated the material with potassium hydroxide ; washed with water ; boiled with aqua regia ; washed with water and passed chlorine over the white-hot material. The product is thus freed from iron, silicon, and hydrogen. O. L. Erdmann and R. F. Marchand found a sample with 0.5 per cent. of silica after this treatment. J. L. Gay Lussac digested the graphite with nitric acid, and P. Schafhäütl, with hydrofluoric acid. H. V. Regnault heated the finely powdered graphite with equal parts of sulphur and sodium carbonate until the blue flame of sulphur had disappeared ; washed the cold mass with water ; with dil. hydrochloric acid ; with a dil. soln. of ammonium chloride ; then boiled with soda-lye ; washed with water ; and calcined in a covered crucible. M. Langheinrich, and the Graphite works at Kropfmühl purified graphite by heating a mixture of

graphite and coal to 2200°, whereby the impurities combined with the graphite are said to be sublimed. M. Pirani and W. Fehse found the sp. gr. and the proportion of ash decreased on calcination at high temp. W. Gross obtained good results with the flotation method for separating native graphite from gangue.

REFERENCES.

- ¹ V. A. Jacquelin, *Ann. Chim. Phys.*, (3), 20, 459, 1847; H. St. C. Deville, *ib.*, (3), 49, 72, 1857; H. L. Fizeau and L. Foucault, *ib.*, (3), 11, 384, 1844; R. Schenck and W. Heller, *Ber.*, 38, 2141, 1905; K. A. Hofmann and C. Röschling, *ib.*, 56, B, 2071, 1923; A. Smits, *ib.*, 38, 4027, 1905; E. Baur, *Zeit. Elektrochem.*, 12, 122, 1906; R. Schenck, *ib.*, 12, 218, 1906; J. N. Pring and W. Fielding, *Journ. Chem. Soc.*, 95, 1497, 1909; H. Moissan, *Le four électrique*, Paris, 1897; London, 1904; *Compt. Rend.*, 116, 218, 460, 608, 1893; 119, 976, 1894; 123, 16, 1896; 124, 653, 1897; *Ann. Chim. Phys.*, (7), 8, 306, 1896; *Bull. Soc. Chim.*, (3), 11, 837, 1894; M. Berthelot, *ib.*, (2), 12, 4, 1869; M. la Rosa, *Ann. Physik*, (4), 30, 369, 1909; F. Fouqué and A. M. Levy, *Synthèse des minéraux et des roches*, Paris, 197, 1882; C. Street, *Monit. Scient.*, (4), 9, 623, 1895; H. Erdmann, *Liebigs Ann.*, 247, 307, 1888; A. Remelé and B. Rassow, *Zeit. angew. Chem.*, 33, 139, 1920; K. Iokibe, *Science Rep. Tohoku Univ.*, 9, 275, 1920; H. Erdmann and P. Köthner, *Zeit. anorg. Chem.*, 18, 48, 1898; A. Bettendorff, *Arch. Pharm.*, (2), 144, 79, 1870; W. Crookes, *Chem. News*, 74, 39, 1896; E. L. Fillis, *ib.*, 98, 309, 1908; H. N. Warren, *ib.*, 55, 124, 1887; W. Skey, *ib.*, 23, 255, 1871; J. Stingl, *ib.*, 27, 264, 1873; *Ber.*, 6, 391, 1873; J. Rudolphs and J. Härden, *German Pat.*, D.R.P. 123692, 1900; A. Roedel, *ib.*, 93313, 1896; F. J. Bergmann, *ib.*, 96427, 1897; A. Frank, *ib.*, 112416, 1899; 174846, 1904; *Zeit. angew. Chem.*, 18, 1733, 1905; R. von Wagner, *Polyt. Centr.*, 1221, 1870; B. Osann, *Stahl. Eisen*, 27, 1491, 1907; E. Donath, *ib.*, 26, 1249, 1906; C. C. von Leonhard, *Neues Jahrb. Min.*, 398, 1856; P. Schafhäütl, *Journ. prakt. Chem.*, (1), 76, 257, 1859; W. Luzzi, *Ber.*, 24, 4085, 1891; N. G. Sefström, *Pogg. Ann.*, 16, 168, 1829; J. W. Döbereiner, *Schweigger's Journ.*, 16, 97, 1816; M. Houdard, *Compt. Rend.*, 143, 1230, 1906; G. Rousseau, *ib.*, 117, 164, 1893; E. Lionnet, *ib.*, 63, 213, 1866; P. and L. Schützenberger, *ib.*, 111, 774, 1890; E. L. Gruner, *ib.*, 73, 28, 1871; G. Charpy, *ib.*, 148, 1767, 1909; G. Rose, *Sitzber. Akad. Wien*, 516, 1872; *Pogg. Ann.*, 147, 497, 1873; M. Jungck, *Zeit. anal. Chem.*, 15, 290, 1876; W. Borchers, *Zeit. Elektrochem.*, 3, 393, 1897; E. G. Acheson, *U.S. Pat. Nos.* 542982, 1895; 568323, 1896; 645285, 1900; *Journ. Amer. Chem. Soc.*, 23, 66, 1901; *Journ. Franklin Inst.*, 147, 475, 1899; 164, 375, 1907; F. A. J. Fitzgerald, *ib.*, 154, 321, 1901; *Journ. Soc. Chem. Ind.*, 20, 444, 1901; H. Ditz, *Chem. Ztg.*, 28, 167, 1904; O. Mühlhäuser, *ib.*, 26, 336, 807, 1902; E. Pietrusky, *Chem. Zeit.*, 2, 1, 201, 1902; W. Thalheim, *Chem. Ind.*, 3, 52, 1880; G. Dragendorff, *Ueber Einwirkung des Phosphors auf einige kohlen- und borsäure Salze*, Rostock, 1861; *Chem. Centr.*, (1), 32, 865, 1861; T. F. Baily, *U.S. Pat. No.* 1402612, 1922; R. Ryschkewitsch, *Brennstoff Chem.*, 4, 39, 1923; *Chem. Ztg.*, 46, 1013, 1923, 1922; *Zeit. Elektrochem.*, 27, 57, 368, 445, 1921; 28, 185, 1922; S. Münch, *ib.*, 27, 367, 1921; F. Sauerwald, *ib.*, 28, 183, 1922; K. P. Gregorovitch, *Messenger Direction Gen. Ind. Mét. Russ.*, 1, 26, 1912; V. Kohlschütter and A. Nägeli, *Helvetica Chim. Acta*, 4, 45, 1921; J. G. Pammer, *Monatsh.*, 41, 467, 1920; A. Thiel and F. Ritter, *Zeit. anorg. Chem.*, 132, 153, 1923; P. Pauli, *Phil. Mag.*, (5), 21, 541, 1861; *Chem. News*, 4, 73, 1861; G. Gore, *ib.*, 48, 124, 1884; 50, 113, 1885.
- ² F. Cirkel, *Graphite*, Ottawa, 95, 1907; L. Jaczewsky, *Neues Jahrb. Min.*, ii, 74, 1901; T. S. Hunt, *Rep. Geol. Sur. Canada*, 22, 1866; *Canadian Naturalist*, 2, 120, 1865; E. Weinschenk, *Compt. Rend. Internat. Geol. Cong.*, 8, i, 447, 1900; *Zeit. prakt. Geol.*, 11, 16, 1903; J. Walther, *Zeit. deut. geol. Ges.*, 41, 359, 1889; A. K. Coomara-Swamy, *Journ. Geol. Soc.*, 56, 609, 1900; M. Diersche, *Jahrb. Geol. Reichsanst. Wien*, 48, 274, 1898; F. Kretschmer, *Oester. Zeit. Berg. Hütt.*, 50, 455, 1902; J. L. Barvir, *Geol. Centr.*, 1, 584, 1901; L. Fourquignon, *Compt. Rend.*, 91, 817, 1880; M. Jungck, *ib.*, 82, 440, 1876; E. L. Gruner, *ib.*, 73, 28, 1871; M. Berthelot, *ib.*, 73, 494, 1871; *Bull. Soc. Chim.*, (2), 16, 237, 1871; H. I. Jensen, *Econ. Geol.*, 17, 55, 1922; J. S. Newberry, *School Mines Quart.*, 8, 334, 1887; A. Osann, *Rep. Geol. Sur. Canada*, 780, 1899; *Graphite*, *Imperial Min. Resources Bur.*, 1923.
- ³ F. Cirkel, *Graphite, its Properties, Occurrence, Refining, and Uses*, Ottawa, 1907; E. Donath, *Der Graphit*, Leipzig, 1904; J. Stingl, *Chem. News*, 27, 264, 1873; *Ber.*, 6, 391, 1873; Gebr. Bessel, *German Pat.*, D.R.P.P. 42, 1877; 39369, 1886; H. Putz, *ib.*, 154516, 1901; 198576, 1906; W. Luzzi, *ib.*, 66804, 1891; Gebr. Douglas, *ib.*, 119592, 1899; H. Langbein, *ib.*, 109533, 1898; 125304, 1900; *Zeit. angew. Chem.*, 13, 354, 1900; A. Lang, *Montan. Runds.*, 19, 1, 1916; W. C. Ratliff and J. D. Davis, *Chem. Met. Engng.*, 23, 1027, 1920; M. F. R. Glogner, *Eng. Min. Journ.*, 76, 320, 1903; *U.S. Pat. No.* 736381, 1903; E. B. Kirby, *ib.*, 809959, 1906; J. D. Darling, *ib.*, 763859, 1904; *Brit. Pat. No.*, 6863, 1904; O. G. Pritchard, *The Manufacture of Electric Light Carbons*, London, 1890; *Electrician*, 24, 492, 545, 668, 616, 1890; F. Gall, *Fabrication et emploi des électrodes de carbone*, Paris, 1923; E. Ornstein, *Fabrication d'électrodes pour fours électriques*, Paris, 1900; Graphitwerk Kropfmühl, *German Pat.*, D.R.P. 358520, 1919; W. Gross, *Zeit. angew. Chem.*, 35, 681, 1922; E. Ryschkewitsch, *Chem. Ztg.*, 46, 1013, 1035, 1922; *Brennstoff Chem.*, 4, 39, 1923; M. Langheinrich, *Brit. Pat. No.* 187080, 1921; B. C. Brodie, *Phil. Trans.*, 149, 249, 1859; J. B. A. Dumas and J. S. Stas, *Ann. Chim.*

Phys., (3), 1, 1841; O. L. Erdmann and R. F. Marchand, *Journ. prakt. Chem.*, (1), 23, 159, 1841; P. Schafhäütl, *ib.*, (1), 19, 159, 1841; (1), 20, 465, 1841; (1), 21, 129, 1841; (1), 76, 257, 1859; C. Winkler, *ib.*, (1), 98, 343, 1866; F. Gottschalk, *ib.*, (1), 95, 326, 1865; J. Löwe, *ib.*, (1), 66, 186, 1855; J. L. Gay Lussac, *Ann. Chim. Phys.*, (2), 4, 69, 1817; H. V. Regnault, *ib.*, (4), 7, 450, 1866; N. G. Sefström, *Pogg. Ann.*, 16, 168, 1829; *Jernkontorets Ann.*, 12, 145, 1829; H. le Chatelier and S. Wologdine, *Compt. Rend.*, 146, 49, 1908; M. Pirani and W. Fehse, *Zeit. Elektrochem.*, 29, 168, 1923.

§ 7. The Preparation of Amorphous Carbon

The term amorphous carbon is applied to a comparatively large variety of carbonaceous substances which are not regarded as diamond or graphite. Though originally intended to imply that these varieties of carbon are non-crystalline, the term is now used for classification purposes without reference to the crystalline character. The term embraces such substances as soot or lampblack, gas carbon, wood charcoal, bone-black, and coke. The various coals are sometimes also included in the term amorphous carbon, although these substances might more accurately be regarded as hydrocarbons, and their study more fittingly belongs to organic chemistry. Amorphous carbon usually contains a small proportion of hydrogen and, maybe, a certain proportion of earthy matter usually regarded as ash. Amorphous carbon is formed in a great variety of ways, which may be arranged in two groups: (1) Metathetical reactions and reactions in which carbon is displaced from combination with other elements; (2) Reactions in which carbon is separated during the thermal decomposition of a carbon compound, a reaction sometimes facilitated by air. Of course, these pyrogenetic processes represent but special modes of formation which could be included in the first group. In some cases what appears to be a mixture of amorphous carbon and graphite is obtained by the solvent action of various agents on metals in which carbon or carbides have been dissolved—*vide* graphite.

(1) *The formation of amorphous carbon by a reaction with other chemical agents.*—H. Moissan¹ found that when fuming sulphuric acid acts on starch at 200° for 24 hrs., a black substance is obtained which can be purified by washing with cold water, alcohol, and ether. The product appears to contain a humic acid analogous to that obtained by M. Berthelot and G. André by the action of hydrochloric acid on sugar. H. Moissan regards the homogeneous powder as *un produit de transformation, un achèvement vers l'élément carbone*. After heating it to 400°, it contained: Ash, 2.64; carbon, 79.69; and hydrogen, 2.29 per cent. If sugar be similarly treated, and heated, much of the hydrogen compounds are destroyed and its analysis furnished: Ash, 4.26; carbon, 88.21; and hydrogen, 0.75 per cent. Some combined sulphur is also present. H. Moissan found *anthracene* reacts vigorously with a sat. soln. of ferric chloride at 180°, contained in a flask fitted with a reflux condenser. After 24 hrs., a dark brown substance is formed which becomes black on drying. The product was washed with hydrochloric acid, boiling water, benzene, alcohol, and ether. It contained: Ash, 21.29; carbon, 62.17; and hydrogen, 0.91 per cent. The ash contained much ferric oxide, and was not homogeneous; it contained some acicular crystals of hexachlorobenzene. The amorphous carbon so obtained is very impure; H. Moissan called it *un composé carboné de transition*.

S. Porcher passed carbon tetrachloride over a layer of heated sodium and obtained carbon quite free from hydrogen. C. Despretz, using a copper anode and platinum cathode, passed an electric current through an alcoholic soln. of carbon tetrachloride for six months; a brown film of carbon was deposited on the cathode. He also passed a feeble electric current for two months through acidulated water using a carbon anode and platinum cathode. The black cathode deposit showed no signs of crystallization. H. Moissan investigated the action of a voltaic couple of aluminium and platinum on hydrocarbons and various organic compounds, but in most cases no decomposition occurred. H. Moissan got very impure products by the action of light or heat on

carbon tetraiodide. An amorphous powder was obtained by the action of *J. Smithson's couple*, a piece of tin wrapped round with gold-leaf—on a soln. of the tetraiodide in carbon disulphide, during four years; a similar product was obtained by the action of zinc dust. After washing with water, alcohol, benzene, and finally alcohol, the light amorphous black powder contained a little zinc oxide. Sodium, silver, and lead, under similar conditions, reduced the tetraiodide to the lower iodide without the separation of carbon; with magnesium, brown amorphous carbon slowly separates and floats on the liquid. After washing as indicated above, the product contains traces of iodine and magnesium. When the metal is covered with a layer of carbon, further action ceases. These varieties hold water very tenaciously, and if dehydrated by heat, the carbon probably polymerizes. M. Berthelot obtained amorphous carbon by washing the product obtained by the slow oxidation of *copper acetylide* at ordinary temp.

According to H. Moissan, amorphous carbon is obtained when *carbon dioxide* is reduced by a heated metal—*e.g.* the alkali metals, calcium, etc.—he found that if with calcium the heat is applied slowly, carbon and calcium oxide together with a little calcium carbide, are formed, but if the heat is applied quickly calcium carbide and oxide are produced. He also found that at a dull red heat boron burns in dry carbon dioxide. When the porous cylinder which remains is treated with water, amorphous carbon is obtained. Traces of boron can be removed by the passage of chlorine at a dull red heat, and washing the product with water. An analysis gave: Ash, 0.96; carbon, 86.16; water, 12.70 per cent. The Aktiebolaget Graaen claimed to have made pure carbon by the action of iron on carbon monoxide under press. J. P. Wibaut found that carbon prepared by passing *carbon monoxide* over iron oxide in a porcelain tube at 450°–470° was always contaminated with much iron oxide, and all attempts to eliminate this impurity were unsuccessful. V. Kohlschütter and A. Nägeli investigated the carbon obtained by passing carbon monoxide, heated to 500°, over powdered nickel, cobalt, and iron. L. Gruner, R. Schenck and co-workers, A. Smits, and O. Boudouard also studied this reaction—*vide infra*. G. Tammann observed that by the action of mercury vap. on carbon tetrachloride at 600°–700°, mercurous chloride is formed and carbon is deposited. Under high press., 900 to 2760 kilos. per sq. cm., the reaction starts at about 400° and is accompanied by a fall in press. Carbon tetrabromide and tetraiodide react similarly. The carbon so formed retains tenaciously 7–10 per cent. of any water present, after heating at 600° in a stream of nitrogen. The density of the carbon so obtained is high, 2.32 from carbon tetrachloride, 2.51 from the tetrabromide, and 2.37 from the tetraiodide, whilst that of graphite is 2.1–2.3. Carbon obtained similarly from hexachloroethane had $d=2.16$, that from hexachlorobenzene 2.46 to 2.22, and from carbon disulphide, 2.38. It appears that carbon formed by reactions not involving the formation of water has a higher density than that which is formed with water. On keeping, this dense form of carbon absorbs much water, and, when it is again dried, its density is found to have diminished. A. Franck obtained amorphous carbon by the action of carbon monoxide or dioxide, or mixtures containing these gases, on *acetylene* in a heated tube, or exposed to electric sparks: $C_2H_2 + CO \rightarrow 3C + H_2O$; and in place of acetylene the *carbides* of the alkaline earths or other metals, at 200°–250°: $CaC_2 + CO \rightarrow CaO + 3C$. He also exploded mixtures of carbon monoxide and acetylene under press. exceeding 6 atm. According to M. Berthelot, amorphous carbon is formed when various *hydrocarbons* are decomposed by chlorine or iodine; and H. Moissan obtained a similar result by treating various metal carbides with the halogens or hydrogen halides. G. Gore obtained a deposit of carbon on the cathode during the electrolysis of a molten mixture of sodium hydroxide, silica, and anhydrous *alkali carbonate*; carbon was also obtained by reducing molten alkali carbonate with aluminium; T. L. Phipson, and C. Winkler used magnesium with the carbonates of the alkalies or alkaline earths. G. Gore found that arsenic or antimony is ineffective. He also showed that a mixture of amorphous carbon and graphite was formed by the action of sodium, phosphorus,

arsenic, or antimony on molten *potassium cyanide*. W. A. Bone and J. C. Cain obtained carbon by exploding a mixture of *cyanogen* and hydrogen with insufficient oxygen for complete combustion.

The amorphous carbon obtained by reactions at a low temp. is more or less impure; a small proportion of the reducing agent is nearly always present, and is not removed by treatment with the solvents applicable under ordinary conditions. H. Moissan said that the product of the action of magnesium on carbon tetraiodide was the purest he had obtained. Hydrogen also is retained so very tenaciously that M. Berthelot inclined to the belief that the products are true hydrides. Water, hydrogen, and hydrocarbons cannot be removed except by raising the temp., but, added H. Moissan, *pour chasser ces impuretés, il faut le chauffer, c'est-à-dire le polymériser*. Hence, the varieties of amorphous carbon prepared at an elevated temp. are said to be more or less polymerized, and more resistant to chemical action. W. A. Roth and H. Wallasch found it to be impossible to prepare pure, amorphous, and thermally well-defined, carbon.

(2) *The formation of amorphous carbon by the pyrogenetic decomposition, or incomplete combustion of organic compounds.*—H. St. C. Deville stated that amorphous carbon is produced when carbon monoxide is heated to redness, or exposed to the action of electric sparks; but R. Schenck and W. Heller said the product is finely divided graphite—*q.v.* M. Berthelot found carbon monoxide is reduced to carbon by iron and manganese minerals. The carbon obtained by T. Sidot by passing carbon disulphide through a red-hot tube is probably graphitic. H. Moissan obtained amorphous carbon by the pyrogenetic decomposition of carbon fluoride at a dull red heat. M. Berthelot observed that cyanogen is decomposed into amorphous carbon and nitrogen by a stream of electric sparks. P. and L. Schützenberger also studied this reaction. O. L. Erdmann and R. F. Marchand, and M. Berthelot obtained carbon by passing the vap. of volatile organic compounds—*e.g.* hydrocarbons, fats, oils, alcohol, ether, etc.—through a white-hot porcelain tube. H. von Wartenberg obtained carbon by the action of heat, at 500°, on methane: $\text{CH}_4 \rightleftharpoons \text{C} + 2\text{H}_2$. Various hydrocarbons and coal gas act in the same way as shown by J. L. Gay Lussac, W. Luzi, I. Szarvsky, H. Colquhoun, E. W. Brayley, M. Berthelot, N. G. Sefström, etc. In 1826, H. Colquhoun noted the formation of *gas carbon* or *charbon de cornue* in gas retorts by the decomposition of hydrocarbons derived from the coal. V. A. Jacquelin found 2·7 per cent. of ash in a sample of gas carbon. According to M. Constant and H. Pélabon, a form of carbon wool is sometimes met with in the upper portions of recuperative coke-ovens, especially at the aperture for the exit of the hot gases. The formation of filamentous carbon is probably due to the decomposition of heavy hydrocarbon vap. by heat.

The carbon wool consists chiefly of grey cylindrical threads with glazed surfaces, sometimes showing a series of expansions, and occasionally bearing bundles of much finer black threads. The average length of the threads is 5 cms., even attaining 8 cms., the diameter varies from 0·03 to 0·15 mm., the black threads being perhaps only 0·002 mm. When heated in dry oxygen, combustion begins at 585° and is complete, only 0·4 per cent. of ash being found. A mixture of nitric acid and potassium chlorate oxidizes the carbon to graphitic acid; and it is therefore graphite.

G. Gore found that the action of red-hot ferric oxide on coal gas is attended by the separation of carbon; silver fluoride and chloride, and lead and cupric chlorides act similarly, but cadmium chloride remains unchanged.

Most organic matter when heated out of contact with the atm.—the so-called dry distillation—is decomposed and a residue, more or less carbonaceous, remains. The product always contains a certain amount of hydrogen, which becomes smaller as the temp. is raised. M. Berthelot² believes that carbon *per se* is the limiting state of a series of hydrocarbons, and that many of the so-called varieties of amorphous carbon are really members of the series of extremely condensed carbides which are verystable at high temp. L. Punier's *carbopétrocène* with 96 to 97 per cent. of carbon is another member of the series of pyrogenetic hydrocarbons. N. K. Chaney has reported

that a hydrocarbon resembling anthracene, b.p. 360°, can be isolated from charcoal which has been heated to 850°; and H. B. Harned showed that heating charcoal to 1200° in vacuo does not suffice to produce a gas-free carbon. O. L. Erdmann and R. F. Marchand could not remove hydrogen and oxygen from charcoal at a white heat.

When purified sugar is slowly heated much bubbling occurs, and a voluminous residue—*sugar charcoal*—is obtained. The product should leave little or no ash. According to O. L. Erdmann and R. F. Marchand, after heating white hot, the product still contains 0.6 per cent. of hydrogen and 3.1 per cent. of oxygen; and after 3 hrs.' heating in a blast flame, it contains 0.2 per cent. of hydrogen and 0.5 per cent. of oxygen. In order to get rid of hydrogen from the different varieties of carbon, J. B. A. Dumas and J. S. Stas, H. V. Regnault, and H. Moissan recommended passing chlorine for 4 or 5 hrs. over the carbon at a red heat (or 1000°). M. Berthelot and P. Petit followed this treatment by digesting the product with hydrochloric and then with hydrofluoric acid, and washing with water.

In the preparation of the so-called **activated charcoal**, or *active charcoal*, for use as an absorbent in gas-masks, etc., a porous charcoal is prepared at a low temp., 850°–900°; and the adsorbed hydrocarbons are removed. The process of manufacturing active carbon has been described by F. M. Dorsey, N. K. Chaney, A. B. Lamb and co-workers, S. Hiller and L. A. Clarke, L. le W. Hamon and T. H. Byrom, J. N. A. Sauer, A. Zelnecyck, M. T. Saunders, W. L. Jordan, N. Suzuki, A. B. Ray, J. C. Philip and co-workers, K. Scheringa, F. H. Carr, E. G. R. Ardagh, J. E. Teeple and P. Mahler, E. R. Sutcliffe, J. C. Morrell, R. A. Demme, F. Bonnett, O. Ruff and co-workers, V. F. Gloag, etc. The general method of procedure is to heat thin layers of charcoal, screened to 14's mesh, between 350° and 450° in a rapid stream of air with the object of breaking down the hydrocarbons of high b.p. into more volatile substances which are removed at a low temp. The hydrocarbons are oxidized rapidly and the carbon slowly. A current of steam between 800° and 1000° has the same effect. If the primary carbon is heated to a high temp., more or less graphitization occurs, and the product is not activated by the subsequent treatment. The material is charged into retorts in thin layers to prevent as much as possible contact between the hydrocarbon vap. and hot charcoal. A slight suction is maintained in the retort, and most of the hydrocarbons are removed before a dangerous temp. is reached. F. E. Bartell and E. J. Miller have described the preparation of activated sugar charcoal by charring sugar in a large platinum dish; afterwards heating it to low redness to drive off the greater part of the volatile matter; and then heating the material, reduced to granules the size of wheat kernels, for 24 hrs. in silica tubes at 100°. V. Lenher and F. M. Dorsey purified carbonized material by treating it with selenium oxychloride, washing with carbon tetrachloride, and heating to volatilize the last-named solvent.

The apparent sp. gr. of primary and purified charcoal from some different sources were determined by A. B. Lamb and co-workers. The following is a selection:

	Syca- more	Cedar	Brazil nut	Ivory nut	Cohune nut	Babassu nut	Cocoa- nut	Sawdust	Bitu- minous coal	Anthra- cite coal
Primary .	0.158	0.223	0.520	0.700	0.659	0.540	0.710	0.542	0.789	0.830
Activated	0.080	0.097	0.316	0.460	0.502	0.322	0.431	0.365	0.430	0.371

The last three varieties in the list were briquetted before charring. The gas adsorption qualities were at the same time so much improved that N. K. Chaney argued that the so-called amorphous carbon exists in two forms, active or *α-carbon*, and inactive or *β-carbon*. He said the active form is readily attacked by oxidizing agents, while the inactive form resembles graphite in its stability towards oxidizing agents. There is, however, no satisfactory evidence that the so-called inactive carbon is anything different from more or less graphitized carbon. According to N. K. Chaney, the active form results when the carbonization occurs below 600°,

and the inactive form above that temp. There is, however, no sharp temp. of demarcation, and no transition temp. has been observed. Inactive carbon is also formed by the decomposition of hydrocarbons. Acetylene below 300° may give active carbon, and above that temp. inactive carbon.

Wood charcoal.—When wood is heated to a high temp. in a closed vessel, much gas and vap. are evolved, and wood charcoal remains. D. Avery obtained what he called a very pure form of charcoal from cocoanut shell. This was strongly heated in closed clay crucibles for some hours, then boiled with nitric acid for 5 or 6 hrs., and washed thoroughly till the runnings were nearly free from acid—the washing taking several days. It was then dried in the air, crushed and sieved, collecting the particles between 1 and 3 mm. diameter. These were dried first in a desiccator over strong sulphuric acid, then over phosphorus pentoxide, and finally heated to redness in a closed platinum crucible and cooled in a desiccator over phosphorus pentoxide. The crucible was heated in a muffle in an oxidizing atm. to avoid the possibility of absorption of hydrogen or other reducing gases from the furnace. The amount of ash in the product was 0.23 per cent., and its hydrogen content was 0.28 per cent. Industrially, wood charcoal is prepared by the incomplete combustion of wood in

a limited supply of air. In outline, the process of manufacturing *pit charcoal* is as follows :

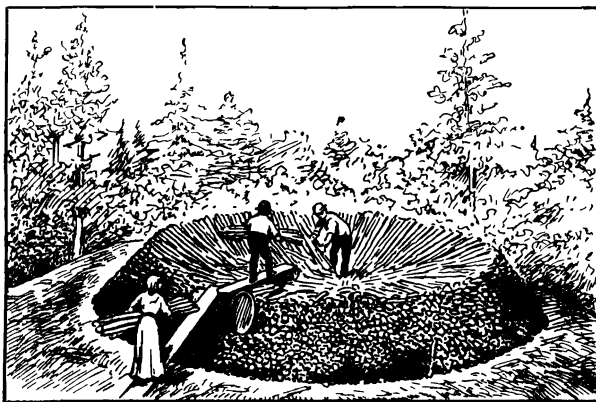

Fig. 6.—Sketch of a Meiler in course of Construction.

Logs or billets of wood are loosely piled into vertical heaps and covered with sods and turf to prevent the free access of air. A shaft is left in the middle of the pile to act as a central chimney or flue; and smaller holes are left round the bottom to admit the air. The pile so prepared is called a charcoal pit or *meiler*. There are several systems of setting or piling the logs; one is illustrated by the sketches, Figs. 6 and 7. In Sweden, rect-

angular piles are used, and the wood is placed horizontally and transversely. The wood is lighted by brushwood at the centre, and just sufficient air to allow the wood to smoulder is passed through the pile. The volatile matter escapes, and in about fifteen days the fire dies out. Between 80 and 90 per cent. of wood, on the average, is lost by combustion, and the remaining 10 to 20 per cent. is wood charcoal; the process can be used satisfactorily only where wood is cheap and abundant because the method is uncertain and wasteful. The process is still employed in a few places in Europe.

Some valuable gaseous and liquid products are lost in making pit charcoal. In modern processes, the wood is heated in ovens, kilns, or retorts, sealed from the outside air and *kiln, stove, or retort charcoal* results. The operation may be conducted simply for charcoal without recovering the by-products, or the operation may be conducted somewhat similarly to the process used for the manufacture of coal gas. The products of the dry distillation of wood include: solid charcoal in the retort; liquids—wood tar (*Stockholm tar* from pine wood); water containing wood spirit; *pyroligneous acid*, that is, impure acetic acid; acetone and fatty oils; and wood-gas—containing hydrogen, carbon dioxide, carbon monoxide, methane, acetylene, etc. The wood gas is used for illuminating purposes only when the temp. of distillation has been very high. The products are approximately: charcoal, 25.3; methyl alcohol, 0.8; acetic acid, 1.0; tar, 4.0; water, 45.9; wood gas, 23 per cent. The charcoal in the retort retains the form of the wood from which it was prepared. Kiln charcoal is more compact than the pit charcoal—in the former case the charcoal weighs 20 lbs. per bushel, and in the latter case, 16 lbs. per bushel.

The yield of charcoal is about 81 per cent. by volume, 28 per cent. by weight. H. Violette recommended carbonizing the wood by superheated steam.

Coke.—Coke is an industrial fuel obtained as a residue in the dry distillation of coal, *i.e.* by heating coal in a closed vessel out of contact with air. The coal should contain sufficient bituminous matters to cement it into masses at a certain temp. Coke generally contains between 85 and 90 per cent. of carbon. Coke is used in the manufacture of iron and steel, and in a great many metallurgical operations where its comparative freedom from sulphur and certain other impurities render it more suitable than coal. Coal may be converted into coke by heating it in closed vessels—gas, tar, and ammonia are obtained as by-products; or if coal gas is being manufactured, coke, tar, and ammonia are the by-products. The properties of coke depend upon the nature of the coal from which it is obtained, and upon the way the coal is “coked.” The main varieties are: (i) *soft coke*—porous, black, and brittle; it ignites with difficulty, and is used for smith’s forges, etc.; (ii) *hard coke*—dark grey in colour, with bright lustre, compact, and with metallic ring when struck, bears great press. without crushing, and is used for furnace work and metallurgical operations generally. Coke may or may not be prepared under conditions where the by-products are recovered. Coke has been made in four ways: (i) in heaps or meilers;

(ii) in gas retorts; (iii) in beehive ovens; and (iv) in by-products ovens. Process (i) is so wasteful that it is obsolete. Commercially, spent wine must and yeast, vine twigs, vine wood, grape husks, fruit stones, spent hops, oil-cake, nut-shells, chestnuts, and various kinds of wood are carbonized or charred to furnish the so-called *carbon-blacks* used by painters under various names—like *Frankfurt black*, *Spanish-black*, *vine-black*, *drop-black*, *noir de vigne*, etc. The



FIG. 7.—Sketch of a Meiler shortly after it has been lighted.

products do not always correspond with their names; indeed, the trade-name rather indicates the quality of the colour rather than the raw material from which it is made. Certain carbon blacks are made by the dry distillation of some of the lignites with a conchoidal fracture, not the earthy kinds, and also fine bituminous shales.

The beehive oven—so called on account of its shape—furnishes an excellent coke, but is rather wasteful. The ovens are built in batteries each of which may include from 20 to 200 ovens. Each oven cokes about 7 tons of coal, and furnishes 4 or 5 tons of coke. The air for burning the coal enters through an opening in the door, and the gases escape through the top flue fitted with a damper. The air supply is diminished from day to day. When no flame is visible, and all the interior is red hot, the openings are luted with clay, and in 24 hrs. (70–84 hrs. in all) the door is opened, and water from a hose is sprayed in the oven, which is then ready for discharging.

Coking in retorts.—The retorts are horizontal chambers built side by side in batteries of 22 to 50. The retorts are worked in pairs—one is discharging when the other is half coked. The retorts are closed except for the exit left for the escape of the volatile products of distillation. The products of distillation are passed through condensers, and the gases are returned to be burnt in the horizontal flues below the retorts. There is a system by which the waste heat from the products of combustion warms up the air—secondary air—which is employed for burning the gas below the retorts. In about 48 hrs., the coke is expelled from the retort by means of a ram, and is at once quenched with water. The retort is recharged through hoppers in the roof, or by a ram-charger. The yield is almost

theoretical. The by-products are recovered. The coke is black, hard, compact, and without metallic lustre. There are numerous varieties of by-product coke-ovens.

In nature, there are cases where igneous rocks have intruded bituminous coal seams, and transformed the coal into a kind of *natural coke* sometimes called *carbonite*. It resembles artificial coke but usually contains more volatile matter, and is more compact.³

Bone or animal charcoal.—This is made by heating bones, bone-cuttings, blood, etc., in closed retorts. The bones may or may not have been subjected to a preliminary extraction with naphtha or benzene to remove the fat—*degreased bones*; or with superheated steam or water to remove gelatine (glue)—*degelatinized bones*. The products of the distillation include: solid bone charcoal in the retort; liquid—a number of ammonium salts, *bone oil*, bone pitch, pyridine, etc.; and gases of various kinds. The manufacturing processes have been described by B. E. R. and J. A. R. Newlands,⁴ T. Lambert, O. Cordel, W. Friedberg, etc. The better quality of bone-black is considered to be that prepared by processes in which the volatile products are entirely disregarded. J. Pilter made animal-black from leather-waste. Bone charcoal contains only about 10 per cent. of carbon, so that it is questionable if it ought to be included with the varieties of carbon at all. T. Lambert gives the following analyses of two chars—the first one is considered good, the second one bad:

C	Ca ₃ (PO ₄) ₂	Mg ₃ (PO ₄) ₂	CaCO ₃	CaSO ₄	CaS	Fe ₂ O ₃	Alkaline salts	SiO ₂
10·76	73·50	6·08	8·69	0·05	0·03	0·16	0·44	0·29
6·83	70·39	8·47	10·92	0·78	0·46	0·63	0·49	10·3

The carbon is very finely divided and disseminated through a porous mass of about 80 per cent. of calcium and magnesium phosphates, and it seems to have specially valuable qualities. N. Gräger purified animal charcoal by grinding the product with 4 to 5 per cent. of a soln. of sodium carbonate, then with water, then with hydrochloric acid, and finally with water. Processes have also been indicated by G. Banfi, G. Hoppe, M. Takahashi, C. Thumb, H. Eisfeld, G. Krieger, etc. Bones furnish *bone-black*—sometimes called *ivory black*—the term *ivory black* is also applied to the product obtained by digesting bone-black with hydrochloric acid to remove the calcium phosphates; very little of the ivory black of commerce is made from ivory cuttings. The carbon blacks of vegetable or animal origin, after treatment with dil. acid, also furnish the so-called Paris black used as a pigment. Blood furnishes *blood charcoal*. For the uses of bone-black and animal charcoal, *vide infra*. There are many trade-names for the decolorizing bone-blacks: *norite*, *darco*, *supchar*, *kelp-char*, *carbros*, *bone-char*, etc. C. H. Hall considers that the active decolorizing agent in bone-black is a mixture of nitrogenous decomposition products of bone-cartilage, etc., with the empirical formula C₂₅H₂₀N₄O₆: these products are insoluble in alcohol, ether, benzene, and chloroform, but soluble in aq. ammonia, conc. sulphuric acid, and conc. hydrochloric acid. Soln. in the two last-named acids are precipitated by adding water. T. L. Patterson has described analogous compounds. F. E. Bartell and E. J. Miller, and P. M. Horton doubted if nitrogenous substances are the active agent. O. Ruff said that the activity of charcoal is due to the atoms and atom-groups of foreign materials bound to the surface of the charcoal. These atoms are the cause of the specific property of active charcoal, and they are characterized by the firmness of their linking to the carbon atoms on the surface. Other atoms can easily attach themselves to the surface, but these are readily replaced by others, and are not firmly bound. With every change in the nature of the surface of the charcoal, the absorptive properties are markedly changed.

Lampblack.—When hydrocarbons like wax, fat, coal gas, turpentine, tar, petroleum, acetylene, etc., are burnt in a limited supply of air, carbon seems to be the last element to oxidize, and if the flame be suddenly cooled, by bringing a cold surface in contact with it, much of the carbon is deposited unburnt. The air supply can be arranged so that the maximum amount of smoke is developed in the combus-

tion of the hydrocarbon. The smoke can be collected as soot, the so-called lampblack, or *noir de fumée*, in chambers hung with sacking. The soot which collects on the surface of the "blankets" is scraped or shaken off from time to time. The old and primitive arrangement illustrated by J. B. A. Dumas'⁵ diagram, Fig. 8, indicates the general principles of the process :

The apparatus consists of a cylindrical brick chamber ten or fifteen feet in diameter provided with a conical roof which has a small opening near its apex, sufficiently large to maintain a slight draught and which causes the smoke to ascend toward the upper part of the chamber. A cone of sheet iron hangs within the cylinder, and this too has a small hole at the top to allow the gases to escape. At the side and base of the chamber there is a kind of furnace, above the fire of which is placed a pan containing resinous or fatty matters, which are heated to a point sufficient to convert them into vap. This vap. then undergoes sufficient combustion to deprive it of its hydrogen, while most of the carbon remains unconsumed. The smoke ascends into the chamber and is mostly deposited upon the hanging canvas or sacking which covers the walls and upon the inner surface of the iron cone, from which it falls after a certain thickness has been collected. The cone is so held by a chain and pulley that it may be raised or lowered, which operation scrapes the lampblack off the sacking. The lampblack thus prepared is not pure carbon, as it is mingled with resinous and bituminous substances, together with ammoniacal and other matters. By heating it to full redness in retorts which are air-tight, nearly all these impurities are driven off and an almost pure, impalpable black powder remains.

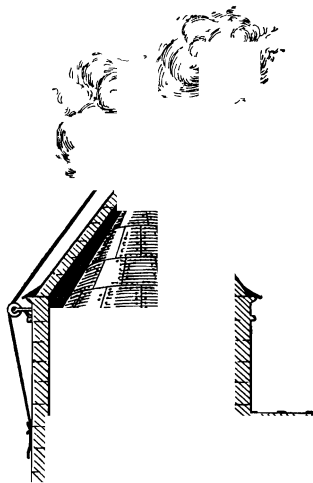

FIG. 8.—Primitive Process for the Manufacture of Lampblack.

The yield is only about 20 or 30 per cent., but the product obtained by this uneconomical process is fairly good. The important point is to keep down the temp. of the flame, for if the temp. be high, the product becomes hard and floury, with poor binding qualities. A great many improvements have been introduced to render it more efficient. The methods of burning the hydrocarbons, devices for cooling the flame, and the arrangements for collecting the soot have been improved by G. Wegelin, F. Meiser, J. Machtolf, etc. R. Thalwitzer burnt mixtures of benzene and oil-gas; A. Geuthe, naphthalene; H. Oishi, camphor; C. S. Bradley, methane; G. Wegelin, tar; and H. Berger and F. Wirth, acetylene or other hydrocarbons with triple-bonded carbon atoms. R. O. Neal, G. L. Cabot, R. Irvine, R. H. Brownlee and R. H. Uhlinger, and others have described the preparation of lampblack from burning natural gas. One process is conducted as follows :

A ring of burners is mounted below a cast-iron disc, with a groove on the rim convex downwards, in such a way that the flame from each burner is divided into two parts. Cold water runs into the upper side of the groove, and away *via* the hollow shaft which rotates the iron disc. This keeps the metal, in contact with the burning gas, cold. Soot is deposited on the groove. As the disc revolves, an automatic scraper removes the lampblack from the grooves of the disc. The lampblack falls into a hopper and is conveyed by elaborate machinery to be ground to the finest powder, sifted, and weighed into sacks.

H. Moissan prepared lampblack from petroleum oil at a dull red heat. It contained: ash, 9.75; carbon, 87.49; and hydrogen, 2.76 per cent. It was purified by successive washings with benzene, alcohol, and ether so as to remove hydrocarbons. The powder was then dried in air and afterwards in an oven at 150°. It contained: ash, 0.28; carbon, 93.03; and hydrogen, 1.12 per cent. The hydrogen comes

partly from water and partly from hydrocarbons. H. Braconnot gave for the analysis of lampblack :

C	(NH ₄) ₂ SO ₄	K ₂ SO ₄	CaSO ₄	(Ca,Fe) ₃ (PO ₄) ₂	KCl	SiO ₂	H ₂ O
79.1	0.3	0.4	0.8	0.3	trace	0.6	8.0

together with resinous matters, 5.3; bituminous matters, 1.7; and ulmine, 0.5 per cent. Amorphous carbon is obtained by burning acetylene at the end of a glass tube 6 mm. in diameter, and surrounding the flame by a hollow copper cylinder 3 cms. in diameter and cooled by a stream of cold water. The amorphous carbon obtained by M. Berthelot by decomposing acetylene with a detonator of fulminating mercury contained: ash, 7.87; carbon, 92.48; hydrogen, 0.40 per cent.; and H. Moissan added *ce carbone amorphe est un des plus purs que nous ayons étudiés*. H. H. Lowry studied the relation between the hydrogen content of charcoals and some of their properties—sp. gr., porosity, oxidizability, etc.

In addition to the ordinary process of producing lampblack by the incomplete combustion of hydrocarbons, etc., with a limited supply of air, processes have been devised which are based on the decomposition of gases and liquids by explosion or by electrical processes. Thus, F. Morani exploded a mixture of acetylene and air under press., the temp. of the explosion is higher than that obtained in the ordinary combustion processes; and, in order to keep down the temp., he recommended mixing the acetylene with an exothermal gas like methane, ethane, etc. G. Wegelin tried to utilize the heat developed in the explosion of acetylene to run a combustion engine. L. J. E. Hubon produced *acetylene black*, or *noir d'acétylène* by exploding acetylene in a closed vessel by an incandescent tube, or wire, or by electricity. J. Machtolf decomposed the hydrocarbon gases by electric sparks, or by a fulminating mercury detonator. A. Schneller and W. J. Wisse decomposed gaseous, liquid, or solid hydrocarbons by high tension sparks—10,000 to 40,000 volts.

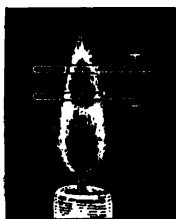

FIG. 9.—The Electrical Precipitation of Lampblack from a Flame.

B. Thieme described an electrical process in which the carbon is separated directly from the flame itself; this has the effect of cooling the flame and at the same time increasing the yield of soot. The principle of the process is illustrated by Fig. 9. If two poles of a source of electricity at about 15 volts be introduced close together in a candle-flame a deposit of soot is formed at the negative pole, and the deposit grows in the direction of the course of the gases. In the technical process, soot is similarly precipitated from the flame, and the apparatus is so arranged that a constant supply of fresh soot is formed at its surface: this prevents the lampblack when once formed from

being impaired by the heat. The precipitation is rapid, so that it is not long exposed to the influence of the flame. The product is said to be very fine in texture and specially suited for making printer's ink. The manufacture of carbon black has also been described by R. O. Neal and G. S. J. Perrott, G. S. J. Perrott and R. Thiessen, L. F. Hawley, etc.

T. Svedberg⁶ prepared **colloidal carbon** as an isobutyl-alcosol by his electrical process (1. 23, 10). H. Freundlich, and W. R. Whitney and A. Straw obtained suspensions of carbon in soln. of hydroxides, and in picric acid. Mixtures were made with lampblack and water, and with 0.0004, 0.0006, 0.001, 0.002, 0.004, and 0.006*N*-soln. of sodium hydroxide. The maximum stability of the suspension was obtained with the conc. approximating 0.001*N*-NaOH. According to P. C. L. Thorne, carbon sols may be prepared by anodic disintegration, by chemical oxidation, and by the decomposition of organic compounds. A stable carbon sol may be prepared by the electrolysis of a soln. of ammonia for 6 hrs. between carbon electrodes with an anode current density of 0.6–1.2 amp. per sq. cm. and a voltage of 220. After filtering, the soln. had an ammonia conc. of 0.145*N* and gave a solid residue of 0.034 g. per 100 c.c. The residue is insoluble in water, but is peptized

again in presence of a trace of ammonia; the excess of ammonia may be removed by boiling, and the sol is then more stable than the original sol, which on dialysis is flocculated when the ammonia conc. falls to 0.039*N*. The ammonia-free sol is deep black in layers greater than 1 cm. thick and brown in thinner layers, and is made up of particles of about the same size as those of metallic sols. The number of millimols of electrolytes necessary to coagulate 1000 c.c. of the given sol was relatively 290; ammonium hydroxide, 9000; sodium chloride, 450; barium chloride, 0.5; and aluminium chloride, 0.3. According to S. Goldberg, colloidal carbon, free from electrolytes, migrates towards the anode with a velocity about 18.3×10^{-5} — 13.5×10^{-5} cm. per sec. per volt. Dilution and filtration increase the velocity up to about 20 per cent. Acids and bases, irrespective of their nature, reduce the velocity by about the same amount, and at the same time change the colour slightly, but the original colour may be restored by neutralization. Of the salts examined, only those of aluminium have any effect on the migration velocity, and these cause an increase to a maximum with 1/500,000 mols aluminium sulphate, followed by a decrease on further increasing the conc. Colloidal ferric hydroxide coagulates colloidal carbon, but if a quantity so small is added that no coagulation takes place, then the velocity of migration is reduced about 20 per cent.

E. G. Acheson obtained a similar preparation of **colloidal graphite**, which he called *deflocculated graphite*, by treating disintegrated graphite with an aq. soln. of tannin containing from 3 to 6 per cent. by weight of the graphite treated. The results are much more pronounced when the mass of graphite, water, and tannin has been pugged or masticated for a considerable time, say one month. While the effect is very satisfactory with distilled water, the water obtained from rivers, deep wells, etc., is improved by the addition of a trace of ammonia. The presence of carbon dioxide in the water prevents deflocculation. The liquid containing the deflocculated graphite has an intense black colour, and the grain-size of the particles is much finer than is possible of attainment by mechanical means. It will pass through ordinary filter-paper. The addition of a trace of hydrochloric acid causes the graphite to flocculate and settle. E. G. Acheson also suspended the graphite in oil. The two suspensions are used as lubricants, and are known commercially as *oiddag* and *aquadag*, where the "dag" is compounded from the first letters of "deflocculated Acheson's graphite." Other tanniferous soln. may be used.

REFERENCES.

- ¹ H. Moissan, *Le four électrique*, Paris, 1897; London, 1904; *Compt. Rend.*; **110**. 276, 951, 1890; **113**. 19, 1891; *Ann. Chim. Phys.*, (7), **8**. 289, 1896; (1), **18**. 343, 1899; J. L. Gay Lussac, *ib.*, (2), **4**. 67, 1817; V. A. Jaquelain, *ib.*, (3), **20**. 437, 1847; M. Berthelot and G. André, *ib.*, (6), **25**. 364, 1892; M. Berthelot, *ib.*, (4), **19**. 425, 1870; *Bull. Soc. Chim.*, (2), **12**. 4, 1869; (2), **16**. 237, 1871; *Compt. Rend.*, **73**. 494, 1871; S. Porcher, *Chem. News*, **44**. 203, 1881; G. Gore, *ib.*, **50**. 113, 124, 1884; T. L. Phipson, *ib.*, **93**. 119, 1906; W. A. Bone and J. C. Cain, *ib.*, **70**. 264, 1894; *Proc. Chem. Soc.*, **10**. 179, 1894; C. Despretz, *Compt. Rend.*, **37**. 369, 1853; E. Lionet, *ib.*, **63**. 213, 1866; T. Sidot, *ib.*, **70**. 605, 1870; *Bull. Soc. Chim.*, (2), **14**. 193, 1870; H. St. C. Deville, *ib.*, (2), **3**. 8, 366, 1865; (2), **5**. 104, 1866; *Compt. Rend.*, **59**. 873, 1864; **60**. 317, 1865; M. Constant and H. Pélabon, *ib.*, **137**. 706, 1903; P. and L. Schützenberger, *ib.*, **111**. 774, 1890; A. Franck, *German Pat.*, D.R.P. 112416, 1899; *Zeit. angew. Chem.*, **18**. 1733, 1906; C. Winkler, *Ber.*, **23**. 2642, 1890; W. Luzi, *ib.*, **25**, 214, 1892; P. Poch, *Anal. Fis. Quim.*, **21**, 291, 1923; Aktiebolaget Graaen, *Swedish Pat. No.* 53821, 1923; I. Szarvsky, *Canadian Pat. No.* 233715, 1923; L. Gruner, *Compt. Rend.*, **73**. 28, 1871; V. Kohlschütter and A. Nägeli, *Helvetica Chim. Acta*, **4**. 45, 1921; W. D. Bancroft, *Journ. Phys. Chem.*, **24**. 127, 1920; G. Tammann, *Zeit. anorg. Chem.*, **115**. 145, 1921; R. Schenck and F. Zimmermann, *Ber.*, **36**. 1231, 1903; R. Schenck and W. Heller, *ib.*, **38**. 2132, 2139, 1905; A. Smits, *ib.*, **38**. 4027, 1905; O. Boudouard, *Compt. Rend.*, **128**. 98, 307, 824, 1522, 1524, 1899; **130**. 132, 1900; **131**. 1204, 1900; *Bull. Soc. Chim.*, (3), **25**. 282, 484, 1901; *Ann. Chim. Phys.*, (7), **24**. 5, 1901; W. A. Roth and H. Wallasch, *Zeit. Elektrochem.*, **15**. 1, 1915; G. Dragendorff, *Chem. Centr.*, (1), **32**. 865, 1861; H. von Wartenberg, *Zeit. phys. Chem.*, **61**. 366, 1907; H. Colquhoun, *Ann. Phil.*, **28**. 1, 1826; E. W. Brayley, *ib.*, **28**. 192, 1826; N. G. Sefström, *Jernkontorets Ann.*, **12**. 145, 1892; *Pogg. Ann.*, **16**. 168, 1829; J. Smithson, *Ann. Phil.*, **1**. 271, 1821; J. P. Wibaut, *Rec. Trav. Chim. Pays-Bas*, **41**. 400, 1922; O. L. Erdmann and R. F. Marchand, *Journ. prakt. Chem.*, (1), **23**. 159, 1841.

² M. Berthelot, *Ann. Chim. Phys.*, (4), **19**, 425, 1870; *Bull. Soc. Chim.*, (2), **12**, 4, 1869; (2), **16**, 237, 1871; *Compt. Rend.*, **73**, 494, 1871; H. Moissan, *Le four électrique*, Paris, 1897; London, 1904; *Compt. Rend.*, **110**, 276, 951, 1890; **113**, 19, 1891; *Ann. Chim. Phys.*, (7), **8**, 289, 1896; (7), **18**, 343, 1899; M. Berthelot and P. Petit, *ib.*, (6), **18**, 80, 1889; M. Berthelot and G. André, *ib.*, (6), **26**, 364, 1892; L. Prunier, *ib.*, (5), **17**, 5, 1879; J. B. A. Dumas and J. S. Stas, *ib.*, (3), **1**, 1, 1841; H. V. Regnault, *ib.*, (4), **7**, 450, 1866; H. Violette, *ib.*, (3), **23**, 475, 1848; (3), **32**, 305, 334, 1851; (3), **39**, 291, 337, 1853; *Compt. Rend.*, **38**, 107, 1854; D. Avery, *Journ. Soc. Chem. Ind.*, **27**, 255, 1908; H. B. Harned, *Journ. Amer. Chem. Soc.*, **42**, 382, 1920; F. M. Dorsey, *Journ. Ind. Eng. Chem.*, **11**, 281, 1919; A. B. Lamb, R. B. Wilson, and N. K. Chaney, *ib.*, **11**, 420, 1919; O. L. Erdmann and R. F. Marchand, *Journ. prakt. Chem.*, (1), **23**, 159, 1841; J. N. A. Sauer, *Brit. Pat. No.* 167195, 1919; A. Zelencyek, *Canadian Pat. No.*, 215478, 1922; V. Lenher and F. M. Dorsey, *U.S. Pat. No.* 1423231, 1922; S. Hiller and L. A. Clarke, *ib.*, 1465131, 1923; M. T. Saunders, *Chem. Met. Engg.*, **28**, 541, 1923; A. B. Ray, *ib.*, **28**, 977, 1923; W. L. Jordan, *U.S. Pat. No.* 1448846, 1923; N. Suzuki, *Japan Pat. No.* 40529, 1921; N. K. Chaney, *Trans. Amer. Electrochem. Soc.*, **36**, 91, 1919; *Amer. Chem. Eng.*, **28**, 19, 1920; N. K. Chaney, A. B. Ray, and A. S. John, *Journ. Ind. Eng. Chem.*, **15**, 1244, 1923; J. C. Philip, S. Dunnill, and O. Workman, *Journ. Chem. Soc.*, **117**, 362, 1920; K. Soheringa, *Pharm. Weekbl.*, **57**, 348, 1920; L. F. Hawley, *Journ. Ind. Eng. Chem.*, **13**, 301, 1921; F. H. Carr, *Journ. Soc. Chem. Ind.*, **38**, 468, E, 1919; E. G. R. Ardagh, *ib.*, **40**, 230, T, 1921; L. le W. Hamon and T. H. Byrom, *Brit. Pat. No.*, 197971, 1921; F. E. Bartell and E. J. Miller, *Journ. Amer. Chem. Soc.*, **44**, 1866, 1912; **45**, 1106, 1923; F. Bonnett, *Amer. Chem. Age*, **31**, 327, 1923; V. F. Gloag, *Chem. Age*, **10**, 260, 1924; O. Ruff, S. Mugden, E. Hohlfeld, and F. Feigh, *Koll. Zeit.*, **32**, 225, 1923; R. Alder, *British Pat. No.* 202639, 1923; L. H. Bonnard, *ib.*, 199751, 1921; J. E. Teeple and P. Mahler, *Journ. Ind. Eng. Chem.*, **16**, 498, 1924; E. R. Sutcliffe, *Journ. Soc. Chem. Ind.—Chem. Ind.*, **43**, 635, 1924; R. A. Demme, *U.S. Pat. No.* 1479851, 1924; J. C. Morrell, *ib.*, 1478985, 1923.

³ J. A. Taff, *Science*, (2), **23**, 696, 1906; E. T. Dumble, *Trans. Amer. Inst. Min. Eng.*, **29**, 546, 1899; G. vom Rath, *Neues Jahrb. Min.*, **i**, 274, 1880.

⁴ T. Lambert, *Bone Products and Manures*, London, 1901; W. Friedberg, *Die Verwertung der Knochen auf chemischen Wege*, Wien, 1901; N. Gräger, *Dingler's Journ.*, **206**, 472, 1872; G. Hoppe, *German Pat.*, *D.R.P.* 195188, 1906; G. Banfi, *ib.*, 168034, 1904; M. Takahashi, *Pharm. Centr.*, **47**, 707, 1906; O. Ruff, *Koll. Zeit.*, **32**, 225, 1923; F. E. Bartell and E. J. Miller, *Journ. Amer. Chem. Soc.*, **44**, 1866, 1922; **45**, 1106, 1923; P. M. Horton, *Journ. Ind. Eng. Chem.*, **15**, 519, 1923; O. Cordel, *Chem. Ztg.*, **4**, 169, 1880; B. E. R. and J. A. R. Newlands, *Journ. Soc. Chem. Ind.*, **7**, 419, 1888; J. Piltner, *Biedermann's Centr.*, **198**, 1879; C. Thumb, *German Pat.*, *D.R.P.* 12500, 1880; H. Eisfeld and C. Thumb, *Bavarian Pat. No.* 40, 1870; C. Krieger, *Dingler's Journ.*, **226**, 603, 1877; T. L. Patterson, *Journ. Soc. Chem. Ind.*, **22**, 608, 1903; C. H. Hall, *Journ. Ind. Eng. Chem.*, **14**, 18, 1922.

⁵ J. B. A. Dumas, *Traité de chimie appliquée aux arts*, Paris, **1**, 441, 1828; G. L. Cabot, *Journ. Soc. Chem. Ind.*, **18**, 128, 1894; R. Irvine, *ib.*, **13**, 131, 1894; R. Furness, *Chem. Age*, **8**, 532, 1923; R. O. Neal, *Chem. Met. Engg.*, **23**, 729, 785, 1920; L. F. Hawley, *Journ. Ind. Eng. Chem.*, **13**, 301, 1921; H. Berger and F. Wirth, *German Pat.*, *D.R.P.* 92801, 1896; A. Schneller and W. J. Wisse, *ib.*, 74270, 1893; F. Morani, *ib.*, 141884, 1901; J. Machtoif, *ib.*, 194301, 194939, 1905; G. Wegelin, *ib.*, 201262, 1907; 105633, 1898; 114220, 127467, 1899; 179179, 1903; 202118, 1907; F. Meiser, *ib.*, 203711, 1906; R. Thalwitzer, *ib.*, 119830, 1899; H. Köhler, *Die Fabrikation des Russes und der Schwärze*, Braunschweig, 1912; H. Oishi, *Pharm. Journ.*, (3), **14**, 166, 1884; H. Moissan, *Le four électrique*, Paris, 1897; London, 1904; *Compt. Rend.*, **110**, 276, 951, 1890; **113**, 19, 1891; *Ann. Chim. Phys.*, (7), **8**, 289, 1896; (7), **18**, 343, 1899; M. Berthelot, *ib.*, (4), **19**, 425, 1870; *Bull. Soc. Chim.*, (2), **12**, 4, 1869; (2), **16**, 237, 1871; *Compt. Rend.*, **73**, 494, 1871; *Les matières explosives d'après la thermochimie*, Paris, **1**, 109, 1883; M. Berthelot and P. Petit, *ib.*, (6), **18**, 80, 1889; M. Berthelot and G. André, *ib.*, (6), **26**, 364, 1892; H. Braconnot, *Ann. Chim. Phys.*, (2), **34**, 53, 1826; L. J. E. Hubon, *Brit. Pat. No.* 7139, 1898; C. S. Bradley, *U.S. Pat. No.* 1396018, 1921; B. W. Bumbarger, *ib.*, 1401737, 1401738, 1921; B. Thieme, *Elektrotech. Zeit.*, **34**, 592, 1913; P. Honig, *Chem. Weekbl.*, **19**, 259, 1922; W. K. Lewis, *U.S. Pat. No.* 1418811, 1922; H. J. Masson, *ib.*, 1418385, 1922; C. Matlock, *ib.*, 1438542, 1922; J. W. Martin, *ib.*, 1477511, 1923; C. S. Bradley, *ib.*, 1396018, 1922; W. H. Frost, *ib.*, 1438032, 1922; L. Wickenden, *ib.*, 1447452, 1923; J. J. Jakowsky, *Journ. Franklin Inst.*, **195**, 123, 1923; G. S. J. Perrott and R. Thiessen, *Journ. Ind. Eng. Chem.*, **12**, 324, 1920; R. O. Neal and G. S. J. Perrott, *Carbon Black—its Manufacture, Properties, and Uses*, Washington, 1922; R. O. Neal, *Chem. Met. Engg.*, **22**, 358, 1920; K. Miyake, *Japan Pat. No.* 40301, 1921; H. E. Brown, *Brit. Pat. No.* 167740, 1921; R. H. Brownlee and R. H. Uhlinger, *U.S. Pat. No.*, 1478730, 1923; H. H. Lowry, *Journ. Amer. Chem. Soc.*, **46**, 824, 1924; H. H. Lowry and S. O. Morgan, *ib.*, **46**, 846, 1924.

⁶ E. G. Acheson, *Journ. Franklin Inst.*, **164**, 375, 1908; *German Pat.*, *D.R.P.* 191840, 21821, 1907; *U.S. Pat. No.* 843426, 844989, 1906; *Electrochem. Met. Ind.*, **5**, 452, 1907; H. Freundlich *Zeit. phys. Chem.*, **57**, 468, 1906; W. R. Whitney and A. Straw, *Journ. Amer. Chem. Soc.*, **29**, 320, 1907; T. Svedberg, *Ber.*, **39**, 1713, 1906; S. Goldberg, *Zeit. Koll.*, **30**, 230, 1922; P. C. L. Thorne, *ib.*, **31**, 119, 1922; *Journ. Chem. Soc.*, **109**, 202, 1916; H. Lachs, *Journ. Phys. Rad.*, **3**, 125, 1922; *Iszyjazzd. Chem. Polskich*, **31**, 1923.

§ 8. The Physical Properties of the Different Forms of Carbon

The clearest and most nearly colourless diamonds without flaws, are most prized as *diamonds of the first water*; ¹ these usually come from India or Brazil. The Cape diamonds usually have a very faint yellow colour, and in consequence, do not command so high a price. An intense coloration combined with transparency is comparatively rare. The commonest colour is yellow, then follow green, red, and blue or violet. The celebrated Hope diamond is blue. C. Doelter attributed the coloration to the presence of the oxides of iron, chromium, manganese, and titanium, which *als inter moleculäre Pigmente vorhanden sind*. Hydrocarbons may also give rise to a yellowish coloration. According to A. des Cloizeaux, some diamonds show a play of colours like the opal. Deep-black diamonds with a brilliant lustre come from Borneo. There is also *le diamant noir* or carbonado. The cloudy diamonds of a lead-grey colour are called boart.

Thin laminae of graphite are opaque. The lustre may be dull and earthy, or bright and metallic with intermediate varieties. The colour of dense aggregates varies from an iron-black to a lead-grey. ² H. Moissan found that the graphite derived from molten platinum is deep grey and paler than that from cast iron. H. N. Warren said that graphite from cobalt and nickel is scarcely to be distinguished from lampblack; that from iron is in large plates; that from manganese is in the form of brown plates, and that from ferromanganese is also in brown scales; that from chrome iron is paler and harder than that from iron; and that from chromium resembles silicon. G. Rousseau said that the graphite from acetylene is in black microscopic plates; and P. and L. Schützenberger, that the graphite from cyanogen is a greyish-black, voluminous, filiform powder. The so-called amorphous carbon is an odourless, tasteless, voluminous, black or brownish-black powder which may or may not have a lustre. W. G. Mixer ³ said that the amorphous carbon prepared from acetylene is porous and without lustre. T. L. Phipson said that the carbon prepared by the action of magnesium on sodium carbonate is black and resembles charcoal.

According to Pliny's description, ⁴ the crystals of adamas are "hexangular and hexahedral; they are doubly turbinated, running to a point at both extremities; and, marvellous to say, they closely resemble two cones united at the base." This would apply to the crystals of quartz. The crystals of the diamond belong to the cubic system, and they are often octahedral in habit. There are rhombic dodecahedral, and hexakis-octahedral forms; the cube with rounded edges is also represented. Tetrahedral forms are also known. In Fig. 10, *A, C, G*, represent selected crystals of Brazilian diamonds; and *B, D, E, F*, selected crystals of South African diamonds. Many of the crystals are well-developed on all sides, so that they must have grown while freely suspended in some medium; their edges are not always

FIG. 10.—Selected Native Crystals of Diamonds.

sharp, but are more or less rounded. The rounded octahedral form is exhibited by the Victoria diamond. Many octahedra have a groove or furrow in place of the octahedral edge. This may be due to some peculiarity in their growth, or it may be an effect of twinning. If a supplementary twin of two tetrahedra have their projecting corners truncated by faces of the inverse tetrahedron, the twin crystal will have the appearance of an octahedron with grooved edges. Twinned crystals are flattened parallel to the twin-plane of an octahedral face as in magnetite. Twinned rhombic dodecahedra are often lenticular. J. R. Sutton found that 1 to 5 per cent. of the diamond crystals of the Kimberley mines are twinned. The faces often show special markings; the octahedral faces may have pits triangular in outline; and cubic faces, pits square in outline. H. R. Göppert also noted that pits with hexagonal outlines are very rare. J. R. Sutton has described overgrowths on the diamond.

Diamonds also have inclusions and cavities. Gaseous or liquid inclusions, observed by D. Brewster, E. Söchting, etc., are not common. H. C. Sorby, and G. A. Kenngott found inclusions of different tints. J. B. A. Dumas, and H. Behrens observed titanite oxide; A. Damour, topazes; E. Cohen, ferric oxide; P. Harting, pyrites; G. Delafosse, and A. des Cloizeaux, gold; and D. Brewster, G. Rose, A. Petzholdt, and C. and G. Friedel, carbonaceous matters. H. R. Göppert imagined that he could detect vegetable debris in diamonds, but this has not been confirmed. According to E. Regener, the scintillation of the diamond is connected with its colour, which in turn is conditioned by impurities. H. Moissan observed carbon inclusions in artificial diamonds obtained from a soln. of carbon in iron; and also some gold in *les diamants noirs* obtained from a soln. of carbon in silver. J. R. Sutton

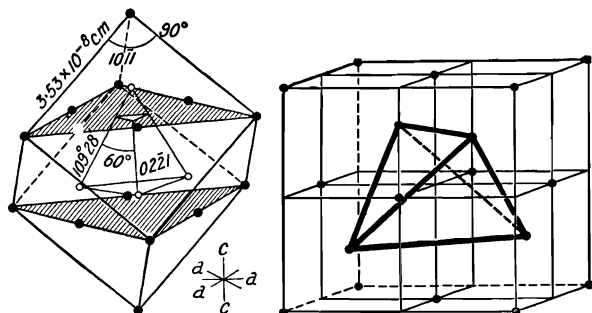

FIGS. 11-12.—Space Lattice of Diamond (P. Debye and P. Scherrer).

studied the macle formed by carbon particles in the middle of the crystals; and noted inclusions of garnet, ilmenite, olivine, pyrite, mica and zircon in diamonds.

W. H. and W. L. Bragg,⁵ and A. W. Hull found that the **X-radiogram** of the diamond corresponded with a lattice with carbon atoms arranged on two interpenetrating face-centred cubic lattices, Fig. 11, so that each carbon atom of the one is

surrounded by four carbon atoms belonging to the other; and links can be drawn from atom to atom, so that each carbon atom is connected with the four carbon atoms which surround it symmetrically in the manner of a tetrahedron, Fig. 11. The sides of the elementary cube are 3.53×10^{-8} cm., and the diagonal 6.12×10^{-8} cm., Fig. 12. The *a*-axis is 2.50×10^{-8} cm., the *c*-axis 3.06×10^{-8} cm., and $a:c=1:1.23$. The closest approach of the atoms in the lattice is 1.50×10^{-8} cm. The subject has been studied by P. N. Pease, A. W. Hull, F. Rinne, E. Q. Adams, E. Mohr, and M. L. Huggins—*vide infra*, graphite.

Graphite may occur in granular, dense, earthy masses when it is soft and friable. It then lacks a definite external crystalline form, and is known as *amorphous, compact, or earthy graphite*. The so-called amorphous graphite was described by J. N. von Fuchs, F. von Sandberger, and W. Luzi. H. Moissan in his syntheses of graphite, found that some amorphous graphite accompanied the crystalline form; and he found that by press., crystals of graphite acquired the appearance of a fused or vitreous mass. It also occurs embedded in foliated masses, and micaceous, columnar, radiated, or fibrous aggregates of imperfect crystals. Each aggregate of *scaly, lamellar, or flaky graphite* is composed of thin foliated plates of fairly uniform

width and ranging up to about 10 cm. in length. Foreign matters may be distributed through the structure and appear as thin films on the surface of the graphite. Well-formed crystals of graphite are rare, and they are nearly always six-sided, tabular, and striated with indistinct faces. The best crystals are usually found in meteorites and in granular crystalline limestones. R. Jameson, F. Mohs, C. F. Naumann, C. Czeck, B. Walter, referred to crystalline graphite as rhomboidal graphite; and R. J. Haüy said that *la forme primitive est un prisme hexaèdre régulier*. H. Erdmann found that the graphite obtained from the naphthalene derivatives furnishes hexagonal crystals, and H. Moissan obtained hexagonal plates from the soln. of carbon in platinum. Pseudomorphs after pyrite have been reported, and L. Fletcher obtained a crystal from the meteorite of Crosby Creek, West Australia, which he regarded as a modification of regular hexagonal graphite, but is more probably a pseudomorph of granite to the diamond. A. E. Nordenskjöld, G. A. Suckow, and W. B. Clarke regarded the crystals of graphite as monoclinic, and gave for the axial ratios $a : b : c = 0.7069 : 1 : 0.5089$, and $\beta = 88^\circ 14'$; and P. Groth (1882) calculated from C. F. Naumann's measurements $a : b : c = 0.5806 : 1 : 0.5730$, and $\beta = 71^\circ 16'$. Later, however, P. Groth accepted G. A. Kenngott's view that the crystals belong to the rhombohedral section of the hexagonal system, and gave for the trigonal crystals $a : c = 1 : 1.3859$. H. Sjögren, and P. P. Ewald believe that the crystals belong to the hexagonal system. P. P. Ewald based his opinion on the X-radiogram, but P. Debye and P. Scherrer showed that a mistake had been made. The view that the crystals are trigonal is now generally accepted. The difficulty in fixing the crystal system arose because of the scarcity of satisfactory samples. For the possible existence of a *polymorphic form of diamond* above 1885° , *vide supra*, the action of heat on the diamond.

J. Beckenkamp has discussed the space lattice, and M. L. Huggins, N. H. Kolkmeijer, P. Debye and P. Scherrer, F. P. Worley, and D. Coster the **electronic structure** of the diamond molecule. A. Landé assumed that cohesion in crystals depends on the electrostatic attractions and repulsions between the stationary atomic nuclei, and the moving electrons. The effect of homogeneous atoms on one another when the electronic motions are executed with equal periods is dependent on orbital differences of the electronic motions. Were the phases of the different atoms distributed according to probability, the average force between two atoms over a period would change by chance from place to place, and no regular crystal lattice could result; but rather would a structure with changing mol. distances result, and the density would be irregularly distributed owing to the slow fluctuations in consequence of the alterations of phase. Hence, *the regular structure of monatomic crystals shows that all like atoms have the same phase; or that at every instant, not only the atomic nucleus, but also the corresponding electrons of all like atoms form a lattice, which oscillates about the stationary lattice of the atomic nuclei*. A. Landé further showed that in the free state, the real vol. of the carbon atom is deformed in a definite manner by the neighbouring atoms. H. Thirring also discussed this subject.

A. W. Hull, P. Debye, M. L. Huggins, and P. Scherrer found the X-radiogram of graphite agreed with the trigonal system; and, assuming the sp. gr. 2.2, it appears that the graphite mol. contains eight atoms arranged in parallel planes, at distances 3.41×10^{-8} cm. apart; W. H. and W. L. Bragg gave 3.42×10^{-8} cm., Fig. 13. The a -axis is 2.52×10^{-8} cm., the c -axis is 5.11×10^{-8} cm., and $a : c = 1 : 2.03$. The nearest approach of the atoms is 1.50×10^{-8} cm. In each plane, the carbon atoms lie at the corners of a regular hexagon so grouped that three alternating corners of the hexagon are occupied by carbon atoms in the plane \odot , Fig. 14, then the three other corners would be occupied by the plane

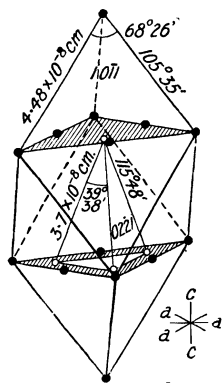

FIG. 13.—Space Lattice of Graphite (P. Debye and P. Scherrer).

○, Fig. 14 above; and the centre of the hexagon in *p* (not occupied) would be vertically beneath one of the corners of the hexagon in ⊗, Fig. 14. The three planes are illustrated by Fig. 14 for atoms which do not lie one above the other. The atoms in the same plane are represented by the same symbol, and those in different planes by different symbols.

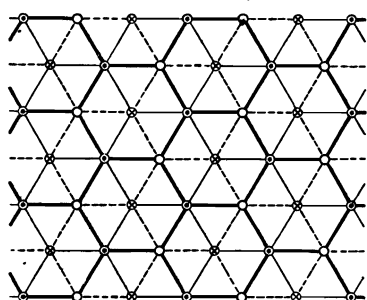

FIG. 14.—Arrangement of Atoms in Graphite.

The side of this hexagon has a length 1.45×10^{-8} cm. While the elementary parallelepiped of the diamond is a cube, that of graphite is a rhomboid; the horizontal projections of both these bodies are hexagons. If the cube has one diagonal placed vertically, and the rhomboid is lying on its face, the hexagonal projections are the same. Hence, the ratio of the diagonals of the rhomboid to that of the cube should be the same as the ratio of the density of graphite to that of the diamond. This ratio is $2.2 \div 3.52 = 0.62$, the calculated values for the diagonals is $6.12 \div 10.22 = 0.598$. The agreement is satisfactory, but would be closer if H. Moissan's value 2.11 were taken for the sp. gr. of graphite.

In the graphite mol., therefore, each carbon atom is coupled with three others in the (111)-plane, all at the same distance and relatively eq.; but the distance from the fourth carbon atom in the plane (above or below) would be greater, and that coupling would be weaker. The weakness of the fourth coupling is shown by the ease with which graphite undergoes cleavage. In the diamond, however, the mol. is perfectly symmetrical, and the four valencies are rigorously the same. While W. H. Bragg holds that the layers of atoms in the lattices of graphite and the diamond are puckered, Fig. 15, P. Debye assumes that the layers are flat. The structure of graphite was also studied by M. L. Huggins. According to W. H. Bragg, it is probable that the benzene and naphthalene rings have a concrete structure in organic compounds. He said:

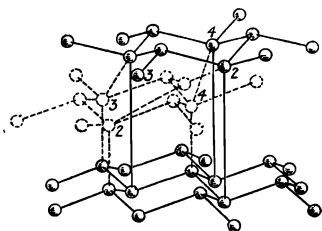

FIG. 15.—Lattices of Graphite (continuous lines), and of Diamond (lower continuous and middle dotted lines).

The X-radiograms of the diamond show that the atoms are probably tied together so that each is at the centre of gravity of four others. The distance from centre to centre is 1.54 Å. The rigidity of the diamond and the open character of its structure, imply that great force is required to alter the orientation of any coupling with respect to the other three belonging to the same atom. Were it otherwise, all atoms would seek to be surrounded by as many neighbours as possible; the substance would be close-packed, and its density would be more than double what it is. The structure of the diamond may also be looked on as consisting of a series of puckered layers parallel to a given tetrahedral plane. A sharp blow may cleave the diamond, along one of these layers. If we take a model showing two layers as in graphite, lay hold of the upper layer, and move it to the new position shown in Fig. 15; the structure is now that of diamond. The bottom and second (dotted) lines of Fig. 15 show the diamond as a series of puckered layers parallel to the perfect cleavage planes, which lie perpendicular to the four triad axes which emerge from the corners of the cube. The structure of graphite is obtained by shifting one of two parallel layers from the position of the dotted lines to that of the continuous lines. According to A. W. Hull's measurements, the shortest distance between each pair of atoms lying in the same layer is shortened from 1.54 Å.—the diamond spacing—to 1.50 Å. The distance between two successive layers has been increased by 1.35 Å. A carbon atom in one layer is now at equal distances from its three nearest neighbours in the next layer, the distance being 3.25 Å. The bonds between one layer and the next are now greatly weakened; the substance cleaves readily in thin flakes. One layer slides with great ease over the other, though the bonds between the atoms in any layer are at least as strong as before. When all the bonds are of the strong kind, as is assumed to be the case with the diamond, the substance will be very hard, and the diamond is the hardest thing known. When the one set of bonds has been weakened, the substance is softer, as is assumed to be the case with graphite which is used as a lubricant. Probably its efficiency as such depends both on the weakness of the one

net of bonds and the strength of the other. Yet these new bonds are perfectly definite, and the distance between two layers—the distance 3.25 Å. between atomic centres—is a perfectly constant and determinate quantity. If the strong bonds between the atoms in a layer remain, and are even drawn a little tighter as occurs when the graphite form replaces that of diamond, it seems very reasonable to suppose that the single ring or multiple rings which are so clearly to be distinguished in the network may be separated out as such without loosening the bonds between their component atoms. In fact, these latter bonds might be expected to tighten even a little more.

H. le Chatelier raised the question whether the so-called amorphous carbon is really non-crystalline. He said :

Un corps réellement amorphe est un corps dans lequel il n'existe certainement aucune orientation d'aucune propriété physique comme le verre, les liquides ordinaires, les résines, les gélatines, etc. Dans le cas du carbone, corps opaque, souvent pulvérulent, nous n'avons aucun moyen de constater la présence ou l'absence d'une orientation cristalline, toute affirmation à ce sujet est une hypothèse purement gratuite, dépourvue de toute valeur scientifique.

P. Poch found that the X-radiograms show that carbon derived from cyanogen has a more finely crystalline structure than carbon derived from carbon monoxide. P. Debye and P. Scherrer, and G. Asahara showed that the X-radiograms of amorphous carbon give the same interference figures as are obtained with graphite, and therefore suggest that amorphous carbon differs from graphite only by its greater degree of subdivision. Amorphous carbon is graphite in an extremely fine state of subdivision which has not broken up the mol. Hence, they conclude that the diamond and graphite are the only two known modifications of carbon. This view is in harmony with the ideas of P. Groth. P. Poch likewise found the carbon obtained by decomposing cyanogen in the electric spark to be crystalline. The mol. of amorphous carbon need not contain more than thirty atoms, and the grouping would be as in graphite—three atoms lying in the same plane symmetrically with a centre (not occupied), and coupled by equal valencies, while the fourth atom is vertically above or below that plane and held by a weaker valency. The four valencies of carbon are usually considered to be eq., but the existence of tervalent carbon in triphenylmethyl, $C(C_6H_5)_3$, shows that the four valencies are not strictly eq. P. Debye and P. Scherrer suggest that graphite or amorphous carbon forms the prototype of the aromatic compounds characterized by the benzene ring or hexagon, while the diamond is the prototype of the aliphatic or fatty acid series. J. Beckenkamp studied the space-lattice of graphite, and M. L. Huggins, the relation of the space-lattices to the cleavages of graphite and the diamond. E. Ryschkewitsch said :

The atomic configuration of graphite is characterized, like that of the metals, by the presence of free electrons which make it a good conductor of heat and electricity and confer on it its metallic lustre. Graphite is a better conductor of electricity than mercury, and a better conductor of heat at high temp. than many pure metals; it resembles metals in not being soluble without change in any solvents except liquid metals, and it yields positive C^{\dots} -ions in sufficient conc. to be electromotively active.

V. Kohlschütter confirmed P. Debye and P. Scherrer's view of the similarity in the constitution of graphite and amorphous carbon. He showed that the physical and chemical properties of graphite vary within such wide limits that no distinct line of demarcation can be drawn between graphite on the one hand and amorphous carbon or soot on the other; and he concluded that all varieties of graphite and amorphous carbon are different physical forms of "black carbon," which is to be regarded as an allotropic modification of diamond. The properties of different samples of graphite depend on the conditions under which it is produced, and its variable character is to be attributed to different degrees of dispersity. V. Kohlschütter added that graphite owes its peculiar properties to its lamellar structure. This type of structure not only accounts for its special physical properties, but also for many chemical properties, such as its resistance to oxidation and to reagents, and for the fact that its formation is favoured when free carbon is produced by a surface reaction. The difference between the densities and heats of combustion of graphite,

and amorphous carbon is not opposed to the theory that they are essentially the same form of carbon. The formation of graphitic acid by the oxidation of graphite, but not of amorphous carbon, is due to the peculiar structure of the former and not to the existence of a distinct graphite mol. G. Asahara's observations on the X-radiograms of graphites and amorphous carbons lead to the conclusion that the term "amorphous" should be replaced by the term "very minutely crystalline."

According to H. Lachs, the ultramicroscopic image of colloidal carbon contains a considerable number of very brilliant stationary particles and a smaller number of fine particles that show a slight Brownian movement. Scattered through the entire field are also some very brilliant particles which show pronounced scintillations. This is due to the shape of the particles. If they are rods or plates the amount of light dispersed varies with the orientation of the particle, thus causing sparkling. This phenomenon may be considered as a kind of *ultramicroscopic anisotropy*.

The **cleavage** of the diamond is perfectly parallel to the faces of the octahedron; and this property enables the diamond cutters to chip away projecting corners and inferior parts without the labour of grinding. The fracture is conchoidal. R. Scharizer, and G. Wulff have discussed the cleavage of the diamond from the point of view of the X-radiogram. The cleavage of graphite is basal and perfect like that of mica, furnishing thin folia. The diamond was the hardest substance known to the ancients and it was made the standard, 10, on Mohs' scale of **hardness**; likewise also on J. R. Rydberg's scale.⁶ On F. Auerbach's scale, the hardness of the diamond is 2500; corundum, 1150; quartz, 308. The hardness of the diamond enables it to scratch the ruby or corundum. Until recently, it was said that the diamond would cut all other substances and not be cut by any. H. Moissan showed that carbon boride cuts slowly into the diamond, and titanium carbosilicide is almost as hard as transparent diamond. Besides carbon boride, the ruby is scratched by many carbides, silicides, nitrides, borides, and carbosilicides. A variety of boart is superior in hardness to the diamond. The so-called anthracitic diamond of C. de Douhet is of adamantine hardness. Australian and Bornean stones are usually considered hardest. Owing to its hardness, a cut diamond does not show any signs of wear. Many fabulous stories about the hardness of the diamond were rife during the Middle Ages; these were based on Pliny's account of the indestructibility of the diamond. Pliny said that "when struck by a hammer, it returns the blow shattering both hammer and anvil." It was said that the hardness could be overcome by the use of goat's blood, especially if the goat had previously drunk wine or eaten parsley. These tales were rejected by A. B. de Boot in 1609. The brittleness of the diamond is very great, so that in spite of its great hardness, it can be readily pulverized by fracture along the cleavage planes; and use is made of this quality in the preparation of diamond powder for use in the lapidary. The hardness of graphite on Mohs' scale is 0.5 to 1.0; consequently, while the diamond is the hardest of the minerals, graphite is one of the softest. G. A. Kenngott mentioned a variety as hard as gypsum. It leaves a black mark on paper, and owing to this quality it is extensively employed in the manufacture of lead-pencils. Hence the name *graphite*—*vide supra*, the history of graphite. F. Monier, and A. V. Rakowsky have discussed the hardness of the different kinds of carbon.

R. Boyle,⁷ in 1690, found the **specific gravity** of the diamond to be 2.955, and in a table of sp. gr. he gave the value 3.4. The reported values for sp. gr. range from 3.336 of V. A. Jacquelin to A. Liversidge's 3.5585. The values of E. H. von Baumhauer range from 3.5065 to 3.5242, or corrected, 3.50307 at 9°/7.5°, and 3.52063 at 8°/8° respectively. The average may be taken as the best representative value; L. Playfair gave 3.46. Other determinations have been made by L. E. Rivot, P. A. Dufrenoy, W. J. Grailich, A. Schrauf, H. Moissan, Y. Tadokoro, A. Wigand, F. Feilitzsch, G. F. Kunz, M. J. Brisson, F. Mohs, J. J. Berzelius, A. Schafarik, T. Thomson, and E. Donath and J. Mayrhofer. E. Wülfing found the sp. gr. of four high-grade stones varied from 3.524 to 3.530; and, combining these values with those of E. H. von Baumhauer, there results 3.520 ± 0.02 at 4°. Impure diamonds

sometimes give relatively high values. A. von Schrötter found sixteen varieties had a sp. gr. ranging from 3·51058 to 3·51947, average 3·51432; and he represented the sp. gr. of the diamond at a temp. of θ° by $3\cdot51432 + 0\cdot00065\theta$. H. Fizeau found that the sp. gr. attains a minimum value at $-38\cdot8^\circ$, *vide* thermal expansion. Values for carbonado range from L. E. Rivot's 3·012 to 3·416; E. H. von Baumhauer's extremes are 3·1552 and 3·5111, or, corrected, 3·15135 at $13^\circ/11\cdot1^\circ$, and 3·50652 at $14^\circ/11\cdot5^\circ$ respectively. The values for boart range from 3·47 to 3·56; E. H. von Baumhauer's extremes are 3·5030 to 3·5100, or, corrected, 3·49806 at $14^\circ/12\cdot5^\circ$, and 3·50383 at $9^\circ/7\cdot5^\circ$ respectively. E. Cohen and J. Olie found the sp. gr. of the diamond referred to water at 4° , is 3·519 at $+163\cdot6^\circ$; 3·510 at -38° ; and 3·514 at 18° . T. W. Richards, and E. Peterson gave 3·4 for the at. vol. of diamond carbon.

Reported values for the sp. gr. of graphite range from C. Mène's⁸ 1·885 for a sample from Terrenoire, to his 2·585 for a sample from Cumberland. There is considerable doubt about the higher values for amorphous carbon and the lower values for graphite, since mixtures of the two forms may be involved. L. Playfair gave 2·29 for the best representative value; H. le Chatelier and S. Wologdine gave 2·255 at $15^\circ/4^\circ$ for natural graphites after purification and compression; H. Moissan gave 2·11; while 2·2 is often adopted. M. Debeaupuis gave 1·99 to 2·38; and C. de Douchet, 1·66 for what he called anthracitic diamond from Brazil. R. M. Burns and G. A. Hulett gave 2·20 for the best representative sp. gr. of pure natural graphite, and 2·30 for Acheson-graphite. Graphite produced by the explosion of graphitic acid has a sp. gr. 2·215. The ordinary graphites showed no "drift" or increase in weight with time after immersion in the liquid used in the density determinations. This phenomenon—*drift* as it is called—was studied by H. E. Cude and G. A. Hulett. M. Pirani and W. Fehse found that the sp. gr. of Ceylon graphite fell from 2·26 to 2·18 after calcination at 3000° , and they attributed this to the loss by volatilization of ferruginous impurities, because the ash obtained with graphite calcined to 500° was one per cent., the ash after calcination to 1800° was 0·66; and to 2200° , 0·36; to 2700° , 0·20; and to 3000° , 0·07 per cent. F. Sauerwald made observations on this subject. W. C. Arsem found that after heating to 3300° , the sp. gr. of lampblack was 2·07 to 2·10; of anthracite, 2·13 to 2·18; retort carbon, 2·11 to 2·26; and the diamond, 1·915. Determinations have also been reported by J. N. von Fuchs, J. J. Berzelius, J. Y. Tadokoro, L. Cellier, C. J. B. Karsten, J. C. Poggendorff, G. A. Kenngott, B. C. Brodie, J. Löwe, H. V. Regnault, C. F. Rammelsberg, W. Luzi, H. Moissan, M. Diersche, and A. Wigand. E. Cohen and J. Olie gave for the sp. gr. of graphite, referred to water at 4° , 2·223 at $-163\cdot6^\circ$; 2·217 at -38° ; and 2·216 at -18° . The at. vol., according to E. Petersen, is 5·3, and, according to T. W. Richards, 5·4. E. Ryschkewitsch and E. Köstermann gave $2\cdot232 \pm 0\cdot0013$ at 16° for the sp. gr. of graphite which had been fused.

The sp. gr. of the so-called amorphous carbon has been determined by numerous observers, and values ranging from 1·45 for poplar and vine charcoals by G. Werther⁹ to A. Frank's value 2·0 for acetylene black have been given. W. G. Mixer gave 1·919 for acetylene black. A. Titoff gave for cocoanut charcoal 1·860, and I. F. Homfray, 1·670. L. Playfair gave 1·87 for the best representative value. H. Violette, W. Hallock, W. Luzi, C. Mène, W. G. Mixer, A. Frank, A. Baudrimont, E. Monier, A. Wigand, L. Playfair, Y. Tadokoro, and F. Exner have made observations on the sp. gr. of amorphous carbon—*vide infra*, Table VI. H. le Chatelier and S. Wologdine gave for lampblack, sugar charcoal, and wood charcoal purified by chlorine and pressed, 1·70 to 1·80. The values for gas carbon range from 1·7 to 2·6. L. Meyn gave for gas-carbon from different parts of the retort the values 1·723, 1·821, 1·982, 2·056, and 2·556 at 18° . The samples with the higher values were probably mixtures with more or less graphite. H. E. Cude and G. A. Hulett showed that the determination of the sp. gr. of charcoal is complicated by a gradual penetration of the liquid into the grains of the solid so that the sp. gr. increases with the time of immersion in the liquid. Thus, the sp. gr. of samples of charcoal after 15 min. immersion in water was 1·829, and after 119 hrs.'

immersion, 1.854; with 15 min. immersion in carbon disulphide, 1.915, and after 362 hrs.' immersion, 1.984; after 15 min. immersion in benzene, 1.734, and after 286 hrs.' immersion, 1.797; and after 15 min. immersion in carbon tetrachloride, 1.596, and after 2856 hrs.' immersion, 1.647. S. McLean gave 1.48 to 1.58 for the sp. gr. of cocoanut charcoal; 1.32-1.35 for lignite carbonized at 350°; at 450°, 1.45 to 1.47; and at 550°, 1.42 to 1.47. H. L. Buff estimated that the **specific volume** of bivalent carbon in combination is greater than that of quadrivalent carbon. Observations were also made by M. Schalfjeff. For the **atomic volume** of carbon, T. E. Thorpe gave 11.0, and E. Petersen, 6.7 to 8.0. R. N. Pease calculated 0.77 Å. for the atomic radii of the atoms in the diamond. T. Graham, and A. Zott discussed the porosity, or rather the permeability of graphite to gases. Owing to the inaccessibility of the surface to liquids when determining the sp. gr. of charcoal, A. W. Williams estimates that the results are low. A specimen with an observed sp. vol. of 0.51 was estimated to have a true sp. vol. of 0.67 c.c. per gram. L. Bell and P. R. Bassett believed that they succeeded in **disintegrating carbon atoms** into helium, etc., by using very powerful carbon arcs. The inference was based on the spectral observations of the "negative tongue" of the arc.

L. H. Adams¹⁰ and co-workers gave 0.18×10^{-6} for the **compressibility**, β , of the diamond between 0 and 10,000 megabars press. J. J. Thomson obtained a similar value from his theory of the structure of solids. T. W. Richards gives for the mean change of volume 0.5 unit between 100 and 500 megabars per megabar (0.987 atm.). He found the average compressibility of the diamond to be very small, 0.5×10^{-6} megabars, and for graphite he gave the compressibility 3.0×10^{-6} at 20° between 100 and 500 megabars. L. H. Adams gave 0.16×10^{-6} megabars for the compressibility of the diamond, and J. J. Thomson calculated 0.178×10^{-6} from his electron theory. According to W. Spring, graphite agglomerates under press., and H. Moissan showed that when prepared under press., the sp. gr. of graphite can be raised to 2.35. K. Försterling studied the relation between the elastic constants and the sp. ht. of the diamond. A. Landé calculated the compressibility of the diamond from the heat of sublimation, the mol. vol., and assumption as to the space-lattice. A. W. Williams calculated the **attractive pressure** in the surface film on charcoal to be of the order 10,000 atm., and the **internal pressure**, 50,000 atm. J. H. Hildebrand and co-workers discussed this subject.

H. Fizeau¹¹ found that the coeff. of **thermal expansion** of the diamond is very small, but that it decreases rapidly on a **falling temp.** He found the coeff. of linear expansion, α , at different temp. to be :

	-38.8°	0°	10°	20°	30°	40°	50°
α . . .	0.0000	0.0562	0.0707	0.0857	0.0997	0.1142	0.1286

He also gave for the linear coeff. at 40°, 0.05118; and for the coeff. of cubical expansion at the same temp., 0.05354. He represented the length l at θ° , when the length at 0° is l_0 , by $l = l_0(1 + 0.0456243\theta + 0.0672385\theta^2)$. W. C. Röntgen gave 0.0000119 at 40°, for the coeff. of linear expansion. J. Joly also found that if 0.00144 denote the length of a diamond at 400°; l the length at a temp. θ° ; and 0.00342 and v the corresponding volumes,

(0.00114- l)/0.00114	580°	686°	750°
(0.00342- v)/0.00342	0.00193	0.00265	0.00338
	0.00579	0.00785	0.01014

The diamond burnt at 850°. From the marked expansion at 750°, J. Joly concluded that the diamond has been formed under press. H. Fizeau gave for the coeff. of linear expansion of graphite at 40°, 0.05786, and at 50°, 0.05796; H. Muraoka gave 0.0538 for a specimen of Siberian graphite, and 0.05095 for a sample of pencil-graphite. J. Dewar gave 0.04244 for the coeff. of thermal expansion of graphite between 17° and -190°. H. Fizeau found that coeff. of expansion of anthracite at 40° to be 0.042078; and, at 50°, 0.041996; for coal at 40°, he found 0.042782; and at 50°, 0.042811. According to J. Monckmann, the rate of expansion of carbon increases as the temp. rises to 250°, and then decreases.

The **thermal conductivity** of acetylene lampblack was found by W. G. Mixer¹² to be high. According to H. Violette, the thermal conductivity of wood-charcoal increases with the coking temp. Carbon prepared between 150° and 300° shows only a feeble conductivity, but as the temp. of production rises, the thermal conductivity—C.G.S. units—increases until it attains two-thirds the conductivity of iron. R. Weber gave for the conductivity of gas-carbon, 0·0103 at 0°; D. Forbes, 0·0₃405 below 0° for carbon; C. A. Hansen, 0·162 for graphite and 0·0162 for carbon; W. Nusselt, 0·0₃156 for charcoal; H. Hecht, 0·0₃43 for coal between 20° and 100°; and F. E. Neumann, 0·0₃297. Y. Tadokoro gave 0·00219 for the thermal conductivity of graphite; 0·00214 for charcoal; 0·00226 for coke; and 0·00099 for coal. The best representative values are taken to be 0·33 for the diamond; 0·0117 for graphite; and 0·000405 for amorphous carbon. J. M. Ordway made some observations on the conductivity of charcoal and plumbago; L. Cellier found the thermal conductivity of graphite, sp. gr. 1·698, to be 0·701; electric light carbon, 0·367 to 0·494 with the sp. gr. 1·467 to 1·567; and gas-retort carbon, 0·400, sp. gr. 1·627. A. Artom, B. Piesch, and H. Muraoka showed that different kinds of graphite have different conductivities; and M. Icole found the thermal conductivity of graphite at θ° to be $K=0\cdot0384-0\cdot0\cdot9\theta+0\cdot0\cdot93\theta^2$. S. Wologdine and A. L. Queneau studied the conductivity of plumbago or graphite bricks. R. S. Hutton and J. R. Beard found powdered retort graphite (sieved through a mesh 600 holes per sq. cm.) had a conductivity of 0·00040 between 20° and 100°. A graphite crucible is said to conduct heat five times better than a clay crucible. H. Sjörgen, and E. Jannetaz showed that the vertical axis of the crystals is the small axis of the isothermal ellipsoids.

P. A. Favre and J. T. Silbermann¹³ found the **specific heat** of the diamond to be 0·147; H. V. Regnault obtained 0·14687 between 8° and 98°; P. J. van Kerckhoff, 0·147; A. Bettendorff and A. Willner, 0·1422 to 0·1512; C. E. Carbonelli, 0·10415; A. Wigand, 0·1128 at 10·7°. F. Marcet and A. A. de la Rive, 0·1192 at 6° to 15°. H. F. Weber found for the sp. ht. of the diamond:

	-50·5°	-10·6°	10·7°	140°	247°	606·7°	806·5°	985·0°
Sp. ht.	0·0635	0·0955	0·1128	0·2218	0·3026	0·4408	0·4489	0·4589

He represented the sp. ht. of the diamond at θ° by $0\cdot0947+0\cdot000994\theta-0\cdot00000036\theta^2$; and he gave for the mean sp. ht. between 0° and θ° , $0\cdot0947+0\cdot000497\theta+0\cdot00000012\theta^2$. J. Dewar gave for the mean sp. ht. of the diamond between -18° and -78°, 0·0794; between -78° and -188°, 0·0190; and between -188° and -252·5°, 0·0043. The sp. hts. of the diamond at low temp., said J. Dewar, are less than that of any other substance so far observed. Values for the at. ht. of the diamond were computed by H. V. Regnault, and by A. Bettendorff and A. Willner. Collecting the results of W. Nernst and co-workers, F. Koref, G. Ewald, J. Dewar, and H. F. Weber, for the **atomic heat** of the diamond, and applying W. Nernst and F. A. Lindemann's formula (I. 13, 12—Fig. 8), there results:

T° K	30°	42°	92°	205°	232°	284°	413°	1160°
C _p (obs.)	0·00	0·00	0·03	0·62	0·86	1·35	2·66	5·45
C _p (calc.)	0·00	0·00	0·009	0·62	0·87	1·37	2·55	5·41
C _v (calc.)	0·00	0·00	0·009	0·62	0·87	1·37	2·53	5·19

P. A. Favre and J. T. Silbermann found the sp. ht. of natural graphite to be 0·20187 and that of graphite from iron, 0·19702; H. Kopp gave for natural graphite, 0·174, and for iron graphite, 0·166; H. V. Regnault gave for natural graphite between 0·1911 and 0·2019, and for iron graphite, 0·1977; and for graphite from tar, 0·1968. P. J. van Kerckhoff gave for natural graphite, 0·2000; Y. Tadokoro, 0·203; A. Bettendorff and A. Willner, 0·1933 to 0·2007, and for iron graphite 0·1952 to 0·1969; and H. F. Weber 0·1439 between 0° and 34°; 0·1967 between 0° and 100°; and 0·1167+0·0008 θ , between 0° and θ° ; and

	-50·3°	-10·7°	10·8°	61·3°	138·5°	201·6°	249·3°	977°	641·9°	822°
Sp. ht.	0·1138	0·1437	0·1604	0·1990	0·2542	0·2966	0·3250	0·4670	0·4454	0·4539

He also found for flaky graphite the values 0.1605 between 0° and 21.6°; 0.1904 between 0° and 99°; and 0.2350 between 0° and 225.3°. A. Magnus gave for the total heat of graphite between 0° and θ° , $Q=0.1520\theta + 3.8885 \times 10^{-4}\theta^2 - 2.885 \times 10^{-7}\theta^3 + 1.4718 \times 10^{-10}\theta^4 - 4.385 \times 10^{-14}\theta^4$. A. Wigand obtained for the sp. ht. of graphite 0.1604 at 10.8°; and W. Spring, 0.20212 to 0.20471 for Cingalese graphite. J. Violle represented the linear increase in the sp. ht. of graphite above 1000°, by $0.355 + 0.0006\theta$, between 0° and θ° ; and if the b.p. is 3600°, 2500 Cals. are evolved on cooling from that temp. to zero. J. Dewar gave for the sp. ht. of graphite between -18° and -78°, 0.1341; between -78° and -188°, 0.0599; and between -188° and 252.5°, 0.0133. W. Nernst found the sp. ht. 0.005 at -244°, and 0.027 at -186° for graphite. L. Cellier gave for the sp. ht. of graphite 0.3055; for electric light carbon, 0.2488 to 0.2667; and for gas-retort carbon, 0.2787. H. V. Regnault, H. Kopp, J. Monckman, and A. Bettendorff and A. Wüllner discussed the at. ht. of graphite.

H. V. Regnault found the sp. ht. of wood charcoal to be between 0.204 and 0.242 at 19° to 99°; for bone charcoal, 0.2608; and for gas carbon, 0.2005; J. Marcet and A. A. de la Rive gave 0.1650 for wood charcoal at 6° to 15°; P. A. Favre and J. T. Silbermann, 0.24150 for wood charcoal, and 0.20360 for gas carbon; H. Kopp gave 0.185 for gas carbon; P. J. van Kerckhoff, 0.2608; A. Bettendorff and A. Wüllner, between 0.2015 and 0.2062 for gas carbon; H. F. Weber, 0.1906 between 0° and 99°, and 0.2340 between 0° and 225.8° for dense amorphous carbon; and 0.1935 between 0° and 99.2°, and 0.2385 between 0° and 223.6° for porous wood charcoal; and A. Wigand gave 0.2040 between 24° and 68°. Y. Tadokoro gave 0.217 for charcoal; 0.201 for coke; and 0.254 for coal. Observations have also been made by D. I. Mendeleeff, K. Puschl, L. Kunz, and J. E. Pionchon. Further, L. Kunz gave for beechwood charcoal:

Sp. ht.	435°	561°	728°	925°	1059°	1197°	1297°
	0.243	0.290	0.328	0.358	0.362	0.378	0.381

J. Violle gave $0.355 + 0.00006\theta$, and hence:

Sp. ht.	0°	1000°	1500°	2000°	2500°	3000°	3500°
Mol. ht.	0.355	0.415	0.445	0.475	0.505	0.535	0.565
	4.260	4.980	5.340	5.700	6.060	6.420	6.780

L. Kunz's results were represented by the formula: sp. ht. = $0.2143 + 0.0001436\theta - 0.0_3 1975\theta^2$; or the at. ht. = $1.64 + 0.0017\theta$. J. Dewar found the value 0.32 between 20° and 1040°; and 0.42, at the temp. of the oxy-hydrogen blowpipe flame impinging on lime; at 2100°, the sp. ht. approximates 0.5. H. F. Weber stated that the sp. ht. of the different forms of carbon approaches a fixed limiting value as the temp. rises; but this J. Monckman denied, and he stated that the sp. ht. of carbon increases fairly regularly up to 250°, but above that temp. falls to one half. H. le Chatelier showed that the sp. ht. of gas carbon increases proportionately with temp., and that the increase is more than was observed by H. F. Weber. He represented the at. ht. between 0° and 250° by $1.92 + 0.0077\theta$, and between 250° and 1000° by $3.54 + 0.00246\theta$. Observations on the at. ht. have been made by H. Kopp, A. Magnus, A. Bettendorff and A. Wüllner, and G. Schmidt. G. N. Lewis and co-workers found the **entropy** of diamond carbon at 25° and one atm. press. to be 0.6, and that of graphite carbon, 1.3.

J. Violle¹⁴ estimated the **boiling point** of carbon to be 3600°; W. Crookes, about 4000°; H. Moissan, 3500°; and W. R. Mott gave 3700°, and J. J. van Laar, 4040°, for the sublimation temp. at 760 mm. The **melting point** of the diamond must be very high—over 3000°. C. Doelter noted that the corners of fragments of diamond are rounded at 2000°–2500°; but it is doubtful if the diamond can be really melted because of volatilization. The transition of amorphous carbon into graphite at high temp., and the possible fusion of graphite in the electric arc have been previously discussed. The action of heat on the different forms of carbon has been previously discussed specially, and also in connection with the synthesis of the

diamond and of graphite. C. Doelter estimates the **transition temperature**, diamond to graphite, to be near 1500°. The guesses which have been made concerning the equilibrium conditions of the different forms of carbon were illustrated by Figs. 2 and 3. The effect of press. on the transition point was calculated by A. König—*vide supra*. According to A. Smithells, if 3500°—*i.e.* 3773° K.—be taken as the b.p. of carbon, and 12 as the vap. density, it follows from Trouton's rule, $12x/3773=13$, that the **heat of vaporization** is 4086 cal. per gram, or 49,032 cal. per gram-atom. A. Thiel and co-workers calculated 125 Cals. per mol, which is much lower than other values. A. von Weinberg also made an estimate by means of Trouton's rule. E. Grüneisen calculated from the relation between the at. ht., C_p , and the coeff. of expansion of the diamond, that the heat of sublimation is 274 Cals., and K. Fajans obtained 287 Cals., from the work of O. Lummer on the variation of the temp. (3940°–4200°) of the positive crater of the carbon arc with press. H. Kohn showed that O. Lummer's temp. estimate is too high, and when corrected, he gives 163.5 Cals. for the heat of sublimation of carbon, and 168 Cals. for that of the diamond. H. Kohn and M. Guckel gave 140 Cals. for the heat of sublimation, M. Padoa gave 150 Cals., and J. J. van Laar 215.7 Cals. The value of this constant is therefore rather uncertain. J. J. van Laar gave 6470° for the **critical temperature** and 2970 atm. for the **critical pressure**.

R. Schenck and W. Heller attempted to estimate the **vapour pressure** of the different forms of carbon by starting from the equation $P=k_1(1+k)/k^2$, where P denotes the total gas press.; k_1 is the equilibrium constant for the system C, CO, CO₂; and k is the equilibrium constant for the system Fe, FeO, CO, CO₂. If k does not vary with the different forms of carbon, then at a constant temp., k_1 for the different modifications of carbon will be proportional to the total gas press., P . A. Thiel and F. Ritter obtained in air:

	3700°	3490°	3250°	2935°	2375°
Vap. press.	760	240	120	20	0.04 mm.

and H. Kohn:

	4190°	4137°	4117°	4081°	4052°	4015°
Vap. press	760	608	509	380	327	243 mm.

O. Lummer represented the sublimation curve, or the vap. press., p atm., of carbon by $\log_{10} p = -282400/4.571T + 14.645$; J. J. van Laar, and J. A. M. van Liempt gave $\log_{10} p = -47120T^{-1} + 9.4$. According to W. Ostwald,¹⁵ "the **heat of combustion** of carbon is one of the most important constants in thermochemistry; it is the foundation of all energy calculations in technical and physiological chemistry." It was first measured by A. L. Lavoisier and P. S. de Laplace, who found that *par le combustion d'une once de charbon 6 livres 2 onces de glace se fondaient*; this corresponds with the generation of about 7624 cal. by the complete combustion of one gram of carbon.

The calorimetric measurements of the heats of combustion of the different modifications of carbon differ considerably with every experimenter. M. Copisaroff attributes this to the different stabilities of the molecules, which in turn depend on the mode of linkage of the units constituting the molecule, and on the complexity of the molecule itself. The **heat of oxidation** of the diamond to carbon dioxide is, according to P. A. Favre and J. T. Silbermann, 7824 cal. per gram; W. A. Roth and H. Wallasch gave 7869 ± 3 cal.; and T. Andrews, 7678 cal. E. Petersen found 93.24 to 94.55 Cals. per gram-atom; and M. Berthelot and P. Petit, 94.31 Cals. per gram-atom of diamond-carbon, and 94.34 Cals. per gram-atom of boart-carbon. For the heat of oxidation of natural graphite to carbon dioxide, P. A. Favre and J. T. Silbermann found 7796.6 cal. per gram, and for artificial graphite, 7762.3 cal.; W. A. Roth and H. Wallasch, 7855 to 7865 cal. for purified cast-iron graphite; T. Andrews gave 7778 cal. per gram; and L. Grassi, 7883 cal. E. Petersen found 93.36 Cals. per gram-atom, and M. Berthelot and P. Petit, 94.81 Cals. per gram-atom. For the heat of oxidation of amorphous carbon to carbon dioxide,

C. M. Despretz gave 7912 cal.; P. L. Dulong, 7288 cal.; and T. Andrews, 8080 cal. For wood charcoal, P. A. Favre and J. T. Silbermann gave 8080 cal. per gram; for sugar charcoal, 8040 cal.; and for gas carbon, 8047.3 cal.; T. Andrews gave 7678 cal. per gram of wood charcoal. J. Thomson gave $C+O=CO+30.15$ Cals., and $C+O_2=CO_2+96.96$ Cals. M. Berthelot and P. Petit gave 97.65 Cals. per gram-atom of carbon oxidized to carbon dioxide. M. Berthelot and P. Vieille also compared the heat of combustion of the different kinds of carbon. Unlike M. Berthelot and P. Petit, W. A. Roth and H. Wallasch found the heat of combustion of the diamond, sp. gr. 3.503 at 18°, is greater than that of graphite. The former was found to be 7869 cal., and the latter 7830 to 7854 cal. N. I. Nikitin gave for wood charcoal with [C] and [H] per cent. of carbon and hydrogen respectively, $Q=80.51[C]+273.4[H]$. W. G. Mixer stated that at 20° acetylene black gives 7894 cal. per gram at a constant press. and vol. This constant is nearly equal to that for graphite, and is quite different from the results with sugar charcoal, wood charcoal, or gas carbon. Contrasting the heats of oxidation per gram-atom of the three allotropes of carbon, it follows that:

	Diamond	Graphite	Amorphous carbon
Heat of oxidation	94.31	94.81	97.85 Cals.

This means that the **heat of transformation**: graphite to diamond is 0.5 Cal.; amorphous carbon to graphite, 3.04 Cals.; amorphous carbon to diamond, 3.34 Cals. P. Poch found the heat of combustion of carbon derived from cyanogen to be greater than that of carbon from carbon monoxide. W. A. Roth and H. Wallasch consider that there are two well-defined varieties of graphite, α -graphite, including all natural varieties, which has a heat of combustion of 7830–7840 cal., and β -graphite, including artificial varieties, which has a heat of combustion of 7856 cal. The heat of combustion of the diamond is 7869 ± 3 cal.

The heat of combustion of ethane, 370.9 Cals., can be resolved into four separate operations: (i) the heat of dissociation of the C-H linkage, x ; (ii) the heat of dissociation of the aliphatic C-C linkage, y ; (iii) the heat of oxidation of monatomic hydrogen, v ; and (iv) the heat of oxidation of carbon, z . Hence, $-6x+6v-y+2z=370.9$ Cals. J. Thomsen found 155.8 Cals. for the heat of combustion of the CH_2 -group in a homologous series of hydrocarbons, so that $-2x+2v-y+z=155.8$ Cals. From these two equations, it follows that $z-2y=96.5$ Cals. Again, W. H. and W. L. Bragg showed that the carbon atoms in the diamond have the aliphatic linkage, so that if y' be the heat of formation of the -C-C- linking in the diamond, the heat of combustion, 94.4 Cals., of the diamond is $z-2y'=94.4$ Cals., which differs by only two Cals. from the value obtained by another process. Hence, the heat of formation of a -C-C- linkage in the diamond is nearly the same as that with the same grouping in aliphatic compounds. From the ionization potential of hydrogen $H+\frac{1}{2}O_2=\frac{1}{2}H_2O_{liquid}+74 \pm 3$ Cals., or $v=74$ Cals. Hence, with a knowledge of the heat of sublimation of the diamond, the first of the above equations is completely solved. The value of this constant is as yet somewhat uncertain.

K. Fajans estimates the heat of formation of a C-H linkage to be 117 Cals.; of a simple C-C linkage, 137.5 Cals.; and the heat of formation of gaseous carbon dioxide from a gram-atom of carbon vap. assumed monatomic is 381 Cals. For carbon in oxygen, making allowance for the heat of sublimation of the diamond, he gives $C_{vapour}+\frac{1}{2}O_2=CO+314$ Cals., and $\frac{1}{2}O_2+CO=CO_2+67.8$ Cals. K. Fajans discussed the energy of at. linkage in the diamond; and A. L. von Steiger, in graphite; W. Swientoslawsky found that the heat of formation of a number of carbon compounds is the sum of quantities made up additively of parts characteristic of single atoms. These characteristics are C-, 68.8 Cals.; H-, 48.2 Cals.; Cl-, 67.4 Cals.; Br-, 23.8 Cals.; and I-, 4.4 Cals. K. von Auwers also discussed this subject.

The anomalies observed in the heats of formation of the aliphatic hydrocarbons led K. Fajans to reject the idea that each carbon and hydrogen atom is respectively associated with four valencies and one valency. He claims that subsidiary valency

are exhibited in carbon compounds by the edges of J. H. van't Hoff's tetrahedron (1. 5, 15). The *edge valencies of carbon* play a considerable part in the internal energies of the compounds. Thus, whereas pentane and isopentane contain an equal number of principal C-C- and -C-H- linkages, the number of edge valencies is dissimilar. The energy in the C-C- edge linking is quite appreciable, and it is responsible for the lower heat of combustion of the diamond as compared with that of carbon in aliphatic compounds. Hydrocarbons with side chains contain more edge-linkages, and this is said to explain their higher heats of formation and lower heats of combustion than those of the isomeric compounds without side chains. The subject has been discussed by F. O. H. Binder, M. Padoa, A. L. von Steiger, J. P. Wibaut, H. Beutler, M. Polanyi, A. Thiel, W. Hüchel, A. von Weinberg, W. Swientoslawsky, F. Kirchhof, etc.

The very high refracting power of the diamond was commented upon by Isaac Newton in his *Opticks* (London, 1704). The **index of refraction** is larger than that of any other substance. Isaac Newton gave 2.439. The great refracting power explains the remarkable scintillations of light which the diamond produces when properly cut. This subject has been discussed by P. Groth.¹⁶ The index of refraction has been measured by J. C. Jamin, A. des Cloizeaux, J. Becquerel, H. Fizeau, F. Peter, A. Rochon, D. Brewster, W. Haidinger, A. Weiss, J. F. W. Herschel, etc. The mean values of determinations by B. Walter, and E. Wülfing respectively are as follow :

A	B	C	D	E	F	G	h	H ₁ -line
2.40242	2.40759	2.41037	2.41752	2.42692	2.43544	2.45129	2.45922	2.46517
2.40245	2.40735	2.41000	2.41734	2.42694	2.43539	2.45141	—	2.46476

A. Schrauf calculated μ_n for light of wave length λ_n from $\mu_n = 2.378531 + 0.038696\lambda_n^2/\lambda_n^{-2}$, or $\mu_n = 2.378531 + 0.013432\lambda_n^{-2}$. In opposition to the usual behaviour of regular crystals, A. Sella found that the index of refraction increases with a rise of temp., and for the interval 22° to 93°, the refractive index, μ , at θ° , is $\mu = \mu_0\{1 + 0.0000771(\theta - \theta_0)\}$. P. Gaubert gave between 1.93 and 2.07 for graphite. J. C. Jamin found the index of refraction for coal to be 1.701; and for anthracite, 1.720. F. de la Provostaye and P. Desains, and W. Rosicky made observations on this subject. A. Schrauf gave for the diamond $(\mu^2 - 1)/D = 0.001820$; and $(\mu - 1)/D = 0.000529$. H. Dufet gave $(\mu - 1)^{-1}d\mu/d\theta = 0.000015$; and, for the H α -line, A. Haagen gave $(\mu - 1)/D = 0.4167$. P. Gaubert rubbed thin plates of graphite between two microscopic slides and obtained minute transparent laminae which were green in transmitted light, and had a refractive index between 1.93 and 2.07; the optical character was negative. J. H. Gladstone said that the **refraction equivalent** of the carbon of diamonds is about 5, while the carbon in hydrocarbons increases as the hydrogen content decreases. F. Peter, A. Haagen, and J. W. Brühl, H. H. Landolt, R. Nasini, M. Zecchini, J. Traube, J. Amar, and A. Schrauf also made observations on the refraction eq., and the at. refraction. The **dispersion coefficient**, said A. Schrauf, is much less than might be anticipated from analogy with the values for organic compounds with a high content of carbon; he gave $\mu_{Na} - \mu_{Li} = 0.008778$; and $\mu_{Ti} - \mu_{Na} = 0.008260$; E. Boutan gave 0.0044 for the dispersion coeff. J. H. Gladstone also made observations on the at. dispersion; and R. W. Wood, on the anomalous dispersion of smoke films.

D. Brewster first noted the marked **double refraction** of the diamond, and observed that it is not what would be expected with isotropic crystals of the cubic system. As A. Schrauf has shown, the diamond is optically uniaxial. J. Dale noted that light is polarized elliptically by the diamond. The double refraction has been observed by many others—e.g. F. J. Arago, M. Trécourt and G. Oberhäuser, E. Mallard, H. C. Sorby and P. J. Butler, A. Schrauf, J. MacCullagh, J. Hirschwald, A. des Cloizeaux, etc. E. Cohen found the polarization with some crystals is as marked in crystals of quartz. The phenomenon has been attributed to inclusions or cracks, but E. Cohen showed that the magnitude of the effect is not dependent on

fiissures or inclusions. E. Jannetaz regarded the double refraction as evidence of strains in the interior of the crystals; and R. Brauns concluded that the strains have not been produced by rapidly cooling the crystals, but rather by the diamond having been formed under great press. E. Mallard showed that the double refraction is not altered by heating the crystals; and H. Moissan observed the phenomenon with artificial crystals.

B. Walter observed in some diamonds an **absorption spectrum** with bands at $\lambda=4155$, between the G- and h-lines; the effect was marked in some yellow crystals, but feeble in red, green, and brown diamonds; a second band occurred with $\lambda=4710$; and another in the violet and ultra-violet. He attributed the absorption spectrum to the presence of rare earths, while J. Beckenkamp assumed that between the structural units of the diamond other carbon atoms—dissociated or in soln.—are present. M. Melloni found the **emissivity** of graphite for heat is 86, if that of soot is 100. W. W. Coblentz and E. Aschkinass measured the percentage **reflecting power, R**, of graphite for heat for rays of wave-length λ . The former found:

λ	500	600	800	1000	2000	3000	4000	5000	7000	9000
R	22.5	23.5	25.0	26.8	35.2	43.0	47.5	50.5	53.5	57.5

W. W. Coblentz said that with graphite the reflectivity is 23 per cent. in the yellow, gradually increasing to 63 per cent. at 10μ . From this low reflectivity at 2μ in the infra-red, there results a high emissivity, so that a graphitized carbon filament lamp cannot have the same luminous efficiency as the tungsten filament lamp at the same temp., although it has the higher emissivity in the visible spectrum. F. Haber¹⁷ found the **vibration frequency** of carbon for red rays to be 39.88×10^{12} , and for the violet rays, 10.84×10^{15} . E. Rutherford and J. Chadwick¹⁸ obtained no evidence of the emission of long-range particles of hydrogen when α -rays pass through carbon.

In 1662, R. Boyle¹⁹ noted the **triboluminescence** of the diamond. He said, in his quaint way:

Being rubb'd upon my cloaths, as is usual, to excite amber, wax, and other electrical bodies; it did, in the dark, manifestly shine like rotten wood, the scales of whittings, or other putrefied fish. . . . But this light was fainter than that of the scales and slime of whittings, and much fainter than the light of a glow-worm. . . . This glimmering, also, very considerably decay'd, immediately upon ceasing the friction; though the stone continued visible for some time after.

The phenomenon was also observed by J. P. Dessaignes, C. F. du Fay, J. Schneider, G. F. Kunz, L. Becker, J. Bernoulli and J. Cassini, and G. Halphen, etc. The last-named found a specimen with a rose-red glow. In the twelfth century, Albertus Magnus, in his *De rebus metallicis et mineralibus*, found that some diamonds became luminescent when placed in warm water; and in 1672, R. Boyle also observed the **thermoluminescence** of the diamond. He said:

I found that holding a diamond a while near the flame of a candle, with my eyes turn'd contrary way, and immediately removing it to the dark, it disclos'd some faint glimmering, but inferior to that acquired by rubbing. . . . I also brought the stone to some glimmering kind of light, by taking it into bed, and holding it a good while upon a warm part of my naked body.

The thermoluminescence was also noted by C. F. du Fay, T. Wedgwood, etc. B. Gudden and R. Pohl found that a small, clear, transparent diamond showed a **photoelectric effect** in strong electric fields; and it varied with the wave-length of the exciting light, falling continuously from $260\mu\mu$ to about $630\mu\mu$, when its value was zero. B. Gudden and R. Pohl studied the photoelectric conductivity of the diamond, and the relation between the structure and the electrical conductivity. The **photoluminescence** of the diamond, after exposure to light, was noted by F. Hoffmann in 1770. J. Wall also noted that the diamond is a *noctiluca*—to adopt R. Boyle's term—because it shines in the dark after it has been exposed to daylight. He noted that the phosphorescence is extinguished in *cold* water, but is restored when the temp. is restored; R. Boyle previously noted that the glow was not quenched

under water. C. F. du Fay, and J. B. Beccari attributed the phosphorescence to the departure or entry of a "coloured sulphur" to or from the diamond. M. de Grosser noted that light filtered through a blue glass was a greater stimulant than light filtered through a red or yellow glass. T. J. Pearsall and A. M. Edwards observed the phosphorescence of diamonds which had been exposed to the light of an electric spark. J. F. Daubuisson, P. Riess, M. Chaumet, J. H. Gladstone, P. Heinrich, E. Becquerel, A. M. Edwards, G. F. Kunz, etc. made some observations on the phosphorescence of the insulated diamonds. G. le Bon found all the Brazilian diamonds he examined were photoluminescent, but only some of those from South Africa. H. Landrin must have made a mal-inference in stating that only cut diamonds are phosphorescent. M. Chaumet noted that diamonds phosphoresce strongly in **ultra-violet light**. O. Rosenheim found that the rays from a phosphorescing diamond, invoked by exposure to a magnesium light, do not affect a photographic plate.

In 1879, W. Crookes observed that diamonds phosphoresce various colours when bombarded by **cathode rays** in a vacuum tube. The gradual conversion of the diamond into graphite by this treatment has been previously mentioned. H. Becquerel found that the **phosphorescent spectrum** of a diamond has two continuous parts from *C* to *E*, and from *F* to *G*. The blue phosphorescence is produced by exposure to ultra-violet light. W. Crookes also studied the phosphorescent spectrum of the diamond exposed to cathode rays in a vacuum tube. The spectrum has a green line, $\lambda=5370$; a greenish-blue line, $\lambda=5130$; and a blue line, $\lambda=5030$. The X-ray spectrum of carbon has been studied by E. H. Kurth, F. L. Mohler and P. D. Foote, O. W. Richardson and C. B. Bazzoni, A. L. Hughes, R. A. Millikan, etc. C. W. Hewlett, and A. H. Compton investigated the scattering of X-rays by the diamond and by graphite, and obtained $\sigma/D=0.199$ for the former, and 0.201 for the latter. A. H. Compton measured the spectrum of the K-rays scattered by graphite. For the absorption coeff., C. W. Hewlett gave $\mu/D=0.551$, and $\mu=0.1084$; E. G. Taylor gave $\mu=0.1134$. F. K. Richtmyer, S. J. M. Allen, and A. R. Olson and co-workers measured the absorption coeff. for different wave-lengths. J. Holtzmark gave $\lambda=42.9$ for the wave-length of the *K*-radiation of carbon. J. A. Becker studied the effect of a magnetic field on the absorption of X-rays. J. C. McLennan and M. L. Clark gave 33.00 and 74.0 respectively for the critical voltages of the L-series of X-rays, $\lambda=373.7 \times 10^{-8}$ cm. and 166.7×10^{-8} cm., from carbon.

H. Becquerel found that the phosphorescence of the diamond is invoked by exposure to **radium rays**; but not to **X-rays**. E. Newbery and H. Lupton also observed the blue luminescence of a diamond exposed to radium rays, and K. Keilhack said that diamonds are phosphorescent in X-rays. W. Marckwald also observed that diamonds become phosphorescent when exposed to radioactive bismuth or polonium. The diamond, said C. Doelter, is extremely transparent to the X-rays, and this is so characteristic that the effect can be used as a test to distinguish diamonds from other gem-stones. He also found that graphite is transparent to the X-rays, and if a plate of graphite, containing foreign matters, be exposed to X-rays, the enclosures appear as dark shades in the otherwise lighted background. P. Sacerdote found the X-rays had no sensible effect on the colour of the diamond, but A. Meyère, S. C. Lind and D. C. Bardwell found that a discoloration is developed. W. Crookes noted that when exposed to the cathode rays, the colour of a diamond turns brown; H. Moissan said that it is probable some graphite is formed, although P. Sacerdote said that this is unlikely because the discoloration vanishes when the stone is heated. J. A. Becker studied the absorption of cathode rays by carbon. W. Crookes noted that a yellow Bingara diamond became greenish-blue when exposed to radium rays, and A. Miethe observed a yellow tint was acquired under similar conditions. C. Doelter found that a yellow diamond became a deeper yellow, a green diamond became a deeper green, and a brown diamond more orange on exposure to radium rays, but with X-rays the brown diamond became slate-grey. The colour acquired by the diamond on exposure to X-rays, cathode

rays, and radium rays, vanishes when warmed to 300° – 400° ; but is not perceptibly affected by exposure to ultra-violet light. The characteristic X-rays from carbon have been studied by A. L. Hughes, R. A. Millikan, E. H. Kurth, P. I. Lukirsky, etc. C. W. Hewlett found the mass scattering coeff. of X-rays of wave-length 0.712 \AA , to be 0.184 for liquid mesitylene, 0.198 for graphite, and 0.234 for the diamond. P. A. Ross measured the angles of reflection of X-rays by graphite. G. A. Hemsalech²⁰ studied the luminous phenomenon which occurs when a plate of graphite is raised to a high temp. by means of an electric current. J. E. P. Wagstaff gave 40×10^{12} for the **vibration frequency** of the diamond and 27.7×10^{12} for graphite.

In 1802, W. H. Wollaston,²¹ in a paper on *A method of examining refractive and dispersive powers by prismatic reflection*, mentioned the **flame spectrum** of carbon. He said:

When a very narrow line of the blue light at the lower part of a flame is examined alone, through a prism, the spectrum, instead of appearing as a series of contiguous lights of different hues, may be seen divided into five images at a distance from each other. The first is broad and of a red colour terminated by a bright yellow line; the second and third are both green; and the fourth and fifth are blue.

J. Fraunhofer, J. F. W. Herschel, H. F. Talbot, F. von Wrede, A. Matthiessen, J. W. Draper, A. Masson, and D. Alter made some related observations. W. Swan²²

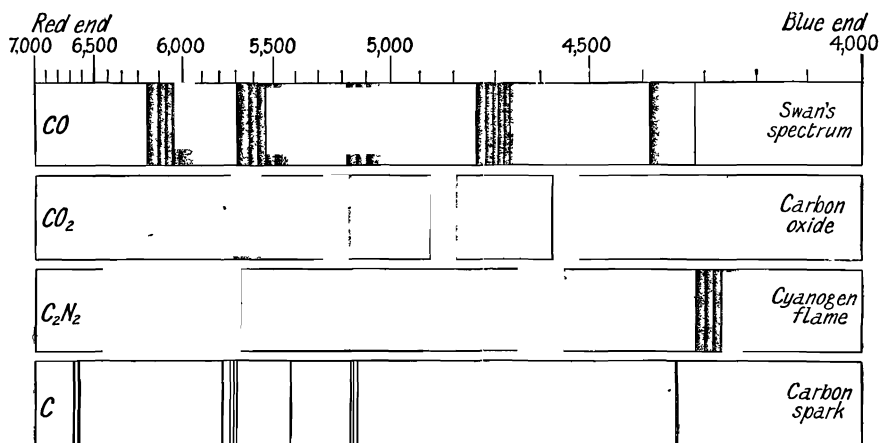

FIG. 16.— Spectra of Carbon and its Oxides, and of Cyanogen.

showed that the spectrum at the base of a candle flame has a number of bands fading away towards the blue with sharp heads on the red side. This spectrum is associated with a greenish-blue light. According to W. M. Watts and H. M. Wilkinson, in the so-called candle spectrum or **Swan's spectrum**, there is first an orange-yellow band, Fig. 16, with heads $\lambda=6188.1$, 6120.0 , 6052.0 , 5999.0 , and 5955.0 ; a greenish-yellow band with heads $\lambda=5435.4$, 5585.5 , 5540.9 , 5500.0 , and 5470.0 ; a green band with heads $\lambda=5165.2$, 5129.4 , 5101.0 , and 5081.9 ; a blue band with heads $\lambda=4737.2$, 4715.3 , 4697.6 , 4684.0 , and 4677.0 ; and an indigo-blue band with a head fading both ways between $\lambda=4381.9$ and 4356.9 ; an indigo-blue detached line $\lambda=4334.4$; and a band between $\lambda=4315.0$ to 4234.0 . Observations and measurements have been made by L. de Boisbaudran, A. J. Angström and R. Thalén, W. M. Watts, C. C. von Wesendonck, R. T. Simmler, R. Fortrat, A. Mitscherlich, J. Plücker and J. W. Hittorf, C. P. Smyth, J. M. Eder and E. Valenta, J. M. Eder, W. N. Hartley, C. Bohn, G. Gehlhoff, A. Smithells, J. R. Merton, E. Hulthén, etc. The spectrum occurs in the blue or greenish-blue parts of hydrocarbon flames burning in oxygen or gases containing oxygen; in the flame of cyanogen burning

air; in the ordinary carbon arc in air; and in the spark discharge of many carbon compounds in the gaseous state.

There has been some controversy as to whether W. Swan's spectrum is produced by the element carbon, by a hydrocarbon, or by a carbon oxide. W. Swan considered that the spectrum is produced by a hydrocarbon, but he worked only with gases containing hydrocarbons. On the other hand, J. Attfield ascribed the spectrum to carbon because (i) the flame of cyanogen, C_2N_2 , burning in oxygen, amongst other bands, shows this spectrum most brilliantly, when both gases are dry; and (ii) the spark spectrum of well-dried and purified cyanogen, carbon monoxide, or carbon disulphide, at atm. press., shows this same spectrum. The only constant in the composition of these gases is carbon, and therefore the spectrum must be due to that element. It has been objected that the temp. of an ordinary flame is not high enough to volatilize carbon, and hence asked: How can carbon be present in a state of vap. and give a continuous spectrum? H. C. Dibbits answered: Before combustion the carbon is present as a hydrocarbon, after combustion as an oxide; consequently, in passing from hydride to oxide, he argued that there must have been a certain stage of transition when each carbon atom was momentarily free and was able to furnish W. Swan's spectrum. He said:

In what state of aggregation the free atoms of carbon exist in the flame at the moment of their separation cannot be determined; solid particles they are not, still less liquid; perhaps they are gaseous; and perhaps they are in a state which is not to be likened to any of the three known states. They do not, at any rate, remain long in this state; they combine with oxygen to form carbon monoxide or dioxide, or if they do not immediately burn, they agglomerate to form small solid particles of carbon, which remain for some time glowing in the flame, and are the cause of the bright light; they give then, like all solid bodies, a continuous spectrum which extends the further into the violet, the higher the temp.

In support of this, he explains the failure of the carbon monoxide flame to show W. Swan's spectrum, by stating that in this case the carbon is never free and uncombined. A. Gouy sprayed salts in a finely divided state into the flame, and showed that in the same zone it is possible to obtain the spectra of elements which it would be impossible to volatilize in the flame. Thus, the flame spectra with salts of iron, cobalt, manganese, and silver have the same lines as the spark spectra obtained with the metals. W. M. Watts observed that carbon tetrachloride also gave the characteristic flame spectrum, and J. N. Lockyer obtained the same spectrum when a strong spark did not reveal the presence of hydrogen. The carbon theory was supported by C. Morren, V. S. M. van der Willigen, W. Huggins, J. Plücker and J. W. Hittorf, A. Wüllner, etc.

J. J. Thomson, in his study *On the electrolysis of gases*, suggested a modification of the carbon hypothesis. In passing the electric discharge through chloroform vap., he found that hydrogen and chlorine collected about the negative electrode, but on the positive side Swan's spectrum was observed at first, and this rapidly changed into the carbon oxide spectrum, Fig. 16. With ethyl alcohol, Swan's spectrum appeared on the positive side, and the carbon oxide spectrum on the negative side. With carbon monoxide, there was no difference in the spectra of the gas about the two electrodes, but if a little hydrogen be present, the carbon oxide spectrum appears on the negative side, and Swan's spectrum on the positive side. He thus summarized his conclusions:

The view which seems most in accordance with these observations is that the so-called candle spectrum or Swan's spectrum is the spectrum of the carbon when the atom is charged with negative electricity, or of some compound of carbon in which the carbon atom is charged with negative electricity; while the carbon oxide spectrum is the spectrum of carbon when the atom is charged with positive electricity or some compound in which the carbon atom is positively charged.

While the supporters of the carbon theory rely on the development of the band spectrum in gases free from hydrogen, and all thoroughly dried, the supporters of the hydrocarbon theory, on the other hand, say in effect that it is a mere *façon de*

parler to say that the gases employed in producing the band spectrum are free from hydrogen because it is impossible to exclude all traces of moisture, and if moisture is present, hydrocarbons will be produced in the burning gas. They also emphasize the fact that this spectrum is well developed when hydrocarbons are known to be present. In their *Recherches sur les métalloïdes* A. J. Angström and R. Thalén, after an examination of the spark spectra of carbon in various gases, in the *auréole* between the electrodes, and not in *le trait de feu*—the path of the spark, decided against the carbon theory and supported the hydrocarbon hypothesis. The *auréole*, when in oxygen, showed the spectrum of carbon monoxide; when in nitrogen, it showed blue and violet bands superposed on W. Swan's spectrum, these were attributed to a compound of carbon and nitrogen; and when in hydrogen, it showed W. Swan's spectrum. Since the discharge from carbon electrodes in hydrogen furnishes acetylene, it is concluded that W. Swan's spectrum is produced by that gas. They state that, in the first instance, they were led to ascribe Swan's spectrum to a hydrocarbon, because of its general resemblance to the spectrum of the oxides of the alkaline earth metals. After describing Swan's spectrum, they said :

Cette description de l'aspect des raies est tout-à-fait identique à celle donnée auparavant par rapport aux raies des oxydes métalliques, et nous pensons que cette analogie remarquable ne peut être entièrement fortuite.

They state that elementary carbon is characterized by a line spectrum, while Swan's spectrum is conditioned by the atm. in which the discharge occurs, for it is found only in the *auréole*. C. P. Smyth supported the hydrocarbon theory. G. D. Liveing and J. Dewar observed the spectrum of the electric arc between carbon poles in air, chlorine, carbon monoxide and dioxide, hydrogen, nitrogen, nitric oxide, and ammonia. They also examined the flames of some carbon compounds. They concluded :

In the next place, the green and blue bands, characteristic of the hydrocarbon flame, are well seen when the arc is taken in hydrogen; but though less strong when the arc is taken in nitrogen or in chlorine, they seem to be always present in the arc whatever the atm. This is what we should expect, if they be due, as A. J. Angström and R. Thalén suppose, to acetylene; for we have found that the carbon electrodes always contain, even when they have been long treated in chlorine, a notable quantity of hydrogen. In the flames of carbon compounds, they by no means always appear; indeed, it is only in those of hydrocarbons or their derivatives that they are well seen. Carbon monoxide and carbon disulphide, even when mixed with hydrogen, do not show them; and if seen in the flames of cyanogen, hydrogen cyanide, and carbon tetrachloride mixed with hydrogen, they are faint, and do not form a principal or prominent part of the spectrum. This is all consistent with the supposition of A. J. Angström and R. Thalén.

G. D. Liveing and J. Dewar later admitted that carbon vap. might exist in the cyanogen flame, and they abandoned the acetylene theory. They regarded acetylene to be the means of bringing carbon vap. into existence in flames, and pointed to the invariable presence of this gas in the interior of hydrocarbon flames. They said that acetylene is a highly endothermal substance, but A. Smithells showed that however true this may be, it is probably very erroneous at the temp. at which carbon is given off as a vapour. He also showed that the acetylene flame is exceptionally opaque.

After reviewing the evidence for the carbon theory, A. Smithells concluded that there is no reliable evidence to warrant the supposition that the flames of carbon compounds contain carbon vapour. On the contrary, there is much evidence against such a supposition. He then showed that the hydrocarbon theory resolves itself into a consideration of acetylene and methane as a likely source, since these are the only two hydrocarbons which W. A. Bone and D. S. Jordan found to be stable at high temp. in the presence of carbon and hydrogen. The fundamental difficulty with either acetylene or methane is presented by the appearance of Swan's spectrum in the flame of cyanogen.

The spectrum of the flame of *cyanogen* burning in air, or generally, in oxidizing

gases, has been observed by J. F. W. Herschel, H. F. Talbot, H. C. Dibbits, A. Mitscherlich, R. Thalén, R. T. Birge, G. Salet, H. Kayser and C. Runge, H. Crew and O. H. Basquin, F. Exner and E. Haschek, H. Deslandres, F. Jungbluth, A. Hagenbach and H. Konen, J. Haferkamp, J. M. Eder, J. M. Eder and E. Valenta, J. Plucker and J. W. Hittorf, C. Morren, M. Berthelot and F. Richard, A. Kratzer, U. S. Uhler and R. A. Patterson, A. Perot, L. Kilchling, J. Okubo, W. Grotrian and C. Runge, Lord Rayleigh, A. S. Herschel, J. Dewar, C. P. Smyth, H. W. Vogel, W. N. Hartley, H. Crew and O. H. Basquin, A. S. King, A. de Gramont and M. Drecq, E. C. C. Baly and H. W. Syers, etc. The flame spectrum of cyanogen includes (i) $\lambda = 7102$ to 5245 ; (ii) $\lambda = 4606.33$ to 4502.35 ; (iii) $\lambda = 4216.12$ to 4152.88 ; (iv) $\lambda = 3883.55$ to 3855.06 ; (v) $\lambda = 3590.48$ to 3584.06 ; and (vi) $\lambda = 3360.1$. As pointed out by J. Attfield, the spectrum of the cyanogen flame includes Swan's spectrum, with presumably the same origin, and two distinct groups; (i) those at the less refrangible or red end extend into the yellow and green. The sharp edge or head is on the most refrangible side—*i.e.* in the opposite way to the hydrocarbon bands—and the bands fade in brightness towards the red end. They are not seen in any other flame; and (ii) the bands at the more refrangible or blue end which fade in brightness towards the violet. The bands corresponding with Swan's spectrum have presumably the same origin, and are superposed on bands produced by a compound of carbon and nitrogen. The same bands occur much fainter in the flame of cyanogen burning in oxygen, and C. Morren, and W. M. Watts attribute this to the smaller proportion of undecomposed cyanogen at the higher temp. of the flame burning in oxygen. The bands in the red become more brilliant when the cyanogen is burnt in oxygen. In addition to the red and yellow bands, there are bands in the blue, violet, and ultra-violet. These latter bands have been ascribed to carbon, since they have been reported in carbon compounds not containing nitrogen; but G. D. Liveing and J. Dewar, in agreement with A. J. Angström and R. Thalén, attributed the channelled spectra of the hydrocarbon and cyanogen flames to acetylene and cyanogen, and not to carbon itself. The presence of traces of moisture and nitrogen as impurities in the gases employed explains the formation of both cyanogen and acetylene. Hence, the flame of cyanogen may show the hydrocarbon spectrum superposed on that of cyanogen; and in vacuum tubes, containing hydrocarbons, the cyanogen spectrum may be observed. G. D. Liveing and J. Dewar found in agreement with W. M. Watts that the bands in the blue, violet, and ultra-violet appear in the spark spectrum of carbon monoxide at ordinary press. if that gas has been made from potassium ferrocyanide, but not if made from the action of sulphuric acid on dried sodium formate, or by heating a mixture of quicklime and dry potassium oxalate; the bands were stated by W. M. Watts, and J. N. Lockyer to occur in the spark spectrum of carbon tetrachloride, but, added G. D. Liveing, not if all traces of air have been expelled from the apparatus. Similar results are obtained with naphthalene.

The spark spectrum in cyanogen gas, or the spectrum of the ordinary carbon arc in air, is due either to carbon plus cyanogen, or to carbon at a high temp. The less refrangible group of the cyanogen flame spectrum is absent in the spark spectrum. It is difficult to obtain cyanogen of a sufficiently high degree of purity to furnish what might be called the pure cyanogen spectrum, but E. C. C. Baly and H. W. Syers obtained cyanogen in vacuum tubes which, in the electric discharge, showed no trace of the carbon spectra, but yielded a "very beautiful and characteristic cyanogen spectrum." The spectrum differs from that derived from the flame. They said:

It presents a series of equidistant flutings through the whole of the red and yellow, somewhat recalling those of the positive band spectrum of nitrogen. The cyanogen bands are, however, much wider than the nitrogen bands, and do not show the break in the orange characteristic of the nitrogen spectrum. The flutings under higher dispersion are split into very fine lines.

On the admission of air or oxygen into the vacuum tube was at once attended by the appearance of Swan's spectrum. They concluded that Swan's spectrum is not

produced by a carbon compound which does not contain oxygen. A. Smithells also, prior to E. C. C. Baly and H. W. Syers, showed that the brilliant Swan's spectrum from the flame of cyanogen burning in oxygen is not likely to depend on the presence of an irremovable quantity of impurity, and he showed it to be far more probable that *Swan's spectrum is due to carbon monoxide* which is "formed in the primary chemical act of combustion whenever Swan's spectrum appears in the hydrocarbon flame."

W. M. Watts described what he called the four spectra of carbon: (i) W. Swan's spectrum of hydrocarbon flames; (ii) the spark spectrum of vacuum tubes containing carbon monoxide or dioxide, or ethylene; (iii) the spectrum of the flame from Bessemer's steel converter; and (iv) the spectrum of the high tension spark in carbon monoxide or dioxide. He later showed that the spectrum of the Bessemer flame was due to manganese oxide; and that the second spectrum is due not to carbon but to some oxide of carbon, and is not given by ethylene if special precautions be taken to exclude oxygen. When an intense spark, obtained with a Leyden jar and air-break in circuit, is sent through carbon monoxide or dioxide, the spectrum of carbon is obtained. W. M. Watts produced the carbon lines in the spectrum from fused alkali carbonates, and also from the spark between carbon electrodes. The more intense lines in the **line or spark spectrum** of carbon are 6439·4, 6162·5, 6122·5, 5857·8, 5594·6, 5589·0, 5349·7, 5270·5, 4878·3, 4586·1, 4455·0, 4435·1, 4425·6, 4302·7, 4226·9, 3968·6, 3933 8, and 3644·5.

The spark spectrum of carbon has been observed and described by W. M. Watts, W. Wüllner, A. J. Angström and R. Thalén, G. D. Liveing and J. Dewar, W. N. Hartley, W. N. Hartley and W. E. Adeney, J. M. Eder, J. M. Eder and E. Valenta, H. Deslandres, A. de Gramont, F. Exner and E. Haschek, J. Hartmann, A. Hagenbach and H. Konen, W. A. Miller, H. C. Dibbits, W. Huggins, J. Plücker and J. W. Hittorf, C. P. Smyth, W. Spottiswoode, W. Crookes, H. A. Rowland, H. Rubens and H. Konen, H. Finger, H. Reubens and A. Aschkinass, J. Trowbridge, A. M. Herbert, J. Hartmann, etc. The **arc spectrum** has been observed by M. le Rosa, A. Secchi, G. D. Liveing and J. Dewar, R. Thalén, A. L. Foley, W. B. Huff, W. W. Coblentz, S. Procopiu, F. Simeon, etc. The effect of an alternating current on the arc spectrum has been studied by L. Pucciatti, H. Crew and B. J. Spence, etc. The effect of an electric spark on carbon vap. in the arc was observed spectroscopically by H. Crew and J. C. Baker. The effect of self-induction on the spectrum was observed by A. de Gramont; and M. Toussaint examined the effect of argon, and of iodine vap. The **band spectrum** has been investigated by J. Attfeld, A. Morren, A. Lielegg, C. P. Smyth, G. Salet, W. M. Watts, C. C. von Wesendonck, L. Thollon, G. D. Liveing and J. Dewar, C. Fievez, J. S. Stas, J. N. Lockyer, J. M. Eder and E. Valenta, A. Smithells, H. Konen, P. Lewis, etc. Attempts to establish series formulæ have been made by H. Deslandres, R. Komp, T. N. Thiele, J. Leinen, H. Kayser and C. Runge, R. Fortrat, O. H. Hindrichs, F. Croze, W. Ritz, J. Halm, F. Jungbluth, J. Haferkamp, A. S. King, A. Fowler and co-workers, T. Lyman, R. J. Strutt, etc. Difficulties have been encountered in separating the lines due to oxygen and those due to carbon. W. Huggins could get this spectrum only from carbon monoxide or dioxide; and A. J. Angström and R. Thalén obtained it in hydrocarbons when they used a large condenser. A. Schuster and H. E. Roscoe showed that the spectra obtained from the different varieties of carbon are identical.

J. Plücker showed that *carbon dioxide* in a vacuum tube gives a spectrum which has, at first, an intense band in the red. This he attributed to carbon dioxide. He found that the carbon dioxide band gradually disappears owing to the slow decomposition of carbon dioxide by the spark. A. Wüllner has given a detailed description of the phenomenon observed at different press., with changes in the character of the discharge, and in the length of the containing tubes. The carbon dioxide spectrum has been investigated by V. S. M. van der Willigen, F. Brasac, W. H. Bair, E. F. Barker, J. N. Collie, E. R. Drew, T. Lyman, F. Himstedt and

H. von Dechend, etc. Neither G. Salet nor A. Smithells could obtain the red line characteristic of carbon dioxide, and the former said that this line belongs to the line spectrum of carbon. A. Smithells worked with carbon dioxide prepared from the liquefied gas, and dried by phosphorus pentoxide. The press. was gradually reduced, and Table III shows the chief consecutive changes. In addition to the carbon oxide spectrum, three other spectra are involved: (i) Swan's spectrum; (ii) The carbon line spectrum; and (iii) The oxygen spectrum. A. Smithells then showed that the so-called carbon oxide spectrum (Fig. 15) is really the spectrum of carbon dioxide—*vide infra*.

TABLE III.—THE EFFECT OF PRESSURE ON THE SPECTRUM OF CARBON DIOXIDE.

Stage of exhaustion.	Ordinary discharge.	Condensed discharge—jar and air-gap.
1	Faint carbon oxide (linear)	Carbon and oxygen lines.
2	Bright carbon oxide (glow)	Carbon and oxygen lines.
3	Brighter carbon oxide	As above with wide gap; with medium gap Swan's spectrum.
4	Very bright carbon oxide	As gap is widened spectrum changes from carbon oxide to Swan's, and to carbon and oxygen lines.
5	Fading carbon oxide	As gap is widened spectrum changes from carbon oxide directly to carbon and oxygen lines.
6	Slow fading of carbon oxide	As before, fading slowly.

The spectrum of the flame of *carbon monoxide* is continuous, but, under reduced press., G. J. Burch observed the flame spectrum shows signs of becoming discontinuous. The spark spectrum is readily obtained from a vacuum tube filled with carbon monoxide. Some of the bands are very close to the bands in W. Swan's spectrum, and the two spectra may easily be confused. C. P. Smyth attributed the spectrum of carbon monoxide to carbon. In the production of the spark spectrum of oxygen, all carbonaceous impurities must be rigorously excluded or else the spectrum will belong to carbon monoxide, not oxygen. The more prominent carbon monoxide bands are: 6079 in the yellow; 5607.5, 5197.0, 5187, 5184, 5182, 5179, 5176, 5173, 5170, and 5167 in the green; the bands 4834, 4823, 4821, 4819, 4817, 4789, 4786, 4510, and 4394 in the blue. The carbon monoxide spectrum has been examined by A. Wüllner, W. M. Watts, H. Nagaoka, A. J. Angström and R. Thalén, J. Plücker, A. de Gramont, W. N. Hartley, E. Hulthén, C. C. von Wesendonck, J. Loos, G. D. Liveing, F. Exner and E. Haschek, M. Tietz, F. Himstedt and H. von Dechend, T. Lyman, etc. A. Smithells examined the effects of different stages of exhaustion on the spectrum of carbon monoxide, and the main features are summarized in Table IV.

TABLE IV.—THE EFFECT OF PRESSURE ON THE SPECTRUM OF CARBON MONOXIDE.

Stage of exhaustion.	Ordinary discharge.	Condensed discharge—jar and air-gap.
1	Swan's spectrum	No discharge.
2	Swan's and faint carbon oxide	Swan's spectrum.
3	Swan's and weak carbon oxide	Swan's spectrum and carbon and oxygen lines.
4	Swan's and carbon oxide equal	Carbon and oxygen lines with a short gap, the carbon oxide is visible; and with a longer gap a faint Swan's spectrum displaces the carbon oxide.
5	Swan's weakening, carbon oxide strengthening	
6	Carbon oxide only	
7	The carbon oxide fades; the spectrum grows in intensity and then fades until the tube is fluorescent	No discharge.

M. Tietz found that the condensed discharge with platinum electrodes at ordinary

atm. press. gave a spectrum with the lines of oxygen and carbon only. Following a hint by G. G. Stokes, A. Smithells demonstrated that in all probability, while the so-called carbon oxide spectrum is the spectrum of carbon dioxide, Swan's spectrum is the spectrum of carbon monoxide; and he summarized the arguments as follows:

(1) The carbon monoxide and Swan's spectra are strikingly similar, and the actual differences are such as might be expected from the mol. differences of the two oxides.

(2) Carbon monoxide gives Swan's spectrum predominantly except under extreme conditions. If the passage of the discharge is electrolytic—alternate dissociation and recombination of carbon and oxygen—the process in the tube has a chemical feature in common with that occurring in flames showing Swan's spectrum.

(3) Under extreme conditions of gaseous or electrical press., carbon monoxide gives either the carbon oxide or the carbon line spectrum, or both. These extreme conditions correspond to the maximum heating effects of the discharge when the gas might be expected to decompose: $2\text{CO} \rightleftharpoons \text{CO}_2 + \text{C}$, as shown by H. St. C. Deville, and V. Meyer and C. Langer. A black deposit formed on the tube near the electrodes observed by G. D. Liveing and J. Dewar, was found by A. Smithells to be carbon, and was formed only when the carbon line spectrum is visible.

(4) Carbon dioxide furnishes the carbon oxide spectrum most readily, and this remains at high exhaustions. At ordinary atm. press., the gas gives only the line spectrum of carbon and oxygen. A condensed discharge favours the formation of Swan's spectrum. This accords with the facts that carbon dioxide is a good conductor; and when the heating effect of the discharge is intensified, the gas is dissociated into carbon monoxide and oxygen. The condensed discharge in the highly rarefied gas produces the line spectrum of carbon and oxygen. If the oxygen lines are visible, the carbon lines are also visible. The gas is not readily dissociated into carbon monoxide and oxygen under these conditions. V. Meyer and C. Langer's experiments showed that carbon dioxide is not readily dissociated at a high temp., whereas carbon monoxide easily breaks down. In opposition to this, J. N. Collie found that carbon dioxide under low press. is rapidly decomposed by the discharge from an ordinary induction coil—65 per cent. being decomposed in 10 secs. Under similar conditions carbon monoxide was found to be far more stable.

(5) G. D. Liveing and J. Dewar found that the carbon arc-discharge in carbon monoxide gave Swan's spectrum with no trace of the carbon oxide spectrum. This is what would be anticipated if Swan's spectrum is due to carbon monoxide, and the carbon oxide spectrum to carbon dioxide.

(6) The spectrum of the carbon arc in air contains Swan's spectrum together with groups of lines which G. D. Liveing and J. Dewar, H. Kayser and C. Runge, and M. Tietz attribute to cyanogen or to carbon in association with nitrogen. Swan's spectrum is ascribed to the well-known fact that carbon monoxide is formed in the arc. In support of this is G. D. Liveing and J. Dewar's observation that the arc in the middle of a magnesia crucible often shows signs of Swan's spectrum although that of cyanogen is strong. If, however, puffs of air or carbon dioxide are passed into the arc, Swan's spectrum is produced; this also is the case if one of the carbon poles be moistened. The spectrum of the arc under water shows Swan's spectrum alone.

E. C. C. Baly and H. W. Syers supported A. Smithells' theories as to the genesis of Swan's and the carbon oxide spectra. They obtained Swan's spectrum from carbon monoxide when highly purified, but a trace of hydrogen or oxygen changed Swan's spectrum into the carbon oxide spectrum. The chief difficulty, said A. Smithells, is to be found in the frequently recorded observations of Swan's spectrum under conditions which appear to exclude the presence of that gas. The spectrum of *hydrocarbons* has been investigated by C. Morren, M. Berthelot and F. Richard, B. von Lengyel, V. Henri, B. Hasselberg, H. Deslandres, C. Fievez, A. Kratzer, E. E. Brooks, etc. F. W. Klingsiedt studied the spectrum of *phenol*; W. C. Holmes, that of *p-cymene*; V. Henri, and W. H. McVicker and co-workers, C. F. Meyer and D. W. Bronk, J. M. Hyatt, J. E. Purvis, that of *benzene*; V. Henri and P. Steiner, that of *naphthalene*; J. W. Ellis, that of *chloroform*; and J. M. Hyatt, that of *anthracene*. H. Konen, and W. M. Watts and H. M. Wilkinson found that organic liquids containing oxygen like *methyl and ethyl alcohols, glacial acetic acid*, etc.; and organic liquids not containing oxygen, like *chloroform, carbon tetrachloride, ethyl bromide, ethylene dibromide, aniline, pyridine, naphthalene, and benzene* purified in many cases by repeated distillation over bright sodium, still gave Swan's spectrum. A. Smithells mentioned the great difficulty encountered by H. B. Baker in freeing

carbon tetrachloride from oxygen; H. B. Baker's, and J. J. Thomson's observations on the important part played by traces of moisture in the passage of electricity through gases; B. Hasselberg's observations that some kinds of glass persistently give rise to carbon and oxygen which bring to light the carbon oxide spectrum; and G. D. Liveing and J. Dewar's observations on the extreme sensibility of the spectroscopic test to traces of impurity.

The **absorption spectra** of the vap. of benzene has been investigated by E. Dickson, L. Grebe, and W. N. Hartley; of toluene, by F. Cremer; of ethylbenzene and para-xylol, meta-xylol, and ortho-xylol by W. Mies; and of chlorobenzene, bromobenzene, iodobenzene, and aniline by H. Koch. The **fluorescent spectra** in general correspond with the absorption spectra. Observations on the spectrum of the flame from Bessemer's converter have been made by W. M. Watts, A. Lielegg, G. J. Snelus, W. M. Williams, etc. For the spectra of the sun, comets, etc., *vide* the occurrence of carbon. The **ultra-red spectrum** has been studied by W. H. Julius, E. C. Kemble, C. Schaefer and M. Thomas, J. M. Eder, A. M. Herbert, E. P. Lewis and E. S. Ferry, K. Angström, H. Rubens and A. Aschkinass, H. Lehmann, H. Hermann, E. R. Drew, W. W. Coblenz, A. Bergmann, W. J. H. Moll, etc. The **ultra-violet spectrum** has been studied by G. D. Liveing and J. Dewar, R. A. Millikan, W. W. Shaver, J. C. McLennan and P. A. Petrie, W. H. Fulweiler and J. Barnes, F. Simeon, etc. The influence of *temperature* on the spectrum has been studied by W. M. Watts, etc.; the influence of *pressure* by E. Villari, F. Benevides, G. D. Liveing and J. Dewar, W. J. Humphreys, J. E. Petavel and R. S. Hutton, A. Hagenbach, J. Haferkamp, etc.; and the influence of *magnetism*, by G. Berndt, and R. Fortrat. The series spectra were discussed by A. Fowler.

R. Boyle²³ stated that the diamond has an electrical virtue, for, after being rubbed on cloth, it attracts light bodies, like amber, jet, etc., though in a less degree. R. J. Haüy said that the raw or cut diamonds are positively electrified by friction, but the charge is rapidly lost; graphite, however, develops no frictional electricity when rubbed with resin or shellac. L. B. G. de Morveau, L. V. Brugnatelli, and J. F. L. Hausmann and F. C. Henrici found the diamond to be a very bad electric conductor; graphite and amorphous carbon, on the contrary, are comparatively good conductors. A. Artom found the sp. **electrical conductivity** of the diamond, at 15°, to be between 0.211×10^{-14} and 0.309×10^{-13} reciprocal ohms. Measurements were made by J. Königsberger, C. Doelter, H. von Wartenberg, D. E. Roberts, W. Geiss, C. E. Williams, and K. Arndt and F. Körner. J. Priestley noted that charcoal is a good conductor of electricity. According to A. Matthiessen, if the electrical conductivity of silver at 0° is 100, that of graphite ranges from 0.00395 to 0.0693. He also found that the electrical conductivity of purified graphite is eighteen times greater than that of natural graphite; and this shows the importance of the degree of purity of graphite on its physical properties. J. Königsberger and O. Reichenheim found for Cingalese graphite, per cm. cube, the sp. **electrical resistance**, *R*,

	-185°	-66	0°	21°	61°	89°	105°	147°	191°
<i>R</i> . .	0.00428	0.00335	0.00295	0.00283	0.00265	0.00254	0.00250	0.00238	0.00220

They did not succeed in establishing data for the resistance parallel and perpendicular to the principal axes. The sp. resistance at θ° between 0° and 280° is $R=0.00291(1-0.00128\theta)$; H. Muraoka gave for Siberian graphite $R=0.00122(1-0.000739\theta+0.0_6273\theta^2)$. The decrease in the resistance with temp. is smaller than is the case with amorphous carbon. J. Zellner gave 2-8 ohms for the resistance of Cingalese graphite at 20° ; and for a commercial graphite electrode, 12 ohms. F. Streintz gave 14.20 ohms for the resistance of powdered graphite, and H. Muraoka, 12.20 ohms. A. Bartoli found that the coarser the grain-size of the graphite the larger the conductivity. A. Artom gave for Greenland graphite the sp. conductivity 0.247×10^4 ; Cumberland graphite, 0.054×10^4 ; and for Siberian graphite 0.082×10^4 reciprocal ohms at 14° . H. Muraoka gave 0.0871×10^4 rec. ohms at 0° , and F. Streintz, 0.0705×10^4 ; B. Piesch gave for Cingalese graphite,

0.079×10^4 to 0.385×10^4 rec. ohms at 0° . L. Cellier gave 13.049×10^{-9} mho for the conductivity of graphite of sp. gr. 1.698; 146.32×10^{-9} for that of electric light carbon of sp. gr. 1.467; 267.88×10^{-9} for the similar material of sp. gr. 1.567; and 185.99×10^{-9} for gas retort carbon of sp. gr. 1.627. Observations have been also made by K. Bädcker, J. Königsberger, W. Geiss, R. von Hasslinger, G. Kirchhoff, F. Auerbach, J. Borgmann, J. W. Howell, F. le Roy, Lord Kelvin, and H. G. Martin. The relative electrical resistances of graphite electrodes were found by C. A. Hansen to be

	25°	400°	800°	1200°	1600°	2000°	2200°
Per cent.	100	94.0	81.5	66.0	65.0	68.0	69.0

Graphite electrodes which had been fired to 1200° and cooled off gave 91.6 per cent. of the original resistance (100), and similarly at other temp.

Fired at	1200°	1600°	2000°	2400°	2800°	3500°
Resistance cold	91.6	87.0	77.6	65.9	50.9	22.4

E. Ryschkewitsch found the resistance, R ohms, of different samples of graphite compressed at different press., p atm. The results are shown in Table V, where the values of a refer to the constant: $R = a/p + 0.0075$.

TABLE V.—ELECTRICAL RESISTANCE OF GRAPHITE AT DIFFERENT PRESSURES.

	Carbon, per cent.	Press. in atm.				a
		14.5	86.8	151.0	215.5	
Madagascar (sieve 100)	94	0.0683	0.0436	0.0251	0.0185	2.10
Ceylon (sieve 160)	97	0.0530	—	0.0232	0.0182	1.80
Acheson amorphous	99	0.0420	0.0281	0.0195	0.0155	1.38
Bohemian amorphous	100	0.0347	0.0253	0.0174	0.0141	1.10
Kropfmühler (sieve 160)	90	0.0306	0.0200	0.0149	0.0122	0.80
Kropfmühler	99	0.0238	—	0.0119	0.0098	0.50
Madagascar coarse	94	0.0182	0.0130	0.0106	0.0089	0.35
Kropfmühler coarse	94	0.0150	0.0122	0.0100	0.0082	0.25

A. Avogadro, F. von Kobell, W. G. Mixter, and A. Franck observed that, compared with other non-metallic conductors, amorphous carbon is a good electrical conductor. A. Matthiessen found that at 25° , the conductivity of gas carbon is 0.0386, when that of silver is 100 at 0° . W. von Siemens gave 0.0145×10^4 mhos for the conductivity of gas carbon at 0° , and H. Muraoka, 0.0204×10^4 for gas carbon, and 0.0248×10^4 mhos for commercial arc-light carbons. J. Dewar and J. A. Fleming found the sp. resistance of a carbon filament of a commercial incandescent lamp to be

	99°	18.9°	1°	-80°	-100°	-182°
$R \times 10^{-3}$	3835	3911	3953	4054	4079	4180

F. Streintz gave 0.25 rec. ohms for the conductivity of amorphous carbon at 12° ; W. Beetz gave for carbon dust 0.0306×10^4 rec. ohms; and F. Lucas, 0.0142×10^4 at 15° . F. Streintz found the sp. resistance of lampblack is 4000 ohms, and as with electrolytes, the resistance decreases as the temp. is raised. H. Violette found that the electrical conductivity of wood-charcoal increases with the charring temp.; and that prepared at 1500° conducts electricity better than gas carbon. R. Ferrini, H. Tomlinson, and S. Bidwell showed that the conductivity of carbon dust increased by compression.

J. Borgmann, W. von Siemens, W. Beetz, and H. Muraoka measured the effect of temperature on the conductivity. The conductivity increases as the temp. is raised. J. Monckmann stated that the rate of the change of the resistance of carbon

with temp. rises up to 250°, and thereafter increases. S. P. Thompson said that the influence of press. on the conductivity is not perceptible. P. W. Bridgman measured the effect of *pressure* on the electrical resistance of massive graphite, but found the results not very reliable. With gas carbon, the resistance at 30° decreases with rising press., and the proportional effect becomes smaller at higher press. The decrease of resistance was 6·86 per cent. at 6000 kgrms. per sq. cm., and 12·07 per cent. at 12,000 kgrms. per sq. cm. At 96° up to 3000 kgrms. per sq. cm. press., the coeff. is about 4 per cent. greater. The resistance decreases linearly with temp. between 0° and 100°, and at 100°, the resistance is 2·56 per cent. less than it is at 0°. With a sample of Acheson-graphite the total fractional increase of resistance under 12,000 kgrms. per sq. cm. decreases with rise of temp., being 4·75 per cent. at 0°, 4·23 per cent. at 50°, and 4·23 per cent. at 100°. The increase is not linear, being 3·44 per cent. at 0° and 6000 kgrms. per sq. cm. The large departure from linearity indicates a maximum, and in no other substance is there any evidence of a maximum or a minimum being reached at high press. The press. coeff. for carbon in the amorphous and graphitic states have opposite signs. K. Arndt and F. Körner measured the electrical resistance of a number of artificial and natural graphites. They also examined the effect of the *grain size* with two samples of graphite; they reported

Grain size	>0·15 mm.	0·06 to 0·15 mm.	<0·06 mm.
Resistance	{ 40	44	52 ohms.
	{ 77	85	123 „

K. Siebel found that the electrical resistance of carbon was raised considerably by *gas absorption*.

E. Aschkinass studied the relation between the electrical conductivity and *reflecting power*; and A. Bartoli compared the conductivity and composition of different kinds of carbon. K. Arndt and W. Fehse, T. C. Mendenhall, O. Boekmann, etc., also made observations on this subject. S. Bidwell found a mixture of finely divided graphite and 20 per cent. of paraffin is a good conductor, but with 30 per cent. of paraffin the conductivity is nearly zero. J. A. Cunningham measured the potential gradient of hot carbon; and J. A. Pollock and A. B. B. Ranclaud, F. Deiminger, and O. W. Richardson studied the emission of negative ions by heated carbon. J. A. Pollock and co-workers studied the potential at the surface of heated carbon.

J. Probert and A. W. Soward²⁴ found that the conductivity is affected by absorbed gases—the magnitude of the effect depends on the nature of the gas. T. Peczalsky found that hydrogen produces no effect on the electrical resistivity of carbon at ordinary temp., or press. up to 33 atm., but the resistance increases considerably when a carbon filament is heated in hydrogen to a high temperature, and the resistance at room temperature after such a heating in hydrogen shows a similar and more marked increase, while if the filament be heated in vacuo to the same temperature the resistance decreases in value. The effect is greater the higher the press. of the hydrogen. According to J. Monckmann, when two rods of carbon, one charged with hydrogen and the other with oxygen, are in electrical contact, the current passes from the hydrogen to the oxygen. The wires and rods are found to have an increased resistance, that of the oxygen rod being the greater. The effect disappears after short-circuiting. If the wires or rods be charged twice in opposite directions, the effect disappears, unless the second charging is of very short duration; in this case, a reversal takes place. With carbon rods at different temp. in contact, reversal occurs at 250°; with a thermoelectric couple of carbon and platinum, the thermoelectric line rises below 250°, and falls above that temp. G. Tammann found that when a cold rod of any substance is dipped in hot carbon powder, it becomes covered with a layer of the powder the thickness of which increases with the difference of temp. between rod and powder. Powders other than carbon do not exhibit this phenomenon, and it is therefore

assumed that the effect is not electrical. It is supposed to be due to the occlusion by carbon of the gases given off by the rod. R. D. Kleeman and W. Frederickson studied the electrical charge assumed by a filament of carbon dipping in a liquid.

J. Buchanan placed carbon between zinc and silver in the **electrochemical series**. According to A. Coehn, H. C. Pease, and A. Avogadro, the **electrochemical equivalent** of carbon is 3, if that of hydrogen be unity. C. Fromme measured the **electromotive force**, *i.e.* the potential difference of gas carbon in nitric and chromic acids. A. Voller found that the potential difference of carbon in nitric acid is not much affected by raising the temp. from 0° to 100°. G. Gore measured the e.m.f. of carbon in soln. of potassium chloride, bromide, iodide, and cyanide. S. Marianini measured the potential difference of carbon in sea-water; M. Faraday, of carbon in hydrochloric acid; J. C. Poggendorff, of carbon and graphite in soln. of ammonium chloride, potassium cyanide, and potassium ferrocyanide. The use of carbon as the negative pole in batteries has been discussed by G. Wiedemann. D. Tommasi described a cell using a carbon rod surrounded by lead dioxide in one compartment, and a carbon rod with a soln. of sodium or calcium chloride in the other. The reactions are said to be $C + 2H_2O = CO_2 + 2H_2$, and $2H_2 + PbO_2 = Pb + 2H_2O$. C. J. Reed said that 42 cal. of energy are consumed and not generated by such a cell. According to F. Haber and L. Bruner, there is a difference of potential of about a volt between carbon and iron rods immersed in fused sodium hydroxide; and in the electrolyte, the current flows from the carbon to the iron. The iron rapidly dissolves, but it may become passive. If the iron is immersed in fused sodium nitrate, it is covered with a dark skin of oxide, which is difficult to remove; such iron is passive. The addition of alkali manganate to the sodium hydroxide also produces the passive condition, and the more readily the less water the sodium hydroxide contains. This is explained by the fact that dry sodium hydroxide does not yield any hydrogen when electrolyzed, and therefore, since no hydrogen can be evolved at the surface of the iron, the skin of oxide is formed more completely. Since all sodium hydroxide, especially when fused in contact with iron and air, contains more or less manganate, it appears that iron protected by a skin of oxide and immersed in sodium hydroxide containing manganate is really an oxygen electrode, the part played by the manganate being that of an intermediary, by means of which the atm. oxygen can pass into the ionic condition. The e.m.f. of the combination, passive iron in sodium hydroxide | calomel electrode, was found to be -0.265 volt at 312°, increasing to -0.472 volt at 532°. This e.m.f. is independent of the quantity of manganate in the electrolyte as this is not very small or very large. The e.m.f. of the combination, carbon in fused sodium hydroxide | calomel electrode, varies greatly with the nature of the carbon employed, -0.66 volt being found with artificial graphite and -1.4 with a partially disintegrated, arc-lamp carbon. The carbon is attacked by fused sodium hydroxide, hydrogen being evolved. The more rapid the evolution of hydrogen, the greater is the e.m.f. When a very rapid evolution of hydrogen is produced by heating the sodium hydroxide to 500°, the e.m.f. rises to -1.5 volts. When a platinum tube, through which a current of hydrogen is passed, is substituted for the carbon electrode, the same e.m.f. is observed, namely, -1.48 to -1.5 volts. It appears, therefore, that the carbon electrode is really a hydrogen electrode. That an e.m.f. lower than -1.5 volts is often observed is readily explained by the partial depolarization of the electrode by the manganate present in the electrolyte. It is only when the temp. is sufficiently high to produce a rapid evolution of hydrogen that the full value is observed. When the carbon is once charged with hydrogen, however, it retains the high e.m.f. for some time at lower temp. The carbon electrode is really a hydrogen electrode, the hydrogen being formed by the action of carbon on sodium hydroxide, and the reaction to which the e.m.f. of the cell is due is the formation of water from this hydrogen and atm. oxygen. The e.m.f. of the cell agrees well with the e.m.f. required to decompose into hydrogen and oxygen the small quantities of water dissolved in fused sodium hydroxide. V. Karpen studied these cells.

E. Newbery found that the **overvoltages** of graphite and gas carbon are very variable in both acid and alkali. In acid, that of graphite rises to a very high value at high current density and the electrode disintegrates rapidly. With gas carbon, the disintegration is still greater, whilst the overvoltage is lower. At low current densities, the disintegration is very slight, especially with graphite, but the surface is softened and the whole electrode becomes very brittle. Little or no deposit appears on the cathode. In alkali-lye, even at the lowest current densities, a black deposit is produced on the cathode, but the disintegration of the anodes is much less. No visible change is produced at the anode after passing currents up to 100 milliampères per sq. cm. for half an hour. With a current at 1000 milliampères per sq. cm., a gas carbon electrode gradually disintegrates, the liquid is discoloured, and a shower of small carbon particles falls to the bottom of the vessel. Under similar treatment, a graphite electrode acquires a crystalline appearance and a few particles fall off, but there is very little discoloration of the electrolyte. The crystalline appearance is produced in acid or alkali at high current densities, and, after drying, microscopic examination reveals the fact that the finely divided materials between the larger crystals have been carried away, leaving the crystals themselves almost untouched. A. Günther-Schulze measured the cathode potential of graphite in different gases. J. W. Langley, C. Liebenoff and L. Strasser, F. Exner and J. Tuma, etc., have studied this subject. H. Ayrtton, W. Mathiesen, A. E. R. Westman and W. J. Clapson, E. Rasch, and V. L. Crisler studied the potential gradient and general characteristics of the **carbon arc**; W. G. Duffield and co-workers, the recoil press.; and K. T. Compton, ionization in the carbon arc.

The **Volta effect** of the sodium and carbon couple was measured by E. Corminas; and that of the couples gas carbon or wood charcoal with gold or platinum, by A. Bartoli and G. Papasogli. W. Skey measured the Volta effect with graphite and native sulphides. The **thermoelectric force** of the platinum and carbon couple was found by J. Buchanan to be $176 + 2.07\theta$ C.G.S. units at θ° ; and of the carbon and lead couple, $390 - 1.87\theta$. J. Weiss and J. Königsberger gave 5.3×10^{-6} volt for the thermoelectric force of the copper and carbon couple. H. Muraoka found graphite to be thermoelectrically negative against other varieties of carbon. H. Zahn made observations on the **thermomagnetic properties** of carbon.

According to M. Faraday,²⁵ amorphous carbon and graphite are but feebly magnetic; and F. Zantedeschi found them to be diamagnetic. A. L. Holtz also said that soot, fir-wood charcoal, and graphite are diamagnetic; P. Pascal found that sugar charcoal, freed from hydrogen and iron, is diamagnetic, the **magnetic susceptibility** is -52×10^{-6} mass units, and it is not affected by six hours' heating in vacuo at a red heat; for the diamond he gave -0.52×10^{-6} units. S. Meyer gave for graphite at 18° , -8×10^{-6} vol. units; and for the diamond at 13° , -1.1×10^{-6} vol. units, and -0.33 mass units. K. Honda found the magnetic susceptibility of arc carbons at 18° to be -2.0×10^{-6} mass units; and at 1160° , -1.5×10^{-6} units; likewise for the diamond, at $18^\circ - 500^\circ$, he gave -0.49×10^{-6} units. P. Pascal computed the at. susceptibility of carbon with various linkages. M. von Pirani found the **dielectric constant** of the diamond to be 16.47 for $\lambda = \infty$; W. Schmidt obtained 5.50 for $\lambda = 75$; and A. Coehn and U. Raydt, 5.18 to 8.0. M. von Pirani gave 2.4 for wood charcoal of sp. gr. 1.4.

REFERENCES.

- A. des Cloizeaux, *Manuel de minéralogie*, Paris, 18, 1874; C. Doelter, *Neues Jahrb. Min.*, 1896, L. E. Rivot, *Ann. Mines*, (4), 14, 423, 1849; H. Moissan, *Compt. Rend.*, 121, 449, 123, 210, 1896; A. Daubrée, *ib.*, 84, 1277, 1877; H. Gorceix, *ib.*, 93, 981, 1881; H. Hobbs, *Journ. Geol.*, 7, 375, 1899; *Amer. Geol.*, 14, 31, 1894; G. F. Kunz and H. S. Washington, *Amer. Journ. Science*, (4), 24, 275, 1907; C. Zerrenner, *Neues Jahrb. Min.*, 230, 1870; E. Jannettaz, *Bull. Soc. Min.*, 14, 65, 1891; F. Imperatus, *Dell'istoria naturale*, Napoli, 4, 122, 1599.

² M. Diersche, *Jahrb. Geol. Reichsanst.*, Wien, 48, 231, 1899; H. Moissan, *Compt. Rend.*, 116.

608, 1893; 121. 538, 1895; P. and L. Schützenberger, *ib.*, 111. 774, 1890; G. Rousseau, *ib.*, 117. 164, 1893; H. N. Warren, *Chem. News*, 69. 291, 1894.

³ W. G. Mixer, *Amer. Journ. Science*, (4), 19. 434, 1905; T. L. Phipson, *Chem. News*, 93. 119, 1906.

⁴ Pliny, *Historia naturalis*, 37. 15, A.D. 77; J. B. L. Romé de l'Isle, *Cristallographie*, Paris, 2. 191, 1783; F. Mohs, *Grundriss der Mineralogie*, Dresden, 2. 351, 1824; C. F. Naumann, *Lehrbuch der Mineralogie*, Berlin, 612, 1828; *Lehrbuch der Krystallographie*, Leipzig, 2. 234, 1829; J. F. L. Hausmann, *Handbuch der Mineralogie*, Göttingen, 4, 1847; A. Breithaupt, *Vollständiges Handbuch der Mineralogie*, Dresden, 624, 1847; H. J. Brooke and W. H. Miller, *Introduction to Mineralogy*, London, 111, 1852; F. von Kobell, *Sitzber. Bayer. Akad.*, 11. 1129, 1872; G. Rose, *Das kristallo-chemischen Mineralsystem*, Leipzig, 144, 1852; *Sitzber. Akad. Berlin*, 633, 1853; *Ber.*, 4. 903, 1871; *Zeit. prakt. Geol.*, 6. 250, 1854; 9. 15, 1857; A. Sadebeck, *ib.*, 30. 605, 1878; *Sitzber. Akad. Berlin*, 578, 1876; J. Hirschwald, *Zeit. Kryst.*, 1. 212, 1887; J. Beckenkamp, *ib.*, 58. 7, 1923; P. Groth, *ib.*, 2. 96, 1888; *Die Mineralien-Sammlung der Universität Strassburg*, Strassburg, 4, 1878; A. des Cloizeaux, *Manuel de minéralogie*, Paris, 2. 18, 1874; *Ann. Mines*, (5), 8. 304, 1855; *Ann. Chim. Phys.*, (3), 14. 301, 1845; *Neues Jahrb. Min.*, 499, 1877; E. Cohen, *ib.*, 752, 1876; i, 318, 1884; G. A. Kenngott, *ib.*, 81, 1859; *Sitzber. Akad. Wien*, 10. 182, 1875; P. Harting, *Neues Jahrb. Min.*, 192, 1859; P. von Jeremejeff, *ib.*, 275, 589, 1871; A. Knop, *ib.*, 785, 1872; E. Weiss, *ib.*, ii, 13, 1880; J. Martin, *Zeit. deut. geol. Ges.*, 30. 521, 1878; H. R. Göppert, *Pogg. Ann.*, 92. 623, 1854; *Abhand. Schles. Ges.*, 61, 1869; A. Schrauf, *Tschermak's Mitt.*, 289, 1873; F. Berwerth, *ib.*, (2), 19. 340, 1900; G. F. Williams, *Trans. Amer. Inst. Min. Eng.*, 35. 440, 1904; D. Brewster, *Journ. Geol. Soc.*, 3. 466, 1833; *Phil. Mag.*, (3), 7. 245, 1835; (4), 3. 284, 1852; *Trans. Roy. Soc. Edin.*, 10. 1. 1823; 23. 39, 1864; C. Friedel, *Bull. Soc. Min.*, 14. 7, 1891; *Bull. Soc. Chim.*, (2), 41. 100, 1884; G. Friedel, *Compt. Rend.*, 177. 1085, 1923; H. C. Sorby, *Ber.*, 2. 126, 1869; H. C. Sorby and P. J. Butler, *Proc. Roy. Soc.*, 17. 291, 1869; S. Tennant, *Amer. Journ. Science*, (2), 22. 278, 1856; N. S. Maskelyne, *ib.*, (2), 17. 136, 1854; E. Regener, *Sitzber. Akad. Berlin*, 948, 1909; A. von Fersmann and V. Goldschmidt, *Der Diamant*, Heidelberg, 1911; J. B. A. Dumas, *Compt. Rend.*, 16. 246, 1843; H. Moissan, *ib.*, 121. 449, 1895; 23. 210, 1896; A. Damour, *L'Institut*, 77, 1853; *Bull. Soc. Géol.*, (3), 13. 542, 1855; G. Delafosse, *Nouveau cours de minéralogie*, Paris, 2. 157, 1860; A. Petzholdt, *Journ. prakt. Chem.*, (1), 23. 474, 1841; *Beiträge zur Naturgeschichte der Diamantes*, Dresden, 1842; E. Söchtling, *Einschlüsse von Mineralien in kristallisierten Mineralien*, Freiburg, 1860; L. S. Ramsdell, *Amer. Min.*, 7. 158, 1922; J. R. Sutton, *Trans. Roy. Soc. S. Africa*, 8. 153, 1920; *Min. Mag.*, 19. 208, 1921; H. Behrens, *Arch. Néerl.*, (1), 16. 377, 1881; W. H. and W. L. Bragg, *Proc. Roy. Soc.*, 89. A, 277, 1913; W. H. Bragg, *Proc. Phys. Soc.*, 33. 304, 1921; 34. 33, 1921; *X-Rays and Crystal Structure*, London, 102, 1915; 99, 1924; E. Q. Adams, *Journ. Washington Acad.*, 8. 240, 1918; E. Mohr, *Journ. prakt. Chem.*, (2), 98. 315, 1918; A. W. Hull, *Phys. Rev.*, (2), 10. 661, 1917; P. N. Pease, *Journ. Amer. Chem. Soc.*, 44. 769, 1922; M. Copisarow, *ib.*, 43. 1870, 1921; *Chem. News*, 118. 301, 1919.

⁵ G. A. Kenngott, *Sitzber. Akad. Wien*, 13. 469, 1854; W. H. and W. L. Bragg, *Proc. Roy. Soc.*, 89. A, 277, 1913; *X-Rays and Crystal Structure*, London, 102, 1915; 99, 1924; A. W. Hull, *Phys. Rev.*, (2), 10. 661, 1917; (2), 20. 113, 1922; J. N. von Fuchs, *Journ. prakt. Chem.*, (1), 7. 353, 1836; F. von Sandberger, *Neues Jahrb. Min.*, i, 202, 1888; W. Luzi, *Ber.*, 25. 1378, 1892; F. Monier, *Compt. Rend.*, 78. 420, 1874; H. Moissan, *ib.*, 116. 608, 1893; 119. 976, 1245, 1894; *Ann. Chim. Phys.*, (7), 8. 306, 1896; B. Walter, *Jahresb. Geol. Ges.*, 41. 359, 1890; H. Erdmann, *Liebig's Ann.*, 247. 307, 1888; W. Haidinger, *Handbuch der bestimmenden Mineralogie*, Wien, 513, 1845; W. B. Clarke, *Chem. News*, 24. 16, 40, 64, 78, 1871; W. C. Brögger, *Zeit. Kryst.*, 10. 507, 1892; A. F. Moses, *ib.*, 23. 506, 1897; R. Jameson, *A System of Mineralogy*, Edinburgh, 2. 216, 1820; F. Mohs, *Grundriss der Mineralogie*, Dresden, 2. 216, 1824; C. F. Naumann, *Lehrbuch der Mineralogie*, Berlin, 615, 1828; *Elemente der Mineralogie*, Leipzig, 548, 1868; M. L. Huggins, *Journ. Amer. Chem. Soc.*, 44. 1841, 1922; 45. 264, 1923; *Phys. Rev.*, (2), 19. 346, 369, 1922; *Amer. Journ. Science*, (5), 5. 303, 1923; J. Beckenkamp, *Zeit. Kryst.*, 58. 7, 1923; R. Scharizer, *ib.*, 55. 440, 1920; A. Landé, *Zeit. Physik*, 4. 410, 1921; H. Thirring, *ib.*, 4. 1, 1921; N. Gross, *Umschau*, 34. 510, 1920; H. Lachs, *Iszy. Zjazd. Chem. Polskich*, 31, 1923; *Journ. Phys. Rad.*, 3. 125, 1922; N. H. Kolkmeijer, *Zeit. anorg. Chem.*, 105. 35, 1919; *Proc. Acad. Amsterdam*, 23. 120, 1920; D. Coster, *ib.*, 22. 536, 1920; G. A. Suckow, *Pogg. Ann.*, 32. 387, 1834; *Neues Jahrb. Min.*, 647, 1834; F. Rinne, *ib.*, ii, 47, 1916; C. Czeck, *ib.*, 309, 1865; A. E. Nordenskjöld, *Beskrif. öfver dei Finland funna mineralier*, Helsingfors, 1855; *Pogg. Ann.*, 96. 110, 1855; H. Sjögren, *Öfvers. Akad. Förh.*, 4. 29, 1884; *Zeit. Kryst.*, 10. 506, 1892; R. J. Haiy, *Traité de minéralogie*, Paris, 4. 85, 1822; G. Wulff, *Phys. Zeit.*, 21. 718, 1920; V. Kohlschütter, *Zeit. anorg. Chem.*, 105. 35, 1919; W. T. Astbury, *Science Prog.*, 386, 1923; G. Asahara, *Journ. Chem. Japan*, 1. 35, 1922; P. Groth, *Tabellarische Uebersicht der Mineralien*, Braunschweig, 11, 1882; 13, 1889; L. Fletcher, *Introduction to the Study of Meteorites*, London, 1896; P. Groth, *Phys. Zeit.*, 1. 11, 1906; P. Debye and P. Scherrer, 291, 1917; *Engg.*, 104. 17, 594, 1917; H. le Chatelier, *Leçons sur le carbone*, Paris, 58, 1923; P. P. Ewald, *Sitzber. Akad. Berlin*, 325, 1914; P. Poch, *Anal. Soc. Espan. Fis. Quim.*, 21. 1923; E. Ryschewitsch, *Chem. Ztg.*, 48. 101, 1924; E. Q. Adams, *Journ. Washington Acad.*, 8. 240, 1918; E. Mohr, *Journ. prakt. Chem.*, (2), 98. 315, 1918; P. N. Pease, *Journ. Amer. Chem. Soc.*, 44. 769, 1922; F. P. Worley, *Rep. Australasian Assoc.*, 16. 212, 1923; G. Asahara, *Science Papers Inst. Phys. Chem. Research*, 1. 23, 1922.

⁶ Pliny, *Historia naturalis*, 37. 15, A.D. 77; H. Moissan, *Le four électrique*, Paris, 1897; London, 79, 1904; C. de Douhet, *Mondes*, 13. 581, 1867; F. Auerbach, *Wied. Ann.*, 53. 1000, 1894; J. R. Rydberg, *Zeit. phys. Chem.*, 33. 353, 1900; G. A. Kenngott, *Sitzber. Akad. Wien*, 13. 469, 1854; A. B. de Boot, *Gemmarum et lapidum historia*, Jena, 1609; F. Monier, *Bull. Assoc. Scient. France*, 14. 18, 1874; *Compt. Rend.*, 78. 420, 1874; A. V. Rakowsky, *Journ. Russ. Phys. Chem. Soc.*, 49. 371, 1917.

⁷ R. Boyle, *Hydrostatic Balance*, London, 1690; *Observations on Diamonds*, London, 1672; M. J. Brisson, *Pesanteur spécifiques des corps*, Paris, 1787; F. Mohs, *Grundriss der Mineralogie*, Dresden, 2. 306, 1824; T. Thomson, *Outlines of Mineralogy*, London, 1. 46, 1836; J. J. Berzelius, *Ann. Chim. Phys.*, (2), 49. 247, 1832; H. Fizeau, *Compt. Rend.*, 60. 1161, 1865; E. Cohen and J. Olie, *Zeit. phys. Chem.*, 71. 385, 1910; E. Wülfing, *Tschermak's Mitt.*, (2), 15. 49, 1896; P. A. Dufrenoy, *Compt. Rend.*, 40. 3, 1855; C. Friedel, *ib.*, 115. 1037, 1893; V. A. Jacquelin, *ib.*, 24. 1050, 1847; *Ann. Chim. Phys.*, (3), 20. 459, 1847; L. E. Rivot, *Ann. Mines*, (4), 14. 423, 1849; *Phil. Mag.*, (3), 34. 397, 1849; *Compt. Rend.*, 28. 317, 1849; H. Moissan, *ib.*, 116. 608, 1893; 119. 976, 1245, 1894; *Ann. Chim. Phys.*, (7), 8. 306, 1896; W. J. Grailich, *Bull. Soc. Géol.*, (2), 13. 542, 1856; *L'Institut*, 25. 324, 1857; A. Schrauf, *Sitzber. Akad. Wien*, 54. 479, 1866; A. von Schrötter, *ib.*, 63. 462, 1871; E. H. von Baumhauer, *Arch. Néerl.*, (1), 8. 1, 97, 1873; *Wied. Ann.*, 1. 466, 1877; A. Wigand, *Ann. Physik*, (4), 22. 64, 1907; F. Feilitzsch, *Pogg. Ann.*, 87. 206, 427, 1852; A. Schafarik, *ib.*, 139. 188, 1870; L. Playfair, *Proc. Roy. Soc. Edin.*, 4. 241, 1862; *Chem. News*, 2. 1, 48, 1860; E. Donath and J. Mayrhofer, *Ber.*, 16. 1588, 1883; E. Petersen, *Zeit. phys. Chem.*, 8. 601, 1891; T. W. Richards, *Zeit. Elektrochem.*, 13. 519, 1907; *Journ. Amer. Chem. Soc.*, 37. 1643, 1915; R. M. Burns and G. A. Hulett, *ib.*, 45. 572, 1923; H. E. Cude and G. A. Hulett, *ib.*, 42. 391, 1920; G. F. Kunz, *Amer. Journ. Science*, (3), 34. 490, 1887; Y. Tadokoro, *Science Rep. Tohoku Univ.*, (1), 10. 339, 1921; A. Liversidge, *Description of the Minerals of New South Wales*, Sydney, 1882.

⁸ C. Mène, *Compt. Rend.*, 64. 1091, 1867; H. le Chatelier and S. Wologdine, *ib.*, 146. 49, 1908; H. Moissan, *ib.*, 116. 608, 1893; 119. 976, 1245, 1894; *Ann. Chim. Phys.*, (7), 8. 306, 1896; H. V. Regnault, *ib.*, (4), 7. 450, 1866; J. Löwe, *Journ. prakt. Chem.*, (1), 66. 186, 1855; J. N. von Fuchs, *ib.*, (1), 7. 353, 1836; B. C. Brodie, *Phil. Trans.*, 149. 249, 1859; S. McLean, *Trans. Roy. Soc. Canada*, 13. iii, 197, 1919; L. Cellier, *Wied. Ann.*, 61. 511, 1897; E. Ryschkewitsch and E. Köstermann, *Zeit. Elektrochem.*, 30. 86, 1924; G. A. Kenngott, *Sitzber. Akad. Wien*, 13. 469, 1854; C. F. Rammelsberg, *Ber.*, 6. 187, 1873; W. Luzi, *ib.*, 25. 1378, 1892; M. Diersche, *Jahrb. Geol. Reichsanst. Wien*, 48. 231, 1899; A. Wigand, *Ann. Physik*, (4), 22. 64, 1907; L. Playfair, *Proc. Roy. Soc. Edin.*, 4. 241, 1862; *Chem. News*, 2. 1, 18, 1860; E. Petersen, *Zeit. phys. Chem.*, 8. 601, 1892; C. de Douhet, *Mondes*, 13. 581, 1867; T. W. Richards, *Zeit. Elektrochem.*, 13. 519, 1907; *Journ. Amer. Chem. Soc.*, 37. 1643, 1905; C. J. B. Karsten, *Schweizer's Journ.*, 65. 394, 1832; J. C. Poggendorff, *Pogg. Ann. Ergbd.*, 2. 363, 1848; J. J. Berzelius, *Ann. Chim. Phys.*, (2), 49. 247, 1832; E. Cohen and J. Olie, *Zeit. phys. Chem.*, 71. 385, 1910; Y. Tadokoro, *Science Rep. Tohoku Univ.*, (1), 10. 339, 1921; M. Pirani and W. Fehse, *Zeit. Elektrochem.*, 29. 168, 1923; F. Sauerwald, *ib.*, 28. 171, 1922; W. C. Arsem, *Trans. Amer. Electrochem. Soc.*, 20. 105, 1911; H. E. Cude and G. A. Hulett, *Journ. Amer. Chem. Soc.*, 42. 391, 1920; R. M. Burns and G. A. Hulett, *ib.*, 45. 572, 1923; M. Debeauvais, *Bull. Soc. Min.*, 46. 49, 1923.

⁹ H. Violette, *Ann. Chim. Phys.*, (3), 39. 291, 1853; H. Moissan, *ib.*, (7), 8. 289, 1896; W. Hallock, *Bull. U.S. Geol. Sur.*, 42. 132, 1887; W. Luzi, *Ber.*, 25. 1378, 1892; G. Werther, *Journ. prakt. Chem.*, (1), 61. 21, 1853; C. Mène, *Compt. Rend.*, 64. 1091, 1867; H. le Chatelier and S. Wologdine, *ib.*, 146. 49, 1908; W. G. Mixter, *Amer. Journ. Science*, (4), 19. 434, 1905; A. Frank, *Zeit. angew. Chem.*, 18. 1733, 1906; A. Wigand, *Ann. Physik*, (4), 22. 64, 1907; L. Bell and P. R. Bassett, *Science*, (2), 56. 512, 1922; R. N. Pease, *Journ. Amer. Chem. Soc.*, 44. 1497, 1922; H. E. Cude and G. A. Hulett, *ib.*, 42. 391, 1920; A. Landé, *Zeit. Physik*, 4. 410, 1921; A. W. Williams, *Proc. Roy. Soc.*, 98. A, 223, 1920; L. Playfair, *Chem. News*, 2. 1, 18, 1860; *Proc. Roy. Soc. Edin.*, 4. 241, 1862; A. Zott, *Wied. Ann.*, 27. 229, 1886; L. Meyn, *Journ. prakt. Chem.*, (1), 26. 482, 1842; A. Baudrimont, *ib.*, (1), 7. 278, 1836; F. Monier, *Bull. Assoc. Scient. France*, 14. 18, 1874; *Compt. Rend.*, 78. 420, 1874; A. Titoff, *Zeit. phys. Chem.*, 74. 647, 1910; I. F. Homfray, *ib.*, 74. 152, 1910; F. Exner, *Monatsh.*, 6. 249, 1885; *Sitzber. Akad. Wien*, 91. 850, 1885; T. Graham, *Phil. Mag.*, (4), 26. 409, 1863; (4), 27. 81, 1864; *Proc. Roy. Soc.*, 12. 611, 1863; T. E. Thorpe, *Journ. Chem. Soc.*, 37. 141, 327, 1880; H. L. Buff, *Liebig's Ann.*, 4. 129, 1866; M. Schalfjeff, *Ber.*, 15. 2209, 1882; E. Petersen, *Zeit. phys. Chem.*, 8. 601, 1891; Y. Tadokoro, *Science Rep. Tohoku Univ.*, (1), 10. 339, 1921.

¹⁰ T. W. Richards, *Zeit. Elektrochem.*, 13. 519, 1907; *Journ. Amer. Chem. Soc.*, 37. 1643, 1915; *The Compressibilities of the Elements and their Periodic Relations*, Washington, 1907; *Spring, Ann. Chim. Phys.*, (5), 22. 190, 1881; H. Moissan, *Compt. Rend.*, 123. 206, 1896; *Forstling, Zeit. Physik*, 8. 351, 1922; J. J. Thomson, *Phil. Mag.*, (6), 44. 659, 1922; A. W. Williams, *Proc. Roy. Soc.*, 98. A, 223, 1920; L. H. Adams, E. H. Williamson, and J. Johnston, *Journ. Amer. Chem. Soc.*, 41. 39, 1919; L. H. Adams, *Journ. Washington Acad. Science*, 11. 45, 1921; A. Landé, *Zeit. Physik*, 4. 410, 1921; J. H. Hildebrand, T. R. Hogness, and N. W. Taylor, *Journ. Amer. Chem. Soc.*, 45. 2828, 1923.

¹¹ H. Fizeau, *Compt. Rend.*, 60. 1161, 1865; 62. 1101, 1133, 1866; 68. 1125, 1869; *Chem. News*, 12. 27, 1865; *Ann. Chim. Phys.*, (4), 8. 335, 1866; (5), 12. 34, 1877; *Amer. Journ. Science*, (2), 43. 255, 1867; H. Murraoka, *Ueber das galvanische Verhalten der Kohle*, Strassburg, 1881; *Wied. Ann.*, 13. 307, 1881; J. Dewar, *Proc. Roy. Soc.*, 70. 237, 1902; J. Monckmann, *ib.*, 44.

220, 1888; J. Joly, *Trans. Roy. Soc. Dublin*, (2), 6. 283, 1896; W. C. Röntgen, *Sitzber. Akad. München*, 381, 1912.

¹² W. G. Mixer, *Amer. Journ. Science*, (4), 19. 434, 1905; H. Violette, *Ann. Chim. Phys.*, (3), 39. 291, 1853; H. Hecht, *F. E. Neumann's Methode zur Bestimmung der Wärmeleitfähigkeit schlecht leitender Körper in Kugel- und Würfelform; und ihre Durchführung an Marmor, Glas, Sandstein, Gyps sowie Serpentin, Basalt, Schwefel, Steinkohle*, Königsberg, 1903; *Ann. Physik*, (4), 14. 1008, 1904; F. E. Neumann, *Ann. Chim. Phys.*, (3), 66. 183, 1862; *Phil. Mag.*, (4), 25. 63, 1863; W. Nusselt, *Zeit. Ver. deut. Ing.*, 57. 906, 1006, 1908; R. Weber, *Arch. Sciences Genève*, (3), 33. 590, 1895; L. Cellier, *Leistungsvermögen der schwarzen Kohle für Wärme und Elektrizität*, Zürich, 1896; *Wied. Ann.*, 61. 511, 1897; D. Forbes, *Trans. Edin. Roy. Soc.*, 24. 73, 1867; *Proc. Roy. Soc. Edin.*, 8. 62, 1875; J. M. Ordway, *Trans. Amer. Soc. Mech. Eng.*, 6. 168, 1884; A. Artom, *Atti Accad. Torino*, 37. 667, 1902; R. S. Hutton and J. R. Beard, *Trans. Faraday Soc.*, 1. 1, 1905; S. Wologdine, *Bull. Soc. Ind. Nat.*, 110. 821, 1908; *Rev. Mét.*, 6. 767, 1909; B. Piesch, *Sitzber. Akad. Wien*, 102. 768, 1893; A. L. Queneau, *Electrochem. Met. Ind.*, 7. 383, 433, 1909; C. A. Hansen, *ib.*, 7. 514, 1909; *Trans. Amer. Electrochem. Soc.*, 15. 279, 1909; H. Sjörög, *Öfvers. Akad. Förh. Stockholm*, 4. 29, 1884; E. Jannetaz, *Bull. Soc. Min.*, 15. 926, 1892; M. Icole, *Ann. Chim. Phys.*, (8), 25. 137, 1912; Y. Tadokoro, *Science Rep. Tohoku Univ.*, (1), 10. 339, 1921; H. Muraoka, *Ueber des galvanische Verhalten der Kohle*, Strassburg, 1881; *Wied. Ann.*, 13. 307, 1881.

¹³ J. E. Pionchon, *Compt. Rend.*, 103. 1122, 1866; H. V. Regnault, *ib.*, 24. 1081, 1847; *Ann. Chim. Phys.*, (4), 7. 450, 1866; P. A. Favre and J. T. Silbermann, *ib.*, (3), 34. 357, 1852; (3), 36. 5, 1852; *Compt. Rend.*, 24. 1081, 1847; J. Violle, *ib.*, 120. 868, 1895; H. le Chatelier, *ib.*, 116. 1051, 1893; J. G. Pammer, *Monatsh.*, 41. 467, 1920; L. Cellier, *Wied. Ann.*, 61. 511, 1897; L. Kunz, *Ann. Physik*, (4), 14. 309, 1904; H. Kopp, *Liebig's Ann. Suppl.*, 3. 1, 289, 1865; *Liebig's Ann.*, 126. 362, 1863; 141. 121, 1867; P. J. van Kerckhoff, *Arch. Néerl.*, 2. 280, 1867; A. Bettendorff and A. Wüllner, *Pogg. Ann.*, 131. 293, 1867; H. F. Weber, *ib.*, 147. 311, 1872; 154. 367, 553, 1875; *Programm Akad. Hohenheim*, 56. 1, 1874; *Arch. Sciences Genève*, (2), 44. 172, 1872; (2), 54. 406, 1875; *Phil. Mag.*, (4), 44. 251, 1872; (4), 49. 161, 276, 1875; J. Dewar, *ib.*, (4), 44. 461, 1872; *Proc. Roy. Soc.*, 76. A, 325, 1905; L. Kunz, *Ann. Physik*, (4), 14. 309, 1904; A. Wigand, *ib.*, (4), 22. 64, 1907; D. I. Mendeléeff, *Ber.*, 2. 662, 1869; K. Puschl, *Sitzber. Akad. Wien*, 69. 142, 1874; G. Schmidt, *ib.*, 52. 417, 1865; C. E. Carbonelli, *Atti Soc. Ligust.*, 2. 1, 1892; *Gazz. Chim. Ital.*, 22. 123, 1892; F. Marcet and A. de la Rive, *Bibl. Univ. Genève*, 32. 349, 1841; *Ann. Chim. Phys.*, (3), 2. 121, 1841; G. N. Lewis and G. E. Gibson, *Journ. Amer. Chem. Soc.*, 39. 2554, 1917; G. N. Lewis, G. E. Gibson, and W. M. Latimer, *ib.*, 44. 1008, 1922; W. R. Mott, *Trans. Amer. Electrochem. Soc.*, 34. 255, 1918; W. Nernst, F. Koref, and F. A. Lindemann, *Sitzber. Akad. Berlin*, 247, 1910; W. Nernst and F. A. Lindemann, *ib.*, 494, 1911; *Zeit. Elektrochem.*, 17. 817, 1911; W. Nernst, *ib.*, 17. 265, 1911; *Sitzber. Akad. Berlin*, 262, 1910; 306, 1911; *Ann. Physik*, (4), 36. 395, 1911; G. Ewald, *ib.*, (4), 44. 1213, 1914; A. Magnus, *ib.*, (4), 70. 303, 1923; F. Koref, *ib.*, (4), 36. 49, 1911; W. Spring, *Ann. Chim. Phys.*, (5), 7. 214, 1876; J. Monckman, *Proc. Roy. Soc.*, 44. 220, 1888; Y. Tadokoro, *Science Rep. Tohoku Univ.*, (1), 10. 339, 1921.

¹⁴ J. Violle, *Compt. Rend.*, 120. 868, 1895; W. Crookes, *Proc. Roy. Soc.*, 76. A, 458, 1905; R. Schenck, *Zeit. Elektrochem.*, 12. 218, 1906; R. Schenck and W. Heller, *Ber.*, 38. 2132, 2139, 1905; A. von Weinberg, *ib.*, 52. 1501, 1919; M. Padoa, *Gazz. Chim. Ital.*, 51. ii, 239, 1921; A. König, *Zeit. Elektrochem.*, 12. 441, 1906; C. Doelter, *Sitzber. Akad. Wien*, 120. 61, 1911; H. Moissan, *Le four électrique*, Paris, 159, 1897; A. Smithells, *Phil. Mag.*, (6), 1. 476, 1901; K. Fajans, *Ber.*, 53. B, 643, 1920; 55. B, 2826, 1922; *Zeit. Physik*, 1. 101, 1920; H. Kohn, *ib.*, 3. 143, 1920; E. Grüneisen, *Verh. deut. phys. Ges.*, 14. 324, 1912; *Ann. Physik*, (4), 55. 377, 1918; A. Thiel and F. Ritter, *Zeit. anorg. Chem.*, 132. 125, 153, 1923; A. Thiel, *Ber.*, 55. 2844, 1922; O. Lummer, *Verfüssigung der Kohle und Herstellung der Sonnentemperatur*, Braunschweig, 1914; H. Kohn, *Zeit. Physik*, 3. 143, 1920; H. Kohn and M. Guckel, *Naturwiss.*, 12. 139, 1924; J. J. van Laar, *Proc. Acad. Amsterdam*, 18. 1220, 1916; 20. 138, 492, 1918; W. R. Mott, *Trans. Amer. Electrochem. Soc.*, 34. 555, 1918; J. A. M. van Liempt, *Zeit. anorg. Chem.*, 115. 218, 1921; P. Wibaut, *Rec. Trav. Chim. Pays-Bas*, 41, 453, 1922; E. Podszus, *Verh. deut. phys. Ges.*, 21, 284, 1919; R. Schenck, H. Semiller, and V. Falcke, *ib.*, 40, 1704, 1907; V. Falcke, *ib.*, 46, 743, 1913; F. Ritter, *Untersuchungen über die Verdampfung des Kohlenstoffs*, Marburg, 1923.

¹⁵ P. A. Favre and J. T. Silbermann, *Compt. Rend.*, 20. 1565, 1845; 21. 944, 1845; 24. 1081, 1847; *Ann. Chim. Phys.*, (3), 34. 357, 1852; C. M. Despretz, *ib.*, (2), 37. 180, 1828; (3), 36. 5, 1852; M. Berthelot and P. Petit, *ib.*, (6), 17. 80, 1889; *Compt. Rend.*, 108. 1144, 1889; M. P. thelot and P. Vieille, *ib.*, 90. 1097, 1884; J. Violle, *ib.*, 120. 868, 1895; P. L. Dulong, *ib.* 871, 1838; T. Andrews, *B. A. Rep.*, 63, 1849; *Chem. Gaz.*, 7. 407, 1849; *Phil. Mag.*, (3), 321, 426, 1848; W. A. Roth and H. Wallasch, *Zeit. Elektrochem.*, 21. 1, 1915; *Ber.*, 46. 896, 1919; N. I. Nikitin, *Journ. Russ. Phys. Chem. Soc.*, 48. 54, 1916; P. Poch, *Anal. Soc. Espan. Fis. Quim.*, 291, 1923; M. Copisaroff, *Journ. Amer. Chem. Soc.*, 43. 1870, 1921; A. von Weinberg, *Ber.*, 53. B, 1347, 1355, 1519, 1920; A. Thiel, *ib.*, 53. B, 1378, 1920; 55. B, 2844, 1922; W. Hüchel, *Journ. prakt. Chem.*, (2), 103, 241, 1921; *Ber.*, 53. B, 1277, 1920; 55. B, 2839, 1922; H. J. Prins, *ib.*, 55. B, 3437, 1922; *Journ. prakt. Chem.*, (2), 89. 414, 425, 1914; *Chem. Weekbl.*, 14. 932, 1917; D. Kononoff, *Journ. Chem. Soc.*, 123, 2184, 1923; E. Petersen, *Zeit. phys. Chem.*, 8. 601, 1891; A. L. Lavoisier and P. S. de Laplace, *Mém. Acad.*, 355, 1780; J. Thomsen, *Ber.*, 5. 508, 1872; 6. 1636, 1873; *Zeit. phys. Chem.*, 1. 369, 1887; *Thermochemische Untersuchungen*, Leipzig, 2.

284, 1882; J. C. Thomlinson, *Chem. News*, **93**, 37, 1906; P. Chappius, *Wied. Ann.*, **19**, 21, 1883; W. G. Mixer, *Amer. Journ. Science*, (4), **19**, 434, 1905; W. Ostwald, *Lehrbuch der allgemeinen Chemie*, Leipzig, 2. i, 171, 1903; L. Grassi, *Journ. Pharm. Chim.*, (3), **8**, 170, 1843; K. Fajans, *Ber.*, **53**, B, 643, 1920; **55**, B, 2826, 1922; *Zeit. phys. Chem.*, **99**, 395, 1921; *Zeit. Physik*, **1**, 101, 1920; H. Kohn, *ib.*, **3**, 141, 1920; W. Swientoslawsky, *Roczniki Chemji*, **1**, 305, 1921; W. H. and W. L. Bragg, *Proc. Roy. Soc.*, **89**, A, 277, 1913; F. O. H. Binder, *Chem. Ztg.*, **45**, 147, 477, 1114, 1921; *Wärme Kälte Techn.*, **25**, 21, 1923; D. Aufhäuser, *Feuerungstechnik*, **11**, 171, 1923; M. Padoa, *Gazz. Chim. Ital.*, **51**, ii, 239, 1921; A. L. von Steiger, *Ber.*, **53**, B, 666, 1766, 1920; **55**, B, 1968, 1922; W. A. Roth and H. Wallasch, *ib.*, **46**, 896, 1913; K. von Auwers, *ib.*, **54**, B, 3188, 1921; **56**, B, 69, 1923; J. P. Wibaut, *Rec. Trav. Chim. Pays-Bas*, **41**, 96, 441, 1922; H. Beutler, *Zeit. anorg. Chem.*, **120**, 24, 31, 1921; M. Polanyi, *Zeit. Physik*, **3**, 31, 1920; F. Kirchoff, *Chem. Ztg.*, **48**, 113, 1924.

¹⁴ H. Fizeau, *Compt. Rend.*, **60**, 1161, 1865; **62**, 1133, 1866; *Ann. Chim. Phys.*, (4), **8**, 334, 1866; J. C. Jamin, *ib.*, (3), **29**, 263, 1850; J. Becquerel, *ib.*, (5), **12**, 5, 1877; *Compt. Rend.*, **84**, 211, 1877; P. Gaubert, *ib.*, **177**, 1123, 1923; F. J. Arago, *ib.*, **16**, 97, 1843; A. des Cloizeaux, *Manuel de minéralogie*, Paris, 19, 1874; *Ann. Chim. Phys.*, (3), **14**, 301, 1845; *Nouvelles recherches sur les propriétés optiques des cristaux*, Paris, 517, 1867; D. Brewster, *Phil. Trans.*, **105**, 31, 1815; **106**, 167, 1816; **108**, 255, 1818; *Trans. Roy. Soc. Edin.*, **8**, 160, 1817; **23**, 41, 1864; *Edin. Phil. Journ.*, **3**, 98, 1820; *Phil. Mag.*, (3), **7**, 245, 1835; (4), **3**, 284, 1852; (4), **25**, 174, 1863; *B.A. Rep.*, **1**, 1852; R. W. Wood, *ib.*, (6), **1**, 405, 1901; B. Walter, *Wied. Ann.*, **42**, 505, 1891; *Jahrb. wiss. Anst. Hamburg*, **8**, 1890; F. Peter, *Zeit. Physik*, **15**, 358, 1923; E. Wülfing, *Tschermak's Mitt.*, (2), **15**, 350, 1896; J. Dale, *B.A. Rep.*, **5**, 1846; *Amer. Journ. Science*, (2), **3**, 262, 1847; A. Sella, *Atti Accad. Lincei*, (4), **7**, ii, 300, 1891; R. Brauns, *Die optischen Anomalien der Krystalle*, Leipzig, 176, 1891; E. Boutan, *Le diamant*, Paris, 1886; R. Pohl, *Phys. Zeit.*, **21**, 628, 1920; J. MacCullagh, *Proc. Irish Acad.*, **1**, 27, 1838; *Pogg. Ann.*, **44**, 544, 1838; E. Mallard, *Bull. Soc. Min.*, **2**, 130, 1879; **5**, 241, 1882; E. Jannetaz, *ib.*, **2**, 124, 1879; E. Cohen, *Neues Jahrb. Min.*, **753**, 1876; **1**, 177, 1882; A. Schrauf, *ib.*, **ii**, 411, 1885; *Pogg. Ann.*, **126**, 177, 1865; **127**, 175, 344, 1866; **133**, 479, 1868; *Sitzber. Akad. Wien*, **41**, 775, 1866; **52**, 176, 1865; *Wied. Ann.*, **22**, 424, 1884; A. Weiss, *Sitzber. Akad. Wien*, **59**, 862, 1860; W. Rosicky, *ib.*, **78**, 417, 1879; J. Beckenkamp, *Zeit. Kryst.*, **22**, 176, 1894; J. Hirschwald, *ib.*, **1**, 212, 1877; W. Haidinger, *Handbuch der bestimmenden Mineralogie*, Wien, 353, 1845; A. Rochoon, *Journ. Phys.*, **53**, 169, 1801; **72**, 319, 1811; J. F. W. Herschel, *Edin. Journ. Science*, **10**, 296, 1829; M. Trécourt and G. Oberhäuser, *Compt. Rend.*, **5**, 638, 1837; *Pogg. Ann.*, **43**, 242, 1838; A. Haagen, *ib.*, **131**, 117, 1867; H. C. Sorby and P. J. Butler, *Proc. Roy. Soc.*, **17**, 291, 1869; P. Groth, *Physikalische Krystallographie*, Leipzig, 29, 1895; J. H. Gladstone, *Chem. News*, **42**, 675, 1880; **55**, 300, 1887; **67**, 94, 1893; *Proc. Roy. Soc.*, **18**, 49, 1870; **31**, 327, 1881; **42**, 401, 1893; H. Dufet, *Journ. Phys.*, (2), **4**, 477, 1886; H. Moissan, *Recherches sur les différentes variétés de carbone*, Paris, 1896; F. de la Provostaye and P. Desains, *Compt. Rend.*, **33**, 444, 1852; *Ann. Chim. Phys.*, (3), **34**, 192, 1852; M. Melloni, *ib.*, (3), **22**, 141, 1848; J. W. Brühl, *Liebig's Ann.*, **293**, **1**, 1887; *Zeit. phys. Chem.*, **1**, 307, 1887; *Ber.*, **13**, 1119, 1880; **20**, 2288, 1887; J. Traube, *ib.*, **30**, 39, 1897; H. H. Landolt, *ib.*, **15**, 1031, 1882; *Liebig's Ann.*, **213**, 75, 1882; *Sitzber. Akad. Berlin*, **64**, 1882; J. Amar, *Compt. Rend.*, **144**, 260, 1907; W. W. Coblentz, *Phys. Zeit.*, **8**, 85, 1907; *Bull. Bur. Standards*, **7**, 198, 1911; *Investigations of Infra-red Spectra*, Washington, **4**, 94, 1906; *Journ. Franklin Inst.*, **170**, 169, 1910; B. Gudden and R. Pohl, *Zeit. tech. Physik*, **3**, 199, 1922; *Zeit. Physik*, **3**, 123, 1920; **16**, 170, 1923; E. Aschkinass, *Ann. Physik*, (4), **18**, 373, 1905; R. Nasini, *Atti Accad. Lincei*, (4), **1**, 878, 1885; M. Zecchini, (5), **1**, ii, 180, 1892; P. Gaubert, *Compt. Rend.*, **177**, 1123, 1923.

¹⁷ F. Haber, *Verh. deut. phys. Ges.*, **13**, 1122, 1911.

¹⁸ E. Rutherford and J. Chadwick, *Nature*, **107**, 41, 1921.

¹⁹ R. Boyle, *An essay about the origin and virtues of gems*, London, 1672; F. Hoffmann, *Demonstrationes physicae curiosae experimentis et observationibus mechanicis ac chymicis illustratae*, Magdeburg, 1700; J. Wall, *Phil. Trans.*, **26**, 69, 1708; T. Wedgwood, *ib.*, **82**, 28, 1792; C. F. du Fay, *Hist. Acad. Paris*, **1**, 1735; *Mém. Acad.*, **347**, 1738; J. B. Beccari, *Comment. Bonon.*, **1**, 274, 1745; M. de Grosser, *Phosphorescentia adamantum novis experimentis illustrata*, Viennae, 1777; A. H. Compton, *Phil. Mag.*, (6), **46**, 897, 1923; G. le Bon, *Rev. Scient.*, (4), **14**, 260, 1894; J. F. Daubuisson, *Journ. Phys.*, **54**, 414, 1802; **55**, 60, 1802; J. P. Dessaignes, *ib.*, **74**, 101, 173, 1812; J. Bernoulli and J. Cassini, *Hist. Acad. Paris*, **1**, 1707; P. Riess, *Pogg. Ann.*, **64**, 834, 1845; T. J. Pearsall, *ib.*, **20**, 252, 1830; J. Schneider, *ib.*, **96**, 282, 1855; M. Chaumet, *Compt. Rend.*, **134**, 1139, 1902; G. Halphen, *ib.*, **62**, 1036, 1866; H. Becquerel, *ib.*, **129**, 1899; H. Moissan, *ib.*, **124**, 653, 1897; P. Sacerdote, *ib.*, **149**, 993, 1909; J. H. Gladstone, *B.A. Rep.*, **69**, 1860; *Chem. News*, **86**, 176, 1902; O. Rosenheim, *ib.*, **86**, 247, 1902; F. Kunz and C. Baskerville, *ib.*, **89**, 1, 1904; C. Baskerville and L. B. Lockhart, *Journ. Science*, (4), **20**, 95, 1905; G. F. Kunz, *Science*, (1), **3**, 649, 1884; *Naturwiss. Ztg.*, **6**, 400, 1891; *Proc. Amer. Acad.*, **10**, 50, 1891; **14**, 260, 1894; L. Becker, *Neues Jahrb. Min.*, **844**, 1849; A. M. Edwards, *La Nature*, **12**, 383, 1884; W. Crookes, *Chem. News*, **45**, 237, 1881; **47**, 26, 1883; **74**, 39, 1896; *Phil. Trans.*, **170**, 135, 641, 1879; **174**, 891, 1883; *Proc. Roy. Soc.*, **32**, 206, 1881; **35**, 262, 1883; **74**, 47, 1905; W. Marckwald, *Chem. Ztg.*, **26**, 895, 1902; P. Heinrich, *Die Phosphoreszenz der Körper nach allen Umständen untersucht und erläutert*, Nürnberg, 1820; E. Becquerel, *Ann. Chim. Phys.*, (3), **55**, 89, 1859; (3), **57**, 62, 1860; (3), **67**, 62, 1859; (3), **62**, 57, 1861; *Compt. Rend.*, **63**, 142, 1866; A. Mèyère, *ib.*, **149**, 994, 1909; E. H. Kurth, *Phys. Rev.*, (2), **17**, 528, 1921; (2), **18**, 99, 461, 1922; C. W. Hewlett,

ib., (2), 17. 284, 1921; (2), 19. 267, 1922; (2), 20. 688, 1922; (2), 21. 477, 1923; E. G. Taylor, ib., (2), 20. 709, 1922; F. Richtmyer, ib., (2), 17. 264, 1921; (2), 18. 13, 1921; (2), 21. 478, 1923; A. R. Olson, E. Dershem, and H. H. Storch, ib., (2), 21. 30, 1923; A. H. Compton, *Phys. Rev.*, (2), 22, 410, 1923; S. C. Lind and D. C. Bardwell, *Journ. Franklin Inst.*, 196, 521, 1923; *Min. Mag.*, 8, 201, 1923; J. C. McLennan and M. L. Clark, *Proc. Roy. Soc.*, 102. A, 389, 1923; F. L. Mohler and P. D. Foote, *Journ. Washington Acad. Science*, 11. 273, 1921; R. A. Millikan, *Astrophys. Journ.*, 52. 47, 1920; A. Miethe, *Ann. Physik.*, (4), 19. 633, 1906; H. Landrin, *Dictionnaire de minéralogie, de géologie, et de métallurgie*, Paris, 1852; C. Doelter, *Das Radium und die Farben*, Dresden, 1910; *Neues Jahrb. Min.*, 1, 87, 1896; *Oester. Chem. Zig.*, 12. 32, 1909; *Monatsh.*, 29. 1149, 1908; 30. 180, 1909; K. Keilhack, *Zeit. deut. geol. Ges.*, 50. 131, 1898; E. Newbery and H. Lupton, *Mem. Proc. Manchester Lit. Phil. Soc.*, 62. 10, 1918; A. L. Hughes, *Phil. Mag.*, (6), 43. 145, 1922; O. W. Richardson and C. B. Bazzoni, ib., (6), 42. 1015, 1921; P. I. Lukirsky, ib., (6), 47. 466, 1924; J. Holtzmark, *Phys. Zeit.*, 23. 252, 1922; C. W. Hewlett, *Phys. Rev.*, (2), 19. 295, 1922; J. A. Becker, ib., (2), 20. 115, 134, 1922; (2), 22. 320, 1923; *Ann. Physik.*, (4), 67. 428, 1922; B. Gudden and R. Pohl, *Zeit. tech. Physik.* 3. 199, 1922; *Zeit. Physik.* 3. 123, 1920; 16. 170, 1923; P. A. Ross, *Phys. Rev.*, (2), 23. 290, 1924; S. J. M. Allen, ib., (2), 23. 291, 1924.

²⁰ G. A. Hemsalech, *Compt. Rend.*, 169, 915, 1034, 1919; J. E. P. Wagstaff, *Phil. Mag.*, (6), 47. 84, 1924

²¹ W. H. Wollaston, *Phil. Trans.*, 92. 365, 1802; J. Fraunhofer, *Gilbert's Ann.*, 74. 337, 1823; J. F. W. Herschel, *Trans. Roy. Soc. Edin.*, 9. 445, 1823; H. F. Talbot, *Phil. Mag.*, (3), 4. 112, 1834; J. W. Draper, ib., (3), 32. 100, 1848; A. Masson, *Ann. Chim. Physik.*, (3), 31. 295, 1851; D. Alter, *Amer. Journ. Science*, (2), 18. 55, 1854; A. Matthiessen, *Compt. Rend.*, 16. 1081, 1843; F. von Wrede, *Pogg. Ann.*, 33. 353, 1834.

²² W. Swan, *Trans. Roy. Soc. Edin.*, 21. 411, 1857; H. C. Dibbits, *De Spectraal-analyse*, Rotterdam, 179, 1863; R. Thalén, *Nova Acta Upsala*, (3), 12. 1, 1884; *Om Spectralanalys*, Upsala, 1866; A. J. Angström, *Pogg. Ann.*, 144. 300, 1871; A. J. Angström and R. Thalén, *Nova Acta Upsala*, (3), 9. 6, 1875; K. Angström, *Phys. Rev.*, (1), 3. 137, 1895; R. Forratt, *Arch. Sciences Genève*, (4), 31. 550, 1911; F. Brasack, *Abhand. Nat. Ges. Halle*, 10, 1866; W. M. Watts, *Phil. Mag.*, (4), 34. 437, 1867; (4), 38. 249, 1869; (4), 40. 100, 1870; (4), 41. 12, 1871; (4), 48. 369, 456, 1874; (4), 49. 104, 1875; *Chem. News*, 21. 80, 1870; 22. 172, 1870; *B.A. Rep.*, 44, 1870; *Quart. Journ. Science*, 8. 1, 1871; *Nature*, 23. 197, 266, 361, 1881; W. M. Watts and H. M. Wilkinson, *Phil. Mag.*, (6), 12. 581, 1906; J. Trowbridge and C. C. Hutchins, ib., (5), 24. 310, 1887; *Amer. Journ. Science*, (3), 34. 345, 1887; J. Trowbridge, (4), 12. 310, 1910; J. E. Petavel and R. S. Hutton, ib., (6), 6. 569, 1903; W. A. Bone and D. S. Jerdan, *Journ. Chem. Soc.*, 71. 41, 1897; G. G. Stokes, *Proc. Chem. Soc.*, 8. 22, 1892; *Mathematical and Physical Papers*, 5. 235, 1905; A. Lielegg, *Sitzber. Akad. Wien*, 55. 153, 1867; 57. 593, 1868; G. L. Ciamician, ib., 79. 8, 1879; 82. 425, 1880; J. M. Eder, ib., 94. 75, 1886; *Denks. Akad. Wien*, 57. 531, 1890; 60. 1, 1893; *Zeit. phys. Chem.*, 19. 20, 1896; C. Bohn, ib., 18. 219, 1895; G. J. Burch, *Nature*, 35. 165, 1886; J. M. Eder and E. Valenta, *Denks. Akad. Wien*, 60. 241, 1893; 67. 483, 1899; *Atlas typischer Spektren*, Wien, 1911; F. Exner and E. Haschek, *Sitzber. Akad. Wien*, 106. 337, 1897; *Tabellen der Funkenspectra*, Wien, 1902; *Tabellen der Bogenspectra*, Wien, 1904; H. Lehmann, *Die ultrarothten Spectren der Alcalien*, Freiburg i. Br., 73, 1899; J. Loos, *Ueber Wellenlängen und Gesetzmässigkeiten in den Hauptbanden des sogenannten Kohlenoxydbandenspectrums*, Bonn, 1903; *Zeit. wiss. Photochem.*, 1. 151, 1903; F. Jungbluth, ib., 2. 89, 1904; *Ueber Gesetzmässigkeiten und Eigenhümligkeiten in der Structur der dritten Cyanbandengruppe*, Bonn, 1904; O. H. Hindrichs, *Ueber Messungen und Gesetzmässigkeiten in der vierten Kohlenbande*, Bonn, 1904; H. Herman, *Messung der Wellenlängen rother Linien in einigen Bogenspectren*, Tübingen, 1904; *Ann. Physik.*, (4), 16. 684, 1905; J. Leinen, *Die Theorie Thiele's über die Structur der Banden geprüft an der dritten Kohlebande*, Bonn, 1905; *Zeit. wiss. Photochem.*, 3. 137, 1905; A. Bergmann, ib., 6. 113, 145, 1908; *Beiträge zur Kenntniss der ultrarothten Emissionsspectren der Alcalien*, Jena, 1907; G. Gehlhoff, *Ueber Kathodengefälle und Spectren einiger zusammengesetzter Gase*, Berlin, 1907; *Ann. Physik.*, (4), 24. 553, 1907; A. Kratzer, ib., (4), 67. 127, 1922; E. Hulthén, ib., (4), 71. 41, 1923; J. Haferkamp, *Das Intensitätsminimum der Cyanbandengruppe*, λ , 3883, 558, Bonn, 1909; *Zeit. wiss. Photochem.*, 9. 19, 1911; H. Kayser, *Handbuch der Spectroscopie*, Leipzig, 5. 190, 1910; R. Komp, *Die Grüne Kohlenbande*, $\lambda=5635$, Leipzig, 1911; *Zeit. wiss. Photochem.*, 10. 117, 1912; P. Wolter, ib., 9. 361, 1911; *Über die ultravioletten Banden des Kohlenoxydspektrums*, Leipzig, 1911; H. Koch, *Die Absorption spektrum des Anilins im Ultravioletten*, Heidelberg, 1911; *Zeit. wiss. Photochem.*, 9. 400, 1911; W. Mies, ib., 7. 357, 1909; *Das Absorptionsspektrum des Paracetols im Ultravioletten*, Bonn, 1909; L. Grebe, *Ueber Absorption der Dämpfe des Benzols und seiner Derivate im Ultravioletten*, Bonn, 1905; *Zeit. wiss. Photochem.*, 9. 130, 1910; E. J. ib., 10. 166, 1911; *Ueber die ultraviolette Fluoreszenz des Benzols und einiger seiner Derivate*, Bonn, 1911; A. Schuster and H. E. Roscoe, *Proc. Manchester Phil. Soc.*, 19. 46, 1880; *Mem. Manchester Phil. Soc.*, (3), 7. 80, 1882; A. Schuster, *Proc. Cambridge Phil. Soc.*, 3. 57, 1877; *B.A. Rep.*, 258, 1880; *Proc. Roy. Soc.*, 37. 317, 1884; J. R. Merton and R. C. Johnson, ib., 103. A, 383, 1923; Lord Rayleigh, ib., 102. A, 453, 1922; F. Simeon, ib., 102. A, 484, 1922; 104. A, 368, 1923; J. N. Lockyer, ib., 27. 308, 1878; 30. 335, 461, 1880; *Nature*, 22. 4, 309, 562, 1880; J. Dewar, *Proc. Roy. Inst.*, 9. 674, 1882; *Proc. Roy. Soc.*, 29. 188, 1879; 30. 85, 1880; G. D. Liveing and J. Dewar, ib., 30. 152, 490, 494, 1880; 33. 3, 403, 1882; 34. 119, 123, 418, 1882; 49. 217, 1891;

Phil. Trans., 174. 187, 1883; *Nature*, 22. 620, 1880; G. D. Liveing, *ib.*, 23. 338, 1881; *Proc. Cambridge Phil. Soc.*, 12. 337, 1904; J. E. Purvis, *Proc. Cambridge Phil. Soc.*, 21. 786, 1923; W. Spottiswoode, *Proc. Roy. Soc.*, 30. 173, 1880; J. J. Thomson, *ib.*, 58. 244, 1893; E. E. Brooks, *ib.*, 80. A, 218, 1908; R. J. Strutt, *ib.*, 86. A, 116, 1912; A. Fowler and H. Shaw, *ib.*, 86. A, 118, 1912; A. Fowler, *Proc. Roy. Soc.*, 105. A, 299, 1924; *Astrophys. Journ.*, 35. 85, 1912; W. H. Bair, *ib.*, 52. 301, 1920; A. de la Baume-Pluvinel and F. Baldet, *Compt. Rend.*, 147. 666, 1908; 148. 762, 1910; S. Procopiu, *ib.*, 176. 385, 1923; A. Perot, *ib.*, 170. 988, 1920; B. Hasselberg, *Mém. Acad. St. Petersburg*, (7), 28. 2, 1880; (7), 30. 7, 1882; (7), 31. 7, 1883; L. Puccianti, *Nuovo Cimento*, (5), 13. 269, 1907; *Phys. Zeit.*, 8. 463, 1907; C. von Wesendonck, *Untersuchungen über die Spectra der Kohlenverbindungen*, Berlin, 1881; *Wied. Ann.*, 17. 427, 1882; *Phys. Zeit.*, 9. 151, 1908; *Nature*, 64. 29, 1901; *Sitzber. Akad. Berlin*, 791, 1880; H. W. Vogel, *ib.*, 523, 1888; H. Kayser and C. Runge, *ib.*, 45, 1889; H. Rubens and A. Aschkinass, *ib.*, 64. 584, 1898; W. H. Julius, *Die Licht und Warmestrahlung verbrannter Gase*, Berlin, 1890; *Arch. Néerl.*, (1), 22. 310, 1888; W. J. H. Moll, *ib.*, (2), 13. 100, 1908; *Onderzoek van ultra-roode Spectra*, Utrecht, 1907; H. A. Rowland, *Astron. Astrophys.*, 12. 321, 1893; E. P. Lewis and E. S. Ferry, *ib.*, 13. 747, 1894; T. Lyman, *Proc. Amer. Acad.*, 45. 315, 1910; H. Crew and O. H. Basquin, *Astrophys. Journ.*, 2. 103, 1895; H. S. Uhler and R. A. Patterson, *ib.*, 42. 434, 1915; R. T. Birge, *ib.*, 46. 85, 1917; 55. 273, 1922; 59. 45, 1924; *Phys. Rev.*, (2), 13. 360, 1919; (2), 21. 712, 1923; E. C. Kemble, *ib.*, (2), 21. 713, 1923; C. F. Meyer and D. W. Bronck, *ib.*, (2), 21. 712, 1923; W. H. Bair, *ib.*, (2), 16. 493, 1920; J. M. Hyatt, *ib.*, (2), 19. 391, 1923; J. W. Ellis, *ib.*, (2), 19. 546, 1922; H. Crew and J. C. Baker, *Astrophys. Journ.*, 16. 61, 1902; H. Crew and B. J. Spence, *ib.*, 22. 199, 1905; P. Lewis, *ib.*, 15. 122, 1902; W. B. Huff, *ib.*, 16. 27, 1902; *Proc. Nat. Acad. Sciences*, 7. 289, 1921; R. A. Millikan, I. S. Bowen, and R. A. Sawyer, *ib.*, 53. 150, 1921; R. A. Millikan and I. S. Bowen, *Phys. Rev.*, (2), 23. 1, 1924; R. A. Millikan, *Astrophys. Journ.*, 52. 47, 1920; J. Hartmann, *ib.*, 18. 65, 1903; T. Lyman, *ib.*, 27. 87, 1908; W. J. Humphreys, *ib.*, 6. 169, 1897; C. Runge, *ib.*, 10. 73, 1899; A. S. King, *ib.*, 14. 323, 1901; *Ann. Physik*, (4), 7. 791, 1902; H. Konen, *ib.*, (4), 9. 741, 1902; G. Berndt, *ib.*, (4), 8. 625, 1902; M. la Rosa, *ib.*, (4), 29. 249, 1909; F. Braun, *ib.*, (4), 17. 359, 1905; A. L. Foley, *Phys. Rev.*, (1), 5. 129, 1897; W. Ritz, *Le Radium*, 8. 177, 1911; *Arch. Sciences Genève*, (4), 32. 491, 1911; J. Halm, *Trans. Roy. Soc. Edin.*, (3), 41. 551, 1905; J. N. Collie, *Journ. Chem. Soc.*, 79. 1063, 1901; M. la Rosa, *Atti Accad. Lincei*, (5), 17. i, 200, 1908; H. Konen and H. Finger, *Zeit. Elektrochem.*, 15. 165, 1909; W. Crookes, *Phil. Trans.*, 172. 387, 1881; *Chem. News*, 9. 135, 1864; G. J. Snelus, *ib.*, 24. 159, 1871; W. M. Williams, *ib.*, 23. 174, 1871; H. Nagaoka, *Proc. Phys. Math. Soc. Japan*, 5. 35, 1923; M. Berthelot and F. Richard, *Compt. Rend.*, 68. 1546, 1869; L. Troost and P. Hautefeuille, *ib.*, 73. 620, 1871; A. de Gramont, *ib.*, 125. 172, 238, 1897; 134. 1205, 1902; 146. 1260, 1908; *Bull. Soc. Chim.*, (3), 19. 548, 551, 1898; *Bull. Soc. Min.*, 21. 94, 1898; A. de Gramont and M. Dreoq, *Compt. Rend.*, 150. 1235, 1910; F. Croze, *ib.*, 150. 1672, 1910; E. Villari, *Rend. Ist. Lombardo*, (2), 3. 594, 1870; C. P. Smyth, *Astron. Obs. Edin.*, 13. 85, 1871; *Phil. Mag.*, (4), 49. 24, 1875; (5), 8. 107, 1879; *Nature*, 20. 75, 1879; 29. 340, 1883; *Chem. News*, 39. 145, 166, 188, 1879; *Roy. Scot. Soc. Arts*, 10. 226, 1883; *Trans. Roy. Soc. Edin.*, 32. 415, 1887; C. P. Smyth and A. S. Herschel, *ib.*, 30. 93, 1882; A. S. Herschel, *Nature*, 16. 22, 1877; 22. 320, 1880; W. W. Coblentz, *Phys. Zeit.*, 9. 60, 1908; *Phys. Rev.*, (1), 20. 122, 395, 1901; (1), 22. 1, 1906; E. R. Drew, *ib.*, (1), 21. 122, 1905; B. von Lengyel, *Lit. Ber. Ungarn*, 3. 177, 1878; W. N. Hartley, *Journ. Chem. Soc.*, 41. 84, 1882; *Trans. Roy. Soc. Dublin*, (2), 1. 231, 1883; *Phil. Trans.*, 175. 49, 1884; 185. A, 161, 1894; 208. A, 475, 1909; *Phil. Mag.*, (5), 31. 359, 1891; *Proc. Roy. Soc.*, 54. 5, 1893; 55. 344, 1894; 60. 216, 1896; 61. 217, 1897; *Proc. Roy. Soc. Dublin*, (2), 9. 289, 1900; *Nature*, 64. 54, 1904; W. N. Hartley and H. W. Moss, *Proc. Roy. Soc.*, 87. A, 38, 1912; J. Okubo, *Science Rep. Tohoku Univ.*, 11. 55, 1922; W. Grotrian and C. Runge, *Phys. Zeit.*, 15. 745, 1914; A. Kratzer, *ib.*, 22. 552, 1921; W. N. Hartley and W. E. Adeney, *Phil. Trans.*, 175. 63, 1884; M. Tietz, *Beitrag zur Kenntniss der Spectrums der Kohlenstoffes und seiner Verbindungen*, Leipzig, 1894; C. Fievez, *Mém. Acad. Belg.*, 47. 3, 1885; *Bull. Acad. Belg.*, (3), 14. 100, 1887; A. Hagenbach, *Wullner's Festschrift*, 128, 1905; A. Hagenbach and H. Konen, *Atlas der Emissionsspectra*, Jena, 1905; V. Meyer and C. Langer, *Pyrchemische Untersuchungen*, Braunschweig, 61, 1885; H. St. C. Deville, *Compt. Rend.*, 49. 873, 1864; V. Henri, *ib.*, 174. 809, 1922; *Journ. Phys. Rad.*, 3. 181, 1922; F. W. Klingstedt, *Compt. Rend.*, 174. 812, 1922; W. H. Fulweiler and J. Barnes, *Journ. Franklin Inst.*, 194. 83, 1922; F. Müller, *Zeit. wiss. Photochem.*, 22. 1, 1922; V. Henri and P. Steiner, *Compt. Rend.*, 175. 421, 1922; R. Fortrat, *Ann. Phys.*, 3. 282, 1915; 19. 81, 1923; L. de Boisbaudran, *Spectres lumineux*, Paris, 1874; J. Plücker, *Pogg. Ann.*, 105. 67, 1858; 107. 497, 638, 1859; J. Plücker and W. Hittorf, *Phil. Trans.*, 155. 1, 1865; V. S. M. van der Willigen, *Pogg. Ann.*, 106. 610, 1859; 147. 473, 1859; R. T. Simmler, *ib.*, 115. 242, 425, 1862; A. Mitscherlich, *ib.*, 121. 459, 1864; Simmler, *ib.*, 144. 481, 1871; *Wied. Ann.*, 14. 355, 363, 1881; 17. 587, 1882; B. W. Snow, *ib.*, 20. 363, 1892; F. Himstedt and H. von Dechend, *Phys. Zeit.*, 9. 862, 1908; C. Morren, *Compt. Rend.*, 48. 342, 1859; 19. 557, 1861; 55. 51, 1862; *Chem. News*, 4. 302, 1861; *Ann. Chim. Phys.*, (4), 4. 305, 1865; W. H. McVicker, J. K. Marsh, and A. W. Stewart, *Journ. Chem. Soc.*, 123. 642, 1923; W. M. McVicker and J. K. Marsh, *ib.*, 123. 817, 820, 1923; G. Schaefer and M. Thomas, *Zeit. Physik*, 12. 330, 1923; M. Toussaint, *ib.*, 19. 271, 1923; G. Salet, *Traité élémentaire de spectroscopie*, Paris, 180, 239, 1888; *Ann. Chim. Phys.*, (4), 28. 5, 1873; F. Benevides, *ib.*, (4), 28. 358, 1873; L. Thollon, *ib.*, (5), 25. 287, 1882; *Compt. Rend.*, 93. 260, 1881; H. Deslandres, *ib.*, 103. 375, 1886; 106. 842, 1888; 112. 661, 1891; 120. 1259, 1895;

137. 457, 1903; 139. 1174, 1904; *Ann. Chim. Phys.*, (6), 15. 5, 1888; *Journ. Phys.*, (2), 10. 276, 1891; H. Deslandres and L. d'Azambuja, *ib.*, 140. 917, 1905; J. Atfield, *Phil. Mag.*, (4), 49. 106, 1875; *Phil. Trans.*, 152. 221, 1862; *Journ. Chem. Soc.*, 16. 97, 1863; *Chem. News*, 9. 166, 1864; W. A. Miller, *Phil. Trans.*, 152. 861, 1862; W. Huggins, *ib.*, 154. 139, 1864; *Phil. Mag.*, (4), 37. 456, 1869; A. Smithells, *ib.*, (6), 1. 476, 1901; E. C. C. Baly and H. W. Syers, *ib.*, (6), 2. 386, 1901; A. M. Herbert, *ib.*, (3), 202, 1902; G. A. Hemsalech, *Phil. Mag.*, (6), 39. 241, 1920; E. F. Barker, *Phys. Rev.*, (2), 19. 247, 1922; A. Secchi, *Compt. Rend.*, 77. 173, 1873; *Mem. Soc. Spettrosc. Ital.*, 2. 119, 1873; J. S. Stas, *ib.*, 14. 55, 1885; J. C. McLennan and P. A. Petrie, *Trans. Roy. Soc. Canada*, 15. 15, 1921; J. F. W. Herschel, *Trans. Roy. Soc. Edin.*, 9. 445, 1823; H. F. Talbot, *Phil. Mag.*, (3), 4. 112, 1834; A. Gouy, *Compt. Rend.*, 84. 231, 1877; J. Hartmann, *Astrophys. Journ.*, 13. 65, 1903; T. N. Thiele, *ib.*, 8. 1, 1898; W. Ritz, *Phys. Zeit.*, 9. 521, 1908; L. Kilehling, *Zeit. wiss. Photochem.*, 15. 293, 317, 1916; F. Cremer, *ib.*, 10. 349, 1912; H. B. Baker, *Journ. Chem. Soc.*, 65. 612, 1894; 81. 400, 1902; A. Kratzer, *Zeit. Physik*, 23. 298, 1924; W. C. Holmes, *Journ. Amer. Chem. Soc.*, 46. 631, 1924; W. W. Shaver, *Trans. Roy. Soc. Canada*, (3), 17. 131, 1923.

²² R. Boyle, *An essay about the origin and virtues of gems*, London, 1672; R. J. Haüy, *Traité de minéralogie*, Paris, 3. 288, 1801; 4. 98, 1801; L. B. G. de Morveau, *Ann. Chim. Phys.*, (1), 31. 72, 328, 1799; *Gilbert's Ann.*, 2. 471, 1799; L. V. Brugnatelli, *ib.*, 16. 91, 1804; *Naudé's Journ. Galv.*, 2. 55, 1803; J. F. L. Hausmann and F. C. Henrici, *Gött. Ver. Berg. Freunde*, 4. 217, 1838; *Neues Jahrb. Min.*, 433, 1838; A. Avogadro, *Arch. Sciences Genève*, (1), 17. 314, 1851; *Mem. Acad. Torino*, (2), 12. 39, 1850; W. G. Mixter, *Amer. Journ. Science*, (4), 19. 434, 1905; J. W. Howell, *Trans. Amer. Inst. Elect. Eng.*, 14. 27, 1897; *Electrician*, 38. 835, 1897; A. Franck, *Zeit. angew. Chem.*, 13. 1733, 1906; J. Zellner, *Die künstlichen Kohlen*, Berlin, 251, 1903; F. von Kobell, *Journ. prakt. Chem.*, (i), 50. 76, 1850; A. Matthiessen, *Phil. Trans.*, 148. 383, 1858; *Pogg. Ann.*, 103. 428, 1858; G. Kirchhoff, *ib.*, 100. 177, 1856; W. Beetz, *ib.*, 111. 119, 1860; *Wied. Ann.*, 12. 65, 1881; L. Cellier, *ib.*, 61. 511, 1897; H. Muraoka, *ib.*, 13. 307, 1881; *Ueber das galvanische Verhalten der Kohle*, Strassburg, 1881; H. Violette, *Ann. Chim. Phys.*, (3), 39. 291, 1853; J. Härdén, *Electrotech. Zeit.*, 22. 584, 1901; K. Siebel, *Zeit. Physik*, 4. 288, 1921; H. G. Martin, *Chem. News*, 86. 295, 1902; 87. 162, 1903; R. Ferrini, *Nuovo Cimento*, (3), 6. 53, 1879; A. Bartoli, *ib.*, (3), 15. 203, 1884; A. Niccari and S. Pagliani, *ib.*, (3), 7. 120, 1880; S. P. Thompson, *Phil. Mag.*, (5), 13. 262, 1882; O. W. Richardson, *ib.*, (6), 16. 740, 1908; J. A. Cunningham, *ib.*, (6), 9. 193, 1905; H. Tomlinson, *ib.*, (5), 22. 442, 1886; J. A. Pollock and A. B. B. Ranclaud, *Phil. Mag.*, (6), 17. 366, 1909; J. A. Pollock, A. B. B. Ranclaud, and E. P. Norman, *ib.*, (6), 18. 229, 1909; T. C. Mendenhall, *ib.*, (5), 22. 358, 1886; J. Dewar and J. A. Fleming, *ib.*, (5), 32. 326, 1892; Lord Kelvin, *ib.*, (6), 4. 117, 1902; P. W. Bridgman, *Proc. Amer. Acad.*, 56. 61, 1921; K. Arndt and F. Körner, *Zeit. angew. Chem.*, 35. 440, 1922; *Investigations of Infra-red Spectra*, Washington, 4. 94, 1906; C. E. Williams, *Trans. Amer. Electrochem. Soc.*, 42. 181, 1922; S. Bidwell, *Proc. Roy. Soc.*, 35. 1, 1883; J. Monckmann, *ib.*, 44. 220, 1888; C. A. Hansen, *Electrochem. Met. Ind.*, 7. 516, 1909; *Trans. Amer. Electrochem. Soc.*, 15. 279, 1909; O. Boekmann, *Wied. Ann.*, 23. 651, 1884; W. von Siemens, *ib.*, 10. 560, 1880; J. Borgmann, *Journ. Russ. Phys. Chem. Soc.*, 9. 163, 1879; E. Aschkinass, *Ann. Physik*, (4), 18. 373, 1905; K. Bädcker, *ib.*, (4), 22. 749, 1907; D. E. Roberts, *ib.*, (4), 40. 455, 1913; F. Streintz, *Monatsh.*, 21. 461, 1900; *Ann. Physik*, (4), 3. 1, 1900; J. Königsberger, *Jahrb. Rad. Elektron.*, 11. 111, 1914; *Ann. Physik*, (4), 35. 37, 1911; *Ber. deut. phys. Ges.*, 5. 386, 1907; 10. 277, 1912; J. Königsberger and O. Reichenheim, *Neues Jahrb. Min.*, ii, 20, 1906; F. Auerbach, *ib.*, 259, 1879; B. Pietsch, *Sitzber. Akad. Wien*, 102. 768, 1893; R. von Hasslinger, *ib.*, 115. 1523, 1906; C. Doelter, *ib.*, 120. 1, 1911; H. von Wartenberg, *Phys. Zeit.*, 13. 1123, 1912; F. le Roy, *Compt. Rend.*, 126. 244, 1898; F. Lucas, *ib.*, 98. 800, 1884; A. Artem, *Atti Accad. Torino*, 37. 475, 1902; F. Deininger, *Ber. deut. phys. Ges.*, 5. 674, 1907; J. Priestley, *The History and Present State of Electricity*, London, 513, 1794; E. Ryschewitsch, *Zeit. Elektrochem.*, 28. 289, 527, 1922; K. Arndt and W. Fehse, *ib.*, 28. 376, 1922; W. Geiss, *ib.*, 28. 527, 1922; M. Pirani and W. Fehse, *ib.*, 29. 168, 1923.

²⁴ J. Monckmann, *Proc. Roy. Soc.*, 44. 220, 1888; G. Gore, *ib.*, 30. 38, 1880; G. Wiedemann, *Die Lehre von der Elektrizität*, Braunschweig, 1. 843, 1893; C. Fromme, *Wied. Ann.*, 18. 552, 1883; 19. 86, 300, 1883; H. Muraoka, *ib.*, 13. 307, 1881; W. Skey, *Chem. News*, 23. 255, 1871; H. C. Pease, *Journ. Phys. Chem.*, 4. 38, 1900; A. Coehn, *Zeit. Elektrochem.*, 3. 424, 1897; A. Avogadro, *Arch. Sciences Genève*, (1), 17. 314, 1851; W. G. Duffield, T. H. Burnhain, and A. H. Davis, *Proc. Roy. Soc.*, 97. A, 326, 1920; K. T. Compton, *Phys. Rev.*, (2), 21. 476, 1923; T. Peczkalsky, *Journ. Franklin Inst.*, 185. 710, 1918; H. Zahn, *Ann. Physik*, (4), 14. 886, 1904; A. Günther-Schulze, *Zeit. Elektrochem.*, 29. 370, 1923; G. Tammann, *ib.*, (4), 18. 856, 1905; A. E. R. Westman and W. J. Clapson, *Trans. Amer. Electrochem. Soc.*, 44. 87, 1923; E. Newell, *Journ. Chem. Soc.*, 109. 1051, 1916; W. Matthiessen, *Untersuchungen über den elektrischen Lichtbogen*, Leipzig, 1921; A. Voller, *Pogg. Ann.*, 149. 394, 1873; J. C. Poggendorff, *ib.*, 50. 263, 1840; *Oken's* 706, 1821; J. Buchanan, *Phil. Mag.*, (5), 20. 117, 1885; A. Bartoli and G. Pappasogli, *Nuovo Cimento*, (3), 12. 181, 1882; E. Corminas, *Centr. Electrotech.*, 7. 491, 1885; J. Probert and A. W. Soward, *Chem. News*, 47. 157, 1883; M. Faraday, *Phil. Trans.*, 130. 93, 1840; S. Marianini, *Schweigger's Journ.*, 49. 52, 1827; J. Weiss and J. Königsberger, *Phys. Zeit.*, 10. 956, 1909; D. Tommasi, *Elect. World*, 28. 558, 1896; C. J. Reed, *ib.*, 28. 630, 1896; V. L. Crisler, *Astrophys. Journ.*, 54. 273, 1921; H. Ayrton, *The Electric Arc*, London, 1901; E. Rasch, *Electric Arc Phenomena*, New York, 1913; F. Haber and L. Bruner, *Zeit. Elektrochem.*, 10. 697, 1904; J. W. Langley, *ib.*, 5.

273, 1899; C. Liebenoff and L. Strasser, *ib.*, 3. 353, 1896; F. Exner and J. Tuma, *Sitzber. Akad. Wien*, 97. 917, 1888; *Monatsh.*, 9. 903, 1888; R. D. Kleeman and W. Frederickson, *Phys. Rev.*, (2), 19. 490, 1923; V. Karpen, *Bull. Acad. Roumaine*, 8. 185, 1923.
²¹ M. Faraday, *Phil. Trans.*, 136. 41, 1846; *Phil. Mag.*, (3), 28. 455, 1846; A. L. Holtz, *Pogg. Ann.*, 151. 69, 1873; F. Zantedeschi, *Atti Accad. Venezia*, 2. 205, 1851; P. Pascal, *Rev. Gen. Scient.*, 34. 388, 1923; M. von Pirani, *Ueber Dielektricitätsconstanten fester Körper*, Berlin, 1903; W. Schmidt, *Ann. Physik*, (4), 9. 919, 1902; (4), 11. 114, 1093; S. Meyer, *ib.*, (4), 1. 664, 668, 1900; *Wied. Ann.*, 68. 325, 1899; 69. 236, 1899; A. Coehn and U. Raydt, *Gött. Nachr.*, 263, 1909; *Ann. Physik*, (4), 30. 777, 1909; K. Honda, *ib.*, (4), 32. 1027, 1910; *Science Rep. Tohoku Univ.*, 1. 1, 1912; 2. 25, 1913; 3. 139, 223, 1914; 4. 215, 1915.

§ 9. The Adsorption of Gases, etc., by Carbon

A. A. C. Swinton¹ found that diamonds contained no occluded neon, krypton, or other rare gas which is set at liberty when the diamond is transformed into graphite. As previously indicated, D. Brewster's discovery of inclusions of liquid carbon dioxide in some diamonds led many to infer that the diamond has been formed in the presence of this gas under press. J. Werth heated boart under water and noted that some gas was given off; the gas contained: Carbon, 97; hydrogen, 0.5; and oxygen, 1.5 per cent., and he referred the small flame observed in the combustion of the diamond to occluded gas. J. Dewar measured the gases occluded in graphites from different sources, and found:

Source	Vol.	CO ₂	CO	H ₂	CH ₄	N ₂
Meteoritic . . .	7.25	91.81	—	2.50	5.50	0.10
Borrowdale . . .	2.60	36.40	7.77	22.20	26.11	6.66
Siberia	2.55	57.41	6.16	10.25	20.83	4.16
Ceylon	0.22	66.60	14.80	7.40	3.70	4.60

While the occluded gas in diamonds is insignificant, the constant presence of hydrocarbons, hydrogen, etc., in amorphous carbon led M. Berthelot to the belief that amorphous carbon is really a hydrocarbon *extrêmement condensé*. O. L. Erdmann and R. F. Marchand were not able to remove all the hydrogen and oxygen from charcoal at the strongest heat of a blast. T. E. Doubt found that the heats of adsorption and evolution by charcoal are equal, and argued that the process is reversible. J. C. Philip and co-workers studied the relation between the temp. of carbonization of charcoal and its adsorptive capacity. A. Vladislavovitch measured the dehydration curves of charcoals charged with adsorbed water vapour, and found a lag behind the hydration curves. Two per cent. of adsorbed water remained after drying to constant weight; and much of the adsorbed water is retained even after heating to redness in a current of nitrogen, and it is probably chemically combined with the charcoal. He therefore argued that charcoal is not appropriate for studying the phenomena of adsorption, since its behaviour depends on the nature and past history of the charcoal used.

In 1777, F. Fontana² discovered that freshly calcined charcoal, cooled under mercury, has the power of absorbing comparatively large volumes of gas; and about the same time C. W. Scheele observed that air was also absorbed in a similar way. J. Priestley, L. B. G. de Morveau, J. C. Delamétherie, G. F. Parrot and D. H. Grindel, H. G. Rouppe and M. van Noorden, and S. Saluzzo made some observations on this subject; and in 1783, C. L. Morozzo showed that the amount absorbed is *specific* in that it depends on the kind of charcoal employed; and *selective* in that it varies with the nature of the gas. In addition to the observations mentioned below, adsorption has been studied by C. F. Schönbein, H. T. Brown, R. Engel and G. Teitssier, N. F. I. Isambert, J. Böhm, F. Hart, S. G. Hedin, W. Vaubel, A. Wohl and M. S. Losanitsch, G. Craig, A. Berliner, W. Müller-Erzbach, H. Vohl and co-workers, E. Blumtritt, P. A. Favre, H. Violette, M. Böttcher, G. Dreyer and J. S. C. Douglas, etc. According to G. Tammann and H. Diekmann, mercury resting over powdered carbon, dried at 300°, runs below the powder when warmed to 35°.

The effect with different kinds of charcoal.—J. Hunter measured the effect with different kinds of charcoal, and found that that made from the shell of the

cocoanut adsorbed the largest proportion of gas—ammonia, carbon dioxide, or cyanogen. K. Hayashi, and A. Piutti and G. Maglia also compared the sp. gr. and the adsorptive power of the different charcoals, and the results of the last-named are indicated in Table VI for temp. between -100° and 550° . Those charcoals

TABLE VI.—ADSORPTIVE POWER AND SPECIFIC GRAVITY OF DIFFERENT CHARCOALS.

Kinds of charcoal.	Vols. of air per vol. of charcoal.	Sp. gr.
Prunus cerasus (Sour cherry)*	280.1	1.6398
Cocus mucifera (Cocoanut)*	251.8	1.4497
Phillyrea media (Jasmine box)	222.4	1.4970
Grevillea robusta (Silky oak)	212.7	1.4383
Abies alba (White spruce)	199.5	1.1901
Castanea vesca (Chestnut)	186.3	1.3000
Buxus sempervirens (Box)	138.5	1.4192
Liospunos kaki (Chinese persimmon)	134.5	1.3398
Populus nigra (Black poplar)	134.1	1.2802
Prunus virginiana (Choke-cherry)	133.0	1.2359
Ceratonnia siliqua (Carob)*	131.5	1.6274
Prunus armeniaca (Apricot)*	129.5	1.3994
Juglans regia (Walnut)	118.6	1.3132
Pinus rigida (Pitch-pine)	111.1	1.3114
Robinia pseudoacacia (Common locust)	99.9	1.2218

marked with an asterisk are from shells and kernels. N. A. Yajnik and T. C. Rana found mulberry charcoal gave better results than that from tali or from acacia in absorbing salts from soln. It will be obvious that although a rough parallelism between density and adsorptive power can be detected in some cases, there are so many deviations from the rule that it is obvious some other factor or factors are involved. M. Berthelot emphasized the fact that charcoal is not pure carbon, and it is probable that the impurities present in the different varieties affect the adsorptive power in different ways. The porosity, in the ordinary sense of the term, is not the determining factor because cocoanut charcoal is one of the densest of charcoals, and yet J. Hunter found it possessed the greatest adsorptive power. N. T. de Saussure considered that the adsorptive power depends on the *area* of the exposed surface; but A. Piutti and G. Maglia state that the amount adsorbed varies with the *structure*, so that, as W. D. Bancroft puts it, narrow pores down to a certain limit adsorb more than the same surfaces would do if the pores were of larger diameter. P. Chappius found that the increased surface produced by grinding is so small in comparison with the total adsorbing surface, that the increased adsorption produced by grinding is inappreciable. In confirmation, L. Gurwitsch, and F. Bergter found that grinding increases the speed of adsorption, but the final result is independent of the grain-size. H. H. Lowry and G. A. Hulett found that no relation exists between the amount of gas—nitrogen, carbon dioxide, or water—adsorbed and the length of time the charcoal has been in use. Differences in the method of preparing the charcoal may change the absorptive capacity 100 per cent.—*vide supra*, activated charcoal. This was also emphasized by H. B. Lemon and H. H. Sheldon. H. H. Lowry and G. A. Hulett also found that the phenomenon with oxygen is complicated by the superposition of two effects—adsorption and surface combination. O. Ruff and E. Hohlfeld assumed that the activity of different kinds of charcoal is proportional to the content of certain foreign atoms. The subject was also investigated by J. C. Philip and co-workers and by H. Briggs.

The effect with different gases.—N. T. de Saussure found the different values indicated in Table VII for the volumes of different gases adsorbed by one vol. of box-wood charcoal at 724 mm. press. and 12° . It was inferred that in general the volume of gas adsorbed is greater the higher its b.p. For comparison, the b.p. of the gases are indicated in the table. The rule is followed roughly, although there

TABLE VII.—THE ADSORPTION OF DIFFERENT GASES BY CHARCOAL.

Gas.	Vol. of adsorbed gas.	B.p. of gas.
Ammonia	90	-35·5°
Hydrogen chloride	85	-82·9°
Sulphur dioxide	65	-10°
Hydrogen sulphide	55	-60·2°
Nitrous oxide	40	-89·8°
Carbon dioxide	35	(-79°)
Ethylene	35	-105°
Carbon monoxide	9·42	-190°
Oxygen	9·25	-182·8°
Nitrogen	7·5	-195·7°
Hydrogen	7·175	-252·6°

are exceptions ; and it is probable that the adsorptive power depends on some specific relation between the gas and the charcoal, as well as on the extent of the adsorbing surface. R. E. Wilson found that the number of mols of oxygen adsorbed at any given final press. is very nearly 1·3 times the number of mols of nitrogen adsorbed at the same final press. J. Driver and J. B. Firth studied the adsorption of alcohol, methyl benzoate, carbon tetrachloride, chloroform, benzene, ethyl propionate, ethyl ether, toluene, and carbon disulphide from sat. vap. B. E. Brown investigated the effect of temp. and press. on the adsorption of water by charcoal ; and W. Möller, the adsorption of formaldehyde. H. Herbst inferred that with gaseous chloropicrin, benzyl chloride, and phosphorus tribromide, one mol is fixed per six gram-atoms of carbon. S. McLean studied the adsorption of helium by charcoal ; A. B. Ray, the adsorption of benzene ; and H. Briggs, the adsorption of organic vapours. The adsorption of chlorine was investigated by C. S. Bohart and E. Q. Adams ; air, by J. Samejima and K. Hayashi ; of hydrogen, and carbon dioxide by R. Lorenz and E. Wiedbrauck ; R. M. Winter and H. B. Baker, sulphur dioxide ; H. Briggs, nitrogen and hydrogen ; A. S. Coolidge, benzene, carbon disulphide, ether, chloroform, carbon tetrachloride, methyl acetate, ethyl formate, and water ; and of carbon dioxide and nitrous oxide by L. B. Richardson and G. B. Woodhouse. H. S. Harned found that with chlorine the adsorption is complicated by a reaction between the water present and the chlorine for which the carbon acts as a catalyst. H. Herbst, A. Vladislavovitsch, and R. E. Wilson, and T. Fuwa studied the humidity equilibrium of different kinds of carbon.

The effect of temperature on the adsorption of gases.—N. T. de Saussure showed that the amount of gas adsorbed by a given mass of charcoal decreases as the temp. is raised. P. Chappius found the volume of carbon dioxide adsorbed at different temp. with the press., maintained constant at 472 mm. (when the vol. of gas is reduced to 0°), to be

	0°	14·94°	25·05°	36·06°	44·41°	54·63°	62·59°	70·92°
Adsorbed gas .	1156·59	940·25	800·77	665·31	574·40	477·89	411·97	347·73

Thus, the amount adsorbed at 70·92° is but one-third of that adsorbed at 0°. J. Dewar found that at temp. in the vicinity of liquid air the adsorption is remarkably great ; thus, the number of c.c. of gas reduced to 0° and 760° mm. press., adsorbed per c.c. of cocoanut charcoal is as follows :

	0°	10°	15°	H ₂	N ₂	O ₂	A	He	CO ₂
				4	15	18	12	2	21
				135	155	230	175	15	190

The press. of the adsorbed gas at these low temp. is very small. Similarly, J. L. Bärwald found with elderberry charcoal :

	10°	0°	-10°	-50°	-100°	-130°	-150°	-185°
H ₂	3	4	4	9	24	44	76	153
O ₂	61·7	66·7	70·0	105·0	165·0	215·0	245·0	—
Air	35·0	36·7	40·0	65·0	116·7	165·0	200·0	262·3

The adsorption with nitrogen is nearly the same as with air. A. M. Williams represents the effect of temp. by $\log(v/p) = a + b/T$, where v denotes the amount of gas adsorbed; p , the equilibrium press.; T , the absolute temp.; and a and b , constants not dependent on T . D. C. Henry represents the effect of temp. on adsorption equilibrium by $p = \xi T e^{-\lambda/Rt}$, when ξ is independent of temp., and λ is the internal heat of evaporation.

The great avidity with which charcoal adsorbs air at a low temp. was utilized by P. G. Tait and J. Dewar, in 1874, in the production of high vacua. An ordinary vacuum tube containing a small piece of charcoal would not allow a spark to pass when it was cooled in liquid air. It was found that with a 300 c.c. bulb with air at 15°, and a press. 1.7 mm., and in contact with another bulb containing 5 grms. of charcoal, when cooled by liquid air, the press. fell to 0.00005 mm. A radiometer attached to a charcoal bulb when cooled by liquid air showed no motion when the beam from an electric arc-light was focussed on the vanes.

The effect of pressure on the adsorption of gases.—N. T. de Saussure showed that the adsorption is increased by raising the press., but not proportionally. According to P. Chappius, if the temp. be 0°, and the press. p mm., then the volume, v , of gas, in c.c. at 760 mm. press., adsorbed by 15.119 grms. of charcoal from the *helvella esculenta*, is:

p	.	.	1.13	2.23	4.70	9.86	20.12	77.12	335.00	763.38
v	.	.	10.50	23.18	52.72	100.57	178.16	438.24	892.76	1165.66
v/p	.	.	9.29	10.39	11.22	10.20	8.85	5.68	2.66	1.53

If Henry's law were applicable, the quotient v/p would be constant. Corresponding results were obtained by H. Kayser, and L. Joulin. B. Gustavson found that at low press.—4.6 to 17.4 mm.—charcoal adsorbs the vapour of water and acetic acid proportionally to the press. The velocity of adsorption is greater the lower the press. Below 7.4 mm., the adsorption involves the formation of solid soln.; above that press., simple adsorption occurs. Higher press. were used by E. W. R. Pfeiffer for carbon dioxide and ammonia. A selection from the results is given in Table VIII.

TABLE VIII.—EFFECT OF VARIATIONS OF TEMPERATURE AND PRESSURE ON THE ADSORPTION OF AMMONIA AND CARBON DIOXIDE BY CHARCOAL.

Press. atm.	Observed vol. of gas.			Vol. reduced to 0° and 760 mm.		
	12.4°	16.4°	20.4°	12.4°	16.4°	20.4°
Carbon dioxide						
2.23	36.42	35.44	34.06	78.43	75.93	71.30
3.57	26.47	25.60	24.87	92.06	87.79	84.36
5.00	20.58	19.92	19.43	101.40	96.77	93.07
6.38	16.73	16.37	15.89	106.76	103.00	98.55
7.22	15.13	14.85	14.61	110.75	106.33	103.06
8.20	13.76	13.30	13.06	114.55	109.66	105.01
Ammonia						
	13.4°	17.4°	20.4°	13.4°	17.4°	20.4°
2.86	65.00	64.34	64.18	177.07	172.48	169.92
3.57	53.84	52.24	52.95	184.89	180.01	176.90
5.00	40.47	39.97	39.78	199.31	193.26	189.82
6.38	34.15	31.72	31.84	225.09	203.46	20

The decrease in the observed (unreduced) vol. with increasing press. is not constant as would be anticipated if Henry's law were applicable. The increase in the reduced vol. with increasing press. becomes less as the press. increases. M. W. Travers measured the press., p , and conc., x , of carbon dioxide and hydrogen occluded by carbon at temp. between -78° and 100° in the former case, and between -190°

and 100° in the latter case. The results show that the relation can be represented by a formula of the type $x^n = kp$, where k is a constant. For hydrogen at -190°, n is nearly 3; and for carbon dioxide at 0°, $n=3$, and at 100°, $n=2$. H. Briggs and W. Cooper found that, at 15°, the capacity of commercial gas cylinders when filled with dry hydrogen, nitrogen, or oxygen at a given press. is greater when the cylinders are filled with an adsorbent such as charcoal or silica gel than when empty. At 35 atm., the capacity for nitrogen is increased 66 per cent. by filling with coconut charcoal. At higher press., the increase in capacity is not so great. To be effective, the adsorbent must be dry. Sudden outbursts of *firedamp* in coal mines have been found to be the result of releasing immense quantities of gas adsorbed under press. in coal.

The vap. press. of a film of adsorbed gas has no known relation with that of the liquefied gas. The equilibrium vap. press. of a liquid is constant at a given temp. only when the disturbing effects due to gravitation, capillary forces, etc., are eliminated. Hence, the equilibrium vap. press. of a thin film of liquid is not the same as the vap. press. of the liquid *en masse*, and it may vary with the nature of the adsorbing solid. J. Dewar found that at -185°, the amounts of hydrogen, v c.c., adsorbed per gram of coconut charcoal at a press., p atm., were :

p	:	:	:	:	1	5	10	15	20	25
v	:	:	:	:	92	138	156	149	145	138

He assumed that the decrease from 156 to 138 c.c. per gram is due to an experimental error. It is assumed that above 10 atm. press. the adsorption is independent of the press., and that the adsorption has reached a limit. According to H. Kayser, if p denotes the press., and v the vol. of hydrogen adsorbed per c.c. of charcoal, $v=0.6036-1.35 \log p$, at 0°.

The curve obtained by plotting the amounts of adsorbed gas at different press., and at a constant temp., is called the **adsorption isotherm**; and with J. Dewar's data, the adsorption isotherm is concave to the press. axis. According to H. Freundlich, if v denotes the vol. of the gas adsorbed by 1 grm. of charcoal, at a temp. θ° , when the equilibrium press. is represented by p ; and v_0 is a constant representing the vol. of gas adsorbed at θ° under a press. of 1 cm., the **adsorption isotherm equation** has the form :

$$v = v_0 p^{1/n}; \text{ or, } p = \left(\frac{v}{v_0}\right)^n;$$

where n is a constant. This empirical equation usually takes the eq. form: $(x/m)^n = kp$, or $n \log (x/m) = \log (kp)$, where n and k are constants, and x represents the amount of gas adsorbed by a mass m of solid. The exponent $1/n$ is less than unity, and geometrically it represents the slope of the logarithmic curve.

The equation $u = kC^{1/n}$ can be derived from the following hypotheses. Let the free surface energy of a bare surface (in vacuo) be σ_0 ergs sq. cm.; and the free surface energy of the same surface covered with a unimolecular layer of gas be σ_1 . When the system is in equilibrium, let u denote the area of the bare surface, and u_1 the area of the surface covered, then the fraction $u/u_1 = \zeta$ will denote the fraction of the surface covered. Let σ denote the free energy of the whole surface when the range of mol. action is small. Then, $\sigma = \sigma_0(1-\zeta) + \sigma_1$; or, $\sigma = \sigma_0 - (\sigma_0 - \sigma_1)u/u_1$. From J. W. Gibbs' equation (1. 13, 22), $\sigma = -Cd\sigma/RTdC$, and by differentiation and substitution,

$$u = \frac{C}{RT} \cdot \frac{\sigma_0 - \sigma_1}{u_1} \cdot \frac{du}{dC}$$

tion, writing $\log k$ for the integration constant, and putting $n = (\sigma_0 - \sigma_1)/RTu_1$, that $\log u = (1/n) \log C + \log k$, or $u = kC^{1/n}$, as above. Similarly, for adsorption, from $\sigma = -Cd\sigma/RTdC$, D. C. Henry concluded that the greater the value of n at a given temp., the greater the work done in the orientation of the surface mol, such that if W denotes the non-osmotic work in the adsorption of a mol of solute from a dil. soln., $n-1 = W/RT$.

F. W. Küster employed a form of this equation where $1/n = \frac{1}{2}$ for the partition of ether between water and caoutchouc. A. M. Williams has deduced an equation :

$$v = p^{\alpha + \beta v}$$

where α and β are functions of the temp. H. Freundlich also tried C. Kröker's formula :

$$\lambda = \beta(a/v)^{-1/n}$$

where a denotes the original amount of solute before adsorption ; a/v is the original conc. of the substance, and $\lambda, \beta,$ and n are constants, but, as J. W. McBain has shown, it is very unsatisfactory. The equation has been discussed by I. M. Kolthoff, W. Ostwald, M. Polanyi, D. C. Henry, M. Geloso, S. Wosnessensky, A. Eucken, D. Reichinstein, B. Iliin, L. Berényi, etc. The general equations for different types of adsorption have been discussed by B. Gustaver, D. C. Henry, W. Ostwald and R. de Izaguirre.

The mean value of $1/n$ in the isotherm equation is always less than unity, and it changes over moderate ranges of press. up to one atm., and it rises with temp., e.g. M. W. Travers' observations on the absorption of carbon dioxide by charcoal show that

	-78°	0°	35°	61°	100°
$\frac{1}{n}$	0.13	0.30	0.46	0.48	0.52

A. E. M. Geddes represented his values of v and p by $v=0.0602p^{0.565}$; the following is a selection of the observed and calculated values of v :

p	41.5	194	340	453	602	698	703
\sqrt{V} Obs.	1.7	4.0	5.4	6.5	7.6	8.6	8.9
\sqrt{V} Calc.	1.7	4.0	5.5	6.4	7.6	8.3	8.4

A. Reychler found that for the absorption of carbon dioxide by blood charcoal, $n=1$, and $v=0.00024p$, which means that the amount of gas adsorbed is proportional to the partial press. of the carbon dioxide in the vap. phase. As shown by A. M. Williams, with gases which are not copiously adsorbed, and where p is accordingly small, the value of n approximates to unity, as is the case, for example, with A. Titoff's observations on the adsorption of hydrogen by charcoal. This is shown by the linear curves, Fig. 17, over moderate press. The isotherm equation then reduces to $v=v_0p$, which is the same as Henry's law. A. M. Williams found the adsorption isotherm of sulphur dioxide and charcoal runs the same course as a typical vap. press. curve. With gases copiously adsorbed—e.g. ammonia or carbon dioxide—the work of I. F. Homfray, L. B. Richardson, etc., shows that the isotherm bends round quickly so that the curves tend to become parallel to the press. axis, showing that a large increase in press. produces only a slight increase in adsorption, Fig. 18. L. B. Richardson's observations on ammonia and carbon dioxide show that through a limited range of press., the degree of adsorption is in fair agreement with the logarithmic form of H. Freundlich's equation ; but at higher press., the adsorption rapidly decreases, indicating that at each temp. there is reached a maximum which cannot be increased by increasing the press. Observations on the effect of press. were made by A. Pickel

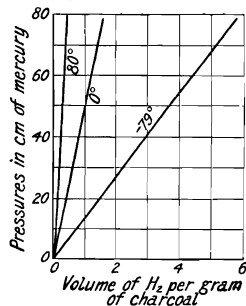

FIG. 17. — Equilibrium Pressures of Hydrogen adsorbed by Charcoal.

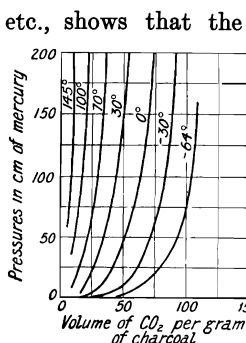

FIG. 18. — Equilibrium Pressures of Carbon Dioxide adsorbed by Charcoal.

etc. According to Lord Blythwood and H. S. A. if p denotes the press. of air at the time, t , reckoned from the commencement of the adsorption, by charcoal, and p_1 is the final press. when the adsorption is completed, $\log(p-p_1)=a+bt$, where a and b are constants. From this it follows, by differentiation, that the velocity of adsorption, at any instant, is proportional to the quantity of air yet to be adsorbed before the saturation limit is

etc.

reached. F. Bergter represented the rate of adsorption of nitrogen between 0.38 and 9.6 mm. press. by the expression $v=v_0(1-0.95e^{-35t}-0.05e^{-0.15t})$, where v_0 is a constant, and v denotes the vol. of gas (reduced to 18° and 760 mm.) adsorbed by a gram of charcoal; and for air, the corresponding expression is $v=v_1t/(a+t)+v_2t/(b+t)$, where v_1 , v_2 , a , and b are constants—*vide infra*, the mechanism of adsorption.

If M denotes the total weight of gas held by 1 grm. of absorbent; M_1 , that part of the gas which is adsorbed; and p , the press., A. M. Williams' relation can be written $\log(M/p)=A_0+A_1M_1$, where A_0 and A_1 are constants, and $M=M_1+kp$, where k is a constant. H. Briggs defines the *prehensibility*, σ , of the substance for a particular gas at a particular temp. as the slope of the curve representing the amount of gas adsorbed and the press., so that $dM/dp=\sigma$; and therefore $\sigma=e^{A_0+k}$. In this way he found the prehensibility of plumstone and cocoanut charcoals for nitrogen to be respectively 9×10^{-2} , and 4.5×10^{-2} ; and likewise for hydrogen, 1.2×10^{-3} and 0.6×10^{-3} .

The adsorption of mixed gases.—The proportions of constituents adsorbed from a mixture of gases has not been closely studied. H. Freundlich found that when charcoal charged with a gas is introduced into an atm. of a more readily adsorbed gas, the former is displaced by the latter, and in rather a larger proportion than would have been predicted from the adsorption coeff. of the individual gases. F. Bergter found that oxygen at 0.5 to 10 mm. press. is adsorbed 30 to 40 times as strongly as nitrogen, and that the presence of oxygen increases the amount of nitrogen adsorbed. J. Hunter noted that the presence of adsorbed water favoured the adsorption of ammonia by charcoal, possibly owing to the dissolution of some of the ammonia in the adsorbed water. J. Matwin noted that a kilogram of charcoal will reduce the sulphur content of illuminating gas in 10 cub. metres of gas to 2.92 grms. by the adsorption of carbon disulphide and carbonyl sulphide. The more porous varieties of charcoals were the most effective. W. Hempel and G. Vater studied the adsorption of mixtures of hydrogen with acetylene, ethylene, methane, and ethane, and of nitrogen with ethane. When the different constituents of a mixture of gases are adsorbed in the same ratio as they occur in the mixture, a separation will not be possible; and when the ratio of the two gases adsorbed by the charcoal differs from the ratio of their proportions in the gas phase a kind of fractional separation will be possible. Thus, J. Dewar used the energetic adsorption of hydrogen by wood charcoal at low temp. to separate this gas from neon, helium, etc., which are adsorbed to a far smaller extent. W. Ramsay, and S. Valentiner and R. Schmidt found the process to be easy and rapid of application. E. Rutherford, R. W. Boyle, J. Satterly, C. Porlezza and G. Norzi, and A. Ritzel have studied the adsorption of the radioactive emanations of radium, thorium, and actinium by charcoal. Technical applications have been discussed by E. Berl and co-workers, H. Carstens, E. B. Miller, G. A. Burrell and co-workers, etc. J. Dewar showed that the composition of the gases adsorbed by charcoal from air at -185° is virtually constant—actually between 56 and 58 per cent. oxygen—and it is not markedly influenced by press. If the gases given by charcoal (sat. by air at -185°) be collected as its temp. slowly rises to -15° , then, the percentages of oxygen in the air evolved are as follows:

	1st	2nd	3rd	4th	5th	6th	litre
Per cent. oxygen .	18.5	20.6	53.0	72.0	79.0	84.0	— mean 56

No sign of the oxidation of carbon by the adsorbed oxygen was noted—*vide infra*. D. C. Henry studied the adsorption of mixed gases. H. Herbst studied the effect of moisture on adsorption by charcoal. H. B. Lemon and K. Blodgett showed that with mixtures of nitrogen and oxygen, one gas interferes with the adsorption of the other. L. B. Richardson and J. C. Woodhouse found that with mixtures of carbon dioxide and nitrous oxide, the total adsorption can be calculated from the adsorption isotherms of the individual gases.

The density of the gas adsorbed by charcoal.—According to A. Mitscherlich, the cells of wood charcoal are, on the average, $\frac{1}{2400}$ th in. in diameter; and he calculated that more than one-third of the gas condensed in the pores of the charcoal is in a liquid state on the walls of the cells; and that the thickness of the layer of carbon dioxide covering the walls of the cells is 0.000002 in. Gases like ammonia, hydrogen chloride, and sulphur dioxide which are adsorbed in greater quantities than carbon dioxide will furnish denser layers. Hence, he concluded that the gases in contact with solids must be in a particular state such as they do not present when in a free state; and since the thickness of the condensed layer of gas must vary, the attraction is not manifested solely on the gas in immediate contact with the solid, but acts at variable distances. G. Quincke estimated that 1 c.c. of box-wood charcoal has a surface area of 220,000 sq. cms.; and assumed that the density of the adsorbed gas near the surface is the same as that of the solid, and rapidly decreases in density in passing from the solid to the free gas. S. Lagergren estimates that a gram of charcoal has a surface of 4 sq. metres when it is composed of 1.4 billion particles. H. H. Lowry and G. A. Hulett found that the apparent sp. gr. of charcoal is 1.07; the capillary volume is about 0.42 c.c.; and the area of the capillaries is not more than 200 sq. metres per gram. A. B. Lamb and co-workers estimated that the pores of charcoal, assumed to be cylindrical, have an average diameter of 5×10^{-7} cm., and that one c.c. of absorbent charcoal has a surface area of about 1000 sq. metres—the apparent sp. gr. is about 0.4. I. Langmuir claimed to have shown that when gases are adsorbed on solid surfaces, the thickness of the adsorbed layer is never greater than the diameter of a molecule. I. Langmuir worked at low press. R. E. Wilson, C. Terzaghi, A. B. Lamb and A. S. Coolidge, and M. H. Evans and H. J. George have shown that the adsorbed layer may be several molecules thick; and E. Edser further demonstrated that the mol. attraction is appreciable at distances as great as 100 times the mol. diameter.

According to E. W. R. Pfeiffer, and A. Winkelmann, if D be the density of the adsorbed gas, and D_0 the density of the gas in a free state, the density of the gas at a distance n from the surface of the solid will be $D_0 + f(n)$, when $f(n)$ is an unknown function of n . At the limiting surfaces, $f(0) = D - D_0$; and $f(h) = 0$, where h is the thickness of the adsorbed layer of gas. If S be the surface area of the body, and m the mass of the adsorbed gas,

$$m = S \int_0^h f(n) \cdot dn$$

E. W. R. Pfeiffer assumes that $f(n)$ decreases uniformly from $n=0$ to $n=h$; and the calculation is then the same as if the whole surface S is covered with a layer of uniform density, $\frac{1}{2}(D - D_0)$, of thickness h . The mass of the adsorbed gas is therefore $m = \frac{1}{2}(D - D_0)Sh$. Observations show that if v be the volume of the adsorbed gas, $m = vD_0$. Combining the last two equations, and solving for h , it follows that $h = vD_0 / \frac{1}{2}(D - D_0)S$. Since 13.76 c.c. of carbon dioxide at 12.4° and 8.2 atm. press. are adsorbed by a c.c. of charcoal, and if 1 c.c. of the charcoal has a surface area of 570,000 sq. cms., it follows that $v/S = 24 \times 10^{-6}$ cm. If the density of the charcoal is 1.4, $D = 1.4$, and the density of the carbon dioxide at 12.4° and 8.2 atm. press. is $D_0 = 0.01539$, and hence the thickness of the adsorbed layer of gas at this temp. and press. is $h = 0.52 \times 10^{-6}$ cm.

J. Dewar calculated the apparent densities of some gases adsorbed by cocoanut charcoal at low temp., and the results are given in Table IX. They show that the

TABLE IX.—THE DENSITIES OF GASES ADSORBED BY CHARCOAL.

Adsorbed gas.	Temp.	Density.	
		Adsorbed gas.	Liquefied gas.
Carbon dioxide	15	0.70	0.80
Oxygen	—183°	1.33	1.12
Nitrogen	—193°	1.00	0.84
Hydrogen	—193°	0.06	0.07
Helium	—258	0.17	0.12

densities of the adsorbed gases are of the same order as those of the liquid gases; and, in some cases, they are greater. At higher temp., the adsorption and apparent condensation would both be smaller. According to W. D. Harkins and co-workers, the liquids which penetrate into the micropores of charcoal are compressed by a force due to molecular attraction which acts as a press. of 20,000 atm. or more.

The heat of adsorption.—Heat is evolved when solids are wetted by liquids—*vide* the Pouillet effect.³ C. S. M. Pouillet gave 1.16° for the magnitude of this effect (1. 9, 9). N. T. de Saussure observed that when gases are adsorbed by solids, heat is evolved. P. A. Favre made the following observations of the heat of adsorption in cal. per mol. at ordinary temp.:

	NH ₃	CO ₂	N ₂ O	SO ₂	HCl	HBr	HI
Heat of adsorption .	7,200	7,300	7,400	10,450	9,700	15,500	22,000
Heat of liquefaction .	5,000	6,250	4,400	5,600	3,600	4,000	4,400

The heats of liquefaction are added for purposes of comparison. He found that the heat of condensation from gas to liquid is less than the heat of adsorption, and hence concluded that the density of the adsorbed gas is greater than that of the liquefied gas. J. Dewar added the following values at -185°:

	H ₂	N ₂	A	O ₂	CO
Heat of adsorption .	1,600	3,686	3,636	3,744	3,416
Heat of liquefaction .	238	1,372	—	1,664	—

P. Chappius measured the heat of adsorption of ammonia by wood charcoal at different stages of the adsorption, and found for the quantity of heat, *Q*, cal. evolved when a vol., *v*, of gas is adsorbed by 2.350 grms. of charcoal:

<i>v</i>	25.79	58.02	59.09	59.27	61.55	59.02	62.77
<i>Q</i>	8.55	20.24	21.45	21.03	22.07	23.54	30.87
Heat per c.c.	0.3298	0.3488	0.3630	0.3701	0.3586	0.3989	0.4910

Consequently, the quantity of heat produced per c.c. of charcoal is less the greater the quantity of gas already adsorbed. According to S. McLean, the thermal effect in the adsorption of air, oxygen, nitrogen, and carbon dioxide, expressed in cal. per c.c. adsorbed, is greatest with oxygen owing to the production of carbon monoxide and carbon dioxide. The largest heat production per gram of adsorbent was obtained with carbon dioxide. The amount was not entirely accounted for by the latent heat of vaporization, indicating that some process other than condensation takes place. Coarser kinds of charcoal form carbon dioxide during oxygen adsorption more readily than others and adsorb more oxygen. The heat effect expressed in terms of the ratio of the observed thermal effect to the saturation effect when *v* c.c. of sulphur dioxide are adsorbed per gram of charcoal was found by A. M. Williams to pass through a minimum and a maximum value, and finally to run parallel to the adsorption axis:

<i>v</i>	8.0	103.5	176	210	242	361	454
Heat effect	1.870	1.426	1.306	1.443	1.417	1.257	1.012

H. L. F. Meslens, and H. Gaudechon have measured the evolution of heat which occurs on wetting wood charcoal with a number of organic and other liquids. The first-named found that when 97 grms. of bromine are added to 11 grms. of charcoal, the temp. rises 30°. The sudden compression of water raises the temp. of water about 0.0013° per atm., hence, H. L. F. Meslens concluded that rise of temp. observed when charcoal is wetted with water, corresponds with a press. of 893 atm. The force of adsorption is then given as follows:

Force of adsorption	Water	Bromine	Éther	Alcohol	Carbon disulphide
	893	3,100	4,620	3,080	13,090 atm.

I. F. Homphray satisfactorily compared the mol. heat of adsorption, *Q*, calculated from the formula $Q=2T^2(d \log_e p)/dT$, with the observed results. A. M. Williams, and A. Titoff obtained expressions for the heat of adsorption.

A. B. Lamb and A. S. Collidge found the heats of adsorption, Q , indicated in Table X, where Q denotes the mol. heat of adsorption of the vap. per normal c.c. of vap. and 10 grms. of charcoal; L , the mol. heat of vaporization; $Q-L$ then denotes the difference between the heat of adsorption and the heat of vaporization, *i.e.* the so-called *net heat of adsorption*. If v c.c. of vap. are adsorbed, the amount of heat, Q , adsorbed per c.c. of vap. is $Q=mv^n$, where m and n are constants. The constant m varies little from vap. to vap.; and n is nearly unity. The variations of m and n are generally in opposite directions. This agrees with the observation that the molar heats of adsorption of the various liquids are not very different. A. Titoff's observations on the heats of adsorption of carbon dioxide and ammonia are, respectively, $Q=0.138$ and 0.293 Cal. per c.c.; the heats of liquefaction $L=0.052$ and 0.187 Cal.; and $Q-L=0.086$ and 0.105 .

These results are all in agreement with the inference that *the net heat of adsorption is practically constant for the different liquids observed, when referred to equal vols. of adsorbent liquid*. The heat of adsorption is therefore assumed to be due to the attractive forces of charcoal on the liquid, and for a given vol. of liquid, or for a given vol. of filled capillary space, the amounts of heat liberated are nearly the same for all the liquids studied. Assuming that the net heat of adsorption results from the force of attraction of the charcoal acting on the liquid, the magnitude of the attractive force can then be calculated from the heats of compression of the liquids. Values for the heats of compression, dQ/dp cal. per c.c. of liquid at atm. press., and 0° , are indicated in Table X. The quotient of the net heat of adsorption by the heat of compression then represents the magnitude of the attractive forces, and these are evidently nearly constant, and average 11,100 atm. If the heats of compression, dQ/dp cal. at press. approaching 12,000 atm., be substituted for those at one atm. press., the absolute value of the attractive force is about 37,000 atm. per c.c. of liquid adsorbed by 10 grms. of charcoal.

TABLE X.—HEATS OF ADSORPTION OF THE VAPOURS OF SOME ORGANIC COMPOUNDS.

Vapour.	Q Cals.	L Cals.	$Q-L$ Cals.	$Q-L$ per c.c. Cals.	n	m	dQ/dp cals.	$Q-L$ dQ/dp $\times 1000\text{atm.}$
Ethyl chloride, C_2H_5Cl	12.33	6.22	6.11	0.0864	0.915	0.7385	0.0101	8.5
Carbon disulphide, CS_2	12.63	6.83	5.80	0.0991	0.9205	0.7525	0.0073	13.5
Methyl alcohol, CH_3OH	12.95	9.33	3.62	0.0908	0.938	0.742	0.0076	12.0
Ethyl bromide, C_2H_5Br	14.33	6.85	7.48	0.1020	0.900	0.900	0.0086	11.9
Ethyl iodide, C_2H_5I	14.25	7.81	6.44	0.0815	0.956	0.737	0.0074	11.0
Chloroform, $CHCl_3$	14.93	8.00	6.93	0.0875	0.935	0.8285	0.0071	12.3
Ethyl formate, $HCOOC_2H_5$	15.42	8.38	7.04	0.0901	0.9075	0.944	0.0087	10.3
Benzene, C_6H_6	15.17	7.81	7.36	0.0850	0.959	0.774	0.0074	11.5
Ethyl alcohol, C_2H_5OH	14.98	10.65	4.33	0.0768	0.928	0.871	0.0066	11.6
Carbon tetrachloride, CCl_4	16.09	8.00	8.09	0.0856	0.930	0.893	0.0076	11.3
Ether, $(C_2H_5)_2O$	16.09	6.90	9.19	0.0803	0.9215	0.917	0.0097	8.3
Mean	—	—	—	0.0877	—	—	—	11.1

A. B. Lamb and A. S. Coolidge further found that the molar adsorption represented by the number of c.c. of gas adsorbed at a fixed gas press., say 20 mm., is inversely proportional to the mol. vol. of the liquid. R. A. Smith ignored the effect of press. on adsorption, and assumed that at atm. press., charcoal adsorbs gases in vols. which are multiples of the vol. of hydrogen adsorbed. It required some juggling with the data to make the assumed law appear even plausible. P. P. Kosakewitsch studied the equilibrium conditions of adsorption.

L. Gurwitsch studied the heat of wetting of charcoal, and regarded this as a kind of measure of the attractive force between adsorbent and adsorbed substances.

He found that oxygen compounds have a greater heat of wetting and are more adsorbed by adsorbents containing oxygen—or are *oxyphilous*—while hydrocarbons are more adsorbed by charcoal or are *carbophilous*—*vide* clay.

Adsorption from solutions.—In 1785, J. T. Lowitz⁴ showed that coloured liquids are decolorized by filtration through charcoal; M. Guilbert stated that the decolorizing power of wood charcoal is improved by exposing it to sunshine for some time while in a wet state; and in 1810, P. Figuier, in his *Mémoire sur la décoloration du vinaigre et nouveau procédé pour décolorer cet acide, et autres liquides végétaux par le carbone animal*, emphasized the marked action of animal charcoal. The fact was utilized by the sugar-refiners of France to clarify their beet-sugar syrups. According to A. Payen, the sugar was boiled with water and about one-sixth of its weight of bone-black for about ten minutes, and the syrup strained. The subject was discussed by A. Bussy, and C. L. Cadet de Gassicourt, etc.; indeed, the early studies on the decolorizing power of “char” were mainly directed to the beet-sugar industry. The strained char was at first discarded, but its regeneration was shown to be practicable about 1825. Soon afterwards, the use of granular char and true filtration was made possible. T. L. Patterson studied the reason why the charcoal slowly deteriorates during revivification. The use of granular char in place of the powder greatly facilitated the handling of the material, and it does not clog the filter presses like the dusty and sooty “blacks.” Animal charcoal is also used for decolorizing other liquids—paraffin, fats, glycerol, etc. The adsorption of air by the charcoal may oxidize certain constituents and darken instead of bleach the liquid. Although animal charcoal stands unrivalled as a decolorant there are quite a number of decolorizing blacks which have special trade-names—the *eponit* of F. Strohmer, and the *karbos, carboraffin, molasocarb*, etc., described by C. F. Bardorf.

As with the adsorption of gases, T. Graham showed that the absorptive action on soln. is selective and specific. In Table XI, a few examples are selected from

TABLE XI.—ADSORPTION OF INDIGO AND SUGAR FROM AQUEOUS SOLUTIONS.

Source of carbon.	Indigo soln.	Sugar syrup.
Blood calcined with potassium carbonate	5·0	20·0
Blood calcined with calcium phosphate	12·0	10·0
Blood calcined with lime	18·0	11·0
Carbon from potassium acetate	5·6	4·4
Carbon from sodium acetate	12·0	8·8
Lampblack	15·2	10·6
White of egg	34·0	15·5
Animal charcoal	1·0	1·0
Animal charcoal washed with acids	1·87	1·6
Animal charcoal washed with acids and calcined with alkali	45·0	20·0

T. Graham's results. T. Graham, and A. W. Hofmann found that 2 ozs. of animal charcoal removed 0·5 grain of strychnine from half a gallon of beer; W. L. Dudley removed the rank odour of raw whisky by filtration through charcoal; and W. Skey freed dil., but not conc., sulphuric acid from nitric acid by shaking with charcoal. Alkaloids are adsorbed from soln., so much so that purified animal charcoal is considered particularly effective as an antidote if administered immediately after the alkaloid has been swallowed. Observations on the decolorizing power of different forms of carbon have been made by E. F. Anthon, E. Bauer, A. Bruno and P. T. d'Auzay, M. Cari-Mantrand, E. Filhol, F. E. Thomas, H. Freundlich and G. Losey, F. Glassner and W. Suida, F. Guthe, L. Pelet-Jolivet and co-workers, L. Rosenthaler and co-workers, H. Schwarz, J. Stenhouse, J. Renner, R. Brimmeyr, K. Vierordt, H. Bodenbender, C. Thumb, H. Eisfeld, G. Krieger, F. E. Bartell and E. J. Miller, E. Spörry, P. M. Horton, J. C. Bock, A. B. Bradley, etc. T. Graham showed that the decolorizing power resides entirely in the charcoal, and not in the earthy matters

associated therewith. T. Graham, and P. Cazeneuve also stated that the nitrogen adsorbed by animal charcoal has no perceptible influence on its decolorizing powers. If the charcoal has been calcined at a very high temp., it loses its decolorizing power. The colouring matters are not destroyed but merely withdrawn from soln., and may be extracted from the charcoal by a suitable solvent. O. C. M. Davis found that the order of adsorption of iodine from different liquids is not the same with different kinds of charcoal. Thus, with animal charcoal, the decrease is in the order: chloroform, alcohol, ethyl acetate, benzene, and toluene; with sugar charcoal, chloroform, toluene, ethyl acetate, benzene, and alcohol; and with coconut charcoal, toluene, chloroform, benzene, alcohol, and ethyl acetate. The adsorption of organic matters from soln. has been investigated by A. Bogojawlensky and V. Humnicky, P. Chappius, O. C. M. Davis, S. Fineschi, H. Freundlich, L. Hermann, R. O. Herzog, J. Hunter, H. Lührig, L. Pincussen, H. R. Kruyt and C. F. van Dunn, I. M. Kolthoff, A. Pickles, L. Rosenthaler and F. Türk, F. Glassner and W. Suida, E. Knecht and E. Hibbert, G. Joachimoglu, H. Rheinboldt and E. Wedekind, L. Joulin, J. Matwin, H. L. F. Melsens, L. Michaelis and P. Rona, A. Reyckler, R. A. Smith, etc. G. Lockemann and M. Paucke have studied the adsorption of arsenic acid by charcoal; and L. and P. Wöhler and co-workers, the adsorption of benzoic acid. Observations on the adsorption of salts from soln. have been made by A. E. Esprit, N. Schilow, L. Liebermann, E. Harms, L. Walkhoff, S. Brussoff, K. Stammer, F. E. Bartell and E. J. Miller, S. Odèn and H. Andersson, P. Rona and L. Michaelis, T. Tadokoro and S. Sato, H. Schwarz, H. Reichardt and D. Cunze, H. Morawitz, K. Birnbaum and A. Bomasch, E. F. Anthon, R. Dupouy, H. Pellet, W. H. Heintz, C. Decharme, G. A. König, E. C. C. Stanford, F. Smith, H. Leplay and J. Cuisinier, E. Moride, W. Wallace, F. Wibel, H. Schulz, F. Knapp, etc. According to H. Hartleben, all alkali chlorides are adsorbed to the same extent by animal charcoal. N. A. Yajnik and T. C. Rana found that temp. has very little effect on adsorption of a substance by charcoal. An increase of temp. produces an increase in adsorption. With an increase in the dilution of a substance in soln., the relative amount of adsorption increases, but at higher conc. the absolute amount of adsorption is greater than at lower conc. Adsorption depends to some extent upon the chemical nature of a substance, sodium, potassium, lithium, and magnesium chlorides, belonging to the same group in the periodic table, possess lower adsorption values than strontium and calcium chlorides. In the adsorption of binary mixtures three things may be observed: (a) The presence of a foreign substance may have no effect on the adsorption of another substance and so adsorption depends very little on the ionization of a substance. (b) A substance may be adsorbed less in presence of another substance than it would be if it were alone in soln. In figurative words, an adsorbent may be poisoned with regard to one substance by the presence of another. (c) The adsorption of a substance may be increased in the presence of another substance or that of one may be increased at the cost of the other. The adsorption of mixtures follows no general rules, and so the effect of one substance on the adsorbability cannot be predicted. The adsorptive power of wood charcoal approximates to, or even exceeds, that of animal charcoal when the former has undergone a heat treatment. With some exceptions, the adsorption numbers with different charcoal can be arranged in the same order. This shows that adsorption also depends upon the chemical properties of a substance. A. Fodor and co-workers studied the adsorption of amino-acids, polypeptides, egg-albumin, and acetic, lactic, and tartaric acids by animal charcoal; H. Freundlich and M. Wreschner, the adsorption of uranium X_1 , and of thorium; and M. A. Rakuzin, the adsorption of gum arabic. A. Pickles studied the velocity of adsorption.

The adsorption of ions is different from the adsorption of neutral mols. in that the adsorbing surface thereby acquires an electrical charge. The electrical charge is determined by the number of ions fixed per unit surface area. The electric charge of the adsorbent determines cataphoresis and electro-endosmosis; and the

peptization of the adsorbent is also facilitated by the electric charge, and this subject has been discussed by W. D. Bancroft, J. N. Mukherjee, and others (3. 23, 8). W. D. Bancroft showed that in general an insoluble electrolyte will adsorb ions markedly, so that a soluble salt having a common ion will tend to peptize a sparingly soluble electrolyte; and conversely with coagulation. In the case where the charge on the surface is due to a strong chemical adsorption of ions of one kind, then, assuming that there is no chemical affinity acting on the ions of opposite charge, a layer of the latter will be electrically attracted and held near the adsorbent, and an eq. amount of ions of opposite sign will remain in the liquid. The observations of G. von Elissafoff on glass and quartz are in agreement with J. N. Mukherjee's calculations. At low conc., the density of the electric charge on the surface increases to a maximum, and at higher conc., falls gradually towards a null-value when the oppositely charged ions are univalent; but, as shown by the observations of R. Ellis, F. Powis, L. Riëty, S. W. Young and R. Neal, H. R. Kruyt, H. A. McTaggart, etc., when the oppositely charged ions are multivalent, or are complex organic ions, the charge passes through a null-value, reverses its sign, reaches a second maximum, and then slowly diminishes. J. N. Mukherjee attributes the negative charge of surfaces in contact with water to the chemical nature of the adsorbed anions or cations.

He suggests that with the simpler electrolytes, the cations are usually simple, while the anions are more or less complex. The anions are therefore subject to the chemical affinity of the surface atoms, while the chemical action on the cations is small. If the chemical affinity acting on the anion of the electrolyte is stronger than the electrostatic attraction of the surface on the cation, then the initial charge of a surface in contact with pure water can be due either (a) to the strong adsorption of an ion of a minute quantity of suitable electrolyte associated with the solid, (b) or to the adsorption of hydroxyl ions from water. On the addition of an electrolyte the density of the electric charge will increase at low concentrations because of the chemical adsorption of the anion. The electrical adsorption of the cation is smaller as the chemical adsorption has been assumed to be stronger. Besides, the electrical charge of the surface is also not at its maximum. As the surface becomes more and more covered by the anions the rate of adsorption of the anions rapidly decreases. Also, the electric charge repels the anions, and those only can strike on it that have sufficient kinetic energy to overcome the potential of the double layer. The number of collisions is thus not proportional to the conc. but rises more slowly. Near about the point where the surface becomes saturated the value of the rate of adsorption of the anions will be almost zero. On the other hand, the electrical adsorption increases continually with the conc. and the increase of the charge. It is apparent that soon a balance will be reached between the chemical adsorption of the anion and the electrical adsorption of the cation. The minimum charge will correspond to the stage when the rate of adsorption of the cation is just equal to the rate of adsorption of the anion. Beyond this conc., the charge will decrease rapidly, and when the surface has been sat. with the anion the subsequent variation in the charge is simply due to electrical adsorption. As the electrically adsorbed *multivalent* cations impart a positive charge to the surface, the adsorption of the cation decreases and the *electrical adsorption* of the anion becomes possible. As long as there is a positively charged surface the adsorption of the anion will increase more rapidly with the conc. than that of the cation. *A second maximum will thus be reached and a decrease in the charge will follow.* The electrical adsorption of the anion is small because of the smallness of the positive charge and an initially existing negative charged surface. A further reversal of the charge is not possible, and, in fact, has never been observed.

The action of acids and alkalis.—J. Perrin, F. Haber and Z. Klemensiewicz, A. T. Cameron and E. Oettinger, etc., have shown that, unlike most univalent ions, hydrogen and hydroxyl ions impart to the surface a charge of the same sign as they carry. In the case where the surface is chemically inert towards the hydrogen and hydroxyl ions, or to the dissolved acid and alkali with which it may be in contact, F. Haber and Z. Klemensiewicz, W. B. Hardy, and A. M. Williams have shown that the adsorbed water mols. behave as a solid layer; and the surface is neutral in contact with water; and that the mols. of water in the adsorbed layer are in thermodynamic equilibrium with the mols. of the water in the body of the liquid. The water mols. are ionizing at a definite rate, and for equilibrium as many ions are uniting to form neutral water mols. According to J. N. Mukherjee, the neutralization of the ions in the adsorbed layer will be very small because the mols. here

behave like a solid layer, and the surface will be neutral. If an acid is added to the water, the neutralization of the H⁺ in the surface layer with the OH⁻ ions in the liquid will be very small, but not necessarily so with the neutralization of the OH⁻ ions in the surface layer with the H⁺ ions in the liquid. This means that a corresponding number of H⁺ ions will remain in the surface layer in excess of the OH⁻ ions. This resulting charge on the surface will increase with a rise in the conc. of the H⁺ ions in the liquid. The opposing factors are: (i) The proportion of H⁺ ions striking the surface decrease as the positive charge of the surface increases, since only those ions can enter the surface which have a sufficient kinetic energy to overcome the electrical repulsion; and (ii) the electrical adsorption of the anion of the acid in the soln.

When the surface is not chemically inert, and there is a preferential adsorption of one of the ions, J. Perrin, G. von Elissaffoff, R. Ellis, F. Powis, etc., have shown that surfaces in contact with water are usually negative owing to the preferential adsorption of OH⁻ ions. This may be related with the potential quadrivalency of oxygen. According to J. N. Mukherjee, in contact with pure water the surface has a layer of adsorbed water and a number of hydroxyl ions. The amount of hydroxyl ions adsorbed by the surface will, in general, be small, as the concentration of the hydroxyl ions is very small in pure water. If, however, the adsorption is very strong the surface will have a considerable negative charge. On the addition of an alkali the negative charge of the surface will increase, due to (i) the preferential adsorption of hydroxyl ions will increase, and (ii) the number of hydrogen ions being formed at the surface will be more and more neutralized by hydroxyl ions in the liquid. A maximum will be reached when the surface is saturated by preferential adsorption. Since the chemical adsorption of hydrogen ions is assumed to be absent, on the addition of an acid the negative charge will decrease owing to electrical adsorption till the surface becomes neutral. At this concentration of the acid, the surface has an adsorbed layer of water, and an equal number of hydrogen and hydroxyl ions. An increase in the positive charge is due to the neutralization of the hydroxyl ions being formed at the surface by impinging hydrogen ions in the liquid. *The maximum charge due to acids thus gives a measure of the hydration of the surface.* The difference between the maximum charge observed with acid and with alkali gives a measure of the amount of hydroxyl ions that is required to saturate the surface. E. J. Miller showed that the hydrolysis of some salts is increased during adsorption by charcoal. H. Lachs stated that substances of a similar electric charge are able mutually to replace one another on an adsorptive surface unity. The results were satisfactory for the adsorption of acetic acid, bromine, and benzoic acid from aq. soln. by blood charcoal. For bromine, with the standard equation $(x/m)^n = kC$, $n=2.4$, and $\log k=0.974$; and when C is expressed in millimols per litre, and x/m in millimols per gram of charcoal.

C	.	.	0.92	2.59	6.69	17.08	29.75
x/m , Obs.	.	.	2.07	3.10	4.27	5.44	6.80
x/m , Calc.	.	.	2.09	2.96	4.10	5.64	6.80

O. C. M. Davis found the above formula represented satisfactorily his observations on the distribution of iodine between charcoal and various organic liquids, and he obtained results with various charcoals which agreed with the assumption that the adsorbed iodine consists partly of a surface condensation and partly of a solid soln., but D. Schmidt-Walter considered that the alleged slow diffusion of iodine from the surface to the interior of the charcoal is a mal-inference, for he attributed the phenomenon to a slow reaction between iodine and the organic liquid where the charcoal acted as a catalyst. G. Wiegner represented the distribution of sucrose and lactose between charcoal and water by the same formula; which also represents the distribution of potassium chloride between stannic oxide and water (J. M. van Bemmelen); and between charcoal and water (H. Lachs and L. Michaelis). Other formulæ have been discussed by H. Freundlich, J. M. McBain, W. Ostwald, I. M. Kolthoff, G. C. Schmidt, G. von Georgievics, R. Marc, G. Trümpler, O. Dietl,

A. M. Williams, etc. H. Freundlich, and G. C. Schmidt showed that the same state of equilibrium with acetic or benzoic acid, charcoal, and water is attained by starting from both sides, so that in these cases the process is reversible. P. J. Moloney and D. M. Findlay studied the selective adsorption as a means of purifying insulin and similar substances.

The selective adsorption of a salt from a soln. will appear to be reversed and the soln. will become more concentrated if relatively more of the solvent than of the solute is absorbed. This is called **negative adsorption**. S. Lagergren, for example, noted the negative adsorption of some chlorides and of ammonium bromide by charcoal; A. E. Esprit, of ammonium iodate, dichromate, and chromate by charcoal; and M. A. Rakuzin and G. F. Pekarskaja, with Bismarck-brown by gelatin, etc. J. Tadokoro and Y. Nakamura measured the adsorption with soln. of potassium iodide by charcoal made from different starches; and Y. Osaka obtained similar results with aq. soln. of sodium chloride, sodium sulphate, and potassium sulphate and with blood charcoal. With potassium chloride, the adsorption is positive when the conc. is relatively high, and negative when the conc. is low. This shows that the amounts adsorbed increases only up to a certain critical point as the conc. of the soln. is increased; any further increase in the conc. of the soln., the surface gives up some of the salt or the amount adsorbed is actually less than is the case with weaker soln. The theory has been discussed by J. N. Mukherjee, and M. A. Rakuzin. According to F. T. Trouton, there are possibly two modes of adsorption. In one, there is a simple increase in the conc. of the soln. in the surface layers; and in the other, with conc. soln., there is a deposition analogous to the solid form.

The cause of the diminution in the conc. of the adsorption layer at a certain critical value of the conc. is difficult to understand. Something analogous has been observed by Lord Rayleigh in the thickness of layers of oil floating on the surface of water. As oil is supplied the thickness goes on increasing up to a certain point; beyond this, on further addition of oil, the layer thins itself at some places and becomes much thicker at others, thicknesses intermediate to these being apparently unstable and unable to exist. As helping towards an explanation of the diminution in the adsorption layer we may suppose that as the strength of the soln. is increased from zero, the adsorption is at first merely an increased density of the soln. in the surface layer. For some reason, after this has reached a certain limit, further addition of salt to the soln. renders this mode of composition of the surface layers unstable, and there is a breaking up of the arrangement of the layer with a diminution in its amount. We may now suppose the second mode of deposition to begin to show its effect with a recovery in the amount of the surface layers and a further building up of the adsorption deposits. On account of passing through this point of instability the process is irreversible, so that the application of thermodynamics to the phenomenon of adsorption is necessarily greatly restricted in its usefulness.

A possible cause of the instability in the adsorption layer which occurs at the critical point may be looked for in the alternations in the sign of the mutual forces between attracting particles of the kind suggested by Lord Kelvin and others. Within a certain distance apart—the mol. range—the particles of matter mutually attract one another, while at very close distances they obviously must repel, for two particles refuse to occupy the same space. At some intermediate distances the force must pass through zero value. It has for various reasons been thought that, in addition, the force has zero value at a second distance lying between the first zero and the mol. range, with accompanying alternations in the sign of the force. Thus, starting from zero distance apart of the particles, the sign of the force is negative or repulsive; then, as the distance apart is supposed to increase, the force of repulsion diminishes, and after passing through zero value becomes positive or attractive; next, as the distance is increased the force diminishes again, and after passing through a second zero becomes negative for a second time; finally, the force on passing through a third zero becomes positive, and is then in the stage dealt with in capillary and other questions.

The mechanism of adsorption.—In order to distinguish the condensation of gases on free surfaces from the absorption of gases in the molecular interstices or throughout the mass of the absorbing liquid or solid, H. Kayser⁵ adopted a suggestion by E. du Bois-Reymond, and called the former case *adsorption*. The term is also applied to the withdrawal of a solute from a soln. by a solid. This may be due to (i) the formation of definite chemical compounds; (ii) the formation of solid

soln.; and of mixed crystals; and (iii) surface condensation. W. Mecklenburg's definition of adsorption is a condensation or combination at the surface only without the interpenetration of the adsorbed substance throughout the mass of the adsorbent. J. W. Gibbs' deduction of his equation (1. 13, 22) also assumes a definition of adsorption analogous to this. J. W. McBain employed the term *sorption* to include both the surface condensation, and interpenetration. The general opinion of most investigators is that with gases adsorption is due to the mere condensation of gas on the capillary and other surfaces of the solid. The very name was intended to emphasize this view of the phenomenon. The preceding estimates of the thickness and density of the adsorbed film, and of the magnitude of the attractive force between the solid and gas assume that the adsorbed gas in a condensed form is spread over the exposed surface of the solid, and that the surface tension of the charcoal is lowered by the presence of the gas.

S. Lagergren considers that adsorption by solids in contact with aq. soln. is due to the compressed state of the water in the surface layer. S. Arrhenius, indeed, has drawn attention to the parallelism between the amounts of different gases adsorbed by charcoal and the coeff., a , of J. H. van der Waals' equation (1. 13, 4), and he regards this as definite evidence of the compressed state of the surface layer. J. J. Thomson showed that Laplace's theory of capillarity leads to the conclusion that in the surface layers chemical actions, etc., which are absent in the body of the liquid, may occur. J. W. Gibbs' thermodynamical treatment of adsorption (1. 13, 22) has been amplified by S. R. Milner, W. C. McC. Lewis, and F. G. Donnan and J. T. Barker. This attributes adsorption to changes produced in the surface tension of the solvent in the boundary layer. This view is adopted by H. Freundlich. Observations show that the amount adsorbed from a soln. is often greatly in excess of that computed from J. W. Gibbs' equation. This arises from the circumstance that here the attempt is made to explain adsorption in terms of the diminution of surface energy, or of a layer under a great internal press.; otherwise expressed, only one source of change in the free energy of the surface layer is considered. G. Bakker showed that if the density of the surface layer is different from that of the liquid in bulk, a second term is needed to represent the change in free energy. At low temp., this second term may be negligible in comparison with the surface tension itself, but at high temp., the second term may be relatively large because the surface tension is small and the saturation press. large. A. M. Williams has also emphasized the effect of the variation in the surface of an adsorbent while it is adsorbing; and S. Arrhenius also emphasized the chemical aspect of the adsorption of gases by solids, since, in addition to the attractions between the mols. of a gas in the surface layer, there is also the chemical attraction of the surface atoms and the mols. of the gas. L. Michaelis and P. Rona also show that the assumption of special forces at the surface fails to account for the facts, and that it is necessary to assume that adsorption is an effect of chemical affinity. They showed that charcoal has a great capacity for adsorbing substances with a chain of carbon atoms.

C. Hoitsema assumed that hydrogen occluded by palladium (*q.v.*) is in the at. state and his isothermal at 0° is almost the same as that obtained by M. W. Travers at -78° for carbon dioxide. There is, however, no satisfactory evidence to show that the adsorption of hydrogen by carbon is attended by such a change. Both P. D. Zacharias, and M. W. Travers favoured the hypothesis that the process involves a kind of clogged diffusion. Thus, H. H. Sheldon says that the action is dual, since besides the surface action, there is a diffusion into the more inaccessible channels, which cannot be expected to take place until the easily accessible or directly exposed parts are saturated. On the other hand, J. W. McBain observed that this assumption does not agree with his observations on the influence of press., where it is shown that the same length of time is taken for hydrogen to diffuse at 160 mm. press. as is taken at 20 mm. press., while P. D. Zacharias' hypothesis predicted that it would occupy 64 times as long. I. F. Homfray regarded the process as one of dissolution or absorption rather than adsorption or surface condensation.

The objection to the soln. hypothesis is that Henry's law does not hold, but she attributes the deviations to the high conc. of the soln. It is assumed that the simple gas laws are valid for dil. soln. but not for conc. soln. The main objection to the soln. hypothesis, said L. B. Richardson, arises from the improbability that equilibrium between the gas and solid phase would be attained so quickly as the 0.5-2.0 hrs. actually observed. J. W. McBain combined the soln. and the surface condensation hypotheses by showing that when carbon is placed in hydrogen, at the temp. of liquid air, there is a rapid decrease of press. for a few minutes, and this is followed by a slow decrease continuing for several hours. It is supposed that the first rapid action is due to surface adsorption, and the slower action is caused by the penetration of the gas into the material of the charcoal by adsorption to form a kind of solid soln. The absorption of carbon dioxide at low temp. gives evidence of the same phenomena, but not at higher temp. J. B. Firth's observations on the sorption of iodine by different forms of carbon at 25°, show that while the first rapid condensation occurs in a few minutes, the slower absorption may extend over months and years. E. F. Lundelius studied the adsorption of iodine from soln. in different solvents. G. Wiegner and co-workers found the adsorption of fatty acids from aq. soln. is augmented when 2*N*-NaCl is used in place of water. B. Gustaver also considers that the isotherms of the adsorption by charcoal of the vapour of water, alcohol, and acetic acid show a well-marked point of inflexion. The first part of the curve is taken to represent the reversible adsorption, and the second part is supposed to be due to the condensation of liquid in the pores of the charcoal. J. R. Katz argued that the application of H. Freundlich's adsorption formula is not a sufficient proof that the fixation of water by charcoal is one of surface adsorption, and he plotted the fixation isotherm and the heat of sorption as a function of the quantity of fixed substance. The curve has an almost horizontal middle part like that also obtained with fresh silicic acid. Assuming that the form of the curve is due to the existence of systems of microcapillaries, the radius of the capillaries is calculated to be 1.2-2.6 μ . J. R. Katz, however, considers it more probable that the effects observed are due to the difficult moistening of the solid by water.

L. B. Richardson explains the adsorption process in the following words :

Layers of gas, decreasing in density outwards, are condensed through the surface energy of the solid at the boundary surfaces. An equilibrium between free and adsorbed gas is thus established. Through a limited range, increase of press. causes increase in quantity of gas adsorbed in a fairly definite logarithmic ratio, but as the press. increases beyond these limits, the relative amount of adsorption becomes less, the density of the surface layers cannot be increased on the former scale; in other words, it becomes increasingly difficult for additional quantities of gas to take their places in the already crowded surface region. A point should finally be reached at which increased press. would cause no measurable increase in adsorption. In the same way the crowding effect causes a decrease in the relative amount adsorbed at constant press. with a lowering of the temp. At low temp., the possibility exists that a small portion of the total gas in the solid phase is absorbed (dissolved) in the structure of the charcoal. This portion is relatively slow either to enter or to leave the charcoal structure.

M. Faraday, in 1834, implied that in the catalytic effect of platinum on the combination of hydrogen and oxygen, there is a kind of combination at the surface, so as to form a transition layer more than one mol. thick. He said :

The surface is dependent on the natural condition of gaseous elasticity combined with the exertion of that attractive force, possessed by many bodies, especially those which are solid, in an eminent degree, and probably belonging to all, by which they are drawn into association more or less close, without at the same time undergoing chemical combination though often assuming the condition of adhesion, and which occasionally leads, under very favourable circumstances, to the combination of bodies simultaneously subjected to this attraction. . . . The sphere of action of particles extends beyond those other particles with which they are immediately and evidently in union, and in many cases produces effects rising into considerable importance.

The failure of the theories of adsorption based on the assumption that the phenomenon is determined, in all cases, solely by surface energy led to the hypothesis that chemical affinity is also concerned in the process—*vide supra*—and this is in harmony with M. Faraday's conception of the adsorption of gases. This view seems the more probable when the preferential or specific nature of adsorption is taken into consideration. This aspect has been particularly emphasized by W. D. Bancroft (3, 23, 8), and the idea has been developed by I. Langmuir. The work of A. Eucken, and R. Lorenz and A. Landé agrees with the assumption that adsorption and mol. surface forces are identical.

T. F. E. Rhead and R. V. Wheeler consider that the fixation of oxygen by carbon involves the formation of a more or less indefinite compound, C_nO_{n+x} , because the adsorbed oxygen cannot be removed by exhaustion alone, and by increasing the temp. during exhaustion, not oxygen, but a mixture of carbon monoxide and dioxide in proportions dependent on the temp. at which the carbon has been heated during the fixation of the oxygen—presumably: $C_nO_{n+x} = xCO_2 + (n-x)CO$ is evolved. The hypothesis was intended to explain phenomena attending the oxidation of carbon rather than the phenomena of adsorption. L. B. Richardson observed no signs of the formation of such compounds in his study of the adsorption of carbon dioxide by charcoal; and A. Eucken showed that in the case of the adsorption of argon by charcoal, it is unlikely that the adsorbed mols. are held by the attractions of chemical forces; and the adsorption forces are similar to forces responsible for condensation phenomena, they are almost independent of temp., and extend over a relatively small distance which is of the same order as the mol. radius. This can be taken to mean that there is an indefinitely large intermediate range of phenomena between the two limiting cases where the chemical forces are indefinitely small, and the surface tension large.

A. Eucken further considered that the adsorbed film of gas on the surface of a solid is a kind of transition layer where the mols. are attracted from a distance to the surface; and G. Bakker employed a similar hypothesis in developing a theory of surface tension, for he assumed that the mols. in the transition layer are attracted to one another by a force which is an inverse exponential function of the distance between them. F. Haber has further emphasized his belief that the forces concerned in adsorption phenomena may be brought in close connection with chemical affinities. He said:

The study of the action of X-rays on crystals has shown that ordinary crystalline salts are not systems in which one anion and one cation form a mol. which is separated from the next, but that one cation is probably bound to all the surrounding anions and one anion to all the surrounding cations. In consequence of that, we may feel inclined to consider the possibility of chemical forces acting between the atoms or ions in the surface of the solid precipitates and the mols. or ions in the final layer of the surrounding liquid, *i.e.* in the adsorption layer. We may remember that there are good reasons for the belief that chemical forces are of electrical character, and we know from electro-osmosis and similar phenomena that electrical forces are always acting between the surface of the solids and the adjacent layer of fluid.

The peculiar relations of the surface atoms or mols. to the other mols. of a liquid or solid led I. Langmuir to assume that they are unsaturated chemically, and are surrounded by an intense field of force. In consequence, when the gas mols. impinge against such a surface, they do not, in general, rebound elastically, but are held there by the field of force (residual valence) of the surface atoms of the solid. The length of time which elapses between the condensation of a mol. and its subsequent evaporation depends on the surface forces. Adsorption is a result of this time-lag, for if the surface forces are weak, evaporation may occur very shortly after the condensation, and only a small fraction of the surface becomes coated with a layer of adsorbed mols.; and if the surface forces are intense, the rate of evaporation will be negligibly small and the surface will become completely covered with a layer of mols. of the gas. The number of layers of mols. so retained on the surface will

depend on the sphere of action of the surface of the solid. A. B. Lamb and A. S. Coolidge showed that the films of adsorbed gas are at least one, and usually many mols. thick; and in support of this view, they quoted G. Quincke's observation that the sphere of action of silver has a radius of 6×10^{-6} cm. which is more than the diameter of a mol., *vide supra*. I. Langmuir, and H. S. Harned adapted the kinetic theory of gases to the adsorption theory. The former started from the relation $\mu = p(2\pi MRT)^{-\frac{1}{2}}$, or $\mu = 43.75 \times 10^{-6} p(MT)^{-\frac{1}{2}}$, representing the rate of bombardment of the gas mols. on a solid surface (1. 13, 2), when μ is the number of molecules striking unit surface per second, M the mol. wt., T the absolute temp., p the press., and R the gas constant in ergs per degree. It was shown that for an ideal gas, the rate of bombardment is proportional to the press.; and further, that the fraction of the solid surface covered or the quantity of gas adsorbed at the press. p is $a_p/(\nu + a_p)$, where a is a constant denoting the fraction of the total number of mols. of the gas that leads to a condensation on the surface—it is usually close to, and can never exceed, unity. Here, ν denotes the rate at which the gas would evaporate if unit area of the surface were completely covered.

In the simplest case, it is assumed that (i) the adsorbed layer is one mol. thick; (ii) all mols. of gas which impinge on the layer of mols. already on the surface, rebound and do not condense; and (iii) the ratio of the number of mols. condensing on unit surface in unit time, to the number evaporating from that surface in the same time, is constant throughout the process. The rate of adsorption will then be proportional to the bare surface; so that if A denotes the absorption capacity by weight per gram of charcoal, and K the weight of gas adsorbed per gram of charcoal in the time t , the rate of adsorption dK/dt , will be:

$$\frac{dK}{dt} = k(A - K); \text{ or } k = \frac{1}{t} \log \frac{A}{A - K}$$

where k is a constant. I. Langmuir deduced

$$\frac{N}{N_0} \nu_1 \left(1 + \frac{a}{\nu_1} \mu\right) = \frac{1}{t} \log \frac{\theta_1}{\theta_1 - \theta'}$$

where N_0 represents the number of the elementary spaces per sq. cm. of surface, N is Avogadro's number, θ_1 , the fraction of the surface covered at equilibrium; and θ' , the fraction covered in a time t . The member on the left of the last equation should be a constant when the press. and temp. are constant. Again, if the sphere of action of the mols. at the surface of the solid extends beyond the film one mol. thick, a fraction of a second layer will be adsorbed. Assuming that the ratio of the number of mols. condensing on the first layer to the number evaporating from that layer is constant, then, for the first and second layers respectively:

$$\frac{dx}{dt} = k_1(a - x); \text{ and } \frac{dy}{dt} = k_2(xF - y)$$

where x is the amount on first layer in time t ; a is the amount on first layer when t is infinite; k_1 is the constant of the first reaction; y is the amount on second layer in time t ; k_2 is the constant of the second reaction; and F is a coeff. such that aF equals the amount on the second layer when t is infinite. Here $x + y = K$, and $a + aF = A$. H. S. Harned tested these relations with chloropicrin and carbon tetrachloride vapour, and found the observed results in general agreement with I. Langmuir's hypothesis.

REFERENCES.

- ¹ A. A. C. Swinton, *Proc. Roy. Soc.*, **82**, A, 176, 1909; J. Werth, *Compt. Rend.*, **116**, 232, 1893; M. Berthelot, *Ann. Chim. Phys.*, (4), **19**, 392, 1870; D. Brewster, *Phil. Mag.*, (4), **25**, 174, 1863; O. L. Erdmann and R. F. Marchand, *Journ. prakt. Chem.*, (1), **23**, 159, 1841; A. Vladislavovitch, *Journ. Russ. Phys. Chem. Soc.*, **40**, 371, 1917; T. E. Doubt, *Phys. Rev.*, (2), **15**, 232, 1920; J. Dewar, *Proc. Roy. Inst.*, **11**, 332, 541, 1886; J. C. Philip and J. Jarman, *Journ. Phys. Chem.*, **28**, 346, 1924.

- ³ C. W. Scheele, *Chemische Abhandlungen von der Luft und Feuer*, Upsala, 1781; R. W. Boyle, *Journ. Phys. Chem.*, 12. 284, 1908; *Phil. Mag.*, (6), 17. 374, 1909; F. Fontana, *Mem. Mat. Fis. Soc. Ital.*, 1. 679, 1777; N. T. de Saussure, *Gilbert's Ann.*, 47. 113, 1814; *Bibl. Brit. Genève*, 49. 299, 1812; 50. 39, 127, 1812; *Ann. Phil.*, 6. 241, 331, 1815; W. D. Bancroft, *Applied Colloidal Chemistry*, New York, 7, 1921; A. Piutti and G. Maglia, *Gazz. Chim. Ital.*, 40. i. 569, 1910; J. Hunter, *Phil. Mag.*, (4), 25. 364, 1863; *Journ. Chem. Soc.*, 18. 285, 1865; 20. 160, 1867; 21. 186, 1868; 23. 73, 1870; 24. 76, 1871; 25. 649, 1872; J. Dewar, *Compt. Rend.*, 139. 261, 421, 1904; *Chem. News*, 90. 73, 90, 141, 1904; 94. 173, 185, 1906; 97. 4, 16, 1908; *Proc. Roy. Soc.*, 74. 124, 1904; *Proc. Roy. Inst.*, 18. 180, 1905; *Ann. Chim. Phys.*, (8), 3. 5, 1904; P. G. Tait and J. J. Dewar, *Proc. Roy. Soc. Edin.*, 8. 348, 628, 1875; J. Dewar and G. Ansell, *Proc. Roy. Inst.*, 11. 332, 641, 1886; W. Hempel and G. Vater, *Zeit. Elektrochem.*, 18. 724, 1912; J. Priestley, *Phil. Trans.*, 60. 211, 1770; *Experiments and Observations on Different Kinds of Air*, London, 1. 129, 223, 1790; C. L. Morozzo, *Obs. Phys.*, 22. 294, 1783; 23. 362, 1783; *Journ. Phys.*, 58. 374, 1804; J. C. Delametherie, *Journ. Phys.*, 29. 222, 396, 1786; 30. 309, 1787; G. F. Parrot and D. H. Grindel, *Scherer's Journ.*, 4. 437, 1800; 5. 384, 1800; *Voigt's Mag.*, 3. 217, 1801; S. Saluzzo, *Mem. Accad. Turin*, 3. 180, 1787; E. W. R. Pfeiffer, *Ueber die Verdichtung von Gasen durch feste Körper unter hohen Drucken, mit Berücksichtigung der Temperatur*, Erlangen, 1882; J. L. Bärwald, *Ueber die Adsorption von Gasen durch Holzkohle bei tiefen Temperaturen*, Freiburg i. Br., 1906; *Ann. Physik*, (4), 23. 84, 1907; P. Chappius, *Recherches sur la condensation des gaz à la surface du verre*, Genève, 1880; *Wied. Ann.*, 12. 175, 1881; W. Müller-Erzbach, *ib.*, 28. 684, 1886; A. Berliner, *ib.*, 33. 289, 1888; H. Kayser, *ib.*, 12. 526, 1881; 14. 450, 1881; A. Vladislavovitch, *Journ. Russ. Phys. Chem. Soc.*, 49. 371, 1817; N. A. Yajnik and T. C. Rana, *Journ. Phys. Chem.*, 28. 267, 1924; L. Joulin, *Compt. Rend.*, 90. 741, 1880; *Ann. Chim. Phys.*, (5), 22. 398, 1881; H. Violette, *ib.*, (3), 39. 291, 1853; *Compt. Rend.*, 36. 850, 1853; P. A. Favre, *ib.*, 39. 729, 1854; R. Engel and A. Moitessier, *ib.*, 88. 1353, 1879; 89. 237, 1879; N. F. I. Isambert, *ib.*, 89. 96, 1879; E. Mitscherlich, *Pogg. Ann.*, 59. 94, 1843; *Taylor's Scientific Memoirs*, 4. 1, 1846; *Sitzber. Akad. Berlin*, 376, 1841; G. Quincke, *Pogg. Ann.*, 108. 326, 1859; *Wied. Ann.*, 2. 145, 1877; *Phil. Mag.*, (5), 3. 314, 1877; A. Winkelmann, *Handbuch der Physik*, Leipzig, 1. ii, 1524, 1908; H. Freundlich, *Zeit. Koll.*, 3. 212, 1908; *Kapillarchemie*, Leipzig, 94, 1909; *Ueber die Adsorption in Lösungen*, Leipzig, 1906; *Zeit. phys. Chem.*, 57. 385, 1907; H. Freundlich and G. Loeffe, *Zeit. phys. Chem.*, 59. 284, 1907; W. Ostwald, *Lehrbuch der allgemeinen Chemie*, Leipzig, 2. iii, 218, 1906; F. W. Küster, *Zeit. phys. Chem.*, 13. 445, 1895; I. F. Homfray, *Proc. Roy. Soc.*, 84. A, 99, 1910; *Chem. News*, 96. 93, 1907; *Zeit. phys. Chem.*, 74. 129, 1910; A. Titoff, *ib.*, 74. 641, 1910; A. Ritzel, *ib.*, 67. 724, 1909; E. Blumtritt, *Journ. prakt. Chem.*, (1), 98. 418, 1866; W. Vaubel, *ib.*, (2), 74. 232, 1906; L. B. G. de Morveau, *Nouv. Mém. Acad. Dijon*, 30, 1782; A. M. Williams, *Proc. Roy. Soc. Edin.*, 37. 161, 1917; 39. 48, 287, 298, 1919; M. Böttcher, *Sprech.*, 42. 117, 133, 153, 168, 186, 199, 217, 233, 252, 1909; L. B. Richardson, *Journ. Amer. Chem. Soc.*, 39. 1828, 1917; G. A. Hulett, *ib.*, 42. 391, 1920; M. W. Travers, *Zeit. phys. Chem.*, 61. 241, 1907; *Proc. Roy. Soc.*, 78. A, 9, 1906; W. Ramsay, *ib.*, 76. A, 111, 1905; 80. A, 599, 1908; R. A. Smith, *ib.*, 12. 424, 1863; H. T. Brown, *ib.*, 18. 286, 1870; G. Dreyer and J. S. C. Douglas, *ib.*, 82. B, 168, 1910; A. E. M. Geddes, *Ann. Physik*, (4), 29. 797, 1909; C. Kröker, *Ueber die Adsorption gelöster Körper durch Kohle*, Berlin, 1892; J. W. McBain, *Journ. Chem. Soc.*, 91. 1683, 1907; O. C. M. Davis, *ib.*, 91. 1666, 1907; H. G. Rouppe, *Ann. Chim. Phys.*, (1), 32. 17, 1799; H. G. Rouppe and M. van Noorden, *ib.*, (1), 32. 3, 1799; A. Reychler, *Bemmelen's Gedenksboek*, 55, 1910; S. Lagergren in J. M. van Bemmelen, *Die Adsorption*, Dresden, 410, 1910; L. Gurwitsch, *Zeit. Koll.*, 11. 17, 1912; A. B. Lamb, R. E. Wilson, and N. K. Chaney, *Journ. Ind. Eng. Chem.*, 11. 420, 1919; W. Skey, *Chem. News*, 15. 27, 1867; G. Craig, *ib.*, 90. 109, 1904; S. Valentiner and R. Schmidt, *Sitzber. Akad. Berlin*, 186, 1905; *Ann. Physik*, (4), 18. 187, 1905; Lord Blythwood and H. S. Allen, *Phil. Mag.*, (6), 10. 497, 1905; J. Satterly, *ib.*, (6), 16. 584, 1908; (6), 20. 778, 1910; E. Rutherford, *Nature*, 74. 634, 1906; C. Porlezza and G. Norzi, *Atti Accad. Lincei*, (5), 20. i, 932, 1911; A. Wohl and M. S. Losanitsch, *Ber.*, 38. 4149, 1905; C. F. Schönbein, *Pogg. Ann.*, 73. 326, 1848; J. Matwin, *Journ. Gasbeleucht.*, 52. 602, 1909; I. M. Kolthoff, *Zeit. Koll.*, 30. 35, 1922; A. Fodor and B. Schönfeld, *ib.*, 31. 75, 1922; Y. Tadokoro and Y. Nakamura, *Journ. Japan Biochem.*, 2. 239, 1923; H. Eulenburg and H. Vohl, *Dingler's Journ.*, 198. 435, 1870; H. Vohl, *Arch. Pharm.*, (2), 145. 193, 1872; J. Böhm, *Botan. Ztg.*, 41. 521, 537, 533, 1883; F. Hart, *Chem. Ztg.*, 30. 1204, 1906; S. G. Hedén, *Zeit. physiol. Chem.*, 50. 497, 1907; H. Briggs, *Proc. Roy. Soc. Edin.*, 42. 26, 1922; H. Briggs and W. Cooper, *ib.*, 41. 119, 1921; H. Briggs, *Proc. Roy. Soc.*, 100. A, 88, 1921; E. Berl and K. Andress, *Zeit. angew. Chem.*, 34. 278, 369, 377, 1921; E. Berl, K. Andress, and W. Müller, *ib.*, 34. 125, 1921; H. Carstens, *ib.*, 34. 389, 1921; L. Berényi, *ib.*, 35. 237, 1922; *Zeit. phys. Chem.*, 94. 628, 1920; 105. 55, 1923; M. Polanyi, *Zeit. Elektrochem.*, 26. 370, 1920; *Ber. deut. phys. Ges.*, 18. 185, 1916; *Festschrift Kaiser-Wilhelm Inst.*, 171, 1920; *Verh. deut. phys. Ges.*, 16. 1012, 1914; 18. 55, 1916; B. Gustaver, *Koll. Beihefte*, 15. 185, 1922; *Koll. Zeit.*, 31. 358, 1922; G. A. Burrell, G. G. Oberfell, and C. L. Voress, *Chem. Met. Eng.*, 24. 156, 1921; E. B. Miller, *ib.*, 23. 1155, 1219, 1251, 1920; W. Ostwald and R. de Izaguirre, *Koll. Zeit.*, 30. 279, 1922; 32. 57, 1923; D. C. Henry, *Phil. Mag.*, (6), 44. 689, 1922; R. E. Wilson and T. Fuwa, *Journ. Ind. Eng. Chem.*, 14. 913, 1922; J. Driver and J. B. Firth, *Journ. Chem. Soc.*, 119. 1126, 1921; 121. 2409, 1922; M. Geloso, *Ann. Chim. Anal. Appl.*, 4. 203, 1822; I. Langmuir, *Trans. Faraday Soc.*, 17. 621, 1922; *Journ. Amer. Chem. Soc.*, 40. 1361, 1918; R. E. Wilson, *Phys. Rev.*, (2), 16. 8, 1920; C. Terzaghi, *ib.*, (2), 16. 54, 1920;

- M. H. Evans and H. J. George, *Proc. Roy. Soc.*, **103**, A, 190, 1923; E. Edser, *B.A. Report on Colloid Chemistry*, **4**, 40, 1922; A. B. Lamb and A. S. Coolidge, *Journ. Amer. Chem. Soc.*, **42**, 1168, 1920; S. Wosnessensky, *Zeit. phys. Chem.*, **104**, 46, 1923; B. Iliin, *ib.*, **107**, 145, 1923; B. E. Brown, *Phys. Rev.*, (2), **17**, 700, 1921; R. E. Wilson, *ib.*, (2), **16**, 8, 1920; H. H. Sheldon, *ib.*, (2), **16**, 165, 1920; H. B. Lemon, *ib.*, (2), **14**, 281, 1919; H. B. Lemon and K. Blodgett, *Proc. Nat. Acad. Sciences*, **5**, 289, 1919; H. Herbst, *Biochem. Zeit.*, **115**, 207, 1921; **118**, 103, 1921; W. Möller, *Koll. Zeit.*, **28**, 127, 1921; H. H. Lowry and G. A. Hulet, *Journ. Amer. Chem. Soc.*, **42**, 13, 93, 1408, 1920; H. S. Harned, *ib.*, **42**, 372, 1920; C. S. Bohart and E. Q. Adams, *ib.*, **42**, 523, 1920; A. Pickles, *Chem. News*, **121**, 1, 1920; G. Bossoni, *ib.*, **127**, 114, 1923; B. Gustafson, *Ark. Kemi Min. Geol.*, **7**, 22, 1917; S. McLean, *Trans. Roy. Soc. Canada*, (3), **12**, 79, 1918; A. B. Ray, *Met. Chem. Engg.*, **29**, 354, 1923; A. Eucken, *Zeit. Elektrochem.*, **28**, 257, 1922; W. D. Harkins and W. W. Ewing, *Journ. Amer. Chem. Soc.*, **42**, 2539, 1920; W. D. Harkins and D. T. Ewing, *ib.*, **43**, 1787, 1921; L. B. Richardson and J. C. Woodhouse, *ib.*, **45**, 2638, 1923; D. Reichstein, *Zeit. phys. Chem.*, **107**, 119, 1923; G. Tammann and H. Diekmann, *Zeit. anorg. Chem.*, **135**, 194, 1924; R. Lorenz and E. Wiedbrauck, *ib.*, **135**, 42, 1924; J. Samejima and K. Hayashi, *Science Rep. Tohoku Univ.*, **12**, 289, 1924; A. S. Coolidge, *Journ. Amer. Chem. Soc.*, **46**, 696, 1924; O. Ruff, *Koll. Zeit.*, **32**, 225, 1923; O. Ruff and E. Hohlfeld, *ib.*, **34**, 135, 1924; M. Berthelot, *Ann. Chim. Phys.*, (4), **9**, 475, 1866; F. Bergter, *Ann. Physik*, (4), **37**, 472, 1912; J. C. Philip, S. Dunnill, and O. Workman, *Journ. Chem. Soc.*, **117**, 362, 1920.
- ³ 1, 9, 9; N. T. de Saussure, *Gilbert's Ann.*, **47**, 113, 1814; *Bibl. Brit.*, **49**, 299, 1812; **50**, 39, 127, 1812; *Ann. Phil.*, **6**, 241, 331, 1815. L. Gurwitsch, *Zeit. phys. Chem.*, **87**, 323, 1914; *Journ. Russ. Phys. Chem. Soc.*, **47**, 805, 827, 1915; *Koll. Zeit.*, **32**, 80, 1923; P. A. Favre and J. T. Silbermann, *Compt. Rend.*, **29**, 449, 1849; *Ann. Chim. Phys.*, (3), **34**, 357, 1852; (3), **36**, 5, 1852; P. A. Favre, *Compt. Rend.*, **39**, 729, 1874; *Ann. Chim. Phys.*, (5), **1**, 209, 1874; C. S. M. Pouillet, *ib.*, (2), **20**, 141, 1822; H. L. F. Melsens, *ib.*, (5), **3**, 522, 1874; *Compt. Rend.*, **77**, 781, 1873; **79**, 375, 1874; J. Dewar, *Proc. Roy. Inst.*, **13**, 183, 1905; J. I. O. Masson, *Proc. Roy. Soc.*, **74**, 249, 1904; H. Gaudechon, *Compt. Rend.*, **157**, 209, 1913; M. Berthelot and A. Guntz, *ib.*, **99**, 7, 1884; *Ann. Chim. Phys.*, (6), **7**, 138, 1886; A. B. Lamb and A. S. Coolidge, *Journ. Amer. Chem. Soc.*, **42**, 1146, 1920; P. C. Appius, *Wied. Ann.*, **19**, 27, 1883; A. M. Williams, *Proc. Roy. Soc. Edin.*, **37**, 161, 1917; A. Titoff, *Zeit. phys. Chem.*, **74**, 641, 1910; I. F. Homfray, *ib.*, **74**, 129, 687, 1910; *Proc. Roy. Soc.*, **84**, A, 99, 1910; A. M. Williams, *Proc. Roy. Soc. Edin.*, **38**, 23, 1918; R. A. Smith, *Proc. Roy. Soc.*, **28**, 322, 1879; *Chem. News*, **18**, 21, 1868; **39**, 77, 1879; S. McLean, *Trans. Roy. Soc. Canada*, **15**, 73, 1921; P. P. Kosakewitsch, *Zeit. phys. Chem.*, **108**, 281, 1924; J. C. Philip, S. Dunnill, and O. Workman, *Journ. Chem. Soc.*, **117**, 362, 1920; R. M. Winter and H. B. Baker, *ib.*, **117**, 319, 1920; H. Briggs, *Proc. Roy. Soc.*, **100**, A, 88, 1921.
- ⁴ J. T. Lowitz, *Crell's Journ.*, **i**, 211, 1786; **ii**, 36, 131, 1788; P. Figuier, *Bull. Pharm.*, **3**, 307, 1811; *Ann. Chim. Phys.*, (1), **79**, 71, 1811; *Phil. Mag.*, (1), **41**, 129, 1813; L. Figuier, *Monit. Scient.*, (4), **9**, 5, 1895; T. Graham, *Quart. Journ. Science*, **1**, 120, 1830; M. Guilbert, *Bull. Pharm. Chim.*, **3**, 264, 1811; A. Payen, *Ann. Chim. Phys.*, (2), **21**, 215, 1822; *Journ. Pharm. Chim.*, (2), **13**, 406, 1827; A. Bussy, *ib.*, (2), **8**, 257, 1822; C. L. Cadet de Gassicourt, *ib.*, (2), **4**, 301, 1817; A. E. Esprit, *ib.*, (3), **16**, 192, 264, 1849; P. Cazeneuve, *Compt. Rend.*, **110**, 788, 1890; L. Pelet-Jolivet, *ib.*, **145**, 1182, 1907; L. Pelet-Jolivet and C. Mazzoli, *Bull. Soc. Chim.*, (4), **5**, 1011, 1909; M. Cari-Mantrand, *ib.*, (3), **27**, 1119, 1903; A. Bruno and P. T. d'Auzay, *Ann. Falsif.*, **2**, 404, 1909; G. F. Bardorf, *Chem. Trades Journ.*, **68**, 373, 1920; *Canadian Chem. Journ.*, **4**, 207, 1920; T. L. Patterson, *Journ. Soc. Chem. Ind.*, **22**, 608, 1903; F. Strohmeyer, *Oester. Zeit. Zucker Ind.*, **39**, 687, 1910; Y. Osaka, *Mem. Coll. Science Univ. Kyoto*, **1**, 267, 1905; F. Guthe, *Arch. Pharm.*, (2), **69**, 131, 1852; L. Rosenthaler, *ib.*, (2), **244**, 535, 1906; L. Rosenthaler and F. Türk, *ib.*, (2), **244**, 298, 1907; (2), **245**, 686, 1907; W. L. Dudley, *Journ. Amer. Chem. Soc.*, **30**, 1784, 1908; E. Filhol, *Compt. Rend.*, **34**, 247, 1852; *Ann. Chim. Phys.*, (3), **35**, 306, 1852; H. Pellet, *ib.*, (5), **28**, 89, 1880; C. Decharme, *ib.*, (5), **3**, 248, 1874; J. Stenhouse, *Pharm. Journ.*, **16**, 363, 1857; L. Liebermann, *Sitzber. Akad. Wien*, **75**, 331, 1875; E. Bauer, *Zeit. angew. Chem.*, **1**, 385, 1888; A. Bogojawliensky and V. Humnicky, *ib.*, **21**, 1639, 1908; F. E. Anthon, *Dingler's Journ.*, **189**, 72, 1838; **213**, 159, 1874; H. Schwarz, *ib.*, **159**, 316, 1861; **205**, 430, 1872; L. Walkhoff, *ib.*, **161**, 380, 1861; K. Stammer, *ib.*, **160**, 378, 1861; **161**, 80, 1861; K. Birnbaum and A. Bomasch, *ib.*, **218**, 418, 1875; H. Schulz, *ib.*, **188**, 314, 1868; R. Brimmeyr, *ib.*, **184**, 615, 1867; J. Renner, *ib.*, **166**, 291, 1862; K. Vierordt, *Pogg. Ann.*, **149**, 565, 1873; E. Harms, *Arch. Pharm.*, (2), **69**, 121, 1852; F. Glassner and W. Suida, *Liebigs Ann.*, **357**, 95, 1907; **361**, 353, 1908; W. H. Heintz, *ib.*, **187**, 127, 1877; H. Reichardt and D. Cunze, *Zeit. Chem.*, (2), **6**, 122, 1870; H. A. McTaggart, *ib.*, (6), **44**, 386, 1922; A. T. Cameron and E. Oettinger, *ib.*, (6), **18**, 586, 1909; J. Hunter, *ib.*, (4), **25**, 364, 1863; *Journ. Chem. Soc.*, **18**, 285, 1865; **20**, 160, 1867; O. C. M. Davis, *ib.*, **91**, 1666, 1907; T. Graham and A. W. Hofmann, *ib.*, **5**, 713, 1853; E. C. C. Stanford, *ib.*, **26**, 14, 1873; R. A. Smith, *Chem. News*, **18**, 121, 1868; W. Skey, *ib.*, **17**, 217, 1866; F. Smith, *ib.*, **33**, 100, 1876; G. A. König, *ib.*, **45**, 215, 1882; H. L. F. Melsens, *Phil. Mag.*, (4), **43**, 410, 1873; *Compt. Rend.*, **77**, 78, 1873; L. Joulin, *ib.*, **90**, 741, 1880; E. Moride, *ib.*, **41**, 215, 1882; H. Leplay and J. Cuisinier, *ib.*, **54**, 270, 1862; E. Spörry, *Chem. Zig.*, **47**, 203, 1923; P. M. Horton, *Journ. Ind. Eng. Chem.*, **15**, 519, 1923; V. Kletzinsky, *Dingler's Journ.*, **209**, 396, 1873; *Polyt. Notizblatt*, **28**, 233, 1872; H. Lachs and L. Michaelis, *Zeit. Elektrochem.*, **17**, 1, 1911; P. Chappius, *Wied. Ann.*, **19**, 21, 1883; H. Lübrig, *Pharm. Centrbl.*, **46**, 951, 1905; R. Dupouy, *ib.*, **38**, 705, 1897; S. Fineschi, *Staz. Agrar. Ital.*, **40**, 545, 1907; H. Freundlich and M. Masius, *Bemmelen's Gedenboek*, **88**, 1910; H. Freundlich,

Kapillarchemie, Leipzig, 147, 1909; *Zeit. phys. Chem.*, 57. 385, 1907; H. Freundlich and G. Losey, *ib.*, 59. 284, 1907; G. C. Schmidt, *ib.*, 15. 56, 1894; 74. 730, 1910; 77. 641, 1911; 78. 667, 1912; 91. 103, 1916; H. Freundlich and H. Kampher, *ib.*, 90. 681, 1915; R. Marc, *ib.*, 81. 641, 1913; N. Schilow and L. Lepin, *ib.*, 94. 25, 1920; N. Schilow, *ib.*, 100. 425, 1922; L. and P. Wöhler and W. Pluddemann, *ib.*, 62. 664, 1908; L. Hermann, *Arch. Physiol.*, 26. 442, 1881; L. Michaelis and P. Rona, *Biochem. Zeit.*, 15. 196, 1908; 16. 489, 1909; R. O. Herzog, *Zeit. physiol. Chem.*, 60. 79, 1909; J. Matwin, *Journ. Gasbeleucht.*, 52. 602, 1909; A. Reyehler, *Journ. Chim. Phys.*, 7. 497, 1909; J. M. van Bemmelen, *Zeit. anorg. Chem.*, 23. 113, 1900; J. C. Bock, *Journ. Amer. Chem. Soc.*, 42. 1564, 1920; A. B. Bradley, *Journ. Soc. Chem. Ind.*, 38. 396, 1919; G. von Georgievics, *Zeit. phys. Chem.*, 83. 269, 1914; *Monatsh.*, 34. 733, 1913; O. Dietl, *ib.*, 35. 784, 1914; J. Trümpler, *Zeit. Koll.*, 15. 10, 1914; D. Schmidt-Walter, *ib.*, 14. 242, 1914; I. M. Kolthoff, *ib.*, 30. 35, 1922; W. Ostwald, *ib.*, 30. 254, 1922; A. Fodor and B. Schönfeld, *ib.*, 31. 75, 1922; E. Abderhalden and A. Fodor, *ib.*, 27. 49, 1920; *Fermentforsch.*, 1. 533, 1916; 2. 74, 151, 1917; G. Joachimoglu, *Biochem. Zeit.*, 184. 493, 1923; H. R. Kruyt and C. F. van Duun, *Rec. Trav. Chim. Pays-Bas*, 39. 679, 1920; N. A. Yajnik and T. C. Rana, *Journ. Phys. Chem.*, 28. 267, 1924; G. Wiegner, *Zeit. Koll.*, 8. 126, 1911; S. Brussoff, *ib.*, 5. 137, 1909; G. Lockemann and M. Plaucke, *ib.*, 8. 273, 1911; A. M. Williams, *Proc. Roy. Soc. Edin.*, 39. 48, 267, 298, 1919; F. Knapp, *Deut. Ind. Zig.*, 205, 1872; S. Lagergren, *Bihang Svenska Akad. Handl.*, 24. 4, 5, 1899; F. T. Trouton, *B.A. Rep.*, 287, 1914; H. Morawitz, *Koll. Beihefte*, 1. 301, 1910; F. Wibel, *Ber.*, 7. 220, 1874; W. Wallace, *Proc. Glasgow Phil. Soc.*, 6. 377, 1868; *Amer. Chemist*, 1. 139, 184, 1870; C. Thumb, *German Pat.*, D.R.P. 12500, 1880; H. Eisfeld, *Bavarian Pat. No.* 40, 1870; H. Bodenbender, *Stammer's Jahresh. Zuckerfab.*, 239, 1870; G. Krieger, *Dingler's Journ.*, 226. 603, 1877; R. Ellis, *Zeit. phys. Chem.*, 78. 321, 1911; 80. 597, 1912; 89. 145, 1914; F. Powis, *ib.*, 89. 91, 179, 1914; F. Haber and Z. Klemensiewicz, *ib.*, 67. 385, 1909; G. von Elissaffoff, *ib.*, 79. 407, 1912; L. Riéty, *Compt. Rend.*, 154. 1411, 1215, 1912; 156. 1368, 1913; S. W. Young and R. Neal, *Journ. Phys. Chem.*, 21. 1, 1917; J. Ferrin, *Journ. Chim. Phys.*, 2. 601, 1904; 3. 50, 1905; H. R. Kruyt, *Verh. Akad. Amsterdam*, 17. 623, 1914; *Koll. Zeit.*, 22. 81, 1918; A. M. Williams, *Proc. Roy. Soc.*, 98. A, 223, 1920; W. B. Hardy, *ib.*, 84. B, 217, 1911; J. N. Mukherjee, *The Physics and Chemistry of Colloids* (Faraday Soc. Discussion), London, 103, 1921; *Phil. Mag.*, (6), 44. 321, 1922; F. E. Thomas, *Chem. Age*, 7. 236, 1922; F. E. Bartell and E. J. Miller, *Journ. Amer. Chem. Soc.*, 44. 1866, 1922; 45. 1106, 1923; M. A. Rakuzin and G. F. Pekarskaja, *Journ. Russ. Phys. Chem. Soc.*, 48, 1889, 1916; M. A. Rakuzin, *ib.*, 53, 357, 369, 374, 1921; T. Tadokoro and Y. Nakamura, *Journ. Japan Biochem.*, 2. 239, 1923; T. Tadokoro and S. Sato, *Journ. Coll. Agric. Hokaido Univ.*, 12. 1, 1923; H. Rheinboldt and E. Wedekind, *Koll. Beihefte*, 17. 115, 1923; E. Knecht, *Chem. News*, 121. 62, 1920; *Journ. Soc. Dyers and Colourists*, 36. 201, 1920; E. Knecht and E. Hibbert, *ib.*, 32. 226, 1916; F. Glassner and W. Suida, *Liebig's Ann.*, 357. 95, 1907; L. Rosenthaler, *Arch. Pharm.*, 244. 535, 1906; L. Rosenthaler and F. Türk, *ib.*, 244. 517, 1906; A. Pickles, *Chem. News*, 121. 1, 25, 49, 1920; H. Hartleben, *Biochem. Zeit.*, 115. 46, 1921; P. Rona and L. Michaelis, *ib.*, 94. 240, 1919; 97. 57, 1919; L. Pinussen, *ib.*, 137, 217, 1923; S. Oden and H. Andersson, *Journ. Phys. Chem.*, 25. 311, 1921; I. M. Kolthoff, *Pharm. Weekbl.*, 18. 630, 1921; H. Lachs, *Izsz. Zjazd Chem. Polskich*, 30, 1923; *Zeit. phys. Chem.*, 91. 155, 1916; E. J. Miller, *Journ. Amer. Chem. Soc.*, 46. 1150, 1924; F. E. Bartell and E. J. Miller, *ib.*, 44. 1866, 1922; P. M. Moloney and D. M. Findlay, *Journ. Phys. Chem.*, 28. 402, 1924; H. Freundlich and M. Wreschner, *Zeit. phys. Chem.*, 106. 366, 1923; J. W. McBain, *Trans. Faraday Soc.*, 14. 202, 1919; *Journ. Chem. Soc.*, 91. 1683, 1907; W. D. Bancroft, *Applied Colloid Chemistry*, London, 1921; J. M. van Bemmelen, *Zeit. anorg. Chem.*, 23. 111, 1900.

* J. N. Mukherjee, *The Physics and Chemistry of Colloids* (Faraday Soc. Discussion), London, 103, 1921; *Phil. Mag.*, (6), 44. 321, 1922; R. Lorenz and A. Landé, *Zeit. anorg. Chem.*, 125. 47, 1922; J. W. McBain, *ib.*, (6), 18. 916, 1909; *Zeit. phys. Chem.*, 68. 671, 1909; P. D. Zacharias, *ib.*, 39. 468, 1902; G. Bakker, *ib.*, 68. 684, 1910; 89. 1, 1915; C. Hoitsema, *ib.*, 17. 1, 1895; H. Kayser, *Wied. Ann.*, 14. 451, 1881; T. F. E. Rhead and R. V. Wheeler, *Journ. Chem. Soc.*, 103. 461, 1913; M. W. Travers, *Proc. Roy. Soc.*, 78. A, 9, 1906; *Zeit. phys. Chem.*, 61. 241, 1907; A. Titoff, *ib.*, 74. 641, 1910; W. Meckenburg, *ib.*, 83. 609, 1903; I. F. Homfray, *ib.*, 74. 129, 687, 1910; *Proc. Roy. Soc.*, 84. A, 99, 1910; M. H. Evans and H. J. George, *ib.*, 103. A, 190, 1923; L. B. Richardson, *Journ. Amer. Chem. Soc.*, 39. 1828, 1917; I. Langmuir, *Trans. Faraday Soc.*, 14. 202, 1909; *Journ. Amer. Chem. Soc.*, 37. 1139, 1915; 38. 1145, 2221, 1916; 40. 1361, 1918; A. B. Lamb and A. S. Coolidge, *ib.*, 42. 1168, 1920; F. Haber, *Journ. Soc. Chem. Ind.*, 33. 49, 1914; *Zeit. Elektrochem.*, 20. 521, 1914; A. Eucken, *Verh. deut. phys. Ges.*, 16. 345, 1914; *Zeit. Elektrochem.*, 28. 6, 1922; G. Quincke, *Pogg. Ann.*, 137. 402, 1869; H. H. Sheldon, *Phys. Rev.*, (2), 19. 253, 1922; B. Gustaver, *Koll. Chem. Beihefte*, 15. 185, 1922; J. W. Gibbs, *Trans. Connecticut Acad.*, 3. 439, 1876; *Scientific Papers*, London, 1. 219, 1906; H. Freundlich, *Kapillarchemie*, Leipzig, 50, 1909; L. Michaelis and P. Rona, *Biochem. Zeit.*, 97. 56, 85, 1919; W. D. Bancroft, *Journ. Franklin Inst.*, 185. 29, 199, 375, 1913; *Journ. Phys. Chem.*, 19. 349, 363, 1915; *Applied Colloid Chemistry*, New York, 1921; R. E. Wilson, *Phys. Rev.*, (2), 16. 8, 1920; M. Faraday, *Phil. Trans.*, 124. 55, 1834; S. Lagergren, *Bihang Svenska Vet. Handl.*, 24. 11, 1898; J. J. Thomson, *Applications of Dynamics to Physics and Chemistry*, London, 206. 236, 1888; S. Arrhenius, *Med. Nobelinst.*, 2. 7, 1911; *Theories of Solutions*, New Haven, 55, 1912; A. M. Williams, *Proc. Roy. Soc. Edin.*, 38. 23, 1918; *Trans. Faraday Soc.*, 10. 155, 1914; *Proc.*

Roy. Soc., 96. A, 287, 1919; 98. A, 223, 1920; F. G. Donnan and J. T. Barker, *ib.*, 85. A, 552, 1911; S. R. Milner, *Phil. Mag.*, (6), 13. 96, 1907; W. C. McC. Lewis, *ib.*, (6), 15. 506, 1908; (6), 17. 466, 1909; *Zeit. phys. Chem.*, 73. 129, 1910; J. B. Firth, *Trans. Faraday Soc.*, 16. 434, 1921; *Journ. Chem. Soc.*, 123. 323, 1923; *Journ. Soc. Chem. Ind.*, 42. 242, T, 1923; J. B. Firth and F. S. Watson, *Journ. Chem. Soc.*, 123. 1219, 1923; J. Driver and J. B. Firth, *ib.*, 119. 1127, 1921; J. B. Firth, W. Farmer, and J. Higson, *ib.*, 125. 488, 1924; G. Joachimoglu, *Biochem. Zeit.*, 134. 493, 1923; E. F. Lundelius, *Koll. Zeit.*, 26. 145, 1920; G. Wiegner, J. Magasanik, and A. J. Virtanen, *Koll. Zeit.*, 28. 51, 1921; J. R. Katz, *Proc. Acad. Amsterdam*, 26. 548, 1923; H. S. Harned, *Journ. Amer. Chem. Soc.*, 42. 372, 1920.

§ 10. The Action of Oxygen, and Water on Carbon

Observations on the combustion of the diamond have been described in a special section in connection with the action of heat on the diamond. E. H. von Baumhauer¹ showed that the flame is bluish-violet resembling that of burning carbon monoxide. G. Rose detected small corrosion pits on the surface of a diamond which had been heated to about 1000°. H. Moissan gave for the **ignition temperature** of different kinds of diamond in oxygen: Yellowish-black diamond, 690°; hard black diamond, 710°–720°; transparent Brazilian diamond, 760°–770°; Cape diamond, 780°–790°; Brazilian boart, 810°; Cape boart, 790°; and hard boart, 800°. G. Rose said that flaky graphite burns less readily and compact graphite more readily than the diamond—thus, after burning 13 min. flaky graphite lost 27.45 per cent.; the diamond, 97.76 per cent.; and compact graphite, 100.00 per cent. R. Blindow also said that flaky graphite burns less readily than the diamond. H. N. Warren noted that the graphite which separates from a soln. of carbon in ferromanganese is not so difficult to burn as that from manganese, while that from chromium was the most difficult to burn; H. Moissan said that the graphite similarly derived from platinum ignites in oxygen at 575°; and that from iron at 670°. H. Moissan gave 300°–500° as the ignition temp. of amorphous carbon in dry or moist oxygen. Amorphous carbon which has been heated at an elevated temp. is more difficult to burn in oxygen than charcoal carbonized at a lower temp. H. Valerius said that the temp. of burning carbon is 1678°. Demonstration experiments illustrating the combustion of carbon, graphite, and diamonds have been devised by R. Blindow, A. P. N. Franchimont, A. W. Hofmann, B. Lepsius, E. Prime, J. Volhard, and C. J. Woodward.

H. Karsten said that finely divided amorphous carbon is oxidized in dry air at ordinary temp., and carbon dioxide is formed. R. A. Smith noticed a peculiarity in the relations of oxygen to charcoal which was not exhibited with hydrogen, nitrogen, and carbon dioxide. The absorption continued for a month, and when the attempt was made to drive off the oxygen by heat, carbon dioxide in place of oxygen was evolved. This observation was confirmed by H. Kayser, and J. Böhm. H. H. Lowry and G. A. Hulett considered that there is evidence of a slow reaction between carbon and adsorbed oxygen at ordinary temp. resulting in the formation of a non-volatile oxide. M. Aubert, indeed, said that large masses of finely divided wood charcoal may ignite spontaneously when exposed to air. F. C. Calvert, however, could detect no evidence of the formation of carbon monoxide or dioxide by the oxygen adsorbed by purified charcoal—the adsorbed oxygen could oxidize ethyl alcohol to acetic acid; and ethylene to carbon dioxide and water. These reactions do not occur with carbon monoxide or dioxide in place of oxygen. The evidence is not always satisfactory because in some cases there is the uncertainty whether the charcoal used contained hydrocarbons, which, as previously indicated, are very likely impurities in charcoal. H. H. Lowry and S. O. Morgan showed that at 450° the rate of oxidation of different samples of charcoal is roughly proportional to the amount of chemically combined hydrogen present, and to the extent of surface exposed. W. Skey showed that at a red heat, the oxygen is probably removed from the adsorbed air by oxidation because nitrogen alone was given off by the cooled charcoal.

H. Moissan found that carefully charred bituminous coal is slowly oxidized at 100° by dry or moist oxygen at atm. press., and this without visible combustion. F. H. Storey and D. S. Lewis obtained evidence of oxidation at 200°; E. Blumtritt, at 140°; and G. Craig, at a red heat. As previously indicated, J. Dewar did not detect any appreciable oxidation of carbon to carbon monoxide or dioxide by adsorbed oxygen between -185° and -15°. C. J. Baker verified R. A. Smith's statement that the moist oxygen adsorbed by carbon at -12° was given up as carbon dioxide when the carbon was heated to 100°. O. Meyerhof and H. Weber studied the **self-oxidation** of charcoal in alkaline soln. When animal charcoal is suspended in dil. alkali-lye, oxygen is absorbed and carbon dioxide formed; 4 cal. of heat are evolved per c.c. of oxygen used. The velocity of oxidation is increased 60 per cent. when air is replaced by oxygen. The self-oxidation is a surface effect and is inhibited by various urethanes to different extents. The inhibition is due to a displacement of the adsorbed substance from the surface, while the adsorbed hydroxyl-ion is not affected. The degree of oxidation is proportional to the amount of adsorbed hydroxyl-ions.

For the rise of temp. which occurs when **water** is mixed with carbon, *vide* W. Skey,² C. S. M. Pouillet, etc. A. Scholtz found a finely ground charcoal dried at 100° absorbed 65 per cent. of water before any supernatant liquid appeared; and with up to 30 per cent. of water, the powder appeared sensibly dry. J. C. Pogendorff noted that if carbon electrodes are used in the electrolysis of water, carbon monoxide and dioxide are given off. According to P. Degener and J. Lach, if freshly calcined animal charcoal be moistened with as much water as it can adsorb, and layers 6-8 cms. deep are exposed to air and light, hydrogen peroxide and ozone are formed. E. H. von Baumhauer observed that diamonds are not changed when heated to whiteness in water vapour. A. P. Dubrunfaut found that sugar charcoal burns when heated electrically in an atm. of water vapour, or in moist air; and B. Lepsius made a similar observation. C. J. Baker showed that neither carbon monoxide nor carbon dioxide is produced when water is boiled with carbon at 100°. F. Clément and J. B. Désormes found that when water vapour is passed over red-hot charcoal, in a porcelain tube, a mixture of hydrogen and carbon monoxide and dioxide is formed. R. Bunsen noted that the system attains a stationary state when the proportions of these gases are 4 vols. of hydrogen, 2 vols. of carbon monoxide, and one vol. of carbon dioxide, but J. H. Long showed that the products are not distributed in the simple proportions assumed by R. Bunsen, for the proportion of carbon monoxide steadily decreases as the carbon is oxidized. According to J. Lang, the reaction between carbon and steam begins at about 600° when 20.4 per cent. of carbon dioxide, and 0.9 per cent. of carbon monoxide are produced along with hydrogen; and at a higher temp., carbon monoxide appears, and the proportion of carbon monoxide increases until the carbon monoxide itself begins to be oxidized by the steam. This proportion is independent of the depth of the carbon through which the gases pass. It was therefore inferred that the primary reaction is $C + 2H_2O \rightleftharpoons 2H_2 + CO_2$, but there are a number of side reactions: $CO_2 + C = 2CO$; and $CO + H_2O = CO_2 + H_2$. The reactions have been studied by A. Naumann. P. Farup investigated the reaction $C + H_2O \rightleftharpoons CO + H_2$. H. A. Neville and H. S. Taylor found that alkali carbonates, alkaline earths, and various salts promote the reaction between steam and carbon. Potassium carbonate is the most active salt catalyst. R. T. Haslam and co-workers showed that the reactions $C + H_2O = CO + H_2$ and $C + 2H_2O = CO_2 + 2H_2$ take place at the surface of the carbon and are unimolecular. C. Sandonnini also inferred that carbon is not a catalyst for a detonating mixture of hydrogen and oxygen, and that from 300° to 500° it absorbs oxygen, which it gives off at a higher temp. as carbon monoxide and dioxide. Nickel accelerates the reaction.

In 1794, Mrs. Fulhame assumed that the presence of moisture is necessary for the combustion of charcoal in air; and in 1871, A. P. Dubrunfaut inferred from some inadequate experiments that carbon does not burn in oxygen without the interven-

tion of water vapour. J. B. A. Dumas denied this by some inconclusive experiments in which carbon and oxygen, dried by potassium hydroxide and sulphuric acid, were found to burn completely to carbon dioxide. He asked: *les gaz deséchés par ces procédés, sont-ils absolument privés d'eau?* and added that it would be difficult to affirm that the gases thus desiccated are absolutely dried since *il n'y a rien d'absolu dans le monde matériel*; but it is certain that any trace of water which remained could not be detected in any known way. The weakest part of J. B. A. Dumas' work was in the drying of the carbon. H. B. Baker has proved, in a most convincing way, that carbon and oxygen, when highly purified, do not readily combine together at a high temp., for, on heating purified charcoal in well-dried oxygen to redness in glass tubes, he observed no glow or scintillation (which is immediately produced in the presence of water-vapour); but on opening the vessels, part of the oxygen was found to have combined with the carbon, forming carbon monoxide and carbon dioxide. Whilst these experiments show the great influence of steam in bringing about the union of carbon and oxygen, they do not decide the question whether charcoal and oxygen would combine at all in the complete absence of moisture. W. G. Mixter added that it has not been decided if carbon would remain unburnt in oxygen if both reagents were perfectly dried, since carbon always retains some occluded hydrogen which burns to water. The subject was also discussed by R. H. Bremridge; K. Broockmann, etc. Mrs. Fulhame explained the function of water as follows:

During the combustion of charcoal in air, the carbon attracts the oxygen of the water and forms carbon dioxide, while the hydrogen of the water unites with the oxygen of the air to form a new quantity of water equal to that decomposed. Hence the carbon of the charcoal does not unite with the oxygen of the air, as Lavoisier supposes, but with the oxygen of the water contained in that gas.

L. C. A. Barreswill³ showed that if carbon be burnt at a low temp., carbon dioxide is almost exclusively formed, and the same result is obtained if air be passed through a thick layer of carbon at a low temp.; but at a white-heat, the product is nearly all carbon monoxide—*vide* carbon monoxide. In confirmation, A. Ledebur found, at the following approximate temp.:

	350°	440°	520°	700°	1100° approx.
CO . . .	21·4	27·6	28·6	37·4	98·7 per cent.
CO ₂ .. .	78·6	72·4	71·4	62·6	1·3 „

According to W. Hempel, at a high temp. carbon monoxide and mere traces of carbon dioxide are produced, and the product is not influenced by the presence of much or little oxygen. F. C. G. Müller discussed this subject. According to R. Ernst, the composition of the products of combustion depends almost exclusively on the temp. The formation of carbon dioxide begins at about 400°, and at this temp. there is already a small quantity of carbon monoxide produced. The maximum production of carbon dioxide occurs at about 700°, and amounts to some 20 per cent. of the products (including the nitrogen of the air used); up to this temp. the formation of carbon monoxide is but small, hardly exceeding 3 per cent.; the oxygen, however, is entirely used. At higher temp., the carbon dioxide rapidly disappears, giving place to carbon monoxide, until at 995° this gas amounts to 34 per cent., the remainder being atm. nitrogen. It must be noted, however, that the rate of passage of the air was much reduced in those experiments in which the highest temp. were maintained; no reason is assigned for this. There was no further change in the composition of the products up to the highest temp., 1092°, at which M. Ernst experimented. The production of carbon monoxide could not be induced at a lower temp. by altering the other experimental conditions. It is concluded that carbon monoxide is the only oxidation product of carbon at 1000°, and that producer gas should be prepared at this temp. By substituting carbon dioxide for air, it was proved that this gas is never entirely reduced to carbon monoxide by the hot fuel, so that, where the production

of carbon monoxide is preceded by that of carbon dioxide, some of this gas must appear among the products of combustion; it may be concluded, therefore, that the carbon burns directly to carbon monoxide at the high temp. O. Manville showed that the formation of carbon monoxide and dioxide by the direct action of oxygen on carbon depends on the nature of the carbon; on its physical and chemical state, the velocity of the current of oxygen, and on the time. When carbon has been heated in vacuo, and cooled slowly, and the operation repeated many times, the temp. at which it unites to form the oxides are higher than the initial values. This effect may partially be due to the gradual removal of hydrocarbons.

It was assumed that the first product of the reaction is carbon dioxide, $C+O_2=CO_2$; and that in a secondary reaction, the carbon dioxide is reduced to the monoxide, $CO_2+C=2CO$. This view is adopted by D. I. Mendeléeff, F. Haber, and others. J. Lang also inferred that carbon dioxide is the first product of the reaction, because when oxygen was passed over gas carbon contained in a glass tube heated to 500° , it was found that the carbon dioxide was not reduced. The products of combustion varied with the speed of the passage of the oxygen, the carbon monoxide formed being less the slower the gas-stream, and disappearing altogether with very slow streams. Hence, argued J. Lang, the carbon monoxide found with quick streams was produced by the reduction of the carbon dioxide first formed, owing to local heating of the carbon. With very slow streams no local heating would occur, and therefore there was no reduction of carbon dioxide. H. B. Dixon claimed that these experiments merely show that carbon dioxide is the end-product of the reaction when oxygen is slowly passed over coke at 500° ; and they do not contradict the hypothesis that carbon monoxide is the first product of the oxidation of carbon.

A mixture of oxygen and carbon monoxide was passed at different speeds over carbon heated at 500° . With slow gas streams the whole of the oxygen was converted into carbon dioxide, and the carbon monoxide passed through the tube unchanged. With rapid streams more carbon monoxide was found in the products than was present in the original mixture, some of the carbon dioxide first formed being reduced by the carbon. J. Lang, therefore, concluded that, since the oxygen was converted into carbon dioxide under such conditions that the carbon monoxide present was not acted on, the carbon dioxide must have been formed without the intermediate formation of carbon monoxide. H. B. Dixon was unable to confirm J. Lang's experiments; and, indeed, obtained contradictory results.

In 1861, P. Tunner, and, in 1872, I. L. Bell argued that carbon monoxide, not carbon dioxide, is the first product of the combustion of carbon, so that the primary reaction is $2C+O_2=2CO$, and the secondary combustion of the monoxide furnishes carbon dioxide: $2CO+O_2=2CO_2$. It will be observed that the theory of probability and the simple kinetic hypothesis (2. 18, 4) make the reaction: $C+O_2=CO_2$ much more likely to occur than $2C+O_2=2CO$. H. B. Baker showed that when a stream of thoroughly dried oxygen is passed over charcoal at a red heat, no glowing occurs, but a little carbon dioxide and much carbon monoxide is formed, the oxygen in all cases being in excess. The drier the materials, the less the amount of carbon dioxide produced. On the other hand, when a mixture of carbon and platinum black was heated to redness in oxygen no glowing was observed, but a portion of the oxygen united with the carbon, forming carbon monoxide only. Since moisture and platinum both induce the union of carbon monoxide with oxygen, and in the absence of these substances carbon monoxide is the main product, the results "seem to point to the conclusion that carbon first burns to carbon monoxide." H. B. Baker also passed mixtures of oxygen and nitrogen, not specially dried, over purified carbon between 400° and 500° , and found that the proportion of carbon monoxide increased as the temp. was lowered, and as the proportion of oxygen in the mixture was diminished. Hence it was inferred that the carbon monoxide in these experiments could not be due

to the reduction of carbon dioxide because carbon monoxide is not reduced by charcoal at 500°. C. J. Baker found that dried carbon which had absorbed dried oxygen at 12°, yielded only traces of gas on raising the temp. until, at 450°, the gases evolved consisted almost exclusively of carbon monoxide. He therefore concluded that carbon is burned directly to carbon monoxide by adsorbed oxygen. H. Wieland confirmed H. B. Baker's observation that carbon burns slowly in dry oxygen at 730°. H. B. Dixon, and H. B. Baker found that purified charcoal does not reduce well-dried carbon dioxide at about 630°. All this favours the assumption that carbon burns to carbon monoxide, but, as H. B. Dixon stated, "a decisive proof is still required." It was not found possible to show that the rate of either $C+O_2=CO_2$, or $2C+O_2=2CO$, can proceed at temp. under which the rate of $CO_2+C=2CO$, is inappreciable.

H. B. Dixon's work on the burning of gaseous carbon compounds leaves little room for doubt that in burning gaseous carbon compounds, carbon monoxide is produced before carbon dioxide. For example, H. B. Dixon, E. H. Strange, and E. Graham showed that the velocity of the explosion-wave is higher when the gas is half-burnt to carbon monoxide than when there is enough oxygen present to burn it completely. Moreover, the substitution of inert nitrogen for the additional mol. volume of oxygen required for complete combustion produces less retardation. So far as the propagation of the explosion-wave is concerned, therefore, the second mol. of oxygen is inert. This is well shown by the following rates of explosion :

Mixture of gases . . .	$C_2N_2+O_2$	$C_2N_2+2O_2$	$C_2N_2+O_2+N_2$
Rate of explosion . . .	2728	2321	2398 metres per second

Further, the flame is not only propagated more quickly, but the press. is higher and the reaction completed sooner in the first than in the second case. The only conclusion to be drawn from these results is that the formation of carbon monoxide precedes that of carbon dioxide.

In every case where attempts have been made to find if carbon oxidized to carbon monoxide or dioxide, both gases occur among the products of the reaction. Hence, it is not at all unlikely that we are dealing with concurrent reactions, say :

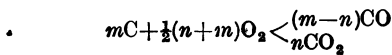

H. E. Armstrong suggested that carbon monoxide and dioxide are produced by the breaking down of a complex oxide of carbon; and T. F. E. Rhead and R. V. Wheeler developed the idea. At no temp. at which the rate of oxidation of carbon can be measured were they able to show that there is a primary formation of carbon dioxide or of carbon monoxide. Some carbon monoxide is produced during the oxidation of carbon at low temp. under conditions which do not admit of the reduction of carbon dioxide by carbon. On the other hand, carbon dioxide is undoubtedly produced at low temp. in quantities which cannot be accounted for by the supposition that carbon monoxide is first formed and then oxidized to carbon dioxide. Their measurements of the rates of the various reactions between oxygen, carbon monoxide, carbon dioxide, and carbon lead to the conclusion that in the burning of carbon, the two oxides are produced simultaneously. Neither of the oxides is the primary product of the oxidation in the sense that it takes precedence over the other. They assume that the oxygen is first fixed by the carbon so as to form what they call "a loosely formed physico-chemical complex" to which no definite mol. formula can be assigned but, they say, which can be regarded as an unstable complex C_xO_y , where the symbol has a different meaning to that usually employed in chemistry. H. H. Lowry and G. A. Hulett support this hypothesis. During combustion, each oxygen mol. which comes into collision with the carbon becomes fixed in so far as it is rendered incapable of further progress by the attraction of several carbon mols. They added :

A considerable evolution of heat takes place during this attachment of oxygen mols., so much so that some of them eventually acquire sufficient energy to seize hold of a carbon atom and depart with it as carbon dioxide. Some of them become torn apart in the process—become atomized—and leave the carbon mol. as carbon monoxide. This formation of a complex, and partial decomposition as fresh oxygen mols. become attached, goes on until the carbon becomes "saturated," the products of combustion during this period (a comparatively short one) being C_xO_y , CO_2 , and CO . After the carbon has become sat. there is an alternate formation and decomposition of the complex. Each oxygen mol. that impinges on the carbon is at once seized hold of to form the complex, but the energy set free when this occurs decomposes an eq. proportion of the complex formed from previous oxygen mols. So that, finally, when air is passed over sat. carbon maintained at a constant temp. by the application of an external source of heat, carbon dioxide and carbon monoxide appear in the products of combustion in volume sufficient to account for the total volume of oxygen in the air originally passed. In the normal burning of carbon, therefore, the carbon dioxide and carbon monoxide found as the apparently primary products of combustion, arise from the decomposition, at the temp. of combustion, of a complex the formation of which is the first result of the encounters between oxygen and carbon mols.

The reaction: $2C + O_2 = 2CO$.—The rate of the reaction: $2C + O_2 = 2CO$ has not been investigated. F. Pollitzer calculated for this reaction, $K = C_{O_2}/C_{CO}^2$; and $\log K = -13148T^{-1} - 1.75 \log T + 0.000634T - 4.2$. The free energy of the reaction $F = 60100 + 8T \log T + 20.4T - 0.0029T^2$; the thermal value of the reaction $Q = 60100 - 3.5T + 0.0029T^2$. Hence, at the absolute temp.

	0°	300°	1000°	2000°
F	60,100	71,800	101,600	141,300
Q	60,100	59,300	59,500	64,700

The reaction: $C + O_2 = CO_2$.—P. Farup determined the rate of the reaction: $C + O_2 = CO_2$ between oxygen and graphite or arc-lamp carbon, at 455°, 485°, and 515°; and between air and graphite at 485° and 515°. If x denotes the per cent. by vol. of carbon dioxide formed in the time t , the rate of formation of carbon dioxide is assumed to be:

$$\frac{dx}{dt} = k(a-x); \text{ or } k = \frac{1}{t} \log \frac{a}{a-x}$$

where k is the velocity constant and a is the initial volume of oxygen.

	455°		485°			515°		
x	2.39	1.62	7.46	5.40	3.73	20.17	11.58	7.67
k	0.11	0.10	0.32	0.33	0.38	1.21	1.16	1.24

Similarly experiments with air gave $k = 1.605$ at 515°, and 0.485 at 485°. For oxygen, at a temp. θ , $\log k = a + b\theta$, and between 455° and 515°, the ratio $k_{\theta+10}/k_{\theta}$ is 1.50; and for air between 485° and 515°, 1.52. T. F. E. Rhead and R. V. Wheeler also made measurements of the rate of oxidation of wood charcoal at 350°, 400°, and 500°. A rise of temp. of 150° from 350° to 500° increases the rate of the reaction five- or six-fold. They noted at 350° and 400° respectively 0.20 and 0.60 per cent. of carbon monoxide; and at 500°,

Time, t min.	0	30	45	60	120
Total press., P mm.	465.2	435.0	424.3	418.3	408.4
Partial press., p_{CO} mm.	—	37.4	38.6	41.0	36.7
Partial press., p_{O_2} mm.	96.4	18.7	8.9	3.3	—
k	—	0.0237	0.0230	0.0244	—

At the end of 30 min., at 500°, the gases contained 8.6 per cent. of carbon monoxide. They found similar rates with air and oxygen, and since the reduction of carbon dioxide by carbon at these low temp. is inappreciable, they concluded that no amount of local heating of the carbon can explain the formation of this carbon monoxide.

For the equilibrium constant $K = C_{O_2}/C_{CO_2}$, F. Pollitzer gave $\log K = -21350T^{-1} - 0.4$, so that for $T = 1273$, $\log K = -17.1$, the observed value is

—16·27. W. Nernst calculated the free energy of this reaction to be $97700 + 1·828T - 0·00007T^2$, from which he inferred that the reversible combustion of a gram-atom of carbon by oxygen to carbon dioxide at atm. press. is 98,240 cal. at $T=300^\circ$; and since the thermal value of the reaction at room temp. is 97,650 cal., it follows that *the heat of combustion of carbon at atmospheric temperatures is almost completely convertible into external work.*

The reaction : $\text{CO}_2 + \text{C} = 2\text{CO}$.—The reversibility of the reaction $\text{CO}_2 + \text{C} \rightleftharpoons 2\text{CO}$ was discovered by H. St. C. Deville ⁴ with his *le tube chaud et froid*, for it was known that heated carbon reduces carbon dioxide to the monoxide, and he observed that when carbon monoxide is heated to a temp. rather lower than the m.p. of silver, a little carbon dioxide is formed, but above 1000° none could be detected. This is in accord with general principles (2. 18, 4), for the reaction $2\text{CO} = \text{CO}_2 + \text{C}$ is exothermic evolving 39 Cals., hence, the quantity of carbon monoxide is increased by raising the temp. I. L. Bell noted that the decomposition is accelerated by finely divided metals—nickel, cobalt, iron, etc. R. Schenck and co-workers also found that the reaction is greatly accelerated by finely divided iron, nickel, or cobalt, but not by the oxides of these metals. With nickel and cobalt the reaction at 445° behaves as if it were bimolecular : $2\text{CO} = \text{C} + \text{CO}_2$, and between 256° and 445° , monomolecular : $\text{CO} = \text{C} + \text{O}$ followed by $\text{CO} + \text{O} = \text{CO}_2$. P. Sabatier and J. B. Senderens explain the catalysis by assuming the cyclic reactions $\text{M} + \text{CO} = \text{MO} + \text{C}$, and $\text{MO} + \text{CO} = \text{M} + \text{CO}_2$. These reactions have also been studied by F. Zimmermann, A. Smits, M. Bodenstein and C. G. Fink, L. Gruner, E. Berger and L. Delmas, etc. H. A. Neville and H. S. Taylor found that the reaction between carbon and carbon dioxide is accelerated by the presence of alkali carbonates, alkaline earths, carbonates, sodium chloride or silicate, borax, nickel, or copper. Potassium carbonate is the most active salt catalyst. Reduced nickel promotes the reaction. It is assumed that the adsorption of carbon dioxide by carbon is augmented at 445° by these accelerating agents which alone show no absorptive capacity for the gas. R. T. Haslam and co-workers say that the reaction between carbon and carbon monoxide is unimolecular, and takes place at the surface of the carbon—*vide* carbon monoxide.

O. Boudouard studied the equilibrium conditions from right to left at 650° , 800° , and 925° . He used iron, nickel, and cobalt as catalytic agents; and from left to right without catalysts. The importance of the reaction in producer-gas practice has attracted other workers—M. Mayer and J. Jacoby, K. Arndt and G. Schraube, T. F. E. Rhead and R. V. Wheeler, J. K. Clement, etc. R. Schenck and F. Zimmermann found that it is not the metal oxides, but rather the reduced metals which act catalytically. This does not agree with O. Boudouard's conclusion. R. Schenck and F. Zimmermann's results at low temp. do not agree with those of O. Boudouard; the latter said that the dissociation of carbon monoxide is complete at 445° , while the former obtained 52·8 per cent. as the equilibrium value. There is a difference in the value of the constant $K = C_{\text{CO}_2}/C_{\text{CO}}^2$ obtained with different kinds of carbon; and R. Schenck and W. Heller obtained 1 : 5 : 5·5 for the values of K with graphite, carbon from carbon monoxide, and wood or sugar charcoal. The difference is a consequence of the law of mass action, for if p denotes the vap. press. of carbon, K is really equal to $K'p$, where K' is a constant; and since the vap. press. of carbon varies from one modification to another $K'p$ will be constant for any particular modification of carbon used. For equilibrium, the results indicated in Table XIII have been observed. F. Pollitzer found that at a constant press., $K = C_{\text{CO}_2}/C_{\text{CO}}^2$, and $\log K_p = 8200T^{-1} - 1·75 \log T + 0·0006T - 3·8$. K. Jellinek and A. Diethelm gave $\log K_p = 8300T^{-1} - 1·78 \log T + 0·000686T - 3·876$. Their data are indicated in Table XIII.

T. F. E. Rhead and R. V. Wheeler found that the effect of temp. and press. on the equilibrium can be represented by H. le Chatelier's formula :

$$500 \int Q \frac{dT}{T} + (N_2 - N_1) \log_e p + \log \frac{C_1^{1} C_1^{n_1} \dots}{C_2^{n_2} C_2^{n_2} \dots}$$

where Q denotes the total heat of the reaction at $T^\circ \text{K.}$; p , the press. in atm.; N_1 and N_2 the numbers of mols. on the left and right sides of the equation respectively—the subscripts 1 and 2 respectively refer to the initial systems; n_1, n'_1, \dots and n_2, n'_2, \dots represent the number of molecules of the different substances taking part in the reaction; and C_1, C'_1, \dots and C_2, C'_2, \dots denote the conc. of the different substances concerned in the reaction. For the system $2\text{CO} \rightleftharpoons \text{CO}_2 + \text{C}$; when $p=1$, with the system in equilibrium, $(N_2 - N_1) \log_e p = 0$; and if $Q=39$ Cals., the equation becomes $19500T^{-1} + \log_e (C'_1/C_2) = k$. For variable press., assuming that the heat of the reaction is $Q=38055 + 2.02T - 0.0031T^2$, the equation becomes $\frac{1}{2}QT^{-1} + \log_e p + \log_e (C'_1/C_2) = k$.

TABLE XII.—PROPORTIONS OF CARBON MONOXIDE IN EQUILIBRIUM WITH CARBON DIOXIDE IN THE PRESENCE OF CARBON AT DIFFERENT TEMPERATURES AND ATMOSPHERIC PRESSURE.

Temp.	O. Boudouard.	M. Mayer and J. Jacoby.	G. Schraube.	T. F. E. Rhead and R. V. Wheeler.
700°	58.67	60.11	63.44	—
750°	75.94	75.94	78.60	—
800°	87.65	86.90	88.59	—
850°	94.05	93.21	94.16	93.77
900°	97.10	96.40	96.95	97.78
950°	98.77	98.12	98.15	98.68
1000°	99.00	98.97	99.00	99.41
1050°	—	—	—	99.63
1100°	—	—	—	99.85
1200°	—	—	—	99.94

TABLE XIII.—ISOTHERMS AND ISOBARS OF THE EQUILIBRIUM CONDITIONS IN THE REACTION $\text{C} + \text{CO}_2 = 2\text{CO}$.

Temp.	log K_p .	Per cent. CO_2 by volume.			
		1 atm.	50 atm.	100 atm.	200 atm.
500	22.503×10^{-3}	92.79	99.00	100.00	100.00
550	15.842×10^{-3}	85.11	97.62	98.63	98.98
600	9.955×10^{-3}	72.88	95.63	96.89	97.79
650	4.717×10^{-3}	56.38	92.08	94.27	96.08
700	3.0003×10^{-3}	38.17	87.50	90.23	93.18
750	2.5770×10^{-3}	22.62	79.48	85.01	98.13
800	2.2020×10^{-3}	12.26	70.29	77.88	83.77
850	1.8570×10^{-3}	6.3	59.38	69.03	76.88
900	1.5420×10^{-3}	3.2	47.68	58.89	68.62
950	1.2550×10^{-3}	1.5	36.48	48.22	59.30
1000	0.9410×10^{-3}	0.7	24.70	35.88	47.72
1050	0.7470×10^{-3}	0.4	17.78	28.53	40.06
1100	0.5260×10^{-3}	0.1	12.00	24.09	32.47

The reaction: $2\text{CO} + \text{O}_2 \rightleftharpoons 2\text{CO}_2$.—H. St. C. Deville⁵ investigated this reaction in the vicinity of 1200° in his *le tube chaud et froid*. The subject was investigated by R. Bunsen, J. M. Crafts, E. Mallard and H. le Chatelier, O. Hahn, C. Langer and V. Meyer, H. B. Dixon and H. F. Lowe, A. Jaquero and F. L. Perrot, M. Berthelot etc. F. Haber and A. Moser investigated the reaction at 445° and 518° by measuring the e.m.f. of a gas cell with a solid electrolyte. H. le Chatelier and E. Mallard, and N. Bjerrum employed the explosion method. I. Langmuir used heated wires; L. Löwenstein, W. Nernst, and F. Emich used the vapour density method. F. Pollitzer computed that the heat of the reaction $Q=135210 + 3.5T - 0.0027T^2$; and $\log K = -29600T^{-1} + 1.75 \log T - 0.00058T + 3.4$. If p be the partial pressures of the components; P , the total press.; and x , the degree of dissociation of the car-

bon dioxide, then, as in the case of water, $K = p^2 \text{CO}_2 / p_{\text{CO}_2}$; or $K = x^2 / (1-x)^2$; and when $P=1$, x is very small, so that $K = \frac{1}{2}x^2$, or $\log K = 3 \log x - \log 2$; hence, $3 \log x = -29600T^{-1} + 1.75 \log T - 0.00058T + 3.4$. Hence, given either x or T , the other can be calculated. W. Nernst and H. von Wartenberg found for $x=0.00419$ per cent., T obs. = 1300° , calc. 1375° ; and for $x=0.029$ per cent., T obs. = 1478° , and calc. 1560° . For the percentage degrees of dissociation of carbon dioxide at different press. and temp., *vide* Table XIV. J. E. Trevor and F. L. Kortright calculated

TABLE XIV.—PERCENTAGE DEGREES OF DISSOCIATION OF CARBON DIOXIDE AT DIFFERENT TEMPERATURES AND PRESSURES.

Temp. T° K.	P=10 atm.	P=1 atm.	P=0.1 atm.	P=0.01 atm.
1000°	7.31×10^{-6}	1.58×10^{-5}	3.40×10^{-5}	7.31×10^{-5}
1500°	1.88×10^{-2}	4.06×10^{-2}	8.72×10^{-2}	0.188
2000°	0.818	1.77	3.731	7.88
2500°	7.08	15.8	30.7	53

the percentage dissociations and heats of dissociation, Q , indicated in Table XV. M. Pier found that the calculated values for the dissociation of carbon dioxide are higher than the observed, and this is taken to mean that the sp. ht. of the gas increases more rapidly above 2000° than is allowed for in the calculation. N. Bjerrum found for the dissociation at the absolute temp. T ,

T	1500°	2640°	2879°	2945°	3116° K.
Dissociation	0.04	21.0	51.7	64.7	76.1 per cent.

TABLE XV.—PERCENTAGE DISSOCIATION OF CARBON DIOXIDE AT DIFFERENT TEMPERATURES AND PRESSURES.

Pressures in atmospheres.

°	0.001	0.01	0.1	1	10	100	Q cal.
1000	0.11	0.05	0.024	0.011	0.005	0.0024	-62,662
1500	9.5	4.6	2.2	1.0	0.5	0.2	-56,125
2000	57.7	34.7	18.3	9.0	4.3	2.0	-46,767
2500	87.0	69.6	46.0	25.7	13.0	6.3	-34,640
3000	93.9	83.4	62.7	[40.0]	21.6	10.8	-19,742
3500	95.4	87.0	69.7	46.1	25.7	13.0	0
4000	95.1	86.4	66.6	45.0	24.9	12.6	+18,343

REFERENCES.

¹ H. Moissan, *Compt. Rend.*, **116**, 460, 1893; **119**, 976, 1245, 1894; **135**, 921, 1902; *Le four électrique*, Paris, 1897; London, 1904; *Bull. Soc. Chim.*, (3), **29**, 101, 1903; *Ann. Chim. Phys.*, (7), **8**, 289, 1896; M. Aubert, *ib.*, (2), **45**, 73, 1830; E. H. von Baumhauer, *Arch. Néerl.*, (1), **8**, 1, 1873; G. Rose, *Sitzber. Akad. Berlin*, 516, 1872; K. Karsten, *ib.*, **38**, 1860; *Pogg. Ann.*, **109**, 346, 1860; R. Bindow, *Ber.*, **9**, 19, 1876; H. Valerius, *Bull. Acad. Belg.*, (2), **33**, 12, 1874; E. Terres, *Journ. Gasbeleucht.*, **63**, 785, 805, 820, 836, 1920; H. N. Warren, *Chem. News*, **69**, 291, 1894; J. Dewar, *Proc. Roy. Inst.*, **18**, 134, 1905; *Proc. Roy. Soc.*, **74**, 126, 1904; W. Skey, *Chem. News*, **15**, 15, 27, 1867; G. Craig, *ib.*, **90**, 109, 1904; F. H. Storey and D. S. Lewis, *Amer. Chem. Journ.*, **4**, 409, 1883; E. Blumtritt, *Journ. prakt. Chem.*, (1), **98**, 418, 1886; F. C. Calvert, *Journ. Chem. Soc.*, **20**, 293, 1867; C. J. Baker, *ib.*, **51**, 249, 1887; H. Kayser, *Wied. Ann.*, **12**, 526, 1884; R. A. Smith, *Proc. Roy. Soc.*, **12**, 424, 1863; J. Böhm, *Bot. Zeit.*, **32**, 1883; W. G. Mixer, *Amer. Journ. Science*, (3), **45**, 363, 1893; A. P. N. Franchimont, *Rec. Trav. Chim. Pays-Bas*, **1**, 275, 1882; E. Prime, *Amer. Chemist*, **3**, 64, 1872; C. J. Woodward, *ib.*, **2**, 454, 1872; *Chem. News*, **25**, 127, 1872; A. W. Hofmann, *Ber.*, **15**, 2656, 1882; B. Lepsius, *ib.*, **23**, 1639, 1890; J. Volhard, *Liebig's Ann.*, **284**, 345, 1895; H. H. Lowry and G. A. Hulett, *Journ. Amer. Chem. Soc.*, **42**, 1408, 1920; H. H. Lowry and S. O. Morgan, *ib.*, **46**, 846, 1924; O. Meyerhof and H. Weber, *Biochem. Zeit.*, **135**, 558, 1923.

² P. Degener and J. Lach, *Dingler's Journ.*, **256**, 519, 1885; J. Lang, *Journ. Gasbeleucht.*, **31**, 932, 967, 1888; *Zeit. phys. Chem.*, **2**, 161, 1888; A. P. Dubrunfaut, *Compt. Rend.*, **73**, 1395, 1871; C. S. M. Pouillet, *Ann. Chim. Phys.*, (2), **20**, 141, 1822; W. Skey, *Chem. News*, **30**, 290, 1874; C. J. Baker, *Journ. Chem. Soc.*, **51**, 249, 1887; *Proc. Roy. Soc.*, **45**, 1, 1889; H. Wieland, *Ber.*, **45**, 2606, 1912; B. Lepsius, *ib.*, **23**, 1639, 1890; A. Naumann and F. G. Mudford, *ib.*, **30**, 347, 1897; *Zeit. angew. Chem.*, **10**, 197, 1897; *Die Heizungsfrage mit besonderer Rücksicht auf Wassergaserzeugung und Wassergasheizung*, Giessen, 1881; A. Scholtz, *Chem. Ztg.*, **46**, 652, 1922; C. J. Baker, *Journ. Chem. Soc.*, **51**, 249, 1887; Mrs. Fulhame, *An Essay on Combustion with a view to a new Art in Dying and Painting*, London, 1794; H. A. Neville and H. S. Taylor, *Science*, (2), **53**, 577, 1921; R. T. Haslam, F. L. Hitchcock, and E. W. Rudow, *Journ. Ind. Eng. Chem.*, **15**, 115, 1923; J. Growsdz, *ib.*, **14**, 69, 1922; O. Meyerhof and H. Weber, *Biochem. Zeit.*, **135**, 558, 1923; F. Clément and J. B. Désormes, *Ann. Chim. Phys.*, (1), **38**, 285, 1801; *Gilbert's Ann.*, **9**, 423, 1801; J. B. A. Dumas, *Compt. Rend.*, **74**, 137, 1872; H. B. Baker, *Phil. Trans.*, **179**, A, 571, 1888; *Journ. Chem. Soc.*, **47**, 349, 1885; R. H. Bremridge, *Pharm. Journ.*, (3), **19**, 958, 1889; K. Broockmann, *Journ. Gasbeleucht.*, **31**, 189, 1888; W. G. Mixter, *Amer. Journ. Science*, (3), **45**, 363; 1893; E. H. von Baumhauer, *Arch. Néerl.*, (1), **8**, 1, 1873; J. C. Poggen-dorff, *Pogg. Ann.*, **54**, 358, 1841; R. Bunsen, *ib.*, **46**, 207, 1839; *Liebig's Ann.*, **85**, 137, 1853; J. H. Long, *ib.*, **192**, 288, 1878; *Ber.*, **11**, 1464, 1878; P. Farup, *Zeit. anorg. Chem.*, **50**, 276, 1906; C. Sandonini, *Gazz. Chim. Ital.*, **52**, i, 394, 1922; **53**, ii, 453, 1923.

³ L. C. A. Barreswill, *Journ. Pharm. Chim.*, (3), **25**, 172, 1854; A. Ledebur, *Stahl Eisen*, **2**, 360, 1882; *Deut. Ing. Ztg.*, 498, 1882; J. Lang, *Journ. Gasbeleucht.*, **31**, 932, 967, 1889; *Zeit. phys. Chem.*, **2**, 161, 1888; P. Tunner, *Rev. Univ.*, **7**, 432, 1860; P. Farup, *Zeit. anorg. Chem.*, **50**, 276, 1906; A. Naumann, *Zeit. angew. Chem.*, **10**, 200, 1896; R. Ernst, *Experimentelle Beiträge zur Kenntnis der Vorgänge bei der Verbrennung von Kohle in Luft*, Giessen, 1892; *Journ. prakt. Chem.*, (2), **48**, **31**, 1891; O. Manville, *Compt. Rend.*, **142**, 1190, 1523, 1906; *Journ. Chim. Phys.*, **5**, 297, 1907; O. Boudouard, *Ann. Chim. Phys.*, (7), **24**, **5**, 1901; H. H. Lowry and G. A. Hulet, *Journ. Amer. Chem. Soc.*, **42**, 1408, 1920; H. B. Baker and H. B. Dixon, *Proc. Roy. Soc.*, **45**, **1**, 1888; H. B. Dixon, *Journ. Chem. Soc.*, **75**, 630, 1899; H. B. Dixon, E. H. Strange, and E. Graham, *ib.*, **59**, 759, 1896; T. F. E. Rhead and R. V. Wheeler, *ib.*, **97**, 2178, 1910; **99**, 1141, 1911; **101**, 831, 846, 1912; **103**, 461, 1913; I. L. Bell, *ib.*, **22**, 203, 1869; *Chemical Phenomena of Iron Smelting*, London, 4, 1872; H. St. C. Deville, *Compt. Rend.*, **59**, 873, 1864; **60**, 317, 1865; F. Haber, *Thermodynamik technischer Gasreaktionen*, München, 1905; London, 255, 1908; D. I. Mendelëef, *Principles of Chemistry*, London, **1**, 388, 1891; J. W. Mellor, *Modern Inorganic Chemistry*, London, **713**, 1912; W. Nernst, *Theoretische Chemie*, Stuttgart, 698, 1912; London, 746, 1916; F. Pollitzer, *Die Berechnung chemischer Affinitäten nach dem Nernstschen Wärmetheorem*, Stuttgart, 130, 1912; H. E. Armstrong, *Journ. Soc. Chem. Ind.*, **24**, 475, 1905; F. C. G. Müller, *Zeit. phys. Chem. Unterricht*, **36**, 260, 1923; H. B. Baker, *Phil. Trans.*, **179**, A, 571, 1888; *Journ. Chem. Soc.*, **47**, 349, 1885; C. J. Baker, *ib.*, **51**, 249, 1887; W. Hempel, *Ber.*, **23**, 1485, 1890; *Zeit. angew. Chem.*, **8**, 729, 1895; H. Wieland, *Ber.*, **45**, 679, 1912.

⁴ H. St. C. Deville, *Compt. Rend.*, **59**, 873, 1864; **60**, 317, 1865; M. Bodenstein and C. G. Fink, *Zeit. phys. Chem.*, **60**, 46, 1907; H. von Juptner, *ib.*, **100**, 231, 1922; A. Smits and L. K. Wolf, *ib.*, **55**, 199, 1903; A. Smits, *Ber.*, **38**, 4027, 1905; R. Schenck and W. Heller, *ib.*, **38**, 2139, 1905; R. Schenck and G. Zimmermann, *ib.*, **36**, 1232, 1903; R. Schenck, *ib.*, **36**, 3663, 1903; F. Zimmermann, *Stahl Eisen*, **25**, 758, 1906; O. Boudouard, *Ann. Chim. Phys.*, (7), **24**, **1**, 1901; *Bull. Soc. Chim.*, (3), **25**, 282, 484, 1901; *Compt. Rend.*, **128**, 98, 307, 824, 1522, 1524, 1899; **130**, 132, 1900; **131**, 1204, 1900; H. L. Gruner, *ib.*, **73**, 28, 1871; E. Berger and L. Delmas, *Bull. Soc. Chim.*, (4), **29**, 68, 1921; H. A. Neville and H. S. Taylor, *Journ. Amer. Chem. Soc.*, **43**, 2055, 1921; *Science*, (2), **53**, 577, 1921; R. T. Haslam, F. L. Hitchcock, and E. W. Rudow, *Journ. Ind. Eng. Chem.*, **15**, 115, 1923; P. Sabatier and J. B. Senderens, *Bull. Soc. Chim.*, (3), **29**, 294, 1903; M. Mayer and J. Jacoby, *Journ. Gasbeleucht.*, **52**, 282, 1909; M. Mayer, *Ueber einige Gasreaktionen, Methanbildung und Kohlenoxyd-Kohlensäuregleichgewicht*, Karlsruhe, 1908; G. Schraube, *Ueber das Gleichgewicht des Generator-gases*, Berlin, 1911; T. F. E. Rhead and R. V. Wheeler, *Journ. Chem. Soc.*, **97**, 2178, 1910; **99**, 1140, 1911; I. L. Bell, *ib.*, **22**, 203, 1869; J. K. Clement, *Bull. Univ. Illinois*, **30**, 1909; K. Arndt and G. Schraube, *Nernst's Festschrift*, 46, 1912; F. Pollitzer, *Die Berechnung chemischer Affinitäten nach dem Nernstschen Wärmetheorem*, Stuttgart, 79, 1912; H. le Chatelier, *Recherches expérimentales et théoriques sur les équilibres chimiques*, Paris, 1888; *Ann. Mines*, (8), **13**, 157, 1888; P. Farup, *Zeit. anorg. Chem.*, **50**, 276, 1906; K. Jelinek and A. Diethelm, *ib.*, **124**, 203, 1922.

⁵ H. St. C. Deville, *Compt. Rend.*, **56**, 195, 729, 1863; **59**, 873, 1864; *Bull. Soc. Chim.*, (1), **5**, 120, 443, 1863; (2), **3**, 8, 366, 1865; (2), **5**, 104, 1866; F. Haber, *Thermodynamik technischer Gasreaktionen*, München, 139, 1905; London, 315, 1908; F. Haber and A. Moser, *Zeit. Elektrochem.*, **11**, 593, 1905; M. Pier, *ib.*, **16**, 897, 1910; W. Nernst, *ib.*, **9**, 625, 1903; A. Schelest, *Dissociation der Gase*, Kniga, 25, 1922; W. Nernst and H. von Wartenberg, *Gött. Nachr.*, **1**, 1905; *Zeit. phys. Chem.*, **56**, 548, 1906; H. von Wartenberg, *ib.*, **56**, 526, 1906; F. Haber and R. le Rössignol, *ib.*, **66**, 181, 1909; O. Hahn, *ib.*, **44**, 646, 1903; N. Bjerrum, *ib.*, **79**, 537, 1912; I. Langmuir, *Journ. Amer. Chem. Soc.*, **28**, 1357, 1906; L. Löwenstein, *Beiträge zur Messung von Dissociationen bei hohen Temperaturen*, Göttingen, 1905; *Zeit. phys. Chem.*, **54**, 707, 1905; H. le Chatelier, *ib.*, **2**, 782, 1888; *Compt. Rend.*, **93**, 1014, 1881; **104**, 1789, 1887; *Ann. Mines*, (8), **4**, 524, 1883; H. le Chatelier and E. Mallard, *ib.*, (8), **13**, 274, 1888; F. Emich, *Monatsh.*, **26**, 505, 1101, 1905; F. Pollitzer, *Die Berechnung chemischer Affinitäten nach dem Nernstschen*

Wärmetheorem, Stuttgart, 80, 1912; R. Bunsen, *Pogg. Ann.*, **131**, 161, 1867; E. Mallard and H. le Chatelier, *Compt. Rend.*, **93**, 1014, 1881; M. Berthelot, *ib.*, **140**, 905, 1905; A. Jaquero and F. L. Perrot, *ib.*, **140**, 1542, 1905; J. M. Crafts, *ib.*, **90**, 309, 1880; *Amer. Chem. Journ.*, **2**: 98, 1880; J. E. Trevor and F. L. Kortright, *ib.*, **16**, 611, 1895; H. B. Dixon and H. F. Lowe, *Journ. Chem. Soc.*, **47**, 571, 1885; *Chem. News*, **51**, 309, 1885; C. Langer and V. Meyer, *Pyrochemische Untersuchungen*, Braunschweig, 1885.

§ 11. The Chemical Properties of Carbon

Carbon, like nitrogen, is chemically inert at ordinary temp., but at high temp. it becomes one of the most active elements; for instance, it will displace oxygen from its combinations with various metals. With the exception of fluorine, and possibly under special conditions, oxygen, J. Thomsen¹ was right in saying that carbon does not unite with other elements at ordinary temp. When compounds are formed at higher temp., the products are usually very stable, and do not readily react or unite with other compounds. As R. Schenck and W. Peller showed, amorphous carbon in general is a more energetic reducing agent than graphite. He also inferred from the vap. press. that the diamond is more reactive than graphite, but the inference is open to doubt, for H. Moissan showed that the higher the temp. of formation, the less reactive is the product. R. Schenck and W. Heller added that for any given temp. in a blast-furnace worked with wood-charcoal the composition of the gaseous mixture will be different (richer in carbon monoxide) from the gaseous mixture of a furnace worked with coke (which is allied to graphite). H. N. Warren said that the reactivity of graphite obtained from a soln. of carbon in the metals varies with the nature of the metal from which it has been formed. Thus, that from chromium is less reactive than that from iron, nickel, or cobalt.

A. Morren² could not detect the slightest change in weight by heating a diamond white hot in an atm. of hydrogen. E. H. von Baumhauer noted a change in colour with green and brown diamonds, but the colour of other varieties and the translucency were not affected. H. Moissan also observed no change in weight when Cape diamonds were heated to 1200° in hydrogen. In a paper: *Formation par synthèse, au moyen de la pile, d'un carbure d'hydrogen*, C. Morren observed that hydrogen can be made to unite directly with carbon. M. Berthelot added that the union does not occur if the sparks are derived from an induction coil, but acetylene is formed with an electric arc in hydrogen. He also stated that no appreciable combination occurred when carbon is heated in hydrogen up to the temp. at which porcelain softens. He also noted the reverse action in that acetylene, methane, and naphthalene were decomposed into carbon and hydrogen when heated to 1400° in quartz tubes. W. A. Bone and J. C. Cain heated sugar charcoal in hydrogen at a white heat and obtained methane. W. A. Bone and D. S. Jerdan observed the formation of no acetylene or other unsaturated hydrocarbon, but found that at 1200° between one and two per cent. of methane is produced. Larger results showed that the gases are generated in definite proportions until equilibrium is attained when the hydrogen contains 7 to 8 per cent. of acetylene, 1.25 per cent. of methane, and 0.75 per cent. of ethane. J. N. Pring and R. S. Hutton found that at 1700°, traces of acetylene are formed and the proportion of that gas increases as the temp. rises to 2800°. The amount of methane upwards of 1000° is very small, and appears to be smaller the higher the degree of purity of the carbon. A part of the gas is decomposed by the hot walls of the tube. J. N. Pring said that above 1100° carbon unites directly with hydrogen, but the velocity of the reaction at 1200° is very slow; about 0.35 per cent. is formed in 22 hrs.; and at 1500°, 0.17 per cent. was formed in 2 hrs. The reaction is accelerated by platinum, so that at 1200°, 0.55 per cent. was formed, and at 1500°, 30 per cent., and W. A. Bone and H. F. Coward found that at 1150° a mixture of 0.03 grm. of carbon with platinum gave a 95 per

cent. conversion into methane in 17 to 20 hrs. J. Sand and co-workers, and H. von Wartenberg have studied the statics and dynamics of these reactions.

According to W. A. Bone and D. S. Jerdan, when, by means of an alternating current at 160 volts, sparks are passed between carbon electrodes in hydrogen, for half an hour, a mixture of hydrogen with 1.51 per cent. hydrogen cyanide, 9.85 per cent. of acetylene and ethylene, and 2.46 per cent. of methane was obtained; and with the press. at 40 to 60 volts, the hydrogen contained 1.00 per cent. hydrogen cyanide; 8.08 per cent. acetylene and ethylene, and 1.62 per cent. of methane. The formation of hydrogen cyanide was attributed to the presence of a little nitrogen in the hydrogen. The rate of formation of the hydrocarbons is at first very great, and equilibrium is attained in about an hour.

The equilibrium conditions of the exothermal reaction $C+2H_2 \rightleftharpoons CH_4$ were studied by M. Mayer, V. Altmayer, J. N. Pring, and D. M. Fairlie. M. Mayer and V. Altmayer worked between 475° and 625°, using nickel as catalyst. They found at one atm. press.:

	475°	500°	550°	600°	625°
Vol. per cent. CH ₄	69.86	62.53	46.69	31.68	24.75

J. N. Pring and D. M. Fairlie worked between 1000° and 1700° at press. between 7 and 200 atm. The condition of equilibrium is $[CH_4] = K[H_2]^2$, and they found at

K	1200°	1275°	1300°	1450°	1500°	1575°
	0.00244	0.00140	0.00136	0.00091	0.00078	0.00062

H. von Wartenberg gave generally for the hydrocarbon reaction $mC + \frac{1}{2}nH_2 = C_mH_n + Q$ calcs., where $[C_mH_n] = K[H_2]^{1/2n}$; and $\log K = QT^{-1} - (\frac{1}{2}N-1)1.75 \log T - (0.8n-3)$. From the heat of formation of methane $Q=18,900$, $\log K=9.3$; for ethylene, $Q=23,000$, and $\log K=6.5$; and for butylene, $Q=35,000$, and $\log K=3.2$. For the reaction $2C + H_2 \rightleftharpoons C_2H_2$, $\log K = -8750T^{-1} + 1.6$. At $T=2000^\circ$, $\log K=2.8$. This corresponds with about 0.1 vol. per cent. of acetylene in the hydrogen at one atm. press.

M. Mayer and V. Altmayer found that carbon is rapidly hydrogenized to methane when treated with **calcium hydride**. The action of **oxygen** and of **water** on carbon has been discussed in a preceding section. B. L. Vanzetti showed that the so-called *carbon hydrate* obtained from metal carbides by dissolving away the metal, is really carbon with adsorbed water. G. Lemoine³ and others have noticed that **hydrogen dioxide** (*q.v.*) at ordinary temp. is rapidly decomposed by wood charcoal; and J. B. Firth and F. S. Watson studied the effect of different kinds of carbon.

According to H. Moissan,⁴ **fluorine** and carbon combine with great energy even at the ordinary temp. Lampblack, purified and dried, immediately becomes incandescent; wood charcoal takes fire spontaneously, with the projection of brilliant sparks. Denser forms of carbon must be heated to 50° or 100° before they will become incandescent. Ferruginous graphite from cast iron unites with fluorine below a dull red heat; Ceylon graphite, purified by fusion with potash, requires to be heated to a somewhat higher temp.; gas carbon burns in fluorine only at a red heat; the diamond is not affected when heated to redness in a current of fluorine. The products are gaseous, and are usually mixtures of different carbon fluorides. The action of fluorine on an excess of one of the lighter forms of carbon, care being taken that the temp. does not rise very high, yields a colourless gas—carbon tetrafluoride, CF₄. The action of fluorine on carbon at a red heat yields a gaseous carbon fluoride which is not decomposed by electric sparks, is not absorbed by aq. or alcoholic potash, is almost insoluble in water, but dissolves in alcohol. A small quantity of a solid product is obtained at the same time. Both J. L. Gay Lussac and L. J. Thénard found that if charcoal be freed from hydrogen and moisture, by ignition in vacuo, it does not combine with **chlorine** even at a white heat. However, if an electric arc be formed between carbon rods in an atmosphere of carbon tetrafluoride, the latter is rapidly decomposed into its elements; if the arc be maintained

in an atmosphere of chlorine, crystals of hexachlorobenzene, C_6Cl_6 , are formed, showing that carbon can unite directly with chlorine. According to W. G. Mixer, hydraulically-compressed sugar charcoal containing 0.13 per cent. of hydrogen and 0.04 per cent. of ash absorbs 4 per cent. of chlorine at a red heat, and does not give it up in a vacuum at that temp. The chlorine cannot be displaced by nitrogen, but can be removed by hydrogen. At the ordinary temp., little or no chlorine is absorbed. Lampblack absorbs more chlorine, and both charcoal and lampblack lose it at the temp. at which porcelain softens. Chlorine seems to act with most energy on those forms of carbon which are contaminated with hydrogen. The form in which it is combined is uncertain; nothing is extracted from the product by chloroform, benzene, alcohol, or ether. H. Moissan said that dry chlorine does not act on the diamond at 1100° – 1200° , and some Cape diamonds changed neither in weight nor colour by the treatment. H. L. F. Melsens took advantage of the great adsorption of chlorine by charcoal to prepare liquid chlorine. The charcoal sat. with adsorbed chlorine is used like the chlorine hydrate in Faraday's experiment (2. 17, 10). W. G. Mixer noted that when charcoal, sat. with adsorbed chlorine, is burnt, a carbon chloride is formed. He found that when hydrogen is passed over purified wood charcoal sat. with chlorine, hydrogen chloride is formed and there is a reduction of temp. M. Berthelot and A. Guntz found the adsorption of 35.5 grms. of chlorine by purified charcoal develops 6.78 cals., a quantity double the heat of volatilization of liquid bromine and iodine, but much below the heat of formation of hydrogen chloride. In the formation of hydrogen chloride by passing hydrogen over charcoal sat. with chlorine, about seven times as large a vol. of chlorine is given off unchanged as the vol. of hydrogen chloride produced. R. Lorenz found that when a mixture of steam and chlorine is passed over charcoal at a dull red heat, hydrochloric acid is quantitatively formed, $H_2O + Cl_2 + C = 2HCl + CO$; but, according to A. Naumann and F. G. Mudford, this is not the primary reaction, for with an excess of steam, the reaction is probably $2H_2O + 2Cl_2 + C = 4HCl + CO_2$, and the carbon dioxide is subsequently reduced to carbon monoxide. C. Willgerodt said that charcoal does not act as a carrier of chlorine to benzene. M. Berthelot found that dry chlorine unites with carbon when an electric arc with carbon electrodes is formed in the gas; and W. von Bolton so produced ethane hexachloride, C_2Cl_6 , and hexachlorobenzene, C_6Cl_6 . W. G. Mixer said that sugar charcoal and lampblack adsorb less bromine than chlorine; and when heated in vacuo, 0.26 to 1.49 per cent. of bromine is retained by the charcoal. The direct union of bromine and carbon has not been recorded. W. G. Mixer found that sugar charcoal and lampblack adsorb iodine in the same way as is the case with bromine. H. Davy said that when the electric discharge from carbon electrodes is passed through iodine vapour no chemical change occurs. At first, white fumes appear, and this is attributed to the action of moisture or hydrogen adsorbed by the charcoal; for the fumes soon cease, and when the tube is cooled the iodine appears to be unaltered.

H. Moissan found that the diamond is not attacked by hydrofluoric acid at 1100° – 1200° . According to A. Bartoli and G. Pappasogli, when wood charcoal or gas-retort carbon, after purification by chlorine, is used as the positive electrode in the electrolysis of aq. hydrofluoric acid, it is partly disaggregated, swelling up in the immersed part, and becoming so brittle that after a while it splits up by its own weight into rather large fragments, whereas the carbon at the negative electrode remains quite unaltered. On repeatedly washing the altered carbon until the wash-water is no longer acid, then drying it at 100° , reducing it to impalpable powder, repeatedly boiling it with hydrochloric acid, and once more thoroughly washing it with water, it exhibits the following properties: (i) It dissolves partially, giving a dark red colour, in strong sulphuric acid. (ii) It is attacked by a hot soln. of sodium hypochlorite, yielding sodium fluoride, mellic acid, and the usual derivatives of the latter. (iii) In addition to carbon, hydrogen, and oxygen, it contains fluorine, amounting to about 3 per cent. of the disaggregated carbon, and not due to electrolysis or mineral matter, inasmuch as the carbon used in the experiment did not yield on

ignition any perceptible quantity of ash. When graphite is employed as positive electrode in the electrolysis of strong aq. hydrofluoric acid, the immersed portion swells up, becomes pappy, and quickly disintegrates; and the disintegrated portion when purified in the manner above described, forms a black powder, which swells up considerably when heated, is insoluble in all solvents, and contains carbon, oxygen, hydrogen, and fluorine. According to H. Debray and E. Péchard, when **hydrochloric acid** is electrolyzed with carbon electrodes, the gas evolved at the positive pole is a mixture of chlorine, carbon dioxide, and oxygen. The positive electrode is disintegrated and forms a black powder, which, after being washed and dried in vacuo, deflagrates below a red heat, giving off carbon monoxide and dioxide. The amount of oxygen in the product varies with the conc. of the acid. No soluble organic compound is formed. G. Gore said that wood charcoal is not changed by liquid hydrogen fluoride or chloride. W. G. Mixter found that after charcoal has been ignited in hydrogen chloride, it retains 0.26 per cent. of chlorine. M. Berthelot found that neither purified wood charcoal nor graphite is attacked by **hydriodic acid**. According to G. Gore, **silver fluoride** is not affected when heated with carbon, but in the presence of chlorine, silver chloride is formed; similarly, in a graphite containing vessel, silver fluoride is converted into the bromide or iodide when heated in the presence of bromine or iodine—a volatile carbon fluoride is formed. J. L. Gay Lussac and L. J. Thénard found that the fire-resisting **chlorides** mixed with carbon are not decomposed when heated, unless water be present; in that case, mercuric and silver chlorides may form carbon monoxide or dioxide, hydrogen chloride and the metal. F. Feigl found that charcoal exerts an **oxidizing action** when boiled with many soln.—*e.g.* **potassium iodide** is oxidized to iodine, and in alkaline soln. to the iodate. According to W. Skey, any surface of graphite, native or artificial, which has been for some time exposed to the air, liberates iodine from a soln. of **potassium iodide** in dil. sulphuric acid. The graphite, which can thus liberate iodine, loses this property when washed in ammoniacal or other alkaline soln.; also when ignited. This property of liberating iodine is restored to such graphite by a short exposure of it to the air, or by evolving nascent hydrogen against it; also by digesting it for a little while with hydrochloric or dil. sulphuric acid, either at a common temp. or at the b.p. of these acids respectively. Graphite, which thus liberates iodine, also rapidly determines a chemical effect upon mercury, when voltaically paired with it in pure hydrochloric acid, mercurous chloride being formed. Charcoal does not, even freshly prepared, notably liberate iodine; but it can be made to do so by digesting it with an acid, the effect of which is perhaps due to its removing all alkaline matters therefrom, and thus enabling the charcoal to retain the oxidizing agent necessary for effecting the liberation in view. When graphite, which has been exposed to the air, is voltaically connected in sea-water with graphite just recently ignited, electric currents are generated; graphite which has been desulphurized also generates electric currents when connected in this manner with any conducting sulphide in a soln. of an alkaline sulphide.

A. J. Balard found that there is an immediate detonation when charcoal is added to **chlorine monoxide**, Cl_2O , but the gas obtained is a mixture of oxygen and chlorine and contains but little carbon dioxide; and he added, "I believe that the decomposition is effected less by the affinity of carbon for oxygen, than by the heat which is developed by the adsorption of the gas in the pores of the charcoal." P. Schützenberger made some observations on this reaction. A. J. Balard said that charcoal did not appear to exert any action on **hypochlorous acid**. A. Bartoli and G. Papasogli found carbon dioxide among the products of the action of **sodium hypochlorite** on lignite. For the action of mixtures of **alkali chlorates** and acids, *vide infra*. H. Moissan said molten potassium chlorate does not act on the diamond. According to A. Ditte, when **iodine pentoxide** is warmed with charcoal, the reduction is accompanied by detonation; charcoal has no action on a boiling aq. soln. of **iodic acid**. At ordinary press., but in a sealed tube, the different varieties of carbon are attacked at different temp., thus, iodine and carbon dioxide are produced at 160°

with wood charcoal; at 180° with sugar charcoal, gas carbon, coal, and coke; and at 210°, with anthracite. Graphite is attacked with difficulty at 210°; but the diamond is not attacked at 260°. H. Moissan said that graphite separated from a soln. of carbon in platinum is readily attacked by iodic acid, giving off iodine vap. and carbon dioxide. J. L. Gay Lussac said that the **iodates** detonate on red-hot carbon. G. Lemoine also found that the separation of iodine from iodic acid is facilitated in the presence of charcoal.

W. Spring⁵ observed no signs of the formation of carbon sulphide by subjecting a mixture of powdered carbon and **sulphur** to great press. F. Clément and J. B. Désormes also found that sulphur could be evaporated from a mixture of the two elements provided a certain temp. be not attained; when sulphur vapour is passed over red-hot carbon, a reaction occurs and carbon disulphide is formed. The reaction was studied by C. Brunner, G. J. Mulder, A. Schrötter, T. Sidot, G. C. Wittstein, etc.—*vide infra*. A. G. Doroshewsky and G. S. Paffoff studied the catalytic effect of carbon on the oxidation of sulphur. According to W. G. Mixer, charcoal adsorbs sulphur when heated to redness in sulphur vapour, or **carbon disulphide**. The sulphur is entirely removed by hydrogen, and is virtually all given up at a red heat. Filter paper soaked in carbon disulphide, and heated in sulphur vap., adsorbs nearly its own weight of the latter, and the product does not give up sulphur to carbon disulphide, or to a boiling aq. soln. of potassium hydroxide. According to H. Moissan, sulphur vapour begins to attack the diamond at about 1000°; while with black diamonds, the attack begins at about 900°. S. Bidwell discussed the influence of temp. on intimate mixtures of sulphur and graphite. B. Rathke, and A. von Barta made carbon selenide, and M. Shimose, carbon telluride, respectively by the action of **selenium** and **tellurium** or of their compounds, on carbon. W. A. Lampadius noted that carbon disulphide is formed when a pyritiferous coal is distilled; and F. Clément and J. B. Désormes observed carbon disulphide is produced when carbon is heated with many metal **sulphides**. F. Feigl found a soln. of an **alkali sulphide** is oxidized to sulphate when boiled with a little charcoal; and in alkaline soln., the **copper sulphides** are oxidized to sulphate; and **cobalt sulphide** to sulphate. M. Houdard studied the solubility of the diamond in molten **manganese sulphide**.

F. Feigl found that a soln. of **hydrogen sulphide** is oxidized to sulphuric acid when boiled with charcoal. G. Gore found carbon to be insoluble in liquid **sulphur chloride**. Purified charcoal was found by M. Berthelot to react with **sulphur dioxide** at a red heat, forming carbon monoxide, carbonyl sulphide, carbon disulphide, and a little free sulphur. B. Lepsius said that when charcoal is heated electrically to a white heat in this gas, carbon monoxide is formed and also some sulphur; A. Eiboart said that carbon dioxide and sulphur are slowly formed; and A. Scheurer-Kestner represented the reaction by the equation: $2\text{SO}_2 + 3\text{C} = 2\text{CO} + \text{CO}_2 + 2\text{S}$. F. Feigl found that **alkali sulphites** are oxidized when boiled with charcoal in alkaline soln. G. Tolomei said that carbon is attacked by **sulphuric acid** only when impurities are present. M. Berthelot stated that purified wood charcoal is not attacked by cold sulphuric acid, but at 100°, small quantities of sulphur and carbon dioxides are formed; purified graphite gives no gas at 100°, but the acid acquires a brown tinge. H. Moissan observed no reaction at the b.p. when sulphuric acid is mixed with graphite which has separated from a soln. of carbon in iron. According to A. Verneuil, when wood charcoal is heated with conc. sulphuric acid, the residue in the flask contains, among other things, *mellitic acid* and *benzene pentacarboxylic acid*:

1400 grms. of ordinary sulphuric acid were heated with 100 grms. of carbon, the process being continued until only from 90 to 100 grms. of residue remained in the flask. The temp. of the reaction was about 280°, but rose towards the end to about 300°, a rapid evolution of gas being maintained in order to ensure that the water formed was expelled with the carbon and sulphur dioxides. When the residue is treated with water, a dark brown soln. is formed, and a black, insoluble coagulum remains, showing no trace of the original structure of the

charcoal. It is soluble in alkalis and in conc. sulphuric acid, and is under investigation. The strongly acid soln. is mixed with just sufficient barium chloride to precipitate the sulphuric acid, filtered, and evaporated to dryness, when a brown, amorphous, strongly acid residue is left, equal in weight to about 20 per cent. of the original carbon. When this residue is dissolved in water, sat. with ammonia, filtered and conc., ammonium mellitate separates in quantity equal to about 4 per cent. of the original carbon. The mother liquor is evaporated with a slight excess of barium hydroxide, and the barium salts are dissolved in hydrochloric acid, and fractionally precipitated with barium hydroxide soln. The first fraction carries down most of the colouring matter, whilst the next fraction is crystalline, and consists of barium benzenepentacarboxylate, which can be recrystallized from hydrochloric acid in the form of an acid salt.

E. Philippi and co-workers described the preparation of pyromellitic acid by the action of sulphuric acid on wood charcoal. According to H. Giraud, during the preparation of sulphur dioxide from charcoal and sulphuric acid, a white crystalline sublimate occasionally forms in the neck of the flask, and may be obtained in quantity by using excess of charcoal and carrying on the action until gas ceases to be evolved. After purification and recrystallization from alcohol, this substance forms small, colourless, efflorescent crystals, which, on sublimation, are transformed into a substance crystallizing in long needles and melting at 280° , and which is probably *pyromellitic anhydride*. H. Debray and E. Péchard found that when sulphuric acid is electrolyzed with carbon electrodes, a mixture of carbon dioxide and oxygen is evolved. The positive electrode is disintegrated, and the black powder which is formed, when washed and dried in vacuo, deflagrates at a temp. below red heat, evolving carbon monoxide and dioxide. A. Bartoli and G. Papasogli obtained a mixture of oxygen, carbon monoxide, and dioxide at the anode during the electrolysis of dil. sulphuric acid with graphite electrodes. By suitable alteration in the conc. of the acid, the temp., and the current density, A. Coehn succeeded in carrying out the electrolysis in such a manner that carbon monoxide and carbon dioxide were almost alone produced at the anode. The gaseous mixture contained 70 per cent. carbon dioxide, about 30 per cent. carbon monoxide, and 1 per cent. of oxygen. At low temp., a disintegration of the anode takes place, and suspended particles of carbon find their way into the acid. At high temp., carbon dissolves in the acid, the soln. being coloured from yellow to reddish-brown. If the soln. thus formed is electrolyzed, using a platinum cathode, a deposit of carbon is obtained, at first as a thin, coloured film and then as a graphitic deposit. The soln. reduces Fehling's soln. and probably contains carbohydrates. In reversal of the above process, a cell was formed by means of a lead peroxide plate and a carbon electrode, in which, working under the conditions previously maintained, the carbon acts as the soluble electrode. This gave 1.03 volts with an external resistance of 100 ohms, and yielded a constant current until the lead peroxide plate was exhausted. F. Vogel said that the electrolytic dissolution of carbon is very improbable, since carbon separates from carbon compounds not as a cation, but rather as an integral part of the cation. K. Heumann and P. Köchlin found that powdered freshly calcined charcoal develops much sulphur and carbon dioxides when heated with chlorosulphuric acid, $\text{SO}_2\text{Cl}(\text{OH})$, but no carbonyl sulphide is formed.

M. Berthelot studied the reduction of sulphates by purified carbon (*vide* 2. 20, 29), and showed that the end-state with potassium sulphate can be represented by $\text{K}_2\text{SO}_4 + 2\text{C} = \text{K}_2\text{S} + 2\text{CO}_2$, if the carbon is not present in too great an excess. J. Mactear represented the reactions with sodium sulphate and an excess of carbon below a red heat: $\text{Na}_2\text{SO}_4 + 4\text{C} = \text{Na}_2\text{S} + 4\text{CO}$; and at 1150° – 1300° : $3\text{Na}_2\text{SO}_4 + 6\text{C} = \text{Na}_2\text{CO}_3 + \text{Na}_2\text{S}_2 + \text{Na}_2\text{S} + 4\text{CO}_2 + \text{CO}$. He added that potassium sulphate behaves similarly but at a lower temp. A. Scheurer-Kestner represented the reaction in the presence of silica: $3\text{Na}_2\text{SO}_4 + 3\text{SiO}_2 + 5\text{C} = 3\text{S} + 4\text{CO}_2 + \text{CO} + 3\text{Na}_2\text{SiO}_3$. These equations, it must be observed, involve some guess-work. E. Kunheim studied the action of mixtures of carbon with an alkaline earth, cerium, thorium, magnesium, aluminium, chromium, or manganese sulphate in the electric arc furnace. H. Moissan

found that molten **potassium sulphate** or **hydrosulphate** does not attack the diamond, and the subject has been further studied by M. C. Schuyten. H. Moissan found that **calcium sulphate** is not reduced by the diamond at 1000°. O. Boudouard found that a mixture of carbon and **barium sulphate** at 800° gives 82 per cent. of carbon monoxide and 17.1 per cent. of carbon dioxide. J. J. Berzelius found that mixtures of carbon and **selenites** furnish carbon monoxide and dioxide without detonation, and either a selenide or selenium is formed. The alkali selenites, said B. Rathke, give mostly polyselenides and very little monoselenide. E. Mitscherlich found that the **selenates** detonate on red-hot carbon and the smell of selenium can be detected. F. Feigl found that **sodium thiosulphate** in alkaline or neutral soln. is not affected by boiling with charcoal.

According to M. Berthelot,⁶ neither the diamond nor graphite is altered when heated in **nitrogen**. He also found that charcoal free from hydrogen does not react with nitrogen either under the influence of an electric spark, or in the electric arc; but if the charcoal is associated with hydrogen, or if hydrogen or water vapour are present, then acetylene is produced, and this reacts with the nitrogen, forming hydrogen cyanide—*vide supra*. If the carbon contains alkalis or alkaline earths, then cyanides are produced. According to W. G. Mixter, nitrogen is not taken up when carbon is heated in nitrogen, but lampblack, sugar charcoal, and blood charcoal may retain nitrogen very tenaciously if they are heated in ammonia or nitrous oxide, and these gases are decomposed. The nitrogen is probably retained by the charcoal in the form of cyanogen, since that substance is adsorbed readily by charcoal at a red heat, and yields a product which, like those obtained by the direct action of nitrogen, furnishes ammonia when heated with steam. No paracyanogen appears to be retained. W. Hempel also found that the simultaneous combustion of nitrogen and oxygen in the presence of carbon furnishes considerable quantities of nitric acid. According to L. Clouet, when carbon is heated with **ammonia**, ammonium cyanide and hydrogen are formed: $2\text{NH}_3 + \text{C} = \text{H}_2 + \text{NH}_4\text{CN}$. The reaction was also discussed by M. Bonjour, C. Langlois, and W. G. Mixter. F. Kuhlmann said that some methane is also formed, but this was denied by C. Weltzien. H. Davy investigated the action of heated carbon on **nitrous oxide**; he said that combustion proceeds more vigorously than in air, so that one vol. of nitrous oxide yields one vol. of nitrogen and half a vol. of carbon dioxide. W. G. Mixter made analogous observations. J. Dalton also found that heated carbon burns more vigorously in **nitric oxide** than it does in air, forming half a vol. of nitrogen and half a vol. of carbon dioxide. P. L. Dulong noted that red-hot carbon burns in **nitrogen tetroxide** with a red flame. C. F. Schönbein discussed the action of this gas on carbon. R. Weber reported that **nitrogen pentoxide** has no action on carbon. F. Feigl found that **sodium nitrate** in alkaline soln. is not affected when boiled with charcoal. According to H. Debray and E. Péchard, when **nitrous acid** is electrolyzed with carbon electrodes, the gas evolved at the positive pole is a mixture of nitrogen oxides and carbon dioxide. The positive pole disintegrates, and furnishes a black powder, which, after being washed and dried in vacuo, deflagrates at a temp. below a red heat with the evolution of carbon monoxide and dioxide. The amount of water and oxygen in the product varies with the conc. of the acid. W. G. Mixter said that charcoal adsorbs nitrogen from nitrous and nitric oxides. E. Philippi and co-workers investigated the action of nitric acid on carbon.

According to C. F. Schönbein,⁷ red-hot carbon burns vigorously in **conc. nitric acid**, and powdered carbon decomposes the acid in the cold—nitrogen peroxide free from carbon dioxide is evolved. H. Moissan found that amorphous carbon at ordinary temp. and press. is oxidized by nitric acid; and A. Scott showed that nitric acid and wood charcoal give a black substance easily soluble in water, alcohol, and ether. It contains over 30 per cent. of carbon; 2 or 3 per cent. of hydrogen; and some nitrogen; it combines with alkalis, and the soln. gives a precipitate with most metal salts, and with hydrochloric or nitric acid. G. Dickson and T. H. Easterfield found that well-burnt wood charcoal reacts readily with fuming nitric acid, and

there is a considerable rise of temp. If wood charcoal be boiled for 24 hrs. with fuming nitric acid, it passes completely into soln., and when diluted with water, a black amorphous substance resembling mellogen is precipitated while mellitic acid and non-crystallizable acids remain in soln. Nitric acid of sp. gr. 1.1 can oxidize well-burnt wood charcoal, and when the mixture is boiled for 7 days, it forms a black mud which is soluble in alkalis. The acid soln. contains mellitic acid, but no oxalic acid. Coal under similar conditions gives a small yield of mellitic acid. F. B. Burls and co-workers noted that when carbon and certain carbon compounds—cane sugar, caramel, etc.—are heated with dil. nitric acid, some hydrogen cyanide is evolved. They suggest that nitrous acid is first formed: $2\text{HNO}_3 + \text{C} = \text{CO}_2 + 2\text{HNO}_2$, and it is this which reacts with the carbon: $\text{HNO}_2 + 2\text{C} = \text{CO}_2 + \text{HCN}$.

According to R. J. Friswell, when bituminous coal is treated with 49 per cent. nitric acid the mass becomes warm, and dense red fumes are given off. When the deep brown liquid is filtered from the unchanged coal, and acidified with hydrochloric acid, it furnishes a deep brown, flocculent precipitate. The precipitate is colloidal and peptizes as the salts and acids are removed by washing.

When washed and dried at 100° , it forms a black friable mass, showing bright conchoidal fractures. If heated on platinum foil it puffs, swells slightly, and leaves a residue of carbon rather more bulky than its original mass, and almost as brilliantly black. The puffing is very like that of a nitro-compound with a very high carbon ratio; attempts to reduce it with zinc dust and caustic soda and with sodium amalgam have hitherto failed, and so have similar attempts with acid-reducing mixtures. The presence of nitrogen is indicated in the usual manner on heating it with sodium; on submitting it to dry distillation with zinc dust, hydrogen and cyanogen are evolved, and a small aq. distillate, smelling of ammonia and faintly of pyridine, and containing a very large quantity of hydrocyanic acid, is also obtained.

L. Carius oxidized graphite by mixing it with nitric acid, sp. gr. 1.5, and heating it in a sealed tube to 250° – 260° , and keeping the temp. at 300° – 330° for 1–2 hrs. W. Luzi's and H. Moissan's observations on the action of nitric acid on the different forms of graphite have been previously described. F. C. G. Müller showed that when wood charcoal is heated in the vapour of nitric acid above 1000° , the issuing gases consist of 52.2–57.2 per cent. CO_2 ; 13.3–14.7 per cent. CO; 3.4–4.6 per cent. H_2 ; 24.9–26.7 per cent. N_2 .

P. Schafhäütl, and later R. F. Marchand, noted the formation of a peculiar substance when graphite is treated with oxidizing agents. This product was then studied by B. C. Brodie, J. Gottschalk, M. Berthelot, etc. B. C. Brodie found that when graphite is heated with a mixture of nitric acid and potassium chlorate, it increases in weight, and what he called **graphitic acid** is formed. To this he assigned the formula, $\text{C}_{11}\text{H}_4\text{O}_5$. He prepared this product in yellow plates by treating an intimate mixture of one part of purified graphite and three parts of potassium chlorate, with sufficient conc. nitric acid to make a liquid mass. The solid residue remaining after the mixture has been heated 3–4 days on a water-bath, is washed with water and dried at 100° . Four or five repetitions of the treatment are needed to ensure the conversion of all the graphite to graphitic acid. H. Moissan's modification of this process has been previously described; and T. Gottschalk stated that five successive treatments were needed to oxidize graphite completely to graphitic acid by the action of fuming nitric acid of sp. gr. 1.525, and potassium chlorate; and he added that the graphite passes through successive stages of oxidation, forming, after three operations, a grass-green substance which is readily oxidized to graphitic acid by heating on a water-bath with a soln. of potassium permanganate and dil. sulphuric acid. L. Staudenmaier claimed that graphitic acid can be prepared in considerable quantity, in a comparatively short time (24 to 48 hrs.), and without danger of explosion by the following process:

Very finely divided graphite (25 grms.) is stirred into a mixture of conc. sulphuric acid (1 litre) and nitric acid of sp. gr. 1.4 ($\frac{1}{2}$ litre), and, at intervals, potassium chlorate is added

(about 450 grms. in all). The mixture is kept at the ordinary temp., is well stirred after each addition of chlorate, and each portion of chlorate is added only after the gas-evolution from the previous addition has completely ceased. When a sample treated with permanganate and acid becomes of a pure yellow colour, the acids are thoroughly washed with cold water from the powder, which is then oxidized with permanganate. Any excess of permanganate is destroyed by hydrogen peroxide, and the resulting graphitic acid washed successively with dil. nitric acid, alcohol, and ether.

F. S. Hyde also suggested modifications of the process. Ordinary charcoal when similarly treated is converted into a brown mass soluble in water, while the diamond is not attacked. M. Berthelot utilized these facts in devising a method for determining the proportions of amorphous carbon, graphite, and diamonds present in a mixture. G. Charpy found that permanganic or chromic acid oxidizes graphite to graphitic acid, but the reaction readily proceeds too far. V. Kohlschütter and P. Haenni assumed that chlorine dioxide is the oxidizing agent in the mixture of potassium chlorate and nitric acid. A. Lang studied the oxidation of graphite with permanganic acid, and conc. sulphuric acid, fuming nitric acid, and potassium chlorate. According to B. C. Brodie, if lampblack sugar charcoal is heated with a mixture of 4 parts of sulphuric acid, and one of nitric acid, the carbon is rapidly oxidized to a black mass which is soluble in conc. acid, and is reprecipitated by water; it is soluble in dil. acids, in salt soln., in water and in aq. alkali hydroxides. The reaction with graphite under similar conditions has been previously discussed.

F. Gottschalk said that the composition of the end-product varies between $C_{11}H_4O_6$ and $C_{33}H_{12}O_{18}$, according to the duration of the oxidation; L. Balbiano, between $C_{13}H_4O_7$ and $C_{14}H_4O_7$. M. Berthelot, W. Luzi, and H. Moissan found that different varieties of graphite furnish different oxidation products. The yellow flakes of graphitic acid do not possess a crystalline structure; they have no effect on polarized light. The flakes are made up of an indefinitely large number of very thin plates of diameter 10μ to 50μ , and of ultra-microscopic thickness. The particles show the Brownian movement. According to P. Gaubert, graphitic acid is crystalline; the optical character is negative; and the index of refraction is 1.93–2.00. V. Kohlschütter and P. Haenni have shown that the apparently crystalline particles of graphitic acid are not crystals, but pseudomorphs of the original graphite particles. After repeated washing with water, graphitic acid passes into a colloidal soln., which can be flocculated by dil. acids, and the precipitated gel is peptized by water. The variously coloured graphitic acids differ merely in their degree of dispersity, the lighter coloured products, obtained by repeated oxidation, being more highly dispersed. It is not true, as was formerly supposed, that the colour of the graphitic acid depends on the sample of graphite from which it is made.

F. A. J. Fitzgerald compared the rapidity of oxidation of E. G. Acheson's graphite with Cingalese graphite when treated by L. Staudenmaier's process under like conditions. The latter variety was all converted into the yellow oxide after five treatments, whereas Acheson's graphite was not all oxidized after seven treatments. This agrees with H. Moissan's observations that the higher the temp. to which the graphite has been heated, the more resistance does it offer to attack by the oxidizing mixture. T. Hübener, and W. Luzi noted that besides graphitic acid, much mellitic acid is produced, and with potassium chlorate and fuming nitric acid, all the graphitic acid can be converted into mellitic acid. Observations have been made by J. C. G. de Marignac, N. Fedoroff, A. Bartoli and G. Papasogli, W. A. Selvig and W. C. Ratliff, M. Berthelot and P. Petit, P. and L. Schützenberger, E. Weinschenk, etc. Graphitic oxide is regarded as an organic compound derived directly from elementary carbon, a link as it were between organic and inorganic chemistry. In contrast with the general stability of graphite, graphitic oxide or acid—as it is variously called—is peculiarly unstable, and B. C. Brodie found that it deflagrates at a temp. just below a red heat, and leaves a black, soot-like residue known as *pyrographitic acid*, $C_{22}H_2O_4$ —probably graphite. J. Stingl said that pyrographitic acid has marked decolorizing powers; heating with sulphuric acid converts it into carbon.

According to M. Berthelot, when a mixture of one part of graphitic oxide and 80 parts of hydriodic acid, of sp. gr. 2.0, is heated to 280°, it forms an amorphous, insoluble, brown substance which he called *hydrographitic acid*. It passed back into graphitic oxide when treated with potassium chlorate and nitric acid. V. Kohlschütter and P. Heanni showed that when heated or treated with reducing agents, graphitic acid is reduced to carbon. Heating experiments have shown that the gases evolved are water, carbon monoxide, and carbon dioxide, the ratio CO/CO₂ being greater the more slowly the heat is applied. The temp. at which the decomposition becomes explosive is also lower the slower the heating, and if the heating is very slow the decomposition may go quietly to completion without explosion. The black, voluminous residue consists of 99.7 per cent. carbon. It has all the properties of soot, but can be compressed into a mass very similar to graphite. When the decomposition of the graphitic acid by heat takes place under press., the graphitic character of the residual carbon is more marked. By decomposing the graphitic acid under sulphuric acid at 160°–180°, a residue was obtained having properties intermediate between those of soot and graphite. Treatment of graphitic acid with reducing agents, such as ferrous or stannous salts, gave products with strongly marked graphitic properties, giving graphitic acid again when oxidized. These products, however, were contaminated with adsorbed iron or tin compounds, which were difficult to remove. L. Balbiano found that when graphitic oxide is heated under reduced press. it furnishes carbon monoxide, carbon dioxide, and water; while at higher temp. the water vapour acts upon the carbon, and small amounts of hydrogen and methane are formed. By treating graphitic oxide with a soln. of hydroxylamine in a mixture of alcohol and water, a residue consisting only of graphite and water remains. The general results of the work of S. Porcher, A. Bartoli and G. Papisogli, H. Moissan, J. Wiesner, E. Weinschenk, F. S. Hyde, G. B. Trener, H. le Chatelier and S. Wologdine, and G. Charpy show that the modifications of carbon obtained by B. C. Brodie, W. Luzi, and M. Berthelot are compounds, soln., or mixtures of carbon with other elements. G. A. Hulett and O. A. Nelson found that on removing water from graphitic acid, the vap. press. drops continuously with no suggestion of a break, and concluded that graphitic acid is a colloidal oxide of carbon in which water is adsorbed on relatively large surfaces. The oxide is assumed to be of the order C₃O or C₁₁O₄. L. Balbiano considered various graphitic acids to be adsorption products of graphite, water, carbon monoxide, and carbon dioxide. They have no acidic or quinonic functions, and he suggested they be called *hydro-carboxygraphites*. P. Debye and P. Scherrer also said that the X-radiograms of graphitic acid show that it is a mixture and not a homogeneous chemical individual.

H. Debray and E. Péchard found that in the electrolysis of nitric acid with graphite electrodes, similar phenomena were observed as with nitrous acid; and A. Bartoli and G. Papisogli stated that with graphite electrodes, nitrogen-free graphitic acid is formed; some carbon monoxide and dioxide are evolved; and the soln. contains mellitic, pyromellitic, and hydromellitic acids. C. F. Rammelsberg said that some graphites burn in contact with fused **potassium nitrate**, while other varieties are not attacked; H. Moissan found that this treatment has no action on the graphite which separates from a soln. of carbon in molten platinum. A. Vogel said that if potassium nitrate be at a temp. a little above its fusion point, the carbon is oxidized to carbon dioxide, and nitrogen, nitric oxide, and nitrogen trioxide are formed; but if the temp. and the proportions of the constituents are suitable a mixture of potassium nitrite and carbonate is formed; if the nitrate is in excess, only potassium nitrite is formed. H. Moissan said that molten potassium nitrite does not act on the diamond. J. Reiset and N. A. E. Millon said that **ammonium nitrate** detonates on red-hot carbon, and an explosion occurs when a mixture of that salt and carbon is heated to 170°. In the electrolysis of various salt soln. with wood charcoal or retort carbon electrodes, A. Bartoli and G. Papisogli found the anode gradually disintegrates to a black powder of mellitic and hydromellitic acids, less gas than the theoretical amount is evolved, and the soln. acquires a brown colour, and an acidic

reaction; with soln. of **nitrates, phosphates, arsenates, and antimonates**, mellogen is formed, and phospho-mellogen or stibio-mellogen. They also found that soln. of **phosphoric, arsenic, and antimonic acids** behave like the soln. of the salts. G. Gore found carbon to be insoluble in liquid **phosphorus trichloride, or antimony pentachloride**.

According to H. M. Kahn,⁸ fused **alkaline earth carbides** dissolve carbon, some of which separates as graphite on cooling. The amount of carbon dissolved by the fused carbide increases with the intensity of the current employed in the furnace and also with the time of passage of the current when its intensity is kept constant. In an experiment in which a current of 500–600 ampères was passed for six and a half minutes, five per cent. of carbon was taken up by the fused carbide. When the period of heating is further prolonged, the results are complicated by decomposition of the carbide. According to G. Gore, carbon is insoluble in liquefied **cyanogen** and in liquid **carbon dioxide**. M. Berthelot said that carbon reacts with **carbonates**, forming carbon monoxide, etc. H. Moissan found that at 1000° to 1200°, the diamond quickly disappears in contact with fused **potassium or sodium carbonate**, the graphite which separates from a soln. of carbon in platinum is rapidly attacked by this mixture; molten alkali carbonates and the diamond furnish carbon monoxide. V. A. Jaquelain and H. Baumhauer, and L. Colomba suggest that the carbon dioxide is reduced by the diamond, $\text{CO}_2 + \text{C} = 2\text{CO}$; while C. Doelter believed that the carbon dioxide is dissociated, and that the diamond is attacked by the liberated oxygen. O. Boudouard found that a mixture of carbon and **calcium carbonate** at 650° gives a mixture of 78 per cent. carbon monoxide and 22 per cent. of carbon dioxide; carbon and **barium carbonate** at 800° give a mixture of 95 per cent. of carbon monoxide and 5 per cent. carbon dioxide. K. E. Glasson found that with **iron carbonate** a mixture of carbon monoxide and dioxide is obtained in the proportions 1 : 5. S. Petuchoff heated the carbonates of the alkalis and calcium with carbon and sulphur, and noted that some carbon monoxide is formed. A number of observations has been made on the action of carbon on **organic compounds**—*e.g.* R. Ehrenfeld, G. Lemoine, and J. B. Senderens studied its action on **alcohols**; P. P. Bedson, on **pyridine**; C. A. Parsons, on **benzene, paraffin, sugar, carbon tetrachloride, and carbon disulphide**; and J. Stenhouse, and C. C. Stanford, on decaying organic matter. H. L. Dejust found a soln. of ***p*-phenylenediamine** is rapidly oxidized by air in the presence of graphite. A. W. Hofmann, P. Cazeneuve, R. Doupouy, M. Bodenstern and C. G. Fink, etc., studied the **catalytic action of carbon**. I. von Ostromisslensky found graphite to be insoluble in **tar, phenanthrene, chrysene, pyrene, picene, and triphenylene**, but it appears to be soluble in **deacetylene**, while the diamond is insoluble in that menstruum. F. Feigl found that **oxalic acid** in aq. soln. is oxidized to carbon dioxide when boiled with charcoal. R. S. Marsden, and J. Violle have noted the slow diffusion of carbon into the walls of heated **porcelain crucibles**. A. Daubrée, A. L. du Toit, etc., have studied the action of fused **silicates** on the diamond—*vide* origin of the diamond.

C. R. A. Wright and A. P. Luff⁹ found that carbon monoxide begins to reduce ferric oxide and copper oxide at a lower temp. than hydrogen, and hydrogen at a lower temp. than carbon. Carbon from carbon monoxide begins to act at a lower temp. than sugar charcoal; and metal oxides prepared by precipitation are often reduced at a lower temp. than those prepared by the ignition of the metal salts. The reduction of **ferric oxide** with sugar charcoal began at 450°; of **cuprous oxide** at 390°; and of **cupric oxide**, between 390° and 440°. With carbon from carbon monoxide, the reduction of ferric oxide began at 430°; of cuprous oxide at 345°; and of cupric oxide, between 350° and 430°. The carbon reduction of **manganese dioxide** began at 260°; of **pyrolusite** at 390°; of **lead monoxide** at 415° to 435°; of **red lead** at 330°; of **lead dioxide**, 250° to 270°; **cobalt monoxide**, 450°; **cobalt sesquioxide**, 260°; **nickel monoxide**, 450°; and **nickel sesquioxide**, 145°; A. Guntz obtained carbon monoxide and metal by heating a mixture of carbon with ferrous oxide or manganous oxide to a high temp. R. Schenck and

W. Heller measured the equilibrium press. between iron, ferrous oxide, carbon, and the two oxides of carbon approached from both sides of the equation. They also used different forms of carbon—sugar charcoal, carbon from carbon monoxide, graphite, and the diamond. They found

Sugar								
Charcoal	·	{	408°	465°	560°	590°	627°	649°
Carbon		{	5·6	10·4	161·7	314·5	546·8	750·1
from CO	·	{	468°	600°	669°	719°	778°	780°
		{	10·3	65·0	169·2	395·8	750·0	780·0
Graphite	·	{	500°	550°	609°	640°	700°	755°
		{	12·3	36·8	77·5	111·0	287·3	574·2
		{	480°	530°	563°	585°	641°	675°
Diamonds	·	{	8·2	54·1	134·7	228·5	521·3	725·1

From which it appears that the diamond reduces more energetically than graphite. They also made similar measurements with manganous oxide where the press. were less than for ferrous oxide, since at 1200° the press. was 10 mm., and at 1229°, 15·3 mm. The application to the blast furnace was also discussed by R. Schenck, A. Smits, B. Osann, E. Baur, etc. H. C. Greenwood gave for the reduction temp. of **chromium sesquioxide** with carbon, 1185°; **manganous oxide**, 1105°; **uranium dioxide**, 1490°; **silica**, 1460°; **zirconia**, 1400°; and **thoria**, 1600°. H. Moissan found that not the smallest trace of calcium carbide was formed when **calcium oxide** was heated with sugar charcoal at the fusion temp. of platinum (over 1755°). H. Moissan said that fused **alumina** is not reduced by carbon, but the vapours of alumina and carbon readily react to form aluminium carbide. E. Berger and L. Delmas examined the behaviour of different forms of carbon when mixed with metal oxides.

N. A. E. Millon¹⁰ found that at 320° wood charcoal in contact with **alkali hydroxide**, and exposed to air, is transformed into a substance with some acidic properties; it is analogous to humus, it is soluble in aq. ammonia, and alkali-lye; but insoluble in water. P. Degener and J. Lach wetted animal charcoal with alkali-lye, and exposed it to air and light; they noted that an alkali peroxide was formed. Similar results were obtained with **alkaline earth hydroxides**. According to F. Haber and L. Bruner, carbon and sodium hydroxide interact to furnish hydrogen. Sodium formate and sodium hydroxide, when fused together, give off pure hydrogen, the reaction begins at about 205° and is quite complete at 350°; it is represented by the equation $\text{HCO}_2\text{Na} + \text{NaOH} = \text{H}_2 + \text{Na}_2\text{CO}_3$. No oxalate is formed. A mixture of sodium oxalate and sodium hydroxide begins to decompose at 270°–280°, evolving pure hydrogen and forming carbonate only. If the potential of the carbon electrode in sodium hydroxide were due to the presence of either formate or oxalate, it should be higher than the hydrogen potential, because both formate and oxalate break up spontaneously, yielding hydrogen. Measurements of the potential of carbon in sodium hydroxide to which sodium formate or oxalate had been added, and from which hydrogen was being evolved owing to their decomposition, always gave the hydrogen potential—1·5 volts. The action of carbon monoxide on sodium hydroxide at 350° was found to be $2\text{NaOH} + \text{CO} = \text{Na}_2\text{CO}_3 + \text{H}_2$. Hence, as previously indicated, it was inferred that the carbon electrode is really a hydrogen electrode.

Carbon exerts a **reducing action** on many salts. Carbon is one of the most important and useful of reducing agents for abstracting oxygen from the metal oxides. It is used in blowpipe reactions on charcoal; in the manufacture of iron and steel; and by its aid, directly or indirectly, the metals copper, zinc, lead, and tin are extracted; and even the metals of the alkalies obtained. It is used likewise in the poling of copper. In the case of animal charcoal, said W. Heintz,¹¹ the reducing action may be due largely to adsorbed hydrogen. C. F. Schönbein noted that soln. of **ferric salts** are reduced to the ferrous state, and D. Tommasi noted that in the electrolysis of soln. of ferric chloride, the carbon electrodes are strongly attacked and chlorine is given off. According to C. Moride, if a purified carbon rod be placed in an acidic

soln. of **cupric sulphate**, it gradually becomes covered with copper. The reduction does not proceed so well in neutral or alkaline soln., and it goes better with soln. acidified with sulphuric acid than with nitric or hydrochloric acid; and worse in the presence of organic acids. A. F. Fol observed the effect with different kinds of carbon. C. F. Schönbein reported the reduction of **mercuric chloride** soln. to mercurous chloride, but A. E. Esprit said that there is really no reduction, the mercuric chloride is merely withdrawn from the soln. by absorption; and F. Feigl showed that when mercurous salts are boiled with blood charcoal, mercurous chloride is oxidized to mercuric chloride. C. Moride, and A. F. Fol noted the ready reduction of neutral or acid soln. of **silver nitrate**, or ammoniacal soln. of **silver chloride** to the metal. D. Avery noted the reduction of a soln. of **auric chloride**, $4\text{AuCl}_3 + 6\text{H}_2\text{O} + 3\text{C} = 4\text{Au} + 12\text{HCl} + 3\text{CO}_2$; but G. A. König said that the action is more physical than chemical. S. Brussoff made observations on the precipitation of gold from soln. of auric chloride by animal and wood charcoal, coke, and graphite. The gold is retained by the carbon, and the chlorine remains in soln. M. Lazowsky found that soln. of copper, silver, gold, mercury, platinum and palladium salts are reduced by this agent and the metal is deposited on the charcoal. W. Heintz noted the precipitation of platinum from soln. of **platinum chloride**.

F. Feigl showed that when a soln. of **potassium chromate** is boiled with blood charcoal **potassium chromate** is formed, and he studied the oxidization of trivalent chromium to chromates. M. Berthelot¹² observed that at ordinary temp. charcoal is oxidized by a soln. of **chromic acid** and a little oxalic acid is formed. H. Moissan also found that amorphous carbon is readily oxidized by a mixture of chromic and sulphuric acids; the resistance to the attack is increased when the carbon has been preheated to a high temp. Molten chromic acid has very little action on graphite prepared from a soln. of carbon in melted platinum. R. E. and W. B. Rogers stated that diamonds are attacked at 180° to 230° by a mixture of **potassium dichromate** and sulphuric acid. G. Charpy found that a mixture of chromic acid and sulphuric acid oxidizes graphitic oxide or graphite to carbon dioxide more quickly than a mixture of conc. sulphuric acid and **potassium permanganate**. The former gives as much carbon dioxide at 45° as the latter does at 100°. A mixture of nitric acid and potassium chlorate was found to be less effective than the conc. sulphuric acid and **potassium permanganate**. The oxidizing action of some of these soln. is utilized in wet processes for the determination of carbon.¹³ L. J. Simon found that a mixture of silver dichromate and sulphuric acid oxidizes Canadian graphite completely, but the diamond, wood charcoal, coke, sugar charcoal, anthracite, and natural coke are only partially oxidized. The action of mixtures of sulphuric or nitric acid and potassium chlorate has been previously discussed.

The uses of carbon.¹⁴—The diamond is used as a gem-stone; for bearings, etc., in watches, electric meters, and scientific instruments; for testing the scratching hardness of minerals, etc.; for cutting glass; drilling glass and pottery; and, as a powder, in cutting diamonds, drilling rocks,—for which purpose carbonado is preferred because it has no tendency to cleavage, etc. Graphite is used in making refractory goods—*e.g.* bricks, crucibles—when the crystalline or flaky variety is preferred. A mixture of plastic clay with 50 to 75 per cent. of Cingalese graphite is moulded, dried, and fired in muffles in a reducing atm. It is used as a resistor in electric furnaces—*e.g.* *kryptol* is a mixture of graphite, carborundum, and clay so compounded as to give a granular mass; but graphite alone gives as good or even better results. Graphite is used in the manufacture of lead pencils. A mixture of graphite and clay, very carefully graded and washed, is moulded by expression, fired, and fitted into the wooden casing. Graphite—particularly the colloidal form (*q.v.*)—is used as a lubricant with or without tallow, grease, palm oil, etc. Graphite is used in the foundry as a facing for moulds; in making paints, particularly for coating iron surfaces; in electrotyping; for commutator brushes; in making battery plates; as a polishing medium—*e.g.* for gunpowder—in making stove polish; as a preventive of boiler scale; etc. Amorphous graphite, and charcoal

are used for decolorizing sugar, fats, glycerol, etc.; in the filtration and disinfection of liquids; for the separation and recovery of gases and vapours; the purification of gases; the storage of gases; as a catalyst in many reactions; in the production of high vacua; as an absorbent in gas masks for noxious gases, and in the removal of industrial stenches. The charcoal mask was recommended by J. Stenhouse in 1854. Charcoal is used as a constituent of some explosives; as a depilatory in the tannery; in making crucibles; battery plates; in the manufacture of indian ink, printers' ink, black paints; etc. The manufacture of carbon electrodes for electric furnaces and arc lighting is one of the most important branches of the carbon industry, and is growing rapidly as electric furnaces are increasingly applied in the metallurgical industries. As experience in the manufacture of carbon electrodes grows, the specifications as to purity, electrical resistance, hardness, and density become more and more stringent. Carbon electrodes were used by H. Davy¹⁵ about 1806. Carbon filaments are employed in incandescent electric lamps. The light emitted by a hot body increases rapidly with rise of temp. A platinum wire heated by the electric current gives a good light, but this metal melts at too low a temp. to render it satisfactory. Carbon filaments were then tried and they gave better results, but they had a comparatively short life. Improvements in the manufacture of the filaments considerably increased the length of their practical life. The useful life of a carbon filament lamp depends more on the vaporization than on the m.p. of the carbon. Different kinds of carbon have different vap. press. The graphitized filaments have the longer life.

The carbons are made by squirting a soln. of cellulose through a die which hardens the liquid into dense fibres; these are carbonized out of contact with air at as high a temp. as possible in a gas-fired oven. The filaments are afterwards heated electrically in an atm. of hydrocarbon gas and the decomposition of the hydrocarbon produces a smooth dense deposit of graphite. The filament is afterwards heated in an electric furnace at over 3000° for a few moments, and the result is known as the *metallized filament* because the temp. coeff. of its resistance is now similar to that of the metals. While the simple carbon filament has a practical life of about 100 hrs. at 3 watts per candle, the graphitized filament burns about 500 hrs., and the metallized filament 1500 hrs. under the same conditions.

Filaments made from osmium, tantalum, and tungsten are superior to carbon. Tungsten withstands the highest temp. without melting or vaporizing, and it gives the highest luminous efficiency.

The compounds of carbon with the other elements are bewildering in number and complexity. Over two hundred thousand have been isolated and analyzed, and more are synthesized every year. Hence, the study of the compounds of carbon, with the exception, conventionally, of a very small proportion, is relegated to a special division called Organic Chemistry.

REFERENCES.

¹ H. N. Warren, *Chem. News*, **59**, 29, 1889; J. Thomsen, *Ber.*, **5**, 769, 1872; R. Schenck and W. Heller, *ib.*, **38**, 2139, 1905; H. Moissan, *Recherches sur les différentes variétés de carbone*, Paris, 1896.

² C. Morren, *Compt. Rend.*, **48**, 342, 1859; M. Berthelot, *ib.*, **54**, 640, 1862; **140**, 905, 1905; H. Moissan, *ib.*, **116**, 460, 1893; A. Morren, *ib.*, **70**, 990, 1870; *Les Mondes*, **22**, 378, 1870; **23**, 25, 1870; *Bull. Soc. Chim.*, (2), **14**, 192, 1870; E. H. von Baumhauer, *Arch. Néerl.*, (1), **8**, 1, 1873; W. A. Bone and J. C. Cain, *Proc. Chem. Soc.*, **10**, 179, 1894; *Chem. News*, **70**, 264, 1894; W. A. Bone and D. S. Jerdan, *ib.*, **73**, 151, 1896; **74**, 268, 1897; *Proc. Chem. Soc.*, **12**, 268, 1896; **17**, 162, 1901; *Journ. Chem. Soc.*, **71**, 41, 1897; **79**, 1042, 1901; W. A. Bone and H. F. Coward, *ib.*, **93**, 1975, 1908; **97**, 1219, 1910; J. N. Pring, *ib.*, **97**, 498, 1910; J. N. Pring and D. M. Fairlie, *ib.*, **99**, 1796, 1910; **101**, 91, 1912; J. N. Pring and R. S. Hutton, *ib.*, **89**, 1591, 1906; *Zeit. Elektrochem.*, **14**, 2, 1907; F. Pollitzer, *Die Berechnung chemischer Affinitäten nach dem Nernstschen Wärmetheorem*, Stuttgart, 79, 1912; H. le Chatelier, *Recherches expérimentales et théoriques sur les équilibres chimiques*, Paris, 1888; *Ann. Mines*, (8), **13**, 157, 1888; P. Farup, *Zeit. anorg. Chem.*, **50**, 276, 1906; H. von Wartenberg, *Zeit. phys. Chem.*, **52**, 299, 1907; **61**, 366, 1907; **63**, 269, 1908; J. Sand and F. Breest, *ib.*, **59**, 424, 1907; J. Sand, *ib.*, **60**, 237, 1907; M. Mayer and V. Altmayer, *Ber.*, **40**, 2134, 1907; M. Mayer, *Ueber einige Gasreaktionen, Methanbildung und*

Kohlenoxyd-Kohlensäuregleichgewicht, Karlsruhe, 1908; V. Altmayer, *Ueber das Methangleichgewicht die Beziehungen zwischen Nickel und Wasserstoff und einige Methansynthesen mit Calciumhydrat*, Karlsruhe, 1909; B. L. Vanzetti, *Atti Real. Veneto*, 79. 471, 1920.

³ G. Lemoine, *Compt. Rend.*, 144. 387, 1907; J. B. Firth and F. S. Watson, *Journ. Soc. Chem. Ind.*, 42. 371, T, 1923; *Journ. Chem. Soc.*, 123. 1750, 1923.

⁴ H. Moissan, *Compt. Rend.*, 110. 276, 1890; 116. 460, 608, 1893; J. L. Gay Lussac and L. J. Thénard, *Recherches physico-chimiques*, Paris, 2. 94, 149, 1811; H. Davy, *Phil. Trans.*, 100. 16, 1810; 104. 74, 1814; H. L. F. Melsens, *Compt. Rend.*, 76. 92, 1872; 77. 781, 1872; *Phil. Mag.*, (4), 46. 410, 1872; G. Gore, *ib.*, (4), 29. 541, 1865; *Chem. News*, 50. 124, 1884; W. Skey, *ib.*, 36. 60, 1877; W. G. Mixter, *Amer. Journ. Science*, (3), 45. 363, 1893; (4), 19. 434, 1905; M. Berthelot and A. Guntz, *Compt. Rend.*, 99. 7, 1884; M. Berthelot, *ib.*, 54. 640, 1042, 1862; *Bull. Soc. Chim.*, (2), 9. 8, 91, 178, 265, 1867; A. Ditte, *ib.*, (2), 13. 318, 1870; *Recherches sur l'acide iodique*, Paris, 1870; *Ann. Chim. Phys.*, (4), 21. 5, 1370; *Compt. Rend.*, 70. 621, 1870; H. Debray and E. Péchard, *ib.*, 105. 27, 1887; P. Schützenberger, *ib.*, 53. 538, 1861; G. Lemoine, *ib.*, 144. 387, 1907; R. Lorenz, *Zeit. anorg. Chem.*, 10. 74, 1895; *Zeit. Elektrochem.*, 8. 203, 1902; W. von Bolton, *ib.*, 8. 165, 1902; 9. 209, 1903; A. Naumann and F. G. Mudford, *Ber.*, 30. 347, 1897; C. Willgerodt, *Journ. prakt. Chem.*, (2), 31. 539, 1885; A. Bartoli and G. Papasogli, *Gazz. Chim. Ital.*, 13. 22, 1883; 15. 446, 1885; *L'Orosi*, 11. 397, 1889; G. Gore, *Chem. News*, 21. 29, 1870; 50. 124, 1884; *Phil. Mag.*, (4), 39. 374, 1870; *Proc. Roy. Soc.*, 18. 157, 1870; F. Feigl, *Zeit. anorg. Chem.*, 119. 305, 1921; A. J. Balard, *Taylor's Scient. Mem.*, 1. 269, 1837; *Ann. Chim. Phys.*, (2), 57. 225, 1834; J. L. Gay Lussac, *ib.*, (1), 88. 311, 319, 1813.

⁵ W. Spring, *Ber.*, 16. 1002, 1883; *Chem. News*, 48. 66, 1883; *Bull. Soc. Chim.*, (2), 39. 641, 1893; *Bull. Acad. Belg.*, (3), 5. 492, 1883; G. Gore, *Chem. News*, 50. 124, 1884; F. Clément and J. B. Désormes, *Ann. Chim. Phys.*, (1), 42. 121, 1802; M. Berthelot, *ib.*, (5), 30. 547, 1883; (6), 21. 397, 1890; (7), 14. 206, 1898; *Bull. Soc. Chim.*, (2), 40. 362, 1883; *Compt. Rend.*, 96. 298, 1883; 110. 1106, 1890; W. G. Mixter, *Amer. Journ. Science*, (3), 45. 363, 1893; C. Brunner, *Pogg. Ann.*, 17. 84, 1829; G. J. Mulder, *Journ. Pharm. Chim.*, (2), 23. 62, 1838; *Journ. prakt. Chem.*, (1), 13. 444, 1838; G. C. Wittstein, *Repert. Pharm.*, 66. 62, 1834; A. Schrötter, *Liebig's Ann.*, 39. 297, 1841; B. Rathke, *ib.*, 152. 199, 1869; *Beiträge zur Kenntnis des Selens*, Halle, 1869; A. von Bartsch, *Chem. Ztg.*, 30. 1044, 1906; M. Shimosé, *Chem. News*, 49. 157, 1884; A. Eiboart, *ib.*, 52. 183, 1885; J. Mactear, *ib.*, 37. 271, 1878; S. Bidwell, *ib.*, 45. 135, 1882; *Phil. Mag.*, (5), 13. 347, 1882; T. Sidot, *Compt. Rend.*, 69. 1303, 1869; H. Moissan, *ib.*, 116. 460, 608, 1893; A. Scheurer-Kestner, *ib.*, 114. 117, 296, 1892; A. Verneuil, *ib.*, 118. 195, 1894; H. Debray and E. Péchard, *ib.*, 105. 27, 1887; M. Houdard, *ib.*, 143. 1230, 1906; B. Lepsius, *Ber.*, 23. 1637, 1890; K. Heumann and P. Köchlin, *ib.*, 15. 416, 1882; G. Tolomei, *L'Orosi*, 30. 8, 1897; F. Feigl, *Zeit. anorg. Chem.*, 119. 305, 1921; H. Giraud, *Bull. Soc. Chim.*, (3), 11. 389, 1894; A. Coehn, *Zeit. Elektrochem.*, 2. 541, 616, 1896; F. Vogel, *ib.*, 2. 581, 1896; A. Bartoli and G. Papasogli, *Gazz. Chim. Ital.*, 11. 236, 1881; 13. 37, 1883; *L'Orosi*, 11. 397, 1889; E. Kunheim, *Ueber die Einwirkung des Lichtbogens auf Gemische von Sulfaten mit Kohle*, Berlin, 1900; A. G. Doroshewsky and G. S. Paffoff, *Journ. Russ. Phys. Chem. Soc.*, 49. 169, 1917; J. J. Berzelius, *Schweigger's Journ.*, 23. 309, 1818; 34. 79, 1818; *Pogg. Ann.*, 7. 242, 1826; 8. 433, 1826; E. Mitscherlich, *ib.*, 9. 623, 1827; W. A. Lampadius, *Gehlen's Journ.*, 2. 192, 1796; *Journ. prakt. Chem.*, (1), 4. 451, 1835; M. C. Schuyten, *Handel. Vlaamsch Nat. Genees. Cong.*, 25, 1904; O. Boudouard, *Bull. Soc. Chim.*, (3), 25. 282, 1901; E. Philippi, *Liebig's Ann.*, 428. 286, 1922; E. Philippi and R. Thelen, *ib.*, 428. 296, 1922.

⁶ M. Berthelot, *Compt. Rend.*, 140. 905, 1905; 144. 354, 1907; *Bull. Soc. Chim.*, (2), 11. 449, 1869; W. Hempel, *Ber.*, 23. 1458, 1890; W. G. Mixter, *Amer. Journ. Science*, (3), 45. 363, 1893; P. L. Dulong, *Ann. Chim. Phys.*, (1), 2. 317, 1816; L. Clouet, *ib.*, (1), 11. 30, 1791; C. Langlois, *ib.*, (3), 1. 111, 1841; M. Bonjour, *Journ. l'École Polyt.*, 1. 436, 1796; *Scherer's Journ.*, 2. 621, 1799; F. Kuhmann, *Liebig's Ann.*, 38. 62, 1841; G. C. Weltzien, *ib.*, 132. 224, 1864; F. Feigl, *Zeit. anorg. Chem.*, 119. 305, 1921; J. Dalton, *Ann. Phil.*, 9. 186, 1817; H. Davy, *Chemical and philosophical researches chiefly concerning Nitrous oxide*, London, 1800; C. F. Schönbein, *Pogg. Ann.*, 73. 326, 1848; 100. 12, 1857; R. Weber, *ib.*, 147. 113, 1872; *Sitzber. Akad. Berlin*, 454, 1872; *Journ. prakt. Chem.*, (2), 6. 342, 1872; H. Debray and E. Péchard, *Compt. Rend.*, 105. 27, 1887; E. Philippi, *Liebig's Ann.*, 428. 286, 1922; E. Philippi and G. Rie, *ib.*, 428. 287, 1922.

⁷ C. F. Schönbein, *Pogg. Ann.*, 73. 326, 1848; 100. 12, 1857; J. Reiset and N. A. E. Millon, *Compt. Rend.*, 16. 1190, 1843; G. A. Hulett and O. A. Nelson, *Trans. Amer. Electrochem. Soc.*, 37. 103, 1920; W. A. Selvig and W. C. Ratliff, *ib.*, 37. 121, 1920; F. C. G. Müller, *Zeit. angew. Chem.*, 33. 1, 40, 1920; A. Lang, *Monat. Runds.*, 16. 1, 1916; A. Scott, *Chem. News*, 25. 77, 1872; G. Gore, *ib.*, 50. 124, 1884; R. J. Friswell, *ib.*, 65. 82, 1892; *Proc. Chem. Soc.*, 8. 9, 1892; F. B. Burls, R. E. Evans, and C. H. Desch, *ib.*, 68. 75, 1893; G. Dickson and T. H. Easterfield, *ib.*, 15. 163, 1898; H. Moissan, *Ann. Chim. Phys.*, (7), 8. 289, 1896; *Compt. Rend.*, 116. 608, 1893; 119. 976, 1245, 1894; 120. 17, 1895; 121. 538, 1895; P. and L. Schützenberger, *ib.*, 111. 774, 1890; P. Gaubert, *ib.*, 177. 1123, 1923; A. Bartoli and G. Papasogli, *Gazz. Chim. Ital.*, 11. 236, 1881; 12. 113, 1882; 13. 22, 1883; 15. 445, 1885; *L'Orosi*, 11. 397, 1889; H. Debray and E. Péchard, *Compt. Rend.*, 105. 27, 1887; A. Vogel, *Neues Jahrb. Pharm.*, 4. 1, 1855; F. Vogel, *Zeit. angew. Chem.*, 10. 18, 1897; G. Charpy, *ib.*, 145. 1173, 1907; 148. 920, 1909; H. le Chatelier and S. Wologdine, *ib.*, 146. 49, 1908; L. Carius, *Ber.*, 3. 697, 1870; W. Luzi, *Zeit. Naturwiss.*, 64. 224, 1892; *Ber.*, 24. 4085, 1891; 25. 1378, 1892; 26. 890, 1893; L. Staudenmaier, *ib.*, 31.

1481, 1898; **32**, 2824, 1899; C. F. Rammelsberg, *ib.*, **6**, 187, 1873; J. Stringl, *ib.*, **6**, 391, 1873; *Chem. News*, **27**, 264, 1873; S. Porcher, *ib.*, **44**, 203, 1881; J. Wilgner, *Monatsh.*, **13**, 371, 1892; E. Weinschenk, *Zeit. Kryst.*, **28**, 291, 1897; G. B. Trener, *Jahresb. Geol. Reichsanst. Wien*, **56**, 405, 1906; B. C. Brodie, *Phil. Trans.*, **149**, 249, 1859; V. Kohlschütter and P. Haenni, *Zeit. anorg. Chem.*, **105**, 121, 1919; F. Gottschalk, *Journ. prakt. Chem.*, (1), **95**, 321, 1865; P. Schafhäütl, *ib.*, (1), **21**, 155, 1840; R. F. Marchand, *ib.*, (1), **35**, 320, 1845; E. G. Acheson, *Journ. Franklin Inst.*, **147**, 475, 1899—*vide supra*; M. Berthelot, *Bull. Soc. Chim.*, (2), **12**, 4, 1869; M. Berthelot and P. Petit, *Compt. Rend.*, **110**, 101, 106, 1890; *Ann. Chim. Phys.*, (4), **19**, 401, 1870; (6), **20**, 20, 46, 1890; F. A. J. Fitzgerald, *Journ. Soc. Chem. Ind.*, **20**, 443, 1901; F. S. Hyde, *ib.*, **23**, 390, 1904; J. C. G. de Marignac, *Arch. Sciences Genève*, (2), **8**, 35, 1860; N. Fedoroff, *Zeit. Chem.*, (2), **5**, 17, 1869; T. Hübener, *Journ. Russ. Phys. Chem. Soc.*, **14**, 440, 1890; P. Debye and P. Scherrer, *Phys. Zeit.*, **18**, 291, 1917; L. Balbiano, *Annali Chim. App.*, **4**, 231, 1915; *Bull. Soc. Chim.*, (4), **19**, 194, 1916; J. Wiesner, *Monatsh.*, **13**, 371, 1892.

⁸ H. M. Kahn, *Compt. Rend.*, **143**, 49, 1906; **144**, 107, 1907; H. Moissan, *ib.*, **110**, 276, 1890; **116**, 460, 1893; J. Violle, *ib.*, **94**, 28, 1882; M. Berthelot, *ib.*, **96**, 298, 1833; *Ann. Chim. Phys.*, (5), **30**, 547, 1883; *Bull. Soc. Chim.*, (2), **40**, 362, 1883; O. Boudouard, *ib.*, (3), **25**, 232, 1901; G. Lemaire, *ib.*, (4), **3**, 935, 1908; *Compt. Rend.*, **144**, 357, 1907; **146**, 1360, 1908; J. B. Senderens, *ib.*, **144**, 381, 1907; P. Cazeneuve, *ib.*, **110**, 788, 1890; R. Ehrenfeld, *Journ. prakt. Chem.*, (2), **67**, 49, 1903; I. von Ostromisslensky, *ib.*, (2), **76**, 283, 1907; R. Doppouy, *Répert. Pharm.*, (3), **9**, 396, 1897; A. W. Hofmann, *Ber.*, **7**, 530, 1874; M. Bodenstein and C. G. Fink, *Zeit. phys. Chem.*, **60**, 1, 1907; C. C. Stanford, *Journ. Chem. Soc.*, **26**, 14, 1873; P. P. Bedson, *Journ. Soc. Chem. Ind.*, **27**, 147, 1906; C. Doelter, *Handbuch der Mineralchemie*, Leipzig, **1**, 37, 1912; V. A. Jaquelain and H. Baumhauer, *Wied. Ann.*, **1**, 173, 1877; L. Colomba, *Atti Accad. Lincei*, **24**, i, 1137, 1915; C. A. Parsons, *Phil. Mag.*, (5), **36**, 304, 1893—*vide synthesis of diamonds*; J. Stenhouse, *Proc. Roy. Inst.*, **2**, 53, 1855; A. Daubrée, *Compt. Rend.*, **110**, 18, 1890; H. L. Dejust, *ib.*, **144**, 1264, 1907; A. L. du Toit, *Zeit. Kryst.*, **45**, 309, 1908; G. Gore, *Chem. News*, **50**, 124, 1884; K. E. Glasson, *Liebig's Ann.*, **62**, 89, 1847; S. Petuchoff, *Journ. Russ. Phys. Chem. Soc.*, **13**, 234, 1881; R. S. Marsden, *Journ. Chem. Soc.*, **39**, 149, 1881; F. Feigl, *Zeit. anorg. Chem.*, **119**, 305, 1921.

⁹ C. R. A. Wright and A. P. Luff, *Journ. Chem. Soc.*, **33**, 1, 504, 1878; H. C. Greenwood, *ib.*, **93**, 1483, 1908; E. Berger and L. Delmas, *Bull. Soc. Chim.*, (4), **29**, 68, 1921; H. Moissan, *ib.*, (3), **31**, 1006, 1904; *Compt. Rend.*, **119**, 935, 1894; **138**, 243, 1904; A. Guntz, *ib.*, **114**, 115, 1892; R. Schenck and W. Heller, *Ber.*, **38**, 2139, 1905; A. Smits, *ib.*, **38**, 4027, 1905; R. Schenck, *Zeit. Elektrochem.*, **12**, 218, 1906; E. Baur, *ib.*, **12**, 122, 1906; B. Osann, *Stahl Eisen*, **27**, 1626, 1907.

¹⁰ N. A. E. Millon, *Compt. Rend.*, **51**, 249, 1860; P. Degener and J. Lach, *Dingler's Journ.*, **256**, 519, 1885; F. Haber and L. Bruner, *Zeit. Elektrochem.*, **10**, 697, 1904.

¹¹ C. F. Schönbein, *Pogg. Ann.*, **78**, 521, 1849; M. Lazowsky, *Journ. Chim. Méd.*, **6**, 43, 1848; *Chem. Gaz.*, **6**, 43, 1848; W. Heintz, *Liebig's Ann.*, **187**, 227, 1877; D. Tommasi, *Gazz. Chim. Ital.*, **11**, 242, 1881; C. Moride, *Compt. Rend.*, **41**, 605, 1855; A. F. Fol, *L'Institut*, **23**, 423, 1855; F. Feigl, *Zeit. anorg. Chem.*, **119**, 305, 1921; A. E. Esprit, *Journ. Chim. Méd.*, (3), **6**, 502, 1850; *Liebig's Ann.*, **76**, 276, 1850; D. Avery, *Journ. Soc. Chem. Ind.*, **27**, 255, 1908; G. A. König, *Chem. News*, **45**, 215, 1882; S. Brusoff, *Zeit. Koll.*, **5**, 137, 1909.

¹² M. Berthelot, *Bull. Soc. Chim.*, (2), **14**, 133, 1870; *Compt. Rend.*, **70**, 256, 1870; G. Charpy, *ib.*, **148**, 920, 1909; H. Moissan, *Ann. Chim. Phys.*, (7), **8**, 289, 1896; R. E. and W. B. Rogers, *Amer. Journ. Science*, (2), **5**, 352, 1848; (2), **6**, 110, 1848; F. Feigl, *Zeit. anorg. Chem.*, **119**, 305, 1921.

¹³ R. Warington and W. A. Peake, *Journ. Chem. Soc.*, **38**, 6, 17, 1880; C. F. Cross and E. J. Bevan, *ib.*, **53**, 889, 1888; A. H. Elliott, **22**, 182, 1869; R. Phelps, *Zeit. anorg. Chem.*, **16**, 85, 1898; L. J. Simon, *Compt. Rend.*, **177**, 122, 1923; E. Finkener, *Zeit. anal. Chem.*, **29**, 66, 1890; *Mitt. Ver. Anstalt. Berlin*, **156**, 1889; H. Heidenhain, *Techniker*, **14**, 66, 1893; L. Gmelin, *Oester. Zeit. Berg. Hütt.*, **32**, 708, 1884; H. von Jüptner, *ib.*, **31**, 493, 1885; **34**, 67, 83, 1886; F. A. Cairns, *Chem. News*, **25**, 271, 1872; *Amer. Chem. Journ.*, **2**, 140, 1872; C. Brunner, *Pogg. Ann.*, **95**, 379, 1855; E. Ullgren, *Liebig's Ann.*, **124**, 59, 1862.

¹⁴ F. Cirkel, *Graphite*, Ottawa, 1907; E. Donath, *Der Graphit*, Leipzig, 1904; A. Haenig, *Der Graphit*, Wien, 1910; A. B. Ray and N. R. Cheney, *Chem. Met. Engg.*, **28**, 1114, 1923; A. B. Ray, *ib.*, **29**, 354, 1923; W. A. Tilden, *Nature*, **103**, 24, 1919; J. Stenhouse, *Proc. Roy. Inst.*, **2**, 53, 1854; R. T. Stull and G. A. Bole, *Report Investigations U.S.A. Bur. Mines*, 2512, 1923.

¹⁵ H. Davy, *Phil. Trans.*, **97**, 1, 1807; L. Foucault, *Compt. Rend.*, **28**, 68, 1849; H. Fizeau and L. Foucault, *ib.*, **18**, 746, 1844; F. Carré, *ib.*, **84**, 346, 1877; W. Greener and W. E. Straites, *Brit. Pat. No.* 11076, 1846; W. E. Straites, *ib.*, 11449, 1846; 11783, 1847; T. Slater and J. J. W. Watson, *ib.*, 212, 595, 1852; A. E. le Molt, *ib.*, 12219, 1848; S. R. Illingworth, *ib.*, 191827, 1921; P. Jablochhoff, *ib.*, 492, 494, 1996, 3839, 1877; L. Siemons, *ib.*, 2199, 1877; J. Lacassagne and R. Thiers, *ib.*, 2456, 1856; *Nouveau système d'éclairage électrique*, Paris, 1857; M. Curmer, *French Pat. No.* 43420, 1860; M. Gauduin, *ib.*, 87569, 113706, 1876; A. Jaquelain, *ib.*, 23842, 1859; *Brit. Pat. No.* 2566, 1859; C. Girard and C. Street, *French Pat. No.* 230341, 231211, 1893; 236406, 240397, 1894; *Bull. Soc. Int. Electriciens*, **12**, 243, 1895; Gebr. Siemens and Co., *German Pat.*, D.R.P. 8253, 1879; O. G. Pritchard, *Electrician*, **24**, 492, 545, 568, 616, 1890; *The Manufacture of Electric Arc Carbons*, London, 1915; F. Je¹ *The Manufacture of Carbons*, London, 1899; F. Gall, *Fabrication et emploi des électrodes de*

are of equal value. The argument is negative rather than positive. A. Popoff showed that the two unsaturated valencies of carbon monoxide are of equal value; and A. Geuther, and L. Henry then attempted to demonstrate the equality of all four carbon valencies in so far as compounds with the same radicles introduced in different positions are identical in their properties. The argument is not conclusive since it can also be interpreted to mean that there is only one orientation for stable equilibrium when the compound is prepared in the different ways. According to J. U. Nef, the two bromopropionic acids

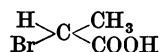
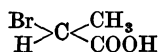

behave differently towards polarized light being respectively dextro- and lævotopic. When heated, hydrogen bromide is given off, and the residual ethylidene carboxylic acid absorbs ammonia, H.NH_2 , water, H.OH , etc., furnishing products which ought to be the same if all the carbon valencies are alike, but two derivatives are obtained from the *d*- and *l*-acids. Hence, argued J. U. Nef, the four carbon valencies are not alike each to each, but are eq. in pairs as illustrated by $\pm \text{C} \mp$, so that the products of decomposition would be represented

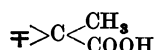
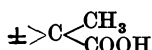

P. Walden found that the *d*- and *l*-monobromosuccinic acids change on standing 2 to 5 years at ordinary temp. so as to form a mixture of equal amounts of the two acids; and a similar change occurs with the *d*- and *l*-lactic acids in 2 or 3 days at 140° .

The disposition of the four valencies of the carbon atom has been the subject of much discussion. J. H. van't Hoff's view that the carbon atom is a material point at the centre of a tetrahedron with its valencies directed towards the four spices has been previously outlined (1. 5, 15). J. A. le Bel has modified this hypothesis. E. Knoevenagel suggested that the valencies of the tetrahedral carbon atom are directed, not to the corners, but to the middle of the sides; and F. W. Hinrichsen showed that the so-called double bonds can then be regarded as expressing the union of two carbon atoms along a common edge. J. Thiele assumed that the carbon atom has a *residual* or *partial valency* over and above its quadrivalency; and that the partial valencies of adjacent carbon atoms are conjugated.

Carbon in triphenyl methyl, $\text{C}(\text{C}_6\text{H}_5)_3$, prepared by M. Gomberg, may be *tervalent*. The compound has been studied by F. Kehrman and F. Wentzel, J. F. Norris and L. R. Culver, W. Loeb, J. Piccard, W. Schlenk and co-workers, J. Schmidlin, A. E. Tschitschibabin, etc. It appears probable that the white solid is hexaphenylethane, $(\text{C}_6\text{H}_5)_3\text{C.C}(\text{C}_6\text{H}_5)_3$, which slowly dissociates in organic solvents, forming a yellow soln. which contains free triphenylmethyl, $(\text{C}_6\text{H}_5)_3\text{C.C}(\text{C}_6\text{H}_5)_3 \rightleftharpoons 2\text{C}(\text{C}_6\text{H}_5)_3$. The case appears to be analogous to that of cuprous chloride, $\text{Cu}_2\text{Cl}_2 \rightleftharpoons 2\text{CuCl}$. A. E. Tschitschibabin, and F. W. Hinrichsen hold that in ethylene, C_2H_4 , carbon is *tervalent* and not *quadrivalent* with a double bond, because the mol. vol. is greater in bodies with the so-called double bond than it is in those with single linkages. This is not what would be anticipated, for atoms with a double bond should be nearer together than if bonded with single linkages. This argument is not conclusive. J. U. Nef, L. Gattermann, R. Scholl, etc., hold that in hydrocyanic acid, $\text{C}:\text{NH}$, the isonitriles, $\text{C}:\text{N.R}$; and fulminic acid, $\text{HO.N}:\text{C}$, carbon is truly *bivalent*. A. E. Tschitschibabin, and F. W. Hinrichsen hold that in acetylene, C_2H_2 , carbon is *bivalent* because with quadrivalent carbon and a triple bond, acetylene is not likely to be so stable as it really is. A. Gillet also discussed the bivalency of carbon. The bivalency of carbon in carbon monoxide has been previously discussed (1. 5, 13). If carbon here be *quadrivalent*, J. W. Brühl said that the calculated and observed values for the mol. refraction are in agreement, but not if the carbon be *bivalent*, $\text{C}:\text{O}$. F. Landolph suggested that in acetone dihydrofluoride, $\text{C}_3\text{H}_6\text{O}.2\text{HF}$, the

carbon is *sexivalent*, but, as F. W. Hinrichsen has shown, there is no need for this assumption; among other possible formulæ, carbon quadrivalent, there is $(\text{CH}_3)_2\text{C}(\text{OH})\text{F}$. Similarly, in J. Thiele and W. Peter's methyl iododichloride, CH_3ICl_2 , carbon appears to be *sexivalent*, and in M. Gomberg's triphenylbromomethane tetraiodide, $\{(\text{C}_6\text{H}_5)_3\text{CBr}\}_4\text{I}_4$, carbon appears to be *octovalent*. In these cases the carbon is quadrivalent when the halogens are assumed trivalent.

The carbon molecule.—D. Aufhäuser² argued that from its position in the periodic table, and the character of its compounds, carbon ought to be a very reactive gas. That it is not is taken as evidence that solid carbon is highly polymerized. The number of atoms contained in the carbon molecule is unknown. The non-volatility of carbon, except at very high temp., has led to the view that the molecule is very complex. According to H. F. Jüptner von Jonstorff, and W. C. Roberts-Austen, the presence of 0.5 per cent. of carbon in iron lowers the m.p. about 70° ; and with this datum the number of atoms per mol. of carbon in molten iron is two; it is also estimated that at 850° , the mol. is triatomic; and at lower temp., still more complex. Here, the assumption is made that the carbon does not form a complex with the iron. From cryoscopic observations on soln. of carbon in iron and cobalt, A. Jouniaux also estimated that the graphite mol. above 1500° is monatomic when in soln. in these metals. H. F. Jüptner, H. W. B. Roozeboom, etc., have shown that the carbon is probably present as a carbide between 1650° and 1250° . P. J. van Kerckhoff assumed that the molecule of amorphous carbon is C_2 , of graphite, C_3 , and of the diamond, C_4 , so as to make the observed sp. hts. fit the mol. ht. 6.4 ; C. E. Carbonelli likewise assumed that the diamond has a molecule C_5 . H. W. Kolbe suggested that graphite has mols. of bivalent carbon, that amorphous carbon has mols. of trivalent carbon, and that the diamond has a mol. C_3 , consisting of two atoms of bivalent carbon and one atom of quadrivalent carbon, $\text{C}:\text{C}:\text{C}$. E. Donath supposed that the diamond mol. is diatomic; and that amorphous carbon is polyatomic. According to W. Vaubel, calculations based on the difference between the heats of combustion of carbon and carbon monoxide lead to the conclusion that the mol. of carbon at its b.p. contains 24 atoms. The heat of dissociation of this complex carbon mol. is taken as 32,300 cal., and hence it is deduced that acetylene, carbon disulphide, and other compounds which have commonly negative heats of formation assigned to them, have really positive heats of formation. All this, however, is merely guessing, and furnishes no precise information. W. Nernst's observations on the sp. ht. of the diamond fit formulæ deduced on the assumption that the mol. of the solid is monatomic; while the sp. ht. of graphite fits better the assumption that the mol. is polyatomic, C_n , where n is greater than unity.

The heat of combustion of carbon is the joint effect of an absorption of heat owing to the degradation of the complex mol. into atoms, and the heat of oxidation of the carbon to its oxide, CO_2 . M. Copisaroff assumes that the cause of the progressive increase in the heat of combustion of carbon in passing from the diamond to charcoal is due to the varying stability of the carbon mol. in the cases, and that this in turn depends upon the mode of linking of the units inside the mol.; that the mols. with atoms free to rotate will be the least stable, while mols. with rigid atoms will be the most stable; and in the intermediate case, some atoms will be rigid and some free. The greater the rigidity, the larger the heat of combustion. In amorphous carbon, added M. Copisaroff, the atoms are mobile and not rigid; in the diamond all the atoms are rigid; and in graphite, some atoms are rigid, and some are mobile. This is also thought to explain the regular gradation in any selected physical property in passing from amorphous carbon to the diamond—*vide supra*, action of nitric acid on carbon.

The intermediate products of the moist oxidation of carbon led V. Meyer to the view that the carbon mol. is polyatomic; similar views have been advocated by many chemists—J. Dewar, F. A. Kekulé, W. Barlow and W. J. Pope, H. S. Redgrove and J. C. Thomlinson, etc. According to H. Meyer, the diamond resists oxidation

by wet processes, while graphite furnishes no mellitic acid, $C_6(COOH)_6$, if oxidized directly, but if it be first converted into graphitic acid, the latter does give some mellitic acid; coal gives very little of this acid, but charcoal gives a relatively large proportion of mellitic acid which occurs combined with aluminium in nature as *honeystone*. This acid has been studied by H. Meyer and K. Steiner, and by W. J. Jarrad. In the presence of osmium tetroxide, as catalytic agent, amorphous carbon can be oxidized to carbon dioxide, mellitic acid, etc., by potassium chlorate at 100° . This curious acid is assumed to have the structural relationship with benzene indicated in the subjoined graphic formulæ, and it is further suggested that mellitic acid and carbon have an analogous structure :

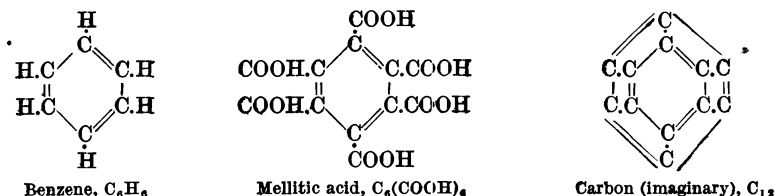

During the wet oxidation of carbon, there is formed a yellow hygroscopic mass with an acid reaction, which is soluble in alcohol and ether, and which becomes black with alkalis. There is evidence that the yellow mass probably contains an acid derivative of a hydrocarbon with a five carbon ring, and O. Dimroth and B. Kerkovius hence believe that the carbon mol. consists of atoms arranged pentagonally as well as hexagonally. O. Aschan considers that the concentric hexagonal arrangement of the carbon atoms in J. Dewar's mol. would leave the atoms so strained that charcoal would be an explosive substance like acetylene. The very great stability of charcoal makes him believe that the mol. has a web-like structure formed of atoms arranged as illustrated in Fig. 19, where the dots represent quadrivalent carbon atoms. He considers that the hydrogen invariably associated with wood charcoal is really united with the carbon atoms at the outer boundary; and the nitrogen (1 per cent.) invariably found with bone charcoal replaces some of the boundary CH-group. This means that wood and bone charcoals are complex organic compounds and not forms of elementary carbon. Modifications of this hypothesis were used by T. F. E. Rhead and R. V. Wheeler, and I. Langmuir to explain the oxygenation of carbon, etc.

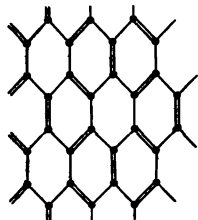

FIG. 19. — O. Aschan's Carbon Molecule.

The term molecule used in this sense has a different connotation to that regularly employed in chemistry. The X-radiogram revelations of the structure of the diamond and graphite have been discussed in a previous section—Figs. 10 to 12. L. F. Hawley and S. S. Aiyar have discussed the presence of a small proportion of methoxy-groups in wood charcoal.

The atomic weight of carbon.—The at. wt. of carbon was first deduced from the analysis and density of carbon dioxide. A. L. Lavoisier³ found that gas contained 24 to 28 per cent. of carbon; F. Clément and J. B. Désormes, 27 to 28 per cent.; N. T. de Saussure, 27.04 to 27.38 per cent.; S. Tennant, 27 to 27.8 per cent.; W. Allen and W. H. Pepys, 28.60 to 28.67 per cent.; and J. L. Gay Lussac, 27.38 per cent. The last-named also obtained 42.99 per cent. of carbon in carbon monoxide, and he later inferred that the at. wt. of carbon is 6, when that of oxygen is 16; and he represented the formula of carbon dioxide by C_2O_2 , and that of carbon monoxide by C_2O , analogous to water H_2O .

According to H. E. Roscoe and A. Harden,⁴ in his first table of at. wt., J. Dalton gave 4.5 for the at. wt. of carbon, and in 1808, he changed this to 5. W. Prout, in 1815, gave 6 for the at. wt. (O=8); in 1817, J. J. G. Meinecke, and L. Gmelin gave 6 (O=8); in 1826, L. J. Thénard gave C=12.25 (H=1); in 1834, P. T. Meissner

gave 4.24 ($H=1$); and in 1837, O. B. Kühn gave $C=6.1$ ($H=1$). This confusion in the at. wt. was not clarified until A. Avogadro's hypothesis had been used as the touchstone. Never less than 12 parts by weight of carbon are present in a molecular proportion of the volatile compounds of carbon (1. 5, 5). This makes the hydrogen eq. of carbon in carbon monoxide to be 6, and in carbon dioxide 3. In cases where the laws are applicable to soln, the same conclusion is obtained with soln. of carbon compounds. There is a vacancy in the periodic table for an element between boron, 11.0, and nitrogen, 14; and carbon fits very well in this place as a member of the family of quadrivalent elements.

The atomic heat of carbon deviates from the normal value 6.4 if 12 be the at. wt. of carbon. H. V. Regnault accordingly proposed 24 for the at. wt. of carbon; and B. C. Brodie, 33 for the at. wt. of graphitic carbon which he called *graphon*. Neither suggestion was of any particular value. This law of isomorphism (1. 11, 10) has not been of much assistance in fixing the at. wt. of carbon, since it shows few crystallographic analogies with the other members of the same family of elements. Indeed, P. Groth said:

The profound chemical differences exhibited by carbon and silicon are reflected in the fact that except for the agreement between the cubic crystalline forms of the two iodides, CI_4 and SiI_4 , there is no isomorphism between analogously constituted compounds of the two elements—between the carbonates and silicates, for example—and also in the fact that the two elements unite to form a very stable compound, carborundum, CSi , whose crystalline form exhibits no relation to that of either of its constituent elements.

The various methods which have been employed for obtaining the at. wt. of carbon can be arranged in two groups—chemical and physical. The chemical methods can be subdivided: (i) The combustion of carbon to carbon dioxide; (ii) the combustion of carbon monoxide or other compounds of carbon to carbon dioxide; and (iii) the analysis of the carbonates or organic salts of the metals—lead, silver, and beryllium. In 1838, J. B. A. Dumas⁵ analyzed naphthalene, and concluded that the at. wt. of carbon, 12.24, obtained by J. J. Berzelius and P. L. Dulong in 1819, by a physical method, was too high. In 1839, J. J. Berzelius analyzed lead oxalate and carbonate, and obtained 12.242, which confirmed his former result.

The determination of the atomic weight of carbon by the combustion of carbon or carbonaceous compounds.—J. B. A. Dumas and J. S. Stas, in their *Recherches sur le véritable poids atomique du carbone*, determined the ratio $C:CO_2$ by burning diamond, and natural and artificial graphite in oxygen. They thus obtained 11.9975 for the at. wt. of carbon. O. L. Erdmann and R. F. Marchand made a similar investigation and obtained 12.0093; H. E. Roscoe likewise obtained 12.0029; C. Friedel, 12.0112; and J. D. van der Plaats, 12.0031. J. B. A. Dumas and J. S. Stas tested the corrections for the change in volume of the soln. of potassium hydroxide produced by the absorption of carbon dioxide, and by some inexplicable error, they concluded that

En tenant compte dans la pesée du diamant du poids de l'air qu'il déplace et dans celle de l'acide carbonique condensé de l'air qu'il déplace aussi ces rapports ne sont pas altérés.

A. Scott showed that the magnitude of the correction is quite serious, lowering the values:

	J. B. A. Dumas and J. S. Stas	O. L. Erdmann and R. F. Marchand	H. E. Roscoe	C. Friedel	J. D. van der Plaats
Uncorrected . . .	11.9975	12.0093	12.0029	12.0112	12.0031
Corrected . . .	11.9938	12.0054	11.9973	12.0056	12.0018

B. Brauner also checked these calculations. J. S. Stas, in his *Recherches nouvelles sur le véritable poids atomique du carbone*, described experiments in which carbon monoxide was passed over heated copper oxide. He determined the loss in weight of the copper oxide, and the weight of carbon dioxide formed. From the ratio $(CuO \text{ less } Cu):CO_2$, he obtained the at. wt. 12.0046. J. S. Stas' results were criticized by A. Scott, and J. D. van der Plaats. A. Scott also analyzed

naphthalene and cinnamic acid by combustion, and obtained, respectively, 11·999 and 12·002 for the at. wt. of carbon.

The determination of the atomic weight of carbon by the analysis of metal salts containing carbon.—In 1811, and in 1814, J. J. Berzelius analyzed lead carbonate, and combining the results with J. L. Gay Lussac's observations on the C : O₂ ratio in carbon dioxide, and from the ratio CO₂ : PbO, obtained results corresponding with the at. wt. 12·026 ; while in 1839, from the ratios PbCO₃ : PbO, and PbC₂O₄ : PbO, obtained 12·242 ; and in 1841, from analysis of the lead salts of organic acids, he obtained 12·118. J. von Liebig and J. Redtenbacher analysed silver acetate, and from the ratio AgC₂H₃O₂ : Ag obtained 12·039 ; with silver tartrate, Ag₂C₄H₄O₆ : Ag, 12·044 ; with silver racemate, Ag₂C₄H₄O₆ : Ag, 12·049 ; and with silver malate, Ag₂C₄H₄O₅ : Ag, 12·050. A. Strecker recalculated these values by the method of least squares. J. C. G. de Marignac obtained with silver acetate, AgC₂H₃O₂ : Ag, 12·036 ; E. J. Maumené with silver acetate, and oxalate and the respective ratios AgC₂H₃O₂ : Ag : CO₂, and Ag₂C₂O₄ : Ag : 2CO₂, obtained 11·934 and 11·928. The general tendency is for these results to be a little high owing to the slight volatilization of silver during the ignition. W. L. Hardin electrolyzed silver acetate and benzoate dissolved in a soln. of potassium cyanide, and from the ratio AgC₂H₃O₂ : Ag obtained 11·9999 ; and from the ratio AgC₇H₅O₂ : Ag, 12·0011. C. L. Parsons analyzed beryllium acetylacetonate and basic acetate, and from the respective ratios Be(C₅H₇O₂)₂ : BeO, and Be₄O(C₂H₃O₂)₆ : 4BeO, obtained 12·007 when the at. wt. of beryllium is 9·112. A. Scott titrated tetramethylammonium bromide and tetraethylammonium bromide with a standard soln. of silver and obtained 12·017 and 12·019 respectively. These determinations were discussed by T. E. Thorpe from the point of view of P. A. Guye and N. Zachariades' observations on the tendency of finely divided substances to absorb air. T. W. Richards and C. R. Roover evaluated the ratio Na₂CO₃ : 2Ag = 29·4351 : 59·91676, and hence computed 12·003 for the at. wt. of silver ; E. Moles argued that if another value were adopted for sodium, these results agree with the at. wt. 12·000 for carbon.

The determination of the atomic weight of carbon by physical methods.—In 1814, W. H. Wollaston⁶ calculated the at. wt. of carbon from the density determinations of oxygen and carbon dioxide by J. B. Biot and F. J. Arago. It was assumed that no change in volume occurs when the oxygen is converted into carbon dioxide. W. H. Wollaston obtained 12·063 for the at. wt. of carbon, oxygen 16. J. J. Berzelius and P. L. Dulong obtained 12·24 in a similar manner. The latter value was accepted for some years, although, in 1836, T. Thomson obtained 12·000 from density determinations. F. J. Wrede showed that, owing to the greater compressibility of carbon dioxide, oxygen yields rather less than its own vol. of carbon dioxide, the density of which is correspondingly high. After making an allowance for this, he obtained 12·023 from the ratio CO₂ : CO ; 12·021 from the ratio CO : O ; and 12·022 from the ratio CO₂ : O. P. A. Guye and T. Batuecas obtained 11·998 by this method. D. Berthelot by his method of limiting densities (l. 5, 8), and the density determinations of A. Leduc, and Lord Rayleigh, obtained numbers ranging from 12·000 to 12·007—probable mean 12·005—for the at. wt. of carbon ; with G. Baume and F. L. Perrot's value for the density of methane, the value 12·0085 was obtained ; and for ethane, 12·036. Lord Rayleigh's value for the density and compressibility of carbon monoxide gave 12·003. A. Jacquerod and F. L. Perrot measured the expansion of carbon monoxide and dioxide up to 1067·4°, and from the mean densities obtained the respective at. wt. 12·009 and 11·992. G. Baume calculated from the density of methyl ether, (CH₃)₂O, the at. wt. 11·9919 ± 0·0010 ; and A. Leduc's value for the density of toluene gave 12·003. A. Leduc's method of limiting densities (l. 13, 4) with carbon monoxide and dioxide, and with acetylene, gave 12·005. P. A. Guye's method of critical constants (l. 13, 4) with carbon monoxide and methane, with Lord Rayleigh's and A. Leduc's data for carbon monoxide, gave 12·003 ; and, with G. Baume and F. L. Perrot's value for methane, 12·004.

Observations or summaries have been made by P. A. Guye, N. Delaunay,

A. Leduc, J. A. Wanklyn, etc. G. D. Hinrichs, and E. Moles advocated the whole number 12 for the at. wt. J. A. Groshans discussed the relation of W. Prout's hypothesis to the at. wt. of carbon. B. Brauner summarized the various determinations of the at. wt. of carbon prior to 1909, and obtained 12.002 with an uncertainty of one unit in the third decimal place; F. W. Clarke obtained 12.0000 ± 0.00029 . The International Table of atomic weights for 1922 gave **12.005** as the best representative value. E. Rutherford and J. Chadwick found no evidence of the **disintegration of the carbon atom** when bombarded by α -rays. The **atomic number of carbon is 6**. F. W. Aston found no **isotopes**.

L. Bell and P. R. Bassett found helium lines in the spectrum of the negative tongue in the carbon arc of at least 100 amp. They assume this shows that some carbon atoms have dissociated into helium; but other more probable interpretations are possible. Some hydrogen lines are attributed to adsorbed water vapour.

REFERENCES.

- ¹ F. A. Kekulé, *Liebig's Ann.*, **101**, 200, 1857; **104**, 129, 1857; H. W. Kolbe, *ib.*, **101**, 262, 1857; A. Popoff, *ib.*, **145**, 283, 1868; E. Knoevenagel, *ib.*, **311**, 194, 1900; F. W. Hinrichsen, *ib.*, **336**, 175, 1904; *Zeit. phys. Chem.*, **39**, 305, 1902; *Ueber den gegenwärtigen Stand der Valenzlehre*, Stuttgart, 1902; H. Kauffmann, *Die Valenzlehre*, Stuttgart, 1911; P. Brühlants, *La valence chimique*, Louvain, 1912; J. Picard, *Liebig's Ann.*, **381**, 347, 1911; W. Schlenk, T. Weickel, and A. Herzenstein, *ib.*, **372**, 1, 1910; H. E. Armstrong, *Science Progress*, **3**, 484, 1909; P. Walden, *Ber.*, **32**, 1833, 1856, 1899; J. W. Brühl, *ib.*, **24**, 663, 1891; A. E. Tschitschibabin, *ib.*, **38**, 771, 1905; *Journ. Russ. Phys. Chem. Soc.*, **37**, 109, 1905; M. Gomberg, *Ber.*, **33**, 3150, 1900; **34**, 2726, 1901; **35**, 2397, 1902; **36**, 376, 3928, 1903; **37**, 1626, 1904; *Journ. Amer. Chem. Soc.*, **20**, 290, 1898; **24**, 597, 1902; *Amer. Chem. Journ.*, **25**, 317, 1901; J. F. Norris and L. R. Culver, *ib.*, **29**, 129, 1903; J. F. Norris, *ib.*, **26**, 117, 1901; F. Kehrman and F. Wentzel, *Ber.*, **34**, 3815, 1901; J. Schmidlin, *ib.*, **39**, 4183, 1906; F. Landolph, *Compt. Rend.*, **86**, 1463, 1878; **96**, 580, 1883; J. A. R. Newlands, *Chem. News*, **13**, 229, 1866; J. U. Nef, *Journ. Amer. Chem. Soc.*, **20**, 645, 1898; **26**, 1549, 1904; *Liebig's Ann.*, **270**, 267, 1892; **280**, 291, 1894; **287**, 265, 303, 1895; **303**, 202, 274, 332, 1897; L. Gattermann, *Ber.*, **31**, 1149, 1898; R. Scholl, *ib.*, **23**, 3506, 1890; **32**, 3492, 1899; J. Thiele and W. Peter, *ib.*, **38**, 2842, 1905; J. Thiele, *Liebig's Ann.*, **306**, 87, 1890; A. Geuther, *ib.*, **205**, 223, 1880; **218**, 12, 1883; **240**, 192, 225, 1887; V. Meyer, *ib.*, **180**, 192, 1876; V. Meyer and E. Reicke, *Ber.*, **21**, 946, 1888; L. Henry, *Compt. Rend.*, **104**, 1106, 1887; *Zeit. phys. Chem.*, **2**, 553, 1888; *Bull. Acad. Belg.*, **722**, 1906; (3), **12**, 644, 1886; (3), **15**, 333, 1888; A. W. Williamson, *Journ. Chem. Soc.*, **4**, 106, 229, 1852; G. J. Burch and J. E. Marsh, *ib.*, **55**, 654, 1889; J. A. N. Friend, *ib.*, **93**, 260, 1908; *The Theory of Valency*, London, 1915; C. F. Gerhardt, *Ann. Chim. Phys.*, (2), **72**, 184, 1839; *Traité de chimie organique*, Paris, 1853-6; R. Hermann, *Journ. prakt. Chem.*, (2), **17**, 49, 289, 1878; J. U. Nef, *Journ. Amer. Chem. Soc.*, **30**, 645, 1908; E. Paterno, *Atti Accad. Lincei*, (5), **16**, ii, 717, 1907; J. H. van't Hoff, *La chimie dans l'espace*, Rotterdam, 1874; J. A. le Bel, *Bull. Soc. Chim.*, (3), **3**, 788, 1890; A. Wunderlich, *Konfiguration organischer Moleküle*, Würzburg, 1886; A. Stock, *Zeit. angew. Chem.*, **35**, 341, 1922; E. Bloch, *Theorie des Kohlenstoffatoms*, Wein, 1903; A. von Weinberg, *Kinetische Stereochemie Kohlenstoffverbindungen*, Braunschweig, 1914; E. Frankland, *Proc. Roy. Soc.*, **14**, 198, 1865; G. Martin, *Researches on the Affinities of the Elements*, London, 187, 1905; A. Gillet, *Bull. Soc. Chim. Belg.*, **30**, 329, 1921; W. Loeb, *Ber.*, **36**, 3063, 1903.
- ² W. J. Jarrad, *Proc. Chem. Soc.*, **29**, 106, 1913; H. Meyer and K. Steiner, *Ber.*, **46**, 813, 1913; A. Jouriaux, *Bull. Soc. Chim.*, (4), **33**, 260, 1923; D. Aufhäuser, *Feuerungstechnik*, **11**, 177, 1923; P. J. van Kerckhoff, *Arch. Néerl.*, (1), **2**, 280, 1867; C. E. Carbonelli, *Gazz. Chim. Ital.*, **22**, 123, 1892; *Atti Soc. Ligust.*, **2**, 1, 1892; E. Donath, *Oester. Zeit. Berg. Hutt.*, **52**, 333, 348, 1894; H. W. Kolbe, *Journ. prakt. Chem.*, (2), **7**, 119, 1873; W. Vaubel, *Zeit. angew. Chem.*, **13**, 60, 1900; D. I. Mendeleeff, *Ber.*, **2**, 664, 1869; F. Schulze, *ib.*, **4**, 802, 806, 1871; W. Nernst, *The Theory of the Solid State*, London, 47, 93, 1914; J. Dewar, *Chem. News*, **97**, 16, 1908; M. Copisaroff, *Mem. Manchester Lit. Phil. Soc.*, **58**, 10, 1914; *Journ. Amer. Chem. Soc.*, **43**, 1870, 1921; V. Meyer, *Ber.*, **4**, 801, 1871; *Liebig's Ann.*, **180**, 195, 1875; H. Meyer, *Monatsh.*, **35**, 163, 1914; W. C. Roberts-Austen, *Journ. Iron Steel Inst.*, **56**, 17, 1899; *Chem. News*, **79**, 246, 257, 271, 1899; O. Dimroth and B. Kerkovius, *Liebig's Ann.*, **399**, 120, 1913; O. Aschan, *Chem. Zig.*, **33**, 561, 1909; T. F. E. Rhead and R. V. Wheeler, *Journ. Chem. Soc.*, **103**, 461, 1913; W. Barlow and W. J. Pope, *ib.*, **89**, 1742, 1906; H. S. Redgrove and J. C. Thomsinson, *Chem. News*, **98**, 37, 1908; L. F. Hawley and S. S. Aiyar, *Journ. Ind. Eng. Chem.*, **14**, 1055, 1922; L. F. Hawley, *ib.*, **15**, 697, 1923; H. W. B. Roozeboom, *Zeit. phys. Chem.*, **34**, 436, 1900; H. F. Jüptner, *Kohlenstoffformen im Eisen*, Stuttgart, 453, 1896; *Journ. Iron Steel Inst.*, **55**, 247, 1898; I. Langmuir, *Journ. Amer. Chem. Soc.*, **37**, 1139, 1915; **38**, 1145, 2221, 1916; F. A. Kekulé, *Zeit. angew. Chem.*, **12**, 950, 1899.
- ³ A. L. Lavoisier, *Mém. Acad.*, 448, 1781; *Crell's Ann.*, **9**, 552, 1788; **10**, 55, 1788;

- N. T. de Saussure, *Ann. Chim. Phys.*, (1), **71**, 254, 1809; F. Clément and J. B. Désormes, *ib.*, (1), **38**, 285, 1801; J. L. Gay Lussac, *Mém. Soc. Arcueil*, **2**, 207, 1809; *Alembic Club Reprints*, **4**, 1893; W. Allen and W. H. Pepys, *Phil. Trans.*, **97**, 267, 1807; S. Tennant, *ib.*, **87**, 123, 1797.
- ⁴ **1**, **2**, **15**; J. Dalton, *A New System of Chemical Philosophy*, Manchester, 1808; B. C. Brodie, *Phil. Trans.*, **149**, 249, 1859; H. V. Regnault, *Compt. Rend.*, **24**, 1081, 1847; W. Prout, *Ann. Phil.*, **11**, 321, 1815; **12**, 111, 1816; P. Groth, *Einleitung in die chemische Krystallographie*, Leipzig, **51**, 1904; London, **77**, 1906; H. E. Roscoe and A. Harden, *A New View of the origin of Dalton's Atomic Theory*, London, 1896; J. J. G. Meinecke, *Die chemische Messkunst*, Halle, 1817; L. Gmelin, *Handbuch der theoretischen Chemie*, Frankfurt a. M., 1817; L. J. Thénard, *Traité de chimie*, Paris, 1827; P. T. Meissner, *Chemische Aequivalenten oder Atomlehre*, Wien, 1834; O. B. Kühn, *Lehrbuch der Stöchiometrie*, Leipzig, 1837.
- ⁵ J. B. A. Dumas, *Compt. Rend.*, **6**, 460, 1838; J. J. Berzelius and P. L. Dulong, *Ann. Chim. Phys.*, (2), **15**, 392, 1819; E. J. Maumené, *ib.*, (3), **18**, 41, 1846; J. B. A. Dumas and J. S. Stas, *ib.*, (3), **1**, 1, 1841; *Compt. Rend.*, **11**, 991, 1008, 1841; J. Persoz, *ib.*, **12**, 512, 1841; H. E. Roscoe, *ib.*, **94**, 1180, 1882; *Ann. Chim. Phys.*, (5), **26**, 136, 1882; J. D. van der Plaats, *Compt. Rend.*, **100**, 52, 1885; C. Friedel, *Bull. Soc. Chim.*, (2), **42**, 100, 1884; J. S. Stas, *Bull. Acad. Belg.*, **16**, 1, 1849; O. L. Erdmann and R. F. Marchand, *Journ. prakt. Chem.*, (1), **23**, 159, 1841; A. Scott, *Journ. Chem. Soc.*, **71**, 550, 1897; **95**, 1200, 1909; *Proc. Chem. Soc.*, **20**, 85, 1904; **25**, 286, 310, 1909; T. E. Thorpe, *ib.*, **25**, 285, 1909; J. J. Berzelius, *Gilbert's Ann.*, **38**, 197, 1811; *Afhand. Fysik. Kemi*, **5**, 116, 1811; *Ann. Phil.*, **3**, 59, 1814; *Liebig's Ann.*, **38**, 195, 1841; J. von Liebig and J. Redtenbacher, *ib.*, **38**, 113, 1841; A. Strecker, *ib.*, **59**, 265, 1846; J. C. G. de Marignac, *ib.*, **59**, 287, 1846; C. L. Parsons, *Journ. Amer. Chem. Soc.*, **27**, 1204, 1905; W. L. Hardin, *ib.*, **18**, 990, 1896; T. W. Richards and C. R. Hoover, *ib.*, **37**, 95, 1915; P. A. Guye and N. Zachariades, *Compt. Rend.*, **149**, 593, 1909; P. A. Guye and T. Batuecas, *Helvetica Chim. Acta*, **5**, 532, 1922; E. Moles, *Anal. Fis. Quim.*, **19**, 255, 1921; *Journ. Chim. Phys.*, **15**, 51, 1917; P. A. Guye, *ib.*, **15**, 60, 1917; B. Brauner in R. Abegg, *Handbuch der anorganischen Chemie*, Leipzig, **3**, ii, 12, 1909; J. L. Gay Lussac, *Mém. Soc. Arcueil*, **2**, 207, 1809.
- ⁶ B. Brauner in R. Abegg, *Handbuch der anorganischen Chemie*, Leipzig, **3**, ii, 12, 1909; F. W. Clarke, *A Recalculation of the Atomic Weights*, Washington, **60**, 1910; P. A. Guye, *Journ. Chim. Phys.*, **3**, 321, 1905; **4**, 174, 1906; A. Leduc, *Compt. Rend.*, **146**, 399, 1908; F. W. Aston, *Phil. Mag.*, (6), **39**, 611, 1920; N. Delaunay, *ib.*, **145**, 484, 1907; J. A. Groshans, *Rec. Trav. Chim. Pays-Bas.*, **7**, 358, 1888; J. A. Wanklyn, *Chem. News*, **69**, 27, 1894; **70**, 88, 247, 1894; **72**, 164, 1895; E. Moles, *Anal. Soc. Espan. Fis. Quim.*, **19**, 255, 1921; L. Bell and P. R. Bassett, *Science*, (2), **56**, 512, 1922; E. Rutherford and J. Chadwick, *Nature*, **113**, 457, 1924; F. P. Worley, *Rep. Australasian Assoc.*, **16**, 212, 1923; J. J. Berzelius and P. L. Dulong, *Ann. Chim. Phys.*, (2), **15**, 392, 1819; J. B. Biot and F. J. Arago, *Mém. Inst.*, **71**, 7, 1781; W. H. Wollaston, *Phil. Trans.*, **98**, 96, 1808; **104**, 1, 1814; T. Thomson, *Ann. Phil.*, **16**, 161, 1820; *Records General Science*, **179**, 1836; D. Berthelot, *Journ. Phys.*, (3), **8**, 263, 1899; *Compt. Rend.*, **126**, 954, 1898; A. Jaqueroed and F. L. Perrot, *ib.*, **140**, 1542, 1905; *Arch. Sciences Genève*, (4), **20**, 506, 1905; G. Baume, *Journ. Chim. Phys.*, **6**, i, 1908; G. Baume and F. L. Perrot, *ib.*, **7**, 369, 1909; *Compt. Rend.*, **148**, 39, 1909; Lord Rayleigh, *Proc. Roy. Soc.*, **62**, 204, 1897; **74**, 446, 1905; G. D. Hinrichs, *The True Atomic Weights of the Chemical Elements and the Unity of Matter*, St. Louis, 1894; W. Prout, *Ann. Phil.*, **11**, 321, 1815; **12**, 111, 1816; P. A. Guye and T. Batuecas, *Helvetica Chim. Acta*, **5**, 532, 1922; F. J. Wrede, *Skand. Nat. Förh.*, **2**, 242, 1848; *Pogg. Ann.* **53**, 225, 1841.

§ 13. The Carbides—The Alkali Carbides

H. Moissan begründete die Chemie der Carbide.—O. HÖNIGSCHEMID (1914).

The binary compounds of carbon with most of the elements are called **carbides**; a few compounds of carbon with the metalloids—*e.g.* oxygen, the halogens, and sulphur—are not usually regarded as carbides. The existence of the metal carbides was recognized by C. A. Vandermonde, C. L. Berthollet, and G. Monge,¹ in their *Mémoire sur le fer considéré dans ses différens états métalliques*, but no definite compound was recognized. It was observed that relatively small proportions of carbon greatly modified the malleability and ductility of the metal, but the low proportion of carbon seemed to exclude the idea that a definite compound was formed. A few years later, A. F. de Fourcroy, in L. B. G. de Morveau's *Encyclopédie*, stated:

Le carbone est susceptible de se combiner directement et entièrement aux métaux. . . . Ce nom *carbure* répond à celui de *sulfure* et de *phosphure* qui appartient à des combinaisons analogues entre le soufre et le phosphore et les différens corps; comme on distingue les sulfures alcalins, alcalino-terreux et métalliques, il est vraisemblable qu'il existe des *carbures alcalins, alcalino terreux, et métalliques*.

The nomenclature was here in advance of the facts. C. J. B. Karsten expressed the idea that in steel the carbon is not distributed uniformly throughout the mass of metal as carbon but rather as the carbide, FeC_3 . J. J. Berzelius thought that he had made a series of definite carbides by heating the cyanides of some of the metals; similarly with the ferrocyanides, but here the product is a mixture of the carbides of iron, and the other metal. J. B. A. Dumas then argued that the products obtained by J. J. Berzelius are not really carbides, but are mixtures of the metal with carbon. Other carbides were reported by E. Davy, F. Wöhler, L. Troost and P. Hautefeuille, L. Maquenne, H. Moissan, etc. In his investigation: *Sur une nouvelle classe de radicaux métalliques composés*, M. Berthelot described sodium and potassium carbides; and he, and M. Keiser, showed their relation to acetylene, a gas which these carbides produce on treatment with water. The carbides of copper, silver, and mercury produced by the action of acetylene on metal salt soln. very readily decompose, maybe explosively, when heated. The other carbides are produced by the direct action of the metal on carbon at a high temp., and, within certain limits of temp., are stable. K. Nischk studied the relative affinities of carbon and oxygen for the metals.

The carbides are made (i) By the direct union of carbon and metal; (ii) By the action of carbon on the oxides or oxysalts of the metals; (iii) By the action of carbon on the hydrides or nitrides of the metals; (iv) By the action of metals on the oxides of carbon; (v) By heating the metallic oxides with calcium carbide in place of carbon; (vi) By the simultaneous action of carbon and of a very oxidizable metal on an oxide of the metal; (vii) By the action of metals on the hydrocarbon gases; (viii) By the action of acetylene on metal salt soln.; (ix) By passing acetylene into a soln. of the metal in liquid ammonia—probably, said H. Moissan, the acetylene-carbide is first formed and the liberated hydrogen converts some acetylene into ethylene: $3\text{C}_2\text{H}_2 + 2\text{NaNH}_3 = \text{C}_2\text{Na}_2\text{C}_2\text{H}_2 + 2\text{NH}_3 + \text{C}_2\text{H}_4$; and (x) By decomposing some organic compounds by heat, as in the case of the thiocyanates of silver, copper, zinc, bismuth, iron, manganese, lead, or tin. F. Haber arranged the carbides in groups according to the periodic classification, as extended in Table XVI. The carbides of the elements in the left division of the different groups are usually stable at a high temp. and are non-volatile solids; while those in the right division are either easily decomposed at a high temp. (metal carbides) or are readily volatile (carbides of the metalloids). Carbon fluoride and carbon dioxide are gaseous but very stable; and paracyanogen is a stable solid. Aluminium and silicon carbides in the division on the right are exceptional.

TABLE XVI.—PERIODIC CLASSIFICATION OF THE CARBIDES.

Group I.	Group II.	Group III.	Group IV.	Group V.	Group VI.	Group VII.	Group VIII.
Li_2C_2	BeC_2	BC	C	(NC) ⁿ	O_2C	F_4C	—
Na_2C_2	MgC_2	Al_4C_3	SiC	P	S_2C	Cl_4C	—
K_2C_2	CaC_2	Sc	TiC	YC	Cr_2C_3	Mn_3C	(Fe, Co, Ni) ₂ C
CuC_2	Zn	Ga	Ge	As	Se	Br_4C	—
Rb_2C_2	SrC_2	YC_2	ZrC	CbC_n	Mo_2C	—	(Ru, Rh, Pd) _n C _n
Ag_2C_2	Cd	In	SnC	Sb	Te	I_4C	—
Cs_2C_2	BaC_2	LaC_2	CeC_2	Di	—	—	—
—	—	—	—	—	—	—	—
—	—	Yb	—	Ta	W_2C	—	(Os, Ir, Pt) _n C _n
AuC^n	HgC_2	Tl	PbC	BiC_n	—	—	—
—	—	—	ThC_2	—	U_2C_3	—	—

The metal carbides can be roughly classified according to their action on water or dil. acids. (i) The **acetylides** are derivatives of acetylene, because they furnish

that gas when treated by these agents—*e.g.* alkali metals ; copper ; silver ; alkaline earth metals ; magnesium ; and mercury. They are constituted :

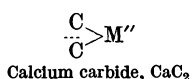
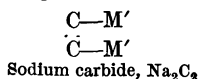

(ii) **Methanides** are derivatives of methane because they furnish that gas when treated with water or dil. acid—*e.g.* beryllium, aluminium, and manganese. They are constituted :

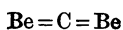

Beryllium carbide, Be_2C

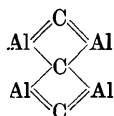

Aluminium carbide, Al_4C_3

There are of course other possibilities—*e.g.* $\text{Al} : \text{C} : \text{Al} : \text{C} : \text{Al}$. (iii) *Mixed carbides* supposed to be partly acetylides and partly methanides in that they furnish

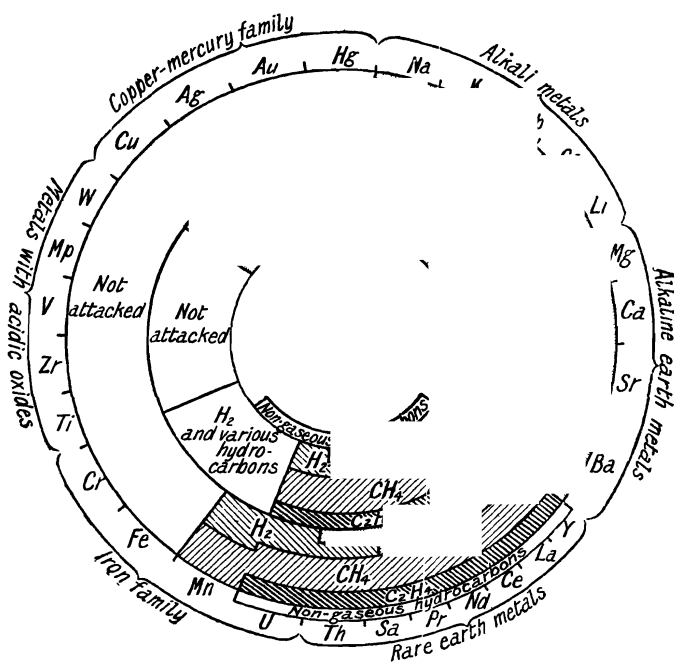
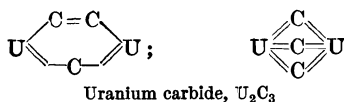

FIG. 20.—Graphic Representation of the Action of Water and Dilute Acids on the Metal Carbides.

both acetylene and methane when treated with dil. acids or by water—*e.g.* lanthanum, cerium, yttrium, and thorium carbides. Uranium carbide has been represented



(iv) The other carbides which are decomposed by water or dil. acids furnish different hydrocarbons—ethylene, etc. (v) The carbides not decomposed by water or dil. acids.

M. Delépine arranged the carbides of the metals about three concentric circles as indicated in Fig. 20. The products with water are indicated in the outer ring,

and the products with dil. hydrochloric acid in the inner ring. Beryllium and aluminium carbides have been omitted from the scheme; they give methane with both liquids.

The following monographs, etc. deal with the carbides: M. Delépine, *Carbures métalliques*, Paris, 1904; O. Hönigschmid, *Karbid und Silizide*, Halle a. S., 1914; F. B. Ahrens, *Die Metallkarbide und ihre Anwendung*, Stuttgart, 1896; A. Frank, *Zeit. Elektrochem.*, 3, 427, 1897; *Journ. Gasbeleucht.*, 41, 682, 1898; O. Sandmann, *Zeit. angew. Chem.*, 14, 673, 1901; J. H. Vogel, *Handbuch der Acetylen*, Braunschweig, 1904.

H. Moissan prepared a series of complex **acetylene carbides**: $\text{Na}_2\text{C}_2\cdot\text{C}_2\text{H}_2$, $\text{K}_2\text{C}_2\cdot\text{C}_2\text{H}_2$, $\text{Li}_2\text{C}_2\cdot\text{C}_2\text{H}_2\cdot 2\text{NH}_3$, and $\text{CaC}_2\cdot\text{C}_2\text{H}_2\cdot 4\text{NH}_3$, by passing acetylene into a soln. of the corresponding metal in liquid ammonia. All these complexes furnish the simple carbides when heated.

The alkali carbides.—H. Moissan obtained **lithium carbide**, Li_2C_2 , by warming lithium acetylenediammoniocarbide in vacuo; he also made lithium carbide by heating lithium in a stream of acetylene. A. Guntz represented the reaction with acetylene: $\text{C}_2\text{H}_2 + 4\text{Li} = 2\text{LiH} + \text{C}_2\text{Li}_2$; and he obtained a similar result with ethylene: $\text{C}_2\text{H}_4 + 6\text{Li} = 4\text{LiH} + \text{C}_2\text{Li}_2$; and with carbon monoxide or dioxide at a dull red heat; at a higher temp., only a little carbide is formed. H. Moissan also obtained lithium carbide by heating four gram-atoms of carbon with a mol. of lithium carbonate in an electric furnace. A. Guntz made lithium carbide by heating a mixture of equal parts of amorphous carbon and lithium at a dull red heat, in vacuo, for half an hour. Diamonds react in the same way as amorphous carbon. The carbide was also made by heating lithium with an electric arc using carbon electrodes in vacuo. According to E. Vigouroux,² sodium has no perceptible action on carbon. S. Opolsky found that where an excess of sodium is used in the preparation of the homologues of thiophene, a brown, explosive **sodium carbide** is formed. M. Berthelot made *sodium acetylene carbide*, $\text{Na}_2\text{C}_2\cdot\text{C}_2\text{H}_2$, by warming sodium in a stream of acetylene gas; when heated to a dull red heat, sodium carbide, Na_2C_2 , is formed; allylene also furnishes sodium acetylene carbide mixed with carbon when the gas is passed over heated sodium. R. de Forcrand prepared the carbide in a similar manner. H. Moissan made it by the dissociation of sodium acetylene carbide in vacuo; and C. Matignon made it of a high degree of purity by heating sodium acetylene carbide in a stream of hydrogen at $220^\circ\text{--}230^\circ$. C. E. Parsons made it by heating borax and carbon over 1000° .

H. Davy noted that if charcoal, graphite, or the diamond be heated to redness with potassium at a temp. at which the metal is volatile, the carbon "seemed gradually to combine with the potassium," and the product, when treated with water, gave off a gas which burnt like hydrogen. According to J. J. Berzelius, the black mass obtained in the preparation of potassium by the reduction of the carbonate with carbon, is a *Kohlenstoffkalium*. In 1836, E. Davy also prepared what he called a peculiar compound of carbon and potassium, or *carburet of potassium*; it gave acetylene when treated with water, and was undoubtedly impure potassium carbide. H. Moissan made **potassium carbide**, K_2C_2 , by the dissociation of potassium acetylene carbide in vacuo. M. Berthelot found that molten potassium inflames in acetylene, and the mixture then explodes—there is a separation of carbon, and potassium carbide is formed. At a dull red heat, ethylene also converts potassium partially into carbide. H. Moissan made **rubidium carbide**, Rb_2C_2 , by rapidly heating rubidium acetylene carbide in vacuo to 300° , and **cæsium carbide**, Cs_2C_2 , was prepared in a similar way.

These carbides appear to be white powders or white masses with a crystalline fracture; if carbon is present as an impurity, the carbide may be grey or black. The sp. gr. of lithium carbide, according to H. Moissan, is 1.65 at 18° ; and sodium carbide, according to C. Matignon, has a sp. gr. of 1.575. H. Moissan said lithium carbide easily breaks and is not hard enough to scratch glass; and C. Matignon said that sodium carbide is not sensitive to percussion or friction. C. Matignon said

that **hydrogen** is without action on sodium carbide. According to H. Moissan, **lithium carbide** at a dull red heat burns vigorously in **oxygen**; sodium carbide was found by C. Matignon to be stable in air or oxygen at ordinary temp., but when heated, combustion occurs, and sodium carbonate is formed; H. Moissan said **rubidium carbide** is not attacked in the cold by oxygen. A. Guntz said that lithium carbide does not dissociate when heated; on the other hand, at a dull red heat, in **vacuo**, said H. Moissan, rubidium or caesium carbide gives amorphous carbon and the metal. R. de Forcrand, and C. Matignon gave for the heat of formation $C_2H_{2(gas)} + 2Na = C_2Na_{2(solid)} + H_2 + 49.3$ Cals.; and $2C_{diamond} + 2Na_{solid} = C_2Na_2 - 8.8$ Cals. H. Moissan said that lithium carbide is decomposed by cold **water**, giving off acetylene only—a kilogram of lithium carbide gives 587 litres of acetylene. A similar reaction was found by C. Matignon to occur with water, but with a large excess of sodium carbide an explosion may occur and carbon be separated. In spite of the apparent irreversibility of the reaction, J. Billitzer considers that the slight increase in the solubility of acetylene in water brought about by the addition of small quantities of salts, indicates the possibility that acetylides may exist in soln. The thermal value of the reaction with sodium carbide, given by C. Matignon, and R. de Forcrand, is: $C_2Na_2 + 2H_2O = C_2H_{2(gas)} + 2NaOH_{aq.} + 37.6$ Cals. The other alkali carbides are also decomposed by water, and acetylene is evolved.

H. Moissan found that cold lithium carbide burns with great brilliancy in **fluorine** or **chlorine**, but it must be warmed a little before combustion occurs in **bromine** or **iodine**. According to C. Matignon, sodium carbide burns in chlorine with the separation of carbon; in bromine, carbon and brominated hydrocarbons are formed; and with iodine, ethylene tetraiodide, C_2I_4 , is formed. H. Moissan found rubidium or caesium carbide burns in fluorine, chlorine, bromine, or iodine. Conc. acids, said H. Moissan, attack lithium carbide very slowly: C. Matignon gave for the action of **hydrochloric acid** on sodium carbide: $C_2Na_2 + 2HCl = 2NaCl + 2C + H_2$; but if the carbide is suspended in ether, acetylene is formed: $C_2Na_2 + 2HCl = 2NaCl + C_2H_2$. H. Moissan found that rubidium or caesium carbide inflames in contact with hydrochloric acid—unless the acid be dil. H. Moissan found that lithium carbide burns in the vap. of **sulphur** or **selenium**; rubidium carbide behaves similarly. C. Matignon found that in contact with sodium carbide at 150° , hydrogen sulphide, acetylene and sodium hydrosulphide are formed. He also observed a separation of carbon when sodium carbide is heated with **sulphur dioxide**; and H. Moissan said that sulphur dioxide in the cold does not attack rubidium carbide, but inflammation occurs when heat is supplied. C. Matignon found that **carbon monoxide** does not attack sodium carbide below 250° , and that the reaction with **carbon dioxide** resembles that with sulphur dioxide; H. Moissan also found the same to be true with respect to rubidium carbide. Rubidium and caesium carbides react vigorously when heated with **silicon** or with **boron**. The action of **nitric oxide** with rubidium carbide resembles that with sulphur dioxide. C. Matignon said that sodium carbide reacts with **nitrogen pentoxide** at 150° with incandescence and the separation of carbon. H. Moissan said that an explosion occurs when rubidium or caesium carbide is brought in contact with **nitric acid**. Lithium carbide burns vigorously in **phosphorus** vap., forming the alkali phosphide which gives phosphine with water. C. Matignon observed a similar result with sodium carbide; and with phosphorus. H. Moissan observed that at a red heat lithium carbide is decomposed by **arsenic**, and a mixture of rubidium carbide and arsenic inflames when heated. C. Matignon observed that carbon is liberated when sodium carbide is triturated in a mortar with **mercury**, **aluminium**, **lead**, or **iron**; the reaction may be very vigorous. H. Moissan found that when a mixture of **calcium** and rubidium carbide is heated, in **vacuo**, rubidium distills off. H. Moissan found that molten **potassium hydroxide** decomposes lithium carbide with the development of much heat. The carbides are powerful reducing agents, and when mixed with oxidizing agents, explosive mixtures may be formed. H. Moissan noted that at 400° , **ferric oxide** or **chromic oxide** is reduced by rubidium

carbide with the development of much heat; ferric oxide is reduced with incandescence when gently heated with cæsium carbide; at 200°, lead monoxide is explosively reduced by rubidium carbide, and lithium carbide is reduced with great vigour and with incandescence. A. Guntz noted that lithium carbide reduces molten lithium chloride to the subchloride, Li_2Cl . C. Matignon found that when sodium carbide is rubbed in a mortar with certain chlorides or iodides, the mixture may become incandescent, and explode; the sulphates are reduced when triturated with sodium carbide.

When a soln. of lithium in liquid ammonia is treated with acetylene, H. Moissan found that fine crystals of lithium acetylenediamminocarbide, $\text{C}_2\text{Li}_2 \cdot \text{C}_2\text{H}_2 \cdot 2\text{NH}_3$, or $\text{C}_2\text{HLi} \cdot \text{NH}_3$, are formed, which, under a lens, appear to resemble the crystals of Iceland spar. The compound readily decomposes into lithium carbide, etc., when heated in air or hydrogen; it burns in contact with water, or chlorine, and also in sulphur dioxide or carbon dioxide. C. Matignon prepared sodium acetylenecarbide, $\text{C}_2\text{Na}_2 \cdot \text{C}_2\text{H}_2$, by passing purified and dry acetylene, warmed to the m.p. of sodium, over sodium heated by an oil-bath. The last particles of sodium are transformed but slowly. H. Moissan made the same compound by passing acetylene over sodium hydride—hydrogen is evolved; the reaction proceeds at -80° ; he also made this compound by passing acetylene into a soln. of sodium in liquid ammonia cooled to -40° ; the blue liquid becomes colourless, and ethylene is evolved. To obtain crystals of the compound, the soln. is cooled to -60° or the ammonia is allowed to evaporate. According to M. Skossarewsky, the mol. electrical conductivity of sodium acetylide, NaHC_2 (more likely $\text{Na}_2\text{C}_2 \cdot \text{C}_2\text{H}_2$), in liquid ammonia is of the same order as that of sodium acetate. H. Moissan made potassium acetylenecarbide, $\text{C}_2\text{K}_2 \cdot \text{C}_2\text{H}_2$; rubidium acetylenecarbide, $\text{C}_2\text{Rb}_2 \cdot \text{C}_2\text{H}_2$; and cæsium acetylenecarbide, $\text{C}_2\text{Cs}_2 \cdot \text{C}_2\text{H}_2$, in a similar manner.

The alkali acetylene carbides all form microscopic, white, rhombic plates resembling boric acid; the crystals are deliquescent. They decompose into the simple carbide when heated in vacuo, or in a stream of hydrogen. The rubidium and cæsium compounds begin to melt with decomposition below 300° . C. Matignon gave for the heat of formation $2\text{C}_{\text{diamond}} + \text{H} + \text{Na} = \text{C}_2\text{HNa} - 29.2$ Cals. Dry air has no action on rubidium acetylenecarbide, which, when heated in oxygen, inflames. The compounds are readily decomposed by water giving the alkali hydroxide and acetylene; for the sodium compound, C. Matignon gave $\text{C}_2\text{NaH} + \text{H}_2\text{O} = \text{NaOH} + \text{C}_2\text{H}_{2\text{gas}} + 14.5$ Cals. Boiling ether has no action on sodium acetylene carbide; alcohol decomposes it energetically with the formation of sodium ethoxide; and it sinks in ligroin, sp. gr. 0.899, without showing any chemical action. H. Moissan found that cæsium acetylenecarbide sinks in benzene and carbon tetrachloride without chemical action. C. Matignon found sodium acetylene carbide inflames at ordinary temp. in chlorine or bromine; and if suspended in ligroin, and iodine be added, the acetylene is attacked and sodium carbide remains. H. Moissan observed that potassium acetylene carbide inflames in chlorine, forming hydrogen chloride and carbon; the rubidium compound inflames at ordinary temp. in fluorine, chlorine, bromine, or iodine vap.; so also does the cæsium compound inflame in fluorine and chlorine, but it must be warmed a little before it inflames in bromine or iodine vap. Cæsium acetylenecarbide takes fire in hydrogen chloride. The rubidium compound inflames in contact with hydrochloric acid, and it also takes fire in contact with molten sulphur. The potassium compound reacts with sulphur dioxide at ordinary temp. and it becomes incandescent; likewise with the cæsium compound. The rubidium compound decomposes in contact with monohydrated sulphuric acid, and burns with a pale flame; likewise also the cæsium compound. C. Matignon found the sodium compound can be recrystallized from liquid ammonia without change. H. Moissan found that the cæsium compound ignites at about 100° in nitrogen peroxide. The cæsium compound burns vigorously in contact with monohydrated nitric acid. The rubidium and cæsium compounds become incandescent when warmed in contact with phosphorus or arsenic. When

the potassium compound is warmed with **carbon dioxide** the mass becomes incandescent. The rubidium compound does not react in the cold, but it does so vigorously when warmed. Amorphous **silicon** and **boron** at about 350° are not attacked by the rubidium compound, while at this temp., **lead dioxide** is reduced explosively, and **cupric oxide** and **manganese dioxide** are vigorously reduced with incandescence. Cupric oxide and lead dioxide are also reduced explosively by the caesium compound at a dull red heat.

A. Lagermark³ prepared **sodium allylenide**, C_3H_3Na , by the prolonged action of allylene on sodium.

REFERENCES.

- ¹ C. A. Vandermonde, C. L. Berthollet, and G. Monge, *Mém. Acad.*, 132, 1876; L. B. G. de Morveau, *Encyclopédie méthodique*, Paris, 1796; C. J. B. Karsten, *Gilbert's Ann.*, 22, 429, 1816; J. J. Berzelius, *Ann. Chim. Phys.*, (2), 14, 190, 1820; (2), 36, 1, 1835; M. Berthelot, *ib.*, (4), 9, 385, 1866; L. Maquenne, *ib.*, (6), 23, 258, 1893; *Bull. Soc. Chim.*, (3), 7, 366, 1892; *Compt. Rend.*, 114, 361, 1892; 115, 558, 1892; L. Troost and P. Hautefeuille, *ib.*, 80, 909, 1875; J. B. A. Dumas, *Traité de chimie*, Paris, 1831; H. Moissan, *Compt. Rend.*, 115, 1031, 1892; 118, 501, 1894; 126, 302, 1897; 127, 911, 917, 1898; 138, 243, 1904; *Bull. Soc. Chim.*, (3), 11, 1002, 1894; (3), 21, 921, 1899; *Ang. Chim. Phys.*, (7), 9, 247, 1896; (7), 18, 334, 1899; E. Davy, *B.A. Rep.*, 62, 1836; 50, 1837; *Thomson's Records*, 4, 321, 1836; M. Keiser, *Amer. Chem. Journ.*, 14, 285, 1292; F. Haber, *Grundriss der technischen Elektrochemie auf theoretischer Grundlage*, München, 393, 1292; M. Delépine, *Carbures métalliques*, Paris, 29, 1904; K. Nischk, *Zeit. Elektrochem.*, 29, 373, 1923; F. Wohler, *Liebig's Ann.*, 124, 220, 1862; A. Guntz, *Compt. Rend.*, 123, 1273, 1896; 126, 1866, 1898.
- ² E. Vigouroux, *Compt. Rend.*, 123, 115, 1896; A. Guntz, *ib.*, 123, 1273, 1896; 126, 1866, 1898; C. Matignon, *ib.*, 124, 775, 1026, 1897; 125, 1033, 1897; 137, 463, 1903; R. de Forcrand, *ib.*, 120, 1215, 1895; 122, 363, 1896; 124, 1153, 1897; H. Moissan, *ib.*, 127, 916, 1898; 136, 1220, 1903; M. Berthelot, *Bull. Soc. Chim.*, (2), 5, 188, 1866; S. Opolsky, *Bull. Acad. Cracow*, 548, 1905; H. Davy, *Phil. Trans.*, 99, 32, 1809; K. Nischk, *Zeit. Elektrochem.*, 29, 373, 1923; E. Davy, *B.A. Rep.*, 62, 1836; 50, 1837; *Proc. Irish Acad.*, 1, 88, 1837; *Trans. Irish Acad.*, 18, 80, 1838; *Thomson's Records*, 4, 321, 1836; J. J. Berzelius, *Gilbert's Ann.*, 36, 247, 1810; 37, 416, 1811; J. Billitzer, *Zeit. phys. Chem.*, 40, 535, 1902; M. Skossarewsky, *Compt. Rend.*, 159, 769, 1914; C. E. Parsons, *U.S. Pat. No. 1473510*, 1923.

³ A. Lagermark, *Journ. Russ. Phys. Chem. Soc.*, 12, 288, 1880.

§ 14. The Carbides of the Copper Family of Elements

The direct action of carbon on copper has been discussed in connection with the last-named element (3. 21, 6). K. Nischk¹ studied the relative affinities of copper for carbon and oxygen. P. Rucktäschel, and W. Hempel made an alloy with 0.3 per cent. of carbon, but no combination between the two elements was observed. E. Briner and R. Senglet found that an endothermic copper carbide is formed from the elements at a high temp. and the product decomposes at 1600° . O. Ruff and B. Bergdahl found the solubility of carbon in copper to be small. As previously cited, J. J. Berzelius' copper carbide was probably a mixture. There are two carbides of copper—cuprous and cupric. Anhydrous cupric carbide has not been prepared. In 1858, before the nature of acetylene had been established, J. A. Quet prepared what was probably **cuprous carbide**, or *cuprous acetylide*, Cu_2C_2 , by passing the gas obtained by sparking alcohol vap. through an ammoniacal soln. of cuprous chloride; and in the same year, R. Böttger obtained it by passing coal gas through an ammoniacal soln. of cuprous chloride or sulphite, a soln. obtained by shaking copper oxide with conc. aq. ammonia, or a soln. of sodium cuprous thiosulphate. M. Berthelot showed that the gas obtained by the incomplete combustion of coal gas gives a good yield, which, according to A. Römer, is still further improved by bubbling the gas through ether before it is burnt. M. Berthelot prepared a similar compound by passing acetylene into an aq. or ammoniacal soln. of cuprous salt. R. Blochmann recommended washing the product with aq. ammonia, and drying first in air and then over calcium chloride. E. H. Keiser passed acetylene into water carrying

cuprous hydroxide in suspension, or into water with finely divided copper in suspension. M. Kuntzmann said that the intermediate formation of ammoniacal cuprous chloride is not necessary, and the washing with ammonia can be eliminated by aspirating the gases containing acetylene through liquor-ammonia, and then through a cylinder containing copper turnings and ammonia. The red carbide forms on the turnings and remains suspended in the liquid, which itself becomes blue. The formation of cuprous carbide on the cupriferous parts of acetylene generators, and in cupriferous conducting tubes has been discussed by J. Torrey, A. Crova, J. Nicklès, etc. If the copper is in contact with a sacrificial metal like zinc, W. Melentjeff found that the copper carbide is not formed. Cuprous carbide can also be made by treating with acetylene a soln. of a cupric salt in contact with a reducing agent. Thus, E. Péchard, H. Erdmann and O. A. W. Makowka, and J. Scheiber passed acetylene through a soln. of cupric sulphate and hydroxylamine at 50°, but there is no action if the soln. is cold. O. A. W. Makowka found that in place of hydroxylamine, hydrazine, hydroquinone, pyrogallol, potassium iodide, arsenious oxide, or sulphur dioxide can be used. H. G. Söderbaum, and A. Schierl used a soln. of sulphur dioxide and ammoniacal cupric sulphate on a water-bath. The acetylene is freed from phosphine by soln. of lead acetate and mercuric chloride. G. S. Johnson treated a soln. of glucose and cupric sulphate with acetylene. E. Reboul made cuprous carbide by the action of acetylene monobromide on an ammoniacal soln. of cuprous chloride; P. Cazeneuve, by the action of bromoform and zinc dust on an ammoniacal soln. of cuprous chloride; and J. F. Durand, by the action of calcium carbide on a soln. of a cuprous salt.

F. Küspert made **colloidal cuprous carbide**, by adding an ammoniacal soln. of cuprous chloride to an aq. soln. of acetylene, when red colloidal copper carbide is formed. This soln. cannot be filtered, but if 0.2 per cent. of gelatine is added, a stable colloidal soln. is obtained.

There have been some differences of opinion as to the composition of the product. This may be due to the difficulties involved in preparing cuprous carbide of a high degree of purity. E. H. Keiser found that when copper carbide is made by passing acetylene into an ammoniacal soln. of cuprous chloride or oxide, or into water with finely divided cuprous chloride in suspension, free carbon is present. He said:

All attempts to make copper acetylide free from carbon have failed. It appears that when acetylene is passed into a cuprous soln., and air or oxygen is present in small quantity, the cuprous compound is oxidized to the cupric condition, and there is formed some red cuprous acetylide, but at the same time, some of the hydrogen of acetylene or the copper of the precipitate is oxidized, and carbon remains behind. In its preparation, too, owing to its colloidal nature, it is liable to carry down any cuprous and cupric salts which may be present.

M. Berthelot represented the composition of the product dried over calcium chloride by $(C_2HCu_2)_2O$ —*cuproacetyloxyde*, and if still further dried, $C_2HCu_2nCu_2O$; A. Schierl found after drying in vacuo over sulphuric acid, or for a month over phosphorus pentoxide, $C_2HCu.CuOH$; J. Scheiber gave $HC : C.Cu.Cu.OH$; E. Reboul, C_2HCu ; R. Blochmann, $C_2H_2Cu_2O$; O. A. W. Makowka, $CHCu_2.COH$; and E. H. Keiser found that the purest specimens, made by the action of acetylene upon cuprous hydroxide suspended in water, and making an allowance for the free carbon present, had a composition corresponding with C_2Cu_2 .

The voluminous precipitate has a red or reddish-brown colour, and when dried, it may be brown. N. Ljubawin said that it decomposes when kept for some time, forming a substance resembling humus, which M. Berthelot said is insoluble in hydrochloric acid. H. Erdmann and O. A. W. Makowka found that cuprous carbide can be kept unchanged in a sat. aq. soln. of acetylene, but when exposed to air, it gradually forms cupric acetate and oxide, but O. A. W. Makowka could detect no cupric acetate. J. A. Quet, and R. Böttger found that cuprous carbide is explosive; and it detonates by percussion, or when heated over 100°. M. Berthelot said that copper, carbon, water, and carbon dioxide and monoxide are formed during the explosion. W. S. Mai said that it can be heated at 60° in air without explosion; and, as observed by

M. Freund and W. S. Mai, if warmed in air or oxygen for some hours it explodes when brought in contact with acetylene. It is suggested that $\text{Cu}_2\text{O} \cdot \text{C}_2\text{H}_2$ is formed which, in contact with acetylene, loses water and then decomposes explosively. R. Blochmann said that the red carbide is insoluble in water. O. A. W. Makowka found that when the thoroughly washed carbide is treated in the cold with 30 per cent. **hydrogen dioxide**, some cupric dioxide is formed, oxygen is given off, and an aldehyde derivative, $\text{Cu}_2\text{CH} \cdot \text{COH}$, is produced; but in alkaline soln. no cupric dioxide is produced, and the filtrate, when neutralized with sulphuric acid, yields a volatile organic compound. M. Berthelot found cuprous carbide inflames spontaneously in **chlorine** and carbon separates. It behaves similarly with **bromine** vap. and finely-divided **iodine**.

E. Reboul noted a crystalline substance is formed when acetylene is passed into bromine, and A. Sabanéeff ascribed to it the formula $\text{C}_4\text{H}_2\text{Br}_6$, hexabromotetramethylene. A. A. Noyes and C. W. Tucker say that the compound is not formed with acetylene from calcium carbide, but it is formed when acetylene is obtained from an ammoniacal soln. of cuprous chloride sat. with acetylene. The gas in the latter case is contaminated with diacetylene $\text{CH} : \text{C} : \text{C} : \text{CH}$ derived from the oxidation of acetylene or cuprous carbide with the intermediate formation of *cuprous diacetylide*, $\text{Cu} : \text{C} : \text{C} : \text{C} : \text{Cu}$; thus, $2\text{C}_2\text{Cu}_2 + 2\text{CuCl}_2 = \text{C}_4\text{Cu}_2 + 4\text{CuCl}$; and $\text{C}_4\text{Cu}_2 + 2\text{HCl} = \text{CH} : \text{C} : \text{C} : \text{CH} + 2\text{CuCl}$.

E. Carstanjen and A. Schertel found that cuprous carbide and **ethylene iodide** furnish cuprous iodide, a gas, and an iodiferous crystalline product. R. Chavastelon observed that no evolution of gas occurs when the carbide is treated with cold **hydrochloric acid**, but gas is evolved when the mixture is heated; and, added N. Caro, some diacetylene, ethylidene chloride, and a solid hydrocarbon resembling cuprene, C_7H_6 , is formed. M. Berthelot found cuprous carbide is soluble in very dil. hydrochloric acid without the development of gas, and a greenish, almost colourless, liquid is formed which when nearly neutralized with potassium hydroxide, precipitates the carbide unchanged; with hydrochloric acid of sp. gr. 1.1, at ordinary temp., only a little gas is developed, but when warmed there is a turbulent evolution of acetylene, and cuprous chloride is formed. R. Blochmann said that conc. hydrochloric acid transforms the freshly prepared carbide into cuprous chloride, acetylene, and a little ethylidene chloride. A. Römer found that with hydrochloric acid on a water-bath, acetylene is slowly and regularly evolved. A. Römer, and A. A. Noyes and C. W. Tucker found some diacetylene to be produced by the action of hydrochloric acid on cuprous carbide; S. Zeisel, some vinyl chloride; J. Scheiber, no acetaldehyde; and M. Berthelot, an amorphous black powder. A. Schierl noted that cuprous carbide is decomposed by **hydrogen sulphide**. M. Berthelot found that the carbide is slowly attacked when heated with dil. **sulphurous acid**. M. Berthelot said that it is soluble in **sulphuric acid**, and the 1 : 1 acid slowly attacks the carbide. R. Böttger, and A. Römer found that dil. sulphuric acid has no action, but a more conc. acid, on the water-bath, develops acetylene, etc. H. Erdmann and O. A. W. Makowka found that an explosion occurs with the conc. acid. They also say that cuprous carbide is soluble in aq. ammonia only in the presence of air. R. Böttger also made observations on this subject. M. Berthelot found that ethylene is formed when the carbide is treated with zinc in the presence of aq. ammonia. A. Schierl said the carbide is soluble in soln. of **ammonium salts**; and M. Berthelot, that it is decomposed when boiled with a solution of **ammonium chloride** and ammonia is evolved. A. Schierl found that the carbide dissolves in cold dil. **nitric acid**; H. Erdmann and O. A. W. Makowka, that it is decomposed slowly by nitric acid, sp. gr. 1.15, when heated on a water-bath; and M. Berthelot, that the moist carbide is oxidized by nitric acid, but the dried carbide explodes with the separation of carbon. E. H. Keiser also found the carbide is decomposed by nitric acid. M. Berthelot, H. Erdmann and O. A. W. Makowka, and H. C. Jones and C. R. Allen noted the formation of acetylene when cuprous carbide is heated with a soln. of **potassium cyanide**. M. Berthelot found the carbide is slowly attacked by **acetic acid**; H. Erdmann and O. A. W. Makowka say that acetic acid and **oxalic acid** have no

action; and A. Schierl said that it is decomposed by acetic and other organic acids. R. Böttger, and H. Erdmann and O. A. W. Makowka say that cuprous carbide is insoluble in aq. soln. of **alkali hydroxides**. Cuprous acetylide gives an explosive mixture of silver and silver acetylide when treated with a soln. of **silver nitrate**; and a mixture of mercury and mercurous acetylide when treated with a soln. of **mercurous nitrate**. Cuprous carbide forms a number of complex salts, thus, M. Berthelot, R. Chavastelon, and K. A. Hofmann and F. Küspert made **cuprous chlorocarbide**, $C_2H_2 \cdot CuCl_2$, or $C_2HCu_2Cl + HCl$, or $(C_2H_2Cu)Cl \cdot CuCl$; **cuprous oxychlorocarbide**, $C_2H_2 \cdot Cu_2Cl_2 \cdot Cu_2O$; **potassium cuprous chlorocarbide**, $C_2H_2(Cu_2Cl_2)_2KCl$; and $C_2H_2[(Cu_2Cl_2)_2KCl]_2$; and M. Berthelot and M. Delépine made **cuprous iodocarbide**, $C_2Cu_2 \cdot 2CuI$. M. Berthelot prepared **cuprous allylenide**, possibly C_3H_3Cu .

According to A. A. Noyes and C. W. Tucker, **cupric carbide**, or **cupric acetylide**, Cu_2C_2 , is formed as an intermediate product when cuprous carbide is heated with cupric chloride and water. J. F. Durand obtained it as a precipitate by adding calcium carbide to an aq. soln. of cupric chloride. F. C. Phillips made the impure carbide by passing acetylene into an ammoniacal soln. of cupric chloride. The deep red precipitate contains hydrogen and oxygen; the pure carbide has not been made. The product becomes brownish-black when exposed to air; it is soluble in hydrochloric acid, but not if it has been long exposed to air; and when boiled, the soln. gives off acetylene. Cupric acetylide with a soln. of mercurous nitrate gives mercurous acetylide; and with silver nitrate, silver acetylide.

According to H. G. Söderbaum, on passing a stream of the purified acetylene into an ammoniacal soln. of either cupric sulphate or nitrate, a black, flocculent precipitate is slowly produced. This substance, after being dried over sulphuric acid, gave various results on analysis, a fact which was found to be due to the absorption of oxygen from the air during the process of drying; in an exhausted desiccator, however, the substance ceased to increase in weight after two days, and the analysis corresponded with the formula $(C_{17}Cu_8H_4O_3)_n$. This **copper acetylide** is a black, amorphous powder insoluble in water and organic solvents; it explodes between 70° and 80° when heated, and decomposes quickly on heating with hydrogen chloride with formation of the halogen salt of copper, and a carbonaceous residue of the formula $(C_{12}H_4O_3)_n$. On passing acetylene into a neutral or faintly acid soln. of copper acetate, a precipitate is formed corresponding in composition with the formula $C_4Cu_4O + (H_2O)_n$, and differing from the compound above mentioned in being stable in the air and non-explosive. It seems, therefore, that a large number of copper acetylides are capable of existence. The composition of the precipitate produced by acetylene in a dil. ammoniacal soln. of cupric sulphate varies with the temp. at which the precipitation is effected. At 5° , the compound, after drying over phosphorus pentoxide, has the composition $C_{24}H_2Cu_{12}O = (12C_2Cu + H_2O)$, and is a black powder, which explodes at 50° when quickly heated, and is dissolved by potassium cyanide and dil. sulphuric and hydrochloric acids, a small amount of a carbonaceous residue being invariably left. At 15° , the acetylide contains less copper, whilst the amount of carbon remains practically unaltered. The atomic ratio of carbon to copper, therefore, is at this temp. greater than 2 : 1.

A number of copper hydrocarbides of indefinite composition have been reported. H. Erdmann and P. Köthner obtained what they regarded as a *Kupferacetylen* approximating to $Cu_3C_{14}H_{44}$, by the action of dry acetylene on copper powder at 230° to 250° . P. Sabatier and J. B. Senderens say that cuprene, C_7H_8 , is a gaseous product under these conditions. H. Alexander said that the copper of H. Erdmann and P. Köthner's product is retained mechanically by a hydrocarbon; F. A. Gooch and D. F. Baldwin also agree that the product is only a hydrocarbon or hydrocarbons mixed with copper or copper oxide.

The direct action of carbon on silver has been discussed in connection with the last-named element (3. 22, 7). O. Ruff and B. Bergdahl observed that carbon is slightly soluble in molten silver. W. Hempel and P. Rucktäschel made an alloy with 0.4

per cent. of carbon. J. L. Gay Lussac's observation² that there is a three per cent. increase in weight when silver is heated with lampblack has been taken as evidence that a *silver tetracarbide*, Ag_4C , is formed; but, as J. Percy emphasized, the sulphur impurities in the lampblack probably accounted for the increase in weight, and the evidence for the existence of this compound is of no value. The carbonaceous residues obtained when certain organic salts of silver are ignited have been supposed to contain a definite carbide because a prolonged calcination did not burn off all the carbon.

C. F. Gerhardt and A. Cahours heated to redness in an open vessel silver cumate, and obtained a dull yellow earthy residue with the composition *silver hemicarbide*, Ag_2C . Dil. nitric acid extracted the silver and left behind carbon. J. von Liebig and J. Redtenbacher heated silver cyanide until at a certain stage there was incandescence, nitrogen was evolved, and a dull white fused silver carbide remained. They stated that when the carbide was heated with access of air, carbon burnt at the surface, and a layer of silver protected the underlying carbide from further oxidation. When treated with nitric acid, silver dissolved and a network of carbon remained. No analyses were made. J. J. Berzelius heated silver pyroracemate, and obtained a grey powder which acquired a metallic lustre when burnished. When boiled with a soln. of potassium carbonate, washed with water, and ignited in air, the composition corresponded with *silver carbide*, AgC ; and in another experiment the composition was represented by Ag_4C_3 . H. V. Regnault heated silver malate to 150° , when a slight explosion occurred, and a dark grey, homogeneous, metallic mass remained. The oily matters were removed by washing with a soln. of potassium hydroxide; then with dil. hydrochloric acid; and with aq. ammonia to remove silver chloride. The dark grey substance so obtained, said H. V. Regnault, can be nothing else than silver carbide, and analyses agree with the formula AgC . Nitric acid dissolved it with the separation of black flakes of charcoal.

Before the nature of acetylene had been established, J. A. Quet, A. Vogel and C. Reischauer, and R. Böttger observed that an explosive compound of silver is formed during the action of pyrogenetic gases on an ammoniacal soln. of silver chloride or nitrate, as in the parallel case of cuprous carbide. The relation of the explosive compound to acetylene was established by M. Berthelot about 1860. The compound was made by M. Miasnikoff, M. Behrend, M. Berthelot, and E. Rebol by passing acetylene into an ammoniacal soln. of silver nitrate: $\text{C}_2\text{H}_2 + 2\text{Ag}(\text{NH}_3)_2\text{NO}_3 = \text{C}_2\text{Ag}_2 + 2\text{NH}_4\text{NO}_3 + 2\text{NH}_3$. E. H. Keiser thus described the process:

Purified acetylene was passed into an ammoniacal soln. of silver nitrate. The precipitate was washed by decantation first with water to which ammonia had been added, afterwards with water, and finally with alcohol and ether. The precipitate was drained on a funnel by means of a filter-pump and quickly transferred to a sulphuric acid desiccator and dried in vacuo. The desiccator should be protected from light, and when dry the colour of the product is snow-white.

R. T. Plimpton said that the precipitate from dil. soln. is pale yellow, and that from conc. soln., yellow; and G. Arth said that the precipitate from ammoniacal soln. is at first yellow, and then becomes white. If a neutral soln. of silver nitrate is used, R. Chavastelon said that the precipitate first formed is a complex silver nitratocarbide which passes into the carbide when the action of the acetylene is continued. R. Kremann and H. Hönel dropped a soln. of acetylene in acetone into a 5 per cent. alcoholic soln. of silver nitrate, and the mixture was allowed to stand in a well-closed vessel and shaken repeatedly. If an aq. soln. of silver nitrate be used, the precipitation is not so sharp.

The composition of the silver compound was represented by the formula $\text{C}_2\text{H}_2\text{Ag}_2$, by M. Miasnikoff; by $(\text{C}_2\text{HAg})_2\text{Ag}_2\text{O}$, by E. Rebol, and M. Berend; by $(\text{C}_2\text{HAg}_2)_2\text{O}$, by M. Berthelot; by $\text{C}_2\text{H}_2\text{Ag}_2\text{O}$, by R. Blochmann, and W. Lossen; by $\text{C}_2\text{Ag}_2 \cdot n\text{H}_2\text{O}$, by R. T. Plimpton; and by C_2Ag_2 , by E. H. Keiser, R. Chavastelon, F. Brandstätter, L. Knorr and H. Mathes, and M. Berthelot and M. Delépine. Silver carbide is a snow-white amorphous powder. M. Berthelot and M. Delépine found the heat of formation to be $\text{C}_2\text{H}_{2\text{soln.}} + 2\text{Ag}(\text{NH}_3)_2\text{NO}_{3\text{soln.}} = \text{C}_2\text{Ag}_2 + 2\text{NH}_4\text{NO}_{3\text{soln.}} + 2\text{NH}_{3\text{soln.}} + 15.55$ Cals.; or $\text{C}_2\text{H}_2 + \text{Ag}_2\text{O} = \text{C}_2\text{Ag}_2 + \text{H}_2\text{O} + 22.25$ Cals. with gaseous acetylene and water, and 32.95 Cals. with acetylene in soln. and liquid water. Hence,

with diamond carbon: $2C + 2Ag = C_2Ag_2 - 87.15$ Cals. The explosiveness of silver carbide is thus connected with its endothermal formation. The carbide readily explodes when dry, and R. Blochmann found it to be as explosive as cuprous carbide; that it decomposes in contact with hydrochloric acid, forming acetylene and silver chloride; and it gradually becomes grey when exposed to light. C. W. B. Normand and A. C. Cumming found that about 2 gram-atoms of iodine are consumed per gram-atom of silver, and silver iodide, $C_4H_2I_2$, etc., are formed. The reaction has been studied by M. Berend, and A. Bayer. G. Arth found that it dissolves in an aq. soln. of potassium cyanide with the evolution of acetylene. J. F. Durand obtained explosive silver nitratocarbide, $Ag_2C_2 \cdot AgNO_3$, by adding calcium carbide to silver nitrate soln. Mercurous acetylide precipitates silver acetylide from aq. soln. of silver nitrate. Silver acetylide has no action on aq. soln. of cupric, mercurous, or mercuric nitrates.

Silver carbide forms complexes with other silver salts, e.g. J. A. Nieuwland and J. A. Maguire prepared **silver fluocarbide**; M. Berthelot, and C. Willgerodt, **silver chlorocarbide**, $C_2Ag_2 \cdot AgCl$, and $2C_2Ag_2 \cdot AgCl$; M. Berthelot, **silver iodocarbide**, $Ag_2C_2 \cdot 2AgI$; J. A. Nieuwland and J. A. Maguire, **silver perchloratocarbide**; and **silver bromatocarbide**; M. Berthelot, and R. T. Plimpton, **silver sulphatocarbide**, $2Ag_2C_2 \cdot Ag_2SO_4$; G. Arth, R. Chavastelon, A. Vogel and C. Reischauer, E. H. Keiser, and R. T. Plimpton, **silver nitratocarbide**, $Ag_2C_2 \cdot AgNO_3$; C. Willgerodt, **silver nitrohydrocarbide**, $AgHC_2 \cdot AgNO_3$; R. Cavastelon and R. T. Plimpton, **silver dinitratocarbide**, $Ag_2C_2 \cdot 2AgNO_3$; J. A. Nieuwland and J. A. Maguire, **silver phosphatocarbide**; A. E. Edwards and W. R. Hodgkinson, **silver chromatocarbide**, $C_2Ag_2 \cdot AgCrO_4 \cdot H_2O$. C. Liebermann made **silver allylenide**, C_3H_3Ag .

The direct action of carbon on gold has been discussed in connection with that metal (3. 23, 6). O. Ruff and B. Bergdahl³ observed the slight solubility of carbon in gold. W. Hempel and P. Rucktäschel prepared an alloy with 0.31 per cent. of carbon. R. Böttger obtained an explosive compound by the action of pyrogenetic gases on soln. of auric chloride. F. C. Phillips said that auric chloride soln. are reduced to gold by acetylene, but, added J. A. Mathews and L. L. Watters, no precipitate is produced if the soln. be made alkaline with potassium hydroxide; nor does any precipitation occur with soln. of potassium cyanaurate. According to M. Berthelot, if acetylene be passed through a soln. of aurous thiosulphate, a yellow explosive compound is formed; and J. A. Mathews and L. L. Watters found that the product obtained by passing acetylene into a soln. of sodium aurous thiosulphate is **aurous carbide**, Au_2C_2 . Aurous carbide forms yellow flakes which are highly explosive by percussion, brushing with a camel's-hair brush, or by rapid heating. If heated very slowly, it can be decomposed without explosion. Aurous carbide is decomposed by hydrochloric acid, giving off acetylene, and leaving a black residue of aurous chloride. Cold water has no action, but when boiled with water, aurous carbide is decomposed into its constituents without forming acetylene. Soln. of cuprous sulphate and neutral ferric chloride do not decompose it in the cold, but if boiled, decomposition without explosion occurs.

REFERENCES.

- ¹ M. Berthelot, *Compt. Rend.*, **50**, 805, 1860; **54**, 515, 640, 1042, 1862; **58**, 977, 1864; *Ann. Chim. Phys.*, (3), **67**, 52, 1863; (4), **9**, 386, 1866; (5), **10**, 365, 1877; *Bull. Soc. Chim.*, (2), **22**, 341, 1874; M. Berthelot and M. Delépine, *ib.*, (7), **19**, 5, 1899; M. Kuntzmann, *ib.*, (3), **6**, 422, 1891; P. Cazeneuve, *ib.*, (3), **7**, 69, 1892; M. Delépine, *Carbures métalliques*, Paris, **131**, 1904; J. A. Quet, *Compt. Rend.*, **46**, 903, 1858; J. Nicklès, *ib.*, **55**, 505, 1862; E. Reboul, *ib.*, **54**, 1229, 1862; **55**, 136, 1862; J. F. Durand, *ib.*, **177**, 693, 1923; E. Péchard, *ib.*, **136**, 504, 1903; A. Crova, *ib.*, **55**, 435, 1862; R. Chavastelon, *ib.*, **126**, 1810, 1898; P. Sabatier and J. B. Senderens, **130**, 250, 1900; E. Briner and R. Senglet, *Journ. Chim. Phys.*, **13**, 351, 1915; K. Nischk, *Zeit. Elektrochem.*, **29**, 373, 1923; E. H. Keiser, *Amer. Chem. Journ.*, **14**, 285, 1892; **15**, 535, 1893; A. A. Noyes and C. W. Tucker, *ib.*, **19**, 123, 1897; H. C. Jones and C. R. Allen, *ib.*, **18**, 375, 1896; J. Torrey, *Amer. Gas Light Journ.*, **1**, 55, 1859; W. Melentjeff, *German Pat.*, *D.R.P.* 177349, 1905; L. Horwitz, *ib.*, 205705, 1907; R. Böttger, *Jahresb. Phys. Ges. Frankfurt*, **37**, 1858; *Liebig's Ann.*, **109**, 351, 1859; H. G. Söderbaum, *Bihang. Akad. Handl.*, **25**, 5, 1900;

Ber., 30. 760, 814, 3014, 1897; J. Scheiber, *ib.*, 41. 3816, 1908; H. Alexander, *ib.*, 32. 2381, 1899; R. Blochmann, *ib.*, 7. 274, 1874; *Zeit. anal. Chem.*, 13. 326, 1874; H. Erdmann and O. A. W. Makowka, *ib.*, 46. 125, 1907; O. A. W. Makowka, *Ueber Metallbestimmungen und Metalltrennungen mit Acetylen*, Halle a. S., 1905; *Ber.*, 41. 824, 1908; G. S. Johnson, *Chem. News*, 49. 127, 1884; W. S. Mai, *Journ. Gasbeleucht.*, 41. 683, 1898; M. Freund and W. S. Mai, *Acetylene*, 285, 1898; N. Caro, *Verh. Ver. Gewerbfl.*, 255, 1906; E. Carstanjen and A. Schertel, *Journ. prakt. Chem.*, (2), 4. 47, 1871; F. Küsspert, *Zeit. anorg. Chem.*, 34. 453, 1903; O. Ruff and B. Bergdahl, *ib.*, 106. 76, 1919; K. A. Hofmann and F. Küsspert, *ib.*, 15. 204, 1897; F. C. Phillips, *ib.*, 6. 241, 1894; H. Erdmann and P. Köthner, *ib.*, 18. 49, 1898; F. A. Gooch and D. F. Baldwin, *ib.*, 22. 235, 1899; *Amer. Journ. Science*, (4), 8. 354, 1899; A. Schieler, *Zeit. Calciumcarbide Fabr.*, 10. 93, 1906; N. Ljubawin, *Journ. Russ. Phys. Chem. Soc.*, 17. 252, 1885; A. Römer, *Liebig's Ann.*, 233. 182, 1886; A. Sabanéeff, *ib.*, 178. 114, 1875; S. Zeisel, *ib.*, 191. 368, 1878; W. Hempel and P. Rucktäschel, *Zeit. angew. Chem.*, 17. 296, 321, 1904; P. Rucktäschel, *Ueber einige Kohlenstoff- und Siliciummetalle, sowie eine neue, allgemeine anwendbare Methode zur Kohlenstoffbestimmung in Metallen*, Rostock, 1893; J. J. Berzelius, *Ann. Chim. Phys.*, (2), 14. 190, 1820; (2), 36. 1, 1835.

² J. Percy, *Silver and Gold*, London, 1. 129, 1880; J. L. Gay Lussac, *Ann. Chim. Phys.*, (2), 58. 218, 1835; H. V. Regnault, *ib.*, (2), 62. 215, 1836; C. F. Gerhardt and A. Cahours, *ib.*, (3), 1. 60, 1841; J. J. Berzelius, *Pogg. Ann.*, 36. 28, 1835; R. Böttger, *Jahresb. Phys. Ges. Frankfurt*, 37, 1858; *Liebig's Ann.*, 109. 351, 1859; J. von Liebig and J. Redtenbacher, *ib.*, 37. 129, 1841; M. Miasnikoff, *ib.*, 118. 330, 1861; W. Lossen, *ib.*, 272. 139, 1892; M. Behrend, *ib.*, 135. 258, 1865; C. Liebermann, *ib.*, 135. 268, 1865; R. Blochmann, *ib.*, 173. 177, 1874; *Ber.*, 7. 274, 1874; L. Knorr and H. Matthes, *ib.*, 32. 741, 1890; C. Willgerodt, *ib.*, 23. 2108, 1895; A. Bayer, *ib.*, 19. 2275, 1885; E. Reiboul, *Compt. Rend.*, 54. 1229, 1862; 55. 136, 1862; G. Arth, *ib.*, 124. 1534, 1897; J. A. Quet, *ib.*, 46. 903, 1858; R. Chavastelon, *ib.*, 124. 1364, 1897; J. F. Durand, *ib.*, 177. 693, 1923; F. Brandstätter, *Zeit. phys. chem. Unterr.*, 10. 140, 1897; R. T. Plimpton, *Proc. Chem. Soc.*, 8. 109, 1892; J. A. Nieuwland and J. A. Maguire, *Journ. Amer. Chem. Soc.*, 28. 1029, 1906; O. Ruff and B. Bergdahl, *Zeit. anorg. Chem.*, 106. 76, 1919; E. H. Keiser, *Amer. Chem. Journ.*, 14. 285, 1892; R. Kremann and H. Hönel, *Monatsh.*, 34. 1089, 1913; C. W. B. Norman and A. C. Cumming, *Journ. Chem. Soc.*, 101. 1852, 1912; M. Delépine, *Carbures métalliques*, Paris, 134, 1904; *Compt. Rend.*, 129. 370, 1899; M. Berthelot and M. Delépine, *ib.*, 129. 361, 1899; *Ann. Chim. Phys.*, (7), 19. 5, 1899; M. Berthelot, *ib.*, (4), 9. 385, 1866; *Compt. Rend.*, 50. 807, 1860; A. Vogel and C. Reischauer, *Ber. Akad. München*, 331, 1858; A. E. Edwards and W. R. Hodgkinson, *Chem. News*, 90. 140, 1904; W. Hempel and P. Rucktäschel, *Zeit. angew. Chem.*, 17. 296, 321, 1904; P. Rucktäschel, *Ueber einige Kohlenstoff- und Siliciummetalle, sowie eine neue, allgemeine anwendbare Methode zur Kohlenstoffbestimmung in Metallen*, Rostock, 1893.

³ R. Böttger, *Journ. prakt. Chem.*, (1), 76. 224, 1859; M. Berthelot, *Ann. Chim. Phys.*, (4), 9. 385, 1866; J. A. Mathews and L. L. Watters, *Journ. Amer. Chem. Soc.*, 22. 108, 1900; F. C. Phillips, *Amer. Chem. Journ.*, 16. 348, 1894; W. Hempel and P. Rucktäschel, *Zeit. angew. Chem.*, 17. 296, 321, 1904; P. Rucktäschel, *Ueber einige Kohlenstoff- und Siliciummetalle, sowie eine neue, allgemeine anwendbare Methode zur Kohlenstoffbestimmung in Metallen*, Rostock, 1892; O. Ruff and B. Bergdahl, *Zeit. anorg. Chem.*, 106. 76, 1919.

§ 15. The Carbides of the Alkaline Earths

After E. Davy¹ had prepared his carburet of potassium, R. Hare, in 1839, experimented on the preparation of calcium by heating an organic salt of calcium—e.g. calcium acetate—or a mixture of calcium oxide and sugar charcoal; he found that when mercuric cyanide is heated with lime, a black mass containing carbon is produced. When these mixtures were heated in the electric arc, there was formed a grey mass containing some free carbon, which oxidized in air, and when treated with water gave a gas with an unpleasant smell. The product must have been an impure calcium or mercury carbide. H. Debray and H. St. C. Deville also seem to have prepared a similar product by melting lime and coal in the oxy-hydrogen furnace. In 1862, F. Wöhler prepared what he called *Kohlenstoffcalcium* by heating an alloy of calcium and zinc with carbon, and he identified the gas which was evolved as acetylene. T. S. Hunt stated in 1886 that in the electric furnace the oxides, not only of the alkali metals, but also those of calcium, magnesium, aluminium, silicon, and boron, in the presence of carbon can be reduced to form carbides. W. Borchers in 1891 concluded that "all the oxides are capable of being reduced by carbon heated by electricity," and although he does not mention calcium carbide, yet, after the com-

mercial importance of this carbide had been established, he claimed that he had obtained **calcium carbide**, CaC_2 , but drew no attention to it since he was seeking for the metals. This claim for priority has no bearing on the history of our knowledge of calcium carbide. L. K. Boehm said that he had made calcium carbide in 1891, by heating carbon and the alkaline earth by means of an electric current. It is evident from all this that calcium carbide had been made in electric furnaces more or less as an accidental product, but it was then of no commercial importance.

T. L. Willson first made calcium carbide and grasped the importance of this compound as a means of preparing acetylene so as to bring it within the range of commercial utility. The general history of calcium carbide has been described by D. Korda, F. Liedbetanz, V. B. Lewes, J. H. Vogel, R. Pitival, etc. Early in 1892, T. L. Willson attempted to reduce magnesium and calcium oxides to the metallic state in the electric furnace, in order to utilize these metals in the reduction of alumina.

In attempting to reduce lime by carbon, he obtained a fused bath which caused a short-circuiting of the current, and to prevent which he added a layer of carbon which prevented the splashing of the bubbling liquid against the sides of the electrodes. He produced in this way calcium carbide as a hard crystalline mass which disintegrated and crumbled on exposure to the air, and gave rise to a violent evolution of gas when brought in contact with water. The gas burnt with a very smoky flame.

The publication by A. C. Frazer of the correspondence with Lord Kelvin, and a report by F. P. Venable show that the carbide was made by electric smelting about the middle of 1892, but the issue of a patent in Feb. 21st, 1893, was the first public announcement of this work. Meanwhile, L. Maquenné studied the observations of C. Winkler (i) on the reduction of the alkaline earth carbonate by magnesium, $\text{CaCO}_3 + 3\text{Mg} = 3\text{MgO} + \text{C} + \text{Ca}$, and (ii) the residue when treated with water gave off hydrogen with a disagreeable smell. L. Maquenné prepared barium carbide by the action of magnesium on a mixture of barium carbonate and retort carbon: $\text{BaCO}_3 + 3\text{Mg} + \text{C} = \text{BaC}_2 + 3\text{MgO}$; and stated that the reaction is successful only with barium carbonate; for the others, particularly calcium carbonate, are only partially attacked, and give on treatment with water a mixture of hydrogen and a little acetylene. At the end of 1892, H. Moissan published an account of the formation in the electric furnace of a fusible calcium carbide. He said:

If the temp. reaches 3000° , calcium oxide is rapidly reduced by carbon, and the metal is set free in large quantities; it combines readily with the carbon of the electrodes, forming a calcium carbide which is liquid at a red heat, and so is easily collected.

Later, he added that at the high temp. of the electric furnace, only a single compound of carbon and calcium can exist; this compound is crystalline, and its analysis corresponds with CaC_2 . L. M. Bulrier applied for a patent for the preparation of the carbides of the alkaline earths based on H. Moissan's researches. H. Moissan's experiments were made in an arc furnace resembling Figs. 4 and 5. H. Moissan thus describes the preparation of the carbide:

An intimate mixture of 120 grms. of calcium oxide made from marble and 70 grms. of sugar charcoal is heated in the crucible of the electric arc furnace. A slight excess of lime is purposely allowed since the crucible supplies some of the carbon required for the carbide; if an excess of lime is used, calcium is the chief product. Calcium carbonate can be substituted for the lime, but not with advantage, because of the large vol. of the substance employed. The yield is 120–150 grms. A lime-containing magnesia yields carbide only with difficulty because magnesium carbide is not readily made, and the magnesia then retards the fusion.

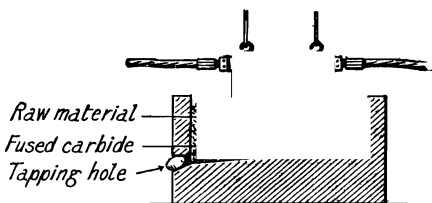

FIG. 21.—Calcium Carbide Furnace (Diagrammatic).

E. Botolfsen has studied the direct combination of carbon and calcium. No combination could be detected by heating the two elements in vacuo at 700° —*i.e.* below the m.p. of the metal—during 50 hrs. Carbide was formed when fused calcium was heated in contact with carbon, but, owing to the distillation of the calcium, only traces were produced. If heated to 850° in an atm. of argon at normal press., no increase in the yield of carbide was observed. If, however, carbon be heated with an excess of calcium to 850° – 870° in contact with calcium vapour, only 17 per cent. of the carbon remains uncombined; and at 925° – 975° , all the carbon had combined in 45 hrs. No trace of a *calcium subcarbide* was observed. H. Moissan made calcium carbide by the action of calcium-ammonium on acetylene. L. Hackspill and E. Botolfsen found the product is impure.

The electric current, said F. Krüger, plays no part in the production of calcium carbide other than as a means of obtaining a high temp. H. Moissan found the carbide is decomposed if the temp. be too high. H. J. Krause and J. Y. Yee said that the reduction of the calcium oxide and the evolution of carbon monoxide begins at about 1200° . V. Rothmund said that the reaction begins at 1620° when the partial press. of the carbon monoxide is one-fifth (M. de K. Thompson says that this should be one-third) of an atm.; at temp. below 1620° in the presence of carbon monoxide, some carbide is decomposed. The temp. of formation may be reduced by decreasing the partial press. of the carbon monoxide. C. Diesler said that good yields can be obtained at 1600° by working at high press. E. Rudolphi gave 1800° – 1819° for the temp. of formation with the partial press. of carbon monoxide one-fifth of an atm. A. Larapen said that below 1700° he could detect no carbide formation with certainty; at 1725° , there were traces of carbide formed; and at 1800° , the mass fused and much acetylene was evolved when the product was treated with water. W. Borchers said that “the reactions taking place in the production of calcium carbide are $\text{CaO} + \text{C} = \text{Ca} + \text{CO}$, and $\text{Ca} + 2\text{C} = \text{CaC}_2$. The second reaction was discovered by F. Wöhler.” The carbons are corroded badly about 6 ins. below the surface of the mixture when the carbons were immersed about a foot in the mixture. G. Gin suggests that free oxygen is found in the gases produced in the hottest portions of a calcium carbide furnace, whilst calcium vap. is found in cooler portions of the furnace. It was suggested that these substances may be formed by the reactions $2\text{CaO} + 4\text{C} = 2\text{CaC}_2 + \text{O}_2$ and $\text{CaC}_2 + 2\text{CaO} = 3\text{Ca} + 2\text{CO}$, the temp. in the hottest zones of the furnace being higher than the dissociation temp. of carbon monoxide. According to C. Bingham, the corrosion of the carbons has been attributed to the action of air on the carbons owing to the latter being raised to a high temp. by the heat (i) produced by the combustion of carbon monoxide on the surface of the charge; (ii) produced by ohmic resistance; and (iii) carried by conduction from the hot zone by the carbons themselves. R. S. Hutton and J. E. Petavel showed that if the carbon is completely burned in the raw material, and the furnace made completely gas-tight so that no air can enter, there is very little consumption of carbon. The subject has also been discussed by O. Ruff and O. Geocke; and the power consumption by H. Furusaki. J. Leede recommended making the charge by coking a mixture of lime with a hydrocarbon—pitch, asphaltum, etc. H. L. Hartenstein, and L. Landin used a similar process, and also recommended adding a little calcium chloride or fluoride to make the product more fusible. T. L. Willson previously said that he obtained “the best results by infusing the lime in tar, and then subjecting the mixture to the electric arc.” One type of furnace employed on a large scale is illustrated diagrammatically by Fig. 20. The general manufacture has been described by J. Baumann, J. H. Reid, F. L. Slocum, F. E. Norton, O. Ruff and E. Förster, C. Bingham, V. B. Lewes, J. H. Vogel, F. Liedbetanz, B. Waeser, P. Schläpfer, P. Wangemann, etc. J. H. Reid degasified a mixture of pulverized calcium carbonate and coal, and passed it on, while still hot, to an electric furnace, where it yielded calcium carbide and carbon monoxide. If required, the carbide was run

into water, and the gaseous products passed through the furnace chamber so as to collect hydrocarbons like methane, ethylacetylene, methylallene, etc.

A great many varieties of furnace and a great many modifications in the details of manufacture have been proposed. Many of these proposals are still-born—*e.g.* R. P. Pictet heated the mixture in a shaft furnace by a ring of tuyères burning water-gas mixed with air, and below that, the mixture was heated in the electric arc at 3000°; the resulting calcium carbide flowed to the bottom of the furnace. F. Sebald added a little lead or tin to make the furnace charge conduct better.

Instead of using calcium oxide or carbonate, E. Jacobsen, and C. M. J. Limb used a mixture of calcium sulphate or sulphide and carbon; R. C. Baker used calcium borate or pandermite and obtained calcium carbide and boride; and H. Hilbert and A. Frank used calcium phosphate: $\text{Ca}_3(\text{PO}_4)_2 + 14\text{C} = 3\text{CaC}_2 + 2\text{P} + 8\text{CO}$. M. W. Travers prepared calcium carbide without electric heating by melting sodium with an intimate mixture of calcium chloride and retort carbon in an iron crucible for half an hour; and P. Wolff inflamed a mixture of calcium oxide, carbon, and aluminium as in the thermite process.

The product obtained in the earlier stages of the industry was very impure until it was recognized that special care must be taken in the choice of raw materials. The lime may contain silicates, phosphates, and sulphates, and these may appear in the carbide as silicides, sulphides, and phosphides, which are decomposable by water, yielding acetylene contaminated with hydrogen, hydrogen sulphide and phosphide. Nitrides, which contaminate the gas with ammonia, may also be formed. The impurities in the carbide have been discussed by C. Willgerodt,² J. de Brévans, E. Hubou, H. Giraud, N. Caro, F. B. Ahrens, L. M. Bullier and M. Perrodil, E. Chuard, A. Bergé and A. Reyehler, etc. Commercial calcium carbide contains as accessory constituents some cyanamide, unconverted carbon, crystallized alumina (corundum), and calcium oxide. J. H. Vogel gave analyses of some of the earlier commercial carbides. The following are selected from his list:

CaC_2	C	$\text{CaO}(\text{CO}_2)$	Si	P	S	N	Fe_2O_3	MgO	Al_2O_3
83.23	6.12	6.62	0.32	0.006	0.020	2.020	2.31	0.32	0.28
90.12	2.36	4.42	1.32	0.005	0.032	0.01	1.03	0.005	0.26

Some of the more recent products have over 95 per cent. CaC_2 . *Silicon* is present as calcium or iron silicide (H. le Chatelier, F. Wöhler, H. Moissan, F. B. Ahrens, O. Hackl); silicon (R. S. Marsden); silica crystals (H. Moissan); carborundum (H. Moissan); and ferrosilicon—*vide* iron; *sulphur*, as calcium or aluminium sulphide (H. Moissan, G. Döllner and E. Jacobsen, A. Mourlot); *iron*, as silicide, phosphide, or carbosilicide or ferrosilicon (H. Moissan, G. Hanekop); *phosphorus*, as calcium or iron phosphide (H. Moissan, A. P. Lidoff); *calcium*, as free oxide, sulphide, phosphide, etc. (J. H. Vogel); *aluminium*, as sulphide; *arsenic* (J. H. Vogel); *cyanides* and *nitrides* (A. Rossel, L. Franck, H. Bamberger, N. Caro); and *carbon* is found as graphite. H. Giraud reported minute crystals in the insoluble residue remaining after the carbide had been treated with water, but H. Moissan could find no diamonds. Several methods have been proposed—by H. L. Hartenstein,³ C. J. Lundström, J. von Orłowsky, W. Rathenau, E. Zühl and R. Eisemann, etc.—for eliminating impurities as slags.

K. Nischk⁴ studied the formation of the carbides of calcium, strontium, and barium. In 1892, L. Maquenné made an impure **barium carbide**, BaC_2 , by fusing together barium carbonate (26 grms.), powdered magnesium (10.5 grms.), and retort carbon (4 grms.), when an intense reaction occurred, $\text{BaCO}_3 + 3\text{Mg} + \text{C} = 3\text{MgO} + \text{BaC}_2$. The mixture of magnesia and barium carbide gave acetylene when treated with water. He also made it by heating barium amalgam with powdered carbon in an atm. of hydrogen; the reaction begins at a red heat. He also made the carbide by heating barium nitride with carbon. H. Moissan, and L. M. Bullier made barium carbide by heating a mixture of sugar charcoal and barium oxide or carbonate in an

electric arc furnace. H. Moissan made **strontium carbide**, SrC_2 , in a similar manner. C. M. J. Limb made barium carbonate by heating native barium manganate, *i.e.* psilomelane, at a high temp. with carbon.

H. Moissan established the composition of the three alkaline earth carbides by analysis. Arguments ⁵ as to whether calcium carbide is or is not a *fine chemical* are futile until the disputants have agreed as to the definition of a *fine chemical*. Similarly, it is a waste of time to discuss whether calcium carbide is or is not an organic compound until it is decided what is an *organic compound*. *E.g.* if organic chemistry be the chemistry of carbon compounds, then the carbonates, carbides, cancrinite (silicate), cast iron, etc., would belong to that department of chemistry. When the definition is settled, there will probably be no need for argument. Without sharp-cut definitions the opponents in this type of disputation cross rapiers without touching one another. Each fights his own shadow.

The properties of calcium, strontium, and barium carbides.—The prevailing colours of commercial calcium carbide are black, reddish-black, or reddish-brown, and less commonly yellowish-red or brown. These colours are attributed by H. Moissan ⁶ to the presence of iron. E. Wedekind, and H. Moissan said that a mere trace suffices to produce both the coloration and a lustrous iridescent sheen. There may be a bluish or purplish iridescence on the surface. The carbide with streaks of a darker colour than the remaining mass owes its colour to the overheating of the furnace which has caused the separation of amorphous carbon, and volatilization of calcium. According to H. Moissan, and E. Botolfsen, if quite free from iron, calcium carbide is white, and as transparent as sodium chloride. The mass cleaves readily and has a crystalline fracture. The carbide which has been cooled slowly is coarsely crystalline; and that which has quickly chilled has a steel-like fracture, with a fine, almost invisible, grain. The **crystals** do not belong to the cubic system. According to C. H. Warren, the **cleavages** are cubic, being nearly equal and parallel to three directions at right angles to one another. The fresh cleavage surfaces may show striations, which indicate that the crystals are built up from a series of thin plates. The thin sections in transmitted light may appear colourless, greenish-yellow, purplish-red, or lilac-yellow. There is a slight pleochroism. The complex polysynthetic twinning is parallel to the diagonals approximately at 45° to the pinacoids. The dodecahedral twinning appears to be mimetic, so that, geometrically, the crystals are pseudo-cubic. The double refraction, rectangular cleavage, and parallel extinction correspond with either the tetragonal or rhombic system—probably the latter. The **index of refraction** exceeds 1.75; and the double refraction is strong, being nearly 6.050. The optical extinction is generally parallel to the rectangular cleavages, but with a yellowish carbide, the extinction may be inclined 12° to 24° with the rectangular cleavages. The interference figures resemble the so-called uniaxial figures. According to H. Moissan, the **specific gravity** of calcium carbide is 2.22 at 18° ; that of strontium carbide, 3.19; and that of barium carbide, 3.75. H. Moissan said that platinum may be melted in contact with the solid carbide. H. M. Kahn found barium carbide fused at a lower temp. than the other alkaline earth carbides. As indicated above, there is evidence that the carbide decomposes at a high temp., but no change occurs at the temp. of molten platinum. E. Botolfsen found that calcium carbide dissociated when heated to 1050° for 3 hrs., and a deposit of finely divided metallic calcium was obtained; the carbon united with the iron containing vessel, forming iron tritacarbide. M. de K. Thompson said that the decomposition of calcium carbide into its elements is appreciable a little above 1475° . E. Tiede and E. Birnbrauer gave 800° for the **dissociation temperature**. V. Ehrlich, and G. Erlwein and co-workers concluded that calcium carbide, when heated, dissociates into *calcium subcarbide*, CaC , and carbon; E. Briner and A. Kurhne found no evidence of a subcarbide, and concluded that the carbide dissociates into its elements; G. Bredig could identify neither a subcarbide nor calcium as a product of the decomposition; E. Botolfsen identified volatilized calcium; O. Ruff and E. Förster obtained no evidence of the existence of a subcarbide; and H. J. Krase and J. Y. Yee showed that above 1100° , there is an appreciable vap.

press. of calcium, and that assuming the reaction is $\text{CaC}_2 \rightleftharpoons \text{Ca} + 2\text{C}$, they found data in agreement with

	1000°	1100°	1200°	1800°
C liberated	0.00	3.68	1.12	22.32

G. Gin and M. Leloux observed a similar decomposition of the other alkaline earth carbides. The decomposition of barium carbide occurs at a lower temp. than the volatilization temp. of carbon. The carbides themselves are non-volatile. The specific heat has not been determined, but B. Carlson calculated from the additive rule :

	0°	1000°	1500°	2000°	2500°	3000°	3500°
Sp. ht.	0.247	0.271	0.296	0.325	0.344	0.363	0.381
Mol. ht.	15.92	18.36	19.58	20.80	22.02	23.24	24.42

O. Ruff and E. Förster gave 2300° for the melting point of calcium carbide, and they found that, owing to the dissociation $\text{CaC}_2 \rightleftharpoons \text{Ca}_{\text{vapour}} + \text{C}_{\text{graphite}}$, the vapour pressure, p mm., in an atm. of the calcium vapour is

	2025°	2200°	2255°	2325°	2405°	2425°	2460°	2500°
p	12	26	128	228	541	631	756	780

so that the dissoc. press. of calcium carbide is 760 mm. at $2500^\circ \pm 50^\circ$, and 1 mm. at $1825^\circ \pm 50^\circ$. A. Guntz and H. Basset gave for the heat of formation from diamond carbon and solid calcium: $\text{Ca} + 2\text{C} = \text{CaC}_2 + 13.15$ Cals. R. de Forcrand gave -7.25 Cals., and with amorphous carbon -0.65 Cal. for calcium carbide, and -7.25 Cals. and -0.65 Cal. respectively for barium carbide. For the heat of formation of the latter from its gaseous elements he gave 76.65 Cals. O. Ruff and E. Förster gave $\text{CaO} + \text{C} \rightleftharpoons \text{Ca} + \text{CO} - 120$ Cals., $\text{Ca} + 2\text{C} \rightleftharpoons \text{CaC}_2 + 13.15$ Cals.; $\text{CaO} + 3\text{C} \rightleftharpoons \text{CaC}_2 + \text{CO} - 97$ Cals.; and $2\text{CaO} + \text{CaC}_2 \rightleftharpoons 3\text{Ca} + 2\text{CO} + 143$ Cals. The temp. of formation has been already discussed. According to G. Hanekop, the electrical conductivity of the molten carbide is from $\frac{1}{350}$ th to $\frac{1}{600}$ th of that of mercury, and that of the solid carbide is still smaller.

Neither F. P. Venable and T. Clarke, nor H. Moissan observed any reaction between dry hydrogen on cold, or on heated, calcium carbide; and they found that dry oxygen reacts with the heated carbide at a dull red heat with incandescence, forming calcium carbonate and carbon dioxide; but O. Ruff and E. Förster found that an appreciable quantity of acetylene, $\text{CaC}_2 + \text{H}_2 \rightleftharpoons \text{Ca} + \text{C}_2\text{H}_2$, is formed at 2200°. Calcium carbide disintegrates and crumbles on exposure to ordinary air, but not to dried air; hence it is preserved by immersion in oil—say kerosine—or in air-tight tins. Like sodium and potassium, it gives rise to a violent evolution of gas when in contact with water. H. Moissan showed that if a fragment of this carbide be passed into a eudiometer tube filled with mercury, and then a few cubic centimeters of water introduced, a violent evolution of gas is produced, which only ceases when all the carbide is decomposed, calcium hydroxide remaining suspended in the liquid. The gas evolved is pure acetylene, completely absorbed by ammoniacal cuprous chloride, and leaving an almost imperceptible trace of impurity at the top of the tube. This decomposition by water takes place with evolution of heat, but without ever reaching the point of incandescence. It is nevertheless as vigorous as the reaction between sodium and water. From the weight of the carbide taken in the experiment and the vol. of the gas produced, the reaction appears to be represented by $\text{CaC}_2 + 2\text{H}_2\text{O} = \text{C}_2\text{H}_2 + \text{Ca}(\text{OH})_2$. O. Ruff and E. Förster found that at 250° water vapour forms acetylene and calcium oxide, but at dull redness, calcium oxide, carbon, and hydrogen: $\text{CaC}_2 + \text{H}_2\text{O} \rightleftharpoons \text{CaO} + 2\text{C} + \text{H}_2$.

C. H. Warren thus describes the slow decomposition of the carbide by water as it appears under the microscope using thin rectangular cleavage fragments, immersed in a mixture of glycerol and water so that the decomposition may be slow enough to prevent effervescence. With crossed nicols, the margins of the grains appear gradually to lose their strong interference colours, and a rim of feebly birefringent material begins to develop. The

corners change more quickly than the sides, so that the unchanged carbide assumes a circular or elliptical outline which constantly diminishes in size until the entire grain has changed to feebly refracting calcium hydroxide. During this change, the structural appearance of the grain does not alter, and the cleavage cracks and twinning lines remain. If enough water is present, the calcium hydroxide may finally dissolve. The change seems to involve the passage of one crystalline substance into another without immediately breaking down the essential crystal structure, so that OH-groups take the place of the carbon atoms. This phenomenon recalls the preservation of the crystalline structure of some zeolites during dehydration.

According to H. Moissan, at room temp. the alkaline earth carbide takes fire in **fluorine** gas, forming calcium and carbon fluorides. F. P. Venable and T. Clarke found that calcium carbide is not attacked by **chlorine** in the cold, but at 245°, the carbide becomes incandescent, forming calcium and carbon chlorides. A. Frank stated that when calcium, barium, and strontium carbides are heated in a stream of chlorine, graphite carbon separates out, but the yield is much less than the theoretical. According to H. Moissan, and F. P. Venable and T. Clarke, **bromine** reacts at 350°, and **iodine** decomposes the carbide at 305°, with incandescence. H. Moissan compared the temp. of incandescence of the three alkaline earth carbides with the dried halogens.

	Chlorine	Bromine	Iodine
Calcium carbide.	245°	350°	305°
Strontium carbide	197°	174°	182°
Barium carbide	140°	130°	122°

E. Barnes found liquid bromine acts slowly on calcium carbide at ordinary temp., forming carbon hexabromide and calcium bromide, but dry chlorine had no action at ordinary temp. on two months exposure. In a sealed tube at 100°, bromine and calcium carbide form carbon and calcium bromide. According to H. Moissan, barium carbide combines with iodine at a lower temp. than that at which it is attacked by chlorine or bromine; this is the reverse of what occurs with calcium carbide. H. Moissan showed that with dil. or conc. acids, the alkaline earth carbides decompose with the evolution of acetylene; the carbides become incandescent when warmed in **hydrogen chloride**, and much hydrogen is formed. Calcium and strontium carbides become incandescent in **sulphur** vap. at about 500°, barium carbide at 150°, and the alkaline earth sulphide and disulphide are formed. Similar results were obtained with **selenium** vap. Fuming **sulphuric acid** slowly attacks the alkaline earth carbides. Fused calcium carbide dissolves **carbon** and gives it up as graphite on cooling; H. M. Kahn's observations have been indicated in connection with carbon, and he obtained similar results with the other carbides of the alkaline earths. A. Frank found that when calcium, strontium, or barium carbide is heated in a current of **carbon monoxide or dioxide**, carbon separates in the form of graphite: $\text{CaC}_2 + \text{CO} \rightleftharpoons \text{CaO} + 3\text{C}$; the reaction is reversible and progresses from right to left above 1600°, and at lower temp. it goes from left to right. O. Ruff and E. Förster represented the reaction at about 1700°, $\text{CaC}_2 + \text{CO} \rightarrow \text{CaO} + 3\text{C}$. V. Rothmund, and C. A. Hansen also studied this reaction. M. de K. Thompson found the partial press. of carbon monoxide in the reversible reaction: $\text{CaO} + 3\text{C} \rightleftharpoons \text{CaC}_2 + \text{CO}$, at 1445° and 1475°—below 1445° the partial press. is too small to measure conveniently, and above 1475° the carbide dissociates $\text{CaC}_2 \rightleftharpoons \text{Ca} + 2\text{C}$. The partial press. at 1445° is 0.44 mm. and at 1475°, 0.82 ± 0.02 mm. From the equation $\log(p_2/p_1) = Q(T_1^{-1} - T_2^{-1})$, at room temp., $Q = 121,000$, and the negative temp. coeff. of 3.3 cal. per degree gives for θ above the room temp., $Q = 121,000 - 3.3\theta$; at 1460°, $Q = 116,000$ Cals. The heat-change is negative in passing from left to right of the given equation. The free energy of the reaction at 1475° is +23,700 cal., and it decreases as the temp. rises to 1920°; above that temp. there is an increase. Assuming the mean values of Q , the equilibrium press., p , of the carbon monoxide calculated for different temp. is

	1475°	1575°	1675°	1775°	1875°	1975°
p .	0.08	0.50	2.53	10.7	10.5	133.0 mm.

The results are graphed in Fig. 22. H. Moissan found that when a mixture of calcium carbide and **alcohol** is heated in a sealed tube, calcium ethoxide and acetylene are formed: $\text{CaC}_2 + 2\text{C}_2\text{H}_5\text{OH} = (\text{C}_2\text{H}_5\text{O})_2\text{Ca} + \text{C}_2\text{H}_2$. He also said that the carbide is insoluble in the reagents—**carbon disulphide, petroleum, or benzene**. P. Lefebure found the primary reaction of calcium carbide on **amyl chloride** is: $2\text{C}_5\text{H}_{11}\text{Cl} + \text{CaC}_2 \rightarrow \text{C}_2\text{H}_2 + 2\text{C}_5\text{H}_{10} + \text{CaCl}_2$, but a complex series of changes follows on. D. Sandmann found that **potassium thiocyanate** reacted with calcium carbide: $\text{CaC}_2 + 5\text{KSCy} = \text{CaS}_5 + 5\text{KCy} + 2\text{C}$. H. Moissan detected no signs of a reaction between the alkaline earth carbides and **silicon** or boron at a white heat; **silica** yields silicon carbide. H. C. Geemuyden found that **boron trioxide** is reduced by calcium carbide in an electric furnace, and calcium boride is formed.

H. Moissan observed no reaction between the alkaline earth carbides and **nitrogen** at 1200° , but A. Frank, and N. Caro showed that at 700° – 800° , dry nitrogen changes barium carbide into barium cyanide and cyanamide in the proportions 30:70; the reactions are represented: $\text{BaC}_2 + \text{N}_2 = \text{Ba}(\text{CN})_2$; and $\text{Ba}(\text{CN})_2 = \text{BaN}_2\text{C} + \text{C}$. The reaction is utilized in the preparation of cyanides. Calcium carbide forms the cyanamide at 1100° – 1200° , and when the resulting calcium cyanamide, CaN_2C , is fused with alkali salts, in the presence of carbon, alkali cyanide is formed. According to N. Caro, at atm. press., the reaction $\text{CaC}_2 + \text{N}_2 = \text{C} + \text{CaN}_2\text{C}$, is reversed at about 1360° , but if free lime is present, the reversal occurs at a lower temp. Thus, M. le Blanc and M. Eschmann found that with a 75 per cent. calcium carbide, the reversal occurs at 1150° . O. Ruff and E. Förster investigated the reaction between nitrogen and calcium cyanamide. The cyanamide formed above 1100° begins to decompose at 1200° . A. Remelé and B. Rassow studied the nature of the carbon formed in this reaction. M. de K. Thompson and R. H. Lombard, V. Ehrlich, and H. J. Krase and J. Y. Yee studied the equilibrium conditions with different press. of nitrogen; there is a disturbance owing to the volatilization of the cyanamide at 1050° . Owing to the reversibility of the reaction, nitrogen is not taken up by fused calcium carbide as it leaves the furnace since the cyanamide cannot exist at the temp. of the fused carbide. As the carbide cools, it becomes impermeable to gases, and absorption occurs only on a thin surface film. H. Moissan passed acetylene into a soln. of calcium in liquid ammonia, and obtained **calcium tetrammino-acetylenecarbide**, $\text{CaC}_2 \cdot \text{C}_2\text{H}_2 \cdot 4\text{NH}_3$. E. Botolfsen also prepared the same compound, and found that when heated to 150° , or even to 700° , the solid residue contains calcium carbide, hydride, cyanide, nitride, and cyanamide. R. Salvadori found that at about 650° , calcium carbide and **ammonia** begin to react according to the equation $\text{CaC}_2 + 4\text{NH}_3 = \text{CaCN}_2 + \text{NH}_4\text{CN} + 4\text{H}_2$. The reaction takes place in two stages, in the first of which the calcium carbide and the nitrogen formed by the decomposition of the ammonia interact forming calcium cyanamide: $\text{CaC}_2 + \text{N}_2 = \text{CaCN}_2 + \text{C}$. The carbon thus liberated then acts on the ammonia, giving ammonium cyanide and hydrogen; he also found that the reaction with **ammonium chloride** and the formation of cyanides or cyanamides (*q.v.*) by the reaction of the carbides with **nitrogen**, is, as stated by F. Fichter and C. Schölly, confined to the carbides of the alkalis or alkaline earths. According to H. Moissan, fuming **nitric acid** does not react in the cold with the alkaline earth carbides, and when heated the reaction is slow. H. Moissan found that **phosphorus vap.** converts the alkaline earth carbides into the phosphides without incandescence; with **arsenic vap.** there is a considerable evolution of heat as the alkaline earth carbide is converted into the arsenide. A. Frank showed that some graphite is formed, but less than the theoretical amount, when the carbides of the alkaline earths are heated in a current of phosphorus or

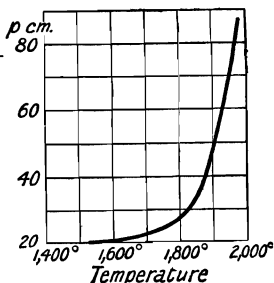

FIG. 22.—Equilibrium Pressure of Carbon Monoxide, $\text{CaO} + 3\text{C} \rightleftharpoons \text{CaC}_2 + \text{CO}$.

arsenic vap. H. Moissan found that at a red-heat, **antimony** and calcium carbide give an alloy of antimony and calcium.

H. Moissan stated that calcium carbide is not decomposed by **sodium** or **magnesium** at the softening temp. of glass; there is no reaction with **iron** at a red heat, but at a higher temp., a carburetted alloy of calcium and iron is formed; **tin** has no perceptible action at a red heat; and **aluminium** forms a carbide. A. Rossel found that when calcium carbide mixed with powdered magnesium, **zinc**, aluminium, iron, or **copper**, is heated in air, a flame appears, and a nitride is formed, $\text{CaC}_2 + 3\text{Mg} + 2\text{N} + 5\text{O} = \text{CaO} + \text{Mg}_3\text{N}_2 + 2\text{CO}_2$. F. P. Venable and T. Clarke noted that soln. of **alkali hydroxides** give acetylene with calcium carbide. O. Ruff and E. Förster gave for the fusibility of mixtures of calcium carbide and **calcium oxide**,

CaO	.	.	.	4	14	25	29	35	42 per cent.
m.p.	.	.	.	2200°	2000°	1715°	1645°	1715°	1815°

which yields a V-shaped curve with a simple eutectic at 1640° and 30 per cent. CaO. H. Moissan noted the energetic reducing action of calcium carbide on **metal oxides**. The metal may separate as in the case of lead, tin, and bismuth, or the metal may combine with other substances present, thus, the oxides of barium, strontium, aluminium, chromium, molybdenum, manganese, tungsten, and titanium furnish the carbides of these metals. H. N. Warren said that the oxides of tin, copper, lead, manganese, iron, nickel, cobalt, chromium, molybdenum, and tungsten give alloys with calcium. According to J. N. Pring, lead oxide dropped into molten calcium carbide reacts violently, some lead is volatilized and an alloy of lead and calcium is formed. N. Tarugi found that the reaction with cupric oxide begins at 432°, but is completed near 1408°. B. Neumann, and F. von Kügelgen added a chloride to the mixture of calcium carbide and metal oxide. The former argued in favour of the reaction, $2\text{M}_2\text{O} + 2\text{MCl} + \text{CaC}_2 = 6\text{M} + \text{CaCl}_2 + 2\text{CO}$; and the latter, $4\text{M}_2\text{O} + 2\text{MCl} + \text{CaC}_2 = 10\text{M} + \text{CaCl}_2 + 2\text{CO}_2$. B. Wedding did not see any application of calcium carbide as a deoxidizing and carburetting agent in the cast-iron industry. L. M. Bullier, O. Fröhlich, B. Neumann, and H. C. Geemuyn den recommended reducing the **chlorides** of copper, silver, manganese, cobalt, zinc, nickel, lead, etc., with calcium carbide accompanied by an alkali chloride, calcium fluoride, or water-glass as a flux. The **carbonates** behave like the oxides; the **sulphates** are not reduced so readily as the chlorides; many natural minerals—**sulphides**, and **silicates**, gave good results. H. C. Geemuyn den found that in the electric furnace, the sulphides of magnesium, antimony, lead, and iron are reduced, and the metals volatilized except in the case of iron; aluminium sulphide was not reduced, and N. Tarugi examined the action of many **metal salts**; he found cupric sulphite and carbonate behave like the oxide; the reaction with lead salts is completed at 400°; lead chromate furnishes free chromium and a lead-calcium alloy; salts of mercury and arsenic give the metal free from calcium; salts of silver, gold, zinc, cadmium, antimony, bismuth, tin, nickel, cobalt, and platinum give alloys with calcium. J. F. Durand found that impure acetylides are precipitated when aq. soln. of cupric, mercuric, silver, lead, ferrous, nickel, cobalt, and manganese salts are heated with calcium carbide. F. P. Venable and T. Clarke found **chromosulphuric acid** oxidizes calcium carbide; and H. Moissan found that calcium carbide and molten **chromic acid** develop carbon dioxide, but a soln. of chromic acid gives acetylene. Molten **potassium chlorate**, or **potassium nitrate**, at a red-heat, forms carbonates; **lead fluoride** at ordinary temp. becomes incandescent.

REFERENCES.

- ¹ E. Davy, *B. A. Reports*, 62, 1836; 50, 1837; *Thomson's Records*, 4, 321, 1836; *Proc. Irish Acad.*, 1, 88, 1837; *Trans. Irish Acad.*, 18, 80, 1838; R. Hare, *Amer. Journ. Science*, (1), 37, 269, 1839; H. Debray and H. St. C. Deville, *Ann. Chim. Phys.*, (3), 56, 385, 1859; *Ann. Mines*, (5), 16, 1, 1859; F. Wöhler, *Göt. Nachr.*, 374, 1862; *Liebig's Ann.*, 124, 220, 1862;

- T. S. Hunt, *Trans. Amer. Inst. Min. Eng.*, **14**, 492, 1886; W. Borchers, *Elektro-Metallurgie*, Braunschweig, 1891; **84**, 1896; *Zeit. Elektrochem.*, **2**, 7, 163, 1895; *Acetylene Ind.*, **4**, 362, 1901; J. Baumann, *Chem. Ztg.*, **44**, 33, 1920; L. K. Boehm, *Mineral Ind.*, **9**, 64, 1901; *Technologist*, **6**, 9, 265, 1901; *U.S. Pat. No.* 552026, 1895; T. L. Willson, *ib.*, 492377, 1893; *Brit. Pat. Nos.* 21701, 1892; 16342, 16705, 1894; 15360, 1895; T. L. Willson and J. J. Suckert, *Journ. Franklin Inst.*, **139**, 321, 1895; K. Nischk, *Zeit. Elektrochem.*, **29**, 373, 1923; A. C. Frazer, *Progressive Age*, **51**, 1898; F. P. Venable, *Amer. Manufacturer and Iron World*, 875, 1898; L. Maquenné, *Bull. Soc. Chim.*, (3), **7**, 370, 756, 1892; *Ann. Chim. Phys.*, (6), **28**, 258, 1893; *Compt. Rend.*, **114**, 361, 1892; **115**, 558, 1892; H. Moissan, **115**, 1031, 1892; **118**, 501, 1894; **126**, 302, 1897; **127**, 911, 1898; **133**, 243, 1904; *Bull. Soc. Chim.*, (3), **11**, 1002, 1894; (3), **21**, 921, 1899; *Ann. Chim. Phys.*, (7), **9**, 247, 1896; (7), **18**, 334, 1899; L. M. Bullier, *Compt. Rend.*, **138**, 904, 1904; *Brit. Pat. Nos.* 2820, 1895; 16255, 1896; J. H. Reid, *ib.*, 185135, 1921; B. Waeser, *Chem. Ztg.*, **46**, 928, 1922; C. Winkler, *Ber.*, **23**, 120, 1890; **24**, 1966, 1891; J. W. Mitchley, *Brit. Pat. No.* 172685, 1920; M. W. Travers, *Proc. Chem. Soc.*, **9**, 15, 1893; R. T. Plimpton and M. W. Travers, *Journ. Chem. Soc.*, **65**, 264, 1894; E. Botolfsen, *Ann. Chim. Phys.*, (9), **18**, 5, 1922; L. Hackspill and E. Botolfsen, *Compt. Rend.*, **173**, 151, 1921; P. Schläpfer, *Zeit. Elektrochem.*, **25**, 409, 1919; J. H. Reid, *Brit. Pat. Nos.* 133098, 133099, 133100, 1918; F. L. Slocum, *ib.*, 133101, 133102, 133103, 1918; F. E. Norton, *U.S. Pat. No.* 1374317, 1921; O. Ruff and E. Förster, *Zeit. anorg. Chem.*, **131**, 321, 1923; H. J. Krause and J. Y. Yee, *Journ. Amer. Chem. Soc.*, **46**, 1358, 1924; R. Pitavel, *Journ. Four Elect.*, **33**, 33, 1924; D. Korda, *Rev. Chim. Ind.*, **7**, 341, 1896; *Monit. Scient.*, (2), **39**, 409, 1895; V. B. Lewes, *Acetylene*, London, 1900; J. H. Vogel, *Handbuch für Acetylen*, Braunschweig, 1904; F. Liebetanz, *Handbuch der Calciumcarbid und Acetylenechnik*, Leipzig, 1899; F. Krüger, *Elektrochem. Zeit.*, **2**, 30, 1895; G. Gin, *Zeit. Elektrochem.*, **8**, 397, 1902; A. Lampen, *Journ. Amer. Chem. Soc.*, **28**, 846, 1906; P. Wagemann, *Chem. Ind.*, **27**, 234, 275, 314, 1904; F. Sebald, *German Pat.*, *D.R.P.* 103367, 1897; L. Landin, *ib.*, 104568, 108584, 1897; J. Leede, *ib.*, 113674, 1898; H. L. Hartenstein, *ib.*, 102820, 1897; 202954, 1906; R. P. Pictet, *ib.*, 97711, 1896; C. Diesler, *ib.*, 125209, 1898; E. Jacobsen, *ib.*, 89959, 1895; C. M. J. Limb, *ib.*, 117920, 1899; P. Wolff, *ib.*, 105631, 1898; E. Hilbert and A. Frank, *ib.*, 92838, 1896; R. C. Baker, *ib.*, 126492, 1900; M. de K. Thompson, *Trans. Amer. Electrochem. Soc.*, **16**, 197, 1910; *Met. Chem. Engg.*, **8**, 279, 324, 1910; C. Bingham, *The Manufacture of Calcium Carbide*, London, 1916; E. Rudolfi, *Zeit. anorg. Chem.*, **54**, 170, 1907; R. S. Hutton and J. E. Petavel, *Proc. Roy. Soc.*, **79**, A, 155, 1907; O. Ruff and O. Goecke, *Met.*, **8**, 417, 1911; H. Furusaki, *Journ. Japan. Chem. Ind.*, **25**, 24, 1922.
- ² H. le Chatelier, *Bull. Soc. Chim.*, (3), **17**, 793, 1897; E. Chuard, *ib.*, (3), **17**, 678, 1897; A. Bergé and A. Reyehler, *ib.*, (3), **17**, 218, 1897; F. B. Ahrens, *Zeit. angew. Chem.*, **13**, 439, 1900; H. Giraud, *Internat. Cong. App. Chem.*, **2**, iv, 574, 1897; R. S. Marsden, *Proc. Roy. Soc. Edin.*, **11**, 20, 1880; C. Willgerodt, *Ber.*, **29**, 2107, 1895; J. de Brévans, *Internat. Cong. App. Chem.*, **2**, iv, 606, 1897; E. Hubou, *ib.*, **2**, iv, 516, 1897; L. M. Bullier and M. Perrodil, *Rec. Tech. Ind. Acet.*, **87**, 1896; V. B. Lewes, *Journ. Soc. Chem. Ind.*, **17**, 532, 1898; *Acetylene*, London, 230, 1900; G. Döllner and E. Jacobsen, *German Pat.*, *D.R.P.* 189959, 1906; H. Moissan, *Compt. Rend.*, **126**, 302, 1897; **127**, 457, 1988; *Le four électrique*, Paris, 1897; P. Lebeau, *Compt. Rend.*, **128**, 25, 1898; A. Mourlot, *ib.*, **123**, 123, 1896; F. Wöhler, *Liebig's Ann.*, **125**, 225, 1863; **127**, 227, 1863; E. Neuberg, *Journ. Gasbeleucht.*, **43**, 174, 1900; N. Caro, *Zeit. Calc. Acet.*, **3**, 97, 1899; **4**, 184, 1900; A. Rossel, *ib.*, **1**, 205, 1897; A. P. Lidoff, *Journ. Russ. Phys. Chem. Soc.*, **29**, 467, 1897; J. H. Vogel, *Handbuch für Acetylen*, Braunschweig, **62**, 1904; G. Hanekop, *Zeit. angew. Chem.*, **12**, 592, 1899; H. Bamberger, *ib.*, **11**, 720, 1898; L. Franck, *Stahl Eisen*, **17**, 485, 1897; *Chem. Ztg.*, **21**, 263, 1897; O. Hackl, *ib.*, **46**, 740, 1922.
- ³ W. Rathenau, *Brit. Pat. No.* 6038, 1900; *German Pat.*, *D.R.P.* 122266, 1900; C. J. Lundström, *ib.*, 104925, 1897; *Brit. Pat. No.* 23793, 1897; J. von Orlovsky, *ib.*, 4298, 1898; *German Pat.*, *D.R.P.* 107048, 1898; E. Zühl and F. Eisemann, *ib.*, 125208, 1900; H. L. Hartenstein, *Brit. Pat. No.* 12465, 1906; *U.S. Pat. No.* 844018, 1907.
- ⁴ K. Nischk, *Zeit. Elektrochem.*, **29**, 373, 1923; L. Maquenné, *Compt. Rend.*, **114**, 361, 1892; **115**, 558, 1892; *Bull. Soc. Chim.*, (3), **7**, 370, 773, 1892; H. Moissan, *ib.*, (3), **11**, 1007, 1894; *Ann. Chim. Phys.*, (7), **9**, 247, 1896; *Le four électrique*, Paris, 1897; London, 1904; *Compt. Rend.*, **118**, 683, 1894; C. M. J. Limb, *Brit. Pat. No.* 7282, 1899; *German Pat.*, *D.R.P.P.* 130664, 1900; 170615, 1905; L. M. Bullier, *Compt. Rend.*, **138**, 904, 1904.
- ⁵ Anon., *Journ. Soc. Chem. Ind.*, **41**, 44, R, 1922; *Chem. Trade Journ.*, **70**, 175, 1922; *Chem. Age*, **6**, 164, 1922; W. J. Pope, *Journ. Soc. Chem. Ind.*, **42**, 5, 8, 1923; A. Colefax, *ib.*, **42**, 8, 1923.
- ⁶ H. Moissan, *Le four électrique*, Paris, 1897; London, 1904; *Bull. Soc. Chim.*, (3), **21**, 921, 1899; *Ann. Chim. Phys.*, (7), **18**, 334, 1899; *Compt. Rend.*, **125**, 839, 1897; **126**, 302, 1897; **127**, 912, 1898; A. Guntz and H. Basset, *ib.*, **140**, 863, 1905; R. de Forcrand, *ib.*, **120**, 682, 1895; A. Rossel, *ib.*, **125**, 839, 1897; H. M. Kahn, *ib.*, **143**, 49, 1906; **144**, 107, 913, 1907; J. F. Durand, *ib.*, **177**, 693, 1923; G. Gin, *Verh. Budapest Kongress*, **141**, 1899; G. Gin and M. Leloux, *ib.*, **126**, 749, 1898; P. Lefebvre, *ib.*, **130**, 1036, 1900; H. C. Geemuyden, *ib.*, **130**, 1026, 1900; L. M. Bullier, *ib.*, **130**, 1109, 1900; *Brit. Pat. No.* 9046, 1900; *German Pat.*, *D.R.P.P.* 118177, 120969, 1899; J. N. Pring, *Journ. Chem. Soc.*, **87**, 1530, 1905; E. Wedekind, *Allgem. Chem. Ztg.*, **4**, 543, 1905; C. H. Warren, *Amer. Journ. Science*, (4), **3**, 120, 1921; E. Botolfsen, *Ann. Chim. Phys.*, (9), **18**, 5, 1922; H. N. Warren, *Chem. News*, **75**, 2, 1897; B. Carlson, *Zeit. Elektrochem.*, **6**, 430, 1900; F. von Kügelgen, *ib.*, **7**, 541, 557, 573, 1901; **9**, 411, 1903; *Chem. Ztg.*, **24**, 1060, 1901;

G. Hanekop, *Zeit. angew. Chem.*, **12**, 592, 1899; O. Fröhlich, *ib.*, **12**, 1179, 1899; D. Sandmann, *ib.*, **15**, 543, 1902; A. Frank, *ib.*, **18**, 1733, 1905; *German Pat.*, *D.R.P.P.* 112416, 1899; F. P. Venable and T. Clarke, *Journ. Amer. Chem. Soc.*, **17**, 306, 1895; V. Rothmund, *Zeit. anorg. Chem.*, **31**, 136, 1902; E. Tiede and E. Birnbrauer, *ib.* **87**, 129, 1914; O. Ruff and E. Förster, *ib.*, **131**, 321, 1923; N. Caro, *Chem. Trade Journ.*, **44**, 621, 1909; *Zeit. angew. Chem.*, **22**, 1178, 1909; G. Erlwein, *ib.*, **16**, 533, 1903; G. Erlwein and A. Frank, *U.S. Pat. No.* 708333, 1902; G. Erlwein, C. Warth, and R. Beutner, *Zeit. Elektrochem.*, **17**, 177, 1911; V. Ehrlich, *ib.*, **28**, 540, 1922; G. Bredig, *Chem. Ztg.*, **37**, 831, 1913; E. Briner and A. Kuhne, *ib.*, **37**, 442, 665, 1913; *Compt. Rend.*, **156**, 620, 1913; *Journ. Chim. Phys.*, (8), **12**, 432, 1914; H. J. Krase and J. Y. Yee, *Journ. Amer. Chem. Soc.*, **46**, 1358, 1924; F. Fichter and C. Schölly, *Helvetica Chem. Acta*, **3**, 164, 1920; A. Remele and B. Rassow, *Zeit. angew. Chem.*, **33**, 139, 1920; E. Barnes, *Chem. News*, **119**, 260, 1919; A. Frank and N. Caro, *Brit. Pat. Nos.* 15066, 1895; 25475, 1898; *U.S. Pat. No.* 785161, 1905; B. Neumann, *Chem. Ztg.*, **24**, 1013, 1901; **26**, 716, 1108, 1902; **27**, 1026, 1903; *Zeit. Elektrochem.*, **8**, 772, 1902; **9**, 696, 1903; M. le Blanc and M. Eschmann, *ib.*, **17**, 20, 1911; M. de K. Thompson and R. H. Lombard, *Met. Chem. Engg.*, **8**, 617, 682, 1910; M. de K. Thompson, *Trans. Amer. Electrochem. Soc.*, **16**, 197, 1910; *Met. Chem. Engg.*, **8**, 279, 324, 1910; C. A. Hansen, *ib.*, **7**, 427, 1909; N. Tarugi, *Gazz. Chim. Ital.*, **29**, i, 509, 1899; R. Salvadori, *ib.*, **35**, i, 236, 1905; **32**, ii, 496, 1903; *Studi Sassarzi*, **1**, 106, 1901; B. Wedding, *Stahl Eisen*, **15**, 574, 1895.

§ 16. The Carbides of the Magnesium-Zinc Family

According to P. Lebeau,¹ when beryllium oxide is mixed with half its weight of sugar charcoal and a small quantity of oil, and heated to a high temp. in the electric tube furnace for 5–10 minutes, **beryllium carbide** is formed. If the temp. is too low, beryllium nitride, or a mixture of nitride and carbide, is produced. The same compound was made by H. Moissan. F. Fichter and E. Brunner found the reaction between beryllia and carbon begins at about 1900°. From the analogy of beryllium and aluminium carbides, P. Lebeau assigned to beryllium carbide the formula Be_4C_3 (Be, 13·8), but, added L. Henry, it does not follow that because beryllium carbide is similar in its properties to aluminium carbide, it must be analogous in composition. Magnesia and silica are both in many respects similar to alumina. The analyses of the carbide quoted by P. Lebeau agree closely with the formula Be_2C , and the apparent analogy between this compound and aluminium carbide cannot be allowed to override the great weight of the other experimental evidence in fixing the valency of beryllium. P. Lebeau showed that beryllium carbide forms transparent yellow-brown, microscopic crystals, similar to those of aluminium carbide. The crystals scratch quartz easily; sp. gr.=1·9 at 15°. The carbide is readily attacked by chlorine at a dull red heat, with formation of beryllium chloride and a residue of amorphous carbon and graphite. Bromine behaves similarly at a somewhat higher temp., but iodine has no action even at 800°. Oxygen produces superficial oxidation at a dull red heat, sulphur vap. attacks it below 1000°, but phosphorus and nitrogen have no appreciable action at dull redness. Dry hydrogen fluoride attacks the carbide with incandescence below a red heat, with formation of fluoride and liberation of carbon; hydrogen chloride behaves similarly, but with less energy. In contact with water or dil. acids, the carbide is slowly decomposed, with liberation of methane, the change occurring rapidly and completely in contact with a hot conc. sodium or potassium hydroxide soln. It reduces conc. boiling sulphuric acid, but is only slowly attacked by conc. nitric or hydrochloric acid, although hot hydrofluoric acid dissolves it rapidly. Fused potassium hydroxide decomposes it with incandescence, potassium nitrate and chlorate are without action, but potassium permanganate and lead peroxide oxidize it readily. F. Fichter and E. Brunner found that ammonia reacts with beryllium carbide at 1000°, forming beryllium nitride with the separation of carbon. H. Moissan found that in the electric furnace beryllium carbide readily dissolves carbon, and on treatment of the cold mass with hydrochloric acid, graphite is obtained. According to P. Lebeau, when a mixture of beryllia (75 parts) and boron (45 parts) is moistened with a little alcohol, compressed, and then heated

in a carbon crucible in an electric furnace for 7-8 minutes, brilliant crystals of **beryllium borocarbide**, $\text{Be}_3\text{B}_6\text{C}_4$, are formed. They have a metallic lustre, a sp. gr. 2.4, and are readily soluble in acids. The compound is not altered by exposure to air at ordinary temp., but it is superficially oxidized at a red heat; it burns in chlorine at about 450° , producing boron and beryllium chlorides, and amorphous carbon. K. Nischk studied the formation of beryllium carbide.

Only impure **magnesium carbide** has hitherto been obtained. J. Parkinson² showed that when heated in a stream of benzene vap. the metal suffers a marked change; it becomes black and brittle; decomposes water; and leaves a residue of carbon when treated with hydrochloric acid. Methane does not act to any great extent on the red-hot metal; but with coal gas there is an increase in weight. C. Winkler stated that magnesium carbide and carbon are produced in the reduction of carbon dioxide by heated magnesium, for the product, when treated with hydrochloric acid, gives a hydrocarbon gas which burns with a luminous flame. The direct union of carbon with the magnesium is only superficial. J. T. Nance obtained similar results, and he noted that some carbide is formed when a mixture of magnesium powder and wood charcoal is gently ignited. M. Berthelot, H. Moissan, and W. Eidmann heated magnesium powder in a stream of acetylene, and obtained an impure magnesium carbide mixed with carbon; it developed acetylene when treated with water.

There are a number of patents for preparing magnesium carbide or magnesium calcium carbide. C. Whitehead heated a mixture of coal with lime and magnesia or dolomite; H. Auziès and A. Ségoffin heated magnesite or dolomite with carbon in an electric furnace; C. J. Wollaston heated briquettes made of calcium sulphate, kieselguhr, and powdered dolomite; and H. S. Blackmore used a mixture of magnesium fluoride and calcium carbide with alkali fluoride as flux: $\text{MgF}_2 + \text{CaC}_2 = \text{MgC}_2 + \text{CaF}_2$.

H. Moissan heated M. Berthelot's carbide in a graphite crucible in an electric furnace. Not the slightest evolution of gas occurred when the cold product was placed in water. Hence, he added that magnesium carbide is completely decomposed at a high temp., and this explains why magnesia can be fired and kept liquid in a carbon crucible without being reduced; magnesium carbide cannot exist at the fusion point of magnesia. W. Borchers claimed to have reduced magnesia by carbon in the electric furnace. P. Lebeau heated a mixture of magnesia and carbon in an electric furnace, and inferred that a carbide is formed because the magnesia volatilizes 3 to 4 times as quickly as it does in the absence of the carbon. The gases in the furnace atm. probably react with the carbide, reproducing magnesia and carbon. He believed that the reaction between magnesia and carbon occurs only between the vap. of these substances at the temp. of the electric arc. O. P. Watts mentioned that carbon can be volatilized from a bed of magnesia, and his sublimate contained magnesia and carbon. R. E. Slade proved that magnesia is reduced by carbon at as low a temp. as 1700° as well as in the electric arc. He was able to collect some of the magnesium produced, and he found it to be always associated with some carbide. There is evidence of the reoxidation of the magnesium by the carbon monoxide in the furnace, $\text{CO} + \text{Mg} = \text{MgO} + \text{C}$. K. Nischk studied the formation of magnesium carbide. B. Oddo made **magnesium bromocarbide**, $\text{HC} : \text{C.MgBr}$; and G. I. Iotsitch and D. Gauthier, **magnesium dibromocarbide**, $\text{MgBr.C} : \text{C.MgBr}$. G. I. Iotsitch made **magnesium bromoallylenide**, $\text{C}_3\text{H}_3\text{MgBr}$.

No carbides of zinc or cadmium have been prepared. Much commercial zinc (*q.v.*) contains free carbon. O. Ruff and B. Bergdahl³ found that only traces of carbon dissolve in zinc, cadmium, or mercury. J. J. Berzelius reported that he had prepared *zinc carbide* by the action of heat on zinc cyanide, but J. B. A. Dumas showed that these products are probably only mixtures. R. T. Plimpton⁴ prepared an explosive compound—probably *mercurous carbide*—by the action of acetylene on mercurous acetate suspended in water. E. Burkard and M. W. Travers showed that to ensure the completion of the reaction, the soln. should be frequently

agitated, and the current of gas continued for 30 hrs. in darkness: $2\text{HgC}_2\text{H}_3\text{O}_2 + \text{H}_2\text{O} + \text{C}_2\text{H}_2 = 2\text{CH}_3\text{COOH} + \text{C}_2\text{Hg}_2 \cdot \text{H}_2\text{O}$. The precipitate was washed with water, and then with alcohol, and dried over sulphuric acid. Its composition corresponds with mercurous carbide, $\text{Hg}_2\text{C}_2 \cdot \text{H}_2\text{O}$. The product is white, and if a little free mercury is present, grey. The elements of water cannot be removed; when dried at 100° , the carbide decomposes. When treated with iodine it furnishes mercurous iodide and ethylene tetraiodide; and with hydrochloric acid, acetylene is evolved.

H. Bassett⁵ passed coal gas through Nessler's reagent, and obtained a yellow precipitate which exploded slightly when heated; and he obtained a purer pale yellow precipitate by using the products of the incomplete combustion of coal gas. The precipitate exploded rather more violently than the former product. Analyses corresponded with $\text{C}_2\text{HHgI} \cdot \text{HgO}$. E. H. Keiser made **mercuric carbide** free from iodine, and with the composition corresponding with C_2Hg , by passing purified acetylene into a soln. of mercuric and potassium iodides containing a little potassium hydroxide. The white flocculent precipitate was washed with distilled water, and dried over sulphuric acid. The water was eliminated only by prolonged heating on a water-bath. The compound begins to decompose at about 100° . If gradually heated, the substance becomes dark and a vap. is evolved which has a smell resembling that of phosphine. If heated rapidly, the compound explodes with extreme violence, forming finely divided carbon and mercury. It dissolves readily in hydrochloric acid, forming a soln. of mercuric chloride, and giving off acetylene. It unites slowly with iodine at ordinary temp., more rapidly when heated, forming di-iodoacetylene, C_2I_2 , which gradually decomposes, $2\text{C}_2\text{I}_2 \rightarrow \text{C}_2\text{I}_4 + 2\text{C}$, when kept for some time.

J. F. Durand obtained mercuric carbide by the action of calcium carbide, or of cupric acetylde on a soln. of mercuric nitrate. R. T. Plimpton and M. W. Travers found that freshly precipitated mercuric oxide, suspended in water, is slowly converted into mercuric carbide when treated with acetylene. Ammoniacal soln. of mercuric salts are only partially precipitated by acetylene, but if the mercuric salt be mixed with cupric sulphate or zinc chloride and ammonia, precipitation is complete. They recommend the following method of preparation:

Freshly precipitated mercuric oxide is dissolved in conc. ammonia, and powdered ammonium carbonate added. The filtered soln. is moderately dil. and sat. with acetylene, preferably in a bottle fitted with a cork and glass stopcock and previously exhausted. The absorption takes place rapidly on shaking, fresh acetylene being admitted from time to time until precipitation is complete. The carbide separates as a heavy, white powder, which is washed by decantation, and finally on a filter until free from ammonia. It may be kept an indefinite time under water without changing, and on account of its highly explosive character is conveniently stored in this condition.

The composition of the white powder is $\text{C}_2\text{Hg} \cdot \frac{1}{3}\text{H}_2\text{O}$; its sp. gr. is 5.3 at $16^\circ/16^\circ$. When gradually heated, it begins to decompose at about 110° into mercury and carbon; when rapidly heated it decomposes with a violent explosion. When dropped on a heated cylinder explosion occurred at all temp. above 230° ; it explodes when struck smartly, but it can be handled with safety. It is insoluble in water, alcohol, and ether. A soln. of ammonium acetate dissolves the fresh precipitate; and a soln. of potassium cyanide readily dissolves the dried compound. When allowed to stand in contact with an alcoholic soln. of mercuric chloride, or when boiled with an aq. soln. of that salt, a non-explosive white substance is formed. Chlorine and bromine cause the compound to explode; a soln. of chlorine in chloroform produces mercuric chloride and what is probably ethane hexachloride. Bromine water yields tetrabromoethylene. The first product of the action of a soln. of iodine in potassium iodide is di-iodoacetylene, and then tetraiodoethylene. Hydrochloric acid in the cold has very little action; when heated, mercuric chloride and acetylene are formed, and some is hydrolyzed to acetaldehyde. It is readily soluble in nitric acid; dil. sulphuric acid has but a slight action, while the conc. acid causes

the carbide to explode. J. F. Durand found that mercuric carbide gives a precipitate of silver acetylide with a soln. of silver nitrate, but no precipitate with cupric chloride or nitrate.

According to R. T. Plimpton and M. W. Travers, if acetylene be passed into a soln. of mercuric acetate, in darkness, a white precipitate is formed which gradually becomes grey. In about 2 hrs. the reaction is complete, and the product after washing, and drying in vacuo over sulphuric acid, has the composition $2\text{HgO} \cdot 3\text{HgC}_2 \cdot 2\text{H}_2\text{O}$, or $2\text{Hg}(\text{OH})_2 \cdot 3\text{HgC}_2$ —**mercuric hydroxycarbide**. The precipitate is non-explosive, but it decomposes at ordinary temp. At 100° , water is given off and carbon separates. With iodine, it forms di-iodoacetylene, and ethylene tetraiodide. When heated with hydrochloric acid in the presence of mercuric salts, aldehyde is formed, but little or no acetylene appears. In 1881, M. Kutscheroff showed that hydrocarbons of the acetylene series unite with water in the presence of mercury salts, forming aldehydes and ketones, e.g. with acetylene $\text{HC}:\text{CH} + \text{H}_2\text{O} = \text{CH}_3 \cdot \text{CO} \cdot \text{H}$, and with allylene $\text{CH}_3 \cdot \text{C}:\text{CH} + \text{H}_2\text{O} = \text{CH}_3 \cdot \text{CO} \cdot \text{CH}_3$. The reaction is employed industrially for making acetaldehyde which is subsequently oxidized to acetic acid. The mechanism of the reaction has been studied by a number of investigators. E. H. Keiser assigned the formula $\text{ClHg} \cdot \text{C}:\text{C} \cdot \text{HgCl}$ to the white precipitate which is formed when acetylene is passed into a soln. of mercuric chloride; K. A. Hofmann considered that the first product of the reaction is a substance with the formula :

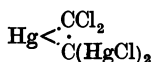

and that this is immediately converted by hydrolysis and intermolecular change to trichloromercuriacetaldehyde, $(\text{ClHg})_3 \cdot \text{C} \cdot \text{COH}$. H. Biltz and O. Mumm agreed that the white precipitate is probably trichloromercuriacetaldehyde, but they doubted if K. A. Hofmann's intermediate compound is formed. A. Bergé and A. Reychler said that acetylene has no action on a soln. of mercuric chloride in dil. hydrochloric acid, and they recommended this soln. as a liquid for purifying acetylene; but P. Biginelli, J. S. S. Brame, and D. L. Chapman and W. J. Jenkins have shown that *chloromercurichloroacetylene*, or *mercuricdichloroacetylene*,



respectively are produced in dil. hydrochloric acid soln. D. L. Chapman and W. J. Jenkins prepared this compound in long, colourless, needle-shaped crystals by circulating acetylene through a sat. soln. of mercuric chloride in absolute alcohol through which a current of hydrogen chloride had been passed for 5 minutes. In 16 hrs. the soln. deposited the crystals with the empirical composition $\text{C}_2\text{H}_2 \cdot \text{HgCl}_2$. The crystals melt with decomposition near 113° ; they are soluble in ether and benzene. The compound is not formed in an ethereal soln. of mercuric chloride in which hydrogen chloride is dissolved. M. Kutscheroff made **mercuric allylenide**, $(\text{C}_3\text{H}_3)_2\text{Hg}$. J. F. Durand made **mercurous carbide or acetylide** by the action of calcium carbide, mercuric acetylide or cupric acetylide, on a soln. of mercurous nitrate:

REFERENCES.

- 1 P. Lebeau, *Ann. Chim. Phys.*, (7), **16**, 476, 1899; *Compt. Rend.*, **121**, 496, 1895; **124**, 1202, 1347, 1898; L. Henry, *ib.*, **121**, 600, 1895; K. Nischk, *Zeit. Elektrochem.*, **29**, 373, 1923; H. Moissan, *Le four électrique*, Paris, 1897; London, 104, 222, 1904; F. Fichter and E. Brunner, *Zeit. anorg. Chem.*, **93**, 84, 1915.
- 2 J. Parkinson, *Journ. Chem. Soc.*, **20**, 125, 309, 1867; R. E. Slade, *ib.*, **93**, 327, 1908; J. T. Nance, *Proc. Chem. Soc.*, **21**, 124, 1905; C. Winkler, *Ber.*, **23**, 2648, 1890; M. Berthelot, *Ann. Chim. Phys.*, (6), **9**, 385, 1886; D. Gauthier, *ib.*, (8), **16**, 335, 1909; K. Nischk, *Zeit. Elektrochem.*, **29**, 373, 1923; B. Oddo, *Atti Accad. Lincei*, (5), **13**, ii, 189, 1904; *Gazz. Chim. Ital.*, **34**, ii, 430, 1904; **38**, i, 627, 633, 1908; G. I. Iotsitsch, *Bull. Soc. Chim.*, (3), **30**, 210, 1903;

Journ. Russ. Phys. Chem. Soc., **34**, 242, 1902; H. Moissan, *ib.*, (3), **19**, 865, 1898; *Compt. Rend.*, **118**, 507, 1894; **126**, 302, 1898; P. Lebeau, *ib.*, **144**, 799, 1907; W. Borchers, *Elektrometallurgie*, Braunschweig, **84**, 1896; C. J. Wollaston, *Brit. Pat. No.* 15302, 1899; H. S. Blackmore, *ib.*, 11933, 1901; W. Eidmann, *Journ. prakt. Chem.*, (2), **59**, 8, 1853; H. Auziès and A. Ségoffin, *French Pat. No.* 337878, 1903; C. Whitehead, *U.S. Pat. No.* 555796, 1896; O. P. Watts, *Trans. Amer. Electrochem. Soc.*, **11**, 279, 1907.

³ J. J. Berzelius, *Ann. Chim. Phys.*, (2), **14**, 190, 1820; O. Ruff and B. Bergdahl, *Zeit. anorg. Chem.*, **106**, 76, 1919; J. B. A. Dumas, *Traité de chimie*, Paris, 1831.

⁴ R. T. Plimpton, *Proc. Chem. Soc.*, **8**, 109, 1892; E. Burkard and M. W. Travers, *Journ. Chem. Soc.*, **81**, 1270, 1902.

⁵ M. Kutscheroff, *Ber.*, **14**, 1532, 1540, 1881; **17**, 25, 1884; K. A. Hofmann, *ib.*, **31**, 2217, 1898; **32**, 870, 1904; **37**, 4459, 1904; H. Biltz, *ib.*, **38**, 133, 1905; H. Biltz and O. Mumm, *ib.*, **37**, 4417, 1904; J. F. Durand, *Compt. Rend.*, **177**, 693, 1923; P. Biginelli, *Ann. Farm. Chim.*, **16**, 1896; E. H. Keiser, *Amer. Chem. Journ.*, **15**, 537, 1893; A. Bergé and A. Reyehler, *Bull. Soc. Chim.*, (3), **17**, 218, 1897; J. S. S. Brame, *Journ. Chem. Soc.*, **87**, 428, 1905; D. L. Chapman and W. J. Jenkins, *ib.*, **115**, 847, 1919; E. Burkard and M. W. Travers, *ib.*, **81**, 1270, 1902; R. T. Plimpton and M. W. Travers, *ib.*, **65**, 265, 1894; H. Bassett, *Chem. News*, **19**, 28, 1869.

§ 17. The Carbides of Aluminium and the Rare Earth Metals

The *boron carbides* have been discussed as carbon borides in connection with boron (5. 32, 4). H. St. C. Deville¹ was unable to make carbon unite with aluminium; even when carbon tetrachloride is decomposed by aluminium, carbon is produced and the excess of aluminium remains unchanged. J. W. Mallet could detect no sign of the formation of a definite carbide when sodium carbonate is reduced by aluminium. The carbon taken up by the excess of metal was mostly, if not altogether, in a state of mere admixture, and produced no marked effect on the physical properties of the metal. He also observed no carbide formation when carbon monoxide is reduced by aluminium; alumina, and carbon with small yellow crystals, said to be aluminium nitride, were obtained—the nitrogen presumably was derived from the contamination of the carbon monoxide, etc., with air. T. S. Hunt, in 1885, exhibited yellow crystals of what he regarded as an alloy of aluminium and carbon which were found in an electric furnace, reducing a mixture of alumina and carbon. The work of H. Moissan, ten years later, showed that T. S. Hunt's crystals were most probably **aluminium carbide**, Al_4C_3 . H. Moissan obtained crystals of this compound in the following way:

Small boats of carbon were filled with aluminium, put into a carbon tube through which a current of hydrogen was passed, and heated in the electric furnace. After cooling, the aluminium was of a grey colour, and on breaking it was seen to be strewn with brilliant fine-yellow crystals. To separate these out, the aluminium is dissolved by conc. hydrochloric acid, surrounding the vessel with ice to keep the temp. low. The residue is washed with ice-cold water, then with alcohol, and finally with ether. This whole operation must be conducted as quickly as possible, since the carbide is attacked by water.

P. W. Askenasy and co-workers used a similar process. According to J. N. Pring, the reaction proceeds from left to right: $6\text{Al} + 3\text{CO} \rightleftharpoons \text{Al}_4\text{C}_3 + \text{Al}_2\text{O}_3$, but at higher temp. the direction is reversed, and aluminium is re-formed. H. Moissan also made the carbide by heating the metal in a carbon crucible in an electric furnace—when the product is contaminated with nitride; by treating a mixture of china clay and carbon in the electric furnace; and by heating aluminium and calcium carbide in the electric arc. S. A. Tucker and H. R. Moody obtained aluminium carbide by reducing alumina with calcium carbide. O. Ohmann ignited a mixture of aluminium filings with a small proportion of a mixture of potassium chlorate and iron, in an atm. of carbon dioxide. The ignition is started by touching the chlorate and iron filings with a glowing wire, and allowing a stream of carbon dioxide to play on the aluminium powder. The product, Al_4C_3 , was used for the preparation of methane. L. Franck, and C. Matignon, made aluminium carbide by heating aluminium and lamp-black to a high temp. M. Barnett and L. Burgess heated, in the electric arc-furnace, an intimate mixture of alumina and carbon. F. E. Weston and H. R. Ellis ignited

mixtures of powdered aluminium with wood charcoal, sugar charcoal, and graphite, by a fuse of magnesium and barium peroxide. The product contained aluminium nitride, carbide, and oxide, and the free elements. Methane was the only gas produced by the action of water, and hence it was inferred that the only carbide formed was C_3Al_4 . It was not easy to initiate the combination in vacuo; and it was assumed that the first action is the oxidation of the carbon to monoxide and dioxide, the heat given out starts the oxidation of the aluminium, and, finally, that the latter reaction raises the temp. sufficiently to bring about combination of the aluminium with carbon and nitrogen. Some mixtures heated to dull redness in a closed crucible reacted vigorously on exposure to air. At 550° , E. Briner and R. Senglet observed no reaction between carbon and aluminium, but at 750° small amounts of carbide were formed. J. N. Pring found that the reaction between carbon and aluminium begins at 650° , and proceeds rapidly at 1400° . C. Matignon made aluminium carbide by heating aluminium in carbon tetrachloride vap. E. Dufau, by heating in the electric furnace, calcium aluminate with carbon—calcium carbide is formed at the same time; A. H. Cowles, by the reduction of sodium aluminate with carbon; L. M. Bullier, by heating sodium chloroaluminate with calcium carbide; and H. Hilbert and A. Frank, by heating aluminium phosphate and carbon: $4AlPO_4 + 19C = Al_4C_3 + 4P + 16CO$ —the phosphorus distils off. L. Franck represented the reaction at 1200° – 1300° with carbon monoxide by $2Al + 3CO_2 = 2AlO_3 + 3C$; and with carbon dioxide by $4Al + 3CO_2 = 2Al_2O_3 + 3C$. At lower temp., A. Guntz and A. Masson obtained $6Al + 3CO = Al_4C_3 + Al_2O_3$; and likewise also with carbon dioxide. P. W. Askenasy and A. Lebedeff found that aluminium and aluminium carbide are formed when alumina and wood charcoal are heated side by side in the electric furnace. They assumed that the carbide is first formed: $2Al_2O_3 + 9C = 6CO + Al_4C_3$, and that at a higher temp., say 2100° , the carbide dissociates or reacts with alumina, forming aluminium which remains dissolved in the carbide, otherwise it would boil away; on cooling, the aluminium separates from the soln. M. Barnett and L. Burgess have described a furnace for the production of the carbide. K. Nischk made some observations on the formation of aluminium carbide.

According to H. Moissan, aluminium carbide forms transparent, yellow crystals sometimes 6 mm. long, and in the form of regular hexagons. According to M. L. Huggins, the rhombohedral crystals have a lattice in which each aluminium atom is surrounded by three carbon atoms, and each carbon atom by four aluminium atoms all at the corners of a tetrahedron; and the axial ratio is estimated to be $a : c = 1 : 1.225$. The sp. gr. is 2.36. The carbide is stable up to 1400° , but is decomposed at the highest temp. of the electric arc. P. W. Askenasy and co-workers believe that the dissociation of the carbide $Al_4C_3 = 4Al + 3C$ proceeds at a much lower temp. than H. Moissan supposed. P. W. Askenasy and A. Lebedeff say that aluminium carbide is not changed by heating in vacuo between 400° and 1400° . O. Ruff found that aluminium carbide sublimes at temp. up to 2200° without melting, and with some decomposition which is independent of temp. The vap. press. was measured up to 2300° ; and at 2200° , aluminium carbide is in equilibrium with graphite and aluminium sat. with graphite and vap. under a press. of 400 mm. E. Briner and R. Senglet said that the reaction $Al_4C_3 \rightleftharpoons 4Al + 3C$ is reversible; dissociation begins below 540° , and, as indicated above, combination begins between 550° and 750° . M. Berthelot gave for the heat of formation: $4Al + 3C_{diamond} = Al_4C_3 + 244.9$ Cals. less about 26 Cals. H. Moissan found that the carbide is attacked superficially by oxygen at a dull red heat. M. Berthelot gave for the heat of oxidation $Al_4C_3 + 6O_2 = 3CO_2 + 2Al_2O_3 + 834$ Cals. H. Moissan noted that when the carbide remains in contact with water at ordinary temp., decomposition takes place very slowly, and methane and aluminium hydroxide are formed. M. Berthelot gave for the heat of decomposition $Al_4C_3 + 12H_2O = 3CH_4 + 4Al(OH)_3 + 183.8$ Cals. plus about 26 Cals.; the change is accelerated by heat, but is not influenced by light. According to H. Moissan, chlorine attacks it at a dull red heat, with incandescence, aluminium chloride volatilizing, and a residue of amorphous carbon, without any

trace of graphite, being left; bromine has no action at the ordinary temp., but attacks the carbide, with incandescence, at about 700°; iodine seems to have no action, even at a bright red heat. At a dull red heat, sulphur attacks the carbide readily, with great development of heat, and formation of aluminium sulphide and traces of carbon bisulphide, although the greater part of the carbon remains in the form of thin lamellæ. Nitrogen and phosphorus have no action on the carbide at a dull red heat, but certain oxidizing agents attack it readily. When slightly heated with dry potassium permanganate, it is oxidized with vivid incandescence; potassium dichromate and chromic anhydride oxidize it slowly at dull redness. The carbide reduces lead peroxide and the red oxide with incandescence, but it is not attacked by potassium chlorate or nitrate. A soln. of an alkali dichromate, acidified with sulphuric acid, attacks it slowly in the cold, or when boiled; fuming nitric acid is without action, even on heating, but on the addition of water the carbide is rapidly attacked; conc. hydrochloric acid attacks it very slowly, but the dil. acid dissolves it in a few hours; boiling conc. sulphuric acid is reduced, with formation of sulphur dioxide, and the dil. acid reacts at about 100°. Fused potassium hydroxide attacks the carbide with great energy at about 300°, but alkali carbonates, even at a bright red heat, produce only incomplete decomposition. J. N. Pring found that with calcium at a high temp., there is a reversible reaction, $2\text{Al}_4\text{C}_3 + 3\text{Ca} \rightleftharpoons 3\text{CaC}_2 + 8\text{Al}$. He added that, up to about 1400°, the carbide behaves as a strong reducing agent, but both aluminium and carbon are simultaneously oxidized, even when the carbide is in excess. Thus, under these conditions, no separation of aluminium or of carbon can be detected. For instance, aluminium carbide interacting with copper oxide produces metallic copper and carbon dioxide, together with small quantities of carbon monoxide. A similar behaviour is noticed when the reactions are brought about in the mass of a flux so as to facilitate the agglomeration of the reduced metal. At higher temp., however, selective reduction begins to be apparent, the reduction being more and more brought about by the carbon of the carbide, with a result that alloys of aluminium and the reduced metal are obtained, the per cent. of aluminium increasing the higher the temp. of reaction. In the case of copper, the per cent. of aluminium in the alloy seems to be limited by the volatilization of aluminium. Copper alloys were obtained containing up to 28 per cent. of aluminium, whereas the equation: $3\text{CuO} + \text{Al}_4\text{C}_3 = 4\text{Al}, 3\text{Cu} + 3\text{CO}$, demands an alloy containing 36 per cent. of aluminium. In the case of iron, an alloy was obtained containing 46.7 per cent. of aluminium, or, subtracting the amount of free carbon, 49.6 per cent. of aluminium. This corresponds to the equation: $\text{Fe}_2\text{O}_3 + \text{Al}_4\text{C}_3 = 2\text{Fe}, 4\text{Al} + 3\text{CO}$, which demands an alloy containing 49.2 per cent. of aluminium. Any excess of oxide used in the reaction resulted in oxidation of the aluminium of the alloy. When the reaction between aluminium carbide and iron oxide was brought about in presence of a bath of molten iron at a high temp., alloys were also obtained in which more than 90 per cent. of the aluminium of the carbide used had been set free and taken up by the iron. Aluminium carbide reacts with copper at a temp. below the m.p. of platinum, and with iron just above this temp., to form an aluminium alloy with liberation of free carbon. At higher temp., the reaction takes place with violence and is complete.

W. Hampe² showed that the yellow crystals of what F. Wöhler and H. St. C. Deville in 1857 regarded as diamond boron is really **aluminium borocarbide**, $\text{Al}_3\text{B}_{48}\text{C}_2$, or $\text{C}_2\text{B}_{12}.3\text{AlB}_{12}$. The crystals are made by heating aluminium with boron trioxide in graphite crucibles to the highest temp. of a wind furnace, and allowing the fused mass to cool slowly. The reaction was examined by A. Joly, and he expressed the opinion that the alleged borocarbide is not a chemical individual, but gives no evidence either way. The crystals, said W. Hampe, belong to the tetragonal system; octahedra are most common, but long prisms are also formed. According to Q. Sella, the axial ratio of the ditetragonal bipyramidal crystals is $a : c = 1 : 0.5762$; W. Sartorius von Waltershausen gave $1 : 0.5736$. The colour of the strongly refracting crystals may be pale yellowish-brown, almost colourless, honey-yellow,

hyacinth-red, dark brown, or almost black. The sp. gr., according to W. Hampe, is 2.615. The crystals are easily broken, and have a conchoidal fracture. They are harder than corundum, but softer than the diamond. Their properties closely resemble those of aluminium boride. The compound can be heated in oxygen without burning. The crystals become matt in hot conc. hydrochloric or sulphuric acid, and are slowly attacked; hot conc. nitric acid gradually dissolves them. A boiling conc. soln. of potassium hydroxide, or molten potassium nitrate, does not attack the crystals, but they are attacked by fused potassium hydroxide or lead chromate. They are slowly oxidized by potassium pyrosulphate at a red heat. They are readily alloyed by fusion with platinum.

Early in the last century, J. G. Children,³ 1815, made an electric arc between the surfaces of cerium oxide and carbon, and obtained a product which gave an unpleasant odour when treated with water, and which later work has shown to have been impure **cerium carbide**, CeC_2 . G. Mosander claimed to have made cerium carbides by calcining cerous oxalate or tartrate at a high temp., but some of his statements of the properties of the products do not agree with those now known to be characteristic of cerium carbide. H. Moissan prepared cerium carbide by heating an intimate mixture of sugar charcoal (48 grms.) with ceric oxide (192 grms.) in a carbon-tube electric furnace. The oxide fuses, and ebullition commences owing to the evolution of carbon monoxide: $\text{CeO}_2 + 4\text{C} = \text{CeC}_2 + 2\text{CO}$. In a few minutes, when the mass is in a state of quiet fusion, the reaction is complete. F. Fichter and C. Schöly used a similar method. J. Sterba supposed that *cerium oxycarbide*, $\text{CeC}_2 \cdot 2\text{CeO}_2$, is formed by the reduction of ceric oxide with insufficient carbon for complete reduction, but A. Damiens denied this. He believed that the reduction occurs in stages: $2\text{CeO}_2 + \text{C} = \text{Ce}_2\text{O}_3 + \text{CO}$; and $\text{Ce}_2\text{O}_3 + 9\text{C} = 2\text{CeC}_3 + 3\text{CO}$; and $\text{CeC}_3 = \text{CeC}_2 + \text{C}$. The red crystals of the intermediate carbide, CeC_3 , can be isolated. P. R. Bassett discussed the formation of cerium carbide in the high intensity arc using a positive electrode of carbon with a core of cerium fluoride. W. Muthmann and co-workers prepared cerium carbide by the electrolysis of ceric oxide in the presence of carbon. O. Petterson, and H. Moissan prepared **lanthanum carbide**, LaC_2 , by a method similar to that employed for cerium carbide; and H. Moissan likewise made **neodymium carbide**, NdC_2 ; **praseodymium carbide**, PrC_2 ; and **samarium carbide**, SaC_2 . O. Petterson, and H. Moissan and A. Étard made **yttrium carbide**, YC_2 ; and O. Petterson, **ytterbium carbide**, YbC_2 ; and **holmium carbide**, HoC_2 , in a similar way.

It will be observed that the rare earth carbides appear to be of the same type as calcium carbide, CaC_2 , and that they are not analogous to aluminium carbide, Al_4C_3 . Cerium carbide appears as a homogeneous mass with a crystalline fracture, and it readily breaks up in the presence of air. When the fragments are examined under the microscope, some appear as well-marked hexagons of a reddish-yellow colour; lanthanum carbide is rather lighter in colour than cerium carbide. O. Petterson gave 4.71 for the sp. gr. of lanthanum carbide; H. Moissan's values at 20°, are

Sp. gr. .	LaC_2	CeC_2	PrC_2	NdC_2	SaC_2	YC_2
	5.02	5.23	5.10	5.15	5.86	4.13

W. R. Mott gave 4600° for the b.p. of yttrium carbide. At a red heat, **hydrogen** has no appreciable action on neodymium and praseodymium carbides; and at 1000°, no action on samarium carbide; **oxygen** readily unites with yttrium carbide; and at a red heat lanthanum and cerium carbides become incandescent, while praseodymium, neodymium, and samarium carbides become incandescent at 400°. The action of **water** on the rare earth carbides is particularly interesting. The principal gas is acetylene. H. Moissan's analyses are summarized in Table XVII. Both acetylene and methane are accompanied by small amounts of their homologues. A. Damiens assumes that the primary reaction is $\text{MC}_2 + 3\text{H}_2\text{O} = \text{M}(\text{OH})_3 + \text{H}_2 + \text{C}_2\text{H}_2$, and part of the acetylene is then hydrogenated to form ethylene and ethane. He found that with cerium, lanthanum, neodymium, praseodymium, and samarium

TABLE XVII.—COMPOSITION OF GASES EVOLVED BY THE ACTION OF WATER ON THE RARE EARTH CARBIDES.

	YC ₂	LaC ₂	CeC ₂	NdC ₂	PrC ₂	SaC ₂
Acetylene .	71·8	70·0–71·8	75·0–76·7	65·4–67·2	67·5–68·3	70·1–71·2
Ethylene .	4·7	2·1	3·5–4·2	6·0–6·9	2·5–3·6	7·6–8·1
Methane .	18·9	27·8–28·0	21·5–20·3	26·8–27·3	28·1–30·0	20·7–22·3
Hydrogen .	4·7	—	—	—	—	—
Liquid or solid hydrocarbons	—	A little	3·5	A little	A little	A little

carbides, the gas evolved in every case consisted of a mixture of hydrogen, sat. hydrocarbons, ethylenic and acetylenic hydrocarbons. The proportion of hydrogen was, in all cases, high. Unlike H. Moissan, he said that in no case was any methane found, the sat. hydrocarbons consisting of ethane, propane, and isobutane. The ethylenic hydrocarbons consisted of ethylene and its homologues. The different constituents of the mixture were invariably present, but their relative proportions varied according to the velocity of the reaction, which was dependent on the physical state of the carbide. The metallic hydroxides produced were always those of the sesquioxides. O. Petterson assumed that the constitution is of the mixed type, so that

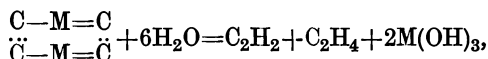

but there is little to support this hypothesis.

All these carbides are readily attacked by **fluorine** with incandescence—yttrium carbide in the cold, the others when warmed; **chlorine** attacks yttrium carbide below a dull red heat; lanthanum carbide at 250°, cerium carbide at 230°; neodymium and praseodymium carbides, above a red heat; and samarium carbide when heated—all with incandescence; **bromine** attacks yttrium carbide below a dull red heat; lanthanum carbide at 255°, cerium carbide above 230°; and praseodymium, neodymium, and samarium carbides at a dull red heat—all with incandescence; and **iodine** attacks yttrium, lanthanum, cerium, and samarium carbides below a dull red heat with incandescence, while praseodymium and neodymium carbides are attacked at a dull red heat without incandescence. Cerium carbide is attacked by **hydrogen chloride** at 650° with incandescence, and neodymium, praseodymium, and samarium carbides at a dull red heat with incandescence; **hydrogen iodide** attacks cerium carbide at a dull red heat with incandescence. Dil. acids easily attack all these carbides with the evolution of gases as in the case of water. The vap. of **sulphur** attacks yttrium and lanthanum carbides; with cerium carbide, the attack is accompanied with incandescence, with neodymium and praseodymium carbides the attack begins at 1000°, and with samarium carbide, above 400°. Yttrium and cerium carbides are attacked by **selenium** vap. at a dull red heat, and lanthanum carbide is attacked more vigorously than with sulphur. Cerium, praseodymium, neodymium, and samarium carbides are attacked when heated with **hydrogen sulphide**. All these carbides are attacked by **sulphuric acid** in the cold, with the evolution of sulphur dioxide. Lanthanum carbide is attacked at 800° by **nitrogen**, forming a nitride; cerium carbide is not attacked at the softening temp. of glass, and neodymium and praseodymium carbides are attacked superficially at 1200°. F. Fichter and C. Schölly found that at 1250°, cerium carbide forms the nitride, not the cyanide or cyanamide. According to H. Moissan, at a red heat lanthanum carbide is attacked with incandescence by **ammonia**; cerium carbide is not attacked at 600°; while praseodymium and neodymium carbides at a red heat form nitrides; and at 1250°, according to F. Fichter and C. Schölly, cerium carbide forms nitride, but rather more slowly than in an atm. of nitrogen. H. Moissan found that fuming **nitric acid** does not act on lanthanum, cerium, praseo-

dymium, and neodymium carbides. Lanthanum carbide is not attacked by phosphorus at 700°–800°, nor is cerium carbide at the softening temp. of glass. Fused potassium hydroxide decomposes the carbides with the evolution of hydrogen; fused potassium carbonate also attacks the carbides. Fused potassium permanganate, chlorate, or nitrate attacks the carbides easily with incandescence.

REFERENCES.

- ¹ L. Franck, *Bull. Soc. Chim.*, (3), 11, 439, 1894; H. Moissan, *ib.*, (3), 11, 1010, 1894; (3), 13, 803, 1895; *Compt. Rend.*, 119, 16, 935, 1894; 125, 839, 1897; *Ann. Chim. Phys.*, (7), 9, 302, 1896; H. St. C. Deville, *ib.*, (3), 43, 15, 1855; C. Matignon, *ib.*, (8), 13, 376, 1908; *Compt. Rend.*, 145, 676, 1907; M. Berthelot, *ib.*, 132, 281, 1901; E. Dufau, *ib.*, 131, 1907; *Trans. Faraday Soc.*, 4, 60, 1908; E. Briner and R. Senglet, *Journ. Chim. Phys.*, 13, 351, 1915; O. Ohmann, *Zeit. phys. chem. Unterrichts.*, 34, 76, 1921; M. Barnett and L. Burgess, *U.S. Pat. No. 1219797*, 1917; K. Nischk, *Zeit. Elektrochem.*, 29, 373, 1923; P. W. Askenasy, W. Jarkowsky, and A. Waiczek, *Zeit. Elektrochem.*, 14, 811, 1900; O. Ruff, *ib.*, 24, 157, 1918; P. W. Askenasy and A. Lebedeff, *ib.*, 16, 559, 1910; T. S. Hunt, *Trans. Amer. Inst. Min. Eng.*, 14, 492, 1886; S. A. Tucker and H. R. Moody, *Journ. Soc. Chem. Ind.*, 20, 970, 1901; M. L. Huggins, *Phys. Rev.*, (2), 21, 716, 1923; J. W. Mallet, *Proc. Roy. Soc.*, 30, 329, 574, 1880; F. E. Weston and H. R. Ellis, *Chem. News*, 97, 219, 1907; L. M. Bullier, *German Pat., D.R.P. 118177*, 1899; H. Hilbert and A. Frank, *ib.*, 92838, 1896; A. Guntz and A. Masson, *Compt. Rend.*, 124, 187, 1897; J. N. Pring, *Journ. Chem. Soc.*, 87, 1530, 1905; A. H. Cowles, *U.S. Pat. No. 319795*, 1903.
- ² W. Hampe, *Liebig's Ann.*, 183, 75, 1876; F. Wöhler and H. St. C. Deville, *ib.*, 141, 268, 1857; *Ann. Chim. Phys.*, (3), 52, 67, 1857; A. Joly, *Compt. Rend.*, 97, 456, 1883; Q. Sella, *Mem. Accad. Torino*, (2), 17, 364, 493, 1858; W. Sartorius von Waltershausen, *Abhand. Gött. Ges.*, 7, 297, 1857.
- ³ J. G. Children, *Phil. Trans.*, 99, 32, 1809; 105, 363, 1815; G. Mosander, *Pogg. Ann.*, 11, 415, 1827; H. Moissan, *Compt. Rend.*, 122, 357, 1896; 123, 148, 1896; 131, 595, 924, 1900; *Bull. Soc. Chim.*, (3), 15, 1293, 1896; (3), 17, 261, 1897; H. Moissan and A. Étard, *ib.*, (8), 15, 1271, 1896; *Compt. Rend.*, 122, 573, 1896; A. Damiens, *Ann. Chim. Phys.*, (9), 10, 137, 330, 1918; *Compt. Rend.*, 157, 214, 1913; J. Sterba, *ib.*, 134, 1056, 1902; *Ann. Chim. Phys.*, (8), 2, 223, 1904; F. Fichter and C. Schölly, *Helvetica Chim. Acta*, 3, 164, 1920; P. R. Bassett, *Trans. Amer. Electrochem. Soc.*, 44, 153, 1923; O. Petterson, *Ber.*, 28, 2419, 1895; W. Muthmann, H. Hofer, and L. Weiss, *Liebig's Ann.*, 320, 231, 1902; W. R. Mott, *Trans. Amer. Electrochem. Soc.*, 34, 255, 1918.

§ 18. The Carbides of the Silicon and Tin Families of Elements

According to J. J. Berzelius,¹ in the preparation of silicon by the reduction of potassium fluosilicate by potassium, a mixture of silicon and *silicon carbide*, or *carbon silicide*, is obtained. The amorphous substance suffered no loss of weight when ignited in a closed vessel, but in air, the carbon burns to a carbon dioxide, and the silicon to silica—in proportions showing that the composition must have been C_3Si_3 . In an attempt to synthesize diamonds, C. M. Despretz also obtained what were most probably crystals of silicon carbide when he passed an electric current through a carbon rod embedded in sand. The crystals were hard enough to cut the ruby, and scratch soft diamonds. R. S. Mardsen also in his work on the solubility of silica in molten silver obtained pale yellow hexagonal lamellæ which he mistook for graphite, but which were, in all probability, silicon carbide. A. H. and E. H. Cowles obtained hexagonal crystals of a substance which C. F. Mabery believed to be silicon suboxide, but which proved later to be crystalline silicon carbide. L. Franck found a few crystals of silicon carbide of adamantine hardness in commercial calcium carbide.

According to A. Colson, when silicon is heated to bright redness in a stream of ethylene, or of hydrogen sat. with benzene vap. at 50°–60°, a mixture of silicon oxycarbides—*vide infra*—with dark green *silicon dicarbide*, SiC_2 , is formed. This substance is not attacked at a red heat by oxygen or chlorine; it is insoluble in acids; and is decomposed by fusion with potassium hydroxide, or with a mixture of lead chromate and lead oxide. E. Kohn-Abrest obtained what he regarded as *silicon pentatritacarbide*, C_5Si_3 , by heating aluminium silicide in a graphite vessel.

P. Schützenberger obtained amorphous **silicon monocarbide**, SiC , by heating to bright redness for a few hours an intimate mixture of silicon and silica in a graphite crucible packed with lampblack inside a larger crucible. The contents were powdered, and boiled with moderately conc. hydrofluoric acid in order to dissolve the silica and the small quantity of silicon nitride which is formed. No free silicon is present. The insoluble residue containing nearly one-half of the silicon employed, is extracted with boiling conc. hydrofluoric acid, and the green powder which remains is silicon monocarbide. This substance is said to be formed by the action of carbon monoxide on the silicon. On treating it with chlorine at a low red heat, silicon chloride is evolved, leaving carbon and part of the carbide unchanged. After burning the carbon in a current of oxygen, a portion of the residue can be acted on by chlorine at a bright red heat, but the residue from this second treatment is not further attacked by chlorine.

H. Moissan said that carbon can dissolve in molten silicon, and the carbide can be detached from the crystals by boiling in a mixture of nitric and hydrofluoric acids, and further purified by treatment with a mixture of nitric acid and potassium chlorate. The crystals may be yellow and quite transparent, or they may have a sapphire-blue colour. In the presence of a solvent, silicon and carbon unite between 1200° – 1400° . H. Moissan obtained almost colourless, prismatic needles of carbon silicide by allowing the vap. of carbon and silicon to react with one another. If iron silicide, mixed with an excess of carbon, be heated in an electric furnace, a regulus containing crystals of silicon carbide is formed. A mixture of iron, silicon, and carbon, or of iron, silica, and carbon, can be similarly treated. The regulus is first digested with aqua regia to remove the iron; then heated for several hours with a mixture of nitric and hydrofluoric acids, and then treated eight to ten times with a mixture of nitric acid and potassium chlorate. H. Moissan also made the carbide by melting a mixture of calcium carbide and silica, and by reducing silica with carbon in an electric furnace. In 1890, E. G. Acheson tried to crystallize carbon by dissolving that element in aluminium silicate in an electric arc. The blue crystals obtained were thought to be a compound of carbon and aluminium. The crystalline compound was called **carborundum**. Subsequent analyses showed the product to be silicon carbide, SiC , and it was then made by reducing silica by carbon in the electric furnace. According to A. Lampen, some of the non-crystalline carbide is found in the parts of the carborundum furnace which have not attained a temp. of 1950° . H. Moissan found crystals of silicon carbide in the meteorite from Cañon Diablo, and G. F. Kunz proposed for the mineral name *moissanite*. H. Hanemann observed no carbide formation by heating a mixture of iron, silica, and carbon to 1500° ; about 1.37 per cent. of silicon was formed. O. Mühlhäuser purified carborundum by passing oxygen over it for an hour while at a dull red heat; boiling the product with potash-lye; and then heating it with a mixture of hydrofluoric and conc. sulphuric acids. L. Weiss and T. Engelhardt, and W. G. Mixter discussed the purification of carborundum.

G. Tammann found that the reaction between silicon and carbon, obtained by the action of mercury on carbon tetrachloride at 450° , started at 1220° ; with soot from turpentine, at 1340° ; with sugar charcoal, at 1410° ; and with graphite, at 1390° . K. Nischk studied the formation of silicon carbide. According to S. A. Tucker and A. Lampen, the temp. of formation of crystalline carborundum from silica and carbon is 1950° ; H. W. Gillet gave $1820^{\circ} \pm 20^{\circ}$; and L. E. Saunders, $1840^{\circ} \pm 30^{\circ}$. For amorphous carborundum, S. A. Tucker and A. Lampen gave 1600° ; H. W. Gillet, $1540^{\circ} \pm 30^{\circ}$; and L. E. Saunders, $1600^{\circ} \pm 50^{\circ}$. For the temp. of decomposition of crystalline carborundum, S. A. Tucker and A. Lampen gave 2220° ; H. W. Gillet, $2220^{\circ} \pm 20^{\circ}$; and L. E. Saunders, $2240^{\circ} \pm 5^{\circ}$. The range of temp. in the carborundum furnace is therefore comparatively small. J. N. Pring found that at a reduced press., 0.01 mm., carborundum is formed at 1250° ; and H. C. Greenwood stated that in vacuo silica is reduced by carbon, and carborundum is formed at 1460° . R. S. Hutton and J. E. Petavel showed that

at 100 atm. press., the formation of crystalline carborundum is hindered, and the formation of amorphous carborundum negligible. According to W. G. Mixer, the heat of formation of crystalline carborundum, $\text{Si}_{\text{cryst}} + \text{C}_{\text{amorphous}} = \text{SiC} + 2.0$ Cals. per 40.4 grms. of carborundum, or 50 cal. per grm. of SiC; and the heat of combustion to silica and carbon dioxide is $\text{SiC} + 2\text{O}_2 = \text{SiO}_2 + \text{CO}_2 + 283.8$ Cals. per 40.4 grms. of carborundum, or 7025 cal. per grm.; H. N. Potter obtained 7595 cal. per grm. W. G. Mixer said that his value falls within the limits of experimental error, so that the heat of formation may be positive or negative.

The first carborundum furnace consisted of an iron bowl lined with carbon, and fitted with a carbon rod. A mixture of carbon and clay was introduced into the bowl and about the rod. A current sufficient to fuse the mixture, or to bring it to a very high temp., was passed through the furnace with the iron bowl and carbon rod as electrodes. When the current was cut off and the furnace cooled, a few bright blue crystals of carborundum were found surrounding the carbon rod. The clay was afterwards replaced by glass-sand. A little salt was added to facilitate the running of the furnaces; and the mixture was made porous by the addition of sawdust so as to facilitate the escape of gas. The furnaces were then increased in size. The manufacture has been described by E. G. Acheson, F. A. J. Fitzgerald, C. A. Kohn, O. Mühlhäuser, J. A. Matthews, A. Dorsemagen, R. Volkmann, K. P. Gregorovitch, etc.

The furnaces are built of brick, and have the form of an oblong box, internally 16 ft. \times 5 ft. \times 5 ft. The ends have a thickness of about 2 ft. The terminals are fitted at the

FIG. 23.—Carborundum Furnace ready for Operation.

centre of each end. They consist of 60 carbon rods, 30 ins. long and 3 ins. diameter. The outer ends of the carbons are enclosed in a square iron frame to which is screwed a stout plate bored with sixty holes corresponding with the ends of the carbons. Through each hole is passed a short piece of $\frac{3}{8}$ th in. copper rod, and this fits tightly into a hole drilled in the carbon. All the free space between the inside of the plate, and the ends of the carbon, is packed tightly with graphite. Each plate has four projections to which the four cables conveying the current are bolted. The ends of the furnace are permanent, the remainder

is built each time the furnace is operated. The side walls are built about 4 ft. high. Pieces of iron plate are placed about 4 ins. from the inner ends of the terminals to keep the mixture from coming in contact with the terminals. The mixture of sand (53.5 per cent.), coke (40 per cent.), sawdust (5 per cent.), and salt (1.5 per cent.) is then thrown into the furnace until it is half full. A central longitudinal trench is then arranged with a radius of about $10\frac{1}{2}$ ins. The bottom of the trench is a little above the level of the bottom row of carbons. The core of the furnace is introduced. The core is a cylinder of granulated coke, about 21 ins. diameter and 14 ft. long, and extending between the sheet iron plates at the ends. Finely ground coke is packed into the spaces between the ends and the pieces of sheet iron. The side walls are built up another foot; the pieces of sheet iron are removed; and more furnace mixture is added to make up a height of about 8 ft. Figs. 23 and 24 give an idea of the appearance of the furnace in Chippawa, Ontario, plant of the Norton Company of Worcester, Mass., where they manufacture carborundum under the name of *crystolon*. The resistance of the furnace diminishes rapidly, and in about an hour approximately 746 kilowatts or 1000 H.P. are being expended in heating the furnace. In about 24 hours, the current is cut off, and the furnace is allowed to cool for a few hours. The



FIG. 24.—Carborundum Furnace in Operation.

side walls are taken down, and the unchanged mixture raked from the top of the furnace until the outer crust of amorphous carborundum is exposed. Beneath the outer crust is another thin layer of light-green amorphous carborundum. Inside this, radiating from the core, is a 10 to 12-in. layer of carborundum crystals. The core has changed into a mass of graphitic carbon, for the high temp. of the furnace has volatilized the impurities of the coke. The carborundum is then crushed by levigation and sieved.

The following are typical analyses of first, medium and low-grade carborundum when the theoretical values for SiC are 70.30 per cent. silicon, and 29.70 per cent. of carbon:

	Si (combined)	C (combined)	Fe	Al	Si (free)	Ca
First . . .	60.60	29.40	0.09	0.55	0.13	0.09
Medium . . .	67.70	28.60	0.65	1.40	—	—
Low . . .	65.31	27.59	0.93	2.02	0.56	0.29

The so-called *carborundum fire-sand* is a layer of carborundum mixed with partly-reduced silica. Analyses range between the limits:

SiC	SiO ₂	Al ₂ O ₃	Fe ₂ O ₃	C (free)	Ca
73.32–85.42	4.64–6.80	1.46–6.05	1.10–4.52	3.12–4.52	0.23

According to H. Moissan, carborundum free from traces of iron is without colour; the best commercial grades are pale green, while the less pure grades are black. H. E. Merwin said that the blue crystals are pleochroic, some with colours passing from light blue, others from olive-green to greenish-blue. Some of the crystals have triangular markings and parallel striæ. There are often spiral markings of different form, maybe 30,000 to 50,000 lines per inch. The crystals of carborundum often exhibit a brilliant play of iridescent colours, which are attributed by W. R. Mott to a very thin film of transparent fused silica on the surface. The green crystals do not show the iridescence, for a black reflecting surface is needed to produce the effect. The iridescence is destroyed by hydrofluoric acid, and is restored by oxidation, or by etching with salt at a higher temp. Silicon carbide occurs both amorphous and crystalline; the crystalline variety first obtained by E. G. Acheson consisted of a mass of loosely aggregated crystals. F. J. Tone produced a dense mass of small, imperfectly developed crystals which had a steel-like appearance and fracture; and which was given the trade-name *silundum*. H. Moissan obtained well-defined crystals which appeared as regular hexagons. F. A. J. Fitzgerald said that sometimes in hollow places in the carborundum furnace, large hexagonal crystals may be found with a side measuring 0.5 in. B. W. Frazier said that carborundum crystals belong to the hemihedral division of the hexagonal system, and are characterized by the predominance of the basal pinacoid. Both direct and reversed rhombohedra may occur on the same crystals giving them the appearance of holohedral symmetry. The axial ratio of the ditrigonal pyramids was found by G. B. Negri to be $a:c=1:1.2265$. B. W. Frazier obtained a similar result. F. Rinne, C. L. Burdick and E. A. Owen, H. Espig, and R. N. Pease studied the **X-radiogram** of silicon carbide, and the latter found the diamond type of lattice with interatomic distances 1.92 Å. H. Espig obtained evidence of an elementary parallelepiped with $a=5.65 \times 10^{-8}$ cm. and $c=15.3 \times 10^{-8}$ cm., and 24 molecules SiC per unit lattice. Some suggestions on the structure of the crystals were made by H. M. Dowsett in order to explain their physical properties. M. L. Huggins discussed the **electronic structure** of the silicon carbide mol. F. Becke found the **corrosion figures** corresponded with the ditrigonal pyramidal symmetry. O. Weigel also studied the corrosion figures with fused potassium carbonate and nitrate. The plane of **twinnings** is the unit rhombohedron. F. Rinne also made observations on the crystals. There is no distinct **cleavage**. The **fracture** of the crystals is subconchoidal. C. L. Burdick and E. A. Owen found the **X-radiogram** of carborundum to show that the silicon and carbon atoms are each arranged on face-centred rhombohedral lattices which are very nearly cubic, for $\alpha=89^{\circ} 56' 10''$. The carborundum lattice is therefore very nearly that of the tetrahedral diamond lattice each being constituted of two interpenetrating face-centred lattices. The vol. of the elementary rhombohedra is 20.70×10^{-24} c.c. and the mol. wt., when the at. wt. of hydrogen is 1.64×10^{-24} gm., is 65.5×10^{-24} gm. The calculated density is therefore 3.11. The side of the elementary rhombohedron is 4.356, and the closest approach of the atoms is 1.88 Å. F. Rinne has made observations on this subject. R. N. Pease calculated 1.94 Å. for the atomic radii of the atoms in silicon carbide.

H. Moissan gave 3.2 for the **specific gravity** of silicon carbide crystals; F. A. J. Fitzgerald found the sp. gr. of carborundum ranged from 3.1716 to 3.214; and O. Mühlhäuser found the sp. gr. to be 3.22 at 15° ; J. W. Richards, 3.125–3.200 at 20° ; L. Franck, 3.10–3.30; and O. Weigel gave

	25.7°	100°	32.3°	113.9°
Sp. gr.	3.2104	3.2086	2.2021	3.2003

The difference, said F. A. J. Fitzgerald, is determined by the proportion of ferrous silicide present as an impurity. The **hardness** of carborundum lies between that of the ruby and that of the diamond or between 9 and 10 on Mohs' scale, perhaps nearer 10, added F. A. J. Fitzgerald, for, although carborundum is scratched by the diamond,

carborundum will scratch many varieties of the latter. G. F. Kunz added that nothing definite is known about the difference in hardness between the units 9 and 10 on Mohs' scale, but there is probably as much difference between them as between the units 1 and 9. J. H. Pratt ranged the following scale of decreasing hardness: carborundum, Georgia corundum, alundum, Chester blue-corundum, Chester emery, and Canadian corundum. P. J. Holmquist measured the abrasive action of carborundum of different grain-size on quartz, topaz, magnetite, fluorite, and apatite. A. Hoenig discussed its use as an abrasive. According to T. W. Richards and co-workers, the **compressibility** of carborundum is 0.21×10^{-6} kgrm. per sq. cm. between 100 and 500 atm. press., and is therefore but little greater than that of silicon which is 0.16×10^{-6} .

The coefficient of **thermal expansion** of carborundum between 15° and 100° is 0.00000658; between 700° and 800° , 0.00000438; between 800° and 900° , 0.00000298; and at $1000^\circ \pm 15^\circ$, 0.00000435. L. E. Muller and L. Baraduc-Muller gave 0.00000539 between 100° and 200° ; W. C. Röntgen, 0.00000234 at 40° ; while C. A. Boeck gave 0.00000474 between 100° and 900° , and for fused alumina 0.00000866 between 100° and 900° . A. Magnus found the coeff. of cubical expansion of carborundum between 0° and 25.027° to be 8.8×10^{-6} . According to O. Weigel, the true cubical and linear expansion coeff. parallel to the vertical axis are as follows:

	0°	100°	200°	300°	400°
Linear $\times 10^6$	2.118	2.666	3.214	3.763	4.310
Cubical $\times 10^6$	6.354	7.998	9.642	11.289	12.930

and he represented the length at θ° by $l_0(1 + 1.0_52118\theta + 0.0_32741\theta^2)$. He also found for the change of the crystal angles

20°	402°	601.5°
$30^\circ 24' 53''$	$30^\circ 24' 54'$	$30^\circ 24' 45''$

H. N. Potter gave 0.1857 for the **specific heat** of crystalline carborundum. W. Nernst and F. Schwes determined the sp. ht. of carborundum below -176.5° , and A. S. Russell between -135° and 25° , and O. Weigel between 0° and 1000° . The latter gave:

Sp. ht.	273°	473°	673°	763.7°	773°	873°	1073°	1273° K
	0.140	0.233	0.277	0.282	0.282	0.275	0.225	0.129

Selecting values for the mol. ht. over the whole range of temp. on the absolute scale, we obtain:

Mol. ht.	52°	63.1°	90.5°	138°	473°	673°	773°	873°	1073°	1273°
	0.099	0.197	1.013	2.06	9.39	11.16	11.36	11.08	9.07	5.20

Half the mol. ht. of carborundum, and the at. ht. of carbon and silicon are plotted

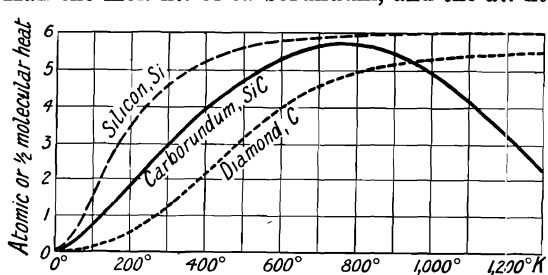

FIG. 25.—Atomic Heats of Carbon and Silicon, and Half the Molecular Heat of Carborundum at Different Temperatures.

different temp. and estimated it to be 2000 cal. at 0° K., falling to about 700 cal. at 700° K. O. Weigel estimated the **melting point** to be near 2227° , or 2500° K., and hence, from J. W. Richard's formula: **heat of fusion** = $1.06RT_s$, or 5250 cal., or from E. Grüneison's formula heat of fusion = $0.96RT_s$, or 4500 cal. E. Tiede and

E. Birnbrauer gave 1650° for the temp. at which vapour is given off. R. S. Hutton and J. R. Beard found the **thermal conductivity** of white Calais sand between 20° and 100° was 0·00060; that of fine carborundum, 0·00050; and that of coarse carborundum 0·00051 cal. per cm. cube per °C. per sec.; and O. S. Beecher reported the thermal conductivity of carborundum bricks to be 0·0150 cal. F. A. J. Fitzgerald found that carborundum at 435° transmits 79 per cent. more heat than fused alumina, and 117 per cent. more than silica; while S. Wologdine gave for the conductivity at 1000°, in gram cal. per cm. cube per °C. per sec., of bricks made from

	Carborundum	Magnesia	Chrome	Clay	Silica
Conductivity . . .	0·0231	0·0071	0·0057	0·0042	0·0020

According to F. Becke, the **double refraction** of carborundum is positive, and the **index of refraction** for Na-light is $\omega=2\cdot786$, and $\epsilon=2\cdot832$; L. E. Jewell gave $\omega=2\cdot72$ for the red and 3·4 for the violet, and for $\epsilon=2\cdot80$ and 3·80 respectively. H. E. Merwin found the indices of refraction for light of wave-length λ to be

λ . . .	755	726	671	535	468	422	416 $\mu\mu$
ω . . .	2·616	2·622	2·633	2·675	2·713	2·753	2·757
ϵ . . .	2·654	2·660	2·673	2·721	2·763	2·808	2·812

O. Weigel represented his observations on ω by $0\cdot83921+5\cdot70990\lambda(\lambda^2-1612)^{-1}$, with good results. He also measured values of ϵ and ω , and found the effect of temp. on ω to be for $\lambda=455\cdot4\mu\mu$, $2\cdot71255(1+0\cdot0_423210\theta+0\cdot0_711237\theta^2)$; for $\lambda=493\cdot4\mu\mu$, $2\cdot68751(1+0\cdot0_421599\theta+0\cdot0_710073\theta^2)$; for $\lambda=553\cdot6\mu\mu$, $2\cdot65921(1+0\cdot0_420689\theta+0\cdot0_88063\theta^2)$; for $\lambda=614\cdot2\mu\mu$, $2\cdot63915(1+0\cdot0_420060\theta+0\cdot0_87831\theta^2)$; for $\lambda=649\cdot7\mu\mu$, $2\cdot63013(1+0\cdot0_42003\theta+0\cdot0_87241\theta^2)$. O. Weigel discussed the **vibration-frequency** of carborundum, and he showed that when a clear, colourless carborundum crystal is heated to redness, it acquires a deep greenish-yellow colour, and again becomes colourless when the crystal has cooled down to its former temp. This behaviour indicates that considerable changes occur in the absorption spectrum as the temp. changes. The following is a selection from O. Weigel's measurements of the **transparency** and the **extinction coefficients** for different wave-lengths at different temp.:

79°	Wave length, λ . . .	417·3	429·0	446·4	504·4	620·5	701·8 $\mu\mu$
	Transparency . . .	0·376	0·509	0·595	0·621	0·575	0·430
	Extinction . . .	0·177	0·0685	0·0137	0·0029	0·0363	0·144
251°	Wave length, λ . . .	423·2	438·8	446·4	504·4	620·5	713·4 $\mu\mu$
	Transparency . . .	0·314	0·466	0·578	0·595	0·583	0·433
	Extinction . . .	0·242	0·100	0·0234	0·018	0·031	0·141
415·3°	Wave-length, λ . . .	429·0	440·5	452·2	504·4	620·5	713·4 $\mu\mu$
	Transparency . . .	0·226	0·361	0·538	0·591	0·571	0·436
	Extinction . . .	0·358	0·190	0·0468	0·0172	0·361	0·136
775°	Wave-length, λ . . .	452·2	493·8	475·4	487·0	562·5	713·4 $\mu\mu$
	Transparency . . .	0·0734	0·196	0·356	0·501	0·587	0·446
	Extinction . . .	0·763	0·410	0·195	0·072	0·0198	0·124
984·8°	Wave-length . . .	487·0	492·8	498·6	504·4	510·2	516 $\mu\mu$
	Transparency . . .	0·127	0·170	0·263	0·310	0·387	0·452
	Extinction . . .	0·562	0·461	0·304	0·234	0·165	0·109

W. W. Coblentz measured the ultra-red reflection spectrum of carborundum, and said that it is the most remarkable one yet discovered. It remains fairly constant up to 9μ , and then drops abruptly to a low value at about 10μ , and then attains an abnormally high value at beyond 13μ , as shown in Fig. 26. C. Schaefer and M. Thomas studied the ultra-red absorption spectrum of silicon carbide.

At ordinary temp., the **electrical conductivity** of carborundum is very low, being much less than that of carbon: the conductivity increases rapidly as the temp. rises, for the temp. coeff. of the **electrical resistance** is large and negative. G. W. Pierce and R. D. Evans showed that contact difficulties prevent accurate

determinations of the conductivity of the crystalline materials. The Carborundum Co. give for the sp. resistance, R , of the dense crystalline material in ohms per cm. cube:

R	25°	100°	200°	400°	600°	800°	1000°	1200°	1400°
	50	46.4	36.9	26.6	14.6	7.8	3.7	1.3	0.65

The values of O. Weigel are plotted in Fig. 27. The effects of alternating and

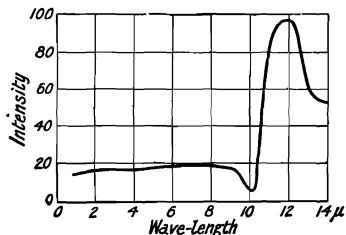

FIG. 26.—Ultra-red Absorption Spectrum of Carborundum.

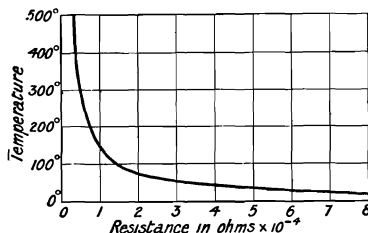

FIG. 27.—The Effect of Temperature on the Electrical Resistance of Carborundum.

direct currents at 14.7° to 15.5° and different voltages on the resistance in ohms are as follow :

Voltage	0.036	0.384	0.840	1.690	5.58	8.10	12.2	31.3
R { Direct	14390	13529	13148	10243	9011	7513	6420	5873
Alternating	8018	8116	8149	8116	8051	8018	7921	7921

The resistivity varies with the porosity and chemical composition, when the material is bonded into bricks with clay, the sp. resistance is much higher, being

$R \times 10^4$	25°	200°	410°	600°	700°	800°	1100°	1200°
	28.4	27.0	7.0	25.0	2.8	2.4	0.15	0.04

F. A. J. Fitzgerald has made analogous observations. G. W. Pierce and R. D. Evans found the **electrostatic capacity** of carborundum to be 0.006–0.022 microfarads; the existence of capacity was attributed to the existence of numerous alternating conducting and insulating strata within the crystal. The action of the carborundum as a detector for electric waves and as a rectifier for electric currents is independent of its action as a condenser; but it will detect electric waves or rectify only, provided contact is made to one or more of the conducting strata. It may detect electric waves with an adjustment that shows no capacity by the present method of measuring capacity. On the other hand, with every adjustment at which there was capacity, there was also a rectification and a detection of the electric waves. H. M. Dowsett measured the rectification effect of carborundum, and he found that the crystals act as normal conductors with a few hundred ohms' resistance for currents flowing parallel to the crystal faces, whereas at right angles to these directions, an e.m.f. has to be applied to force an elastic opening into the path or paths parallel to that crystal face; this opening has a high resistance—of the order 20,000–250,000 ohms—until its elastic limit is exceeded. The crystals of green carborundum find it easier to receive than to give up electrons, and conversely with the crystals of black carborundum. According to H. S. Roberts and L. H. Adams, in wireless telegraphy, the inducted alternating currents are of such high frequency that if the diaphragm of a telephone could be made to vibrate in unison, the sound would be so shrill as to be beyond the range of the human ear. To make them audible, the waves must either be broken up into like groups or trains which follow one another at an audible frequency as in wireless telegraphy, or modulated so that their amplitude varies in time with an audible vibration as in wireless telephony. In either case they remain high-frequency electromagnetic waves. In the receiving apparatus the high-frequency e.m.f. is impressed on a circuit whose function is to distort the

alternating current wave so that more current flows in one direction than another. The distorted wave then behaves as if it were the sum of a high-frequency alternating current and a direct current, of which only the latter is capable of actuating the telephone receiver. The ideal detector would allow current to pass in one direction only, and it is therefore an electrical rectifier. The *crystal detector* consists of a small area of contact between two suitable conductors at least one of which is a crystal; it operates in virtue of the fact that the current flowing through such a contact is not proportional to the e.m.f. driving it. The effect with carborundum is illustrated by Fig. 28, where the current in millionths of an ampère is plotted against the potential difference in volts between the fusible metal in which the crystal carborundum was mounted and the spring contact against one of the corners of the crystal. The subject has also been discussed by H. M. Dowsett, and F. Luchsinger. Carbon silicide is not **magnetic**. The magnetic properties of commercial carborundum depend on the ferruginous impurities in the crystals. Medium grades of carborundum show from 5 to 10 per cent. of grains are susceptible to a magnet.

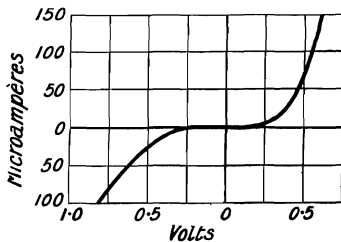

FIG. 28.—Current-Voltage Curve of Carborundum.

Carborundum is highly resistant to chemical action. There is little or no action when carborundum is heated in **hydrogen**. Similar results were obtained with **nitrogen** or **carbon monoxide**. According to H. Moissan, and L. E. Muller and L. H. Baraduc, carborundum is not altered at 1000°, in **oxygen**, but between 1000° and 1350°, it is slightly oxidized in **air**; between 1350° and 1500°, the silica which is formed is fused; between 1500° and 1600°, oxidation is much retarded by the fused silica coating; and at 1750°, oxidation proceeds quickly. The vap. of **water** and **carbon dioxide** become active only at their dissociation temp., 1775°–1800°. At 600°, carborundum is but superficially attacked by **chlorine** in 1½ hrs., but at 1200°, decomposition is complete. At 900°, the reaction furnishes silicon tetrachloride and carbon; at 1000° to 1100°, both carbon and silicon tetrachlorides are formed. Boiling **hydrochloric acid**, **hydrofluoric acid**, or a mixture of monohydrated **nitric acid** and hydrofluoric acid, which attacks silicon very readily, is without action on carborundum. The vap. of **sulphur** does not attack carborundum at 1000°, and boiling **sulphuric acid** has no action. Carborundum is attacked energetically by **silica** at 2000°–2500°, forming silicon. M. Wunder and B. Jeanneret found that when carborundum is heated for 3 hrs. with **phosphoric acid** of sp. gr. 1.75, at 230°, a syrupy liquid and a gelatinous precipitate are formed; any carbon present remains undissolved. O. Mühlhäuser, and B. Neumann found that it forms a metal silicide with **copper oxide** at 800°; with **iron** or **nickel oxide** at 1300°; with **manganese oxide** at 1360°; and with **chromic oxide** at 1370°. Carborundum does not attack **platinum** over an ordinary Bunsen burner, but the metal is attacked if it be heated over a blast-flame. Fused **potassium hydroxide** gradually disintegrates and slowly dissolves carborundum, forming potassium carbonate and silicate; carborundum is also decomposed by fused **potassium carbonate**. O. Weigel gave for the action of sodium carbonate: $\text{CSi} + 3\text{Na}_2\text{CO}_3 = \text{Na}_2\text{SiO}_3 + 2\text{Na}_2\text{O} + 4\text{CO}$. Carborundum is decomposed by fused **alkali sulphates**, fused **borax**, or fused **cryolite**; and it is attacked by **calcium oxide** or **magnesium oxide** at 1000°. Fused **potassium chlorate** and fused **potassium nitrate** have no action. Carborundum is attacked by **sodium silicate** at 1300°, and the attack is specially active in the presence of oxidizing gases or oxidizing salts. Carborundum is slowly but completely oxidized by fused **lead chromate**; and when heated with a mixture of **potassium dichromate** and lead chromate, the reaction is explosive.

According to P. Schützenberger and A. Colson, when crystallized silicon is heated almost to whiteness in a porcelain tube in an atm. of carbon dioxide, the latter is absorbed, with

formation of a greenish-white mass, which may be freed from silicon by washing with hot, moderately conc. potash. The residue is then treated with hydrofluoric acid, which dissolves out silica, leaving a greenish powder, insoluble in boiling soln. of the alkalis, and not attacked by any acids. It has a composition corresponding with **silicon oxycarbide**, $(\text{SiC})_n$, and is formed in accordance with the equation $3\text{Si} + 2\text{CO}_2 = \text{SiO}_2 + 2\text{SiC}$. When heated in oxygen, it yields only a trace of carbon dioxide, but is oxidized with incandescence when heated with litharge or a mixture of litharge and lead chromate. By passing hydrogen gas mixed with benzene vap., or ethylene over silicon heated to bright redness, A. Colson obtained a mixture of silicon dicarbide, SiC_2 , **silicon dioxycarbide**, SiC_2O , and **silicon trioxycarbide**, SiC_3O_2 ; and he obtained **silicon oxydicarbide**, $\text{Si}_2\text{C}_2\text{O}$, by heating silicon sulphocarbide, $\text{Si}_4\text{C}_4\text{S}$, in oxygen, or by the action of carbon dioxide on heated silicon. He found that when powdered silicon is placed in a gas-carbon crucible lined with compressed lampblack, and this, in turn, is placed inside a brasqueon crucible and heated to whiteness, a regulus containing silicon oxycarbide is formed. The regulus is detached, freed from adhering charcoal, powdered, and purified by treatment with potash and hydrofluoric acid. The bottle-green powder thus obtained is **silicon dioxytriacarbide**, $\text{Si}_2\text{C}_3\text{O}_2$. Prolonged action of oxygen at a red heat gradually removes the excess of carbon. If a mixture of somewhat thick iron wire with lampblack and silica be similarly treated, a crystalline **silicon hexaferrocarbide**, $\text{Fe}_6\text{Si}_2\text{C}$ (sp. gr. = 6.6), is formed. This compound is formed only after prolonged heating at a very high temp. There is nothing to show if these **oxycarbides**, or **carboxides**, are not simply mixtures of silicon, silica, and silicon carbide. E. G. Acheson noted their presence in the zone of the so-called amorphous carborundum in the electric furnace. In fact, this form of amorphous carborundum appears to be incompletely reduced silica, and is regarded as a solid soln. of silicon carbide in silica. A similar product with a felt-like structure was made by F. J. Tone. E. G. Acheson gave the material the trade-name *silizicon*; its composition ranges from $\text{Si}_2\text{C}_2\text{O}$ to $\text{Si}_7\text{C}_7\text{O}$. The general formula is $(\text{SiC})_n\text{O}$, where n varies from 1 to 7. The higher the temp. of formation, the greater the value of n . These oxycarbides oxidize more easily than carborundum when used as furnace linings: $(\text{SiC})_n\text{O} + \frac{1}{2}(4n-1)\text{O}_2 = n\text{SiO}_2 + n\text{CO}_2$. It is analogous to the carborundum fire-sand. It has been described by G. Krell, P. E. Spielmann, N. Heym, F. Bölling, R. Amberg, etc. In 1894, O. Mühlhäuser noted the presence of a fibrous material in the manufacture of carborundum and assumed its composition to be AlSi_2C_7 ; and in 1897, C. A. Kohn made a similar observation, but regarded the material as finely divided carborundum. According to E. Weintraub, when silicon is heated in a graphite crucible at $1400^\circ\text{--}1500^\circ$, a small quantity of calcium fluoride being present, the crucible becomes filled in a few hours with a fibrous mass of silicon oxycarbide. After breaking away the slag and reheating, a further quantity may be obtained. This material, known as *fibrox*, is made up of very fine, amorphous threads, sometimes carrying minute beads of vitreous silica. It is formed by reactions in the state of vap., and experiments in an electric furnace show that the presence of carbon dioxide is necessary. The sp. gr. varies from 1.84 to 2.2, increasing with the percentage of silicon. The apparent sp. gr. of the fibrous mass is only 0.0025–0.0030, or 2.5–3.0 grms. per litre. The thermal resistance in the loosely packed condition is very high, but diminishes with rising temp. Thus, the resistivity in ohms is 4190 at 100° ; 3300 at 200° ; 2265 at 300° ; and 2195 at 500° . Fibrox is not hygroscopic and is permanent in air; above 1000° , it oxidizes slowly and is transformed into silica. It is a relatively good electrical conductor, and its conductivity increases with compression, and it also depends on the carbon content. For *monox*, see silicon monoxide.

According to L. Franck,² carbon unites with titanium in all proportions, forming crystalline carbides. P. W. Shimer isolated **titanium carbide**, TiC , in minute, metal-like, cubic crystals from the residue left on dissolving 250 grms. of pig-iron in dil. hydrochloric acid. H. Moissan prepared this carbide by heating a mixture of titanic oxide (160 parts) and carbon (70 parts) in an electric arc furnace for 10 min., $\text{TiO}_2 + 2\text{C} = \text{TiC} + \text{CO}_2$. F. M. Becket obtained the carbide by a similar process. H. Moissan obtained titanium carbide by heating titanic oxide with calcium carbide. The carbide occurs in fused masses with a crystalline fracture, or in crystal aggregates. There is always a slight excess of carbon which has crystallized from the fused mass as graphite. The graphite retains tenaciously traces of titanium. K. Nischk studied the formation of titanium carbide. P. W. Shimer gave 5.1 for the sp. gr. of titanium carbide, and H. Moissan, 4.25. W. R. Mott gave 4300° for the b.p. of titanium carbide at 760 mm. P. W. Shimer said that titanium carbide is soluble in nitric acid; H. Moissan said that, unlike titanium, the carbide is not attacked by hydrochloric acid; but it is slowly attacked by aqua regia. The vap. of water has no action at 600° . The reactions of the carbide resemble closely those of titanium, but the carbide burns more easily in oxygen, for it ignites at a dull red

heat, and the evolution of heat causes the mass to become incandescent. When the powder is sprinkled in a Bunsen's flame, it furnishes sparks more vivid than those obtained with titanium.

According to J. J. Berzelius,³ **zirconium carbide** is formed when zirconium is prepared by reducing a zirconium compound with potassium containing carbon. It resembles zirconium in appearance; it dissolves in hydrofluoric acid, leaving a residue of carbon; with boiling hydrochloric acid it evolves hydrogen and some hydrocarbons; and when burnt it forms zirconia, which is not perfectly white because a portion of the carbon escapes combustion. L. Troost made a product with 77.6 per cent. of Zr, namely, **zirconium dicarbide**, ZrC_2 , by heating an intimate mixture of zirconia and sugar charcoal in an electric furnace. It is not clear whether the product is a chemical individual or a mixture. It is readily attacked by dil. or conc. hydrofluoric acid, but not by other acids; L. Renaux made zirconium carbide from a mixture of zircon and calcium carbide; and E. Wedekind, from a mixture of zircon, carbon, and lime. According to H. Moissan and M. Lengfeld, zirconium dicarbide is obtained by heating to a high temp. in an electric arc furnace, a mixture of zirconia and sugar charcoal. W. R. Mott gave 5100° for the b.p. of zirconium carbide at 760 mm. This carbide, said H. Moissan, has a grey colour and a metallic lustre, scratches quartz but not rubies, and is not attacked by dry or moist air even at 100°. It burns in fluorine in the cold, in chlorine at 250°, in bromine at 300°, and in iodine at about 400°, and it is readily attacked by halogen hydracids. At a dull red heat, it burns brilliantly in oxygen, and is slightly attacked by sulphur vap. at the same temp. Water, ammonia, and hydrochloric acid do not attack the carbide even when strongly heated. Nitric and sulphuric acids attack it, and oxidizing agents such as potassium chlorate, nitrate, or permanganate, as well as the hydroxide, decompose it readily, but fused potassium cyanide is without action.

No *germanium carbide* has been reported. L. M. Dennis⁴ and co-workers failed to obtain one by heating a mixture of carbon and finely powdered germanium up to the temp. at which the metal volatilized. O. Ruff and B. Bergdahl found that tin dissolves only traces of carbon, while lead dissolves 0.024 per cent. at 1170°, and 0.094 per cent. at 1555°. According to H. Moissan, tin does not unite with carbon; when stannic oxide is heated with calcium carbide, the metal is produced but no *tin carbide* is formed. He likewise failed to prepare **lead carbide**. According to J. F. Durand, calcium carbide precipitates impure lead carbide, PbC_2 , from a soln. of normal lead acetate. The greyish powder is stable in air and water, but it gives acetylene when treated with dil. hydrochloric acid—*vide* the action of carbon on lead.

The *carbide of cerium* has been described in connection with the rare earth metal carbides—*vide supra*. L. Troost⁵ found that a mixture of thoria and sugar charcoal in the electric arc furnace furnishes **thorium dicarbide**, ThC_2 , more readily than does zirconia. H. Moissan and A. Étard prepared it in a similar manner; and E. Kunheim, by heating a mixture of thorium sulphate and retort carbon in the electric arc. According to H. Moissan and A. Étard, thorium carbide forms a homogeneous mass possessing a crystalline fracture. It consists of small, transparent, yellow crystals mixed with some graphite laminae; its sp. gr. is 8.96 at 18°; L. Troost gave 10.15 at 15°, and he found that the product is not so hard as zirconium carbide, but it is brittle and scratches glass slightly. W. R. Mott gave 5000° for the b.p. of thorium carbide at 760 mm. H. Moissan and A. Étard said that thorium carbide closely resembles yttrium carbide in its properties. When exposed to moist air, thorium carbide slowly decomposes with intumescence. When heated in air, it readily burns with incandescence. It is decomposed by cold water giving off a mixture of gases containing

	C_1H_2	C_2H_4	CH_4	H_2
Per cent.	47.6	5.8	29.4	17.1

and some liquid and solid hydrocarbons. P. Lebeau and A. Damiens obtained

from thorium carbide and water a mixture of gases similar to those obtained from uranium carbide, excepting that more acetylene homologues and less methane were present. H. Moissan and A. Étard found that sulphur vap. attacks heated thorium carbide with incandescence; selenium vap. acts in a similar way. In the one case, thorium sulphide, and, in the other case, thorium selenide are formed. With hydrogen sulphide at a red heat, the reaction proceeds slowly without incandescence. Hydrogen chloride attacks the carbide at a dull red heat with incandescence. Conc. acids have but little action, while dil. acids rapidly attack the carbide. When heated to about 500° in ammonia gas, thorium carbide furnishes hydrogen and thorium nitride. Fused potassium hydroxide, potassium chlorate, or potassium nitrate decomposes the carbide with incandescence. L. Troost said that if a mixture of thorium carbide and an excess of thorium oxide is heated in the electric arc furnace, it furnishes small metallic masses which do not alter in air. E. Kunheim confirmed many of these observations.

REFERENCES.

- ¹ J. J. Berzelius, *Gilbert's Ann.*, **36**, 89, 1810; *Pogg. Ann.*, **1**, 169, 1824; R. Flusin, *L'Ind. Chim.*, **9**, 391, 1922; *Chem. Trade Journ.*, **71**, 445, 1922; C. M. Despretz, *Compt. Rend.*, **29**, 720, 1849; P. Schützenberger and A. Colson, *ib.*, **92**, 1508, 1881; P. Schützenberger, *ib.*, **114**, 1080, 1892; A. Colson, *Bull. Soc. Chim.*, (2), **38**, 56, 1882; *Compt. Rend.*, **94**, 1316, 1856, 1882; M. Wundler and B. Jeanneret, *ib.*, **152**, 1770, 1911; H. Moissan, *ib.*, **117**, 423, 425, 1893; **120**, 1393, 1893; **125**, 839, 1897; **140**, 405, 1905; *Bull. Soc. Chim.*, (3), **13**, 972, 1895; *Le four électrique*, Paris, 1897; London, 263, 1904; *Ann. Chim. Phys.*, (7), **9**, 289, 1896; A. S. Russell, *Phys. Zeit.*, **13**, 62, 1912; K. Nischk, *Zeit. Elektrochem.*, **29**, 273, 1923; R. S. Marsden, *Proc. Roy. Soc.*, **11**, 20, 1881; A. Lampen, *Journ. Amer. Chem. Soc.*, **28**, 846, 1906; S. A. Tucker and A. Lampen, *ib.*, **28**, 853, 1906; C. F. Mabery, *ib.*, **22**, 706, 1900; J. A. Matthews, *School Mines Quart.*, **5**, 16, 1894; F. J. Tone, *Amer. Iron Age*, **63**, 5, 1899; *U.S. Pat. Nos.* 913324, 1909; 992608, 1013700, 1013701, 1911; 1028303, 1912; F. A. J. Fitzgerald, *Carborundum*, Halle a. S., 1904; *Met. Chem. Engg.*, **10**, 129, 1912; *Journ. Franklin Inst.*, **143**, 81, 1897; *U.S. Pat. Nos.* 650234, 650235, 1900; *Brit. Pat. No.* 5242, 1900; E. G. Acheson, *U.S. Pat. Nos.* 492767, 1893; 527826, 1894; 560291, 1896; 615648, 1898; 718891, 718892, 1903; 722792, 722793, 723631, 1903; *Brit. Pat. Nos.* 17911, 1892; 12221, 18339, 1894; 11473, 1895; *Chem. News*, **68**, 179, 1893; *Journ. Franklin Inst.*, **136**, 194, 279, 1893; **155**, 465, 1903; B. W. Frazier, *ib.*, **136**, 287, 1893; C. A. Kohn, *Journ. Soc. Chem. Ind.*, **16**, 863, 1897; P. E. Spielmann, *ib.*, **24**, 654, 1905; O. Mühlhäuser, *Zeit. anorg. Chem.*, **5**, 105, 1893; *Zeit. angew. Chem.*, **6**, 485, 1893; *Journ. Amer. Chem. Soc.*, **15**, 411, 1893; *Zeit. anal. Chem.*, **32**, 564, 1893; C. L. Burdick and E. A. Owen, *ib.*, **40**, 1749, 1918; R. Volkmann, *Oestern. Zeit. Berg. Hütt.*, **42**, 7, 115, 1894; J. W. Richards, *Trans. Amer. Elektrochem. Soc.*, **2**, 51, 1902; *Journ. Franklin Inst.*, **136**, 37, 116, 178, 1893; B. Neumann, *Chem. Ztg.*, **24**, 869, 1013, 1900; F. Bölling, *ib.*, **32**, 1104, 1908; R. S. Hutton and J. R. Beard, *Chem. News*, **92**, 51, 1905; *Trans. Faraday Soc.*, **1**, 1, 1905; R. S. Hutton and J. E. Petavel, *Phil. Trans.*, **207**, A, 421, 1908; W. G. Mixer, *Amer. Journ. Science*, (4), **24**, 130, 1906; G. F. Kunz, *ib.*, (3), **46**, 471, 1893; (4), **19**, 396, 1895; *Trans. Amer. Elektrochem. Soc.*, **12**, 46, 1907; E. Weintraub, *ib.*, **27**, 267, 1915; F. Becke, *Zeit. Kryst.*, **24**, 537, 1895; G. B. Negri, *Rév. Min. Crist. Ital.*, **29**, 33, 1903; A. Magnus, *Ann. Physik*, (4), **70**, 303, 1923; L. Franck, *Stahl Eisen*, **17**, 485, 1897; F. Luermann, *Zeit. Elektrochem.*, **3**, 113, 1896; N. Heym, *ib.*, **16**, 199, 1909; R. Amberg, *ib.*, **15**, 725, 1908; W. Nernst and F. Schwerns, *Sitzber. Akad. Berlin*, **355**, 1914; C. Schaefer and M. Thomas, *Zeit. Physik*, **12**, 330, 1923; G. Krell, *Zeit. angew. Chem.*, **17**, 591, 1904; O. Weigel, *Gött. Nachr.*, **264**, 320, 1915; W. W. Coblenz, *Investigations of Infra-red Spectra*, Washington, **4**, 94, 1906; **6**, 43, 1908; H. Espig, *Abhand. Sächs. Akad.*, **28**, 3, 1921; H. S. Roberts and L. H. Adams, *Amer. Min.*, **7**, 131, 1922; F. Luchsinger, *Phys. Zeit.*, **22**, 487, 1921; R. N. Pease, *Journ. Amer. Chem. Soc.*, **44**, 1497, 1922; M. L. Huggins, *ib.*, **44**, 1843, 1922; A. H. and E. H. Cowles, *U.S. Pat. No.* 319945, 1885; J. W. Richards, *Chem. News*, **75**, 278, 1897; E. Grüneisen, *Ber. deut. phys. Ges.*, **14**, 334, 1912; W. C. Röntgen, *Sitzber. Akad. München*, **381**, 1912; A. Dorsemeden, *German Pat.*, D.R.P. 128535, 1900; L. E. Muller and L. Baraduc-Muller, *ib.*, 210216, 1906; *Rev. Mét.*, **6**, 700, 1909; *Le carborundum*, Paris, 1908; *Proc. Soc. Ing. Civ.*, **245**, 1908; L. Weiss and T. Engelhardt, *Zeit. anorg. Chem.*, **65**, 95, 1909; G. Tamman, *ib.*, **115**, 141, 1921; J. N. Pring, *Journ. Chem. Soc.*, **93**, 2101, 1909; H. C. Greenwood, *ib.*, **93**, 1483, 1908; H. Hanemann, *Ueber die Reduktion von Silicium aus Tegelmater durch geschmolzenes kohlehaltiges Eisen*, Berlin, 1909; K. P. Gregorovitch, *Messenger Direction Gén. Ind. Mét. Russ.*, **1**, 26, 1921; J. H. Pratt, *Mineral Ind.*, **15**, 98, 1906; C. A. Boeck, *Trans. Amer. Cer. Soc.*, **14**, 477, 1912; E. Kohn-Abrest, *Compt. Rend.*, **150**, 169, 1910; H. M. Dowsett, *Radio. Rev.*, **2**, 582, 642, 1921; H. W. Gillet, *Journ. Phys. Chem.*, **15**, 213, 1911; L. E. Saunders, *Trans. Amer. Elektrochem. Soc.*, **22**, 87, 1912; H. N. Potter, *ib.*, **11**, 263, 1907; **12**, 202, 1907; W. R. Mott, *ib.*, **12**, 241, 1907; R. N. Pease, *Journ. Amer. Chem. Soc.*, **44**, 769, 1922; C. L. Burdick and E. A. Owen, *ib.*, **40**, 1749, 1918; E. Tiede and E. Birnbrauer, *Zeit. anorg. Chem.*, **87**, 129, 1914;

P. J. Holmquist, *Geol. För. Förh. Stockholm*, **44**, 485, 1922; T. W. Richards, W. N. Stull, and F. N. Brink, *The Compressibilities of the Elements and their Periodic Relations*, Washington, 40, 1907; F. Rinne, *Ber. Sächs. Ges. Wiss.*, **67**, 303, 1915; *Neues Jahrb. Min.*, ii, 20, 1897; S. Wologdine, *Electrochem. Met. Engg.*, **7**, 383, 1909; L. E. Jewell, *Mineral Ind.*, **16**, 153, 1907; H. E. Merwin, *Journ. Washington Acad. Sciences*, **7**, 445, 1917; G. W. Pierce and R. D. Evans, *Proc. Amer. Acad.*, **47**, 793, 1912; R. Amberg, *Zeit. Elektrochem.*, **15**, 725, 1909; O. S. Buckner, *Journ. Amer. Cer. Soc.*, **7**, 19, 1924; A. Haenig, *Emery and the Emery Industry*, London, 1912. I am indebted to Mr. F. A. J. Fitzgerald for the photographs from which Figs. 22 and 23 were made.

² L. Franck, *Stahl Eisen*, **17**, 449, 1897; K. Nischk, *Zeit. Elektrochem.*, **29**, 373, 1923; P. W. Shimer, *Proc. Roy. Soc.*, **42**, 89, 1887; *Chem. News*, **55**, 156, 1887; F. M. Becket, *U.S. Pat. No.* 910894, 1909; *Electrochem. Ind.*, **1**, 123, 1909; H. Moissan, *Bull. Soc. Chim.*, (3), **13**, 13, 959, 1895; *Ann. Chim. Phys.*, (7), **9**, 229, 1896; *Compt. Rend.*, **120**, 290, 1895; **125**, 839, 1897; W. R. Mott, *Trans. Amer. Electrochem. Soc.*, **34**, 255, 1918.

³ J. J. Berzelius, *Schweigger's Journ.*, **21**, 40, 1817; *Ann. Chim. Phys.*, (2), **29**, 337, 1825; *Pogg. Ann.*, **4**, 117, 1825; L. Troost, *Compt. Rend.*, **116**, 1227, 1893; H. Moissan and M. Lengfeld, *ib.*, **122**, 651, 1896; *Bull. Soc. Chim.*, (3), **15**, 1275, 1896; H. Moissan, *ib.*, (3), **11**, 863, 1893; *Compt. Rend.*, **116**, 1222, 1893; L. Renaux, *Contribution à l'étude de la zirconne*, Vincennes, 1900; F. P. Venable and R. O. Deitz, *Journ. Elisha Mitchell Scient. Soc.*, **38**, 74, 1922; C. R. Böhm, *Chem. Ztg.*, **31**, 985, 1907; E. Wedekind, *ib.*, **31**, 654, 1907; *Zeit. anorg. Chem.*, **33**, 81, 1903; W. R. Mott, *Trans. Amer. Electrochem. Soc.*, **34**, 255, 1918.

⁴ H. Moissan, *Compt. Rend.*, **125**, 840, 1898; J. F. Durand, *ib.*, **177**, 693, 1923; O. Ruff and B. Bergdahl, *Zeit. anorg. Chem.*, **106**, 76, 1919; L. M. Dennis, K. M. Tressler, and F. E. Hance, *Journ. Amer. Chem. Soc.*, **45**, 2033, 1923.

⁵ L. Troost, *Compt. Rend.*, **116**, 1229, 1893; H. Moissan, *ib.*, **119**, 16, 1894; P. Lebeau and A. Damiens, *ib.*, **156**, 1987, 1913; H. Moissan and A. Etard, *ib.*, **122**, 576, 1896; *Ann. Chim. Phys.*, (7), **12**, 427, 1897; E. Kunheim, *Ueber die Einwirkung des Lichtbogens auf Gemische von Sulfaten mit Kohle*, Berlin, 1900; W. R. Mott, *Trans. Amer. Electrochem. Soc.*, **34**, 255, 1918.

§ 19. Carbides of the Nitrogen, Vanadium, and Chromium Families of Elements

Cyanogen, C_2N_2 , and paracyanogen represent the binary combination of carbon and nitrogen, *nitrogen carbide* or *carbon nitride*; and hydrogen cyanide, HCN, is the hydrogen derivative.

E. de Mahler¹ found that the soln. of the halides of the metalloids react quantitatively with G. I. Iotsitsch's halides of magnesium carbide to form a carbide of the metalloid. For example, **phosphorus tricarbide**, PC_3 , or P_2C_6 , was formed as a yellowish-white amorphous precipitate, $2PCl_3 + 3C_2Mg_2I_2 = P_2C_6 + 3MgI_2 + 3MgCl_2$, insoluble in ordinary solvents, and not attacked by acids or alkalis. It takes fire when slightly heated and burns to phosphorus pentoxide without liberating carbon. The corresponding **arsenic tricarbide**, AsC_3 , or As_2C_6 , was similarly obtained as a brown amorphous precipitate with properties resembling the phosphorus compound. It explodes when warmed or rubbed, with the liberation of arsenic and carbon. H. Moissan failed to make *bismuth carbide* by the action of calcium carbide on the oxide. O. Ruff and B. Bergdahl found that arsenic and bismuth dissolve only traces of carbon; antimony dissolves 0.033 per cent. at 1055°, and 0.094 per cent. at 1327°. No *antimony carbide* has been made.

H. Moissan² prepared **vanadium carbide**, VC, by heating the oxide with carbon in the electric furnace. The crystalline mass has a sp. gr. 5.36; it scratches quartz, and fuses at a higher temp. than molybdenum. W. R. Mott gave 3900° for the b.p. of vanadium carbide at 760 mm. When heated to dull redness in oxygen the carbide burns with incandescence; it is not attacked by water at a dull red heat; it becomes incandescent in chlorine at 500°; it is not attacked by hydrogen chloride or sulphide at a dull red heat; it does not unite with sulphur vap. at the softening temp. of glass; and it is not attacked by hydrochloric or sulphuric acid. When heated to redness in nitrogen, or ammonia, the carbide forms the metal nitride; it is attacked in the cold by nitric acid; and when melted with potassium chlorate or nitrate.

A. Joly³ heated potassium columbate with sugar charcoal and dry potassium

carbonate in a carbon crucible to the m.p. of nickel, and purified the product by digesting it at ordinary temp. in conc. sulphuric acid; then at 50° – 60° with 1:1 sulphuric acid; and finally washing thoroughly with water. The dark-blue, acicular crystals had a composition corresponding with **columbium carbide**, CbC . He also obtained a carbide by similarly treating columbite from Greenland. H. Moissan observed that carbon is slowly absorbed by molten columbium, and he made the carbide by reducing columbium pentoxide with carbon in the electric furnace. Similar products were prepared by A. Larsson, and W. von Bolton. The product is very hard; scratches glass and quartz; and is not attacked by acids excepting sulphuric and hydrofluoric acids. W. R. Mott gave 4300° for the b.p. at 760 mm. A. Joly, H. Moissan, and W. von Bolton prepared **tantalum carbide**, TaC , in a similar manner. It resembles columbium carbide in its properties. W. R. Mott gave 5500° for the b.p. at 760 mm.

According to H. St. C. Deville,⁴ a compound of chromium and carbon is formed when chromium is reduced from the oxide by an excess of carbon; and H. St. C. Deville and H. Debray made observations to the same effect. W. Hempel and P. Rucktäschel made alloys of chromium with 2.23 per cent. of carbon. According to H. Moissan, chromium readily dissolves carbon at a high temp., forming two carbides, Cr_4C and Cr_3C_2 ; at still higher temp. relatively large amounts of carbon are dissolved, and these are rejected on cooling in the form of graphite lamellæ. He made **chromium ditritacarbide**, Cr_3C_2 , by heating in an electric furnace a mixture of chromium and an excess of carbon. The same product was obtained by heating a mixture of chromic oxide and calcium carbide. The lamellar or acicular crystals have a sp. gr. 6.47 and scratch quartz and topaz. The carbide is stable at a high temp. O. Ruff and T. Foehr gave 6.683 for the sp. gr. at $21.3^{\circ}/4^{\circ}$, and $1890 \pm 10^{\circ}$ for the m.p. W. R. Mott gave 3800° for the b.p. of chromium carbide at 760 mm. The carbide is not attacked by water at ordinary temp. or at 100° ; it is not attacked by conc. hydrochloric acid, but is slowly attacked by the dil. acid; it is not attacked by ordinary or fuming nitric acid or by aqua regia; it is slightly attacked by fused potassium hydroxide; and it is readily attacked by fused potassium nitrate. O. Ruff and T. Foehr found it is decomposed by chlorine at a red heat, and when molten it reduces magnesia, alumina, and zirconia. H. Moissan sometimes found reddish-brown needles on the surface of ingots of chromium, and in geodes in the middle of the mass. The composition corresponds with **chromium tetracarbide**, Cr_4C . The sp. gr. is 6.75. O. Ruff and T. Foehr observed no trace of Cr_4C in their study of the Cr-C system. O. Ruff studied the composition-temp. diagram for press. of 10 mm.; at 2270° , the mixture boils, and the vapour is wholly that of chromium; between 2050° and 2250° , the fusion is constant in composition and corresponds with Cr_3C_2 ; between 1875° and 2050° , graphite and carbon exist side by side as solid phases; and there is evidence of the existence of **chromium dipentitacarbide**, Cr_5C_2 , which O. Ruff and T. Foehr prepared as silvery crystals of sp. gr. 6.915 at $24.8^{\circ}/4^{\circ}$; and m.p. 1665° . It is not attacked by aqua regia, and is not decomposed on melting. K. Nischk studied the formation of chromium carbides, and claimed to have made *chromium hemiacarbide*, Cr_2C , but O. Ruff said that K. Nischk has mistaken this for the dipentitacarbide. O. Ruff and T. Foehr obtained evidence of the existence of Cr_2C , or Cr_4C_2 , but they could not isolate the compound from alloys with 23 per cent. carbon. When this alloy is treated with hot, 24 per cent. hydrochloric acid, and graphite is removed from the residue, the ditritacarbide remains. The portion of the f.p. curve which has been explored is indicated in Fig. 29, where the dotted lines are uncertain. C. R. Austin made some observations on this subject.

H. Debray⁵ obtained **molybdenum carbide** by heating molybdenum oxide with carbon. H. Moissan found that molybdenum dissolves carbon readily in the electric furnace and it forms two carbides. More carbon is dissolved at a higher temp., and this separates out as graphite on cooling. He prepared **molybdenum dicarbide**, MoC_2 , by heating molybdenum dioxide (250 grms.) for 10 mins. in an electric furnace

with an excess of carbon (50 grms.). The excess carbon is transformed into graphite. It is also made by heating a mixture of molybdenum dioxide and calcium carbide.

M. Guichard obtained the carbide by heating molybdenite in a carbon tube in an electric furnace. J. N. Pring and W. Fielding made the carbide by electrically heating a carbon rod above 1330° in an atm. of molybdenum pentachloride. The white mass has a crystalline fracture. It may be readily broken on the anvil, and well-defined prismatic crystals may be readily separated. Its sp. gr. is 8.9; and it readily scratches quartz and steel. W. R. Mott gave 4500° for the b.p. of molybdenum carbide. H. Moissan and K. Hoffmann prepared molybdenum carbide, MoC, by heating a mixture of molybdenum, carbon, and an excess of aluminium in an electric furnace. K. Nischk studied the formation of molybdenum carbide. The dark grey crystalline powder had a sp. gr. 8.48 at 20°, and a hardness between 7 and 8. The carbide is not attacked by hydrogen at a red heat, burns readily in fluorine, forming carbon tetrafluoride and molybdenum fluoride, is attacked at a red heat by chlorine, at a higher temp. by bromine, and is only superficially attacked at a still higher temp. by iodine; is readily attacked by a mixture of hydrogen chloride and bromine vap. and oxidized by heating in air or oxygen, by projecting on to fused potassium chlorate or nitrate, or by the action of cold nitric acid. It does not decompose water even at 500°-600°, is only slowly attacked by hydrochloric, hydrofluoric, or sulphuric acid, whilst it is unaltered by soln. of alkali hydroxides. M. Ornstein studied the catalytic activity of molybdenum carbide on mixtures of methane and carbon monoxide.

W. Riche⁶ observed that tungsten becomes carbonized when melted in a carbon crucible in the electric arc; and C. Matignon observed that at 2130°, a mixture of tungstic oxide and carbon forms tungsten and its carbide. W. Hempel and P. Rucktäschel prepared an alloy of tungsten with 3.3 per cent. of carbon. H. Moissan found that molten tungsten dissolves very large proportions of carbon, up to 18.8 per cent., and the soln. furnishes graphite on cooling. O. Ruff and R. Wunsch gave for the m.p. of soln. of carbon in tungsten :

C.	. . . 0.12	0.50	0.73	1.10	1.72	2.20	3.20	4.13 per cent.
M.p.	. . . 2706°	2692°	2706°	2664°	2806°	2585°	2682°	2682°

H. Moissan showed that if the tungsten or tungstic oxide be heated with an excess of carbon in the electric furnace, **tungsten hemicarbide**, W_2C , is formed as an iron-grey mass. He also made it by heating tungstic oxide with calcium carbide. J. N. Pring and W. Fielding prepared tungsten hemicarbide by electrically heating a carbon rod above 1500° in an atm. of tungsten hexachloride. M. R. Andrews made this carbide by heating electrically a tungsten filament in hydrocarbon vapour—naphthalene, benzene, toluene, anthracene, acetylene, methane, and coal gas. The existence of the hemicarbide and the monocarbide is shown by points of inflexion on the resistance curve of the filament. The carbide is decarbonized by heating the filament in vacuo at 2700° K., whereby carbon is volatilized without loss of tungsten. P. C. Rushen described the manufacture of tungsten carbide by working at a temp. higher than that required for the formation of the carbide, and removing the free graphite which separates during cooling by the addition of 7 to 8 per cent. molybdenum or one of its compounds. The molybdenum volatilizes completely and enables the free carbon to be readily removed. The sp. gr. of the tungsten hemicarbide is 16.06 at 18°. It is hard enough to scratch corundum. The properties approximate to those of the metal, but the carbide is more readily attacked by reagents.

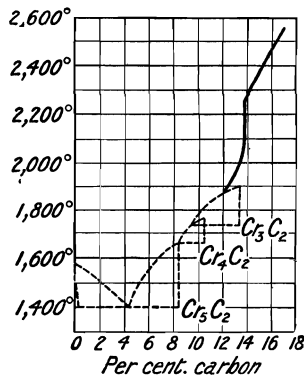

FIG. 29.—Part of Freezing-point Curve of the Chromium-Carbon System.

According to H. Moissan, it is not attacked by water; it burns in oxygen at about 500° producing tungstic oxide and carbon dioxide. In cold fluorine the carbide becomes incandescent; when heated to redness in nitrous oxide or nitrogen peroxide it burns with incandescence; it is but slowly attacked by conc. sulphuric or hydrochloric acid; but it is dissolved by boiling nitric acid: and it is oxidized with incandescence by fused potassium chlorate, or a mixture of fused potassium nitrate and carbonate. P. Williams found that if tungstic oxide, carbon, and a large excess of iron be heated combination occurs at a much lower temp. than when the iron is absent, and a **tungsten carbide**, WC, is formed. O. Ruff and R. Wunsch obtained this carbide by rapidly cooling a soln. of carbon in the liquid metal; if slowly cooled, decomposition with the separation of graphite occurs. M. R. Andrews made this carbide by electrically heating a tungsten filament in hydrocarbon vapour. This carbide is an iron-grey powder, consisting of microscopic, cubical crystals, which are harder than quartz and have a sp. gr. = 15·7 at 18°. A. Westgren and G. Phragmen examined the X-radiograms of iron tungsten carbide. When the carbide is strongly heated in a closed vessel, it melts and decomposes into graphite and the carbide W₂C, whilst in presence of air or oxygen, it slowly oxidizes with the formation of tungstic and carbonic anhydrides. It is attacked by fluorine in the cold with incandescence, but it is not acted on by chlorine, bromine, iodine, and the halogen acids. Sulphuric and nitric acids have but little action on the carbide, but it is readily oxidized by heating with potassium chlorate or nitrate. M. Ornstein studied the catalytic action of tungsten carbide on mixtures of methane and carbon monoxide. W. R. Mott gave 6000° for the b.p. of tungsten carbide at 760 mm. S. Ozawa studied the tungsten-iron carbides. O. Ruff and R. Wunsch heated tungsten in a carbon-tube electric furnace and found carbon to be absorbed, and **tungsten tritacarbide**, W₃C, to be formed. It melts above 2700°, and it does not form solid soln. with tungsten. M. R. Andrews obtained no evidence of this compound when a tungsten filament is heated in the vapour of hydrocarbons.

According to H. Moissan,⁷ the solubility of carbon in molten uranium approaches that of carbon in iron; and he prepared **uranium hemitricarbide**, U₂C₃, by heating an intimate mixture of uranium oxide (500 grms.) and sugar charcoal (50 grms.) in a carbon crucible in an electric furnace for 5–10 mins. When the emission of sparks has ceased, the liquid carbide is allowed to cool and solidify in the furnace. P. Lebeau's analyses bring the composition that of **uranium dicarbide**, UC₂, into line with the carbides of the rare earth elements. O. Ruff also agrees with this. The metallic-looking mass has the colour of bismuth, and a crystalline fracture. The crystals have a sp. gr. 11·28 at 18°. The compound scratches glass and quartz, but not corundum. When struck by a hard body, the carbide emits sparks, and when quickly powdered in a mortar, it takes fire and burns. The m.p. is above that of platinum. O. Ruff gave 2425° for the m.p. of the dicarbide; and E. Tiede and E. Birnbrauer, 2260°. W. R. Mott gave 4100° for the b.p. of uranium carbide at 760 mm. According to H. Moissan, uranium carbide burns brightly in oxygen at 370°, and when once started, the reaction is propagated throughout the whole mass—carbon dioxide and a dark violet uranium oxide are formed. With water at ordinary temp. there is a slow evolution of gas which is accelerated if the proportion of water be small or the temp. be raised—in the absence of air, a green hydroxide is formed, in the presence of air, the hydroxide is grey. The analyses of the gas gave

Per cent.	Acetylene	Ethylene	Methane	Hydrogen
	0·17–0·72	5·16–6·77	78·05–80·60	13·52–15·01

The total carbon in the gas is about two-thirds short of that in the carbide when the reaction is complete. The missing carbon is obtained as a mixture of liquid and solid hydrocarbons by extracting the aq. soln. with ether. P. Lebeau and A. Damiens obtained H₂, CH₄, C₂H₆, C₃H₈, and small amounts of C₄H₁₀, C₅H₁₂, C₂H₄, and acetylene homologues from uranium carbide and water. According to H. Moissan, uranium carbide, at a dull red heat, is decomposed by steam with

incandescence, forming a black oxide and carbon dioxide. In the cold, fluorine has no action, but if warm, the carbide burns with incandescence; chlorine attacks it with incandescence at 300°; bromine reacts at 390° with a slight glow; and iodine attacks it without incandescence below a red heat, forming an agglomerated mass slightly soluble in water, giving a green soln. At about 600°, hydrogen chloride reacts with the carbide with incandescence. Dil. hydrochloric, nitric, and sulphuric acids attack the carbide slowly in the cold, giving a soln. which is first green and then turns yellow: the conc. acids, excepting nitric acid, attack the carbide with difficulty in the cold, but the decomposition is rapid on heating. The carbide burns in sulphur vap. at the softening point of glass forming uranium and carbon sulphides, selenium acts at a lower temp., forming uranium selenide; at 600°, hydrogen sulphide forms uranium sulphide. The carbide is attacked by nitrogen at 1100°, forming some nitride. Uranium carbide becomes incandescent in nitric oxide at 370°, and a complex black residue is formed. At a red heat, ammonia forms some nitride. F. Haber found that when uranium carbide is heated in a mixture of nitrogen and hydrogen, uranium nitride is formed, and this acts catalytically on the mixed gases, forming ammonia. According to H. Moissan, uranium carbide reacts with fused potassium nitrate or chloride, becoming incandescent and forming alkali uranate.

REFERENCES.

- ¹ E. de Mahler, *Bull. Soc. Chim.*, (4), **29**, 1071, 1921; G. I. Iotsitsch, *Journ. Russ. Phys. Chem. Soc.*, **34**, 242, 1902; H. Moissan, *Compt. Rend.*, **125**, 839, 1897; O. Ruff and B. Bergdahl, *Zeit. anorg. Chem.*, **106**, 76, 1919.
- ² H. Moissan, *Compt. Rend.*, **116**, 1225, 1893; **122**, 1297, 1896; *Bull. Soc. Chim.*, (3), **11**, 857, 1894; (3), **15**, 1279, 1896; W. R. Mott, *Trans. Amer. Electrochem. Soc.*, **34**, 255, 1918.
- ³ A. Joly, *Ann. École Norm.*, (2), **6**, 147, 1877; W. von Bolton, *Zeit. Elektrochem.*, **11**, 47, 51, 1905; **13**, 145, 1907; A. Larsson, *Zeit. anorg. Chem.*, **12**, 206, 1896; H. Moissan, *Compt. Rend.*, **133**, 20, 1901; *Bull. Soc. Chim.*, (3), **27**, 431, 1902; W. R. Mott, *Trans. Amer. Electrochem. Soc.*, **34**, 255, 1918.
- ⁴ H. St. C. Deville, *Ann. Chim. Phys.*, (3), **46**, 182, 1856; H. St. C. Deville and H. Debray, *ib.*, (3), **56**, 408, 1859; O. Ruff and T. Foehr, *Zeit. anorg. Chem.*, **104**, 27, 1918; O. Ruff, *Zeit. Elektrochem.*, **24**, 157, 1918; **29**, 469, 1923; K. Nischk, *ib.*, **29**, 373, 1923; H. Moissan, *Compt. Rend.*, **116**, 349, 1893; **119**, 185, 1894; **125**, 841, 1897; *Bull. Soc. Chim.*, (3), **11**, 13, 1016, 1894; W. Hempel and P. Rucktäschel, *Zeit. angew. Chem.*, **17**, 296, 321, 1904; P. Rucktäschel, *Ueber einige Kohlenstoff- und Siliciummetalle, sowie eine neue, allgemeine anwendbare Methode zur Kohlenstoffbestimmung in Metallen*, Dresden, 1893; W. R. Mott, *Trans. Amer. Electrochem. Soc.*, **34**, 255, 1918; C. R. Austin, *Journ. Iron Steel Inst.*, **108**, ii, 235, 1923.
- ⁵ H. Moissan, *Bull. Soc. Chim.*, (3), **11**, 857, 1894; (3), **13**, 966, 1896; *Compt. Rend.*, **116**, 1225, 1893; **120**, 1320, 1895; **125**, 839, 1897; H. Moissan and K. Hoffmann, *ib.*, **138**, 1558, 1904; H. Debray, *ib.*, **46**, 1098, 1858; M. Guichard, *ib.*, **122**, 1270, 1896; M. Ornstein, *Ueber Wolfram-, Molybdän- und Eisencarbide und ihre katalytische Wirksamkeit bei der Zersetzung von Methan und Kohlenoxyd*, Berlin, 1913; J. N. Pring and R. W. Fielding, *Journ. Chem. Soc.*, **95**, 1497, 1909; W. R. Mott, *Trans. Amer. Electrochem. Soc.*, **34**, 255, 1918; K. Nischk, *Zeit. Elektrochem.*, **29**, 373, 1923.
- ⁶ W. Hempel and P. Rucktäschel, *Zeit. angew. Chem.*, **17**, 296, 321, 1904; *Ueber einige Kohlenstoff- und Siliciummetalle, sowie eine neue, allgemeine anwendbare Methode zur Kohlenstoffbestimmung in Metallen*, Dresden, 1893; M. R. Andrews, *Journ. Phys. Chem.*, **27**, 270, 1923; C. A. Matignon, *Compt. Rend.*, **177**, 1290, 1923; W. Riche, *Ann. Chim. Phys.*, (3), **50**, 12, 1857; H. Moissan, *ib.*, (7), **8**, 570, 1896; *Bull. Soc. Chim.*, (3), **11**, 1894; (3), **15**, 1289, 1896; *Compt. Rend.*, **116**, 1225, 1893; **123**, 15, 1896; P. Williams, *ib.*, **126**, 1722, 1898; **127**, 410, 1898; P. C. Rushen, *Brit. Pat. No.* 185313, 1921; O. Ruff and R. Wunsch, *Zeit. anorg. Chem.*, **85**, 292, 1914; J. N. Pring and W. Fielding, *Journ. Chem. Soc.*, **95**, 1497, 1909; W. R. Mott, *Trans. Amer. Electrochem. Soc.*, **34**, 255, 1918; M. Ornstein, *Ueber Wolfram-, Molybdän- und Eisencarbide und ihre katalytische Wirksamkeit bei der Zersetzung von Methan und Kohlenoxyd*, Berlin, 1913; A. Westgren and G. Phragmen, *Nature*, **113**, 122, 1924; S. Ozawa, *Science Rep. Tohoku Univ.*, **11**, 333, 1922.
- ⁷ H. Moissan, *Ann. Chim. Phys.*, (7), **9**, 232, 1896; *Bull. Soc. Chim.*, (3), **11**, 11, 1894; (3), **17**, 13, 266, 1897; *Compt. Rend.*, **116**, 347, 1394; **122**, 274, 1088, 1896; P. Lebeau, *ib.*, **152**, 955, 1911; P. Lebeau and A. Damiens, *ib.*, **156**, 1987, 1913; O. Ruff, *Ber.*, **43**, 1564, 1910; O. Ruff and A. Heinzelmann, *Zeit. anorg. Chem.*, **72**, 63, 1911; E. Tiede and E. Birnbrauer, *ib.*, **87**, 129, 1914; W. R. Mott, *Trans. Amer. Electrochem. Soc.*, **34**, 255, 1918; F. Haber, *German Pat.*, D.R.P. 229126, 1909

§ 20. The Carbides of Manganese and of the Iron and Platinum Family of Elements

The early workers on manganese—*e.g.* J. F. John,¹ etc.—noted that when the metal is prepared by reducing the oxide with charcoal, no carbon remains as a residue when the metal is dissolved in acid. S. Brown stated that when manganese thiocyanate is ignited it leaves a residue of *manganese carbide*, MnC ; and manganese cyanide, *manganese dicarbide*, MnC_2 , in colourless octahedra. Neither statement has been confirmed. J. F. John observed that if manganese is fused a long time in a charcoal crucible it dissolves carbon, and gives it up on cooling as *manganese graphite*. W. H. Wollaston stated that the graphite which separates from manganeseiferous cast iron is largely manganese carbide; but this statement has not been verified. A. Gautier and L. Hallopeau said that a little manganese carbide and sulphide are formed when manganese at 1400° is exposed to the vap. of carbon disulphide. W. Hempel and P. Rucktäschel obtained an alloy of manganese with 0.47 per cent. of carbon. A. Stadelcr said manganese does not take up carbon when heated with sugar charcoal for 12 hrs. at 1100° . H. F. Jüptner von Jonstorff found that a ferromanganese can dissolve 7.75 per cent. of carbon, forming $Mn_{3.2}C$. L. Troost and P. Hautefeuille, and H. le Chatelier found that molten manganese in a carbon crucible took up 6.7 per cent. of carbon, and gave, on cooling, a crystalline solid with a composition corresponding to **manganese tritacarbide**, Mn_3C . H. Moissan noted that manganese rapidly dissolves carbon at the temp. of the electric furnace. The manganese can be all removed by volatilization leaving behind crystals of graphite free from manganese. H. Moissan obtained the tritacarbide by heating a mixture of 200 grms. manganosomanganic oxide and 500 grms. of sugar charcoal in the electric tube-furnace at a temp. upward of 1500° . He also made it by heating the same oxide with calcium carbide; the impurities can be removed by treatment with cold water. L. M. Bullier made this carbide by the action of calcium carbide on molten manganese chloride. O. Ruff and W. Bormann found the solubility of carbon in manganese increases slowly from 1360° to 1525° , the

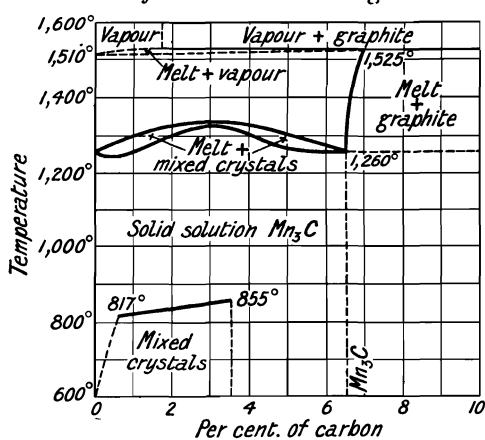

FIG. 30.—The Solubility of Carbon in Manganese.

b.p. of the soln. at 30 mm. press. The results are shown in Fig. 30. The manganese then contains 7.12 per cent. of carbon. Manganese boils at 1510° under the same press. The vap. of the alloy contains 1.94 per cent. of carbon. The whole of the carbon in the rapidly quenched alloy is combined as manganese tritacarbide and they form a continuous series of mixed crystals. According to A. Stadelcr, the mixed crystals range from 817° and 0.72 per cent. of carbon to 855° and 3.60 per cent. of carbon; they then break up into one series with almost pure manganese, and another series rich in carbide. There is evidence of the existence of a compound richer in carbon. The equilibrium diagram has been also studied by K. Kido. E. Müller and H. Barck found manganese carbide is formed when manganese is heated in an atm. of carbon dioxide. K. Nischk also studied the formation of this carbide.

Manganese tritacarbide forms a metallic-looking regulus with a brilliant crystalline fracture. A. Stadelcr said that crystals occur as glistening fibres and needles in alloys with over 3.32 per cent. of carbon, and as polyhedra in alloys with less

carbon. The crystals of manganese tritacarbide have been examined by E. Mallard, B. Rathke, and L. J. Spencer. All agree that they are pseudo-hexagonal prisms, and that they are isomorphous with iron tritacarbide. A. Stadelé said that the sp. gr. is 6.888; and H. Moissan, 6.89 at 17°. The mol. vol. is 25.70, the calculated value from the sp. gr. of the constituents is 29.80. The hardness is between that of talc and gypsum. G. Gin and M. Leleux found that manganese carbide dissociates at the high temp. of the electric furnace yielding the metal, which volatilizes, and graphite—*vide supra*. O. Ruff and E. Gersten found the molar heat of combustion to manganese and carbon dioxide to be 410.9 ± 2.0 Cals., and H. le Chatelier gave 412.4 Cals.; O. Ruff and E. Gersten found the heat of formation, $3\text{Mn} + \text{C} = \text{Mn}_3\text{C} + 12.9 \pm 2.14$ Cals.; and H. le Chatelier, 9.34 Cals. L. Troost and P. Hautefeuille's estimate of 191.4 Cals. is high. The last-named found that when the carbide is exposed to air for several days, it disintegrates. H. Moissan found that when gently heated in oxygen, manganese tritacarbide burns with incandescence. A. Stadelé found that alloys with over 3 per cent. of carbon fall to pieces at once in water, and even disintegrate spontaneously in closed vessels after a few weeks, "apparently owing to the evolution of retained gas." H. Moissan found that when treated with water, a mixture of methane and hydrogen, free from acetylene and ethylene, is evolved. The carbide with an excess of manganese gives a larger proportion of hydrogen: 56.43 per cent. of hydrogen and 43.75 per cent. of methane; while the carbides more or less rich in carbon, give 50.6 to 51.0 per cent. of methane, and 48.68 to 49.40 per cent. of hydrogen. The results are in agreement with $\text{Mn}_3\text{C} + 6\text{H}_2\text{O} = 3\text{Mn}(\text{OH})_2 + \text{CH}_4 + \text{H}_2$. No liquid or solid hydrocarbons were observed amongst the products of the action. M. Berthelot showed that if acetylene, ethylene, or ethane were produced, the thermal value of the reaction would be less than that observed. The reaction has also been studied by E. Wedekind. S. Cleoz found that ferromanganese carbides gave liquid hydrocarbons. The alloy with Fe, 56.5; Mn, 38.2; and C, 5.0, was acted on by water only at 300°; an alloy with Fe, 5.7; Mn, 85.4; Si, 1.2; C, 3.7, was readily attacked at ordinary temp., and it gave hydrogen, olefines, and solid and liquid hydrocarbons. H. Moissan showed that the carbide is attacked by fluorine in the cold with incandescence; chlorine decomposes it at a rather higher temp., and the incandescence which occurs at the commencement is not maintained; and hydrogen chloride below a red heat furnishes manganese chloride, and hydrogen containing a small quantity of gaseous hydrocarbons. Dil. acids readily attack manganese tritacarbide; with hydrochloric acid, liquid hydrocarbons are formed. These were studied by R. Schenck and co-workers. S. Cleoz found that a ferromanganese alloy containing 56.5 per cent. Fe, 38.2 per cent. Mn, and combined carbon 5 per cent. with dil. sulphuric acid, gave a gas containing large proportions of paraffins and olefines. R. Schenck and co-workers have examined the action of acids on the manganese carbides. H. Moissan found that ammonia reacts with manganese carbide yielding hydrogen and the metal nitride; the carbide burns when heated in nitrous oxide or nitrogen peroxide. L. Troost and P. Hautefeuille obtained manganese boride by heating manganese carbide with boric oxide; and cupromanganese or antimoniomanganese was obtained free from carbon by heating manganese carbide with copper or antimony. Graphite is formed in this reaction.

According to J. F. Durand, when calcium carbide is added to a soln. of manganous chloride, an impure **manganous carbide or acetylde**, MnC_2 , is formed.

In 1774, S. Rinman² showed that a drop of nitric acid simply whitens wrought iron, but leaves a black stain on steel. In 1781, T. Bergman showed that steel differs from wrought iron by containing 0.2 to 1.5 per cent. of plumbago. C. A. Vandermonde, C. L. Berthelot, and G. Monge said that iron unites chemically with carbon, but they gave no evidence of the formation of definite compounds. L. Clouet showed that steel is produced when the diamond is heated in contact with iron, but there was a complication in this experiment due to *l'aciération* of the iron by carbon derived from the furnace gases. This factor was eliminated by W. H. Pepys

in 1815 for the mixture of diamond dust and iron was heated by the "agency of a powerful electric battery." C. J. B. Karsten's experiments on the residues left after treating some varieties of iron containing carbon with acids have been taken to prove the existence of *iron tricarbide*, Fe_3C , but in his paper *Ueber die Carburete des Eisens*, 1846, he stated that "there is no satisfactory proof of the existence of such a carbide." P. Berthier found that the residues remaining after cast steel had been treated with aq. soln. of bromine or iodine correspond with *iron monocarbide*, FeC . The fact that some of the residues remaining after the treatment of steel with different solvents have a composition corresponding with definite carbides is to be regarded as a mere coincidence. Neither H. Caron nor C. Bromeis could satisfy himself that a definite carbide can be so obtained; and the former said that P. Berthier's carbide "was probably only a mixture of carbon and the metal, and the metal was mechanically protected by the carbon from the action of the solvent." Numerous solvents have been tried. T. Bergman, C. A. Vandermonde and co-workers, H. Behrens and R. van Linge, and F. Mylius and co-workers used dil. acids—hydrochloric, sulphuric, and acetic acids; P. Berthier, and H. Moissan used iodine or bromine water; C. Ullgren, F. Abel and W. H. Deering used a dil. soln. of chromic anhydride; W. Weyl, F. Osmond and J. Werth, J. O. Arnold and A. A. Read, F. Mylius and co-workers, and E. D. Campbell electrolyzed an electrolyte using the carbonized iron as positive electrode in order to isolate the carbides. A. Gurlt maintained that grey cast-iron contains *iron octitacarbide*, Fe_8C , mixed with graphite, and cast-iron with the maximum amount of carbon is *iron tetracarbide*, Fe_4C . He said that the latter is formed at a comparatively low temp., and at a higher temp. is resolved into the octitacarbide and graphite. There is, however, no satisfactory evidence of the existence of these chemical individuals. R. von Carnall reported "octahedral crystals" of a carbide in cast iron, and J. F. L. Hausmann "three-sided rectangular laminæ" in wrought iron. F. von Ittner noted the carbonaceous nature of the residues obtained by igniting the ferrocyanides. J. J. Berzelius claimed to have made *iron dicarbide*, FeC_2 , by distilling ammonium ferrocyanide in a retort. At first ammonium cyanide and water are evolved, and then nitrogen is given off. Towards the end of the operation, if the dicarbide is heated to redness, it seems to burn as if in oxygen gas. N. Ljubavin also prepared what he regarded as the dicarbide in a similar way. J. J. Berzelius also reported *iron sesquicarbide*, Fe_3C_3 , to be formed when Prussian blue is treated in a similar way. J. von Liebig and C. F. Gerhardt accepted the view that these residues are combinations of iron and carbon, but P. J. Robiquet considered them to be mixtures of carbon and slightly carbonized iron, for the residues are magnetic; they readily rust in moist air, and acids readily extract iron from them. A. Terreil, and A. Etard and G. Bémont studied the decomposition of potassium ferrocyanide by heat, but obtained no signs of the formation of iron carbides. J. F. Durand obtained impure **ferrous carbide or acetylide**, FeC_2 , by adding calcium carbide to a soln. of ferrous chloride.

In 1846, C. J. B. Karsten abandoned his earlier opinion that the residue left by the action of dil. sulphuric or hydrochloric acid on slowly cooled iron or steel is iron tricarbide, Fe_3C . F. Abel obtained **iron tritacarbide**, Fe_3C , by treating drillings of annealed steel with a soln. of potassium dichromate and sulphuric acid; and likewise also F. C. G. Müller, and A. Ledebur, who showed that with very dil. sulphuric acid at ordinary temp., and a current of inert gas to prevent access of air, the residue corresponds with iron tritacarbide. If hot acid be used, the carbide is decomposed, and hydrocarbons are evolved. S. Rinman called this residue *cement carbon* and H. M. Howe *cementite*. The latter term has been used in a general way for all the carbides which exist in iron and steel, even when these carbides contain manganese, chromium, etc. F. Osmond and J. Werth, and J. O. Arnold and A. A. Read employed an electrolytic method and obtained the carbide as a greyish-black powder, or in brilliant magnetic plates or scales. The general principle employed in isolating the tritacarbide depends on the fact that iron is more readily

attacked by reagents than the carbide, so that the latter remains after treating the iron with dil. mineral or organic acids, aq. iodine, chromic acid, etc. O. Werkmeister did not recommend the preparation of the carbide by the electrolytic process because there is formed so much brown carbonaceous matter which is difficult to separate. He made his specimens by melting a mixture of iron and sugar charcoal; or by the cementation of iron with sugar charcoal at a red heat; or by the cementation of iron at 600° with carbon monoxide. W. Hempel and P. Rucktäschel made a number of alloys in the electric furnace.

H. Moissan recommended the following process for preparing the carbide: Two pieces of iron, dipping in a soln. of 7 per cent. hydrochloric acid, were connected with the positive pole of two Bunsen's cells, and the two negative poles were connected with a carbon plate in the middle of the containing vessel. In 24 hrs. the pieces of iron were removed, and the adherent mixture of carbide and amorphous carbon brushed off. In another process, the pieces of iron together with a very dil. acid soln. and carbon were kept for some weeks in a glass tube drawn out at one end to keep out the air. $\frac{1}{2}N\text{-HNO}_3$ yields the carbide in a few hours. The carbide prepared by these methods contains liquid and solid hydrocarbons only slightly soluble in ether. The carbide may be purified by treatment with fuming nitric acid for 2 hrs. at 30°. The hydrocarbons and the free carbon are converted into soluble compounds and gases. The carbide is not attacked. The mixture is poured into an excess of water, the liquid decanted, and the residue washed with alcohol and ether, and dried at 100° in an atm. of carbon dioxide. The carbide should not be exposed to air in a moist state. The purifying action of nitric acid can be hastened by the addition of a little potassium chlorate. A boiling, 10 per cent. soln. of chromic acid can be allowed to act until the crystals of carbide assume a bright glistening appearance.

The carbon in iron and steel may therefore be present (i) in the form of *carbide carbon* or *combined carbon* such as occurs in cementite. The carbide carbon may be scattered through the metal in microscopic granules, or in relatively large distinct plates. The form of carbon which confers hardness to quenched steel is called *hardening carbon*, and is usually considered to be a form of carbide carbon. (ii) The carbon which separates as graphite during the solidification of highly carburized molten iron is called *graphite carbon* or simply graphite. I. Runge studied the velocity of diffusion of carbon in iron.

C. J. B. Karsten showed that iron completely sat. with carbon at the m.p. approximates in composition to *iron tetracarbide*, Fe_4C ; but of course this does not mean that the product is a chemical compound. J. B. J. D. Boussingault said the maximum solubility of carbon in iron is 4.1 per cent. and nearer Fe_5C than Fe_4C . Observations on the solubility of carbon in iron have been made by C. Benedicks, H. F. Jüptner von Jonstorff, H. Lutke, O. Ruff and O. Goecke, K. Thomsen, etc. According to R. Ruer and J. Biren, the solubility of graphite in molten Swedish iron increases as the temp. is raised from 1152° to 2700°. The solubility curve is linear from 1152° to 1700°; it then bends away from the conc. axis, slightly at first and then more strongly as the temp. increases. The conc. of the graphite eutectic at 1152° is 4.25 per cent. carbon, and that of the cementite eutectic at 1145° is 4.30 per cent. carbon. J. Percy estimated the maximum amount of carbon required to sat. molten iron to be 4.87 per cent. Equilibrium diagrams, developed later in connection with iron and steel, have been studied by H. W. B. Roozeboom, W. C. Roberts-Austen, H. le Chatelier, F. Osmond, H. Jüptner von Jonstorff, E. Heyn, R. Ruer and co-workers, C. Benedicks, F. Wüsu, N. Gutowsky, J. I. Wark, P. Goerens and co-workers, A. Smits, G. P. Royston, G. Charpy, O. Ruff, W. Wittorf, H. Hanemann, D. M. Levy, E. A. Sperry, etc. The results shown in Fig. 31 summarize the observations of O. Ruff and co-workers. A soln. of carbon in iron rapidly quenched contains the following percentage amounts of carbon in a combined state:

	1220°	1522°	1823°	2122°	2169°	2220°	2271°	2420°	2626°
C	4.58	5.46	6.59	7.51	8.21	9.60	8.97	8.09	7.45

These results give a portion of the curve *DHF*, Fig. 31; the solidus curve *A* is due to N. Gutowsky. The point *D* represents the conc. of a sat. soln. of carbon in

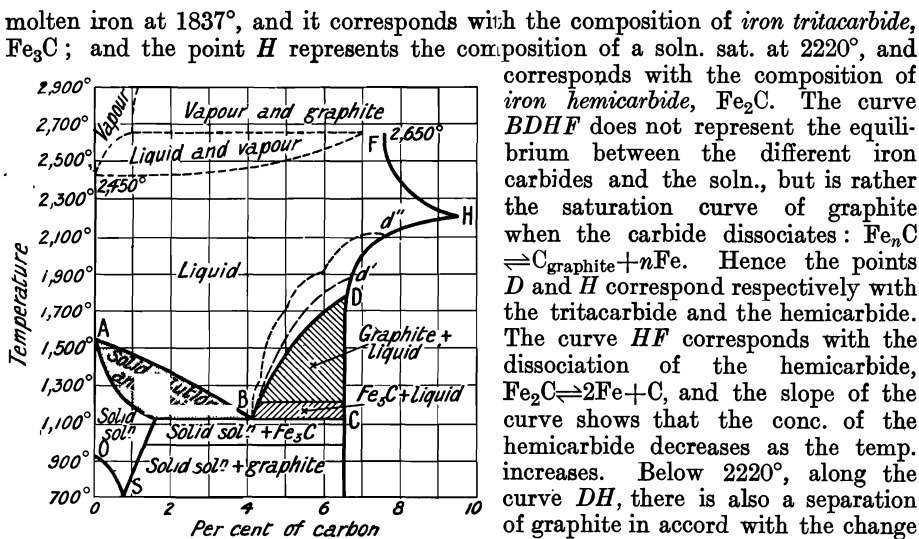

FIG. 31.—The Solubility of Carbon in Iron.

reduced, and attains a maximum at 1837°, or *D*. At lower temp., the conc. of the tritacarbide decreases since it decomposes into iron and carbon, $\text{Fe}_3\text{C} \rightleftharpoons 3\text{Fe} + \text{C}$. H. Hanemann gave the curve *Bd'*, and W. Wittorf the curve *Bd''*. From the existence of three breaks in his curve, W. Wittorf inferred the existence of the four carbides—iron tetracarbide, Fe_4C ; iron tritacarbide, Fe_3C ; iron monocarbide, FeC ; and iron dicarbide, FeC_2 , but these observations have not been confirmed, and the phenomena occurring in this region have been discussed by O. Ruff, A. Smits, H. Hanemann, E. Heyn, H. M. Howe, E. D. Campbell and co-workers, etc. R. Ruer and J. Biren studied the solubility of graphite in molten iron; and G. Tammann and K. Schönert, the diffusion of carbon in iron.

J. O. Arnold showed that almost all the carbon in steel containing 1.4 per cent. of carbon is in the free state after the steel has been heated for 72 hrs. at 1000°, and slowly cooled. It is therefore inferred that iron tritacarbide is unstable below 1000°. Nevertheless, this carbide has been repeatedly isolated. Hence, there is probably a range of temp. in the equilibrium diagram where this carbide can exist an indefinite length of time. This is represented diagrammatically in Fig. 30. G. B. Upton inferred that for the mixture with over one per cent. of carbon, iron hexitacarbide, Fe_6C , is first formed by the dissociation of the solid soln. of carbon in iron; and that this dissociates into the tritacarbide at about 800°, and this again into the hemicarbide, Fe_2C , at about 915°. The deduction was largely based on the breaks in H. C. H. Carpenter and B. F. E. Keeling's cooling curves. E. D. Campbell and M. B. Kennedy found the carbide obtained from annealed cast iron with a large proportion of carbon, varied in composition between the tritacarbide and hemicarbide, and hence inferred that both carbides have a real existence. The unsegregated eutectic with 0.89 per cent. of carbon is considered by J. O. Arnold to be an iron subcarbide, Fe_{24}C ; it may be a compound of cementite and iron, $\text{Fe}_3\text{C} \cdot 21\text{Fe}$; or simply a congealed soln. of the tritacarbide in iron. W. Wittorf claimed to have made iron dicarbide, FeC_2 , by cooling soln. of 6–10 per cent. of carbon in molten iron; crystallization begins at 2380°–2000°, furnishing a yellow carbide with a silvery reflex. It is slowly attacked by nitric acid, and when immersed in a dil. soln. of cupric sulphate, it acquires a film of copper. J. J. Berzelius' and N. Ljubavin's observations on the dicarbide have been previously described. L. Franck claimed to have made iron tetracarbide, FeC_4 , and iron ditritacarbide, Fe_3C_2 . A. Gautier and P. Clausmann found that two carbides—iron pentitacarbide,

Fe_5C , and *iron dodeciticarbide*, Fe_{12}C —produced when carbon monoxide is passed over red-hot iron. The former dissolves more quickly in sulphuric acid, and the less quickly dissolved residue is the pentitacarbide. They also obtained the dodeciticarbide by the action of a mixture of carbon monoxide and hydrogen on heated ferrosiferrous oxide. The reaction between sulphuric acid and the dodeciticarbide is symbolized: $\text{Fe}_{12}\text{C} + 12\text{H}_2\text{SO}_4 = 12\text{FeSO}_4 + \text{CH}_4 + 10\text{H}_2$; the pentitacarbide gives methane, hydrogen, and other hydrocarbons when digested with sulphuric acid. In no case is there sufficient evidence to establish a belief in the real existence of these carbides. K. Nischk studied the formation of iron carbides.

J. O. Arnold and A. A. Read obtained iron tritacarbide in the form of microscopic granules, or small plates, and, added F. Mylius and co-workers, in small needles. The plates of iron tritacarbide or cementite often occur in patches alternating with ferrite—i.e. iron—to form well-marked microscopic striæ giving the metal the peculiar mother-of-pearl effect which led H. C. Sorby to call it the *pearly constituent of steel*, and H. M. Howe, *pearlite*. The rhombic prismatic crystals are pseudo-hexagonal and isomorphous with manganese carbide. They have been examined by C. F. Rammelsberg, N. T. Belaiev, E. Hussak, O. Sjöström, D. J. McAdam, E. Weinschenk, J. Fahrenhorst, G. Florence, E. Mallard, L. J. Spencer, and C. Hlawatsch. G. Tammann discussed the space-lattice of iron tetracarbide; and A. Westgren and G. Phragmen showed that cementite has probably four mols. of Fe_3C per unit cell so that the chemical mol. is Fe_3C , and the crystal mol. Fe_{12}C_4 . F. Wever found the **X-radiogram** corresponds with a rhombohedron space-lattice whose lengths of side are $a=4.481 \times 10^{-8}$, $b=5.034 \times 10^{-8}$, and $c=6.708 \times 10^{-8}$ cm. respectively; and that four molecules are involved. The values of these constants at temp. above the magnetic transformation point show that the magnetic changes in iron carbide are similar to those of iron and nickel, and are not due to the lattice arrangement; the new rhombohedral lattice has sides of length $a=4.52 \times 10^{-8}$, $b=5.08 \times 10^{-8}$, and $c=6.77 \times 10^{-8}$ cm. A. M. Portevin studied the **microscopic structure** of the iron carbides in iron and steel. A complex carbide, $(\text{Fe}, \text{Co}, \text{Ni})_3\text{C}$, occurs in distorted crystals in meteorites. L. J. Spencer said the crystals are probably cubic. It has been studied by E. Cohen and E. Wienschenk, and called *cohenite*. It is tin-white in colour and becomes bronze-yellow on exposure to air. The sp. gr. is 6.977, and the hardness is 5.5 to 6.0. F. C. Thompson discussed the etching of the alloy steels to bring out the structure of the cementite. E. D. Campbell found the **specific gravity** of the crystals to be 6.944 at 23°; H. Moissan gave 7.07 at 16°; O. Werkmeister, 7.17 at 15°; and O. Ruff and E. Gersten, 7.396 at 21°. The mol. vol., according to O. Ruff and E. Gersten, is 24.34. The crystals are hard and brittle, but not so hard as glass; O. Ruff and E. Gersten represented the **hardness** as 3.2 to 3.3 on Moh's scale.

P. Oberhoffer and A. Meuthen calculate the **specific heat** to be 0.1581. H. Moissan found that if highly purified iron be fused with sugar carbon in an electric furnace, the fused mass becomes more and more viscid as the temp. rises until the containing vessel can be turned upside down without loss. On cooling, the metal soon becomes as mobile as water. On solidification, the metal has all the characteristics of grey cast iron. About one per cent. of the carbon is combined, and the mass contains numerous crystals of graphite—*vide* synthesis of diamonds. F. Mylius and co-workers, E. H. Saniter, and J. O. Arnold showed that the tritacarbide is decomposed below 1000°. A. Anthon tried to measure the **melting point**, and said that it is about 1300°; O. Ruff's diagram, Fig. 29, places it at 1837°. O. Werkmeister studied the thermal behaviour of the carbide; the results of O. Ruff have been previously discussed. A. Meuthen measured the **specific heat** of various iron-carbon alloys. L. Troost and P. Hautefeuille gave a small negative value for the **heat of formation** of the carbide: $3\text{Fe} + \text{C} = \text{Fe}_3\text{C} - 20.48$ Cals., and hence stated that the absorption of heat in the formation of iron carbide indicated that the carbon is simply dissolved by the iron. According to O. Ruff and E. Gersten, the **heat of oxidation** is $\text{Fe}_3\text{C} + 3\text{O}_2 = \text{Fe}_3\text{O}_4 + \text{CO}_2 + 377.2 \pm 0.1$ Cal.; and since $\text{C}_{\text{graphite}} + \text{O}_2$

$=\text{CO}_2 + 94.8$ Cals., $\text{Fe} + \text{O} = \text{FeO} + 60.4 \pm 1.8$ Cals., and $3\text{Fe} + 2\text{O}_2 = \text{Fe}_3\text{O}_4 + 267.1 \pm 0.2$ Cal., it follows that $3\text{Fe} + \text{C} = \text{Fe}_3\text{C} - 15.3 \pm 0.2$ Cal. E. D. Campbell gave $+8.494$ Cals. for the heat of formation; R. Schenck and co-workers, $+8.940$ Cals. J. Jermiloff, $+2.27$ Cals.; and A. Baykoff said that the heat of formation has no perceptible value. From these discordant estimates not much more can be inferred than that the heat of formation has a small negative value. A. Meuthen measured the heat content of iron-carbon alloys containing between 0.06 and 4.03 per cent. of carbon, between 650° and 920° . The heat of transformation of pearlite, containing 0.9 per cent. carbon, is 15.9 Cals. per gram, and that of β - into α -iron, 5.6 Cals. per gram. One gram of α -iron separating from solid soln. develops 14.1 Cals. The horizontal line in the equilibrium diagram, which represents the transformation of β - into α -iron, does not extend beyond 0.32 per cent. carbon. Within the limits 650° - 700° , the heat-content of the alloys is not directly proportional to the carbon conc., but the curve consists of two straight lines, intersecting at a considerable angle at a conc. just above that of pearlite.

F. Mylius and co-workers found that dry iron tritacarbide is not altered by exposure to dry **air**, but some specimens are pyrophoric. H. Moissan found that the carbide is not attacked in the cold by dry **oxygen**, but when heated to 150° in oxygen, it becomes incandescent. If heated to 100° in a stream of hydrogen, and then exposed to air, iron tritacarbide glows and forms iron oxide; the same phenomenon occurs occasionally when it is dried at a low temp. in carbon dioxide or nitrogen. In moist air, H. Moissan, and F. Mylius and co-workers noted that iron carbide is rapidly oxidized, it furnishes a brown powder consisting of a mixture of ferric oxide, carbon, and the carbhydrate, $\text{C}_{12}\text{H}_6\text{O}_3$, described by A. Bourgeois and P. Schützenberger, and J. A. Zabudsky. F. Mylius and co-workers say that this carbhydrate is most easily obtained by the action of a soln. of ammonium sulphate in dil. sulphuric acid on the carbide. According to H. Moissan, water or an aq. soln. of sodium chloride or magnesium chloride does not attack iron carbide when contained in a sealed tube at 0° to 150° . F. Mylius and co-workers found that the carbide is only slightly decomposed when heated with **water** at 145° ; but at 400° - 450° , in a current of steam and nitrogen, it increases 13 per cent. in weight in half an hour, and yields a combustible gas mostly hydrogen, and a black residue which is a mixture of carbon and iron oxide. At a red heat, in steam for half an hour, it yields ferrosferric oxide, and a gaseous mixture of hydrogen and carbon mono- and di-oxides.

According to H. Moissan, the carbide becomes incandescent in **sulphur** vap. at 500° ; it burns in **chlorine** below 100° with incandescence; it behaves similarly with **bromine** at about 100° ; and it reacts with **iodine** vap. only at a red heat, without incandescence. **Hydrogen chloride** acts at 600° , forming iron chloride, and hydrogen mixed with some hydrocarbons. All the dil. **acids** attack the metal more readily than the carbide; complete decomposition occurs only on boiling the acid. F. Mylius and co-workers found that the carbide is not appreciably affected by very dil. acids, but with $\frac{1}{10}$ N-**hydrochloric acid** at 80° a distinct evolution of hydrogen is observed. It is very gradually dissolved by normal hydrochloric acid, and 1 gm., after remaining sealed up in a vacuum tube for 10 days with normal hydrochloric acid, gave only 2.5 c.c. of a combustible gas. In conc. hydrochloric acid, it is easily soluble, and leaves only a minute residue which is insoluble in water, but easily soluble in alcohol or ether. In no case did the authors observe the formation of amorphous, intermediate carbonaceous products during the dissolution. An analysis of the gas evolved on dissolving the carbide in hydrochloric acid gave 92.3 per cent. H, 6.3 per cent. hydrocarbons, 1.4 per cent. N. The ratio of the combined hydrogen to the carbon very nearly approaches that required for a member of the series $\text{C}_n\text{H}_{2n+2}$, and the density of the hydrocarbon is about the same as that of pentane. E. D. Campbell found that when heated with conc. hydrochloric acid, a mixture of hydrogen with sat. and unsaturated hydrocarbons is formed. Three-fifths of the carbon furnishes gaseous derivatives—a gram of the carbide gave approxi-

mately 250 c.c. of gas containing 15–17 per cent. of hydrocarbons, methane, ethane, and butane; and 9–10 per cent. of olefines—principally butylene and dibutylene. H. Moissan found that with dil. hydrochloric acid in a sealed tube, the gas contained 13.7 per cent. of methane and 86.3 per cent. of hydrogen; and with conc. hydrochloric acid, 26.5 per cent. of methane and 73.5 per cent. of hydrogen.

The peculiar nature of the gases evolved when iron carbide, or the solid soln. of the carbide in rapidly quenched steel or pig-iron, is treated with an acid, has been the subject of many investigations. R. Boyle, for instance, referred to “the belching up of copious and stinking fumes” when steel filings are treated with an acid; and J. Priestley mentioned the fetid odour of the inflammable air given off when iron is treated with acid. In 1786, S. Rinman measured the relative vol. of gas given off by different kinds of iron and steel under these conditions, and noted that the gas evolved from steel contains more carbon than that obtained from soft iron. C. A. Vandermonde and co-workers noted the carbonaceous nature of the residue obtained when iron is treated with acids. In 1799, J. L. Proust observed that the vessel in which the iron has been dissolved has a film of a fatty substance which is not cleaned off by water, but it is removed by alcohol, which dissolves the fatty substance and acquires the same odour as the evolved gas. C. J. B. Karsten showed that when steel is treated with dil. acid, “an offensive kind of hydrogen containing carbon is evolved, and a brown solid is produced.” M. Berthelot in 1858, C. E. Schafhäütl in 1859, J. E. Reynolds in 1861, H. Hahn in 1864, and O. Werkmeister in 1910, established the presence of olefines in these gases ranging from C_2 to C_{18} , but H. Hahn said that he was never able to prove the presence of acetylene in the gas. S. Cleoz found that when 200 kgrms. of cast iron were treated with sulphuric acid, he obtained (i) 640 grms. of oily hydrocarbons condensed in the first wash-bottles; (ii) 2780 grms. of brominated ethylenic compounds; (iii) 532 grms. of hydrocarbons homologous with methane (paraffins), isolated by sulphuric acid; (iv) 3800 grms. of insoluble residue; and (v) 408 grms. of an oily body, extracted from the insoluble residue by alcohol, and separated from the alcohol by water. The paraffins, decanted from the sulphuric acid, washed with water, and dried, first with potassium hydrate, and then with sodium, were fractionally distilled; the liquid began to boil at 155° giving the following fractions:

155°–160°	178°–180°	195°–198°	215°–220°	234°–238°	258°	276°–280°
$C_{10}H_{22}$	$C_{11}H_{24}$	$C_{12}H_{26}$	$C_{13}H_{28}$	$C_{14}H_{30}$	$C_{15}H_{32}$	$C_{16}H_{34}$

The fact that with some steels and iron carbide all can be dissolved without residue in non-oxidizing acids leaves no room for doubting that the carbon must have been evolved as hydrocarbon. The evidence is not all concordant. H. Hahn said all the products are ethylenic, while S. Cleoz, and H. Moissan found a large proportion of methane derivatives. The dark brown carbonaceous residue has been studied by A. Bourgeois and P. Schützenberger, and by J. A. Zabudsky. R. Schenck and co-workers studied the action of acids on the iron carbides.

C. Schols studied the effect of silicon on the solubility of iron carbide in iron. H. Jüptner von Jonstorff attempted to determine the mol. wt. of iron tritacarbide in soln. of iron; but the conclusions were not convincing. E. D. Campbell assumed that iron carbide has the constitutional formula:

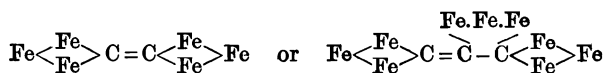

and he represents the main reaction of acids by the equation $(\text{Fe}_3\text{C})_2 + 12\text{HCl} = \text{C}_2\text{H}_4 + 4\text{H}_2 + 6\text{FeCl}_2$; and supposes that the ethylene condenses with itself or with hydrogen, forming more complex products. The reaction in H. Moissan's experiment can be symbolized, $\text{Fe}_3\text{C} + 6\text{HCl} = 3\text{FeCl}_2 + \text{CH}_4 + \text{H}_2$; or $(\text{Fe}_3\text{C})_3 + 18\text{HCl} = 9\text{FeCl}_2 + 6\text{H}_2 + \text{C}_3\text{H}_6$ (or $\text{CH}_4 + \text{C}_2\text{H}_2$).

Cold fuming **nitric acid**, said H. Moissan, has no action on iron tritacarbide even when finely divided or when in contact with a platinum wire; but the carbide is attacked by the boiling acid; and decomposition rapidly occurs if water be added. C. J. B. Karsten found that when nitric acid or aqua regia acts on rapidly cooled steel or pig iron, no hydrocarbon oil is formed, but a reddish-brown carbonaceous substance, studied by P. Schützenberger and A. Bourgeois, and by J. A. Zabudsky, is formed; it is considered to be a *nitrographitic acid*, $\text{C}_{22}\text{H}_{17}(\text{NO}_2)\text{O}_{11}$. The soln.

of cementite in nitric acid of sp. gr. 1.18 to 1.20 furnishes a brown soln., and the intensity of the colour, under constant conditions, is proportional to the amount of carbide in the soln. This principle is applied in the determination of carbon by the so-called *colour test of V. Eggertz*. Here the colour of a given amount of a soln. of a steel with an unknown amount of carbon is compared with that produced by the same weight of a steel with a known amount of carbon prepared under similar conditions. The catalytic activity of iron on methane is conditioned, according to M. Ornstein, by the formation of unstable iron carbide.

A number of complex iron carbides have been made. Thus, J. O. Arnold and A. A. Read³ reported **ferromanganese carbides**, Fe_7MnC_3 and $\text{Fe}_{17}\text{MnC}_8$; H. Behrens and A. R. van Linge, **ferrochromium carbides**, FeCr_3C_2 and $\text{Fe}_7\text{Cr}_2\text{C}_3$; A. Carnot and E. Goutal, $\text{Fe}_9\text{Cr}_3\text{C}_5$ and $\text{Fe}_3\text{Cr}_3\text{C}_7$; and P. Williams, $\text{Fe}_9\text{Cr}_6\text{C}_7$. P. Williams reported **ferromolybdenum carbide**, $\text{Fe}_3\text{Mo}_2\text{C}_2$; and **ferrotungsten carbide**, $\text{Fe}_6\text{W}_6\text{C}_5$. S. Ozawa made a partial study of the ternary system: C—W—Fe. A. Westgren and G. Phragmen examined the X-radiogram of the tungsten iron carbide. H. Moissan and A. Kouznetoff investigated **chromotungsten carbide**, $\text{Cr}_3\text{W}_2\text{C}_7$. J. de Benneville reported **ferrochromomolybdenum carbide**, $\text{Fe}_7\text{Cr}_6\text{Mo}_8\text{C}_4$; and **ferrochromotungsten carbide**, $\text{Fe}_7\text{Cr}_6\text{W}_6\text{C}_4$; and J. W. Weitzenkorn, the **ferrochromotungstovanadium carbide**, $\text{VCr}_2\text{W}_{20}\text{Fe}_2\text{C}_9$, in ferrotungsten.

R. Vogel and G. Tammann studied the ternary system with iron and up to about 10 per cent. each of boron and carbon. The area *AVL*, Fig. 32, represents the

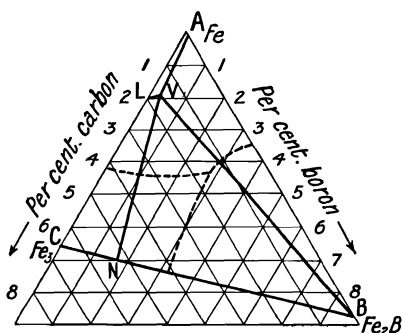

FIG. 32.—Ternary System Fe—C—B.

ternary system with γ -iron mixed crystals, when the maximum carbon and boron contents are respectively 1.9 and 0.3 per cent. Here *LVNC* represents the ternary γ -iron mixed crystals, *LV*, when the carbon content is about 1.9 per cent. and the boron content up to 0.3 per cent.; and *CN*, cementite mixed crystals with carbon between 5.3 and 6.6 per cent., and boron up to 1.7 per cent. *AVB* represents ternary γ -iron mixed crystals *AV* with carbon up to 1.9 per cent., and boron between 0.08 and 0.3 per cent.; *B* represents iron boride, Fe_2B , corresponding with 91.2 per cent. of iron, and 8.3 per cent. of carbon. *VNB* includes the carbon and boron sat. ternary mixed crystals *V*, with carbon about 1.9 per cent. and boron 0.3 per cent. *N* represents the boron sat. cementite mixed crystals with about 5.3 per cent. of carbon, and 1.7 per cent. of boron. The dotted curves in Fig. 32 represent the eutectic lines. They found the eutectics in the binary systems, Fe—C, 1150° ; Fe—B, 1165° ; Fe_3C — Fe_3B , 1155° ; and Fe— Fe_3C , 1100° . They also measured the hardness of the ternary alloys.

P. Berthier⁴ noticed that when nickel is prepared by reducing the oxide, etc., with carbon, the product is carboniferous nickel. W. Ross, and R. Irving found that the button of metal obtained by reducing nickel oxide with carbon is often covered with soft, crystalline, steel-grey scales which was called *nickel-graphite*. This was probably graphite which separated during the cooling of the soln. of carbon in molten nickel. When nickel is heated in contact with carbon, the metal is carbonized in an analogous manner to iron, but, added H. Moissan, rather less carbon is dissolved. Thus, J. W. Döbereiner mentioned that when fused on charcoal before the oxyhydrogen blowpipe the metal takes up carbon and becomes brittle, but it remains magnetic. R. Tupputi, O. L. Erdmann, and J. B. J. D. Boussingault also made observations on the change produced in the properties of the metal when it is alloyed with carbon. L. Mond and co-workers noticed that nickel takes up carbon when heated with carbon monoxide—*vide* nickel carbonyl. R. Schenck and F. Zimmerman noted the action of carbon monoxide on nickel when studying the system $2\text{CO} \rightleftharpoons \text{CO}_2 + \text{C}$. L. Mond and

C. Langer studied the action of nickel on hydrocarbons. J. J. Berzelius did not prove that the magnetic residue obtained on igniting nickel cyanide is a definite carbide. According to L. Pebal, nickel obtained by the reduction of the oxide by charcoal at a white heat, may contain as much as 1.4 per cent. of carbon. On treatment with acids the metal dissolves, leaving a residue of graphite. One specimen of the nickel containing 0.98 per cent. of graphite, and 0.28 per cent. of combined carbon, was melted in a graphite crucible, and rapidly cooled in an iron mould, and the product analyzed. It now contained 0.78 per cent. of graphite and 0.61 per cent. of combined carbon. W. Hempel prepared nickel alloys containing 1.71, 2.14, 4.69, and 6.25 per cent. of carbon respectively. K. Nischk studied the formation of nickel carbide. In the nickel alloys, the carbon is in the state of

mechanical admixture, whilst in the iron and cobalt alloys a large proportion of the carbon is chemically combined with the metal. The solubility of carbon in nickel has been measured by O. Ruff and co-workers, and by K. Friedrich and A. Leroux. The results shown in Fig. 33 are due to O. Ruff and W. Bormann. The eutectic is at 1311° and 2.2 per cent. of carbon. The solubility of carbon in nickel increases with temp. up to 6.3 per cent. at 2075°, and then remains constant to the b.p. 2490° at 30 mm. press., only 0.28 per cent. of carbon is in the vap. at the b.p. Pure nickel is taken to boil at 2340°. The constant boiling mixture is assumed to contain **nickel tritacarbide**, Ni_3C . E. Gersten found -2095 cal. for the heat of formation of a gram of this carbide, or $3\text{Ni} + \text{C} = \text{Ni}_3\text{C} - 394$ Cals. E. Briner and R. Senglet saw that nickel tritacarbide is formed at about 2100°, and it dissociates into its elements rapidly at 1600°, and slowly at 900°, so that the reaction $3\text{Ni} + \text{C} \rightleftharpoons \text{Ni}_3\text{C}$ is reversible. The reaction between the solid elements is endothermal, and between the gaseous elements, exothermal. J. F. Durand obtained impure **nickelous carbide or acetylide**, NiC_2 , by the action of calcium carbide on a soln. of nickelous chloride.

L. Thompson⁵ made a carboniferous cobalt by heating for six hours a mixture of cobalt oxide and alkali tartrate in a crucible lined with carbon. The product was very hard and brittle, and had a sp. gr. of 8.4; it was magnetic and contained 4 per cent. of carbon. K. Nischk studied the formation of cobalt carbides. R. Schenck and F. Zimmermann studied the action of cobalt on carbon monoxide; L. Mond and co-workers observed that no carbonyl is formed by heating cobalt with carbon monoxide; L. Mond and C. Langer noted the action of hydrocarbons on nickel and cobalt. H. N. Warren, and H. Moissan noted the formation of plates of graphite when a soln. of carbon in cobalt is cooled. W. Hempel and P. Rucktäschel prepared cobalt alloys with 0.44, 0.62, 1.87, 1.88, 2.65, 2.80, 6.47, and 8.45 per cent. of carbon respectively, and they noted that a large proportion of the cobalt is chemically combined. G. Boecker, and O. Ruff and F. Keilig studied the cobalt-carbon system. The results by the former are summarized in Fig. 34. There is a eutectic at 1300° with 2.4 per cent. of cobalt; and the solubility increases with temp. up to 7.3 per cent. carbon at 2415°, the b.p. of the system at 30 mm. press. The curve has a point of inflexion corresponding with the formation of **cobalt tritacarbide**, Co_3C . The sat. vap. has 2 per cent. of carbon. The b.p. of pure cobalt is 2415° at 30 mm.

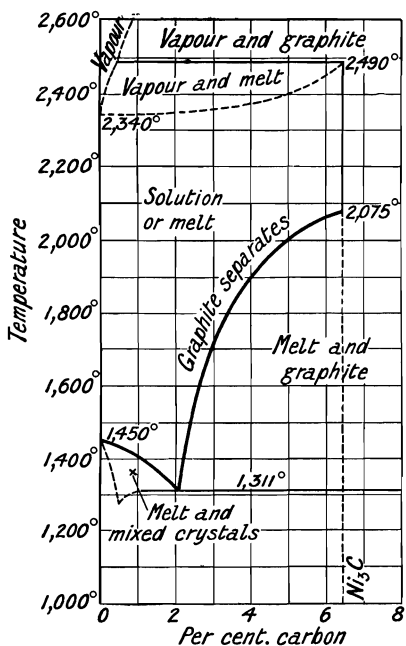

Fig. 33.—The Solubility of Carbon in Nickel.

press. The carbide decomposes so quickly on cooling that even in rapidly quenched specimens it is absent. J. F. Durand obtained impure **cobaltous carbide or acetylide**, CoC_2 , by the action of calcium carbide on a soln. of cobaltous chloride.

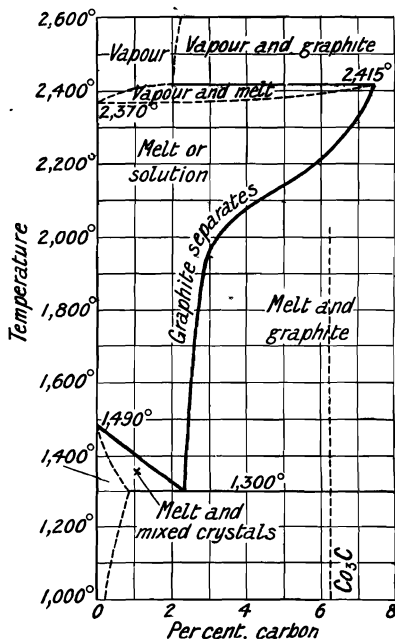

FIG. 34.—The Solubility of Carbon in Cobalt.

The union of platinum with carbon when the two elements are heated has been discussed by J. B. J. D. Boussingault,⁶ A. Rémont, J. J. Berzelius, W. Hempel, P. Rucktäschel, R. Chenevix and H. V. Collet-Descotils, P. Schützenberger and A. Colson, C. G. Memminger, N. W. Fischer, V. Meyer, C. L. Berthollet, etc. In using platinum vessels, direct contact with hot smoking flames, the reducing zones of hydrocarbon flames, charcoal, coal, coke, etc., must be avoided, since the platinum becomes brittle under these conditions owing to the dissolution of carbon by the metal. A. B. Griffiths said that platinum fuses at a comparatively low temp. when in contact with carbon. P. Schützenberger claimed to have made **platinum dicarbide**, PtC_2 , by heating platinum in a stream of cyanogen; and W. C. Zeise, by heating mesityl chloroplatinite, $[\text{Pt}(\text{C}_6\text{H}_{10}\text{O})\text{Cl}_2]_2$, to redness, and cooling out of contact with air. J. J. Berzelius also mentioned **iridium carbide** to be formed by heating iridium in contact with carbon.

REFERENCES.

- J. F. John, *Gehlen's Journ.*, **3**, 452, 1807; **4**, 436, 1807; W. H. Wollaston, *Phil. Trans*, **106**, 281, 1816; S. Brown, *B.A. Rep.*, **39**, 1839; *Journ. prakt. Chem.*, (1), **17**, 492, 1839; H. F. Jüptner von Jonstorff, *Oester Zeit. Berg. Hütt.*, **44**, 447, 1896; L. Troost and P. Hautefeuille, *Compt. Rend.*, **80**, 964, 1875; *Ann. Chim. Phys.*, (5), **9**, 60, 65, 69, 1876; H. Moissan, *ib.*, (7), **9**, 286, 320, 1896; *Bull. Soc. Chim.*, (3), **11**, 13, 1894; (3), **15**, 1266, 1896; *Le four électrique*, Paris, 1897; London, **239**, 1904; *Compt. Rend.*, **116**, 349, 1893; **122**, 421, 1896; **127**, 840, 1897; A. Gautier and L. Hallopeau, *ib.*, **108**, 806, 1889; H. le Chatelier, *ib.*, **122**, 80, 1896; S. Cloez, *ib.*, **85**, 1003, 1878; **86**, 1248, 1878; M. Berthelot, *ib.*, **132**, 281, 1901; J. F. Durand, *ib.*, **177**, 693, 1923; G. Gin and M. Leleux, *ib.*, **126**, 749, 1898; E. Wedekind, *Allgem. Chem. Ztg.*, **4**, 543, 1904; L. M. Bullier, *German Pat.*, *D.R.P.* 118177, 1899; L. J. Spencer, *Min. Mag.*, **13**, 296, 1903; O. Ruff, *Ber.*, **45**, 3139, 1912; O. Ruff and W. Bormann, *Zeit. anorg. Chem.*, **88**, 365, 1914; O. Ruff, W. Bormann, and F. Keilig, *Forsch. Geb. Ing.*, **209**, 1918; R. Schenck, J. Giessen, and F. Walter, *Zeit. anorg. Chem.*, **127**, 101, 1923; **129**, 108, 1923; W. Bormann, *Ueber die Temperaturkonzentrationsdiagramme des Kohlenstoffs mit Mangan, Nickel, und Eisen*, Danzig, 1914; O. Ruff and E. Gersten, *Ber.*, **46**, 400, 1913; K. Kido, *Science Rep. Tohoku Univ.*, **9**, 305, 1920; K. Nischk, *Zeit. Elektrochem.*, **29**, 373, 1923; E. Gersten, *Ueber die Karbide des Eisens, Mangans, und Nickels*, Freiberg, 1912; A. Stadelcr, *Met.*, **5**, 260, 1908; B. Rathke, *Liebig's Ann.*, **260**, 326, 1890; E. Mallard, *Bull. Soc. Min.*, **2**, 47, 1878; W. Hempel and P. Rucktäschel, *Zeit. angew. Chem.*, **17**, 296, 301, 1904; P. Rucktäschel, *Ueber einige Kohlenstoff- und Silicium-metalle, sowie eine neue, allgemeine anwendbare Methode zur Kohlenstoffbestimmung in Metallen*, Dresden, 1893; E. Müller and H. Barck, *Zeit. anorg. Chem.*, **129**, 321, 1923.
- S. Rinman, *Journ. prakt. Chem.*, (1), **100**, 33, 1867; *Försök til Järnets historia med tillämpning för slögder och handverk*, Stockholm, 1782; *Kongl. Vet. Akad.*, **35**, 3, 1774; *Crell's Ann.*, **1**, 276, 1786; T. Bergman, *De analysi ferri*, Upsala, 1783; C. A. Vandermonde, C. L. Berthollet, and G. Monge, *Mém. Acad.*, **132**, 1786; R. A. F. de Réaumur, *ib.*, **273**, 1826; A. L. Lavoisier, *ib.*, **553**, 1782; L. Clouet, *Ann. Chim. Phys.*, (1), **31**, 328, 1799; W. H. Pepsy, *Phil. Trans.*, **105**, 371, 1815; J. Priestley, *ib.*, **75**, 279, 1785; *Experiments and Observations on different kinds of Air*, Birmingham, **1**, 56, 1774; C. J. B. Karsten, *Gilbert's Ann.*, **52**, 429, 1816; *Sitzber. Akad. Berlin*, **51**, 1846; *Journ. prakt. Chem.*, (1), **40**, 229, 1847; C. E. Schafhäutl, *ib.*, (1), **76**, 272, 1859; P. Berthier, *Ann. Mines*, (3), **3**, 229, 1818; *Traité des essais par la voie sèche*, Liège, **2**, 199, 1847; M. Berthelot, *Ann. Chim. Phys.*, (3), **53**, 116, 1853; J. B. J. D. Boussingault, *ib.*, (4), **19**, 78, 1870;

- Compt. Rend.*, **80**. 850, 1875; J. F. Durand, *ib.*, **177**. 693, 1923; I. Runge, *Zeit. anorg. Chem.*, **115**, 293, 1921; K. Nischk, *Zeit. Elektrochem.*, **29**. 373, 1923; J. Stodart and M. Faraday, *Phil. Trans.*, **112**. 253, 1822; *Quart. Journ. Science*, **9**. 319, 1920; J. L. Proust, *Journ. Phys.*, **49**. 155, 1799; C. Schöls, *Met.*, **7**. 644, 1910; W. Weyl, *Liebig's Ann.*, **114**. 507, 1861; C. Ullgren, *ib.*, **124**. 59, 1862; H. Hahn, *ib.*, **129**. 57, 1864; B. Rathke, *ib.*, **260**. 333, 1890; C. Bromeis, *ib.*, **43**. 241, 1842; *B. A. Rep.*, **34**. 1842; J. E. Reynolds, *Chem. News*, **4**. 4, 1861; P. Schützenberger and A. Bourgeois, *Compt. Rend.*, **80**. 911, 1875; L. Troost and P. Hautefeuille, *ib.*, **80**. 964, 1875; S. Cloez, *ib.*, **85**. 1003, 1877; **86**. 1248, 1878; F. Osmond and J. Werthe, *Ann. Mines*, **(8)**, **8**. 5, 1885; *Compt. Rend.*, **100**. 450, 1885; **104**. 1800, 1887; F. Osmond, *ib.*, **100**. 1228, 1885; H. Caron, *ib.*, **1**. 43, 1835; **56**. 44, 1863; G. Charpy, *ib.*, **141**. 948, 1905; H. Moissan, *ib.*, **124**. 716, 1897; *Bull. Soc. Chim.*, **(3)**, **17**. 540, 1897; F. Abel, *Proc. Inst. Mech. Eng.*, **30**, 1885; F. Abel and W. H. Deering, *Journ. Chem. Soc.*, **43**. 303, 1883; J. O. Arnold and A. A. Read, *ib.*, **65**. 788, 1894; J. O. Arnold, *Journ. Iron Steel Inst.*, **45**. 314, 1894; H. Behrens and R. van Linge, *Zeit. anal. Chem.*, **33**. 513, 1894; F. C. G. Müller, *Stahl Eisen*, **8**. 291, 1888; **9**. 634, 1891; **14**. 849, 1894; A. Ledebur, *ib.*, **8**. 42, 1888; *Journ. Iron Steel Inst.*, **45**. 53, 1893; F. Mylius, F. Förster, and G. Schöne, *Ber.*, **29**. 2991, 1896; *Zeit. anorg. Chem.*, **13**. 38, 1896; R. Schenck, J. Giesen, and F. Walter, *ib.*, **127**. 101, 1923; **129**. 108, 1923. E. D. Campbell, *Journ. Iron Steel Inst.*, **59**. 217, 1901; *Amer. Chem. Journ.*, **18**. 836, 1896; **20**. 78, 1898; **22**. 205, 1899; E. D. Campbell and P. Thomson, *ib.*, **19**. 754, 1897; E. D. Campbell and M. B. Kennedy, *Metallographist*, **6**. 139, 1903; *Journ. Iron and Steel Inst.*, **62**. 288, 1902; A. Gurli, *Chem. Gaz.*, **14**. 230, 255, 1856; *Der Bergwerksfreund*, **18**. 325, 341, 357, 373, 1855; R. von Carnall, *Zeit. deut. geol. Ges.*, **10**. 230, 1858; J. F. L. Hausmann, *Gött. Nachr.*, **109**, 1858; F. C. Thompson, *Metal Ind.*, **22**. 675, 1923; N. T. Belaiev, *Rev. Mét.*, **19**. 593, 1922; J. von Liebig and C. F. Gerhardt, *Traité de chimie organique*, Paris, **1**, 157, 1840; **1**. 326, 1853; P. J. Robiquet, *Ann. Chim. Phys.*, **(2)**, **12**. 277, 1819; **(2)**, **17**. 196, 1821; H. M. Howe, *The Metallurgy of Steel*, New York, 1892; *Ferrum*, **11**. 170, 193, 1914; H. C. Sorby, *B. A. Rep.*, **189**, 1864; **139**, 1865; *Journ. Iron Steel Inst.*, **29**. 140, 1886; **33**. 255, 1888; A. Meuthen, *Ferrum*, **10**. 1, 1912; A. Westgren and G. Phragmen, *Journ. Iron Steel Inst.*, **103**. i, 303, 1921; W. C. Roberts-Austen, *Proc. Inst. Mech. Eng.*, **70**, 90, 1897; **169**, 1899; *Proc. Roy. Soc.*, **63**. 447, 1898; J. Percy, *Iron and Steel*, London, **102**, 1864; P. H. Berggren, *Bull. Amer. Inst. Min. Eng.*, **913**, 1914; H. Hanemann, *Stahl Eisen*, **31**. 333, 1911; O. Ruff, W. Bormann, F. Keilig, *Forsch. Geb. Ing.*, **209**, 1918; O. Ruff and O. Goecke, *Zeit. anorg. Chem.*, **84**. 1, 1914; *Met.*, **8**. 417, 1911; O. Ruff, *ib.*, **8**. 456, 497, 1911; *Ferrum*, **12**. 121, 1915; *Ber.*, **45**. 3143, 1912; *Zeit. Elektrochem.*, **18**. 761, 1912; **19**. 133, 1913; *Zeit. anorg. Chem.*, **89**. 39, 1914; O. Ruff and W. Bormann, *ib.*, **88**. 397, 1914; W. Wittorf, *ib.*, **79**. 1, 1913; *Journ. Russ. Phys. Chem. Soc.*, **43**. 1613, 1911; O. Ruff and E. Gersten, *Ber.*, **45**. 63, 1912; **46**. 394, 1913; E. Gersten, *Über die Karbide des Eisens, Mangans, und Nickels*, Freiberg, 1912; N. Gutowsky, *Met.*, **6**. 731, 737, 1909; H. Lutke, *ib.*, **7**. 268, 1910; P. Goerens and H. Meyer, *ib.*, **7**. 307, 1910; P. Goerens, *ib.*, **4**. 137, 1907; **6**. 514, 1909; H. W. B. Roozeboom, *Zeit. phys. Chem.*, **34**. 437, 1900; *Journ. Iron Steel Inst.*, **59**. 311, 1900; *Zeit. Elektrochem.*, **10**. 489, 1904; *Metallographist*, **3**. 293, 1900; G. Tammann, *Zeit. anorg. Chem.*, **116**. 206, 1921; G. Tammann and K. Schönert, *ib.*, **22**. 27, 1922; L. Franck, *Stahl Eisen*, **15**. 585, 1896; H. F. Jiptner von Jonstorff, *ib.*, **19**. 237, 278, 1899; **20**. 1205, 1269, 1900; **21**. 795, 1901; *Journ. Iron Steel Inst.*, **53**. 248, 1897; **54**. 243, 1898; **55**. 204, 1899; **57**. 219, 1900; *Oester. Zeit. Berg. Hütt.*, **44**. 211, 447, 1896; *Kohlenstoffformen im Eisen*, Stuttgart, 1896; G. B. Upton, *Journ. Phys. Chem.*, **12**. 507, 1908; R. Ruer and G. Klesper, *Ferrum*, **11**. 254, 1913; R. Ruer and K. Kaneko, *ib.*, **11**. 33, 1913; R. Ruer and K. Fick, *ib.*, **11**. 39, 1913; R. Ruer and P. Goerens, *ib.*, **13**. 1, 1915; R. Ruer and N. Ilijn, *Met.*, **8**. 97, 1911; J. I. Wark, *ib.*, **8**. 704, 1911; F. Wüst, *Met.*, **5**. 86, 1908; **6**. 3, 1900; *Zeit. Elektrochem.*, **15**. 577, 1909; A. Smits, *ib.*, **18**. 51, 362, 816, 1081, 1912; G. Florence, *Amer. Journ. Science*, **(4)**, **49**. 105, 1895; E. H. Saniter, *Journ. Iron Steel Inst.*, **53**. 115, 1897; O. Sjöström, *Sitzber. Akad. Berlin*, **1037**, 1042, 1897; *Medd. Grönland*, **15**. 293, 1897; *Ann. Nat. Hist. Museum Wien*, **12**. 56, 1897; J. Fahrenhorst, *ib.*, **16**. 374, 1901; C. Benedicks, *Recherches physiques et physico-chimiques sur l'acier au carbone*, Upsala, 1904; *Zeit. phys. Chem.*, **52**. 733, 1905; F. Osmond, *Contributions à l'étude des alliages*, Paris, 277, 1901; *Metallogrist*, **4**. 150, 1901; G. P. Royston, *Journ. Iron Steel Inst.*, **52**. 166, 1897; H. C. H. Carpenter and B. F. E. Keeling, *ib.*, **67**. 224, 1904; H. le Chatelier, *ib.*, **61**. 40, 1902; *Metallographist*, **3**. 290, 1900; **4**. 161, 1901; R. Boyle, *On the difficulty of preserving flame without air*, London, 1672; E. Heyn, *Zeit. Elektrochem.*, **10**. 491, 1904; *Mitt. Materialprüf. Technik*, **(1)**, **24**. 29, 1906; **(2)**, **2**. 1, 1912; E. A. Sperry, *Met. Chem. Engg.*, **13**. 469, 1915; D. M. Levy, *ib.*, **8**. 531, 1910; *Journ. Iron Steel Inst.*, **77**. 403, 1910; N. Ljubavin, *Journ. Russ. Phys. Chem. Soc.*, **44**. 609, 1912; J. A. Zabudsky, *ib.*, **14**. 3, 111, 1882; R. Schenk, H. Semiller, and V. Falcke, *Ber.*, **40**. 1704, 1907; J. Jermiloff, *Journ. Russ. Metal. Soc.*, **357**, 1911; E. Hussak, *Arch. Muses Nat. Rio de Janeiro*, **9**. 130, 1896; J. F. Weyer, *Mitt. Kaiser Wilhelm Inst.*, **4**. 67, 1922; R. Ruer and J. Biren, *Zeit. anorg. Chem.*, **113**. 98, 1920; D. J. McAdam, *Chem. Met. Engg.*, **25**. 623, 1921; A. M. Portevin, *Journ. Iron Steel Inst.*, **106**. ii. 93, 1923; A. Bourgeois and P. Schützenberger, *Compt. Rend.*, **80**. 911, 1875; A. Terreil, *ib.*, **82**. 455, 1876; A. Étard and G. Bémont, *ib.*, **99**. 972, 1884; **100**. 108, 1885; A. Gautier and P. Clausmann, *ib.*, **151**. 16, 355, 1910; J. J. Berzelius, *Ann. Chim. Phys.*, **(2)**, **14**. 190, 1820; **(2)**, **15**. 245, 1820; *Traité de chimie*, Paris, **3**. 270, 1831; **2**. 692, 1846; L. J. Spencer, *Min. Mag.*, **13**. 296, 1903; C. F. Rammelsberg, *Sitzber. Akad. Berlin*, **190**, 1863; E. Mallard, *Bull. Soc. Min.*, **2**. 47, 1878; C. Hlawatsch, *Tschernak's Mitt.*, **(2)**, **22**. 497, 1903; P. Oberhoffer and A. Meuthen, *Met.*, **5**. 173, 1908; A. Baykoff, *Rev. Mét.*, **8**. 316, 1911;

A. Meuthen, *Kalorimetrische Untersuchung des Systems Eisen-Kohlenstoff*, Halle a. S., 1912; M. Ornstein, *Ueber Wolfram-, Molybdän-, und Eisencarbid und ihre katalytische Wirksamkeit bei der Zersetzung von Methan- und Kohlenoxyd*, Berlin, 1913; A. Anton, *Beiträge zur Kenntnis der Eisenkohlenstoffverbindungen und der Konstitution des Kohlenstoffeisens*, Berlin, 1905; O. Werkmeister, *Ueber Bildung und Zerfall von Eisenkarbid und die gasförmigen Produkte der Einwirkung von Mineralsäuren*, München, 1910; E. Cohen and E. Weinschenk, *Ann. Nat. Hist. Museum Wien*, 6, 131, 1891; E. Weinschenk, *ib.*, 4, 94, 1889; V. Eggertz, *Jernkontorets Ann.*, 17, 49, 1862; 36, 301, 1881; K. Thomsen, *Beiträge zur Kenntnis der Löslichkeit des Graphits in festen Eisen und der Schmelzerscheinungen des grauen Roheisens*, Berlin, 1910; W. Hempel and P. Rucktäschel, *Zeit. angew. Chem.*, 17, 296, 1904; P. Rucktäschel, *Ueber einige Kohlenstoff- und Siliciummetalle, sowie eine neue, allgemeine anwendbare Methode zur Kohlenstoffbestimmung in Metallen*, Dresden, 1893; F. von Ittner, *Beiträge zur Geschichte der Blausäure mit Versuchen über ihre Verbindungen und Wirkungen auf den thierischen Organismus*, Freyburg, 1809; E. D. Campbell, W. L. Fink, and J. F. Ross, *Journ. Iron Steel Inst.*, 108, ii, 173, 1923.

³ J. O. Arnold and A. A. Read, *Journ. Chem. Soc.*, 68, 788, 1894; J. de Benneville, *Journ. Amer. Chem. Soc.*, 17, 791, 1895; H. Behrens and A. R. van Linge, *Zeit. anal. Chem.*, 33, 513, 1894; A. Carnot and E. Goutal, *Compt. Rend.*, 126, 1240, 1898; P. Williams, *ib.*, 127, 410, 483, 1898; H. Moissan and A. Kouznetzoff, *ib.*, 137, 292, 1903; R. Vogel and G. Tammann, *Zeit. anorg. Chem.*, 123, 225, 1922; A. Westgren and G. Phragmen, *Nature*, 113, 122, 1924; S. Ozawa, *Science Rep. Tohoku Univ.*, 11, 333, 1922; J. W. Weitzkorn, *Chem. Met. Engg.*, 26, 504, 1922.

⁴ L. l'Hôte, *Ann. Chim. Anal. App.*, 10, 253, 1905; L. Mond, C. Langer, and F. Quincke, *Chem. News*, 62, 97, 1890; L. Mond and C. Langer, *German Pat., D.R.P. 51572*, 1889; J. W. Döbereiner, *Trommsdorff's Journ. Pharm.*, 4, 293, 1797; R. Tupputi, *Ann. Chim. Phys.*, (2), 78, 133, 1840; (2), 79, 153, 1841; J. F. Durand, *Compt. Rend.*, 177, 693, 1923; O. L. Erdmann, *Ueber das Nickel und Weisskupper*, Leipzig, 1827; *Journ. prakt. Chem.*, (1), 7, 249, 1836; J. B. J. D. Bous-singault, *Chem. Ind.*, 130, 1878; R. Irving, *Ann. Phil.*, 18, 149, 1821; W. Ross, *ib.*, 18, 62, 1821; L. Pebal, *Liebig's Ann.*, 233, 160, 1886; W. Hempel and P. Rucktäschel, *Zeit. angew. Chem.*, 17, 296, 321, 1904; P. Rucktäschel, *Ueber einige Kohlenstoff- und Siliciummetalle, sowie eine neue, allgemeine anwendbare Methode zur Kohlenstoffbestimmung in Metallen*, Dresden, 1893; O. Ruff and W. Bormann, *Zeit. anorg. Chem.*, 83, 386, 1914; O. Ruff, W. Bormann, and F. Keilig, *Forsch. Geb. Ing.*, 209, 1918; O. Ruff and W. Martin, *Met.*, 9, 143, 1912; O. Ruff and E. Gerstein, *ib.*, 9, 145, 1912; E. Gerstein, *Ueber die Karbid des Eisens, Mangans und Nickels*, Friburg, 1912; K. Friedrich and A. Leroux, *ib.*, 7, 10, 1910; P. Berthier, *Ann. Chim. Phys.*, (2), 13, 52, 1820; (2), 25, 94, 1824; (2), 33, 49, 1826; J. J. Berzelius, *ib.*, (2), 14, 190, 1820; H. Moissan, *Compt. Rend.*, 116, 349, 1893; *Bull. Soc. Chim.*, (3), 11, 13, 1894; K. Nischk, *Zeit. Elektrochem.*, 29, 373, 1923; R. Schenk and F. Zimmermann, *Ber.*, 36, 1231, 3663, 1903; E. Briner and R. Senglet, *Journ. Chim. Phys.*, 13, 351, 1915.

⁵ O. Ruff and F. Keilig, *Zeit. anorg. Chem.*, 83, 410, 1914; O. Ruff, W. Bormann, and F. Keilig, *Forsch. Geb. Ing.*, 209, 1918; G. Boecker, *Met.*, 9, 296, 1912; W. Hempel and P. Rucktäschel, *Zeit. angew. Chem.*, 17, 296, 321, 1904; P. Rucktäschel, *Ueber einige Kohlenstoff- und Siliciummetalle, sowie eine neue, allgemeine anwendbare Methode zur Kohlenstoffbestimmung in Metallen*, Dresden, 1893; L. Thompson, *London Journ. Arts Sciences*, (4), 17, 65, 1863; *Le Technologiste*, 24, 337, 1863; R. Schenk and F. Zimmermann, *Ber.*, 36, 1231, 3663, 1903; H. N. Warren, *Chem. News*, 59, 29, 1889; L. Mond, C. Langer, and F. Quincke, *ib.*, 62, 97, 1890; L. Mond and C. Langer, *German Pat., D.R.P. 51572*, 1889; J. F. Durand, *Compt. Rend.*, 177, 693, 1923; K. Nischk, *Zeit. Elektrochem.*, 29, 373, 1921.

⁶ J. J. Berzelius, *Traité de chimie*, Paris, 2, 425, 1846; A. Rémont, *Bull. Soc. Chim.*, (2), 35, 486, 1881; P. Schützenberger, *ib.*, (2), 35, 355, 1881; R. Chenevix and H. V. Collet-Descotils, *Ann. Chim. Phys.*, (1), 67, 89, 1808; C. L. Berthollet, *ib.*, (1), 67, 88, 1808; J. B. J. D. Bous-singault, *ib.*, (2), 16, 5, 1821; (5), 8, 175, 1876; *Compt. Rend.*, 82, 591, 1876; A. Colson, *ib.*, 93, 1074, 1881; 94, 26, 1882; P. Schützenberger and A. Colson, *ib.*, 94, 26, 1882; W. Hempel and P. Rucktäschel, *Zeit. angew. Chem.*, 17, 322, 1904; P. Rucktäschel, *Ueber einige Kohlenstoff- und Siliciummetalle, sowie eine neue, allgemeine anwendbare Methode zur Kohlenstoffbestimmung in Metallen*, Dresden, 1892; A. B. Griffiths, *Chem. News*, 51, 97, 1885; V. Meyer, *ib.*, 73, 235, 1896; W. C. Zeise, *Journ. prakt. Chem.*, (1), 20, 209, 1841; *Ann. Chim. Phys.*, (2), 72, 132, 1839; C. G. Memminger, *Amer. Chem. Journ.*, 7, 172, 1886; N. W. Fischer, *Karsten's Archiv.*, 14, 145, 1828.

§ 21. The Carbon Oxides and Suboxides

The complete oxidation or combustion of carbon furnishes the gas **carbon dioxide**, CO₂. There is an intermediate product in which the carbon is only partially oxidized or burnt. This product, **carbon monoxide**, CO, is itself a combustible gas which burns to form the end-product, carbon dioxide. If carbon be quadrivalent and oxygen bivalent, the constitutional formula of carbon dioxide is O=C=O; but there is then a difficulty with carbon monoxide, and it can be assumed that two

of the four valencies in carbon are latent or dormant. With this hypothesis, H. Staudinger and E. Anthes¹ tried unsuccessfully to prepare the polymer $O=C=C=O$ by the action of metals on oxalyl bromide, $Br.OC.CO.Br$. With zinc and mercury, carbon monoxide is evolved, showing that if a polymer be capable of a separate existence, it is not stable at ordinary temp. With potassium or the liquid alloy of potassium and sodium, **potassium oxycarbide**, $KO.C:C.OK$, is formed. This compound explodes violently when subject to vibration. It can also be assumed, with J. A. R. Newlands, that carbon is bivalent, forming $C=O$, and $C < \begin{smallmatrix} O \\ O \end{smallmatrix}$; or, with J. H. Heyes, and J. W. Brühl, that oxygen is quadrivalent, forming carbon monoxide $C \equiv O$ and carbon dioxide $C < \begin{smallmatrix} O \\ \vdots \\ O \end{smallmatrix}$. As indicated above, this subject has been discussed by A. Geuther and R. Rübencamp, L. Mond, D. Lagerlof, etc.—*vide* 1. 6, 13. J. A. Wanklyn assumed that oxygen in carbon monoxide is tervalent.

P. G. Tait and T. Andrews² noted that when the silent electric discharge is passed through carbon monoxide, a bronze-coloured product appears on the platinum anode, and by passing an electric discharge through carbon monoxide, B. C. Brodie observed that the products are carbon dioxide and a reddish-brown solid which appears as a film on the walls of the tube. The dry solid appears to be either **carbon suboxide** or a mixture of two or more oxides—possibly C_3O_3 and C_5O_4 —since the composition is not always the same. This suboxide is easily soluble in water, and the coloured soln: has a strong acid reaction. M. Berthelot represented the reaction $5CO=CO_2+C_4O_3$. He said that the suboxide is a brown, amorphous body, which is soluble in water and absolute alcohol, but not in ether. It has an acid reaction, and gives with silver nitrate, lead acetate and baryta-water, brown, amorphous precipitates. On heating to $300^\circ-400^\circ$ in an atm. of nitrogen it yields equal vols. of carbon monoxide and dioxide, and a dark brown carbon tri-oxitoxide, C_3O_3 , thus, $3C_4O_3=2CO+2CO_2+C_3O_3$. When this oxide is more strongly heated, it is decomposed, carbon, still containing oxygen, being left behind. P. Schützenberger said that with thoroughly dried carbon monoxide, the composition of the product is variable, and the conversion ceases as soon as the gas contains 10 per cent. of carbon dioxide. If the ozone discharge tube be surrounded by dry air, the dry gas suffers very little condensation, but if it be immersed in acidified water—Fig. 5, 1. 14, 2—the condensation is much greater. Hence, he inferred that the presence of small quantities of water is essential to the formation of the black product, and that the electric discharge carries oxygen and water through the glass, and that there is also some evidence of a transport of matter in the opposite direction, since the total quantity of carbon in the condensed product and in the carbon dioxide was less than that in the carbon monoxide which disappeared. M. Berthelot, however, claimed that P. Schützenberger was misled in assuming that the discharge causes water to pass through glass; the traces of moisture he observed were derived from imperfectly-dried glass and mercury. These materials require for desiccation a moderately high temp.

Another carbon suboxide, C_3O_2 , or **carbon dinitritoxide**, was prepared by O. Diels and B. Wolf³ in 1906. It is really **malonic anhydride**, C_3O_2 , derived from malonic acid, $CH_2(COOH)_2$, by the loss of two mols. of water:

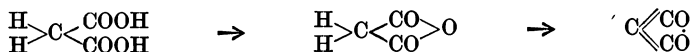

A. Michael, however, considers it to be the lactone of β -hydroxypropionic acid:

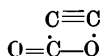

but O. Diels and J. Meyerheim prefer the dioxoallene formula $O : C : C : C : O$, and in confirmation, O. Diels and L. Lalin observed that the suboxide behaves like a ketene

giving with formic acid the additive compound $\text{COOH}(\text{COH}) : \text{C} : (\text{COH})\text{COOH}$. A. Nowak showed it to be formed by the action of the silent discharge on carbon monoxide: $4\text{CO} = \text{C}_3\text{O}_2 + \text{CO}_2$. The compound shows certain analogies with the metal carbonyls, and it can therefore also be regarded as *carbon carbonyl*, $\text{C}(\text{CO})_2$. H. S. Redgrove computed the mol. heats of combustion and formation, respectively 243.6 Cals. and 47.4 Cals. for $\text{O} : \text{C} : \text{C} : \text{C} : \text{O}$, and 286.1 Cals. and 4.8 Cals. for

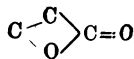

O. Diels and B. Wolf made this compound by distilling malonic acid or one of its esters with a large excess of phosphorus pentoxide under reduced press. (12 mm. mercury) at about 300° . The gases are cooled so as to remove the unchanged acid, carbon dioxide, ethylene, etc. The condensate is allowed to boil at atm. temp. and the residue vaporized and collected at -60° . A. Stock and H. Stolzenberg found that the poor yields of carbon suboxide which are usually obtained by the action of phosphoric oxide on malonic acid are due largely to the polymerization of the suboxide under the catalytic influences of the dehydrating agent. If the suboxide be removed rapidly by carrying out the reaction in a good vacuum and condensing the product by means of liquid air, a vol. of the gas corresponding with as much as 25 per cent. of the malonic acid can be obtained. According to E. Ott and K. Schmidt, a superior yield—amounting to 41 per cent.—can be obtained by leading the vap. of diacetyltartaric anhydride, boiling under diminished press., over a platinum wire heated to bright redness. The process has the further advantage that the carbon suboxide so prepared can be preserved for long periods without change in sealed tubes, whereas the product obtained with the help of phosphorus pentoxide rapidly polymerizes, probably owing to the presence of traces of phosphorus oxide. Carbon suboxide is formed by the action of silver, zinc, or lead oxide on malonyl chloride: $\text{CH}_2(\text{COCl})_2 + \text{Ag}_2\text{O} = \text{C}_3\text{O}_2 + 2\text{AgCl} + \text{H}_2\text{O}$; H. Staudinger and St. Bereza employed silver oxalate or malonate in place of the oxide. E. Ott claims a good yield of purer suboxide by using tartaric acid and acetic anhydride in place of malonic acid in O. Diels and B. Wolf's process. This suboxide at ordinary temp. is a colourless, mobile, volatile, refractive liquid with an odour resembling that of acrolein and mustard oil, and it is poisonous. The vap. attacks the eyes, throat, and respiratory organs producing symptoms of suffocation. When passed through a tube dipping in liquid air, a white solid with a pungent odour is obtained. The solid melts between -107° and -108° and boils at 7° . A. Stock and H. Stolzenberg give -111.3° for the m.p.; 6° for the b.p.; and 587–589 mm. for the vap. press. at 0° . O. Diels and co-workers add that the vap. density corresponds with the formula C_3O_2 . When treated with water, carbon suboxide re-forms malonic acid, and hence this oxide is regarded as malonic anhydride; and with hydrogen chloride, ammonia, and aniline it forms malonyl chloride, malonamide, and malonanilide respectively. The suboxide is combustible, and burns with a blue, smoky flame, forming carbon dioxide: $\text{C}_3\text{O}_2 + 2\text{O}_2 = 3\text{CO}_2$. The vapour and liquid polymerize at ordinary temp. in a few days; the liquid becomes yellow and deposits a dark red solid soluble in water. The suboxide decomposes rapidly at 37° and instantaneously at 100° . It was suggested that the solid decomposition products are probably similar to and perhaps identical with the products of B. C. Brodie and M. Berthelot described above. A. Stock and H. Stolzenberg found that the polymerization of the gas to the red substance, which is soluble in water, is catalyzed remarkably by the polymeride itself. The gas may sometimes be kept for days, but once polymerization sets in, it completely disappears within a day. In contact with phosphoric oxide, the gas polymerizes in a fraction of a minute. Carbon suboxide is very soluble in carbon disulphide or xylene.

H. Meyer and K. Steiner⁴ made a suboxide, C_{12}O_9 , **carbon enneadodecixoxide** or **mellitic anhydride** by boiling acid, $\text{C}_6(\text{COOH})_6$, under reflux with much benzoyl

chloride during six hours. It separates from boiling benzoyl chloride in colourless crystals, which are perfectly stable and non-hygroscopic. It is practically insoluble in cold water, but unites with warm water to form mellitic acid. It gives characteristic colorations when treated with various solvents of high b.p.; thus, with naphthalene, retene, phenanthrene, and fluorene it yields rose-red to bluish-red soln., and with nitrobenzene, a bluish-green soln. It darkens when heated above 320°. The graphic formulæ for acid and anhydride are :

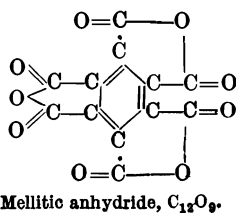
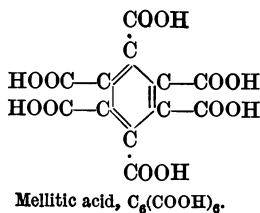

REFERENCES.

¹ J. A. R. Newlands, *Chem. News*, **13**, 229, 1866; J. A. Wanklyn, *ib.*, **70**, 88, 1894; J. H. Heyes, *Phil. Mag.*, (5), **25**, 221, 1888; J. W. Brühl, *Ber.*, **28**, 2865, 1895; H. Staudinger and E. Anthes, *ib.*, **46**, 1426, 1913; A. Geuther and R. Füßencamp, *Liebig's Ann.*, **225**, 267, 1884; L. Mond, *Monit. Scient.*, (4), **6**, 185, 1892; D. Lagerlöf, *Journ. prakt. Chem.*, (2), **69**, 273, 513, 1904; (2), **70**, 521, 1904.

² B. C. Brodie, *Proc. Roy. Soc.*, **20**, 472, 1872; **21**, 245, 1873; *Phil. Trans.*, **162**, 435, 1872; *Chem. News*, **27**, 187, 1873; P. G. Tait and T. Andrews, *Phil. Trans.*, **150**, 1, 1856; M. Berthelot, *Bull. Soc. Chim.*, (2), **26**, 101, 1876; *Compt. Rend.*, **82**, 1360, 1878; **110**, 609, 684, 1890; **142**, 533, 1906; P. Schützenberger, *ib.*, **110**, 560, 681, 1890.

³ O. Diels and B. Wolf, *Ber.*, **39**, 689, 1906; O. Diels and J. Meyerheim, *ib.*, **40**, 355, 1907; O. Diels and L. Lalin, *ib.*, **41**, 3426, 1908; O. Diels, *ib.*, **50**, 753, 1917; H. Staudinger and St. Bereza, *ib.*, **41**, 4461, 1908; A. Michael, *ib.*, **39**, 1915, 1906; A. Stock and H. Stolzenberg, *ib.*, **50**, 498, 1917; E. Ott and K. Schmidt, *ib.*, **55**, 2126, 1922; H. S. Redgrove, *Chem. News*, **120**, 209, 1920; E. Ott, *Umschau*, **26**, 576, 1922; A. Nowak, *Ueber die chemische Wirkung dunkler elektrischer Entladungen auf Kohlenoxyd und kohlenoxydhaltige Gasgemenge*, München, 1910.

⁴ H. Meyer and K. Steiner, *Ber.*, **46**, 813, 1913.

§ 22. The History of Carbon Monoxide

Carbon dioxide was for a long time considered to be the only oxide of carbon, and the lower oxide of carbon being combustible was for a long time confused with inflammable air—hydrogen. In 1716, F. Hoffmann¹ wrote on the toxic vapours which emanate from burning charcoal, but he did not recognize this gas. In his memoir: *Notices d'une suite d'expériences nouvelles, qui font connoître la nature et les propriétés de plusieurs espèces d'air ou emanations aëriiformes, extraites par diverses voies d'un grand nombre de substances*, J. M. F. de Lassone described the preparation of a combustible gas by heating a mixture of charcoal and zinc oxide. A. L. Lavoisier also obtained a combustible gas with carbon dioxide when a mixture of carbon and alum was calcined; the combustible gas was shown to be different from inflammable air obtained by the action of acids on metals, and on combustion it yielded carbon dioxide. J. Priestley obtained an inflammable air by treating hammer-slag (iron-oxide) with well-calcined charcoal. P. J. Macquer (1778), L. B. G. de Morveau (1784), M. Meusnier and A. L. Lavoisier (1784), and A. F. de Fourcroy (1793) made confirmatory observations, but they did not distinguish between it and the inflammable gas composed of carbon and hydrogen. The gases were confused and called inflammable air. J. Priestley made much of the view of the anti-phlogistians that the gas furnished by heating iron oxide and charcoal should be incombustible carbon dioxide, whereas, according to his version of the phlogiston theory, the oxides contain water, and the inflammable air from iron

oxide and charcoal was considered to be phlogisticated water. In support of this hypothesis, J. Priestley argued that when steam is passed over red-hot charcoal it is phlogisticated to inflammable air. This explanation puzzled the supporters of A. L. Lavoisier's theory of combustion, and P. A. Adet attempted a reconciliation by assuming that even the most strongly calcined charcoal still contains hydrogen; but J. Priestley (1800) showed that P. A. Adet's hypothesis is not in accord with facts. J. Woodhouse (1799) prepared the combustible air by heating charcoal with other oxides—*e.g.* zinc, copper, lead, manganese, and bismuth oxides—he too showed that P. A. Adet's hypothesis is untenable; and that the combustible air contains carbon. He concluded that the gas in question is a compound of hydrogen and carbon.

In 1800, W. Cruickshank examined the gas obtained by heating carbon with different metal oxides, and he showed that it contained no hydrogen, for, on combustion, it yields no water, and furnishes nothing but an equal vol. of carbon dioxide. Hence, he concluded that it must be an oxygen compound, and called it *gaseous oxide of carbone*—it is now called carbon monoxide. F. Clément and J. B. Désormes made some analogous observations and confirmed W. Cruickshank's results; they determined the composition of the gas, and showed that it is formed when carbon dioxide is passed over red-hot charcoal: C. L. Berthollet opposed the views of W. Cruickshank, and F. Clément and J. B. Désormes, for he said that if carbon monoxide contains more carbon than carbon dioxide it should be specifically heavier. This is not the case, and hence the gas must contain hydrogen, and in 1803, he called it *hydrogene oxi-carburé*. He discounted the absence of any signs of water in the combustion of carbon monoxide by stating that the water remains intimately bound to the carbon dioxide. J. R. Deiman and co-workers (1798) even denied that carbon monoxide contains any oxygen at all, and they regarded it as a hydrocarbon. However, the subsequent work of A. F. de Fourcroy, J. L. Gay Lussac and L. J. Thénard, W. Henry, and F. Clément and J. B. Désormes has shown that carbon monoxide contains no hydrogen; that both carbon monoxide and carbon dioxide are compounds of oxygen and carbon; and that carbon dioxide contains just twice as much oxygen per atom of carbon as is contained in carbon monoxide; or, as J. Dalton expressed it, "carbonic oxide is a binary compound consisting of one atom of charcoal and one of oxygen . . . and carbonic acid is a ternary compound consisting of one atom of charcoal and two of oxygen," *i.e.* carbon monoxide in modern symbols is represented by CO, and carbon dioxide by CO₂. Carbon monoxide was liquefied by L. P. Cailletet in 1877; and solidified by S. von Wroblewsky in 1885.

REFERENCES.

- ¹ F. Hoffmann, *Gründliche Anweisung wie ein Mensch von dem frühzeitigen Tod und allerhand Arten Krankheiten durch ordentliche Lebens-Art sich verwahren Können*, Halle, 5. 606, 1719; J. M. F. de Lassone, *Mém. Acad.*, 686, 1776; A. L. Lavoisier, *ib.*, 363, 1777; 468, 1784; M. Meunier and A. L. Lavoisier, *ib.*, 269, 1784; P. J. Macquer, *Dictionnaire de chimie*, Paris, 2. 305, 1778; L. B. G. de Morveau, *Ann. Chim. Phys.*, (1), 38. 285, 1801; (1), 39. 287, 1801; A. F. de Fourcroy, *ib.*, (4), 43. 113, 132, 1802; *Elémens d'histoire naturelle et de chimie*, Paris, 2. 237, 1793; A. F. de Fourcroy and C. L. Berthollet, *Ann. Chim. Phys.*, (1), 26. 303, 1798; P. A. Adet, *Ann. Chim. Phys.*, (1), 26. 302, 1798; J. Priestley, *Observations on the Doctrine of Phlogiston, and the Composition of Water*, London, 1796; *The Doctrine of Phlogiston Established*, London, 1800; J. Woodhouse, *Trans. Amer. Phil. Soc.*, 4. 452, 1799; W. Cruickshank, *Nicholson's Journ.*, 5. 1, 201, 1801; F. Clément and J. B. Désormes, *Ann. Chim. Phys.*, (1), 38. 285, 1801; C. L. Berthollet, *Bibl. Brit.*, 18. 265, 1801; *Ann. Chim. Phys.*, (1), 42. 282, 1801; *Tilloch's Mag.*, 13. 276, 1802; *Essai de statique chimique*, Paris, 2. 61, 1803; J. R. Deiman, A. P. van Troostwijk, A. Lauwerenburgh, and G. Vrolik, *Ann. Chim. Phys.*, (1), 29. 225, 1798; J. L. Gay Lussac and L. J. Thénard, *Mém. Soc. d'Arcueil.*, 2. 339, 1809; J. Dalton, *A System of Chemical Philosophy*, Manchester, 1808; W. Henry, *Phil. Trans.*, 98. 430, 1809; L. P. Cailletet, *Compt. Rend.*, 85. 1213, 1217, 1877; S. von Wroblewsky, *ib.*, 100. 979, 1885; *Sitzber. Akad. Wien*, 90. 667, 1885; *Monatsh.*, 6. 245, 1885.

§ 23. The Occurrence and Preparation of Carbon Monoxide

Traces of carbon monoxide in atmospheric *air* have been reported by A. Müntz and E. Aubin,¹ M. Gruber, F. Clowes, J. Ogier and E. Kohn-Abrest, O. Spitta, A. Mermet, etc. Carbon monoxide has been reported in the gases emitted from *volcanoes* by T. Poleck,² M. Scholz, E. T. Allen and E. G. Zies, H. Moissan, E. S. Shepherd, A. Gautier, K. W. Charitschkoff, etc. It has been found in various *minerals* by A. Gautier, W. A. Tilden, R. T. Chamberlin, etc.; in *Stassfurt salts* by H. Precht;³ in the *diamantiferous earths* at Kimberley by W. Ramsay and M. W. Travers;⁴ in *graphite* by J. Dewar and G. Ansdell;⁵ in coal, lignites, and coke by A. W. H. Kolbe, F. H. Storer, etc.; in *meteorites* by J. W. Mallet,⁶ T. Graham, A. W. Wright, J. Dewar and G. Ansdell, R. T. Chamberlin, etc.; in *iron and steel* by F. C. G. Müller;⁷ in the *flue gases* from various industrial furnaces by A. Desgrez,⁸ etc. It is one of the main constituents of water gas. It is also found as an intermediate product in the combustion of various hydrocarbons—*e.g.* in the interconal gases of Bunsen's flame. Carbon monoxide was found in *coal gas* by P. F. Frankland,⁹ A. Wagner, A. Bunte, etc.; and *tobacco smoke* by J. Habermann,¹⁰ R. Liebig, O. Krause, F. Wahl, H. Schwarz, H. Vohl and H. Eulenberg, etc. M. Nicloux¹¹ found carbon monoxide in the blood of newly-born infants, and numerous observations have been made on carbon monoxide in blood. A. Desgrez, and M. Nicloux found about 1.6 c.c. of carbon monoxide per litre in the normal blood of dogs. E. Pflüger found carbon monoxide in the intestinal gases of some herbivora, but J. Reiset found none. Carbon monoxide has been reported¹² to be formed in the germination of plants.

J. B. J. D. Boussingault¹³ observed that small quantities of carbon monoxide are formed at ordinary temp. by the oxidation of organic substances by oxygen or atm. air—*e.g.* tannic and gallic acids, pyrogallol, etc., in the presence of an alkali. F. C. Calvert noted that after being in contact with pyrogallol, the oxygen will be contaminated with 2 to 4 per cent. of carbon monoxides according to the conc. of the alkali soln. of pyrogallol. The maximum amount is formed with one eq. of the pyrogallol and rather more than one eq. of alkali. The reaction is rather important when, in the analysis of mixed gases, the oxygen is removed by pyrogallol, because the results for carbon monoxide, determined after the oxygen, may be too high. The subject has been discussed by S. Cloez, W. Hempel, B. Take, L. de St. Martin, etc. F. Clowes found that the absorption of oxygen with a mixed soln. of 24 per cent. potassium hydroxide and 18 per cent. of hydroquinone is slow but complete, without the evolution of carbon monoxide.

Carbon monoxide and dioxide are found amongst the products of the dry distillation of coal and other organic compounds, and, according to L. Vignon,¹⁴ this the more, the richer the coal is in oxygen; at 900°, he found less than one-third the oxygen in the coal appears as a mixture of these two gases. Carbon monoxide and dioxide are also formed when carbon or organic compounds are burnt in oxygen or air. The former gas is absent if a sufficient excess of oxygen be present—*vide supra*. The equilibrium conditions in the reaction $C + CO_2 \rightleftharpoons 2CO$ have been previously discussed. Carbon monoxide can be made on a large scale by passing carbon dioxide derived from lime-kilns, and flue-gases, through a bed of heated carbon.¹⁵ F. C. G. Müller found that 85 per cent. carbon monoxide is produced when oxygen is passed downwards through a vertical quartz tube packed with wood charcoal the size of linseed. The upper part of the tube should be heated before oxygen is admitted, and the combustion should proceed under reduced press. According to A. K. Huntington, carbon monoxide can be recovered from flue gases, etc., by passing the gas under press. through a soln. of cuprous chloride in ammonium chloride, and the carbon monoxide recovered by reducing the press. A. Fritsch used a soln. of cuprous chloride in hydrochloric acid. The formation of carbon monoxide during the incomplete oxidation of hydrocarbons (*q.v.*) has been noted.¹⁶ A. Kling and D. Florentin found the amount of carbon monoxide produced in the combustion

of fuel gases depended rather on the nature of the burner than on the composition of the gas. R. Girard, and E. Kohn-Abrest have discussed this question. R. Bunsen¹⁷ showed that the incomplete combustion of cyanogen furnishes a mixture of carbon monoxide and dioxide. The subject was also investigated by H. B. Dixon and co-workers. A. Gärtner has discussed the contamination of the air of rooms by gas stoves, etc. L. T. Wright, and T. E. Thorpe observed the formation of carbon monoxide in the combustion of coal gas; I. V. Brumbaugh and G. W. Jones, in the combustion of natural gas; Y. Henderson and H. W. Haggard, in the exhaust gases from gas-engines; and W. Cullen, and O. Poppenberg and E. Stephan, in the products of the explosion of blasting gelatin.

The formation of carbon monoxide by the action of steam on red-hot carbon has been previously discussed; so also has the formation of carbon monoxide by heating a mixture of carbon with the carbonates of the alkalis, alkaline earths, and iron; by heating a mixture of carbon and the sulphates of the alkalis and alkaline earths; by heating carbon with sulphur dioxide, or steam and chlorine. The formation of carbon monoxide by heating a mixture of charcoal and a metal oxide has been discussed in connection with the history of this gas. Carbon monoxide is accordingly made by heating to redness mixtures of graphite with the oxides of copper, zinc, lead, or iron; or by heating to redness mixtures of iron or graphite with the carbonate of an alkali or alkaline earth metal. The carbon dioxide is removed by scrubbing with a soln. of alkali hydroxide. H. Jahn found that various alcohols are decomposed into hydrogen, and carbon monoxide. According to E. Noack,¹⁸ when carbon dioxide is passed over heated zinc dust contained in a combustion tube, it is reduced to carbon monoxide; the last traces of carbon dioxide are removed by passing the gas through a soln. of alkali hydroxide. L. P. Kinnicutt said that it is more convenient to heat chalk or magnesite with zinc dust, and added that after the first five minutes, the gas has a high degree of purity. G. Williams noted that hydrogen is produced by heating zinc dust with zinc or some other hydroxide, and H. Schwarz obtained a mixture of hydrogen and carbon monoxide by heating a mixture of 20 grms. of zinc dust, 22.8 grms. of calcium hydroxide, and 30 grms. of calcium carbonate. H. Köhler found that carbon dioxide is reduced by hydrogen sulphide: $\text{CO}_2 + \text{H}_2\text{S} = \text{S} + \text{H}_2\text{O} + \text{CO}$; and A. Eiloart, by the vap. of carbon disulphide in the presence of red-hot copper: $\text{CS}_2 + \text{CO}_2 + 4\text{Cu} = 2\text{Cu}_2\text{S} + 2\text{CO}$. H. W. Paulus prepared hydrogen chloride and carbon monoxide by passing a mixture of chlorine and steam through a column of incandescent carbon. The hydrogen chloride can be removed as hydrochloric acid by scrubbing the gases in a water tower.

R. Ehrenfeld¹⁹ found that at a dark red heat, alcohol and charcoal give a mixture of carbon monoxide, methane, and hydrogen. J. A. Muller and E. Peytral observed the formation of some carbon monoxide in the pyrogenic decomposition of formic acid. V. B. Lewes found that phenol reacts $\text{C}_6\text{H}_5\text{OH} + \text{C} = \text{CO} + \text{C}_6\text{H}_6$. S. M. Losanitsch found carbon monoxide among the products of the action of the silent electric discharge on methyl alcohol. Cresol behaves similarly. M. Berthelot represented the reaction between acetaldehyde vap. (2 vols.) and hydrogen (5 vols.) at a dark red heat: $\text{CH}_3\text{COH} = \text{CO} + \text{CH}_4$. According to R. Ehrenfeld, aluminium powder on ethyl alcohol at a red heat furnishes carbon monoxide, ethylene, water, and hydrogen, and, according to H. Jahn, zinc dust at 300°–350° gives with methyl alcohol a mixture of carbon monoxide, hydrogen, methane, etc.; ethyl alcohol at a red heat gives carbon monoxide, methane, hydrogen, and a little acetylene; ether, at 300°–350°, gives ethylene and water and traces of carbon monoxide and methane; formic acid gives carbon monoxide, hydrogen, and a trace of methane; acetic acid gives acetone, acetic anhydride, carbon monoxide, hydrogen, ethylene, and propylene; butyric acid gives carbon monoxide, water, propylene, and a ketone; and ethyl acetate gives carbon monoxide and dioxide, ethylene, hydrogen, and acetone. Quite a number of organic products give carbon monoxide and other products when heated *e.g.* aldehyde (A. Bistrzycky and M. Fellmann);²⁰ citronic acid (C. Wilde); dioxysuccinic acid and oxomalonic ester (R. Anschütz and H. Pauly);

benzoylformic acid (L. Claisen); etc. A. Bistrzycky found carbon monoxide is evolved when the tertiary acids are treated with sulphuric acid; and C. F. Cross and E. J. Bevan found much carbon monoxide is formed when cellulose is heated with sulphuric and chromic acids. P. Schützenberger²¹ found that carbonyl chloride when heated with sodium gives sodium chloride and carbon monoxide; and J. Davy found that with antimony pentoxide, carbonyl chloride gives antimony chloride and trioxide and carbon monoxide, while with arsenic, antimony, tin, or zinc, the metal chloride and carbon monoxide are formed. C. von Than, and A. Emmerling and B. von Lengyel said that at a red heat, carbonyl sulphide decomposes into carbon monoxide, sulphur, etc. A. Cöhn and H. Becker found carbon monoxide among the products of the action of the light of a mercury lamp on carbonyl chloride. L. Mond also found carbon monoxide is given off when the metal carbonyls are heated.

According to J. W. Döbereiner,²² carbon monoxide can be made by heating oxalic acid with sulphuric acid, and removing the carbon dioxide simultaneously formed by scrubbing the gas with calcium oxide or potassium hydroxide. In place of oxalic acid, J. B. A. Dumas used potassium oxalate, and T. D. Mitchell, and L. D. Gale used ammonium oxalate. G. Chevrier passed the mixed gases over red-hot carbon, and then through potash-lye and lime-water. J. S. Stas, and F. W. Skirrow employed his process. A. Scott said that the gas is contaminated with a little hydrogen or hydrocarbons.

Carbon monoxide is made by gently heating, say, 20 to 30 grms. of crystalline oxalic acid, $(\text{COOH})_2 \cdot 2\text{H}_2\text{O}$, just covered with conc. sulphuric acid. The rate of evolution of the gas is determined by the temp. of the mixture. Equal vol. of carbon dioxide and carbon monoxide are produced: $(\text{COOH})_2 + \text{H}_2\text{SO}_4 = \text{H}_2\text{SO}_4 + \text{H}_2\text{O} + \text{CO} + \text{CO}_2$. The former is removed by passing the gas through a series of wash-bottles containing a soln. of sodium hydroxide. This process is more troublesome than the formic acid process.

M. Berthelot heated equi-molar proportions of oxalic acid and glycerol to 100° , and decomposed the product at 190° - 200° . The gas was washed in potash-lye. C. Moureu found that oxalates are decomposed by thionyl chloride into carbon monoxide and dioxide. B. Blount obtained carbon monoxide by heating a mixture of calcium oxide and oxalate. C. Engler and J. Grimm also noted that many formates and oxalates decompose when heated giving off carbon monoxide; for instance, 10 c.c. of ethyl oxalate in a sealed tube at 200° furnish a litre of a mixture of carbon monoxide and dioxide, and olefines in the respective proportions by vol. 48·4; 43·8; 7·8. W. Wislicenus found that the esters of oxaloacetic acid at 200° form carbon monoxide and malonic esters.

J. W. Döbereiner²³ prepared carbon monoxide by heating formic acid or a formate with conc. sulphuric acid. The process was employed by F. Göbel, J. Riban, G. André, E. Rupp, Lord Rayleigh, etc. V. Merz and J. Tibirica used lead formate and sulphuric acid.

Carbon monoxide is perhaps most conveniently made in the laboratory by heating conc. sulphuric acid to about 100° in a flask fitted with a double-bored rubber stopper; one hole of the stopper is fitted with a gas delivery tube, and the other with a tap funnel containing conc. (98 per cent.) formic acid, H.COOH . The tip of the funnel dips below the surface of the sulphuric acid. Each drop of formic acid produces some bubbles of gas. The reaction is simple: $\text{H.COOH} + \text{H}_2\text{SO}_4 = \text{H}_2\text{SO}_4 + \text{H}_2\text{O} + \text{CO}$. There is no frothing, and the velocity of the stream of gas is regulated by the rate at which formic acid is dropped on the sulphuric acid. The gas is washed by bubbling it through a conc. soln. of sodium hydroxide. Conc. sulphuric acid can also be mixed with sodium formate in a flask provided with a safety funnel, and very gently warmed. Carbon monoxide is evolved. The rate of evolution of the gas depends on the conc. of the acid. The dynamics of the reaction have been studied by J. Meyer, V. H. Voley, J. S. Morgan, T. Okaya, P. Sabatier and A. Maible, M. Wegner, and E. R. Schierz.

M. Berthelot found that formic acid decomposes largely into water and carbon monoxide when kept for some hours in a sealed tube at 200° - 250° . C. Engler and J. Grimm found that 10 c.c. of the acid when heated 8 hrs. at 150° - 160° , furnish 300 c.c. of gas containing 98·8 per cent. of carbon monoxide and 1·2 per cent. of

carbon dioxide; ethyl formate under similar conditions gave 300 c.c. of gas with 18.2 per cent. of carbon monoxide; 29.5 per cent. of carbon dioxide, 7.2 per cent. of ethylene, and 45.1 per cent. of hydrogen. Amyl formate behaves similarly, furnishing amylene in place of ethylene. When formic acid is decomposed by the electric current, carbon monoxide, carbon dioxide, and hydrogen are formed, the proportion of carbon monoxide is decreased by working under press. A 2 per cent. soln. of formic acid was found by J. Riban to give 1.18 c.c. of carbon monoxide, 0.35 c.c. of carbon dioxide, and 0.39 c.c. of hydrogen when heated for 24 hrs. G. André found that hydrochloric acid accelerated the decomposition of formic acid; and that in the absence of hydrochloric acid, some carbon dioxide is formed. M. Berthelot and H. Gaudechon found carbon monoxide among the products of the decomposition of formic acid by ultra-violet light. J. E. Lorin made carbon monoxide by the action of dehydrated alkali formates or acetates on formic acid at 135°–150°.

Other carboxylic acids—*e.g.* tartaric and citric acids—behave in an analogous manner to formic and oxalic acids. J. Peterson found that carbon monoxide is formed during the electrolysis of malonic acid: $\text{CH}_2(\text{COOH})_2 + \text{H}_2\text{O} = 3\text{H}_2 + 2\text{CO}_2 + \text{CO}$. The reaction is said to occur in a series of stages: $\text{CH}_2(\text{COOH})_2 = \text{CH}_2(\text{COO})_2'' + 2\text{H}^+$; $\text{CH}_2(\text{COO})_2 + \text{H}_2\text{O} = \text{CH}_2(\text{COOH})_2 + \text{O}$; $\text{CH}_2(\text{COO})_2 = \text{CH}_2 + 2\text{CO}_2$; and $\text{CH}_2 + 2\text{O} = \text{CO} + \text{H}_2\text{O}$.

The cyanides can be regarded as nitrile derivatives of formic acid. G. Fownes²⁴ made carbon monoxide by heating finely pulverized potassium ferrocyanide with 8–10 times its weight of conc. sulphuric acid: $\text{K}_4\text{FeC}_6\text{N}_6 + 6\text{H}_2\text{O} + 6\text{H}_2\text{SO}_4 = 6\text{CO} + 2\text{K}_2\text{SO}_4 + \text{FeSO}_4 + 3(\text{NH}_4)_2\text{SO}_4$. A little carbon dioxide and sulphur dioxide are produced at the beginning of the action, but soon afterwards almost pure carbon monoxide is given off. If the temp. be too high, much frothing will occur. The process was employed by C. Grimm and G. Ramdohr, and by Lord Rayleigh. If the acid be too dil., hydrocyanic acid will be formed: $2\text{K}_4\text{FeC}_6\text{N}_6 + 3\text{H}_2\text{SO}_4 = 3\text{K}_2\text{SO}_4 + \text{K}_2\text{Fe}_2\text{C}_6\text{N}_6 + 6\text{HCN}$:

Carbon monoxide is prepared by heating, say, 30 grms. of potassium ferrocyanide with 300 c.c. of conc. sulphuric acid in a capacious flask. In this case, the temp. of decomposition is high, and if the mixture be heated too quickly, the gas is apt to come off so quickly as to be beyond control. If dil. sulphuric acid be used, hydrocyanic acid as well as carbon monoxide may be formed. The process is more troublesome than the formic acid process.

J. Wade and L. C. Panting used potassium cyanide in place of the ferrocyanide. Here again, with dil. sulphuric acid, hydrogen cyanide is produced; and with conc. sulphuric acid, carbon monoxide is produced: $\text{KCN} + 2\text{H}_2\text{SO}_4 + \text{H}_2\text{O} = \text{KHSO}_4 + \text{NH}_4\text{HSO}_4 + \text{CO}$. Presumably hydrogen cyanide is formed in both cases, but in the presence of conc. sulphuric acid, formic acid is first produced, and this is converted into carbon monoxide. The carbon monoxide is freed from carbon and sulphur dioxides, and from hydrogen cyanide by scrubbing it twice with a conc. soln. of potassium hydroxide. The carbon dioxide is derived from the presence of carbonates in the potassium cyanide.

A. Geuther²⁵ obtained carbon monoxide by the action of an aq. or alcoholic soln. of alkali hydroxide on chloroform, CHCl_3 . G. Moser added that some ethylene and formic acid are produced at the same time. According to A. Desgrez, the reaction with a mixture of 50 grms. of chloroform, 400 grms. of water, and 50 grms. of potassium hydroxide, is symbolized: $\text{CHCl}_3 + 2\text{KOH} = 2\text{KCl} + \text{HCl} + \text{H}_2\text{O} + \text{CO}$; or, $\text{CHCl}_3 + \text{KOH} = \text{KCl} + 2\text{HCl} + \text{CO}$. The reaction is accelerated by heat and sunlight; it is retarded in darkness; and it is faster than when bromoform is used. J. Thiele and F. Dent said that 50–100 c.c. can be very conveniently made in a nitrometer by adding a few drops of chloroform to a 40 per cent. aq. soln. of potassium hydroxide, and shaking the mixture. G. André, and A. Desgrez noted that when chloroform is heated with ten times its vol. of water to 255°, it furnishes hydrogen chloride and formic acid, and that the latter breaks down into carbon monoxide, etc. G. André found that when a mixture of chloroform and aq. ammonia is heated for six hours at 200°–225°, ammonium formate and carbon monoxide are

formed: $2\text{CHCl}_3 + 3\text{H}_2\text{O} + 7\text{NH}_3 = \text{H COONH}_4 + 6\text{NH}_4\text{Cl} + \text{CO}$. At 180° , a part of the chloroform is not attacked. A. Desgrez and M. Nicloux stated that the proportion of carbon monoxide in blood increases during anaesthesia by chloroform. This subject has been also discussed by L. de St. Martin. According to M. Hermann, bromoform behaves like chloroform, but the action is slower. No reaction occurs with iodoform; but L. von Stubenrauch found that iodoform is decomposed by silver nitrate: $\text{CHI}_3 + 3\text{AgNO}_3 + \text{H}_2\text{O} = 3\text{AgI} + 3\text{HNO}_3 + \text{CO}$; the reaction is apparently favoured by the formation of the insoluble silver iodide.

According to M. Tanret, if a mixture of soln. of chloral-hydrate, $\text{CCl}_3\text{CH}(\text{OH})_2$, and potassium permanganate be made alkaline, say with potassium hydroxide, gas is evolved, the liquid becomes discoloured, and sesquioxide of manganese is precipitated. If several grams of chloral-hydrate be acted upon, and the temp. not raised above 40° , the reaction will last for some hours; then on filtering the liquid the filtrate will be found to contain chloride, carbonate, and formate of potassium. The gas evolved is carbon monoxide. The reaction occurs equally well with very dil. soln., and even if borax be substituted for potassium hydroxide. This decomposition leads to a theory to account for the action of chloral-hydrate upon the animal system; it is suggested that when this substance is taken into the circulation, it is submitted to oxidizing agencies; the alkalinity of the serum determines its decomposition; the carbon monoxide displaces the oxygen from the arterial blood, and produces an effect similar to that resulting from poisoning by carbon monoxide. The lowering of the temp. of the body and the prolonged action of the chloral-hydrate, owing to slow decomposition, tend to make this theory more tenable than the assumption of its conversion into chloroform. The slow decomposition of chloral by an oxidizing agent also explains the continuity of its action as a hypnotic, which would not be the case if it were transformed into chloroform. A. Desgrez also found that chloral is rapidly decomposed by an alkali hydroxide with the formation of carbon monoxide. It is assumed that chloroform and alkali formate are produced in the first stage of the reaction; that alkali carbonates or hydrocarbonates do not decompose the chloral; and that aq. ammonia does not act in the cold.

The reputed formation of carbon monoxide and dioxide by the action of radium radiations on silicon, titanium, zirconium, thorium, and lead, is probably a mal-inference from W. Ramsay's experiments.²⁶

REFERENCES.

- ¹ A. Müntz and E. Aubin, *Compt. Rend.*, **99**, 871, 1884; F. Clowes, *Chem. News*, **74**, 188, 1896; M. Gruber, *Dingler's Journ.*, **241**, 219, 1881; O. Spitta, *Arch. Hyg.*, **46**, 284, 1903; A. Mermet, *Ann. Chim. Anal. App.*, **2**, 163, 1897; J. Ogier and E. Kohn-Abrest, *ib.*, **13**, 169, 218, 1908.
- ² T. Poleck, *Jahresb. Sches. Ges. Vaterl. Cultur.*, **60**, 155, 1882; M. Scholz, *Jahresb. Geol. Landesanst.*, **95**, 1883; H. Moissan, *Compt. Rend.*, **135**, 1085, 1902; *Bull. Soc. Chim.*, (3), **29**, 434, 1903; A. Gautier, *Compt. Rend.*, **148**, 1708, 1909; **149**, 84, 1909; E. S. Shepherd, *Bull. Hawaiian Volcano Obs.*, **7**, 94, 1919; **8**, 65, 1920; **11**, 86, 1921; K. W. Charitschkoff, *Zeit. Vulkanologie*, **1**, 92, 1915; E. T. Allen and E. G. Zies, *Contrib. Tech. Papers Nat. Geogr. Soc. Washington*, **2**, 1923; E. T. Allen, *Journ. Franklin Inst.*, **193**, 29, 1922; A. W. Tilden, *Proc. Roy. Soc.*, **64**, 453, 1897; *Chem. News*, **75**, 169, 1897; R. T. Chamberlin, *The Gases in Rocks*, Washington, 1908.
- ³ H. Precht, *Ber.*, **12**, 557, 1879.
- ⁴ W. Ramsay and M. W. Travers, *Proc. Roy. Soc.*, **60**, 442, 1897.
- ⁵ J. Dewar and G. Ansdell, *Proc. Roy. Inst.*, **11**, 332, 541, 1886; A. W. H. Kolbe, *Journ. prakt. Chem.*, (2), **6**, 79, 1872; F. H. Storer, *Amer. Chem. Journ.*, **4**, 409, 1883.
- ⁶ J. W. Mallet, *Proc. Roy. Soc.*, **20**, 365, 1879; *Phil. Mag.*, (4), **44**, 311, 1879; *Chem. News*, **25**, 292, 1879; T. Graham, *Proc. Roy. Soc.*, **15**, 502, 1867; A. W. Wright, *Amer. Journ. Science*, (3), **9**, 294, 459, 1875; (3), **11**, 253, 1876; (3), **12**, 165, 1876; (3), **21**, 209, 1881; J. Dewar and G. Ansdell, *Proc. Roy. Inst.*, **11**, 332, 541, 1886; R. T. Chamberlin, *The Gases in Rocks*, Washington, D.C., 1908.
- ⁷ F. C. G. Müller, *Ber.*, **12**, 93, 1879.
- ⁸ A. Desgrez, *Stahl Eisen*, **25**, 1066, 1905.
- ⁹ P. F. Frankland, *Journ. Chem. Ind.*, **3**, 271, 1884; *Journ. Chem. Soc.*, **45**, 30, 189, 227, 1884; A. Wagner, *Repert. anal. Chem.*, **131**, 1887; A. Bunte, *Journ. Gasbeleucht.*, **46**, 706, 733, 1903.
- ¹⁰ J. Habermann, *Zeit. physiol. Chem.*, **33**, 55, 1901; H. Vohl and H. Eulenburg, *Arch.*

Pharm., (2), **147**. 130, 1871; H. Vohl, *Dingler's Journ.*, **215**. 191, 1875; H. Schwarz, *ib.*, **226**. 305, 1887; O. Krause, *ib.*, **213**. 495, 1874; F. Wahl, *Arch. Physiol.*, **78**. 262, 1899; R. Liebig, *German Pat.*, *D.R.P.P.* 166343, 1904; 167845, 1904; A. Desgrez and M. Nicloux, *Compt. Rend.*, **125**. 973, 1897; J. Toth, *Chem. Ztg.*, **31**. 98, 1907; *Rev. Internat. Falsif.*, **21**. 8, 1908; H. Marcelet, *Bull. Soc. Chim.*, (4), **3**. 556, 1908.

¹¹ M. Nicloux, *Compt. Rend.*, **123**. 1501, 1901; **133**. 67, 1901; R. Lepiné and R. Boulud, *ib.*, **143**. 374, 1906; J. Reiset, *ib.*, **66**. 176, 1868; N. Gréhan, *ib.*, **113**. 289, 1891; **116**. 235, 1893; **123**. 1013, 1896; **125**. 735, 1897; **143**, 813, 1906; E. Pflüger, *Karsten's Archiv.*, **9**. 98, 1832; G. A. Buckmaster and J. A. Gardner, *Proc. Roy. Soc.*, **81**. B, 515, 1909; A. Desgrez, *Compt. Rend.*, **125**. 780, 1898; *Stahl Eisen*, **25**. 1066, 1905; A. Desgrez and M. Nicloux, *Compt. Rend.*, **125**. 973, 1897.

¹² A. Vogel, *Journ. Pharm. Chim.*, (3), **25**. 255, 1854; A. C. Oudemans and N. W. P. Rauwenhoff, *Scheikunde. Verh. Onderzoekingen*, (2), **1**. 1, 1858; J. B. J. D. Boussingault, *Compt. Rend.*, **53**. 862, 1861; *Ann. Chim. Phys.*, (3), **68**. 295, 1862; B. Corenwinder, *Bull. Soc. Chim.*, (2), **3**. 145, 1865; *Compt. Rend.*, **60**. 102, 1865; A. Mermet, *ib.*, **124**. 621, 1897; F. Hoppe-Seyler, *Ber.*, **12**. 702, 1879.

¹³ J. B. J. D. Boussingault, *Ann. Chim. Phys.*, (3), **66**. 295, 1862; *Compt. Rend.*, **57**. 885, 1863; L. de St. Martin, *ib.*, **126**. 533, 1898; S. Cloez, *ib.*, **57**. 875, 1863; F. C. Calvert, *Chem. News*, **8**. 272, 1863; F. Clowes, *ib.*, **72**. 288, 1895; W. Hempel, *Neue Methoden zur Analyse der Gase*, Braunschweig, **45**, 1890; B. Take, *Arch. Physiol.*, **38**. 401, 1886.

¹⁴ L. Vignon, *Compt. Rend.*, **145**, 1177, 1907; *Bull. Soc. Chim.*, (4), **3**. 109, 1908.

¹⁵ G. W. Hart, *Journ. Soc. Chem. Ind.*, **9**. 486, 1890; R. S. Hutton and J. E. Petavel, *ib.*, **23**. 87, 1904; A. T. D. Berrington and J. Parry, *Brit. Pat. No.* 9270, 1884; M. Cahen, *ib.*, 11335, 1884; A. K. Huntington, *ib.*, 15310, 1884; W. Engels, *German Pat.*, *D.R.P.* 121221, 1898; C. G. P. de Laval, *ib.*, 192888, 1904; A. Fritsch, *ib.*, 36710, 1885; J. Quaglio, J. Pintsch, and A. Lentz, *Dingler's Journ.*, **256**. 319, 1885; A. Kling and D. Florentin, *Compt. Rend.*, **169**. 1404, 1919; F. C. G. Müller, *Zeit. angew. Chem.*, **33**. i, 36, 1920; *Zeit. Phys. Chem. Unterr.*, **32**. 40, 1919.

¹⁶ W. A. Bone and J. C. Cain, *Journ. Chem. Soc.*, **71**. 26, 1897; *Chem. News*, **70**. 264, 1894; **74**. 268, 1896; W. A. Bone and R. V. Wheeler, *Journ. Chem. Soc.*, **81**. 535, 1902; **83**. 1074, 1903; W. A. Bone and W. E. Stockings, *ib.*, **85**. 693, 1904; J. Lang, *Zeit. phys. Chem.*, **2**. 161, 1888; *Journ. Gasbeleucht.*, **31**. 932, 967, 1888; M. Coquillion and J. Henrivaux, *ib.*, **34**. 458, 1891; *Journ. Usin. Gaz.*, **14**. 355, 1890; O. Angelucci, *Gazz. Chim. Ital.*, **36**. ii, 517, 1907; W. Löb, *Zeit. Elektrochem.*, **11**. 751, 1905; *Landw. Jahrb.*, **35**. 541, 1906; D. Berthelot and H. Gaudechon, *Compt. Rend.*, **150**. 1327, 1910; A. Kling and D. Florentin, *ib.*, **169**. 1404, 1919; A. Gautier, *ib.*, **142**. 1382, 1906; R. Girard, *Rev. Scient.*, **60**. 195, 1922; E. Kohn-Abrest, *Chim. Ind.*, **7**. 590, 1922; H. B. Dixon, *Journ. Gaslighting*, **86**. 745, 1905.

¹⁷ R. Bunsen, *Liebig's Ann.*, **85**. 137, 1853; H. B. Dixon, E. H. Strange, and E. Graham, *Journ. Chem. Soc.*, **69**. 759, 1896; T. E. Thorpe, *ib.*, **83**. 318, 1903; L. T. Wright, *Journ. Gaslighting*, **66**. 1023, 1895; A. Gärtner, *Journ. Gasbeleucht.*, **43**. 268, 332, 1900; W. Cullen, *Quarry*, **14**. 98, 1909; O. Poppenberg and E. Stephan, *Zeit. Scheiss. Sprengstoffwesen*, **4**. 281, 305, 388, 1909; I. V. Brumbaugh and G. W. Jones, *Journ. Franklin Inst.*, **194**. 103, 1922; Y. Henderson and H. W. Haggard, *Journ. Ind. Eng. Chem.*, **14**. 229, 1922; H. Jahn, *Sitzber. Akad. Wien*, **81**. 756, 1880; **82**. 511, 1880; *Monatsh.*, **1**. 378, 675, 1880.

¹⁸ E. Noack, *Ber.*, **16**. 75, 1883; H. Jahn, *ib.*, **13**. 985, 3107, 1880; **16**. 308, 1883; H. Schwarz, *ib.*, **19**. 1141, 1886; H. Köhler, *ib.*, **11**. 265, 1883; L. P. Kinnicutt, *Amer. Chem. Journ.*, **5**. 43, 1883; G. Williams, *Chem. News*, **52**. 205, 301, 1885; A. Eiloart, *ib.*, **52**. 183, 1885; H. W. Paulus, *U.S. Pat. No.* 1420209, 1922.

¹⁹ R. Ehrenfeld, *Journ. prakt. Chem.*, (2), **67**. 49, 1903; V. B. Lewes, *Chem. News*, **63**. 32, 40, 1891; M. Berthelot, *Compt. Rend.*, **79**. 1100, 1874; H. Jahn, *Sitzber. Akad. Wien*, **81**. 756, 1880; **82**. 511, 1880; *Monatsh.*, **1**. 378, 675, 1880; S. M. Losanitsch, *Ber.*, **43**. 1871, 1910; A. Cöhn and H. Becker, *ib.*, **43**. 130, 1910; J. A. Muller and E. Peytral, *Bull. Soc. Chim.*, (4), **20**. 34, 1921.

²⁰ C. Wilde, *Liebig's Ann.*, **127**. 170, 1863; R. Anschütz and H. Pauly, *Ber.*, **27**. 1304, 1894; L. Claisen, *ib.*, **10**. 1667, 1877; A. Bistrizycky, *ib.*, **34**. 3073, 3079, 1901; **36**. 3558, 1903; **37**. 655, 1904; **39**. 51, 1906; **40**. 4370, 1907; **41**. 686, 1665, 1908; A. Bistrizycky and M. Fellmann, *ib.*, **43**. 772, 1910; C. Engler and E. Löw, *ib.*, **26**. 1438, 1893; C. Engler and L. Dengler, *ib.*, **26**. 1445, 1893; C. F. Cross and E. J. Bevan, *Chem. News*, **25**. 207, 1885.

²¹ P. Schützenberger, *Compt. Rend.*, **69**. 352, 667, 747, 1869; *Bull. Soc. Chim.*, (2), **10**. 188, 1868; (2), **12**. 198, 1869; C. von Than, *Liebig's Ann. Suppl.*, **5**. 236, 1867; A. Emmerling and B. von Lengyel, *ib.*, **7**. 101, 1869; *Ber.*, **2**. 546, 1869; J. Davy, *Phil. Trans.*, **102**. 144, 1812; *Nicholson's Journ.*, (2), **30**. 28, 1811; L. Mond, *Proc. Roy. Inst.*, **13**. 668, 1892; *Journ. Pharm. Chim.*, (5), **27**. 575, 1893; A. Cöhn and H. Becker, *Ber.*, **43**. 130, 1910.

²² J. W. Döbereiner, *Schweigger's Journ.*, **16**. 106, 1816; **23**. 68, 1818; J. E. Lorrin, *Monit. Scient.*, (3), **7**. 974, 1877; *Compt. Rend.*, **82**. 750, 1876; G. Chevrier, *ib.*, **69**. 138, 1869; C. Moureu, *ib.*, **119**. 337, 1894; *Bull. Soc. Chim.*, (3), **11**. 1066, 1894; J. B. A. Dumas, *Ann. Chim. Phys.*, (2), **33**. 110, 1826; M. Berthelot, *ib.*, (3), **46**. 477, 1856; *Compt. Rend.*, **42**. 447, 1856; C. Engler and J. Grimm, *Ber.*, **30**. 2921, 1897; W. Wislicenus, *ib.*, **27**. 792, 1091, 1894; **28**. 811, 1895; A. Scott, *Journ. Chem. Soc.*, **71**. 550, 1897; F. W. Skirrow, *Zeit. phys. Chem.*, **41**. 141, 1902; T. D. Mitchell, *Amer. Journ. Science*, (1), **25**. 344, 1833; L. D. Gale, *ib.*, (1), **27**. 129, 1835; J. S. Stas, *Bull. Acad. Belg.*, (1), **16**. 9, 1849; B. Blount, *Analyst*, **43**. 88, 1918.

²³ J. W. Döbereiner, *Schweigger's Journ.*, **32**. 345, 1821; F. Göbel, *ib.*, **65**. 155, 1832; **67**.

74, 1833; G. André, *Compt. Rend.*, **102**, 553, 1474, 1886; J. Riban, *ib.*, **93**, 1023, 1881; M. Berthelot and H. Gaudechon, *ib.*, **150**, 1690, 1910; J. E. Lorin, *ib.*, **82**, 750, 1876; *Monit. Scient.*, (3), **7**, 974, 1877; L. Maquenne, *Compt. Rend.*, **96**, 63, 1883; *Bull. Soc. Chim.*, (2), **39**, 306, 1883; M. Berthelot, *ib.*, **42**, 447, 1856; *Ann. Chim. Phys.*, (3), **46**, 477, 1856; C. Engler and J. Grimm, *Ber.*, **30**, 2921, 1897; V. Merz and J. Tibirica, *ib.*, **13**, 23, 1890; E. Rupp, *Chem. Ztg.*, **32**, 983, 1908; Lord Rayleigh, *Proc. Roy. Soc.*, **62**, 204, 1897; J. Meyer, *Zeit. Elektrochem.*, **14**, 506, 1909; V. H. Veley, *Phil. Mag.*, (6), **6**, 271, 1903; P. Sabatier and A. Maible, *Compt. Rend.*, **152**, 1212, 1911; J. S. Morgan, *Journ. Chem. Soc.*, **109**, 274, 1916; T. Okaya, *Proc. Phys. Math. Soc. Japan*, (3), **1**, 43, 1919; M. Wegner, *Zeit. anal. Chem.*, **42**, 427, 1903; E. R. Schierz, *Journ. Amer. Chem. Soc.*, **45**, 447, 1923; J. Peterson, *Zeit. phys. Chem.*, **33**, 699, 1900.

²⁴ G. Fownes, *Phil. Mag.*, (3), **24**, 21, 1844; C. Grimm and G. Ramdohr, *Liebig's Ann.*, **98**, 127, 1856; Lord Rayleigh, *Proc. Roy. Soc.*, **62**, 204, 1897; J. Wade and L. C. Panting, *Journ. Chem. Soc.*, **73**, 255, 1898.

²⁵ A. Geuther, *Liebig's Ann.*, **123**, 121, 1862; J. Thiele and F. Dent, *ib.*, **302**, 273, 1898; M. Hermann, *ib.*, **95**, 211, 1855; M. Tanret, *Compt. Rend.*, **79**, 662, 1874; G. André, *ib.*, **102**, 553, 1886; A. Desgrez, *ib.*, **125**, 780, 1897; A. Desgrez and M. Nicloux, *ib.*, **125**, 973, 1898; L. de St. Martin, *ib.*, **126**, 533, 1036, 1898; G. Moser, *Monatsh.*, **29**, 573, 1908; L. von Stubenrauch, *Zeit. Nahr. Genuss.*, **1**, 737, 1898.

²⁶ W. Ramsay, *Journ. Chem. Soc.*, **95**, 624, 1909; *Amer. Chem. Journ.*, **42**, 150, 1909; W. Ramsay and F. L. Usher, *Ber.*, **42**, 2930, 1909.

§ 24. The Physical Properties of Carbon Monoxide

Carbon monoxide may be obtained in all states of aggregation. At ordinary temp. it is a colourless gas without smell or taste; L. P. Cailletet¹ condensed the gas by cooling and obtained a colourless and transparent liquid; while S. von Wroblewsky by further cooling obtained a snow-white crystalline solid. A. Livsidge observed dendritic crystals. According to W. Wahl, when cooled by liquid air carbon monoxide crystallizes in the cubic system. The manner of growth indicates that the prevailing form is that of the rhombic dodecahedron. A. Eucken said that the solid exists in two allotropic forms with a transition temp. at -213° . W. Cruickshank gave 0.9678 for the **relative density** of the gas at 0° , air unity; F. J. Wrede gave 0.96779; R. F. Marchand, 0.96812 in 1845, and 0.87563 in 1848; T. Thomson, 0.9698; H. V. Regnault, 0.9673; A. Leduc, 0.96702; and Lord Rayleigh, 0.96716. The last-named found that the relative densities of the gas prepared by different methods are in close agreement. For the **weight of a litre** of the gas, at 0° and 760 mm., P. A. Guye gave 1.2504 grms.; and A. Jaquerod and F. L. Perrot gave 1.25025 grms. at 0° and 760 mm., and 0.25445 at 1067.4° and 760 mm. P. A. Guye also gave for the gas constant R , 22.413. From his data A. Leduc computed 27.793 for the **molecular weight** of carbon monoxide if that of oxygen be 31.96. Lord Rayleigh calculated that the mol. wt. is 27.9989, if that of oxygen be 32; A. Scott gave 27.99; and A. Jaquerod and F. L. Perrot, 28.009 (at 1067°). The computed mol. wt. is 28.002, and hence at ordinary temp. carbon monoxide approximates closely to an ideal gas. From A. Jaquerod and F. L. Perrot's datum it follows that there is no perceptible dissociation at 1067° , and the gas is virtually in an ideal state; they also pointed out that the mol. wt. of carbon monoxide is the same as that of nitrogen, and that the relative densities and a whole series of physical constants are the same for the two gases—**3**, 27, 4. The comparison was afterwards used by I. Langmuir. The **specific gravity** of the liquefied gas at different temp., and referred to water at 4° , is, according to E. C. C. Baly and F. G. Donnan:

	-205.0°	-200°	-195°	-190° (b.p.)	-185°	-184°
Sp. gr., D	0.8558	0.8348	0.8138	0.7929	0.7718	0.7676

and the data can be represented by the expression $D=0.8558-0.0042(T-68)$, when T represents the temp. on the absolute scale.

The **molecular volume** calculated by L. Meyer² from T. Graham's diffusion experiments is 15.4; from H. Kopp's rules, 23.2; and from assumption as to the vol. of the atoms, 18.8; and from J. Loschmidt's assumption, 25. The deviations are in part due to the different concepts involved in the term mol. vol.—in some

cases the vol. occupied by the mol. is implied, and in others the sphere of action of the mol. A. Naumann also made observations on this subject. D. Berthelot gave 0.99954 for v_0 calculated from $v_0 = (vp/p_0)\{1 + 0.00046(p - p_0)\}$, when v is the vol. under a very small press. p , and p_0 is the normal press. The **weight** of the mol. of carbon monoxide is $28 \times 1.56 \times 10^{-24}$ grm.; the **mean diameter** of the mol. is 3.76×10^{-8} cm. C. E. Guye and R. Rudy calculated the mol. diameter from the electromagnetic rotation. The **mean free path** of the mol. computed by J. H. Jeans, etc., is 5.8×10^{-6} cm.; the **collision frequency**, 4800×10^6 encounters per sec.; and the **molecular velocity** represented by the arithmetical mean of the mol. velocities is 454 metres per sec., and by the mean square of the mol. velocities, 493 metres per sec. E. D. Eastman gave for the molar entropy of carbon monoxide 45.6 cal. per degree at 25°. P. D. Foote and F. L. Mohler gave 10.1 and 14.3 volts for the **ionization potentials** of carbon monoxide. R. Gans discussed the symmetry of the mol. of carbon monoxide; M. F. Skinkær and J. V. White, and H. B. Wahlin, the motion of the **electrons** in the molecule; and I. Langmuir, E. D. Eastman, V. Henri, H. Nagaska, and G. W. F. Holroyd, the **electronic structure** of the molecule—*vide* 4. 27, 4; L. B. Loeb, the affinity of the mols. for electrons. The value of **J. D. van der Waals' constant** $a = 1.38 \times 10^6$ to 1.43×10^6 , say, 1.40×10^6 ; and of his $b = 37.7$ to 38.6 , say 38.1 , when vols. are expressed in c.c. and press. in atm., and if in litres per mm., $a = 1064$, and $b = 0.061$. J. A. Muller estimated for the degree of **polymerization** in the critical state, 1.328.

O. E. Meyer³ gave 0.000194 for the **viscosity** coeff. of the gas. T. Graham's values are 0.0001630 at 0° and 0.0001840 at 20°. A. Wüllner, and A. von Obermayer have made observations on this subject. W. Sutherland gave for the effect of temp. on the viscosity, η , of the gas $\eta = \eta_0(1 + 100\alpha)(1 + \alpha\theta)^{-1}(1 + 100/T)^{-1}$, where α is the coeff. of thermal expansion; η_0 , the viscosity at 0°; θ , the temp. in centigrade degrees, and T the temp. in °K. C. J. Smith gave for the viscosities of mixtures of carbon monoxide and nitrogen, 0.0001665 C.G.S. units at 0°; 0.0001737 at 15°; and 0.0002118 at 100°; and the calculated mean **collision area** is 0.767×10^{-15} sq. cm. The **surface tension** of liquid carbon monoxide was measured by E. C. C. Baly and F. G. Donnan,⁴ who found that

		−205°	−203°	−198°	−193°	−188°	−183°
σ	.	11.00	1.053	9.39	8.27	7.20	6.16
$\sigma(Mv)^{\frac{2}{3}}$.	112.67	108.67	98.66	88.65	78.65	68.64

where M denotes the mol. wt.; v , the sp. vol. in c.c. per gram; and σ , the surface tension in dynes per cm. The effect of temp. on the surface tension was represented by $\sigma = 23.77(1 - m)^{0.8197}$, where m denotes the reduced temp. J. Dewar gave for the **specific cohesion**, $a^2 = 3.088$ per sq. mm. at −203°, 2.824 at −193°, and 2.494 at −183°. The effect of temp. on the mol. **surface energy** was represented by $\sigma(Mv)^{\frac{2}{3}} = 1.996(132.47 - T)$, corresponding with a liquid with normal mol. CO. According to W. J. M. Rankine, the **velocity of sound** in carbon monoxide gas at 0° is 337.40 metres per sec.; A. Masson gave 339.76 metres per sec.; and A. Wüllner, 337.129 metres per sec. Values were also obtained by C. Bender.

T. Graham⁵ found that the **diffusion** of carbon monoxide through red-hot iron is such that a capillary tube with walls 1.7 mm. thick allowed 76.5 c.c. of hydrogen to pass per sq. metre per minute, and 0.284 c.c. of carbon monoxide under the same conditions. He also found that the time of transpiration of carbon monoxide through capillary tubes is 0.8750 when that of oxygen is unity; H. St. C. Deville and L. Troost verified this observation and found that even at ordinary temp., cast iron is not impervious to this gas. Similar observations were made by A. J. Morin, and P. J. Coulier. M. Berthelot found that at 625°–650° carbon monoxide can diffuse through glass, and at 800°–810°, the permeability is less. N. R. Campbell discussed the disappearance of carbon monoxide in electric discharge tubes. L. Spencer found carbon monoxide does not diffuse in silver. T. Graham found that the permeabilities of rubber to nitrogen,

carbon monoxide and dioxide are in the proportion 13·585 : 12·203 : 1, but the velocities of diffusion are as 1 : 1·113 : 13·535. J. Dewar studied the rate of diffusion of carbon monoxide through indiarubber; and A. von Obermayer, the speed of the mutual diffusion of hydrogen and carbon monoxide, carbon monoxide and dioxide, and carbon monoxide and ethylene; and J. Loschmidt, carbon dioxide and carbon monoxide, and oxygen and carbon monoxide. J. C. Maxwell made observations on this subject. T. Graham found the speed of diffusion of carbon monoxide through a porous plug agreed with his law, velocity of diffusion = D^{-1} . J. Sameshima and K. Fukaya studied the **atmolytic** of carbon monoxide. F. G. Donnan found the speed of **effusion** of carbon monoxide through a fine opening agreed with T. Graham's law. E. Budde⁶ observed a compression of $\frac{1}{727}$ th vol. by a press. of 2·79 atm. J. O. Natterer measured the **pv-isothermal curves** of carbon monoxide. He showed that if unit vol. of carbon monoxide be compressed by 3600 atm. press., the vol. is not reduced $\frac{1}{3600}$ th as required by Boyle's Law, but it is rather reduced $\frac{1}{505}$ th. The values of p_0v_0/pv for different values of p , when p_0v_0 is unity, become

p atm.	77	307	629	911	1264	1584	1867	2209	2709
p_0v_0/pv	1·000	0·935	0·727	0·578	0·464	0·396	0·352	0·311	0·261

The values of p_0v_0/pv may be taken to represent the **compressibility** of carbon monoxide. E. H. Amagat found for press. p mm., the following relative values of pv at 18°–22° :

p	24·1	34·9	55·5	72·2	101·5	177·6	304·1
pv	27147	27102	27025	27071	27420	29217	33919

H. V. Regnault found the compressibility of carbon monoxide to be 1·00005 between 75 and 150 atm.; Lord Rayleigh gave $\beta = p_1v_1/p_2v_2 = 1·00028$ between 0·5 and 1·0 atm.; and at 13·8° and 0·5 atm., 1·0026. Since $pv = p_0v_0(1 + \alpha p)$, $\beta = 1 - \frac{1}{2}\alpha$; and $\alpha = d(pv)/pv \cdot dp = 2(1 - \beta)$. For carbon monoxide, $\alpha = -0·00081$; and C. Schlatter gave $-0·00048$. E. Mascart made some observations on the compressibility of this gas.

H. V. Regnault⁷ found the **coefficient of thermal expansion** up to 100° at one atm. initial press.—press. variable and vol. constant—to be 0·0036667; and with press. constant at one atm., and vol. variable between 0° and 100°, 0·0036688. These values are very close to those of an ideal gas. A. Jaquerod and F. L. Perrot found 0·0036648 between 0° and 1067°, and initial press. 230 mm. at constant vol. A. Winkelmann gave for the **thermal conductivity**, 0·0000510 cal. per cm. cube per sec. per degree between 7° and 8°; A. Wüllner, 0·0000499 at 0°, and 0·0000545 at 100°. J. Stefan, and F. Soddy and A. J. Berry made observations on this subject. E. Mallard and H. le Chatelier found the **velocity of cooling** of carbon monoxide between 1800° and 300° to be represented by $V = kp^{-0·75}e(e - 200)$, where p denotes the gas press.; e , the excess of the temp. of the gas over that of its surroundings; and k is a constant independent of e and p , but dependent on the character of the containing vessel. The value of k for the iron cylinder they used was 0·043381.

According to H. V. Regnault,⁸ the **specific heat** of carbon monoxide at constant press. is 0·2450–0·2479; and at constant vol., 0·2370–0·2399. E. Wiedemann found at constant press., 0·2425 between 23° and 99°; and 0·2426 between 26° and 198°. M. Berthelot and P. Vieille measured the sp. ht. of mixtures of carbon and nitrogen monoxides. P. Vieille estimated the mean **molecular heat** at ordinary temp. to be $C_v = 4·8$; at 3100°, $C_v = 6·30$; at 3600°, $C_v = 7·30$; and at 4400°, 8·10, on the assumption that dissociation does not occur. E. Mallard and H. le Chatelier represented the effect of temp. on the mol. ht. of carbon monoxide by $C_p = 6·5 + 0·0006T$. K. Scheel and W. Heuse found for C_p , 7·006 at 18°, and 7·244 at -180° . A. Eucken found the mol. ht. of solid α -carbon monoxide, or carbon monoxide-II to be $C_p = 2·62$, and $C_v = 2·58$ at 17·5° K.; and $C_p = 13·64$ and $C_v = 9·99$ at 57·1° K. The value of C_p was calculated from that of C_v by W. Nernst and F. A. Lindemann's expression $C_p - C_v = AT C_p^2$, where the constant A is $3·3 \times 10^{-4}$. For liquid carbon monoxide, $C_p = 12·28$ at 62·95° K., and 14·47 at 77·9° K. The

value of P. Debye's constant θ is 119. A. Cazin found the ratio of the two specific heats, C_p/C_v , of carbon monoxide to be 1.41; A. Masson gave 1.413; A. Leduc, 1.401; and A. Wüllner, 1.40320 at 0° , and 1.39565 at 100° . K. Scheel and W. Heuse found 1.398 for the ratio at 18° , and 1.472 at -180° . J. R. Partington gave 1.205 for the **chemical constant**. H. C. Urey calculated the **entropy** of carbon monoxide at 25° to be 45.6, and R. C. Tolman and R. M. Badger also calculated values for this constant.

M. Faraday,⁹ M. Berthelot, and J. O. Natterer failed to liquefy carbon monoxide—M. Faraday worked at 40 atm. press. and a bath of carbon dioxide in vacuo, and J. O. Natterer used a press. of 2790 atm. L. P. Cailletet observed that carbon monoxide remains in the gaseous state when cooled to -29° by sulphur dioxide, and kept under a press. of 300 atm.; if, however, the press. be suddenly relieved, an opaque mist is produced by the liquefaction of the gas. S. von Wroblewsky and K. Olszewsky found that carbon monoxide is not liquefied by a press. of 150 atm. at -136° , but if the press. is suddenly released, liquefaction occurs, and if the release of the press. be not too rapid, the gas is completely liquefied. They announced their discovery in a despatch to the Paris Academy, April 21, 1883, in these words: "Oxyde de carbone liquéfié dans les mêmes conditions que l'azote. Mémisque visible. Liquide incolore." In the modern apparatus, the liquefaction of carbon monoxide is a comparatively simple operation. S. von Wroblewsky found that if liquid carbon monoxide be evaporated in vacuo, the temp. falls to -200° . K. Olszewsky found that the liquid freezes to a snow-like mass or an opaque solid when the liquid is evaporated in vacuo. Before solidification occurs, S. von Wroblewsky said that the liquid becomes viscid and turbid. At a press. of 90–100 mm., and at -199° , a crust of solid forms on the surface of the liquid; the crust then crazes, and the whole mass solidifies. K. Olszewsky found the **temperature of liquefaction**, θ° , of carbon monoxide under different press. p , in atm. to be:

p	25.7	21.5	18.1	14.8	4.6	1.0
θ	-145.3°	-148.8°	-152.0°	-155.7°	-172.6°	-190.0°

S. von Wroblewsky, K. Olszewsky, and E. Cardoso respectively give for the **critical temperature** -141.1° , -139.5° , and -138.7° ; and for the **critical pressure**, 35.9, 35.5, and 34.6 atm. H. K. Onnes and co-workers gave -132° for the critical temp. and 35.9 for the critical press. E. Cardoso gave 0.3110 for the **critical density**; and D. A. Goldhammer, 0.2982. S. F. Pickering gave for the best representative values, $\theta_c = -134.4^\circ$; $p_c = 34.6$ atm.; and $D_c = 0.3110$. Carbon monoxide furnishes a colourless transparent liquid with a marked meniscus. It evaporates very quickly. K. Olszewsky gave -190° for the **boiling point** at atm. press., and S. von Wroblewsky, -193° . The latter also said that it boils at -190° under a press. of 735 mm., and at -201.6° under 40 mm. press.; and if 6 per cent. of carbon dioxide be present, the liquid boils at -116° under atm. press. The **vapour pressures** of the liquid and solid have been measured by K. Olszewsky, S. von Wroblewsky, E. C. C. Baly and F. G. Donnan, and H. Happel. The values of S. von Wroblewsky are:

Vap. press., p	-201.6°	-198.83°	-197.5°	-190°	-159.7°	-154.73°	-147.73°	-141.2°	-140.2°
	40	100	160	735	12.80	16.21	23.58	34.42	39.0
	Solid p in mm.				Liquid p in atm.				

E. C. C. Baly and F. G. Donnan gave:

Vap. press., mm.	-205°	-200°	-195°	-191°	-190°	-185°	-183°
	114.30	248.80	483.96	772.35	863.06	1429.98	1722.63

L. P. Cailletet found that carbon monoxide solidifies at -211° ; S. von Wroblewsky, at -199° ; and K. Olszewsky, at -207° and under 100 mm. press. The **melting point**, according to A. Eucken, is -212.6° , or 60.4° K. The solid exists in two forms with a transition point at -213° or 60° K. Hence,

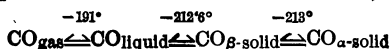

A. Eucken found 144.1 cal. per mol for the **heat of transformation** of the solid; 224.1 cal. per mol for the **heat of fusion**; and 1414 cal. per mol for the **heat of vaporization**. K. Bennewitz and F. Simon studied Trouton's constant for carbon monoxide.

J. Thomsen¹⁰ obtained for the **heat of formation** of carbon monoxide $C+O=CO+30.315$ Cals.; M. Berthelot and C. Matignon +26.1 Cals.; and M. Berthelot, 25.7 Cals. with diamond carbon, and 28.7 Cals. with amorphous carbon. H. Jüptner von Jonstorff found the **free energy, F** , of the reaction $C+\frac{1}{2}O_2=CO$ to be $F=28652.2+2.53T+4.56T \log p_{O_2}/p_{CO}$; and for the reaction $C+CO_2=2CO$, $F=-40657.8+40.15T+4.56T \log p_{CO_2}/p_{CO}^2$. G. Bodländer, and E. Baur made observations on this subject. The **heat of solution** of 28 grms. of carbon monoxide in an acid soln. of cuprous chloride was found by H. Hammerl to be 11.37 Cals. J. Bronn calculated 5000° for the temp. of combustion of carbon monoxide, and for the **heat of combustion** of carbon monoxide, P. L. Dulong gave 69.9 Cals.; and C. Grassi, 52.5 Cals. T. Andrews found for a litre of carbon monoxide with excess oxygen, 3.057 Cals.; for a litre of oxygen with excess carbon monoxide, 6.114 Cals.; for a gram of oxygen with excess carbon monoxide, 4.255 Cals.; and for a gram of carbon monoxide with excess oxygen, 2.431 Cals., P. A. Favre and J. T. Silbermann gave 2.403 Cals. per gram of carbon monoxide. J. Thomsen gave $CO+O=CO_2+66.810$ Cals.; and $(CO, O, aq.)=72.69$ Cals. M. Berthelot gave 68.3 Cals.; D. Lagerlof, 68.4 Cals. at constant vol.; and M. Berthelot and C. Matignon, 67.9 Cals. at constant vol., and 68.2 Cals. at constant press. The subject has been discussed by H. E. Armstrong, A. Boillot, and by S. U. Pickering—*vide* combustion of carbon.

Carbon monoxide thus represents partially-burnt carbon. When formed by the combustion of carbon in air, the product is called *simple producer gas*. It is used as a fuel in the so-called gas-firing. In the ideal case, producer gas contains 34.7 per cent. by vol. or weight of carbon monoxide, and 65.3 per cent. of nitrogen. One pound of carbon furnishes 6.71 lbs. of simple producer gas:

	Heat units.
One pound of carbon burning to carbon dioxide gives	8080
6.71 lbs. of producer gas burning to carbon dioxide give	5588
Difference	2492

This difference, approximately 31 per cent., represents a kind of dead charge on the process of converting the solid fuel into gaseous fuel—simple producer gas. It shows that so far as mere fuel-saving is concerned, the use of gaseous fuel in preference to direct firing is not necessarily economical.

W. H. Miller¹¹ showed that carbon monoxide gas is transparent to the chemical rays. The **index of refraction** has been determined by E. Mascart, F. Perreau, J. Koch, H. C. Rentschler, M. Croullebois, C. and M. Cuthbertson, J. Klemencic, F. Mohr, and G. Gruschke. The following are selected from their results for light of wave-length λ :

$\lambda(\mu\mu)$. 334.2	471.3	501.6	546.2	589.6	644.0	670.9	867.8
Index	1.0003442	1.0003394	1.0003379	1.0003361	1.000349	1.0003328	1.0003325	1.00033255

T. M. Lowry inferred from the index of refraction and sp. inductive capacity that the mol. is not internally ionized. E. Mascart gave for the **dispersion** 0.0075. A. Kundt and W. C. Röntgen found 0.000232 for the electromagnetic **rotation of the plane of polarized light** in carbon monoxide at 20° and atm. press., referred to that of carbon disulphide at the same temp. E. von Bahr measured the absorption of the ultra-violet rays by carbon monoxide; H. Baerwald, A. Becker, and J. Robinson, the absorption coeff. for **cathode rays**; and J. J. McHenry, the action of the **positive rays** on carbon monoxide. A. Forshaw investigated the **luminosity** of the burning gas. The **spectrum** of carbon monoxide has been discussed in connection with that of carbon. E. C. Kembel¹² computed the relative intensities of the bands in the ultra-red spectrum; and C. Schaefer, and M. Thomas studied the structure of the ultra-red absorption spectrum; and V. Henri, the absorption

spectrum. M. Duffieux calculated the mass of the particles that emit the spectrum of carbon monoxide. W. W. Coblentz measured the ultra-red spectrum of carbon monoxide at 0.8 mm. press. and obtained the result shown in Fig. 35. C. Schaefer measured the ultra-red spectrum of carbon monoxide.

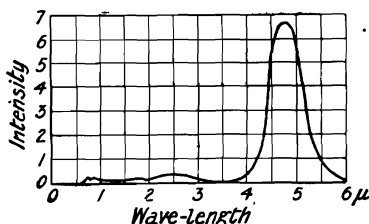

FIG. 35.—Ultra-red Emission Spectrum of Carbon Monoxide.

G. Gehlhoff¹³ measured the **cathode fall of potential** of carbon monoxide eliminating the effects of decomposition. He was unable to confirm the statement that the cathode fall of potential of a compound gas is the sum of the separate values calculated for the component atoms. G. Stead and B. S. Gossling gave 15 volts, and C. G. Found 13.5 to 14 volts for the **ionizing potential**; and A. L. Hughes and A. A. Dixon, 7.2 volts. P. D. Foote and F. L. Mohler

found two ionizing potentials, 10.1 volts and 14.3 volts; and C. A. Mackay gave 14.1 and 15.6 volts. H. B. Wahlin measured the affinity of the mols. of carbon monoxide for the electrons. E. P. Metcalfe measured the **ionization by α -rays** in various gases. Assuming that the additive law applies, the value for carbon was 0.42 from the series oxygen, carbon dioxide, carbon monoxide; while for the series methyl, ethyl, and butyl alcohols the value 0.69 was obtained, and a similar value was obtained for carbon from the series hydrogen, methane, ethane, propane, butane, and pentane. Hence, only for a series of related compounds is the additive law applicable. The combustion of dry filtered carbon monoxide gives rise to ions of an order of mobility totally different from those produced by the moist gas. Direct comparison of the ions produced in air by radium and by a dry carbon monoxide flame showed that the mobility of the positive ions is 20 per cent. greater, and of the negative ions 70 per cent. greater, in the case of radium. Hence it is inferred that the ions produced by the combustion of carbon monoxide and by radium have very similar mobilities and are probably identical. M. F. Skinner and co-workers, and R. N. Chaudhuri also studied the motion of the electrons in crossed electric and magnetic fields. M. Brotherton studied the emission of electrons when liquid alloys of sodium and potassium act on carbonyl chloride.

M. de Broglie, and V. Hoepfer measured the **electromotive force** of carbon monoxide and oxygen gas cells, and found the e.m.f. of the combination Pt : CO : HCl : HgCl : Hg : HgCl : HCl : O : Pt is 0.45 volt, and when carbon is substituted for platinum, a similar value is obtained. H. Kallmann found that the e.m.f., E , of cells containing carbon monoxide, carbon dioxide, and oxygen on one side of a glass wall, and air on the other at 717° and at press. between 800–920 mm., could be expressed by the equation $E = 1.118 - 0.0707 \log p_{CO_2}/p_{CO}p_{CO_2}^{\dagger}$. From the effects obtained by mixing air with the carbon monoxide, V. Hoepfer inferred that carbon monoxide is not indifferent to oxygen but unites with it to form carbon dioxide. It was also found that the potential difference between platinum and a soln. of cuprous chloride is the same whether the soln. contains carbon monoxide or not. Similar results were obtained with carbon. The basis of W. Borchers' cell, Cu : CO : CuCl : O : C, is Cu : CuCl : C with an e.m.f. of 0.45 volt. The e.m.f. is not appreciably affected by introducing carbon monoxide about the copper electrode and oxygen about the carbon electrode. The oxygen, however, prevents the separation of copper at the carbon electrode, and thus the element cannot assume the form Cu : CO : CuCl : Cu with an e.m.f. practically zero. The carbon monoxide is oxidized to carbon dioxide at the copper electrode, and this gives a continuous current. F. Haber and A. Moser made cells in the following manner :

The lower end of a test-tube was etched inside and outside with hydrofluoric acid, the roughened surfaces moistened with platinic chloride and heated so as to produce a coating of **spongy platinum**; electrical contact was made to the coatings by means of platinum

wires, and suitable tubes were introduced to allow carbon monoxide, oxygen, or other gases to be brought into contact with the platinum coatings. The whole was heated by a jacket of boiling sulphur or phosphorus pentasulphide. The hot glass itself acted as the electrolyte, the two coatings of platinum being the electrodes. Air about the outer coating may be considered as the gas about one electrode.

The e.m.f. observed for $\text{CO} + \frac{1}{2}\text{O}_2 = \text{CO}_2$ were in agreement with those calculated from $F = 67440 - 2.42T \log T + 0.0017T^2 - 4.56 \log_{10} p_{\text{CO}_2}/p_{\text{CO}}p_{\text{O}_2} - 5.95T$, between 717° and 791° . When pure carbon monoxide is used, it decomposes in presence of the platinum, depositing carbon. This deposit of carbon produces an e.m.f. of nearly 1 volt. That the e.m.f. is due to the carbon is proved by the fact that it persists in presence of carbon dioxide, but disappears if oxygen be passed in. The resistance of the carbon monoxide-oxygen cell is about 500 ohms. When closed through an external resistance, a current was produced which at first rapidly diminished; after a minute it reached the value 0.32×10^{-4} ampère and the e.m.f. of the cell had fallen to 0.26 volt. M. Faraday, and J. Plücker found carbon monoxide to be diamagnetic. L. Boltzmann gave for the **dielectric constant** at 0° , and one atm. press., 1.000690; J. Klemencic, 1.000695, and A. P. Carman and G. T. Lorange, 1.00099. H. Riegger found 1.002633 at -189° . C. E. Guye and R. Rudy measured the **electromagnetic rotation** of the gas. H. Weigt gave $(0.1180 \pm 0.0016) \times 10^{-18}$ for the **electrical moment** of carbon monoxide.

REFERENCES.

- ¹ W. Cruickshank, *Nicholson's Journ.*, 5, 1, 201, 1801; F. J. Wrede, *Scand. Nat. Förh.*, 2, 242, 1841; *Pogg. Ann.*, 53, 225, 1841; R. F. Marchand, *Journ. prakt. Chem.*, (1), 35, 320, 1845; (1), 44, 38, 1848; H. V. Regnault, *Mém. Acad.*, 26, 701, 1863; Lord Rayleigh, *Proc. Roy. Soc.*, 62, 204, 1897; 73, 153, 1904; T. Thomson, *Ann. Phil.*, 16, 161, 1820; W. Wahl, *Proc. Roy. Soc.*, 89, A, 327, 1914; P. A. Guye, *Arch. Sciences Genève*, (4), 24, 34, 1907; *Compt. Rend.*, 144, 976, 1907; A. Jaquerod and F. L. Perrot, *ib.*, 140, 1542, 1905; *Arch. Sciences Genève*, (4), 20, 506, 1905; A. Leduc, *Recherches sur les gaz*, Paris, 1898; *Ann. Chim. Phys.*, (7), 15, 29, 1898; *Compt. Rend.*, 155, 1072, 1892; L. P. Cailletet, *ib.*, 85, 1213, 1217, 1877; S. von Wroblewsky, *ib.*, 100, 979, 1885; *Sitzber. Akad. Wien*, 90, 667, 1885; *Monatsh.*, 6, 245, 1885; A. Scott, *Proc. Chem. Soc.*, 20, 85, 1904; F. Mohr, *Ber.*, 4, 151, 1871; E. C. C. Baly and F. G. Donnan, *Journ. Chem. Soc.*, 81, 911, 1902; I. Langmuir, *Journ. Amer. Chem. Soc.*, 41, 868, 1543, 1919; 42, 274, 2190, 1920; A. Liversidge, *Chem. News*, 77, 216, 1898; A. Eucken, *Ber. deut. phys. Ges.*, 18, 4, 1916; P. D. Foote and F. L. Mohler, *Phys. Rev.*, (2), 17, 394, 1921.
- ² J. H. Jeans, *Phil. Mag.*, (6), 8, 692, 1904; *The Dynamical Theory of Gases*, Cambridge, 1916; P. D. Foote and F. L. Mohler, *Phys. Rev.*, (2), 17, 394, 1921; D. Berthelot, *Compt. Rend.*, 126, 954, 1898; C. E. Guye and R. Rudy, *ib.*, 174, 382, 1922; J. A. Müller, *ib.*, 175, 760, 1922; E. Dorn, *Wied. Ann.*, 13, 378, 1881; E. D. Eastman, *Journ. Amer. Chem. Soc.*, 45, 80, 1923; J. C. Maxwell, *Phil. Mag.*, (4), 46, 453, 1873; L. Meyer, *Liebig's Ann. Suppl.*, 5, 129, 1867; A. Naumann, *ib.*, 5, 252, 1867; *Phil. Mag.*, (4), 34, 551, 1867; G. W. F. Holroyd, *Journ. Soc. Chem. Ind.*, 42, 681, 1923; I. Langmuir, *Journ. Amer. Chem. Soc.*, 41, 868, 1919; H. Nagaoka, *Proc. Phys. Math. Soc. Japan*, 5, 35, 1923; R. Gans, *Ann. Physik*, (4), 65, 97, 1921; E. D. Eastman, *Journ. Amer. Chem. Soc.*, 144, 438, 1922; L. B. Loeb, *Phil. Mag.*, (6), 43, 229, 1922; M. F. Skinner and J. V. White, *ib.*, (6), 46, 630, 1923; V. Henri, *Compt. Rend.*, 177, 1037, 1923; H. Kopp, *Liebig's Ann.*, 96, 1, 153, 303, 1855; 100, 19, 1856; J. Loschmidt, *Sitzber. Akad. Wien*, 52, 395, 1865; T. Graham, *Phil. Mag.*, (3), 2, 175, 1883; *Phil. Trans.*, 136, 573, 1846; 153, 385, 1863; J. Robinson, *Ann. Physik*, (4), 81, 769, 1910; H. B. Wahlin, *Phys. Rev.*, (2), 21, 517, 1923.
- ³ T. Graham, *Phil. Trans.*, 136, 573, 1846; O. E. Meyer, *Pogg. Ann.*, 143, 14, 1871; O. E. Meyer and F. Springmühl, *ib.*, 148, 526, 1873; C. J. Smith, *Proc. Phys. Soc.*, 34, 155, 1922; A. Wüllner, *Wied. Ann.*, 4, 321, 1878; A. von Obermayer, *Sitzber. Akad. Wien*, 71, 6, 1875; 73, 443, 1876; W. Sutherland, *Phil. Mag.*, (5), 36, 507, 1893.
- ⁴ E. C. C. Baly and F. G. Donnan, *Journ. Chem. Soc.*, 81, 911, 1902; W. J. M. Rankine, *Phil. Mag.*, (4), 5, 483, 1853; A. Masson, *Compt. Rend.*, 44, 464, 1857; C. Bender, *Ber.*, 6, 665, 1873; A. Wüllner, *Wied. Ann.*, 4, 321, 1878; J. Dewar, *Proc. Roy. Soc.*, 68, 360, 1901.
- ⁵ T. Graham, *Proc. Roy. Soc.*, 16, 422, 1867; *Phil. Mag.*, (3), 2, 175, 269, 351, 1833; (4), 32, 401, 503, 1866; *Phil. Trans.*, 136, 573, 1846; 139, 349, 1849; *Journ. Chem. Soc.*, 20, 235, 1867; A. von Obermayer, *Sitzber. Akad. Wien*, 87, 188, 1883; 96, 546, 1888; J. Loschmidt, *ib.*, 61, 367, 1870; 62, 468, 1870; N. R. Campbell, *Phil. Mag.*, (6), 42, 227, 1921; L. Spencer, *Journ. Chem. Soc.*, 123, 2124, 1923; J. Sameshima and K. Fukaya, *Journ. Chem. Soc. Japan*, 44, 690, 871, 1923; P. J. Coulier, *Journ. Pharm. Chim.*, (4), 8, 246, 1869; H. St. C. Deville and L. Troost, *Compt. Rend.*, 66, 83, 1868; A. J. Morin, *ib.*, 68, 1006, 1869; M. Berthelot, *ib.*, 140,

1286, 1905; J. C. Maxwell, *Phil. Mag.*, (4), 46. 453, 1873; F. G. Donnan, *ib.*, (5), 49. 423, 1900; J. Dewar, *Proc. Roy. Inst.*, 21. 813, 1918.

* J. O. Natterer, *Sitzber. Akad. Wien*, 5. 351, 1850; 6. 557, 1850; 12. 199, 1854; *Pogg. Ann.*, 94. 436, 1855; E. H. Amagat, *Ann. Chim. Phys.*, (5), 19. 345, 1880; *Compt. Rend.*, 88. 336, 1879; 89. 437, 1879; A. Leduc, *ib.*, 148. 1173, 1909 E. Mascart, *ib.*, 78. 617, 1874; H. V. Regnault, *Mém. Acad.*, 26. 229, 1862; Lord Rayleigh, *Proc. Roy. Soc.*, 73. 153, 1904; 74. 446, 1905; *Phil. Trans.*, 196. A. 205, 1901; 198. A. 417, 1902; 204. A. 351, 1905; E. Budde, *Journ. prakt. Chem.*, (2), 9. 30, 1874; C. Schlatter, *Sur la compressibilité à 0° et au dessous de l'atmosphère et sur l'écart à la loi d'Avogadro de plusieurs gaz Oxyde de Carbone, Oxyde d'Azote, Acide Chlorhydrique et Oxygène*, Genève, 1923.

† H. V. Regnault, *Ann. Chim. Phys.*, (3), 4. 52, 1842; A. Jaquero and F. L. Perrot, *Arch. Sciences Genève*, (4), 20. 506, 1905; *Compt. Rend.*, 140. 1542, 1905; E. Mallard and H. le Chatelier, *ib.*, 93. 962, 1881; A. Leduc, *ib.*, 148. 1173, 1909; J. Stefan, *Sitzber. Akad. Wien*, 72. 69, 1875; A. Winkelmann, *Pogg. Ann.*, 156. 497, 1875; A. Willner, *Wied. Ann.*, 4. 321, 1878; F. Soddy and A. J. Berry, *Proc. Roy. Soc.*, 83. A, 254, 1910.

‡ E. Wiedemann, *Pogg. Ann.*, 157. 1, 1876; *Phil. Mag.*, (5), 2. 81, 1876; H. V. Regnault, *ib.*, (4), 5. 473, 1853; *Ann. Mines*, (5), 4. 37, 1853; *Mém. Acad.*, 26. 701, 1863; *Compt. Rend.*, 36. 676, 1853; P. Vieille, *ib.*, 96. 1218, 1358, 1883; E. Mallard and H. le Chatelier, *ib.*, 93. 1014, 1076, 1881; A. Leduc, *ib.*, 127. 659, 1898; M. Berthelot and P. Vieille, *ib.*, 98. 545, 601, 1884; *Bull. Soc. Chim.*, (2), 41. 554, 1884; W. D. Womersley, *Proc. Roy. Soc.*, 100. A. 483, 1921; A. Willner, *Wied. Ann.*, 4. 321, 1878; A. Cazin, *Ann. Chim. Phys.*, (3), 56. 206, 1862; A. Eucken, *Ber. deut. phys. Ges.*, 18. 4, 1916; W. Nernst and F. A. Lindemann, *Zeit. Elektrochem.*, 17. 817, 1911; K. Scheel and W. Heuse, *Sitzber. Akad. Berlin*, 44, 1913; J. R. Partington, *Phil. Mag.*, (6), 44. 988, 1922; H. C. Urey, *Journ. Amer. Chem. Soc.*, 45. 1445, 1923; R. C. Tolman and R. M. Badger, *ib.*, 45, 2277, 1923; A. Masson, *Ann. Chim. Phys.*, (3), 53. 257, 1858; *Phil. Mag.*, (4), 13. 533, 1857.

§ M. Faraday, *Phil. Trans.*, 135. 155, 1845; K. Bennewitz and F. Simon, *Zeit. Physik*, 16. 183, 1923; J. O. Natterer, *Sitzber. Akad. Wien*, 5. 351, 1850; 7. 557, 1851; 12. 199, 1854; M. Berthelot, *Ann. Chim. Phys.*, (3), 30. 357, 1850; *Compt. Rend.*, 30. 666, 1850; I. P. Cailletet, *ib.*, 85. 815, 1213, 1217, 1877; S. von Wroblewsky and K. Olszewsky, *ib.*, 96. 1140, 1225, 1884; *Ann. Chim. Phys.*, (6), 1. 112, 1884; *Chem. News*, 47. 193, 1884; *Monatsh.*, 4. 415, 1884; S. von Wroblewsky, *ib.*, 6. 237, 1885; *Sitzber. Akad. Wien*, 90. 667, 1885; *Monatsh.*, 6. 236, 1885; *Wied. Ann.*, 20. 251, 1883; 25. 399, 404, 1885; *Compt. Rend.*, 98. 982, 985, 1884; 100. 979, 1885; K. Olszewsky, *ib.*, 98. 706, 1884; 99. 706, 1884; 100. 350, 1885; *Phil. Mag.*, (5), 39. 188, 1895; *Anz. Akad. Cracow*, 375, 1908; *Monatsh.*, 6. 495, 1885; H. K. Onnes, E. Mathias, and C. A. Crommelin, *Proc. Amsterdam Acad.*, 5. 1401, 1903; S. F. Pickering, *Journ. Phys. Chem.*, 28. 97, 1924; E. Cardoso, *Arch. Sciences Genève*, (4), 39. 403, 1915; E. C. C. Baly and F. G. Donnan, *Journ. Chem. Soc.*, 81. 907, 1902; H. Happel, *Phys. Zeit.*, 8. 204, 1907; A. Eucken, *Ber. deut. phys. Ges.*, 18. 4. 1916; D. A. Goldhammer, *Zeit. phys. Chem.*, 71. 577, 1910.

|| J. Thomsen, *Ber.*, 5. 508, 1872; 6. 1553, 1873; M. Berthelot, *Compt. Rend.*, 90. 1240, 1880; *Bull. Soc. Chim.*, (2), 35. 422, 1881; M. Berthelot and P. Vieille, *ib.*, (2), 41. 561, 566, 1884; *Compt. Rend.*, 98. 770, 852, 1884; H. Hammerl, *ib.*, 89. 97, 1879; M. Berthelot and C. Matignon, *ib.*, 116. 1333, 1893; P. L. Dulong, *ib.*, 7. 871, 1838; H. Jüptner von Jonstorff, *Zeit. anorg. Chem.*, 39. 49, 1904; 40. 61, 1904; C. Grassi, *Journ. prakt. Chem.*, (1), 36. 193, 1845; D. Lagerlof, *ib.*, (2), 69. 273, 513, 1904; (2), 70. 521, 1904; J. Bronn, *Zeit. angew. Chem.*, 35. 328, 1922; P. A. Favre and J. T. Silbermann, *Ann. Chim. Phys.*, (3), 34. 357, 1852; (3), 36. 5, 1852; T. Andrews, *Phil. Mag.*, (3), 32. 321, 426, 1847; H. E. Armstrong, *ib.*, (5), 23. 73, 1887; S. U. Pickering, *ib.*, (5), 23. 109, 1887; G. Bodländer, *Zeit. Elektrochem.*, 8. 833, 1902; E. Baur, *ib.*, 16. 300, 1910; A. Boillot, *ib.*, 97. 490, 1883.

¶ W. H. Miller, *Phil. Trans.*, 153. 1, 1863; *Journ. Chem. Soc.*, 17. 59, 1864; G. Gruschke, *Die Brechung und Dispersion des Lichtes in einigen Gasen*, Breslau, 1910; H. C. Rentschler, *Astrophys. Journ.*, 28. 345, 435, 1908; F. Perreau, *Ann. Chim. Phys.*, (7), 7. 289, 1896; J. J. McHenry, *Phil. Mag.*, (6), 45. 433, 1923; C. and M. Cuthbertson, *Proc. Roy. Soc.*, 97. A, 152, 1920; C. Schaefer and M. Thoms, *Zeit. Physik*, 12. 330, 1923; J. Koch, *Dispersionmessungen an Gasen im sichtbaren und im ultraroten Spektrum*, Upsala, 1907; *Arkiv. Mat. Astr. Fysik*, 8. 20, 1912; *Ann. Physik*, (4), 17. 658, 1905; E. Mascart, *Compt. Rend.*, 78. 617, 679, 1874; M. Croulebois, *ib.*, 87. 692, 1868; *Ann. Chim. Phys.*, (4), 20. 136, 1870; J. Klemencic, *Sitzber. Akad. Wien*, 91. 712, 1885; A. Kundt and W. C. Röntgen, *Wied. Ann.*, 10. 257, 1880; F. Mohr, *Ber.*, 4. 151, 1871; E. von Bahr, *Ann. Physik*, (4), 29. 780, 1909; A. Becker, *ib.*, (4), 17. 381, 1905; J. Robinson, *ib.*, (4), 31. 769, 1910; A. Forshaw, *Journ. Gasbeleucht.*, 52. 940, 1909; H. Baerwald, *Phys. Zeit.*, 11. 145, 1910; *Verh. deut. phys. Ges.*, 12. 159, 1910 E. P. Metcalfe, *Phil. Mag.*, (6), 18. 878, 1909; T. M. Lowry, *Trans. Faraday Soc.*, 18. 82, 1922.

||| W. W. Coblentz, *Investigations of Infra-red Spectra*, Washington, 314, 1905; M. Duffieux, *Compt. Rend.*, 175. 159, 1922; V. Henri, *ib.*, 177. 1037, 1923; E. C. Kemble, *Phys. Rev.*, (2), 21. 689, 713, 1923.

¶¶ M. Faraday, *Phil. Mag.*, (3), 51. 401, 1847; *Phil. Trans.*, 141. 7, 45, 1851; J. Plücker, *Pogg. Ann.*, 73. 571, 579, 1848; L. Boltzmann, *Sitzber. Akad. Wien*, 69. 795, 1874; J. Klemencic, *ib.*, 91. 712, 1885; H. Riegger, *Ann. Physik*, (4), 59. 753, 1919; H. Weigt, *Phys. Zeit.*, 22. 643, 1921; V. Hoepfer, *Zeit. anorg. Chem.*, 20. 419, 1899; G. Gehlhoff, *Ann. Physik*, (4), 24. 553, 1907;

C. Schaefer, *ib.*, (4), 67, 407, 1922; F. Haber and A. Moser, *Zeit. Elektrochem.*, 11, 593, 1905; H. Kallmann, *ib.*, 28, 81, 1922; W. Borchers, *ib.*, 4, 42, 1897; F. Haber, *Thermodynamik technischer Gasreaktionen*, München, 1905; London, 319, 1908; E. P. Metcalfe, *Phil. Mag.*, (6), 18, 878, 1909; M. de Broglie, *Compt. Rend.*, 150, 1425, 1910; C. E. Guye and R. Rudy, *ib.*, 174, 382, 1922; H. B. Wahlin, *Phys. Rev.*, (2), 19, 173, 1922; P. D. Foote and F. L. Mohler, *ib.*, (2), 17, 394, 1921; C. G. Found, *ib.*, (2), 15, 132, 1920; A. P. Carman and G. T. Loranoe, *ib.*, (2), 20, 715, 1922; G. Stead and B. S. Gossling, *Phil. Mag.*, (6), 40, 413, 1920; R. N. Chaudhuri, *ib.*, (6), 46, 461, 1923; M. F. Skinner, *ib.*, (6), 44, 994, 1922; M. F. Skinner and J. V. White, *ib.*, (6), 46, 630, 1923; A. L. Hughes and A. A. Dixon, *Phys. Rev.*, (2), 10, 495, 1917; C. A. Mackay, *ib.*, (2), 23, 553, 1924; M. Brotherton, *Proc. Roy. Soc.*, 105, A, 468, 1924.

§ 25. The Solubility of Carbon Monoxide

H. Davy¹ reported that water absorbs $\frac{1}{50}$ th of its vol. of this gas; J. Dalton said $\frac{1}{27}$ th; and T. de Saussure, $\frac{1}{16}$ th. Other observations have been made by K. Angström, A. Christoff, S. Gniewasz and A. Walfisz, G. Hüfner, E. Wiedemann, and A. Findlay and H. J. M. Creighton. R. Bunsen represented his determinations of the solubility by the formula: $\beta = 0.032874 - 0.00081632\theta + 0.000016421\theta^2$, where β , the **absorption coefficient**, denotes the vol. of carbon monoxide reduced to n.p. θ , absorbed by one vol. of water when the press. of the gas apart from that of the solvent is 760 mm. F. Henrich recalculated R. W. Bunsen's data and gave the formula $\beta = 0.032784 - 0.00080094\theta + 0.000015872\theta^2$. The following is a selection from L. W. Winkler's observations:

	0°	5°	10°	15°	20°	40°	60°	80°	100°
s.	0.03537	0.03149	0.02816	0.02543	0.02319	0.01775	0.01488	0.01430	0.01410
g.	0.0044	0.0039	0.0035	0.0031	0.0028	0.0021	0.0015	0.0010	0.0000

It also includes g , the number of grams of carbon monoxide absorbed by 100 grms. of water at a total press. of 760 mm. The **solubility coefficient**, l , representing the ratio of the vol. v of the gas absorbed at any press. and temp., to the vol., V , of the absorbing liquid such that $l = v/V$, can be calculated from the absorption coeff. by the relation $l = \beta(1 + 0.00367\theta)$. G. Just gave 0.02586 for water at 20°, and 0.02404 for water at 25°. K. Angström estimated that the absorption by water of a vol. of carbon monoxide equal to its own vol. causes an expansion of 0.00127 vol.

According to F. Leblanc,² soln. of *cuprous chloride* in hydrochloric acid readily absorb carbon monoxide, and this is accompanied by a slight rise of temp.; ammoniacal soln. of cuprous chloride is also a good absorbent. The soln. sat. with carbon monoxide can be treated with much water without the separation of cuprous chloride, or the evolution of gas. The gas is given off when the soln. is boiled or treated in vacuo. These soln. of cuprous chloride are accordingly used as absorbents for carbon monoxide in gas analysis—*vide* cuprous chloride, 3, 21, 13. A. Kropf found that a little stannous chloride in a hydrochloric acid soln. of cuprous chloride increased the absorptive power for carbon monoxide. A. T. Larson and C. S. Teits worth studied the absorption of carbon monoxide by ammoniacal soln. of cuprous carbonate and formate. F. Jean showed that the gas is also absorbed by an ammoniacal soln. of *silver oxide*. A. Desgrez and co-workers, and A. Piutti discussed the rate of absorption of carbon monoxide by chromic acid, potassium permanganate, alkali peroxides, and iodine pentoxide, from currents of gas. A. B. Lamb and co-workers reported on the removal of carbon monoxide from air.

L. W. Winkler developed an empirical relation between the absorption coeff., β , and the viscosity coeff., η , such that at temp. θ and θ_1 ,

$$\frac{\beta_\theta - \beta_{\theta_1}}{\beta_\theta} = \frac{\eta_\theta - \eta_{\theta_1}}{\eta_\theta} \cdot \frac{M\beta}{k}$$

where k is a constant, and M is the mol. wt. of the gas. T. E. Thorpe and J. W. Rodger showed that the real relation can be represented by

$$\frac{1}{\beta} \cdot \frac{d\beta}{d\theta} = k \frac{1}{\eta} \frac{d\eta}{d\theta}$$

K. Angström found that the increase in the vol. of water sat. with carbon monoxide is 0·0000418, or 0·00127 per unit vol. of gas absorbed. The press. necessary to compress the gas from unit vol. to 0·00127 vol. is 3200 atm. L. Cassuto measured the effect of press. on the solubility of carbon monoxide in water. P. Villard observed no signs of the formation of a hydrate when carbon monoxide dissolves in water.

A. Christoff³ measured the solubility coeff. of carbon monoxide in dil. *sulphuric acid*, at 25°, and found for water, 0·02482; for 35·82 per cent. sulphuric acid, 0·0114; for 61·62 per cent. acid, 0·00958; and for 95·6 per cent. acid, 0·0245. G. R. Fonda measured the solubility in aq. soln. of *sodium hydroxide*, of *potassium hydroxide*, and of *sodium nitrate*. The results with the alkali-lye are attended by the formation of sodium formate: $\text{CO} + \text{NaOH} \rightleftharpoons \text{H.COONa}$; if p_0 represents the initial press. of the carbon monoxide, and p the press. at the time t , $k = \{\log(p_0/p)\}/t$. The results are shown graphically in Fig. 36.

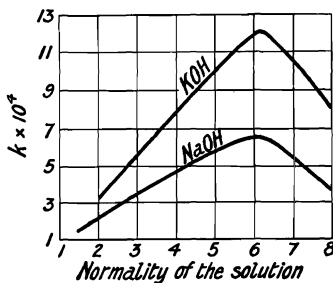

FIG. 36.—Solubility of Carbon Monoxide in Solutions of Potassium and Sodium Hydroxides.

The solubility of carbon monoxide in a number of organic solvents has been determined. M. Berthelot said that the solubility in *ethyl alcohol* is seven or eight times as great as it is in water. L. Carius found that the solubility in ethyl alcohol between 0° and 25° was constant within the limits of his experimental error such that $\beta = 0\cdot20443$, but G. Just gave for the solubility coefficients respectively at 20° and 25°, ethyl alcohol, 0·1901 and 0·1921; *methyl alcohol*, 0·1830 and 0·1955; *amyl alcohol*, 0·1706 and 0·1714; *aniline*, 0·05055 and 0·05358; *carbon disulphide*, 0·08112 and 0·08314; *nitrobenzene*, 0·09105 and 0·09366; *benzene*, 0·1645 and 0·1707; *acetic acid*, 0·1689 and 0·1714; *xylene*, 0·1744 and 0·1781; *toluene*, 0·1742 and 0·1808; *chloroform*, 0·1897 and 0·1954; *amyl acetate*, 0·2108 and 0·2140; *acetone*, 0·2128 and 0·2225; *isobutyl acetate*, 0·2314 and 0·2365; and *ethyl acetate*, 0·2419 and 0·2516. A. Christoff gave for the solubility coeff. of carbon monoxide in *ether* at 0° and 10° respectively 0·3618 and 0·3842. G. Claude measured the solubility of carbon monoxide in ether between 20° and -40°, and for press. up to 1600 atm. S. Gniewasz and A. Walfisz found 100 vols. of *petroleum* absorb 13·4 vols. of carbon monoxide at 10°, and 12·3 vols. at 20°. P. Falcicola made cryoscopic observations on the solubility of carbon monoxide in water, *formic acid*, *acetic acid*, *benzene*, *nitrobenzene*, *acetophenone*, *phenol*, *p-xylene*, *bromoform*, and *ethylene dibromide*. O. Lubarsch gave for the solubility of carbon monoxide in mixtures of ethyl alcohol and water at 20° and 760 mm.

Per cent. alcohol	0	9·9	16·67	23·08	28·57	33·33	50·00
Per cent. CO absorbed	2·41	1·87	1·75	1·68	1·50	1·94	3·20

F. W. Skirrow observed the solubility of carbon monoxide in a number of mixtures at 25°—*e.g.* in a soln. of *aniline*, *carbon disulphide*, *naphthalene*, *phenanthrene*, *α -naphthol*, *β -naphthol*, *ethyl alcohol*, *nitrobenzene*, *chloroform*, *toluene*, or *benzene* in *acetic acid*, *acetone*, *benzene*, or *toluene*; also in mixtures of *methyl alcohol* with *chloroform* or *glycerol*, or in a mixture of *carbon disulphide* and *ethylene dichloride*. It was concluded that the solubility in various mixtures of organic solvents is, in general, an additive function.

According to A. Schwenkenbecher,⁴ carbon monoxide is not absorbed through the *skin*. G. Hüfner found the absorption coeff. in hæmoglobin between 19·50° and 20·25° varies from 0·02018 to 0·02290. Hence, the gas is less soluble in hæmoglobin soln. than in water. A. Findlay and H. J. M. Creighton measured the solubility of carbon monoxide in the *blood* and *serum* of the ox. In both cases

the solubility is less than in water. N. Gréhant found that 100 c.c. of blood absorbed from air mixed with carbon monoxide :

Parts of CO	0.001	0.0050	0.00250	0.00167	0.00083	0.00067	0.00038	0.00019
Absorbed CO in 1 hr.	8.0	4.1	3.0	1.6	—	0.59	0.44	0.22
Absorbed CO in 2 hrs.	10.0	7.8	4.2	3.1	1.63	1.18	0.88	0.45

J. Hunter⁵ found that one vol. of wood charcoal at ordinary temp. adsorbed 21.2 vols. of carbon monoxide, reduced to 0° and 760 mm.; R. A. Smith found 6.00 to 6.03 vols. of gas were adsorbed. J. Dewar found that one c.c. of wood charcoal at 0° adsorbed 21 c.c. of gas, and at -185°, 190 c.c.; 27.5 cal. of heat were developed during the adsorption. J. F. Homfray, W. Hempel and G. Vater, and E. Blumtritt made observations on this subject—*vide supra*. T. Graham observed that at a dull red heat, iron absorbs 4.15 vols. of carbon monoxide which is given up at a higher temp. or in vacuo. H. Caron said that molten cast iron does not adsorb carbon monoxide—*vide supra*, diffusion of carbon monoxide. A. Sieverts and W. Krumbhaar found carbon monoxide dissolves in solid and in molten nickel, but it does not dissolve in copper at 1520°. A. Matthiessen and W. J. Russell said that copper melted under charcoal does not adsorb carbon monoxide, but H. Caron reported that molten copper absorbs some carbon monoxide and gives it up on cooling. T. Graham found that silver adsorbs 0.15 vol. and gold 0.29 vol. of carbon monoxide. The adsorption of carbon monoxide by iron, nickel, cobalt, copper, palladium, and platinum was studied by H. S. Taylor and R. M. Burns—*vide the respective metals*—and also by copper, cobalt, manganese, and silicon oxides. W. W. Hurst and E. K. Rideal studied the adsorption of carbon monoxide by copper, and copper-palladium. A. Berliner, F. H. Pollard, and D. Tommasi found that platinum adsorbs carbon monoxide. According to M. Berthelot, the vol. of carbon monoxide retained by air-dried clay-soil is equal to the vol. of air which it can retain, and hence the retention of carbon monoxide by the earth after an explosion in a mine, for example, is not due to any specific action between the soil and the gas. For the solubility of carbon monoxide in glass, *vide supra*, diffusion.

REFERENCES.

- ¹ J. Dalton, *Mem. Manchester Lit. Phil. Soc.*, 1. 284, 1789; 5. 11, 1905; T de Saussure, *Gilbert's Ann.*, 47. 163, 1814; H. Davy, *Elements of Chemical Philosophy*, London, 1812; R. Bunsen, *Liebig's Ann.*, 93. 1, 1855; 95. 1, 1855; *Phil. Mag.*, (4), 9. 116, 181, 1855; *Gasometrische Methoden*, Braunschweig, 1857; G. Just, *Zeit. phys. Chem.*, 37. 342, 1901; S. Gniewasz and A. Walfisz, *ib.*, 1. 70, 1887; F. Henrich, *ib.*, 9. 435, 1892; A. Christoff, *ib.*, 55. 627, 1906; E. Wiedemann, *Wied. Ann.*, 17. 349, 1882; G. Hüfner, *Arch. Anat. Physiol.*, 209, 1895; A. Findlay and H. J. M. Creighton, *Biochem. Journ.*, 5. 294, 1911; A. Krogh, *Skand. Arch. Physiol.*, 23. 224, 1910.
- ² F. Leblanc, *Compt. Rend.*, 30. 483, 1850; F. Jean, *ib.*, 135. 746, 1902; L. de St. Martin, *ib.*, 114. 1006, 1892; N. Gréhant, *ib.*, 114. 309, 1892; *Journ. Pharm. Chem.*, (5), 25. 451, 1892; A. B. Lamb, W. C. Bray, and J. C. W. Frazer, *Journ. Ind. Chem. Eng.*, 12. 213, 1920; W. R. Hainsworth and E. Y. Titus, *Journ. Amer. Chem. Soc.*, 43. 1, 1921; M. Berthelot, *Ann. Chim. Phys.*, (3), 46. 488, 1856; (7), 23. 32, 1901; W. Manchot and J. A. N. Friend, *Liebig's Ann.*, 359. 100, 1908; R. Böttger, *ib.*, 109. 351, 1859; C. Winkler, *Lehrbuch der technischen Gasanalyse*, Freiburg, 1884; *Zeit. anal. Chem.*, 28. 269, 1889; R. W. Bunsen, *Gasometrische Methoden*, Braunschweig, 1857; L. M. Dennis and C. G. Edgar, *Journ. Amer. Chem. Soc.*, 19. 859, 1898; A. T. Larson and C. S. Teitworth, *ib.*, 44. 2878, 1922; A. Desgrez, H. Guillelard, A. Hemmerdinger, and A. Labat, *Chim. Ind.*, 6. 118, 1921; D. Welitschkowsky, *Arch. Hyg.*, 1. 231, 1883; O. Binder, *Chem. Ztg.*, 15. 617, 1891; W. Thörner, *ib.*, 15. 767, 1891; A. Kropf, *Zeit. angew. Chem.*, 35. 451, 1922; H. Drehschmidt, *Ber.*, 20. 2762, 1887; 21. 2167, 1888; F. Hamitz-Harnitzky, *Gazz. Chim. Ital.*, 6. 529, 1876; W. Hempel, *Neue Methoden der Gasanalyse*, Braunschweig, 1880; *Ber.*, 20. 2344, 1887; 21. 898, 1888; W. Herapel and L. M. Dennis, *ib.*, 24. 1162, 1891; F. Jean, *Ann. Chim. Anal. Appl.*, 3. 260, 1898; V. B. Lewes, *Journ. Soc. Chem. Ind.*, 10. 407, 1891; T. Lonatschewsky-Petrunjaki, *Journ. Russ. Phys. Chem. Soc.*, 20. 108, 1888; E. H. Richards, *Amer. Chem. Journ.*, 7. 143, 1885; J. W. Thomas, *Journ. Chem. Soc.*, 33. 72, 1878; B. Verver, *L'éclairage au gaz à l'eau de Narbonne et l'éclairage au gaz Leprince examinés et comparés*, Leide, 1858; L. Cassuto, *Nuovo Cimento*, (6), 6. 1903, 1913; K. Angström, *Wied. Ann.*, 15. 297, 1882; A. Piutti, *Rend. Accad. Napoli*, 28. 91, 1922; *Giorn. Chim. Ind. Appl.*, 5. 70, 1923;

L. W. Winkler, *Zeit. phys. Chem.*, **9**, 171, 1892; *Ber.*, **34**, 1408, 1901; T. E. Thorpe and J. W. Rodger, *Journ. Chem. Soc.*, **65**, 782, 1894; P. Villard, *Compt. Rend.*, **106**, 1602, 1888; *Étude expérimentale des hydrates de gaz*, Paris, 1896.

³ L. Carius, *Liebig's Ann.*, **94**, 129, 1855; M. Berthelot, *Ann. Chim. Phys.*, (3), **61**, 463, 1861; O. Lubarsch, *Wied. Ann.*, **37**, 524, 1889; S. Gniewasz and A. Walfisz, *Zeit. phys. Chem.*, **1**, 70, 1887; F. W. Skirrow, *ib.*, **41**, 139, 1902; G. Just, *ib.*, **37**, 342, 1901; A. Christoff, *ib.*, **55**, 627, 1906; P. Falciola, *Atti Accad. Lincei*, (5), **17**, ii, 324, 1908; G. Claude, *Compt. Rend.*, **172**, 974, 1921; G. R. Fonda, *Ueber die Einwirkung von Kohlenoxyd auf Laugen*, Karlsruhe, 1910.

⁴ A. Schwenkenbecher, *Arch. anal. Physiol.*, **121**, 1904; G. Hüfner, *ib.*, **209**, 1895; *Journ. prakt. Chem.*, (2), **30**, 63, 1884; G. Hüfner and R. Külz, *ib.*, (2), **28**, 256, 1895; N. Gréhan, *Compt. Rend.*, **70**, 1182, 1870; **113**, 289, 1891; **116**, 235, 1893; **118**, 594, 1894; **123**, 1013, 1896; **125**, 735, 1897; **143**, 813, 1906; *Compt. Rend. Soc. Biol.*, **163**, 1892; A. de Dominicis, *Boll. Chim. Farm.*, **47**, 258, 1908; *Vierteljahr. Ger. Med.*, (3), **38**, 326, 1909; F. Falk, *ib.*, (2), **53**, 77, 1890; K. Ipsen, *ib.*, (3), **18**, 46, 1899; H. Bertin-Sans, *Bull. Soc. Chim.*, (3), **6**, 663, 1891; (3), **9**, 722, 1892; H. Dresser, *Arch. exp. Path.*, **29**, 119, 1891; N. Zuntz and S. Kostin, *Arch. anat. Physiol.*, **315**, 1900; A. Welzel, *Verh. phys. med. Ges. Würzburg*, **23**, 3, 1889; F. von Fodor, *Zeit. anal. Chem.*, **20**, 574, 1881; W. Hempel, *ib.*, **18**, 399, 1879; F. Hoppe-Seyler, *ib.*, **3**, 439, 1864; F. Nawrocki, *ib.*, **6**, 287, 1867; *Centr. Med. Wiss.*, **5**, 177, 1867; S. von Horozzkiewicz and H. Marx, *Klin. Wochschr. Berlin*, **43**, 1156, 1906; A. Katayama, *Arch. path. Anat.*, **114**, 53, 1888; S. Kostin, *Arch. Physiol.*, **83**, 572, 1901; R. Külz, *Zeit. physiol. Chem.*, **7**, 384, 1883; J. Marshall, *ib.*, **7**, 81, 1883; E. Salkowsky, *ib.*, **7**, 114, 1883; **12**, 227, 1889; S. Zalesky, *ib.*, **9**, 225, 1885; A. J. Kunkel, *Centr. Physiol.*, **651**, 1889; *Sitzber. Phys. Med. Ges. Würzburg*, **86**, 1888; L. Landois, *Deutsch. Med. Wochschr.*, **256**, 1893; E. Richter, *ib.*, **16**, 199, 1890; E. Salfeld, *Repert. anal. Chem.*, **3**, 35, 1883; H. Wolff, *ib.*, **3**, 82, 1833; R. Rubner, *Arch. Hyg.*, **10**, 397, 1890; J. Uffelman, *ib.*, **2**, 145, 1884; L. de St. Martin, *Compt. Rend.*, **126**, 1036, 1908; R. Schulz, *Apoth. Ztg.*, **10**, 754, 1895; H. W. Vogel, *Ber.*, **10**, 792, 1877; **11**, 235, 1878; T. Weyl and V. K. von Anrep, *ib.*, **13**, 1294, 1880; A. Findlay and H. J. M. Creighton, *Journ. Chem. Soc.*, **97**, 536, 1910; *Biochem. Journ.*, **5**, 294, 1911; A. Jäderholm, *Die gerichtlich-medizinische Diagnose der Kohlenoxydvergiftung*, Berlin, 1876.

⁵ J. Hunter, *Phil. Mag.*, (4), **29**, 116, 1865; R. A. Smith, *Chem. News*, **18**, 121, 1868; **39**, 77, 1879; *Proc. Roy. Soc.*, **28**, 322, 1879; J. Dewar, *Proc. Roy. Inst.*, **18**, 183, 1905; *Compt. Rend.*, **139**, 261, 1904; H. S. Taylor and R. M. Burns, *Journ. Amer. Chem. Soc.*, **43**, 1273, 1921; E. Blumtritt, *Journ. prakt. Chem.*, (1), **98**, 418, 1866; E. Reichardt, *ib.*, (1), **98**, 458, 1866; W. Hempel and G. Vater, *Zeit. Elektrochem.*, **18**, 724, 1912; J. F. Homfray, *Proc. Roy. Soc.*, **84**, A, 99, 1910; *Zeit. phys. Chem.*, **74**, 129, 1910; F. H. Pollard, *Journ. Phys. Chem.*, **27**, 356, 1923; W. W. Hurst and E. K. Rideal, *Journ. Chem. Soc.*, **125**, 694, 1924; T. Graham, *Phil. Trans.*, **156**, 399, 1866; D. Tommasi, *Ber.*, **11**, 811, 1878; H. Caron, *Compt. Rend.*, **30**, 483, 1850; A. Sieverts and W. Krumbhaar, *Zeit. phys. Chem.*, **74**, 277, 1910; W. J. Russell and A. Matthiessen, *Phil. Mag.*, (4), **23**, 81, 1862; A. Berliner, *Wied. Ann.*, **35**, 791, 1888; M. Berthelot, *Compt. Rend.*, **111**, 469, 1890; *Ann. Chim. Phys.*, (6), **24**, 133, 1891.

§ 26. The Chemical Properties of Carbon Monoxide

Carbon monoxide can be preserved an indefinitely long time in a glass gas-holder.¹ According to W. Henry,² and J. Plücker, the gas is slowly decomposed by the passage of an electric discharge, forming, said H. St. C. Deville, carbon and carbon dioxide; if the latter gas be absorbed by a soln. of potassium hydroxide, the decomposition may be complete. H. Buff and A. W. Hofmann said that the induction spark is without action on the dried gas. J. N. Collie noted that carbon monoxide is far more stable than carbon dioxide. He stated that the gas may be treated with powerful sparks for half an hour without an appreciable result, and the product gives no turbidity with baryta-water. If, however, the current be sufficiently strong to make the negative electrode red hot, a very small amount of carbon dioxide is produced, too little to measure, but sufficiently great to cause a white precipitate with baryta-water, and small specks of something black, presumably carbon, collect on the positive electrode. P. G. Tait and T. Andrews observed that the silent discharge caused the gas steadily to contract. After 60 hrs.' exposure, the gas had contracted one-third in vol. and contained carbon dioxide, oxygen, and undecomposed carbon monoxide. A bronze-coloured deposit appeared on the positive electrode. This deposit was investigated by M. Berthelot, etc.—*vide* carbon suboxide. A. Grau and F. Russ studied the action of an electric arc between platinum electrodes in carbon monoxide contained in a quartz tube. A. T. Cameron

and W. Ramsay found carbon dioxide is formed when **radium emanation** acts on carbon monoxide.

H. St. C. Deville³ found that carbon monoxide is reversibly decomposed at a bright red heat: $2\text{CO} \rightleftharpoons \text{C} + \text{CO}_2$, but, said M. Berthelot, the amount decomposed is very small. Very little change was observed in carbon monoxide contained in a quartz tube at 1000° , and rapidly cooled. C. Langer and V. Meyer said that carbon monoxide is not appreciably affected at 1200° , and at 1690° the gas is partially decomposed; but H. C. Woltereck said that the dissociation begins between 570° and 580° . F. Württenberger observed that the carbon monoxide in producer gas at 1000° was practically decomposed: $2\text{CO} = \text{CO}_2 + \text{C}$. A. Gautier said that the formation of carbon dioxide at 560° is perhaps conditioned by the presence of a trace of hydrogen in the gas: $2\text{CO} + 2\text{H}_2 = \text{CO}_2 + \text{CH}_4$. The reversibility of the reaction, and the equilibrium conditions have been previously discussed in connection with the action of oxygen on carbon. By using a catalytic mass of palladium deposited on activated charcoal or upon activated silicic acid, G. Fester and G. Brude found that the reaction $2\text{CO} = \text{C} + \text{CO}_2$ occurs at moderate temp., thus, at 65° , one per cent. carbon dioxide was formed; at 110° , 11 per cent.; and if the mixed gases were left in contact with the catalyst, 0.6 per cent. at 35° ; 12 per cent. at 100° ; and 55 per cent. at 240° . A little hydrogen was also derived from the moisture in the silica.

According to K. G. Falk,⁴ and M. Berthelot, mixtures of carbon monoxide and **hydrogen** do not show any inclination to react when inflamed; and H. le Chatelier and O. Boudouard found the inflammability of the mixture is such that if n and n' respectively represent the lower limits of inflammability of carbon monoxide and hydrogen in air, and N and N' the limits for the gases separately mixed with air, then the relation $n/N + n'/N' = 1$ holds approximately. M. Berthelot found that if sparks from an induction coil be sent through a mixture of carbon monoxide and hydrogen, traces of acetylene are produced only when moist potassium hydroxide is present to absorb the moisture and carbon dioxide which are formed. B. C. Brodie found that when the mixed gases are sparked, the decrease in vol. is accompanied by the formation of some methane, carbon dioxide, and small drops of a liquid, probably formic acid, H.CO.OH . M. Berthelot obtained ethane, and a condensation product, $(\text{C}_4\text{H}_6\text{O}_3)_n$. With the equal vols. of the mixed gases in an ozone tube, S. M. Losanitsch and M. Z. Jovitschitsch, and A. de Hemptinne observed the formation of formic acid, H.CO.OH ; M. Berthelot, the formation of carbohydrates $n\text{CO} + n\text{H}_2 = \text{C}_n\text{H}_{2n}\text{O}_n - m\text{H}_2\text{O}$; and A. Slosse, and A. Nowak, and W. Löb, the formation of formaldehyde, H.CO.H , and methyl alcohol, CH_3OH . W. Löb observed that some glycollic aldehyde is also formed. E. Sarrau and P. Vieille observed the reduction of carbon monoxide to methane in the presence of finely-divided nickel. A. Gautier represented the formation of carbon dioxide in the reaction by assuming that water is first formed and that this reacts with the monoxide to form the dioxide. He said the reduction begins at about 400° , and that some methane is formed. When a mixture of carbon monoxide and hydrogen is passed over finely-divided nickel at 190° – 200° , a reaction sets in, $\text{CO} + 3\text{H}_2 = \text{CH}_4 + \text{H}_2\text{O} + 51.1$ Cals., which progresses smoothly at 250° . The nickel is not appreciably influenced during the operation. At 280° , some carbon dioxide is also formed. The reduction of carbon monoxide by hydrogen in the presence of finely-divided cobalt begins at 270° and proceeds smoothly at 300° . E. F. Armstrong and T. P. Hilditch found that towards 300° , in the presence of nickel, one of the reactions is represented by the equation $2\text{CO} + 2\text{H}_2 = \text{CO}_2 + \text{CH}_4$. F. Fischer and co-workers studied the formation of methane from carbon monoxide and hydrogen in the presence of iron at 400° ; the amount formed is small under ordinary press., but at 40 atm. press. 33.5 per cent. of methane and a little ethane were produced. The hydrogenation with cobalt is less marked than with nickel. With finely-divided platinum, palladium, or iron, methane is not formed below 400° . M. Mayer and co-workers noted that much methane is formed when nickel is the catalyst, and but little when iron is the catalyst. As

indicated above, G. Fester and G. Brude passed a mixture of hydrogen and carbon monoxide over palladium deposited on activated charcoal or silica, and found 16.1 per cent. of carbon dioxide at 100°. F. Orloff noted the formation of some ethylene, C_2H_4 , when nickel or palladium is used as catalyst at 95°–100°; but G. Fester and G. Brude could not confirm this. G. Fester, however, confirmed the observation that with nickel or palladized asbestos as catalyst, at 100°, unsaturated hydrocarbons and not methane are formed. The catalyst soon loses its activity. H. S. Elworthy and E. H. Williamson patented processes for converting water-gas—a mixture of carbon monoxide and hydrogen—into methane. D. Berthelot and H. Gaudechon found that in ultra-violet light, a mixture of carbon monoxide and hydrogen produces some formaldehyde. M. Mayer and V. Altmayer found that carbon monoxide is reduced to methane by **calcium hydride** at 400°–600°.

Carbon monoxide is combustible and readily burns in **air or oxygen**, forming carbon dioxide: $2CO + O_2 = 2CO_2$, so that, as J. L. Gay Lussac,⁵ and B. Lepsius showed, two vols. of carbon monoxide unite with one vol. of oxygen to form two vols. of carbon dioxide. A mixture of the two gases is explosive. The flame of burning carbon monoxide is blue, and, according to J. W. Draper, the colour is the same when the gas burns in oxygen. According to M. Berthelot and G. Vieille, carbon monoxide burns more slowly than hydrogen or the fatty hydrocarbons; and still more slowly in the presence of carbon dioxide. The carbon monoxide and oxygen unite when heated, when exposed to electric sparks, or, according to W. G. Mixter, and A. de Hemptinne, when the mixed gases are exposed to the silent electric discharge; combination also occurs when the mixed gases are passed over finely divided platinum and some other metals. A. B. Ray and F. O. Anderegk studied the oxidation of carbon monoxide during its passage, mixed with oxygen or air, through the silent discharge or over catalysts. F. Haber and F. Richardt found that in the presence of heated palladium wire, the union of the two gases is complete at 300°. W. W. Hurst and E. K. Rideal studied the catalytic effect of copper and the promotor action when palladium is present. For catalytic actions, and the action of ultra-violet light, *vide infra*. S. Medsforth studied the catalytic action of ceria, thoria, beryllia, alumina, silica, zirconia, magnesia, the oxides of chromium, molybdenum, vanadium, and tin, and the metals copper, silver, and nickel—*vide methane*. R. T. Haslam considered that both the reactions usually represented: $2CO + O_2 = 2CO_2$ and $2H_2 + O_2 = 2H_2O$, are trimolecular, and found the ratio of the velocity constants between 900° and 1500° to be $k_{H_2}/k_{CO} = 2.86$, meaning that the hydrogen burns 2.86 times as fast as the carbon monoxide. It is supposed that the mechanism of the combustion of the individual gases alone is different from what it is when the gases are burned in the presence of one another. W. A. Whitehead and J. C. W. Frazer found that manganese oxide, and T. H. Rogers and co-workers, and D. R. Merrill and C. C. Scalione, mixtures of manganese oxide with silver or copper oxide, acting as catalysts in oxidizing carbon monoxide at ordinary temp. H. S. Taylor and H. A. Neville studied the effect of the carbonates of potassium, sodium, lithium, barium, and calcium, and of sodium chloride, borax, ferric oxide, sodium silicate, nickel, or copper—*vide action of carbon on carbon dioxide*. K. W. Rosenmund and P. Langer studied the effect of the support on which the catalyst is deposited on the oxidation.

H. B. Dixon found that X-rays did not inflame a dried mixture of carbon monoxide and oxygen. According to M. Berthelot, carbon monoxide and oxygen do not unite when exposed to sunlight. M. Potain and R. Drouin reported that when a mixture of carbon monoxide with a large proportion of air is exposed to light, carbon dioxide is slowly formed. The change is retarded and limited by the presence of the dioxide. M. Berthelot believed that the experimental conditions must have been faulty because he observed no change in moist and dry mixtures of carbon monoxide and oxygen after seven years' exposure. If the mixture be confined over a conc. soln. of potassium hydroxide for 15 months, the carbon monoxide is converted into formate which is absorbed by the liquid, the oxygen,

however, is not changed and no carbonate is formed; nor is any ammonium carbonate produced, if a mixture of carbon monoxide and aq. ammonia be used. Ultra-violet light brings about the union of carbon monoxide and oxygen; and carbon dioxide is decomposed by that agency, so that the reaction $\text{CO} + \text{O} \rightleftharpoons \text{CO}_2$ is reversible. The reaction was studied by A. K. Sanyal and N. R. Dhar.

The **temperature of combustion** of a mixture of carbon monoxide and oxygen was estimated by M. Berthelot to be 3600° , and with air in place of oxygen, 3000° ; M. Berthelot and P. Vieille gave for carbon monoxide with oxygen 2490° – 3972° ; 2351° – 3745° with hydrogen and oxygen; and 2217° – 2839° with nitric oxide and hydrogen. R. Bunsen gave 3033° for the maximum temp. of combustion of equal vols. of oxygen and carbon monoxide in a closed vessel; and E. Mallard and H. le Chatelier, 3200° , when about 30 per cent. of the carbon dioxide is dissociated. H. Valerius gave 1430° for the temp. of combustion of carbon monoxide in air, and P. Geipert found the temp. of producer gas burning in air to be 1569° , and F. Haber and H. J. Hodsmann found the temp. of the flame of a theoretical mixture of oxygen and carbon monoxide to be 2600° ; K. G. Falk gave 2764° . F. Pollitzer made some observations on this subject.

According to H. Davy, carbon monoxide is inflamed by contact with red-hot charcoal, or iron wire, or a heated platinum spiral. P. Sabatier and J. B. Senderens observed that in contact with nickel, oxidation does not commence before 230° ; with iron, not before 330° ; and with platinum, not before 450° . L. Mond and C. Langer noted that with nickel and cobalt at 350° – 450° a carbide and carbon dioxide are formed; the carbide is decomposed by water vap. W. Henry noted that platinum foil slowly converts a mixture of carbon monoxide and oxygen (2:1) into carbon dioxide at ordinary temp.; J. W. Döbereiner, and W. Henry noted that platinum sponge acts similarly when warmed; and P. L. Dulong and L. J. Thénard observed the action in the cold. P. J. van Kerckhoff noted that slow oxidation occurs with platinized asbestos at 5° – 15° ; while pumice-stone, or porous earthenware acts very slowly at 80° – 90° . F. C. Phillips found palladized asbestos acts below a red heat; A. Pleischl, and A. de la Rive and F. Marcet, platinized or palladized paper ash at ordinary temp.; and E. D. Campbell, palladized cupric oxide at 100° – 105° . H. B. Dixon found that a dried mixture of carbon monoxide and oxygen does not explode in contact with a red-hot platinum wire; and H. B. Dixon and H. F. Lowe found a red-hot platinum wire, freed from occluded hydrogen, glows intensely in the mixed gases, and completely oxidizes the carbon monoxide. According to A. F. Girvan, a silver or gold wire may be fused in the gases, dried by cooling to -80° , without causing visible union of the mixture; with an explosive mixture dried by cooling to -35° , a spiral of platinum wire at a red heat caused a quiet and feeble explosion; with a mixture dried by cooling between -80° and -180° , the platinum acted catalytically, and glowed for several seconds, but there was no other sign of chemical action; the coil was then heated white hot for a few minutes, and when cold, about one-eighth of the mixture was absorbed by a soln. of potassium hydroxide, the remainder represented the uncombined mixture. The catalytic oxidation of carbon monoxide was also studied by T. H. Rogers and fellow-workers, D. R. Merrill and C. C. Scalione, J. C. Clancy, etc. The carbon monoxide mixed with hydrogen is preferentially oxidized in the presence of mixed oxides of iron, chromium, cerium, thorium, bismuth, etc., as shown by J. Harger and H. Terrey, E. K. Rideal and H. S. Taylor, and R. N. Pease and H. S. Taylor and co-workers, A. B. Lamb and co-workers, R. S. Tour, etc. J. A. Almquist and W. C. Bray studied the effect of cupric and manganese oxides; and W. A. Whitesell and J. C. W. Frazer, the effect of manganese dioxide. I. Langmuir discussed the hypothesis that the oxygen is condensed on the platinum, the carbon monoxide mols. strike the surface, and a certain fraction is condensed, forming carbon dioxide which distils off at a certain rate.

E. Mallard and H. le Chatelier found the **ignition temperature** of mixtures of carbon monoxide with air and oxygen, and the results are shown in Table XVIII.

A. Krause and V. Meyer found that the explosion temp. of a theoretical mixture of carbon monoxide and oxygen, confined in thin sealed glass bulbs, to be between

TABLE XVIII.—IGNITION TEMPERATURES OF CARBON MONOXIDE.

Percentage composition.				Ignition temp.
CO	Oxygen.	Air.	CO ₂	
85	15	—	—	630° to 650°
70	30	—	—	645° to 650°
30	70	—	—	650° to 680°
30	—	70	—	650° to 657°
35	15	—	50	695° to 715°
15	—	35	50	715° to 725°

518° and 606°; F. Freyer and V. Meyer gave 650°–730°; and V. Meyer and A. Münch, 636°–814°. According to K. G. Falk, the lowest ignition temp. for a mixture $2\text{CO} + \text{O}_2$ is 601°, and in the presence of an indifferent gas—nitrogen—the absolute temp. of ignition, T , becomes $T = T' + 80(\text{Vol. N}/\text{Vol. CO})$. H. B. Dixon and H. F. Coward gave 637°–658° or 650° for the ignition temp. of moist carbon monoxide in oxygen; and in air, 644°–658° or 651°. W. M. Thornton made observations on the ignition of carbon monoxide under reduced press.

According to A. Krause and V. Meyer, a considerable amount of carbon monoxide is oxidized at 448°; and K. W. Charitschkoff found that purified carbon monoxide is oxidized at 290°. H. Hélier passed a dry mixture (1 : 2) of oxygen and carbon monoxide at a constant velocity through a porcelain tube packed with porcelain rods, and surrounded by an iron tube; he found the following proportions of carbon dioxide were formed at different temp.:

	195°	302°	408°	500°	600°	689°	788°	855°
Per cent. CO ₂ . . .	0·13	0·44	3·03	6·2	21·14	46·36	60·3	65·0

The admixture of nitrogen lowers the proportion of carbon dioxide which is formed, and the presence of carbon dioxide hinders the reaction. According to H. Kühl, the velocity of the reaction at 570° appears to be somewhat irregular because, although the reaction in general appeared to be of the third order, the velocity varied according as one or the other of the gases was first introduced into the reaction vessel, which was made of internally glazed porcelain. Thus the initial velocity when dry oxygen is added to moist carbon monoxide is ten times greater than that observed when moist carbon monoxide is added to dry oxygen, carbon dioxide being originally present in both cases; when carbon dioxide has not been previously introduced, the velocities in question are in the ratio 2 : 1. The initial velocity is in general retarded when carbon dioxide is originally present; it is in the main independent of the oxygen concentration, but proportional to the first power of the carbon monoxide concentration; it increases with the amount of water vap. present, although somewhat irregularly, and to an extent less than proportionality. Further, the initial velocity is increased when the reaction vessel has been previously exhausted. These observations agree with the assumption that the seat of the reaction is on the surface of the containing vessel. According to M. Bodenstein and F. Ohlmer, the reaction $2\text{CO} + \text{O}_2 = 2\text{CO}_2$ is catalytically accelerated when it takes place in a vessel of quartz-glass. The rate of the change is adequately represented by the empirical formula $dx/dt = k(m+a-x)/(n+b-x)$, where a and b are the initial concentrations of oxygen and carbon monoxide respectively, m and n are constants. The chief feature of the investigation is the fact that carbon monoxide retards its own combustion in the quartz-glass vessel, so that the velocity of the reaction is almost inversely proportional to the conc. of carbon monoxide. This, therefore,

to be regarded as a case of negative autocatalysis. This peculiarity is not observed in the reaction takes place in an ordinary glass vessel containing pieces ofartzite or rock crystal. With both these catalysts, the reaction velocity is directly proportional to the carbon monoxide conc., and proportional also, although only slightly, to the square root of the oxygen conc. In all cases, the temp. coeff. (for interval of 10°) was between 1.4 and 1.8. K. G. Falk found the reaction to be molecular, but if an excess of carbon monoxide be present, the results do not follow the equation for such reactions.

E. Mallard and H. le Chatelier⁶ found that there is a sudden and momentary press. during the explosive combustion of a mixture of carbon monoxide with air or oxygen, and give the following explanation of the phenomenon :

The first portion of the mixture in exploding compresses the adjoining layer. If now the velocity of propagation of ignition is sufficiently rapid, this adjoining layer of the explosive mixture will be ignited before an equalization of press. can take place, and hence the press. due to this explosion will be superimposed on that derived from the first portion of the mixture. This will be repeated, the press. in each succeeding wave becoming greater, and the momentary press. due to one of these explosive zones will be that registered by the ton. This hypothesis is supported by the fact that the excess of press. above the normal increases with the velocity of propagation of ignition of the mixture.

Berthelot and P. Vieille found the press. at the moment of explosion to be 10.12 atm., with the mixture of carbon monoxide and oxygen, and 8.79 to 9.81 atm. with a mixture of these gases with hydrogen. The **velocity of propagation of the flame** as found by R. Bunsen to be less than a metre per sec. E. Mallard and H. le Chatelier gave 2.2 metres per sec. H. B. Dixon gave for the **velocity of the explosion wave** in a mixture of carbon monoxide and oxygen sat. at 10° with water vap., in a tube 13 mm. diameter, the value 1500 metres per sec. The velocity varies with the proportion of moisture. Thus, at 760 mm. press., with gas sat. at a temp. θ° , the velocity, V , of the explosion wave in metres per sec. with the mixture $2\text{CO} + \text{O}_2$, increased to a maximum, and then diminished :

	Dried	Partially dried	10°	28°	35°	45°	65°	75°
V	1264	1305	1676	1713	1738	1693	1526	1266

Bötsch showed that if the press. be sufficiently reduced, the propagation of the flame can be prevented in the dried or moist gas. L. Meyer and E. Seubert found the gas burnt at press. as low as 219 mm. H. B. Dixon also found the velocity is diminished from 1676 to 1576 metres per sec. by reducing the press. from 760 to 700 mm. in a gaseous mixture sat. with moisture at 10° . H. B. Dixon also photographed the front of the advancing explosion wave, and of the wave reflected in the opposite direction. H. B. Dixon, E. H. Strange, and E. Graham observed that the explosion flame of a dried mixture of carbon monoxide and oxygen is longer than is the case with a moist mixture. By using carbon monoxide from carbonyl sulphide, J. Russell inferred that there is not "a great difference between the behaviour of nascent carbon monoxide and that of the ordinary gas."

M. Berthelot measured the speed of the explosion wave in mixtures of hydrogen, carbon monoxide, and oxygen; and H. B. Dixon and N. S. Walls measured the effect of the substitution of hydrogen for carbon monoxide in the $2\text{CO} + \text{O}_2$ mixture, and found for the rates of the explosion wave, V ,

.	100	99.25	98.5	92.5	85	62.5	50	25	15	7.5	0
.	0	0.75	1.5	7.5	15	37.5	50	75	85	92.5	100
.	1750	1754	1758	1796	1858	2020	2130	2391	2507	2643	2810

Berthelot measured the initial speed of propagation of flame in mixtures of these three gases, and found that the speeds in mixtures $2(\text{H}_2, \text{CO}) + \text{O}_2$ were greater than the arithmetical mean of the rates in $2\text{H}_2 + \text{O}_2$ and $2\text{CO} + \text{O}_2$ mixtures, he concluded that the gases burnt separately—the hydrogen burning first.

W. A. Bone and W. A. Haward have made determinations of the time taken from

the moment of firing until the maximum press. is reached when explosive mixture of hydrogen and carbon monoxide with air are fired in a closed bomb initially under atm. press. The interval between the spark and the maximum press. is much less in pure hydrogen than in the pure carbon monoxide detonating gas, and the compared the time-intervals when different quantities of hydrogen replace carbon monoxide with the times calculated on the assumption that each explosive mixture carries the flame in turn at its own rate over lengths proportional to the vol. of each present. The "times" so calculated are the sum of the times taken by each explosive constituent; just as in a relay race the total time is the sum of the times taken by each runner over the distance he is set to run. The numbers so calculated in no way agree with the rates found for the mixed gases; and they directed attention to the great effect on the rate of combination when small quantities of hydrogen replace carbon monoxide in the explosive mixture, and, like M. Berthelot, they attributed this to the dominating influence of the hydrogen "which catalyzes the reaction." Later, W. A. Bone and co-workers found that the comparative slowness at which the press. is developed in a mixture of carbon monoxide and air is not due to any inherent slow-burning property of carbon monoxide, and it is not much affected by the proportion of water vap. present in the system. When the nitrogen is wholly replaced by oxygen, carbon monoxide, or argon, the time required for the attainment of maximum press. is reduced from 0.18 sec. to 0.005, 0.010, and 0.010 sec. respectively. Hence, it was inferred that in the presence of nitrogen and high press., a considerable part of the energy radiated by burning carbon monoxide instead of being absorbed by the walls of the explosion chamber, is intercepted and adsorbed by the nitrogen present whereby the nitrogen becomes chemically activated. The radiant energy so absorbed affected the maximum press. attained only when the conditions permitted a secondary oxidation of the activated nitrogen to nitric oxide. The radiant energy absorbed by the nitrogen is gradually liberated in its kinetic form after the attainment of the maximum press., as the activated nitrogen slowly reverts to the ordinary form. A. Payman and R. V. Wheeler found that in the slow initial uniform phase of combustion of gases the rates for mixtures are the means of the individual maximum rates: thus, "if on a speed-per cent. graph the maxima for any two gases taken singly are joined by a straight line, all the maxima for mixtures of these gases lie approximately on this line."

H. Davy⁷ noted that a mixture must contain at least one vol. of oxygen to 3 vols. of carbon monoxide to explode by the electric spark. The limits, as determined by M. Berthelot, vary with the intensity of the spark, and even when the mixture is non-explosive, the carbon monoxide is oxidized by the sparking. P. Eitner gave

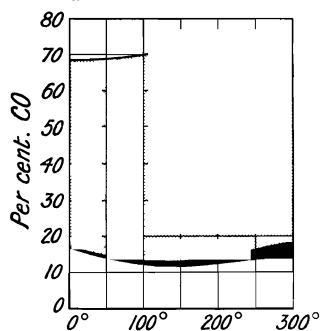

Fig. 37.—Explosion Limits of Carbon Monoxide and Air.

for the upper and lower limits of explosive mixture 75.1 and 16.4 per cent. of carbon monoxide. E. Terres, 73.5 and 16.1; and H. Bunte and J. Roszkowsky, 74.8 and 14.1. E. Berl and H. Fischer's results are indicated in Fig. 37. In a glass globe 27 mm. diameter the limits were 15.7 and 71.6; in a glass globe 18 mm. diameter the limits were 16.0-66.5; in an iron vessel at ordinary temperature the limits were 15.8-63.8; at 100°, 14.05-69.6; at 200°, 13.8-76.55; and at 300°, 14.10-75.6. The black portion represents oxidation without inflammation. H. F. Coward and F. Brinsley gave the lower limit 12.5 per cent. carbon monoxide. J. Roszkowsky found that the dilution of the explosive mixture of carbon monoxide and oxygen with an indifferent gas like carbon dioxide decreases the tendency to explosion and this decrease is less the higher the temp. This is probably due to the heat generated by the combination of the two gases being largely used in raising the temperature of the indifferent gas rather than in propagating the explosion. E. Terres found that

the limits of inflammability of carbon monoxide in air were 15·6–70·9 per cent.; and in oxygen, 16·7–93·5 per cent. N. N. Beketoff found that sulphur dioxide or carbon dioxide had no influence on the explosion of a dried mixture of carbon monoxide and oxygen, but 10 per cent of cyanogen causes the immediate explosion of the dried mixture on sparking. He suggests that the action of cyanogen may be explained on the assumption that the heat liberated in the decomposition of the cyanogen is added to the heat of combustion of the carbon, and he further assumes that the dissociation temp. of the water mol. being lower than that of the oxygen mol. the proper explanation of the fact that the presence of water in a mixture of carbon monoxide and oxygen assists the combustion of the latter gases. H. B. Dixon, however, showed that when a dried mixture of cyanogen, carbon monoxide, and an excess of oxygen is exploded, much of the carbon monoxide escapes oxidation. Similar results were obtained with carbon disulphide. G. Schlegel found that chlorine hinders or inhibits the combustion or explosion of a mixture of carbon monoxide and oxygen. H. B. Dixon and E. J. Russell observed that with nascent hydrogen, as when a mixture of carbon monoxide and chlorine dioxide is exploded, the drier the mixture, the greater the proportion of carbon monoxide which escapes oxidation; the oxidation does not proceed any faster with oxygen *in statu nascendi*. Similar results were obtained by E. J. Russell with chlorine monoxide. W. A. Jones found that when carbon monoxide is led into a U-tube in which acidified water is undergoing electrolysis and is allowed to bubble directly against the electrode at which the oxygen is being evolved, no carbon dioxide is produced. Electrolytic hydrogen, therefore, has not the power of oxidizing carbon monoxide.

H. B. Dixon⁸ discovered that an explosion is not propagated in a dried mixture of carbon monoxide and oxygen. The addition of a minute trace of water or a volatile body containing hydrogen renders the mixture inflammable, thus, a dried mixture of carbon monoxide and oxygen explodes in the presence of traces of water, hydrogen sulphide, ethane, formic acid, ammonia, pentane, hydrogen chloride—but not in the presence of gases or vapours free from hydrogen—*e.g.* sulphur dioxide, carbon dioxide, carbon disulphide, nitrogen, cyanogen, carbon tetrachloride, etc. Hence, *only steam, or bodies which can form steam under the conditions of the experiment, are capable of determining the explosion of carbon monoxide and oxygen*; other gaseous bodies not capable of forming steam have no action. When a long tube full of the dried mixture is moistened at one end, and the gases are ignited there, the flame reverses the moist gases but dies out on reaching the dried gases. H. von Hartenberg and B. Sieg supported the hypothesis that the reaction between burning carbon monoxide is preceded by the formation of an unstable additive compound. Traube also found that the flame of dry carbon monoxide burning in air is extinguished if plunged into dry air. N. N. Beketoff found that while no explosion occurs with the mixed gases dried by phosphorus pentoxide, the propagation of the flame is so slow that it can be followed by the eye when the gases have been dried by sulphuric acid, presumably because the latter desiccative leaves more moisture in the gas than the former. A. F. Gryan found that the drying of the gases by cooling will also prevent explosion. The vap. press. of the moisture in gases dried at different temp is approximately

	–36°	–45°	–51°	–56·5°	–61°
Vap. press. of water .	0·160	0·052	0·029	0·01	0·008

When the vap. press. of the water is less than about 0·03 mm., as is the case with the mixture after cooling at –50°, the gases will not explode. When the vap. press. is less than about 0·16 mm., the explosion is very feeble. In the first case, the amount of water vap. present is about one part in twenty-four thousand by vol., and in the second, one part in five thousand. At –61°, the amount of water vap. would be about one part in a hundred thousand of gas. It would appear then that the mixture will not explode when sparked at the ordinary temp. if there is less than one mol. of

water vap. to twenty-four thousand mols. of the gas. K. Bötsch failed to confirm these observations, but H. B. Dixon showed that the gases were probably inadequately dried. L. Meyer found that if the gases are sufficiently well dried, the mixture can be exploded only by a very powerful spark, and a tolerably large g. press. is employed; while H. B. Dixon showed that with a dried mixture of the two gases, a spark between platinum wires 7 mm. apart produced no explosion, but a blue aureole appeared about the track of the spark. L. Meyer, and N. N. Beketoff found that the dried gases unite in the track of the spark; and H. B. Dixon and H. F. Lowe showed that the amount of combination depends on the nature of the spark, a limit being reached when the rate of combination is equal to the rate of decomposition of the carbon dioxide formed. They also showed that the dried gases combine completely without flame, in contact with a platinum wire. C. Montmartini observed that the corona effect in circuits traversed by continuous current forms carbon dioxide and hydrogen from a mixture of carbon monoxide and water. A. Coehn and H. Tramm found that while a moist mixture of carbon monoxide and oxygen can be exploded by a spark at any press., a mixture, dried by a short exposure to the action of solid carbon dioxide and alcohol, cannot be exploded, but inflames and burns quietly, and that a mixture which has been cooled for a sufficient time cannot be inflamed; a pale blue zone forms round the spark gap and slight combination is indicated by a small diminution of press. Exposure of mixtures belonging to the three types to the ultra-violet rays from a quartz mercury lamp leads to practically the same result in each case, combination occurring to the extent of 4-5 per cent. within an hour. It follows, therefore, that the presence of aq. vap. does not play a part in the union of carbon monoxide and oxygen under the influence of radiant energy—*vide* photo-decomposition of carbon dioxide.

A. Smithells and F. Dent found that dry carbon monoxide proceeding from a half-burnt cyanogen flame will burn in dry air provided the two flames are close together, and N. N. Beketoff showed that an explosion of cyanogen and oxygen will cause the union of admixed carbon monoxide with the oxygen. F. Haber and J. E. Coates noted that some nitric oxide is formed during the combustion of carbon monoxide in air; and A. Bach stated that if the flame of this gas is allowed to impinge on cold water, the water afterwards exhibits the peroxide reaction. According to R. de Muynck, a mixture of oxygen and carbon monoxide is electrically conducting at the moment of the explosion; he calculates that one ion is produced for every 200 million mols. of carbon dioxide which are formed. This result favors the view that the conducting power of the exploded mixture is to be attributed to the heat liberated in the change. The drying of the gas had no perceptible influence on the effect.

K. A. Hofmann and co-workers studied the oxidation of carbon monoxide at ordinary temp. It was found that on a surface of copper moistened with alkali, carbon monoxide is slowly oxidized in open circuit, the electrolyte ultimately containing, in addition to carbonate, traces of formate but scarcely any oxalate; carbon monoxide is gradually replaced by hydrogen, so that the reaction proceeds according to the scheme: $\text{CO} + 2\text{KOH} = \text{K}_2\text{CO}_3 + \text{H}_2$. In the closed circuit, the hydrogen is oxidized to water by oxygen liberated at the opposite electrode. Copper cannot, however, bring gaseous molecular hydrogen into a condition of electromotive activity, but can be very actively charged by nascent hydrogen, most simply by cathodic polarization. It was suggested that owing to the existence of subsidiary valencies, carbon monoxide has the power to unite with alkali hydroxide in the presence of copper yielding small amounts of an isoformate, $\text{Cu} \dots \text{C}(\text{OH})(\text{OK})$, which then combines with a further mol. of the hydroxide to yield the alkali carbonate, whilst the hydrogen is liberated in the atomic state at the copper. This conception is supported by the observation that active elements are not formed from copper, carbon monoxide, and water, or from carbon monoxide and alkali hydroxide alone, but only from copper, alkali hydroxide, and carbon monoxide in conjunction. It is further found that hydrated cupric oxide is reduced by carbon monoxide in

presence of alkali at an appreciable rate only if a certain amount of metallic copper is present. Again, the electromotive activity of carbon monoxide at a copper, and to a less degree at a platinum, surface is not immediately developed, whilst, in the absence of hydroxyl ions, carbon monoxide is not noticeably activated by copper. Cuprous oxide does not play a part in the phenomena, since it is found that hydrated cupric oxide is directly reduced in the presence of alkali to the metal, whilst the presence of a minute amount of oxygen diminishes the electromotive force of the system Cu-CO-alkali in a striking, if transitory, manner. F. Auerbach added that the calculated e.m.f. for the gas-cell $O_2 | CO$, is smaller than for the oxidation $CO + O_2 \rightleftharpoons 2CO_2$.

M. Berthelot⁹ showed that when a mixture of carbon monoxide and oxygen is sparked, some carbon suboxide, C_4O_3 , is formed (*q.v.*). H. Fassbender found that when a mixture of carbon monoxide and oxygen is exposed to the silent discharge, the rate of explosion is increased. This is attributed to the formation of **ozone** by the discharge, for, when a mixture of the two gases is exploded, a piece of potassium iodide and starch paper is coloured blue by the ozone formed in the explosion; but L. B. Dixon did not detect any marked increase in the inflammability of a mixture of carbon monoxide and oxygen in the presence of ozone.

H. Thiele, and S. Chadwick and co-workers found that ultra-violet light from quartz mercury lamp oxidized carbon monoxide in the presence of oxygen when the mixed gases were dried with sulphuric acid, and with phosphorus pentoxide, and when the gases were sat. with moisture at 16°. The last-named found that with the dried gases, there was at first a slow contraction, the rate of contraction then gradually increased, attained a maximum, and then slowly decreased until the change became very slow. With the moist gas, the rate of contraction was uniform throughout the experiment at less than half the speed of the maximum rate of the dried mixture. When the contraction had attained the same values:

	H ₂ SO ₄ —dried	P ₂ O ₅ —dried	Moist
Carbon monoxide oxidized	22.95	19.42	53.2 per cent.
Oxygen ozonized	39.63	37.48	2.6 „ „

It was assumed that the first action of the ultra-violet light is to break up the oxygen mols. into atoms, the atoms of oxygen thus formed prefer to combine with the mols. of carbon monoxide when the gases are moist, but with oxygen mols. when the gases are dry. The rate of chemical change was not accelerated by the presence of moisture, although the course of the reaction was determined by the hygroscopic condition of the mixture. Against the view that the accelerating action of water vapour on the reaction between a heated mixture of carbon monoxide and oxygen is due to the production of formic acid, H. Tramm showed that mixtures of oxygen and formic acid do not explode while an eq. mixture of hydrogen, oxygen, and carbon monoxide does so.

I. Remsen and M. S. Southworth found that ozonized oxygen does not oxidize carbon monoxide in diffused daylight, in direct sunlight, or at 300°; and I. Remsen showed that the ozone does not oxidize carbon monoxide at the moment of its transformation into oxygen. On the other hand, W. A. Jones found that oxygen, with 3.78 per cent. of ozone, slowly oxidizes carbon monoxide at ordinary temp. and more rapidly at 250°. In general, the oxidizing power of ozone was found to vary according to its conc. and temp. C. E. Waters observed no oxidation at ordinary temp., but at 240°–280°, some carbon dioxide was produced, the amount depending on the conc. of the ozone. P. Clausmann said the oxidation occurs in darkness, but more rapidly in light. Moisture accelerates the reaction. J. B. J. D. Boussingault noted that in the oxidation of moist phosphorus in the presence of air and carbon monoxide, some carbon dioxide is formed; and E. Baumann, and A. R. Leeds stated that when a mixture of air and carbon monoxide is passed over moist phosphorus, carbon dioxide is formed. I. Remsen and E. H. Keiser failed to confirm these observations, but W. A. Jones found that under these conditions some carbon dioxide is always formed, and that the amount

varies with the quantity of phosphorus exposed and the rate at which the gas passed over it. When pure carbon monoxide is brought into contact with phosphorus immersed in a soln. of hydrogen peroxide, carbon dioxide is not produced and it is therefore very improbable that the oxidation of carbon monoxide by moist phosphorus is due to the action of the phosphorus on hydrogen peroxide formed in the course of the experiment. I. Remsen and E. H. Keiser said that the source of the carbon dioxide is the carbon in the phosphorus, but E. Baumann denied this. A. R. Leeds also showed that carbon dioxide is formed when organic matters are excluded. I. Remsen¹⁰ found that carbon monoxide is not oxidized when in contact with decomposing **hydrogen dioxide**. This statement was confirmed by F. C. Phillips, W. A. Jones, and M. Traube. P. Waentig and O. Steche, and G. Senter investigated the effect of carbon monoxide on the catalytic decomposition of hydrogen dioxide by hæmase.

W. Henry¹¹ compared the action of the electric spark, heat, and of platinum sponge on mixtures of carbon monoxide, hydrogen, and oxygen, and found that the lower the temp., the greater the proportion of carbon dioxide produced. With a mixture of hydrogen, carbon monoxide, and oxygen in the proportions 1 : 2 : 4 by vol., the oxidation in the presence of platinum sponge at 171° converted 4 vols. of carbon monoxide per vol. of hydrogen; at the softening temp. of glass two-thirds vol. of carbon monoxide per vol. of hydrogen; and with the electric spark, one-third vol. of carbon monoxide per vol. of hydrogen. E. von Meyer, and D. Tommasi found that the activity of the platinum is lowered in the presence of carbon monoxide. F. C. Phillips found that in the presence of hydrogen and oxygen, carbon monoxide is oxidized below 100° in contact with platinum sponge or palladium. M. Traube, and E. Baumann made observations on this subject. M. Traube found that oxidation does not occur in the presence of zinc and water.

R. Bunsen then studied the simultaneous oxidation of hydrogen and carbon monoxide. He made a *mal-inference*, for he said that if a mixture of carbon monoxide and hydrogen gases be exploded with a quantity of oxygen not sufficient to oxidize the mixed gases completely, the oxygen will divide itself between the carbon monoxide and hydrogen not in proportion to their quantities present, but so that the quantities of carbon dioxide and water formed will stand in some simple ratio. Thus, on exploding a mixture of carbon monoxide and hydrogen, R. Bunsen found the ratio $\text{CO}_2 : \text{H}_2\text{O} = 2 : 1$; and an increase in the quantity of hydrogen made no change in the value of the ratio until sufficient hydrogen had been added when the ratio suddenly jumped to 1 : 1; similarly with further additions of hydrogen the ratio jumped to 1 : 2, then to 1 : 3, and then to 1 : 4. E. von Meyer confirmed R. Bunsen's observation that the proportions in which oxygen is distributed between carbon monoxide and hydrogen alters *per saltum* but not in such simple proportions as R. Bunsen supposed, for E. von Meyer obtained ratios like 17 : 18 : 18 : 19; etc. A. Horstmann showed that R. Bunsen's observations were vitiated by the condensation of steam on the walls of the containing vessel; and also by the counter-reaction $\text{H}_2\text{O} + \text{CO} \rightleftharpoons \text{CO}_2 + \text{H}_2$. The change is gradual and does not proceed *per saltum*; the law of mass action is valid in its simple form: $[\text{H}_2\text{O}][\text{CO}] = K[\text{H}_2][\text{CO}_2]$, where the symbols in brackets represent concentrations, and K is the equilibrium constant. This conclusion was also verified by H. B. Dixon, who in his study of the distribution of oxygen between carbon monoxide and hydrogen during explosion, showed that the equilibrium constant K is nearly 4.0.

The decomposition of **water** vap. by carbon monoxide in contact with a heated platinum wire, or by heating the mixed gases in a tube, was established by W. R. Grove, H. Buff and A. W. Hofmann, B. Verver, L. Maquenne, J. Coquillon, etc. (1. 9, 9). L. Maquenne observed the reaction between steam and carbon monoxide at 150° in the presence of platinum sponge. W. G. Mixter, A. de Hempel, and S. M. Losanitsch and M. Z. Jovitschitsch found that carbon dioxide and formic acid are produced when carbon monoxide and water vap. are exposed in an ozonizer; W. Löb found formaldehyde, formic acid and carbon dioxide to be formed

L. Thiele also noted the production of formic acid when a mixture of carbon monoxide and water vap. in a quartz bulb is exposed to ultra-violet light. A. Naumann and C. Pistor reported that at 560° steam and carbon monoxide do not react; at 600°, two per cent. of the carbon monoxide is oxidized; at 900°, 8 per cent.; and at 904°, 10.5 per cent. All the conditions which hinder the reaction between hydrogen and carbon dioxide, favour that between steam and carbon monoxide, since such a change is exothermal, $\text{CO} + \text{H}_2\text{O}_{\text{gas}} = \text{CO}_2 + \text{H}_2 + 10.72 \text{ Cals.}$, and the carbon dioxide is very stable at a high temp., while the steam is readily decomposed into hydrogen and oxygen, the latter of which can burn the carbon monoxide. L. Maquenne also inferred that carbon monoxide is a stronger reducing agent than hydrogen. J. Lang said that carbon monoxide is not attacked by water vap. at 600°; C. Engler and J. Grimm found that carbon monoxide free from oxygen does not react with water vap. at 250°, but does react at 300°, forming carbon dioxide; and C. Hoitsema found the velocity of the reaction $\text{CO} + \text{H}_2\text{O} \rightleftharpoons \text{CO}_2 + \text{H}_2$ in either direction at ordinary temp. is practically zero; the oxidation of the carbon monoxide by steam at 600° is measurable, but the reduction of carbon dioxide by hydrogen cannot be observed below 900°. A. Gautier studied the reversibility of the reaction at 1200°–1250°, and observed that traces of formic acid are also formed. H. B. Dixon, and O. Hahn established the accuracy of the law of mass action for: $\text{CO} + \text{H}_2\text{O} \rightleftharpoons \text{H}_2 + \text{CO}_2$, by proving the constancy of K for $\frac{[\text{CO}][\text{H}_2\text{O}]}{[\text{H}_2][\text{CO}_2]} = K$ at different temp.:

	786°	886°	986°	1005°	1086°	1205°	1405°
K	0.81	1.19	1.54	1.68	1.95	2.10	2.49

and he represented the results by $\log K = 2226T^{-1} - 0.0003909T + 2.4506$.

C. N. Hinshelwood and co-workers studied the decomposition of formic acid on glass, silver, and platinum surfaces. The consecutive reactions are $\text{H.COOH} = \text{H}_2\text{O} + \text{CO}$, and $\text{H.COOH} = \text{CO}_2 + \text{H}_2$. On glass surfaces the two reactions proceed at about equal rates at 280°; on platinum and silver, the second reaction predominates; at about 180°, the second reaction predominates on silver; and the first reaction on glass. H. St. C. Deville and H. Debray studied the catalytic decomposition of formic acid by rhodium, iridium, and thallium; and E. Müller, by rhodium and osmium.

Other observations have been made on the reaction between steam and carbon monoxide by H. Luggin, C. Harries, O. Boudouard, F. Pollitzer, W. H. Engels, etc. According to F. Haber, $\log K = -2170T^{-1} + 0.979 \log T - 0.001082T + 0.061734T^2 - 0.02858$ and the thermal value of the reaction $Q = -9916 - 1.943T + 0.004945T^2 - 0.0515847T^3$ cal. E. F. Armstrong and T. P. Hilditch found that copper is a more active catalyst than iron oxide between 200° and 300°; the reaction with copper commences at 220°, whereas iron oxide is only slightly active at 250°, and does not reach full activity till 400°. At higher temp., iron oxide is the more active catalyst in the reaction $\text{CO} + \text{H}_2\text{O} \rightleftharpoons \text{CO}_2 + \text{H}_2$.

Several explanations of the catalytic effect of water on the oxidation of carbon monoxide have been devised. H. B. Dixon showed that the dissociation of carbon monoxide at the temp. at which carbon monoxide and oxygen combine would explain the inertness of a dry mixture of carbon monoxide and oxygen; and he assumed that the carbon monoxide is directly oxidized by the steam: $\text{CO} + \text{H}_2\text{O} = \text{CO}_2 + \text{H}_2$; and that the liberated hydrogen recombines with the oxygen to form steam: $\text{H}_2 + \text{O}_2 = 2\text{H}_2\text{O}$, and the cycle begins anew. The water vap. thus acts as a carrier of oxygen to the carbon monoxide. M. Traube argued that moist carbon monoxide does not furnish a trace of hydrogen and carbon dioxide when sparked for several hours, while hydrogen reduces carbon dioxide at a white heat; but H. B. Dixon, quoting his own and W. R. Grove's experiments, showed that carbon monoxide can be directly oxidized by steam. M. Traube¹² suggested that the water mol. deliver their oxygen to the carbon monoxide, and the remaining hydrogen unites with the free oxygen to form hydrogen peroxide: $\text{CO} + \text{H}_2\text{O} + \text{O}_2 = \text{CO}_2 + \text{H}_2\text{O}_2$; the hydrogen peroxide then reacts with carbon monoxide to form

water, and carbon dioxide: $\text{CO} + \text{H}_2\text{O}_2 = \text{CO}_2 + \text{H}_2\text{O}$; the water then commences the cycle anew. D. I. Mendeléeff adopted a somewhat similar explanation of the reaction; but H. B. Dixon, and H. Wieland both oppose this interpretation of the mechanism of the reaction. H. Wieland assumes that formic acid is the first product of the reaction $\text{CO} + \text{H}_2\text{O} = \text{H.CO.OH}$; and that this then decomposes into carbon dioxide and hydrogen, $\text{H.CO.OH} = \text{CO}_2 + \text{H}_2$; while the hydrogen unites with the oxygen to form water, which then repeats the cycle of changes. H. E. Armstrong assumed that two gases which are inert in a highly purified state are able to react when a conducting circuit is formed—e.g. carbon monoxide, conducting water, and oxygen:

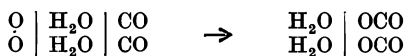

Against this, it has been urged that when dry cyanogen is exploded with an excess of oxygen, or burnt in a flame separator, it furnishes carbon monoxide and nitrogen; the monoxide then burning to carbon dioxide in the absence of water.

According to H. Moissan,¹³ **fluorine** does not react in the cold with carbon monoxide. J. Davy found that dry **chlorine** does not act on dry carbon monoxide. The two gases unite slowly in daylight and rapidly in sunlight, forming carbon chloride, COCl_2 (*q.v.*). J. Schiel prepared carbonyl bromide, COBr_2 , (*q.v.*), by exposing to sunlight a mixture of **bromine** vap. and carbon monoxide. S. P. Cowardins said that **carbonyl iodide**, COI_2 , is not formed by heating a mixture of **iodine** and carbon monoxide, or by exposing the mixture to sunlight; or by heating carbon monoxide with **arsenic penta-iodide**, or **lead iodide**. S. M. Losanitsch and M. Z. Jovitschitsch exposed a mixture of carbon monoxide and **hydrogen chloride** to the silent electric discharge, and the resulting contraction indicated the possible formation of formyl chloride. K. Stammer found **ammonium chloride** is not altered by heating it in carbon monoxide; nor is **cupric chloride** altered. For the action of carbon monoxide on **cuprous chloride** see the last-named salt. K. Stammer and A. G. Bloxam found that **silver chloride** is not altered by heating it in a stream of carbon monoxide, but F. Göbel said that some reduction occurs. F. C. Phillips found that soln. of **auric chloride** are reduced at 0° and at 100° by carbon monoxide forming brown gold and carbon dioxide. J. Donau prepared colloidal gold by this reducing agent. K. Stammer said **lead chloride** is not reduced, F. Göbel said that it is reduced when heated in a stream of carbon monoxide. A. G. Bloxam found that at a red heat no reduction occurs with the dry gas, but with the moist gas some hydrogen chloride is formed. P. Schützenberger obtained addition compounds of carbon monoxide with **platinous chloride** (*q.v.*). These were studied by F. Mylius and F. Förster, W. Pullinger, etc. F. C. Phillips found soln. of **platinic chloride** are attacked at 0° and at 100° with the formation of carbon dioxide. A lower chloride is slowly formed, and after a long time some platinum is deposited. F. von Fodor and F. C. Phillips showed that soln. of **palladium dichloride** are rapidly reduced by carbon monoxide: $\text{PdCl}_2 + \text{H}_2\text{O} + \text{CO} = \text{Pd} + 2\text{HCl} + \text{CO}_2$, and C. Winkler showed that by the aid of this reaction 0.01 c.c. or 0.0000125 grm. of carbon monoxide can be detected. The test was investigated by M. Potain and R. Drouin, F. Jean, L. M. Dennis and C. G. Edgar, etc. The reaction was utilized by J. Donau for preparing colloidal palladium. F. C. Phillips noted that **rhodium chloride**, RhCl_3 , is not reduced in the cold, but it is slowly reduced at 100° ; and **iridium chloride**, IrCl_4 , is also slowly reduced by carbon monoxide.

A. J. Balard found that carbonyl chloride was formed by the action of **chlorine monoxide** on carbon monoxide for a few hours. E. J. Russell found that when a mixture of an excess chlorine monoxide and carbon monoxide is sparked, 5–10 per cent. of the latter remains unburnt, while with **chlorine dioxide** under similar conditions, H. B. Dixon and E. J. Russell found that 50–70 per cent. remains unoxidized. A. J. Balard found that an aq. soln. of **hypochlorous acid** has no effect on carbon monoxide. F. C. Phillips said that **calcium hypobromite** is also not

ected. A. Ditte found that carbon monoxide has no action on **iodic acid**, but if heated, carbon dioxide is formed and iodine is liberated. C. de la Harpe and F. Reverdin say the reaction occurs at 150°; and A. Gautier, at 60°-70°; and

Nicloux represents it by $5\text{CO} + 2\text{HIO}_3 = 5\text{CO}_2 + \text{H}_2\text{O} + \text{I}_2$, and if **iodine pentoxide** is used, A. Gautier gives $\text{I}_2\text{O}_5 + 5\text{CO} = 5\text{CO}_2 + \text{I}_2$. The reaction is employed in the determination of the amount of carbon monoxide in air and other gases. The quantitative determination of small amounts of carbon monoxide is based upon A. Ditte's reaction: $\text{I}_2\text{O}_5 + 5\text{CO} = 5\text{CO}_2 + \text{I}_2$, which is quantitatively complete between 60° and 70°, and enables carbon monoxide to be estimated in the presence of 20,000 times its vol. of air. Hence, if air is being investigated, it is first cleaned from the gases which react with iodine pentoxide by passage through tubes containing potassium hydroxide, and sulphuric acid; and then through a U-tube containing iodine pentoxide heated in a suitable bath. The liberated iodine passes on and may be absorbed in a soln. of potassium iodide, and subsequently titrated with $\frac{1}{1000}N$ -sodium thiosulphate. The vol. of air aspirated over the hot iodine pentoxide is also measured. C. de la Harpe and F. Reverdin employed this method for detecting the gas; and M. Nicloux used it quantitatively by estimating the liberated iodine colorimetrically in chloroform soln. A. Gautier measured the carbon dioxide evolved. The action of carbon monoxide on iodine pentoxide has been studied from the point of view of the analyst by A. Lévy and A. Pécou, A. Gautier and P. Clausmann, M. Pellet, J. L. R. Morgan and J. E. McWhorter, J. P. Kennicut and G. R. Sanford, B. Nowicki, etc. F. C. Phillips found that **potassium iodate** at 593° is not reduced by carbon monoxide.

C. Than¹⁴ showed that carbonyl sulphide, COS, contaminated with much carbon monoxide, is formed when a mixture of carbon monoxide and **sulphur vap.** is passed through a heated tube; or, according to G. Chevrier, when the mixture is sparked. F. Gonzalez and E. Moles denied the latter statement. M. Berthelot found that slight traces of **carbonyl selenide**, and **carbonyl telluride** are formed when **selenium** and **tellurium** are similarly treated. Carbon monoxide does not react with **hydrogen sulphide**, but S. M. Losanitsch and M. Z. Jovitschitsch exposed a mixture of the two gases to the silent electrical discharge, and found that sulphur and formaldehyde are rapidly formed: $\text{CO} + \text{H}_2\text{S} = \text{H.COH} + \text{S}$, followed by $\text{H.COH} + \text{H}_2\text{S} = \text{H}_2\text{O} + \text{HCSH}$. M. Berthelot said that a trace of methane is formed when a mixture of carbon monoxide and hydrogen sulphide acts on heated iron. K. Stammer found that **copper, lead, and iron sulphides** are not changed by carbon monoxide. M. Berthelot noted the reduction of **sulphur dioxide** by carbon monoxide when the mixed gases are passed through a red-hot tube; or treated with electric sparks: $\text{SO}_2 + 2\text{CO} = \text{S} + 2\text{CO}_2$. W. Smith and W. B. Hart confirmed this reaction.

K. Stammer found that **ammonium sulphate** is reduced to the sulphite by heating it in an atm. of carbon monoxide. E. Jacquemin found that **potassium, sodium, magnesium, strontium and barium sulphates** are decomposed when heated in an atm. of carbon monoxide and steam, forming hydrogen sulphide and carbon dioxide; at a high temp., sulphur is formed; and probably the metal sulphide is an intermediate product of the reaction. According to K. Stammer, A. Levil, and M. Berthelot, potassium sulphate is reduced to the sulphide: $\text{K}_2\text{SO}_4 + 4\text{CO} = 4\text{CO}_2 + \text{K}_2\text{S} + 16.6$ Cals.; and with sodium sulphate: $\text{Na}_2\text{SO}_4 + 4\text{CO} = 4\text{CO}_2 + \text{Na}_2\text{S} + 17.6$ Cals. W. Smith and W. B. Hart, and K. Stammer observed no action with sodium sulphate below dull redness, but at a bright red heat, the sulphite and sulphide are formed. K. Stammer noted the reduction of barium sulphate; and K. Stammer, and A. Herzfeld and K. Stiepel the reduction of **calcium sulphate**. K. Stammer also reported that **cupric sulphate**, and **silver sulphate** are reduced to the metals; magnesium sulphate is not changed; **zinc sulphate** forms zinc oxide; **aluminium sulphate**, alumina; **lead sulphate**, lead and lead sulphide; **manganese sulphate**, manganese oxide and sulphide; **ferrous sulphate**, ferrous sulphide and iron; and **barium selenate**, barium carbonate and selenium.

F. Briegleb and A. Geuther¹⁵ found that carbon monoxide reacts with heated **magnesium nitride**, forming cyanogen, magnesia, and carbon. S. M. Losanitsch and M. Z. Jovitschitsch, and D. Berthelot and H. Gaudechon found that under the influence of the silent electrical discharge, carbon monoxide and **ammonia** combine to produce formamide: $\text{CO} + \text{NH}_3 = \text{CHO.NH}_2$. A. Slosse under similar conditions obtained white crystals of a substance resembling carbamide. P. R. V. de Lambilly obtained ammonium formate by passing the mixed gases through a tube packed with pumice-stone or animal charcoal at 80°–150°. H. Jackson and D. N. Laurie said that when heated in contact with platinum, or exposed to an electric discharge of high frequency, ammonium cyanate is formed, which rapidly changes to carbamide; some ammonium carbonate is also produced. M. Berthelot observed no formation of hydrocarbons when a mixture of dry carbon monoxide and ammonia is passed over copper filings or over sodium. E. J. Mills and R. L. Barr and co-workers said that when a mixture of ammonia and carbon monoxide is passed several times over a heated mixture of potassium hydroxide and carbon, a potassium salt with 70 per cent. of cyanide is formed. M. Berthelot found an alcoholic soln. of ammonia absorbs no carbon monoxide at ordinary temp. J. T. Conroy obtained potassium cyanide by the action of carbon monoxide on **potassium amide**, KNH_2 ; F. Beilstein and A. Geuther obtained analogous results with **sodium amide**. W. Henry found that a mixture of carbon monoxide and **nitrous oxide** or **nitric oxide** is explosive, and carbon dioxide is formed; nitrous oxide or nitric oxide was also found by S. Cook to be reduced by carbon monoxide in contact with platinum. W. G. Mixer found that some carbon monoxide is oxidized when a mixture of that gas and nitric oxide is subjected to the silent discharge. At the moment of explosion, M. Berthelot and P. Vieille found a press. of 11.41 atm. is developed by a mixture of carbon monoxide and nitric oxide. C. W. Hasenbach found that carbon monoxide is oxidized at ordinary temp. by **nitrogen peroxide**, at the same time a liquid, decomposable by water, is formed. K. Stammer found that cold or boiling **nitric acid** of sp. gr. 1.2 does not attack carbon monoxide, but F. C. Phillips found that with the fuming acid carbon dioxide is produced. A. Vogel said that carbon monoxide does not act on molten **potassium nitrate**; K. Stammer stated that red-hot potassium nitrate and **barium nitrate** are reduced. F. C. Phillips found that an ammoniacal soln. of **silver nitrate** produces ammonium nitrite and silver. M. Berthelot observed the reduction of an ammoniacal soln. of silver nitrate, and J. Habermann said that 0.5 per cent. by vol. of carbon monoxide produces a distinct brown coloration, but 0.1 per cent. gives no coloration. A. Gautier made some observations on the subject. A. R. Leeds found that when carbon monoxide and air are allowed to stand in contact with moist **phosphorus**, some carbon dioxide is formed—*vide* action on ozone. Carbon monoxide does not react with **phosphine**. T. E. Thorpe and A. E. H. Tutton found that **phosphorus tetroxide** does not react with carbon monoxide at ordinary temp. or when heated. K. Stammer found that **lead, iron, and copper phosphates** are not altered when heated in carbon monoxide. F. Schlagdenhauffen and M. Plagel found that **arsenic trioxide** or **pentoxide** or **antimony trioxide** or **pentoxide** is not reduced at 150° or 300°, but I. W. Fay and co-workers said that reduction occurs at 60°. Carbon monoxide does not react with **arsine**. K. Stammer found that **sodium arsenate** or **antimonate** furnishes arsenic or antimony, respectively, when heated in carbon monoxide. A. W. Hofmann, and A. M. Butleroff obtained carbonyl chloride by heating **antimony pentachloride** with carbon monoxide: $\text{SbCl}_5 + \text{CO} = \text{COCl}_2 + \text{SbCl}_3$.

According to H. Moissan,¹⁶ at 1200°, amorphous **boron** reduces carbon monoxide to carbon. M. Foix found that when the diamond is heated above 1100° in an atm. of **carbon dioxide**, the reaction $\text{CO}_2 + \text{C} \rightleftharpoons 2\text{CO}$ does not occur in the time available, but amorphous carbon is deposited on the diamond, which itself is not changed. A. Frank found that **calcium carbide** at 200°–250° reacts with carbon monoxide, forming carbon and calcium oxide. A. T. Larson and

S. Teitsworth studied the absorption of carbon monoxide by ammoniacal soln. of **cuprous carbonate and formate**; and they measured the partial press. of carbon monoxide in contact with these soln. According to M. Berthelot, carbon monoxide and **methane** give propylene; W. Odling said acetylene and water are formed: $\text{H}_4 + \text{CO} = \text{H}_2\text{O} + \text{C}_2\text{H}_2$; but F. C. Phillips could not verify this statement. M. Losanitsch and M. Z. Jovitschitsch found that with the silent discharge, acetaldehyde is formed, $\text{CO} + \text{CH}_4 = \text{CH}_3\text{COH}$, a conclusion in agreement with that of A. de Hemptinne. E. Sarrau and P. Vieille studied the equilibrium conditions between a mixture of carbon monoxide, methane, hydrogen, and nitrogen. A. de Hemptinne formed some aldehyde and what was thought to be acetone by the action of the silent discharge on a mixture of carbon monoxide and **ethane**: $2\text{H}_6 + \text{CO} = \text{C}_3\text{H}_6\text{O}$. S. M. Losanitsch found that with the silent discharge, **ethylene** and carbon monoxide furnish a substance, $(\text{C}_2\text{H}_4)_2\text{CO}$, soluble in ether, and an insoluble substance; and with **acetylene**, there is formed a yellowish-brown substance which rapidly absorbs oxygen. A. Frank represented the action of carbon monoxide on acetylene by $\text{C}_2\text{H}_2 + \text{CO} = 3\text{C} + \text{H}_2\text{O}$; and H. le Chatelier and O. Boudouard found the inflammability of the mixed gases is similar to that of mixtures of carbon monoxide and hydrogen (*q.v.*). E. Frankland found a mixture of carbon monoxide and **carbon disulphide** inflames at 210° . M. Berthelot, and S. M. Losanitsch and M. Z. Jovitschitsch obtained carbonyl sulphide by the action of the silent discharge on the mixed gases. P. Schützenberger found that when a mixture of carbon monoxide and **carbon tetrachloride** is passed over pumice-stone at $350^\circ\text{--}400^\circ$, carbonyl chloride and tetrachloroethylene are formed: $2\text{CCl}_4 + 2\text{CO} = 2\text{COCl}_2 + \text{C}_2\text{Cl}_4$. J. Stammer said that **potassium carbonate** is not altered when heated in carbon monoxide, but **potassium oxalate** furnishes carbon, carbon dioxide, and potassium carbonate. E. Carstanjen and A. Schertel found that carbon monoxide does not react with **cyanogen** in direct sunlight. C. Böttinger found that carbon monoxide is conspicuously absorbed by liquid **hydrogen cyanide**, but is not miscible with conc. hydrochloric acid. On removing the product from the freezing-mixture, carbon monoxide was evolved in a regular stream. On gently warming, the gas is given off more rapidly, and ultimately the liquids mix, when the evolution of gas becomes turbulent. According to E. Carstanjen and A. Schertel, no carbonyl cyanide is produced when carbon monoxide is passed over heated **mercuric cyanide**. F. C. Phillips found that **potassium ferricyanide** has no action on carbon monoxide; and J. Milbauer obtained a trace of potassium cyanide and a volatile product—possibly carbonyl sulphide—by passing carbon monoxide over heated **potassium thiocyanate**. The action of carbon monoxide on many **organic compounds** has been studied.¹⁷ L. Bell¹⁸ found that graphitoidal **silicon** is not changed when heated in carbon monoxide, while **titanic oxide** loses 4.7 per cent. of oxygen, and forms some carbon. F. H. Pollard found that carbon monoxide is adsorbed by platinized asbestos.

The action of carbon monoxide on the metals is discussed in connection with the metal carbonyls—*vide infra*. When heated with magnesium, **magnesium oxide** and carbon are formed; **nickel** undergoes a slight carbonization; and **chromium** and **manganese** are oxidized. N. N. Beketoff¹⁹ found that at $290^\circ\text{--}310^\circ$, **sodium oxide** reacts with carbon monoxide, forming sodium carbonate and sodium; and F. Haber and L. Bruner, that fused **sodium hydroxide** gives sodium carbonate and hydrogen. M. C. Boswell and J. V. Dickson found that at $410^\circ\text{--}430^\circ$, carbon monoxide is oxidized by fused sodium hydroxide, forming sodium carbonate, and evolving hydrogen: $2\text{NaOH} + \text{CO} = \text{Na}_2\text{CO}_3 + \text{H}_2$, i.e. essentially $\text{CO} + \text{H}_2\text{O} = \text{CO}_2 + \text{H}_2$. R. E. Wilson and co-workers studied the removal of small quantities of carbon monoxide from gases by absorption at 100° by soln. of sodium hydroxide: $2\text{NaOH} + \text{CO} = \text{H}_2 + \text{Na}_2\text{CO}_3$. M. Berthelot found that when **potassium hydroxide** is heated with carbon monoxide in a sealed vessel on a water-bath, some potassium formate, H.COOK , is formed. The reaction is faster if more water be used than that required just to moisten the alkali; with

methyl or ethyl alcohol in place of water the reaction is 10–15 times as fast—with ethyl alcohol, a little propionic acid is formed; with amyl alcohol the action is about half as fast as with methyl or ethyl alcohol; with glycerol the action is slower than with water; with ether the absorption is faster than with any other substance tried; and with methyl or ethyl nitrate, the reaction is faster than with water. According to A. Geuther, and V. Merz and J. Tibirica, the formation of salts of formic acid by the action of carbon monoxide on alkali hydroxides takes place at about 200° but the temp. should not exceed 220° since sodium formate is then decomposed into carbonate and hydrogen; with potassium formate the temp. of decomposition is lower than 220°. The gas should be moist; and in order to saturate the alkali completely it is best to use soda-lime. The commercial production of formates by these reactions has been exploited. By working under press. and with a mixture of sodium carbonate and calcium hydroxide the Farbwerk vorm. Meister, Lucius und Brüning prepared sodium formate: $\text{Na}_2\text{CO}_3 + \text{Ca}(\text{OH})_2 + 2\text{CO} = 2\text{HCOONa} + \text{CaCO}_3$. F. C. Phillips said that **calcium hydroxide** alone does not absorb carbon monoxide. W. H. Engels studied the production of hydrogen by the action of carbon monoxide on calcium hydroxide at 500°. The main reaction is represented $\text{Ca}(\text{OH})_2 + \text{CO} = \text{CaCO}_3 + \text{H}_2$; and the side reaction: $\text{CO} + \text{H}_2\text{O} = \text{CO}_2 + \text{H}_2$. The presence of iron accelerates the reaction tenfold. M. Berthelot found that the absorption by **calcium oxide** in the presence of alcohol is not more energetic than by an aq. soln. of potassium hydroxide. The last-named also studied the absorption of carbon monoxide by **barium oxide** in the presence of alcohol and ether.

G. Bodländer²⁰ discussed the theory of the reduction of metal oxides by carbon monoxide—*vide* the respective oxides. I. W. Fay and co-workers compared the reducing action of carbon monoxide, hydrogen, ammonia, and methane:

	Au_2O_3	Ag_2O	Hg_2O	HgO (red)	PbO	CuO	Cu_2O	CoO	ZnO
CO	$<0^\circ$	0°	0°	90°	160°	75°	—	140°	170°
H_2	$<0^\circ$	0°	80°	115°	190°	125°	—	—	—
NH_3	—	—	67°	157°	299°	225°	208°	—	230°
CH_4	—	—	220°	205°	210°	280°	230°	—	150°

For yellow mercuric oxide with carbon monoxide and hydrogen the numbers are respectively $<0^\circ$ and 50° ; for lead dioxide, 110° and 150° ; for red lead, 150° and 170° . In many cases the carbon monoxide is burned preferentially before the hydrogen, as shown by E. D. Campbell, C. R. A. Wright and A. P. Luff, I. W. Fay and co-workers, etc. A. F. Benton considered the mechanism of the reduction involves adsorption of the gas, isomeric change, and evaporation of the gaseous product of the reaction from the surface of the oxide. A. de Hemptinne studied the reducing action of the electric discharge on metal oxides in the presence of carbon monoxide. H. Quantin studied the joint action of carbon monoxide and chlorine on some metal oxides. The reduction of **cuprous oxide** by carbon monoxide has been studied by F. Schlagdenhauffen and M. Pagel, and by C. R. A. Wright and A. P. Luff; that of **cupric oxide** by K. Stammer, A. de Hemptinne, I. L. Bell, and C. R. A. Wright and co-workers—*vide* the respective oxides. The reduction of **silver oxide** by carbon monoxide has been studied by F. Schlagdenhauffen and M. Pagel and A. Gautier—*vide infra*. The latter showed that with moist silver oxide a basic carbonate is formed: $3\text{Ag}_2\text{O} + \text{CO} = \text{Ag}_2\text{O} \cdot \text{Ag}_2\text{CO}_3 + 2\text{Ag}$. H. Dejust gave for the heat of the reaction at ordinary temp.: $\text{CO} + \text{Ag}_2\text{O} = 2\text{Ag} + \text{CO}_2 + 61.2$ Cals. For **mercuric oxide**, *vide infra*. K. Stammer found that carbon monoxide does not reduce **zinc oxide**. F. J. Brislie studied the reduction of **cadmium oxide** and of bismuth oxide by carbon monoxide. F. C. Phillips found that a soln. of **cerium dioxide** in sulphuric acid is not reduced by carbon monoxide. The reduction of **lead oxide** has been discussed by C. R. A. Wright and A. P. Luff, A. de Hemptinne and F. J. Brislie; **tin oxide**, by K. Stammer, and F. Schlagdenhauffen and M. Pagel; **manganese oxide**, by I. L. Bell, K. Stammer, C. R. A. Wright and A. P. Luff, and

Charpy; **chromic oxide**, by G. Charpy, F. C. Phillips, A. Gautier, and F. Schlagdenhauffen and M. Pagel. According to K. A. Hofmann, carbon monoxide is reduced by a soln. of **chromic acid** to which mercuric oxide has been added as catalyst—*vide supra*. The oxidation is then sufficiently rapid to remove carbon monoxide from air and other gases with sufficient rapidity for analytical and hygienic purposes. The reduction of **molybdenum oxide** by carbon monoxide was observed by F. Schlagdenhauffen and M. Pagel; **iron oxide**, by W. Müller, O. Boudouard, J. Baur and F. Glässner, B. Osann, L. Gruner, A. de Hemptinne, A. Gautier and J. Clausman, J. Braithwaite, G. Charpy, I. L. Bell, etc. G. Chaudron found that below 580° , the reaction is $\text{Fe}_3\text{O}_4 + 4\text{CO} \rightleftharpoons 4\text{CO}_2 + 3\text{Fe}$; above 580° , there are two equilibria: $\text{Fe}_3\text{O}_4 + \text{CO} \rightleftharpoons 3\text{FeO} + \text{CO}_2$; and $\text{FeO} + \text{CO} \rightleftharpoons \text{Fe} + \text{CO}_2$; and all three solid phases are in equilibrium at 580° ; ferrous oxide is unstable below 580° , reacting $4\text{FeO} \rightleftharpoons \text{Fe}_3\text{O}_4 + \text{Fe}$ —*vide iron oxides*. The action of carbon monoxide on **nickel oxide** has been studied by I. L. Bell, C. R. A. Wright and A. P. Luff, O. Boudouard, etc.; on **cobalt oxide**, by C. R. A. Wright and A. P. Luff, I. L. Bell, and O. Boudouard; and on **osmium tetroxide**, by F. C. Phillips. O. Boudouard found that soln. of **potassium ruthenate** are rapidly reduced by carbon monoxide. J. Stammer found that **potassium chromate** is reduced by carbon monoxide, forming chromic oxide and potassium carbonate; while **lead chromate** furnishes lead and chromic oxides. F. C. Phillips found that neutral, acid, and alkaline soln. of **potassium permanganate** are easily reduced by carbon monoxide. V. Meyer and M. von Recklinghausen, H. Hirtz and V. Meyer, and C. Engler and W. Wild made observations on this subject. A. Vermet found that a soln. of potassium permanganate, acidified with nitric acid, and mixed with silver nitrate, is decolorized by carbon monoxide.

The physiological action of carbon monoxide.—The toxic nature of the fumes from burning charcoal was commented upon by F. Hofmann²¹ in an essay: *Grundliches bedenken von dem schädlichen Dampf der Holzkohlen* (1719), and H. Davy, and F. Clément and J. B. Désormes showed that when mixed with one-fourth its bulk of air and inspired, carbon monoxide immediately produces giddiness and fainting fits. In acute poisoning there is a preliminary period of excitation followed by a sensation of heaviness, dizziness noises in the ear, accelerated cardiac and respiratory movements, oppression on the chest, and maybe nausea and vomiting; there is also muscular weakness, drowsiness, loss of sensation, coma, and convulsions which precede death. The earlier symptoms of slow chronic poisoning are headache, neuralgic pains, anæmia, loss of flesh, and a sensation of breathlessness developed by incommensurate exertion. According to L. Hill, and C. le Neve Foster and J. S. Haldane, when the blood is 20 per cent. sat. with carbon monoxide, there occurs dizziness and shortness of breath on exertion; the symptoms are aggravated by increasing the conc. of the gas; at 50 per cent. sat., it is scarcely possible to stand, and the slightest exertion causes a temporary loss of consciousness. Exertion, by using up the oxygen in the muscles, hastens the failure of the heart's action; and with those rescued from death, degenerative changes may set in and a lasting weakness of the heart be produced. Any quantity above 0.14 per cent. of carbon monoxide in the air is dangerous; and 1 per cent. will nearly always cause death.

Carbon monoxide is present in the products of combustion from domestic places, stoves, etc., and is exhaled from the various chimneys of a large city considerable vol. A smoky chimney or a defective flue may introduce carbon monoxide into the living rooms. The fumes from slow combustion stoves or fire-places with a restricted exit contain carbon monoxide. The fumes evolved from burning charcoal or coke in a closed room are toxic in virtue of the contained carbon monoxide. The poisonous nature of these fumes has been utilized particularly in France and Germany, as a method of suicide, on account of the supposed painlessness of the death; and also as an instrument of murder. The products of combustion of coal gas may under certain conditions contain much carbon monoxide.

T. E. Thorpe, for example, showed that an ordinary Bunsen burner, heating sand tray, evolves 0.022 c. ft. of carbon monoxide per hour. The gas burner employed to heat large masses of cold water in bath-rooms are a source of danger unless provision be made for abundant ventilation. Coal gas contains carbon monoxide, and poisoning by coal gas is practically poisoning by carbon monoxide. Employees in works where water gas or producer gas is made incur the risk of both acute and chronic carbon monoxide poisoning. Water gas, used as a substitute for and as an adjunct to, coal gas contains up to 40 per cent. of carbon monoxide, and its poisonous qualities are still more dangerous owing to the absence of a characteristic odour. The slightest leak in the household gas fittings—and few are perfect—is an insidious source of chronic poisoning.

J. S. Haldane showed that the toxic action of carbon monoxide is directly due to its combining with the hæmoglobin of the blood to form *carboxyhæmoglobin*²² which interferes with the activity of the hæmoglobin in forming oxyhæmoglobin, and acting as a carrier of oxygen. He found that (i) when animals were placed in oxygen at 2 atm. press., the blood dissolves enough oxygen to render the animals independent of the red corpuscles; carbon monoxide at one atm. press. was then added but no toxic effects were observed; and that (ii) animals with no hæmoglobin were not affected when placed in an atm. containing 75 per cent. carbon monoxide and 25 per cent. oxygen. The carboxyhæmoglobin is more stable than oxyhæmoglobin and is more slowly decomposed and eliminated. According to N. Gréham, if air with 0.07–0.12 per cent. of carbon monoxide be breathed for half an hour, one-fourth part of the hæmoglobin in the blood is put out of action as a carrier of oxygen owing to the formation of carboxyhæmoglobin. According to L. Hill, if blood be shaken with 0.07 per cent. of carbon monoxide, and 21 per cent. of oxygen, the two gases will be shared equally with the hæmoglobin so that carbon monoxide has 20 times more affinity for hæmoglobin than oxygen. According to P. Spica and G. P. Menegazzi, subcutaneous injections of hydrogen dioxide can convert carboxyhæmoglobin into carbon dioxide, etc.

The blood in the case of death from asphyxia is dark in colour; in the case of carbon monoxide poisoning it is bright florid red. P. A. Piorry noticed that the blood—living or dead—is coloured a bright red by the action of carbon monoxide. This is due to the formation of carboxyhæmoglobin, which retains its colour under conditions where oxyhæmoglobin would lose its oxygen and assume the dark appearance of reduced hæmoglobin. The spectra of hæmoglobin, oxyhæmoglobin and carboxyhæmoglobin by J. Formanek are shown in Fig. 38; that of oxyhæmoglobin

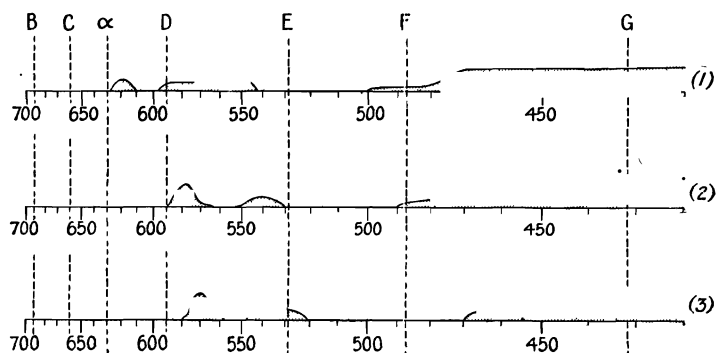

FIG. 38.—Absorption Bands in the Spectra of Hæmoglobin (1), Oxyhæmoglobin (2), and Carboxyhæmoglobin (3).

globin is characteristic of flesh blood diluted with water. There are here two bands—the one near the sodium line is well-defined with a head of wave-length 5781; the other, less well-defined, is in the green, and has a head of wave-length 5417. The

spectrum of carboxyhæmoglobin is somewhat similar, but the two bands are slightly displaced towards the violet end of the spectrum and have heads of wave-length 720 and 5381 respectively. The difference is so small that the changed position is appreciable only when the two spectra are compared side by side. H. Hartridge has developed a method of estimating the magnitude of the displacement by the movement on a micrometer required to bring one of the two bands of the carboxyhæmoglobin spectrum coincident with the corresponding band of the oxyhæmoglobin spectrum. When ammonium sulphide is added to the dil. blood soln., the absorption bands of carboxyhæmoglobin remain unaltered, while those of oxyhæmoglobin are merged into one broad band. Since in the case of carbon monoxide poisoning death ensues before all the hæmoglobin has been converted into carboxyhæmoglobin, the spectrum does not necessarily remain unchanged on the addition of ammonium sulphide; but the two persistent bands of carboxyhæmoglobin may be superposed on the broad band of the reduced hæmoglobin.

Carbon monoxide, according to G. Senter,²³ has no effect on the action of ferments, though G. Bredig showed that it retards the catalytic activity of colloidal platinum. T. B. Bottomley and H. Jackson, A. Marcacci, L. Just, and G. Linossier have discussed the effect of carbon monoxide on plants, and on the germination of seeds.

The methods of detecting and measuring small amounts of carbon monoxide in gas can be divided into two classes: (1) those in which carbon monoxyhæmoglobin is formed; and (2) those in which it is oxidized to carbon dioxide. The methods employed in the first class are virtually all modifications of F. Hoppe-Seyler's method²⁴ which is based on the fact that both carbon monoxyhæmoglobin formed by the action of carbon monoxide on arterial blood, and oxyhæmoglobin give distinct absorption spectral bands—*vide supra*. Of the oxidation methods, the one employing iodine pentoxide is well suited for the work—*vide supra*. The reducing action of carbon monoxide on mercuric or silver oxide at 60° has been recommended for the quantitative determination of this gas: $\text{Ag}_2\text{O} + \text{CO} = \text{CO}_2 + \text{Ag}$, by Nesmjeloff, L. Moser and O. Schmid, F. Schlagdenhauffen and M. Pagel, and Glaser. Other reactions utilized in the determination of carbon monoxide have been previously discussed; they involve the absorption of the gas by an ammoniacal soln. of silver hydroxide: $\text{Ag}_2\text{O} + \text{CO} = \text{CO}_2 + \text{Ag}$, or by an ammoniacal or hydrochloric acid soln. of cuprous chloride; and the effect of the gas on stannous chloride. The gas can also be estimated by oxidizing it with oxidized asbestos and air, or cupric oxide at 250° under conditions²⁵ which do not affect methane. A. B. Lamb and co-workers discussed the preferential combustion of carbon monoxide in the presence of hydrogen when *hopcalite*—*i.e.* a mixture of metallic oxides, say, 60 per cent. of manganese dioxide, and 40 per cent. of cupric oxide—is used as catalyst at ordinary temp. Hydrogen is not affected.

REFERENCES.

- V. Hoyer, *Zeit. angew. Chem.*, **20**, 419, 1899.
 J. Plücker, *Pogg. Ann.*, **105**, 67, 1858; H. Buff and A. W. Hofmann, *Liebig's Ann.*, **113**, 1860; *Journ. Chem. Soc.*, **12**, 273, 1860; J. N. Collie, *ib.*, **79**, 1063, 1901; A. W. Hofmann, *ib.*, **23**, 3303, 1890; A. Grau and F. Russ, *Zeit. Elektrochem.*, **13**, 345, 1907; P. G. Tait and Andrews, *Phil. Trans.*, **150**, 113, 1860; H. St. C. Deville, *Compt. Rend.*, **59**, 873, 1864; **60**, 317, 1865; M. Berthelot, *ib.*, **96**, 298, 1883; *Bull. Soc. Chim.*, (2), **40**, 362, 1883; *Ann. Chim. Phys.*, (5), **30**, 547, 1883; W. Henry, *Phil. Trans.*, **114**, 266, 1824; A. T. Cameron and W. Ramsay, *Phil. Mag.*, **93**, 966, 1908.
 H. St. C. Deville, *Compt. Rend.*, **59**, 873, 1864; **60**, 317, 1865; H. C. Woltereck, *ib.*, **147**, 1908; M. Berthelot, *ib.*, **96**, 298, 1883; **110**, 609, 1890; **112**, 594, 1891; **140**, 905, 1905; *Ann. Chim. Phys.*, (5), **30**, 547, 1883; (6), **24**, 126, 1891; (7), **14**, 170, 1898; *Bull. Soc. Chim.*, **40**, 362, 1883; C. Langer and V. Meyer, *Pyrochemische Untersuchungen*, Braunschweig, 1885; Gautier, *Compt. Rend.*, **150**, 1383, 1910; F. Würtenberger, *Stahl Eisen*, **23**, 447, 1903; Fester and G. Brude, *Ber.*, **56**, B, 2245, 1923.
 M. Berthelot, *Compt. Rend.*, **72**, 94, 1866; **82**, 1283, 1357, 1876; **83**, 677, 933, 1876; **126**, 1898; *Bull. Soc. Chim.*, (2), **5**, 91, 95, 169, 1866; (2), **26**, 58, 98, 1876; B. C. Brodie, *Proc. Roy. Soc.*, **21**, 245, 1873; *Chem. News*, **27**, 137, 1873; F. H. Pollard, *Journ. Phys. Chem.*, **27**, 137, 1873.

356, 1923; E. F. Armstrong and T. P. Hilditch, *Proc. Roy. Soc.*, **97**, A, 265, 1920; **103**, A, 2, 1923; R. T. Haslam, *Journ. Ind. Eng. Chem.*, **15**, 679, 1923; F. Fischer and H. Tropsch, *Brennstoff Chem.*, **4**, 193, 1923; F. Fischer, H. Tropsch, and W. Mohr, *ib.*, **4**, 197, 1923; K. G. Falk, *Journ. Amer. Chem. Soc.*, **29**, 1536, 1907; *Ann. Physik*, (4), **24**, 450, 1907; A. de Hemptinne, *Bull. Acad. Belg.*, (3), **34**, 269, 1897; A. Slosse and A. Nowak, *ib.*, (2), **35**, 547, 1898; G. Feste, *Brennstoff Chem.*, **3**, 244, 1922; G. Fester and G. Brude, *ib.*, **5**, 49, 1924; *Ber.*, **56**, A, 226, 1923; S. M. Losanitsch and M. Z. Jovitschitsch, *Ber.*, **30**, 136, 1897; W. Löb, *Zeit. Elektr. chem.*, **11**, 750, 1905; *Landw. Jahrb.*, **35**, 541, 1906; P. Sabatier, *French Pat. No.* 35590, 1905; *La catalyse en chimie organique*, Paris, 151, 1920; S. Medsforth, *Journ. Chem. Soc.* **123**, 1452, 1923; P. Sabatier and J. B. Senderens, *Ann. Chim. Phys.*, (8), **4**, 424, 1905; *Compt. Rend.*, **134**, 514, 689, 1902; A. Gautier, *ib.*, **150**, 1383, 1564, 1910; D. Berthelot and H. Gaudechon, *ib.*, **150**, 1690, 1910; E. Sarrau and P. Vieille, *ib.*, **105**, 1225, 1887; H. S. Elworth and E. H. Williamson, *Brit. Pat. Nos.* 12461, 1902; 14333, 1905; M. Mayer and V. Altmayer, *Ber.*, **41**, 3074, 1908; M. Mayer, F. Henseling, V. Altmayer, and J. Jacoby, *Journ. Gasbeleucht.* **52**, 166, 194, 238, 282, 305, 326, 1909; F. Orloff, *Journ. Russ. Phys. Chem. Soc.*, **40**, 158, 1909; H. le Chatelier and O. Boudouard, *Compt. Rend.*, **126**, 1344, 1903.

^b M. Potain and R. Drouin, *Compt. Rend.*, **126**, 938, 1898; M. Berthelot, *ib.*, **60**, 527, 1865; *Ann. Chim. Phys.*, (4), **6**, 292, 329, 1865; (7), **15**, 350, 1898; (7), **21**, 205, 1900; (8), **6**, 195, 1905; M. Berthelot and P. Vieille, *Compt. Rend.*, **98**, 545, 601, 646, 1884; *Bull. Soc. Chim.*, (2), **4**, 554, 1884; R. T. Haslam, *Journ. Ind. Eng. Chem.*, **15**, 679, 1923; S. Medsforth, *Journ. Chem. Soc.*, **123**, 1452, 1923; T. H. Rogers, C. S. Piggot, W. H. Bahlke, and J. M. Jennings, *Journ. Amer. Chem. Soc.*, **43**, 1973, 1921; D. R. Merrill and C. C. Scalione, *ib.*, **43**, 1982, 1921; H. S. Taylor and H. A. Neville, *ib.*, **43**, 2055, 1921; A. K. Sanyal and N. R. Dhar, *Zeit. anorg. Chem.*, **12**, 212, 1923; F. Haber and H. J. Hodsman, *Zeit. phys. Chem.*, **67**, 343, 1909; R. Bunsen, *Pog. Ann.*, **131**, 161, 1867; H. Valerius, *Bull. Acad. Belg.*, (2), **38**, 654, 1874; E. Mallard and H. le Chatelier, *Recherches expérimentales et théoriques sur la combustion des mélanges gazeux explosifs*, Paris, 1903; *Compt. Rend.*, **91**, 825, 1880; **93**, 1076, 1881; **95**, 1352, 1882; *Bull. Soc. Chim.* (2), **39**, 2, 1883; P. Geipert, *Journ. Gasbeleucht.*, **49**, 478, 1906; K. G. Falk, *Journ. Amer. Chem. Soc.*, **29**, 1836, 1907; *Ann. Physik*, (4), **24**, 450, 1907; V. Meyer and A. Münch, *Ber.*, **26**, 242, 1893; F. Freyer, *Ueber die Entzündungstemperaturen explosiver Gasgemische*, Berlin, 1893; F. Freyer and V. Meyer, *Zeit. phys. Chem.*, **11**, 28, 1893; V. Meyer, *Naturw. Rund.*, **6**, 349, 1891; A. Krause and V. Meyer, *Liebig's Ann.*, **264**, 85, 1891; K. W. Charitschkoff, *Journ. Russ. Phys. Chem. Soc.*, **34**, 461, 1902; J. C. Clancy, *U.S. Pat. No.* 1376514, 1921; A. B. Ray and F. O. Anderegg, *Journ. Amer. Chem. Soc.*, **43**, 967, 1921; D. R. Merrill and C. C. Scalione, *ib.*, **43**, 1982, 1923; J. A. Almqvist and W. C. Bray, *ib.*, **45**, 2305, 1923; W. A. Whitesell and J. C. W. Frazer, *ib.*, **45**, 2841, 1923; W. M. Thornton, *Phil. Mag.*, (6), **40**, 450, 1920; I. Langmuir, *Journ. Amer. Chem. Soc.*, **37**, 1162, 1915; A. B. Lamb, C. C. Scalione, and G. Edgar, *ib.*, **44**, 73, 1922; A. B. Lamb, W. C. Bray, and J. C. W. Frazer, *Journ. Ind. Eng. Chem.*, **12**, 213, 1920; R. S. Tour, *ib.*, **12**, 844, 1920; H. B. Dixon and H. F. Coward, *Journ. Chem. Soc.*, **95**, 514, 1908; J. W. Draper, *Phil. Mag.*, (3), **30**, 945, 1847; (3), **32**, 100, 1848; H. Héliar, *Ann. Chim. Phys.* (7), **10**, 521, 1897; *Recherches sur les combinaisons gazeuses*, Paris, 1896; H. Kühl, *Zeit. phys. Chem.*, **44**, 385, 1903; M. Bodenstein and F. Ohlmer, *ib.*, **53**, 166, 1905; A. de Hemptinne, *ib.*, **46**, 18, 1903; J. L. Gay Lussac, *Mém. Soc. Arcueil*, **2**, 207, 1809; H. Davy, *Phil. Trans.*, **10**, 557, 1814; W. G. Mixter, *Amer. Journ. Science*, (4), **4**, 51, 1897; F. Haber and F. Richardt, *Zeit. anorg. Chem.*, **38**, 69, 1904; B. Lepsius, *Ber.*, **23**, 1422, 1890; F. C. Phillips, *Amer. Chem. Journ.* **16**, 255, 1894; E. D. Campbell, *ib.*, **17**, 681, 1896; P. J. van Kerckhoff, *Arch. Néerl.*, (1), **7**, 2, 1872; *Chem. News*, **26**, 219, 1872; F. Pollitzer, *Zeit. angew. Chem.*, **35**, 683, 1922; J. Harger and H. Terrey, *Brit. Pat. No.* 127609, 1917; E. K. Rideal and H. S. Taylor, *Analyst*, **44**, 89, 1917; E. K. Rideal, *Journ. Chem. Soc.*, **115**, 993, 1919; R. N. Pease and H. S. Taylor, *Journ. Phys. Chem.*, **24**, 241, 1920; H. A. Jones and H. S. Taylor, *ib.*, **27**, 623, 1923; A. de la Rive and F. Maroet, *Ann. Chim. Phys.*, (2), **39**, 328, 1828; P. L. Dulong and I. J. Thénard, *ib.*, (2), **440**, 1823; (2), **24**, 380, 1823; A. Pleischl, *Gilbert's Ann.*, **76**, 98, 1824; *Schweigger's Journ.*, **142**, 201, 351, 1823; J. W. Döbereiner, *ib.*, **34**, 91, 1822; **38**, 321, 1823; **39**, 159, 1823; **42**, 1824; **63**, 465, 1831; *Gilbert's Ann.*, **74**, 269, 1823; W. Henry, *Phil. Mag.*, (1), **6**, 354, 1824; *Ann. Phil.*, **21**, 364, 1823; **25**, 416, 1825; A. F. Girvan, *Proc. Chem. Soc.*, **19**, 236, 1903; L. M. and C. Langer, *German Pat.*, *D.R.P.* 51572, 1889; P. Sabatier and J. B. Senderens, *Bull. Soc. Chim.*, (3), **29**, 294, 1903; H. B. Dixon and H. F. Lowe, *Journ. Chem. Soc.*, **47**, 571, 1885; *Chem. News*, **51**, 309, 1885; H. B. Dixon, *ib.*, **46**, 151, 1882; **73**, 139, 1896; *Journ. Chem. Soc.*, **69**, 7, 1896; W. W. Hurst and E. K. Rideal, *ib.*, **125**, 685, 694, 1024; W. A. Whitehead and J. C. W. Frazer, *Journ. Amer. Chem. Soc.*, **45**, 2841, 1923; K. W. Rosenmund and P. Langer, *Ber.*, **56**, B, 2262, 1923; W. A. Jones, *Amer. Chem. Journ.*, **30**, 40, 1903; E. D. Campbell, *ib.*, **17**, 6, 1895.

^c E. Mallard and H. le Chatelier, *Recherches expérimentales et théoriques sur la combustion des mélanges gazeux explosifs*, Paris, 1883; *Compt. Rend.*, **93**, 145, 1881; **95**, 599, 1352, 1882; M. Berthelot and P. Vieille, *ib.*, **98**, 545, 601, 1884; *Bull. Soc. Chim.*, (2), **41**, 554, 1884; *Ann. Chim. Phys.*, (5), **28**, 289, 1881; (6), **4**, 13, 1885; H. B. Dixon, *Phil. Trans.*, **175**, 640, 1882; **184**, A, 111, 1893; **200**, A, 315, 1903; *Proc. Roy. Soc.*, **37**, 56, 1884; *Chem. News*, **46**, 151, 1885; **73**, 139, 1896; *Journ. Chem. Soc.*, **69**, **74**, 1896; H. B. Dixon, E. H. Strange, and E. Graham, *ib.*, **69**, 759, 1896; H. B. Dixon and N. S. Walls, *ib.*, **123**, 1025, 1925; E. J. Russell, *ib.*, **77**, 36, 1900; K. Bötsch, *Liebig's Ann.*, **210**, 207, 1881; *Unvollständige Verbrennung von Gasen*, Tübingen

1881; L. Meyer and K. Seubert, *Liebig's Ann.*, **226**, 87, 1884; W. A. Bone and W. A. Howard, *Proc. Roy. Soc.*, **100**, A, 67, 1921; **103**, A, 205, 1923; W. A. Bone, D. M. Newitt, and D. T. A. Townend, *ib.*, **103**, A, 205, 1923; **105**, A, 406, 1924; *Journ. Chem. Soc.*, **123**, 2008, 1923; W. Payman, *ib.*, **115**, 1436, 1446, 1454, 1919; **117**, 48, 1920; W. Payman and R. V. Wheeler, *ib.*, **121**, 363, 1922; **123**, 1251, 1923; R. Bunsen, *Gasometrische Methoden*, Braunschweig, 48, 1877; London, 1857.

⁷ H. Davy, *Phil. Trans.*, **104**, 557, 1814; M. Berthelot, *Compt. Rend.*, **68**, 1035, 1869; *Ann. Chim. Phys.*, (4), **18**, 178, 1869; *Bull. Soc. Chim.*, (2), **13**, 99, 1869; E. Berl and H. Fischer, *Zeit. Elektrochem.*, **30**, 29, 1924; E. Terres, *Journ. Gasbeleucht.*, **63**, 785, 805, 820, 836, 1920; H. Bunte and J. Roszkowsky, *ib.*, **33**, 491, 524, 535, 553, 1890; P. Eitner, *ib.*, **45**, 21, 69, 90, 112, 1902; J. Roszkowsky, *Zeit. phys. Chem.*, **7**, 485, 1891; N. N. Beketoff, *Bull. Acad. St. Petersburg*, (2), **2**, 175, 1891; L. Meyer, *Ber.*, **19**, 1104, 1886; H. B. Dixon, *ib.*, **38**, 2419, 1905; *Journ. Chem. Soc.*, **49**, 94, 1886; **69**, 774, 1896; H. B. Dixon and E. J. Russell, *ib.*, **71**, 605, 1897; E. J. Russell, *ib.*, **77**, 361, 1900; G. Schegel, *Liebig's Ann.*, **226**, 133, 1884; H. F. Coward and F. Brinsley, *Journ. Chem. Soc.*, **105**, 1853, 1914; W. A. Jones, *Amer. Chem. Journ.*, **30**, 40, 1903.

⁸ H. B. Dixon, *B.A. Rep.*, 503, 1880; *Chem. News*, **46**, 151, 1882; *Phil. Trans.*, **175**, 617, 1884; *Proc. Roy. Soc.*, **57**, 56, 1884; *Ber.*, **38**, 2419, 1905; *Journ. Chem. Soc.*, **49**, 94, 1886; **69**, 774, 1896; H. B. Dixon and H. F. Lowe, *ib.*, **47**, 571, 1885; A. Smithells and F. Dent, *ib.*, **65**, 603, 1884; K. Bötsch, *Liebig's Ann.*, **210**, 207, 1881; *Unvollständige Verbrennung von Gasen*, Tübingen, 1881; L. Meyer and K. Seubert, *Liebig's Ann.*, **226**, 87, 1884; L. Meyer, *Ber.*, **19**, 1099, 1886; H. von Wartenberg and B. Sieg, *ib.*, **53**, B, 2192, 1920; M. Traube, *ib.*, **18**, 1890, 1885; N. N. Beketoff, *Bull. Acad. St. Petersburg*, (2), **2**, 175, 1891; A. F. Girvan, *Proc. Chem. Soc.*, **19**, 236, 1903; F. Haber and J. E. Coates, *Zeit. phys. Chem.*, **69**, 337, 1909; A. Coehn and H. Tramm, *Ber.*, **54**, B, 1148, 1921; H. Tramm, *Zeit. phys. Chem.*, **105**, 356, 1923; A. Bach, *Compt. Rend.*, **124**, 951, 1897; R. de Muynck, *Bull. Acad. Belg.*, 901, 1907; C. Montemartini, *Gazz. Chim. Ital.*, **52**, ii, 96, 1922; K. A. Hofmann and O. Schneider, *Ber.*, **46**, 1720, 1913; **48**, 1585, 1915; K. A. Hofmann, *ib.*, **45**, 3329, 1912; **49**, 1650, 1916; **51**, 1334, 1918; **53**, B, 914, 1920; K. A. Hofmann and H. Schibsted, *ib.*, **49**, 1663, 1916; K. A. Hofmann and B. Wurthmann, *ib.*, **52**, B, 1185, 1919; F. Auerbach, *Zeit. Elektrochem.*, **25**, 82, 1919.

⁹ M. Berthelot, *Ann. Chim. Phys.*, (5), **17**, 142, 1879; *Compt. Rend.*, **88**, 50, 1879; J. B. J. D. Boussingault, *ib.*, **58**, 777, 1884; *Bull. Soc. Chim.*, (2), **1**, 452, 1864; G. Senter, *Proc. Roy. Soc.*, **74**, A, 201, 1904; H. Fassbender, *Zeit. phys. Chem.*, **62**, 743, 1908; I. Remsen and M. S. Southworth, *Ber.*, **8**, 1414, 1875; *Amer. Journ. Science*, (3), **11**, 136, 1876; I. Remsen, *Amer. Chemist*, **4**, 50, 1882; E. Baumann, *Zeit. physiol. Chem.*, **5**, 244, 1881; *Ber.*, **16**, 2145, 1883; **17**, 283, 1884; W. A. Jones, *Amer. Chem. Journ.*, **30**, 40, 1903; C. E. Waters, *ib.*, **30**, 50, 1903; I. Remsen and E. H. Keiser, *ib.*, **4**, 454, 1883; **5**, 424, 1883; *Chem. News*, **49**, 142, 1884; A. R. Leeds, *ib.*, **48**, 25, 1883; *Ber.*, **12**, 1836, 1879; H. Thiele, *ib.*, **40**, 4915, 1907; H. B. Dixon, *ib.*, **28**, 2419, 1905; S. Chadwick, J. E. Ramsbottom, and D. L. Chapman, *Proc. Chem. Soc.*, **21**, 287, 1905; P. Clausmann, *Compt. Rend.*, **150**, 1332, 1910; H. Tramm, *Zeit. phys. Chem.*, **105**, 356, 1923.

¹⁰ I. Remsen, *Amer. Chemist*, **4**, 50, 1882; F. C. Phillips, *Amer. Chem. Journ.*, **16**, 255, 1894; W. A. Jones, *ib.*, **30**, 40, 1903; M. Traube, *Ber.*, **15**, 2326, 1882; P. Waentig and O. Steche, *Zeit. physiol. Chem.*, **72**, 226, 1911; G. Senter, *Proc. Roy. Soc.*, **74**, 201, 1904; *Journ. Phys. Chem.*, **9**, 311, 1905; *Zeit. phys. Chem.*, **44**, 257, 1903; **74**, 101, 1911.

¹¹ H. B. Dixon, *B.A. Rep.*, 503, 1880; *Chem. News*, **46**, 151, 1882; *Phil. Trans.*, **175**, 617, 1884; W. Henry, *ib.*, **114**, 266, 1824; R. Bunsen, *Gasometrische Methoden*, Braunschweig, 349, 877; *Pogg. Ann.*, **46**, 193, 1839; *Liebig's Ann.*, **85**, 131, 1853; A. Horstmann, *ib.*, **190**, 228, 877; *Ber.*, **10**, 1626, 1877; **12**, 64, 1879; W. Hempel, *ib.*, **12**, 1006, 1879; L. Meyer, *ib.*, **10**, 117, 1877; E. von Meyer, *Journ. prakt. Chem.*, (2), **10**, 273, 1874; (2), **13**, 121, 1876; (2), **14**, 24, 1876; (2), **18**, 290, 1878; K. Bötsch, *Liebig's Ann.*, **210**, 207, 1881; *Unvollständige Verbrennung von Gasen*, Tübingen, 1881; C. Hoitsuma, *Zeit. phys. Chem.*, **25**, 686, 1898; J. Lang, *ib.*, **2**, 161, 1888; O. Hahn, *ib.*, **42**, 705, 1903; **44**, 513, 1903; **48**, 735, 1904; F. Haber, *ib.*, **3**, 726, 1910; *Thermodynamik technischer Gasreaktionen*, München, 103, 1905; London, 1908; A. Pollitzer, *Die Berechnung chemischer Affinitäten nach dem Nernst'schen Wärmetheorem*, Stuttgart, **2**, 1912; W. Löb, *Zeit. Elektrochem.*, **11**, 749, 1905; *Journ. Science*, (4), **4**, 51, 1897; (4), **6**, 17, 1898; H. Luggin, *Journ. Gasbeleucht.*, **41**, 712, 1898; I. Langmuir, *Trans. Faraday Soc.*, **7**, 607, 621, 1922; C. Harries, *ib.*, **37**, 82, 1894; W. G. Mixter, *Amer. Journ. Science*, (4), **4**, 1, 1897; (4), **6**, 217, 1898; E. F. Armstrong and T. P. Hilditch, *Proc. Roy. Soc.*, **97**, A, 265, 1920; O. Boudouard, *Bull. Soc. Chim.*, (3), **25**, 484, 1901; W. H. Engels, *Über die Wasserstoffgewinnung aus Kohlenoxyd und Kalkhydrat und die Beschleunigung der Wasserreaktion durch Eisen*, Karlsruhe, 1911; H. C. Tingley and C. N. Hinshelwood, *Journ. Chem. Soc.*, **121**, 1668, 1922; C. N. Hinshelwood, H. Hartley, and B. Topley, *Proc. Roy. Soc.*, **100**, A, 575, 1922; B. Verver, *L'éclairage au gaz à l'eau de Narbonne et l'éclairage au gaz Leprince examinés et comparés*, Leide, **858**; L. Maquenne, *Bull. Soc. Chim.*, (2), **39**, 308, 1883; A. Gautier, *ib.*, (3), **35**, 929, 1906; *Compt. Rend.*, **142**, 1382, 1906; J. Coquillon, *ib.*, **88**, 1204, 1879; E. Müller, *Zeit. Elektrochem.*, **8**, 307, 1922; D. Tommasi, *Ber.*, **11**, 811, 1878; M. Traube, *ib.*, **15**, 2854, 1882; **16**, 123, 1883; **8**, 1877, 1885; E. Baumann, *ib.*, **16**, 2149, 1883; *Zeit. physiol. Chem.*, **5**, 244, 1881; F. C. Phillips, *Amer. Chem. Journ.*, **16**, 163, 1894; W. R. Grove, *Phil. Trans.*, **137**, 1, 1847; *Phil. Mag.*, (3), **31**, 20, 91, 96, 1847; H. Buff and A. W. Hofmann, *Liebig's Ann.*, **113**, 140, 860; A. Naumann and C. Pistor, *Ber.*, **18**, 2894, 1885; C. Engler and J. Grimm, *ib.*, **30**, 2925,

- 1897; S. M. Losanitsch and M. Z. Jovitschitsch, *ib.*, **30**, 136, 1897; H. Thiele, *ib.*, **40**, 4914, 1907; H. St. C. Deville and H. Debray, *Compt. Rend.*, **78**, 1782, 1874; A. de Hemptinne, *Bull. Acad. Belg.*, (3), **34**, 269, 1897.
- ¹² M. Traube, *Ber.*, **16**, 123, 1883; **18**, 1890, 1885; H. B. Dixon, *Journ. Chem. Soc.*, **49**, 94, 1885; **69**, 776, 1896; *Phil. Trans.*, **175**, 617, 1884; *Gas World*, **40**, 1052, 1904; *Ber.*, **38**, 2419, 1905; H. Wieland, *ib.*, **45**, 679, 1912; D. I. Mendeleëff, *Principles of Chemistry*, London, **1**, 312, 1905; H. E. Armstrong, *Proc. Roy. Soc.*, **40**, 287, 1886; *Journ. Chem. Soc.*, **49**, 112, 1886; **67**, 1105, 1895; **83**, 1088, 1903; G. Martin, *Chem. News*, **81**, 25, 1900.
- ¹³ H. Moissan, *Le fluor et ses composés*, Paris, 136, 1900; J. Davy, *Phil. Trans.*, **102**, 144, 1812; J. Schiel, *Liebig's Ann. Suppl.*, **2**, 311, 1863; S. P. Cowardins, *Chem. News*, **48**, 97, 1883; A. G. Bloxam, *ib.*, **52**, 183, 1885; S. M. Losanitsch and M. Z. Jovitschitsch, *Ber.*, **30**, 136, 1897; A. J. Balard, *Ann. Chim. Phys.*, (2), **57**, 225, 1834; F. J. Russell, *Journ. Chem. Soc.*, **77**, 368, 1900; H. B. Dixon and E. J. Russell, *ib.*, **71**, 605, 1897; A. Ditte, *Recherches sur l'acide iodique*, Paris, 1870; *Compt. Rend.*, **70**, 621, 1870; *Ann. Chim. Phys.*, (4), **21**, 5, 1870; *Bull. Soc. Chim.*, (2), **13**, 318, 1870; C. de la Harpe and F. Reverdin, *Chem. Ztg.*, **12**, 1726, 1888; A. Gautier, *Compt. Rend.*, **126**, 793, 871, 931, 1299, 1898; **142**, 15, 1906; M. Nicloux, *ib.*, **126**, 746, 1898; A. Lévy and A. Pécoul, *ib.*, **140**, 98, 1905; **142**, 162, 1906; P. Schützenberger, *ib.*, **66**, 666, 1868; M. Potain and R. Drouin, *ib.*, **126**, 938, 1898; F. Jean, *ib.*, **135**, 746, 1902; G. F. Jaubert, *ib.*, **141**, 1233, 1905; A. Gautier and P. Clausmann, *ib.*, **142**, 485, 1906; *Bull. Soc. Chim.*, (3), **35**, 513, 1906; M. Pellet, *Bull. Assoc. Chim. Sucr. Dist.*, **24**, 1649, 1907; J. L. R. Morgan and J. E. McWhorter, *Journ. Amer. Chem. Soc.*, **29**, 1589, 1907; L. P. Kennicut and G. R. Sanford, *ib.*, **22**, 14, 1900; B. Nowicki, *Oester. Zeit. Berg. Hütt.*, **54**, 6, 1906; K. Stammer, *Pogg. Ann.*, **82**, 135, 1851; F. Göbel, *Journ. prakt. Chem.*, (1), **6**, 388, 1835; J. Donau, *Monatsh.*, **26**, 525, 1905; **27**, 71, 1906; F. C. Phillips, *Amer. Chem. Journ.*, **16**, 255, 1894; W. Pullinger, *Ber.*, **24**, 2291, 1891; F. Mylius and F. Förster, *ib.*, **24**, 2424, 1891; F. Förster, *ib.*, **24**, 3751, 1892; J. von Fodor, *Dingler's Journ.*, **237**, 456, 1880; C. Winkler, *Zeit. anal. Chem.*, **28**, 269, 1889; L. M. Dennis and C. G. Edgar, *Journ. Amer. Chem. Soc.*, **19**, 859, 1897.
- ¹⁴ C. Than, *Liebig's Ann. Suppl.*, **5**, 236, 1857; G. Chevrier, *Compt. Rend.*, **69**, 136, 1869; M. Berthelot, *Ann. Chim. Phys.*, (7), **22**, 303, 1901; (3), **53**, 69, 1858; (5), **30**, 547, 1883; *Bull. Soc. Chim.*, (2), **40**, 362, 1883; *Compt. Rend.*, **96**, 298, 1883; **110**, 1106, 1890; E. Jacquemin, *ib.*, **46**, 1164, 1858; F. Gonzalez and E. Moles, *Anal. Fis. Quim.*, **17**, 55, 1919; *Journ. Chim. Phys.*, **17**, 408, 1919; S. M. Losanitsch and M. Z. Jovitschitsch, *Ber.*, **30**, 136, 1897; W. Smith and W. B. Hart, *Journ. Soc. Chem. Ind.*, **5**, 643, 1886; K. Stammer, *Pogg. Ann.*, **82**, 135, 1851; A. Lovel, *Journ. Pharm. Chim.*, (3), **22**, 289, 1852; A. Herzfeld and K. Stiepel, *Zeit. Ver. Zuckerind.*, **921**, 1897.
- ¹⁵ K. Stammer, *Pogg. Ann.*, **82**, 135, 1851; *Liebig's Ann.*, **80**, 243, 1851; F. Briegleb and A. Geuther, *ib.*, **123**, 228, 1862; F. Beilstein and A. Geuther, *ib.*, **108**, 88, 1858; S. M. Losanitsch and M. Z. Jovitschitsch, *Ber.*, **30**, 136, 1897; A. R. Leeds, *ib.*, **12**, 1836, 1879; W. G. Mixer, *Amer. Journ. Science*, (4), **4**, 51, 1897; (4), **6**, 217, 1898; A. Slosse, *Bull. Acad. Belg.*, **35**, 547, 1898; P. R. V. de Lambilly, *Brit. Pat. No. 3735*, 1893; R. L. Barr, J. Macfarlane, E. J. Mills, and S. Young, *ib.*, 3092, 1892; F. C. Phillips, *Amer. Chem. Journ.*, **16**, 163, 1894; E. J. Mills, *Proc. Chem. Soc.*, **21**, 118, 1905; H. Jackson and D. N. Laurie, *ib.*, **21**, 118, 1905; *Journ. Chem. Soc.*, **87**, 433, 1905; T. E. Thorpe and A. E. H. Tutor, *ib.*, **59**, 1019, 1891; M. Berthelot, *Ann. Chim. Phys.*, (3), **53**, 69, 1858; (3), **61**, 463, 1861; (6), **24**, 132, 1891; *Compt. Rend.*, **112**, 597, 1891; A. Gautier, *ib.*, **126**, 871, 1898; D. Berthelot and H. Gaudechon, *ib.*, **150**, 1690, 1910; M. Berthelot and P. Vieille, *Bull. Soc. Chim.*, (2), **41**, 554, 1884; *Compt. Rend.*, **98**, 545, 601, 1884; F. Schlagdenhauffen and M. Pagel, *ib.*, **128**, 309, 1889; C. W. Hasenbach, *Amer. Journ. Science*, (3), **2**, 362, 1871; I. W. Fay, A. F. Seeker, F. H. Lane, and G. E. Ferguson, *Polyt. Eng. Brooklyn*, **10**, 72, 1910; J. T. Conroy, *Journ. Soc. Chem. Ind.*, **15**, 8, 1896; S. Cook, *Chem. News*, **58**, 130, 1888; J. Habermann, *Zeit. angew. Chem.*, **5**, 323, 1892; W. Henry, *Ann. Phil.*, **8**, 299, 344, 1824; *Mem. Manchester Lit. Phil. Soc.*, (2), **4**, 493, 1824; A. W. Hofmann, *Liebig's Ann.*, **70**, 139, 1849; *Journ. Chem. Soc.*, **2**, 36, 1850; A. M. Butleroff, *Zeit. Chem.*, (1), **6**, 484, 1865; A. Vogel, *Neues. Jahrb. Pharm.*, **4**, 1, 1855.
- ¹⁶ H. Moissan, *Ann. Chim. Phys.*, (7), **6**, 296, 1895; K. Stammer, *Pogg. Ann.*, **82**, 135, 1851; *Liebig's Ann.*, **80**, 243, 1851; A. Frank, *German Pat.*, D.R.P. 112416, 1899; M. Foix, *Bull. Soc. Chim.*, (4), **33**, 678, 1922; E. Carstanjen and A. Schertel, *Journ. prakt. Chem.*, (2), **4**, 49, 1871; A. T. Larson and C. S. Teitsworth, *Journ. Amer. Chem. Soc.*, **44**, 2878, 1922; C. Böttinger, *Ber.*, **10**, 1122, 1877; S. M. Losanitsch, *ib.*, **40**, 4656, 1907; **41**, 2683, 1908; S. M. Losanitsch and M. Z. Jovitschitsch, *ib.*, **30**, 136, 1897; F. C. Phillips, *Amer. Chem. Journ.*, **16**, 163, 1894; J. Milbauer, *Zeit. anorg. Chem.*, **49**, 46, 1906; E. Sarrau and P. Vieille, *Compt. Rend.*, **105**, 122, 1887; M. Berthelot, *ib.*, **54**, 515, 1862; **129**, 133, 1899; H. le Chatelier and O. Boudouard, *ib.*, **126**, 1344, 1898; P. Schützenberger, *ib.*, **66**, 667, 747, 1868; **69**, 352, 1869; *Bull. Soc. Chim.*, (2), **10**, 188, 1868; (2), **12**, 198, 1869; A. de Hemptinne, *Bull. Acad. Belg.*, (3), **34**, 269, 1897; E. Frankland, *Chem. News*, **6**, 3, 1862; W. Odling, *A Manual of Chemistry*, London, 1861.
- ¹⁷ M. Berthelot, *Ann. Chim. Phys.*, (3), **61**, 463, 1861; *Bull. Soc. Chim.*, (2), **6**, 1, 1867; J. A. Wanklyn, *Phil. Mag.*, (4), **31**, 305, 1866; *Proc. Roy. Soc.*, **9**, 697, 1858; A. Geuther, *Liebig's Ann.*, **109**, 73, 1858; **202**, 288, 1880; A. Lieben, *ib.*, **112**, 326, 1859; W. Pötsch, *ib.*, **218**, 56, 1869; M. Schröder, *ib.*, **221**, 34, 1883; W. A. Beatty, *Amer. Chem. Journ.*, **30**, 224, 1903; V. Merz and J. Tibirica, *Ber.*, **13**, 23, 1880.
- ¹⁸ I. L. Bell, *Chem. News*, **24**, 258, 267, 1871; F. H. Pollard, *Journ. Phys. Chem.*, **27**, 356, 1923

¹⁹ M. Berthelot, *Ann. Chim. Phys.*, (3), **46**, 479, 1856; (3), **53**, 69, 1858; (3), **61**, 463, 1861; *Compt. Rend.*, **41**, 955, 1855; **46**, 1102, 1161, 1858; N. N. Beketoff, *Journ. Russ. Phys. Chem. Soc.*, **15**, 277, 1883; R. E. Wilson, C. A. Hasslacher, and E. Masterson, *Journ. Ind. Ing. Chem.*, **15**, 698, 1923; M. C. Boswell and J. V. Dickson, *ib.*, **40**, 1779, 1918; W. H. Engels, *Journ. Gasbeleucht.*, **62**, 477, 493, 1919; V. Merz and J. Tibirica, *Ber.*, **13**, 23, 1880; V. Merz and W. Weith, *ib.*, **13**, 718, 1880; A. Geuther, *ib.*, **13**, 323, 1880; M. Goldschmidt, *German Pat.*, D.R.P. 86419, 1894; Elektrochemische Werke Bitterfeld, *ib.*, 179515, 1905; Farbwerke Vorm. Meister, Lucius, und Brüning, *ib.*, 212844, 1909; F. C. Phillips, *Amer. Chem. Journ.*, **16**, 255, 1894; F. Haber and L. Bruner, *Zeit. Elektrochem.*, **10**, 697, 1904.

²⁰ I. W. Fay, A. F. Seeker, F. H. Lane, and G. E. Ferguson, *Polyt. Eng. Brooklyn*, **10**, 72, 1910; F. Schlagdenhauffen and M. Pagel, *Compt. Rend.*, **128**, 309, 1889; A. Gautier, *ib.*, **126**, 871, 1898; **128**, 487, 1899; H. Dejust, *ib.*, **140**, 1250, 1905; G. Charpy, *ib.*, **137**, 122, 1903; **148**, 560, 1909; L. Gruner, *ib.*, **73**, 28, 1871; H. Quantin, *ib.*, **104**, 223, 1887; A. Mermet, *ib.*, **124**, 621, 1897; A. Gautier and P. Clausmann, *ib.*, **151**, 355, 1910; O. Boudouard, *ib.*, **128**, 98, 307, 822, 1522, 1899; **140**, 40, 1905; *Bull. Soc. Chim.*, (3), **21**, 269, 463, 712, 1899; E. Baur and A. Glässer, *Zeit. phys. Chem.*, **43**, 354, 1903; B. Osann, *Stahl Eisen*, **27**, 1626, 1907; G. Chaudron, *Compt. Rend.*, **172**, 152, 1921; A. de Herpantinne, *Bull. Acad. Belg.*, (5), **5**, 249, 1919; (5), **7**, 146, 458, 590, 1921; A. F. Benton, *Journ. Amer. Chem. Soc.*, **45**, 887, 900, 1923; K. A. Hofmann, *German Pat.*, D.R.P. 307614, 1919; V. Meyer and M. von Recklinghausen, *Ber.*, **29**, 2549, 1896; H. Hirtz and V. Meyer, *ib.*, **29**, 2828, 1896; C. Engler and W. Wild, *ib.*, **30**, 1681, 1897; I. L. Bell, *Chem. News*, **23**, 135, 146, 159, 258, 267, 1871; J. Braithwaite, *ib.*, **72**, 211, 1895; K. Stammer, *Pogg. Ann.*, **82**, 135, 1851; W. Müller, *ib.*, **133**, 336, 1868; **144**, 609, 1871; C. R. A. Wright and A. P. Luff, *Journ. Chem. Soc.*, **33**, 1, 1878; C. R. A. Wright, A. P. Luff, and E. H. Rennie, *ib.*, **35**, 475, 1879; F. J. Brislie, *ib.*, **93**, 154, 1908; E. D. Campbell, *Amer. Chem. Journ.*, **17**, 681, 1896; G. Bodländer, *Zeit. Elektrochem.*, **8**, 833, 1902; F. C. Phillips, *Amer. Chem. Journ.*, **16**, 163, 1894.

²¹ F. Hofmann, *Gründliche Anweisung wie ein Mensch von dem frühzeitigen Tod und allerhand Arten Krankheiten durch ordentliche Lebens-Art sich verwahren könne*, Halle, **5**, 539, 1719; F. Clément and J. B. Désormes, *Ann. Chim. Phys.*, (1), **38**, 285, 1801; H. Davy, *Phil. Trans.*, **99**, 69, 1809; **104**, 557, 1814; J. S. Haldane, *Journ. Physiol.*, **18**, 201, 1895; W. Sachs, *Die Kohlenoxyd-Vergiftung in ihrer klinischen, hygienischen, und gerichtsarztlichen Bedeutung*, Stuttgart, 1900; P. Spica and G. P. Menegazzi, *Atti Ist. Veneto*, (7), **4**, 1506, 1893; J. Barcroft, *The Respiratory Function of the Blood*, Cambridge, 1914; H. Haertel, *Differentialdiagnose zwischen Kohlendunst- und Leuchtgasvergiftung*, Berlin, 1897; T. E. Thorpe, *Journ. Chem. Soc.*, **83**, 318, 1903; L. Hill, *Trans. Fed. Inst. Min. Eng.*, **35**, 26, 1908; G. Linossier, *Mém. Soc. Biol.*, **41**, 1, 1891; J. R. Wilson, *Chem. News*, **69**, 159, 1894; H. Letheby, *Pharm. Journ.*, (2), **3**, 531, 1862; W. P. Mason, *Journ. Amer. Chem. Soc.*, **10**, 176, 1888; A. B. Clifford, *Chem. Trade Journ.*, **71**, 733, 1922; R. Biefel and T. Poleck, *Zeit. Biol.*, **16**, 279, 1880; T. Poleck, *Repert. anal. Chem.*, **5**, 225, 1885; A. Wagner, *ib.*, **4**, 337, 1884; A. Chenot, *Compt. Rend.*, **38**, 735, 830, 1854; N. Gréhant, *ib.*, **91**, 858, 1880; **102**, 825, 1886; **106**, 289, 1888; **114**, 309, 1892; **116**, 235, 1893; **125**, 735, 1893; *Compt. Rend. Soc. Biol.*, **166**, 182, 1886; N. Gréhant and C. E. Quinquand, *Compt. Rend.*, **97**, 330, 1883; M. Niouloux, *ib.*, **132**, 1501, 1901; **133**, 67, 1901; L. de St. Martin, *ib.*, **128**, 533, 1898; C. Fleig, *ib.*, **146**, 776, 1908; M. von Pettenkofer, *Ber. Bayer. Akad.*, **179**, 887; V. Desplats, *Journ. V. Anal.*, **22**, 213, 1887; G. Gaglio, *Ann. Chim. Farm.*, (4), **4**, 146, 886; H. Dreser, *Arch. Exp. Path.*, **29**, 119, 1890; P. Ferchland and E. Vahlen, *ib.*, **48**, 106, 902; E. Hoke, *ib.*, **56**, 201, 1907; Z. von Vamosy, *ib.*, **41**, 273, 1898; St. Zalesky, *ib.*, **20**, 34, 886; W. Rosenstein, *ib.*, **40**, 363, 1898; W. Straub, *ib.*, **38**, 139, 1896; L. Lewin and O. Poppenberg, *ib.*, **60**, 434, 1909; A. Gärtner, *Journ. Gasbeleucht.*, **43**, 268, 332, 1900; C. G. L. Wolf and J. Oesterberg, *Biochem. Zeit.*, **16**, 476, 1909; J. Geppert, *Deut. Med. Wochschr.*, **20**, 19, 1892; J. Richter, **18**, 199, 1890; G. Patein, *Journ. Pharm. Chim.*, (6), **29**, 417, 1909; P. Giagosa, *Atti Accad. Torino*, **38**, 864, 1903; Y. Henderson and H. W. Haggard, *Journ. Ind. Eng. Chem.*, **14**, 229, 1922; F. Greiff, *Arch. Hyg.*, **10**, 231, 1890; C. Bohr, *Skand. Arch. Physiol.*, **22**, 221, 1909; A. and M. Krogh, *ib.*, **23**, 236, 1910; Y. Henderson and H. W. Haggard, *Journ. Ind. Eng. Chem.*, **14**, 229, 1922; E. O. Lippmann, *Chem. Ztg.*, **33**, 633, 1909; H. Milrath, *ib.*, **33**, 65, 1909; H. Grünbaum, *ib.*, **33**, 709, 1909; L. Lewin, *Arch. Gesch. Med.*, **3**, 1, 1909; C. le Neve Foster and J. S. Haldane, *The Investigations of Mine Air*, London, 146, 1905; M. Gruber, *Engler's Journ.*, **241**, 219, 1881; A. Herzen, *Arch. Physiol.*, **30**, 295, 1883; E. Kreis, *ib.*, **26**, 65, 1882; O. Weiss, F. Wachholtz, and F. Worgitzky, *ib.*, **112**, 361, 1906; A. Kast, *Zeit. Physiol. Chem.*, **12**, 267, 1888; K. Kotsnyama, *ib.*, **34**, 83, 1901; A. J. Kunkel, *Sitzber. Phys. Med. Ges. Würzburg*, **86**, 1888; E. Münzer and P. Palma, *Zeit. Heilkund.*, **15**, 185, 1894; R. Ruber, *Arch. Hyg.*, **10**, 397, 1890; A. Welzel, *Verh. Phys. Med. Ges. Würzburg*, **23**, 3, 1889.

²² H. Hartridge, *Proc. Roy. Soc.*, **86**, B, 128, 1913; **102**, A, 575, 1923; H. Hartridge and J. W. Roughton, *ib.*, **94**, B, 336, 1923; A. Gamgee, *ib.*, **68**, 503, 1901; A. Gamgee and A. C. Hill, *ib.*, **36**, 913, 1903; T. Weyl and B. von Anrep, *ib.*, **13**, 1294, 1880; H. W. Vogel, *ib.*, **10**, 792, 1877; **11**, 235, 1878; C. K. A. L. Landois, *Deut. Med. Zeit.*, **256**, 1893; *Deut. Med. Wochschr.*, **9**, 996, 1892; E. Richter, *ib.*, **16**, 199, 1890; J. Formanek, *Zeit. anal. Chem.*, **40**, 505, 1901; *Die qualitative Spektralanalyse anorganischer und organischer Körper*, Berlin, 1905; E. F. Adolph and L. J. Henderson, *Journ. Biol. Chem.*, **50**, 463, 1922; L. Lewin and E. Stenger, *Zeit. wiss. Photochem.*, **21**, 221, 1922; F. Hoppe-Seyler, *Tübing. Unters.*, **1**, 224, 1867; *Virchow's Arch.*, **1**, 288, 1857; *Phil. Mag.*, (4), **30**, 456, 1865; *Zeit. anal. Chem.*, **3**, 439, 1864; C. Liman, *ib.*,

16. 132, 1877; F. Nawrocki, *ib.*, 2. 117, 1863; J. von Fodor, *ib.*, 20. 574, 1881; W. Hempel, *ib.*, 18. 399, 1879; N. Zuntz and S. Kostin, *Arch. Anal. Physiol. Suppl.*, 315, 1900; H. Wolff, *Repert. anal. Chem.*, 3. 82, 1883; F. Eschbaum, *Ber. deut. pharm. Ges.*, 19. 284, 1909; N. Gréhan, *Compt. Rend. Soc. Biol.*, 166, 182, 1886; *Compt. Rend.*, 70. 1182, 1870; 86. 895, 1878; 106. 289, 1888; 113. 289, 1891; 114. 309, 1892; 118. 594, 1894; 133. 951, 1901; N. Gréhan and C. E. Quinquand, *ib.*, 97. 330, 1883; J. L. Soret, *ib.*, 97. 1269, 1883; L. de St. Martin, *ib.*, 112. 1232, 1891; 115. 865, 1892; A. Chenot, *ib.*, 38. 735, 830, 1854; C. Bernard, *ib.*, 47. 245, 1858; H. Bertin-Sats and J. Moitessier, *ib.*, 113. 210, 1891; 116. 591, 1893; *Bull. Soc. Chim.*, (3), 9. 722, 1893; H. Dreser, *Arch. Exp. Path.*, 29. 119, 1890; A. Grüber, *ib.*, 58. 343, 1908; St. Zalesky, *ib.*, 20. 34, 1886; *Zeit. physiol. Chem.*, 9. 225, 1885; R. Schulz, *Arch. Hyg.*, 10. 754, 1895; J. Uffelmann, *ib.*, 2. 145, 1884; P. Giacosa, *Atti Accad. Torino*, 38. 864, 1903; G. Gaglio, *Ann. Chim. Farm.*, (4), 4. 146, 1886; J. Bock, *Centr. Physiol.*, 8. 385, 1894; A. J. Kunkel, *ib.*, 3. 651, 1889; S. von Horoszkiewig and A. Marx, *Berlin. Klin. Wochschr.*, 43. 1156, 1906; P. F. Frankland, *Zeit. Hyg.*, 6. 13, 1889; A. Welzel, *Verh. Phys. Med. Ges. Würzburg*, 23. 3, 1889; A. J. Kunkel, *ib.*, 22. 86, 1888; G. Hüfner, *Journ. prakt. Chem.*, (2), 30. 68, 1884; G. Hüfner and R. Külz, *ib.*, (2), 28. 256, 1883; G. Hüfner and P. W. Küster, *Arch. Anal. Physiol. Suppl.*, 2. 387, 1904; A. Katayama, *Arch. Path. Anat.*, 114. 53, 1888; P. A. Piorry, *Arch. Gén. Méd.*, 12. 527, 1826; W. Kühne, *Virchow's Arch.*, 34. 244, 1865; H. Lethéby, *Pharm. Journ.*, (2), 3. 531, 1862; G. Linossier, *Mém. Soc. Biol.*, 41. 1, 1891; R. Liebig, *German Pat.*, D.R.P. 167845, 1904; W. Manchot, *Liebig's Ann.*, 370. 241, 1909; A. Krough, *Skand. Arch. Physiol.*, 23. 217, 1910; A. Jäderholm, *Die gerichtlich-medizinische Diagnose der Kohlenoxydvergiftung*, Berlin, 1876; H. Bertin-Sans, *Bull. Soc. Chim.*, (3), 6. 663, 1891; (3), 9. 722, 1893; A. de Dominicis, *Boll. Chim. Farm.*, 47. 1258, 1908; *Viertelj. Ger. Med.*, 38. 326, 1909; K. Ipsen, *ib.*, (3), 18. 46, 1899; R. Kobert, *Lehrbuch der Intoxikation*, Stuttgart, 2. 888, 1906; L. Lewin, A. Miethe, and E. Stenger, *Arch. Physiol.*, 118. 80, 1907; G. P. Menegazzi, *Atti Ist. Veneto*, (7), 4. 1660, 1893; F. Pregl, *Zeit. physiol. Chem.*, 44. 173, 1900; T. Saiki and G. Wakayama, *ib.*, 34. 96, 1901; E. Salkowsky, *ib.*, 27. 297, 1899; R. Külz, *ib.*, 7. 384, 1883; J. Marshall, *ib.*, 7. 81, 1883; L. Hill, *Trans. Fed. Inst. Min. Eng.*, 35. 26, 1908; P. Spica and G. P. Menegazzi, *Atti Ist. Veneto*, (7), 4. 1506, 1893.

²³ G. Senter, *Proc. Roy. Soc.*, 74. 201, 1904; *Zeit. phys. Chem.*, 51. 694, 1905; G. Bredig, *Anorganische Fermente*, Leipzig, 58, 1901; W. B. Bottomley and H. Jackson, *Proc. Roy. Soc.*, 72. 130, 1903; A. Maracci, *Arch. Ital. Biol.*, 19. 140, 1893; L. Just, *Forsch. Agrik. Phys.*, 5. 60, 1882; G. Linossier, *Compt. Rend.*, 108. 820, 1889.

²⁴ F. Hoppe-Seyler, *Zeit. anal. Chem.*, 3. 439, 1864; V. Nesmjeloff, *ib.*, 48. 232, 1909; L. Moser and O. Schmid, *ib.*, 53. 211, 1914; F. Schlagdenhauffen and M. Pagel, *ib.*, 43. 702, 1904; E. Glaser, *Feuerungstechnik*, 6. 149, 157, 165, 1918.

²⁵ V. Nesmjeloff, *Zeit. anal. Chem.*, 48. 232, 1909; A. B. Lamb, C. C. Scalione, and G. Edgar, *Journ. Amer. Chem. Soc.*, 44. 738, 1922.

§ 27. The Metal Carbonyls

E. Müller¹ has discussed the amphoteric nature of the carbonyl radicle. Some metals unite with carbon monoxide, forming a series of carbonyls. Most of these substances are volatile. They differ considerably in their physical properties, but they are very similar in their chemical properties. Thus, all these carbonyls have very similar chemical properties—for instance, when heated, they all decompose into carbon monoxide and the metal, which is deposited in the form of a bright metallic mirror. They are not attacked by non-oxidizing acids, but are quickly dissolved by oxidizing acids, and specially by aq. soln. of the halogens, with the evolution of carbon monoxide. At least one of the carbonyls of each metal is volatile without decomposition, and can be purified by distillation or sublimation. They are all more or less soluble in the usual organic solvents, such as ether, ethyl alcohol, benzene, oils, etc., and are insoluble in water.

J. L. Gay Lussac and I. J. Thénard showed that when potassium or sodium is heated to redness in carbon monoxide, the gas inflames furnishing the metal oxide and carbon. At a low temp., G. B. H. Kühnemann found that the carbon monoxide absorbed by potassium is decomposed, and at a temp. below redness, there is formed potassium oxide, and a black product which furnishes *potassium rhodizonate* when treated with water. The early chemists noted the formation of a compound of carbon monoxide and potassium during the preparation of this element by the reduction of potassium compounds with carbon. They referred to it as "croconaceous" matter. Thus A. Pleischl said that when the croconaceous matter has attracted a little moisture

from the air there is formed a product which sometimes explodes spontaneously; and, after any contaminating potassium has been distilled from it, it furnishes potassium rhodizonate or croconate. According to J. von Liebig, and J. F. Heller, at a low temp. molten potassium absorbs carbon monoxide and forms the so-called *Kohlenoxydkalium*, and, added B. C. Brodie, at about 80°, potassium unites with carbon monoxide, forming an aggregate of crystals with a composition approximating K_2CO ; at a lower temp., carbon monoxide is given off and the dark red product with the composition KCO is probably a mixture of potassium oxide and rhodizonate; J. U. Lerch said that moisture is probably necessary for the formation of the red product. C. Winkler noted the formation of the explosive compound of potassium and carbon monoxide when a mol of potassium carbonate and two gram-atoms of magnesium powder are heated together. R. Nietzki and T. Benckiser regard the potassium carbonyl, $K_6C_6O_6$, formed by the action of carbon monoxide on potassium, to be the potassium derivative of hexahydroxybenzene, $C_6(OH)_6$. They say that this compound is not explosive, but becomes so on keeping. When treated with dil. alcohol, potassium dioxycarboxylate, $C_6(OK)_4O_2$, is formed. J. U. Lerch also studied the products obtained from potassium carbonyl. According to A. Joannis, when purified and dry carbon monoxide is passed into a soln. of potassium-ammonium in liquefied ammonia at about -50° , the blue colour gradually becomes weaker, and at last changes to pink. At this point the reaction is complete, and if the ammonia is allowed to evaporate, the compound **potassium carbonyl**, $K_2C_2O_2$, is obtained as a pale, rose-coloured powder which detonates in contact with air or water, or when heated to 100° . If, however, it is allowed to come in contact with water vap. in a vacuum, it deliquesces and forms a yellow soln. The corresponding **sodium carbonyl**, $Na_2C_2O_2$, is obtained in a similar manner as a white powder with a lilac tint. It detonates at 90° in vacuo, or when brought in contact with air or water, but deliquesces quietly in contact with water vap. in a vacuum. When it detonates, very little gas is evolved, and a small quantity of sodium cyanide is formed, but the principal reaction is represented by the equation $2Na_2C_2O_2 = Na_2CO_3 + Na_2O + 3C$. When detonation takes place in the presence of water, the small quantity of gas evolved contains 86 per cent. of hydrogen and 14 per cent. of carbon monoxide.

The action of carbon monoxide on copper has been discussed in connection with the metal (3. 21, 13). L. Mond² and co-workers did not succeed in preparing **copper carbonyl**. According to G. Bertrand, if carbon dioxide be passed over heated cupric oxide, no unusual effect is observed, but if the gas be first passed over red-hot carbon, a mirror-like deposit of copper is produced, presumably owing to the intermediate formation of copper carbonyl; but E. Mond and C. Heberlein could find no evidence of the existence of this carbonyl. N. D. Zelinsky has described an application of the reaction to cover organisms with a film of metallic copper. According to M. Berthelot, when silver foil is heated for four hours at 500° in a sealed tube containing dried carbon monoxide, about 3.6 per cent. of carbon dioxide is formed, and some carbon is deposited. This reaction begins even at 300° , but at this temp. its progress is very slow. Carbon monoxide, when heated at temp. not exceeding 550° , yields carbon dioxide without depositing carbon; it is therefore probable that the deposition of carbon in the foregoing experiment results from the decomposition of a *silver carbonyl* compound analogous to the corresponding iron derivative.

According to H. Moissan,³ calcium at a dull red heat decomposes carbon monoxide, but no carbonyl has been reported. G. Roederer found that when a soln. of strontium-ammonium is treated with carbon monoxide at -45° , a dull yellow, pulverulent mass of **strontium carbonyl**, $Sr(CO)_2$, is obtained; this becomes bright yellow on exposure to moist air, forms a limpid, yellow soln. with water, and blackens when heated under reduced press., yielding a mixture of strontia, strontium carbonate, and carbon. Similarly, A. Guntz and M. Mentrel found that when carbon monoxide is passed into a soln. of barium-ammonium in liquid ammonia, **barium carbonyl**, $Ba(CO)_2$, is formed as yellow powder which is unstable in air,

becomes brown at 100°, and incandescent at 250°, forming barium oxide and carbonate and carbon. Carbon monoxide reacts with metallic barium at 500° producing a superficial layer of barium carbide.

J. Parkinson,⁴ C. Matignon, and C. Winkler found that magnesium at a dull red heat burns brilliantly in carbon monoxide with the separation of carbon. G. Gore passed a stream of carbon monoxide for two days through a soln. of potassium cyanide in which dipped a strip of magnesium; he found that the metal acquired a black film. A. Guntz and A. Masson found that if aluminium be heated to dull redness in an atm. of carbon monoxide containing a small proportion of the vap. of aluminium chloride or iodide, the metal becomes incandescent and is more or less completely converted into aluminium carbide. According to A. von Bartsch, when dry carbonyl chloride is passed into fused aluminium iodide, at 195°–200°, until its weight has increased 25 per cent., and iodine and unaltered iodide are removed from the product by washing with carbon disulphide, a light brown amorphous residue of aluminium dicarbonyl dichloroiodide, $Al_3(CO)_2Cl_2I$, remains; this compound cannot be melted even by heating in a sealed tube; it decomposes on heating at 270°–300° in an open tube, aluminium chloride and iodine volatilizing, and a black compound of **aluminium carbonyl**, $Al_2(CO)_2$, insoluble in water and acid, remains; the carbonyl is converted into aluminium oxide and carbon dioxide on prolonged heating in air.

A. Guntz heated finely divided manganese in carbon monoxide, and found that a reaction occurs: $Mn + CO = MnO + C + 34.5$ Cals. G. Charpy obtained an analogous result with ferromanganese, and with chromium, carbon and chromic oxide was formed. L. Mond and co-workers⁵ tried to prepare carbonyls of manganese, chromium, and tungsten by the action of carbon monoxide on the finely divided metals at press. up to 500 atm., and at temp. up to 450°, but without success. Finely divided molybdenum, prepared by reducing the oxychloride by hydrogen at a low temp., at 200–250 atm., and about 200°, is attacked by carbon monoxide and forms highly refracting white crystals of **molybdenum carbonyl**, $Mo(CO)_6$. The sp. gr. of the compound is 1.96, and it is soluble in benzene. The crystals evaporate before melting, and can easily be sublimed in an atmosphere of hydrogen or of carbon monoxide at a temp. of 30° or 40°. The vap. begins to decompose at 150°. The chemical properties resemble those of the other carbonyls. It is scarcely attacked by non-oxidizing agents, but quickly by oxidizing agents, especially by bromine; carbon monoxide is eliminated, and molybdic acid is left in suspension. R. L. Mond and A. E. Wallis give $Mo_5(CO)_{26}$ for the composition of molybdenum carbonyl. Two years were required to prepare 170 mgrms. It is insoluble in common solvents.

In 1871, I. L. Bell⁶ stated that when nickel is heated with carbon monoxide a little carbon is formed, but most of the gas remains unaltered. In the presence of finely divided nickel, P. Sabatier and J. B. Senderens say that the reaction $2CO = C + CO_2$ begins at about 230°, and is completed at about 349°. G. Charpy said that nickel turnings at 1000° are not attacked. In 1890, L. Mond and co-workers showed that when carbon monoxide is passed over finely divided metallic nickel at a temp. between 350° and 450°, carbon dioxide is formed, and a black amorphous powder is obtained consisting of nickel and carbon. The composition of this powder varies very widely with the temp. employed, and still more according to the time the operation has been carried on. A small quantity of nickel can decompose a very large amount of carbon monoxide. At the commencement, a fast current of carbon monoxide is completely changed into carbon dioxide by a comparatively small quantity of nickel. By-and-by, the change becomes less complete but the gas may be passed for several weeks before carbon dioxide ceases to be formed. They have in this way obtained a product containing as much as 85 per cent. carbon and 15 per cent. nickel. Further,

When finely divided nickel, such as is obtained by reducing nickel oxide by hydrogen at about 400°, is allowed to cool in a slow current of carbon monoxide, the flame of a Bunsen burner into which the escaping gas is introduced becomes highly luminous, and when the

tube through which the gas passed is heated, a mirror of metallic nickel, mixed with a small quantity of carbon, is produced. The gas contains a compound of nickel and carbon monoxide—nickel carbonyl. The carbon monoxide is very readily absorbed by the nickel as soon as the temp. has descended to about 100°, and if the current of carbon monoxide is continued, or if this gas is replaced by a current of an inert gas (such as carbon dioxide, nitrogen, hydrogen, or even air), a mixture of gases is obtained which contains upwards of 10 per cent. of nickel carbonyl. After a time (with a moderate current of gas, about an hour), the quantity of this compound given off becomes less and gradually diminishes till it practically ceases altogether. The property of the nickel to form this compound is restored by heating it again to about 400°, and cooling it down; and, for a time, it yields the compound more abundantly after repeated use. When these mixtures of gases are heated above 50°, their vol. increases and nickel separates, which, according to the temp., is more or less contaminated with carbon resulting from the action of the nickel upon the carbon monoxide generated.

Nickel carbonyl is conveniently made by passing carbon monoxide over finely divided nickel at 30° to 50°; the nickel is made by the reduction of the oxide with hydrogen at 400°. The carbonyl is condensed from the escaping gases by passing them through a tube cooled by a refrigerating mixture of ice and sodium chloride. According to J. Dewar, the reaction may be advantageously carried out under a press. of 2–100 atm. when the temp. may be raised to 250° without fear of decomposition, and the reaction is then greatly accelerated; the condensation of the carbonyl is also best performed under press. so that the excess of carbon monoxide is led back over the nickel while under the same press. E. Tassily and co-workers passed carbon monoxide over reduced nickel deposited on puzzolana, and they found the optimum temp. to be 45° at 30 mm. press. According to H. Frey, sodium decomposes ethyl oxalate into ethyl carbonate and carbon monoxide. If ethyl oxalate be added from a dropping funnel to finely divided nickel chloride or bromide and sodium suspended in dry ligroin, at 0°, the escaping gas contains nickel carbonyl. J. H. Weibel observed the formation of nickel carbonyl when an aq. soln. of a nickel salt is treated with carbon monoxide at 100 atm. press. at 150°. According to R. Lessing, nickel carbonyl for organic preparations is conveniently stored in an absorbent material like charcoal or coke impregnated with oil; when desired for use, it is taken up by passing hydrogen, nitrogen, or other gas into the stored material.

At ordinary temp., nickel carbonyl is a colourless volatile liquid. L. Mond and co-workers gave 1·3185 for the sp. gr. at 17°; and L. Mond and R. Nasini gave 1·36153 at 0°; 1·34545 at 8°; 1·32446 at 14°; 1·31032 at 20°; 1·29832 at 25°; 1·28644 at 30°; and 1·27132 at 36°. Hence, the vol. of the liquid at θ° is $(1 + 0\cdot0016228\theta + 0\cdot0_5608\theta^2 + 0\cdot0_5505\theta^3)$, where v_0 represents the vol. at 0°. The mean coeff. of cubical expansion between 0° and 36° is therefore 0·001853. L. Mond and co-workers found the vap. density to be 6·01 corresponding with a mol. wt. of 100; the formula $\text{Ni}(\text{CO})_4$ requires a vap. density 5·9. L. Mond and R. Nasini further found the lowering of the f.p. in benzene soln. is normal in agreement with the formula $\text{Ni}(\text{CO})_4$. The b.p. is 43° at 751 mm.; M. Berthelot gave 46°; and Dewar and H. O. Jones, 43·2° to 43·33° at atm. press. L. Mond and co-workers found the liquid solidified to needle-like crystals at -25°. According to J. Dewar and H. O. Jones, the critical temp. is about 200°, and the critical press. about 100 atm. A. Mittasch found the vap. press. p mm., at the indicated temp., to be:

	2·05°	7·56°	15·27°	20·20°	24·26°	29·52°	34·29°	39·97°
p	133·1	170·5	238·2	294·3	349·7	444·2	532·6	647·2

According to L. Mond and R. Nasini, nickel carbonyl begins to decompose at about 36°, and A. Mittasch estimates the percentage decomposition:

	62°	69°	79°	90°	98°
Decomposition	0·38	0·80	1·10	2·60	5·80 per cent.

L. Mond and co-workers said that when passed through a hot tube at 180°–200°, the nickel is deposited as a brilliant metallic mirror. J. Garnier attributed the separation of nickel in the flues of furnaces heating ferro-nickel to the formation and decomposition of a gaseous nickel compound. The vap. may explode if rapidly

heated to 60°, but, added J. Dewar and H. O. Jones, only in the presence of air or oxygen. L. Mond said that the liquid carbonyl does not explode, but it decomposes rapidly when heated. It may be distilled if it is dissolved in a liquid of higher boiling point, but even then it also decomposes with the evolution of carbon monoxide and the deposition of nickel in a very finely divided state.

According to M. Berthelot, the reaction $\text{Ni}(\text{CO})_4 = \text{Ni} + 4\text{CO}$ is endothermic and reversible; while the reaction $\text{Ni}(\text{CO})_4 = \text{Ni} + 2\text{C} + 2\text{CO}_2$ is exothermic and reversible. He said that the former reaction occurs if the compound is slowly heated, and the latter if rapidly heated. A. Mittasch observed no signs of the formation of carbon dioxide; and M. Berthelot (1901) obtained only 1 c.c. of carbon dioxide after heating a 35 c.c. bulb of gas for some hours at 550°. According to A. Mittasch, if x denote the conc. of carbon monoxide when the system is in equilibrium, $a-x$ will be the conc. of the nickel carbonyl; and since the conc. of the solid phase—nickel—is a constant for equilibrium, $\text{Ni}(\text{CO})_4 \rightleftharpoons \text{Ni} + 4\text{CO}$, $x^4 = K(a-x)$, where K is the equilibrium constant. The observed values of K are in agreement with this assumption. The internal heat of the reaction calculated from $(d \log K)/dt = Q/RT^2$ give $\text{Ni} + 4\text{CO} = \text{Ni}(\text{CO})_4 + 43.63$ Cals. L. T. Reicher obtained 59.5 Cals. from the heat of combustion, but by correcting this for the external work the observed value becomes 50.7 Cals. Observations on the speed of decomposition show that the decomposition of nickel carbonyl is a reaction of the first order, which is explained by assuming the reaction occurs only on the walls of the containing vessel, while the formation of nickel carbonyl is a reaction of the second order, and this is explained by assuming that the reaction occurs in stages: $\text{Ni} + 2\text{CO} \rightleftharpoons \text{Ni}(\text{CO})_2$, and $\text{Ni}(\text{CO})_2 + 2\text{CO} \rightleftharpoons \text{Ni}(\text{CO})_4$. Traces of air, or of hydrogen sulphide, retard the reaction to a very marked degree, and small quantities of water vapour exert a slight disturbing action. The temp. coeff. of the decomposition is greater than that of the formation of nickel carbonyl. J. Dewar and H. O. Jones gave 6.4 Cals. for the mol. heat of vaporization.

L. Mond and R. Nasini found the at. refraction of the nickel in nickel carbonyl to be about three times as great as nickel in the metallic state or in its salts. A. J. F. de Silva showed that the mol. refraction of nickel carbonyl is higher than the sum of the at. refractions of nickel oxide and carbon monoxide. J. H. Gladstone found the mol. refraction for the H_α -line is 57.7°; and the mol. dispersion between the H_γ - and the H_α -lines is 5.93. L. Mond gave 58.63 for the mol. refraction μ/D ; and 1.123 for the dispersion coeff. He added that the compound is opaque to rays of wavelength exceeding 3.820. He also found that the gas burns with a faintly luminous flame in which metallic nickel is liberated, and which gives a continuous spectrum. When sparked in a vacuum tube at 5 mm. press., the spectrum of carbon monoxide alone is obtained. When the gas is diluted with hydrogen, it burns with a yellowish green flame which furnishes the line spectrum characteristic of nickel. L. Mond found nickel carbonyl to be a bad conductor of electricity. G. Jaffé said that the ionization is 5.1 times as great as that of air. A. Mittasch gave 10^{-9} rec. ohms for the sp. conductivity of the liquid. L. Mond gave 38.21 for the magnetic rotatory power, a value greater than that of all other substances with the exception of phosphorus. The diamagnetic constant is -3.131×10^{10} . Unlike the general paramagnetic properties of the nickel salts, nickel carbonyl is thus strongly diamagnetic.

Attempts by L. Mond, H. Hirtz, and M. D. Cowap to prepare nickel tricarbonyl analogous with cobalt tricarbonyl were not successful. L. Mond suggested the first of the following formulæ to explain the physical properties of nickel carbonyl. Here nickel is represented as an octovalent element. H. E. Armstrong, J. H. Gladstone, H. O. Jones, and A. J. F. de Silva preferred the ring formula with nickel divalent.

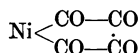

The main argument in favour of the cycloid or ring formula is that it affords an explanation of the complete masking of the metal, comparable, for example, with that which

Sulphur suffers in thiophene. L. Mond added that it is doubtful if all the carbonyl radicals are directly associated with nickel since it would then be necessary to assume an excessive valency for the element. On the other hand, the ring formula does not explain why in the case of the analogous cobalt compound one carbonyl group is more easily eliminated than the others; and why the cobalt compound has double the formula weight in benzene soln. Consequently, said L. Mond and co-workers, these compounds probably have a molecular rather than an atomic constitution, similar to the hydrates of salts or of acids, the carbonyl group taking the place of the water in crystallization or hydration. Here again, however, the difficulty arises that we have to assume that these compounds, although they can be obtained in a gaseous form, have a normal gas density, and so far as they could be investigated therein, exist in the gaseous state also in this molecular condition.

According to M. Berthelot, at ordinary temp. nickel carbonyl is stable in the gaseous or liquid state when it is sealed up in glass tubes; if exposed to the air, oxidation occurs, and there separates, according to L. Mond, nickelous carbonate, and, according to M. Berthelot, green nickelous hydroxide; at the same time, a part of the vap. oxidizes, forming a white deposit having the composition $C_2O_3NiO.H_2O$. The mixture of the vap. with air or oxygen burns or explodes on contact with a red-hot substance, according to the relative proportions of oxygen and vap. present. The explosion of a mixture of dry nickel carbonyl and oxygen can be produced by shaking energetically with mercury. Nickel carbonyl is insoluble in water. The gaseous mixture in presence of a little water oxidizes slowly, with formation of a greenish, gelatinous precipitate. This compound contains nickel, oxygen, water, and some combined carbon; it blackens on heating from separation of carbon. Simultaneously with the production of this complex oxide in the cold, carbonic oxide is regenerated. The dry mixture undergoes a similar decomposition, but the oxide formed is yellowish-brown; in time it blackens by further decomposition. Liquid nickel carbonyl kept under water without exclusion of air decomposes in a similar manner, but more slowly. Nickel carbonyl thus behaves in a manner analogous to the organo-metallic radicles and the metallic derivatives of acetylene. Nickel carbonyl is insoluble in dil. acids or alkalies, and in acid soln. of cuprous chloride. The most suitable solvents are the hydrocarbons—*e.g.* turpentine. L. Mond and J. Langer found it to be soluble in alcohol, benzene, and chloroform; and V. Lenher and H. A. Loos, in toluene, acetone, and methyl or ethyl alcohol. When soln. in chloroform, acetone, benzene, toluene, and methyl or ethyl alcohol are allowed to stand for some time, there separates a green gelatinous precipitate which is possibly a mixture of nickel hydroxide and carbonyl. E. Hatschek and P. C. L. Thorne found that the soln. in benzene begins to dissociate below the b.p. turning greenish-brown and then black. Colloidal nickel is formed.

Oxidizing agents were found by L. Mond and co-workers to decompose nickel carbonyl; chlorine furnishes nickel chloride and carbonyl chloride; bromine behaves in an analogous manner; F. E. E. Lamplough studied the reaction with iodine. Mittasch found that iodine gives a nickel salt and carbon dioxide. According to Dewar and H. O. Jones, a soln. of chlorine, bromine, or iodine in an organic solvent decomposes the carbonyl with the evolution of carbon monoxide; liquid chlorine or bromine decomposes the solid carbonyl; iodine has no action on the liquid carbonyl; a soln. of iodine mono- or tri-chloride or cyanogen iodide in carbon tetrachloride is decomposed by the carbonyl, iodine is first set free, and this decomposes more carbonyl. Hydrogen chloride reacts readily with the carbonyl; hydrogen bromide and iodide has no action.

L. Mond and co-workers, and A. Mittasch found that sulphur decomposes nickel carbonyl; and J. Dewar and H. O. Jones found a soln. of sulphur in an organic solvent soon liberates carbon monoxide from the carbonyl. According to M. Berthelot, hydrogen sulphide in the cold rapidly precipitates a black sulphide from the vap. J. Dewar and H. O. Jones obtained nickel sulphide, hydrogen, and carbon monoxide by the action of hydrogen sulphide. The dry carbonyl in contact

with conc. sulphuric acid detonates in a few moments ; but if the carbonyl be diluted with nitrogen, the decomposition may proceed quietly—each atom of nickel furnish a mol. of nickel sulphate and four mols of carbon monoxide—at the same time some of the sulphuric acid is reduced. J. Dewar and H. O. Jones found that with sulphuric acid, nickel sulphate, hydrogen, and carbon monoxide are slowly formed

$$\text{Ni}(\text{CO})_4 + \text{H}_2\text{SO}_4 = \text{NiSO}_4 + \text{H}_2 + 4\text{CO}.$$

M. Berthelot observed that ammonia gas does not act on nickel carbonyl immediately, but if oxygen be gradually added to the mixture, a white complex substance is formed which blackens when heated. According to H. O. Jones, nickel carbonyl in alcoholic soln. reacts with hydroxylamine, NH_2OH , forming a bluish-violet mass which solidifies in the desiccator, is insoluble in all solvents tried, and decomposes at 100° . The ratio of nickel to hydroxylamine in the compound is 1 : 4 or 1 : 5. Hydrazine, $\text{N}_2\text{H}_4 \cdot \text{H}_2\text{O}$, furnishes analogous compounds. M. Berthelot found that nitric oxide, passed into liquid nickel carbonyl, or mixed with its vap. volatilized in nitrogen, produces blue fumes, slowly deposited. The addition of a further quantity of nitric oxide, even when its initial vol. was four times that of the gaseous nickel carbonyl, reproduces these fumes. The inference is drawn that the vap. of another nickel compound is present as well as the nickel carbonyl, and forms a blue compound immediately with nitric oxide, which is present in excess. If a few bubbles of oxygen be introduced in place of the second quantity of nitric oxide, a blue compound different from the one noticed above, is formed. According to R. L. Mond and A. E. Wallis, nitric oxide colours a one per cent. soln. of nickel carbonyl in chloroform an intense blue ; and on evaporation in the absence of air, a blue powder is produced. It is assumed that a nickel nitrosocarbonyl is formed, but the analyses were unsatisfactory. L. Mond and co-workers found that nitric acid oxidizes nickel carbonyl and colours the alcoholic soln. blue. M. Berthelot found that phosphine reacts with nickel carbonyl, forming a black shining compound.

According to J. Dewar and H. O. Jones, aluminium chloride does not react with nickel carbonyl nor has the carbonyl any action on the aliphatic hydrocarbons, but with benzene or toluene, aluminium chloride, and nickel carbonyl, a rapid evolution of hydrogen chloride occurs and a dark viscid mass is formed ; toluene, *m*-xylene, naphthalene, and mesitylene also react more or less slowly. Nickel carbonyl reacts with benzene in the presence of aluminium bromide. H. O. Jones found that nickel carbonyl reacts like the keto-compounds. Alkyl magnesium compounds, phenyl magnesium iodide, etc., also react with nickel carbonyl. J. Dewar and H. O. Jones found that nickel carbonyl and carbon disulphide do not react to any appreciable extent in the liquid state, unless the two liquids be exposed to light, but they readily interact in the vaporous state, and the reaction is favoured by decrease of press. as is also the case with the oxidation of phosphorus and of aldehyde vap. The reaction is represented by $2\text{Ni}(\text{CO})_4 + \text{CS}_2 = 2\text{NiS} + 8\text{CO} + \text{C}$ rather than by $\text{Ni}(\text{CO})_4 + \text{CS}_2 = \text{NiS} + \text{CS} + 4\text{CO}$. The reaction proceeds in darkness and in the absence of moisture. Carbonyl sulphide, allyl sulphide, thiophene, ethyl trithiocarbonate, ethyl dithiocarbonate, thiocarbonyl chloride, and thiocarbamide all react with nickel carbonyl to produce brown or black deposits. J. Dewar and H. O. Jones found that a soln. of cyanogen in an organic solvent decomposes nickel carbonyl with the evolution of carbon monoxide. The physiological action of nickel carbonyl has been studied by H. W. Armit, J. G. McKendrick and W. Snodgrass, L. Mond, E. Vahlen, A. Mittasch, etc. Small quantities of the vap. are very poisonous, being decomposed in the lungs into carbon monoxide and a nickel derivative.

L. Mond said that the metals and the metal salts do not react with nickel carbonyl. A. Mittasch found that sodium chloride, lithium chloride, mercuric chloride or cyanide, chromic chloride, potassium iodide, potassium nitrate, nickel sulphate and silver nitrate are insoluble in liquid nickel carbonyl ; traces of some salts do dissolve but the soln. are non-conducting. He also found that silver nitrate and platinum tetrachloride are decomposed by nickel carbonyl ; L. Mond and co-workers also found that ammoniacal silver and cupric salt soln. are reduced. M. Berthelot

id that a dil. or conc. soln. of potassium hydroxide has no action on the carbonyl. L. Mond and A. E. Wallis found that moist air, carbon monoxide, and nickel tetracarbonyl at 200° give a yellow deposit of colloidal basic nickel carbonate of variable composition.

Cobalt was found by I. L. Bell to react with carbon monoxide less readily than nickel, furnishing a little carbon. P. Sabatier and J. B. Senderens also found that the reaction $2\text{CO}=\text{C}+\text{CO}_2$ occurs at a higher temp. with cobalt than with nickel. L. Mond, C. Langer, and L. Quincke obtained no cobalt carbonyl under the conditions employed for the nickel compound; but later L. Mond, H. Hirtz, and M. D. Cowap found that **cobalt tetracarbonyl**, $\text{Co}(\text{CO})_4$, can be made by heating cobalt over 150° in an atm. of carbon monoxide at a press. between 30–40 atm. The higher the press. up to at least 250 atm., the more rapid the formation of the carbonyl, likewise also when the temp. is raised to 220°. Cobalt tetracarbonyl furnishes orange-coloured transparent crystals which are best preserved by sealing them in an atm. of hydrogen or carbon monoxide in a glass tube. The sp. gr. of the crystals is 1.73 at 18°, if kept for a few hours the sp. gr. increases owing to decomposition. The vap. density could not be determined directly owing to the decomposition of the carbonyl. The crystals melt without decomposition at 51°; very slow decomposition sets in immediately after melting, and it is quite appreciable at 53°, and fairly rapid at 60°. Decomposition is complete at the last-named temp. in two days, and cobalt tricarbonyl is formed. The vap. press. at 15° is 0.072 mm. The mol. wt. by the cryoscopic method in benzene is 328, corresponding with the doubled formula $\text{Co}_2(\text{CO})_8$. The crystals decompose when exposed to the atm., a deep violet substance, consisting of a basic cobalt carbonate, being left behind. Cobalt carbonyl is very slowly attacked by non-oxidizing acids, such as hydrochloric or sulphuric, whereas when nitric acid or bromine is present, the reaction is accelerated considerably, and the corresponding cobalt salt is formed with the elimination of carbon monoxide, according to the equation $\text{Co}(\text{CO})_4+\text{Br}_2=\text{CoBr}_2+4\text{CO}$. Cobalt carbonyl is insoluble in water, but more or less soluble in organic solvents, such as carbon disulphide, ether, phthalic acid, alcohol, and also in nickel carbonyl. If these soln. are kept for some time, and if they are warmed, decomposition ensues. R. L. Mond and A. E. Wallis found that nitric oxide reacts with cobalt tetracarbonyl slowly at room temp., instantly at 40°, forming a cherry-red liquid with the composition **cobalt nitrosotricarbonyl**, $\text{Co}(\text{CO})_3\cdot\text{NO}$. The mol. wt. by the vapour density method is 171.7; theory requires 172.3. The mobile liquid is very volatile; its sp. gr. is 1.5126 at 14°; its b.p. 78.6° at 761 mm.; and its m.p. is -1.05° . The vap. press. at 14° is 77 mm., at 23°, 100 mm.; at 36°, 171 mm.; at 45°, 251 mm.; at 56°, 361 mm.; and at 66°, 517 mm. The compound slowly decomposes above 66°. It is stable under water in which it is insoluble; it is miscible in all proportions with alcohol, benzene, ether, chloroform, and carbon disulphide. It may be distilled in a current of inert gas at 50°–60°, with only a slight decomposition into cobalt tricarbonyl and nitric oxide. As indicated above, when cobalt tetracarbonyl is allowed to stand for a couple of days at 60°, it furnishes **cobalt tricarbonyl**, $\text{Co}(\text{CO})_3$, which is purified by cooling the soln. in warm benzene. The crystals are jet-black. They are so slightly soluble in the various menstrua tried that their mol. wt. was not determined. The compound decomposes when heated above 60°. At temp. up to 60°, nitric oxide does not react with cobalt tricarbonyl, but at 75°–80° there is a slight reaction. J. H. Weibel observed that traces of cobalt carbonyl appear when an aq. soln. of a cobalt salt is treated with carbon monoxide at 100 atm. press. and at 150°.

K. Stammer said that iron at a dull red heat decomposes carbon monoxide with the separation of carbon; H. Buff and A. W. Hofmann, I. L. Bell, A. Guntz, P. Sabatier and J. B. Senderens, A. Gautier and P. Clausmann, G. Charpy, M. van Heuleveken and A. ter Horst, etc., have made observations on the reactions: $\text{Fe}+\text{CO}=\text{FeO}+\text{C}+20.1$ Cals., and $\text{FeO}+\text{CO}=\text{Fe}+\text{CO}_2$; and on the cementation of iron by the carbon. L. Mond, C. Langer, and F. Quincke obtained no carbonyl under the conditions they employed for nickel tetracarbonyl. L. Mond and

F. Quincke volatilized reduced iron to a slight extent by heating it to 80° in a stream of carbon monoxide, and concluded by analogy with nickel tetracarbonyl, that iron tetracarbonyl was formed. J. Garnier also inferred that from the luminosity of the flame of carbon monoxide a volatile compound of this gas with iron was formed in the manufacture of iron and steel. M. Berthelot also treated reduced iron at 45° with carbon monoxide and obtained evidence that a small quantity of volatile iron carbonyl was formed. L. Mond and C. Langer isolated the compound and showed it to be **iron pentacarbonyl**, $\text{Fe}(\text{CO})_5$, and not the tetracarbonyl. Fine divided iron was allowed to remain in contact with carbon monoxide at ordinary temp., and then heated to 120° to distil off the iron carbonyl. A better yield was obtained by distilling in a slow current of carbon monoxide. The iron carbonyl condensed in a tube cooled to -20° . The remaining iron was allowed to cool, and again to stand in contact for 24 hrs. with carbon monoxide. The daily yield is about a gram of carbonyl per 100 grms. of iron. No increase in the yield was obtained by working with carbon monoxide under a press. of 10 atm. R. L. Mond and A. E. Wallis studied the best conditions for making this compound. A. Stoff investigated the conditions governing the formation of iron pentacarbonyl. Up to 60° , the influence of temp. on the reaction is slight, but just below 80° , adsorption of the reaction product by the iron at first retards the formation of the carbonyl and finally inhibits it. Above 80° , dissociation stops the action, so that large quantities in the state of vap. cannot be formed. The presence of ammonia accelerates the combination of carbon monoxide and iron; that of hydrogen sulphide exerts no influence. R. L. Mond and A. E. Wallis measured the yields at different temp. and press., and found that the formation of the carbonyl rapidly diminishes when the temp. exceeds 200° , but up to that temp. the yield is greater the higher the temp. and at a press. of 300 atm. is 4 to 5 times as great as at 100 atm. press. J. H. Weibel observed no formation of an iron carbonyl when an aq. soln. of an iron salt is treated with carbon monoxide at 100 atm. press. at 150° .

L. Mond and C. Langer found that iron pentacarbonyl is a pale yellow, viscous liquid. J. Dewar and H. O. Jones found the sp. gr. of the liquid referred to water at 4° :

	-20°	0°	21.1°	40°	60°	80°	120°
Sp. gr.	1.53	1.4937	1.4565	1.4330	1.3825	1.3510	1.3

The coeff. of expansion between 0° and 21° is accordingly 0.00121; between 20° and 40° , 0.00128; and between 40° and 60° , 0.00142—the mean coeff. of expansion over the whole range is 0.00138. According to L. Mond and C. Langer, the pentacarbonyl distils without decomposition at 102.8° and 749 mm. It solidifies below -21° to a mass of yellow, needle-shaped crystals. When heated to 180° , it is completely decomposed into iron and carbon monoxide. The dissociation at 130° amounts to about one per cent.; at 140° , it is quite marked, and is attended by the separation of iron; at 216° the dissociation is complete. The reaction is reversible. The dissociation increases with a diminution of press., and is smaller in an atm. of carbon monoxide than in an inert gas. Iron pentacarbonyl is more stable, and dissociates more slowly than nickel tetracarbonyl. J. Dewar and H. O. Jones found the b.p. to be 102.7° at 764 mm.; or 102.5° at 760 mm.; the m.p. is between -19.5° and -21° . The critical temp. is 255° – 288° ; the critical press., 29.6 atm.; and the critical density, 0.49. The vap. press., p mm., is:

	-7°	0°	16.1°	18.4°	35.0°	57°	74°
p	14.0	16.0	25.9	28.2	52.0	133.0	31

The heat of vaporization is 39.45 cal. per gram.

The vap. density 6.5 corresponds with the value 6.7 calculated for the pentacarbonyl. Analyses also agree with the pentacarbonyl. The formula $\text{Fe}(\text{CO})_5$ agrees with the f.p. of a soln. of the carbonyl in benzene. The formation of ferrous salts when the pentacarbonyl is decomposed by non-oxidizing and non-reducing agents agrees with the assumption that the iron is bivalent; and the masking

The optical properties of the iron by the carbonyl groups is in agreement with the following formula :

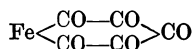

advocated by L. Mond, J. H. Gladstone, A. J. F. de Silva, etc. J. Dewar and H. O. Jones gave 1.519 for the index of refraction for Na-light at 22°, and 1.528 with H-light. L. Mond, and J. H. Gladstone found for the mol. refraction $\mu/D=69.30$; and for the H-line, 68.5. The mol. dispersion between H_γ and $H_\alpha=6.6$. The atomic dispersion of iron in this compound is much greater than that of iron in the salts of that element.

According to J. Dewar and H. O. Jones, iron pentacarbonyl is not altered when confined in a sealed tube in darkness, but it is decomposed in sunlight whether it be alone or in soln., and yellow crystals of the enneacarbonyl appear. When iron pentacarbonyl is exposed to air, L. Mond and C. Langer state that it is slowly decomposed with the formation of a brown precipitate, mainly hydrated ferric oxide. The pentacarbonyl is soluble in many organic liquids such as alcohol, ether, benzene, mineral oils, etc. According to L. Mond and co-workers, and J. Dewar and H. O. Jones, the halogens chlorine, bromine, and iodine react with decreasing velocity, forming the iron halide and carbon monoxide. Chlorine or bromine water acts quickly on the carbonyl. H. Freundlich and E. J. Cuy also noted that iodine and the pentacarbonyl react in sunlight or when warmed in alcoholic soln., forming ferrous iodide. L. Mond, J. Dewar, etc., showed that gaseous hydrogen iodide reacts with the evolution of hydrogen and carbon monoxide; gaseous hydrogen bromide or chloride does not act, but a soln. of these compounds in chloroform acts on the carbonyl. Dil. hydrochloric acid does not act at ordinary temp. Chloroform soln. of the mono- and trihalides of iodine furnish ferrous chloride and carbon monoxide; and a soln. of cyanogen iodide in chloroform forms ferrous cyanide, and a little ferrous iodide. Cyanogen has no action on iron pentacarbonyl, but in alcoholic soln. there is a slow reaction. These reactions resemble those with nickel carbonyl, but they take place more slowly. Iron carbonyl, however, does not react with sulphur dissolved in xylene or carbon disulphide. Gaseous hydrogen sulphide is without action, but when dissolved in alcohol, it forms ferrous sulphide, hydrogen and carbon monoxide. Dil. sulphuric acid or dil. nitric acid has no action at ordinary temp., but when the acid is dissolved in ether or carbon tetrachloride there is a turbulent evolution of hydrogen and carbon monoxide—*e.g.* $\text{H}_2\text{SO}_4 + \text{Fe}(\text{CO})_5 = \text{FeSO}_4 + \text{H}_2 + 5\text{CO}$. Conc. nitric acid forms ferric nitrate quite readily. Iron carbonyl has no action on nitric acid dissolved in carbon disulphide or xylene. When heated with benzene and aluminium chloride in a sealed tube at 100°, benzaldehyde and anthracene are formed; no anthracene is produced in the cold. H. Freundlich and E. J. Cuy found a red compound with alcohol can be formed which is soluble in ether, and iron forms a green tetracarbonyl; it is a very strong reducing agent. According to L. Mond and C. Langer, alcoholic soln. of sodium and potassium hydroxides absorb the vap. rapidly, and also dissolve the liquid without the evolution of gas. After a while, a greenish precipitate is formed, which contains chiefly hydrated ferrous oxide, and the soln. becomes brown. On exposing it to the air, it takes up oxygen, and the colour changes to a dark red, whilst hydrated ferric oxide separates out. When an acid is added to an alkaline soln. of the pentacarbonyl, H. Freundlich and E. J. Cuy found that a white milky precipitate is produced which soon decomposes with the evolution of carbon monoxide and dioxide, and hydrogen, and the last-named gas in the proportion to be expected if the iron in the carbonyl is dissolved as metal, so that in alkaline soln., the iron is present in the same state of oxidation as it is in the pentacarbonyl. According to J. Dewar and H. O. Jones, on mixing alcoholic soln. of ferropentacarbonyl and mercury chloride, a slight evolution of carbon monoxide is observed, and a yellowish, crystalline precipitate is formed containing iron, mercury, chlorine, and carbon monoxide. The analyses, however, did not give figures from which a definite formula could be deduced.

When iron pentacarbonyl in a sealed tube, below 60° , is exposed to sunlight either in the gaseous state or in soln.—in ether, amylene, alcohol, or ligroin which gives better results as solvents than benzene—golden-yellow, tabular crystals are formed and the press. in the tube becomes very great. The dry crystals have a metallic lustre and resemble flakes of gold. L. Mond and C. Langer regarded this product as iron heptacarbonyl, $\text{Fe}_2(\text{CO})_7$, but J. Dewar and H. O. Jones showed that the product is orange-red, and is **iron enneacarbonyl**, $\text{Fe}_2(\text{CO})_9$, or $\text{Fe}(\text{CO})_5 \cdot \text{Fe}(\text{CO})_4$. The reaction is symbolized; $2\text{Fe}(\text{CO})_5 = \text{Fe}_2(\text{CO})_9 + \text{CO}$. The reaction induced by light is slowly reversed in darkness. The graphic formula is:



The light from the electric arc induces the change slowly, while the light from an acetylene flame has very little influence. Blue light is most active, and the activity diminishes towards the red end of the spectrum. Variations of press. up to 125 atm have no appreciable influence on the reaction; and the change is inhibited at 60° to 100° : but at the temp. of liquid air, there is a slow decomposition. R. L. Mond and A. E. Wallis observed no reaction between nitric oxide and iron enneacarbonyl below 60° ; at 63° , there is a slight reaction and beads of a red liquid appear. At 100° , the reaction is complex, some liquid pentacarbonyl and some tetracarbonyl are formed, and after a time the whole decomposes with violence. The reaction at 70° – 85° is regular, and is represented $2\text{Fe}_2(\text{CO})_9 + \text{NO} = \text{FeNO} \cdot 3\text{Fe}(\text{CO})_5 + 3\text{CO}$. The red liquid, **iron nitrosopentadecarbonyl**, $\text{Fe}_4(\text{CO})_{15}\text{NO}$, is decomposed by repeated distillation, forming iron pentacarbonyl, and a brown powder containing iron and nitric oxide. The properties of the red liquid resemble those of the nickel nitrosotricarbonyl. When iron pentacarbonyl is dissolved in nickel carbonyl, the decomposition by light is very slow, and a 10 per cent. soln. does not deposit solid or evolve gas, even after several weeks' exposure to bright sunlight. To account for this, it is suggested that combination takes place, resulting in the formation of **ferronickel enneacarbonyl**, $\text{FeNi}(\text{CO})_9$, which is not acted on by light. This view is in harmony with the fact that these soln. are much paler in colour than corresponding soln. of the pentacarbonyl in other solvents. The crystals are dried over sulphuric acid and solid paraffin. The orange-red hexagonal plates are stable in dry air. The sp. gr. is 2.085 at $18^\circ/18^\circ$; and when warmed to 100° , the enneacarbonyl decomposes, forming the pentacarbonyl, etc., $2\text{Fe}_2(\text{CO})_9 = 3\text{Fe}(\text{CO})_5 + \text{Fe} + 3\text{CO}$. The enneacarbonyl is almost insoluble in ether, benzene, or ligroin; rather more soluble in ethyl alcohol, methylal, or acetone; and still more soluble in pyridine. Alumina adsorbs about 2.5 per cent. of its weight of iron pentacarbonyl; on exposure to light the powder becomes deeply coloured, and carbon monoxide is evolved.

When the crystals of the enneacarbonyl are heated between 50° and 90° in the presence of ether, ligroin, or toluene, in an atm. of carbon dioxide, the liquid becomes intensely green. J. Dewar and H. O. Jones cooled the green toluene soln. and obtained green prismatic crystals of **iron tetracarbonyl**, $\text{Fe}(\text{CO})_4$, the analogue of nickel tetracarbonyl. The crystals have a sp. gr. 1.994 at $18^\circ/18^\circ$. From the effect of the tetracarbonyl on the f.p. of benzene soln., the mol. wt. is higher than represented by the normal formula. Iron tetracarbonyl is stable under ordinary conditions, but at 140° – 150° , it dissociates into metallic iron and carbon monoxide. The tetracarbonyl is soluble in toluene, ligroin, ether, etc. The dark green soln. slowly lose their colour at 100° , rapidly at 140° , and iron is deposited. The soln. in pyridine and alcohol are green at first, but they turn red on standing.

H. Buff and A. W. Hofmann, and I. L. Bell found that carbon monoxide has no action on heated platinum; nor, according to P. Sabatier and J. B. Senderens, has finely divided platinum any action at 450° . L. Mond, C. Langer, and F. Quinck could not prepare a platinum carbonyl by the method employed for nickel carbonyl. According to E. Harbeck and G. Lunge, the presence of 2.6 per cent. of carbon monoxide is sufficient to prevent the action of platinum black on a mixture

f ethylene and hydrogen. Moreover, if platinum black is sat. with carbon monoxide and the excess driven out with hydrogen, its action on a mixture of ethylene and hydrogen is destroyed. Platinum black absorbs about 60 times its vol. of carbon monoxide, and palladium black about 36 times its vol. The compound formed is probably a true chemical compound, since the carbon monoxide is not eliminated by the subsequent action of other gases, such as hydrogen; it is very stable, but suddenly decomposes at 250° into its constituents. Attempts to isolate the compound were not successful since it is not volatile, and cannot be extracted by the ordinary solvents. L. Mond, H. Hirtz, and M. D. Cowap showed that if ruthenium-black is subjected to the action of carbon monoxide, a very small quantity of a yellow-orange deposit is formed in a cooled glass tube, and a comparatively strong mirror is formed in a heated glass tube. The reaction does not start below a press. of about 350–450 atm., and a temp. of 300°. The deposit is insoluble in hydrochloric acid, but soluble in nitric acid or bromine, gas being evolved. It contains ruthenium, and forms a ruthenium mirror when heated. The mirror obtained in the heated glass tube is soluble to a slight extent in hydrochloric acid (soln. contains iron). The insoluble part is not dissolved by aqua regia, and consists of ruthenium. The orange-yellow deposit obtained by heating finely divided ruthenium at 300° in carbon monoxide at 400 atm. press. is extracted by alcohol. The non-volatile product, **ruthenium dicarbonyl**, $\text{Ru}(\text{CO})_2$, is insoluble in benzene, and in hydrochloric acid, but is soluble in ethyl alcohol, water, nitric acid, and in bromine with the evolution of gas. R. L. Mond and A. E. Wallis obtained another volatile ruthenium carbonyl which is crystalline and soluble in benzene.

REFERENCES.

- ¹ J. L. Gay Lussac and L. J. Thénard, *Recherches physico-chimiques*, Paris, 1, 266, 1811; B. H. Kühnemann, *De kalio atque ea ratione quam idem cum carbone oxydato et gase oxygenii habeat*, Lipsiæ, 1863; J. von Liebig, *Pogg. Ann.*, 30, 90, 1834; J. F. Heller, *Liebig's Ann.*, 34, 232, 1840; B. C. Brodie, *Journ. Chem. Soc.*, 12, 269, 1860; J. U. Lerch, *Sitzber. Akad. Wien*, 5, 721, 1862; *Liebig's Ann.*, 124, 20, 1862; C. Winkler, *Ber.*, 23, 44, 1890; R. Nietzki and F. Benckiser, *ib.*, 18, 499, 1833, 1885; A. Joannis, *Compt. Rend.*, 116, 1518, 1893; A. Pleischl, *Zeit. Phys. Math.*, 2, 307, 343, 1883; 3, 326, 1835; E. Müller, *Zeit. angew. Chem.*, 35, 689, 1922.
- ² M. Berthelot, *Ann. Chim. Phys.*, (7), 22, 300, 1901; *Compt. Rend.*, 131, 1167, 1900; F. Bertrand, *ib.*, 177, 977, 1923; N. D. Zelinsky, *ib.*, 177, 1041, 1923; L. Mond, C. Langer, and F. Quincke, *Journ. Chem. Soc.*, 57, 749, 1890; E. Mond and C. Heberlein, *ib.*, 125, 1222, 1924.
- ³ H. Moissan, *Bull. Chim. Soc.*, (3), 21, 817, 897, 1899; *Ann. Chim. Phys.*, (7), 18, 303, 1899; *Compt. Rend.*, 126, 1753, 1898; 127, 584, 1898; G. Roederer, *ib.*, 140, 1252, 1905; *Bull. Soc. Chim.*, (3), 35, 715, 1906; A. Guntz and M. Mentrel, *ib.*, (3), 29, 578, 1903.
- ⁴ J. Parkinson, *Journ. Chem. Soc.*, 20, 125, 309, 1867; G. Gore, *Chem. News*, 48, 295, 1883; Winkler, *Ber.*, 23, 2642, 1890; A. Guntz and A. Masson, *Compt. Rend.*, 124, 187, 1897; A. von Bartal, *Zeit. anorg. Chem.*, 55, 152, 1907; 58, 49, 1907; C. Matignon, *Bull. Soc. Chim.*, (4), 5, 59, 1909.
- ⁵ L. Mond, H. Hirtz, and M. D. Cowap, *Journ. Chem. Soc.*, 97, 808, 1910; R. L. Mond and A. E. Wallis, *ib.*, 121, 29, 1922; A. Guntz, *Compt. Rend.*, 114, 115, 1892; G. Charpy, *ib.*, 148, 0, 1909.
- ⁶ I. L. Bell, *Chem. News*, 23, 135, 146, 159, 258, 267, 1871; L. Mond, C. Langer, and F. Quincke, *Chem. News*, 62, 97, 1890; *Journ. Chem. Soc.*, 57, 749, 1890; R. L. Mond and A. E. Wallis, *ib.*, 121, 29, 32, 1922; L. Mond, H. Hirtz, and M. D. Cowap, *B.A. Rep.*, 665, 1908; *Chem. News*, 98, 165, 1908; *Journ. Chem. Soc.*, 97, 808, 1910; L. Mond and F. Quincke, *ib.*, 9, 604, 1891; *Ber.*, 24, 2248, 1891; *Chem. News*, 63, 381, 1891; L. Mond, *B.A. Rep.*, 602, 1891; 93, 1915; *Proc. Roy. Inst.*, 13, 668, 1892; *Journ. Soc. Chem. Ind.*, 14, 945, 1895; L. Mond and C. Langer, *ib.*, 10, 774, 1090, 1891; *Chem. News*, 64, 108, 294, 1891; *Brit. Pat. No.* 12432, 1891; Nasini and F. Anderlini, *Atti Accad. Lincei*, 10, 49, 1894; L. Mond and R. Nasini, *ib.*, 7, i, 11, 1890; *Zeit. phys. Chem.*, 8, 150, 1891; A. Mittasch, *ib.*, 40, 1, 1902; 46, 37, 1903; *Arch. Exp. Path.*, 49, 367, 1903; W. C. Roberts-Austen, *Proc. Inst. Civil Eng.*, 135, 29, 1899; *Chem. News*, 78, 260, 1898; J. Dewar, *Brit. Pat. No.* 9300, 1902; J. Dewar and H. O. Jones, *Proc. Roy. Soc.*, 71, 427, 1903; 76, A, 558, 1905; 79, A, 66, 1907; 80, A, 229, 1908; H. W. Armit, *Journ. Hygiene*, 7, 525, 1907; K. Stammer, *Pogg. Ann.*, 82, 135, 1851; J. H. Weibel, *Reaktionen einiger Metallsalzlösungen unter erhöhten Temperaturen und Drucken*, Zurich, 1923; H. Buff and A. W. Hofmann, *Liebig's Ann.*, 113, 140, 1860; P. Sabatier and J. B. Senderens, *Bull. Chim. Soc.*, (2), 29, 249, 1903; A. Guntz, *ib.*, (3), 7, 278, 1892; *Compt. Rend.*, 114, 115, 1892; A. J. F. de Silva, *Bull. Soc. Chim.*, (3), 19, 441, 1898; E. Tassilly, H. Pénaud, and E. Roux, *ib.*, (4), 29, 862, 1921; van Breukelveen and A. ter Horst, *Rec. Trav. Chim. Pays-Bas*, 19, 27, 1900; G. Charpy, *Compt.*

Rend., 137. 120, 1903; A. Gautier and P. Clausmann, *ib.*, 151. 16, 1910; M. Berthelot, *ib.*, 112. 1343, 1891; 113. 680, 1891; *Ann. Chim. Phys.*, (6), 26. 562, 1892; (7), 22. 304, 1901; J. Garnier *ib.*, 113. 89, 1891; G. Krüss and F. W. Schmidt, *Zeit. anorg. Chem.*, 2. 243, 1892; E. Harbeck and G. Lunge, *ib.*, 16. 60, 1898; T. W. Richards and A. S. Cushman, *ib.*, 16. 167, 1898; H. Frey, *Ber.* 28. 2512, 1895; H. Freundlich and E. J. Cuy, *ib.*, 56. B, 2264, 1923; J. H. Gladstone, *Phil. Mag.*, (5), 35. 204, 1893; *Chem. News*, 67. 94, 1893; H. O. Jones, *ib.*, 90. 144, 1904; H. E. Armstrong, *ib.*, 67. 153, 1893; V. Lenher and H. A. Loos, *Journ. Amer. Chem. Soc.*, 22. 114, 1900; J. G. McKendrick and W. Snodgrass, *Brit. Med. Journ.*, 1215, 1891; E. Hatschek and P. C. L. Thorne, *Proc. Roy. Soc.*, 103. A, 276, 1923; E. Vahlen, *Arch. Exp. Path.*, 48. 117, 1902; R. Wachsmuth, *Wied. Ann.*, 44. 377, 1891; J. Apt., *Schrift. Nat. Ver. Schleswig-Holstein*, 11. 2, 1898; L. T. Reicher, *Die Verbrandingswarmie van Nikkelkooloxyde*, Amsterdam, 1896; G. Jaffé, *Phil. Mag.*, (6), 8. 556, 1904; F. E. E. Lamplough, *Proc. Chem. Soc.*, 22. 280, 1906; 24. 29, 1908; V. Wartha, *Chem. Ztg.*, 15. 916, 1891; A. Stoffel, *Chem. Weekbl.*, 8. 722, 1911; R. Lessing, *U.S. Pat. No.* 1436662, 1922.

§ 28. The Carbonyl Halides

In 1811, J. L. Gay Lussac and L. J. Thénard,¹ and J. Murray said that chlorine does not unite with carbon monoxide. J. Murray's statement was based on an attempt to refute the elementary nature of chlorine in favour of the hypothesis that chlorine is oxymuriatic acid. He showed that when carbon monoxide and chlorine are exposed to sunlight, and then treated with ammonia, the soln. gives off carbon dioxide when treated with nitric acid. He therefore concluded that the soln. contained ammonium chloride and carbonate, and that the carbonate was formed by the alleged oxymuriatic acid (chlorine) oxidizing the carbon monoxide. In opposition, J. Davy showed that no combination occurs when equal vols. of the dried gases are mixed in the dark, but combination does occur in light, and more particularly in sunlight. The gases contract to half their former vol. during the combination, and the product contains neither hydrochloric acid nor carbon dioxide. It is absolutely necessary that the constituents should be dried, otherwise a mixture of carbon dioxide and hydrogen chloride will be formed "in proportion to the quantity of water present." He named the product *phosgene*—from $\phi\omega\varsigma$, light; and $\gamma\epsilon\nu\acute{\alpha}\nu$, I give rise to—it is now called **carbonyl chloride**, COCl_2 , or *carbon oxychloride*. T. Wilm and G. Wischin consider a modification of this process to be the best method of preparing the gas. The constituent gases are introduced at about the same rate into a ten-litre gas balloon, and thence into a second smaller balloon. Both balloons are exposed to sunlight. It is best to employ a slight excess of chlorine, and then to get rid of the excess, as recommended by A. Klepl, by passing the product through a tube packed with pieces of antimony; or, as recommended by M. Berthelot, by treating the gas with mercury. The gas thus purified can be liquefied by passing it into a tube surrounded by ice or a freezing mixture. T. Wilm and G. Wischin used this method of preparation; and J. Cathala devised a special apparatus for the synthesis.

M. von Recklinghausen observed that at the moment of illumination the mixture expands slightly; there is then a period of induction. G. Dyson and A. Harden observed that there is a well-marked period of induction with the gases dried by sulphuric acid. The effect of the insolation slowly disappears when the isolated gas is placed in darkness. The period of induction is greatly diminished by admixture with air, but does not appear to be specifically affected by the presence of carbonyl chloride, hydrogen chloride, excess of carbon monoxide, carbon tetrachloride vap. or small amounts of water vap. M. Wildermann showed that after the period of induction, the rate of combination is in accord with the mass law, being proportional to the conc. of the uncombined gases present. G. Dyson and A. Harden stated that the phenomenon with a mixture of carbon monoxide and chlorine has probably the same explanation as in the case of a mixture of hydrogen and chlorine (2. 18, 5) and that the light exerts a specific action on the chlorine in the presence of a gas with which it can combine. D. L. Chapman and F. H. Gee found that the period of

induction is extended by small quantities of nitric oxide, ozone, and nitrogen chloride. They therefore explained the photochemical action to the use which the chlorine can make of the absorbed light-energy to effect the union of the two gases before that energy is degraded to ineffective heat. The inhibitory gases hasten the process of energy degradation, and in consequence the chlorine becomes less efficient. A. Coehn and H. Tramm found that the speed of the reaction is reduced by drying the gases, but the process invariably proceeds at an appreciable rate. J. Cathala found the presence of air and carbon dioxide also retarded the speed of reaction. K. F. Bonhöffer studied the photosensitive reaction $\text{CO} + \text{Cl}_2 = \text{COCl}_2$; and M. Bodenstein the dynamics of the photochemical reaction.

J. Davy did not succeed in making carbonyl chloride in quantity by passing a mixture of the component gases through a red-hot earthenware tube, but some of the compound is formed under these conditions. M. Bodenstein and G. Dunant showed that the reaction $\text{CO} + \text{Cl}_2 \rightleftharpoons \text{COCl}_2$ is reversible, and that above 800° the decomposition of the compound is complete. They found:

	503°	553°	603°	800°
Amount decomposed	67	80	91	100 per cent.

The effect of time at 503° is illustrated by Fig. 39. S. Dushman, and J. A. Christiansen discussed the thermal decomposition of carbonyl chloride; the latter found that the velocity of the reaction $ds/dt = k\sqrt{C_{\text{Cl}_2}(C_{\text{COCl}_2})^{-x}}$, where the

constant k at different temp. is represented by $\log k = -11420T^{-2} + 15.154$. The thermal dissociation of carbonyl chloride was also studied by R. H. Atkinson and co-workers. P. Schützenberger found that carbonyl chloride is formed when the constituent gases are passed over spongy platinum at 300° – 400° ; and E. Paterno, when these gases are passed over animal charcoal. E. Paterno made the gas by passing a rapid current of the mixed carbon monoxide and chlorine at ordinary temp. over animal charcoal; there is a rapid production of carbonyl chloride with the evolution of heat. R. H. Atkinson, C. T. Heycock, and W. J. Pope found that

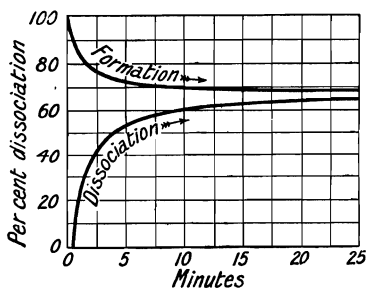

FIG. 39.—Reversibility of the Reaction $\text{CO} + \text{Cl}_2 = \text{COCl}_2$ at 503° .

for good yields special precautions must be taken in the preparation of the charcoal and that highly activated wood charcoal is even more efficient than bone charcoal, so that the catalytic reaction is effected 50° lower than is the case with a mixture of hydrogen and chlorine. E. Schering also favoured activated charcoal. V. A. Plotnikoff showed that carbonyl chloride is formed when carbon monoxide and chlorine are passed through a tube containing pieces of aluminium chloride at 30° – 35° ; or, better, if the gaseous mixture is passed through a sat. soln. of aluminium chloride in chloroform. He also draws attention to the connection of this mode of preparing the gas with E. Baud's complexes of aluminium and carbonyl chlorides.

The union of carbon monoxide and chlorine has been discussed by J. Schiel, R. H. Atkinson and co-workers, and by A. S. Lavroff. F. Weigert found that although visible light accelerates both the decomposition and formation of carbonyl chloride, it is incapable of altering the percentage composition of the mixture in thermal equilibrium at temp. between 450° and 510° . Hence he argued that the effect of light is catalytic. A. Cöhn and H. Becker claim that this inference is not necessarily applicable to waves of smaller wave-length in the ultra-violet, because these very refrangible rays can decompose carbonyl chloride confined in quartz tubes. G. Kornfeld studied the radiations from the reacting system—*vide* carbon dioxide.

Carbonyl chloride is prepared by the action of carbon monoxide on chlorinating agents. Thus, F. Göbel made it by passing carbon monoxide over red-hot silver or

lead chloride; and A. W. Hofmann, by passing carbon monoxide into boiling antimony pentachloride. Carbonyl chloride is also made by oxidizing carbon tetrachloride. Thus, P. Schützenberger made it by passing a mixture of carbon tetrachloride and carbon monoxide or dioxide over pumice-stone at 350° ; and by passing carbon tetrachloride over zinc oxide at 200° . H. Goldschmidt made it by heating carbon tetrachloride with water in a sealed tube at 250° ; H. E. Armstrong, V. Grignard and E. Urbain, E. Paterno and A. Mazzucchelli, J. Prud'homme, and P. Schützenberger, by the action of sulphuric anhydride at 100° on carbon tetrachloride. According to E. Paterno and A. Mazzucchelli, the main reaction between fuming sulphuric acid and carbon tetrachloride is represented by the equation: $\text{CCl}_4 + 2\text{SO}_3 = \text{COCl}_2 + \text{S}_2\text{O}_5\text{Cl}_2$; but there is a side reaction with the hot fuming acid: $\text{CCl}_4 + 4\text{SO}_3 = 2\text{S}_2\text{O}_5\text{Cl}_2 + \text{CO}_2$. V. Grignard and E. Urbain represent the reaction with pyrosulphuric acid: $\text{CCl}_4 + \text{SO}_3 + \text{H}_2\text{SO}_4 = \text{COCl}_2 + 2\text{HClSO}_3$; and with ordinary sulphuric acid, and kieselguhr as catalyst, $2\text{H}_2\text{SO}_4 + 3\text{CCl}_4 = 3\text{COCl}_2 + 4\text{HCl} + \text{S}_2\text{O}_5\text{Cl}_2$, together with a slight secondary reaction: $\text{S}_2\text{O}_5\text{Cl}_2 + \text{CCl}_4 = \text{COCl}_2 + 2\text{SO}_2\text{Cl}_2$. The presence of hydrogen chloride may be objectionable. G. Gustavson made carbonyl chloride by the action of phosphoric anhydride at 200° – 210° on carbon tetrachloride: $\text{P}_2\text{O}_5 + 2\text{CCl}_4 = \text{CO}_2 + 2\text{POCl}_3 + \text{COCl}_2$. H. Erdmann thus describes the preparation of carbonyl chloride by the sulphuric anhydride process:

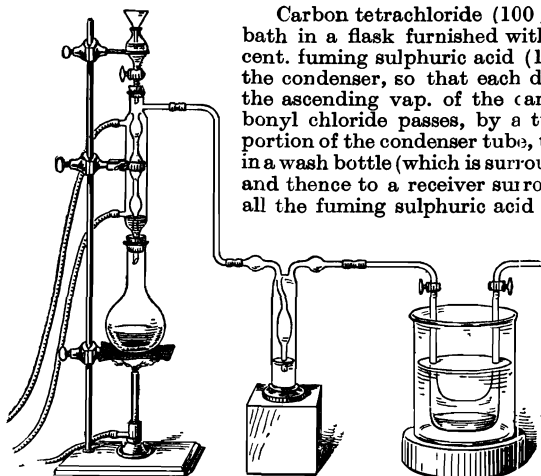

FIG. 40.—H. Erdmann's Process for Preparing Phosgene.

Carbon tetrachloride (100 grms.) is heated to boiling on a water-bath in a flask furnished with a vertical reflux condenser; 80 per cent. fuming sulphuric acid (120 c.c.) is run in drop by drop down the condenser, so that each drop comes into intimate contact with the ascending vap. of the carbon tetrachloride. The evolved carbonyl chloride passes, by a tube fused at right angles to the upper portion of the condenser tube, through conc. sulphuric acid contained in a wash bottle (which is surrounded by water during the experiment), and thence to a receiver surrounded by a freezing mixture. When all the fuming sulphuric acid has been run in, the globular flask is boiled over a free flame for five minutes. The yield of crude carbonyl chloride is 90 per cent. of the theoretical. It is rectified, the boiling flask being heated by the hand. The accompanying product is a mixture of pyrosulphuryl chloride, $\text{S}_2\text{O}_5\text{Cl}_2$, and chlorosulphonic acid, SO_3HCl .

Carbonyl chloride is formed during the oxidation of chloroform, CHCl_3 . Thus, M. Adrian found that a little carbonyl chloride and hydrogen chloride is

formed when chloroform in the presence of air is exposed to sunlight; the reaction is retarded if ethyl alcohol be present. N. School and L. M. van den Berg have shown that when chloroform is decomposed by the action of light in the presence of an excess of oxygen, carbon dioxide, water, and chlorine are formed, but that when insufficient oxygen is present, carbon oxychloride and hydrogen chloride are produced in mol. proportions. G. Mossler observed the formation of carbonyl chloride when air and chloroform vap. are passed over a layer of potassium hydroxide. M. Schumburg, and R. Kobert observed the formation of carbonyl chloride when chloroform is burnt in a gas flame; and H. Erdmann, and C. D. Harries, when ozone acts on well-cooled chloroform; A. Emmerling and B. von Lengyel, by oxidizing chloroform with a mixture of sulphuric acid and potassium dichromate, a reaction which they represented by the equation: $2\text{CHCl}_3 + \text{K}_2\text{Cr}_2\text{O}_7 + 5\text{H}_2\text{SO}_4 = 2\text{COCl}_2 + 2\text{KHSO}_4 + \text{Cr}_2(\text{SO}_4)_3 + \text{Cl}_2 + 5\text{H}_2\text{O}$; but H. Erdmann said that free chlorine is not formed, and prefers: $2\text{CHCl}_3 + \text{CrO}_3 + \text{O}_2 = 2\text{COCl}_2 + \text{CrO}_2\text{Cl}_2 + \text{H}_2\text{O}$. J. Dewar

and G. Cranston found that carbonyl chloride is formed when equimolar proportions of chloroform and chlorosulphonic acid are heated to 120°.

J. Schiel noted that carbonyl chloride is formed when a mixture of chlorine and carbon dioxide is passed over red-hot carbon. G. Gustavson observed that some carbonyl chloride is formed when anhydrous sodium carbonate is heated in a sealed tube with phosphorous pentachloride; A. Emmerling and B. von Lengyel, when carbonyl sulphide is treated with chlorine at a red heat, or passed over molten copper chloride, or through boiling antimony pentachloride; and P. Schützenberger, by the action of chlorine monoxide on carbon disulphide. H. Gautier found that chlorine gas does not act on chloral, but in diffused daylight or in direct sunlight a reaction occurs in a few hours which he symbolized: $\text{CCl}_3.\text{COH} + 2\text{Cl}_2 = \text{CCl}_4 + \text{COCl}_2 + \text{HCl}$. According to W. Hentschel when trichloromethyl chloroformate, $\text{COCl}.\text{OCCl}_3$, is heated to 300° it decomposes into twice its vol. of carbonyl chloride, but at a dull red heat it yields carbon dioxide and carbon tetrachloride. H. Staudinger showed that oxalyl chloride decomposes, forming carbonyl chloride and carbon monoxide when distilled through a glass tube heated to 600°, or when boiled with aluminium chloride in carbon disulphide soln. A. Cahours found that bis-trichloromethyloxalate, $\text{CCl}_3.\text{O}.\text{CO}.\text{CO}.\text{O}.\text{CCl}_3$, decomposes at 350°–400° into carbonyl chloride and carbon monoxide. L. Michalski found that some carbonyl chloride is formed when a mixture of carbon, calcium oxide and chloride is heated in the electric furnace: $\text{CaO} + \text{CaCl}_2 + 5\text{C} = 2\text{CaC}_2 + \text{COCl}_2$. S. Peacock made it by passing air and chlorine over heated carbonaceous materials.

Carbonyl chloride, said J. Davy, is a colourless gas with a smell "more suffocating than that of chlorine, and it occasions a very painful sensation in the eyes." It does not fume in air. W. Wahl found that carbonyl chloride crystallizes homogeneously. On cooling, the liquid becomes supercooled, and, as a rule, an unstable modification crystallizes out of the supercooled melt. If cooled rapidly, the growth of this modification may be entirely arrested and the remainder of the melt becomes quite viscous. If the preparation is allowed to become warm after the unstable modification has been formed, a transition into the stable form very soon takes place. When this again is partially melted, it crystallizes readily on cooling. The stable modification possesses a high double-refraction, but isotropic sections also occur. It belongs, therefore, either to the tetragonal or hexagonal system, but it has not been possible to determine to which of the two, as the cleavage is not very distinct. The optical character of the stable modification is positive. The unstable modification possesses an extremely high double-refraction and shows parallel extinction. It is probably orthorhombic. J. Davy gave for the **vapour density** of the gas, 3.6808; T. Thomson, 3.4249; and A. Emmerling and B. von Lengyel, 3.505 at 0° and 760 mm. A. F. O. Germann and V. Jersey gave 4.4708 to 4.5263, A. Emmerling and B. von Lengyel found the gas readily condenses to a colourless liquid of **specific gravity** 1.432 at 0°/4°, or 1.392 at 18.6°/4°; W. H. Perkin gave 1.4204 at 0°/4°, and 1.4115 at 4°/4°; and E. Beckmann and F. Junker, 1.42 at 8.2°—*vide infra*. E. Paterno and A. Mazzucchelli made observations of the sp. gr. between -15.4° and 59.9°; and they represented the sp. gr., *S*, at *θ*°, by $S = 1.4264 - 0.002326\theta$. R. H. Atkinson and co-workers gave for the **mean coeff. of cubical expansion** of the liquid between -79° and +49.9°, 0.00177. A. F. O. Germann and V. Jersey found the **vapour pressure** at 0° = 552 mm. N. I. Nikitin found the vap. press. of carbonyl chloride to be 889.2 mm. at 12.6°; 540.4 mm. at -0.41°; 232.2 mm. at -19.43°; and at -94.2°, a few tenths of a mm. R. H. Atkinson, C. T. Heycock, and W. J. Pope found for the vap. press. *p* mm., and density *D*:

	-110°	-80°	-50°	-20°	0°	+20°	+40°	+50°
<i>p</i>	—	4	47.5	226	568	1212	—	388360
<i>D</i>	1.685	1.617	1.549	1.481	1.435	1.388	1.338	1.314

E. Paterno and A. Mazzucchelli represented their measurements between -23° and 25°, by $\log p = 7.5995 - 1326T^{-1}$, where *p* represents the press. in mm. of mercury, and *T* denotes the absolute temp. N. I. Nikitin also measured the

vap. press. between -99° and 12.6° . The central constants were discussed by S. F. Pickering. L. Hackspill and M. Mathieu gave $183^{\circ} \pm 0.5^{\circ}$ for the **critical temperature**, and E. Paterno and A. Mazzucchelli, 187° ; the last-named found for the **critical density**, 0.5135; and the **critical pressure**, 51.5 atm. The law of rectilinear diameters applies to this compound, and the equation of the line below 111° , is $1.4277 - 0.00214\theta$, and above 111° , $1.4380 - 0.0022\theta$. H. Erdmann gave -118° for the **melting point**; R. H. Atkinson and co-workers gave -104° ; S. von Wroblewsky and K. Olszewsky, -103.5° ; and R. H. Atkinson and co-workers gave -126° to -128° ; A. Emmerling and B. von Lengyel, 8.2° at 756.4 mm. for the **boiling point**; E. Beckmann and F. Junker, 8.2° at 756 mm.; and E. Paterno and A. Mazzucchelli, 8.02° at 760 mm. M. Berthelot gave for the **heat of formation** from amorphous carbon, $(C, O, Cl_2) = 44.1$ Cals., at constant press. J. Thomson gave 55.14 Cals.; and for the heat of formation, (CO, Cl_2) , M. Berthelot gave 18.8 Cals.; J. Thomson, 26.14 Cals.; and M. Bodenstein and G. Dunant, 23.0 Cals. E. Beckmann and F. Junker gave 29° for the mol. rise of the b.p. F. Weigert examined the **absorption spectrum**. A. Emmerling and B. von Lengyel gave 3.936 for the **index of refraction**; and W. H. Perkin, 1.0295 for the **specific magnetic rotation**, and 4.003 for the **molecular magnetic rotation** at 2.8° . V. Henri studied the **absorption spectrum** of the vapour.

R. H. Atkinson, C. T. Heycock, and W. J. Pope gave the following data for the solubility of carbonyl chloride expressed in grams per 100 grms. of solvent: *toluene*, at 17.0° , 23.5° , 30.5° , and 31.5° : 244.7, 124.2, 79.38, and 74.48 respectively; *coal-tar xylene*, at 12.3° , 16.4° , 16.9° , 23.8° , and 29.8° : 457.3, 225.6, 217.9, 103.4, and 71.24 respectively; *creosote oil*, at 16.2° : 77.42; *petroleum boiling at 180° – 280°* , at 12.3° , 15.8° , 16.7° , 22.4° , 23.7° , 29.9° , and 30° : 263.8, 163.1, 143.4, 79.5, 71.2, 49.2, and 48.6 respectively; *heavy lubricating oil*, at 15.6° , 23.5° , and 31.0° : 79.7, 39.3, and 24.5 respectively; *nitrobenzene*, 106.4 at 16.8° ; *o-chloronaphthalene*, 104.5 at 17.0° ; *chlorobenzene*, at 12.3° , 16.6° , 16.7° , 24.2° , and 29.7° : 422.1, 204.3, 221.6, 99.9, and 81.9 respectively; *acetylene tetrachloride*, at 16.8° , 25.1° , and 29.9° : 149.7, 89.4, and 74.9 respectively. Toluene, coal-tar, xylene, and chlorobenzene are by far the best solvents of those examined, and in view of their elevated b.p. would appear to offer most advantages as scrubbing agents for effluent gases containing carbonyl chloride. Ordinary burning petroleum boiling at 180° to 280° is the next best solvent, but heavy mineral lubricating oil and acetylene tetrachloride are not quite so good. N. W. Taylor and J. H. Hildebrand made some observations on this subject. C. Baskerville and P. W. Cohen gave the results indicated in Table XIX. M. Berthelot found carbonyl chloride to be very sparingly soluble in cold water; and readily soluble in benzene, toluene, and other hydrocarbons, as well as in glacial acetic acid.

TABLE XIX.—SOLVENTS FOR CARBONYL CHLORIDE

Solvent.	Wt. of solvent grms.	Wt. $COCl_2$ absorbed grms.	Wt. ratio of $COCl_2$: solvent.	Reaction.
Carbon tetrachloride	79.5	22	1:3.6	None
Chloroform	49.4	29	1:1.7	Change
Gasoline	37.0	30	1:1.2	Change
Paraffin oil	34.6	0	0	None
Russian mineral oil	30.1	10.8	1:2.8	None
Benzene	43.9	43.6	1:1	None
Toluene	50.3	33.5	1:1.5	Change
Glacial acetic acid	31.4	19.5	1:1.6	Change
Ethyl acetate	20.5	20.2	1:1	None
Chlorococane	25.2	7.8	1:3.2	None

J. Davy said that carbonyl chloride is not decomposed by **hydrogen**; neither

hydrogen nor oxygen singly produces any effect when the mixture is sparked, but when a mixture of 2 vols. of hydrogen, one of oxygen, and two of carbonyl chloride is sparked, hydrogen chloride and carbon dioxide are formed. B. Humiston found that fluorine furnishes some carbonyl fluoride when it reacts with phosgene. Carbonyl chloride dissolves ozone, forming a blue liquid. E. Paterno and A. Mazzucchelli found that below 0°, carbonyl chloride dissolves large proportions of chlorine, forming at -15°, a golden-yellow liquid with 28.3 per cent. of free chlorine. A. F. O. Germann and V. Jersey measured the m.p. curve of soln. of chlorine and carbonyl chloride, and found a eutectic with 25 molar per cent. of chlorine, and angular points with 6, 11, 50, 63, 75, and 91 molar per cent. of chlorine. These are taken to indicate the existence of a series of chlorocarbonyl chlorides— $\text{COCl}_2 : \text{Cl}_2$ as 16 : 1, 8 : 1, 1 : 1, 3 : 5, 1 : 3, and 1 : 10—which dissociate at the m.p. The second corresponds with octohydrated chlorine. J. A. Besson found that hydrogen iodide readily dissolves in liquid carbonyl chloride, but even when cooled with ice and salt, there is a violent reaction with the liberation of iodine. M. Delépine and L. Ville found that carbonyl chloride slowly liberates iodine from an aq. soln. of potassium iodide. J. Davy found that carbonyl chloride reddens litmus; and J. Davy, and M. Berthelot found that it is slowly decomposed by cold water and rapidly by hot water: $\text{COCl}_2 + 2\text{H}_2\text{O} = 2\text{HCl} + \text{H}_2\text{CO}_3$; and the carbonic acid then decomposes into carbon dioxide and water. Hence carbonyl chloride, COCl_2 , can be regarded as a chloride of carbonic acid, $\text{CO}(\text{OH})_2$. M. Berthelot considered that carbonyl chloride dissolves unaltered to the extent of 2 to 3 vols. in water, and that it reacts with the water only slowly; but V. Grignard and E. Urbain, and E. Paterno and A. Mazzucchelli found that the chloride cannot exist for an appreciable time in contact with water without forming carbonic and hydrochloric acids. In the case of gaseous carbonyl chloride, carbon dioxide forms an inert separating layer at the surface of the liquid; and in the case of liquid carbonyl chloride, the water in immediate contact with the carbonyl chloride is sat. with hydrochloric acid and this retards the reaction. The action is therefore immediately dependent on diffusion. Acids retard the reaction between carbonyl chloride and water. Attempts were made to measure the speed of the reaction. W. D. Bancroft has discussed the reaction $\text{COCl}_2 + \text{H}_2\text{O} = \text{CO}_2 + 2\text{HCl}$ which is irreversible, and with an excess of water goes to completion, but in hydrochloric acid, the rate of hydrolysis is negligibly small. With alcohol, carbonyl chloride yields ethyl chlorocarbonate, $\text{COCl}(\text{OC}_2\text{H}_5)$, and ethyl carbonate, $\text{CO}(\text{OC}_2\text{H}_5)_2$.

E. Beckmann and F. Junker found that at a low temp. liquid carbonyl chloride acts as a solvent. It dissolves iodine; iodine trichloride; arsenic trichloride; antimony tri- and pentachlorides; sulphur chloride; and many organic substances; but it does not dissolve red phosphorus; arsenic; arsenious oxide; boric oxide; antimony; bismuth; stannous chloride; sulphur; selenium and its chlorides; potassium; sodium; calcium; the thiocyanates; sulphides, and sulphates of the alkalis; zinc chloride; ferric chloride and sulphate; chromic chloride, mercuric chloride and iodide; cuprous and cupric chloride; lead chloride and chromate; or silver chloride.

H. V. Regnault found that the aq. soln. with conc. hydrochloric acid gives carbon dioxide. According to E. Baud, aluminium chloride dissolves in liquid carbonyl chloride, and on evaporation of the soln. at the ordinary temp., there remains a colourless liquid which solidifies at -2° and has the composition $2\text{AlCl}_3 \cdot 5\text{COCl}_2$. Its dissociation tension is equal to 760 mm. at 30°. By removal of carbonyl chloride, the compound $2\text{AlCl}_3 \cdot 3\text{COCl}_2$ is formed; this has a dissociation tension of 760 mm. at 55°. On further removal of carbonyl chloride, the compound $4\text{AlCl}_3 \cdot \text{COCl}_2$ is obtained in the form of silky needles which do not decompose to an appreciable extent below 750°. The last two compounds are formed when aluminium chloride is distilled in a current of dry carbonyl chloride, and also when the vap. of aluminium chloride is led by means of a current of carbonic oxide through a red-hot tube. These two compounds are present in commercial aluminium chloride. J. A. Besson

found that when a soln. of **aluminium bromide** in carbonyl chloride is exposed to light, or heated at 100°-150°, bromine and carbon monoxide are liberated. A. von Bartal found that aluminium chlorobromide is a product of the action of carbonyl chloride and molten aluminium bromide at 100°: $\text{AlBr}_3 + \text{COCl}_2 = \text{CO} + \text{Br}_2 + \text{AlCl}_2\text{Br}$, while the action of an excess of liquid carbonyl chloride furnishes carbonyl chlorobromide, COClBr . He also obtained a complex product of the composition $\text{Al}_3\text{C}_2\text{O}_2\text{Cl}_2\text{I}$, by the action of carbonyl chloride on molten **aluminium iodide**. J. A. Besson, and A. von Bartal studied the action of **boron bromide**. The former said that if boron bromide is heated in sealed tubes at 150° for about 10 hrs. with half its weight of carbonyl chloride, almost the whole of the carbonyl chloride is decomposed, and the liquid remains colourless provided the temp. has not materially exceeded 150°. The product yields two fractions, 30°-40° and 60°-70°, the latter or both containing a liquid which is only slowly attacked by water. If these fractions are added slowly to a soln. of sodium thiosulphate cooled to 0°, and the oily liquids that separate are again distilled, they yield respectively carbonyl chlorobromide and carbonyl bromide.

J. Davy sublimed **sulphur** in carbonyl chloride without change. J. A. Besson found that under press. and at 200°, **hydrogen sulphide** furnishes carbonyl sulphide: $\text{COCl}_2 + \text{H}_2\text{S} = \text{COS} + 2\text{HCl}$. Some sulphur and carbon dioxides are also formed, and **hydrogen selenide** at 200° gives selenium, hydrogen chloride, and carbon monoxide; and at 230°, the selenium acts on the excess of carbonyl chloride producing selenium chloride. J. Nuricsan found that carbonyl chloride reacts with **cadmium sulphide** at ordinary temp., or better at 260°-280°, forming carbonyl sulphide. H. V. Regnault found that the aq. soln. with conc. **sulphuric acid** gives carbon dioxide. E. Paterno and A. Mazzucchelli found the reactivity of aq. soln. of sulphuric acid with carbonyl chloride decreases continuously with increasing conc. of the acid, and with fall of temp. According to E. Chauvenet, carbonyl chloride attacks metallic sulphides between 300° and 450° in accordance with the equation $\text{MS} + \text{COCl}_2 = \text{MCl}_2 + \text{COS}$. The ease with which sulphides are thus converted into anhydrous chlorides furnishes a useful method for the treatment of minerals in analysis. The process is also suitable for preparing carbonyl sulphide.

J. Davy noted that carbonyl chloride unites with **ammonia**, "forming a salt perfectly neutral and dry, but deliquescent by attracting moisture from the air. It is remarkable that in the formation of this ammoniacal salt, the gas combined with as much as four times its bulk of ammoniacal gas." The product of the action is carbamide or urea: $\text{COCl}_2 + 4\text{NH}_3 = \text{CO}(\text{NH}_2)_2 + 2\text{NH}_4\text{Cl}$. There are numerous products of side reactions studied by A. Hantzsch and B. C. Stuer, S. Natanson, H. V. Regnault, and G. Bouchardt. According to L. Gattermann and G. Schmidt when dry carbonyl chloride is passed into **ammonium chloride** heated to 400° chloroformamide distils over. A. Hantzsch and B. C. Stuer showed that if the liquid obtained by the action of aq. **hydroxylamine** on carbonyl chloride, be treated with nitrous acid, carbon dioxide, nitrous oxide, and water are produced; but if the operation be conducted in methyl alcohol, there is evidence of the formation of hyponitrous acid. H. V. Regnault found that the aq. soln. with conc. **nitric acid** gives carbon dioxide. J. Davy said **phosphorus** can be sublimed unchanged in carbonyl chloride. J. A. Besson found that carbonyl chloride has virtually no action on phosphine in the cold, there is a slow reaction with **phosphonium bromide**, but a rapid one at 50°, and in sealed tubes the action is complete in a few hours. The products are hydrogen chloride, hydrogen bromide, hydrogen phosphide, carbon monoxide, and solid yellow hydrogen phosphide; **phosphonium iodide** reacts slowly with the chloride at 0°, and in sealed tubes between 0° and 10°, the action proceeds somewhat rapidly with production of hydrogen chloride, carbon monoxide, phosphorous iodide, P_2I_4 , and red phosphorus, which retains about 10 per cent. of iodine, seemingly in the form of a subiodide. H. M. Bunbury measured the adsorption of carbonyl chloride by birchwood charcoal and observed at the

final press. p mm., grams of carbonyl chloride adsorbed by 2.1922 grms. of charcoal:

COCl ₂	18°					100°		
	730	217	147	56	2.7	1596	825	292 mm.
	1.385	0.985	0.962	0.715	0.428	0.945	0.693	0.420

The results can be represented by the usual formula $x/m=0.255p^{0.231}$ at 18°, and $x/m=0.038p^{0.488}$ at 100°. The rate of adsorption at 14° in the presence of 0.7434 grm. of carbonyl chloride is:

Time	6	8	10	12	18 min
Press.	160	115	100	94	91 „

J. Davy found that when **zinc, tin, arsenic, antimony, or potassium** is heated in carbonyl chloride, the chloride of the metal and carbon monoxide are formed. The decomposition is effected in a few minutes, without explosion or ignition; in the case of potassium, some carbon monoxide is decomposed and carbon deposited. O. W. Richardson measured the ionization which occurs during the action of carbonyl chloride on potassium-sodium alloys. R. H. Atkinson and co-workers suggest that the action on **mercury** may be symbolized: $2\text{Hg} + \text{COCl}_2 = \text{CO} + 2\text{HgCl}$. M. Delépine and L. Ville showed that if a little free chlorine is present, carbonyl chloride slowly attacks iron, and this is the source of the yellow colour of the commercial liquid. The liquid, free from chlorine, dissolves iron-rust. When **zinc oxide** is similarly treated, zinc chloride and carbon dioxide are formed. According to E. Chauvenet, when the **oxides** of the metals are heated in a slow current of carbonyl chloride at a temp. varying from about 350° in the case of vanadium oxide, to 650° in the case of thoria, the chlorides are formed. Chlorides of the following elements have been prepared in this way: vanadium, tungsten, tantalum, titanium, zirconium, thorium, tin, barium, magnesium, zinc, beryllium, aluminium, iron, chromium, manganese, nickel, uranium, cerium, yttrium, and lanthanum. An excellent yield of the anhydrous higher chloride was obtained in each instance, except with tungstic oxide, when the oxychloride was formed, and in the case of titanium, when a mixture of chloride and oxychloride was produced. The method is specially suitable for preparing the chlorides of the rare-earth metals. **Silica** is not attacked by carbonyl chloride. The reactions were also studied by F. P. Venable and D. H. Jackson. It was used by C. Baskerville for decomposing zircon, and thorianite, and in preparing chlorides from alumina, ceria, zirconia, and thoria. C. Baskerville mentioned that heated silica bricks were bleached in contact with heated phosgene owing to the removal of iron; and sand could be likewise freed from ferruginous pigments. E. W. Washburn and E. E. Libman recommended the reaction for removing iron from zirconia.

J. Barlot and E. Chauvenet also showed that carbonyl chloride will attack numerous natural **phosphates**, such as vivianite, pyromorphite, uranite, and monazite, and natural silicates, such as thorite, gadolinite, cerite, and zircon, yielding in each case the anhydrous metallic chloride. The phosphates are attacked at temp. between 300° and 500°, whilst the **silicates** require temp. above 1000°, emerald not being decomposed at 1400°. This reaction forms a ready method of analysis of such minerals, and also of preparing anhydrous metallic chlorides from these minerals. W. Gintl found that carbonyl chloride reacts with **silver cyanide**, forming silver chloride, and cyanogen chloride. Numerous reactions between carbonyl chloride and **organic compounds** have been studied; and this reagent is employed in the manufacture of organic dye-stuffs, and some pharmaceutical products. D. lo Monaco studied the adsorption by straw, hay, grass, leaves, sawdust, cotton, charcoal, etc. E. Paterno and A. Mazzucchelli found that carbonyl chloride is absorbed with avidity by heavy lubricating oils, and expelled rapidly and almost completely by a current of air. Its physiological action has been described by R. Kobert, and by R. Müller.

J. Schiel² found that some **carbonyl bromide**, COBr₂, is probably formed when a mixture of the vap. of bromine and carbon monoxide is exposed to sunlight. The

rate of combination of the gases was found by A. Piva to depend on the proportion of moisture present, and when special care is taken to dry the bromine and carbon monoxide, the velocity of the change is extremely low. Were complete absence of moisture attainable, it appears probable, but is not certain, that no reaction would occur. The reaction yields carbon dioxide and hydrogen bromide as final products, and takes place in two stages, $\text{CO} + \text{Br}_2 = \text{COBr}_2$ and $\text{COBr}_2 + \text{H}_2\text{O} = \text{CO}_2 + 2\text{HBr}$. In the first stage, equilibrium is reached with a small conc. of the carbonyl bromide, which must be removed as it is formed in order that the reaction may continue. K. F. Bonhöffer studied the photosensitiveness of the reaction $\text{COBr}_2 = \text{CO} + \text{Br}_2$. A. von Bartal obtained a small quantity of carbonyl bromide by the action of bromine on carbon monoxide in the presence of aluminium bromide, or by the action of the silent discharge. A. Brochet possibly obtained it by the action of bromine on trioxymethylene, $\text{CH}_2 : (\text{O} \cdot \text{CH}_2)_2 : \text{O}$. A. J. Besson found that impure carbonyl bromide is produced by heating at 150° a mixture of boron tribromide or phosphorous tribromide and carbonyl chloride for 10 hrs.—*vide supra*. A. Emmerling, and A. von Bartal prepared it by oxidizing bromoform with potassium chromate and conc. sulphuric acid in a flask with a reflux condenser. The liquid bromide was rectified by slow distillation over antimony. The latter considers that the best method of preparation is to allow sulphuric acid of sp. gr. 1.84 to drop slowly into carbon tetrabromide at 160° – 170° . The red distillate is then shaken with mercury, distilled, shaken with powdered antimony, and again distilled. The yield is 50–60 per cent.

At ordinary temp., according to A. von Bartal, carbonyl bromide is a heavy, mobile, colourless liquid, which fumes in air, and smells like carbonyl chloride. A. J. Besson gave 6.60 for the vap. density; and 2.48 for the sp. gr. of the liquid at 0° ; A. von Bartal gave 2.45 for the sp. gr. at 15° . A. Emmerling gave the b.p. between 12° and 30° ; A. J. Besson, 63° – 66° ; and A. von Bartal, 64° – 65° with slight decomposition. The last-named also said that the compound is decomposed by light or heat. It is decomposed by water, but rather more slowly than is the case with carbonyl chloride. It is very sensitive towards oxidizing agents. The vap. attacks caoutchouc very quickly. It also reacts readily with many organic compounds, and has been used in the preparation of dye-stuffs.

As indicated above, A. J. Besson made **carbonyl chlorobromide**, COBrCl , by the action of boron bromide on carbonyl chloride; and A. von Bartal made it by heating equal weights of carbonyl chloride and aluminium bromide in a sealed tube at 140° – 145° . The colourless or slightly yellowish liquid has a smell like that of carbonyl chloride. A. J. Besson gave 4.85 for the vap. density; and 1.98 for the sp. gr. at 0° . A. von Bartal gave 1.82 for the sp. gr. at 15° , and 25° for the b.p., whereas A. J. Besson gave 35° – 37° for the b.p. According to A. von Bartal, the chlorobromide attracts moisture from the air, and the liquid thereby becomes turbid; it is coloured yellow by exposure to sunlight. *Carbonyl iodide*, COI_2 , has not been prepared. As previously indicated, H. Moissan found that fluorine does not react in the cold with carbon monoxide; and S. P. Cowardins showed that iodine and carbon monoxide do not react when heated or when exposed to sunlight; nor does carbon monoxide react with lead iodide or arsenic pentaiodide. When carbonyl chloride is gradually added to cooled arsenic trifluoride, W. Steinkopf and J. Herold found that **carbonyl fluoride**, COF_2 , was formed. It solidified in liquid air, and boiled at -150° to -160° . B. Humiston also prepared some carbonyl fluoride by the action of fluorine on carbonyl chloride

REFERENCES.

- ¹ J. L. Gay Lussac and L. J. Thénard, *Recherches physicochimiques*, Paris, 2, 150, 1811; J. Murray, *Nicholson's Journ.*, 30, 226, 1811; J. Davy, *Phil. Trans.*, 102, 144, 1812; W. Wahl, *Proc. Roy. Soc.*, 89, A, 317, 1914; G. Dyson and A. Harden, *Proc. Chem. Soc.*, 10, 165, 1893; *Journ. Chem. Soc.*, 83, 201, 1903; D. L. Chapman and F. H. Gee, *ib.*, 99, 1726, 1911; W. H. Perkin, *ib.*, 65, 402, 1894; M. Wildermann, *Proc. Roy. Soc.*, 70, 66, 1902; *Zeit. phys. Chem.*, 42, 259,

03; M. von Recklinghausen, *Ber.*, **29**, 2549, 1896; *Zeit. phys. Chem.*, **14**, 491, 1894; A. Christiansen, *ib.*, **103**, 99, 1922; M. Bodenstein and G. Dunant, *ib.*, **61**, 437, 1908; J. Schiel, *ebig's Ann. Suppl.*, **2**, 311, 1863; *Zeit. Chem.*, (1), **7**, 220, 1864; A. Emmerling and von Lengyel, *ib.*, **7**, 101, 1871; *Ber.*, **2**, 546, 1869; A. Cöhn and H. Becker, *ib.*, **43**, 130, 1910; lo Monaco, *Arch. Farm. Sper. Science*, **29**, 3, 1920; L. Hackspill and M. Mathieu, *Bull. Soc. chim.*, (4), **25**, 482, 1919; H. Erdmann, *Liebig's Ann.*, **362**, 148, 1908; *Ber.*, **26**, 1993, 1893; Gustavson, *ib.*, **3**, 990, 1870; **5**, 30, 1872; H. E. Armstrong, *ib.*, **3**, 730, 1870; *Proc. Roy. Soc.*, **18**, 504, 1870; *Journ. prakt. Chem.*, (2), **245**, 1870; H. Goldschmidt, *Ber.*, **14**, 928, 1881; Staudinger, *ib.*, **41**, 3558, 1908; J. Nuricsan, *ib.*, **24**, 2970, 1891; A. R. Hantzsch and C. Stuer, *ib.*, **38**, 1042, 1905; L. Gattermann and G. Schmidt, *ib.*, **20**, 858, 1887; *Liebig's Ann.*, **244**, 30, 1888; N. I. Nikitin, *Journ. Russ. Chem. Soc.*, **52**, 235, 1920; V. A. Plotnikoff, *ib.*, **457**, 1916; M. Schumburg, *Hyg. Rund.*, **8**, 921, 1898; R. Kobert, *Lehrbuch der Intoxikation*, Stuttgart, **2**, 888, 1906; T. Thomson, *Ann. Phil.*, **1**, 177, 1813; E. Beckmann and F. Junker, *Zeit. org. Chem.*, **55**, 371, 1907; J. Thomsen, *Thermochemische Untersuchungen*, Leipzig, **2**, 359, 362, 382; *Ber.*, **16**, 2619, 1883; *Zeit. phys. Chem.*, **52**, 343, 1905; M. Bodenstein, *Rec. Trav. Chim. Pays-Bas*, **41**, 585, 1922; J. Cathala, *Bull. Soc. Chim.*, (4), **33**, 576, 1923; L. Michalski, *Zeit. angew. Chem.*, **1775**, 91, 1898; R. Müller, *ib.*, **23**, 1489, 1911; A. von Bartal, *Zeit. anorg. Chem.*, **55**, 152, 1907; **56**, 157, 1908; *Liebig's Ann.*, **345**, 336, 1906; T. Wilm and G. Wischin, *ib.*, **147**, 150, 1868; F. O. Germann and V. Jersey, *Science*, (2), **53**, 582, 1922; E. Chauvenet, *Compt. Rend.*, **152**, 87, 50, 1911; J. Barlot and E. Chauvenet, *ib.*, **157**, 1153, 1913; G. Bouchard, *ib.*, **69**, 961, 1869; W. Richardson, *Phil. Trans.*, **222**, A, 1, 1921; H. M. Bunbury, *Journ. Chem. Soc.*, **121**, 1525, 1922; D. D. Berolzheimer has compiled a bibliography of carbonyl chloride in *Journ. Ind. org. Chem.*, **11**, 263, 1919; T. Wilm and G. Wischin, *Liebig's Ann.*, **147**, 150, 1868; G. Schlegel, *ib.*, **226**, 133, 1884; A. Römer, *ib.*, **233**, 172, 1886; A. W. Hofmann, *ib.*, **70**, 139, 1849; D. Harries, *ib.*, **343**, 340, 1905; S. Natanson, *ib.*, **98**, 288, 1856; A. R. Hantzsch and A. Sauer, **299**, 91, 1898; E. Paterno and A. Mazzucchi, *Gazz. Chim. Ital.*, **50**, i, 30, 1920; E. Paterno, **8**, 233, 1878; *Compt. Rend.*, **66**, 667, 742, 1868; **69**, 352, 1869; *Bull. Soc. Chim.*, (2), **10**, 8, 1868; (2), **12**, 198, 1869; P. Schützenberger, *ib.*, (2), **12**, 198, 1869; M. Delépine and Ville, *ib.*, (4), **27**, 283, 1820; A. S. Lavroff, *ib.* (2), **36**, 305, 1880; C. Friedel, J. M. Crafts, and M. Ador, *Compt. Rend.*, **85**, 673, 1877; V. Grignard and E. Urbain, *ib.*, **169**, 17, 1919; E. Baud, *ib.*, **140**, 1688, 1905; J. A. Besson, *ib.*, **120**, 191, 1895; **122**, 142, 1896; *ib.* *Soc. Chim.*, (3), **13**, 144, 1895; F. Weigert, *Ann. Physik*, (4), **24**, 55, 243, 1907; Göbel, *Journ. prakt. Chem.*, (1), **6**, 388, 1835; A. Klepl, *ib.*, (2), **26**, 447, 1882; Hentschel, *ib.*, (2), **36**, 101, 214, 1887; W. Gintl, *ib.*, (2), **4**, 362, 1871; H. Gautier, *Compt. Rend.*, **101**, 1161, 1885; J. Prud'homme, *ib.*, **70**, 1137, 1870; M. Berthelot, *ib.*, **87**, 571, 1878; *ib.* *Soc. Chim.*, (2), **41**, 7, 1884; (2), **13**, 9, 15, 1870; *Ann. Chim. Phys.*, (5), **17**, 129, 1879; Cahours, *ib.*, (3), **19**, 352, 1847; H. V. Regnault, *ib.*, (2), **69**, 180, 1838; R. H. Atkinson, T. Heycock, and W. J. Pope, *Journ. Chem. Soc.*, **117**, 1410, 1920; E. Schering, *German Pat.*, **R.P.** 369369, 1919; N. W. Taylor and J. H. Hildebrand, *Journ. Amer. Chem. Soc.*, **45**, 7, 1923; C. Baskerville and P. W. Cohen, *Journ. Ind. Eng. Chem.*, **13**, 333, 1921; A. Coehn and H. Tramm, *Ber.*, **56**, B, 458, 1923; M. Adrian, *Journ. Pharm. Chim.*, (6), **18**, 5, 1903; von Wroblewsky and K. Olszewsky, *Compt. Rend.*, **96**, 1140, 1883; N. Schoorl and M. van den Berg, *Pharm. Weekbl.*, **42**, 877, 1905; **43**, 8, 1905; G. Mossler, *Monatsh.*, **29**, 9, 1908; C. S. Wehrly, *Colour Trade Journ.*, **2**, 8, 1918; J. Dewar and G. Cranston, *Chem. News*, **20**, 174, 1869; K. F. Bonhöffer, *Zeit. Physik*, **13**, 94, 1923; S. Peacock, *U.S. Pat. No.* 60312, 1920; W. D. Bancroft, *Trans. Amer. Electrochem. Soc.*, **36**, 139, 1919; S. Dushman, *Journ. Amer. Chem. Soc.*, **43**, 417, 1921; F. P. Venable and D. H. Jackson, *ib.*, **42**, 2531, 1920; *Journ. Elisha Mitchell Soc.*, **35**, 87, 1920; B. Humiston, *Journ. Phys. Chem.*, **23**, 572, 1919; P. Baud, *Compt. Rend* **140**, 1688, 1905; S. F. Pickering, *Journ. Phys. Chem.*, **28**, 97, 1924; Tramm, *Zeit. phys. Chem.*, **105**, 356, 1923; V. Henri, *Compt. Rend.*, **177**, 1037, 1923; G. Kornd, *Zeit. phys. Chem.*, **108**, 118, 1924; E. W. Washburn and E. E. Libmann, *Journ. Amer. Cer. C.*, **3**, 634, 1920.

² J. Schiel, *Liebig's Ann. Suppl.*, **2**, 311, 1863; W. Steinkopf and J. Herold, *Journ. prakt. Chem.*, (2), **101**, 79, 1920; B. Humiston, *Journ. Phys. Chem.*, **23**, 572, 1919; A. Piva, *Gazz. Chim. Ital.*, **45**, i, 219, 1915; A. von Bartal, *Liebig's Ann.*, **345**, 335, 1906; *Zeit. anorg. Chem.*, **157**, 1905; A. Emmerling, *Ber.*, **13**, 874, 1380; S. P. Cowardins, *Chem. News*, **48**, 97, 1883; J. Besson, *Compt. Rend.*, **120**, 191, 1895; *Bull. Soc. Chim.*, (3), **13**, 444, 1895; A. Brochet, (3), **17**, 223, 1897; *Compt. Rend.*, **121**, 1156, 1895; *Ann. Chim. Phys.*, (7), **10**, 313, 1897; Moissan, *Le fluor et ses composés*, Paris, 136, 1900; K. F. Bonhöffer, *Zeit. Physik*, **13**, 94, 1923.

§ 29. Carbonyl Sulphide

In 1841, J. P. Couerbe¹ studied the products obtained when the xanthates are subjected to dry distillation, and he reported that a gas which he called *xanthin*, (SH), was given off. A. Fleischer and W. Hanke found that the alkali xanthates

furnish the mercaptan, the two ethyl sulphides, carbon disulphide, and carbon sulphide, when the anhydrous salts are used; and mercaptan, the two ethyl sulphides, carbon disulphide, carbon dioxide, and hydrogen sulphide when the hydrated salts are employed. They therefore suggest that the xanthin gas obtained by J. P. Couerbe was really carbonyl sulphide contaminated with hydrogen sulphide and mercaptan vapour. J. P. Couerbe did not isolate the pure gas. Up to the time of C. Than's discovery, 1867, carbonyl sulphide was regarded as a mixture of carbon dioxide and hydrogen sulphide. In that year, C. Than showed that when a mixture of sulphur vapour and carbon monoxide is passed through a moderately heated tube a compound is formed corresponding with *carbon oxysulphide*, or **carbonyl sulphide**, COS . C. Than showed that carbonyl sulphide probably occurs in some hepatic waters; and A. W. Hofmann, H. Kolbe, and F. Salomon showed that this compound is also present in volcanic gases, and in the sulphuretted waters of volcanic districts. It is possibly formed by the reaction $8\text{CO}_2 + 9\text{H}_2\text{S} = 3\text{COS} + 5\text{CO} + \text{H}_2 + 8\text{H}_2\text{O} + 6\text{S}$, a reaction which can be imitated by passing a mixture of carbon dioxide and hydrogen sulphide through a red-hot tube. Carbonyl sulphide also occurs in the products of the decomposition of some organic substances.

G. Chevrier said that when a mixture of sulphur vapour and carbon monoxide is sparked, carbonyl sulphide is formed, but F. González and E. Moles obtained none at 110° – 260° under atm. press. or under reduced press. They explain that the statement is based on the result obtained when moisture is present. C. Than, P. Klason, C. Bender, and L. Ilosvay de N. Ilosva, made carbonyl sulphide by the action of potassium thiocyanate on dil. sulphuric acid. The thiocyanate is first resolved into thiocyanic acid, and the acid is then hydrolyzed to carbonyl sulphide and ammonia: $\text{HCNS} + \text{H}_2\text{O} = \text{COS} + \text{NH}_3$; the ammonia then unites with the excess of acid present: $\text{KCNS} + \text{H}_2\text{O} + 2\text{H}_2\text{SO}_4 = \text{COS} + \text{KHSO}_4 + (\text{NH}_4)\text{HSO}_4$. P. Klason recommended the following procedure:

Fifty c.c. of a conc. aq. soln. of potassium or ammonium thiocyanate are added to a mixture of 290 c.c. or 520 grms. of conc. sulphuric acid, and 400 c.c. of water. The mixture is contaminated with about 2.5 per cent. of carbon dioxide and 0.05 per cent. of carbon disulphide is given off at 25° . A. W. Hofmann recommended passing the gas through an ethereal soln. of triethylphosphine to free it from carbon bisulphide. P. Klason found that the absorption of this latter is much more rapid and complete if a small quantity of pure triethylphosphine is used instead of a soln., the gas being then passed through pure sulphuric acid to free it from traces of the phosphine. Carbon oxysulphide is only absorbed very slowly by a 33 per cent. aq. soln. of potash. If the gas obtained as above is passed slowly through about 20 cms. of such a soln., the whole of the carbonic anhydride is absorbed with a loss of only about 7 per cent. of the oxysulphide.

Carbonyl sulphide was made by F. G. Reichel by passing carbon monoxide over heated magnesium sulphate; A. Cossa, G. Chevrier, and M. Berthelot, by the action of carbon dioxide on boiling sulphur: $2\text{CO}_2 + 3\text{S} = 2\text{COS} + \text{SO}_2$; A. Gautier, by passing a mixture of hydrogen sulphide and carbon dioxide through a red-hot tube; A. J. Besson, by heating carbonyl chloride and hydrogen sulphide at 200° under press.; J. Nuricks and F. Weigert, by passing carbonyl chloride over cadmium sulphate at ordinary temp. or better, at 260° – 280° ; and A. Gautier, by passing hydrogen sulphide over carbon monoxide over china clay contained in a porcelain tube at a bright red heat. The issuing gas contains 60–64 per cent. of carbonyl sulphide, 35–39 per cent. of carbon monoxide, about one per cent. of carbon dioxide, traces of hydrogen sulphide, and the excess of carbon disulphide. The proportion of carbon monoxide is low, and the proportion of carbonyl sulphide higher, the higher the temp. The products are passed into a flask half filled with ice-cold water, which condenses the greater part of the disulphide; then through potassium hydroxide, which absorbs hydrogen sulphide and carbon dioxide; then through acidified cuprous chloride, which absorbs carbon monoxide, and finally through a 12-per-cent. soln. of aniline in alcohol and over pumice and sulphuric acid. Alcoholic aniline has no action on carbonyl sulphide, but readily absorbs carbon disulphide. The tube contains crystals of silicon sulphide, etc. Alumina can be used in place of china clay, but it becomes

ely divided and difficult to manage; zinc oxide also furnishes carbonyl sulphide, but copper, iron, and lead oxides do not. C. Böttinger used a mixture of ultra-marine and carbon in place of china clay.

F. G. Reichel made carbonyl sulphide by passing a mixture of carbon dioxide and disulphide over heated magnesia. J. Dewar and G. Cranston found carbonyl sulphide is formed by heating carbon disulphide and chlorosulphonic acid in a sealed tube at 100° ; H. E. Armstrong, by heating sulphur trioxide and carbon disulphide in a sealed tube at 100° : $3\text{SO}_3 + \text{CS}_2 = \text{COS} + 4\text{SO}_2$; or chromic anhydride and carbon disulphide at 180° ; T. Carnelley, by passing a mixture of alcohol vap. and carbon disulphide over red-hot copper when ethylene and acetylene are formed along with carbonyl sulphide; C. Winkler, by passing a mixture of carbon dioxide and carbon disulphide over red-hot platinized asbestos; A. Ladenburg, by heating in a sealed tube, carbon disulphide and carbamide at 110° , or with oxamide at 200° , or with acetamide at 210° ; A. R. Hantzsch, by heating a mixture of triethylphosphine and carbon disulphide, $(\text{C}_2\text{H}_5)_3\text{P} \cdot \text{CS}_2$, with acetic, propionic, or butyric acid; A. Ladenburg, by heating thioacetic acid to 300° , and by passing carbon disulphide over ethyl isocyanate; A. W. Hofmann, by shaking allyl thiocyanate with conc. sulphuric acid; and F. Salomon, by treating Bender's salt, $\text{C}_2\text{H}_5\text{O} \cdot \text{CO} \cdot \text{SK}$, with hydrochloric acid, $\text{SK} \cdot \text{CO} \cdot \text{OC}_2\text{H}_5 + \text{HCl} = \text{COS} + \text{KCl} + \text{C}_2\text{H}_5\text{OH}$. L. Ilosvay and N. Ilosva used potassium ethyl thiocarbonate and sulphuric acid. N. D. Costeanu found carbonyl sulphide is formed when dry carbon dioxide acts on the alkali carbonates at 220° . According to A. Stock and E. Kuss, carbonyl sulphide in a highly purified condition can be most conveniently made by the decomposition of ammonium thiocarbonate, $\text{NH}_4 \cdot \text{CO} \cdot \text{SNH}_2$, by means of an acid: $\text{NH}_4 \cdot \text{CO} \cdot \text{SNH}_2 + 2\text{HCl} = \text{COS} + 2\text{NH}_4\text{Cl}$. There is a simultaneous hydrolysis of a little carbonyl sulphide into carbon dioxide and hydrogen sulphide: $\text{COS} + \text{H}_2\text{O} \rightleftharpoons \text{CO}_2 + \text{H}_2\text{S}$, but these impurities can be removed by alkali which does not appreciably affect the carbonyl sulphide. The gas is free from carbon disulphide which contaminates the gas prepared from a thiocyanate and acid.

A short-necked, 750 c.c. flask with 500 c.c. of a 10 per cent. soln. of hydrochloric acid is fitted with a wide tube *A*, Fig. 41, 12 mm. bore, connected by a rubber connector with a small flask *B* containing 20 grms. of ammonium thiocarbonate. A stream of dry hydrogen is led through the apparatus by the inlet tube *C*, and exit tube *D*. The tube *D* is connected with an ordinary wash bottle with 50 c.c. and two 10 bulb tubes with 40 c.c. of a 33 per cent. soln. of soda-lye. If the lye is more dilute, more gas is decomposed. Following on in the train after the soda-lye is a calcium chloride tube, a U-tube packed with glass wool and phosphorus pentoxide, and finally a U-tube dipping in liquid air for condensing the carbonyl sulphide. The flask *B* is turned so that the salt enters the apparatus at the rate of about a gram per minute, and the gas comes off rapidly, uniformly, and without any particular rise of temperature. The stream of hydrogen prevents any marked decomposition of the moist gas by the soda-lye, and also keeps the tube *A* clear. The liquid carbonyl sulphide is then fractionally distilled in vacuo. The first fraction at -66° contains so small a quantity of carbon dioxide that if all were distributed in the resulting gas, the impurity would be only 0.03 per cent. by volume. Hydrogen sulphide was not present. All the subsequent fractions have the tension of pure carbonyl sulphide. The yield is 62.5 per cent. of the theoretical.

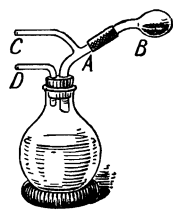

FIG. 41.—Preparation of Carbonyl Sulphide.

L. Ilosvay de N. Ilosva emphasized that the physical and chemical properties of carbonyl sulphide come midway between those of carbon dioxide and carbon disulphide. P. Klason said that the purified gas is colourless and has no smell. F. Wahl found that carbonyl sulphide crystallizes in extremely fine needles, which grow with great rapidity. The double-refraction of these needles is very high, and they always extinguish the polarized light when parallel to the principal sections of the nicols. The needles are thus either tetragonal, hexagonal, or orthorhombic, but it has not been possible to find any experimental evidence from which conclusions might be drawn as to which of these crystal systems carbonyl sulphide belongs. No polymorphic change has been observed above -200° . C. Than

said that the vap. density is 2.1046 (air unity). L. Ilosvay de N. Ilosva found the mean coeff. of expansion of the gas between 0° and 100° to be 0.0037317 at constant vol., and 0.0037908 at constant press. The gas condenses to a colourless, mobile highly refractive liquid, which, according to A. Stock and E. Kuss, has a sp. gr. of 1.24 at -87°. C. J. Smith found the viscosity of the vap. in C.G.S. units to be 0.0001135 at 0°, 0.0001200 at 15°, and 0.0001554 at 100°; the viscosity constant in W. Sutherland's formula, 330; and the mean collision area of the mols. of the vap. is 1.06×10^{-15} sq. cm.; A. O. Rankine estimates this to be 1.06×10^{-15} sq. cm. with a possible error of 2 to 3 per cent. The press., p atm., necessary to liquefy the gas at different temp. is :

	0°	3.8°	10.7°	12.0°	17.0°	38.8°	41.2°	63.0°	69.0°	74.6°	85.8°
p	12.5	15.0	17.5	19.6	21.5	44.0	45.0	59.0	65.0	74.0	80.0

A. Stock and E. Kuss represent the vap. press. of the liquid :

	-133°	-111°	-98.5°	-86°	-75°	-54	-50.2°
Vap. press.	1	12	37	100	210	635	760 mm.

According to W. Hempel, the critical temp. is 105°, and the critical press., 60 atm. the b.p. of the liquid is -47.5° at atm. press.; A. Stock and E. Kuss say -50.2° at 760 mm. Carbon dioxide boils at -78°, and carbon disulphide at 46°. According to L. Ilosvay de N. Ilosva, the liquid solidifies when poured from one vessel to another; A. Stock and E. Kuss gave -138.2° for the m.p. Carbon dioxide melts at -56.4°; carbon disulphide at -112.1°. The higher m.p. of carbon dioxide is thought to be an effect of polymerization. M. Berthelot found the heat of combustion to be 131.01 Cals. at constant press., and the heat of formation from amorphous carbon and rhombic sulphur: (C,S,O)=19.6 Cals.; J. Thomsen's value is about twice as great: (C,S,O)=37.32 Cals., (CO,S)=8.03 Cals.; and G. N. Lewis and W. N. Lacey found for the free energy of formation of (S_{liquid},CO)=-6070 cal. at 302°. V. Henri studied the absorption spectrum of the vapour.

W. Hempel found that 100 c.c. of water at 13.5° dissolve 80 c.c. of carbonyl sulphide; A. Stock and E. Kuss, that 54 c.c. are dissolved at 20°; and L. W. Winkler found the absorption coeff., β , and the weight, w , of gas dissolved by 100 grms of solvent at 760 mm. press. to be :

	0°	5°	10°	15°	20°	25	30°
β	1.333	1.056	0.836	0.677	0.561	0.468	0.403
w	0.356	0.281	0.221	0.179	0.147	0.122	0.104

A. W. Hofmann said that 100 vols. of triethylphosphine dissolve about 100 vols. of the gas, and, unlike carbon disulphide, does not form a compound. W. Hempel found 100 c.c. of a hydrochloric acid soln. of cuprous chloride dissolved 20 c.c. of carbonyl sulphide at 13.5°; 100 c.c. of an alcoholic soln. (2 c.c. water and 2 c.c. alcohol) of potassium hydroxide (1 gm.) dissolve 7200 c.c. of the gas (13.5 c.c.); 100 c.c. of pyridine dissolve 4.4 c.c. of gas (13.5°); and 100 c.c. of nitrobenzene dissolve 12.0 c.c. of gas (13.5°). M. Berthelot noted the ready solubility of the gas in absolute alcohol. A. Stock and E. Kuss found that 100 c.c. of alcohol dissolve 800 c.c. of gas (22°) and 100 c.c. of toluene, 1500 c.c. of gas (22°). It is slowly and regularly absorbed by 33 per cent. sodium hydroxide (about 2 per cent. per minute), much more readily by an 8 per cent. soln. (33 per cent. per minute), or by a 23 per cent. soln. of potassium hydroxide (8 per cent. per minute). It is therefore quite possible to estimate readily absorbable gases in the carbonyl sulphide by using 33 per cent. sodium hydroxide, and allowing for the loss of the latter gas during the time of the absorption. Liquid carbonyl sulphide was found by L. Ilosvay de N. Ilosva to dissolve sulphur, and to mix readily with alcohol or ether, but not with water or glycerol. For the absorption coeff. in various salt soln., *vide* Table XX.

R. Witzcek, and A. Stock and E. Kuss found the dry gas is permanent even in sunlight, but if moisture be present, the gas forms carbon dioxide and hydrogen sulphide. The decomposition is very slow in diffuse daylight. C. Than found that

at a red heat, carbonyl sulphide decomposes into sulphur and carbon monoxide, and R. Witzeck said that it is slowly decomposed when heated in a sealed tube at 200°-300°. According to W. Hempel, a platinum wire heated to whiteness by an electric current decomposes the gas completely without change of vol., forming sulphur and carbon monoxide. G. N. Lewis and W. N. Lacey studied the equilibrium conditions of the reaction $\text{CO} + \text{S} = \text{COS}$, and found $K = [\text{COS}]/[\text{CO}] = 201$ at 302°; and 435 at 260°. A. Stock and P. Seelig showed that two equilibria are probably involved, (i) $\text{COS} = \text{CO} + \text{S}$, and (ii) $2\text{COS} = \text{CO}_2 + \text{CS}_2$; the second may be due to $2\text{CO} + \text{S}_2 = \text{CO}_2 + \text{CS}_2$. There was no evidence of the formation of carbon monosulphide mentioned by G. N. Lewis and W. N. Lacey, or of sulphur dioxide mentioned by P. Winternitz. The reaction $2\text{COS} = \text{CO}_2 + \text{CS}_2$ in either direction is rather slow, and $2\text{COS} = 2\text{CO} + \text{S}_2$, rather fast. The dissociation of carbonyl sulphide was independent of the amounts of carbon dioxide or disulphide present, thus showing that carbon monoxide and sulphur are formed directly from carbonyl sulphide and not primarily from carbon dioxide or disulphide. At 800°, 64 per cent. of carbonyl sulphide was dissociated, and at 950°, 76 per cent. A. Stock, W. Siecke, and E. Pohland found that near 400°, the equilibrium in reaction (i) is disturbed by the separation of sulphur. When this reaction is suppressed by the addition of carbon monoxide, reaction (ii) can be studied below 500°. The decomposition (i) is not evident below 400°, and attains a maximum of 64 per cent. at 900°. Reaction (ii) reaches a maximum of 43 per cent. at 600°, and 16 per cent. by (i). The equilibrium (i) depends on the press., while (ii) does not. Quartz is a marked catalyst for (ii), but has little influence on (i). Hence, carbonyl sulphide at room temp. can be kept for years in glass vessels, but is rapidly decomposed in quartz vessels.

C. Than showed that the gas is very inflammable, taking fire even when brought in contact with a red-hot splinter of wood, and burning with a blue, slightly luminous flame. A mixture of one vol. of the gas with $1\frac{1}{2}$ vols. of oxygen inflames with a slight explosion, burning with a blue flame; but, said W. Hempel, if the gas be mixed with $7\frac{1}{2}$ vols. of air, the mixture burns without explosion. E. J. Russell found that a thoroughly dried mixture of carbonyl sulphide and oxygen does not explode with the passage of an electric spark. C. Than showed that carbonyl sulphide is slowly decomposed by water: $\text{COS} + \text{H}_2\text{O} = \text{CO}_2 + \text{H}_2\text{S}$. The pure gas, said A. Stock and E. Kuss, does not at once give a precipitate with a soln. of barium hydroxide or of cupric sulphate. P. Klason said that with baryta-water, a turbidity occurs in half a minute. P. Klason found that an aq. soln. of starch iodide is soon decolorized, and a soln. of lead acetate rendered turbid. M. Berthelot found that cuprous sulphate separates very slowly from a soln. of carbonyl sulphide in a hydrochloric acid soln. of cuprous chloride. In the reacting system, $\text{COS} + \text{H}_2\text{O} = \text{CO}_2 + \text{H}_2\text{S}$, when the water is in large excess, if C denotes the conc. of the carbonyl sulphide, the rate of decomposition will be $-dC/dt = k'C$. G. Buchböck's results show that the velocity constant k' is very nearly 0.0005267; and this shows that the reverse reaction is negligible, and that the products of the reaction have no influence on the velocity. He suggests that the decomposition is the resultant of two reactions: $\text{COS} + \text{H}_2\text{O} = \text{HS.CO.OH}$, and $\text{HS.CO.OH} \rightarrow \text{H}_2\text{S} + \text{CO}_2$, in which the quantity of biocarbonic acid, HS.CO.OH , is always proportional to the carbonyl sulphide. The effect of temp. is represented by $\log_3 k = -11736.73T^{-1} + 45.66354$. R. Witzeck found that the decomposition is very rapid at a high temp., and he measured the effect of various acids and salts in isohydric soln., and found that if S denotes the absorption coeff. of the carbonyl sulphide, $-dC = kC/S$, where $k = k'S$. The results are indicated in Table XX, and they agree well with theory only when referred to particular groups of salts. In general, the rate of decomposition decreases with the addition of acids, and the decrease is greater the more ionized the acid; and increases with the conc. Monochloroacetic acid caused a slight increase in the velocity of decomposition, and the effect of many of the metal salts also is to cause slight increase. P. Klason found that carbonyl sulphide can be preserved for a time over 50 per cent.

TABLE XX.—EFFECT OF ACIDS AND SALTS ON THE DECOMPOSITION OF CARBONYL SULPHIDE

Added substance.	Isohydric soln. contains grm. eq. per litre.	$k \times 10^6$.	Absorption coeff. S.	Velocity in sat. soln. $k \times S \times 10^6$.
KI . . .	1.143	571	0.0174	9.94
KNO ₃ . . .	1.355	668	0.0165	11.02
KCl . . .	1.151	632	0.0156	9.86
HBr . . .	0.968	371	0.0218	8.09
HCl . . .	1.000	391	0.0209	8.17
NaNO ₃ . . .	1.317	542	0.0156	8.45
NaCl . . .	1.119	534	0.0148	7.90
LiCl . . .	1.141	436	0.0154	7.15
H ₂ SO ₄ . . .	1.908	415	0.0180	7.47
BaCl ₂ . . .	1.507	503	0.0136	6.84
SrCl ₂ . . .	1.459	476	0.0141	6.71
CaCl ₂ . . .	1.401	452	0.0146	6.60
MgCl ₂ . . .	1.358	422	0.0153	6.46
H.CO.OH . . .	2.073	501	0.0219	10.97
CH ₃ .CO.OH . . .	2.069	479	0.0243	11.64
CH ₂ .Cl.CO.OH . . .	2.245	488	0.0231	11.27
OHCl ₂ .CO.OH . . .	1.860	414	0.0255	10.56
CCl ₂ .CO.OH . . .	1.117	403	0.0236	9.51
H ₂ O . . .	—	534	0.0216	11.53

sulphuric acid, and, unlike hydrogen sulphide, it is not decomposed by a sulphuric acid soln. of cupric sulphate. G. Buchböck found that the presence of carbamide and of glycerol accelerated the speed of decomposition. G. Buchböck claimed that the velocity of decomposition is almost inversely proportional to the viscosity, η , of the solvent, or $dC = kC/S\eta$. P. Klason found that soln. of alkalis and alkaline earths decompose carbonyl sulphide more rapidly than does water; as previously indicated by P. Klason, and M. Berthelot, carbonyl sulphide is absorbed but slowly by a 33 per cent. soln. of sodium hydroxide; but R. Witzeck found the contrary. The reaction probably occurs in two stages, say: $\text{COS} + 2\text{KOH} = \text{KS.CO.OK} + \text{H}_2\text{O}$; and $\text{KS.CO.OK} + \text{KOH} = \text{KSH} + \text{KO.CO.OK}$. Conc. alkali-lye absorbs the gas more slowly than more dil. soln., and potash-lye more quickly than soda-lye. P. Klason found the gas to be completely and rapidly absorbed by a 33 per cent. aq. soln. of potassium hydroxide mixed with its own vol. of alcohol; with an alcoholic soln. of potassium hydroxide, C. Bender obtained potassium ethyl thiocarbonate, $\text{C}_2\text{H}_5\text{.O.CS.OH}$. C. Than found that chlorine, and fuming nitric acid, at ordinary temp. have no action on carbonyl sulphide; but at a red heat, A. Emmerling and B. von Lengyel found carbon monoxide, sulphur chloride, and carbonyl chloride are formed: $\text{COS} + 2\text{Cl}_2 = \text{COCl}_2 + \text{SCl}_2$. The last-named also found that with boiling or cold antimony pentachloride, carbonyl chloride is formed. C. Than said that mixtures of nitric oxide and carbonyl sulphide are not explosive. According to M. Berthelot, gaseous ammonia, and, according to P. Kretzschmar, an alcoholic soln. of ammonia rapidly absorb carbonyl sulphide, forming ammonium thiocarbamate. When the soln. in aq. ammonia is evaporated, E. Schmidt, and M. Berthelot obtained carbamide and thiocarbamide. The action of carbonyl sulphide on a number of organic products has been studied by B. Holmberg, F. Weigert, M. Freund and E. Asbrand, etc. Heated mercury, copper, iron, and silver were found by M. Berthelot to remove sulphur from carbonyl sulphide; and cuprous chloride reacts: $\text{COS} + 2\text{CuCl} + \text{H}_2\text{O} = \text{CO}_2 + 2\text{HCl} + \text{Cu}_2\text{S}$. P. Klason, and W. Hempel found carbonyl sulphide to be a narcotic poison. The analytical determination of carbonyl sulphide has been discussed by P. Klason, W. Hempel, E. J. Russell, and other workers.

REFERENCES.

- ¹ A. Fleischer and W. Hanke, *Ber.*, **10**, 1295, 1877; J. Nuricsan, *ib.*, **24**, 2971, 1891; A. Cossa, *ib.*, **1**, 117, 1868; H. E. Armstrong, *ib.*, **2**, 712, 1869; A. Ladenburg, *ib.*, **1**, 273, 1868; **2**, 30, 53, 1869; A. W. Hofmann, *Liebig's Ann. Suppl.*, **1**, 26, 59, 1862; *Ber.*, **1**, 181, 1868; A. R. Hantzsch, *ib.*, **40**, 1517, 1907; A. Emmerling and B. von Lengyel, *ib.*, **2**, 546, 1869; C. Böttiger, *ib.*, **22**, 306, 1889; F. Weigert, *ib.*, **36**, 1007, 1903; E. Schmidt, *ib.*, **10**, 191, 1877; A. Stock and E. Kuss, *ib.*, **50**, 159, 1917; A. Stock and P. Seelig, *ib.*, **52**, 681, 1919; A. Stock, W. Siecke, and E. Pohland, *ib.*, **57**, B, 719, 1924; F. González and E. Moles, *Journ. Chim. Phys.*, **17**, 408, 1919; *Anal. Fis. Quim.*, **17**, 55, 1919; G. Chevrier, *Compt. Rend.*, **69**, 136, 1869; J. P. Couerbe, *Journ. prakt. Chem.*, (1), **23**, 117, 1841; F. G. Reichel, *ib.*, (2), **12**, 71, 1875; F. Salomon, *ib.*, (2), **5**, 480, 1872; P. Klason, *ib.*, (2), **36**, 66, 1887; B. Holmberg, *ib.*, (2), **73**, 241, 1906; P. Kretzschmar, *ib.*, (2), **7**, 476, 1873; H. Kolbe, *ib.*, (2), **4**, 381, 1871; C. Than, *Liebig's Ann. Suppl.*, **5**, 237, 1867; C. Bender, *Liebig's Ann.*, **148**, 137, 1868; M. Freund and E. Asbrand, *ib.*, **285**, 173, 1895; R. Anschütz, *ib.*, **359**, 202, 1908; A. Gautier, *Compt. Rend.*, **107**, 911-1888; **143**, 10, 148, 1906; *Bull. Soc. Chim.*, (3), **35**, 942, 1906; L. Plosvay de N. Plosva, *ib.*, (2), **37**, 294, 1882; A. O. Rankine, *Phil. Mag.*, (6), **44**, 292, 1922; C. J. Smith, *ib.*, (6), **44**, 289, 1922; A. J. Besson, *Compt. Rend.*, **122**, 142, 1896; W. Wahl, *Proc. Roy. Soc.*, **89**, A, 327, 1914; J. Dewar and G. Cranston, *Chem. News*, **20**, 174, 1869; C. Winkler in H. von Fehling, *Neues Handwörterbuch der Chemie*, Braunschweig, **3**, 1097, 1878; R. Witzack, *Journ. Gasbeleucht.*, **46**, 21, 41, 67, 84, 144, 164, 185, 1903; W. Hempel, *Zeit. angew. Chem.*, **14**, 865, 1901; L. W. Winkler, *Zeit. phys. Chem.*, **55**, 351, 1906; G. Buchböck, *ib.*, **23**, 123, 1897; **77**, 361, 1900; J. Thomsen, *ib.*, **52**, 348, 1905; *Ber.*, **16**, 2619, 1883; *Thermochemische Untersuchungen*, Leipzig, **4**, 199, 1886; M. Berthelot, *Ann. Chim. Phys.*, (4), **26**, 170, 1872; (5), **17**, 129, 1879; (7), **14**, 205, 1898; *Bull. Soc. Chim.*, (2), **31**, 227, 1879; (1), **9**, 6, 1868; *Compt. Rend.*, **96**, 298, 1883; G. Chevrier, *ib.*, **69**, 138, 1869; E. J. Russell, *Journ. Chem. Soc.*, **77**, 356, 1900; T. Carnelley, *ib.*, **28**, 523, 1875; G. N. Lewis and W. N. Lacey, *Journ. Amer. Chem. Soc.*, **37**, 1976, 1915; P. Winternitz, *Ueber die Einwirkung von Schwefel auf CO und CO₂, und die SO₂-Dissoziation*, Berlin, 1914; N. D. Costeau, *Étude de l'action du gaz carbonique sur les sulfures minéraux*, Paris, 1914; V. Henri, *Compt. Rend.*, **177**, 1037, 1923.

(Chapter XXXIX continued in Volume VI)