

**MSAART PATENT APPLICATION NOTES**

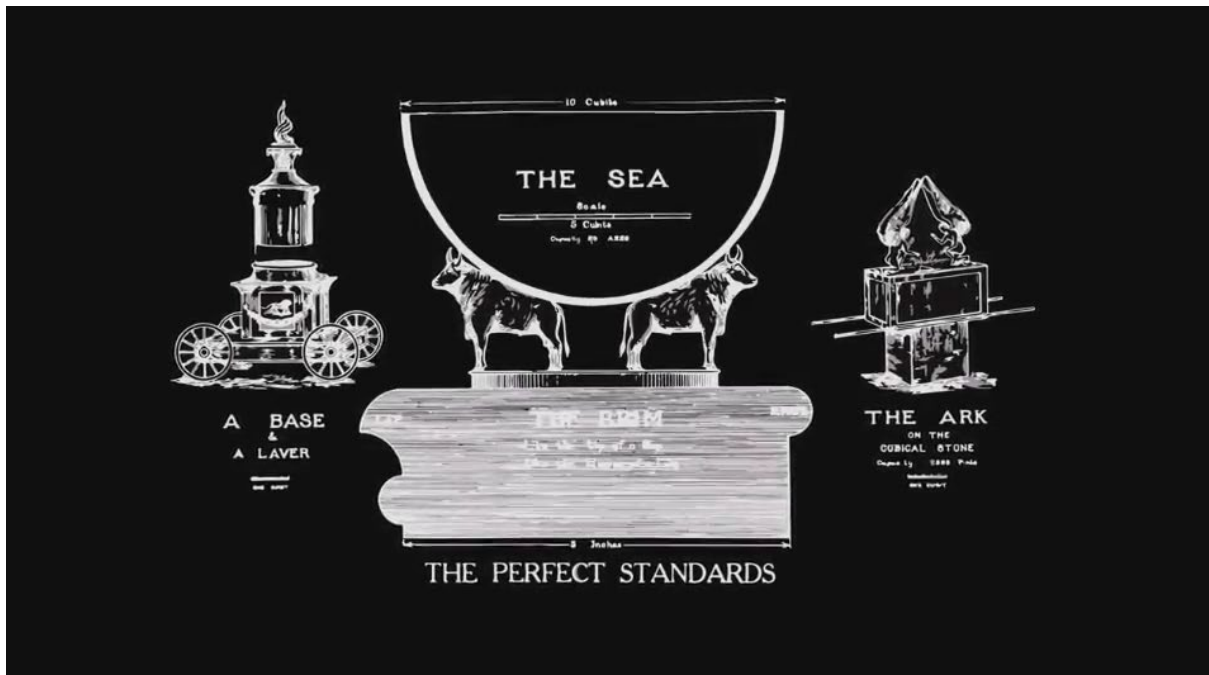
**APPENDIX 11:- SOLOMON'S MOLTEN SEA LENSE  
PLASMOID GENERATOR AND ARC CHARGER**

**PART THIRTEEN OF TWENTY**

**DRAFT 518,400 B KMV**

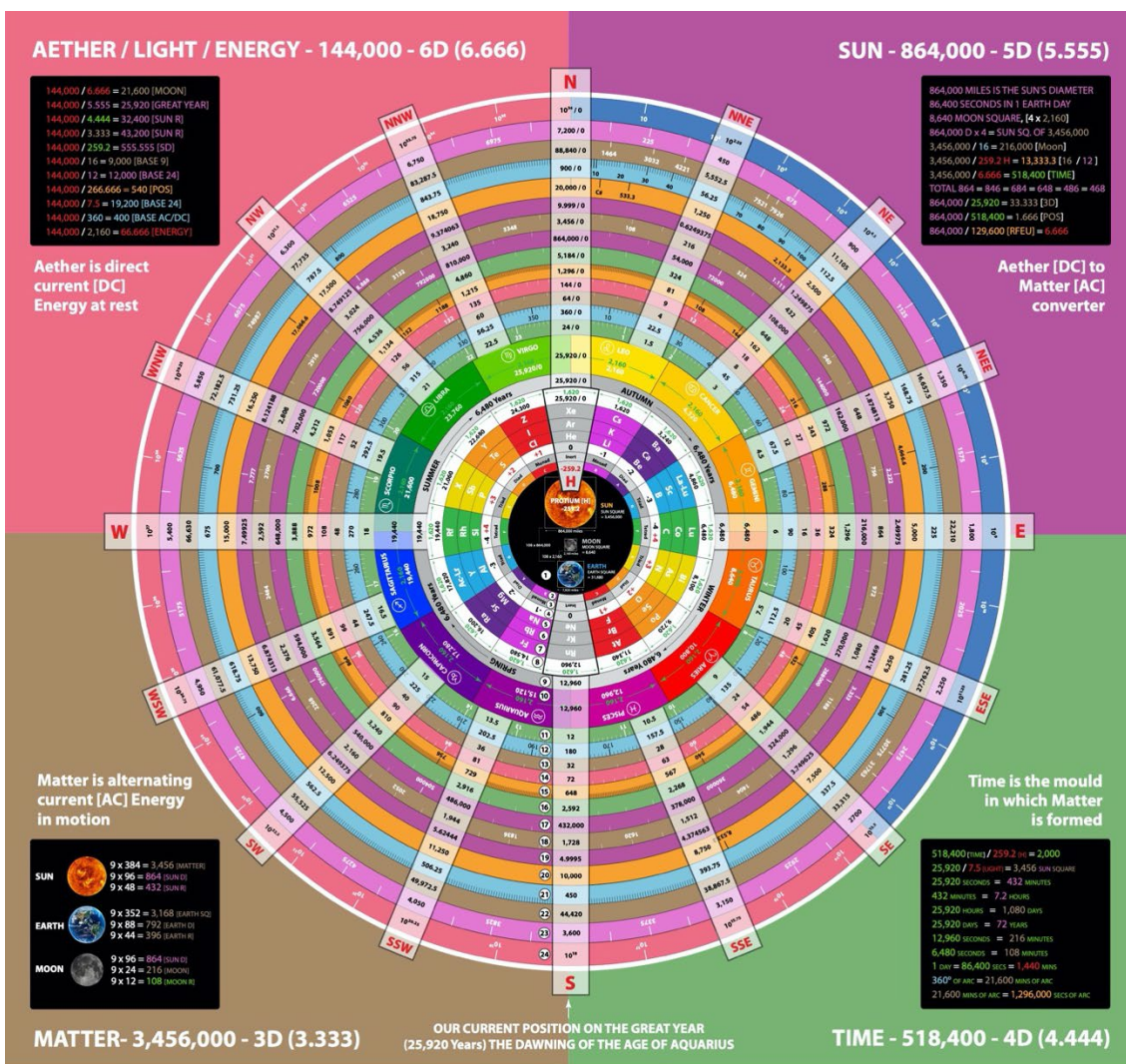
**BY**

MALCOLM V of SCOTLAND | MALCOLM BENDALL  
THURSDAY 22ND SEPTEMBER 2022



**FIG 313 : -SOLOMONS MOLTEN SEA**

# APPLICATIONS FOR A PLASMOIDS FORM AND FUNCTIONS



## PLASMOID UNIFICATION MODEL

Plasmoids are doughnut or toroidal shaped clusters of net Protons or net Electrons that once captured and placed into a Toroidal orbit are capable of absorbing, storing and releasing enormous amounts of energy present within their self-generated and structured electro-magnetic containment field. Plasmoids, in effect, function as an atomic battery that can be self-charging due to its ability to convert matter to available clean energy. Plasmoids by their unique geometry cause a consequential electro-magnetic containment field to generate a Zero point naturally and casually, without much effort, have the ability to convert the nuclear Mass of Protium (Atoms) into energy.

The Plasmoid Unification Model (PUM) posits that Plasmoids are epoch-making and that knowledge of them has been hidden in plain sight for centuries. This PUM 'slide rule' reveals the algorithmic relationships between life's elements critical to mankind's existence and development. It starts with Protium [H] which has a melting point of -259.2°C and is the most abundant element in our Solar System. Protium determines the 25,920 Great Year frequency of our Solar System. The resonant frequencies of all other elements can then be calculated when 25,920 years is reduced from years to days, hours and seconds.

The PUM is evidence that the Universe is an intelligent design. That design is in perfect octave harmonic resonance with itself. Therefore, all of creation from Galaxies to Planets to Elements all resonate in unison with a collective chord 'As Above So Below'. This is interconnected with an energy 'web', the 24 components and laws of which are all based and governed on the same 16 sector Torus Plasmoid precepts shown. The concepts and ruling principles of the PUM can, and have, been applied to make Energy to Matter and Matter to Energy conversions. When applied to the modern hydrocarbon powered internal combustion engine, PUM technology removes exhaust toxic waste products and increases the engine power output by transforming waste energy back into fuel. Plasmoids employed in conjunction with the Plasmoid Toroidal Impulsive Turbine provide a new novel Matter to Energy and Energy to Matter propulsion device for water, land, air and space travel.

## LEGEND

- Sun (864,000) [DC], Earth (7,920) [AC], Moon (2,160) [AC]
- Music [AC] (Do = C = 24 x 11.111 = 266.666)
- Elemental Crystal Forms + / - Monad, Diad, Triad, Tetrad
- Elemental Valencies (0, -1, -2, -3, -4 and 0, +1, +2, +3, +4)
- Elements 1-16 (He - Cl)
- Elements 17-32 (Ar - I)
- Elements 33-48 (Xe - Z')
- Elemental Frequencies (1,620 x 16 = 25,920 light frequency of -259.2 C)
- Seasons of Great Year (25,920 / 0 years)
- Zodiac Great Year (25,920 / 0 years)
- Clock 24 Hour / 0 Hour [AC] / 0 Hour [DC] Clock
- Compass 360° Degrees (AC) / 0° Degrees [DC]
- Matter 64 / 0 64 Points being 32 Resonant Planes / 0
- Light 144 / 0
- Resonate Frequency Energy Unit (RFEU) - 1,296 (129,600)
- All Time 5,184 (518,400 secs)
- Aether-Sun (864,000 miles diameter, 432,000 miles radius)
- Matter 3,456 (3,456,000 miles - Sun Square)
- Dimensions 3D Matter = 3.33, 4D Time = 4.44, 5D Aether = 5.55, 6D Light = 6.666
- Sound and Music (0 - 20,000 Hz)
- Language 1-9, 10-90, 100-900 [111,222,333,444,555,666,777,888,999] [45,450,4,500]
- Solar System Sun & Planetary Diameters and Radii in miles
- Plasmoids 7,200 Degrees / 0, 32 Planes 64 Radial Points, One Zero Point
- All Plasmoid Energy = All Alternating Current [AC] Frequencies  
( = Non Ionizing ) ( = Ionizing )

© PLASMOID INTERNATIONAL

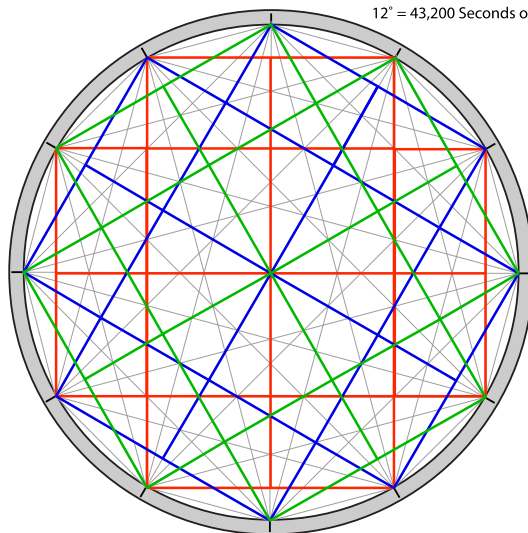
FIG 314 : -16 = AETHER SQUARES, MOLTEN SEA AETHER TO MATTER GEOMETRY

## APPLICATIONS FOR A PLASMOIDS FORM AND FUNCTIONS

### 12 = AETHER SQUARES, MOLTEN SEA AETHER TO MATTER GEOMETRY

#### 12 = AETHER [DC] - PART 1

Grand Total = 77,760  
 Earth Sun Sun Moon  
 311,040 // 155,520 // 77,760 // 38,880 // 19,440 // 9,720 // 4,860 // 2,430 // 1,215 //  
 12° = 43,200 Seconds of Arc



8 rectangles + 4 squares = 2,160° x 12 = 25,920°

8 rectangles + 4 squares = 2,160° x 12 = 25,920°

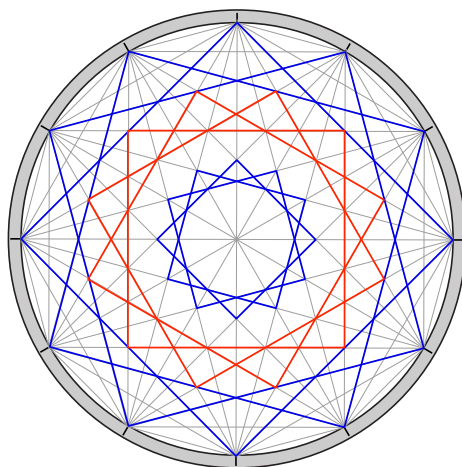
8 rectangles + 4 squares = 2,160° x 12 = 25,920°

<u>24 x 2,160°</u>	<u>12 x 2,160°</u>	<u>TOTAL = 77,760° (1)</u>
= 51,840°	= 25,920°	

77,760 (1)
+ 84,240 (2)
GRAND TOTAL = 162,000

**FIG 315 : - 12 = AETHER = AETHER SQUARES, MOLTEN SEA AETHER TO MATTER GEOMETRY**

#### 12 = AETHER [DC]



6 x 2,160 = 12,960 x 4 = 51,840
3 x 2,160 = 6,480 x 4 = 25,920
9 x 2,160 =

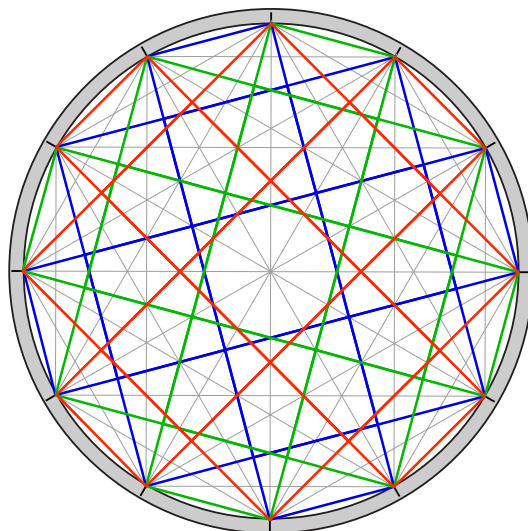
**FIG 316 : - 12 = AETHER SQUARES, MOLTEN SEA AETHER TO MATTER GEOMETRY**

**APPLICATIONS FOR A PLASMOIDS FORM AND FUNCTIONS**

**12 = AETHER MOLTEN SEA AETHER TO MATTER GEOMETRY**

**12 = AETHER [DC] - PART 2**

5,184,000 // 2,592,000 // 1,296,000 // 648,000 // 324,000 // **162,000** //  
 81,000 // 40,500 // 20,250 // 10,125 // 5,062.5 // 5,184,000

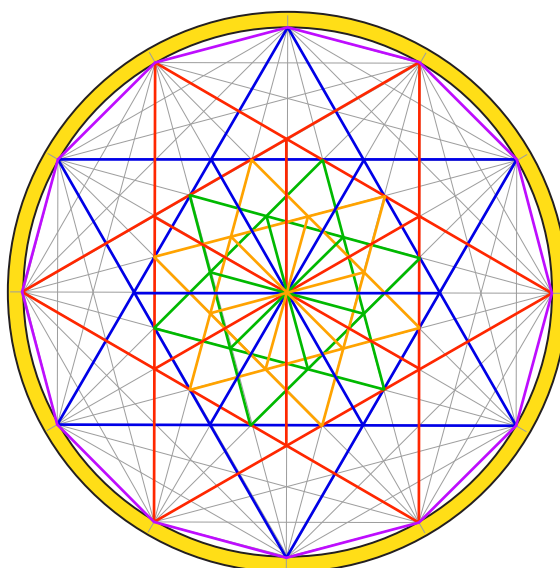


3 x 34,560 = 103,680 + 77,760 = 181,440      135sq x 2,160° = 28,080°  
 [+4 Large Rectangles 12+4 = 16 x 360 = 5,760 , 16 x 2,160 = 34,560]    135sq x 360° = 4,680°  
 4 Half Squares (2 Sq), 8 Small Squares, 2 Large Squares = 115sq x 360° = 3,960°  
 4 x 360° = 1,440°, 8 x 360° = 2,880°, 8 x 2,160° = 17,280° = 115sq x 2,160° = 23,760°  
 4 x 2,160° = 8,640°

11 x 3 = 33 x 360° = 11,880°, 11 x 3 = 33 x 2,160° = 71,280°      **77,760 (1)**  
 13 x 3 = 39 x 360° = 14,040°, 13 x 3 = 39 x 2,160° = 84,240°      **+ 84,240 (2)**  
**162,000**

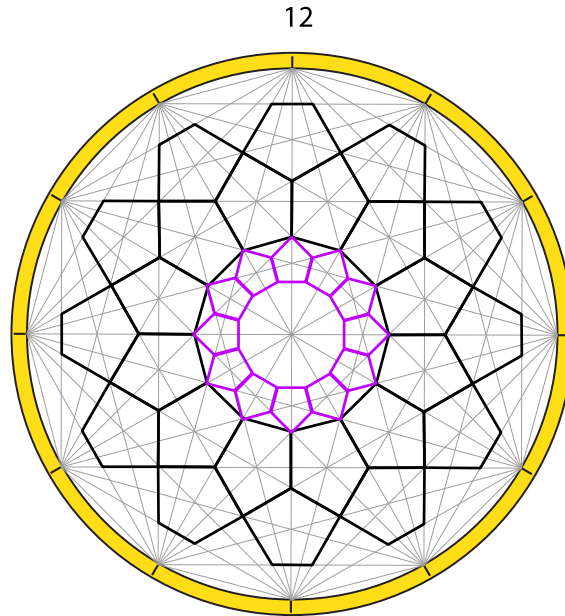
**FIG 317 : - 12 = AETHER MOLTEN SEA AETHER TO MATTER GEOMETRY**

12

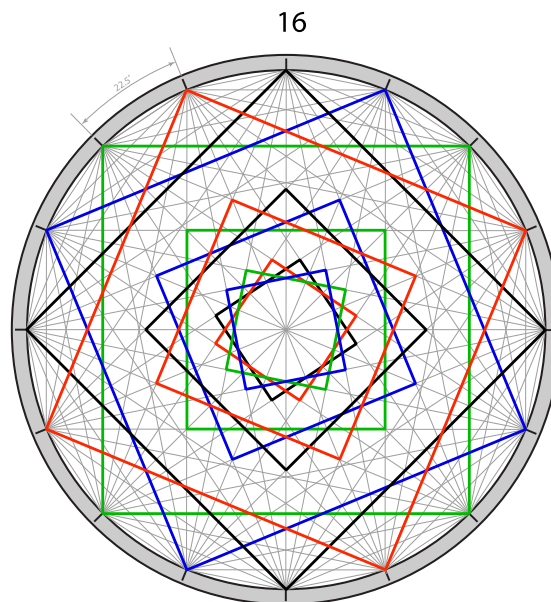


**FIG 318 : - 12 = AETHER, MOLTEN SEA AETHER TO MATTER GEOMETRY  
APPLICATIONS FOR A PLASMOIDS FORM AND FUNCTIONS**

**12 = AETHER MOLTEN SEA AETHER TO MATTER GEOMETRY**



**FIG 319 : - 16 = MATTER - MOLTEN SEA MATTER TO AETHER GEOMETRY**

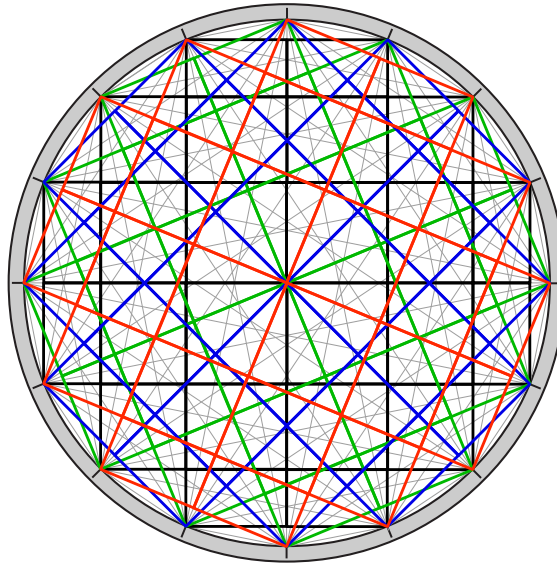


<b>3 squares x 360° = 1,080</b>	<b>3 x 2,160 = 6,840</b>
<b>3 squares x 360° = 1,080</b>	<b>3 x 2,160 = 6,840</b>
<b>3 squares x 360° = 1,080</b>	<b>3 x 2,160 = 6,840</b>
<b>3 squares x 360° = 1,080</b>	<b>3 x 2,160 = 6,840</b>
<b>12 squares x 360° = 4,320</b>	<b>12 x 2,160 = 25,920</b>
<b>48 corners</b>	

**FIG 320 : - 16 = MATTER - MOLTEN SEA AETHER TO MATTER GEOMETRY**  
**APPLICATIONS FOR A PLASMOIDS FORM AND FUNCTIONS**

**16 = MATTER - MOLTEN SEA AETHER TO MATTER GEOMETRY**

24 Boxes x 360° = 8,640° x 4 = 34,560° [MATTER]  
 24 Boxes x 360° = 8,640°      34,560° = 124,416,000 secs of Arc  
 24 Boxes x 360° = 8,640°      34,560° = 2,073,600 mins of Arc [792]  
 24 Boxes x 360° = 8,640°      Earth diameter

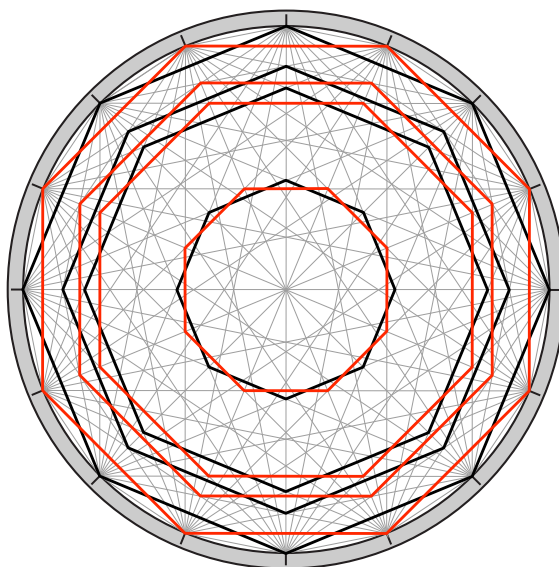


24 Boxes x 2,160 = 51,840  
 24 Boxes x 2,160 = 51,840  
 24 Boxes x 2,160 = 51,840  
 24 Boxes x 2,160 = 51,840  
96                      207,360

8 small rectangles = 8 x 2,160 = 17,280 [SUN].    8 x 360° = 2,880 [1,440 x 2 LIGHT]  
 12 large squares = 12 x 2,160 = 25,920 [EQUI].    12 x 360 = 4,320  
 4 large squares = 4 x 2,160 = 8,640 [SUN D].      4 x 360° = 1,440

**FIG 321 : - 16 = MATTER - MOLTEN SEA AETHER TO MATTER GEOMETRY**

16

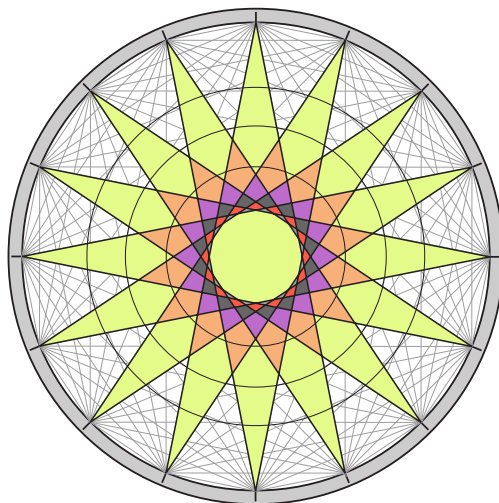


**FIG 322 :- 16 = MATTER - MOLTEN SEA AETHER TO MATTER GEOMETRY APPLICATIONS FOR A PLASMOIDS FORM AND FUNCTIONS**

**16 = MATTER - MOLTEN SEA AETHER TO MATTER GEOMETRY**

11.25 = 40,500 seconds of Arc = 576,000 seconds of Arc  
 22.5 = 81,000 seconds of Arc = 960 minutes of Arc  
 = 40 hours of Arc

16



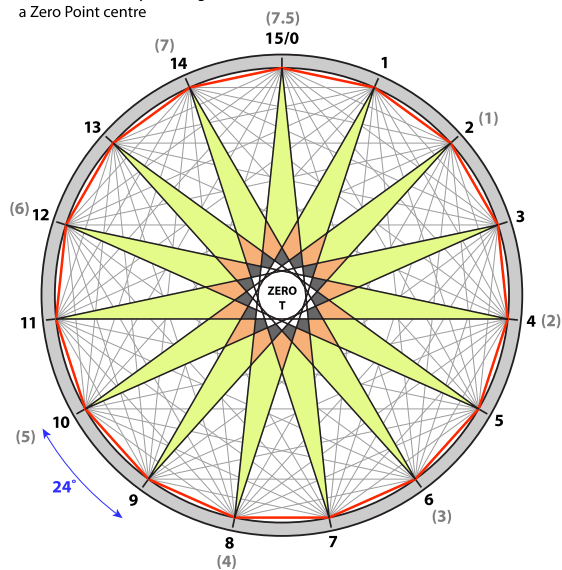
16 points making 5 circles. 4+1  
 5 arrows [5x16 = 80]

**FIG 323 :- SOLOMONS MOLTEN SEA**

**15 = TIME**

A 15 point circle misses the centre, thereby creating a Zero Point centre

7.5 = 27,000 Arc seconds  
51.84 = 186,624 Arc seconds



24° = 86,400 Arc seconds in a day

20 squares of Time x 360 = 7,200

**FIG 324 : -SOLOMONS MOLTEN SEA  
APPLICATIONS FOR A PLASMOIDS FORM AND FUNCTIONS**

**MOLTEN SEA GEOMETRY**



**FIG 325 : -SOLOMONS MOLTEN SEA**

10 CUBITS IN DIAMETER FULL OF 2,000 BATHS OF WATER WHICH IS HIN AND 144,000 LOGS



Aether 150 Suns x 864,000 = 129,600,000 150 Suns x 12 = 1,800 12 x 864,000 = 10,368,000

Matter 150 Suns x 3,456,000 = 518,400,000 TIME

Matter 150 Suns x 144,000 = 21,600,000

864,000 x 144,000 = 124,416,000,000

Aether 150 Moons x 2,160 = 324,000

Aether 2,160 x 144,000 LIGHT = TIME 311,040,000

Matter 150 Moons x 8,640 = 1,296,000 129,000 x 150 = 19,440,000 //972 //486//243

Aether 150 Moons x 16 = 900 2,160 x 16 = 34,560

Matter 150 Moons x 51,840 miles in 24 hours = 7,776,000

## MOLTEN SEA NUMBERS

### NUMBERS FOR THE OUTSIDE OF THE MOLTEN SEA TIMES 11.111

Earth 7,920 x 11.111 = 87,999.9999999912 [88,000] 1 / x = 0.00001136363

88,000 / 266.666 = 330 1 / x = 0.00303030

Earth 7,920 / 266.666 = 29.7 1/x = 0.12345679012345

7,920 x 266.666 = 2,112,000

Sun 864,000 x 11.111 = 9,599,999.999999904 [9,600,000] 1 / x = 0.0000001041667

9,600,000 / 266.666 = 36,000

Moon 2,160 x 11.111 = 23,999.9999999976 [24,000] 1/x = 0.000041666

2,160 / 266.666 = 8.10000002025 1 / x = 0.123456789814815

(432,000 x 11.111 = (300 x 11.111 = 3,333.333) (150 x 11.111 = 1,666.666) (50 x 11.111 = 555.555)

(6 x 11.111 = 66.666) (3,333.333 / 0.125 = 26,666.666) (1,666.666 / 0.125 = 13333.33)

(555,555 / 0.125 = 4,444,440) (4,444,440 / 1.3333 = 3,333,330.000000083333)

(4,444,440 / 0.125 = 35,555,520 / 0.125 = 284,444,160 / 0.125 = 2,275,553,280 / 0.125 =)

### NUMBERS FOR THE INSIDE OF THE MOLTEN SEA IN HANDS TIMES 11.111

$$(45 \times 11.111 = 500 \quad 1/x = 0.002)$$

(45 x .666 = 30 [29.999] = 2x Depth of water in the Molten Sea but it is an inverted sphere 1/x = 0.0333)  
 (266.666/30 = 8.888 1/x = 0.1125 the area of the surface of the molten sea water is [Area = pie r (15)  
 squared] = 706.86 square hands 706.86/ 16 = 44.17875 / 22.5 = 1.9635 x 400 = 785.4 RFEU

(22.5 x 11.111 = 250 1/x = 0.004 x 266.666 = 1.0666 ) (22.5 x 0.666 = 15 hands is the Depth of water in the  
 molten sea 15 /2 = 7.5 hands resonant air cavity (light travels 7.5 times around the earth in one second  
 giving the Standard Light Earth Frequency (SLEF) above the water to the Rim)  
 (266.666 / 15 = 17.777 1/x = 0.05625, 266.666 / 7.5 = 35.555 1 / x = 0.28125)

$$360 \times 11.111 = 4,000 \quad 1/x = 0.00025 \quad [4,000/266.666 = 15/0.125 = 120.00000000000018 \quad 1 / x = .008333$$

$$180 \times 11.111 = 2,000 \quad 1 / x = 0.0005$$

$$90 \times 11.111 = 1,000 \quad 1 / x = 0.001 \quad [1,000 / 266.666 = 3.75/ 0.125 = 30.000000000000075 \quad 1 / x = 0.001$$

$$(16 \times 11.111 = 177.777 \quad 1 / x = ) \quad (400 \times 11.111 = 4,444.444 \quad 1/x = )$$

$$(9 \times 11.111 = 10 [99.9999] \quad 1/x = 0.01))$$

$$(11.111 \times 11.111 = 123.456790123457 \quad 1 / x = .0081)$$

**NUMBERS FOR THE MOLTEN SEA IN CUBITS 10 and 5 TIMES 11.111**

(5 x 11.111 = 55.55), (10 x 11.111 = 111.111), (30 x 11.111 = 333.333).

## ARK OF THE COVENANT SACRED RULING NUMBERS

**NUMBERS FOR THE ARK OF THE COVENANT IN CUBITS**

$$(2.5 \times 11.111 = 27.777) \quad (1.25 \times 11.111 = 13.888) \quad (1.5 \times 11.111 = 16.666)$$

$$(2.5 \times 1.5 \times 1.5 = 5.625 / 0.125 = 45)$$

$$(1.25 \times 1.5 \times 1.5 = 2.8125 / 0.125 = 22.5)$$

$$27.777 \times 16.666 \times 16.666 = 7,715.2160790120 / 0.125 = 61,721.728632096$$

**NUMBERS FOR THE ARK OF THE COVENANT IN INCHES**

$$(45 \times 11.111 = 500), \quad (22.5 \times 11.111 = 250), \quad (27 \times 11.111 = 300)$$

$$(45 \times 27 \times 27 = 32,805 / 0.125 = 262,440)$$

$$(300 \times 300 \times 500 = 45,000 / 0.125 = 360,000,000)$$

$$(300 \times 300 \times 250 = 22,500,000 / 0.125 = 180,000,000)$$

**NUMBERS FOR THE ARK OF THE COVENANT IN HANDS**

$$(11.25 \times 11.111 = 125), \quad (5.625 \times 11.111 = 62.5), \quad (6.75 \times 11.111 = 75)$$

$$(11.25 \times 6.75 \times 6.75 = 512.578125 / 0.125 = 4,100.625)$$

$$(75 \times 75 \times 125 = 703,125 / 0.125 = 5,625,000)$$

$$(75 \times 75 \times 62.5 = 351,562.5 / 0.125 = 2,812,500)$$

## THE HIGH PRIESTS EPHOD RULING NUMBERS AND FORM

### NUMBERS FOR THE EPHOD IN HANDS

( $2.25 \times 11.111 = 25$ ,  $2.25 \times 2.25 = 5.0625$  /  $0.125 = 40.5$   
 ( $25 \times 25 = 625$  /  $0.125 = 5,000$ )

## MOLTEN SEA RULING NUMBERS

RULING NUMBER 1.1111

RULING NUMBER 1.3333

RULING NUMBER 5

RULING NUMBER 9

RULING NUMBER 10

RULING NUMBER 11.11

RULING NUMBER 12

RULING NUMBER 16

RULING NUMBER 22.5

4,500/

RULING NUMBER 27

RULING NUMBERS 37

RULING NUMBER 45

RULING SUN'S LIGHT NUMBER 144

**RULING NUMBER 150 SUNS AND 150 MOONS ON OUTER MOLTEN SEA RIM**

$$150 / 12 / 1.111 = 11.25 \quad 150 / 360 / 1.111 = .375$$

$$150 \times 1.333 = 199.999 \quad 150 / 16 = 150 / 12$$

**RULING NUMBER 300 TOTAL NUMBER OF SUNS AND MOONS ON MOLTEN SEA RIM**

$$300 \times 1.333 \times 1.111 = 444.444 \text{ IN MUSIC A}$$

$$300 / 12 / 1.111 = 22.5$$

$$300 / 16 = 18.753 \quad 300 / 12 = 25$$

$$\text{LILLIES } 4,800 \text{ lilies} \times 1,800 \text{ petals} = 8,640,000$$

**RULING NUMBER 360****RULING NUMBER 432****RULING NUMBER 450****RULING NUMBER 720**

$$720 / 16 = 45 \quad 720 / 1.333 = 540 \quad 720 / 1.111 = 432 \text{ [} 432 + 234 = 666 \text{]}$$

**RULING NUMBER 2,520**

$$2,520 = 3 \times 4 \times 5 \times 6 \times 7$$

$$2,520 = 3 \times 7 \times 10 \times 12 \text{ (all perfect numbers)}$$

$$2,520 \times 2 = 5,040$$

$$2,520$$

**RULING NUMBER 4,500 VOLUME OF RIM OF THE MOLTEN SEA**

$$4,500 / 0.125 = 36,000$$

**RULING NUMBER 14,400**

$$14,400 = 1 + 2 + 3 + 4 + 5$$

**MOLTEN SEA NUMBERS**

**VOLUME OF THE MOLTEN SEA IS 3,000 BATHS x 72 = 216,000 LOGS**

$$216,000 \text{ Logs} = 300 \text{ Homer} = 54,000 \text{ Cad}$$

**VOLUME OF THE MOULTEN SEA IS 3,000 BATHS X 72 = HANDS**

**VOLUME OF THE MOULTEN SEA IS 2,000 BATHS x 72 = 144,000**

$$1,44,000 / 11.11 \text{ EQUALS } 129,600 \text{ RESONANT FREQUENCY ENERGY UNITS [RFEU]}$$

**VOLUME OF THE MOULTEN SEA IS 2,000 BATHS x 72 = 144,000 logs**

$$144,000 \text{ logs} = 36,000 \text{ Cad} = 200 \text{ homer} = 18,000 \text{ Him} = 36,000 \text{ Kab} = 144,000 \text{ Logs}$$

$$1,44,000 / 11.11 \text{ EQUALS } 129,600 \text{ RESONANT FREQUENCY ENERGY UNITS [RFEU]}$$

**VOLUME OF THE MOULTEN SEA IS 2,000 BATHS = 150 RITUAL BATHS**

VOLUME OF THE MOLTEN SEA INNER SPHERE =  $47,712 / 2 = 23,856 / 0.666 = 35,784$

VOLUME OF THE MOULTEN SEA IS  $2,000 \text{ BATHS} \times 72 = 129,600 \text{ (RFEU)}$

VOLUME OF THE MOULTEN SEA IS  $129,600 \times 1.333 = 172,800$

$172,800 \text{ RFE} [1728 + 8271 = 9,999]$

VOLUME OF THE MOLTEN SEA OUTER SPHERE =  $56,684 / 2 = 28,342 / 0.666 = 42,513$

MINUS VOLUME OF THE INNER SPHERE =  $8,972 / 2 = 4,486 / 0.6666 = 6,729$

AREA OF TOP OF THE MOLTEN SEA =

CIRCUMFERANCE OF THE MOLTEN SEA =

## RULING NUMBERS **129,600**, **9,999** AND **36** MADE FROM REFLECTIVE NUMBER **3456** AND

$259,200 \text{ [EARTHS EQUINOX]} = 3 \times 4 \times 5 \times 6 \times 6 \times 5 \times 4 \times 3 \times 2 / 2 = 129,600 / 0.125 = 1,036,800$

$129,600 / 36 = 3,600 \text{ [} 36 = 3+4+5+6+6+5+4+3 \text{]} \quad 9,999 = 3,456 + 6,543$

$129,600 / 1.111 = 116,640 \quad 129,600 \times 1.111 = 144,000$

$129,600 / 1.333 = 97,200.0000000024 \quad 129,600 \times 1.333 = 172,800$

$129,600 / 360 = 129,600/180 = 129,600/ 90 = 129,600/45 = 129,600/22.5 =$

$129,600 / 9,999 = 12.9612961 \quad 9,999/129,600 = 0.077152777$

$9,999 = 3,456 + 6,543 \quad 9,999/36 = 277.75 / 0.125 = 2,222$

$9,999 / 3,456 = 2.8932291666 = 1/X = 0.3456345634563456$

$9,999 / 6,543 = 1.52819807427785 \quad 1/x = 0.654365436543$

$6,543 / 9,999 = 0.654365436543$

$9,999 / 720 = 13.8875 \quad 9,999 / 360 = 27.775 \quad 9,999 / 180 = 55.55 \quad 9,999 / 90 = 111.111$

$9,999 / 45 = 222.2 \quad 9,999 / 11.25 = 888.8$

$144,000 / 1.111 = 129,600$

$$360 \times 360 = 129,600 \quad 180 \times 720 = 129,600$$

$$129,600 \times 7.5 = 972,000 / 360 = 2,700 / 9 = 300 / 1.333 = 225 / 1.111 =$$

$$202.5000000000070875 = 1/x = 0.00493827160494$$

## RULING NUMBER 1,776 = 999 + 777 AND 48 MADE FROM REFLECTIVE NUMBER 789

$$789 + 987 = 1,776 \quad 999 + 777 = 1,776$$

$$7 + 8 + 9 + 9 + 8 + 7 = 48$$

$$7 \times 8 \times 9 \times 9 \times 8 \times 7 = 254.016$$

## RULING NUMBER 144,000, 7,777 AND 28 MADE FROM REFLECTIVE NUMBER 2345

At Base 9 the harmonic speed of light is 144,000 minutes of Arc

Where normal 86,400 (864,000 Sun 888) seconds in a day based on harmonic 8 are expanded to 9,720 (9,720 Earth 999) based on harmonic 9 splitting the earth into 27 grid hours the number of grid seconds then equals 97,200. Therefore the grid speed of light is 144,000 minutes of Arc per grid second.

$$2 \text{ to the } 7^{\text{th}} + 3 \text{ SQUARED} + 5 \text{ CUBED} = 144,000$$

$$144,000 = 2 \times 3 \times 4 \times 5 \times 5 \times 4 \times 3 \times 2 \times 10 \quad 144,000 / 0.125 = 1,152,000$$

$$144,000 / 28 = 5,142.85714285714 \quad [28 = 2+3+4+5+5+4+3+2] \quad 7,777 = 2,345 + 5,432$$

$$144,000 / 7,777 = 18.5161373280185 \quad 7,777 / 144,000 = 0.054006944$$

$$144,000 \times 144,000 = 20,736,000,000 / 7,777 = 2,66,323.7752346663238$$

$$144,000 \times 144,000 \times 144,000 = 2,985,984,000,000,000 / 7,777 = 383,950,623,633.792$$

$$144,000 \text{ SQUARE ROOT} = 379.473319220205 / 7,777 = 0.0487943061875$$

$$144,000 \text{ CUBE ROOT} = 52.4148278841779 / 7,777 = 52.4148278841779$$

$$7,777 / 1.5241579027586648377 = 5,102.48970000042$$

$$7,777 = 2,345 + 5,432 \quad 7,777/28 = 277.75 / 0.125 = 2,222$$

$$7,777 / 2,345 = 3.31641791044776 = 1/x = 0.30153015$$

$$7,777 / 5,432 = 1.43170103092784$$

$$5,432 / 7,777 = 0.698469846984$$

$$2,345 / 7,777 = 0.30153015301$$

$$144,000 / 1.111 = 129,600$$

$$360 \times 400 = 144,000 \quad 180 \times 800 = 144,000 \quad 200 \times 720 = 144,000$$

## RULING NUMBER 1,728,000 [Suns Resonant Frequency Energy units] 9999 AND 36 and 48 MADE FROM REFLECTIVE NUMBER 1728

$$1,728 + 8,271 = 9,999 \quad 1+7+2+8+8+2+7+1= 36$$

$$1,728 / 36 = 48$$

$$1 \times 7 \times 2 \times 8 \times 8 \times 2 \times 7 \times 1 = 12,544 \quad / 36 = 348.444$$

## SANSKRIT LONG 100 YR RULING NUMBER 3,110,400,000,000

$$311,040,000,000,000 / 25,920 = 12,000,000,000,000$$

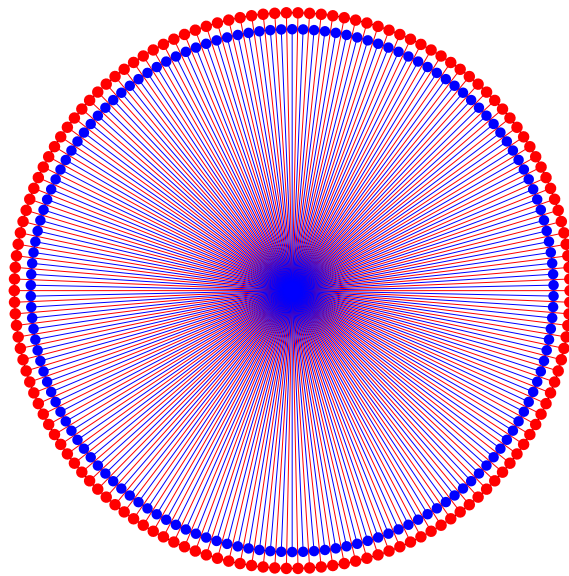
$$3,110,400,000,000 / 25,920 = 120,000,000$$

$$3,110,400,000,000 / 864,000 = 3,600,000 / 266.666 = 13,500 / 22.5 =$$

$$3,110,400,000,000 / 7.5 =$$

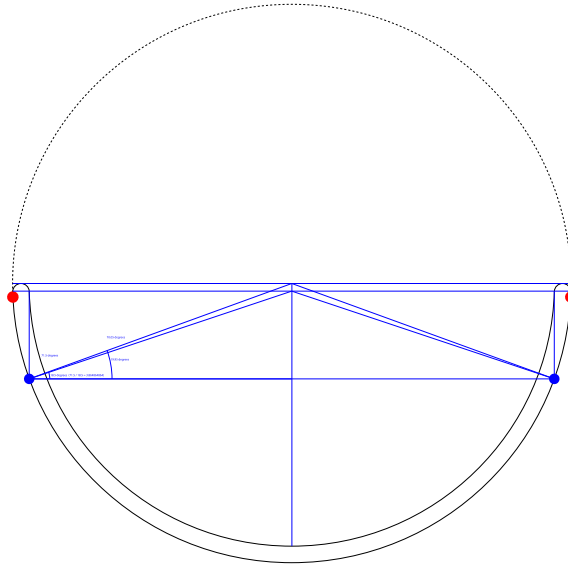
***APPLICATIONS FOR A PLASMOIDS FORM AND FUNCTIONS***

***MOLTEN SEA GEOMETRY***



***FIG 326 : -SOLOMONS MOLTEN SEA 150 SUNS AND 150 MOONS***





**FIG 327 : -SOLOMONS MOLTEN SEA SCHEMATIC**