



IRRIGATION ENGINEERING

By Dr. K N Tiwari Dr. N S Raghuwanshi

Irrigation Engineering

-: Course Content Developed By :-

Dr. K N Tiwari

Professor

Dept. of Agricultural and Food Engg., IIT, Kharagpur

Dr. K N Tiwari

Dr. N S Raghuwanshi

Professor

Dept. of Agricultural and Food Engg., IIT Kharagpur

-:Content Reviewed by :-

Dr. S D Gorantiwar

Professor & Head

**Department of Irrigation and Drainage
Engineering, Mahatma Phule Krishi Vidyapeeth
Rahuri,Ahmednagar (MS)**

INDEX

SN	Lesson Name	Page No
1	Water Resources of India and its Demand in Various Sectors	5-10
2	Irrigation Development	11-14
3	Irrigation Projects	15-19
4	Environmental Impact Assessment & Inter Basin Water Transfer	20-26
5	Methods of Water Measurements in Open Channels	27-35
6	Weirs	36-44
7	Flumes	45-50
8	Orifices	51-55
9	Water Flow Measurement in Pipes	56-62
10	Pipe Orifice, Water Meter and Propeller Meter	63-67
11	Open Channel Flow	68-74
12	Design of Open Channel	75-82
13	On Farm Structures for Water Conveyance	83-86
14	Structures for Diversions and Channel Crossings	87-90
15	Underground Pipeline Systems	91-98
16	Design and Operation of Underground Pipeline System	99-103
17	Land Grading Survey and Design	104-110
18	Land Leveling Methods	111-118
19	Contour Bench Levelling and Earthwork Quantities Computation	119-125
20	Equipment for Land Grading	126-129
21	Soil Water	130-140
22	Infiltration	141-147
23	Soil Water Movement	148-155
24	Soil Water Constants	156-165
25	Evapotranspiration	166-176
26	Crop Water Requirement	177-182
27	Irrigation Scheduling	183-190
28	Irrigation Efficiency	191-197
29	Surface Irrigation	198-103
30	Surface Irrigation Methods	104-212
31	Surface Irrigation Hydraulics	213-218
32	Furrow Irrigation System	219-222
33	Border Irrigation System	223-232

34	Basin Irrigation System	233-238
35	Sprinkler Irrigation	239-243
36	Types and Components of Sprinkler System	244-248
37	Design of Sprinkler Irrigation System-I	249-255
38	Design of Sprinkler Irrigation System-II	256-268
39	Application of Fertilizers and Chemicals through Sprinkler System	269-279
40	Evaluation of Rotating Head Sprinklers and Operation of Sprinkler System	280-288
41	Drip Irrigation	289-297
42	Components of Drip Irrigation System-I	298-305
43	Description of Drip System Components and their Selection-II	306-315
44	Planning and Design of Drip Irrigation System	316-324
45	Evaluation of Drip Emitters and Design of Drip Irrigation System	325-335
46	Installation Operation and Maintenance of Drip Irrigation Systems	336-340
47	Project Planning and Financial Analysis of Irrigation Project	341-354
48	National Water Policy and Participatory Irrigation Management	355-360

LESSON 1 Water Resources of India and its Demand in Various Sectors

1.1 Definition

Irrigation is defined as the science of artificial application of water to the land, in accordance with the 'crop water requirements' throughout the 'crop period' for full-fledged nourishment of the crops (Garg, 1996).



Fig. 1.1. Application of water by drip.

Irrigation water is supplied to supplement the water available from rainfall, soil moisture storage and capillary rise. However, in many cases, it is not possible to meet the full crop water requirement throughout the season due to limited water availability. In such cases, deficit irrigation is provided in the form of life saving or supplemental irrigation. Besides meeting the crop water requirement, irrigation is also provided for field preparation, climate control (crop cooling and frost control), and leaching of excessive salts.

Irrigation is very ancient practice and can be traced with the beginning of human civilization. Importance of irrigation in agriculture is very well documented in Namrada Smriti XI, 9 which states that "no grain is ever produced without water, but too much water tends to spoil the grain; an inundation is as injurious to crop growth as a dearth of water." Hence, irrigation is essential.

Irrigation however has several advantages and disadvantages which are listed below:

Advantages

- Increases agricultural productivity and allows for multiple cropping during an year Provide jobs.
- Reduces risk of crop failures.
- Higher productivity results in steady supply of food at lower prices (supply demand principle of economics)
- Improves socioeconomic conditions of farmers

Disadvantages

1. Excessive irrigation may cause decrease in crop yield
2. Excessive irrigation may cause leaching of pesticide, insecticide, nitrogen and nitrates to groundwater and may also transport them to surface water systems.
3. In poorly drained soils water logging and salinity may occur.
4. In poorly maintained canals- excessive seepage may cause water logging.
5. Excessive groundwater pumping may cause decrease in groundwater levels which may damage aquifer structure and increase the risk of land subsidence.

1.2 Purpose of Irrigation

Some of the main purposes of irrigation are enlisted below:

1. To supply essential moisture for plant growth
2. Transportation of fertilizers (Fertigation)
3. To leach or dilute salts in soil
4. To help in field preparation, dust control etc.
5. Other benefits of irrigation include cooling of the soil and atmosphere to create more favourable environment for crop growth and frost control

1.3 Sources of Water

1.3.1 Natural Sources

Rain, snow, hail and sleet are precipitated upon the surface of the earth as meteorological water and may be considered as the original source of all the water supplied. Surface and groundwater are main sources of irrigation water. Three aspects should be considered in appraising water resources which are the quantity, the quality, and the reliability of availability of water. Rainwater, rivers, lakes, streams, ponds and springs are natural sources of water. Dams, wells, tube wells, hand-pumps, canals, etc. are man-made sources of water.

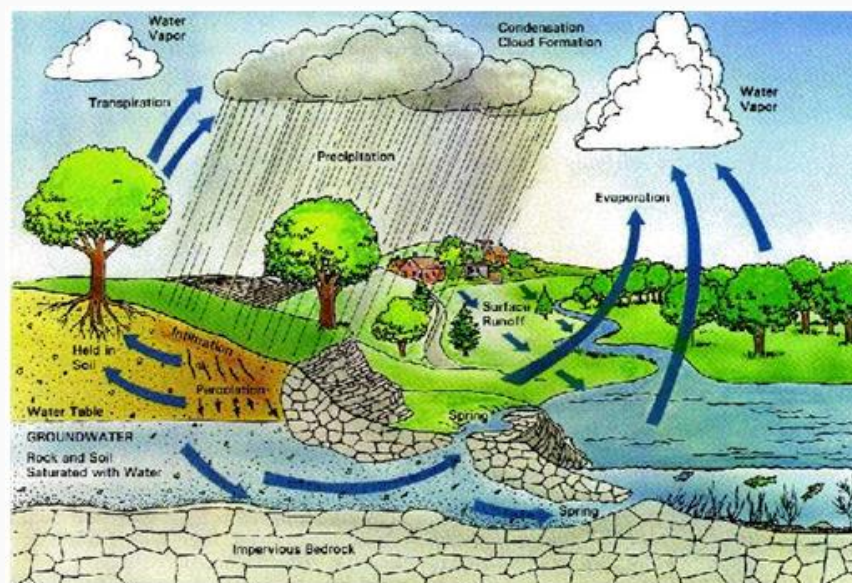

Fig. 1.2.Sources of water.

Irrigation water sources can be broadly classified into two main groups, namely,

1. Surface water sources and
2. Groundwater sources.

Irrigation water supply can be either obtained from surface water sources or groundwater sources or both. Both of these depend upon the precipitation.

1.3.2 Surface Water

Water present on the surface of the earth in the form of oceans, rivers, lakes, ponds and streams is called surface water. Surface water accumulates mainly by direct runoff from precipitation i.e., rain or snow melting. The amount of available surface water depends largely upon rainfall.

Surface water sources consists river, lake, and reservoir supplies. Dams or reservoirs are constructed to create artificial storage of water. Canals or open channels can be constructed to convey surface water from the rivers or reservoirs to the farm fields where it may directly applied to the field or stored in farm irrigation structures like ponds or tanks. The water is also conveyed through pipes by gravity or pumping. Thus, sources of surface water are i) Rivers and streams ii) Reservoirs iii) Tanks, ponds and lakes.

1.3.2.1 River

A river is a natural water course, usually of freshwater, flowing towards an ocean, a lake, a sea, or another river. In a few cases, a river simply flows into the ground or dries up completely before reaching another body of water.



Fig. 1.3. River Ganga.

1.3.2.2 Reservoir

A reservoir is a natural or an artificial lake, storage pond or impoundment from a dam which is used to store water. Reservoirs may be constructed across the rivers or may be excavated in the ground.



Fig.1.4. Reservoir. (Idukki Arch dam -Kerala, India).

1.3.2.3 Lake

A lake is an inland water body of considerable size. Lakes can serve as the source or termination point for rivers or smaller streams. Lakes are distinct from lagoons as they are not part of the ocean. Lakes are larger and deeper than ponds.

1.3.2.4 Ponds

A pond is a body of standing water, either natural or man-made, that is usually smaller than a lake. Generally, they contain shallow water with marsh and aquatic plants and animals.

1.3.2.5 Tank

Tanks are large excavations in which water is stored. They form an important source of water in many of the Indian villages.

1.3.3 Ground Water

A part of the water which infiltrates into the soil after any rainfall event percolates to the groundwater table. Ground waters, generally, characterized by higher concentrations of dissolved solids, lower levels of colour, higher hardness (as compared with surface water), dissolved gasses and freedom from microbial contamination. Wells are generally used to extract groundwater.

The extraction of groundwater is mainly by:

1. Dug well with or without straining walls
2. Dug cum bore wells
3. Cavity Bore
4. Radial collector wells
5. Infiltration galleries
6. Tube wells& bore wells.

Groundwater that flows naturally from the ground is called a spring.

1.4 Present Status, Development and Utilization of Water Resources

1.4.1 Surface Water

In India, surface flow takes place through 14 major rivers basins. In addition to major rivers there are 44 medium and 55 minor basins. The total water potential of these basins is estimated at 187.9 million ha million. A break up of this resource reveals that 105 million ha m is the runoff from rainfall that flows into rivers and streams including reservoir and tanks. The largest potential of water is available in Ganga-Brahmaputra-Meghna basin with a total of 117 million ha m followed by Godavari and west flowing rivers from Tapi to Tadri each having an average annual potential of more than 10 Mha m.

1.4.2 Ground Water

Ground water resources are abundant only in the northern and coastal plains. Agriculture is the major source of groundwater use. It has been found that excessive use of ground water depletes aquifers, lowers the water table and may lead to salivation, water logging and alkalization of the soils.

In India, the total utilizable water resource is assessed as 1123 Billion Cubic Meters (BCM) (Table 1.1). Keeping a provision of about 71 BCM/year out of 433 BCM of groundwater, 362 BCM/year of the resource is estimated to be available for irrigation. The net draft of groundwater for irrigation is around 150 BCM/yr. The per capita availability of water at national level has been reduced from about 5177 cubic meters in 1951 to the estimated level of 1,820 cubic meters in 2001 with variation in water availability in different river basins. Given the projected increase in population by the year 2025, the per capita availability is likely to drop to below 1,000 cubic meters, which could be labelled as a situation of water scarcity (GOI, 2006).

In the major part of the country, rainfall is the only sources for water which is available mainly during the monsoon season lasting for less than 3 months. Due to tropical climate and its geographical location, the country experiences vast spatial and temporal variation in precipitation. About one- third of the country's area is drought prone. The south and western parts comprising the states of Rajasthan, Gujarat, Andhra Pradesh, Madhya Pradesh, Maharashtra, Tamil Nadu and Karnataka are the drought prone areas. On the other hand, north and north eastern regions including states of Uttar Pradesh, Bihar, West Bengal and Assam are subjected to periodic flooding.

The total availability of water in the 76 major reservoirs was 109.77 BCM at the end of the monsoon of 2005 (GOI, 2006). The Central Ground Water Board (CGWB) has estimated that it is possible to increase the groundwater availability by about 36 BCM, by taking up rainwater harvesting and artificial recharge over an area of 45 M ha through surplus monsoon runoff. Thus, the groundwater availability may correspondingly increase.

The recent estimates (GOI, 2006) on water demand are made by a) Standing Sub-Committee of the Ministry of Water Resources (MoWR) and b) the National Commission for Integrated Water Resources Development (NCIWRD); their estimates (shown in Table 1.2) are made till the year 2050. The estimates by MoWR indicates that, by year 2050, the demand for water will increase by 5 times for industries, 16 times for energy production, while its drinking water demand will double, and irrigation demand will raise by 50 percent.

Table 1.1. Availability of Water Resources in India

Sr. No	Particulars	Quantity (Billion Cubic Meter)
1.	Annual Precipitation (Including snowfall)	4000
2.	Average Annual Availability	1869
3.	Per Capita Water Availability (2001)	1820
4.	Estimated Utilizable Water Resources	1123
	(i) Surface Water Resources	690 km ³
	(ii) Ground Water Resources	433 km ³

Table 1.2 Water Demand (in BCM) for various Sectors

Sector	Standing Sub-Committee of MoWR			NCIWRD		
	2010	2025	2050	2010	2025	2050
Year	2010	2025	2050	2010	2025	2050
Irrigation	688	910	1072	557	611	807
Drinking Water	56	73	102	43	62	111
Industry	12	23	63	37	67	81
Energy	5	15	130	19	33	70
Others	52	72	80	54	70	111
Total	813	1093	1447	710	843	1180

(Source: GOI, 2006)



LESSON 2 Irrigation Development

2.1 Irrigation Development

Irrigated agriculture has developed most extensively in the arid and semi-arid regions and areas having prolonged dry spells. The practice is essentially to supplement the available rainfall in an area. The principle irrigation practice of ancient times was building of temporary bunds across streams and then diverting their flow to the fields. The practice of storing water in tanks was developed at a later stage. Modern well-designed large-scale irrigation system with reservoirs and delivery systems developed mainly after 18th century.

Vedas, Ancient Indian writers and ancient Indian scriptures have made references to wells, canals, tanks and dams. These irrigation technologies were in the form of small and minor works, which could be operated by small households to irrigate small patches of land. In the south, perennial irrigation may have begun with construction of the Grand Anicut by the Cholas as early as second century to provide irrigation from the Cauvery River. The entire landscape in the central and southern India is studded with numerous irrigation tanks which have been traced back to many centuries before the beginning of the Christian era. In northern India also there are a number of small canals in the upper valleys of rivers which are very old.

2.1.1 Irrigation during Medieval India

Irrigation is said to be one of the major reasons for the growth and expansion of the Vijayanagar Empire in southern India in the fifteenth century. Babur, in his memoirs called 'Baburnamah' gave a vivid description of prevalent modes of irrigation practices in India at that time. The Gabar Bunds captured and stored annual runoff from surrounding mountains to be made available to tracts under cultivation.

2.1.2 Irrigation Development under British rule

According to sources of irrigation close to nineteenth century; canals irrigated 45 %, wells 35 %, tanks 15 % and other sources 5 %. Famines of 1897-98 and 1899-1900 necessitated British to appoint first irrigation commission in 1901, especially to report on irrigation as a means of protection against famine in India. As a result of recommendations of the first irrigation commission total irrigated area by public and private works increased to 16 Mha in 1921. From the beginning of 19th century to 1921 there was no significant increase in tube well irrigated area. During 1910 to 1950 growths rate of irrigation was estimated at 2.0 % per annum for government canal irrigation, 0.54 % per annum for well irrigation and 0.98 % per annum in respect of irrigation from all sources.

2.1.3 Irrigation Development at Time of Independence

At time of independence net irrigated area of India under British rule which include Bangladesh and Pakistan was 28.2 M ha. After partition net irrigated area in India and Pakistan being 19.4 Mha and 8.8 Mha respectively.

Irrigation development in India was taken up in a big way after independence through major, medium and minor irrigation schemes. The irrigation potential has gone up from 22.6 Mha (9.76 Mha through Major and Medium and 12.84 Mha through Minor) prior to Plan period to 93.95 Mha by the end of IX Plan and further to 97.15 Mha (38.87 Mha through Major & Medium and 58.28 Mha through Minor) up to March 2004 against the Ultimate Irrigation Potential of 139.91 Mha (58.49 Mha through Major & Medium and

81.42 Mha through Minor). This development of irrigation facilities has largely contributed to country's self-sufficiency in food grains which has gone up from 51 Million tons in 1950 to 210 million tons in 2000. Additional Irrigation Potential of 10.50 Mha (6.5 through Major and Medium and 4.00 Mha. through Minor) is planned to be created during the X Plan totalling to 104.45 Mha by the end of the Xth Plan (MoWR, 2007).

2.2 Plan Development

- a) Accelerated Irrigation Benefit Programme (AIBP)
- b) Command Area Development and Water Management Programme (CADWM)
- c) Bharat Nirman

a) Accelerated Irrigation Benefit Programme (AIBP)

The Accelerated Irrigation Benefits Programme (AIBP) was launched during 1996-97 to provide loan assistance to the states to complete some of the incomplete major/medium irrigation projects, which were in an advanced stage of completion. The criteria for AIBP was further relaxed from April 2005 to include minor irrigation schemes of non-special category States with potential of more than 100 ha with preference to Tribal Areas and drought-prone areas. After commencement of this programme 50 major/medium and 3480 Surface minor irrigation schemes have been completed. An additional irrigation potential for 3.25 million hectare has been created through major/medium irrigation projects up to March 2005 and an irrigation potential of 123,000 hectare has been created through surface minor irrigation schemes up to March 2006 (GoI, 2006).

b) Command Area Development and Water Management Programme (CADWM)

The Centrally sponsored Command Area Development (CAD) Programme was launched in 1974-75 with the objective of bridging the gap between irrigation potential created and that utilized through efficient utilization of created irrigation potential. The other aim was optimizing agricultural production from irrigated lands on a sustainable basis. The CAD programme was initiated with 60 major and medium irrigation projects. So far 310 irrigation projects with a Culturable Command Area (CCA) of about 28.45 Mha have been included under the programme, out of which 133 projects are currently under implementation (GOI, 2005). However, there have been certain constraints which are:

- Unreliability of water supply from the government sources mainly due to system deficiency, Water logging, non-availability of drainage system and unscientific water use,
- Gap between scientific technologies of efficient water use and the technologies adopted at the farm level,
- Lack of participation of farmers in water management,
- Lack of conjunctive use of surface and groundwater, f) Non-inclusion of corrective measures for system deficiencies
- Lack of matching budgetary support by State Governments to execute the programme.

The restructured Command Area Development and Water Management Program (CADWM) from 2002, considered almost all aspects of the water resources management. The programme covers a great deal of activities responsible for bringing in greater efficiencies in land water and crop management. The success of the programme would, however, depend on the CADAs/State agencies that are implementing the program through coordination of the concerned organizations and other related inputs.

c) Bharat Nirman

Under the irrigation component of Bharat Nirman, the target of creation of additional irrigation potential of 10 M ha in 4 years (2005-06 to 2008-09) is planned to be met largely through expeditious completion of identified ongoing major and medium irrigation projects. Irrigation potential of 42 lakh hectare is planned to be created by expeditiously completing such on-going major and medium projects (GOI, 2005).

2.3 Irrigation Potential Created and Utilized

Ultimate Irrigation Potential (UIP): This term refers to the gross area that could be irrigated theoretically if all available land and water resources would be used for irrigation.

Irrigation Potential Created (IPC): This term refers to the total gross area proposed to be irrigated under different crops during a year by a scheme. The area proposed to be irrigated under more than one crop during the same year is counted as many times as the number of crops grown and irrigated.

Irrigation Potential Utilized (IPU): This term is defined as the gross area actually irrigated during the reference year out of the gross proposed area to be irrigated by the scheme.

Irrigation Potential Creation: Expansion of irrigation facilities, along with consolidation of the existing systems, has been the main part of the strategy for increasing production of food grains. With sustained and systematic development of irrigation, the irrigation potential through major, medium and minor irrigation projects has increased from 22.6 Mha in 1951, when the process of planning began in India, to about 98.84 Mha at the end of the year 2004-05. Plan wise irrigation potential created and utilized through major, medium and minor irrigation projects in the country is shown in Table 2.1 and Figure 2.1.

Table 2.1. Irrigation potential created and utilized during Plan periods in India

Plan Period	Potential (cumulative) created (Mha)	Potential (cumulative) utilized (Mha)
Pre-Plan period	22.60	22.60
First Plan (1951-56)	26.26	25.04
Second Plan (1956-61)	29.08	27.80
Third Plan (1961-66)	33.57	32.17
Annual Plans (1966-69)	37.10	35.75
Fourth Plan (1969-74)	44.20	42.19
Fifth Plan (1974-78)	52.02	48.46
Annual Plans (1978-80)	56.61	52.64
Sixth Plan (1980-85)	65.22	58.82
Seventh Plan (1985-90)	76.53	68.59
Annual Plans (1990-92)	81.09	72.86
Eighth Plan (1992-97)	86.26	77.24

Ninth Plan (1997-2002)	93.95	80.06
Tenth Plan (upto 2004-05)	98.84	83.56

(Source: www.wrmin.nic.in)

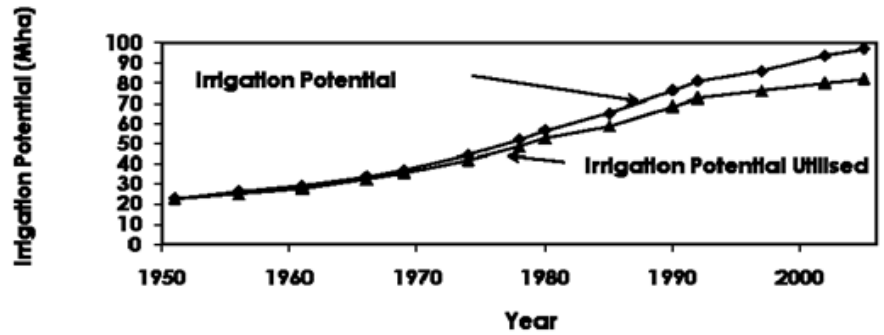

Fig. 2.1. Irrigation potential created and utilized.

2.4 Causes for gap in potential Created and Utilized (Ramanayya et al., 2008)

2.4.1 Measurement Problems

- The estimates made by the Irrigation Department do not take into account the unauthorized irrigation and pilferages of water.
- The Revenue Department goes by the revenue collected and not by actual area irrigated.
- The meaning of IPU is similar to the meaning of the GIA, but the statistics are collected and published by the Ministry of Water Resources instead of the Ministry of Agriculture. The differences between the most recent reported IPU (80.06 Mha) and GIA (75.87 Mha for 2000/2001) can be explained by the difference in the data collection and sampling strategies adopted to calculate the two quantities and by considering minor irrigation schemes inside the command area of major or medium irrigation schemes.

2.4.2 Design Problems

- There are certain assumptions made at the time of designing the project. It is necessary to verify and validate these assumptions after completing the project and redefine the quantum of potential created.
- The average rainfall in the area over a period of 30 years or so is considered while designing the project and calculating the dependable yield. It does not make any allowances for variations.
- The assumption made about the cropping pattern at the time of estimating the irrigation potential created may not hold good after implementation of the project.
- Availability of water at the beginning of each agricultural season should be the criterion for defining the potential created. In other words, the potential is based on the availability of water in a particular season and varies every year.
- The estimation of potential utilized should also take into account the canal breaches and unauthorized irrigation.

LESSON 3 Irrigation Projects

3.1 Irrigation Projects

In India irrigation has always been the largest user of water. Irrigation projects mainly consists engineering (or hydraulic) structures which collect, convey, and deliver water to areas on which crops are grown.

Irrigation projects may range from a small farm unit to those serving extensive areas of millions of hectares. A small irrigation project may consist of a low diversion weir or an inexpensive pumping plant along with small ditches (channels) and some minor control structures. A large irrigation project includes a large storage reservoir, a huge dam, hundreds of kilometres of canals, branches and distributaries, control structures, and other works (Asawa, 2005).

3.2 Irrigation Projects Classification

Irrigation projects are classified in different ways, however, in Indian context it is usually classified as follows:

3.2.1 Based on Cultural Command Area (CCA)

- Major Irrigation Projects: The area envisaged to be covered under irrigation is of the order over 10000 hectare (CCA>10,000 ha). This type of project consist huge storage reservoirs, flow diversion structures and a large network of canals. These are often multi-purpose projects serving other aspects like flood control and hydro power.
- Medium Irrigation Projects: Projects having CCA less than 10,000 ha but more than 2,000 ha are classified as medium irrigation projects. These are also multi-purpose surface water projects. Medium size storage, diversion and distribution structures are the main components of this type of project.
- Minor Irrigation Projects: Projects having CCA less than or equal to 2,000 ha are termed as minor irrigation project. The main sources of water are tanks, small reservoirs and groundwater pumping. A number of minor irrigation projects may exist individually within the command area of a major or medium irrigation project.

The Major and Medium Irrigation (MMI) projects are further classified into two types based on irrigation method adopted.

- Direct Irrigation method: In this method water is directly diverted from the river into the canal by the construction of a diversion structure like weir or barrage across the stream without attempting to store water. This method is practiced where the stream has adequate perennial supply. Direct irrigation is usually practiced in deltaic tracts that is, in areas having even and plane topography.
- Indirect or Storage Irrigation Method: In this system, water is stored in a reservoir during monsoon by construction of a dam across the river. The stored water is diverted to the fields through a network of canals during the dry period. Evidently indirect irrigation is adopted where the river is not perennial or flow in the river is inadequate during lean period.

3.2.2 Based on the Way of Water Application

The Irrigation schemes are classified into two types based on way of water application.

- Gravity/Flow Irrigation Scheme: This is the type of irrigation system in which water is stored at a higher elevation so as to enable supply to the land by gravity flow. Such irrigation schemes consists head works across river to store the water and canal network to distribute the water. The gravity irrigation scheme is further classified as:
 1. Perennial Irrigation Scheme: In this scheme assured supply of water is made available to the command area throughout the crop period to meet irrigation requirement of the crops.
 2. Non-Perennial Irrigation (Restricted Irrigation) Scheme: Canal supply is generally made available in non-monsoon period from the storage.
- Lift Irrigation Scheme: Irrigation systems in which water has to be pumped to the field or canal network form lower elevations are categorised as lift irrigation schemes.

3.3 Some of the Major Irrigation Projects

Since independence, India has developed several major irrigation projects. Some of the major irrigation projects are listed in Table 3.1 and also shown in Fig. 3.1.

Table 3.1. Major irrigation projects of India

Name	River	State	CCA, ha	Year of completion
Bhakra Nangal Project	Sutlej	Punjab and Himachal Pradesh	40,00,000	1963
Beas Project	Beas River	Punjab, Haryana and Rajasthan	21,00,000	1974
Indira Gandhi Canal	Harike (Sutlej and Beas)	Punjab	5, 28,000	1965
Koshi Project	Kosi River	Bihar and Nepal	8.48,000	1954
Hirakund Project	Mahanadi	Orisa	10,00,000	1957
Tungabhadra project	Tungbhadra -Krishna	AP-Karnataka	5,74,000	1953
Nagarjuna Sagar Project	Krishna	AP	13,13,000	1960
Chambal Project	Chambal	Rajasthan and Madhya Pradesh	5,15,000	1960
Damodar valley project	Damodar	Jharkhand, West Bengal	8,23,700	1948

Gandak project	Gandak	Bihar-UP	16,51,700	1970
Kakrapar project	Tapti	Gujarat	1,51,180	1954
Koyna Project	Koyna- krishna	Maharashtra		1964
Malprabha project	Malprabha	Karnataka	2,18,191	1972
Mayurakshi Project	Mayurakshi	West Bengal	2,40,000	1956
Kangsabati project	Kangsabati and Kumari river	West Bengal	3,48,477	1956



Fig. 3.1. Major Irrigation Projects of India.

3.3.1 Major, Medium and Minor Irrigation Projects - Potential Created and Utilized

Demand for irrigation water in India is huge; however, the limits to storage and transfer of water restrict the potential for irrigation. The assessment of Ultimate Irrigation Potential (UIP) needs to be periodically reviewed to account for revision in scope, technological advancement, inter basin transfer of water, induced recharging of ground water, etc. The UIP of projects covered under the Accelerated Irrigation Benefit Program (AIBP) is of the order of 139.9 Mha. Potential Created (PC) & Potential Utilised (PU) up to end of IXth Plan are given in Table 3.2.

Table 3.2. Sector wise UIP, PC and PU Till end of IXth Plan (in Mha)

Sector	UIP	PC	PU
MMI	58.47	37.05	31.01
Minor Irrigation (MI)			
Surface water	17.38	13.6	11.44
Ground water	64.05	43.3	38.55
Sub-Total	81.43	56.9	49.99
Total	139.9	93.95	81.00

3.3.2 Procedure for Setting up a MMI Project in India

The state planning to start a new irrigation project shall have to prepare a report based on “Guidelines for Submission, Appraisal and Clearance of Irrigation and Multipurpose Projects” brought out by the Central Water Commission (CWC). This report has to be sent to the project appraisal organization of the CWC for the clearance with a note certifying the following:

1. All necessary surveys and investigations for planning of the proposed irrigation project and establishing its economic feasibility have been carried out depending on certain guidelines.
2. 10% of the command area of the proposed project has been investigated in details in three patches of land representing terrain conditions in the command for estimation of the conveyance system up to the last farm outlets.
3. 10% of the canal structures have been investigated in full detail.
4. Detailed hydrological, geological, construction material investigations have been carried out for all major structures, that is, dams, weirs (or barrages, as the case may be), main canal, branch canal up to distributaries carrying a discharge of $10 \text{ m}^3\text{s}^{-1}$.
5. Soil survey of the command area has been carried out as per IS 5510-1969.
6. Necessary designs for the various components of the project have been done in accordance with the guidelines and relevant Indian standards. Necessary studies for utilization of ground water have been done with special regard to the problem of water logging and suitable provisions have been made for conjunctive use of ground water and drainage arrangements.
7. The cost estimates and economic evaluations were carried out as per guidelines issued by the CWC.

It may be noted that similar report has to be made even for multipurpose projects having irrigation as a component. Apart from the above techno-economic studies carried out by the state design organization, the project report should be examined by the state-level project appraisal/technical advisory committee comprising representatives of irrigation, agriculture, fisheries, forests, soil conservation, ground water, revenue and finance departments and state environmental management authority. The techno-economic feasibility report should also be supplemented with “Environmental Impact Assessment Report” and “Relief and Rehabilitation Plan” because of major impact of an irrigation project on environment.

The project proposal submitted to the CWC shall be circulated amongst the members of the advisory committee of the ministry of water resources for scrutiny. Once the project is found acceptable it shall be

recommended for investment clearance to the planning commission and inclusion in the five year plan/annual plan.

3.3 Environmental Impact of Irrigation Projects

All water resource projects, whether for irrigation or for hydro-electric power or for flood control or for water supply, are constructed for the well-being of human beings and have definite impact on the surrounding ecosystems and environment. If the projects are properly planned and suitably designed, the adverse impacts can be minimized. Environmental evaluation or assessment is generally done at the planning and design stages of the project. There is a need to develop a complete checklist of the impacts and an environmental evaluation system to quantify the impacts of irrigation projects.

The purpose of the assessment is to ensure that decision makers consider the ensuing environmental impacts when deciding whether or not to proceed with a project. The International Association for Impact Assessment (IAIA) defines an environmental impact assessment (EIA) as "the process of identifying, predicting, evaluating and mitigating the biophysical, social, and other relevant effects of development proposals prior to major decisions being taken and commitments made." EIAs are unique in that they do not require adherence to a predetermined environmental outcome, but rather they require decision makers to account for environmental values in their decisions and to justify those decisions in light of detailed environmental studies and public comments on the potential environmental impacts of the proposal.



LESSON 4 Environmental Impact Assessment & Inter Basin Water Transfer

4.1 Environmental Impact Assessment

All water resource projects, whether for irrigation or for hydro-electric power or for flood control or for water supply have definite impact on the surrounding ecosystems and environment. If the projects are properly planned and suitably designed, the adverse impacts can be minimized. Environmental evaluation or assessment is generally done at the planning and design stages of the project. There is a need to develop a complete checklist of the impacts and an environmental evaluation system to quantify the impacts of irrigation projects.

4.1.1 Definition and Purpose

The purpose of the assessment is to ensure that decision makers consider the ensuing environmental impacts when deciding whether or not to proceed with a project. The International Association for Impact Assessment (IAIA) defines an EIA as "the process of identifying, predicting, evaluating and mitigating the biophysical, social, and other relevant effects of development proposals prior to major decisions being taken and commitments made". EIA has three main functions (FAO, 53):

- to predict problems,
- to find ways to avoid them, and
- to enhance positive effects

The aim of an EIA is to ensure that potential impacts are identified and addressed at an early stage in the projects planning and design. The assessment findings are communicated to all the relevant groups who will make decisions about the proposed projects, the project developers and their investors as well as regulators, planners and the politicians. Having read the conclusions of an environmental impact assessment, project planners and engineers can shape the project so that its benefits can be achieved and sustained without causing adverse impacts.

Objective of EIA

Immediate Objectives of EIA:

- Improve the environmental design of the proposal.
- Ensure that resources are used appropriately and efficiently.
- Identify appropriate measures for mitigating the potential impacts of the proposal.
- Facilitate informed decision making, including setting of the environmental terms and conditions for implementing the proposal.

Long Term Objectives of EIA:

- Protect human health and safety.
- Avoid irreversible changes and serious damages to the environment.

- Safeguard valued resources, natural areas and ecosystem components.
- Enhance the social aspects of the proposal.

4.1.2 History of EIA

EIA was made legislation in the US in the National Environmental Policy Act (NEPA) 1969 as part of a technical evaluation that would lead to an objective decision making. It has since evolved as it has been used increasingly in many countries around the world. As per Jay et al. (2006), EIA as it is practiced today, is being used as a decision aiding tool rather than decision making tool.

The Ministry of Environment and Forests (MoEF) of India has made a substantial effort in the implementation of the EIA in India. The main laws in action are the Water Act (1974), the Indian Wildlife (Protection) Act (1972), the Air (Prevention and Control of Pollution) Act (1981) and the Environment (Protection) Act (1986). The responsible body for this is the Central Pollution Control Board. EIA studies need a significant amount of primary and secondary environmental data. The primary data are those which need to be collected in the field to define the status of the environment (like air quality data, water quality data etc.). The secondary data are those data which have been collected over the years and can be used to understand the existing environmental scenario of the study area.

4.1.3 Status of EIA in India

The importance and role for EIA was formally recognized at the earth summit held at Rio conference in 1992. Principle 17 of the Rio declaration states that –“EIA as a national instrument shall be undertaken for the proposed activities that are likely to have significant adverse impact on the environment and are subject to a decision of a competent national authority”.

In India many of the developmental projects till as recently as the 1980s were implemented with very little or no environmental concerns. The environmental issues began receiving attention when a national committee on environmental planning and coordination was set up under the 4th five year plan. Till 1980, the subjects of environment and forests were the concern of the Department of Science and Technology and Ministry of Agriculture respectively. Later, the issues were formally attended by the Department of Environment which was established in 1980. This was then upgraded to the Ministry of Environment & Forest in 1985. In 1980, clearance of large projects from the environmental angle became an administrative requirement to the extent that the planning commission and the central investment board sought proof of such clearance before according financial sanction.

Five years later, guidelines for Environmental Assessment of river valley projects were issued by the Department of Environment and Forests, Government of India. These guidelines require various studies such as impacts on forests and wild life in the submergence zone, water logging potential, upstream and downstream aquatic ecosystems and fisheries, water related diseases, climatic changes and seismicity.

A major legislative measures for the purpose of environmental clearance was in 1994 when specific notification was issued under section 3 and rule 5 of the environment protection Act, 1986 called the “Environment Impact Assessment Notification 1994”.

The first step in seeking environmental clearance for a development project is to determine what statutory legislations apply to the particular project. The MOEF has brought out several notifications restricting the development of industries in specified ecologically sensitive areas. In addition there are also draft rules framed for the siting of industries.

Environmental clearance for development projects can be obtained either at the state level or at the central level depending on certain criteria concerning the characteristics of the project. However (regardless of

where the final environmental clearance is obtained from), for most projects the consent must first be taken from the state pollution control board or pollution control committees in the case of union territories.

4.1.4 Main Steps in the EIA Process

The way in which an EIA is carried out is not rigid: it is a process comprising a series of steps.

- **Screening:** First stage of EIA, which determines whether the proposed project, requires an EIA and if it does, then the level of assessment required. The output from the screening process is often a document called an Initial Environmental Examination or Evaluation (IEE).
- **Scoping:** The process of determining the most critical issues is done in this stage. Scoping is important for two reasons. First, so that problems can be pinpointed early allowing mitigating design changes to be made before expensive detailed work is carried out. Second, to ensure that detailed prediction work is only carried out for important issues. The main EIA techniques used in scoping are baseline studies, checklists, matrices and network diagrams.
- **Prediction and Mitigation:** Once the scoping exercise is complete and the major impacts to be studied have been identified the prediction and mitigation work can start. This stage forms the central part of an EIA. The aim is to introduce measures which minimize any identified adverse impacts and also to enhance the positive impacts. Some of the techniques used for prediction are Mathematical modelling and Expert advice where as Checklists, matrices, networks diagrams, graphical comparisons and overlays are mitigation techniques.
- **Management and Monitoring:** The main output report called an Environmental Impact Statement contains a detailed plan for managing and monitoring the environmental impacts both during and after implementation of the project. The part of the EIS covering monitoring and management is often referred to as the Environmental Action Plan or Environmental Management Plan. The purpose of monitoring is to compare predicted and actual impacts, especially if the impacts are critical to the society or ecosystem or the scale of the impact cannot be accurately predicted.
- **Auditing:** Finally, an audit of the EIA process is carried out some times after the implementation. The audit serves a useful feedback and learning function. The audit should include an analysis of the technical, procedural and decision-making aspects of the EIA.
- **Managing Uncertainty:** An EIA involves prediction and thus uncertainty is an integral part. There are two types of uncertainties that associated with the EIAs viz. processes and predictions. For processes, the uncertainty lies in the proper assessment of the importance of the different aspects and in accepting or discarding of the recommendations. For predictions the uncertainty lies in the accuracy of the findings.

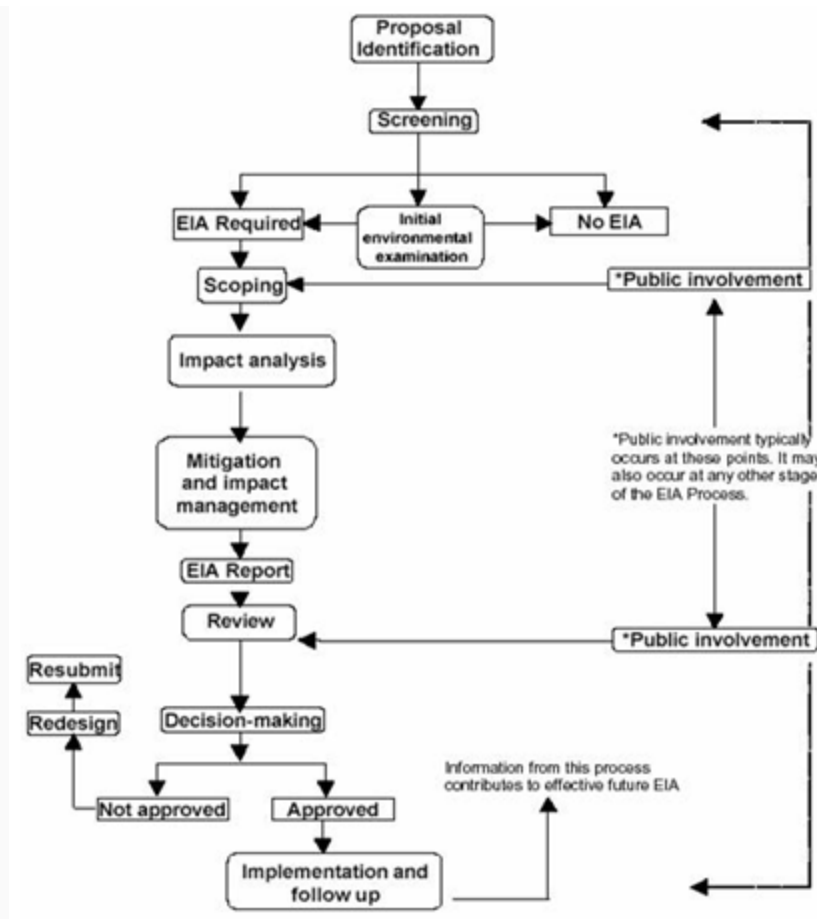

Fig. 4.1. EIA Process.

The three core values of any EIA study that have been identified till date are:

1. Integrity: The EIA process should be fair, objective, unbiased and balanced.
2. Utility: The EIA process should provide balanced, credible information for decision- making.
3. Sustainability: The EIA process should result in environmental safeguards which are sufficient to mitigate serious adverse effects and avoid irreversible loss of resource and ecosystem functions.

4.2 Inter Basin Water Transfer (IBWT)

Water transfer is one of the most important ways to eliminate water resources deficits and to solve water management problems.

4.2.1 The Need

The spatial and temporal variability of rainfall distribution results in surplus and deficit available water resources in many of the river basins in India at the same time. The river basins with surplus (largely unutilized) water resources often cause floods and hence submergence of crops whereas the river basins with lesser available water cause draughts. Making the required water (of proper quantity and quality) available at the place of need at the proper time is the duty of the government. These calls for the development and management of the water resources in an integrated and sustainable manner: equitably, economically and efficiently. This management process is broadly termed as Integrated Water Resources Development and Management which includes both within basin and inter-basin water transfer (Thatte, 2006).

4.2.2 Definition and Objective

Inter-basin water transfer (IBWT) schemes are used to describe man-made conveyance schemes which move water from one river basin where it is surplus, to another basin where water is scarce. The major objective of the proposed inter-basin transfer of water is to meet requirements of highly water deficit areas, where no other sources are available. IBWT projects are commonly proposed as solutions to water distribution and supply problems.

4.2.3 Emergence of Concept

The earliest linking works of river basin in India are the Periyar-Vaigai Project of late 19th century. Parambikulam-Aliyar Project, Kurnool-Cudappa canal and the recent Telugu Ganga Project are other examples. The concept of inter-basin transfer of water within India has been started for over 40 years with two independent inter-basin water transfer proposals. The first Dr. K. L. Rao's proposal (1972) known as the 'Ganga-Cauvery Link' consisted of 2640 km link from Ganga near Patna to transfer the water to the south during high flow. Another proposal which received considerable publicity was that of Captain Dastur's proposal (1977) known as the 'Garland Canal Link' consisted of a 4200 Km long 'Himalayan Canal' and a 9300 km long 'Southern Garland Canal'. After study of these proposals, the Government of India in 1980 prepared a National Perspective Plan for interlinking the rivers. The plan comprises two components:

- The Himalayan Rivers Development: The Himalayan river component envisages storages and interlinking canal systems to transfer surplus flows of the Kosi, Gandak and Ghagra to the west; Brahmaputra-Ganga link to augment the dry weather flows of the Ganga; Ganga-Yamuna link to serve the drought areas of Haryana, Rajasthan, Gujarat and also south Uttar Pradesh and south Bihar. This scheme will benefit not only parts of India but also neighbouring countries of Nepal and Bangladesh (NWDA, 1998).
- The Peninsular Rivers Development: Among the Peninsular rivers, the Mahanadi and Godavari are considered to have sizeable surpluses after meeting the existing and projected needs of the states within these basins. It is therefore, proposed to build terminal storages on Mahanadi and Godavari rivers to divert surplus flows of Mahanadi to the Godavari system and to further transfer surplus from the Godavari system to water short rivers namely, Krishna, Pennar and Cauvery. This component is divided into four major parts:
 - Interlinking of Mahanadi-Godavari-Krishna-Cauvery rivers and building storages at potential sites in these basins.
 - Interlinking of west flowing rivers, north of Mumbai and south of Tapi.
 - Interlinking of Ken-Chambal rivers.
 - Diversion of other west flowing rivers.

4.2.4 Classification of IBWT Projects (Proceedings of the International Workshop on Inter-basin Water Transfer, 1999)

At present, a great number of various water transfer systems operate or are under construction (local, intra-basin, inter-basin, inter-zonal, etc.). The amount of transferred volume (V) and distance (L) of the transfer are the most important characteristics of such systems. These components determine both the cost of the system and its impact on the environment. It is thus reasonable to classify the water transfer systems

by using a combined index ($V \times L$). The classification of water transfer projects by this indicator is shown in Table 4.1.

Table 4.1. Classification of water transfer projects according to its scale

Category of transfer	Volume (V, km ³ /yr)	Distance (L, km)	Scale index (V x L, km ³ /yr.km)
Small	<1	<100	<100
Medium	1-2.5	100-400	100-1000
Large	2.5-5	400-1000	1000-5000
Very large	5-10	1000-2500	5000-25000
Largest	>10	>2,500	>25000

4.2.5 Some of the Existing Inter-basin Water Transfers Projects

Long distance inter basin transfer of water is not a new concept and has been in practice in India since long. The details for some of the existing links for inter-basin transfer of water are given Table 4.2.

Table 4.2. Some of Existing IBWT Projects in India

Project Name	Location	Description
Periyar Project	Southern India	Transfer water from Periyar river in Kerala to the Vaigai basin in Tamil Nadu
<u>Parambikulam Aliyar Project</u>	Southern India	Transfer water from Chalakudy river basin to the Bharatapuzha and Cauvery basins for irrigation in Coimbatore district of Tamil Nadu and the Chittur area of Kerala states
<u>Kurnool Cudappah Canal</u>	Southern India	Transfer water from <u>Krishna River</u> basin to the <u>Pennar</u> basin
<u>Telugu Ganga Project</u>	Southern India	It brings <u>Krishna River</u> water through 406 km of canals
<u>Indira Gandhi Canal</u>	Northern India	Linking the Ravi river, the Beas river and the Sutlej river through a system of dams, hydropower plants, tunnels, canals and irrigation systems

4.2.5 Environmental Impacts of Inter-basin Water Transfer Projects

In India, the planners are familiar with the social and environmental concerns caused by small, medium and large inter-basin projects. So, Environmental Assessment (EA) has become a necessary step in the evaluation of any major irrigation project, including IBWT projects. It was noted that EAs are sometimes simplified to safeguard water quality. Some of the impacts caused by IBWT projects are shown below:

- These projects lead to inadvertent introduction of flora and fauna alien to the recipient basin from the donor basin. This introduced flora and fauna could theoretically grow to a proportion where it becomes a menace to the ecology of the recipient area and can disturb the ecological balances.
- The large storages and long links could involve a much larger resettlement problem.
- The link canals may involve large scale interruption of natural drainage and also a large barrier between neighbouring communities.



LESSON 5 Methods of Water Measurements in Open Channels

5.1 Units of Water Measurement

Irrigation water is conveyed either through open channels or pipes and knowing the quantity of water available is essential for irrigation water management. Sometimes one will want to know only the volume of water used; while, at other times one will want to know the rate of flow. Conversion factors simplify changing from one unit of measurement to another.

Water may be measured in two condition viz. (i) at rest and (ii) in motion. At rest means volume of water is measured and different units used for volume measurement are litre, cubic metre, hectare-centimetre, hectare-metre etc. Water is measured in motion means rate of flow is measured and different units used for this are litre per second, cubic metre per second, etc.

1. Litre: The volume equal to one cubic decimetre or 1/1000 cubic metre.
2. Cubic metre: A volume equal to that of a cube 1 metre long, 1 metre wide and 1 metre deep.
3. Hectare - centimetre: A volume necessary to cover an area of 1 hectare (10,000 sq.m) up to a depth of 1 centimetre (1 hectare - centimetre = 100 cu. m = 100,000 litres)
4. Hectare -metre: A volume necessary to cover 1 hectare (10,000 sq.m) up to a depth of 1 metre (1 hectare -meter = 10,000 cu. m = 10 M litres)
5. Litre per second: A continuous flow amounting to 1 litre passing through a point each second.
6. Cubic metre per second: A flow of water equivalent to a stream 1 metre wide and 1 metre deep, flowing at a velocity of 1 metre per second.

5.1.1 Methods of Water Measurements

There are several methods used for the measurements of irrigation water on the farm. They can be grouped into four categories as,

1. Volumetric or volume methods of water measurement
2. Area - Velocity Method
3. Measuring Structures (Orifices, Weirs and Flumes)
4. Tracer methods.

5.2 Volume Methods of Water Measurement

This method is suitable for measuring small irrigation stream. In this case, water is collected in a container of known volume and the time taken to fill the container is recorded. The rate of flow is measured by the formula

$$\text{Discharge rate } \left(\frac{l}{s}\right) = \frac{\text{Volume of container (l)}}{\text{Time required to fill (s)}}$$

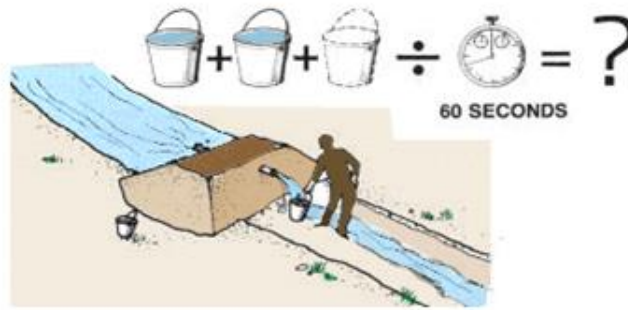

5.1. Volume Method.

5.2.1 Area-velocity Method

The rate of flow of water passing a point in open channel is determined by multiplying the cross sectional area of the flow section at right angles to the direction of flow by the average velocity of water. The cross sectional area is determined by measuring the depths at various locations. The depth can be measured by different methods like sounding rods or sounding weights or echo-depth sounder for accurate measurement.

For discharge calculation the entire cross section is divided into several subsections and the average velocity at each of these sub-sections is determined by current meters or floats. The accuracy of discharge measurement increases with the increase in the number of segments. Some guidelines for choosing the number of sections are:

- The discharge in the segment should not be more than 10% of total discharge.
- The difference in velocities between two adjacent sections should not be more than 20%.
- The segment width should not $1/15^{\text{th}}$ to $1/20^{\text{th}}$ of total width.

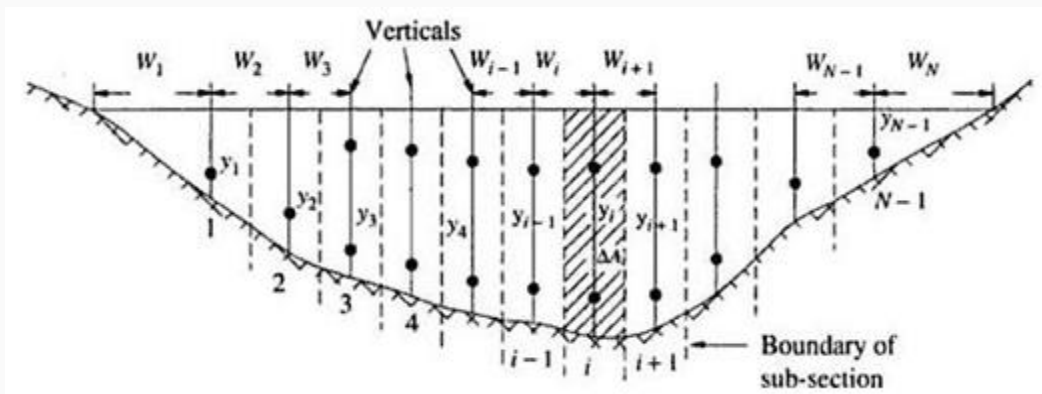

Fig.5.2. Stream section for area velocity method.

Calculation of Discharge

The total discharge is calculated using the method of mid sections. It has been considered that the section is divided into N-1 sections.

$$Q = \sum_{i=1}^{N-1} \Delta Q_i \quad \text{.....(5.2)}$$

Where,

ΔQ_i = discharge in i^{th} section.

= (depth at i^{th} section) \times ($\frac{1}{2}$ width to the left + $\frac{1}{2}$ width to the right) \times (average velocity in the i^{th} section)

$$= y_i \times \left(\frac{w_i}{2} + \frac{w_{i+1}}{2} \right) \times v_i \text{ (for } i=2 \text{ to } i=N-1) \quad \text{.....(5.3)}$$

For the first and last sections, the area is calculated as:

$$\Delta A_1 = y_1 \bar{W}_1 \quad \text{.....(5.4)}$$

where,

$$\bar{W}_1 = \frac{(w_1 + \frac{w_2}{2})^2}{2w_1} \quad \text{.....(5.5)}$$

and

$$\Delta Q_1 = \Delta A_1 \cdot \bar{v}_1 \quad \text{.....(5.6)}$$

Similarly

$$\Delta Q_{1N-1} = \Delta A_{N-1} \cdot \bar{v}_{N-1} \quad \text{.....(5.7)}$$



Fig.5.3. Discharge measurement at a section.

The cross sectional area is determined as discussed above and velocity is generally measured with a current metre. Approximate values of velocity may also be obtained by the float method. The detailed description of current meter method is given in section 5.2.2.

5.2.1.1 Float Method

It is inexpensive and simple. This method measures surface velocity. Mean velocity is obtained using a correction factor. The basic idea is to measure the time that it takes for the object to float a specified distance downstream.

$$V_{\text{surface}} = \text{travel distance} / \text{travel time} = L/t \quad \text{.....(5.8)}$$

Because surface velocities are typically higher than mean or average velocities

$$V_{\text{mean}} = k \cdot V_{\text{surface}} \quad \text{.....(5.9)}$$

Where,

k is a coefficient that generally ranges from 0.8 for rough beds to 0.9 for smooth beds (0.85 is a commonly used value).

Step 1- Choose a suitable straight reach with minimum turbulence (ideally at least 3 channel widths long).

Step 2 - Mark the start and end point of your reach.

Step 3 - If possible, travel time should exceed 20 seconds.

Step 4 - Drop your object into the stream upstream of your upstream marker.

Step 5 - Start the watch when the object crosses the upstream marker and stop the watch when it crosses the downstream marker.

Step 6 -You should repeat the measurement at least 3 times and use the average velocity in further calculations.

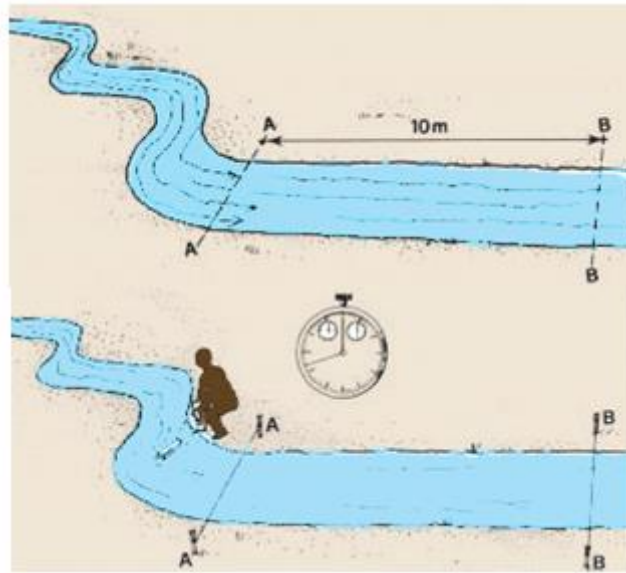

Fig.5.4. Float Method

5.2.2 Current Meters

In the area velocity method current meters are generally used to measure the velocity of flow at the different sections. The current meter consists of a small revolving wheel or vane that is turned by the movement of water. It may be suspended by a cable for measurements in deep streams or attached to a rod in shallow streams. The propeller is rotated by the flowing water and speed of propeller is proportional to the average velocity of flow. Corresponding to the number of revolutions, the velocity can be obtained from calibration graphs or tables.



Fig. 5.5. Current meter.

Procedure for velocity measurement using the current meter: Stretch a tape across the channel cross-section. Divide the distance across the channel to at least 25 divisions. Use closer intervals for the deeper parts of the channel.

1. Stretch a tape across the channel cross-section. Divide the distance across the channel to at least 25 divisions. Use closer intervals for the deeper parts of the channel.
2. Start at the water's edge and call out the distance first, then the depth and then the velocity. Stand downstream from the current meter in a position such that the velocity is least affected by the meter. Hold the rod in a vertical position with the meter directly into the water.
3. To take a reading, the meter must be completely under water, facing the current, and free of interference. The meter may be adjusted slightly up or downstream to avoid boulders, snags and other obstructions. The note taker will call out the calculated interval, which

the meter operator may decide to change (e.g., taking readings at closer intervals in deep, high-velocity parts of the channel). Record the actual distance called out by the meter operator as the center line for the subsection.

- Take one or two velocity measurements at each subsection.
 - If depth (d) is less than 60 cm, measure velocity once for each subsection at 0.6 times the total depth (d) measured from the water surface.
 - If depth (d) is greater than 60 cm, measure velocity twice, at 0.2 and 0.8 times the total depth. The average of these two readings is the velocity for the subsection.
4. Allow a minimum of 40 seconds for each reading. The operator calls out the distance, then the depth, and then the velocity. The note taker repeats it back as it is recorded, as a check.
 5. Calculate discharge in the field. If any section has more than 5% of the total flow, subdivide that section and make more measurements.

Current meters are designed in a manner such that the rotation speed of the blades varies linearly with the stream velocity. This can be expressed by the following equation:

$$v = a N_s + b \quad \dots\dots\dots(5.10)$$

Where,

v = stream velocity at measuring site in m/s

N_s = revolutions per second of the meter

a, b = constants of the meter.

To determine the constants, which are different for each instrument, the current meter has to becalibrated before use. This is done by towing the instrument in a tank at a known velocity and recording the number of revolutions N_s. This procedure is repeated for a range of velocities.

It has to be kept in mind that for shallow streams the measurement can be taken at a depth= 0.6 of the total depth, whereas for deeper streams two measurements are needed at 0.2 and 0.8 of total depth and then averaged to get the actual velocity.

Example 5.1:

Data pertaining to a stream-gauging operation at a gauging site are given below. The rating equation of the current meter is $v = 0.63N_s + 0.08m/s$. where N_s = revolutions per second. Calculate the discharge in the stream.

Distance from the left water edge (m)	0	5.0	8.0	11.0	14.0	17.0	20.0	24.0
Depth (m)	0	1.8	3.4	4.6	3.7	2.6	1.5	0
Revolutions of a current meter kept at 0.6 depth	0	42	55	93	87	48	28	0
Duration of observation (s)	0	120	120	125	135	110	100	0

Solution:

$$\bar{W} = \frac{(W_1 + \frac{W_2}{2})^2}{2W_1}$$

For the last and first section using equation

Average width,

$$= \frac{(5 + \frac{3}{2})^2}{2 \times 5} = 4.225 \text{ m}$$

For the rest of the segments,

$$\bar{W} = \left(\frac{W_i}{2} + \frac{W_{i+1}}{2} \right)$$

$$= \left(\frac{3}{2} + \frac{3}{2} \right) = 3.0 \text{ m}$$

Since the velocity is measured at 0.6 depth the measured velocity is the average velocity at that vertical

The calculation of discharge is shown below:

Distance from the left water edge (m)	Average width (m)	Depth y (m)	$N_s = \text{rev./sec}$	Velocity (m/s)	Segmental discharge (m ³ /s)
0	0	0			0.0000
5	4.225	1.8	0.350	0.3005	2.2853
8	3	3.4	0.458	0.3688	3.7613
11	3	4.6	0.744	0.5487	7.5723
14	3	3.7	0.644	0.4860	5.3946
17	3	2.6	0.436	0.3549	2.7683
20	4.225	1.5	0.280	0.2564	1.6249
24	0	0			0.0000
Sum				= 23.4067	

∴ Discharge in the stream = 23.40 m³/s **Ans.**

5.2.3 Other Method

5.2.3.1 Tracer Method

In the tracer-dilution methods, a tracer solution is injected into the stream at one point and the tracer is measured at a point downstream to the first point. Knowing the rate and concentration of tracer in the injected solution and the concentration in the downstream section, the stream discharge can be computed. Either constant rate injection method or sudden injection method may be used for determining the discharge of a stream by tracer dilution.

Constant rate injection method: In this method the tracer solution is injected at a constant rate into the stream till a constant concentration of the tracer in the stream flow at the downstream sampling cross section is achieved. Fig. 5.6 shows constant rate injection system.

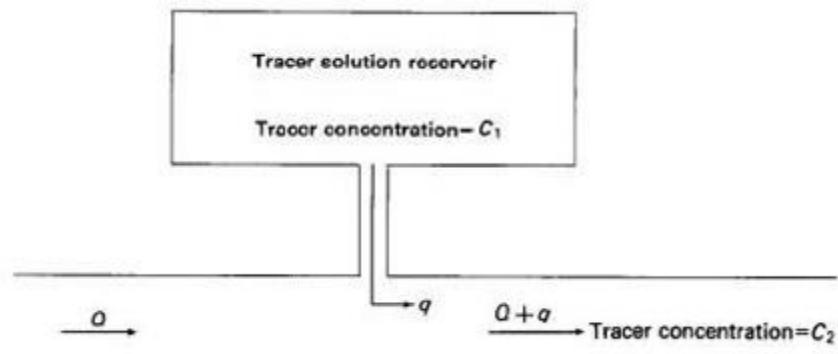

Fig.5.6.Constant rate injection system.

If the tracer is injected for a sufficiently long period, sampling of the stream at the downstream sampling cross section will produce a concentration-time curve similar to that shown in Fig. 5.7.

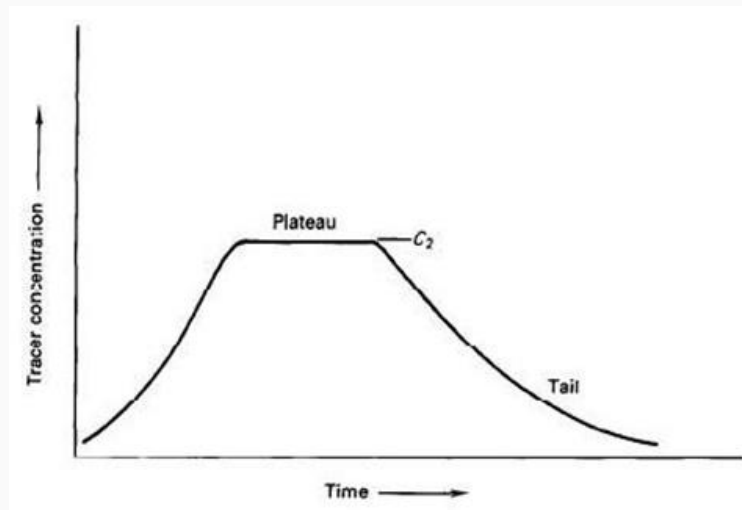

Fig. 5.7. Concentration-time curve at downstream sampling site for constant-rate injection.

The stream discharge is computed from the equation for the conservation of mass, which follows:

$$QC_b + qC_1 = (Q + q)C_2$$

.....(5.11)

$$Q = \left[\frac{C_1 - C_2}{C_2 - C_b} \right] \cdot q$$

.....(5.12)

Where,

q is the rate of flow of the injected tracer solution,

Q is the discharge of the stream,

C_b is the background concentration of the stream,

C₁ is the concentration of the tracer solution injected into the stream, and

C₂ is the measured concentration of the plateau of the concentration-time curve (Fig. 5.7).

Example 5.2:

A 12g/L solution of a tracer was discharged into a stream at a constant rate of 15 cm³s⁻¹. The background concentration of the dye in the stream water was found to be 2 parts per billion. At a downstream location sufficiently far away, the dye was found to reach an equilibrium concentration 7 parts per billion. Estimate the stream discharge.

Solution:

From equation 5.12 we know the stream discharge,

$$Q = \left[\frac{C_1 - C_2}{C_2 - C_b} \right] \cdot q$$

Given: q = 15 cm³/s = 15 x 10⁻⁶ m³s⁻¹

C₁ = 0.012, C₂ = 7 x 10⁻⁹, C_b = 2 x 10⁻⁹

Putting the above values in the equation,

$$Q = \left[\frac{0.012 - 7 \times 10^{-9}}{7 \times 10^{-9} - 2 \times 10^{-9}} \right] \times 15 \times 10^{-6}$$

= 60 m³/s

∴ Discharge through the stream = 60 m³/s **Ans.**

LESSON 6. Weirs

6.1 Introduction

Effective use of water for irrigation requires that flow rates and volumes be measured and expressed quantitatively. Measurement of flow rates in open channels is difficult because of non-uniform channel dimensions and variations in velocities across the channel. A weir is a calibrated instrument used to measure the flow in an open channel, or the discharge of a well or a canal outlet at the source.

6.1.1 Terms Used

1. **Weir Pond:** Portion of the channel immediately upstream from the weir.
2. **Weir Crest:** The edge over which the water flows is the weir crest.
3. **Broad-crested weir:** A weir having a horizontal or nearly horizontal crest sufficiently long in the direction of flow. When the crest is "broad", the streamlines become parallel to the crest invert and the pressure distribution above the crest is hydrostatic.
4. **Sharp Crested Weir:** A weir having thin- edged crest such that the over flowing sheet of water has the minimum surface contact with the crest. A sharp-crested weir allows the water to fall cleanly away from the weir, e.g., V notch, Cipolleti weir etc. Fig. 6.1 shows sharp crested weir.
5. **Head:** The depth water flowing over the weir crest measured at some point in the weir pond.
6. **End Contraction:** The horizontal distance from the ends of the weir crest to the sides of the weir pond.
7. **Weir Scale or Gauge:** The scale fastened on the sides of the weir or on a stake in the weir pond to measure the head on the weir crest.
8. **Nappe:** The sheet of water which overflows a weir is called a nappe.

6.1.2 Advantages of Weirs

- a) Capable of accurately measuring a wide range of flows
- b) Can be both portable and adjustable
- c) Easy to construct
- d) Tends to provide more accurate discharge rating than flumes and orifices

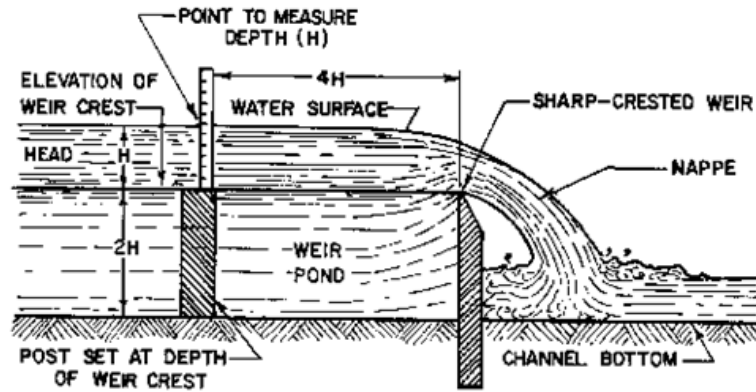

Fig. 6.1. Profile of a Sharp-crested weir.

6.1.3 Disadvantages of Weir

- a) Relatively large head required, particularly in free flow condition.
- b) The upstream pool must be maintained clean of sediment and kept free of weeds and trash. Otherwise, measurement accuracy will be compromised.

6.2 Classification of Weirs

Weirs are classified based on the shape of their opening or notch. The edge of the opening can be either sharp or broad-crested.

6.2.1 Sharp-Crested Weir

These are generally used for water measurement on the farm. They are generally of three types depending upon the shape of notch. These are

- Rectangular Weir
- Cipolletti Weir or Trapezoidal Weir
- V Notch Weirs or Triangular Weir

Fig. 6.2 shows different types of sharp created weirs.

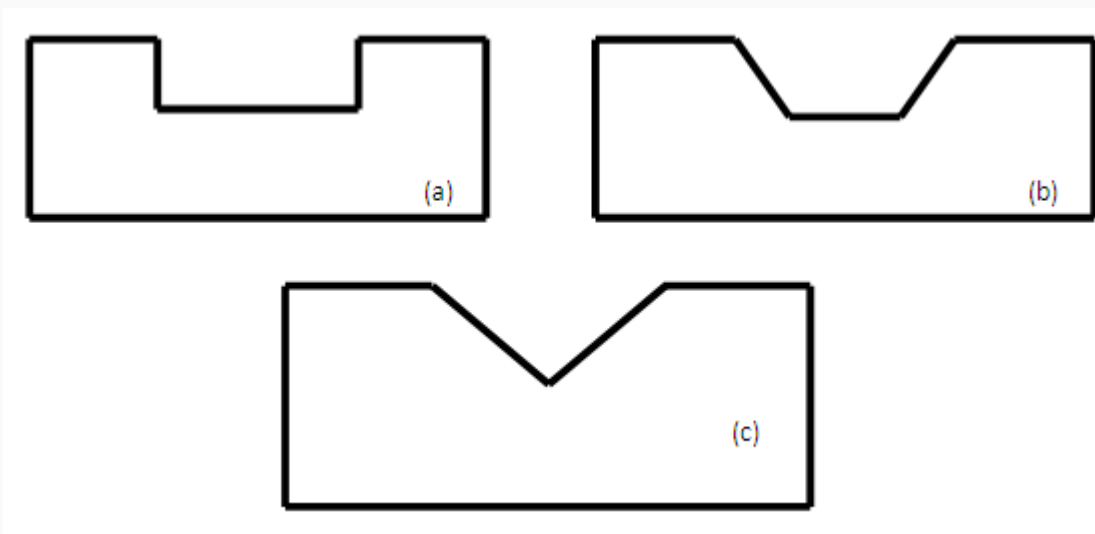

Fig. 6.2. Sharp created weirs (a) rectangular, (b) Cipolletti or trapezoidal and (c) V-notch or triangular.

6.2.2 Broad-crested Weirs

A weir that has a horizontal or nearly horizontal crest sufficiently long in the direction of the flow so that the nappe will be supported and hydrostatic pressures will be fully developed for at least a short distance. Broad crested weir is shown in Fig. 6.3.

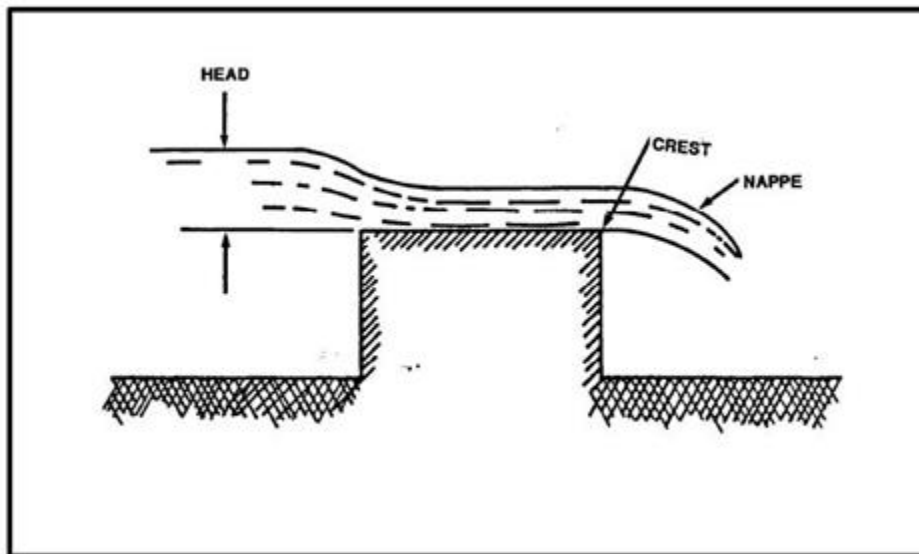

Fig. 6.3. Broad crested weir.

Weirs may also be classified as suppressed and contracted.

6.2.3 Suppressed Weir

A rectangular weir whose notch or opening sides are coincident with the sides of the approach channel, also rectangular, which extend unchanged downstream from the weir. It is the lateral flow contraction that is "suppressed". Fig. 6.4 shows suppressed and contracted rectangular weir.

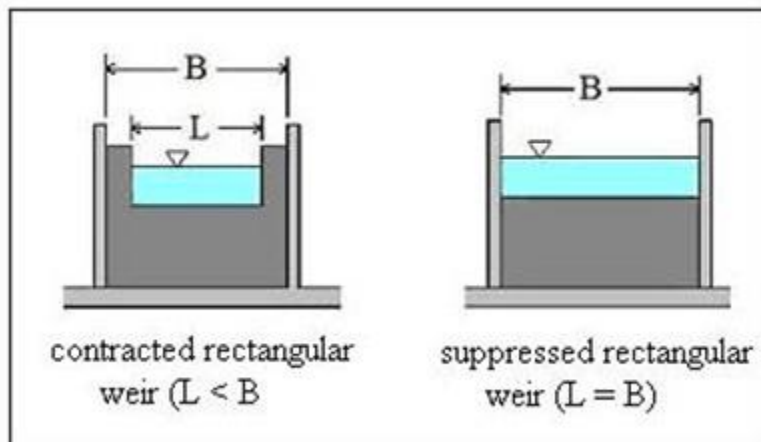

Fig. 6.4. Suppressed and contracted rectangular weir.

6.2.4 Contracted Weir

The sides and crest of a weir are far away from the sides and bottom of the approach channel. The nappe will fully contract laterally at the ends and vertically at the crest of the weir. Also called an "unsuppressed" weir.

6.3 Rectangular Weirs

Rectangular weir takes its name from the shape of its notch. The discharge through a weir or notch is directly related to the water depth (H), (Fig. 6.5) and H is known as the head. This head is affected by the condition of the crest, the contraction, the velocity of approaching stream and the elevation of the water surface downstream from the weir. Rectangular weirs can be suppressed, partially contracted, or fully contracted.

6.3.1 Derivation of Equation

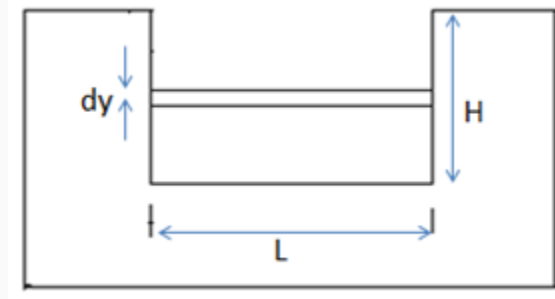

Fig. 6.5. Definition sketch for rectangular weir.

Consider Fig. 6.5

$$\text{Cross sectional area} = a = L.dy \quad \dots\dots(6.1)$$

Velocity,

$$V = \sqrt{2gy} \quad \dots\dots(6.2)$$

Total discharge

$$Q = \int_0^H L dy \cdot \sqrt{2gy} \quad \dots\dots(6.3)$$

$$= L \cdot \sqrt{2g} \left[\frac{y^{\frac{3}{2}}}{\frac{3}{2}} \right]_0^H$$

$$= \sqrt{2g} \cdot L \cdot \frac{2}{3} \cdot H^{\frac{3}{2}}$$

$$= \frac{2}{3} L \sqrt{2g} \cdot H^{\frac{3}{2}} \quad \dots\dots(6.4)$$

Let

$$C = \frac{2}{3} \sqrt{2g} = \text{Discharge coefficient of weir.}$$

$$Q = CLH^{\frac{3}{2}} \quad \dots\dots\dots(6.5)$$

If Q = lt/s, L and H in cm then,

$$Q = 0.0184LH^{\frac{3}{2}} \quad \dots\dots\dots(6.6)$$

For one side contraction,

$$Q = 0.0184 (L-0.1H)H^{\frac{3}{2}} \quad \dots\dots\dots(6.7)$$

For both side contraction,

$$Q = 0.0184(L-0.2H)H^{\frac{3}{2}} \quad \dots\dots\dots(6.8)$$

Example 6.1:

Water flows through a contracted rectangular weir 120 cm long to a depth of 30 cm, it then flows along a rectangular channel 150 cm wide and over a second weir which has length equal to the width of the channel. Determine the depth of water over the second weir.

Solution:

The first weir is contracted, i.e. both end contracted.

Given,

Length of the weir (L) = 120 cm

Depth of water over the weir (H) = 30 cm

$$\begin{aligned} \text{So, Discharge of flow} &= 0.0184(L - 0.2H)H^{\frac{3}{2}} \\ &= 0.0184 * (120 - 0.2 * 30) * 30^{\frac{3}{2}} \\ &= 344.67 \text{ L/sec} \end{aligned}$$

In second weir, length of the weir (L) =150 cm

Discharge through first weir and second weir is same.

Let assume, depth of water over second weir is = H cm

Now,
$$Q = 0.0184LH^{\frac{3}{2}}$$

$$344.67 = 0.0184 * 150 * H^{\frac{3}{2}}$$

H = 24.97 cm Ans.

So, the depth of water over the second weirs is 24.97 cm.

6.4 Cipoletti Weirs

The Cipolletti weir (Fig. 6.6) is trapezoidal in shape. The slope of the sides, inclined outwardly from the crest, should be one horizontal to four vertical. The selected length of notch (L) should be at least 3H and preferably 4H or longer. Cipoletti weirs are considered fully contracted.

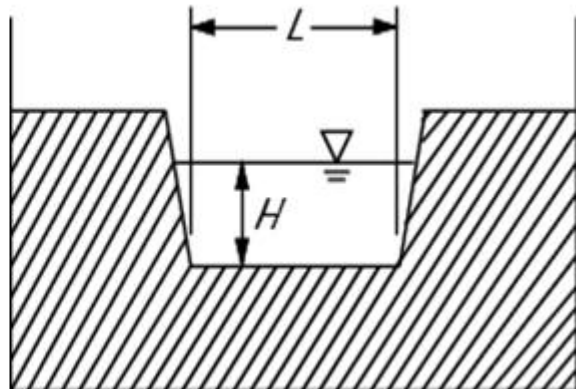

Fig. 6.6 Cipoletti weirs.

Discharge through Cipoletti weir is calculated as:

$$Q = 0.0186 L H^{\frac{3}{2}} \quad (6.9)$$

Example 6.2:

A Cipolletti weir has a breadth of 60 cm at its crest. The head of water flowing over the crest is 30 cm. Determine its discharge.

Solution:

Given,

Crest width (L) = 60 cm

Head of flow over the crest (H) = 30 cm

So, discharge through the weir (Q) = $0.0186 L H^{\frac{3}{2}}$

$$Q = 0.0186 * 60 * 30^{\frac{3}{2}}$$

= 183.37 L/sec

Discharge of Cipoletti weir is 183.37 L/sec Ans.

6.5 V- notch Weir

In this case, the notch is “V” in shape. Depth of water above the bottom of the V is called head (H). The V-notch design causes small changes in discharge hence causing a large change in depth and thus allowing more accurate measurement than with a rectangular weir. Head (H) should be measured at a distance of at least 4H upstream of the weir.

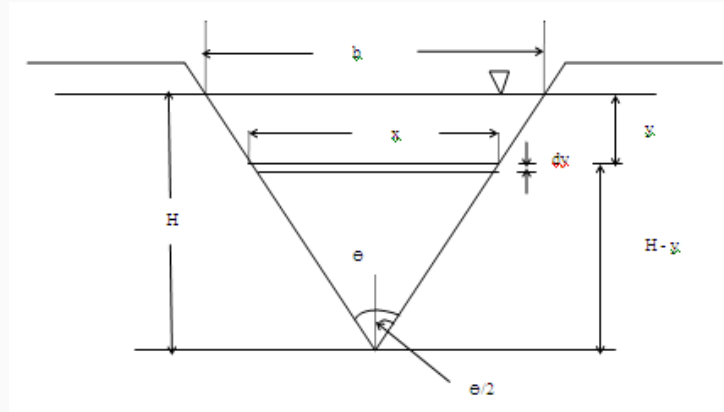

Fig.6.7. Triangular notch weir.

Derivation of Equation:

Consider the Fig. 6.7,

$$\text{Crosssectional area, } dA = xdy \quad (6.10)$$

$$\text{Velocity of flow, } V = \sqrt{2gy} \quad (6.11)$$

$$dQ = xdy \cdot \sqrt{2gy} \quad (6.12)$$

By Similar triangles $\frac{x}{b} = \frac{H-y}{H}$ and $b = 2H \tan \frac{\theta}{2}$

On Substituting and integrating both sides of Eq. 6.12,

$$Q = \int_0^H 2(H-y)\sqrt{2gy} \cdot \tan\left(\frac{\theta}{2}\right) dy$$

$$= 2\sqrt{2g} \tan\left(\frac{\theta}{2}\right) \int_0^H (H\sqrt{y} - y\sqrt{y}) dy$$

$$\begin{aligned}
 &= 2\sqrt{2g} \tan\left(\frac{\theta}{2}\right) \left[\frac{2}{3}H \cdot y^{\frac{3}{2}} - \frac{2}{5}y^{\frac{5}{2}}\right]_0^H \\
 &= 2\sqrt{2g} \tan\left(\frac{\theta}{2}\right) \left[\frac{2}{3}H^{\frac{5}{2}} - \frac{2}{5}H^{\frac{5}{2}}\right] \\
 &= 2\sqrt{2g} \tan\left(\frac{\theta}{2}\right) H^{\frac{5}{2}} \left(\frac{2}{3} - \frac{2}{5}\right) \\
 &= \frac{8}{15}\sqrt{2g} \tan\left(\frac{\theta}{2}\right) H^{\frac{5}{2}} \\
 &\quad (6.13)
 \end{aligned}$$

$$Q = C \cdot H^{\frac{5}{2}} \quad (6.14)$$

Where,

$$C = \frac{8}{15}\sqrt{2g} \tan\left(\frac{\theta}{2}\right) \quad (6.15)$$

If $\theta = 90^\circ$ then

$$C = \frac{8}{15}\sqrt{2g}$$

For $\theta = 90^\circ$, H in cm and Q in L/s

$$Q = 0.0138H^{\frac{5}{2}} \quad (6.16)$$

Example 6.3:

Determine discharge of 90° V-notch having 30 cm head of flow.

Solution:

Discharge through V-notch $Q = 0.0138H^{\frac{5}{2}}$

$$\begin{aligned}
 &= 0.0138 * 30^{\frac{5}{2}} \\
 &= 68.02 \text{ L/sec}
 \end{aligned}$$

So, Discharge through 90° V-notch having 30 cm head of flow is 68.02 litres/sec.

6.6 Operation & Limitations

Properly constructed and installed weirs provide most accurate flow measurement. However improper setting and operation may result in large errors in the discharge measurements. To ensure reliable results in measurement, the following precautions are necessary in the use of weirs.

1. The weirs should be set at lower end of a long pool sufficiently wide and deep having smooth flow at velocities less than 15cm/sec.
2. Baffles may be put in weir pond to reduce velocity.
3. The weir wall must be vertical.
4. The center line of the weir should be parallel to the direction of flow.
5. The crest of weir should be level so that water passing over it will be of the same depth at all points along the crest.
6. Notch should be of regular shape and its edge must be rigid and straight.
7. The weir crest should be above the bottom of the approach channel.
8. The crest of weir should be placed high enough so that water will fall freely below weir.
9. The depth of water flow over the rectangular weir should not less than about 5 cm and not more than about 2/3 crest width.
10. The scale or gauge used for measuring the head should be located at a distance of about four times the approximate head. Zero of scale should be exactly at the same level as the crest level of the weir.

Limitations of Weirs:

1. Weirs are not always suitable for measuring flow. Sufficient head is required for operating any type of weir.
2. They are not accurate unless proper conditions are maintained.
3. They require a considerable loss of head which is mostly not available in channels on flat gradients.
4. Weirs are not suitable for water carrying silt.
5. Weirs are not easily combined with turnout structures.



LESSON 7 Flumes

7.1 Parshall Flume

Parshall flumes are devices for the measurement of flow of water in open channels when depth of flow is less i.e., head drop is very small, the volume of flow is less and channel bed slope is less. The flume consists a converging section with a level floor and walls converges towards the throat section, a throat section with a downward sloping floor and parallel walls, and a diverging section with an upward sloping floor and diverging walls towards the outlet. The size of flume is determined by the width of its throat. The size ranges from 7.5 cm to several metres in throat width.

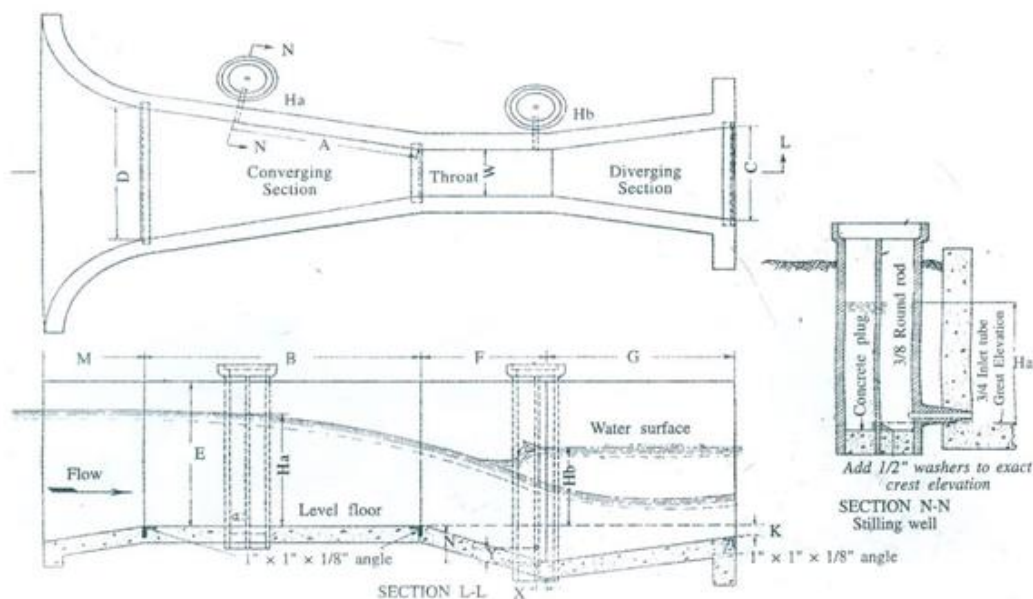

Fig. 7.1. Parshall flume.

Parshall flumes are available in various sizes. Care must be taken while constructing the flumes exactly in accordance with structural dimensions.

On the basis of the throat width, Parshall flumes have been classified into three main groups.

- Very small - 25.4 mm to 76.2 mm.
- Small 152.40 mm to 2438.4 mm.
- Large 3048 mm to 15240 mm.

Standard dimensions of Parshall flumes with discharge values are presented in Table 7.1 and 7.2, respectively. Discharge through the flume can occur under either free or submerged flow condition. Flow is submerged when the down-stream water elevation retards the rate of discharge. To determine discharge through the flume under free flow condition, head is measured at upstream section (H_a). However, downstream head (H_b) is also measured for submerged flow condition. Free flow condition prevails if the

submergence ratio (H_b/H_a) remains within 0.5, 0.6 and 0.7 for width of throat varying from 2.5 to 7.5 cm, 1.5 to 22.5 cm and 3.0 to 24.0 cm, respectively.

Table 7.1. Dimensions and capacities of Parshall flume of various sizes (Letter, refer Fig. 7.2)

Throat width	A	B	C	D	E	F	G	K	N	X	Y	Free-flow capacity	
	cm	cm	cm	cm	cm	cm	cm	cm	cm	cm	cm	Minimum, L s ⁻¹	Maximum, L s ⁻¹
7.5	31	46	18	26	46	15	30.5	2.5	5.7	2.5	3.8	0.85	28.4
15	41.4	61	39	39.7	61	30.5	61	7.6	12	5.1	7.6	1.4	110.8
23	58.8	86	38	57.5	76	30.5	45.5	7.6	12	5.1	7.6	2.5	253
30	91.5	134	61	84.5	92	61	91.5	7.6	23	5.1	7.6	3.13	456.6

Table 7.2. Free flow discharge values for Parshall Flume

Discharge, L s ⁻¹				
Head	Throat width			
	7.5 cm	15 cm	23 cm	30 cm
3	0.8	1.4	2.6	3.1
4	1.2	2.3	4	4.5
5	1.7	3.3	5.5	7
6	2.3	4.4	7.2	9.6
7	2.7	5.4	8.5	11.4
8	3.4	7.2	11.1	14.4
9	4.3	8.5	13.5	17.7
10	5	10.2	15.9	21.1
11	5.8	11.6	18.1	23.8
12	6.7	13.5	21.1	27.5
13	7.5	15	23.3	31
14	8.5	17.3	26.7	35

15	9.4	19.2	29.5	38.7
16	10.4	21.2	32.5	42.7
17	11.4	23.2	35.6	46.6
18	12.4	25.3	39	51.2
19	13.6	27.8	42.5	55
20	14.3	30	45.8	59.7
21	15.8	32.7	49.3	64.7
22	17.1	35.2	53.3	69.8
23	18.2	37.7	56.8	74
24	19.4	40.1	60.5	79
25	20.7	42.7	64.5	84.1
26	22	45.7	69.3	89
27	23.3	48.1	72.4	94.3
28	24.8	51.5	76.7	100
29	26	54	80.7	105.1
30	27.5	57.3	85.2	111

The discharge is measured by the following formula:

$$Q = CH^n$$

.....(7.1)

Where, Q is the discharge; C, n are the flume coefficients which vary with the size of the flume and H is the measuring head.

Table 7.3 gives a set of standard values for the C,n for different dimensions (these co-efficient are in fps units so the calculated discharge would be in ft³/s and head has to be in ft,)

Table 7.3. Value of C and n for different throat widths

Throat width	Coefficient (C)	Exponent (n)
1 in	0.338	1.55
2 in	0.676	1.55
3 in	0.992	1.55
6 in	2.06	1.58
9 in	3.07	1.53
1 ft	3.95	1.55
2 ft	8.00	1.55
3 ft	12.00	1.57
4 ft	16.00	1.58
5 ft	20.00	1.59
6 ft	24.00	1.59
7 ft	28.00	1.60
8 ft	32.00	1.61
10 ft	39.38	1.60
12 ft	46.75	1.60
15 ft	57.81	1.60
20 ft	76.25	1.60
25 ft	94.69	1.60
30 ft	113.13	1.60
40 ft	150.00	1.60
50 ft	186.88	1.60

In the above Fig., H_a is upstream head and H_b is downstream head.

Advantages

- This instrument is effective when the total head drop is small.

- b) Its operation is independent of approaching velocity.
- c) Being a self-cleaning device, it is not affected by sand or silt deposition.

7.2 Cut-throat Flume

The geometry of the throat-less flumes with broken plane transition was first developed in Punjab by Harvey in 1912. In the cut throat flume however, the flume discharge and the modular limit are related to the piezometric heads at two points in the converging section (h_a) and in the downstream expansion (h_b). One of the advantages of a cut- throat measuring flumes is that there are only two walls on each side, resulting in an economic installation. The cross-section can be rectangular, trapezoidal or triangular, depending only on the availability of appropriate calibration. A U- shaped section can also be used for critical depth flumes.

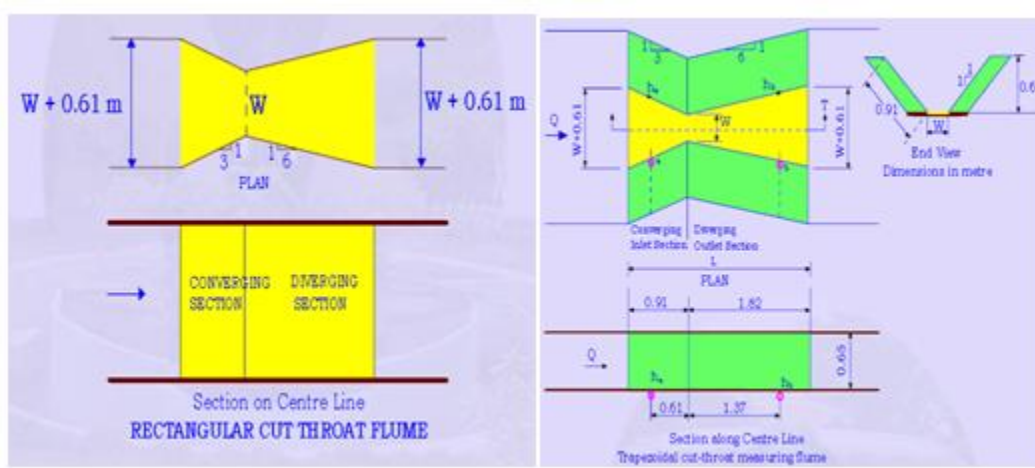

Fig. 7.2. Cut-throat flume. (Source: NPTEL, IIT Madras)

Design specifications of a cut-throat flume

L = Total length of the flume,

L_1 = Converging section = $L/3$

L_2 = Diverging section = $2L/3$,

L_a = Distance to piezometer tap a = $2L/9$

L_b = Distance to piezometer tap b = $5L/9$

B = width of the converging and diverging section = $W + L/4.5$

The cut-throat flume can operate either as a free flow or a submerged flow structure. Under free flow conditions, critical depth occurs in the vicinity of minimum width, w , which is called the flume throat or the flume neck. The attainment of critical depth makes it possible to determine the flow rate, knowing only an upstream depth, h_a . The relationship between flow rate Q and upstream depth of flow h_a , in a cut-throat flume under free flow conditions is given by the following experimental relationship:

$$Q = C_1 h_a^n L \quad (7.2)$$

In which,

Q = flow rate

C_1 = free flow coefficient, which is the value of Q when h_a is 1.0 foot.

n = exponent, whose value depends only on the flume length L.



LESSON 8. Orifices

8.1 Free Flow Orifice

Orifices may be used to measure rates of flow when the size and shape of the orifice and head acting upon them are known. Orifices used in measurement of irrigation water are commonly circular or rectangular in shape and are generally placed in vertical surfaces, perpendicular to the direction of channel flow. The section where contraction of the jet is maximal is known as the vena contracta. The vena contracta of a circular orifice is about half the diameter of the orifice itself.

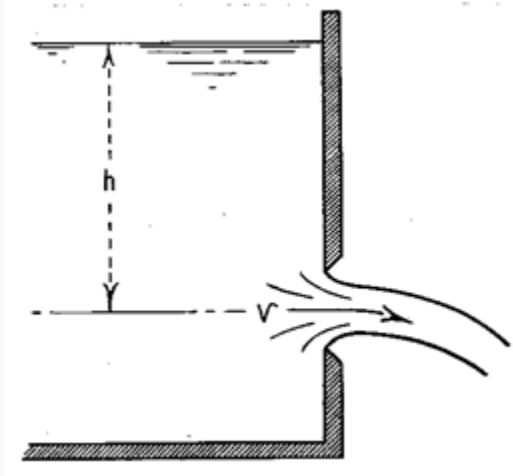

Fig.8.1. Free discharging through orifice.

Derivation of Equation

Velocity of flow through orifice

$$V = \sqrt{2gh} \quad \dots\dots\dots(8.1)$$

Where, h=head

Discharge through orifice. $Q=AV$

$$Q = \frac{\pi d^2}{4} \cdot C_d \cdot \sqrt{2gh} \quad \dots\dots\dots(8.2)$$

Where, C_d = discharge coefficient

Co-efficient of Velocity (C_v): It is defined as the ratio of the actual velocity of a jet of liquid at vena-contracta and the theoretical velocity of the jet. It is mathematically expressed as:

$$C_v = \frac{\text{Actual velocity of the jet at vena-contracta}}{\text{Theoretical velocity}} \quad \text{.....(8.3)}$$

$$C_v = \frac{V}{\sqrt{2gh}} \quad \text{.....(8.4)}$$

Where, V = actual velocity and h = head.

Co-efficient of Contraction (C_c): It is defined as the ratio of the area of the jet at vena-contracta to the orifice. It is mathematically expressed as:

$$C_c = \frac{\text{area of jet at vena-contracta}}{\text{area of the orifice}} \quad \text{.....(8.5)}$$

Co-efficient of Discharge (C_d): It is defined as the ratio of the actual discharge from an orifice to the theoretical discharge from the orifice. It is mathematically expressed as:

$$C_d = \frac{Q}{Q_{th}} = \frac{\text{actual velocity} \times \text{actual area}}{\text{theoretical velocity} \times \text{theoretical area}} \quad \text{.....(8.6)}$$

$$C_d = C_v * C_c \quad \text{.....(8.7)}$$

8.2 Submerged Orifice

8.2.1 Fully Submerged Orifice

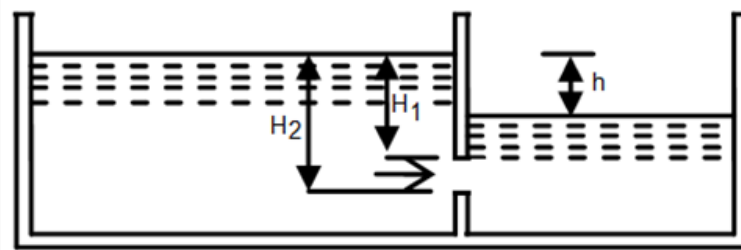

Fig.8.2. Fully submerged orifice.

In fully sub-merged orifice, the outlet side is fully sub-merged under the liquid and it discharges a jet of liquid into the liquid of the same kind. It is also called totally drowned orifice. Discharge through fully sub-merged orifice is calculated as

$$Q = C_d \times b(H_2 - H_1) \times \sqrt{2gh} \quad \dots\dots(8.8)$$

Where,

H_1 = height of water above the top of the orifice on the upstream side

H_2 = height of water above the bottom of the orifice

H = difference in water level

b = width of orifice

8.3.2 Partially Submerged Orifice

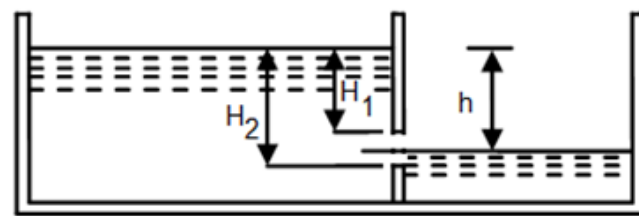

Fig. 8.3. Partially submerged orifice.

In this case, its outlet side is partially sub-merged under liquid. The discharge through partially submerged orifice is calculated as:

$$Q = C_d \times b(H_2 - H_1) \times \sqrt{2gh} + \frac{2}{3} C_d \times b \times \sqrt{2g} [H_2^{\frac{3}{2}} - H_1^{\frac{3}{2}}] \quad \dots\dots(8.9)$$

The first term in RHS in Eq. (8.9) represents flow through drowned (submerged portion of orifice same as Eq. (8.8)), whereas the second term represents discharge through free portion.

Example 8.1:

The head of water over an orifice of diameter 100 mm is 10 m. The water coming out from orifice is collected in a circular tank of diameter 1.5 m. The rise of water level in the tank is 1.0 m in 25 seconds. Also the co-ordinates of a point on the jet, measured from vena-contracta are 4.3 m horizontal and 0.5 m vertical. Find the coefficients, C_d , C_v and C_c .

Solution:

Given,

Head H = 10 m.

Diameter of orifice d = 100 mm = 0.1 m

So, area of orifice a = $\pi/4 \times (0.1)^2 = 0.007853 \text{ m}^2$

Diameter of measuring tank, D = 1.5 m

So, area = $\pi/4 \times (1.5)^2 = 1.767 \text{ m}^2$

Rise of water, $h = 1 \text{ m}$

Time $t = 25 \text{ sec}$

Horizontal distance $x = 4.3 \text{ m}$

Vertical distance $y = 0.5 \text{ m}$

Now, theoretical velocity,

$$V_{th} = \sqrt{2gH} = \sqrt{2 \times 9.81 \times 10}$$
$$= 14 \text{ m/s.}$$

Theoretical discharge,

$$Q_{th} = V_{th} \times \text{area of the orifice}$$
$$= 14 \times 0.077854 = 0.1099 \text{ m}^3/\text{s}$$

Actual discharge,

$$Q = \frac{A \times H}{t} = \frac{1.767 \times 1.0}{25}$$

$$= 0.07068 \text{ m}^3/\text{s}$$

So,

$$C_d = \frac{Q_{th}}{Q} = \frac{0.07068}{0.1099} = 0.643$$

We know,

$$C_v = \frac{x}{\sqrt{4yH}} = \frac{4.3}{\sqrt{4 \times 0.5 \times 10}} = 0.96$$

And

$$C_c = \frac{C_d}{C_v} = \frac{0.643}{0.96} = 0.669$$

Example 8.2:

Find the discharge through a fully sub-merged orifice of width 2 m if the difference of the water levels on the both sides of the orifice is 50 cm. The height of water from top and bottom of the orifice are 2.5 m and 2.75 m respectively. Take $C_d = 0.6$.

Solution:

Given,

Width of the orifice $b = 2$ m

Difference in water level $H = 50$ cm = 0.5 m

Height of water from top of orifice $H_1 = 2.5$ m

Height of water from bottom of orifice $H_2 = 2.75$ m

Now, discharge through fully submerged orifice is

$$Q = C_d \times b(H_2 - H_1) \times \sqrt{2gH}$$

$$= 0.6 \times 2.0 \times (2.75 - 2.5) \times \sqrt{2 \times 9.81 \times 0.5}$$

= 0.9396 m³/s Ans.



LESSON 9 Water Flow Measurement in Pipes

In the previous lesson, we have studied methods for water flow measurements in open channel. However, irrigation water also conveyed through pipes and therefore we will now study methods of flow measurements in pipes.

9.1 Difference between Pipe Flow and Open Channel Flow

Open Channel Flow	Pipe Flow
<ul style="list-style-type: none"> • Defines as a passage in which liquid flows with its upper surface exposed to atmosphere. The flow is due to gravity. Flow conditions are greatly influenced by slope of the channel. • Hydraulic grade line coincides with the water surface • The maximum velocity occurs at a little distance below the water surface. • The shape of the velocity profile is dependent on the channel roughness. • For laminar flow, Reynolds number and for turbulent flow, . • Flow cross section is unknown because flow depth is unknown. • Flow depth is deduced simultaneously from solving both continuity and momentum equation. 	<ul style="list-style-type: none"> • A pipe is a closed conduit which is used for carrying fluids under pressure. The flow in a pipe is termed as pipe flow only when the fluid completely fills the cross section & there is no free surface of fluid. • Hydraulic grade line does not coincide with the water surface. • The maximum velocity occurring at the pipe centre. • Velocity distribution is symmetrical about the pipe axis. • For laminar flow, Reynolds number and for turbulent flow, • Flow cross section is known and fixed. • Velocity is deduced from continuity equation.

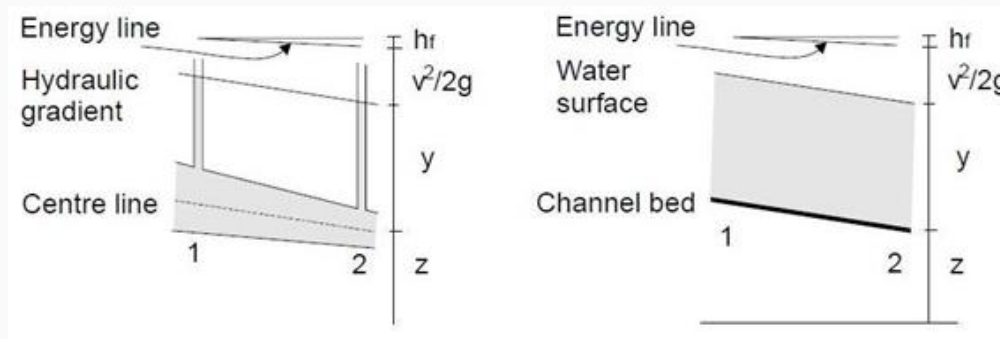

Fig. 9.1. Pipe flow (left) and open channel flow (right).

From the above Fig. 9.1 we can see that in the pipe flow there is a pressure equal to a head y whereas in the open channel the surface is at atmospheric pressure. hr denotes the head loss from section 1 to section 2. In case of open channel the conditions are much more varied than pipe flow in terms of surface geometry, surface roughness, depth and velocity of flow and uniformity of flow.

9.2 Venturimeter

9.2.1 Definition: A venturimeter is a device used to measure the rate of flow of a fluid through a pipe and is often fixed permanently at different sections of the pipeline to know the discharge there.

9.2.2 Description: Venturimeter consists of three parts:

1. A short converging part
2. A throat
3. A diverging part

Due to the constriction there is an increase in the flow velocity and hence an increase in the kinetic energy. In the venturimeter (Fig.9.2) the fluid is accelerated through a converging cone of angle 15-20° and the pressure difference between the upstream side of the cone and the throat is measured and provides the signal for the rate of flow.

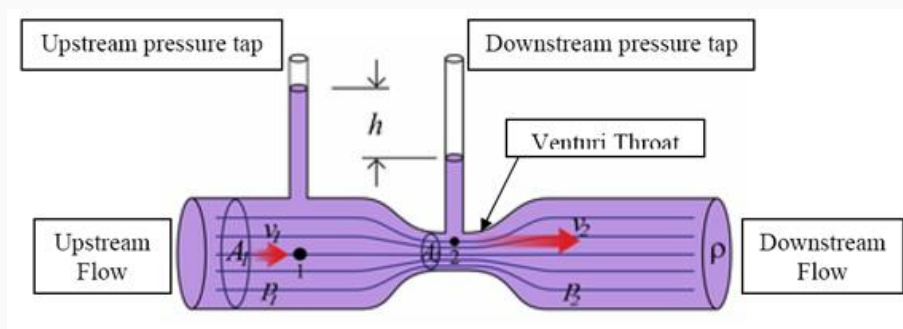

Fig.9.2. Venturimeter and its operations.

The fluid slows down in a cone with smaller angle (5-7°) where most of the kinetic energy is converted back to pressure energy. Because of the cone and the gradual reduction in the area there is no "vena contracta". The flow area is at minimum at the throat.

9.2.3 Principle of Operation

It works on the Bernoulli's principle. From Bernoulli's principle the increase in kinetic energy gives rise to a reduction in pressure. Rate of discharge from the constriction can be calculated knowing the pressure reduction across the constriction, area of cross-section, density of fluid and the coefficient of discharge, Coefficient of discharge is the ratio of actual flow to the calculated flow and it takes into account the stream contraction and frictional effects.

For measuring discharge we should apply Bernoulli's equation at point 1 and at point 2 (Fig.9.2). The following treatment is limited to incompressible fluids. Friction is neglected, the meter is assumed to be horizontal and there is no pump. If v_1 and v_2 are the average velocities at point 1 and point 2 respectively and ρ is the density of fluid, then Bernoulli's equation can be written as

$$\frac{P_1}{\rho g} + \frac{v_1^2}{2g} + Z_1 = \frac{P_2}{\rho g} + \frac{v_2^2}{2g} + Z_2$$

.....(9.1)

Where,

$P_1 = P_2$ pressure at section 1 and 2

Since $Z_1 = Z_2$,

$$\frac{v_2^2}{2g} - \frac{v_1^2}{2g} = \frac{P_1}{\rho g} - \frac{P_2}{\rho g}$$

.....(9.2)

Now applying the equation of continuity at both points, we have

$$A_1 v_1 = A_2 v_2 \quad (9.3)$$

$$v_2 = \frac{d_1^2 v_1}{d_2^2}$$

.....(9.4)

Where d_1, d_2 and v_1 are the diameters at point 1(pipe) and at point 2(throat) respectively.

Now putting the value of v_2 in equation (2) and if

$$\beta = \frac{d_1}{d_2}$$

we have

$$Q = A_2 \cdot \sqrt{\frac{2(P_1 - P_2)}{\rho(1 - \beta^4)}}$$

.....(9.5)

To account for the friction losses a coefficient of discharge, C_d , is introduced in the above equation and the final equation becomes:

$$Q_{act} = C_d \cdot A_2 \cdot \sqrt{\frac{2(P_1 - P_2)}{\rho(1 - \beta^4)}}$$

.....(9.6)

depends upon the type of flow, type of fluid and dimensions of venturi tube and pipe.

Given below are the formulae to calculate the value of head difference in terms of the liquid flowing through the venturi from the head difference observed in the manometric liquid:

1. When the manometric liquid is heavier than the liquid flowing through the pipe:

$$h = x \left[\frac{S_h}{S_o} - 1 \right]$$

.....(9.7)

2. When the manometric liquid is lighter than the liquid flowing in the pipe:

$$h = x \left[1 - \frac{S_h}{S_o} \right] \quad \dots\dots(9.8)$$

Where,

h = head difference in terms of the liquid flowing in the pipe

x = head difference in the manometer

S_h = specific gravity of the liquid flowing in the pipe

S_o = specific gravity of the manometric liquid

Merit:

- Widely used particularly for large volume liquid and gas flows.

Demerits:

- Highly expensive
- Occupies considerable space
- Cannot be altered for measuring pressure beyond a maximum velocity.

Example 9.1:

A horizontal venturimeter with inlet and throat diameters 36 cm and 18 cm respectively is used to measure the flow of water. The reading of the differential manometer connected to the inlet and the throat is 15 cm of mercury. Determine the rate of flow. Take C_d = 0.98.

Solution:

Given

Diameter at inlet, d₁ = 36 cm

Diameter at throat, d₂ = 18 cm

$$\therefore a_2 = \frac{\pi}{4} d_2^2 = 254.47 \text{ cm}^2$$

$$\beta = \frac{d_2}{d_1} = 0.5$$

From equation (6) we know:

$$Q_{act} = C_d \cdot A_2 \cdot \sqrt{\frac{2(P_1 - P_2)}{\rho(1 - \beta^4)}}$$

We know that, $\frac{2(P_1 - P_2)}{\rho} = 2gh$

Calculating h from equation (7)

$$h = 15 \left[\frac{13.6}{1} - 1 \right] = 189.0 \text{ cm of water}$$

$$\therefore 2 \times g \times h = 2 \times 981 \times 189 = 370818 \text{ cm}$$

Putting the values in equation (6):

$$Q_{act} = C_d \cdot A_2 \cdot \sqrt{\frac{2(P_1 - P_2)}{\rho(1 - \beta^4)}} = 0.98 \times 254.47 \times \sqrt{\frac{370818}{(1 - 0.5^4)}}$$

$$= 156840.21 \text{ cm}^3/\text{s} = 0.157 \text{ m}^3/\text{s}$$

9.3 Pitot Tube

9.3.1 Definition

It is a device to measure the fluid flow velocity at any point in a pipe or channel.

9.3.2 Description

In its simplest form the pitot tube consists of a glass tube bent at right angles.

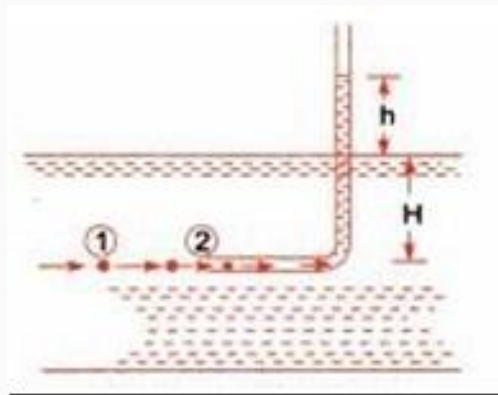

Fig.9.3.Pitot tube.(Source: Bansal, 2005.)

9.3.3 Principle of Operation

The velocity calculation is done by measuring the stagnation pressure and then applying the Bernoulli's theorem, the basic working principle being the conversion of kinetic energy to pressure energy at the point where velocity becomes zero.

Applying Bernoulli's theorem at points 1 and 2 shown in Fig.9.3.

$$\frac{P_1}{\rho g} + \frac{v_1^2}{2g} + Z_1 = \frac{P_2}{\rho g} + \frac{v_2^2}{2g} + Z_2 \quad \dots\dots(9.9)$$

The symbols have same meaning as in case of venturimeter.

As $Z_1 = Z_2$ and $v_2 = 0$

$$\text{Also, } \frac{P_1}{\rho g} = H \text{ and } \frac{P_2}{\rho g} = (H + h)$$

$$H + \frac{v_1^2}{2g} = (h + H)$$

$$\therefore v_1 = \sqrt{2gh} \quad \dots\dots(9.10)$$

This gives the theoretical velocity. The actual velocity is given by:

$$v_1 = C_v \sqrt{2gh} \quad \dots\dots (9.11)$$

Where,

h = height to which the liquid rises above the pipe.

C_v = the co-efficient of pitot tube.

Merits:

- Simple in construction having no moving parts.
- Easy to install.
- Requires no external power source.
- Easy measurement and velocity.

Demerits:

- Can't be used for turbulent flow, i.e. only used for laminar flow.
- Less accurate in measurement of velocity due to assumption of ideal fluid.

Example 9.2:

A pitot static tube placed in the centre of a 325 mm pipeline has one orifice pointing upstream and other perpendicular to it. The mean velocity in the pipe is 0.85 of the central velocity. Find the discharge if the pressure difference between the two orifices is 50 mm of water. Take the coefficient of pitot tube as:

$$C_v = 0.98$$

Solution:

Given, Diameter of pipe = 325mm = 0.325m

Difference in pressure head = 50mm = 0.05m of water

$$C_v = 0.98$$

Calculating the central velocity using equation (9.11)

$$v_1 = C_v \sqrt{2gh} = 0.98 \times \sqrt{2 \times 9.8 \times 0.05} = 0.97 \text{ m/s}$$

$$\therefore \text{Mean velocity} = 0.85 * 0.97$$

$$= 0.825 \text{ m/s}$$

$$\therefore \text{Discharge} = \text{mean velocity} * \text{area}$$

$$= 0.825 \times \frac{\pi}{4} d^2 = 0.825 \times \frac{\pi}{4} (0.325)^2 = 0.068 \text{ m}^3/\text{s (ans)}$$



LESSON 10 Pipe Orifice, Water Meter and Propeller Meter

10.1 Pipe Orifice

10.1.1 Definition

Orifice meter or orifice plate is a device (cheaper than a venture meter) employed for measuring the discharge of fluid through a pipe (shown in Fig.10.1). It also works on a same principle of a venture meter.

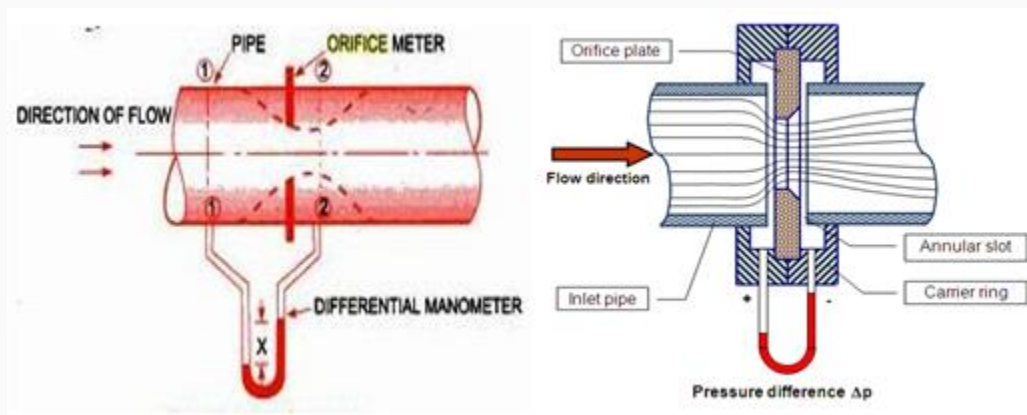

Fig. 10.1. Orifice plate.

10.1.2 Description

It consists of a flat circular plate which has a circular sharp edged hole called orifice, which is concentric with the pipe. The orifice diameter is kept generally 0.5 times the diameter of the pipe, though it may vary from 0.4 to 0.8 times the pipe diameter.

10.1.3 Principle of Operation

The fluid on reaching the orifice plate converges to pass through the small hole and in doing so the velocity and pressure changes. The point of maximum contraction is called the vena contracta. Beyond the vena contracta, the fluid expands and the velocity and pressure change once again. By measuring the difference in fluid pressure between the normal pipe section and at the vena contracta, the volumetric and mass flow rates can be obtained from Bernoulli's equation.

The value of discharge Q through the pipe is given by the following equation:

$$Q = \frac{C_d a_0 a_1 \sqrt{2gh}}{\sqrt{a_1^2 - a_0^2}} \quad \dots (10.1)$$

Where,

a_1 = area of pipe at section 1

a_0 = area of orifice

h = differential head

g = acceleration due to gravity

c_d = co-efficient of discharge for orifice meter.

The coefficient of discharge for orifice meter is much smaller than that of venture meter.

Merits:

- Simple in construction.
- Installation is cheaper.

Demerit:

- Measurement of flow is not accurate as compared to venturimeter.

Example10.1:

An orifice meter with an orifice diameter 10 cm is inserted in a pipe of diameter of 30 cm diameter. The pressure gauges fitted upstream and downstream of the orifice meter give readings of 25.524 N/cm² and 19.62 N/cm² respectively. Coefficient of discharge is given as 0.6 for the pipe. Find the discharge through the pipe.

Solution:

Given, diameter of orifice, = 10 cm

∴ Area of orifice, $a_0 = \frac{\pi}{4} (10)^2 = 78.54 \text{ cm}^2$

Diameter of pipe, $d_1 = 20 \text{ cm}$

∴ Area of orifice, $a_1 = \frac{\pi}{4} (30)^2 = 706.85 \text{ cm}^2$

$$P_1 = 25.524 \text{ N/cm}^2 = 25.524 \times 10^4 \text{ N/m}^2$$

$$\therefore \frac{P_1}{\rho g} = \frac{25.524 \times 10^4}{1000 \times 9.81} = 25 \text{ m of water}$$

Similarly, $\frac{P_2}{\rho g} = \frac{19.62 \times 10^4}{1000 \times 9.81} = 20 \text{ m of water}$

$$\therefore h = \frac{P_1}{\rho g} - \frac{P_2}{\rho g} = 5 \text{ m of water} = 500 \text{ cm of water}$$

$$C_d = 0.6$$

Calculating the discharge using equation (10.1)

$$Q = \frac{C_d a_0 a_1 \sqrt{2gh}}{\sqrt{a_1^2 - a_0^2}} = \frac{0.6 \times 78.54 \times 314.16 \sqrt{2 \times 981 \times 500}}{\sqrt{(706.85)^2 - (78.54)^2}}$$
$$= 20873.62 \text{ cm}^3/\text{s}$$
$$= 20.87 \text{ L s}^{-1}$$

10.2 Water Meter

10.2.1 Definition

A water meter is a scientific instrument for accurate measurement of quantity of water distributed to the consumers. A typical water meter is shown in Fig. 5.

10.2.2 Description

There are two basic requirements for accurate operation of the water meter: (1) the pipe must flow full at all time, and (2) the rate of flow must exceed the minimum for the rated range. Meters are calibrated in the factory and field adjustments are usually not required. When water meters are installed in open channels, the flow must be brought through a pipe of known cross sectional area.



Fig.10.2. Water meter. (Source: wikipedia accessed on 05/06/2012)

10.2.3 Type

Three basic type of water meters are:

- a) Low pressure line water meter: They are used in underground pipe line water distribution system.

b) Open flow meters: They are used to measure the flow in open channels or gravity-flow in closed conduit system.

c) Vertical flow meter: They are used to measure flow in vertical pipes.

Merit:

- Mainly applied flow in pipeline.

Demerit:

- Costly device.

10.3 Propeller Meter

10.3.1 Definition

Propeller meters (mechanical meter) are commercial flow measuring devices used at the ends of pipes and in conduits flowing full and under pressure.

10.3.2 Description

Propeller meters uses multiple blades made of rubber, plastic, or metal. The main parts of the flow meter consist of a propeller (A) mounted in a short section of pipe and geared to a revolution counter (B) which records the rate of flow and the cumulative total. A typical propeller meter is shown in Fig.10.3.

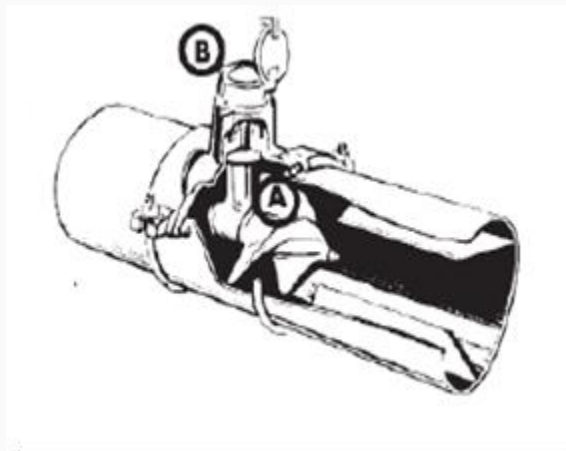

Fig.10.3. Propeller meter inside pipe.

10.3.3 Principle of Operation

Flow meter measures velocity of flow by the water turning the propeller as it passes by, and the area is determined from the size of the pipe. The dial of the meter then reads directly in volume (m^3 , gallon, liters etc). Rate of flow (i.e., liter per second) is then obtained by simply noting the rate of flow on the dial for any given length of time as measured by a watch.

The meters are available for a range of pipe diameters from 5 to 183 cm. They are normally designed for water flow velocities up to 5.18 meter per second (m/s). Propeller meters should be selected to operate near the middle of their design discharge range. This equipment can be a problem in existing irrigation systems with oversized pipes relative to delivery needs. Sections of the oversized pipe may need to be replaced with smaller pipes to provide enough velocity and approach pipeline length to allow development of velocity profiles.

Propellers are designed to pass (to some degree) weeds, moss, and other debris, only a limited amount of foreign material that can be tolerated in the flow. Even moderate amounts of floating moss or weeds can foul a propeller unless it is protected by screens.

Merit

- Takes accurate measurement

Demerit

- Expensive



LESSON 11 Open Channel Flow

There are two kinds of flow: Open channel and pipe. These flows differ in many ways. The important difference is that open channel flow has free water surface whereas pipe flow does not have free water surface.

11.1 Open Channels

Irrigation water is conveyed in either open channel or closed conduits. Open channels receive water from natural streams or underground water and convey water to the farm for irrigation. Open channels have free surface. The free surface is subjected to atmospheric pressure. The basic equations used for water flow in open channels are continuity equation, Bernoulli equation and Darcy Weisbach equation.

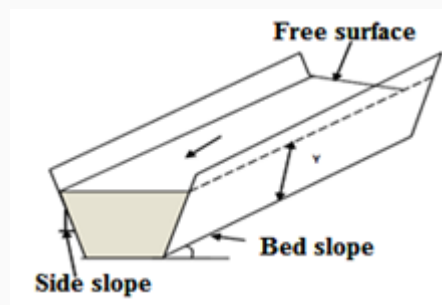

Fig. 11.1. A trapezoidal shaped open channel.

11.2 Types of Open Channels

(a) Prismatic and Non-Prismatic Channels

A channel in which the cross sectional shape, size and the bottom slope are constant over long stretches is termed as prismatic channel. Most of the man-made or artificial channels are prismatic channels. The rectangular, trapezoidal (Fig. 11.2), triangular and half-circular are commonly used shapes in manmade channels. All natural channels generally have varying cross section and consequently are nonprismatic.

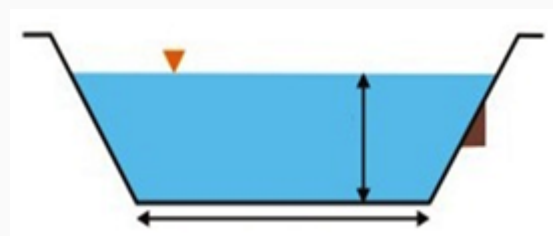

Fig. 11.2. Sketch of a prismatic channel.

(b) Rigid and Mobile Boundary Channels

Rigid channels are those in which the boundary or cross section is not deformable. The shape and roughness magnitudes are not functions of flow parameters. The lined channels and non erodible unlined channels are rigid channels. In rigid channels the flow velocity and shear stress distribution are such that

no major scouring, erosion or deposition takes place in the channel and the channel geometry and roughness are essentially constant with respect to time. Channels are classified as mobile channels when the boundary of the channel is mobile and flow carries considerable amounts of sediment through suspension and is in contact with the bed. In the mobile channel, depth of flow bed width, longitudinal slope of channel may undergo changes with space and time depending on type of flow. The resistance to flow, quantity of sediment transported and channel geometry all depend on interaction of flow with channel boundaries.

11.3 Types of Open Channel Flow

Open channel flow can be classified into many types and described in various ways. The following section describes classification based on variation of flow properties such as depth of flow, velocity etc. with respect to time and space.

a) Steady and Unsteady Flows

Flow is steady if the velocity and depth are constant with respect to time. If the depth velocity or discharge changes with time, the flow is termed as unsteady.

Flood flows in rivers and rapidly varying surges in canals are examples of unsteady flow.

b) Uniform and Non-Uniform Flows

If the flow properties, say the depth of flow and discharge in an open channel remain constant along the length of the channel, the flow is said to be uniform. A prismatic channel carrying a certain discharge with a constant velocity is an example of uniform flow.

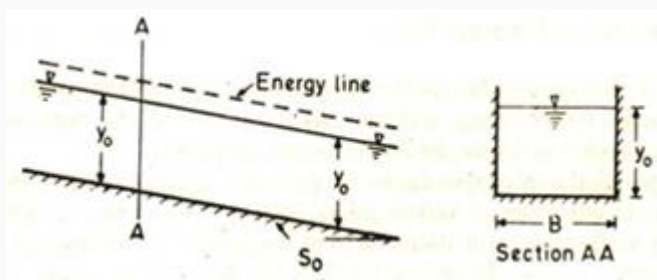

Fig. 11.3. Uniform flow in a prismatic channel.

If the flow properties such as depth and discharge vary with distance along the channel is termed as non-uniform flow

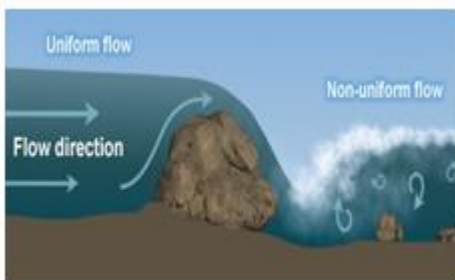

Fig. 11.4. Uniform and non-uniform flows.

Fig. 11.4 shows a view of uniform and non uniform flow. In uniform flow, the gravity force on the flowing water balances the frictional force between the flowing water and inside surface of the channel, which is in contact with the water. In case of non-uniform flow, the friction and gravity forces are not in balance.

The flow in open channel can be steady or unsteady. It can be uniform or non -uniform. A non-uniform flow is also termed as varied flow. Steady and unsteady flows can be uniform or varied.

c) Gradually Varied and Rapidly Varied Flow

The non-uniform flow can be classified as gradually varied flow (GVF) and rapidly varied flow (RVF). Varied flow assumes that no flow is externally added to or taken out of channel system and hence the volume of water in a known time interval is conserved in the channel system and hence the volume of water in a known time interval is conserved in the channel system. If the change of depth is gradual so that the curvature of streamlines is not excessive, such a flow is said to be gradually varied flow (GVF).

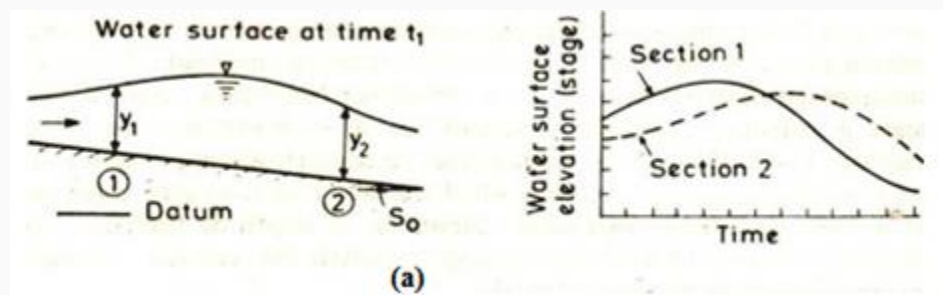

Fig. 11.5. (a) Gradually flow. (Source: Subramanya, 2000)

Fig. 11.5 (a) shows water surface profile of a GVF; here y_1 and y_2 are the depth at section 1 and 2, respectively. In GVF, the loss of energy is essentially due to boundary friction. Therefore, the distribution of pressure in the vertical direction may be taken as hydrostatic. If the curvature in a varied flow is large and the depth changes appreciably over short lengths, then the flow is termed as a varied flow. It is a local phenomenon. The examples of RVF are hydraulic jump and hydraulic drop.

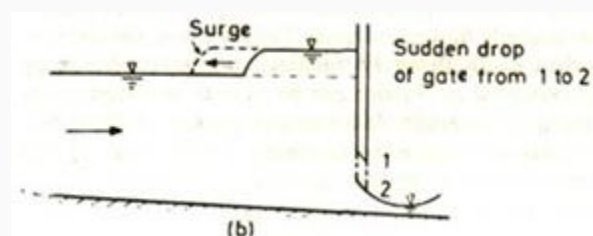

Fig. 11.5. (b) Rapidly varied flow. (Source: Subramanya, 2000)

d) Spatially Varied Flow (SVF)

Addition or diminution of water along the course of flow causes non uniform discharge and the resulting flow is known as spatially varied flow (SVF). Hydraulic behaviour of spatially varied flow with increasing discharge (case of drainage channel) is different in certain respects from that of spatially varied flow with decreasing discharge (in case of irrigation channel). Figs. 11.6 (a) shows a case of spatially varied flow with decreasing discharge. Figs. 11.6 (b) shows case of increasing discharge.

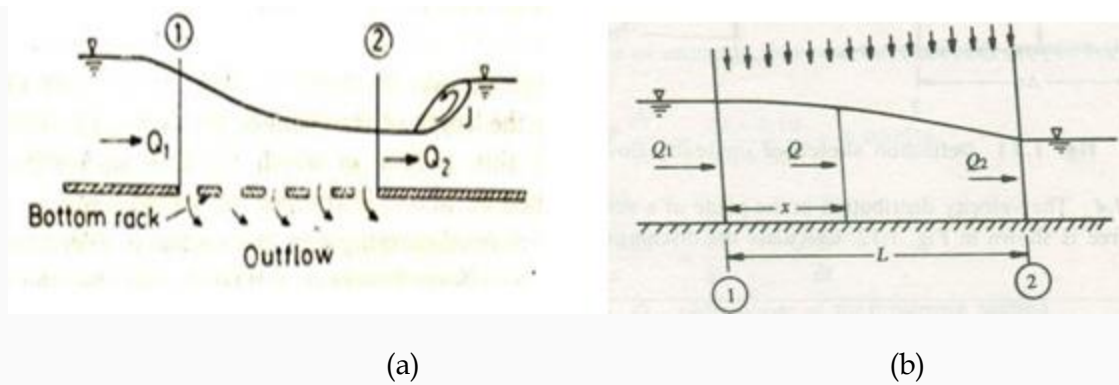

Fig. 11.6. Spatially varied flow: a) decreasing discharge, b) increasing discharge.

i) Spatially Varied Flow with Increasing Discharge

In this type of spatially varied flow, an appreciable portion of the energy loss is due to the turbulent mixing of the added water and the water flowing in the channel. In the most cases, this mixing is of relatively high magnitude and uncertainty. Because of the resulting high and uncertain losses, the momentum equation is more convenient than the energy equation in solving spatially varied flow with increasing discharge. From a practical viewpoint, the high energy loss seems to make channels designed for such spatially varied flow hydraulically inefficient, but physical circumstance and economical considerations sometimes make the use of such channels desirable.

ii) Spatially Varied Flow with Decreasing Discharge

Fundamentally, these types of spatially varied flow may be treated as a flow diversion where the diverted water does not affect the energy head. This concept has been verified by both theory and experiments. Therefore, the use of the energy equation is more convenient in solving spatially varied flow with decreasing discharge. The theory of spatially varied flow with decreasing discharge was probably employed first in the design of lateral spillways or side spillway weirs. This type of structure is usually a long notch installed along the side of a channel for the purpose of diverting or spilling excess flow.

The spatially varied flow with decreasing discharge is encountered in the design of irrigation water conveyance system whereas with increasing discharge in design of surface and subsurface drainage systems.

11.4 State of Flow

The state of flow in open channels is influenced by viscosity, gravity and inertial forces. The ratio of inertial to viscous force is the Reynolds number.

11.4.1 Effect of Viscosity

In open channel flow may be laminar, transitional or turbulent depending on viscosity in relation to inertial force. If viscous forces are strong in comparison to inertial force, the flow can be laminar otherwise vice versa for turbulent flow.

The characteristic length-scale for an open channel of width (b) and depth (y), the hydraulic radius (R) = $(by/b+2y)$. As a general rule, open channel flow is laminar, if Reynolds number defined by

$$Re = \frac{VR}{\nu} \text{ is less than 500.}$$

Where,

V = Flow Velocity

R = Hydraulic radius

ν = Kinematic viscosity.

In open channels the transitional range of Re for practical purpose, is considered between 500 and 2000. The value exceeding 2000 is considered as turbulent flow.

In close conduits the flow is i) laminar for $Re < 2000$, ii) transitional $2000 < Re < 4000$ and iii) turbulent $Re > 4000$.

11.4.2 Effect of Gravity

The effect of gravity is represented by ratio of inertial forces to gravitational forces. This ratio is known as Froude number (Fr), given by

$$Fr = \frac{V}{\sqrt{gL}} \quad (11.1)$$

V = mean flow velocity,

g = acceleration due to gravity

L = characteristic length (it can be hydraulic depth, y or hydraulic radius, R).

For the flow to be critical ($Fr = 1$) i.e.

$$V = \sqrt{gy} \quad (11.2)$$

For sub critical flow ($Fr < 1$) i.e.

$$V < \sqrt{gy} \quad \text{and}$$

For super critical flow ($Fr > 1$) i.e.

$$V > \sqrt{gy}$$

11.5 Seepage in Canals and Field Channels

Seepage loss in unlined canals and farm ditches often range from one-fourth to one-third of the total water diverted. In extremely sandy or gravelly ditches, half the water can be lost through seepage. Reducing seepage by using improved conveyance facilities can increase water available for crop needs, allowing irrigation of additional land, prevent water-logging, increase in channel capacity, reduction in maintenance cost and more importantly enable to use available water sustainably. Especially in the regions of water scarcity, minimising the seepage losses is important.

11.6 Measurement of Seepage in Canal

The most commonly used methods applied for measuring the quantity of water lost due to seepage in a canal section are as follows:

1. Ponding method
2. Inflow-outflow method
3. Seepage meter method

11.6.1 Ponding Method: The ponding method is one of the simplest methods of determining seepage from a canal section. Water is ponded in temporary water-tight dikes constructed in a straight length of canal under investigation. The time rate of drop of the water in the canal level is measured. The dimension of the ponded reach of the canal are measured the seepage computed as volume of water lost from the canal per unit wetted area of canal per unit time and normally is expressed as $\text{m}^3/\text{m}^2/\text{day}$.

11.6.2. Inflow-Outflow Method: The inflow-outflow method is based on measuring the rates of water flowing into and out of selected section of canal reach. It is based on water balance approach considering the inflows outflows and losses into account. Canal sections with minimum number of outlets and diversions and no appreciable inflow from higher lands are considered for seepage measurement. Water stage recorders are also used to record the height of flow in the flume as a function of the elapsed time. The seepage is computed as the difference in inflow and outflow per unit wetted area of canal section under consideration.

11.6.3. Seepage Meter Method: The seepage meter is a device for directly measuring the flow between ground water and surface water body such as lake or stream. The seepage meter is a modified form of the constant head permeameter. It is mainly used to determine location of relatively high seepage losses. Seepage meter can be constructed from inexpensive material such as galvanised iron sheet. Seepage meters are suitable when many measurements are needed to characterize groundwater surface water exchange in different sequent of water body.

11.7 Materials for Lining Canals and Field Channels

A large variety of lining materials for seepage loss control from canals and field channels is available for use. Lining of canals or channels offers other advantage such as enhance stability, increasing life, protection from flood in addition to seepage control. The various types of channel lining material commonly used are as follows:

a) Hard surface linings

- i) Cement concrete or pre cost concrete,
- ii) Stone masonry,
- iii) Brick tile or concrete tile
- iv) Asphaltic concrete

b) Earth type lining

- i) Compacted earth
- ii) Soil cement

iii) Bentonite - clay soil mixture

c) Synthetic sheet/film

i) Rubber or synthetic materials

ii) Low density polyethylene sheet

The following points are normally considered for selecting method of lining and materials.

a) Availability and cost of the material at the site or within reach.

b) Labour available for lining at a reasonable cost

c) Degree of water-tightness desired

d) Velocity of flow in the channel

e) Useful life of the lining material

f) Maintenance cost.



LESSON 12 Design of Open Channel

12.1 Introduction

Open Channel is a passage through which water flows and has upper surface exposed to atmosphere. Open channel design involves determining cross-section dimensions of the channel for the amount of water the channel must carry (i.e., capacity) at a given flow velocity, slope and, shape or alternatively determining the discharge capacity for the given cross-section dimensions.

The terminologies used in the design of open channels of different geometry are given below:

i) Area of Cross Section (a): Area of cross section of for a rectangular cross section, of wetted section. For a rectangular cross section, if b = width of channel and y = depth of water, the area of wetted section of channel (a) = $b \cdot y$.

ii) Wetted Perimeter (p): It is the sum of the lengths of that part of the channel sides and bottom which are in contact with water. The wetted perimeter (p) = $b + 2y$.

iii) Hydraulic Radius (R): It is the ration of area of wetted cross section to wetted perimeter. The hydraulic radius

$$(R) = \frac{a}{p} = \frac{by}{b+2y}$$

iv) Hydraulic Slope (S): It is the ratio of vertical drop in longitudinal channel section (h) to the channel length (l). Hydraulic slope

$$(S) = \frac{h}{l}$$

v) Freeboard: It is the vertical distance between the highest water level anticipated in channel flow and the top of the retaining banks. This is provided to prevent over topping of channel embankments or damage due to trampling. This is provided between 15.25% of normal depth of flow.

12.2 Discharge Capacity of Channel

Channel capacity can be estimated by equation given as:

$$Q = \frac{(16667)(DDIR)(A)}{(HPD)(E_i)} \quad (12.1)$$

where,

Q = channel capacity (L/min)

DDIR = design daily irrigation requirement (mm/day)

A = irrigated area supplied by canal or ditch (ha)

HPD = hours per day that water is delivered

E_i = irrigation efficiency including conveyance efficiency of canal or ditch (percent).

The velocity of flow in a canal or ditch should be non erosive and non silting that prevent the deposition of suspended substances. Normally flow velocity in excess of 0.6 m/s is non silting (Schwab et al., 1993). The maximum velocity that does not cause excessive erosion depends on the erodibility of the soil or lining material. The maximum allowable velocities for lined canals and unlined ditches listed in Table 12.1 can be used when local information is not available.

12.3 Economical Section of a Channel

A channel section is said to be economical when the cost of construction of the channel is minimum. The cost of construction of a channel depends on depth of excavation and construction for lining. The cost of construction of channel is minimum when it passes maximum discharge for its given cross sectional area. It is evident from the continuity equation and uniform flow formulae that for a given value of slope and surface roughness, the velocity of flow is maximum when hydraulic radius is maximum. The hydraulic radius is maximum for given area if wetted perimeter is minimum. Hence the wetted perimeter, for a given discharge should be minimum to keep the cost down or minimum. This condition is utilized for determining the dimensions of economical sections of different forms of channels. Most economical section is also called the best section or hydraulic efficient section as the discharge passing through a most economical section of channel for a given cross-sectional area (A), slope of the bed (S_0) and a roughness coefficient (n), is maximum.

The conditions for the most economical section of channel

1. A rectangular channel section is the most economical when either the depth of flow is equal to half the bottom width or hydraulic radius is equal to half the depth of flow.
2. A trapezoidal section is the most economical if half the top width is equal to one of the sloping sides of the channel or the hydraulic radius is equal to half the depth of flow.
3. A triangular channel section is the most economical when each of its sloping side makes an angle of 45° with vertical or is half square described on a diagonal and having equal sloping sides.

The discharge from a channel is given by

$$Q = AV = AC\sqrt{RS_0} = AC\sqrt{\frac{A}{P}S_0} = K * \frac{1}{\sqrt{P}} \quad (12.2)$$

where Q = discharge (m^3/s), A = area of cross section (m^2), C = Chezy constant,

R= Hydraulic radius (m), P = wetted perimeter (m), S_0 = bed slope (fraction or m/m), K = constant for given cross sectional area and bed slope and $= A^{3/2} C S_0^{1/2}$

In equation (12.2) the discharge Q will be maximum when the wetted perimeter P is minimum.

(i) Channel Shape: Among the various shapes of open channel the semi-circle shape is the best hydraulic efficient cross sectional shape. However the construction of semicircle cross section is difficult for earthen unlined channel. Trapezoidal section is commonly used cross section.

(ii) Channel Dimensions: The channel dimensions can be obtained using uniform flow formula, which is given by

$$Q = A V \quad (12.3)$$

Where,

V = flow velocity (m/s)

A = cross-sectional area of canal perpendicular to flow (m²)

Q = capacity of the channel (m³/s)

Velocity is computed by Manning's formula or Chezy formula.

Manning's Equation is given by

$$V = \frac{1}{n} R^{2/3} S^{1/2} \quad (12.4)$$

Chezy's equation is given by

$$V = C R^{1/2} S^{1/2} \quad (12.5)$$

Where,

n = Manning's roughness coefficient

C = Chezy's roughness coefficient

R = hydraulic radius (m)

S = bed slope (m/m)

Table 12.1. Limiting velocities for clear and turbid water from straight channels after aging (Source: Schwab et al., 1993)

Material	Velocity		Water transporting
	Clear	colloidal silts	
	m/s		m/s
Fine sand, colloidal	0.46		0.76
Sandy loam, noncolloidal	0.53		0.76
Silt loam, noncolloidal	0.61		0.92
Alluvial silts, noncolloidal	0.61		1.07

Irrigation Engineering

Ordinary firm loam	0.76	1.07
Volcanic ash	0.76	1.07
Stiff clay, very colloidal	1.14	1.52
Alluval silts, colloidal	1.14	1.52
Shales and hardpans	1.83	1.83
Fine gravel	0.76	1.52
Graded loam to cobbles when noncollodal	1.14	1.52
Graded silts to cobbles when colloidal	1.22	1.68
Coarse gravel, noncolloidal	1.22	1.83
Cobbles and shingles	1.53	1.68

Example12.1: Compute the mean velocity and discharge for a depth of flow of 0.30 m from a lined trapezoidal channel of 0.6 m wide and side slope of 1.5 horizontal : 1 vertical. The Manning's roughness (n) is 0.012 and the bed slope is 0.0003.

Solution:

Area of cross section (a) = $by + zy^2$

$$= 0.60 \times 0.30 + 1.5(0.30)^2$$

$$= 0.18 + 0.135$$

$$= 0.315 \text{ m}^2$$

Wetted perimeter

$$\begin{aligned}(p) &= b + 2y\sqrt{(z^2 + 1)} \\ &= 0.60 + 2(0.3)\sqrt{(1.5)^2 + 1} \\ &= 0.60 + 1.08 \\ &= 1.68 \text{ m}\end{aligned}$$

$$\begin{aligned} &= \frac{A}{P} \\ &= \frac{0.315}{1.68} \\ &= 0.187 \text{ m} \end{aligned}$$

Hydraulic radius (R)

$$\begin{aligned} &= \frac{1}{n} R^{2/3} S^{1/2} \\ \frac{1}{0.012} &= (0.187)^{2/3} (0.0003)^{1/2} \\ &= 0.473 \text{ ms}^{-1} \end{aligned}$$

Mean velocity (v)

Discharge (Q) = A x V

$$= 0.315 \times 0.473$$

$$= 0.149$$

12.4 Energy Depth Relationship

From hydraulic point of view, the total energy of water in any streamline passing through a channel section may be expressed as total head, which is equal to sum of the elevation above a datum, the pressure head, and the velocity head. The total energy at the channel section is given by

$$H = z + y + \frac{V^2}{2g} \quad (12.6)$$

where,

H = total energy, z = elevation head above datum, y = depth of water in channel, V = velocity of flow, g = acceleration due to gravity. The specific energy is the total energy at any cross section with respect to channel bed. Considering slope of the channel bed is very small, the specific energy E is

$$E = y + \frac{V^2}{2g} \quad (12.7)$$

For the channel of rectangular section having width b, the cross sectional area of channel

$$A = b y$$

then

$$E = y + \frac{Q^2}{2gb^2y^2} \quad (12.8)$$

Differentiating equation (12.8), equating it to zero for minimum condition, this becomes

$$\frac{dE}{dy} = 1 - \frac{Q^2 dA}{gA^3 dy} = 1 - \frac{v^2}{gA} \frac{dA}{dy};$$

but $\frac{dA}{dy} = b$

Hence $\frac{dE}{dy} = 1 - \frac{V_c^2}{gy_c} = 0$

When $V = V_c, Y = Y_c$ (Critical depth)

$$\frac{V_c^2}{gy_c} = 1 \quad (12.9)$$

$\frac{V}{\sqrt{gy_c}}$ is defined as Froude number, for flow to be critical its value is equal to 1. It is greater than 1 for super critical flow and less than 1 for sub critical flow.

Critical depth (Y_c) for rectangular channel is given by

$$y_c = \left[\frac{Q^2}{gb^2} \right]^{1/3} \quad (12.10)$$

The principle of design of flumes and hydraulic structures (open drop and chute spillways) is based on the concept of specific energy and critical flow.

Example 12.2: Compute the critical depth and specific energy for discharge of $6.0 \text{ m}^3\text{s}^{-1}$ channel from a rectangular channel. The bottom width of rectangular is 2.4 m.

Solution:

Discharge / unit width (q) = $\frac{6}{2.4} = 2.5 \frac{\text{m}^3}{\text{m}}$

Critical depth

$$y_c = (q^2/g)^{1/3} = \left[\frac{2.5^2}{9.81} \right]^{1/3}$$

$$= 0.860 \text{ m.}$$

Since specific energy at critical depth (E_c) = $\frac{3}{2} y_c$ Therefore $E_c = 1.290 \text{ m.}$

Example 12.3: Determine the critical depth for specific energy head of 2.0 m in a trapezoidal channel of 2.0 m bottom width and side slopes of 1:1.

Solution:

Specific energy at initial depth (y_c) is given by

$$E_c = y_c + \frac{v^2}{2g}$$

$$\frac{Ac^3}{Tc} = \frac{Q^2}{g}$$

$$\frac{Q^2}{2gAc^2} = \frac{Ac}{2Tc}$$

$$E_c = y_c + \frac{Ac}{2Tc}$$

As for critical flow

where,

A_c = Area at critical depth
 T_c = Top width at critical Depth

$$2.0 = y_c + \frac{(2 + y_c)y_c}{2(2 + 2y_c)}$$

$$y_c = 2 - \frac{(2 + y_c)y_c}{2(2 + 2y_c)}$$

12.5 Velocity Distribution in a Channel Section

The velocity of flow in any channel section is not uniformly distributed. The non- uniform distribution of velocity is due to the presence of a free surface and the frictional resistance along the channel surface. In a straight reach of channel section, maximum velocity usually occurs below the free surface at a depth of 0.05 to 0.15 of the total depth of flow. The velocity distribution in a channel section depends on various factors such as the shape of the section, the roughness of the channel and the presence of bends in the channel alignment. The man velocity of flow in a channel section can be computed from the vertical velocity distribution curve obtained by actual measurements. It is observed that the velocity at 0.6 depth from the free water surface or average of the velocities measured at 0.2 depth and 0.8 depth from free water surface which is very close to the mean velocity of flow in the vertical section. The velocity can be measured by pitot tube or current meter.



LESSON 13. On Farm Structures for Water Conveyance

It is necessary that the flow of irrigation water in the water conveyance system is always under control. Water control structures are therefore required for water conveyance system to control the flow of water and dispose at safer velocity. The different types of flow control structures used to regulate water flow are presented in this lesson

13.1 Drop Structures

Drop structure is used for conveying water in the channel from higher elevation to lower elevation while controlling the energy and velocity of the water as it passes over. These structures are needed in canals and ditches to convey water down steep slopes at non-erosive velocities. Drop structure is constructed at end of each reach to lower water head abruptly in to the next reach by subdividing the slope in to several reaches with relatively flat slopes. Water is conveyed down the slope in the stepwise manner. The components of drop structure include an inlet section, a vertical or inclined drop, a stilling pool or other means of dissipating energy, and an outlet section for discharging water into the next reach. Kruse et al., (1980) recommend that drop heights in conveyance canals and ditches be limited to maximum of 0.6 m to 1 m and that drop height in distribution laterals be less than 15 to 30 cm. Fig. 13.1 shows series of drop structures on a steep sloping land.

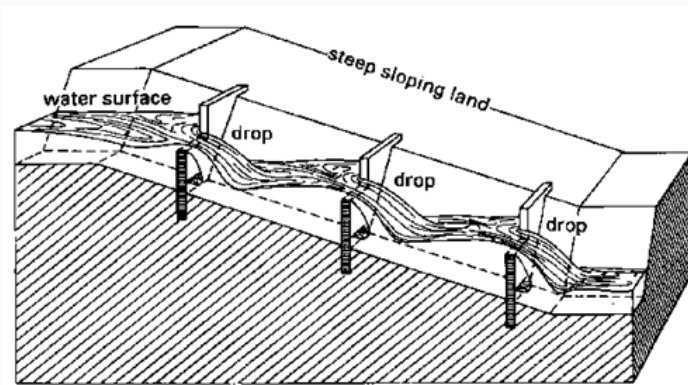

Fig. 13.1. A view of Drop structures in a canal on steep sloping land.

13.2 Chute Spillways

These are used to convey water from steep slopes. Chutes are lined, high-velocity open channels (Fig. 13.2 and 13.3). Chute structures are constructed with concrete, bricks or cement. They have an inlet, a steep-sloped section of lined canal where the elevation change occurs, a stilling pool or other energy dissipation device, and an outlet section. Chutes may be made to control flow for elevation changes up to 6m. A straight apron is used for small structure used in small irrigation channel.



Fig. 13.2. Chute spillway.

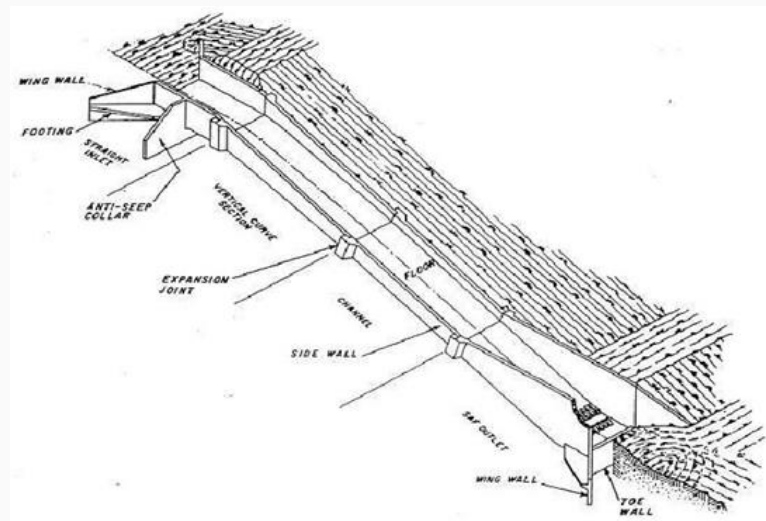

Fig. 13.3. Section of Chute spillway.

13.3 Pipe Drop Spillways

Pipe drop structure (Fig. 13.4) is used where a channel has to cross an embankment. In such cases water can be safely discharged from a higher to a lower one by providing a pipe drop. This type of structure allows the discharge of water through a pipeline, without disturbing the existing bunds or embankment. The components of structures are gated pipe, stilling basin with end sill. Stilling basin is provided for dissipation of energy of water flow. A stilling basin is made up of brick or stone masonry, or concrete. A masonry or concrete apron is provided at the inlet end of the pipe to prevent seepage around it. The discharge capacity of the pipe drop structure may be determined by the relationship

$$Q = A V$$

in which,

$$Q = \text{discharge (m}^3\text{s}^{-1}\text{)}$$

$$A = \text{area of cross-section of the pipe (m}^2\text{)}$$

$V =$ velocity of flow (m/sec)

In designing the pipe size, head loss due to friction in the pipe line, entrance losses and loss at the bends are considered.

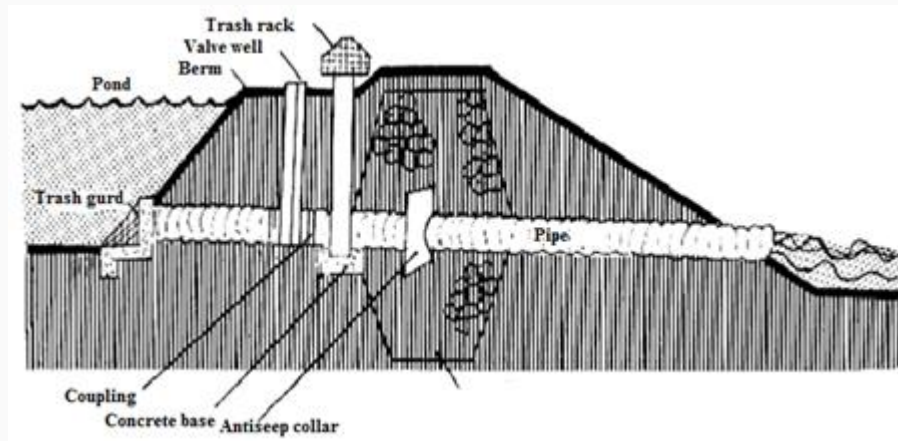

Fig. 13.4. A drop-inlet pipe spillway with drain pipe.

Example 13.1: Determine the capacity of 3.5 m long (l) pipe of pipe drop spillway to be used for effective drop in head (H) as 1.2 m. The diameter of pipe (d) is 100 mm and friction coefficient (f) is 0.012.

Solution:

The applicable formula for the total head in pipe drop spillway is

$$H = \frac{4flv^2}{2gd} + \frac{v^2}{2g} + 0.5 \frac{v^2}{2g} + 0.25 \frac{v^2}{2g}$$

where

$v =$ velocity of flow and $g =$ acceleration due to gravity

Substituting the values in above equation

$$H = 1.2 \text{ m, } d = 100 \text{ mm, } l = 3.5 \text{ m}$$

$$1.2 = \frac{4 \times 0.012 \times 3.5 \times v^2}{2 \times 9.81 \times 100/1000} + \frac{v^2}{2 \times 9.81} + 0.5 \frac{v^2}{2 \times 9.81} + 0.25 \frac{v^2}{2 \times 9.81}$$

$$1.2 = v^2(0.0856 + 0.05097 + 0.002548 + 0.01274)$$

$$1.2 = v^2 \times 0.1748$$

$$v = 2.62 \text{ m s}^{-1}$$

$$a = \frac{1}{4}(\pi d^2) = \frac{1}{4}(3.14) \times \left(\frac{100}{1000}\right)^2$$

$$= 7.8 \times 10^{-3} \text{ m}^2$$

$$Q = a \cdot v$$

$$= 7.85 \times 10^{-3}$$

$$= 2.056 \times 10^{-2} \text{ m}^3 \text{ s}^{-1} = 20.56 \text{ L s}^{-1}$$

***** 😊 *****

LESSON 14 Structures for Diversions and Channel Crossings

Water from the farm irrigation channel is diverted to branch channels or into field channels by means of junction boxes, and gates and siphons. These structures are used as water diversions structures or application structures for water application from irrigation channels of the fields. Brief description of these structures is given in this lesson.

14.1 Check Gates

The check gate is a structure used to maintain or increase water level in an open channel. Check is placed in an irrigation channel to form an adjustable dam to control or rise the elevation of the water surface upstream by at least about 8 to 12 cm above ground surface so as to use siphon tubes or turnouts for water diversion from channel to field efficiently. Fig. 14.1 shows the canal check gates. There may or may not be flow past a check. When there is no flow past them, checks act as dam that confine water release in the area along the canal or ditch being used for irrigation. Permanent check can be used in either lined or unlined channels. A check structure consists of canvas, metal or masonry walls built across the channel and provided with a suitable gate or outlet device. The masonry wall is built in place while the check gate is usually precast and fixed to the wall. The crest of the check gate is at the same level as the bottom of the upstream channel.



Fig. 14.1. Canal check gates.

14.2 Portable Check Dams

Portable checks can be removed when irrigation is complete and reset at another location along the canal or open channel to irrigate another area. They are used when the water level in canals and ditches must be raised above the normal depth of flow to provide head for operating outlets. Portable check dams are made of sheet metal or plastic sheet or canvas. Canvas or plastic dams are supported on a pipe or wooden cross-bar with suitable loops. A loop is usually provided at the bottom to anchor the dam to a small post. A sleeve made near the bottom of a canvas dam allows any desired quantity of water to pass downstream, while maintaining a constant level upstream. In very hard soil it may be necessary to make grooves with the shovel to insert the edges. The canvas and plastic dams are removed after irrigation, properly washed, dried and stored in order to protect them and make usable for the next season. Metal sheet of about 18 gauge mild steel is cut to suit the channel cross section and driven at about 10 cm deep. Metal sheet has greater durability than other materials. Metal dams are always painted to prevent rusting (Michael, 2010).

14.3 Turnouts

Turnouts are constructed in the bank of a canal to divert part of the water from the canal and ditches to basins, borders, and distribution laterals. Turnouts can be concrete structures or pipe structures. A turnout may have a fixed opening in the side and equipped with the device to control the area of opening. They usually have removable flashboards or a circular or rectangular slide gate to regulate flow. Drop-open gates (similar to drop-open checks) are utilized in semiautomatic turnouts. Turnout commonly used is a metal pipe with slide gate on the inlet. The orifice flow formula is commonly used to determine the capacity of pipe turnout.

14.4 Siphon Tubes

Siphon tubes (Fig. 14.2) are curved plastic, rubber or aluminum pipes that are laid over the bank of delivery channels to deliver water to borders and furrows. The siphon tubes are completely filled and dipped in to water. Water flows into the tube, is pulled (siphoned) over the bank of the delivery channel, and delivered into borders and furrows when there is sufficient operating head and the tube is properly positioned and full of water (primed). For a free-flowing tube, the effective operational head is difference in elevation between the water surface at the tubes entrance and the center of its outlet end.

Siphon tubes are available in diameters ranging between 13 and 150 mm and length of 1.2 to 3.0 m. The discharge of a siphon tube depends on its diameter, length, and inside roughness the number and degree of bends and the operating head.

The discharge from a siphon tubes depend on the diameters of the tube and the difference in elevation between the water surface at the upstream and downstream ends of the tube. It may be estimated by the following formula:

$$Q = 0.65 \times 10^{-3} a \sqrt{2gH}$$

in which,

Q = discharge from siphon tube (L s⁻¹)

a = internal area of cross-section of tube (cm²)

g = acceleration due to gravity (cm/sec²)

H = effective head causing flow (cm)

If the outlet is not submerged, the effective head is the vertical distance from the water level over the inlet end to the center of the discharge end.



Fig.14.2. Siphon tubes.

14.5 Flumes

Flumes are constructed to carry irrigation water across streams, canals, gullies, ravines or other natural depressions. They may be open channels or pipes which are often supported by pillars or may be fixed to bridges. Open channels are made of concrete or wooden having rectangular or trapezoidal shapes. Alternative steel, concrete or vitrified clay pipes could also be used. However while using pipes, care should be taken to position them below the water surface at the upstream end to ensure that they are full. The supporting structure may be made of timber, steel or concrete. Manning's equation is used to estimate discharge of the flumes. Flumes constructed in specially shaped and stabilized channel section may also be used to measure flow. Flumes are generally less inclined to catch floating debris and sediment than weirs and therefore, they are particularly suited for measurement of runoff.

14.6 Culverts

A culvert is a drain or pipe that allows water to flow under a road. Fig 14.3 Shows culvert pipes below a road. Culverts are most suitable structures at the channel crossing when the road fill is sufficiently high and the channel bed lies on the field surface on either side. About 45 cm soil cover is desired above the culvert pipe (Michael, 2010). The pipe used as a culvert has the simple function of providing passage for water underneath the path. The headwater elevation may be above or below the top of the inlet section. Solution of a culvert problem is primarily the determination of the type of flow that will occur under a given head and tail water conditions. Pipe flow (conduit controlling capacity) will occur under most conditions when the slope of the culvert is less than the natural slope and entrance capacity is not limiting. The natural slope for small angles of θ is

$$S_n = \tan \theta = \sin \theta = \frac{H_f}{L} = K_c \frac{v^2}{2g}$$

where,

θ = slope angle of conduit (degrees)

H_f = friction loss in conduit of length L (L)

L = length of conduit (L)

K_c = friction loss coefficient (L/L)

v = velocity of flow (L/T)

g = acceleration due to gravity (L/T²)



Fig. 14.3. Culverts.

14.7 Inverted Siphons

The inverted siphon (Fig. 14.4) is constructed when a channel has to cross a wide depression or where the road surface lies close to the field surface. It has an inlet and an outlet tank connected together at their bottom by a pipe. A check gate is used at the inlet end to control the water surface level in the upstream channel. The tank of an inverted siphon also acts as stilling basin. The bottom of the tanks is kept about 15-20 cm below the bottom of the pipe to collect the silt deposited due to slow down velocity of silt carrying water from upstream erosion.

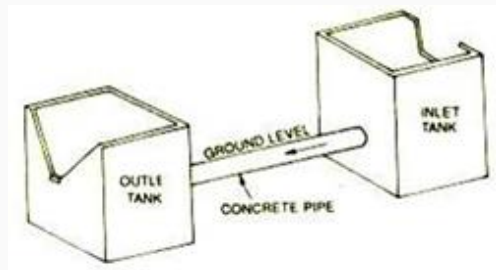

Fig. 14.4. Inverted siphons.



LESSON 15 Underground Pipeline Systems

Water is conveyed from the water source to the cropped field using networks of open channels and or pipe lines. Pipe lines have several advantages over open channels. A properly designed pipeline system saves water, energy consumption and land used for field channels. Underground pipe line types and its components are presented in this lesson.

15.1 Advantages of Underground Pipeline System

The water distribution system of deep wells tube, which are usually owned by the government or cooperative or group farming societies, usually comprise of open channels or buried pipes (underground pipe) with outlets at suitable points in the command area. Buried pipeline water distribution systems, though comparatively more expensive, have major advantages over surface water distribution systems comprising of network of field channels. The following are the major advantages:

1. The farmers get water at or near their fields.
2. Water conveyance losses through seepage, evaporation and breaches in the channels are avoided.
3. The quantity of water delivered from each outlet remains the same, irrespective of the elevation of the outlet.
4. The pipeline can be laid with complete freedom to best suit the requirements of water supply and cost of pipelines, irrespective of the topographic features of the tube well command area.
5. Outlet valves can be provided wherever desired in the pipeline, as determined in the interest of minimising the distance from the outlet to the field, the number of cultivators served by an outlet and ensuring gravity flow from outlet to the fields.
6. Water is supplied to each field plot either directly or through a field channel of short length originating from the outlet.
7. Maintenance cost of the water distribution system is very low.
8. There is full control of the water supply to the fields within a tube well command area.

Limitations

Underground pipe line irrigation system requires high initial investment as compared to open channel systems. This also needs higher operating pressure and additional power to distributed water, whereas in open channel system do not need. The canal carrying svet laden water cannot be connected with underground pipe line system as canal provide very little head and pipe lines are likely to be blocked.

15.2 Low-Head Pipelines

In low head pipe line system water is taken from the water source and directly distributed to basins, borders, and furrows. These low head pipeline works satisfactorily on non-uniform grades, and also at uphill and downhill the land slopes. Such pipeline consists of an inlet, one or more outlets, with head control devices and surge protection structures, air relief valve, flow meter and debris and sand removal devices. Pressure relief, air release, and vacuum relief valves that are used for pressurized pipelines are also used with low-head pipelines. Pipelines permit the conveyance of water on uphill or downhill slopes.

These systems are also suitable to undulating topography and can supply water at any part of the farm. The pipe line systems can be buried or on the surface. Surface pipe lines portable and these are brought back after irrigation. The buried pipe lines placed below the ground surface are permanent and called as permanent underground pipeline. Underground pipe line conveyance system is preferred over surface pipe lines as the cultivation can be done on the land above pipeline and it does not affect farming operation.

15.3 Types of Irrigation Water Conveyance Pipeline System

Generally there are three types of irrigation water conveyance pipe line systems. The first is the completely portable surface pipe line system. In this system water is supplied from source and applied to the field from open end of pipe line or using gated outlets. In second system, a combination of buried and surface pipes are used, where buried permanent pipe lines are used to transmit water from source to risers. These risers supply water to surface pipes. In third system, water is delivered from riser/alfalfa valve and channel border or basins, eliminates the need for surface pipes. Water is released on the portion of the field to be irrigated from risers. Irrigation pipe must be sized carefully to deliver enough discharge and at the same time it should be economical.

15.4 Pressure Variations in Irrigation Pipe Lines

Pressure in the pipe line increases or decreases due to change in elevation (uphill or downhill conditions).

The difference in pressure between two locations along a pipeline can be estimated using following equation.

$$H_d = H_u - 9.81(H_L \pm \Delta H_e) \quad (15.1)$$

Where,

H_d, H_u pressure at down- and upstream position, respectively (kPa);

H_L = energy loss in pipe between the up-and downstream positions (m);

ΔH_e = difference in elevation between up-and downstream positions (m);

When the change in elevation between the up-and downstream positions is uphill, the sign of is plus (+) conversely, this sign is negative () when the elevation at the upstream location exceeds the elevation at the downstream location.

Equation 15.2 can be used to estimate the energy loss term,

$$H_L = F \cdot H_{f+MI} \quad (15.2)$$

Where,

F = constant that depends on the number of outlets removing water from the pipe between source and application points

H_f = friction head loss in pipe (m). This is also called as the major loss.

M_I = minor head losses through the fittings provided in the pipeline system (m)

Estimation of Head Loss Due to Friction or Major Loss: Head loss due to friction in irrigation pipe is estimated by using Darcy Weisbach, Hazen Williams or Scobey equations. Fresh live Darcy Weisbach equation computes head loss due to friction in laminar or turbulent flow in pipelines on rational basis as given by equation (15.3).

Darcy Weisbach Equation:

$$H_f = f \frac{L V^2}{D 2g} \quad (15.3)$$

where

H_f = loss of head due to friction

L = length of pipe

D = the inside pipe diameter

V = the mean velocity

g = the acceleration due to gravity, and

f = friction coefficient.

Equation (15.3) is dimensionally consistent and can be used with the same 'f' values for FPS or SI units. Values of f have been related to boundary roughness dimensions on pipe surface and determined empirically. These are tabulated in

Hazen Williams Equation: The Hazen Williams equation can be written as:

$$V = K R^{0.63} S^{0.54} \quad (15.4)$$

where

V = velocity of flow in pipe line

R = the hydraulic radius of pipe and

S = the slope of pipeline (fraction)

In SI units (R in mm),

The constant $K = 0.0109K_1$

Where

K_1 = the Hazen - Williams resistance coefficient

The values of K_1 range from 144 to 146 for aluminium pipes. K_1 values for the pipes of other materials are available in hydraulic handbooks. (James, 1988).

Scobey Equation: The Scobey equation given for riveted steel pipe has also been used to compute head loss in aluminium pipe. The Scobey equation is given by

$$S = 10^{-3}KV^{1.9}D^{-1.1} \quad (15.5)$$

In SI units velocity (V) in m/s, inside diameter (D) in mm

S = slope (m/m)

The constant $K = 516 K_S$, where K_S = Scobey resistance coefficient

The exponents in the Scobey equation may have different values for other pipe materials (Brater and King, 1976). Recommended values for K_1 and K_S available in the chapter 5 in James (1988), are used to compute pipe size.

Estimation of Minor Losses: Energy losses through fittings and valves also need to be considered in the design of an irrigation pipeline. These so-called "local" or minor losses are frequently estimated by applying a coefficient to the velocity head at the fitting. The sum of all local losses is then added to frictional head loss to estimate total loss in the pipeline. Local loss coefficients to be used in the equation is given:

$$H_f = \frac{KV^2}{2g}$$

The values of local loss coefficient (K) due to fittings, joints, valves, elbows and Tees can be obtained from the book entitled "Design and Operation of Farm Irrigation Systems" Kruse, et al. (1980).

15.5 Components of Underground Pipelines

All the low head underground pipe line system requires pump stand as inlet or gravity inlet, gate stands, pressure relief valves, outlets and end plug. Typical components of underground pipeline are illustrated in Fig. 15.1.

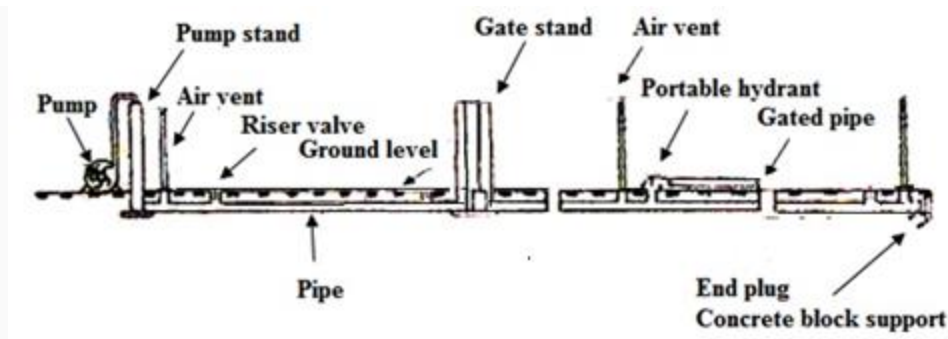

Fig. 15.1. Components of an underground pipeline irrigation system.

15.5.1 Inlet Components of Underground Pipeline System

Water inlet components are required to carry water from the source in to low head underground pipelines. An inlet structure is required to develop adequate pressure and full flow capacity so as to distribute water at different points on the farm. Inlet components use a sand trap and trash screen to prevent entry of debris and heavy suspension of sand in the pipe lines.

Pump Stand

A pump stand is located at the inlet end of underground pipeline system. Pump stand must be high enough to provide the pressure needed at all the pipe outlets. Pump stands size is larger than the diameter of pipe line, to dissipate high velocity stream and release of entrapped air before water enters pipeline. A view of the pump stand is shown in Figure 15.2.

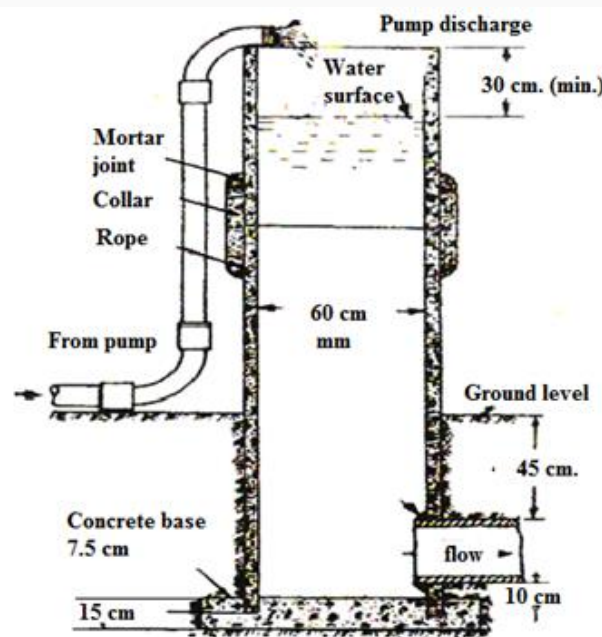

Fig. 15.2. Pump stands for underground pipeline.

Gravity Inlets

The gravity inlet is used when water surface elevation of the water source is sufficient to allow gravity flow into the pipeline and to provide the adequate pressure needed at every point of pipe line and outlet. The low head underground pipe line directly connected with water source can be used for delivering water from a minor canal as shown in Fig. 15.3.

Gate Stands

Gate stands are installed to control flow into branch lines. These are installed where branch lines take off from main line. They also prevent high pressure and act as surge chamber. Each outlet of a gate stand is equipped with slide gate or gate valve to release water through a particular gate valve. Fig. 15.4 shows branching off water from main pipeline and (gate stand).

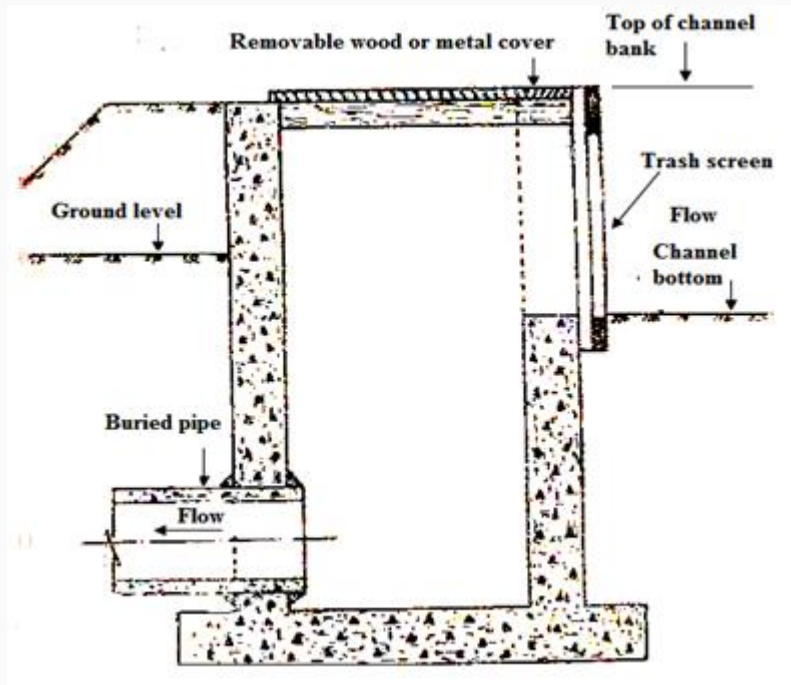

Fig. 15.3. A sectional view of an inlet for taking water from a minor canal into an underground pipeline. (Source: Michael, 2010)

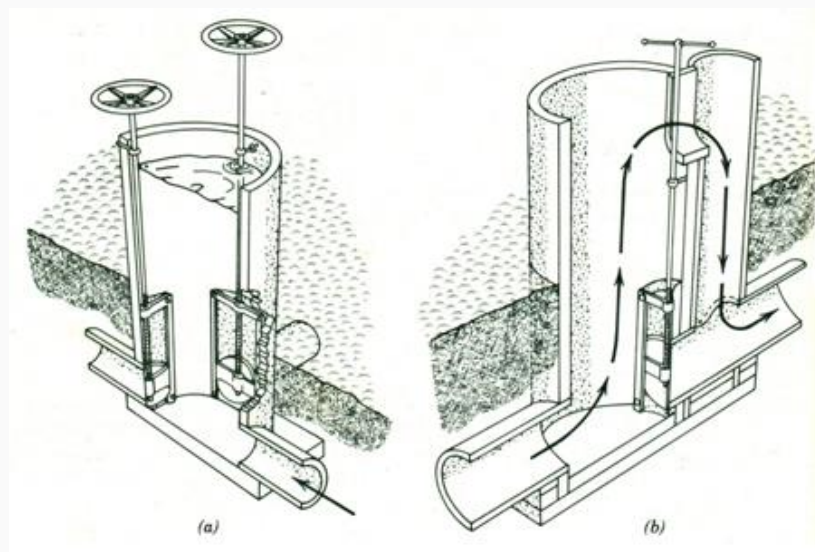

Fig. 15.4. (a) Gate stands and (b) Overflow from Gate stands.

Pressure Relief Valves

Pressure relief valves open at certain preset pressure and discharge fluid to relieve the surge. They close immediately when pressure drops below settings. In situation, when rapid changes in flow velocity are necessary, the pressure relief valves are used to prevent water hammering. The air inlet valves (also called vacuum relief) are used at desired places in the pipe lines to prevent vacuum formation. The air vents are also used to release entrapped air and to prevent vacuum formation. These air release devices (air vents) are installed at inlet end near pump stands, sharp bends, high elevation points and before end of pipe lines.

15.5.2 Outlet Structures

Outlet structures are devices that release water from pipelines to any desired locations in the farm. They consist of a riser pipe, and one or more valves to control the flow. The most common outlet consists of a concrete riser pipe and valves to control the flow. The riser valves, hydrants and gated pipes are connected with riser pipe to distribute water to furrow or a border or a basin. A section of riser pipe with alpha-alpha valve is shown through Fig. 15.5.



Fig. 15.5. Section of an alfalfa valve for a low head pipeline.

Hydrants

Hydrants are devices placed over riser valve outlets as a means of connecting portable gated pipes to the pipeline. They are portable so that they can be moved from one valve outlet to another to serve the portion of the field which is being irrigated at a particular time. Hydrant can also be used for connecting the suction hose of a pump to the water supply carried in the pipeline under low pressure, so that the pump can develop the high pressure.

End Plug

The function of an end plug is to close a line and to absorb the pressure developed at the end of the line, on account of water hammer. The plug is backed by a masonry block which provides sufficient strength to meet unexpected high pressure developed due to sudden opening or closing of valves.

15.6 Underground Pipeline Materials

Both reinforced concrete pipes and PVC pipes are used for constructing water distribution systems in the command areas of wells. PVC pipes are often preferred because of the ease of installation and ensure leak proof joints. Other factors favouring its use are speed of laying and greater resistance to internal friction, as compared to concrete pipes of a given diameter, to convey large quantities of water. However, skill and adherence to proper procedure in laying the pipes and accessories can be used more economically and with equal efficiency, as compared to PVC pipes on plain land. PVC pipes have distinct advantages over

concrete pipes. In undulation topography, however, they need to be buried to avoid UV degradation. HDPE pipe can be used above ground level.



LESSON 16. Design and Operation of Underground Pipeline System

16.1 Design of Underground Pipeline Systems

The design of underground pipe line system requires information on land topography, location of water source and water discharge. Pump stands must be of high elevation to allow sufficient operating head for the pipeline. However, stands higher than necessary may permits high heads of water to build up, leading to excessive line pressures. The working pressures in the pipeline are kept within one-fourth the internal bursting pressures of the pipe. When it is necessary to design pipelines with higher heads, reinforced concrete pressure pipes are used. The sizes of the outlets are selected to suit the flow required at diversion points. The PVC and HDPE are also used for water distribution at low and moderate pressure. The components of the systems such as pipeline size and height of Pump stands and control stands must be designed so as to obtain a balanced water distribution and provide trouble free operation.

The height of water in the pump stands is estimated as follows:

Depth of water in pump stand (H_{PS}) (m) = Reduced level at height point (m) + losses in the pipe line Reduced level at pump stand (m). A free board of 0.5m of water head is added to get the height pump stand.

Losses in pipe line are head loss due to friction and also known as major loss. Various equations such as Darcy-Weisbach, Hazen Williams and Scobey have been proposed to determine head loss due to friction (Refer lesson 15). The Darcy's Weisbach equation is scientifically based and applicable to both laminar and turbulent flows.

The Darcy-Weisbach equation is

$$H_f = f \frac{L}{D} \frac{V^2}{2g} \quad (16.1)$$

where,

H_f = head loss due to friction,(m)

f = friction factor,

L = length of the pipe(m)

d = Inside diameter of the pipe (m)

V = mean velocity of flow (m s⁻¹)

g = acceleration due to gravity (m s⁻²)

The friction factor f is function of Reynolds number (Re) and relative roughness ϵ . For laminar flow ($Re < 2300$), the friction factor is

$$f = \frac{64}{Re} \quad (16.2)$$

where

$$Re = \frac{VD}{\nu}$$

V = velocity, m s⁻¹

D = diameter of pipe, m

ν = Kinematic viscosity, m² s⁻¹

For Re between 2000 and 100,000 (Turbulent flow)

$$f = 0.32 Re^{-0.25} \quad (16.3)$$

For Re > 100,000 (Fully turbulent flow)

$$f = 0.80 + 2.0 \left(\frac{Re}{\sqrt{f}} \right) \quad (16.4)$$

For most commercial materials, the friction factor is represented by the semi-empirical equation

$$\frac{1}{\sqrt{f}} = 1.14 - 2 \log \left(\frac{e}{D} + \frac{9.35}{Re\sqrt{f}} \right) \quad (16.5)$$

Minor Losses

Head losses in underground pipeline are also caused by inlets, bends, gate valves, outlets (rivers, valves etc.) and other appliances such as fittings expansions and constructions due to entry and exit losses and abrupt and gradual changes in velocity. These losses are, referred to as minor losses.

These losses are given by equation (16.6). Each term in the equation represents the head loss due exit, entry or fitting or connections in the pipeline.

$$K_1 \frac{V^2}{2g} + K_2 \frac{V^2}{2g} + K_3 \frac{V^3}{2g} + \dots \dots \dots K_n \frac{V^2}{2g} \quad (16.6)$$

Where,

K_1, K_2, \dots, K_n are coefficients for each item where minor head loss exists.

These minor loss coefficients can be obtained from Michael, (2010).

The values of coefficient as 0.5 for pipe flush with wall, 0.1 for bell entrance and 1.0 for bends. are used. If the gated pipes are used, then pressure required to operate these pipes are included (Michael, 2010).

Diameter of Pipe Line

The diameter of pipe line is computed considering the head loss due to friction in pipe line (Equation 16.1) and discharge. Too small, diameter will increase the pumping cost due to increased frictional head losses and too large pipe diameter will add to the system cost. The material and size of pipe are selected considering the hydraulically efficiently and pumping cost.

Example 16.1: A 500 m long 200 mm diameter pipe is used as underground irrigation water supply system. The velocity of water flow is 5m/s, the PVC pipe is used which has $k_s = 0.00026$ m. Use kinematic viscosity $\nu = 1.007 \times 10^{-6}$ m²/s, Determine the head loss in pipe.

Solution:

The head loss due to friction is computed using the Darcy-Weisbach equation

$$h_f = f \frac{L}{D} \frac{V^2}{2g}$$
$$Re = \frac{VD}{\nu} = (5 \times 0.2) / (1.007 \times 10^{-6})$$
$$= 9.93 \times 10^5$$

The relative roughness

$$k_s = \frac{0.00026}{0.2} = 0.0013$$

From Moody diagram, the friction factor (f) (at $Re = 9.93 \times 10^5$ and $\frac{k_s}{D} = 0.0013$) = 0.021

Head loss due to friction (H_f)

$$H_f = 0.021 \frac{500}{0.2} \times \frac{5^2}{2 \times 9.81} = 66.89 \text{ m}$$

16.2 Laying Out of Underground Pipeline System

Preparation of contour map is essential requirement to lay and construct underground pipeline for a command area. The map should depict North direction and important features locating revenue division and sub divisions. The map should show field boundaries, streams, rivers, tanks, earth embankments, roads, wells and village boundary and other major features of the area which will come under the command of the tubewell and the area immediately adjoining it. The alignment of the buried pipeline water distribution system and the location of the valves should be planned based on the inspection of the field contours and the various features on the ground. The alignment of the earthen field channels and essential field structures like inverted siphons are decided based on the ground elevation. Profiles along each pipe and channel route are surveyed and plans are prepared showing depth, gradient and earth work along their length and the location of the structures. These include inlet, water control and diversion structures, air release vents and end plugs.

After laying of PVC pipes and backfilling of the trenches and construction of the outlet structure, the water is allowed to pass through the pipeline. All air in the pipe should be allowed to escape through the pressure release pipe. For 3 to 4 days, all the outlets are kept open for 3 to 4 hours, with the pump in operation, in order to check if there are any leakages in the pipe or in any of the outlets. If leakage is noticed, repairs are done after draining the entire pipeline system.

16.3 Operation and Maintenance of Underground Pipeline Systems

The underground pipeline may fail due to i) lack of inspection or maintenance, ii) improper construction, iii) improper design and iv) wrong manufacturing processes and poor quality materials used.

The underground pipelines operate without trouble when it is properly designed and correctly installed. Inadequate procedures in design and installation and unforeseen situations give rise to the following troubles.

- a) Development of longitudinal cracks in the pipe, usually at the top or both at top and bottom
- b) Telescoping of sections
- c) Pushing of the pipe into the stands
- d) Development of circumferential cracks
- e) Surging or intermittent flow of water

Leak Testing and Repair

All buried low pressure irrigation pipelines should be tested for leaks before the trench is filled. The pipeline should be filled with water and slowly brought up to operating pressure with all turnouts closed. Any length of pipe section or joints showing leakage should be replaced and the line retested. The water should remain in pipelines throughout the backfilling of trenches, because the internal pressure helps to prevent pipe deformation from soil loading and equipment crossings. Underground pipelines should be

inspected for leakage at least once a year. Leaks may be spotted from wet soil areas above the line that are otherwise unexplained. Small leaks in concrete pipeline can be repaired by carefully cleaning the pipe exterior surrounding the leak, then applying a patch of cement mortar grout. For larger leaks, one or more pipe sections may have to be replaced. Longevity of concrete pipelines can be increased by capping all opening during cold winter months to prevent air circulation. Small leaks in plastic pipe, except at the joints, can sometimes be repaired by pressing a gasket-like material tightly against the pipe wall around the leak and clamping it with a saddle. Where water is supplied from a canal to portable surface pipe, sediment often accumulates in the pipe. This sediment should be flushed out before the pipe is moved. Otherwise, the pipe will be too heavy to be moved by hand and may be damaged if it is moved mechanically. Buried plastic pipelines can be expected to have a usable life of about 15 years, if well maintained. The annual cost of maintenance can be estimated as approximately 1% of the installation cost.



LESSON 17 Land Grading Survey and Design

Land grading is the operation carried out to reshape the land by cutting, filling and smoothing to a designed continuous surface grade. The uniform grade is needed to control flow for irrigation and drainage purposes without soil erosion. A topographic map is a map that contains the information about the general topography of an area on the earth surface. The topographic map includes contours lines, location of natural features such as gullies, ditches and location of man-made features, such as buildings, roads, culverts, bridges etc. These are needed for detailed planning. Contour lines of the topographic map present the topography of an area. A contour line is an imaginary line that is obtained by joining the points of constant elevation on the surface of the ground. Fig. 17.1 depicts the different characteristics of contour lines.

A series of closed contours with higher values inside indicates a summit or hill and outside indicate a depression (Fig. 17.1 a & b). The contours lines form U-shaped curves and the higher values of contour inside the loop indicate a ridge line, V-shaped curves and the lower values of contour inside the loop indicate a valley line (Fig. 17.1 c & d). Contour lines cannot cross one another or merge on the map except in case of an overhanging cliff (Fig. 17.1 e & f). If several contour lines coincide the horizontal equivalent to zero then it indicates a vertical cliff. Four sets of contours (shown in Fig. 17.1g) shows a saddle depression between summits. It is a dip in a ridge or the junction of two ridges. Line passing through the saddle and summits shows a watershed line.

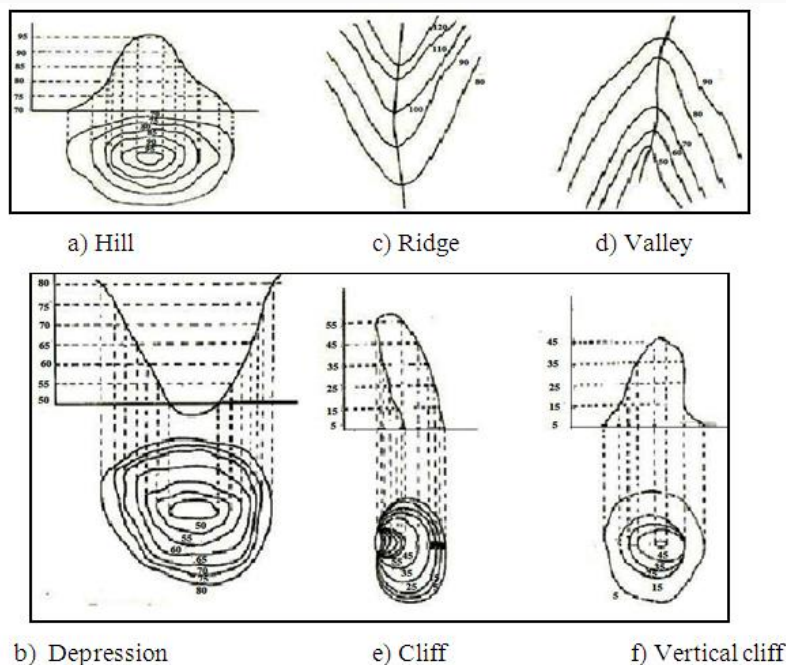

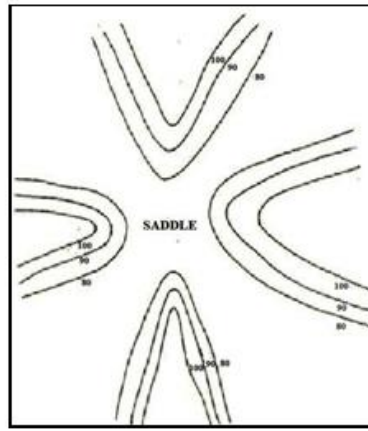

g) Shaddle

Fig. 17.1. Characteristics of contour lines. (Source: Mal, 1995)

After the topographic survey, proper estimation for cut and fill depths at different locations are prepared to obtain a suitable grade with a minimum volume of earthwork. The uniform grades allow fields to be laid out for irrigation runs of the proper length for border and ridges and furrows irrigation methods. Land grading is also beneficial in unirrigated areas to conserve moisture. In the process of land grading, the soil surface is formed to a predetermined grades so that each row or the surface slopes can also meet drainage requirement. This is accomplished by cutting, filling, and smoothing to a planned continuous surface grades with uniform slopes but not necessarily plane surfaces. In developing a land grading plan, filling depressions with soil from adjoining mounds and ridges and establishing grade in the direction of row grade, tillage or predominant natural slope is emphasized to minimize cuts and fills.

17.1 Land Levelling

Land levelling is the process of modifying the surface relief by grading and smoothing to a planned grade and to certain specifications required to facilitate or to improve the uniform application of water for irrigation and drainage purpose.

17.1.1 Criteria for Land Levelling

Criteria for land levelling depend on the soil profile conditions, land slope, climate, crops to be grown, methods of irrigation, and the farmers' requirement. Land levelling should never be planned without knowing the soil-profile conditions and the maximum cut that can be made without seriously affecting agricultural production. Land levelling modifies the land surface for efficient surface irrigation. Irrigated land is also levelled to obtain good surface land drainage. The entire farm should be divided into smaller field subdivisions based on natural topographical boundaries in the initial plan itself, even though only a part of the farm may be levelled at the first instant. Each field subdivision may be further divided into relatively narrow strips on the approximate contour to reduce the slope of safe limits and avoid deep cuts of the surface soil. Each strip is a separate field for land levelling design. The irrigation and drainage systems for a particular field should be taken up simultaneously. The earth work (a cut) soil can be used as a fill (making embankment) for irrigation channel and cut soil area can be used for making channel.

a) Soil Profile Conditions

Soil profile study is desired before undertaking the levelling work. The soil profile map should depict details of soil texture of surface and subsurface soils. This should also include physical properties including infiltration rate, irrigation properties and the soil bulk density. The soil properties with reference to field capacity, wilting point and bulk density are required for deciding the duration of irrigation. The infiltration rate is required for deciding length of border & furrow and size of basins. Soil profile map

should also provide the details of sand, depth of gravel, hard pans, rock or other material that might limit the depth of cut, as well as the extent of such areas. Soils with deep, well drained subsoils generally have little limitation on depth of cut. Cuts of 3 to 4 m can be made in soils with deep subsoils without permanently reducing potential crop production (Anderson et al., 1980). Deep cuts in shallow soils may expose inert materials which may not be desirable to grow crops. Addition of organic matter and fertilizers in soils can amend soil condition to grow crops without affecting crop productivity appreciably. Where deep cuts are unavoidable and the soil is shallow the harmful effects of top soil removal may be mitigated by scraping and storing the top soil, which is then replaced by the new grade after the movement of the subsoil material. Bench terracing in small strips minimises the harmful effects of severe top soil removal.

b) Land Slope

A good land grade is designed to achieve high irrigation efficiencies considering soil infiltration characteristics, irrigation stream size, the crops to be grown and erosion hazard from rainfall and degree of uniformity in water distribution. Sometimes excessive cuts are desired to eliminate cross slopes. To reduce the extent of cuts, the field is divided into parts and the levelling is done in strips at different elevations, separated by low ridges. This practice of grading is known as bench levelling. This type of levelling is especially required if there is considerable difference in elevation between adjacent strips. Earth work is done along the width of benches. The amount of earthwork is governed by the magnitude of the diagonal slope at right angles to the direction of irrigation. Safe limits of longitudinal slope of fields for different soil types are given in Table 17.1. (a).

Table 17.1. (a) Recommended safe limits of land slope for efficient irrigation

Type of soil	Longitudinal slope %
Heavy (clay) soils	0.05 to 0.20
Medium (loamy) soils	0.20 to 0.40
Light (sandy) soils	0.25 to 0.65

c) Cross Slope

Cross slope (slope perpendicular to longitudinal slope) is desired to reduce cut yardage or to establish the "plane of best fit." Cross slopes must be such that "breakthroughs" from both irrigation water and runoff from rainfall are held to a minimum. Recommended cross slopes for different furrow grades are presented in Table 17.2. (b).

Table 17.1. (b) Maximum recommended cross slope

Furrow Grade	Cross Slope
0.1 percent	0.3 percent
0.2 percent	0.3 percent
0.3 percent	0.3 percent

0.4 percent	0.4 percent
0.5 percent	0.5 percent

d) Rainfall Characteristics

Rainfall characteristics viz. depth, duration and frequency influence the land drainage requirement or drainage coefficient. Land grading must meet the drainage requirements. Land grades should be non erosive so as to dispose excess rainfall at safer velocity without causing soil erosion.

e) Cropping Pattern

The high value crops with high labourer requirement along with their sensitivity to water stagnation justify the need for degree of levelling to reduce labour and production costs. Vegetables, oil seeds, pulses, medicinal plants justify a high levelling cost whereas a fodder crop or some cereal crops may need a much smaller investment as they tolerate some degree of water logging.

f) Irrigation Methods

Pressurized irrigation methods may not need high degree of land levelling, whereas surface irrigation needs proper land grading and levelling. When several methods of irrigation are to be used in the same field, the requirements of maximum length of run for surface irrigation methods should be worked out based on the soil texture.

Land Clearing

The land clearing includes removal of unwanted trees, brush, vegetation, trash and boulders from the area specified for land grading. The land clearing operation involves heavy earth moving machineries such as bulldozers, root rakes, stumpers, root cutters, rotary choppers and other appropriate machinery.

17.2 Levelling Layout of Field for Irrigation and Drainage Systems

The location of the field boundaries, irrigation water supply system, drains and farm roads and other physical features are required to be known prior to land levelling. The levelling plans should include estimate of volume of earth work for cut and fill. There should be proper ratio between excavations and fill. The plan should furnish information on soil, topography, and the requirement of the farmer. So that alternative field plan arrangements to accommodate desired changes. The planner should consider and visualise all possible layouts and the one best suited to the site should be selected considering water application methods, crops to be grown and the farmer's choice. In making layout, planner should also consider location, size of drainage and irrigation ditches, pipelines location for water supply, easy access of movement of farm machineries to all fields, provision for combining smaller fields to larger fields and possibility of changing in cropping system.

Plans and Specifications

The field layout involves proper planning of field to arrange irrigation, drainage and roads for efficient irrigation and disposal of water.

a) Field Arrangement

Laying out fields of workable size and shape is important for successful irrigation farming. The fields are laid out as nearly rectangular as possible. Sharp turns in field boundaries should be avoided as far as

possible in order to facilitate the use and movement of farm equipment. The field length is based on the maximum allowable length of run for the irrigation method selected. The field length may be equal to single run length or a multiple of the run lengths. Alternatively the field lengths may be limited by ownership boundaries. Table 17.2 provides the range of lengths for border strip and furrow methods of irrigation.

Table 17.2. Recommended length of run for border strip and furrow methods of irrigation

Soil type	Length of run
Sandy and sandy loam soils	60 to 120 m
Medium loam soils	100 to 180 m
Clay loam and clay soils	150 to 300 m

Separation of fields will be desirable along the line of slope change. Sharp bends in otherwise nearly straight contours indicate change in the direction of maximum slope. Separation of fields at the bend is desirable for surface irrigation methods. Contour lines either close together or far apart may imply that the average natural slope is either too steep or too flat. Normally the lengths of fields are kept minimum to reduce the amount of cuts and fills required. Greater irregularity in spacing and direction of contours may show that the topography is non-uniform to the extent that it fails to show where a separation into fields can be made advantageously. Such areas are set apart to be graded individually as units. Excessively irregular or closely spaced contours indicate high cost of levelling.

b) Field Road System

Field road system is made to provide access to all areas of the farm for equipment, transportation of farm produce and operation of the irrigation system. Normally field roads are located at higher elevation than irrigation channels and followed below by field drains.

c) Drainage

Provision should be made to drain the excess rainfall promptly and safely. If the land is not naturally well drained, artificial drainage must be established along with installation of irrigation system. Seepage from over-irrigated areas at higher elevations and irrigation canals can damage lands in low-laying area. Interceptor drains may be necessary at the upper boundaries of the low-laying area to divert the seepage and prevent water logging. Integrated irrigation and drainage planning is often necessary for laying out a farm area for efficient water use.

17.3 Survey and Staking

a) Land Levelling Design

In order to carryout land levelling program topographic survey is performed.

The field is divided in the grids of equal sizes. Generally grids of 15 m×15 m or 30 m×30 m are used. The size of grid depends on degree of precision required. The grid points are located by establishing two or

more base lines in each direction then to sight in the rest of the stakes. The elevations at each stakes are determined using the dumpy level. The normal procedure of survey is adopted for determination of elevation. Based on the observations of staff reading, the reduced levels of the grid points are estimated. The contour lines are drawn using the elevation values, and contour map is prepared. The field is graded as per requirement using contour map.

b) Procedure for Determination of Centroid of a Field

The field could be a rectangular, triangular or an irregular in shape. The centroid of a rectangular field is located at the point of intersection of its diagonals, whereas the intersection of the lines drawn from its corner to mid points of the opposite sides of triangle is the centroid of triangular field. In case of irregular field the area is divided into rectangles and right angled triangles for the determination of centroid. The centroid is located by computing moments from two reference lines at right angle to each other. The distance to the centroid of the field from any line of reference is equal to the sum of the products obtained by multiplying the area of each part times the distance from the line of reference to its centroid, divided by the total area of the field. By computing the distance to the centroid from two lines of reference perpendicular to each other, the exact point of centroid can be obtained.

The following example 17.1 illustrates the procedure to compute centroid of a field.

Example 17.1: Compute the elevation of centroid of a rectangular field. Stakes are to be kept to carry out levelling work of the field. The elevations at grid points as obtained from a topographic survey are stated below.

Elevation of stations at lines					
Stations	1	2	3	4	5
A	9.56	9.34	9.02	8.84	8.76
B	8.37	8.24	8.98	8.68	8.57
C	9.22	9.04	8.94	8.56	8.48
D	8.92	8.84	8.76	8.31	8.02

Solution:

Sum of elevations of the 20 stations = 175.45 m

Total number of stations = 20

Elevation of centroid =
$$\frac{\text{Sum of the elevations of the grid points}}{\text{Number of grid points}}$$

$$= \frac{175.45}{20} = 8.77 \text{ m}$$



LESSON 18 Land Leveling Methods

A precise land leveling improves irrigation and energy efficiency. This also reduces labor requirement for water application. A properly leveled land can be properly irrigated and excess water can be drained out. However, major topographical changes in the process of land leveling may reduce crop production in the cut areas or additional soils may have to be added in cut areas for improving soil fertility. Further farm machineries movement compact soil and disturb soil pores and thereby reduces water movement through side. Hence it is essential to estimate locations and volumes of cuts and fills, maintain proper cut-fill ratio by minimally affecting the crop production and at the same time involving the less cost for land leveling. Hence for land leveling design should be done properly. There are several methods for land leveling design. These methods are: Plane method, Profile method, Plan inspection method and Contour adjustment methods. The procedures adopted to use these methods are briefly presented in this lesson.

18.1 Plane Method

The plane method is the most commonly used method of land levelling design. This method is feasible whenever it is required to grade the field to a true plane. The procedure involves first determining the centroid of the field as per the procedure explained in section 17.3 of lesson 17 and then determining the average elevation of the field. This is obtained by adding the elevations of all grid points in the field and dividing the sum of elevations by number of grid points. Any plane passing through the centroid at average elevation will produce equal volume of cut and fill. Based on the longitudinal down field grade and cross field grade required for the field, the elevation of each grid points are computed from estimated centroid. The following example illustrates the method to estimate average elevation and elevation at different grid points for a desired slope.

Example 18.1: The elevations of grid points selected at 25 m interval are determined from a topographic survey for land leveling programme. The elevations of points are as given below in the table.

Stations	Elevation (m)				
	Line No. 1	Line No. 2	Line No. 3	Line No. 4	Line No. 5
A	97.30	97.75	98.30	98.52	99.40
B	96.90	97.12	97.90	97.80	98.62

C	96.14	96.86	97.35	97.60	97.42
D	95.72	96.28	96.94	97.16	96.84

The field is to have downfield slope of 0.2%. Determine: i) elevation of centroid of the field, and ii) formation levels at grid points and amount of cut and fill at each grid point.

Solution:

$$\text{Elevation of centroid} = \frac{\text{sum of elevation of all station}}{\text{Number of station}}$$

Total number of stations = 20

Sum of the elevations of the 20 stations = 1947.92 m

Elevation of the centroid m

The field is to be given 0.2% slope. At 50 m from the North South line passing through centroid, the elevation of this point is 0.1 m below the centroid, or 97.296 m.

The formation of grid levels at each point are estimated as given in this table

Stations	Elevation (m)				
	Line No. 1	Line No. 2	Line No. 3	Line No. 4	Line No. 5
A	97.296	97.346	97.396	97.446	97.496
B	97.296	97.346	97.396	97.446	97.496
C	97.296	97.346	97.396	97.446	97.496
D	97.296	97.346	97.396	97.446	97.496

Cuts and Fills

Cut and fill are computed by subtracting the original elevation of the point from the formation level at the grid point. At station A1, the cut/fill is $97.296 - 97.30 = (-) 0.004$. The results of cut / fill are given in following table.

Stations	Elevation (m)				
	Line No. 1	Line No. 2	Line No. 3	Line No. 4	Line No. 5
A	- 0.004	- 0.404	- 0.904	- 1.074	- 1.904
B	+ 0.396	+ 0.226	- 0.504	- 0.354	- 1.124
C	+ 1.156	+ 0.486	+ 0.046	- 0.154	+ 0.076
D	+ 1.576	+ 1.066	+ 0.456	+ 0.286	+ 0.656

(+ Sign indicates fill and - sign indicates cut)

$$\Sigma \text{ cut} = \Sigma \text{ fill} = 6.426 \text{ m}$$

Computation of Slopes of Plane of Best Fit

The computation of slopes of plane of best fit is given by

$$E = a + S_x X + S_y Y \tag{18.1}$$

where,

E = elevation at any point (L)

a = elevation at the origin (L)

S_x and S_y = slope in the x and y directions, respectively (L/L)

X any Y = distance from the origin (L)

The slope of any line in X or Y direction is determined by the statistical least - square procedure, (Schwab et al., 1993). The least -squares plane by definition is that which gives the smallest sum of all the squared differences in elevation between the grid points and the plane. It is called the plane of best fit. These slopes can be computed from two simultaneous equations stated below

$$(\Sigma X^2 - n X_c^2)S_x + [\Sigma (XY) - nX_cY_c]S_y = \Sigma (XE) - nX_cE_c \quad (18.2)$$

$$(\Sigma Y^2 - nY_c^2)S_y + [\Sigma (XY) - nX_cY_c]S_x = \Sigma (YE) - nY_cE_c \quad (18.3)$$

where

n = total number of grid points

X_c = X distance to the centroid

Y_c = Y distance to the centroid

E_c = elevation of the centroid (average elevation of all points).

For rectangular fields the terms involving XY become zero and

$$S_x = \frac{\Sigma (XE) - nX_c E_c}{\Sigma X^2 - n X_c^2} \quad (18.4)$$

The slope S_y can be obtained from Eq. (18.4) by substituting Y for X. Although Eq. (18.4) is valid only for rectangular fields, a satisfactory solution can often be obtained by taking one or more arbitrarily selected rectangular areas within the field and extending the slopes of the plane to the remaining areas.

Average elevation of the field is determined by adding the elevations of all the grids and dividing the sum by number of points.

Example 18.2: Establish the equation for determining the elevation at any point using plane of best fit approach for the field shown in Fig. 18.1.

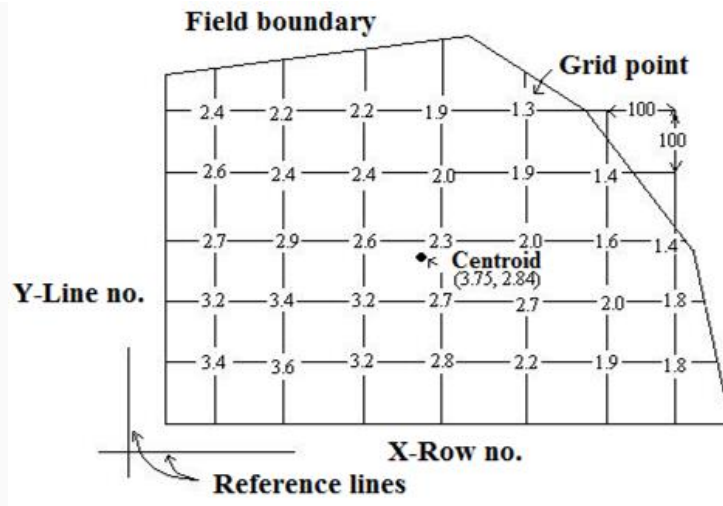

(Elevations of different grids of field are in meter)

Solution:

The plane of best fit approach uses following equations for determination of slopes in X and Y direction. The following table illustrates the computation procedure for determining plane of best fit.

Line No.	1	2	3	4	5	6	7
No. of stakes in Y-direction	5	5	5	5	5	4	3
Product of line × stake	5	10	15	20	25	24	21

In X- direction,

i) Total no. of stakes = 32

ii) Product = 120

iii) Average $= \frac{120}{32} = 3.75$

Line no.	No. of stakes in X- direction	Product of line (no.) × stake (no.)
5	5	25
4	6	24

3	7	21
2	7	14
1	7	7

In Y- direction,

i) Total no. of stakes = 32

ii) Sum of product is = 91

iii) Average $= \frac{91}{32} = 2.84$

Hence co-ordinates of centroid = (3.75, 3.84)

No. of stakes (n) = 32, $X_c = 3.75, Y_c = 2.84$

$E_c = (3.4 + 3.2 + 2.7 + \dots + 1.8 + 1.4) / 32 = 2.37 \text{ m}$

$$\sum X^2 = 1^2 + 1^2 + 1^2 + 1^2 + 1^2 + 2^2 + \dots + 6^2 + 7^2 + 7^2 + 7^2 = 566$$

$$nX_c^2 = 32 \times 3.75^2 = 450$$

$$nY_c^2 = 32 \times 2.84^2 = 258.1$$

$$\sum (YE) = 204.2$$

$$nY_c E_c = 32 \times 2.84 \times 2.37 = 215.4$$

$$\sum (XY) = (1 \times 1) + (1 \times 2) + (1 \times 3) + \dots + (7 \times 1) + (7 \times 2) + (7 \times 3) = 327$$

$$nX_c Y_c = 32 \times 3.75 \times 2.84 = 340.8$$

$$\sum (XE) = 255.8$$

$$nX_c E_c = 32 \times 3.75 \times 2.37 = 284.4$$

Equation (18.2) is replaced here

$$(\Sigma X^2 - n X_c^2)S_x + [\Sigma (XY) - nX_cY_c]S_y = \Sigma (XE) - nX_cE_c$$

or, $(566 - 450) S_x + (327 - 340.8) S_y = 255.8 - 284.4$ (18.5)

Equation (18.3) is reproduced

$$(\Sigma Y^2 - nY_c^2)S_y + [\Sigma (XY) - nX_cY_c]S_x = \Sigma (YE) - nY_cE_c$$

or, $(319 - 258.1) S_y + (327 - 340.8) S_x = 204.2 - 215.4$ (18.6)

From Eq. (18.6)

$$60.9 S_y - 13.8 S_x = -11.2$$
 (18.7)

From Eq. (18.5)

$$13.8 S_y + 116 S_x = -28.6$$
 (18.8)

$$\text{Eq. 18.7} \times 13.8 \Rightarrow 840.42 S_y - 190.44 S_x = -165.6$$
 (18.9)

$$\text{Eq. 18.8} \times 60.9 \Rightarrow -840.42 S_y + 7064.4 S_x = -1741.74$$
 (18.10)

From Eq. 18.9 and Eq. 18.10

$$6873.96 S_x = -1896.3$$

or, $S_x = -0.276 / 100 \text{ m}$

From Equation (18.7)

$$60.9 S_y - 13.8 \times (-0.276) = -11.2$$

or, $S_y = -0.246 / 100 \text{ m}$

Since the plane of best fit must pass through the centroid, substituting the above values in Eq. (18.1).

$$E = a + S_x X + S_y Y$$
 (18.12)

or, $2.37 = a + ((-0.276) \times 3.75) + ((-0.246) \times 2.84)$

or, $a = 4.103 \text{ m}$

The elevation of the origin as 4.103 m

Hence elevation at any point in the field is given by

$$E = 4.103 - 0.276 X - 0.246Y$$

18.2 Profile Method

The profile method of land levelling design consists of plotting the profiles of the grid lines and then laying the desired grade on the profiles. With this method, ground profiles are plotted and a grade is established that will provide an appropriate balance between cuts and fills as well as reduce haul distances to a reasonable limit. It is usually well adopted to leveling design of very flat land with undulating topography on which it is desired to develop a fairly uniform surface relief. Using profile method the designer works with profiles of the grid lines rather with elevations. The profiles are normally plotted in one direction with the individual profiles located on the paper so that the datum line for each profile is in the correct position with adjacent profiles. Profiles may be plotted across the slope or down the slope. Trial grade lines are plotted on each profiles based on the design criteria. The balance between cuts and fill is approximated by eye and comparing the areas between the plotted profiles and the trial grade line. Usually several trials are necessary before a satisfactory set of grade lines are attained. The volume of cut and fill is computed and further adjustment of the grade lines is done to obtain desired cut-fill ratio for the field.

18.3 Plan Inspection Method

The plan inspection method is a rapid method. Although this method does not ensure minimum cuts and fills or the shortest length of haul, however it gives quick estimate. This method is adapted to moderate flat land slopes. A proposed ground surface map is overlaid on the original contour map. Hence it involves contour adjustment using procedure. New contour lines are drawn using uniform slope and spacing between them.

18.4 Contour Adjustment Method

A balance between the cut and fill can be approximated by maintaining the proposed contour in an average position with reference to the original contour at the same elevation. Sum of the design cut and fills from the stake points are compared with total and then readjusted to obtain design levels. Contour adjustment method is adapted to smoothening of steep lands that are to be irrigated. This method demands considerable judgment on the part of designer to keep the earthwork and haul to a minimum. The design grade elevations are determined after a careful study of the topography. It involves trial and error method considering down grade and cross slope limitations.



LESSON 19 Contour Bench Levelling and Earthwork Quantities Computation

In this lesson, purpose of construction of contour benches, its design and computation of earth work quantities are presented. Irrigation in undulating fields and steep slope is a very difficult task. Rainfall erosion and moisture conservation can be controlled and retained by forming contour benches. Earthwork computation is an important task in land levelling.

19.1 Contour Bench Levelling

Contour bench levelling is a method for cutting length of slope to a desired grade and preparing land for irrigation. The undulated field is cut into a number of steps approximately by using contours; each step is levelled and made as an independent area. Thus a series of steps are formed in successive elevations around the slope. Benches are used for forming the border, furrow and check basin the slope. The contour bench levelling provides controlled irrigation water flow on the flat slopes and for efficient irrigation. Contour bench levelling controls erosion from rainfall, and permits soil building processes thereby resulting in increase of fertility and improved soil structure. The flat benches provide greater opportunity time for infiltration thereby reducing the quantity of irrigation water needed to meet plant requirements.

19.1.1 Construction of Contour Benches

The components of bench cross-section are shown through Fig. 19.1. Selecting the proper cross section for contour benches is one of the most important steps of planning for contour bench construction.

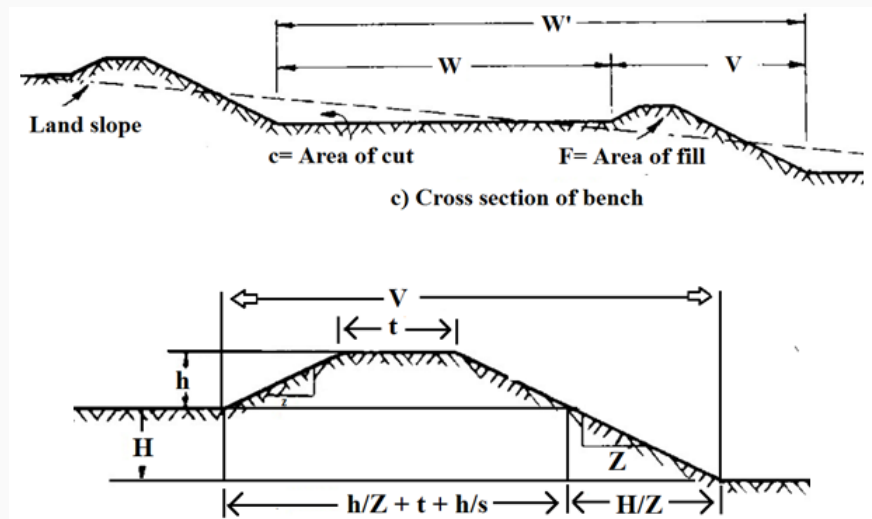

Fig. 19.1. Cross section of bench and bund. (Source: Michael, 2010)

Let W be the bench width of the farmable area. This width should be such that it can accommodate the widest of farm equipment to be used for farming.

The other parameters are:

W' = overall bench width (m)

W = width of cultivable strip (m)

t = top width of dike (m)

h = height of dike (m)

H = vertical interval between benches (m)

Z = side slope of dike (dimensionless)

S = slope of land (dimensionless)

The relationship between W, W' and H can be expressed as:

$$W' = H/S \quad (19.1)$$

or, $H = W' S \quad (19.2)$

$$W' = W + \frac{h}{Z} + t + \frac{h}{Z} + \frac{W' S}{Z}$$

$$W' - \frac{W' S}{Z} = W + t + \frac{2h}{Z}$$

$$W' \left(1 - \frac{s}{z} \right) = W + t + \frac{2h}{Z}$$

$$W' = \left(W + t + \frac{2h}{Z} \right) \left(\frac{1}{1 - s/z} \right) = \left(W + B + \frac{2h}{Z} \right) \left(\frac{z}{z - s} \right) \quad (19.3)$$

The side slopes of dike (Z) should have stable side slopes. The side slope of 2:1 is normally provided. The area where stones are presents in the field much steeper slope can be used. Stones should be used to support the bund. Top width of the dike, (t) should be sufficient to prevent further lowering of its height by trampling or by other sources.

It is a usual practice to keep the top width of dike equal to the vertical interval between benches.

$$t = H \quad (19.4)$$

Example 19.1: A trapezoidal bund of 80 m long is to be constructed having bottom width as 4 m and top width as 2 m. The height of one end of bund is 1.2 m and that of the other end is 1.5 m. Determine the volume of earth fill for making bund.

Solution:

$$V = \frac{(A_1 + A_2)}{2} \times L$$

The volume of earth fills for making bund

$$\text{Area of one end of bund } (A_1) = \frac{1}{2}(4+2) \cdot 1.2 = 3.6 \text{ m}^2$$

$$\text{Area of other end of bund } (A_2) = \frac{1}{2}(4+2) \cdot 1.5 = 4.5 \text{ m}^2$$

$$V = \frac{(3.6 + 4.5)}{2} \times 80$$

$$V = 324.00 \text{ m}^3$$

Hence volume of earth fill = 324.00 m³

Example 19.2: The random field ditch drains are to be used for removal of drainage water. The plan, profile and cross section are shown Fig.19.1. Estimate the volume of earth work for cutting.

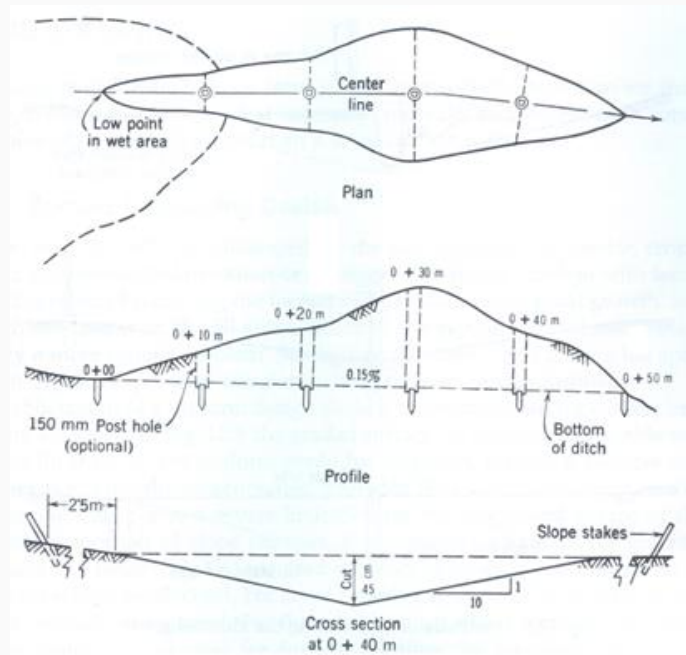

Fig. 19.2. Layout of random field drain for computing the earth work in cutting. (Source: Schwab et al., 1993)

Solution:

The levelling instrument was used to obtain the depth of cut for the ditch grade of 0.15 per cent. The procedure used to compute earth work is illustrated in the following Table 19.1.

Station (m)	Cut (m)	Top Width (m)	Cross- sectional area (m ²)	Average Cross- sectional area (m ²)	Distance (m)	Volume of cut (m ³)
0+00	0	0	0			
0+10	0.20	2.0	0.40	0.2	10	2.00
0+20	0.35	3.5	1.23	0.82	10	8.20
0+30	0.70	7.0	4.9	3.07	10	30.70
0+40	0.45	4.5	2.03	3.47	10	34.70
0+50	0.00	0.0	0.0	1.02	10	10.20
Total						85.80

The total volume of earthwork in cutting is 85.8 m³

19.2 Earthwork Quantities Computation

Earthwork quantities need to be computed for desired land levelling method and for generated cross section. The common methods for computing earthwork quantity are: end area method, prismatic and four point method.

a) End Area Method

The areas of cuts and fills on the profiles or grid lines are used to compute the volume between the adjacent profile or grid lines, given by relationship

$$V = L \frac{(A_1 + A_2)}{2} \quad (19.5)$$

In which,

V = volume of cut or fill, m³

L = distance between profiles or lines, m

A_1 = area of cut or fill in the first profile or line, m^2

A_2 = area of cut or fill in the second profile, m^2

b) Prismoidal Formula

A precise method of computing the volume of earthwork in land levelling makes use of the prismoidal formula

$$V = \frac{L}{6} (A_1 + 4A_m + A_2) \quad (19.6)$$

In which

V = volume of earthwork, m^3

L = perpendicular distance between end planes, m

A_1 = area of the first end plane, m^2

A_2 = area of the second end plane, m^2

A_m = area of middle section parallel to end planes (m^2)

c) Four - Point Method

A commonly used method called the four-point method is sufficiently accurate for land grading. Volume of cuts for each grid square is given by

$$V_c = \frac{L^2 (\sum C)^2}{4(\sum C + \sum F)} \quad (19.7)$$

where,

V_c = volume of cut, m^3

L = grid spacing, m

C = sum of cut on the four corners of a square grid, m

F = sum of fill on the four corners of a square grid, m

For computing V_f the volume of fills, $(\Sigma C)^2$ in the numerator of equation 19.7 is replaced by (ΣF) .

Example 19.3: Compute the balancing depth (volume of earthwork in cutting is equal to volume of earthwork in filling) for a canal having a bed width as 8 m with side slopes of 1:1 in cutting and 2:1 in filling. The bank embankments are kept 2 m higher than the ground level (berm level) and crest width of embankments is 2.0 m.

Solution:

The channel section is shown in Fig 19.3. Let d_1 be the balancing depth, i.e. the depth for which excavation and filling becomes equal.

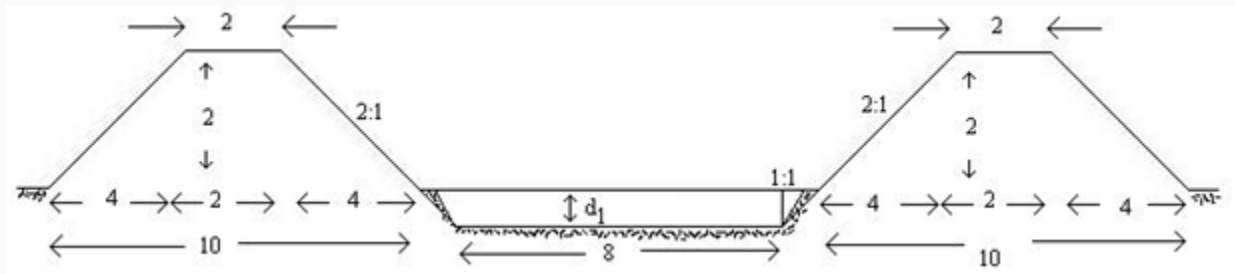

(All dimensions are in meter)

Fig. 19.3. Cross section of a canal with embankment.

Let the length of canal be L meter.

Area of cutting $(A_1) = (8+d_1) d_1$

Volume of earthwork in cutting $V_1 = [(8+d_1).d_1].L$ (19.8)

$$= 2 \left[\frac{2+10}{2} \times 2 \right] = 24 \text{ m}^2$$

Area of cross section of two embankments

Volume of earthwork in filling in construction of embankments = 24 L m²

Equating equations (19.8) and (19.9), we get

$$[(8+ d_1) d_1]L = 24L \quad (19.10)$$

or, $d_1+ 8 d_1 - 24 = 0$

$$d_1 = \frac{-8 \pm \sqrt{64 - 4(-24)}}{2}$$

$$= \frac{-8 \pm \sqrt{64 + 96}}{2}$$

$$= \frac{-8 \pm 12.65}{2}$$

$$d_1 = \frac{-8 + 12.65}{2} = 2.325 \text{ m}$$

$$d_1 = \frac{-8 - 12.65}{2} = -10.325 \text{ m}$$

Ignoring infeasible -ve sign, we get = 2.325 m

Balancing depth = 2.325 m



LESSON 20 Equipment for Land Grading

Land levelling involves cutting, moving and filling earth material, where cut and fill areas separated by some distance. Land levelling is performed in 5 to 10 years period.

Land grading involves smoothing of the soil surface to correct localized minor surface irregularities. Land grading is reshaping of the field surface to make field suitable to control flow of water, to check soil erosion and to provide efficient surface drainage system. In rice field, the land grading is often performed under saturated conditions with animal or machinery power.

Land grading is performed using equipment operated by animal and mechanical power. The brief descriptions of the land levelling/land grading equipments are presented in this lesson.

20.1 Equipment Operated with Animal Power

20.1.1 Animal Drawn Buck Scraper

Animal drawn buck scraper is used for land grading and leveling fields of smaller and medium sizes. Buck scraper is a simple implement for land grading. The operator can control the depth of cut depends upon the load on scraper. The operator stands on the scraper board to allow deeper cut. Some time it is used to move the soil. The parts of the buck scrapers are the front board, the tail board, joints, handle and hitch. The implement has several operation features. The most important dimensions of the implement are the location of the hinge point of the tail board at the back of the front board and the position of 'eye bolt' or hitch of the chain on the front board. The centre of hinge pin is set at 11 cm, from the bottom of the front board (Fig. 20.1). The position of 'eye bolt' or hitch points on either side is set at 6.5 cm from the bottom of the front board (Michael, 2010).

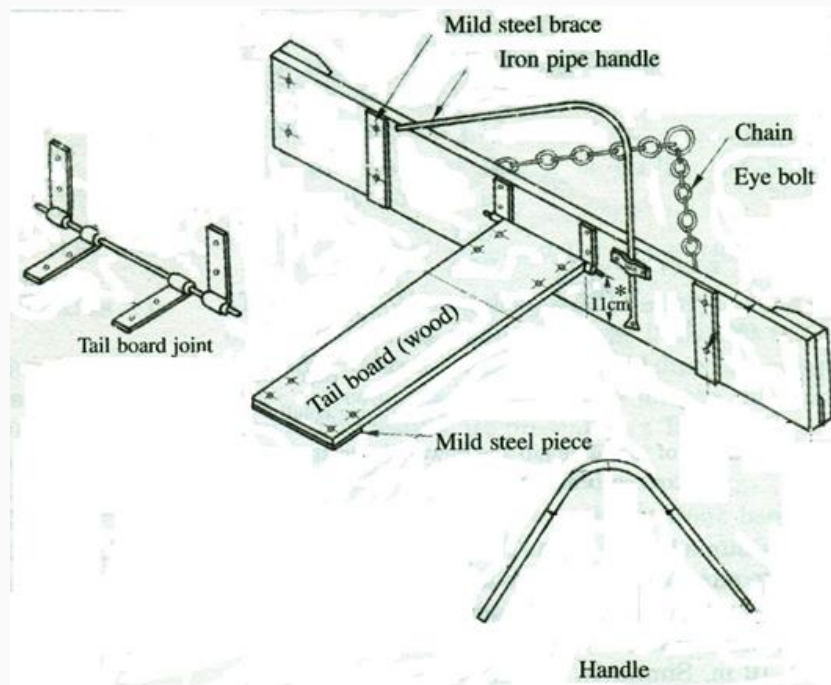

Fig. 20.1. Animal drawn wooden buck scraper.

After loading, the operator can move back and walk behind the implement, since the scraper will usually carry a full load without the operator riding or holding the handle unload, the handle is lifted and the soil load is dumped. Uniform spreading of the earth material may be done by slightly raising the handle to distribute out material in a thin layer.

20.1.2 Animal Drawn Bund Former

It is a simple implement for making bunds (ridges). It is used for preparation of ridges or bund for check basin or border irrigation. It can also be used in dry farming areas to conserve soil moisture. On steep slopes, bunds are made along the contour to prevent soil erosion during heavy rains. The implement consists of two blades, flat iron frame bent at an angle a handle attached to the frame with tie bars and wooden beam. The operator's handle is made of wood for providing better grip and convenience, and it's attached to the frame with the help of suitable brackets. The frame is bent at an angle and has holes for adjusting the space between the blades. The profile of blades is made to a shape so that bund formed is trapezoidal and remains stable. The blades are attached to the frame with fasteners. For operation, a pair of bullock pulls the implement; the blades gather the loose soil and accumulate it in the form of bund. Fig. 20.2 shows an animal drawn bund former.



Fig. 20.2. Animal drawn bund former.

20.2 Equipment Operated with Mechanical Power

Mechanical power drawn equipment such as bulldozers, tractor drawn scrapers and disc ridges are used for land grading and earth forming operation. Land smoothing is done by tractor drawn land planes. The crawlers and rubber tired wheel type tractors are also used for land grading. The sizes of equipment vary and operated by medium size farm tractors to heavy crawler tractors. The crawler tractor is used for heavy earth movement and it gives greater traction on the varying ground conditions encountered in land grading. It is more capable than wheel tractor in loading an attached scraper, and for cutting and pushing of earth when equipped with dozer blade. There is a variety of equipment that is used for land shaping; each type of machine has its own capabilities and limitations. Land shaping is done with an earth moving scraper. A motor grader is used on small fields for narrow benches or where only minor grading work is needed. It is also used to shape the ridge on the downhill side of benches and the slope from one bench to another.

20.2.1 Bulldozers

A bulldozer is a specialized tractor with two additional parts; a blade and a ripper. It is used to level the ground at construction sites and in many other places. Bulldozer, consists of crawler tractors equipped with dozer blades, is frequently employed in cutting and pushing earth to short distance. They are suitable for rough grading when the haul distance does not exceed 25 meters.

Bulldozer has attachments such as rippers, brush rakes and U blades.

- a) Rippers: Rippers are hydraulically operated devices that consist of one or more shanks or teeth. It is mounted on the rear of the bulldozer tractor used to remove material from the ground and remove rocks from the soil. It is also used to aerate the soil for drying or adding moisture.
- b) Brush Rakes: Brush rakes are attached to the front of the bulldozer in place of the blade. It is used to clear vegetation and debris from the soil without removing the top soil.
- c) U-blade: A U-blade is attached to bulldozer in place of the standard blade. The U-blade gets its name from the fact that when viewed from above it looks like a "U". Because the blade is curved in at both edges, it will lose less soil in front of it than a standard blade and it will carry the soil for a longer distance.

20.2.2 Tractor Drawn Scrapers

Scrapers are available in a wide range of sizes. The size ranging in capacity from 1.5 m³ to 19 m³. Large size scrapers where large quantities of earth are to be moved over an appreciable distance. The carrier-type scrapers are widely used for large scale land grading operations. It consists of a bowl or bucket mounted on rubber-tyred wheels with a blade and apron across its front end for cutting, scooping and retaining soil. To load, the bowl is lowered and the apron is partly lifted. In hauling position the apron is closed and the bowl is lifted clear of the ground. To dump or spread, the apron is lifted and the load is pushed forward through the open end of the bowl by an ejector bowl. The machine cuts to grade, hauls the load for fairly long distances and spreads the soil evenly at the desired location. The capacity of carrier type scrapers range from 1 to 2.5 cubic meters. For medium size and small level levelling work the wheeled type scrapers are used. To operate such scrapers it is necessary to loosen the ground with a plough or harrow. The scrapping operation is done by pushing the soil in a short distance and dumping at a desired place.

20.2.3 Elevating Scraper

Elevating Scraper are suitable for large size farm, the 5-and 8- yard sizes can be easily handled by a 3-4 plough tractor, whereas the 11- yard size pulled by larger farm or industrial tractors is becoming increasingly popular. Their desirable feature is the ability of the PTO driven elevator to get a heaping load each time under varying depths of cut and soil textures. Also the cutting and spreading can be done evenly.

20.2.4 Bottomless Scraper

Bottomless scrapers are used as finishing equipment to obtain desired uniform surface. The two wheeled bottomless scraper is sometimes used ahead of land planning to remove surface irregularities too large to be planned and too small to be taken care of economically with a carryall scraper. This machine has number of widths that serve various purposes, including widths up to 18 feet for handling large volume of earth over a short haul. Hydraulic controls facilitated cutting, dragging, and dropping the load.

20.2.5 Levellers and Floats

The levellers and floats that can be pulled by medium sized farm tractors are more important in maintaining the smoothness of levelled field than in removing small irregularities left by heavy levelling equipment. Even wooden floats or drags ensure better land preparation.

20.2.6 Crawler Tractors

A crawler tractor gives superior traction on various soil and ground conditions encountered during operations. The top speed is limited to about 5 miles per hour when pulling a scraper; it is restricted to relatively short hauls.

20.2.7 Tractor Drawn Two Wheeled Automatic Levellers

The use of automatic type levellers each year does much to improve field surfaces for irrigation. The two wheeled automatic type leveller is usually used for the fine grading of small and medium size fields. It is operated on a medium size field by a medium size wheel tractor. The machine has an adjustable blade which is so constructed that it will drag a considerable volume of earth. Wheeled scrapers and leveller blades are frequently used for medium and small scale levelling. They are also called bottomless scrapers.

20.3 Laser Guided Land Levelling

The word “laser” is an acronym for Light Amplification by Stimulated Emission of Radiations. The lasers used in agricultural land levelling and in construction are usually of the helium-neon type, producing red coloured light. Such machines are now becoming very common in agricultural operations (laying pipe lines, excavating ditches and canals and lining canals) in developed and developing countries. The laser guided system can be mounted on bulldozers, scrapers, road graders and even terracers. Some of the advantages over conventional land levelling are: time saving, little or no error, less labour, cost effective and downloading the land elevation data on laptop for land levelling design.

The laser guided land levelling consists of following components:

- 1) Laser Transmitter
 - 2) Laser Sensor
 - 3) Electronic Hydraulic Control System
- 1) Laser Transmitter: The laser transmitter sends a self levelled 360° continuous laser from a tripod in the middle of work site, where a person is excavating. The laser is projected at the plane or slope desired for excavation.
 - 2) Laser Sensor: The laser is picked up by one or more receivers that are hand held, rod mounted or equipment mounted receivers.
 - 3) Electronic Hydraulic Control System: The laser receivers are connected to the equipments hydraulics. The signals from laser are used to control hydraulic valves. These controls are basically for controlling the desired depth of cut and tracking the elevation of the field.



LESSON 21 Soil Water

21.1 Introduction

Soil-water-plant relationship relates to the properties of soil and plant that affect the movement, retention and use of water. Due to inadequate and/or uneven distribution of rainfall during the cropping season, it becomes necessary to apply additional water to the soil for plant use in the form of irrigation. Therefore, proper understanding of the soil-water-plant relationship is a prerequisite for the sound design of any efficient irrigation system.

21.1.1 Soil

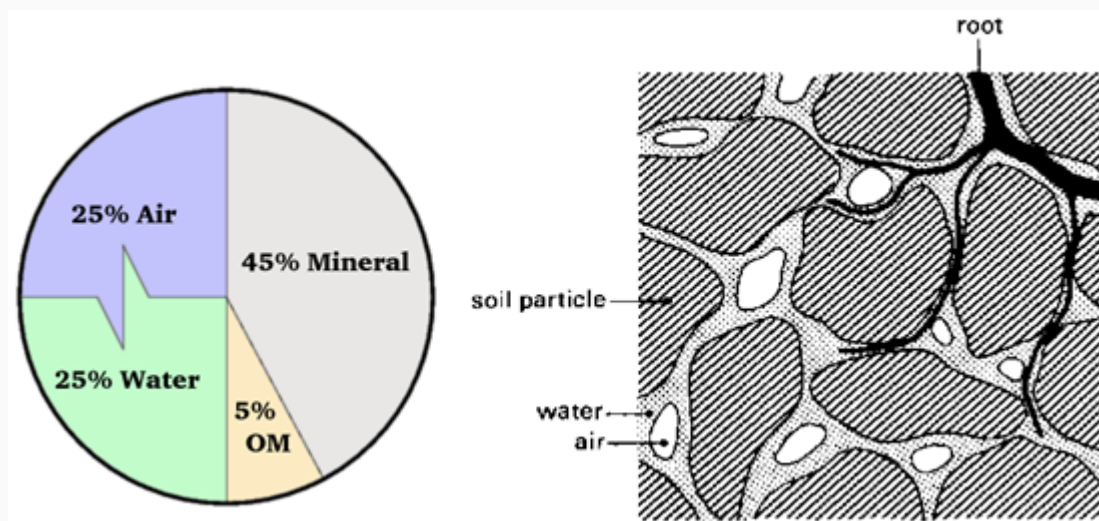

Fig.21.1. Volume composition & sectional view of soil.

A soil matrix consists of solid, liquid and gaseous phases (Fig 21.1). The solid phase is the soil matrix comprising mineral, organic matter and various chemical compounds. The liquid phase contains all the dissolved substances. Liquid phase also referred by the soil moisture or soil water or soil solution. The gaseous portion of the soil consists of soil air and it occupies those spaces between the soils particles which are not filled with water (Fig 21.1).

In a completely dry soil, all of the pore spaces (i.e., space between soil particles) are filled with air, and in a completely wet soil all of the pores are filled with water. However, in most of the field situations the pore spaces are filled with both air and water. Finally, soil water and air vary in composition, both in time and space.

21.1.2 Soil texture

It refers to the relative proportion of sand, silt and clay in a given soil. Various combinations of sand silt and clay are used to classify soil according to its texture (Table 21.1).

Table 21.1. Common textural classes found in the field

Common names of soils (General texture)	Sand	Silt	Clay	Textural class
Sandy soils (Coarse texture)	86-100	0-14	0-10	Sand
	70-86	0-30	0-15	Loamy sand
Loamy soils (Moderately coarse texture)	50-70	0-50	0-20	Sandy loam
Loamy soils (Medium texture)	23-52	28-50	7-27	Loam
	20-50	74-88	0-27	Silty loam
	0-20	88-100	0-12	Silt
Loamy soils (Moderately fine texture)	20-45	15-52	27-40	Clay loam
	45-80	0-28	20-35	Sandy clay loam
	0-20	40-73	27-40	Silty clay loam
Clayey soils (Fine texture)	45-65	0-20	35-55	Sandy clay
	0-20	40-60	40-60	Silty clay
	0-45	0-40	40-100	Clay

(Source:FAO: accessed on May 26, 2013)

The textural class of a soil can be accurately determined in the laboratory by mechanical analyses. Fig. 21.2 show various textural classes and is used to identify soil textural class based on information on Percent sand, silt and clay fraction in soil sample. Sand, silt and clay are size groupings of soil particles as shown below in Table 21.2:

Table 21.2. Size groupings of soil particles

Name of soil separate	Diameter limits (mm) (USDA classification)
Clay	less than 0.002
Silt	0.002–0.05
Very fine sand	0.05–0.10
Fine sand	0.10–0.25
Medium sand	0.25–0.50
Coarse sand	0.50–1.00
Very coarse sand	1.00–2.00

Water holding capacity, permeability and infiltration rate of soil depends on the texture. For example, fine textured soils (clayey soils) have relatively higher water holding capacity, but the permeability for water and air is slow resulting in poor drainage and hence water logging. On the other hand, coarse textured soils (sandy soils) have very low water holding capacity and hence rapid drainage takes place. Therefore, crops grown on these soils require frequent irrigations in smaller amounts. Considering its various effects, the loamy soils are ideal for growing most crops under irrigated conditions.

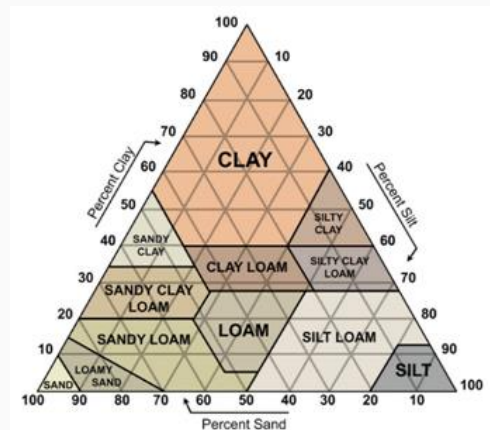

Fig. 21.2. Textural soil classes.

21.1.3 Soil Structure

The structure of a soil refers to the arrangement of the individual soil particles with respect to each other and the formation of aggregates within the soil mass (Fig. 21.3). Soil structure has important role in water movement, plant root penetration, air movement etc.

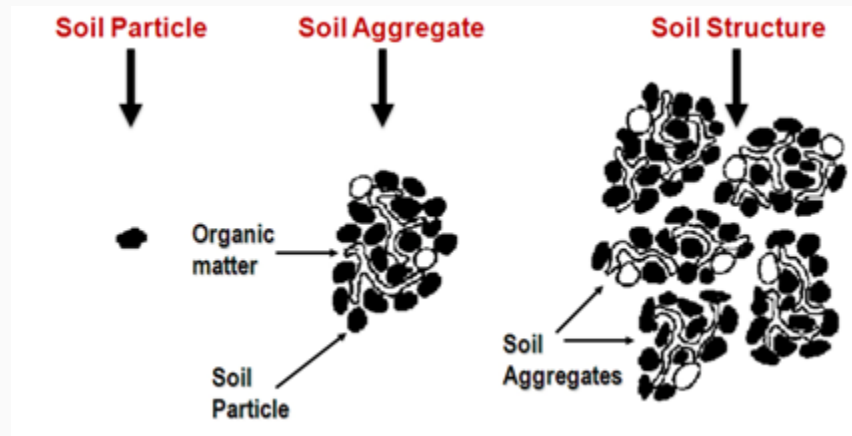

Fig. 21.3. Soil structure. (Source: Rao, et al., 2010)

The dominant shape of soil aggregates in a horizon determines their structural type, and it include spheroidal (granular or crumbly subtypes), platy; prism like (columnar or prismatic subtypes) and block like (cube and sub-angular subtypes) (Fig. 21.4). The soil structure primarily influences root penetration and proliferation, total porosity and permeability of air and water.

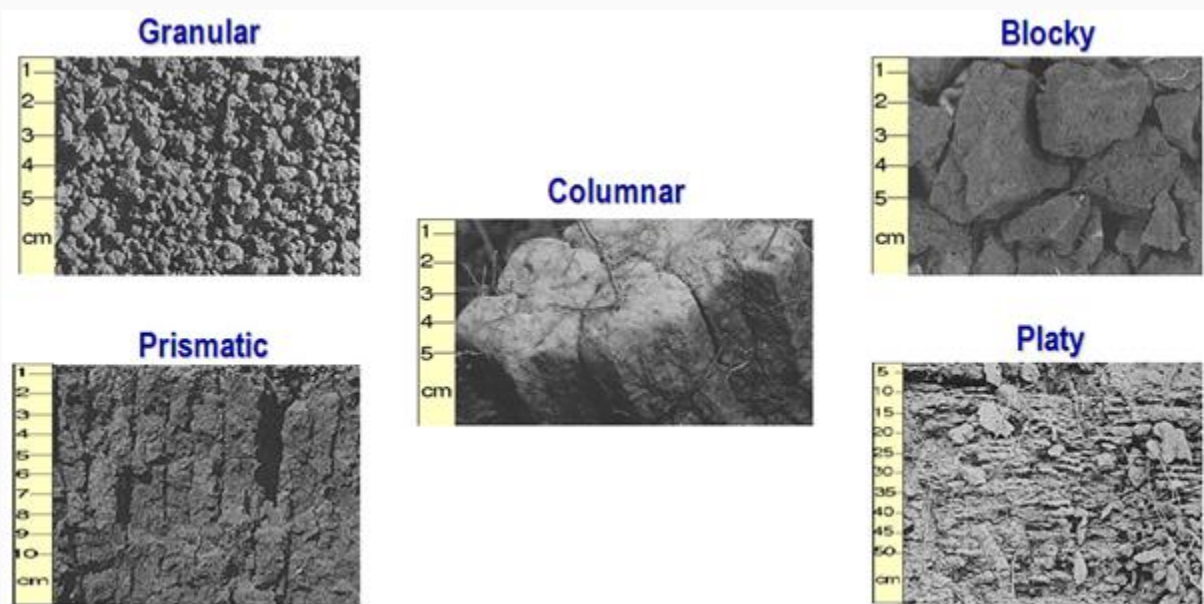

Fig. 21.4. Soil structural types. (Source: Rao, et al., 2010)

21.2 Soil Water Relations

As we discussed earlier the basic components of the soil consists of solid mineral particles, organic matter, the voids among the particles and water and air occupying the voids. Fig. 21.5 shows a schematic representation of the soil in relative proportions both in masses and volumes. The physical properties of the soil, including its ability to store water, are highly related to the fraction of the bulk soil volume that is filled with water and air. For plant growth and development to be normal, a balance of water and air

in the pore space must be attained. If water is limited, plant growth may be inhibited by water stress. If air (aeration) is limited, usually by too much water, then growth may be limited by insufficient aeration.

The relationship between the three phases of soil can be described in a number of mathematical relationships. These relationships can be used to calculate one soil property from another.

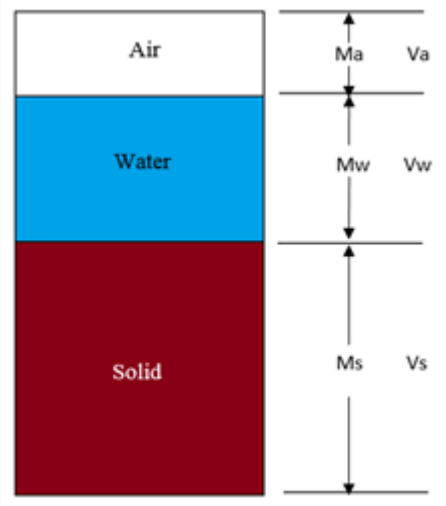

Fig. 21.5. Three phases of soil.

Referring to Fig. 21.5 the following notations are used:

V_a = Volume of air

V_w = Volume of water

V_s = Volume of solids

V_v = Volume of voids (V_a+V_w)

V_t = Total Volume ($V_a+V_w+V_s$)

M_a = Mass of air (negligible)

M_w = Mass of water

M_s = Mass of solids

M_t = Total mass ($M_a+M_w+M_s$)

21.2.1 Particle density (ρ_s)

It is the ratio of a given mass (or weight) of soil solids to that of its volume and it is given by

$$\rho_s = \frac{M_s}{V_s} \quad (21.1)$$

Sometimes it is referred to as true density. It is usually expressed in terms of g/cm³ and varies between the narrow limits of 2.6 to 2.75 g/cm³. Particle density is a constant for a soil with a given texture and is independent of size and arrangement of the soil particles.

21.2.2 Dry Bulk Density (ρ_b)

It is the density of the undisturbed (bulk) soil sample which is the ratio of dry mass of the soil to its total volume. It is given by

$$\rho_b = \frac{M_s}{V_t} = \frac{M_s}{V_s + V_a + V_w} \quad (21.2)$$

This is expressed as gm/cm³. Dry bulk density can be calculated by collecting a known volume of soil to get the soil volume (V_t), and drying the associated soil to get the mass of dry soil (M_s).

21.2.3 Total (Wet) Bulk Density (ρ)

It is the mass of moist soil per unit volume and is represented as:

$$\rho = \frac{M_t}{V_t} = \frac{M_s + M_a + M_w}{V_s + V_a + V_w} \quad (21.3)$$

Bulk density has a pronounced effect on the soil properties like permeability of soil for water and air, and penetration of plant roots through the soil. Compression or compaction of soil particles can increase bulk density but it reduces the soil porosity and in turn the soil water storage capacity. The bulk density values for different soil textural classes are given in Table 21.3.

Table 21.3. Bulk density values of various soil types (USDA - SCS)

Soil texture	Bulk density (g/cm ³)
1. Sandy	1.60–1.70
2. Loamy sand	1.60–1.70
3. Sandy loam	1.55–1.65
4. Fine sandy loam	1.50–1.60
5. Loamy soil	1.45–1.55
6. Silty loam	1.40–1.50
7. Silty clay loam	1.35–1.45
8. Sandy clay loam	1.40–1.50
9. Clay loam	1.30–1.50
10. Clay soil	1.25–1.35

Example 21.1:

Calculate the dry bulk density from the following data

Fresh weight of soil = 2505g; Weight of water = 740g; Height of core = 10cm;

Diameter of the core = 12cm

Solution:

$$\text{Volume of the core} = V = \pi r^2 h = \pi \times (6)^2 \times 10 = 1130.4 \text{ cm}^3$$

$$\text{Dry Bulk density} = \frac{M_s - 740}{V_t} = \frac{2505 - 740}{1130.4} = 1.561 \text{ g/cm}^3$$

21.2.4 Porosity ()

Porosity is the void space in a given volume of soil that is occupied by air and water. The total porosity is calculated as follows:

$$n (\%) = \left(1 - \frac{\rho_b}{\rho_s} \right) \times 100 \quad (21.3)$$

$$n (\%) = \left(\frac{V_a + V_w}{V_t} \right) \times 100 \quad (21.4)$$

Generally total porosity varies from 30% to 60% for agricultural soils. Coarse textured soils are normally less porous (35% - 50%) than the fine textured soils (40% - 60%). However, the mean size of individual pores is greater (>0.06mm in diameter) in the coarse textured soils than the fine textured soils. From irrigation water management point of view, knowledge of porosity in a given volume of soil is very important, because it is an index of moisture storage capacity and the aeration conditions. These are two most important factors that influence the plant growth.

Example 21.2

Calculate the porosity from the following data

Bulk density = 1.31 g/ cm³ and particle density = 2.64 g /cm³.

Solution:

$$\text{Porosity (n)} = \left(1 - \frac{1.31}{2.64}\right) \times 100 = 50.37 \%$$

21.2.5 Void Ratio (e)

It is the ratio of the pore space to the volume of solids and is given by

$$e = \frac{V_v}{V_s} = \frac{V_a + V_w}{V_t - V_v} = \left(\frac{\rho_s}{\rho_b} - 1\right) = \frac{n}{1-n} \quad (21.5)$$

21.2.6 Soil Water Content

The mass water content or soil moisture content (θ_m) is the ratio of the mass of water in a sample to the dry soil mass, expressed as either a decimal fraction or as percentage. It is often referred to as 'gravimetric water content'. The mass water content is found by

$$\theta_m = \frac{M_w}{M_s} \quad (21.6)$$

It is determined by weighing the soil sample collected from field, drying the sample for at least 24 hours at 105 °C, and then weighing the dry soil. Difference in mass of the wet and dry sample represents the mass of water in the soil sample (M_w). The mass of the sample after drying represents the mass of dry soil (M_s).

The volumetric water content () represents the volume of water contained in total volume of undisturbed soil. The volumetric water content is defined as

$$\theta_v = \frac{V_w}{V_t} \quad (21.7)$$

Determination of volumetric water content requires the volume of the undisturbed soil sample which is sometimes difficult to measure. However, it can also be determined from mass water content and specific gravity (ratio of bulk density of soil to density of water) as follows

$$\theta_v = \theta_m \frac{\rho_b}{\rho_w} \quad (21.8)$$

Where,

ρ_w = density of water which is 1 g/cm³

When comparing water amounts per unit of land area, it is frequently more convenient to speak in equivalent depths of water rather than water content. The relationship between volumetric water content and the equivalent depth of water in a soil layer is:

$$d = \Theta_v \cdot L \quad (21.9)$$

Where,

d = equivalent depth of water in a soil layer and

L = depth increment of the soil layer.

Example 21.3

A field soil sample prior to being disturbed has a volume of 82 cm³. The sample weighed 125 grams. After drying at 105°C for 24 hours, the dry soil sample weighs 100 grams. What is the mass water content? What is the volumetric water content? What depth of water must be applied to increase the volumetric water content of the top 1m of soil to 0.40?

Given: $M_s = 100$ g

$M_w = 125$ g - 100 g = 25 g

$V_t = 82$ cm³

Find: Θ_m , Θ_v and d

Solution:

$$\theta_m = \frac{M_w}{M_s} = \frac{25}{100} = 0.25 \text{ g of water / g of soil.}$$

$$\text{Dry bulk density} = \frac{M_s}{V_t} = \frac{100}{82} = 1.21 \text{ g/cm}^3.$$

$$\Theta_v = \Theta_m = \frac{\rho_b}{\rho_w} = 0.25 \times \frac{1.21}{1} = 0.3025 \text{ cm}^3 \text{ of water / cm}^3 \text{ of soil.}$$

The current depth of water in 1 m of soil is: $d = \Theta_v \cdot L = 0.3025 \cdot 1 = 0.3025 \text{ m}$.

The depth of water in 1 m of soil when $\Theta_v = 0.40$ will be

$$d = \Theta_v \cdot L = 0.4 \times 1 = 0.4 \text{ m.}$$

Thus, the depth of water to be added is 0.0975 m (0.4m - 0.3025m).

21.3 Kinds of Soil Water

Water present in the soil is referred to as the soil moisture. It is divided into three categories viz., gravitational water, capillary water and hygroscopic water (Fig. 21.6).

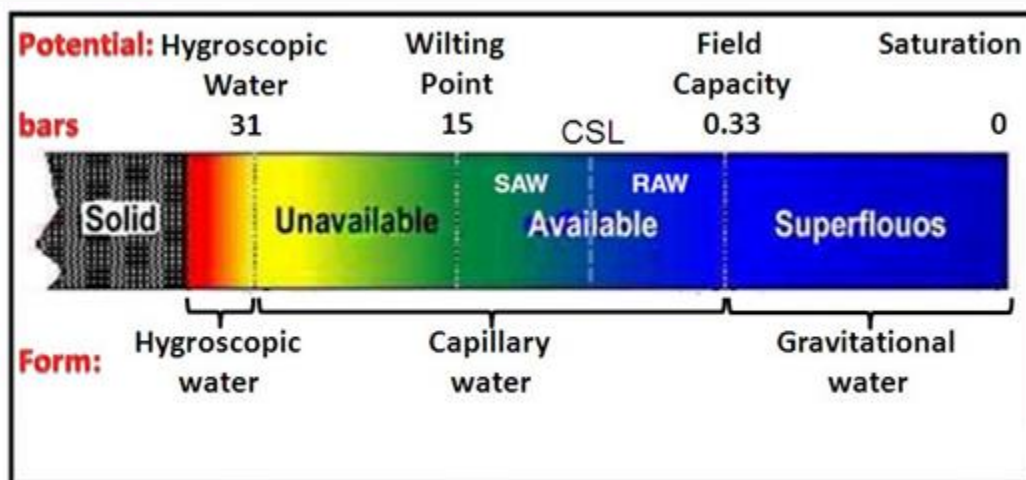

Fig. 21.6. Physical classification of soil water.

21.3.1 Gravitational Water

Water held between 0.0 to 0.33 bars (0 to -33 kPa) soil moisture tension, that moves downward freely under the influence of gravity to the water table is termed as gravitational water (Fig. 21.). It is also referred to as free water. Gravitational water is of no use to plants as it drains out due to gravity. It reduces aeration in the soil and hence, its removal from soil is necessary for optimum plant growth.

21.3.2 Capillary Water

Capillary water is the water held in the capillary pores (micro pores). Capillary water is retained on the soil particles by surface forces, adhesion i.e., attraction of water molecules for soil particles, cohesion i.e., attraction between water molecules and surface tension phenomena. Adhesion is a process of the attraction of solid surface for water molecules and forms a very thin film of water at solid-liquid interface. On the other hand, cohesion is attraction of water molecules for each other. Capillary water is held between tension of about 0.33 bars (-33 kPa or 1/3 atmosphere, moisture content at field capacity) to 31 bars (-3100 kPa or 31 atmosphere, hygroscopic coefficient) as shown in Fig. 21.7. However, the water within the capillary range is not equally available i.e., it is readily available starting from 0.33 bars

up to a certain point often referred to as critical soil moisture and thereafter up to 15 bars (-1500 kPa) it is available in lesser amounts. Further below, the water is held very tightly in thin films and is practically not available for plant use between 15 bars and 31 bars tension.

21.3.3 Hygroscopic Water

It is the water held tightly to the surface of soil particles by adsorption forces. Hygroscopic water is held tightly in thin films of 4 - 5 milli microns thickness on the surface of soil colloidal particles at 31 bars tension (-3100 kPa) and above (Fig. 21.7). It is essentially non-liquid and moves primarily in the vapour form. This water is unavailable to the plants as huge pressure force would be needed to extract it.

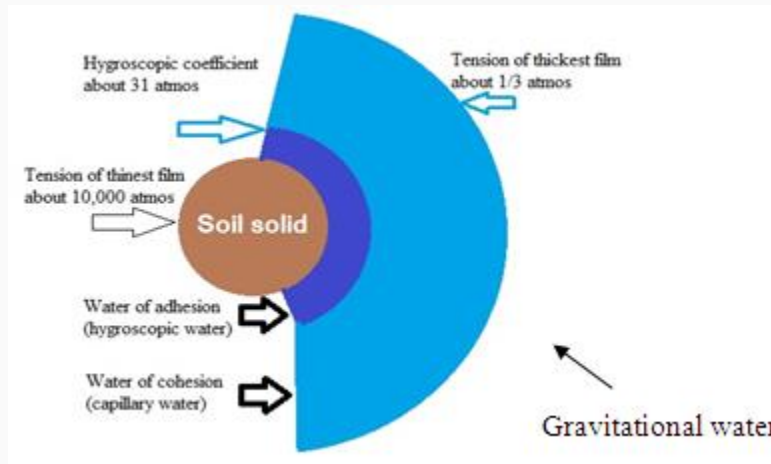

Fig. 21.7. Diagrammatic representation of different types of water.



LESSON 22. Infiltration

22.1 Infiltration Process

The process of entry of water into the soil is called infiltration, and the time rate at which water percolates into the soil is known as infiltration rate. Thus information about infiltration is needed for –

- 1) Hydrologic studies to determine runoff and percolation components
- 2) Designing irrigation systems
- 3) Managing of irrigation event, i.e., to determine water application rate and application time.

During the initial conditions when the soil is dry, the infiltration rate is high and decreases with time and tends to approach a constant rate (Fig. 22.1). This constant rate of infiltration is referred as the basic infiltration rate or final infiltration capacity or simply infiltration capacity of soil. The downward movement of infiltrated water through the soil profile is known as percolation. Accumulated infiltration or cumulative infiltration is the total quantity of water infiltrated into the soil in a given time. Fig. 22.1 shows both infiltration rate curve and accumulated or cumulative infiltration curve. Infiltration rate may change with respect to location, time/season and initial soil moisture content.

In water management and conservation studies, accurate information regarding the rate at which different soils will take water under different field conditions is required. The rate of entry of water into soil and the cumulative infiltration varies widely across different soil types and also within a single soil type, depending upon soil water content and management practices.

Why Infiltration Rate Decreases with Time?

1. The decrease in infiltration rate results from the decrease in the matric suction gradient (constituting one of the forces drawing water into the soil) which occurs as infiltration proceeds. If the surface of an initially dry soil is suddenly saturated, the matric gradient acting in the surface layer is at first very steep. As the wetted zone deepens, however, this gradient is reduced. Furthermore, as the thickness of the wetted soil increases the matric suction gradient eventually tends to become vanishingly small. Finally, infiltration rate reaches steady state condition.

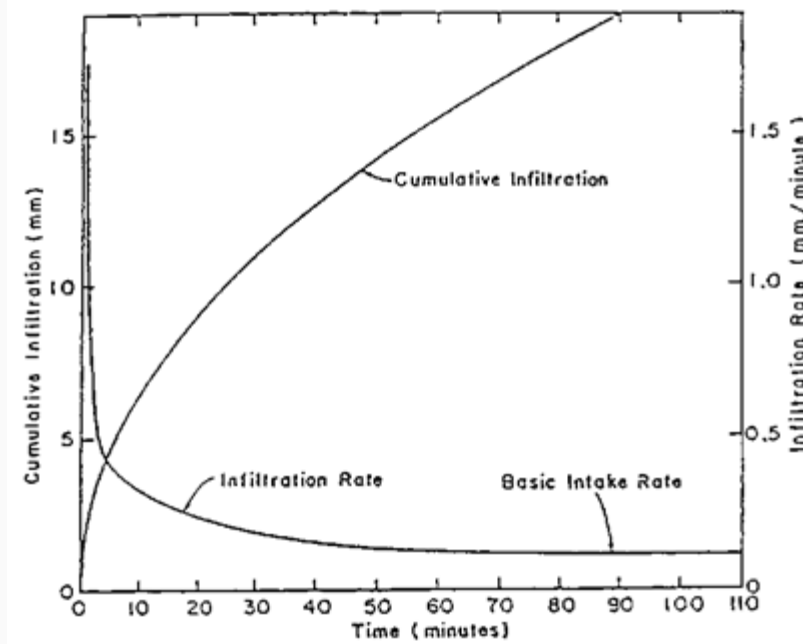

Fig.22.1. Plot of accumulated infiltration and average infiltration rate against elapsed time.

2. The decrease of infiltration rate from an initially high rate can in some cases result from gradual deterioration of soil structure, and consequent partial sealing of the profile by the formation of a dense surface crust or from the detachment and migration of pore-blocking particles or swelling of clay or air entrapment.

22.2 Infiltration Equations

Many equations have been developed to represent the infiltration phenomena. Most of them are empirical equations and have been developed to match observed data sets. One of the most commonly used infiltration equations particularly in the field of irrigation is the Kostiakov equation. It is described by the following equation:

$$Z = a t^b \quad (22.1)$$

and infiltration rate is given by,

$$I = (a b) t^{b-1} \quad (22.2)$$

Where,

Z = depth of infiltration, cm

t = time or intake opportunity time, min

I = infiltration rate, cm/min, and

a and b = parameters ($a > 0$ and $0 < b < 1$)

From Eq. (22.2), it is clear that as $t \rightarrow 0, I \rightarrow \infty$ and as $t \rightarrow \infty, I \rightarrow 0$. In reality, infiltration rate, I , does not attain these values. However, because of the simplicity of the model it has been used widely in irrigation studies. Parameters of Eq (22.1) can be determined by plotting on log-log paper the accumulated infiltration Z against time and fitting a straight line. Similarly, parameters of Eq. (22.2) can also be determined.

$$\log Z = \log a + b \log t \quad (22.3)$$

Or $\log I = \log (ab) + (b-1) \log t \quad (22.4)$

Example 22.1:

A double ring infiltrometer test was conducted prior to an irrigation event and data recorded are given Table 21.1. Determine the parameters of the Kostiaikov infiltration Equation (22.1).

Solution:

Take the log of time, t and as well as accumulated infiltration, Z . The log values are reported in Table 22.1. These log-log values are plotted and simple linear regression was performed, which resulted the following equation:

$$\log Z = -0.502 + 0.773 \log t$$

Taking the anti-log, the following equation results

$$Z = 0.315 \log t^{(0.773)}$$

Time, t	Cum. Infil., Z	log(t)	log(Z)	Predicted, Z
(min)	(cm)			(cm)
3	0.85	0.477	-0.071	0.736
5	1.12	0.699	0.049	1.093
10	1.77	1	0.248	1.868
15	2.44	1.176	0.387	2.555
20	3.07	1.301	0.487	3.191
25	3.63	1.398	0.56	3.792
30	4.18	1.477	0.621	4.366
35	4.73	1.544	0.675	4.919
40	5.26	1.602	0.721	5.454
45	5.8	1.653	0.763	5.973

50	6.34	1.699	0.802	6.48
55	6.83	1.74	0.834	6.976
60	7.31	1.778	0.864	7.461
65	7.82	1.813	0.893	7.937
70	8.3	1.845	0.919	8.405
75	8.79	1.875	0.944	8.866
80	9.27	1.903	0.967	9.319
85	9.78	1.929	0.99	9.766
90	10.26	1.954	1.011	10.208
95	10.7	1.978	1.029	10.643
100	11.2	2	1.049	11.074
105	11.67	2.021	1.067	11.499
110	12.16	2.041	1.085	11.92
115	12.62	2.061	1.101	12.337
120	13.09	2.079	1.117	12.75
125	13.59	2.097	1.133	13.158
130	14.02	2.114	1.147	13.563
135	14.48	2.13	1.161	13.965
140	14.98	2.146	1.176	14.363

Fig. 22.2 shows the comparison between the observed and predicted cumulative infiltration.

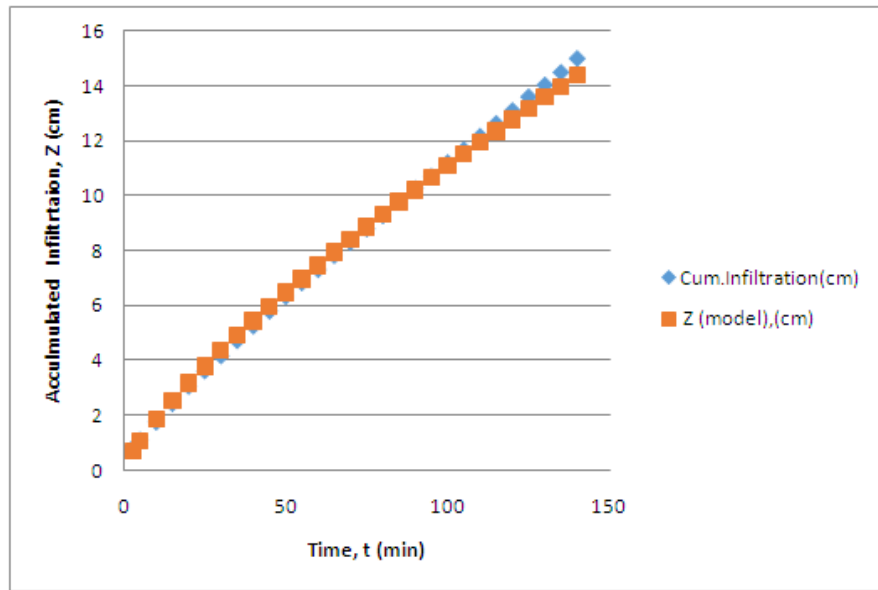

Fig. 22.2. Comparison between observed and predicted accumulated infiltration using the Kostikov model.

To overcome the restrictions of original Kostikov infiltration equation, it was modified to include steady state infiltration term. The Modified Kostikov Equation is given by

$$Z = a t^b + c \cdot t \quad (22.4)$$

$$I = (ab) t^{b-1} + C \quad (22.5)$$

Where a and b are the parameters and c is the steady state infiltration rate. The steady infiltration rate can be determined from infiltration measurements, when infiltration rate approaches near steady-state condition.

22.3 Measurement of Infiltration

Infiltration rates are measured in a number of different ways. Out of several methods three which are commonly used are:

- a) The use of double ring or cylinder infiltrometer (Fig 22.3)
- b) Measurement of subsidence of free water in a large basin
- c) Estimation of water front advance data

Infiltration rates for border type, and sometimes furrow type, irrigation systems are commonly measured with a single-ring or double-ring type infiltrometer. Fig. 22.3 shows double ring infiltrometer.

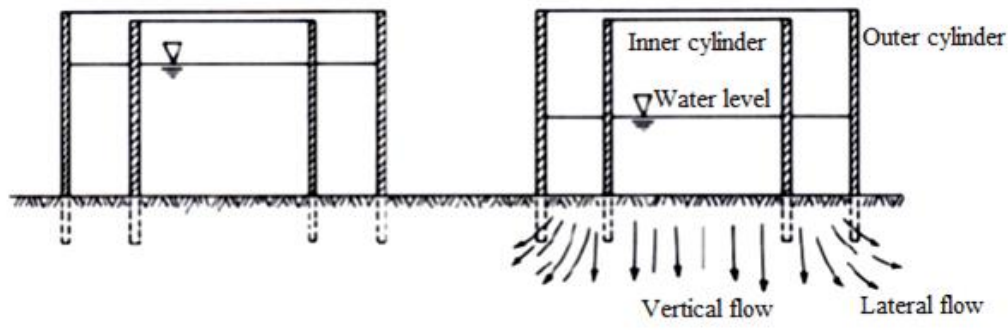

Fig.22.3. Section view of double-ring infiltrometer.

View at left is at $t = 0$ and view at right is after infiltration has proceeded for some time.

The cylinders are usually 25 cm deep and are formed of 2 mm rolled steel. The measurements are taken in inner cylinder having diameter of 30 cm. The outer cylinder, having 60 cm diameter, is used to create a buffer zone to reduce the lateral flow of water from the inner one. The cylinders are installed 10 cm deep in the soil. The water level in the inner cylinder is measured with a point gauge or ordinary scale installed inside the cylinder. The change in water level is measured with respect to time using a stop watch until the infiltration rate reached steady state (basic infiltration rate).

22.4 Factors Affecting Infiltration

The major factors influencing the infiltration include initial soil moisture content, soil surface conditions, hydraulic conductivity of the soil profile, texture, porosity, degree of swelling of soil colloids, organic matter, and vegetative cover, duration of irrigation or rainfall and viscosity of water. Initial moisture content has direct effect on infiltration rate and total amount of infiltration. Infiltration decreases with increase in initial soil moisture content. Infiltration rate or total infiltration increases as permeability and porosity increases. Cultivation increases the infiltration by improving the porosity. Infiltration rates are normally lower in heavy textured soils than in light textured soils (Figs. 22.4 and 22.5). Vegetation improves the infiltration of soil.

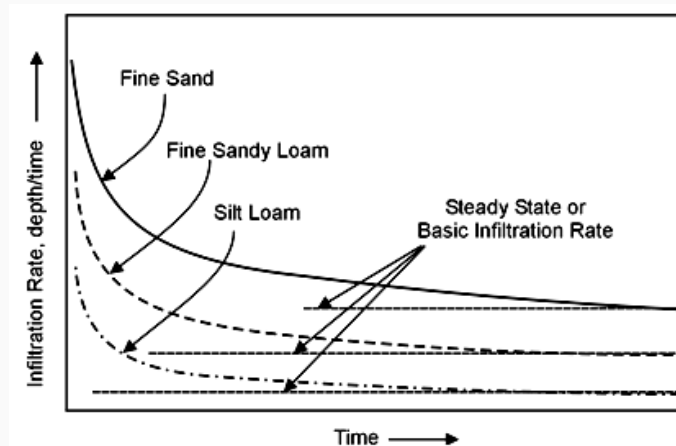

Fig.22.4. Rate of infiltration as an irrigation proceeds and the steady rate of infiltration for three soil textures. (Source: Okstate.edu: accessed on May 28, 2013)

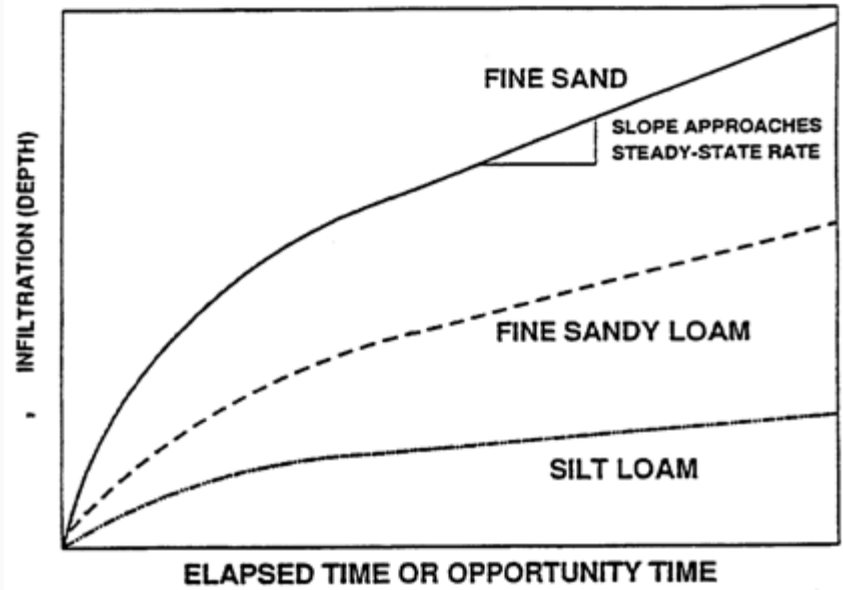

Fig. 22.5. Cumulative infiltration for three soil textures.(Source: Okstate.edu: accessed on May 28, 2013.)

Finally, it may be noted that infiltration characteristics of soils are highly vary both in space as well as in irrigation season. This is implies that there is need to evaluate infiltration characteristics at multiple sites as well as during crop season to obtain representative values of infiltration. Such information will be helpful to both designing and managing irrigation systems.



LESSON 23 Soil Water Movement

23.1 Types of Water Movement

Movement of water within the soil is a highly complex phenomenon due to the variation in the states and directions in which water moves and the variation in the forces that cause it to move. Generally three types of water movement within the soil are recognized –saturated flow, unsaturated flow and water vapour flow (Fig. 23.1). Water in the liquid phase moves through the water filled pores within the soil (saturated condition) under the influence of gravitational force. Water exists as thin films surrounding the soil particles (unsaturated condition), which moves under the action of surface tension. Water in the vapour form diffuses through air filled pores along the vapour pressure gradient. In all cases water flow is along the energy gradients i.e., from a higher to lower potential.

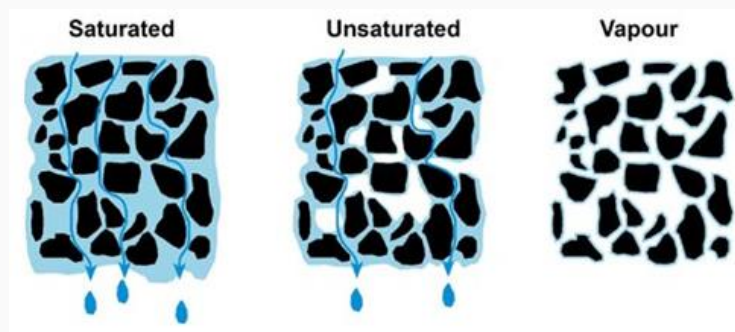

Fig. 23.1. Different types of soil water movement.

23.2 Soil Water Movement in Saturated Condition

Under saturated condition of soil, all the macro and micro pores are filled with water and any water flow under this condition is referred to as saturated flow. The saturated flow of water depends upon two factors namely hydraulic gradient i.e., the hydraulic force driving the water through the soil and hydraulic conductivity i.e., the ease with which the soil pores permit water movement.

Assuming the soil to be a bundle of straight and smooth tubes, knowledge of the size distribution of the tube radii could enable us to calculate the total flow through a bundle caused by known pressure difference, using Poiseuille's equation:

$$q = \frac{P\pi r^4}{8l\mu} \quad (23.1)$$

Where, q = volume of flow per unit time cm^3/sec

P = pressure difference between two ends of the tube of length l , dynes/cm^2

r = radius of the tube, cm

l = length of the tube, cm

μ = viscosity of liquid, $\text{dynes-sec}/\text{m}^2$

The above equation indicates that the pore size is of outstanding significance, as its fourth power is proportional to the rate of saturated flow. Generally the rate of flow follows:

Sand > Loam > Clay

Unfortunately, soil pores are not like straight tubes, but are of varying shapes and sizes, highly irregular and interconnected. This complexity in shape causes change in fluid velocity from point to point, even along the passage. For this reason, flow through complex porous media is generally described in terms of macroscopic flow velocity vector, which is the overall average of the microscopic velocities over a total volume of soil. The quantity of water flowing through a section of saturated soil per unit of time is given by the Darcy's law. Fig. 23.2 show typical setup for Darcy's Law.

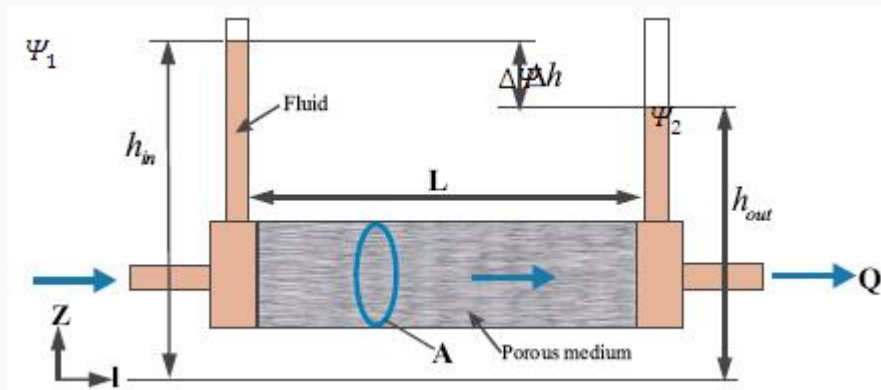

Fig. 23.2 Definition sketch of Darcy's Law.

(Source: <http://doi.ieeecomputersociety.org>)

The law states that, the quantity of water passing through a unit cross sectional area of soil is directly proportional to the hydraulic gradient. Mathematically,

$$\frac{Q}{t} = q = -AK_{sat} \frac{h_{in} - h_{out}}{L} = -AK_{sat} \frac{\Delta h}{L} \quad (23.2)$$

$$\frac{q}{A} = V = -K_{sat} \cdot i \quad (23.3)$$

Where, Q = volume flow cm^3

q = volume of flow per unit time cm^3/sec

t = time, sec

A = cross-sectional area of the soil through which the water flows, cm^2

K_{sat} = saturated hydraulic conductivity, cm/sec

Δh = change in water potential between the ends of the column, cm

(for example, $\Psi_1 - \Psi_2$)

L = the length of column, cm

$i =$, hydraulic gradient.

$V =$ velocity of flow cm/sec or velocity flux, v . It is the flow per unit area.

The negative sign denotes that the direction of flow is opposite to that of the head causing the flow. It is omitted in further discussions as its significance lies only in indicating the direction which is the same (towards the decreasing gradient) in all cases.

Darcy's law is valid only when flow is laminar. Reynold's number, the index used for describing the nature of flow is given by

$$Re = \frac{\rho v d}{\mu} \quad (23.4)$$

Where, $Re =$ Reynold's number

$\rho =$ density of fluid

$V =$ velocity of flow

$D =$ mean diameter of the soil particles

$\mu =$ dynamic viscosity of the fluid.

The Darcy's law is valid for flows where Re is less than one.

In equation 23.3 the replacing $\Delta\mu$ by $\Delta\psi$ and we get

$$v = -K_{sat} \frac{\Delta\psi}{l} \quad (23.5)$$

Where, $\Delta\psi =$ is the change in potential between two points at a distance l .

Application of Darcy's law and continuity equation of three dimensional flow of an incompressible fluid through a porous medium results in the derivation of Laplace equation. It is given by

$$\frac{\partial^2 \psi}{\partial x^2} + \frac{\partial^2 \psi}{\partial y^2} + \frac{\partial^2 \psi}{\partial z^2} = 0 \quad (23.6)$$

It states that the second partial derivatives of the water potential with respect to x, y and z directions sums to zero.

23.3 Unsaturated Water Movement

As gravity drainage continues the soil macropores emptied and are mostly filled up with air and the micro pores or capillary pores with water and some air. Movement of water occurring under this condition is termed as the unsaturated flow condition. In the case of unsaturated flow condition, the water potential is the sum of metric potential (ψ_m) and gravitational potential (ψ_g). Metric potential is

only applicable in the case of horizontal movement of water. In the case of downward movement of water, capillary and gravitational potential act together. In the case of upward capillary movement of water, metric potential and gravitational potential oppose one another. For unsaturated flow condition of water through soil, equation 23.5 can be modified as:

$$v = -K \frac{\Delta(\Psi_g + \Psi_m)}{\Delta l} \quad (23.7)$$

Darcy's law can be applied in the case of unsaturated flow conditions with some modifications.

Unsaturated, 1-D horizontal flow is given by

$$\frac{\partial \theta}{\partial t} = \frac{\partial}{\partial x} \left[K(\theta) \frac{\partial \Psi}{\partial x} \right] \quad (23.8)$$

Unsaturated, 1-D vertical flow is given by

$$\frac{\partial \theta}{\partial t} = \frac{\partial}{\partial z} \left[D(\theta) \frac{\partial \theta}{\partial z} \right] + \frac{\partial K(\theta)}{\partial z} \quad (23.9)$$

Where K is hydraulic conductivity and D is diffusivity.

23.4 Hydraulic Conductivity

The hydraulic conductivity of a soil is the ability of soil to transmit water when subjected to a hydraulic gradient. Hydraulic conductivity is defined by Darcy's law Eq. (23.3).

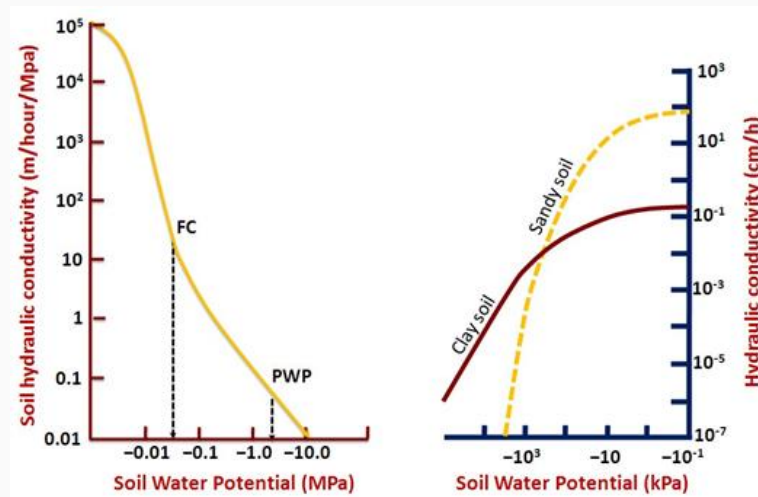

Fig. 23.3. Soil hydraulic conductivity versus soil water potential. (Source: Rao et. al, 2010)

The hydraulic conductivity is defined as the ratio of Darcy's flow velocity at unit hydraulic gradient. K has a dimension of length per unit of time (L/T) which is same as that for velocity. The hydraulic conductivity is more or less constant in a soil having a stable structure, however, it changes as the soil structure, density and porosity change. With variation in soil texture the hydraulic conductivity

values are different. Typical values of saturated Hydraulic conductivity for different soil texture are given in Table 23.1.

Table 23.1. Saturated hydraulic conductivity for different soil textures

Soil class	Hydraulic conductivity, K (mm/hr)	Soil class	Hydraulic conductivity, K (mm/hr)
Sand	50 (25-250)	Clay loam	8 (3-15)
Sandy loam	25 (12-75)	Silty clay	3 (0.25-5)
Loam	12 (8-20)	Clay	5 (1-10)

(Source: Hansen et al., 1979)

Clay soil with a large proportion of fine pores shows poor hydraulic conductivity as compared to a sandy soil with higher proportion of larger pores (Fig. 23.3). Higher bulk density and massive structure reduce the hydraulic conductivity of the soil. Saturated hydraulic conductivity for a particular soil is always constant, whereas unsaturated hydraulic conductivity is a function of soil water content.

23.4.1 Laboratory Determination of Hydraulic Conductivity

Darcy's law can be applied for the determination hydraulic conductivity in laboratory. There are two methods which are used for the determination for this purpose.

23.4.1.1 Constant Head Permeameter

The constant-head permeameter test is the most commonly used method for the determination of the saturated hydraulic conductivity of coarse-grained soils in the laboratory. In this method a constant hydraulic gradient is maintained by adjusting the inflow to maintain a constant level in the inflow tank. Figure 23.4 shows the setup of constant head and falling head permeameters.

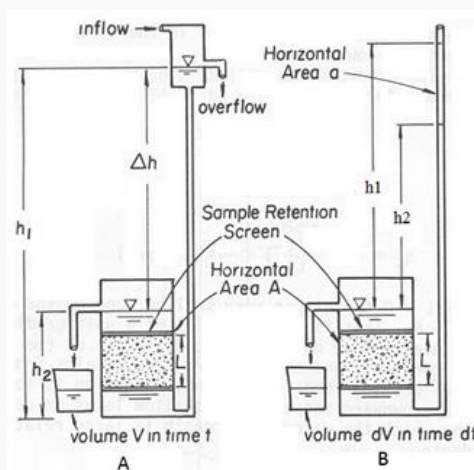

Fig. 23.4. Experimental set for the determination of saturated hydraulic conductivity in Laboratory. A) Constant head method. B) Falling head method.

The hydraulic conductivity, K is determined by the equation

$$K = \frac{V.L}{A.t.\Delta h} \quad (23.10)$$

Where,

V= flow volume in time t

A= cross sectional area of sample

L= length of sample

Δh = difference in head (h_1-h_2).

23.4.1.2 Falling Head Permeameter

The falling-head test is meant for fine-grained soils. Like the constant-head method, the falling-head test is having the direct application of Darcy's law to a one-dimensional, saturated column of soil with a uniform cross-sectional area. The falling-head method differs from the constant-head method in that the liquid that percolates through the saturated column is kept at an unsteady-state flow regime in which both the head and the discharged volume vary during the test. In the falling-head test method, a cylindrical soil sample of cross-sectional area A and length L is placed between two highly conductive plates. The soil sample column is connected to a standpipe of cross-sectional area a, in which the percolating fluid is introduced into the system. Thus, by measuring the change in head in the standpipe from h_1 to h_2 during a specified interval of time t, the saturated hydraulic conductivity can be determined as follows

$$K = \frac{L a}{A(t_2 - t_1)} \ln \left[\frac{h_1}{h_2} \right] \quad (23.11)$$

Example 23.1:

If the elevation of h_1 is 35m and the elevation of h_2 is 0m, what is the hydraulic gradient if the distance from h_1 to h_2 is 5.6 km? (Answer in m/km).

Solution:

Given, $h_2-h_1= 35\text{m}$ and $L=5.6 \text{ km}$

We know: $i= (h_2-h_1)/L$

$$i= 35/5.6 = 6.25\text{m/km. Ans.}$$

Example 23.2:

Find the velocity of the water flow between two wells located at a distance of 1000 m and the hydraulic conductivity is 114m/day. Drop in elevation between two well is given as 60 m.

Solution:

Given: $K=114\text{m/day}$, $h_2-h_1=60\text{m}$, $L=1000\text{m}$

We know, Hydraulic gradient, $i = \frac{h_2-h_1}{L} = \frac{60}{1000}$

$$= 0.06$$

We know,

$$V=KI \text{ or}$$

$$V=K(h_2-h_1/L)$$

$$V=114\text{m/day} * 0.06$$

$$V=6.84 \text{ m/day. Ans.}$$

Example 23.3

An aquifer is 2045 m wide and 28 m thick. Hydraulic gradient across it is 0.05 and its hydraulic conductivity is 145m/day . Calculate the velocity of the groundwater as well as the amount of water that passes through the end of the aquifer in a day if the porosity of the aquifer is 32%.

Solution:

Given: $K=145\text{m/day}$, $i= 0.05$, $W=2045\text{m}$, $D=28\text{m}$, Porosity =32%

First we must solve for V. We know,

$$V= Ki =145\text{m/day} \times 0.05$$

$$=7.25\text{m/day}$$

Now that we know V we can determine the discharge (Q) of water through the end of the aquifer

$$Q= \text{Area. Velocity} = A. V= (2045\text{m} \times 28\text{m}) \times 7.25\text{m/day}$$

$$Q=415,135 \text{ m}^3/\text{day.}$$

This means that each day, if the aquifer had a porosity of 100%, like a river, would have discharge of $415,135 \text{ m}^3/\text{day}$.

However, the aquifer has porosity of 32 % and hence discharge through aquifer would be

$$415,135 \text{ m}^3/\text{day} \times 0.32 = 132843.2 \text{ m}^3/\text{day. Ans}$$

Example 23.4:

A constant head permeability test was performed on a medium dense sand sample of diameter 60 mm and height 150 mm. The water was allowed to flow under a head of 600 mm. The permeability of sand was 4×10^{-1} mm/s. Determine (a) the discharge (mm^3/s), (b) the discharge velocity.

Solution:

(a) We know,

Discharge
$$Q = KiA = K \times \frac{H}{L} \times A = 4 \times 10^{-1} \times \frac{600}{150} \times \frac{\pi}{4} \times (60)^2 = 4523.89 \text{ mm}^3/\text{s}$$

(b) Discharge velocity
$$V = \frac{Q}{A} = \frac{4523.89}{\frac{\pi}{4} \times (60)^2} = 1.60 \text{ mm/s}$$

Example 23.5:

During a falling head permeability test, the head fell from 600 mm to 300 mm in 540 s. the specimen was 50 mm in diameter and had a length of 100 mm. The cross - sectional area of the stand pipe was 60 mm^2 . Compute the coefficient of permeability of the soil.

Solution:

Given, $a = 60 \text{ mm}^2$, $L = 100 \text{ mm}$, $A = \frac{\pi}{4} \times (D)^2 = \frac{\pi}{4} \times (50)^2 = 1963.5 \text{ mm}^2$, $t = 540 \text{ s}$, $h_1 = 600 \text{ mm}$, $h_2 = 300 \text{ mm}$.

We know,

$$K = \frac{L a}{A t} \ln \left[\frac{h_1}{h_2} \right] = \frac{100 \times 60}{1963.5 \times 540} \ln \left[\frac{600}{300} \right] = 0.0039 \text{ mm/s}$$



LESSON 24 Soil Water Constants

24.1 Soil Moisture Constants

In the previous lecture (21) we have discussed the types of soil water and also measures of water content in the soil. From previous discussion, it is clear that a part of capillary water is useful for plant uptake and thus we need to replenish this part of soil water during irrigation. In order to manage irrigation, we need to define soil water constants that are used as reference points for practical irrigation water management. These constants are briefly explained below:

24.1.1 Saturation Capacity

Saturation capacity of soil refers to the condition when all the macro and micropores are filled with water and the soil is at maximum water retention capacity (Fig. 24.1). The metric suction at this condition is almost zero and it is equal to free water surface.

24.1.2 Field Capacity

The field capacity is the amount of water held in soil after excess water has been gravity drained and the rate of downward movement has relatively stable, which usually takes place within 1 – 3 days after a rain or irrigation. At field capacity, the soil moisture tension depending on the soil texture ranges from 0.10 to 0.33 bars. Field capacity is the upper limit of available soil moisture. The field capacity is greatly influenced by soil texture, finer the soil particles higher the water retention due to very large surface area and vice versa. It can be seen from Table 2.1 that moisture content at field capacity of clay soil is much higher (40%) as compared to that of coarse sand (10%).

Field capacity of soil can be determined by ponding water over the area of 2 to 5m² for two to three days, with surface evaporation prevented by spreading polyethylene sheet on thick straw mulch over the soil surface. After three days soil samples from different depth will give the field capacity. As a rule of thumb, 1 day of drainage will generally be adequate for sandy soils, 2 days for silt loam soils, and 3 days for silty clay loam soils.

24.1.3 Permanent Wilting Point

Permanent wilting point is considered as lower limit of available soil moisture. At this stage, water is held tightly by the soil particles that the plant roots can no longer obtain enough water to satisfy the transpiration requirements; and remain wilted unless the moisture is replenished. The soil moisture tension at permanent wilting point is about 15 bars.

24.1.4 Available Soil Moisture

Available soil moisture is the moisture between field capacity (0.33 bars) and permanent wilting point (15 bars) which is referred as readily available water (TAW) for plant growth. The water present above the field capacity and below the permanent wilting point is not available to the plant. The available soil moisture is expressed as depth of water per unit of soil and is calculated according to the following formula:

$$TAW = (\theta_{FC} - \theta_{PWP}) \times dz \quad (24.1)$$

Where,

TAW = Total available water (cm)

Θ_{FC} = Volumetric moisture content at field capacity (fraction)

Θ_{PWP} = Volumetric moisture content at Permanent wilting point (fraction)

drZ = Depth of root zone(cm).

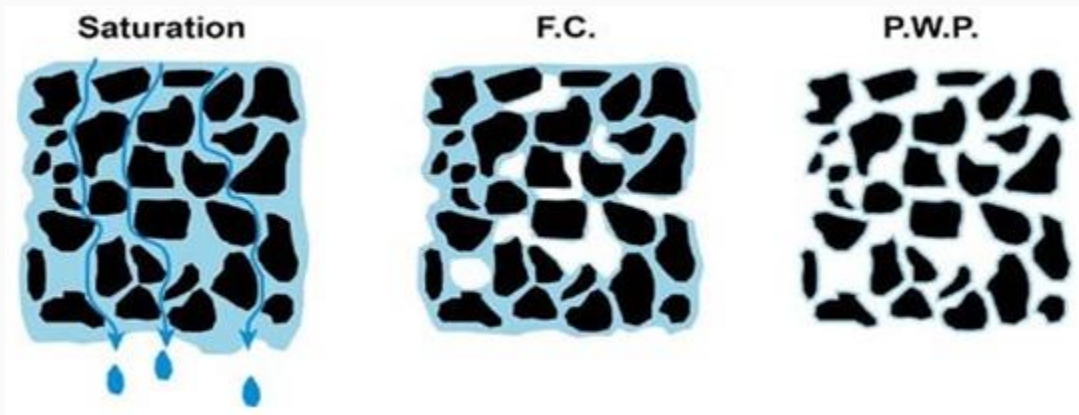

Fig. 24.1. Soil condition at Saturation, Field Capacity and Permanent wilting point.

(Source: www.terragis.bees.unsw.edu.au: accessed on May 30, 2013)

Soil texture	θ_{fc}	θ_{wp}	AWC
----- in/in or m/m -----			
Coarse sand	0.10	0.05	0.05
Sand	0.15	0.07	0.08
Loamy sand	0.18	0.07	0.11
Sandy loam	0.20	0.08	0.12
Loam	0.25	0.10	0.15
Silt loam	0.30	0.12	0.18
Silty clay loam	0.38	0.22	0.16
Clay loam	0.40	0.25	0.15
Silty clay	0.40	0.27	0.13
Clay	0.40	0.28	0.12

* Example values are given. You can expect considerable variation from these values within each soil texture.

Table 24.1. soil water characteristics for various soil textures*

Although plants are theoretically able to obtain water from the soil whenever water contents exceed PWP, the actual rate at which they transpire decreases as stomata close in response to declining soil water contents. Fig. 24.2 indicate that soil moisture stress coefficient (K_s) remains almost unity for soil water content reductions between F_c and θ_t indicate that water is more readily available. However, as the moisture content decrease below θ_t soil moisture stress coefficient decreases below unity and causes decreases in the crop transpiration (ET) at the same rate. Therefore, irrigations are generally scheduled

to maintain soil water contents above θ_t . The water content between θ_{FC} & θ_t is called Readily Available Water (RAW). The concept of maximum allowable deficiency (MAD), is also used to determine the amount of water that can be used without adversely affecting the plant. The MAD is defined as:

$$MAD = \frac{RAW}{TAW} \quad (24.2)$$

The value of MAD depends on soil and crop generally assumed a constant, but should be optimised based on local conditions.

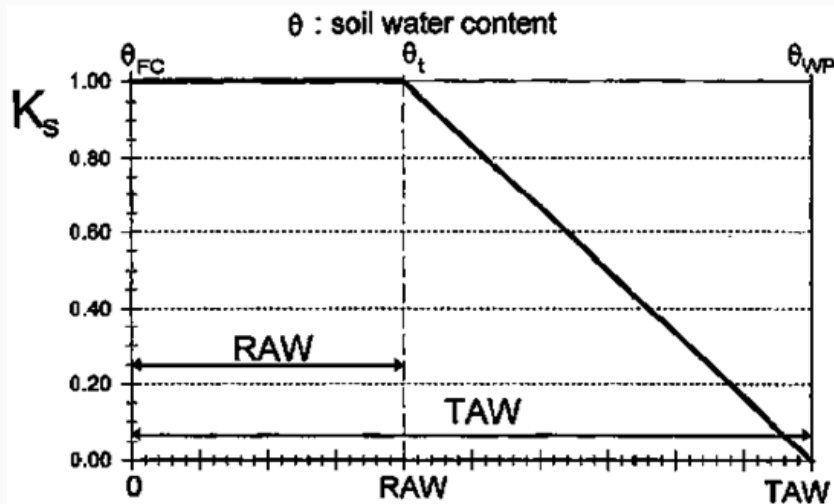

Fig. 24.2. Soil moisture stress as a function of TAW.

24.2 Soil Water Potential

The driving force for water flow in the soil-plant-atmosphere-continuum (SPAC) is the difference in water potential. Water flows from high to low potential. Soil water potential (Ψ_t) is an indicator or measure of amount of work needed to be done to displace a unit quantity of water from a given reference point. The water potential (ψ) can be expressed as the potential energy per unit mass, volume or weight.

Units of Water Potential

Mass basis : Joules/kg

Volume basis: Pascal

Weight basis : Meters or mm

The three major components of soil water potential are gravitational potential (Ψ_g), matric potential (Ψ_m), and osmotic potential (Ψ_o). The soil water potential (Ψ_t) then is

$$\Psi_t = \Psi_p(m) + \Psi_z + \Psi_o \quad (24.3)$$

Where,

$\Psi_p(m)$ = Pressure or (matric) potential

Ψ_z = gravitational potential

Ψ_o = osmotic potential

24.2.1 Gravitational Potential (Ψ_z)

Gravitational potential energy at a point Z above a reference point can be expressed as

$$\text{Potential Energy} = MgZ = \rho_w VgZ \quad (24.4)$$

Where, ρ_w = density of water

V = Volume of water, cm^3

g = Acceleration due to gravity

M = Mass of water

Gravitational potential energy per unit mass of water is the gravitational constant multiplied by the distance of the reference position and can be expressed as

$$\Psi_z / \text{unit mass of water} = \frac{\rho_w VgZ}{M} = \frac{MgZ}{M} = gZ \quad (24.5)$$

If the unit quantity of weight is used then the gravitational potential can be related to a distance. In other words, it is a vertical distance from an arbitrary reference elevation to the point of question.

$$\Psi_z / \text{unit weight of water} = \frac{\rho_w VgZ}{Mg} = \frac{MgZ}{Mg} = Z \quad (24.6)$$

Example 24.1:

Given: Two points in a soil. Each point is located a specified distance above a reference elevation. Point A is 150mm above the reference and point B is 100 mm below reference.

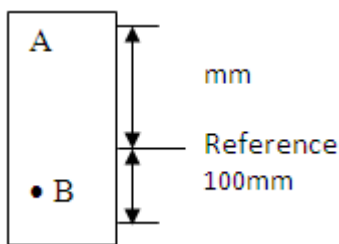

Find: - The Ψ_z at each point

- Difference in Ψ_z ($\Delta \Psi_z$) between the two points.

Solution:

$$\Psi_x(A) = 150\text{mm}, \Psi_x(B) = -100\text{mm}$$

$$\Delta \Psi_x = \Psi_x(A) - \Psi_x(B)$$

$$= 150 - (-100) = 250 \text{ mm}$$

24.2.2 Pressure Potential (Ψ_p)

Pressure potential, under field conditions, applies mostly to saturated soil. For weight basis, it is the vertical distance from a point in question to tree water surface. The hydrostatic pressure of water with reference to atmospheric pressure can be expressed as:

$$\text{Pressure (P)} = \rho_w g h \quad (24.7)$$

The potential energy of the water is Pdv , where dv is the infinitesimal volume of water. The pressure potential on volume, weight and mass basis can be expressed as

$$\Psi_p(\text{volume}) \text{ per unit volume} = \frac{Pdv}{dv} = P \quad (24.8)$$

$$\Psi_p(\text{mass}) \text{ per unit mass} = \frac{\rho_w g h}{\rho_w} = g h \quad (24.9)$$

$$\Psi_p(\text{weight}) \text{ per unit weight} = \frac{\rho_w g h}{\rho_w g} = h \quad (24.10)$$

The pressure potential also known as the submergence potential, is an expression of the +ve pressure exerted on a point by the overburden pressure. It is measured by piezometer. Ψ_p is always be positive and to be zero if the water table below the point is question. In the example 24.1, if water table is reference and point B lies 100 mm below the water table then

$$\Psi_p(A) = 0 \quad \Psi_p(B) = 100\text{mm}$$

If

$$\Psi_p > 0 \text{ then +ve number and } \Psi_m = 0$$

$$\Psi_m > 0 \text{ then -ve number and } \Psi_p = 0$$

24.2.3 Metric Potential (Ψ_m)

It is the negative pressure potential related to the adsorptive forces of the soil matrix. Considering an infinitesimal volume dv of water, with pressure deficit, P , the metric potential will be Pdv . The pressure potential on volume, weight and mass basis can be expressed as

$$\text{Metric potential per unit volume} = \frac{Pdv}{dv} = P = \rho_w gh \quad (24.11)$$

$$\text{Metric potential per unit mass} = \frac{\rho_w gh}{\rho_w} = gh \quad (24.12)$$

$$\text{Metric potential per unit weight} = \frac{\rho_w gh}{\rho_w g} = h \quad (24.13)$$

On weight basis Ψ_m is the vertical distance between a point in the soil and the water level of manometer connected to this point.

24.2.4 Osmotic Potential (Ψ_o)

Osmotic potential exists when soil water is having dissolved solids or salts. The osmotic potential affects the water uptake by plants. The osmotic potential is nearly zero where rainfall is significant and irrigation water is nearly free of salts, i.e., the concentration of salts in the soil is generally low. The osmotic potential has no effect on the flow of water through the soil profile.

24.3 Soil Moisture Measurement Methods

Measurement of soil-water is very important for many studies related to water management including irrigation scheduling, but it is not a simple process. Several methods have been proposed and each method has its own advantages and disadvantages. Some of the methods most commonly used are discussed below:

24.3.1 Direct Methods

24.3.1.1 Gravimetric Method

The gravimetric method is the standard, direct measurement of soil water by which all indirect methods are calibrated. This method involves collecting soil sample from the field using auger, and determining its moist and dry weights. The moist weight is determined by weighing the soil sample (M_s) as it is at the time of sampling, and the dry weight is obtained after drying the soil sample in an oven at 105°C for 24 hours. The weight loss represents the soil water (M_w).

$$\theta_m = \frac{M_w}{M_s} \quad (24.14)$$

24.3.1.2 Volumetric Method

The volumetric water content is defined as the volume of water present in a given volume (usually 1 m^3) of dry soil. This method involves collecting soil sample from the field using core sampler of known volume from representative depths in the root zone and then determining its moist and dry weights using the similar process as in case of gravimetric water content method. The difference in wet and dry mass of soil represent amount of water in the sample. The volumetric wetness can then be calculated as follows:

$$\theta_v = \frac{M_w}{V_t \times \rho_w} \times 100 = \frac{\text{Mass of water}}{\text{Volume of core} \times \text{Density of water}} \times 100 \quad (24.15)$$

To calculate the volume water content from gravimetric water content, we need to know the bulk density ρ_b of dried soil and is calculated as follows:

$$\theta_v = \theta_m \times \rho_b / \rho_w \quad (24.16)$$

$$\text{Depth of water (mm) per unit depth of soil (ds)} = \theta_v \times ds = \theta_m \times \rho_b \times ds \quad (24.17)$$

24.3.2 Indirect Methods

24.3.2.1 Electrical Resistance Blocks

Electrical resistance blocks consist of two electrodes enclosed in a block of porous material. The block is often made of gypsum, and is referred to as gypsum blocks. The electrodes are connected to insulated lead wires that extend upward to the soil surface. Gypsum blocks or electrical resistance blocks, with two electrodes, are placed at a desired soil depth and allowed to equilibrate (Fig. 24.3). Resistance blocks work on the principle that water conducts electricity. When properly installed, the water suction of the porous block is in equilibrium with the soil-water suction of the surrounding soil. Electrical resistance of the block is measured by a meter. Electrical resistance of the soil decreases with increase in water content, i.e., low resistance (400 - 600 ohms) at field capacity and high resistance (50,000 to 75,000 ohms) at wilting point. Soil water content is obtained with calibration curve, for the same block, of electrical resistance against known soil water content.

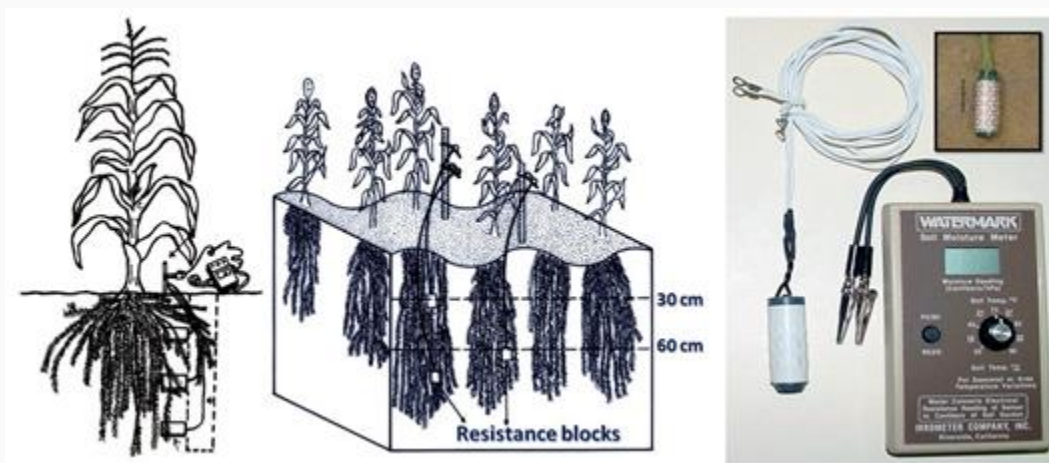

Fig. 24.3. Measurement of soil moisture by Resistance blocks.

24.3.2.2 Neutron Scattering Technique

The neutron scattering method is an efficient and reliable technique for monitoring soil moisture in the field. The neutron moisture meter consists of two main components (Fig. 24.4) viz., a probe and scaler. A probe contains a source of fast neutrons either mixture of americium and beryllium or mixture of radium and beryllium, whereas scaler monitors the flux of slow or thermalized neutrons, which is proportional to soil water content. When the probe is inserted in the access tube at desired depth, the fast neutrons are emitted radially into the soil. These fast neutrons are thermalized when they collide with hydrogen nuclei (namely protons). Sphere of influence is spherical in shape, and ranges in size from 10 cm in wet soil to 25 cm or more

in dry soil. The slowed or thermalized neutrons when pass through detector, create a small electrical pulses which are amplified and counted by scaler over a specified interval of time. Scaler displays either counts or volumetric water content.

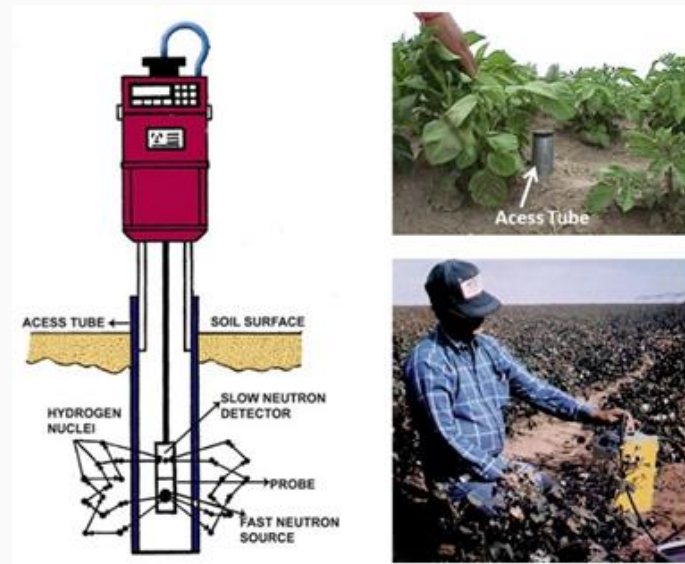

Fig. 24.4.Measurement of soil moisture by neutron probe.

24.3.2.3 Time Domain Reflectometry (TDR)

Time domain reflectometry (TDR) is a relatively new method for the measurement of soil water content and electrical conductivity. Fig. 24.5 shows TDR probe for soil moisture measurement. TDR measures the transit time of an electrical signal along metallic probes. This time is closely related to the dielectric constant of the material surrounding the probe. The dielectric constant of liquid water is much higher (about 80) than soil solids (2 to 5). Thus, the time measured can be related to soil water content. The TDR method offers a number of advantages over other soil water measurement methods. These include

- Better accuracy to within 1 or 2% volumetric water content;
- Soil-specific calibration is not needed in many case;
- TDR has excellent spatial and temporal resolution; and
- Measurements are simple to obtain, and the method is capable of providing continuous measurements through automation and multiplexing.
- Allows to measure moisture content near soil surface thus is compliments neutrons probe, which not measure surface water contents well.



Fig. 24.5. TDR probe for soil water measurement.

24.3.2.4 Tensiometer

Tensiometer measures the matric potential, which indicate the tenacity with which water is held by the soil (Fig. 24.6). To obtain soil water content from tensiometer, soil moisture characteristics curve (a relationship between soil water content and matric potential) is required. Tensiometer consists of a porous ceramic cup which is connected through a tube to a vacuum gauge (or manometer). The tensiometer is filled with water before inserting in the soil. When the Tensiometer is initially placed in the soil, the water contained in the tensiometer is generally at atmospheric pressure (essentially, 0 bar tension). Soil water, being generally at sub-atmospheric pressure, exercises a suction, which draws out a certain amount of water from the rigid and air tight tensiometer thus causing negative pressure inside the tube. This is indicated by a vacuum gauge or manometer. Under field conditions the sensitivity of most tensiometers is a maximal tension of about 0.85 bars or 85 kPa. Tensiometers are suited well for use in sandy soil since large part of plant available water is held at tension less than 1 atmosphere. On the other hand, they are not well suited for fine textured soil since only part of plant available water is held at tension less than 1 bar.

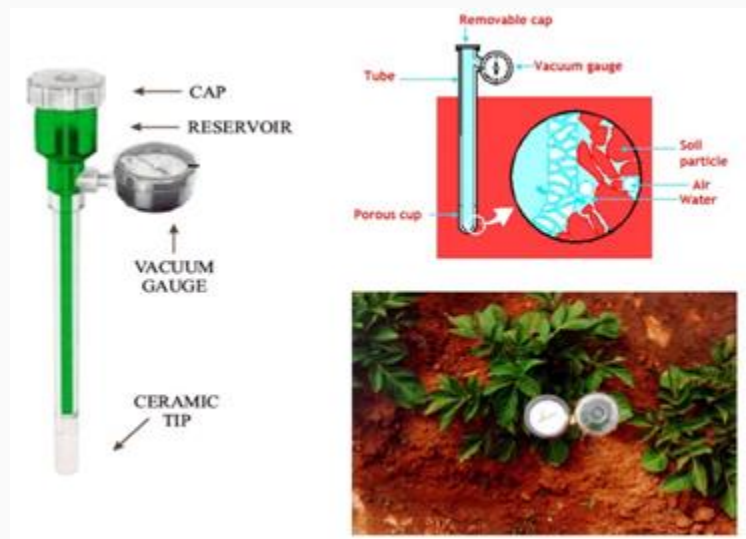

Fig. 24.6. Measurement of soil moisture tension by tensiometer.

(Source: <http://www.angrau.ac.in/media/7380/agro201.pdf>: accessed on May 30, 2013)

Example 24.2:

A moist soil sample collected from agricultural field weighs 120 g. When it is dried the soil weighs 100 g. density of soil is 2.4 g/cm³. Calculate the gravimetric moisture content and volumetric moisture content of the soil sample. Depth of water present in soil as the depth of soil is 75 cm.

Solution:

Water mass = weight of moist sample- weight of dried sample= 120 - 100 = 20 g.

We know,

$$\theta_m = \frac{M_w}{M_s} \times 100$$
$$= \frac{\text{Weight of moist soil} - \text{Weight of oven dry soil}}{\text{Weight of oven dry soil}} \times 100$$

Therefore, $\theta_m = \frac{120-100}{100} \times 100 = 20\%$

And, $\theta_v = \theta_m \times \rho_b = 20 \times 2.4 = 48\%$

Depth of water (mm) per unit depth of soil (ds) = $\Theta_v \times ds = 0.48 \times 75 = 36$ cm (Ans)



LESSON 25 Evapotranspiration

25.1 Evaporation and Transpiration

Evapotranspiration is one of the major components of the hydrologic cycle and affects crop water demand. Therefore, its quantification is necessary for proper irrigation planning. The term evapotranspiration refers to combination of two processes, namely, evaporation and transpiration (Fig. 25.1). Evaporation is a process by which water is lost in the form of vapour from natural surfaces, such as free water surface, bare soil, from live or dead vegetation. Transpiration is a process by which water is lost in the form of vapour through plant leaves. Therefore evapotranspiration is a combined loss of water from the soil (evaporation) and plant (transpiration) surfaces to the atmosphere through vaporization of liquid water, and is expressed in depth per unit time (for example mm/day).

Consumptive use (CU) – CU is used to designate the losses due to ET and water that is used for its metabolic activities of plants thus CU exceed ET by the amount of water used for digestion, photosynthesis, transport of minerals and photosynthates, structural support and growth. Since this difference is usually less than 1%, ET and CU are normally assumed to be equal. But both (CU & ET) terms are used simultaneously.

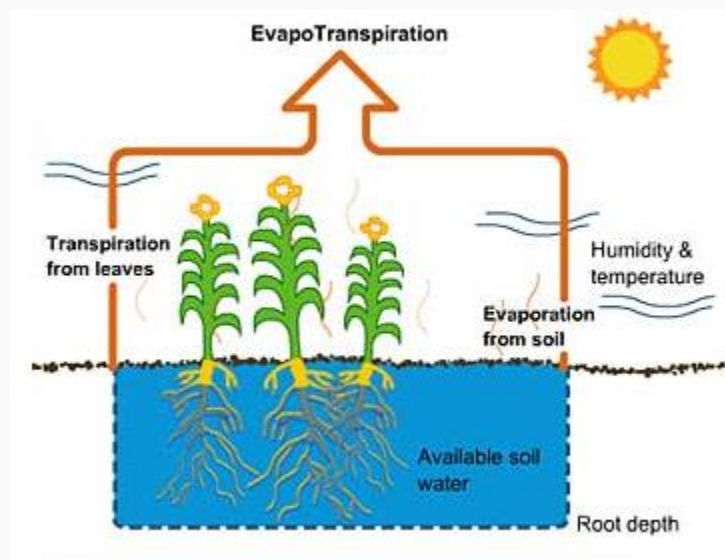

Fig.25.1. Evapotranspiration process.

ET can be either directly measured for a given crop, soil and climatic conditions or computed using the reference crop ET, which is generally estimated by various methods depending upon availability of data for a particular case.

25.2 Concept of Reference Crop Evapotranspiration

Reference Crop ET – is the potential ET for a specific crop (usually either grass or alfalfa) and set of surrounding (advective) conditions. According to Doorenbos and Pruitt (1977) "ET from an extensive surface of 8 10 15 cm tall, green grass covers of uniform height, actively growing, completely shading the ground and not short of water". Allen et al. (1998) modified the above definition to represent hypothetical grass surface. Reference crop evapotranspiration from an extensive surface of green grass of uniform

height (0.12m), actively growing, completely shading the ground with an albedo of 0.23 and having ample water supply is called reference crop evapotranspiration and is denoted by ET_o (Fig. 25.2).

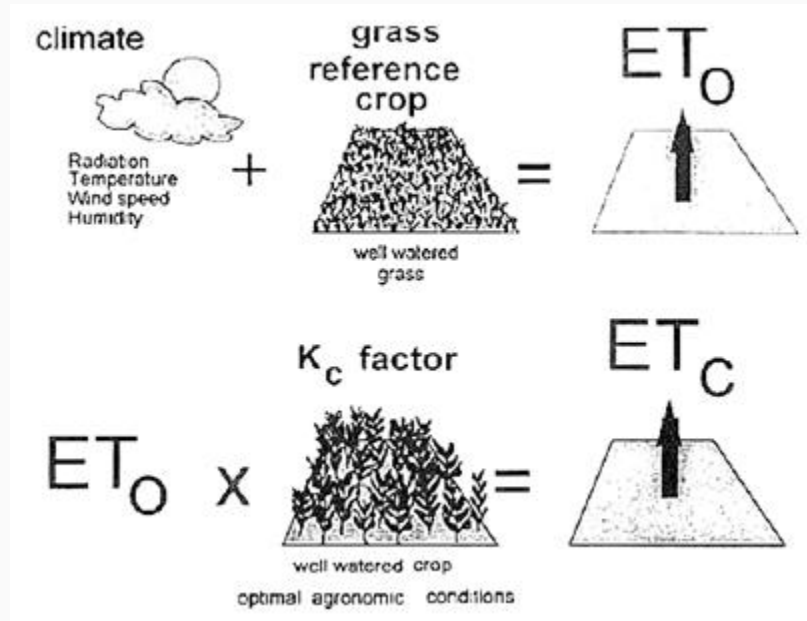

Fig. 25.2. Estimation of reference crop evapotranspiration.

Climatic parameters are the only factors affecting ET_o and it can be computed from weather data. ET for specific crop can be estimated using reference crop ET and crop coefficients. Typical ranges for ET_o values for different agro-climatic regions are given in Table 25.1.

Table 25.1. Average ET_o for different agro-climatic regions in mm/day

Regions	Mean daily temperature (°C)		
	Cool (~10°C)	Moderate (20°C)	Warm (> 30°C)
Tropics and subtropics			
Humid and Sub-humid	2 – 3	3 - 5	5 – 7
Arid and Semi-arid	2 – 4	4 - 6	6 – 8
Temperate region			
Humid and Sub-humid	1 – 2	2 - 4	4 – 7
Arid and Semi-arid	1 – 3	4 - 7	6 – 9

25.3 ET Estimation Methods

Due to wide application of evapotranspiration data, various indirect ET estimation methods have been developed over the years. These methods can be grouped into four major categories. Although there is large number of methods developed in each category, a few examples are given below:

1. Temperature based (Thornwaite, SCS Blaney Criddle, FAO24 Blaney Criddle, Hargreaves)
2. Radiation based (Turc, Priestly Taylor, Jensen-Haise, and FAO 24 Radiation)
3. Pan evaporation based (Pan evaporation, FAO 24 Pan)
4. Combination (Penman, Penman Moneith, FAO 56 Penman Monteith)

Data requirement as well as performance of each of these methods varies. In order to help user with ETo estimation, A Decision Support System for ETo estimation is developed at IIT Kharagpur (Bandopadhyaya et al. 2012), which estimates ETo by 22 well established method and ranks them based on their ETo estimation performance.

25.3.1 Hargreaves Methods

Hargreaves method is a temperature based method and it was derived to overcome non availability of solar radiation data at many locations. Hargreaves and Samani (1985) recommended estimating solar radiation from extraterrestrial radiation and proposed the following equation for estimating ETo in mm/day

$$ET_o = 0.0023 R_A \sqrt{TD} (T_{mean} + 17.8) \quad (25.1)$$

Where,

TD = difference between mean monthly maximum and minimum temperatures in °C,

R_A = extraterrestrial solar radiation in MJ m⁻² d⁻¹,

T_{mean} = mean monthly air temperature in °C.

25.3.2 Thornthwaite Method

The relationship is expressed as:

$$ET_o = 1.6 (10 T/I)^a \quad (25.2)$$

Where,

ET_o = Monthly potential evapotranspiration (cm) or reference crop ET (i.e., ET_o)

T = Mean monthly temperature (°C)

I = A heat index for a given area which is the sum of 12 monthly index values i

i is derived from mean monthly temperatures using the following formula:

$$i = (T/5)^{1.514} \quad (25.3)$$

a = an empirically derived exponent which is a function of I

$$a = 6.75 \times 10^{-7} I^3 - 7.71 \times 10^{-5} I^2 + 6.75 \times 10^{-7} I^3 + 1.79 \times 10^{-2} I + 0.49 \quad 25.4$$

25.3.3 Pan Method

The amount of water evaporating from a pan is determined by measuring change in water level in the pan and correcting from precipitation (assuming that water loss due to wind action, animals, birds etc., has been prevented or is negligible). USBR Class A Pan evaporimeter is most commonly used for estimation of pan evaporation and is shown in Fig. 25.3. It is relatively inexpensive and simple way of assessing the evaporative capabilities of the atmosphere.



Fig. 25.3. Pan evaporimeter.

Reference Crop ET (ET_o) is related to E_p as follows:

$$ET_o = E_p \cdot k_p \quad (25.5)$$

Where,

ET_o = Reference crop ET_o in mm/day

E_p = pan evaporation (mm/day)

K_p = pan coefficient

K_p accounts for differences in pan type and conditions upwind of the pan, and for dissimilarities between plants and evaporation pans. K_p values for USBR class a Pan can be chosen from Table 25.2.

Table 25.2. Pan Coefficient for USBR Class a pan at varying location of fetch, mean RH and wind run

Wind	Windward side distance of green crop	RH mean %		
		low	medium 40-70	high > 70
km/day	M	< 40		
Light	1	0.55	0.65	0.75
< 175	10	0.65	0.75	0.85
	100	0.7	0.8	0.85
	1000	0.75	0.85	0.85
Moderate	1	0.5	0.6	0.65
175-425	10	0.6	0.7	0.75
	100	0.65	0.75	0.8
	1000	0.7	0.8	0.8
Strong	1	0.45	0.5	0.6
425-700	10	0.55	0.6	0.65
	100	0.6	0.65	0.7
	1000	0.65	0.7	0.75
Very strong	1	0.4	0.45	0.5
> 700	10	0.45	0.55	0.6
	100	0.5	0.6	0.65
	1000	0.55	0.6	0.65

(Source: FAO 24)

25.3.4 FAO-56 Penman - Monteith Method

Allen et al. (1998) modified the Penman-Monteith equation for estimation of grass reference crop evapotranspiration (ET₀). The mathematical relationship is as follows:

$$ET_0 = \frac{0.408 \Delta (R_n - G) + \gamma \frac{900}{T + 273} U_2 (e_s - e_a)}{\Delta + \gamma (1 - 0.34 U_2)} \quad (25.6)$$

Where,

ET₀ = Reference crop evapotranspiration (mm/day)

R_n = Net radiation at the crop surface (MJ/m²/day)

G = Soil heat flux density (MJ/m²/day)

T = Air temperature at 2 m height (°C)

U_2 = Wind speed at 2 m height (m/s)

e_s = Saturation vapour pressure (kPa)

e_a = Actual vapour pressure (kPa)

$(e_s - e_a)$ = Saturation vapour pressure deficit (kPa)

Δ = Slope vapour pressure curve (kPa/°C)

γ = Psychrometric constant (kPa/°C)

Details of parameter estimation for the above ETo methods can be found in Allen et al. (1998) and Michael (2008).

Application & Limitations

- Method requires all weather data, i.e., minimum and maximum temperature, minimum and maximum RH, wind speed, Solar radiation or sunshine hour
- Wide applicability i.e., in arid, semi-arid, humid, sub-humid conditions
- Gives a very satisfactory estimate of ETo
- Can provide basis for developing consistent crop coefficients

25.4 Crop Evapotranspiration

Estimation of evapotranspiration for a specific crop (ET_c) requires first calculating the reference evapotranspiration (ET_o) and then multiplying the crop coefficients (K_c) to estimate actual:

$$ET_c = ET_o \times K_c \quad (25.7)$$

Where, ET_c is the ET of a specific crop, ET_o is the grass-reference ET, and K_c is the crop coefficient for a given crop.

25.4.1 Crop Coefficient Concept

While ET_o accounts for variations in weather and is used as an indicator of atmospheric demand for water, K_c values account for the difference between ET_o and ET_c and link them. K_c is the crop coefficient for a given crop and growth stage, and is usually determined experimentally. Each agronomic crop has a set of specific crop coefficients used to predict water use rates at different growth stages.

There are four main crop growth stages: initial, crop development, mid-season, and late season:

- a) Initial period – planting to 10% ground cover
- b) Crop development – 10% ground cover to effective cover i.e., flowering
- c) Mid-season – Effective cover to start of maturity i.e., senescence of leaves

d) Late season – Start of maturity to harvest.

These crop development stages along with crop coefficient variation for a typical crop are depicted in Fig. 25.3. Tables 25.3 presents length of growth stages of some of the representative crops whereas Table 25.4 shows values of crop coefficient during different stages. Crop coefficient values vary with the development stage of the crop. In the case of annual crops, K_c is typically low at seedling, emergence and establishment stage, increases with increase in ground cover and attains maximum value at mid-season stage and there after decreases towards ripening and maturity stage.

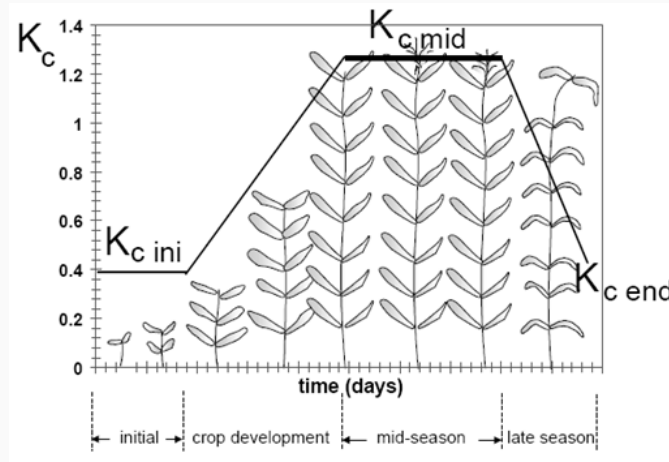

Fig. 25.3. Variation of crop coefficient with crop growth stages. (Source: Allen et al. 1998)

Table 7.7.Length of crop growth stages (days)

Crop	Initial (L_{ini})	Development (L_{dev})	Mid (L_{mid})	Late (L_{lat})	Panting date	Region
Bean, green	20	30	30	10	Feb/Mar	Calif., Mediterrian
Cabbage	40	60	50	15	Sept	Calif. Desert, USA
Cauliflower	35	50	40	15	Sept	Calif. Desert, USA
Tomato	35	40	50	30	Apr/May	Calif., USA
Cucumber	20	30	40	15	Jun/Aug	Arid region
Potato	30	35	50	30	Apr	Europe
Groundnut	35	35	35	35	May	High Latitudes
Lentil	25	35	70	40	Oct/Nov	Arid region
Soybeans	20	30/35	60	25	May	Central USA
Cotton	30	50	60	55	Mar-May	Egypt; Pakistan; Calif.

Sesame	20	30	40	20	Jun	China
Sunflower	25	35	45	25	Apr/May	Medit.; Calif.
Wheat	15	25	50	30	Nov	Central India
Maize (grain)	20	35	40	30	Oct	India (dry, cool)
Rice	30	30	60	30	Dec; May	Tropics; Medit
Sugarcane, ratoon	30	50	180	60		Tropics
Banana, Istyr	120	90	120	60	Mar	Mediterranean
Grapes	20	40	120	60	Apr	Low Latitudes
Citrus	60	90	120	95	Jan	Mediterranean

(Source: Allen et. al, 1998)

Table 7.8. Single crop coefficients for grass reference crop and mean maximum plant heights for well managed no stressed condition in sub-humid regions ($RH_{\min} = 45\%$ and $u_2 = 2 \text{ ms}^{-1}$)

Crop	Kc_ini	Kc_mid	Kc_end	Maximum crop height, h (m)
Bean, green	0.5	1.05	0.90	0.4
Cabbage	0.7	1.05	0.95	0.4
Cauliflower	0.7	1.05	0.95	0.4
Tomato	0.6	1.15	0.70 – 0.90	0.6
Cucumber	0.5	1.00	0.90	0.3
Potato	0.5	1.15	0.75	0.6
Groundnut	0.4	1.15	0.60	0.4
Lentil	0.4	1.10	0.30	0.5
Soybeans	0.4	1.15	0.50	0.5-1.0
Cotton	0.35	1.15-1.20	0.70-0.50	1.2-1.5
Sesame	0.35	1.10	0.25	1.0
Sunflower	0.35	1.0-1.15	0.35	2.0
Wheat	0.3	1.15	0.25 – 0.40	1.0

Maize (grain)	0.3	1.20	0.60, 0.35*	2.0
Rice	1.05	1.20	0.90-0.60	1
Sugarcane	0.40	1.25	0.75	3
Banana, Istyr	0.50	1.10	1.00	3
Grapes	0.30	0.85	0.45	2
Citrus**	0.65	0.60	0.65	3

(Source: Allen et. al., 1998)

* First and second values correspond to harvest at high grain moisture and at complete field dry conditions, respectively.

** No ground cover, 50% canopy

Example 25.1:

Determine ETo for March from pan evaporation data of Palakkad, Kerala. Daily mean pan evaporation for the month of March = 7.01mm, Average relative humidity = 63.45 %, Average wind speed at 2m height = 1.157 m/s. At Palakkad, evaporation pan is placed in an area surrounded by green crops. The windward side distance of green crops is about 100 m.

Solution:

For the given conditions, Kp from Table 25.2 is 0.8

$$\begin{aligned}
 ETo &= Kp \times Epan \\
 &= 0.8 \times 7.01 \\
 &= 5.61 \text{ mm. Ans}
 \end{aligned}$$

Example 25.2:

Determine monthly water requirements and total water requirement of a groundnut crop grown in the rice fallows at Palakkad, Kerala.

Month	January	February	March	April
Kc Values	0.51	0.93	1.14	0.82
ETo mm/day	4.60	5.00	5.59	5.20

Solution:

For the month of January:

$$K_c = 0.51$$

No of days = 31

$$E_{To} = 4.60$$

Therefore, $E_{Tc} = E_{To} \times K_c \times \text{No of days}$

$$= 4.60 \times 0.51 \times 31$$

$$= 72.725 \text{ mm}$$

For the month of February:

$$K_c = 0.93$$

No of days = 28

$$E_{To} = 5.00$$

Therefore, $E_{Tc} = E_{To} \times K_c \times \text{No of days}$

$$= 5.00 \times 0.93 \times 28$$

$$= 130.2 \text{ mm}$$

For the month of March:

$$K_c = 1.14$$

No of days = 31

$$E_{To} = 5.59$$

Therefore, $E_{Tc} = E_{To} \times K_c \times \text{No of days}$

$$= 5.59 \times 1.14 \times 31$$

$$= 197.47 \text{ mm}$$

For the month of April:

$$K_c = 0.82$$

No of days = 30

$$E_{To} = 5.20$$

Therefore, $E_{Tc} = E_{To} \times K_c \times \text{No of days}$

$$= 5.20 \times 0.82 \times 30$$

= 85.2 mm

Total water requirement = Jan +Feb+Mar+Apr = 485.72 mm Ans.

Irrigation requirement for the above months are calculated by subtracting monthly effective rainfall from ETc of respective months.

Key Words: Evapotranspiration, Crop coefficient



LESSON 26 Crop Water Requirement

26.1 Crop Water Requirement

It is defined as the total quantity of water required by a crop irrespective of its source in a given period of time for its normal growth and development under field conditions at a given place. It means that it is the total quantity of water required to mature an adequately irrigated crop to meet the losses due to evapotranspiration (ET), plus the losses during the application of irrigation water (unavoidable losses) and the additional quantity of water required for special operations such as land preparation, transplanting, leaching of salts below the crop root zone, frost control etc. It is expressed in depth per unit time.

$$WR = ET \text{ or } CU + \text{Application losses} + \text{Special needs} \quad (26.1)$$

In other words, crop water requirement is total water demand for growing a crop. Crop water demand can also be expressed in term of supply as:

$$WR = IRR + ER + \Delta S + GWC \quad (26.2)$$

Where:

WR = Total depth of water required during the life of crop irrespective of source

CU = Consumptive use (total water required for all plant processes)

ER = Effective rainfall received during crop life

ΔS = Profile water use i.e., difference in soil moisture in the crop root zone at the beginning and end of the crop

GWC = Groundwater contribution, if any

IRR = Irrigation

In the previous lecture crop ET estimation procedure based on reference crop ET and crop coefficient approach is described. A number of methods are available for estimation of reference crop ET (ET_o) using the weather data. However, crop ET can also be measured using the field water balance or lysimeter. These methods are laborious and time consuming and therefore, indirect methods of crop ET estimation are commonly used and will be covered in this lecture.

The term effective rainfall has a different meaning to different users. For example for hydrologist effective rainfall means runoff, whereas for irrigation engineers of agriculturist effective rainfall means useful or utilizable rainfall for the purpose of crop growth. Dastane (1974) has defined effective rainfall as "that portion of the total annual or seasonal rainfall which is useful directly and/or indirectly for meeting the crop water needs in crop production at the site where it falls but without pumping". Thus, it is the portion of rainfall that does not include losses due to surface runoff, unnecessary deep percolation and residual moisture after harvest. This concept of effective rainfall is suggested for use in planning and operation of irrigation projects. A number of factors affects effective rainfall include, rainfall characteristics, land topography, soil and crop characteristics, management practices, carryover moisture content and

groundwater contribution. A number of methods are in practice for determining effective rainfall. These include, field water balance approach, drum culture approach for rice, and empirical relationship (SCS method). The water requirement of different crops are given in Table 26.1.

Table 26.1. Water requirement of different crops

Crop	Water requirement (mm)	Crop	Water requirement (mm)
Rice	1200	Tomato	600 – 800
Wheat	450 – 650	Potato	500 – 700
Sorghum	450 – 650	Pea	350 – 500
Maize	500 – 800	Onion	350 – 550
Sugarcane	1500 – 2500	Chillies	400 – 600
Sugarbeet	550 – 750	Cabbage	380 – 500
Groundnut	500 – 700	Banana	1200 – 2200
Cotton	700 – 1300	Citrus	900 – 1200
Soybean	450 – 700	Grapes	700 – 1200
Tobacco	400 – 600	Mango	1000 – 1200
Beans	300 – 500	Turmeric	1200 – 1400

26.1.1 Net Irrigation Requirement

The net irrigation requirement is the total amount of irrigation water required to bring the soil moisture content in the root zone depth of the crops to field capacity i.e., difference between the field capacity and the soil moisture content in the root zone before application of irrigation water. This may be obtained by the relationship given below:

$$NIR = \sum_{i=1}^n \frac{M_{fci} - M_{bi}}{100} \cdot \rho_{bi} \cdot D_i \quad (26.3)$$

Where,

NIR = net amount of water to be applied during an irrigation, cm

M_{fci} = gravimetric moisture content at field capacity in the i th layer of the soil, (%)

M_{bi} = gravimetric moisture content before irrigation in the i th layer of the soil, (%)

ρ_{bi} = bulk density of the soil in the i th layer, g/cm^3

D_i = depth of the i th soil layer, cm, within the root zone, cm

N = number of soil layers in the root zone D .

26.1.2 Gross Water Requirement

The total amount of water, inclusive of losses, applied through irrigation is termed as gross irrigation requirement which in other words is net irrigation requirement plus application and other losses.

$$GIR = \frac{NIR}{\text{Overall irrigation efficiency}} \quad (26.4)$$

26.1.3 Duty of Water (D)

This is defined as the area that can be irrigated with a continuous non-stop supply of irrigation water at the rate of one cumec or cusec throughout the base period. It is expressed as acre/cusec or hectare/cumec.

26.1.4 Base Period (B)

This is the period over which irrigation water is to be supplied for the production of any crop. Normally this is equal to the period between the first and last irrigation applied to a crop.

26.1.5 Delta (Δ)

This the depth of water required by a crop during the crop season to meet its requirements. This does not have any relevance to the area of the cropped field. It is expressed in mm or cm.

Relationship between D, Δ and B

$$\Delta = 864 \frac{B}{D} \quad (26.5)$$

Where, Δ in cm, B in days and D in ha/cumec.

26.2 Methods of Crop Water Requirement Determination

26.2.1 Direct Measurement of Evapotranspiration

Plant water use is an important management input, thus, it is critical to know ET. Several methods have been developed to measure evapotranspiration is already discussed earlier (see section 25.3), a few are summarized here.

26.2.1.1 Aerodynamic Methods

The vapour pressure of the air and air flow velocities can be measured at several levels above a plant canopy. By evaluating these measurements, the instantaneous evapotranspiration rate can be determined. Summing these instantaneous measurements provides an estimate of evapotranspiration for a day. This technique requires very accurate equipment because the air moves erratically above the canopy.

26.2.1.2 Soil Water Balance Methods

Soil water is the source for evapotranspiration, and several methods have been used to relate changes in soil water to plant water use. The primary components of the soil water balance are illustrated in Figure 26.1. The soil water balance can be expressed as:

$$ET = AW_b - AW_e + P + d_g + U_f + R_i - R_o - d_p \quad (26.6)$$

Where,

ET = amount of evapotranspiration during the period,

AW_e = amount of soil water in the root zone at the end of a period,

AW_b = amount of soil water in the root zone at the beginning of a period,

P = total precipitation during the period,

d_g = gross irrigation during the period,

U_f = groundwater contribution to water use during the period,

R_i = surface water that runs onto the area during the period,

R_o = surface runoff that leaves the area during the period, and

d_p = deep percolation from the root zone during the period.

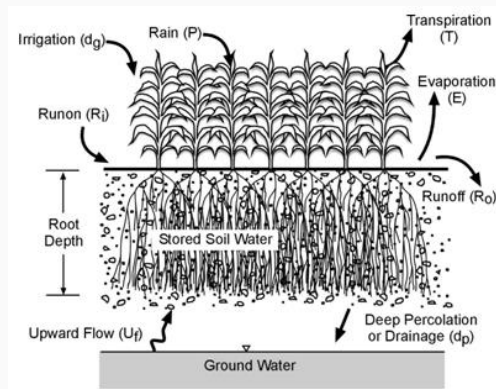

Fig.26.1. Sketch illustrating the components of the soil water balance.

Soil water content can be measured using neutron scattering or other techniques described earlier. Deep percolation is difficult to measure and is often assumed to be insignificant unless substantial rainfall occurs or large irrigations are applied. A significant problem with the soil water balance technique is that repetitive measurements must be made throughout the season. One week is usually the shortest period for using the soil water balance method to estimate ET.

26.2.1.3 Lysimetry

Lysimeters are measuring devices used for estimating evapotranspiration. It consists of specially designed open-top tanks buried in the field that are filled with undisturbed soil, and planted with the same crop as the surrounding area. Water used for ET by plants grown in the lysimeter must come from the soil water within the tank. ET can be measured by monitoring soil water contents and water applications from irrigation or rain. The soil tank is used to isolate soil water from the surrounding area and to prevent runoff, upward groundwater flow, and drainage entering into the system. For some applications drainage is allowed and the volume of deep percolation is measured. The soil water within the tank can be measured with traditional methods such as neutron probes. The amount of water in the tank can also be determined by weighing the tank, soil, plants, and soil water. Since soil water is the only item that changes significantly over short time periods, the change in weight equals the amount of water used for ET.

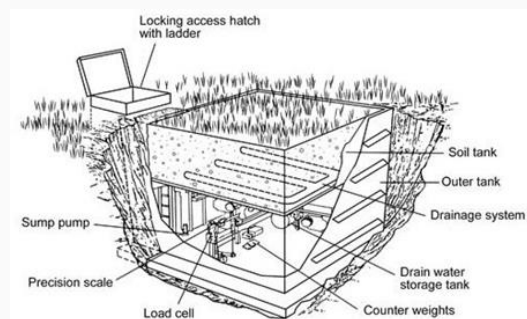

Fig.26.2. Cutaway drawing of weighing type lysimeter.

Example 26.1:

A tank has a water spread area of 40 ha. With an average water depth of 3m. Calculate the area of paddy crop (120 days duration) that can be irrigated, if the duty is expressed as:

- 960 ha per m³s⁻¹
- 110 ha cm and
- 90 ha / million cu m of water

Solution:

The total water available = 40 x 3 x 100 ha. Cm

$$\Delta = 846 \times \frac{B}{d} = 864 \times \frac{120}{960} = 108 \text{ cm}$$

1. Area that can be irrigated = $\frac{40 \times 3 \times 100}{108} = 111 \text{ ha. Ans.}$

2. Area that can be irrigated = $\frac{40 \times 3 \times 100}{110} = 108 \text{ ha. Ans.}$

3. Water available in million cu. m = $\frac{40 \times 3 \times 10,000}{10,00,000}$

Area that can be irrigated = $\frac{40 \times 3 \times 10,000}{10,00,000} \times 90 = 108 \text{ ha. Ans.}$

Example 26.2:

The following data were obtained in determining the soil moisture content at successive depths in the root zone prior to applying irrigation water.

Depth of sampling, cm	Wt. moist soil sample, gm	Oven dry wt. of soil sample, gm
0-25	135.60	127.82
25-50	137.28	128.95
50-75	123.95	116.32
75-100	111.92	103.64

The bulk density of the soil in the root zone was 1.65 gm/cc. the available moisture holding capacity of the soil was 18.0 cm/m depth. Determine

1. The moisture content at different depths in the root zone
2. Moisture content in the root zone at the time of irrigation
3. Net depth of water to be applied to bring the moisture content to field capacity

4. Gross irrigation requirement at an estimated field irrigation efficiency of 70 %

Solution:

a. Soil moisture content at different depths

$$\begin{aligned} 0-25 \text{ cm: } & \frac{(135.6-127.82)100}{127.82} = 6.08\% = 6.08 \times 1.65 = 10 \text{ cm/ m depth} \\ & = 10 \times 25/100 = 2.5 \text{ cm} \end{aligned}$$

$$\begin{aligned} 25-50 \text{ cm: } & \frac{(137.28-128.95)100}{128.95} = 6.46\% = 6.46 \times 1.65 = 10.66 \text{ cm/ m depth} \\ & = 10.66 \times 25/100 = 2.66 \text{ cm} \end{aligned}$$

$$\begin{aligned} 50-75 \text{ cm: } & \frac{(123.95-116.35)100}{116.35} = 6.53\% = 6.53 \times 1.65 = 10.77 \text{ cm/ m depth} \\ & = 10.77 \times 25/100 = 2.69 \text{ cm} \end{aligned}$$

$$\begin{aligned} 75-100 \text{ cm: } & \frac{(111.92-103.64)100}{103.64} = 7.98\% = 7.98 \times 1.65 = 13.18 \text{ cm/ m depth} \\ & = 13.18 \times 25/100 = 3.292 \text{ cm} \end{aligned}$$

b. Moisture content in the root zone at the time of irrigation = 2.5+2.66+2.69+3.292 = 11.14 cm

c. Net irrigation requirement = 18 - 11.14 = 6.85 cm

d. Gross irrigation requirement = 6.85 / 70 x 100 = 9.79 cm. Ans.

Example 26.3:

Determination of monthly water requirements of groundnut having monthly crop coefficient 1.12 and ETo = 5.06 mm /day. Consider month with 30 days.

Solution:

Daily water requirement ETc= ETo x Kc = 5.06 x 1.12 = 5.66 mm

Monthly water requirement = 5.66 mm x 30 = 170.016 mm Ans.



LESSON 27. Irrigation Scheduling

27.1 Irrigation Scheduling Concept

Irrigation scheduling is essential for good water management and it deals with two classical questions related to irrigation. These are (1) how much to irrigate and (2) How often to irrigate. How often and how to irrigate is function of irrigation water needs of the crop. For example, if irrigation water need of crop is 5 mm/day, each day crop needs a water layer of 5 mm over the whole cropped area. However, 5 mm of water need not be supplied every day. Generally, drips irrigation systems are designed to meet irrigation water requirement on daily or at an interval of 2-3 day days. However, longer gap between irrigations is maintained in other irrigation system. In any case, irrigation interval is chosen such that crop does not suffers from water tress.

In many cases irrigation scheduling is performed based on the irrigator's personal experience, plant appearance, watching the neighbor, or just simply irrigating whenever water is available. However, over the year a number of irrigation scheduling techniques based on soil water monitoring, plant monitoring and water balance approach have been developed. Soil water monitoring techniques are already covered. We will summarize these methods in this lecture but will focus on irrigation scheduling based on soil water balance approach. Each of these irrigation scheduling philosophies have some shortcomings. To overcome these in the future a combination of soil water monitoring and plant status will be the most appropriate choice.

27.1.1 Advantages of Irrigation Scheduling

Irrigation scheduling offers several advantages:

1. It enables the farmer to schedule water rotation among the various fields to minimize crop water stress and maximize yields.
2. It reduces the farmer's cost of water and labour as it minimizes the number of irrigations.
3. It lowers fertilizer costs by holding surface runoff and deep percolation (leaching) to a minimum.
4. It increases net returns by increasing crop yields and crop quality.
5. It minimizes water-logging problems by reducing the drainage requirements.
6. It assists in controlling root zone salinity problems through controlled leaching.
7. It results in additional returns by using the "saved" water to irrigate non-cash crops that otherwise would not be irrigated during water-stress periods.

27.1.2 Full Irrigation

It provides the enough water to meet the entire irrigation requirement and is aimed at achieving the maximum production potential of the crop. Excess irrigation may reduce crop yield because of decreased soil aeration.

27.1.3 Deficit Irrigation

It means partially meeting the crop water requirement. It is practiced when there is water scarcity or the irrigation system capacity is limited. With deficit irrigation root zone is not filled to the field capacity moisture level. Deficit irrigation is justified in case where reducing water application below full irrigation causes production cost to decrease faster than revenue decline due to reduced yield. This method allows plant tress during one or more periods of growing season. However, adequate water is applied during the critical growth stages to maximize water use efficiency. Critical growth stage of some the crops are shown in the following Table 27.1.

Table 27.1. Critical growth stages for managing water use efficiency

Crop	Growth period Most sensitive to water Stress	Growth Interval in which irrigation Produces Greatest Benefits
Sorghum	Boot- heading	Boot- soft dough
Wheat	Boot- flowering	Jointing- soft dough
Corn	Tassel- pollution	12 leaf- blister kernel
Cotton	First bloom- peak bloom	First bloom- boils well- formed
Dry beans	Flowering –early podfill	Axillary bud- podfill
Potatoes	Tuberization	Tuberization- maturity
Soybean	Flowering- early podfill	Axillary bud- podfill
Sugarbeets	No critical stages	WUE ^a is maximized when water depletion is limited ton about 50% available water depletion

27.1.4 Irrigation Interval

It is the number of days between two successive irrigations. It depends on the crop ET, effective rainfall, and available water holding capacity of the soil in the crop root zone and management allowable depletion.

27.2 Methods of Irrigation Scheduling

Over the years, a number of methods have been developed for irrigation scheduling. These can be broadly classified into following categories:

1. Soil indicators
2. Climatological
3. Plant indices
4. Water balance

27.2.1 Soil Indicator

There are number of methods based on soil indicators. These include feel and appearance, soil moisture monitoring using gravimetric method, neutron probe, TDR, or soil moisture tension measurement using tensiometer, porous block etc. Soil moisture as well as soil moisture tension measurement is already discussed in previously. In these methods, the available soil water held between field capacity and permanent wilting point in the effective crop root zone depth is taken as guide for determining practical irrigation schedules. Alternatively soil moisture tension is also used as a guide for timing irrigations. Feel and appearance is one of the oldest and simple methods of determining the soil moisture content. It is done by visual observation and feel of the soil by hand. The accuracy of judgment improves with experience.

27.2.2 Climatological Approach (IW: CPE Ratio)

Irrigation scheduling on the basis of ratio between the depth of irrigation water (IW) and cumulative evaporation from U.S.W.B. Class A pan evaporimeter minus the precipitation since the previous irrigation (CPE) proposed by Prihar et al. (1974). The accuracy of the method depends on proper installation of pan evaporimeter and rain gauge and the measurements of pan evaporation and rainfall. Further, suitability of the method is site specific and limited to particular variety of crop. An IW/CPE ratio of 1.0 indicates irrigating the crop with water equal to that lost in evaporation from the evaporimeter. A few examples of optimal IW/CPE ratios for important crops are given in Table 27.2.

Table 27.2. Optimum IW/CPE ratios for scheduling irrigation in important crops

Crop	Optimum IW/CPE ratio	
Groundnut	◆	0.75 to 1.0 IW/CPE ratio depending on crop developmental stages in Andhra Pradesh, Maharashtra & West Bengal
Sunflower	◆	0.5 to 1.0 IW/CPE ratio depending on crop developmental stages at Hyderabad & Kanpur
Wheat	◆	1.0 IW/CPE ratio at Ludhiana, Kanpur and Bikramganj
Bengal gram	◆	0.4 IW/CPE ratio at Ludhiana
Mustard	◆	0.4 IW/CPE ratio at Hissar
Maize	◆	0.75 to 1.0 IW/CPE ratio depending on crop developmental stages at Delhi & Hyderabad
Sugarcane	◆	0.5 to 1.0 IW/CPE ratio depending on crop developmental stages at Lucknow

27.2.3 Plant Indices Approach

The plants readily respond to the deficit in soil water. Some of the indices used to schedule irrigation based on this response are discussed below:

27.2.3.1 Visual Plant Symptoms

The visual signs of plants are used as an index for scheduling irrigations. These include colour of plants, curling and rolling of leaves, wilting of leaves, change in leaf angle etc. Plant water stress in maize and beans crop is reflected through rolling of leaves in case of maize and change in angle of leaves in case of bean (Fig. 27.2). Successful interpretation of crop stress requires keen observation and experience. Secondly sometimes symptoms may be misleading and by the time they appear it may be too late to irrigate.



Fig. 27.3. Rolling of leaves in maize and change of leaf angle in beans.

27.2.3.2 Plant Water Potential

Plant water potential is a measure of the energy status of plant water and is analogous to the energy measurements of soil water. This serves as a better index of physiological and bio-chemical phenomena occurring in the plant. Plant or leaf water potential can be precisely measured either by a Pressure bomb or pressure chamber apparatus (figure. 27.4) are generally used for in situ measurement of leaf water potential, whereas the dye method is used in the laboratory. The critical plant water potential varies with crop. When potential values falls below critical limits specific to crop and growth stage, physiological and growth factors are adversely affected and thus they can serves as a guideline for irrigation scheduling. In case of cotton critical potential ranges from 1.2 to 1.25 MPa throughout the crop life, whereas for sunflower they are 1.0, 1.2 and 1.4 MPa at vegetative, pollination and seed formation, respectively.

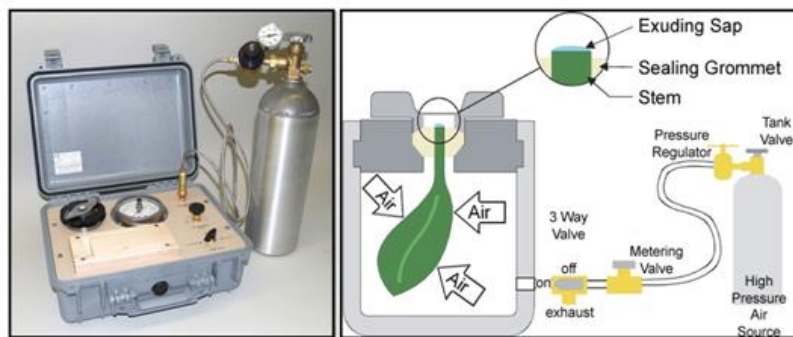

Fig. 27.4. Pressure chamber apparatus.

27.2.3.3 Canopy Temperature

The canopy temperature reflects the internal water balance of the plant, and can be used as a potential indicator for scheduling irrigation to crops. It can be measured by porometer, infrared thermometer (Fig 27.5) etc. The leaf canopy temperature is sensitive index in crops like soya bean, oats, barley, wheat, sorghum and maize.

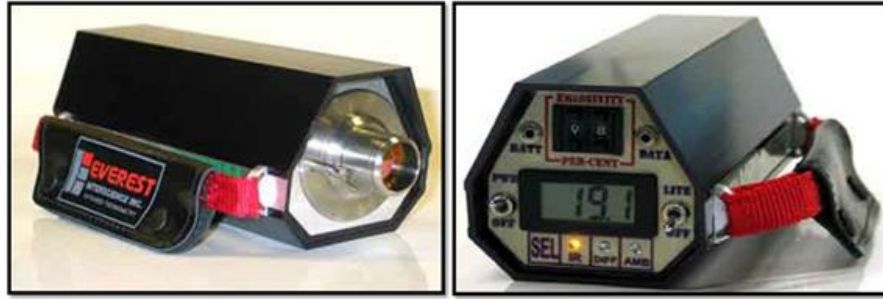

Fig. 27.5. Infrared thermometer for scheduling irrigations to crops.

27.2.4 Water Balance Approach

Irrigation scheduling based on water balance approach uses readily available information on weather, crop and soil information. The soil water balance can be expressed in terms of soil moisture depletion as follows:

$$SMD_i = SMD_{i-1} + ET_{c,i} + DP_i - I_i - P_{e,i} + GW_i \quad (27.1)$$

where SMD= total soil moisture depletion in the root zone and is defined as the difference between total soil moisture stored in the root zone at the field capacity and the current moisture status; ET_c = crop evapotranspiration; DP = deep percolation; I = irrigation amount; P_e = effective rainfall; GW = the capillary rise/ground water contribution and i = time index.

The initial soil moisture depletion at the beginning of the water balance or can be either assumed at field capacity or determined using the measured value of moisture content as follows:

$$SMD_{i-1} = (\theta_f - \theta_{i-1}) D_{rz} \quad (27.2)$$

Where, D_{rz} = effective root zone depth, which increases during the growing season and reaches a maximum depth, θ_f = volumetric moisture content at field capacity and θ_{i-1} = initial volumetric moisture content.

Daily crop evapotranspiration can be calculated as:

$$ET_{c,i} = ET_{o,i} [K_{c,i} \times K_{s,i}] \quad (27.3)$$

Where ET_o = grass reference crop ET and can be estimated using the methods discussed previously; K_c = crop coefficient which is a function of the crop type and the growth stage; K_s = crop stress coefficient which is a function of the soil moisture available to the crop.

Crop stress coefficient varies with moisture content as shown in Fig. 24.2. It can be estimated as follows for soil moisture depletion greater than readily available water ($SMD_i > RAW$):

$$K_{s,i} = \frac{TAW - SMD_i}{TAW - RAW} \quad (27.4)$$

$$K_{s,i} = 0$$

$$SMD_i < RAW \quad (27.5)$$

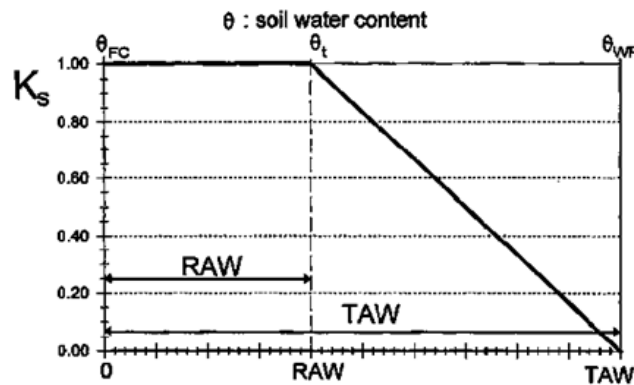

Fig. 24.2. Crop stress coefficient variation with moisture content. (Source: FAO 56)

Deep percolation from the root zone occurs when excess water from rain or irrigation fills the root zone beyond field capacity. It can be assumed that soil water content returns to the field capacity within the same day of wetting event. The deep percolation can be determined as follows:

$$DP_i = P_{e,i} + I_i - SMD_{i-1} - ET_{c,i} > 0 \quad (27.6)$$

The deep percolation is zero ($DP_i = 0$), when irrigation and effective rainfall are less than or equal to SMD and ET_c .

Effective rainfall can be considered as some fixed percentage of rainfall and capillary rise can be neglected if water table is far below root zone. After evaluating each term of Eq. (27.1), irrigation scheduling can be performed based on fixed interval, fixed depth or management allowable depletion (MAD) criteria.

- For fixed interval, the estimated irrigation requirement is equal to soil moisture depletion at the end of the interval,
- For fixed depth case, irrigation is required when soil moisture depletion becomes equal to irrigation depth.
- In the case of irrigation scheduling based on MAD, both day of irrigation and depth are estimated as follows:

$$AD = TAW \cdot MAD \quad (27.7)$$

Where AD = allowable depletion, MAD = management allowable depletion limit, defined as the fraction of TAW that can be safely removed from the soil to meet the daily ET demand on day i. In this case irrigation is given on the day i, when the soil moisture depletion reaches the allowable depletion. The required irrigation depth is equal to soil moisture depletion.

NRCS (1997) reported that MAD should be evaluated according to crop needs, and, if needed, adjusted during the growing season. Values of MAD, during the growing season are typically 25 to 40 percent for high value, shallow rooted crops; 50 percent for deep rooted crops; and 60 to 65 percent for low value deep rooted crops. Recommended MAD values by soil texture for deep rooted crops are:

- Fine texture (clayey) soils 40%
- Medium texture (loamy) soils 50%
- Coarse texture (sandy) soils 60%

Note that in all the cases, irrigation depth calculated is net irrigation depth and in order to determine gross application depth leaching requirement and application efficiency need to be taken into consideration. However, in many field conditions leaching requirement is need not to be considered for each irrigation.

Example 27.1:

For a crop with effective rooting depth of 150 cm, calculate the irrigation interval. Given, field capacity = 14%, permissible depletion 7 %, and crop evapotranspiration = 285 mm/ month.

Solution:

$$\text{Irrigation interval} = \frac{(0.15-0.08)}{285/30} \times 1500 = 11.05 = 11 \text{ days}$$

Example 27.2:

In the above problem, if during the period under consideration there is an effective rainfall of 35 mm, the irrigation interval will be,

$$\text{Irrigation interval} = \frac{(0.15-0.08) \times 1400 + 35}{285/30} = 14 \text{ days}$$

Example 27.3:

A bean crop is grown in clay loam soil and is completely developed. The groundwater table is more than 5 m below the surface. At the beginning of midseason stage of crop, the moisture content is at field capacity. Reference crop evapotranspiration and precipitation values for the 10 day period are given below.

Day	1	2	3	4	5	6	7	8	9	10
ETo mm/d	5.6	5.4	5.9	5.8	5.6	5.8	5.9	5.8	5.2	5.4
P, mm/d	0	0	0	0	5	0	0.2	0	0	0

Furthermore, consider effective root zone depth as 60 cm, crop coefficient as $K_{C_{mid}}=1.05$, volumetric water content at field capacity and permanent wilting points as 36% and 18%, respectively. Using the above information develop irrigation schedule based on a fixed interval of a week and MAD.

Solution:

Effective root zone depth = 60 cm, $K_{C_{mid}} = 1.05$, $\theta_{fc} = 36\%$, $\theta_{pwp} = 18\%$ and $MAD = 0.5$ (based on soil)

Total available water, $TAW = (\theta_{fc} - \theta_{pwp}) \cdot D_{rz} = (0.36 - 0.18) (60) = 10.80 \text{ cm}$

Allowable depletion, $AD = MAD \cdot TAW = (0.5)(10.80) = 5.4 \text{ cm} = 54 \text{ mm}$

At the beginning soil moisture is at field capacity and thus $SMD_{i-1} = 0$. Calculation for each day is shown below:

Day	SMD_{i-1}	ET_{o_i}	K_{c_i}	K_{s_i}	ET_{c_i}	DP_i	I_i	Pe_i	SMD_i
	(mm)	(mm)			(mm)	(mm)	(mm)	(mm)	(mm)
1	0.0	5.6	1.05	1.0	5.9	0.0	0.0	0.0	5.9
2	5.9	5.4	1.05	1.0	5.7	0.0	0.0		11.6
3	11.6	5.9	1.05	1.0	6.2	0.0	0.0		17.7
4	17.7	5.8	1.05	1.0	6.1	0.0	0.0		23.8
5	23.8	5.6	1.05	1.0	5.9	0.0	0.0	5.0	24.7
6	24.7	5.8	1.05	1.0	6.1	0.0	0.0		30.8
7	30.8	5.9	1.05	1.0	6.2	0.0	0.0	0.2	36.8
8	36.8	5.8	1.05	1.0	6.1	0.0	0.0		42.9
9	42.9	5.2	1.05	1.0	6.0	0.0	0.0		48.4
10	48.9	5.4	1.05	1.0	6.2	0.0	0.0		54.0

For MAD based scheduling, 54.0 mm of irrigation would be required on the morning of 11th day, whereas irrigation amount would be 36.8 mm after a week.



LESSON 28. Irrigation Efficiency

The term irrigation efficiency expresses the performance of a complete irrigation system or components of the system. Irrigation efficiency is defined as the ratio between the amount of water used to meet the consumptive use requirement of crop plus that necessary to maintain a favourable salt balance in the crop root zone to the total volume of water diverted, stored or pumped for irrigation. Thus, water applied by the irrigation system and not being made available to be taken up by plant roots is wasted and reduces irrigation efficiency. Fig. 28.1 shows components of water loss from source to point of application. In addition, losses can also occur during storage in case of pond, tank, or reservoirs. The major causes for reduced irrigation efficiency include storage losses, conveyance losses and field application losses. In India, overall irrigation efficiency of major irrigation projects ranges between 35-40%. This is one of the reasons for increasing gap between irrigation potential created (102.77 M ha till end of 10th plan 2007) and utilized (87.23 M ha). This gap of about 16%, is same as the irrigation potential created between 1951 and 1970. At the end of eighth plan, Planning commission estimated that with a 10% increase in the present level of water use efficiency in irrigation systems, an additional 14 Mha area can be brought under irrigation from the existing irrigation capacities. In order to meet the growing demands of water for food, environment, urban and industry, it is necessary to improve irrigation efficiency at all levels.

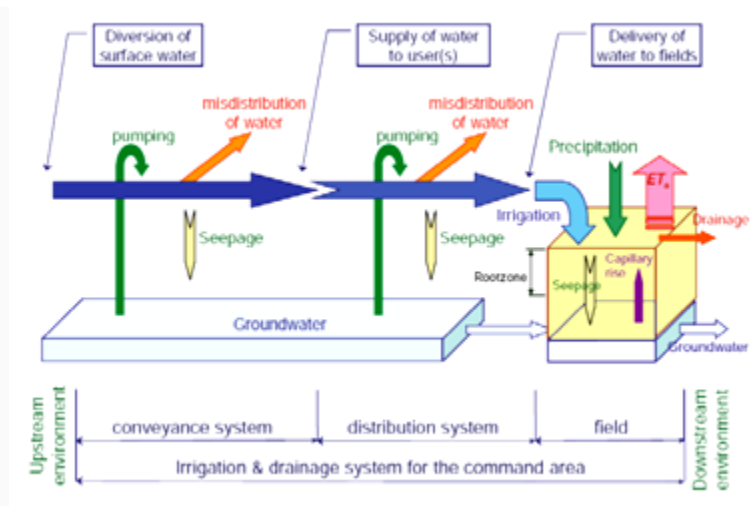

Fig. 28.1. Schematic water flow in irrigation drainage system.

28.1 Definition of Various Efficiencies

28.1.1 Reservoir Storage Efficiency

It is the efficiency with which water is stored in the reservoir. It is expressed as follows,

$$E_r = 100 \times \left(1 - \frac{V_e + V_s}{V_i}\right) = 100 \left(\frac{V_o + \Delta S}{V_i}\right) \quad (28.1)$$

Where,

V_e = evaporation volume from the reservoir

V_s = seepage volume from the reservoir

V_f = inflow to the reservoir

V_o = volume of out flow from the reservoir

ΔS = change in reservoir storage

28.1.2 Water Conveyance Efficiency

The conveyance efficiency is used to measure the efficiency of water conveyance systems associated with the canal network, water courses and field channels. It is defined as the ratio between the water that reaches a farm or field and that diverted from the irrigation water source. Mathematically it is represented as follows:

$$E_c = 100(V_f / V_d) \quad (28.2)$$

Where,

E_c = the conveyance efficiency (%),

V_f = the volume of water that reaches the farm or field (m^3),

V_d = the volume of water diverted (m^3) from the source.

E_c also applies to segments of canals or pipelines, where the water losses include canal seepage or leaks in pipelines. The global E_c can be computed as the product of the individual component efficiencies, E_{ci} , where i represent the segment number. Typically, conveyance losses are much lower for closed conduits or pipelines compared with unlined or lined canals. Even the conveyance efficiency of lined canals may decline over time due to material deterioration or poor maintenance.

28.1.3 Application Efficiency

Application efficiency relates to the actual storage of water in the root zone to meet the crop water needs in relation to the water applied to the field. It might be defined for individual irrigation or parts of irrigations or irrigation sets. Application efficiency includes any application losses to evaporation or seepage from surface water channels or furrows, any leaks from sprinkler or drip pipelines, percolation beneath the root zone, drift from sprinklers, evaporation of droplets in the air, or runoff from the field. In case of surface irrigation evaporation losses are generally small but runoff and deep percolation are substantial. However, air losses (droplet evaporation and drift) can be very large if the sprinkler design or excessive pressure produces a high percentage of very fine droplets. Application efficiency is defined as:

$$E_a = 100(V_s / V_f) \quad (28.3)$$

Where,

E_a = the application efficiency (%),

V_s = the volume of water stored in root zone (m^3),

V_f = the water delivered to the field or farm (m^3).

Table 28.1. Typical values of application efficiency for different irrigation systems

System Type	Application Efficiency Range* (%)
Surface Irrigation	
Basin	60 - 95
Border	60 - 90
Furrow	50 - 90
Surge	60 - 90
Sprinkler Irrigation	
Handmove	65 - 80
Traveling Gun	60 - 70
Center Pivot & Linear	70 - 95
Solid Set	70 - 85
Microirrigation	
Point source emitters	75 - 95
Line source emitter	70 - 95

28.1.4 Storage Efficiency

The water storage efficiency evaluates the storage of water in the root zone after the irrigation in relation to the need of water prior to irrigation.

$$E_s = 100 (V_s / V_{rz}) \quad (28.4)$$

Where,

E_s = the storage efficiency (%)

V_{rz} = the root zone storage capacity (m^3).

The root zone depth and the water-holding capacity of the root zone determine V_{rz} . The storage efficiency has little utility for sprinkler or micro irrigation because these irrigation methods seldom completely refill the root zone.

28.1.5 Water Distribution Efficiency

It is the ratio between the mean of numerical deviations from the average depth of water stored during irrigation (Y) and the average depth stored during irrigation (d). It is mathematically expressed as:

$$E_d = \left(1 - \frac{\bar{Y}}{\bar{d}}\right) \times 100 \quad (28.5)$$

Where,

Y = Average numerical deviation in depth of water stored from average depth stored during irrigation

d = Average depth of water stored during irrigation.

It is a measure of water distribution within the field. A low distribution efficiency means non-uniformity in the distribution of irrigation water. This may be due to uneven land levelling. There may be existing low patches where water will penetrate more and high patches where water cannot reach. This leaves some spots unirrigated unless excess irrigation water is applied. Excess water application lowers irrigation efficiency. It may be noted that water distribution efficiency is identical to Christiansen's Uniformity Coefficient which is discussed later.

28.1.6 Water Use Efficiency

The term water use efficiency denotes the production of crops per unit water applied. It is expressed as the weight of crop produce per unit depth of water over a unit area. i.e., kg/cm/ha.

28.1.6.1 Crop Water Use Efficiency

It is the ratio of crop yield per amount of water depleted by the crop in the process of evapotranspiration (ET).

$$\text{Crop water use efficiency} = Y/ET \quad (28.6)$$

28.1.6.2 Field Water Use Efficiency

It is the ratio of crop yield (Y) to the total amount of water used in the field (WR).

$$\text{Field water use efficiency} = Y/WR \quad (28.7)$$

28.2 Irrigation Uniformity

Uniformity is a measure to describe evenness of water application over the length of the field. It is a statistical measure of the distribution of the applied water, which is affected by various factors such as the method of irrigation, topography, infiltration characteristics, and hydraulic characteristics (pressure, flow rate, etc.) of the irrigation system.

It is generally expressed using Christiansen's coefficient of uniformity (CU), distribution uniformity (DU) and emission uniformity (EU) for drip irrigation systems. Irrigation application distributions are usually based on depths of water (volume per unit area); however, for micro irrigation systems they are usually based on emitter flow volumes because the entire land area is not typically wetted.

28.2.1 Christiansen's Uniformity Coefficient

Christiansen proposed a coefficient intended mainly for sprinkler system based on the catch volumes given as:

$$CU = \left[\frac{1 - (\sum |X-x|)}{\sum X} \right] \quad (28.8)$$

Where, CU is the Christiansen's uniformity coefficient in percent, X is the depth (or volume) of water in each of the equally spaced catch containers in mm or ml, and x is the mean depth (volume) of the catch (mm or ml).

28.2.2 Low-Quarter Distribution Uniformity

It is defined as the ratio of the average infiltration in the lower quarter to the average infiltration over the entire field

$$DU = 100 \left(\frac{V_p}{V_t} \right) \quad (28.9)$$

Where,

DU is the distribution uniformity (%) for the lower quarter of the field, V_p is the mean application volume (m^3) or depth in the lower quarter, and V_t is the mean application volume (m^3) or depth for the whole field.

28.3 Deep Percolation Ratio and Tail Water Ratio

The Deep Percolation Ratio (DPR) and Tail Water Ratio (TWR) were developed to take into account the losses occurring via deep percolation and runoff in surface irrigation methods.

28.3.1 Deep Percolation Ratio

It is the ratio of amount or depth of deep percolation to the amount or depth of applied water and is expressed as:

$$DPR = \frac{V_{DP}}{V_f} \times 100 \quad (28.10)$$

Where,

V_{DP} = amount of water lost to deep percolation

V_f = amount of water delivered to the field

28.3.2 Tail Water Ratio

It is the ratio of amount or depth of runoff to the amount or depth of applied water and is expressed as:

$$TWR = \frac{V_{ro}}{V_f} \times 100 \quad (28.11)$$

Where,

V_{ro} = amount of runoff from field.

28.4 Overall Project Efficiency

It is the ratio between the average depth of water stored in the root zone during irrigation and water diverted from the reservoir. It is mathematically expressed as:

$$E_o = \frac{V_s}{V_d} \times 100 \quad (28.12)$$

Where:

E_o = overall efficiency (%)

V_s = Water stored in the root zone (cm)

V_d = Water diverted from the reservoir (cm)

Or

$$E_o = \frac{E_a}{100} \times \frac{E_c}{100} \quad (28.13)$$

Example 28.1:

Compute the reservoir storage efficiency for a 24 hr period when 3795 lit/min of water are diverted from reservoir based on the following data,

Reservoir inflow rate = 4425 lit/min and $\Delta S = 415 \text{ m}^3$.

Solution:

We know,

$$E_r = 100 \left(\frac{V_o + \Delta S}{V_i} \right)$$

Where,

$$V_i = 4425 \text{ lit/min} = \frac{4425 \times 60 \times 24}{1000} = 6372.0 \text{ m}^3$$

$$V_o = 3795 \text{ lit/min} = \frac{3795 \times 60 \times 24}{1000} = 5464.8 \text{ m}^3$$

$\Delta S = 415 \text{ m}^3$

$$E_r = 100 \left(\frac{5464.8 + 415}{6372.0} \right) = 92.27\% \text{ Ans.}$$

Example 28.2:

A stream of 140lps was diverted from a canal and 110 lps were delivered to the field. An area of 1.65 ha was irrigated in eight hours. The effective depth of root zone was 1.85 m. The runoff loss in the field was 435 m³. The depth of water penetration varied linearly from 1.85 m at the head end of the field to 1.25 m at the tail end. Available moisture holding capacity of the soil is 25 cm/m depth of soil.

Determine the water conveyance efficiency, water application efficiency, water storage efficiency and water distribution efficiency, irrigation was started at a moisture extraction level of 50 percent of the available moisture.

Solution:

1. Water conveyance efficiency, $E_c = 100(V_f/V_d) = 100(110/140) = 78.5\%$

2. Water application efficiency, $E_a = 100(V_s/V_f)$

Water delivered to the field = $(110 \times 60 \times 60 \times 8) / 1000 = 3168 \text{ m}^3$

Water stored in the root zone = $3168 - 435 = 2733 \text{ m}^3$

$$= (2733 \times 100) / 3168 = 86.26\%$$

3. Water storage efficiency

We Know, $E_s = 100 (V_s/V_{rz})$

Now, Water holding capacity of the root zone = $20 \times 1.85 = 37 \text{ cm}$

$$\text{Moisture required in the root zone} = 37 - \frac{37 \times 50}{100} = 18.5 \text{ cm}$$

Or
$$= \frac{18.5}{100} \times 1.65 \times 10,000$$

$$= 3052.5 \text{ m}^3$$

$$\text{Water storage efficiency} = \frac{3052.5}{3168} \times 100$$

$$= 96.3\%$$

4. Water distribution efficiency

We know,
$$Ed = \left(1 - \frac{\bar{y}}{\bar{d}}\right) \times 100$$

$$\bar{d} = \frac{1.85 + 1.25}{2} = 1.55 \text{ m}$$

Numerical deviation from depth of penetration

$$\text{At upper end} = 1.85 - 1.55 = 0.3$$

$$\text{At lower end} = 1.55 - 1.25 = 0.3$$

$$\text{Average numerical deviation} = \frac{0.3+0.3}{2} = 0.3$$

$$Ed = \left(1 - \frac{0.3}{1.55}\right) \times 100 = 80.6\%$$



LESSON 29 Surface Irrigation

29.1 Introduction

Surface irrigation is the oldest and widely used method of water application to agricultural land. The term 'surface irrigation' refers to a broad class of irrigation methods in which water is distributed over the field by overland flow. A flow is introduced at upper edge of the field which covers the field gradually. The water front advance is dependent largely on the differences between the inflow onto the field and the accumulating infiltration into the soil. In addition, other factors such as field slope, surface roughness, and the geometry or shape of the flow cross-section also influence advance rate. In this chapter the components and hydraulics of irrigation will be discussed.

29.1.1 Physical Systems

The primary purpose of the physical system is to supply water to an area for crop production and it consists of four subsystems as shown in Fig 1 and Fig 2. These are:

1. The water supply subsystem
2. The water delivery subsystem
3. The water use subsystem
4. The water removal subsystem

1. Water Supply Subsystem

The sources of water for supply to the water supply subsystem include both surface and subsurface water resources. The water supply sub-system constitute mainly reservoirs, river diversions, ponds, tanks, open wells and pumping of groundwater.

2. Water Delivery Subsystem

The function of water delivery sub-system is to convey good quality water in adequate quantities from the source to the fields through main canal, distributaries, minors and field channels. The flow in the delivery system is regulated using a number of structures (gate, turnouts, valves etc.). Water delivery system is designed to reduce seepage and erosion.

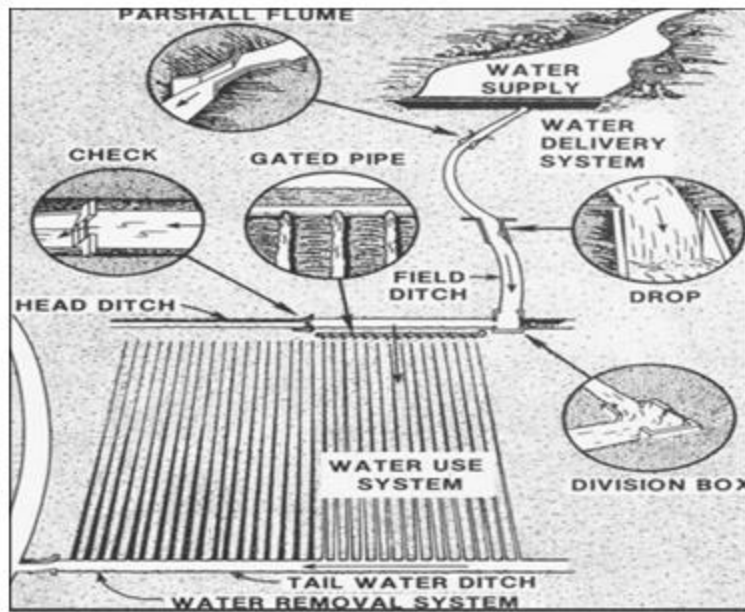

Fig.29.1. Typical irrigation physical system components.

(Source: Chapter_two_Surface_Irrigation%20pdf-2)

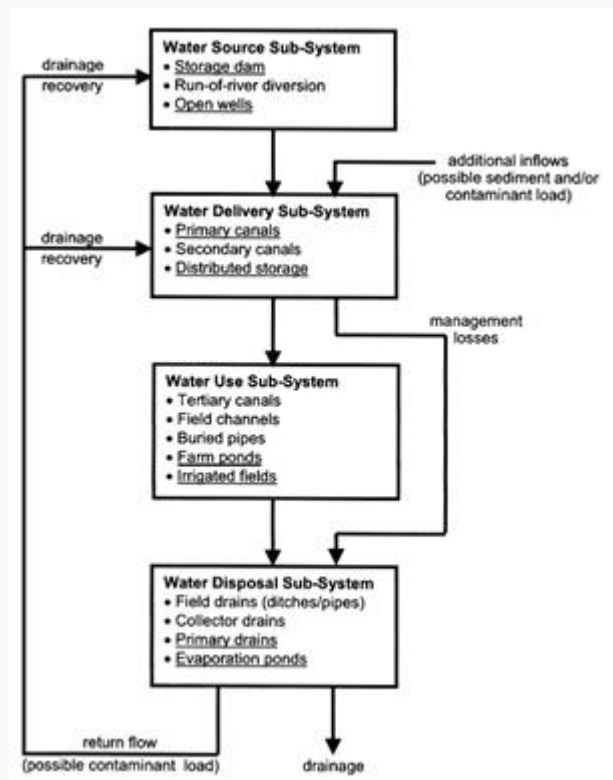

Fig.29.2. Flowchart showing the different subsystems and their interconnection.

3. Water Application Subsystem

The output from water delivery sub-system is the input for water application sub-system. Water application system deals with on farm irrigation. Water available at field is applied using either surface or pressurised irrigation methods. The main function of this system is to distribute the desired amount of

water to field to provide favourable environment for crop production while ensuring minimum environmental damage.

4. Water Removal Subsystem

This sub-system is used for removal and disposal of surface and sub- surface waters from the fields to facilitate agricultural operations and crop growth.

The functions of this subsystem are as follows:

- To provide proper root aeration by lowering ground water table.
- To maintain appropriate salinity levels within the soil profile.
- To dispose (remove) excess irrigation or rainwater from the field.

29.2 Surface Irrigation Process (Hydraulic Phases)

In surface irrigation, water is applied directly to the soil surface from a channel located at the upper reach of the field. Gravity provides the major driving force to spread water over the irrigated field. Once distributed over the surface of the field and after it has entered the soil, water is often redistributed by forces other than gravity. Generally, in a surface irrigation event four distinct hydraulic phases can be discerned, as illustrated graphically in Fig. 29.3:

1. Advance Phase

The time interval between the start of irrigation and arrival of the advancing (wetting) front at the lower end of the field is known as advance phase. Rate of advance depends on the factors like inflow, field slope, soil intake rate and surface roughness.

2. Ponding (Wetting Storage Or Continuing) Phase

The period of time between the end of the advance phase and the cutoff of inflow is known as ponding phase or wetting phase. The term “wetting phase” is usually used for furrow and border where tail water runoff can occur, whereas “ponding” is the preferred term for basin irrigation (no tail water runoff). The wetting or ponding phase will not be present if the inflow is terminated before the advance phase is completed, a typical situation in borders and basins, but a rarity in furrows.

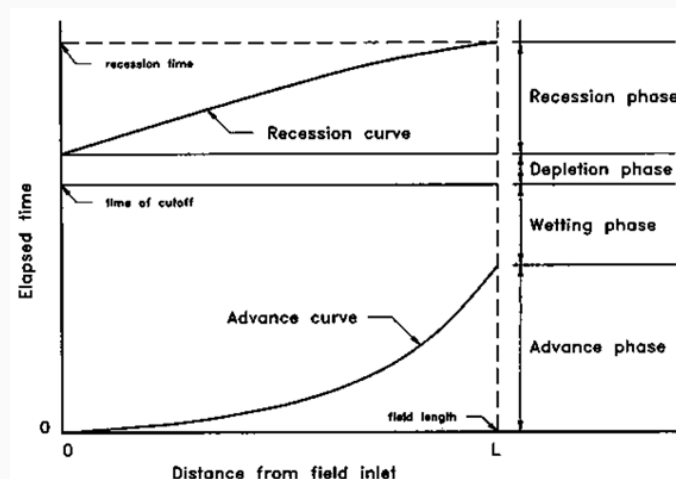

Fig.29.3. Time-space trajectory of water during a surface irrigation showing its advance, wetting, depletion and recession phases.

3. Depletion (Vertical Recession) Phase

The time interval between the cut-off of the supply and the complete disappearance of water from the inflow end is called the depletion phase.

4. Recession (Horizontal Recession) Phase

The time required the water to recede from all points in the channel, starting from the end of the depletion phase is known as recession phase. Recession continues until either the front reaches the end of the field. Like advance phase, the rate of recession also depends upon the inflow rate, the slope of the field, the infiltration capacity of the soil, and hydraulic roughness. Recession will tend to be most rapid when the inflow rate is low, the field slope is steep, the infiltration capacity is high, and/or the hydraulic roughness is small.

- Cut off time (t_{co}): Cumulative time since the initiation of irrigation until the inflow is terminated.
- Cutback irrigation: The practice of using a high unit discharge during the advance phase and a reduced one during the wetting or ponding phase to control runoff.

The time and space references are shown in Fig.3 are relatively standard. Time is cumulative since the beginning of the irrigation, distance is referenced to the point of the field upto which water has entered or is receding from. The advance and recession curves are therefore trajectories of the advancing and receding water fronts. The period defined between the two curves at any distance is the time water is on the surface, at that point, and therefore is also the time during water is infiltrating into the soil (known as the infiltration opportunity time or intake opportunity time).

29.3 Factors Affecting Performance of Surface Irrigation

The performance of a surface irrigation system is dependent on many factors, which are shown in the following functional relationship; it has of a paramount importance to discuss each one of them in detail.

$$P = f(I, S_0, n, Z_r, G, q_0, L, t_{co}) \quad (29.1)$$

Where, P = performance of surface irrigation

I = symbolizes the infiltration parameters

S_0 = channel bed slope

n = hydraulic resistance

G = symbolizes geometry parameters

Z_r = required amount of application

q_0 = unit flow rate at the head end of the channel

t_{co} = time of cut off

L = furrow length

29.3.1 Unit Flow Rate (q_0)

Inlet flow rate is one of the key variables in influencing the outcome of an irrigation event. It affects, the rate of advance to a significant degree and also recession to a lesser extent. Thereby having a significant effect on uniformity, efficiency and adequacy of irrigation, it should not be too high as to cause scouring and should not be too small as otherwise the water will not advance to the downstream end.

29.3.2 Cut of Time(t_{co})

Cut off time is the time at which the supply is turned off, measured from the onset of irrigation. The ideal time of cutoff occurs when the infiltrated depth in the least-watered portion of the field is equal to the irrigation requirement. The most important effect of cutoff is reflected on the amount of losses, deep percolation and surface runoff, and hence efficiency and adequacy of irrigation.

29.3.3 Channel Length(L)

The length of a basin or border or a furrow should be determined considering the soil type, method of irrigation and from previous studies to estimate advance and recession over the length of the channel, the resulting distribution of infiltrated water, volume of runoff and the performance indices. There always exist a certain optimal channel length that would minimize irrigation water losses yet results in acceptable levels of adequacy and uniformity.

29.3.4 Required Amount of Application (Z_r)

This parameter represents the amount of water that needs to be stored in the crop root zone per irrigation to sustain normal crop growth. The crop type, stage of growth, presence or absence of shallow water table, and limiting soil horizons (such as hard pans), among other things, determine the effective crop root depth. Soil type is the factor that determines how much water can be stored per unit depth of soil. These factors, along with the climatic conditions of an area should be considered to determine the required amount of application).

29.3.5 Manning's Roughness Coefficient (n)

A parameter in Manning's equation, known as the Manning's n, is used as a measure of the resistance effects that flow might encounter as it moves down the furrow, border or basin, which is in fact a representation, in lumped form, of the effect of the roughness of the physical boundaries of the flow and cultivation practices. The Manning's n has a pronounced effect on the hydraulics of the surface irrigation and hence on the efficiency.

29.3.6 Channel Bed Slope (S_0)

The bed slope of a furrow or a border or a basin needs to be known in order to estimate maximum non-erosive flow rates. Bed slope is the average slope in the direction of irrigation and is an easy parameter to measure. For borders and furrows bed slope should not be too high to cause scouring and must not too low so as to result in a very slow advance with the end outcome being an inefficient irrigation.

29.3.7 Infiltration Parameter

Knowledge of the infiltration characteristics of the soil is critically important for evaluation, design or management of a surface irrigation system, without which it is very difficult to accurately judge system performance, application efficiency and uniformity. Therefore, infiltration parameter, (in case of the modified Kostikov infiltration function $k, a,$) and should be determined prior to the actual design stage.

29.4 Intake Opportunity Time

Time interval during which water is available to enter the soil between the time it arrives at a point during the advance phase and departs during recession. It is the vertical distance between the advance and recession curves. For irrigation uniformity to be high opportunity time must be same throughout the field.



LESSON 30 Surface Irrigation Methods

30.1 Surface Irrigation Methods

Surface irrigation methods refer to water application through gravity flow to the cultivated land. Water is applied either the entire field (uncontrolled flooding) or part of the field (furrows, basins, border strips). For efficient application of water it is important to select the method of irrigation which best suits the crop and soil characteristics of the field. In doing so it may be essential to use more than one method of irrigation in an area or a given farm (shown in Fig. 30.1).

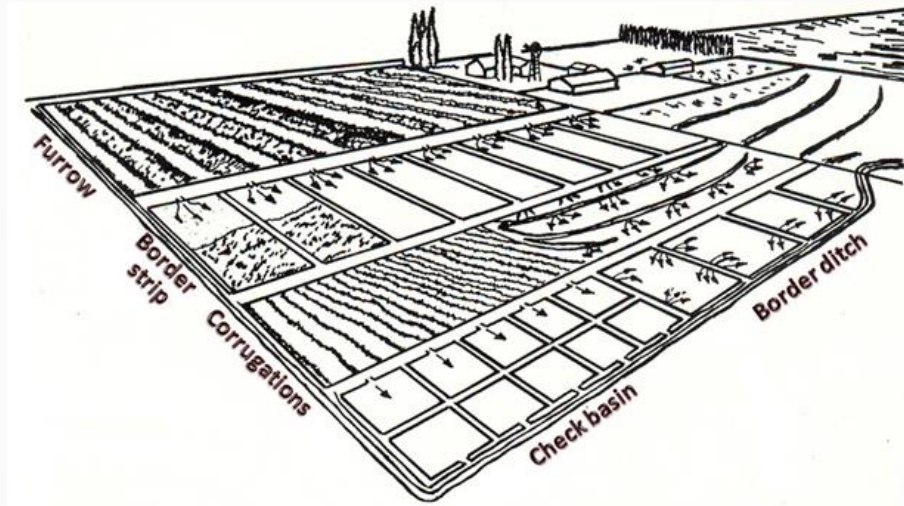

Fig. 30.1. Different methods of irrigation on a farm.

The factors which determine the suitability of any method of irrigation are local conditions (soil type - its permeability & water storage capacity; land topography, climate, water availability & water quality), crop type, type of technology, previous experiences, required labour inputs etc. Good yield of crops can be obtained from irrigated land only if the water is applied judiciously to meet the needs of the plant. Fig. 30.2 provides a brief classification of surface irrigation methods.

Irrigation Method can be broadly classified into three categories.

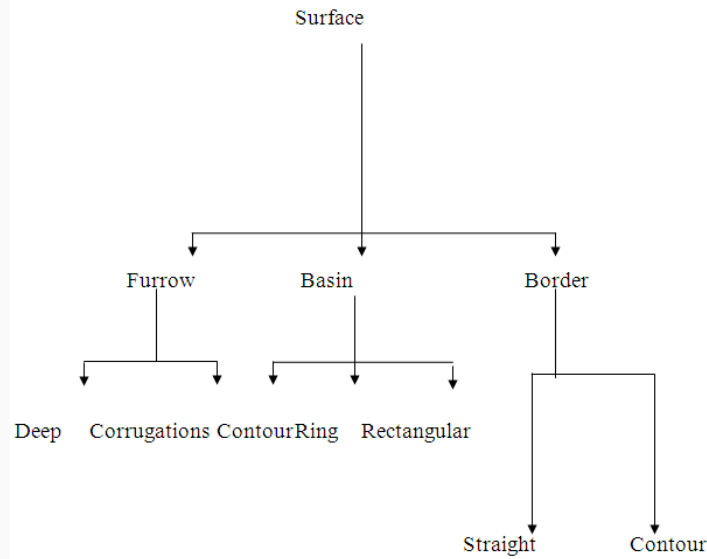

Fig.30.2. Classification of surface irrigation methods.

Surface irrigation method can also be divided into the following two groups

1. Uncontrolled Surface Flooding
2. Controlled Surface Flooding

30.1.1 Uncontrolled Surface Flooding or Flooding

It consists of applying water to the field without any bunds to guide the flow of water wetting the soil surface completely. Generally it is practiced only when irrigation water is abundant and where land levelling is not followed (shown in Fig 30.3). Sometimes it is also adopted in the initial stages of land development. This method is most commonly used for irrigation of crops sown by broadcasting method viz., rice, low value pastures, lawns and millets etc.



Fig.30.3.Wild flooding.

Advantages:

1. No land levelling & land shaping required
2. Low labour and land preparation costs
3. Less skill required by irrigator

Disadvantages:

1. Applied water is lost by deep percolation & surface runoff
2. Low irrigation application efficiency

30.1.2 Controlled Surface Flooding

30.1.2.1 Basin Irrigation

In this method the field is divided into square or rectangular plots of 4 to 4000 m² guided by bunds on all the sides (Fig. 30.4). In some cases (ring basin) the plot may also be circular. This method is usually practiced in nearly level led lands and hence the depth of wetting is more uniform in this method. However, it is particularly useful on fine textured soils with low infiltration and percolation ratesso that the water is retained on the surface and in the root zone for a longer period of time. The field channels supply water to each basin, during which the basins are filled to desired depth and water is retained until it infiltrates into the soil. This method is most commonly used for irrigating crops like groundnut, finger millet, sorghum, vegetable crops etc. Basin irrigation is generally not suited to crops which cannot stand in wet or waterlogged conditions for periods longer than one day. These are generally tuber and root crops like potato, cassava beet and carrot. Basins are also used for leaching salts below the crop root zone depth by percolating water in the reclamation of saline soils.

Basins are mainly of two types:

1. Check basin (square or rectangular in shape)
2. Ring basin (circular in shape)

30.1.2.1.1 Check Basin

The size of check basins may vary from one meters square, used for growing vegetables and other intensive cultivation, to as large as one or two hectares or more, used for growing rice under wet land conditions. The shape and design of basins generally depends on the topography of the area it is being designed for. Check basins can be further divided into rectangular and contour types.

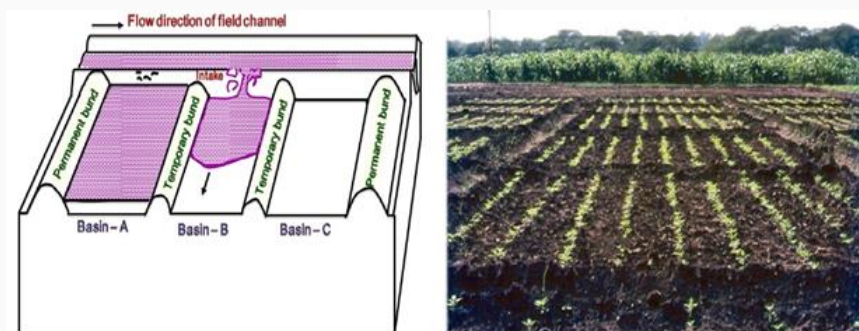

Fig.30.4.Check basin method of irrigation.

Advantages:

1. Water can be applied uniformly.
2. Even small streams can be used for irrigation of crops efficiently.
3. Simple and cheap when equipment is used for constructing bunds

Disadvantages:

1. Unless the land is levelled, distribution of water in plot is uneven.
2. Considerable area is lost under field channels and bunds i.e. nearly 30% of area.
3. Bunds interfere in working of inter-cultivation equipment
4. More labour is required for field layout and irrigation

30.1.2.1.2 Ring Basin Method

This method is a modification of check basin method and is suitable for sparsely grown orchard crops and cucurbits (Fig. 30.5). In this method a circular bund is constructed around each tree/plant or group of plants/trees to create a basin for irrigation. These basins are suitably connected to irrigation conveyance channels in such a way that either each basin is irrigated separately or a group of basins are irrigated at once by flowing water from one basin to another through inter-connections.



Fig.30.5.Ring basin method of irrigation.

Advantages:

1. High irrigation application efficiency can be achieved with properly designed system
2. Unskilled labour can be used

Disadvantages:

1. High labour requirement
2. Bunds restrict use of modern machinery in the field
3. Limited to relatively uniform lands

30.1.2.2 Border Irrigation Method

In case of border irrigation, the field is divided into a number of long parallel strips, generally 5 to 15 m in width and 75 to 300 m in length separated by small border ridges or low dykes of about 15 cm (Fig. 30.6).

Irrigation water is released into each strip connected directly to irrigation channel situated at the upstream end of the border strip. The sheet of water advances towards the downstream (Fig.30.6). After sufficient water is applied to one strip, the irrigation stream is turned into another strip. A specific requirement in border irrigation is that the longitudinal slope must be uniform, and the transverse slope must be zero or negligible ($< 0.03\%$). This method is suitable for irrigating a wide variety of close growing crops such as wheat, barley, groundnut, bajra and berseem.

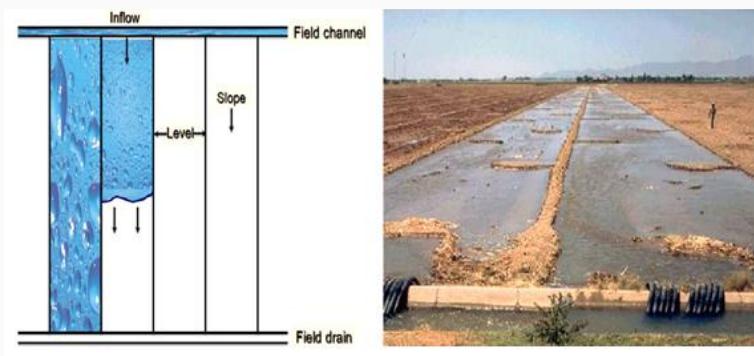

Fig.30.6.Border irrigation method.

Two types of borders are formed:

1. Straight Border

These borders are formed along the general slope of the field. These are preferred when fields can be levelled or be given a gentle slope economically.

2. Contour Border

These are formed across the general slope of the field and are preferred when land slope exceeds the safe limits. Based on the management strategy adopted, borders can be grouped into three major categories which are fixed flow, cutback and tail water reuse.

Advantages:

1. Large water streams can be used safely
2. Provides uniform wetting of soil profile
3. Low labour requirement

Disadvantages:

1. Requires relatively large water streams for quick advance of water to minimize deep percolation losses at the upper end of the border strip.
2. Wastage of water by deep percolation in coarse textured soils.

30.2 Furrow Irrigation Method

Furrow irrigation system is primarily used for vegetables. Furrows are sloping channels dug in the soil with the crops being planted on the ridges. It has advantage that water is applied only in furrows instead of being applied on the whole field. This saves water and at the same time the plant does not come in direct contact with water which is an added advantage as some plants, like vegetable crops, are very sensitive to ponded water. Infiltration occurs laterally and vertically through the wetted perimeter of the furrow thus the root zone of the crops gets the desired moisture.

On the basis of their alignment furrows may be classified into straight furrows (Fig30.7) and contour furrows (Fig30.8).

Based on their size and spacing furrows may be classified as deep furrows and corrugations. In general, small plants need small furrows; like vegetables need furrows of 7.5 to 12.5 cm depth while some row crops like orchards need much deeper furrows. Corrugation irrigation consists of running water in small furrows called corrugation which direct the flow down the slope. Corrugations (Fig 9) are V-shaped or U-shaped channels about 6 to 10 cm deep, spaced 40 to 75 cm apart.

It is commonly used for irrigating non-cultivated crops like small grains and pastures growing on steep slopes.

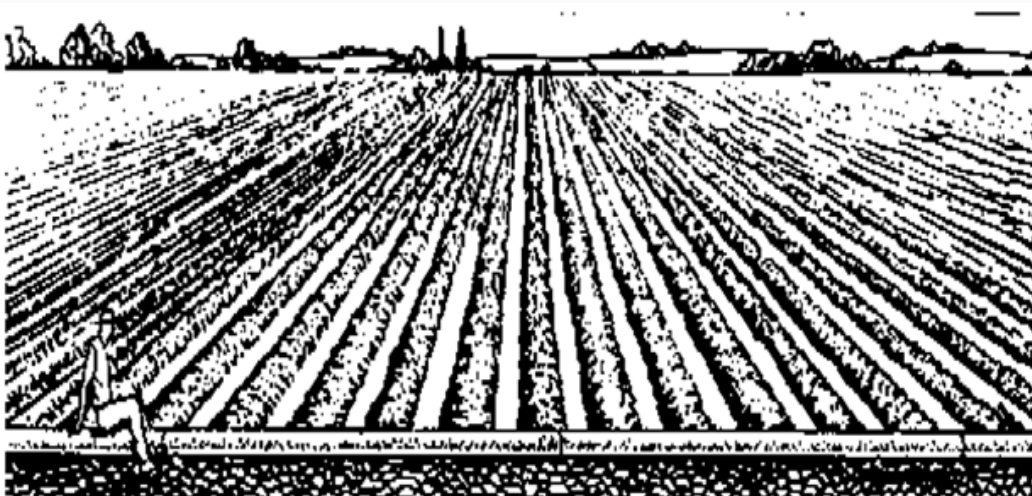

Fig.30.7. Straight furrow. (Source: Furrow irrigation configurations (after USDA-SCS, 1967))



Fig.30.8. contour furrow irrigation system. (Source: Furrow irrigation configurations (after USDA-SCS, 1967))

Advantages:

1. Fairly high irrigation application efficiency among surface irrigation methods
2. Furrows serve as field drains in areas of heavy rainfall
3. Low evaporation losses

Disadvantages;

1. Not suitable in coarse textured soils with high infiltration rates
2. Possibility of intra-furrow soil erosion
3. Labour intensive

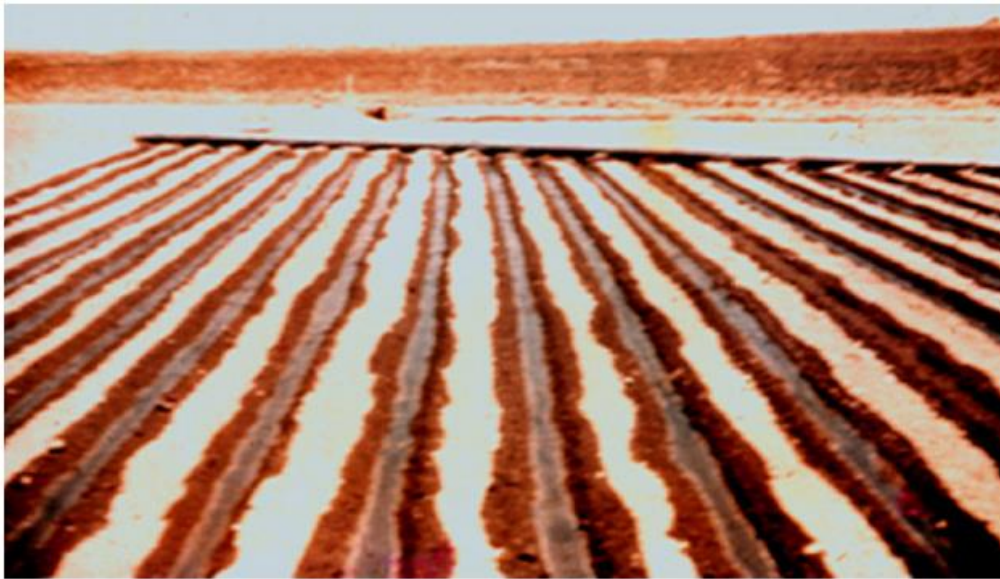

Fig.30.9.Corrugation system.

30.3 Criteria for Surface Irrigation Method Selection

The deciding factors for the suitability of any surface irrigation method are natural conditions (slope, soil type), type of crop, required depth of application, level of technology, previous experiences with irrigation, required labour input. Moreover the irrigation system for a field must be compatible with the existing farming operations, such as land preparation, cultivation, and harvesting practices.

The following outline lists a number of factors of the environment which will have a bearing on the evaluation of irrigation system alternates and the selection of a particular system. Not all points will be equally significant in each case, but the outline can serve as a useful checklist to prevent overlooking important factors:

30.3.1. Physical Factors

Crops and cultural practices are of prime importance while selecting an irrigation system. Hence, proper knowledge of agronomic practices and irrigation intervals is necessary for proper use of irrigation water and to increase water use efficiency.

The following physical factors need to be given due consideration.

Crop Parameters

- Tolerance of the crop to soil salinity during development and maturation.
- Magnitude and temporal distribution of water necessary for maximum production.
- Economic value of crop.
-

Soils Parameters

- Texture and structure; infiltration rate and erosion potential; salinity and internal drainage, bearing strength.
- Sandy soils have a low water storage capacity and a high infiltration rate. Under these circumstances, sprinkler or drip irrigation are more suitable than surface irrigation. Clay soils with low infiltration rates are ideally suited to surface irrigation.
- High intake characteristic require higher flow rate to achieve the same uniformity and efficiency.
- Crusting of soil and its effects on infiltration
- Reclamation and salt leaching- basin irrigation
- Spatial variability

Field Topography

- Uniform, mild slopes facilitate surface irrigation.
- Location and relative elevation of water source – water diversion, pumping
- Acreage in each field
- Location of roads, natural gas lines, electricity lines, water lines and other obstructions.
- Shape of field – non rectangular shapes are more difficult to design for
- Field slope – steepness & regularity
- Furrow & borders 2-6% maximum

Climate and Weather Conditions

- Under very windy conditions, drip or surface irrigation methods are preferred.
- Scalding (the disruption of oxygen-carbon dioxide exchange between the atmosphere and the root)& the effect of water temperature on the crop at different stages of growth -risk in basin irrigation.
- Irrigation with cold water early in the spring can delay growth, whereas in the hot periods of the summer, it can cool the environment – both of which can be beneficial or detrimental in some cases.

Water Supply

The following parameters are important:

- Source and delivery schedule
- Water quantity available and its reliability
- Water quality
- Water table in case of ground water source.

Availability and Reliability of Electricity

Availability and reliability of energy for pumping of water is of much importance.

30.3.2 Economic Considerations

The following points need to be considered while selecting irrigation alternatives.

- Capital investment required and recurring cost.
- Credit availability and interest rate.
- Life of irrigation system, efficiency and cost economics.

30.3.3 Social Considerations

- The education and skill of common farmers and labours available for handling the irrigation system
- Social understanding of handling of cooperative activities and sharing of water resources
- Legal and political considerations, local cooperation and support, availability and skill of labour and level of automatic control



LESSON 31 Surface Irrigation Hydraulics

31.1 Flow Regimes and Models

The process of surface irrigation combines the hydraulics of surface flow in the furrows or over the irrigated land with the infiltration of water into the soil profile.

The flow is unsteady and varies spatially. The flow at a given section in the irrigated field changes over time and depends upon the soil infiltration behaviour.

Performance necessarily depends on the combination of surface flow and soil infiltration characteristics.

The Equations describing the hydraulics of surface irrigation are the continuity and momentum equation. These equations are known as the St.Venant equation. In general, the continuity equation expressing the conservation of mass, can be written as:

The momentum equation expressing the dynamic equilibrium of the flow process is:

Where, y - Depth of flow (m)

t - Time from beginning of irrigation (sec)

v - Velocity of flow as $f(x, t)$ (m/s)

x - Distance along the furrow length (m)

I - Infiltrations rate as $f(x, t)$ (m/s)

g - Acceleration due to gravity (m/s^2)

S_o - Longitudinal slope of furrow (m/m)

S_f - Slope of energy grade line (friction slope) in (m/m)

A - Cross-sectional area as $f(x, t)$ (m^2)

Q - The discharge (m^3/s)

These equations are first-order nonlinear partial differential Eq. without a known closed-form solution. Appropriate conversion or approximations of these equations are required. So, several mathematical simulation models (Full hydrodynamic, zero-inertia, kinematic-wave and volume-balance) have been developed, however, among them volume balance models are more commonly used for design. The volume balance models consider only the continuity eq. (31.1) and ignore the momentum eq. (31.2).

Empirical Infiltration Equation

Infiltration rate affects surface flow as well as performance of irrigation. Several expressions have been proposed for expressing infiltration rate as a function of elapsed time.

31.1.1 The Lewis- Kostiakov Equation

A widely used empirical expression, for design of surface irrigation system, was originally proposed by Lewis (1937) but was erroneously attributed to Kostiakov.

Fig.31.1. Infiltration rate and Cumulative infiltration vs. elapsed time.

(Source: <http://www.fao.org/docrep/t0231e/t0231e05.htm>)

$$\text{Cumulative: } Z = kt^a \quad (31.3)$$

$$(31.4)$$

Where, Z = the cumulative depth of infiltration or the volume of water per unit soil surface area

t = elapsed time

k and a = empirical parameters

i = the infiltration rate

Disadvantages of the original Lewis- Kostiakov Equation

- It doesn't account for different initial soil water contents.
- For long infiltration times it erroneously predicts zero rate.

Infiltration rate never becomes zero instead it reaches a steady state or constant rate condition after a long time. Therefore, the above Eq. was modified to reflect the steady state infiltration rate which may occur during surface irrigation system with longer set times.

31.1.2 Modified Kostiakov Equation

The later problem can be fixed by adding a parameter representing a final infiltration rate (constant infiltration rate) to the previous Eq. (31.1) and (31.2). So the equation becomes:

$$Z = kt^a + f_o t \quad (31.5)$$

$$(31.6)$$

Because of its simplicity, this model is frequently used in agricultural irrigation studies.

- Parameters k and a can be estimated by plotting the infiltration rate (I) or cumulative infiltration (Z) against time on log-log paper and fitting a straight line.

31.2 Volume Balance Concept

Volume balance equation

$$(31.7)$$

Fig. 31.2. Approximation of sub-surface and surface profiles during volume-balance.

Also assume that advance characteristics follow a power function

$$x = pt^r \quad (31.8)$$

Power Advance Volume Balance Model

Using power advance, Elliott and Walker (1982) gave the following solution to the volume balance considering Modified Kostiakov eq:

$$(31.9)$$

Where, Q_0 = inflow rate, m^3/min

A_0 = cross sectional area of flow inlet, m^2

x = the advance distance, m

t = the advance time to distance x since beginning of irrigation, min

k and a= coefficients of modified Kostikov's Eq.

f_0 = basic infiltration rate, $m^3/m/min$

p and r =empirical parameters of advance curve

σ_y =surface storage factor and generally it has a value of 0.77

σ_z is defined as:

$$(31.10)$$

31.3 Advance Time Determination

Water will be distributed within a surface-irrigated field non-uniformly due to the differential time required for water to cover the field. To account for these differences in the design procedures, it is necessary to calculate the advance trajectory (curve).

It is first necessary to describe the flow cross section using two of the following functions:

$$A = a^1 y^{a2} \quad (31.11)$$

And

$$WP = b_1 y^{b2} \quad (31.12)$$

Or as a simpler substitute,

$$AR^{0.67} = p_1 A^{p2} \quad (31.13)$$

Where, A = cross sectional flow area, m^2

R = hydraulic radius, m

y = flow depth, m

WP = wetted perimeter, m

$a_1, a_2, b_1, b_2, p_1, p_2$ = empirical shape coefficients

For border and basin systems, a_1, a_2, b_1 and p_1 are equal to 1. The value of b_2 is 0.0 and p_2 is 3.3333.

The next step is to determine the cross-sectional flow area at the field inlet . For sloping fields, this can be accomplished with the Manning Eq. as follows:

$$A_0 = \left(\frac{Q_0 n}{60 \rho_1 S_0^{0.5}} \right)^{1/\rho_2} \quad (31.14)$$

Where, Q_0 = Field inlet discharge, $m^3/min/unit\ width$

n = Manning roughness coefficient

S_0 = field slope

The design input data required at this point are , field length (L), S, and . This information can be used to solve the volume balance Eq. for the time of advance,

$$Q_0 t_L - 0.77 A_0 L - \sigma_z k t_L^a L - \sigma'_z f_0 t_L L = 0 \quad (31.15)$$

Where, $\sigma_z = \frac{a+r(1-a)+1}{(1+a)(1+r)}$ and $\sigma'_z = \frac{1}{r}$

Computation Steps of Advance Time

1. The first step is to compute the flow cross-sectional area
2. Make an initial estimate of power advance exponent (r) and label this value , usually setting , = 0.1 to 0.9 are good initial estimates. Then, a revised estimate of r is computed and compared below.
3. Calculate the subsurface shape factors
4. Calculate the time of advance by Newton- Raphson technique.

$$T_1 = \frac{5(A_0 L)}{Q_0}$$

- Assume an initial estimate of t_L as T_1 , Then
- Compute a revised estimate of t_L (say T_2) as,

$$T_2 = T_1 - \frac{Q_0 T_1 - 0.77 A_0 L - \sigma_z k T_1^a L - \frac{T_1 f_0 L}{1+r_1}}{Q_0 - \frac{ak\sigma_z L}{T_1^{1-a}} - \frac{T_1 f_0 L}{1+r_1}} \quad (31.16)$$

- Compare the initial and revised of. If they are within about 0.5 minutes or less, the analysis proceeds to step 4. If they are not equal, let $T_1 = T_2$ and repeat steps b through c. It should be noted that if the inflow is insufficient to complete the advance phase in about 24 hours, the value of is too small or the value of L is too large and the design process should be restarted with revised values. This can be used to evaluate the feasibility of a flow value and to find the inflow.
5. Compute the time of advance to the field midpoint, using the same procedure as outlined in Step 4.
 - The half-length (0.5L) is substituted for 'L' and '' for ''.
 - Volume balance Eq. is used with half length (0.5L) to find an appropriate value of
 6. Compute a revised estimate of 'r' say

$$r_2 = \frac{\log 2}{\log \frac{t_L}{t_{0.5L}}} \quad (31.17)$$

7. Compare the initial estimate with the revised estimate

- If the difference between the two values is less than 0.0001 (error criterion), the procedure for finding is concluded.
- If not then is replaced with and steps 3-6 are repeated until the prescribed error criterion is satisfied.

31.4 Intake Opportunity Time Determination

The basic mathematical model of infiltration utilized in the intake opportunity time determination is the Kostiakov- Lewis relation:

$$Z = kt^a + f_0 t \quad (31.18)$$

Where, Z- required infiltrated volume per unit length, m³/m

(per furrow or per unit width are implied)

t- The design intake opportunity time, minute

a -The constant exponent

k - The constant coefficient, m³/min^a/m of length

f₀ - the basic intake rate, m³/min/m of length

In order to express intake as a depth of application, Z must be divided by the unit width. For furrows, the unit width is the furrow spacing, w, while for borders and basins it is 1.0. Values of k, a, f₀ and w along with the volume per unit length required to refill the root zone, Z_{req}, are design input data.

The volume balance design procedure requires that the intake opportunity time associated with be known. This time, represented by can be obtained from modified Kostiakov Eq. using the Newton-Raphson procedure.

A step by step procedure for the calculation of intake opportunity time is given below:

1. Make an initial estimate of and level it

2. Compute a revised estimate of ,

$$T_2 = T_1 - \frac{Z_{req} - kT_1^a - f_0 T_1}{-akT_1^{1-a} - f_0} \quad (31.19)$$

3. Compare the values of the initial and revised estimates of () by taking their absolute difference. If they are equal to each other or within an acceptable tolerance of about 0.5 minutes, the value of is determined as the result. If they are not sufficiently equal in value, replace() and repeat steps 2 and 3.



LESSON 32 Furrow Irrigation System

As discussed in the previous lecture on surface irrigation methods, furrow irrigation is a class of surface irrigation methods in which water is field is divided into ridge and furrows. The crop is grown on the ridge whereas irrigation water is applied to the furrow.

32.1 General Adoptability

The adaptability of furrow irrigation to a specific site depends on climate, soils, topography, crops to be grown, and water supply.

32.1.1 Climatic Factors

- Precipitation and wind may affect suitability as well as the design criteria.
- Risk of surface runoff and excessive soil erosion due to excessive precipitation, concentrated runoff in the channels resulting in crop damage from flooding; these conditions must be considered in determining which furrow method is suitable for a given area.

32.1.2 Soil

- Medium to moderately fine-textured soils of relatively high available water holding capacity are desirable
- Intake characteristics should facilitate both lateral and vertical water penetration (Fig. 32.1)
- Furrow irrigation generally is not recommended on soils containing high concentrations of salts.

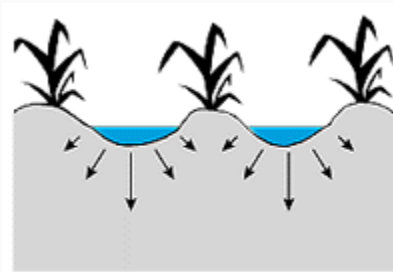

Fig. 31.1. Lateral and vertical water movement during furrow irrigation.

32.1.3 Topography

- The rows can be laid out on a continuous grade.
- The topography must be such that levelling does not expose unproductive soil or that the cost of levelling is not excessive.
- The topography must not be so steep that it exceeds the allowable corrugation grade or prohibits installation of graded contour furrows that meet the design grade and cross-slope criteria.

32.1.4 Crops

- Adapted for nearly all irrigated crops except those grown in ponded water, such as rice.
- Suitable for irrigating crops subject to injury if water covers the crown or stems of the plants.

32.1.5 Water Supply

The quantity and quality of the water supply determines its suitability for use in furrow irrigation.

32.2 Furrow Irrigation Design Consideration

Efficient irrigation by furrow method is obtained by selecting proper combination of spacing, length, slope of furrows, suitable size of the irrigation stream and duration of water application.

32.2.1 Furrow Spacing

Furrows should be spaced close enough to ensure that water spreads to the sides into the ridge and the root zone of the crop, to replenish the soil moisture uniformly.

Table 32.1. Recommended furrow spacing for different soil types, and depths of irrigation for complete wetting

Soil type	Depths of irrigation (m)	Furrow spacing (cm)
Sandy soil	1 to 1.5	50 to 60
Clay soil	1 to 1.5	100 or more

32.2.2 Furrow Length

The optimum length of a furrow is usually the longest furrow that can be safely and efficiently irrigated. Proper furrow length depends largely on the hydraulic conductivity of soil. The length of furrow may be limited by the size and shape of the field.

Table 32.2. Recommended furrow length for different soil types, furrow slopes and depths of irrigation

Furrow slope (%)	Furrows length (m)						
	Slope type						
	Clay	loam			sands		
	Net depth of water application						
	7.5 cm	15cm	5 cm	10 cm	5 cm	7.5 cm	10 cm
0.05	300	400	120	270	60	90	150
0.10	350	440	180	330	90	120	190

0.20	370	470	220	370	120	190	250
0.30	390	500	280	400	150	225	280
0.50	380	500	280	370	120	190	250
1.0	270	400	250	300	90	150	220

32.2.3 Furrow Slope

Furrow slope controls the speed at which water flows down the furrow. A minimum slope of 0.05% is needed to ensure surface drainage. In general, the ranges in slope recommended for borders apply to furrows also.

32.2.4 Furrow Stream

The size of furrow stream usually varies from 0.5 to 2.5 litres per second.

The maximum size of irrigation stream that can be used at the start of the irrigation is limited by considerations of erosion in furrows, overtopping of furrows and prevention of runoff at the downstream end. The maximum non-erosive flow rate in furrows is estimated by the following empirical formula:

$$q_m = \frac{0.60}{s} \quad (32.1)$$

Where,

q_m = maximum non-erosive stream, Lsec⁻¹

s = slope of furrow expressed in percent

The average depth of water applied during irrigation can be calculated from the following relationship:

$$d = \frac{q \times 360 \times t}{w \times L} \quad (32.2)$$

Where,

d = average depth of water applied, cm

q = stream size, Ls⁻¹

t = duration of irrigation, h

w = furrow spacing, m

L = furrow length, m

Problem 32.1:

A non-erosive stream is applied for a period of 15 minutes in a furrow of 80 m long spaced 65 cm apart and having a slope of 0.15 %. Determine the average depth of water applied?

Answer:

In case of furrow irrigation non-erosive stream,

$$q_m = \frac{0.60}{s}$$

Where,

q_m = maximum non-erosive stream, litres per second

s = slope of furrow expressed as a percent

So,

$$q_m = \frac{0.60}{0.15} = 4 \text{ L/s}$$

In a furrow 4lt/s water is applied.

Average depth of water applied, $d = \frac{q \times 360 \times t}{w \times L}$

Where,

d = average depth of water applied, cm

q = stream size, L s^{-1}

t = duration of irrigation, h

w = furrow spacing, m

L = furrow length, m

Now,
$$d = \frac{q \times 360 \times t}{w \times L} = \frac{4 \times 360 \times 0.25}{0.65 \times 80} = 6.92 \text{ cm}$$



LESSON 33 Border Irrigation System

In border irrigation the field is divided into number of graded strips by constructing dikes or ridges. Water is introduced at the upper end and flows as a sheet down the strip. The strips are generally not closed at the end.

33.1 General Adaptability

Border irrigation is suited to all crops that are not damaged by inundation for short periods. It can be used on nearly all irrigable soils but is best suited to soils whose intake rates are neither extremely low nor extremely high.

33.2 Design Considerations

33.2.1 Layout

The border strips are so located that a supply channel or pipeline delivers water to the upper end of the border. It is also suggested that the border strips are constructed parallel to the field boundary to facilitate the intercultural operations. For long fields with soils having high infiltration capacity more than one border strip should be constructed along the entire length of the field. The main factors to be considered during the design of layout are given below:

33.2.2 Water Source Location

It is desirable to choose a water source in the central position of the field to minimize the construction of channel and pipes also keeping in mind the fact that the water source should be in a position to facilitate the gravity flow to the field channels.

33.2.3 Border Strip Width

- Border strip widths suitable for any particular field depend on (1) available stream size (2) amount of cross slope that must be removed, (3) kind of equipment used, and (4) accuracy of land levelling as related to the normal depth of flow expected.
- The width of a border usually varies from 3 to 15 meters, depending on the size of irrigation stream available and the degree of land levelling practicable.

33.2.4 Border Strip Length

Longer border strip are desirable to reduce the labour and other operating costs, however the aspect of uniformity and application efficiency of the border strip should be kept in mind while determining the length of the border. Long border strips are easier to farm than short strips because fewer turns by farm equipment are required. Soil type is the most important aspect which determines the length of the border. Typical border lengths for different soils are given in Table 33.1

Table 33.1. Recommended border length for different type of soil for moderate slopes and small to moderate size irrigation streams

Type of soils	Border length, (m)
Sand	60 to 90
Loamy sand	75 to 150
Sandy loam	90 to 250
Clay loam	90 to 300
Clay	180 to 350

33.2.5 Land Smoothing

Land smoothing increases the efficiency by eliminating any furrows in which the flow might accumulate. Borders with zero cross slopes are preferred for higher irrigation efficiencies however in undulating terrain cross slopes might be present. While levelling the land the topography must be studied carefully to economize the operation by levelling the smaller slopes.

33.2.6 Stream Size

The design stream size should be large enough to spread adequate amounts of water across the length and breadth of the border; however it should be erosive in nature. The design stream size should also result in rates of advance and recession which are essentially equal.

- The size of irrigation stream needed depends on the infiltration rate of the soil and the width of the border strip.
- The depth of water applied to the soil can be regulated by the size of the irrigation stream.

Table 33.2. Some typical values of stream sizes to suit varying soil characteristics and border slopes

Soil Type	Border Slope (%)	Flow per metre width of border strip, litre per second
Sandy soil, infiltration rate 2.5 cm per hour	0.20-0.40	10-15
	0.40-0.65	7-10
Loamy sand, infiltration rate 1.8 to 2.5 cm per hour	0.20-0.40	7-10
	0.40-0.60	5-8
Sandy loam, infiltration rate 1.2 to 1.8 cm per hour	0.20-0.40	5-7
	0.40-0.60	4-6

Clay loam, infiltration rate 0.60 to 0.80 cm per hour	0.15-0.30	3-4
	0.30-0.40	2-3
Clay, infiltration rate 0.20 to 0.60 cm per hour	0.10-0.20	2-4

33.2.7 Irrigation Time

Irrigation time is the infiltration opportunity time. It is calculated from the empirical equations to calculate depth of infiltration noting that the cumulative infiltration should be able to meet the irrigation requirements.

33.2.8 Inflow Time

The inflow time is selected keeping in mind that the desired depth of irrigation be applied in the far end of the border. The inflow time is calculated assuming that the advance and the recession curves are parallel.

33.2.9 Border Ridge Height

- On non-cohesive soils, border ridges with a settled height of more than 20 cm are difficult to construct and maintain without making them excessively wide.
- In addition, where salinity is a problem, salt can accumulate in the ridge crest. The higher the ridge, the more pronounced the salt accumulation is likely to be.

33.3 Design of Border Irrigation SystemAssumptions

- Surface water profiles at time of cutoff (the time at which water inflow is shutoff to the field,) as well as (at the end of depletion and also at the beginning of recession,) are straight lines with end points corresponding to uniform flow conditions (Fig.33.1).
- Depth at the downstream end remains constant during the depletion phase and runoff () occurs at a constant rate.
- During both depletion and recession phases, the sum of infiltration (I) and runoff () remains equal to the pre cutoff unit inflow rate

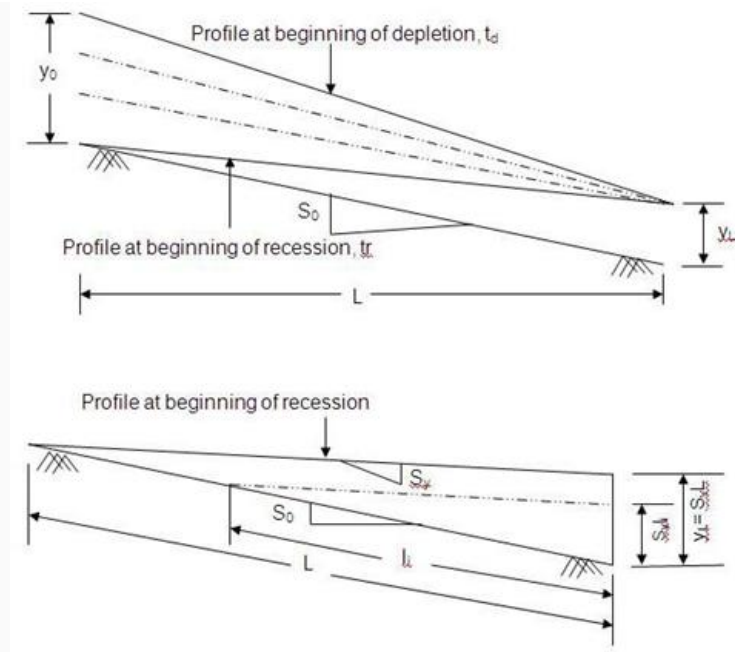

Fig.33.1. Water surface profiles at the beginning of depletion and recession phases.

With these assumption, the time required from the cutoff time to the end of depletion phase, is equal to the time required to remove a triangular volume of length L and height at a constant rate as both infiltration and runoff. It can be expressed as:

$$t_d = T_{co} + \frac{y_0 L}{Q_0} \quad (33.1)$$

At the beginning of recession, it is assumed that the depth changes with distance at uniform rate over the entire length of border, which can be expressed as:

$$S_y = \frac{y_L(t_d)}{L} \quad (33.2)$$

Where is function of at time t_d and can be evaluated as follows:

$$Q_r(t_d) = Q_0 - IL = A \cdot \frac{R^{2/3} S_0^{1/2}}{n} \quad (33.3)$$

For border, $A = y$ and $WP = 1$ and therefore $R = y$ or y and I is the average infiltration rate (m/sec) over the length, L .

S_y becomes

$$S_y = \frac{1}{L} \left[\frac{(Q_0 - IL)n}{60 S_0^{1/2}} \right]^{3/5} \quad (33.4)$$

I can be expressed as a mean of infiltration rate at the upstream end (I_0) and at the downstream end $I(t_d - t_L)$:

$$I = \frac{ak}{2} [t_d^{a-1} + (t_d - t_L)^{a-1}] + f_o \quad (33.5)$$

Walker and Skogerboe (1987) provided an equation for estimating the recession time as follows

$$t_r = t_d + \frac{0.095n^{0.47565} S_y^{0.20735} L^{0.6829}}{r^{0.52435} S_0^{0.237825}} \quad (33.6)$$

A step wise design procedure for free drained borders:

1. Collect information related to field characteristics, soil, crop, and water supply.

Table 33.3. Data required for the design of basin irrigation systems

Sl. no	Design variables	symbols
1	Kostiakov-Lewis infiltration model parameters	a ,k ,f _o
2	Field length	L
3	Field width	W _f
4	field slope	S ₀
5	Mannings roughness coefficient	n
6	Border shape coefficients	ρ ₁ ,ρ ₂
7	Required depth of irrigation	Z _{req}
8	Soil erosive velocity	V _{max}
9	Water supply rate	Q
10	Duration of water supply	T

2. Determine the maximum (Q_{max}) and minimum (Q_{min}) values of unit inflow rate Q₀ (m³/min/m) using below equation (to limit the flow within the non-erosive velocity with sufficient depth to spread laterally):

$$Q_{max} = \left(V_{max}^{\rho_2} \frac{n}{60\rho_1 S_0^{0.5}} \right)^{1/(\rho_2-1)} \quad (33.7)$$

$$Q_{min} = \frac{0.000357LS^{0.5}}{n} \quad (33.8)$$

3. Select unit flow rate) between and in such a way that it results in a set width that contains an even number of borders of satisfactory width and integer number of sets using below equation:

$$W_0 = \frac{Q_T}{Q_0} \quad (33.9)$$

$$N_b = \frac{W_T}{W_0} \quad (33.10)$$

4. Compute the inflow depth at the inlet (m) using below equation:

$$Y_0 = \left(\frac{Q_0 n}{60 S_0^{0.5}} \right)^{0.6} \quad (33.11)$$

5. Compute (min) to satisfy the irrigation requirement from the following equation

$$Z_{req} = kt_{req}^a + f_0 t_{req} \quad (33.12)$$

Where Z_{req} is the required depth of infiltration.

6. Compute the time of advance to the end of border (min) (using procedure described in Lecture 31).

7. Compute the time of recession (minutes since the beginning of irrigation) assuming that the design will meet irrigation requirement at the end of the border

$$t_r = r_{req} + t_L$$

8. Compute the depletion time (min) by using Newton Raphson method as follows:

a) Assume initial guess of t_d as $T_1 = t_r$

b) Compute the average infiltration rate along the border by averaging the rates as both ends at time T_1

$$I = \frac{ak}{2} [T_1^{a-1} + (T_1 - t_L)^{a-1}] + f_0 \quad (33.13)$$

c) Compute the relative water surface slope,

$$S_y = \frac{1}{L} \left[\frac{(Q_0 - IL)n}{60 S_0^{0.5}} \right]^{0.6} \quad (33.14)$$

d) Compute a revised estimate of the depletion time,

$$T_2 = t_r - \frac{0.095n^{0.47565} S_y^{0.20735} L^{0.6829}}{I^{0.52435} S_0^{0.237825}} \quad (33.15)$$

e) Compare the initial guess, with the new computed value. If both values are equal then is found and continue with step 9. Otherwise, set and repeat steps b through e.

9. Compare the depletion time with the required intake opportunity time. As recession is an important process in border irrigation, it is possible for the applied depth at the end of the field to be greater than at the inlet. If $t_d > r_{req}$, the irrigation at the field inlet is adequate and the application efficiency, E_a can be calculated by using the following estimate of time of cutoff

$$T_{co} = t_d - \frac{y_0 L}{2Q_0} \quad (33.16)$$

$$E_a = \frac{z_{req} L}{Q_0 T_{co}} \quad (33.17)$$

10. If $t_d < r_{req}$ the irrigation is not complete and the cutoff time must be increased so the intake at the inlet is equal to the required depth. The computation proceeds as follows

$$T_{co} = r_{req} - \frac{y_0 L}{2Q_0} \quad (33.18)$$

Example 33.1:

Design a border irrigation system for the following conditions:

Field length, $L = 200$ m

Field width, $W = 100$ m,

The typical slopes are 0.8% in the 100 m dimension and 0.1% in the other

the Manning roughness coefficient for first irrigations will be taken as 0.04 and for the later irrigations as 0.10

Soil texture = silt

Design irrigation requirement = 8 cm

Shape parameters $\rho = 1$ and $\rho_2 = 1.67$

Soils appear to be relatively non-erosive and have been tested to yield the following infiltration function:

First irrigation: $z = 0.00484 r^{0.388} + 0.00008 r$

Second irrigation: $z = 0.0053 r^{0.327} + 0.000052 r$

Infiltration function parameters: $k = 0.0053$, $a = 0.327$ and $b = 0.000052$

Available supply rate, $Q = 1.8$ m³/min

Supply duration = 36 hrs.

Solution:

1. Calculate the maximum inflow per unit width for the first irrigation along the 200 m length where erosion is most likely:

$$Q_{max} = \left(13^{1.67} \frac{0.04}{60 * 1.0 * 0.001^{0.5}} \right)^{1/(1.67-1)} = 1.889 \text{ m}^3/\text{min}$$

And similarly for irrigations along the 100 m (SO = 0.008) direction

$$Q_{max} = \left(13^{1.67} \frac{0.04}{60 * 1.0 * 0.008^{0.5}} \right)^{1/(1.67-1)} = 0.397 \text{ m}^3/\text{min}$$

The minimum flow using later field roughness where spreading may be a problem is for the 200 m length

$$Q_{min} = \frac{0.000357LS^{0.5}}{n} = \frac{0.000357(200)(0.001)^{0.5}}{0.04} = 0.0226 \text{ m}^3/\text{min}$$

Or in the 100 m direction:

$$Q_{min} = \frac{0.000357LS^{0.5}}{n} = \frac{0.000357(100)(0.008)^{0.5}}{0.04} = 0.032 \text{ m}^3/\text{min}$$

2. Compute (min) to satisfy the irrigation requirement ,for first irrigation and for second irrigation

3. Select within the range of and in case of later irrigation

- The flow is adjusted and possible combinations are listed below

Number of borders, (N _b)	Border width,(W _b) m	Unit inflow rate (Q ₀) m ³ /min/m
1	100	0.018
2	50	0.036
3	33	0.545

Q₀ = 0.036m³/ min/ m is selected

4. For an inflow of 0.036 m³/ min/ m, the advance time along the 200 m length under later conditions is about 301.8 min

5. Compute the inflow depth at inlet (m) using the Mannings equation as follows:

$$Y_0 = \left(\frac{Q_0 n}{60 S_0^{0.5}} \right)^{3/5} = \left(\frac{0.036(0.01)}{60(1)(0.001)^{0.5}} \right)^{0.6} = 0.0058 \text{ m}$$

And value should be less than the ridge height

6. Compute the time of recession (in minutes since the beginning of irrigation) assuming that the design will meet the irrigation requirement at the end of the border

$$t_r = t_{req} + t_L = 679 + 301.8 = 980.8 \text{ min}$$

7. Compute the depletion time in min using the Newton Raphson method as follows:

a) Assume an initial estimate of t_d as t_d = t_r = 980.8 min

b) Compute the average infiltration

$$I = \frac{ak}{2} [T_1^{a-1}(T_1 - t_L)^{a-1} + f_0]$$

$$I = \frac{(0.327)(0.0053)}{2} [(980.8)^{0.327-1} + (980.8 - 145)^{0.327-1}] + 0.000052$$

$$= 0.000069 \frac{m^3}{min}/m$$

c) Compute

$$S_y = \frac{1}{L} \left[\frac{(Q_0 - IL)n}{60S_0^{1/2}} \right]^{0.6} = \frac{1}{200} \left[\frac{(0.036 - (0.000069)(200))0.01}{60(0.001)^{1/2}} \right]^{0.6} = 0.000462$$

d) Compute new value of T as using below equation as follows:

$$T_2 = 980.8 - \frac{0.095 (0.01)^{0.47565} (0.000462)^{0.20735} (200)^{0.6829}}{(0.000069)^{0.52435} (0.001)^{0.237825}} = 917.47 \text{ min}$$

e) The initial guess (T) is not close to the new computed value (T_2) and repeat step b through e.

8. Correct value of $T = 802.7$ min

9. Compute new T_{co} by substituting T in place of T in following equation

$$T_{co} = t_d - \frac{y_0 L}{2Q_0} = 802.7 - \frac{(0.0058)(200)}{2(0.036)} = 786.6 \text{ min}$$

10. Compute application efficiency

$$E_a = \frac{(0.08)(200)}{(0.036)(786.6)} = 56.5\%$$

11. Check the water availability constraint and repeat steps 4 to 10 for other unit inflow rates. Choose the design which gives maximum E_a value.

This series of computations is repeated for the full range of discharges, field lengths and infiltration conditions. The following table gives a detailed summary of selected options for the first and subsequent irrigation conditions running in both the 200 m and 100 m directions.

First irrigation, $L = 200$ m

Sets	Border width,m	Unit flow,m ³ /min	Advance time,hr	Cutofftime,hr	Recession time,hr	Field on time,hr	Application efficiency,%
------	----------------	-------------------------------	-----------------	---------------	-------------------	------------------	--------------------------

2	50	0.036	6.36	11.34	12.83	22.67	65.3
3	33	0.545	3.11	8.10	9.59	24.29	60.4
4	25	0.072	2.14	7.12	8.61	28.49	52
5	20	0.09	1.64	6.63	8.12	33.16	44.7

Later irrigation, L= 200m

Sets	Border width,m	Unit flow,m ³ /min	Advance time,hr	Cutofftime,hr	Recession time,hr	Field on time,hr	Application efficiency,%
1	100	0.018	15.55	23.66	26.86	23.66	62.6
2	50	0.036	5.03	13.12	16.34	26.24	56.5
3	33	0.0545	3.15	11.25	14.47	33.76	43.4

First irrigation, L= 100m

Sets	Border width,m	Unit flow,m ³ /min	Advance time,hr	Cutofftime,hr	Recession time,hr	Field on time,hr	Application efficiency,%
2	100	0.018	5.27	11.21	11.74	22.42	66.1
3	67	0.0269	2.35	8.30	8.83	24.89	59.8
4	50	0.036	1.44	7.39	7.92	29.55	50.1
5	40	0.045	1.03	6.98	7.51	34.91	40.4

Later irrigation, L= 100m

Sets	Border width,m	Unit flow,m ³ /min	Advance time,hr	Cutofftime,hr	Recession time,hr	Field on time,hr	Application efficiency,%
1	200	0.009	12.89	23.07	24.20	23.07	64.2
2	100	0.018	3.45	13.61	14.76	27.23	54.5

LESSON 34. Basin Irrigation System

Basin irrigation is a class of surface irrigation methods in which area is divided into number checks or basins.

34.1 General Adoptability

Basin irrigation design is simpler than either furrow or border design since tail water is prevented from the existing field and the slopes are usually very small or zero. Thus, recession and depletion are accomplished at the same time and nearly uniform over the entire basin. Because longitudinal and transverse slopes are small or zero, the driving force in the flow is limited to the hydraulic slope of the water surface. Consequently, the uniformity of the field surface topography is critically important.

Check basin irrigation is suited for smooth gentle and uniform land slopes and for soils having moderate to low infiltration rates. Steep slopes require complex layouts and heavy land levelling. Both row crops and close-growing crops are adopted to be used with basins as long as the crop is not affected by temporary inundation or is planted in raised beds so that it will remain above the water level. The method is specially adopted for irrigation of grain and fodder crops in heavy soils where water is absorbed slowly and is required to stand for a relatively long time to ensure adequate irrigation.

Check basins are useful when leaching is required to remove salts from the soil profile. The method enables the conservation of rainfall and reduction in soil erosion by retaining a large part of the rain in the basin to be infiltrated gradually, without loss due to surface runoff. The method usually results in high water application and distribution efficiencies if the desired net depth of irrigation can be estimated adequately and if the size of the irrigation streams measured properly.

34.2 Design Consideration

Check basins are necessarily rectangular or square areas with bunds constructed around the area to control the irrigation water. However for rolling topography the bunds are constructed along the contours and are intersected at definite intervals by cross ridges. The size of the area may vary widely (1 sq. m to 2 ha), based upon the crop, available water supply, soil infiltration characteristics and other local factors. For soils with high infiltration capacity (loam and sandy loam) large sized basins may prove to be uneconomical and inefficient (in terms of irrigation efficiencies). However for clay soils with lower infiltration rates the size can of the check basin can be increased. The height of the bund depends on the amount of water to be retained while its width depends mainly on the bearing strength of the soil.

34.2.1 Layout

In order to maximize the spacing between supply channels it is desirable that the long axis of the basin be perpendicular to the supply channel or pipe line (Fig 1). The main factors to be taken into consideration are:

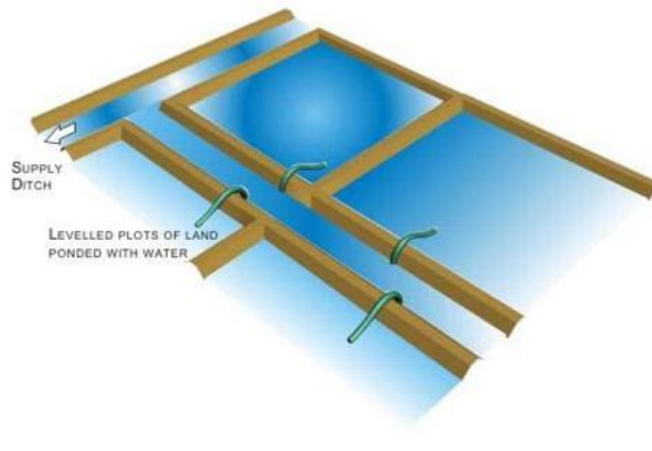

Fig.34.1.Layout of check basin irrigation system.

34.2.2 Water Source Location: It is desirable to choose a water source in the central position of the field to minimize the construction of channel and pipes also keeping in mind the fact that the water source should be in a position to facilitate the gravity flow to the field channels.

34.2.3 Terrain: Level land facilitates the construction of rectangular basin whereas in undulating topography the basin shapes are generally irregular. In case of high slopes terracing is done to obtain level basins.

34.2.4 Basin sizes: Basin dimensions are generally determined by the inflow stream size and the infiltration characteristics of the soil. Longer basins can be designed for fine textured soils whereas the basin size has to be kept small for sandy soils. The following table (Table 34.1) gives a rough estimate of the basin size for different soil types. However local factors and previous experience play a major role in the determination of basin size.

Table 34.1. Area of basins for different soil types.

Slope %	Maximum width (m)	
	average	range
0.2	45	35-55
0.3	37	30-45
0.4	32	25-40
0.5	28	20-35
0.6	25	20-30
0.8	22	15-30
1.0	20	15-25
1.2	17	10-20
1.5	13	10-20

2.0	10	5-15
3.0	7	5-10
4.0	5	3-8

34.2.5 Basin Width

The main limiting factor for basin width is the slope of the land. For higher slopes the width should be small or else huge amount of earthwork would be necessary to level the land. The other factors which play an important role in the determination of basin width are depth of fertile soil, method of basin construction and agricultural practices.

If the topsoil is shallow, there is a danger of exposing the infertile subsoil when the terraces are excavated. This can be avoided by reducing the width of basins and thus limiting the depth of excavation. Basins are narrow if they are constructed by the hand but they are wider when machines are used. The basins can be narrow if hand implements are used for intercultural operations however if machines are to be used for intercultural operations the width should be larger. Table 34.2 gives a standard for the basin width in different slopes.

Table 34.2. Approximate values for the maximum basin or terrace width(m)

Slope %	Maximum width (m)	
	average	range
0.2	45	35-55
0.3	37	30-45
0.4	32	25-40
0.5	28	20-35
0.6	25	20-30
0.8	22	15-30
1.0	20	15-25
1.2	17	10-20
1.5	13	10-20
2.0	10	5-15
3.0	7	5-10
4.0	5	3-8

From the above discussions the following conclusions can be drawn:

Basins should be small if the

1. Slope of the land is high
2. Soil is highly permeable (sandy)
3. Inflow stream is small in size
4. Required depth of the irrigation is small
5. Field preparation is done by hand or animal traction.

Basins can be large if the

1. Slope of the land is gentle or flat
2. Soil has low infiltration rate (clay)
3. Inflow stream is large in size
4. Required depth of the irrigation application is large
5. Field preparation and intercultural operations are mechanized.

34.2.6 Land Smoothing

The levelling of the land by the removal of high and low areas, which cause uneven infiltration, is essential to achieve higher irrigation efficiencies. The levelling of the land also facilitates the construction of supply channels and farm roads.

34.2.7 Stream Size

For level basins the maximum non erosive stream size should be used to achieve better uniformity and minimum deep percolation losses.

34.2.8 Irrigation Time

Irrigation time is the infiltration opportunity time. It is calculated from the empirical equations to calculate depth of infiltration noting that the cumulative infiltration should be able to meet the irrigation requirements. The level of water in the field may be maintained by the use of check gates with the height of the shutter adjusted to the required depth of submergence.

34.2.9 Inflow Time

The time for which the water flows into the basin is called the inflow time. This is selected to allow the desired depth of infiltration taking place at the far end of the basin. In general this is the summation of the advance time and the time required to deliver the volume of water needed for adequate irrigation.

34.2.10 Ridge/Bunds Dimensions

Bunds form an important part of any basin. Bunds are small earthen borders which contain the irrigation water within the basin. The height of the bund is determined by the depth of irrigation to be maintained within the basin. The width of the bund should be such that the bund is stable.

Temporary bunds are usually 60-120 cm wide at the base and have a height of 15-30 cm above the original ground surface, including a freeboard of 10 cm (which means an irrigation depth of 5-20 cm). Temporary bunds are rebuilt each season and they surround fields on which annual crops are grown. Permanent bunds usually have a base width of 130-160 cm and a height of 60-90 cm when constructed. The settled height will be 40-50 cm. This settling (compaction of the soil) will take in several months. Permanent bunds are mostly used in rice cultivation, where the same crop is planted on the same fields year after year. The bunds are used as paths in the rice fields as well.

Water is conveyed to the field by a network of laterals which are fed by a main supply channel situated on the upper side of the field. Generally every two rows of check basins are fed by one lateral (Fig.34.1). The size of the inflow stream should be sufficient enough to cover the basin within a short period of time and provide adequate amount of water to supply the infiltration demands.

For irrigating widely spaced plants in the orchards ring basins may be used. In this method, generally for each tree, a separate basin is made which is usually circular in shape as shown in Fig. 34.2. The size of the basin may be increased as the plant matures. The entire area is not flooded in the case of ring basin and hence the irrigation efficiency increases.

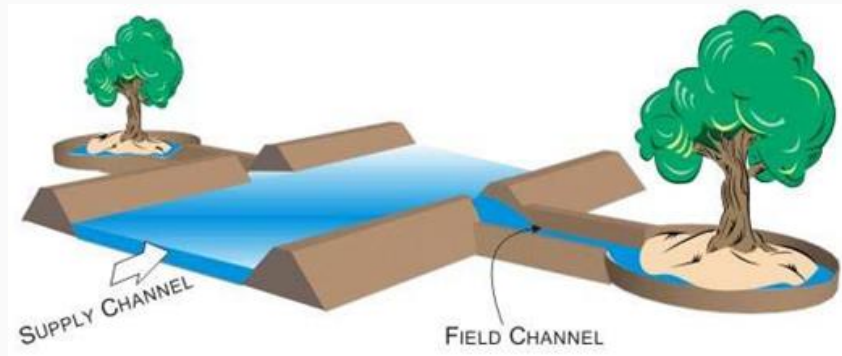

Fig 34.2. Layout of ring basin irrigation system.

34.3 Hydraulics of Check Basin

The irrigation event in the check basin can be considered to have the following four phases.

34.3.1 Initial Spreading of the Entrance Stream To Cover The Full Width

After the initiation of the stream into the field the stream spreads along the width of the border till the total width of the border is covered. The stream also advances along the slope during this period.

34.3.2 Water Front Advance

The water front advance takes place in almost similar manner to that of border irrigation. Land slope, surface roughness, soil type and stream size play the main role in determining the advance characteristics of the water front.

34.3.3 Water Storage

The ponding of water begins once the water reached the downstream end of the check basin. The volume of water stored during a time period is equal to the difference of the volume admitted to the basin and the amount of infiltration taking place.

34.3.4 Recession of Water

In case of check basin the recession of water takes place due to infiltration and the empirical infiltration equations can be used calculate the time required for complete subsidence of water.

Advantages

1. Water can be applied uniformly.
2. Even small streams can be used for irrigation of crops efficiently.

3. Simple and cheap when equipment is used for constructing bunds.

Disadvantages

1. Unless the land is levelled, distribution of water in plot is uneven.
2. Considerable area is lost under field channels and bunds i.e. nearly 30% of area.
3. Bunds interfere in working of inter-cultivation equipment
4. More labour is required for field layout and irrigation



LESSON 35. Sprinkler Irrigation

The sprinkler irrigation is one of the pressurised irrigation methods, in which water is sprayed into the air and fall on the ground surface somewhat resembling rainfall. The spray of water is developed by the flow of water under pressure through small orifices or nozzles. The pressure created by the pump, which causes the water to flow out through the sprinkler nozzle. The nozzles are mounted on the pressurized pipe system. With careful selection of nozzle sizes and spacing, sprinkler pipe spacing and operating pressure the amount of irrigation water required to fill the crop root zone can be applied nearly uniform at the sprinkling rate to suit the infiltration rate of soil. Pipes used for the sprinkler irrigation system are usually light in weight hence can be conveniently installed and transported in the field from one place to another. The pipes need to be flexible, crack and impact-proof, capable to sustain the desired pressure and temperature; and durable.

In this system the water is supplied from the water source through network of pipes and sprinkler nozzles located at a fixed height and a velocity which breaks water jet into small droplets that fall on to the soil or crop surface. As water is not allowed to flow over land surface, the water losses in the process of conveyance and distribution are completely eliminated. Hence compared to surface irrigation methods, high irrigation efficiency is achieved in sprinkler irrigation method of water application. The sprinkler irrigation system requires less labour than surface irrigation. This method is highly suitable on sandy soils where water lost through infiltration is very high. Fig. 35.1 shows application of irrigation water in the form of spray resembling rainfall through sprinkler nozzles using a pump for developing the required pressure.



Fig. 35.1. Farmland sprinkler irrigation.

35.1 Critical Appraisal of the Adaptability of Sprinkler Irrigation

Sprinkler system needs the various essential components to enable the water to fall on soil surface in the form of spray and hence involves high initial capital cost. Comparatively sprinkler system requires higher pressure to develop the spray having the droplets of required size, hence this method needs more energy than other water application methods. The method also requires needs high operational skills, desired pressure, application rate, droplet sizes and application uniformity are to be maintained for successful

implementation. The maintenance cost of various components used in the system is relatively greater. Hence there exists a need to make efficient design and layout the system to tap its full potential for water saving and crop yield.

Sprinkler irrigation system is adoptable to following situations:

- Almost all types of soils and terrains.
- Successfully irrigate high permeable soils that are difficult to irrigate using surface irrigation methods.
- Lands with combination of shallow soils and terrain that prevent proper land grading smoothing.
- Lands having steep slopes and erodible soils and undulating terrain that would be too costly to make smooth for use.
- Areas prone to frost and fog in Northern India this method can be used to minimise their effect of frost and fog on crop damage.
- Suppressing dust during to dust storm during summer and cooling the local environment.

35.2 Advantages and Limitations of Sprinkler Irrigation

- **Advantages**

(i) In sprinkler method of irrigation the water is moved through the network of pipes from the source to the field, thereby minimising the water losses in the process of conveyance and distribution. The studies conducted in different parts of India showed that this method can save water to the extent of 30 per cent compared to surface irrigation method. Hence this method has the distinct advantage of water saving over surface irrigation methods.

(ii) Frequent application of water and depths matching with the water requirement of crops. Therefore it is possible to maintain the soil moisture in the root zone of crops within allowable depletion level for a specified type of soil.

(iii) As there is no overland flow, water is not moved on land surface, this method is suitable for irrigating all types of soils except very heavy clay. This method is particularly suitable for irrigating close growing crops where the plant population per unit area is more.

(iv) It is suitable for oil seeds and cereal and vegetable crops.

(v) It is not necessary to overland flow by gravity therefore expenditure of land levelling and smoothening are not required done in surface irrigation methods.

(vi) There is no necessity of making bunds, ridges, field channels etc. for ponding or guiding water. The land used for these construction is saved and can be used for crop cultivation.

(vii) Due to high pressure requirement the nozzles are less susceptible to clogging compared to drip irrigation method.

(viii) Chemicals and fertilizers can be applied along with water.

(xi) This method saves the fertilizers and other nutrients there is no deep percolation and leaching.

- (x) The damage on vegetables, citrus, apple, mango, litchi, and other fruit crops to fog, frost and high solar radiations can be protected.
- (xi) High water use efficiency can be achieved with proper planning and design of sprinkler irrigation system.
- (xii) Plant protection chemicals can be applied to distant part of plant, which is not possible in other methods of irrigation.

Limitations

Alongside the different benefits offered by this method as explained above, there are certain limitations of this method. These are stated below.

- (i) High initial investment as compared to surface irrigation methods.
- (ii) The fine-textured soils which have a low infiltration rate cannot be irrigated efficiently.
- (iii) Sprinkler irrigation is not feasible in hot climate and high wind areas, as major portion of water will be lost through evaporation and water distribution is affected due to high wind speed.
- (iv) High operational costs due to higher energy requirements.
- (v) Not suitable for crops that require ponding water. However, research experiments on paddy crops have given promising results.
- (vi) In humid regions, not suitable for crops prone to diseases due to moist environment.
- (vii) Water with impurities and sediments may damage the system components.

35.3 Scope and Status of Sprinkler Irrigation in India

Agricultural sector is the largest consumer of water and consuming more than 80% water available. However the demand of water has been consistently increasing from other sectors like municipal, industry, hydropower etc. and each of these sectors is provided water often be at the cost of agriculture. The surface method of irrigation is practiced in large parts of the country. In this method more than 50% of applied water is lost in the process of conveyance, application, runoff and evaporation and less than 50% water is utilized for consumptive use of crop. The drip and sprinklers methods of water application, the crop efficiency utilize water for consumptive use. The drip and sprinkler methods saves the water more than 50% of water applied and hence these methods assume high importance. Hence these two methods are to be used for efficient distribution and application of water for crop production under the circumstances of increasing competition of water from other sectors and need to bring more area under irrigation due to increased demand for food.

In India, the area irrigated by the sprinkler system is about 3.59 million ha, which is less than 2.5 % of the total area under irrigation. Table 35.1 provides the statistics of a area under sprinkler and drip irrigation systems in different states of India. As on March 31, 2012 Rajasthan has the largest area under sprinkler irrigation followed by Haryana. The sprinkler system was first introduced in the mid-1950s by few progressive farmers of the Narmada valley in Madhya Pradesh, Southern region of Haryana and north eastern part of Rajasthan and parts of Punjab to overcome the problem of water scarcity. Realizing the importance of this system, its adoption later spread to more areas in these states and also in the states of Maharashtra and Karnataka. It is estimated that about 1, 35,000 sprinkler sets were in use in India in 1997 (INCID, 1994). About 65 % of the area under sprinkler irrigation is under field crops like cereals, pulses, oilseeds, cotton, sugarcane and vegetables and the rest 40% under tea, coffee and cardamom plantations

in the Western Ghats region and in the North Eastern states. The popularization of sprinkler irrigation in India received significant support from the various schemes involving subsidies by the central and state governments. In India, per hectare investment for irrigation projects has increased enormously. Therefore it is necessary to bring more area under sprinkler and drip irrigation methods so that the saved water can be utilized for bringing more area under irrigation. In view of the scarcity of water and the cost escalation of irrigation projects, it is essential and necessary to economize the use of water and at the same time increase the productivity per unit area. This could be achieved only by large-scale adoption of sprinkler and drip irrigation systems for achieving economy. The application of sprinkler and drip irrigation at commercial level was encouraged by the formation of a National Committee on the use of Plastics in Agriculture under the Ministry of Agriculture Government of India. Later on it was renamed as the National Committee on Plasticulture Applications in Horticulture. The Committee established twenty two Precision Farming Development Centres in different agro climatic regions of the country for conducting research on micro irrigation and to take the proven technologies to the farmers through demonstrations and training. Thus in view of water scarcity, growing demands of water from other sectors, increasingly high investment of creation of new water resources and encouragement of State and Central Governments, there is scope for adoption of sprinkler and drip irrigation methods of irrigation in India Tiwari (2009).

Table 35.1. Area under Sprinkler and Drip Irrigation Methods

AREA AS ON 31.03.2012 (Ha)				
Sl. No.	State	Drip	Sprinkler	Total
1	Rajasthan	55715	1098133	1153848
2	Maharashtra	778660	347623	1126283
3	Andhra pradesh	665661	323457	989118
4	Karnataka	293593	385675	679268
5	Haryana	17772	542431	560204
6	Gujarat	309520	246222	555742
7	Madhya Pradesh	110550	176223	286774
8	Tamil Nadu	206756	28217	234973
9	West Bengal	589	150576	151165
10	Chhattisgarh	11328	136310	147638
11	Orissa	12320	46090	58410
12	Sikkim	3460	2339	14799
13	Punjab	27615	11559	39174
14	UP	13973	17328	31301
15	Kerala	17301	4280	21581

16	Bihar	752	36628	37381
17	Nagaland	0	3962	3962
18	Jharkhand	1273	8842	10115
19	Goa	874	761	1635
20	HP	116	581	697
21	Ar Pradesh	613	0	613
22	Assam	116	129	245
23	Mizoram	72	106	178
24	Uttranchal	38	6	44
25	Manipur	30	0	30
26	Others	15000	30000	45000
Grand Total		2543696	3597479	6150176

Source: NCPAH (2013)



LESSON 36 Types and Components of Sprinkler System

The success of sprinkler irrigation system depends on the selection of appropriate sprinkler type and their components. These components together are responsible for efficient application of water as well as high application efficiency. This lesson deals with types and components of sprinkler irrigation system.

36.1 Types of Sprinkler System

Sprinkle irrigation systems are classified on the basis of portability of different components and on the basis of spray pattern. On the basis of portability these can be portable, semi portable, semi-permanent and permanent.

36.1.1 Classification Based on Spray Pattern

Sprinkler systems are classified into the following two major types (on the basis of the arrangement for spray of irrigation water).

- i. Rotating head or revolving sprinkler system.
- ii. Perforated pipe system.

i) Rotating Head: In this type of system small spraying size nozzles are placed on pipes of certain height known as riser pipes. The nozzles mounted on the riser pipes are fixed at uniform intervals along the length of the pipe laid on the ground surface called as lateral pipes. Water is supplied from the source to laterals through network of pipes consisting of mainline and sub mainline, called as main and sub main. Water with pressure is supplied to main; main to sub main and sub main to laterals using a pump. The sprinkler heads mounted on the risers which are above the crop height and rotated through 90° to 360° , to irrigate a rectangular strip. In rotating type sprinklers, the most common device to rotate the sprinkler nozzle is a small hammer activated by the thrust of water striking against a vane connected to it. The pressure requirement varies from 2.0 to 4.0 kg cm^{-2} with application rate from 4.0 to 20.0 mm hr^{-1} depending on the nozzle size, spacing etc. Fig. 36.1. shows different type of rotating type sprinkler irrigation systems.



Fig. 36.1. Rotating type sprinkler irrigation systems.

ii) Perforated Pipe System: This system consists of pipes having holes or nozzles along its length through which water is sprayed under pressure. This system is usually designed for relatively low pressure (1 kg cm^{-2}). The application rate ranges from 1.25 to 5 cm per hour for various pressure and spacing. The example shown in the Fig. 36.2.

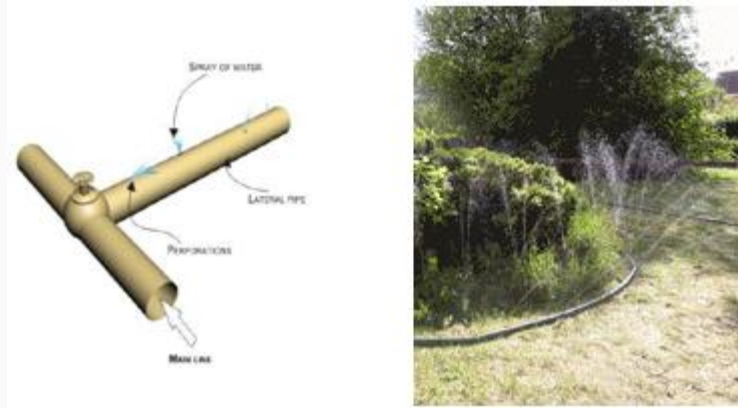

Fig. 36.2. Perforated pipe type of sprinkler system.

36.1.2 Classification Based on the Portability

i) Portable System: A portable system has portable mainlines, submains, laterals, and a portable pumping unit. The entire system can be moved from field to field. As all the components of the system need to be moved, the labour requirement is high; however initial investment on this type of the system is less.

ii) Semi-Portable System

A semi-portable system is similar to a portable system except that the location of water source and pumping plant is fixed. Fig. 36.3 shows Semi-portable sprinkler system. Other components are moved from one field to another. Such a system may be used for more than one field where there is an extended mainline, but may not be used for more than one farm unless there are additional pumping units.

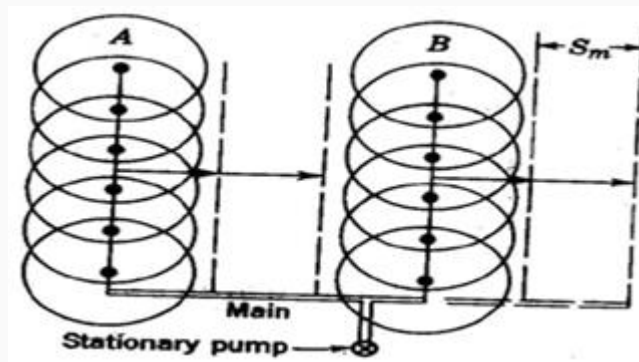

Fig. 36.3. Semi-portable sprinkler irrigation system.

iii) Semi-Permanent System: A semi-permanent system has portable lateral lines, permanent mainlines, submains, and a stationary water source with pumping unit. The mainlines and/or submains are usually buried. The risers are located for nozzle connections at suitable intervals to connect with laterals.

iv) Permanent System: A permanent system has buried mainlines, submains, and laterals with a stationary pumping plant and/or water source. Sprinkler nozzles are permanently located on each riser. Such systems are expensive, however these are suitable for automation. Permanent systems are suitable for orchards.

v) Solid Set System: In case of a solid set system, the movement of laterals is eliminated at least for one crop season their movement. The laterals are positioned in the field before the crop season starts and kept there for the whole crop season. This system is beneficial when frequent moving of the laterals is not required crops need frequent irrigation in small depth.

vi) Set-Move Irrigation Systems: Set-move sprinkler irrigation systems are moved from one set (irrigation) position to another by hand or mechanically. Set-move systems remain stationary when water is applied. When the desired amount of water has been applied, the water is shut off and the sprinkler laterals are drained and moved to the next set position. When the move is complete the water is turned on and irrigation resumed at the new set position. This sequence is repeated until the entire field has been irrigated. Set-move systems commonly have a single mainline laid through the centre of the field with one or more laterals on each side of the mainline.

The systems can be moved by different means as described below:

a) Hand-Move: Hand-move laterals are moved by uncoupling, picking –up, and carrying sections of lateral pipe by hand to the next set position where the lateral sections are reconnected. Earlier hand-move sprinkler lateral were made up of aluminium of different diameter. Now these are made with HDPE available in 50 to 150 mm (2 to 6 in) in diameter and 6, 9, or 12 m (20, 30, or 40 ft) long.

b) Tow-Move: Tow-move sprinkler systems are the least expensive type of mechanically moved set-move system. Each section of a tow-move lateral has skids or wheels so that the entire laterals can be pulled to the next set position. Usually a tractor is hooked to the mainline end attached with lateral and the lateral is dragged in the other direction across the mainline in an opposite S-shaped curve. The moves are made easier when mainlines are buried.

Tow-move systems are not used extensively because moving the lateral is tedious. It requires careful attention and may damage crops. Tow-move systems are suitable to forage and row crops.

c) Side-Roll: A side-roll or wheel-move system, is the mechanically moved set-move system. Each section of pipe in a side-roll lateral has a wheel, with the pipe serving as the axle of the wheel. A gasoline engine and transmission with a reverse gear at the centre or the end of the lateral supplies the power needed to roll the lateral, which may be as long as 800 m (about one-half mile), from one set position to the next. The lateral is commonly 100 or 125 mm (4 or 5 in) in diameter. Each lateral section is usually 12.2 m (40 ft) long with a wheel at its centre and a sprinkler mounted on a short riser at one end. Often the sprinklers have self –levellers to “right” the sprinkler when the lateral is stopped so that the riser is tilted” from its upright position. A drain valve that opens automatically when there is a loss of pressure is usually located opposite each rise. This allows the lateral to be quickly drained and permits moving the lateral with a minimum time loss. The most common spacing along the mainline is 18.3 m (60 ft).

d) Gun-Type: The set-move system consists of a larger-volume (big-gun) sprinkler mounted on a wheeled cart or trailer that is moved from set to set with a tractor or by hand. Sprinklers with capacities as large as 4700 L min⁻¹ (about 1250 gpm), wetted diameters of as much as 180 m (about 600 ft), and a recommended operating pressure range of 480 to 896 kPa (70 to 130 psi) are commonly used. These systems are sometimes used for waste water disposal.

36.2 Components of Sprinkler System

Sprinklers or nozzles, laterals, sub-mains, and mainlines are the primary components of a sprinkle irrigation system. Sprinklers spread water as “rainlike” droplets over the land surface. Laterals receive water from the mainline and sub-main and convey to the sprinklers. Mainlines convey water from the water source to the sub-mains and laterals. Fig.36.4. shows the components of a portable sprinkler irrigation system. A sprinkler system usually consists of the following components.

1. A pump unit
2. Fertiliser application units and filters
3. Pipe network- main/sub-mains and laterals
4. Sprinkler head

5. Couplers, valves, risers, bends, plugs etc.

i) Pumping Unit: Sprinkler irrigation system distributes water by spraying it over the fields. The water from the source (ground water / surface water) is pumped under pressure to sprinkler system. The pressure created through pump forces water through sprinklers or through perforations or nozzles in pipelines and then forms a spray. A high speed centrifugal or turbine pump can be used for operating sprinkler irrigation to individual fields. Centrifugal pump is used when the distance from the pump inlet to the water surface (suction head) is less than eight meters. For pumping water from deep wells or more than eight meters, a submersible pump is used. The driving unit of pump may be either an electric motor or an internal combustion engine.

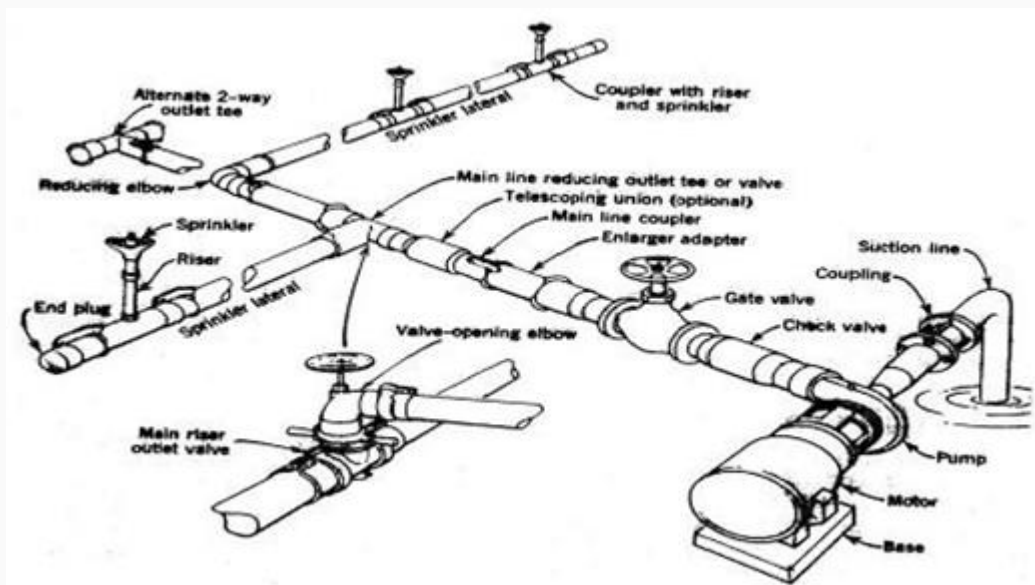

Fig. 36.4. Component of a portable sprinkler irrigation system

ii) a. Fertiliser Application Unit: Soluble chemical fertilizers can be injected into the sprinkler system and applied to the crop. The fertilizer applicator consists of a sealed fertilizer tank with necessary tubings and connections. A venturi injector is connected with the main line, which creates the differential pressure to suck fertilizer solution to flow in the main line.

b. Filters: Filters are used to filter the suspended particles and debris flowing with water.

iii) Pipe Network: The pipe network consists of mains/submains and laterals. Main line conveys water from the source and distributes it to the submains. The submains convey water to the laterals which in turn supply water to the sprinklers. Aluminium or PVC or HDPE pipes are generally used for portable systems, while steel pipes are usually used for center-pivot laterals. Asbestos, cement, PVC and wrapped steel are also used for buried laterals and main lines.

iv) Sprinkler Head: Sprinkler head distributes water uniformly over the field without generating runoff and loss due to deep percolation. Types of sprinklers are rotating head or fixed type. The rotating type can be adopted for a wide range of application rates and spacing (Fig. 36.5). They are effective with pressure of about 10 to 70 m head at the sprinkler. Pressures ranging from 16 to 40 m head are considered to be the most practical for normal uses.

Fixed head sprinklers are commonly used to irrigate small lawns and gardens. Perforated lateral lines are also used to sprinkle water. They require less pressure than rotating sprinklers. However they release

more water per unit area than rotating sprinklers. Hence fixed head sprinklers are adoptable for soils with high intake rate. Fig. 36.5 shows the rotating head sprinkler head.



Fig. 36.5. Sprinkler head.

iv) Couplers & Fitting Accessories: Couplers are used for connecting two pipes and uncoupling quickly and easily. Essentially a coupler should provide: a) a reuse and flexible connection, b) not leak at the joint, c) be simple and easy to couple and uncouple, and d) be light, non-corrosive, durable. Fig 36.6 shows different types of sprinkler fittings and accessories. Some of the important fittings and accessories used in sprinkler system are given below.

a) Water meters: It is used to measure the volume of water delivered in to the system. This is necessary to operate the system to supply the required quantity of water.

b) Flange, couplings and nipples are used for proper connection to the pump, suction and delivery.

c) Pressure gauge: It is used to measure operating pressure of sprinkler system. The sprinkler system is operated at the pressure to apply the desired depth of water and ensure application uniformity.

d) Bend, tees, reducers, elbows, hydrants, butterfly valve and plugs are other components of a sprinkler system. They are used as per requirements.



Fig. 36.6. Different fittings and accessories.

LESSON 37 Design of Sprinkler Irrigation System-I

37.1 General Considerations

A sprinkler irrigation system needs to be laid and designed properly to suit the conditions of a particular site to achieve high efficiencies. The choice of sprinkler system depends on i) land topography that cannot be properly leveled owing to the subsoil being exposed and cost involved in land leveling ii) soil texture, particularly infiltration rate of the soil so that the application or precipitation rate of the system is less than the infiltration rate of the soil iii) available water resources and eventually matching the capacity of sprinkler system with the water requirement of the crops and, the system with high water application efficiency, and iv) cost effective from the point of crop production economics. This lesson deals with various aspects required for the design of sprinkler irrigation system.

37.2 Inventory of the Land and Water Resources

The inventory of resources includes following:

i) Topographical map of the Area: The topographical map of the field needs to be prepared. The map should include the field boundaries and the locations of the bunds, farm roads building and location of water resources. The map may also include possibly the areas selected for cultivation of different crops in the field. This is required for knowing the total area to be irrigated for different crops and then estimating the quantity of water required for each irrigation. The map should also include the contour map of the area. The contour map enables to determine the slope of the field, if any, in both the direction. The slope is required to decide the layout and placement of the pipe network (main, sub main and laterals) and computation of the elevation difference which is required for the design of pipes in terms of its diameter and length.

ii) Water Resources: The information on quantity and quality of available water resources is required for design of sprinkler system. The quantity of the water resources in terms of the seasonal availability of the water; and discharge available for irrigating the field and duration for which it is available per day are required to match with the crop water requirement. This information is particularly required for deciding whether the entire area of the proposed field or the portion of the area of the field can be irrigated. The location of the source of water in the field is desired to estimate the length and diameter of the main, sub main and lateral pipes. The water quality parameters include EC, pH and SAR. Some crops may have detrimental or scorching effect on leaves, if water having high soluble salts used for sprinkling water. The quality of water is thus important to decide its suitability for crops for sprinkler irrigation. This information is also required for deciding the irrigation frequency. The water with high soluble salt contents may be required to be applied more frequently compared to good quality water.

iii) Crops to be Irrigated: The information on crops, its root zone depth, crop coefficient, and allowable depletion level is required for computing the water requirement of the crops and irrigation frequency. The climatic and soil parameters are required to determine crop water requirement.

iv) Soils: The soil parameters such as field capacity, wilting point, bulk density and infiltration rate are used for irrigation system design. Field capacity, wilting point, bulk density are required for estimating the available soil water in the root zone. Allowable soil water depletion for a specified crop and climate data are required for computing the depth of irrigation and frequency of irrigation. The information on infiltration rate is used in selecting the nozzle size, type of nozzle and lateral spacing.

v) Climate: The weather parameters such as pan evaporation, rainfall, temperature, relative humidity, wind speed and sunshine hours are required to compute the water requirement of the crops. The peak water requirement estimation requires peak summer weather parameters such as solar radiation, temperature, humidity etc.

vi) Availability of Power Source: The type of source of power can be electricity or diesel or both. Irrigation system can be planned and designed based on the assured timings of availability of power supply.

37.3 Types of Sprinkler Systems Layout

The layout of sprinkler system is made based on water source and location of water supply. The source of water supply for sprinkler irrigation can be surface water (river, canal, pond etc.) or ground water (a tube well or open well). When deciding the location of well, it can be located at a corner or, at the center of the farm to minimize the length of main pipe. The source at higher elevation is desirable. The layout of the mains depends on the location of the well. Fig. 37.1 shows the layout of stationary water source and pump at center of field and laterals are moved to successive position up one side of the main and then down on the other. Fig. 37.2. shows fully portable pumping set unit. In a Portable sprinkler system field channel runs along one edge of the farm. In this system a portable pumping set and sprinkler unit with the lateral extending to the field are used to draw water directly from the channel and distribute it through the sprinklers. Another alternative is to have a permanent pumping plant at the source and distribute water in buried pressurized pipelines. These pipelines will usually run down the center of the field so that the outlets offer little hindrance to tillage and other farm operations.

To obtain a reasonable degree of uniformity in the discharge of each sprinkler, the mains should run in the direction of the steepest slope, with the laterals at right angles and as close as on contours. Generally design is made considering running on level land. If the lateral slopes upgrade appreciably, it is difficult to design for a very long pipe length. If it slopes downgrade, the length can be longer than usual, but rarely does the slope remains uniform for each setting.

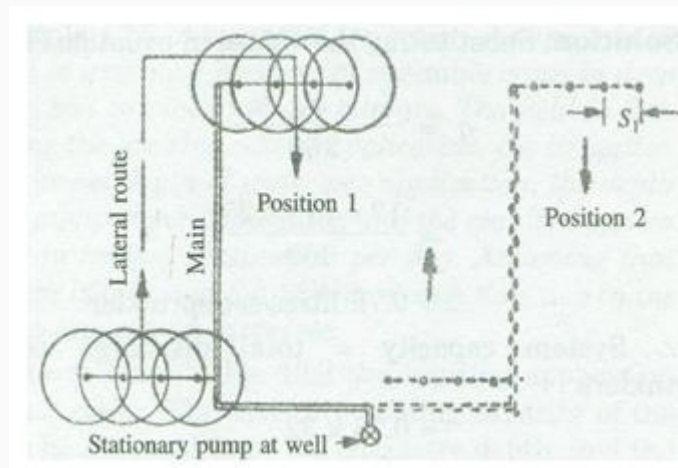

Fig. 37.1. Layout plan for sprinkler irrigation system for stationary water Source of well and pump.
(Source: Michael, 2010)

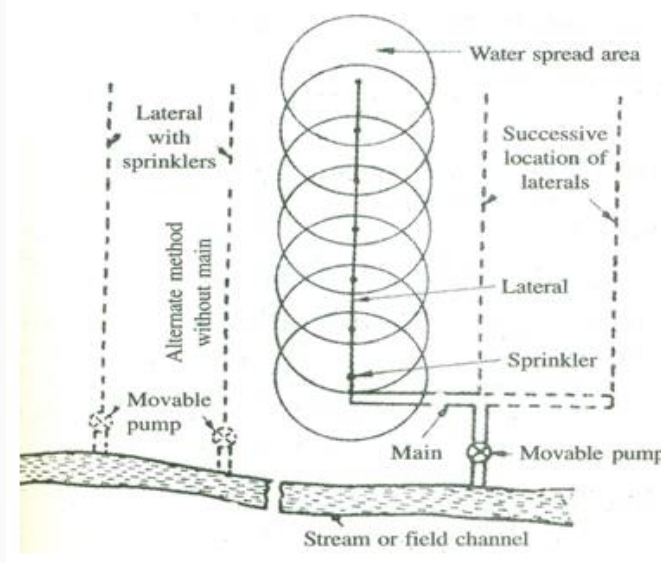

Fig. 37.2. Typical field layouts for fully portable sprinkler units drawing water from streams or field channels. (Source: Michael, 2010)

37.3.1 Layout for Set-Move Sprinkler System

Different layouts for set-move sprinkle systems are shown through Figs. 37.3 (a), (b), (c), (d), (e), & (f). The guide lines for set-move sprinkler system are stated below:

- i) Mains should be laid up and downhill.
- ii) Laterals should be laid across slope or nearly on the contour as far as possible.
- iii) For multiple lateral option, lateral pipe sizes should be limited to not more than two diameters.
- iv) If possible, water supply nearest to the center of area should be chosen.
- v) Layouts should facilitate minimal lateral movement during a crop season.
- vi) Differences in number of sprinklers operating for various setups should be minimum.
- vii) Booster pumps should be considered where small portions of field would require high pressure at the pump.
- viii) Layout should be modified to apply different rates and amounts of water where soils are greatly different in the design area.
- ix) Mainline and sub main layout is keyed to lateral layout.
- x) When laterals run across prominent slopes, mainlines or sub mains will normally run up and down the slopes Fig 37.3(a) and (b).
- xi) When it is necessary to run laterals up and down hill, the mainlines or sub mains should be located on ridges Fig 37.3(c), (d), (e) & (f) to avoid laterals to run uphill.

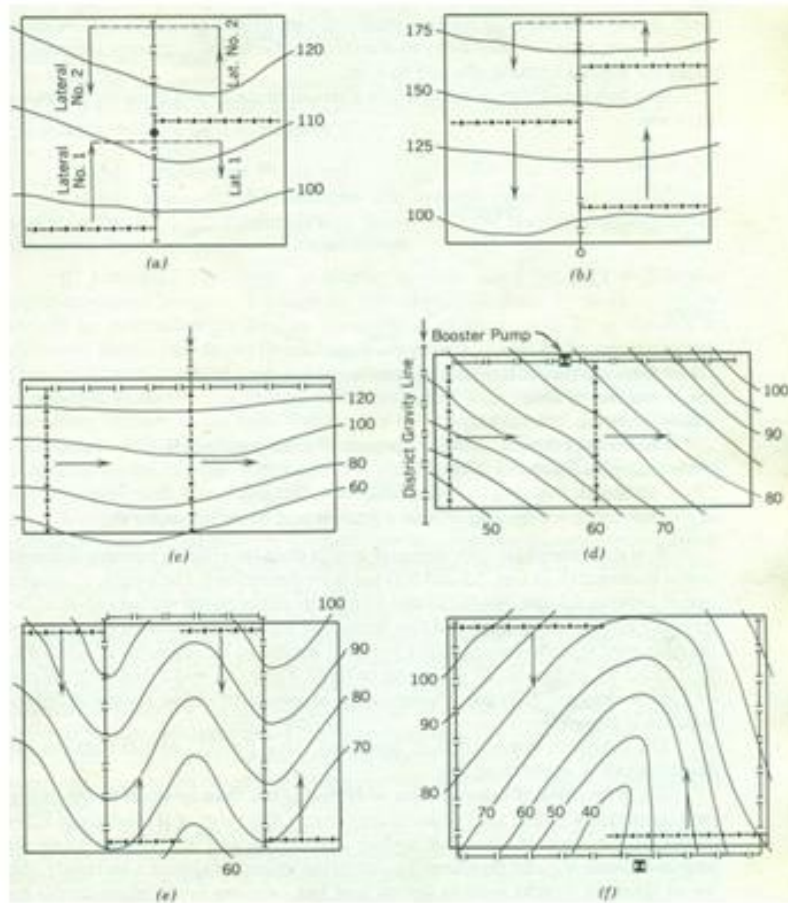

Fig. 37.3. Layouts for set-move sprinkler systems. (Source: James Larry, 1988)

(a) Layout on moderate, uniform slopes with water supply at center (b) Layout illustrating use of odd number of laterals to provide required number of operating sprinklers. (c) Layout with gravity pressure where pressure gain approximates friction loss and allows running laterals downhill. (d) Layout illustrating area where laterals have to be laid downslope to avoid wide pressure variation caused by running laterals upslope. (e) Layout with two main lines on ridges to avoid running laterals uphill. (f) Layout with two main lines on the sides of the area to avoid running the laterals uphill.

37.3.2 Split Lateral Layouts

- i) In this layout mainlines and sub mains are located such that set move laterals may operate on either side of them (Fig. 37.3 (a), (b) and (e)).
- ii) They minimize friction loss because of shorter laterals.
- iii) Split layouts also allow set-move laterals to be rotated around mainlines (Fig.37.3 (a), (b)).
- iv) Labor requirement is reduced by eliminating the need to move lateral pipes back to starting point (Fig 37.3(c) and 37.3(d)).

37.4 Sprinkler System Design Parameters

37.4.1 Sprinkler Discharge Considering Area of Coverage: The actual selection of different components of the sprinkler system is based on specifications furnished by the manufacturers of the equipment. The

selection depends on wetting diameter of nozzle, at a given operating pressure at nozzle, sprinkler discharge, combination of sprinkler spacing and lateral moves, application rate suiting to soil and wind conditions. The required discharge of an individual sprinkler is a function of the water application rate and the two-way spacing of the sprinklers. It may be determined by the following equation:

$$q = \frac{S_1 \times S_m \times I}{3600} \quad (37.1)$$

in which,

q = required discharge of individual sprinkler,

S₁ = spacing of sprinklers along the laterals, m

S_m = spacing of laterals along the main, m

I = optimum application rate, mm

The values of maximum rate of application for various soil types and slopes are presented in Table 37.1.

Table: 37.1 Maximum application rates for different types of soils

Soil texture and profile	0 to 5% slope	5 to 8 % slope	8 to 12 % slope
Coarse sandy soils to 2 m	5.10	3.75	2.54
Coarse sandy soils over more compact soils	3.75	2.54	1.9
Light sandy loams to 2 m	2.54	2.03	1.5
Light sandy loams over more compact soil	1.9	1.27	1.02
Silt loam to 2 m	1.27	1.02	0.76
Silt loams over more compact soils	0.76	0.63	0.38
Heavy textured clays or clay loams	0.38	0.25	0.20

Source: Adapted from SCS (1993).

37.4.2 Height of Sprinkler Riser Pipes: Sprinklers are located just above the crops to be irrigated and, therefore, the height of the risers depend upon the maximum height of the crop. To avoid excessive turbulence in the riser pipes the minimum height of riser is 300 mm for 25 mm diameter and 150 mm for 15 mm to 20 mm diameter.

37.4.3 Sprinkler Spacing: The uniformity of water distribution from sprinklers depends on the operating pressure, wind velocity, rotation of sprinklers, spacing between sprinklers and laterals. The spacing of sprinklers on laterals and the laterals spacing are adjusted for obtaining maximum uniformity for given condition. Greater depth of water accumulate near sprinkler head and depth decreases gradually with distance from the sprinklers. Therefore there is a necessity of overlapping of the spray pattern of the individual sprinkler, to obtain uniform depth of water application. Sprinklers are arranged along a lateral such that the diameter of the water spread area of sprinkler is overlapped. If there is a wind of considerable speed, the spacing between sprinklers is further reduced as given in Table 37.2.

Table. 37.2. Overlapping of sprinkler spacing for different wind speeds.

Sl.No.	Average wind speed	Spacing
1	No wind	65% of the water spread area of a sprinkler
2	0-6 km/h	60% of the water spread area of a sprinkler
3	6.5 to 13 km/h	50% of the water spread area of a sprinkler
4	Above 13 km/h	30% of the water spread area of a sprinkler

Source: Adapted from SCS (1993)

37.4.4 Capacity of sprinkler system: The capacity of a sprinkler system is a important design parameter. This is estimated after knowing the total area to be irrigated by a sprinkler irrigation system. The formula to compute system capacity is given by

$$Q = 2780 \frac{A \times d}{F \times H \times E} \quad (37.2)$$

in which,

Q = discharge capacity of the pump,

A = area to be irrigated, ha

d = net depth of water application, cm

F = number of days allowed for the completion of one irrigation

H = number of actual operating hours day⁻¹

E = water application efficiency, per cent

37.4.5 Sprinkler Discharge: The discharge of a sprinkler is estimated by knowing the diameter of nozzle and operating pressure available at the nozzle by following formula.

$$Q = C A \sqrt{2 g h} \quad (37.3)$$

where,

Q = discharge, $\text{cm}^3 \text{s}^{-1}$

C = sprinkler discharge coefficient which vary from 0.80 to 0.95

A = cross - sectional area of nozzle or orifice, cm^2

g = acceleration due to gravity, cm/s^2 , and

h = pressure head, cm

37.4.6 Spread of Sprinkler: The area covered by a rotating head sprinkler can be estimated from the formula stated in equation 37.4.

$$R = 1.35\sqrt{dh} \quad (37.4)$$

where,

R = radius of the wetted area covered by sprinkler, m

d = diameter of nozzle, m

h = pressure head at nozzle, m

The maximum coverage is attained when the jet emerges from the sprinkler nozzle at angle between 30° and 32° .

37.4.7 Rate of Water Application or Precipitation Intensity: The rate of water application by an individual nozzle is estimated by the formula as stated below.

$$R_a = \frac{Q}{360 \times A} \quad (37.5)$$

where,

R_a = rate of water application, cm

Q = rate of discharge of sprinkler,

A = wetted area of sprinkler, m^2



LESSON 38 Design of Sprinkler Irrigation System-II

In previous lesson, the inventory of the resources required for the design of sprinkler system, layout and types of the sprinkler system and the formulae for estimating the sprinkler discharge etc. were described. This lesson presents the design description of network of the pipes i.e. lateral, sub main and main.

38.1 Hydraulic Design of Pipe Network

As stated in previous lesson, the pipe network in the sprinkler irrigation system consists of the lateral, sub main and main pipeline. The sprinkle nozzles are mounted on the laterals; laterals are connected to the sub main and sub main to the main. Main pipe line takes water from the source through the pump. It is desired to design the pipe network appropriately for uniform water application and economical system cost. As the sprinkler system requires pressure to operate, both uniformity water application and system economy are affected by the frictional head loss through the pipes. Large variation in friction head loss in the lateral or sub main reduces the uniformity in water application on the other hand too small variation results in high uniformity, which requires larger pipe size makes system more expensive. Hence it requires optimal combination of hydraulic and economic consideration.

There are several formulae available in the literature for estimating frictional head loss through sprinkler pipes.

However the Hazen-Williams equation is commonly adopted and given by

$$H_f(100) = K \frac{(Q/C)^{1.852}}{D^{4.87}} \quad (38.1)$$

Where,

$H_f(100)$ = a friction loss per 100 m (100 ft) of pipe, m/100 m.

C = a friction coefficient which is a function of pipe material characteristics;

Q = the flow of water in the line $L s^{-1}$ ($ft^3 s^{-1}$) ($gal min^{-1}$);

D = the inside pipe diameter, mm (ft) (in.);

K = a constant which is 1.22×10^{12} for metric units, 473 for Q in $ft^3 s^{-1}$ and D IN ft, and 10.46 for Q in $gal min^{-1}$ and D in inch: the value C increases as the pipe increases. As the number of couplers decreases, the value C increases. Pipe materials with smoother inside wall will have a higher C value. Table 38.1 provides the values of C for different pipe materials.

Table 38.1. Typical values of C for use in Hazen-Williams equation

Sl. No.	Pipe material	C
1	Plastic	150
2	Epoxy-coated steel	145
3	Cement asbestos	140
4	Galvanized steel	135
5	Aluminum (with coupler every 9.0 m)	130
6	Steel (new)	130
7	Steel (15 years old) or concrete	100

(Source: Keller and Bliesner, 1990)

Flow Velocity in Pipe: Normally flow velocities in pipes should not exceed 3 m s^{-1} (10 ft s^{-1}). For permanent systems with polyvinyl chloride (PVC) plastic pipe, and asbestos cement (AC) pipe used for water supply, water flow velocity should not exceed 2.25 m s^{-1} and most manufactures caution against using water flow velocity in excess of 1.6 m s^{-1} .

Allowable Head Loss in Sprinkler Pipe: Pressure loss occurs due to friction and joints. This should not exceed practical value. Normally it should be between 15 and 20 per cent of the total head. The recommended practice to design the sprinkler lateral is not to exceed the pressure variation more than 20% of the higher pressure. The difference in elevation head is considered while determining the variation in pressure. This may be paying of laterals in upward slope or down slope. While the lateral is laid on up slope direction, the less pressure is available at the nozzle while lateral laid on down slope direction, the additional pressure is available at the sprinkler nozzle due to gain in energy.

Pipe with Multi Outlet: When there are no outlets along the length of the lateral or sub main (usually called as closed pipe line or blind pipe), the head loss due to friction can be computed by Hazen-William formula (Equation 38.1). However, in sprinkler lateral or sub main, outlets along the length of the pipe are given as sprinkler heads or sprinkler laterals as the case may be. Flow of water through the closed or blind pipe of a given diameter causes more frictional head loss compared to that of a pipe with number of outlets along the length of the pipe which is due to the fact that the flow rate decreases with every passing outlet. To accurately compute friction loss in the lateral with multi outlet, start at the last outlet on the pipe line and work back to the head of the pipeline, computing the friction head loss between each outlet for the flow rate between two outlets. Table 38.2 is a ready reckoner table for estimation of head loss due to friction from aluminum pipe. Christainsen (1942) has simplified the procedure for choosing size of pipe for a given discharge and friction loss (Table 38.2). In case of multiple outlets the frictional head loss through the blind pipe is computed for the given flow rate and then multiply with reduction factor (F) due to reducing flow rate. The reduction factor depends on the number of equally spaced outlets on the lateral.

Table: 38.2 Friction head loss in irrigation pipes.

Friction head loss in meters per 100 meters in lateral line of portable aluminum pipe with coupling
(Based on Scobey's formula and 9 meters pipe length)

Flow litres/sec	Diameter of pipe				
	5.0 cm K _s 0.34	7.5 cm K _s 0.33	10.0 cm K _s 0.32	12.5 cm K _s 0.32	15.0 cm K _s 0.32
1.26	0.32				
1.89	2.53				
2.52	4.49	0.565	0.130		
3.15	6.85	0.858	0.198		
3.79	9.67	1.21	0.280		
4.42	12.9	1.63	0.376	0.122	
5.05	16.7	2.10	0.484	0.157	
5.68	20.8	2.63	0.605	0.196	
6.31	25.4	3.20	0.738	0.240	0.099
7.57		4.54	1.04	0.339	0.140
8.83		6.09	1.40	0.454	0.188
10.10		7.85	1.80	0.590	0.242
11.36		9.82	2.26	0.733	0.302
12.62		12.0	2.76	0.896	0.370
13.88		14.4	3.30	1.07	0.443
15.14		16.9	3.90	1.26	0.522
16.41		19.7	4.54	1.47	0.608
17.67		22.8	5.22	1.70	0.700
18.93		25.9	5.96	1.93	0.798
20.19		29.3	6.74	2.18	0.904
21.45		32.8	7.56	2.45	1.02
22.72		36.6	8.40	2.74	1.13

23.98		40.6	9.36	3.03	1.26
25.24		44.7	10.3	3.34	1.38
26.50			11.3	3.66	1.51
27.76			12.3	4.00	1.66
29.03			13.4	4.35	1.80
30.29			14.6	4.72	1.95
31.55			15.8	5.10	2.12
34.70			18.9	6.12	2.52
37.86			22.2	7.22	2.98
41.01			25.9	8.40	3.46
44.17			29.8	9.68	3.99
47.32			33.8	11.0	4.54
50.48				12.5	5.15
53.63				14.0	5.78
56.79				15.6	6.44
59.94				17.3	7.14
63.10				19.0	7.86

(Source: Michael, 2010)

Assuming first sprinkler is at the same as other sprinklers located on the lateral, The F can be computed using following expression (Christiansen, 1942).

$$F = \frac{1}{m+1} + \frac{1}{2N} + \frac{\sqrt{m-1}}{6N^2} \quad (38.2)$$

where

F = reduction factor

N = number of outlets

m = exponent used in the head loss equation (In Hazen-William's equation the m = 1.852 and for Darcy's Weisbach equation m=2)

For N>10, the last term in equation 38.2 can be omitted.

Jensen and Fratini (1957) modified the above expression for F to account for the first sprinkler being located one-half the sprinkler spacing from the supply line. They assumed that no water flows past the last sprinkler. The modified expression (Equation 38.3) indicates that the F factor is more than 5 percent larger for N<20.

$$F = \frac{1}{2N-1} + \frac{2}{(2N-1)N^m} [(N-1)^m + (N-2)^m + \dots + 1^m] \tag{38.3}$$

Estimates of F values are easy to obtain using Equation (38.2), but these estimates become much more tedious when using equation (38.3) for large values of N. To simplify their use, F values for m = 1.90 are presented in Table 38.3.

38.1.1 Design of Sprinkler Laterals

As stated earlier in design of sprinkler laterals the pressure variation should not exceed more than 20% of the higher pressure. The design capacity for sprinklers on a lateral is based on the average operating pressure.

Table 38.3. Reduction factor 'F' for friction loss in aluminum pipe with

No. of sprinklers on lateral	1 st sprinkler is one sprinkler interval from main	1 st sprinkler is 1/2 sprinkler interval from main	No. of sprinklers on lateral	1 st sprinkler is one sprinkler interval from main	1 st sprinkler is 1/2 sprinkler interval from main
1	1.000	1.000	16	0.365	0.345
2	0.625	0.500	17	0.363	0.344
3	0.518	0.422	18	0.361	0.343
4	0.469	0.393	19	0.360	0.343
5	0.440	0.378	20	0.359	0.342
6	0.421	0.369	22	0.357	0.341
7	0.408	0.363	24	0.355	0.341
8	0.398	0.358	26	0.353	0.340
9	0.391	0.355	28	0.351	0.340
10	0.385	0.353	30	0.350	0.339
11	0.380	0.351	35	0.347	0.338
12	0.376	0.349	40	0.345	0.338
13	0.373	0.348	50	0.343	0.337
14	0.370	0.347	100	0.338	0.337

15	0.367	0.346	>100	0.335	0.335
----	-------	-------	------	-------	-------

multiple outlets

Where, the friction loss, H_f in the laterals is within 20% of the average pressure.

The average pressure head, can be expressed approximately by

$$H_a = H_o + \frac{1}{4} H_f \tag{38.4}$$

where, = pressure at the sprinkler on the farthest end.

If the lateral is on nearly level land or on the contour, the head at the main is given

$$H_n = H_o + H_f \tag{38.5}$$

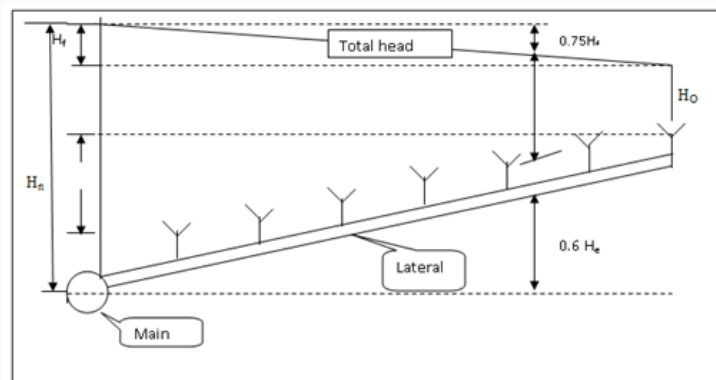

Fig. 38.1. Pressure profile in a lateral laid uphill. (Source: Michael, 2010)

Solving Equation (38.4) in terms of H_o and substituting in Equation 38.5 it becomes

$$H_n = H_a + \frac{3}{4} H_f \pm \frac{3}{4} H_e + H_r \tag{38.6}$$

where,

H_a = Average pressure

H_f = Head loss due to friction in lateral pipe

H_n = Pressure required at the main to operate, m

H_e = Maximum difference in elevation between the first and last sprinkler on a lateral pipe, m

H_r = the riser height, m

The term $\frac{3}{4} H_e$ is positive if lateral is laid up slope and negative, if lateral is laid down slope

38.1.2 Design of Main Pipe

As stated earlier the sub main pipe supplies the water to sprinkler lateral and main supplies water to the sub main. If more numbers of sub mains are operated simultaneously at same time (a case for the large field) the procedure described for the design of the lateral may be used. However, when a single sub main is operated, the size of sub main and main pipe line is selected such that the annual operating cost and initial cost of the sub main line and mainline should be low.

Normally friction loss of 3 m for small sprinkler system and 12 m for large sprinkler systems are used in design of main pipe line.

38.2 Pumps and Power Units

The suitable size of pump is selected considering the maximum total head against which the pump expected to operate and deliver the required discharge. This is determined by

$$H_t = H_n + H_m \pm H_j + H_s \quad (38.7)$$

where,

H_t = total design head against which the pump is working, m

H_n = maximum head required at the main to operate the sprinklers on the lateral at the required average pressure, including the riser height, m

H_m = maximum friction loss in the main and in the suction line, m

H_j = elevation difference between the pump and the junction of the lateral and the main, m, and

H_s = elevation difference between the pump and the source of water after drawdown, m

The discharge required to be delivered by pump is determined by multiplying the number of sprinklers that are operated at any given instant of time by the discharge of each sprinkler. Once the head and discharge of the pumps are known, the pump may be selected from rating curves or tables provided by the manufacture.

The horse power requirement of pump is given by

$$h_p = Q_t \times H_t / 75 \times n_p \quad (38.8)$$

Q_t = total discharge, L s⁻¹,

H_t = total head, m

n_p = efficiency of pump(fraction)

Example 37.1:

Design a sprinkler irrigation system to irrigate 5 ha Wheat crop.

Assume

Soil type = silt loam, Infiltration rate at field capacity = 1.25 cm h^{-1} , Water holding capacity = 15 cm m^{-1} ,
Root zone depth = 1.5 m, Daily consumptive use rate = 6 mm day^{-1} , Sprinkler type = Rotating head.

This example is adopted from Tiwari (2009).

Solution:

Step I

Given infiltration capacity = 1.25 cm h^{-1}

Hence maximum water application rate = 1.25 cm/h

Step II

Total water holding capacity of the soil root zone = $15 \times 1.5 = 22.5 \text{ cm}$

Let the water be applied at 50% depletion, hence the depth of water to be

applied = $0.50 \times 22.5 = 11.25 \text{ cm}$

Let the water application efficiency be 90 per cent

Depth of water to be supplied = $11.25 / 0.9 = 12.5 \text{ cm}$

Step III

For daily consumptive use rate of 0.60 cm

Irrigation interval = $11.25 / 0.6 = 19 \text{ days}$

In period of 19 days, 12.5 cm of water is to be applied on an area of 5 ha. Hence assuming 10 hrs. of pumping per day, the sprinkler system capacity would be

$$= \frac{5 \times 10^4 \times 12.5 \times 10^{-2}}{19 \times 10 \times 3600} = 0.009 \text{ m}^3\text{s}^{-1}$$

Step IV

Let the spacing of lateral (S_m) = 18 m,

Spacing of Sprinklers in lateral (S_l) = 12 m

This selection is based on using following consideration:

Operating pressure of nozzle = 2.5 kg cm^{-2}

Maximum application rate = 1.25 cm h^{-1}

Referring sprinkler manufacturer's M/S NOCIL, Akola catalogue (Table 38.4), the nozzle specifications with this operating pressure and application rate is:

Nozzle size : 5.5563 x 3.175 mm

Operating pressure : 2.47 kg/cm² and

Application rate : 1.10 cm hr⁻¹ (which is less than the maximum allowable application rate of 1.25 cm h⁻¹)

Diameter of coverage : 29.99 ≈ 30.0 m

Discharge of the nozzle : 0.637 L s⁻¹ = 0.637 x 10⁻³ m³s⁻¹

Step V

$$\text{Total no. of sprinkler required} = \frac{0.009}{0.637 \times 10^{-3}} = 14.12 \approx 14 \text{ sprinklers}$$

Considering two sprinkler laterals, therefore 7 sprinklers on each lateral.

Step VI

Using Table 38.3, the sprinklers spaced at 12 m intervals on each lateral. The lateral lines will be at 18 m spacing.

Step VII

Total length of each lateral = 12 x 7 = 84

Operating pressure = 2.47 kg cm⁻²

Total allowable pressure variation in the pressure head is 20%, hence maximum allowable pressure variation in pressure = 0.2 x 2.47 = 0.494 kg/cm² = 4.94 m

Assume pressure variation due to elevation = 2 m

Permissible head loss due to friction = 4.94 - 2 = 2.94 m

Total flow through the lateral = 7 x 0.637 x 10⁻³ = 4.459 x 10⁻³ m³s⁻¹

$$\text{Reduction factor (F)} = \frac{1}{3} + \frac{1}{2 \times 7} + \frac{1}{6 \times 7^2} = 0.333 + 0.071 + 0.0034 = 0.407$$

Head loss due to friction = using Darcy's weisbach equation and reduction factor.

$$H_f = \frac{0.811 \times 0.04 \times 277778 \times 84 \times (4.459 \times 60)^2}{9.81 \times D^5} \times 0.407$$

$$\text{or } 2.94 = \frac{0.811 \times 0.04 \times 277778 \times 84 \times (4.459 \times 60)^2}{9.81 \times D^5} \times 0.407$$

$$\Rightarrow D^5 = \frac{0.811 \times 0.04 \times 277778 \times 84 \times (4.459 \times 60)^2}{9.81 \times 2.94} \times 0.407$$

$$\Rightarrow D = 59.79 \approx 63 \text{ mm}$$

Hence diameter of lateral = 63 mm

Assume height of riser pipe = 1 m

The head required to operate the lateral lines (H_m) = 24.7 + 2.94 + 2 + 1 = 30.6 m

Frictional head loss in main pipe line (H_f) = 30.6 \times 0.2 = 6.12 m

Calculating in the same way as done in case of lateral

$$6.12 = \frac{0.811 \times 0.04 \times 277778 \times 36 \times (0.009 \times 1000 \times 60)^2}{9.81 \times D^5}$$

$$D^5 = \frac{0.811 \times 0.04 \times 277778 \times 36 \times (0.009 \times 1000 \times 60)^2}{9.81 \times 6.12}$$

or

$$D = 69.10 \approx 75 \text{ mm}$$

Total design head (H) = $H_m + H_f + H_j + H_s$

Where,

H_j = Difference in highest junction point of the lateral and main from pump

level = 0.5 m (assume)

H_s = Suction lift (20 m, assume)

$$H = 30.6 + 6.12 + 0.5 + 20 = 57.22 \text{ m}$$

The pump has to deliver 0.009 m³s⁻¹ of water against a required head of 57.22 m

Hence, the horse power of a pump at 60% efficiency

$$= \frac{0.009 \times 57.22 \times 10^3}{0.6 \times 75} = 11.44 \text{ hp}$$

Table 38.4 Design specifications of sprinkler with different nozzle size and operating pressure for high pressure models Model HP.

Nozzle Size		Operating Pressure		Dia of Spray		Discharge		Application rate									
								12 x 12		12 x 18		18 x 18		18 x 24		24 x 24	
Range	Spread	Kg/cm ²	psi	m	ft	L s ⁻¹	gpm	cm/h	in/h	cm/h	in/h	cm/h	in/h	cm/h	in/h	cm/h	in/h
7/32" 5.5563mm	1/8" 3.175mm	2.11	30	27.7	92.3	0.588	7.76	1.50	0.58	NA	NA	NA	NA	NA	NA	NA	NA
		2.47	35	29.9	99.7	0.637	8.40	1.60	0.63	1.10	0.42	0.71	0.28	NA	NA	NA	NA
		2.82	40	32.0	106.7	0.680	8.97	1.70	0.67	1.10	0.45	0.76	0.30	NA	NA	NA	NA
		3.17	45	33.9	113.0	0.721	9.51	1.80	0.71	1.20	0.47	0.80	0.32	NA	NA	NA	NA
		3.52	50	35.8	119.3	0.760	10.03	1.90	0.75	1.30	0.50	0.74	0.33	0.63	0.25	NA	NA
		4.23	60	39.2	130.7	0.833	10.99	2.10	0.82	1.40	0.53	0.93	0.36	0.69	0.27	0.52	0.20
9/32" 7.1438mm	1/8" 3.175mm	2.11	30	31.4	104.7	0.878	11.59	2.20	0.86	1.50	0.58	0.98	0.39	NA	NA	NA	NA
		2.47	35	34.0	113.3	0.950	12.54	2.40	0.94	1.60	0.62	1.10	0.42	NA	NA	NA	NA
		2.82	40	36.3	121.0	1.016	13.41	2.50	1.00	1.70	0.67	1.10	0.44	0.85	0.33	NA	NA
		3.17	45	38.5	128.3	1.077	14.21	2.70	1.10	1.80	0.71	1.20	0.47	0.90	0.35	NA	NA
		3.52	50	40.6	135.3	1.135	14.98	2.80	1.10	1.90	0.74	1.30	0.50	0.95	0.37	0.71	0.28
		4.23	60	44.5	148.3	1.244	16.42	3.10	1.20	2.10	0.82	1.40	0.54	1.00	0.41	0.78	0.31
3/8"	1/8"	2.11	30	36.3	121.0	1.449	19.12	3.60	1.40	2.40	0.95	1.60	0.63	1.20	0.48	NA	NA

9.525mm	3.175mm	2.47	35	39.2	130.7	1.568	20.69	3.90	1.50	2.60	1.00	1.70	0.69	1.30	0.51	0.98	0.39
		2.82	40	41.9	139.7	1.676	22.12	4.20	1.60	2.80	1.10	1.90	0.73	1.40	0.55	1.00	0.41
		3.17	45	44.5	148.3	1.777	23.45	4.40	1.70	3.00	1.20	2.00	0.70	1.50	0.58	1.10	0.44
		3.52	50	46.9	156.3	1.872	24.71	4.70	1.80	3.10	1.20	2.10	0.82	1.60	0.61	1.20	0.46
		4.23	60	51.4	171.3	2.052	27.08	5.10	2.00	3.40	1.30	2.30	0.90	1.70	0.67	1.30	0.50

(Source: M/S NOCIL, Akola, Maharashtra)

Table 38.5. Design specifications of sprinkler with different nozzle size and operating pressure for low pressure models Model LP

Nozzle Size		Operating Pressure		Dia of Spray		Discharge		Application rate									
								6 x 6		6 x 9		9 x 9		6 x 12		12 x 12	
Range	Spread	Kg/cm ²	psi	m	ft	L s ⁻¹	gpm	cm/h	in/h	cm/h	in/h	cm/h	in/h	cm/h	in/h	cm/h	in/h
7/32"	1/8"	1.06	15	19.6	65.3	0.417	5.50	4.20	1.60	2.80	1.10	1.90	0.73	2.10	0.82	1.00	0.41
5.5563mm	3.175mm	1.41	20	22.6	75.3	0.481	6.34	4.80	1.90	3.20	1.30	2.10	0.84	2.40	0.95	1.20	0.47
		1.76	25	25.3	84.3	0.537	7.08	NA	NA	3.60	1.40	2.40	0.94	2.70	1.10	1.30	0.53
		2.11	30	27.7	92.3	0.588	7.076	NA	NA	3.90	1.50	2.60	1.00	2.90	1.20	1.50	0.58
		2.47	35	29.9	99.7	0.637	8.40	NA	NA	4.20	1.70	2.80	1.10	3.20	1.30	1.60	0.63
		2.87	40	32.0	106.7	0.680	8.97	NA	NA	4.50	1.80	3.00	1.20	3.40	1.30	1.70	0.67
13/64"	1/8"	1.06	15	18.9	63.0	0.374	4.93	3.70	1.50	2.50	0.98	1.70	0.65	1.90	0.74	NA	NA

5.1594mm	3.175mm	1.41	20	21.8	72.7	0.431	5.68	4.30	1.70	2.90	1.10	1.90	0.75	2.20	0.85	1.11	0.42
		1.76	25	24.3	81.0	0.482	6.36	4.80	1.90	3.20	1.30	2.10	0.84	2.40	0.95	1.20	0.47
		2.11	30	26.7	89.0	0.527	6.95	NA	NA	3.50	1.40	2.30	0.92	2.60	1.00	1.30	0.52
		2.47	35	28.9	96.3	0.571	7.53	NA	NA	3.80	1.50	2.50	1.00	2.90	1.10	1.40	0.56
		2.82	40	30.8	102.7	0.610	8.05	NA	NA	4.10	1.60	2.70	1.10	3.10	1.20	1.50	0.60
5/32"	1/8"	1.06	15	16.5	55.0	0.263	3.47	2.60	1.00	1.80	0.69	1.20	0.46	1.30	0.52	NA	NA
3.9688mm	3.175mm	1.41	20	19.1	63.7	0.303	4.00	3.00	1.20	2.00	0.80	1.30	0.53	1.50	0.60	NA	NA
		1.76	25	21.3	71.0	0.339	4.47	3.40	1.30	2.30	0.89	1.50	0.59	1.70	0.67	0.88	0.35
		2.11	30	23.4	78.0	0.371	4.89	3.70	1.50	2.50	0.97	1.60	0.65	1.90	0.73	0.93	0.37
		2.47	35	25.3	84.3	0.401	5.29	4.00	1.60	2.70	1.10	1.80	0.70	2.00	0.79	1.00	0.39
		2.82	40	27.0	90.0	0.429	5.66	4.30	1.70	2.90	1.10	1.90	0.75	2.20	0.84	1.10	0.42



LESSON 39 Application of Fertilizers and Chemicals through Sprinkler System

Sprinkler systems are also used to apply should fertilizers, herbicides, and pesticides along with water. The process of applying fertilizers along with water through pressurized irrigation system is known as the fertigation. The process of applying all types of soluble chemicals including fertilizers along with water through the pressurized irrigation system is known as chemigation. The commonly used to inject chemicals and fertilizers through a sprinkler system devices are: Pressurized tank, venture system and pump.

39.1. Advantages of Fertigation/ Chemigation

1. The fertigation/chemigation facilitates frequent application of fertilizers and chemicals to the crop in an amount as per the need of the crops during a specified crop growth stage and conditions.
2. There is controlled application of fertilizers and chemicals along with water and hence if the uniformity in application of water is high the, efficiency of application of fertilizers and chemicals will also be high.
3. There is less wastage of fertilizers and chemicals therefore saving the expensive commodity.
4. Due to efficient application, the crop yield also increases.
5. As there is controlled application, the leaching of the fertilizers and chemicals is minimized, reducing the groundwater pollution and environmental hazards.

39.2 General Points Consideration for Fertigation

1. The following points should be considered in operation of fertigation/chemigation system.
2. The fertilizers/chemicals to be used should be water soluble.
3. The fertilizers/chemicals should be injected at the upstream end of the filters to ensure that any undissolved particles of the fertilizers/chemicals are removed before entering in to the system.
4. The irrigation system should be pressurized before starting the process of fertigation and chemigation.
5. The system should be equipped with the anti-siphon device to protect the water supply from contamination of the fertilizers/chemicals. For this purpose, it is important to provide check and vacuum relief valves (anti-siphon devices) for preventing the chemical from draining or siphoning back into the irrigation well or to other water supply source. The vacuum and check valves must be located between the pump and the point of chemical injection. If water is blend from the main irrigation supply into the chemical supply tank, the connecting line too must be equipped with a check valve to prevent the supply tank from overflowing and contaminating the adjacent area with chemical solution.
6. The coefficient of uniformity (CU) of water application of irrigation system should be between 80 to 90%. This is use to ensure uniform application of the chemicals to the area that is being fertilized or treated with herbicides or pesticides. Non uniform systems would results in poor placement of the chemicals.
7. The size of the pump or rate of chemical injection into the sprinkler system should be checked closely so as to ensure desired application rate of the chemical. The rate of injection also depends on requirement: a) for continuous injection b) the entire volume of chemical is injected in the

beginning or at the end of the irrigation set. Intermittent injection requires the system to be flushed intermittently.

39.3 Fertigation / Chemigation Devices

There are several equipments available for the application of fertilisers/chemicals through the sprinkler irrigation systems. The choice of a particular method depends on: flow rate, operating pressure, type of fertilizers/chemicals to be used, concentration of the fertilisers/chemicals, time of operation and power source.

The selected equipment should be able to satisfy the following requirements.

- Desired rate of application
- Desired duration of application
- Desire proportion of fertilizers
- Starting and completion time
- Normally the concentration of the fertilizers is in the range of 200 to 500 ppm and that for bactericides it is in the 0.5 to 10 ppm

39.3.1 Pressurized Tank

A pressure differential is created by throttling the water flow in the control head and diverting a fraction of the water through a tank containing the fertilizer solution. Fig.39.1 shows a fertilizer used for sprinkler and micro irrigation system. A gradient of 0.1 to 0.2 bar (1 – 2 m) is required to redirect an adequate stream of water through a connecting tube of 9 – 12 mm diameter. The pressurized tank is generally, made of corrosion resistant enamel-coated or galvanized cast iron, stainless steel or fiberglass. This should withstand the network working pressure. The diverted water is mixed with solid soluble or liquid fertilizers in the pressure tank. Once the solid fertilizer had been fully dissolved, continuous dilution by water gradually decreases the concentration of the chemical solution. The tank should have enough capacity to store the required quantity. This device is cheap and simple to use. A wide dilution ratio can be attained without external source of energy.



Fig. 39.1. Fertilizer tank.

Limitations: Nutrient/Chemical concentration in the irrigation water cannot be precisely regulated. Prior to each application, the tank has to be refilled with fertilizer. Valve throttling generates pressure losses, and the system cannot be straight forwardly automated.

39.3.2 Venturi Injector

The fertilizer solution is injected in to the system by suction generated by water making water to flow through a constricted passageway called venturi. The high flow velocity of water in the constriction reduces water pressure below the atmospheric pressure, so that the vacuum is created and fertilizer solution is sucked from an open tank into the constriction through a small diameter tube. Fig. 39.2 shows a venturi injector used for chemicals and fertilizer injection.

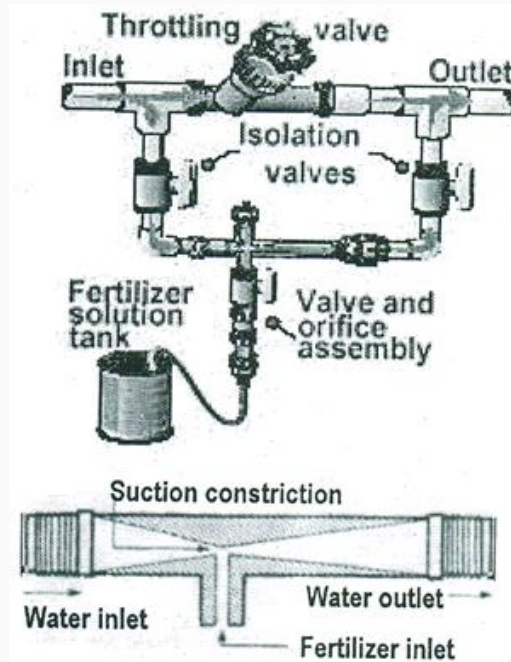

Fig. 39.2. Venturi injector.

Venturi is made of corrosion-resistant materials such as copper, brass, plastic and stainless steel. Venturi devices require excess pressure to allow for the necessary pressure loss. Maintaining a constant pressure in the irrigation system guarantees uniform long-term nutrient concentration. Common head losses are above 33% of the inlet pressure. Double stage ventury injectors have lower pressure loss and pipe diameter. It can be adjusted by valves and regulators, suction rates vary from 0.1 to 2000 . Venturi injectors are installed on the line or on a bypass. The injection rate depends upon the pressure loss, which ranges from 10% to 75% of the system's pressure and is controlled by the injector type and operating conditions. The injection rate can be controlled by

- Changing the flow through the venturi injector
- Controlling the system operating pressure
- Adjusting the control valve at discharge side
- Using the metering valve

Advantages: Cheap open tanks may be used for storing the fertilizers/chemical. A wide range of suction rates can be created by changing the diameter of the venturi dimensions of converging and diverging sides; and valves. It has simple operation and low wear. It requires easy installation and mobility. It is compatible with automation. It provides uniform nutrient concentration.

Limitations: There is a significant pressure loss. The injection rates are affected by pressure fluctuations.

39.3.3 Injection Pumps

Hydraulic Pumps: These are versatile, reliable feature low operation and maintenance costs. A diaphragm or piston movement injects the fertilizer solution into the irrigation system. Water-driven diaphragm and piston pump combine precision, reliability and low maintenance costs. Fig. 39.3 shows piston and diaphragm pump.

Hydraulic pump used in fertigation can be automated. A pulse transmitter is mounted on the pump. The movement of the piston or diaphragm spoke sends electrical signals to the controller that measures the delivered volume. Measurement can also be performed by small fertilizer-meters installed on the injection tube. The controller allocates fertilizer solution according to a preset program.

In glasshouses, simultaneous application of a multi-nutrient solution is routine practice. When the distinct chemical compounds in the fertilizers are incompatible and cannot be combined in a concentrated solution due to the risk of decomposition or precipitation, two or three injectors are installed inline one after another, in the control head. The application ratio between the injectors is coordinated by the irrigation controller. In high value crops grown in glasshouses on detached media, the irrigation water is mixed with fertilizers in a mixing chamber (mixer).

Electric Pump: Electric pumps are inexpensive and reliable (Fig.39.4). Operation costs are low. They can be readily integrated into automatic systems. A wide selection of pump is available from small low-capacity to massive high-capacity pumps. The injection pressure is the range of 1 - 10 bars. Electric piston pumps are exceptionally precise and appropriate for accurate mixing in constant proportions of several stock solutions.

Variable speed motors and variable stroke length allow for a wide range of dosing from 0.5 to 300 Lh⁻¹ at the working pressure of 2 - 10 bars.

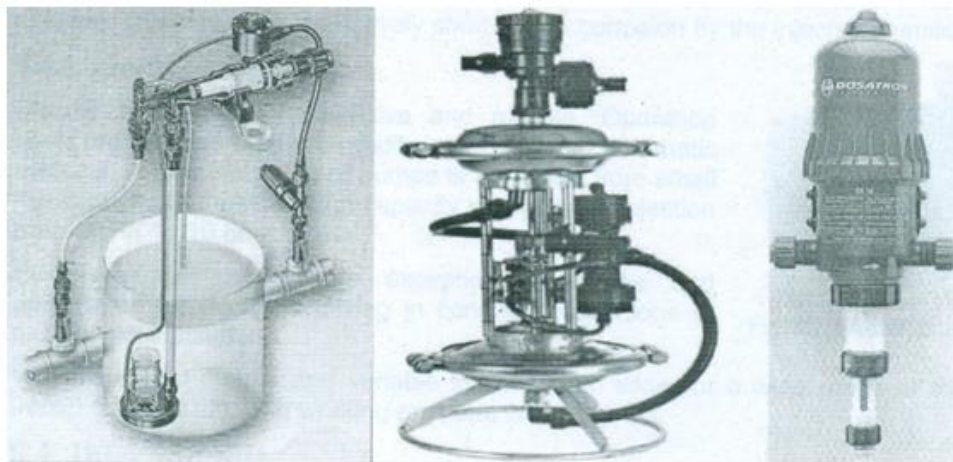

Fig. 39.3. Piston (left) and diaphragm (right) hydraulic pumps and no - drain hydraulic pump.



Fig. 39.4. Electric pump.

39.4 Dosing Patterns

Normally two types of dosing are practiced for chemicals and fertilizers injection. These are: i) quantitative and ii) proportional dosing.

I) Quantitative Dosing: A measured amount of fertilizer is injected into the irrigation system during each water application. Injection may be initiated and controlled automatically or manually.

ii) Proportional Dosing: It maintains a constant predetermined ratio between the irrigation water and the fertilizer solution. Pumps inject the fertilizer solution in a pulsating pattern. Venturi injectors apply the fertilizer continuously and in constant concentration.

39.5 Prevention and Precautions

Avoiding Corrosion Damage: Most fertilizer solutions are corrosive. Accessories exposed to the injected solution should be corrosion-resistant. The injection device and irrigation system must be thoroughly flushed after fertilizer injection.

Backflow Prevention: Whenever the irrigation system is connected to a potable water supply network, strict precautions should be taken to avoid backflow of fertilizer containing irrigation water. Fig. 39.5 shows back flow prevention valves.

Back - siphonage: Back siphonage occurs when low pressure in the supply line is created by an excessive hydraulic gradient in undersized pipes in the supply line. A break in the supply line, pump or power failure occurs.

Back - Pressure: It occurs when the pressure in the irrigation system is higher than in the water supply network. This happens when booster pumps are used for irrigation or when the area under irrigation is topographically higher than a local water supply tank.



Fig. 39.5. Tadem backflow preventer.

An atmospheric vacuum breaker installed beyond the last valve allows air to enter downstream when pressure falls. A pressure vacuum breaker has an atmospheric vent valve that is internally loaded by a

spring. This valve is unsuitable for fertigation system and it is operated by an external source of energy. Vacuum breakers are effective only against back- siphonage and do not prevent back-pressure.

Location of Fertigation Device: The fertigation devices should be installed between the sand filter, (if installed) and the screen or disc filter. It is essential that the fertigation devices be installed at the upstream end of the screen or disc filters to prevent any impurities in the fertiler/chemical solution from entering the irrigation system.

39.6 Fertilizer Quantity Computation

The quantity of fertilizer to be injected in the system is calculated using the following formula given by Michael (2010).

$$W_F = \frac{D_s \times D_l \times N_s \times Q_f}{10,000}$$

in which,

W_F = amount of fertilizer required in per setting, kg

D_s = distance between sprinklers, m

D_l = distance between laterals, m

N_s = number of sprinklers, and

Q_f = recommended fertilizer dose, kg/ha

Example 39.1: A sprinkler system is used apply fertilizer at the recommended dose of 60 kg/h at each setting. The sprinkler laterals are spaced at 20 m on the main line. Ten sprinklers are attached in a lateral and these are spaced at 12 m apart. Determine the amount of fertilizer to be applied in each setting.

Solution:

$D_s = 12$ m, $D_l = 20$ m, $N_s = 10$ and $Q_f = 60$ kg/ha

$$W_F = \frac{D_s \times D_l \times N_s \times Q_f}{10,000}$$

$$= 14.4 \text{ kg}$$

39.1. Advantages of Fertigation / Chemigation

- i) The fertigation/chemigation facilitates frequent application of fertilizers and chemicals to the crop in an amount as per the need of the crops during a specified crop growth stage and conditions.
- ii) There is controlled application of fertilizers and chemicals along with water and hence if the uniformity in application of water is high the, efficiency of application of fertilizers and chemicals will also be high.
- iii) There is less wastage of fertilizers and chemicals therefore saving the expensive commodity.
- iv) Due to efficient application, the crop yield also increases.

- v) As there is controlled application, the leaching of the fertilizers and chemicals is minimized, reducing the groundwater pollution and environmental hazards.

39.2 General Points Consideration for Fertigation

The following points should be considered in operation of fertigation/chemigation system.

- i) The fertilizers/chemicals to be used should be water soluble.
- ii) The fertilizers/chemicals should be injected at the upstream end of the filters to ensure that any undissolved particles of the fertilizers/chemicals are removed before entering in to the system.
- iii) The irrigation system should be pressurized before starting the process of fertigation and chemigation.
- iv) The system should be equipped with the anti-siphon device to protect the water supply from contamination of the fertilizers/chemicals. For this purpose, it is important to provide check and vacuum relief valves (anti-siphon devices) for preventing the chemical from draining or siphoning back into the irrigation well or to other water supply source. The vacuum and check valves must be located between the pump and the point of chemical injection. If water is blend from the main irrigation supply into the chemical supply tank, the connecting line too must be equipped with a check valve to prevent the supply tank from overflowing and contaminating the adjacent area with chemical solution.
- v) The coefficient of uniformity (CU) of water application of irrigation system should be between 80 to 90%. This is use to ensure uniform application of the chemicals to the area that is being fertilized or treated with herbicides or pesticides. Non uniform systems would results in poor placement of the chemicals.
- vi) The size of the pump or rate of chemical injection into the sprinkler system should be checked closely so as to ensure desired application rate of the chemical. The rate of injection also depends on requirement: a) for continuous injection b) the entire volume of chemical is injected in the beginning or at the end of the irrigation set. Intermittent injection requires the system to be flushed intermittently.

39.3 Fertigation / Chemigation Devices

There are several equipments available for the application of fertisers/chemicals through the sprinkler irrigation systems. The choice of a particular method depends on: flow rate, operating pressure, type of fertilizers/chemicals to be used, concentration of the fertisers/chemicals, time of operation and power source.

The selected equipment should be able to satisfy the following requirements.

- Desired rate of application
- Desired duration of application
- Desire proportion of fertilizers
- Staring and completion time
- Normally the concentration of the fertilizers is in the range of 200 to 500 ppm and that for bactericides it is in the 0.5 to 10 ppm

39.3.1 Pressurized Tank

A pressure differential is created by throttling the water flow in the control head and diverting a fraction of the water through a tank containing the fertilizer solution. Fig.39.1 shows a fertilizer used for sprinkler and micro irrigation system. A gradient of 0.1 to 0.2 bar (1 – 2 m) is required to redirect an adequate stream of water through a connecting tube of 9 – 12 mm diameter. The pressurized tank is generally, made of corrosion resistant enamel-coated or galvanized cast iron, stainless steel or fiberglass. This should withstand the network working pressure. The diverted water is mixed with solid soluble or liquid fertilizers in the pressure tank. Once the solid fertilizer had been fully dissolved, continuous dilution by water gradually decreases the concentration of the chemical solution. The tank should have enough capacity to store the required quantity. This device is cheap and simple to use. A wide dilution ratio can be attained without external source of energy.

Limitations: Nutrient/Chemical concentration in the irrigation water cannot be precisely regulated. Prior to each application, the tank has to be refilled with fertilizer. Valve throttling generates pressure losses, and the system cannot be straight forwardly automated.

39.3.2 Venturi Injector

The fertilizer solution is injected in to the system by suction generated by water making water-to flow through a constricted passageway called venturi. The high flow velocity of water in the constriction reduces water pressure below the atmospheric pressure, so that the vacuum is created and fertilizer solution is sucked from an open tank into the constriction through a small diameter tube. Fig. 39.2 shows a venturi injector used for chemicals and fertilizer injection.

Venturi is made of corrosion-resistant materials such as copper, brass, plastic and stainless steel. Venturi devices require excess pressure to allow for the necessary pressure loss. Maintaining a constant pressure in the irrigation system guarantees uniform long-term nutrient concentration. Common head losses are above 33% of the inlet pressure. Double stage ventury injectors have lower pressure loss and pipe diameter. It can be adjusted by valves and regulators, suction rates vary from 0.1 to 2000 . Venturi injectors are installed on the line or on a bypass. The injection rate depends upon the pressure loss, which ranges from 10% to 75% of the system's pressure and is controlled by the injector type and operating conditions. The injection rate can be controlled by

- Changing the flow through the venture injector
- Controlling the system operating pressure
- Adjusting the control valve at discharge side
- Using the metering valve

Advantages: Cheap open tanks may be used for storing the fertilizers/chemical. A wide range of suction rates can be created by changing the diameter of the venturi dimensions of converging and diverging sides; and valves. It has simple operation and low wear. It requires easy installation and mobility. It is compatible with automation. It provides uniform nutrient concentration.

Limitations: There is a significant pressure loss. The injection rates are affected by pressure fluctuations.

39.3.3 Injection Pumps

Hydraulic Pumps: These are versatile, reliable feature low operation and maintenance costs. A diaphragm or piston movement injects the fertilizer solution into the irrigation system. Water-driven diaphragm and piston pump combine precision, reliability and low maintenance costs. Fig. 39.3 shows piston and diaphragm pump.

Hydraulic pump used in fertigation can be automated. A pulse transmitter is mounted on the pump. The movement of the piston or diaphragm spoke sends electrical signals to the controller that measures the delivered volume. Measurement can also be performed by small fertilizer-meters installed on the injection tube. The controller allocates fertilizer solution according to a preset program.

In glasshouses, simultaneous application of a multi-nutrient solution is routine practice. When the distinct chemical compounds in the fertilizers are incompatible and cannot be combined in a concentrated solution due to the risk of decomposition or precipitation, two or three injectors are installed inline one after another, in the control head. The application ratio between the injectors is coordinated by the irrigation controller. In high value crops grown in glasshouses on detached media, the irrigation water is mixed with fertilizers in a mixing chamber (mixer).

Electric Pump: Electric pumps are inexpensive and reliable (Fig.39.4). Operation costs are low. They can be readily integrated into automatic systems. A wide selection of pump is available from small low-capacity to massive high-capacity pumps. The injection pressure is the range of 1 – 10 bars. Electric piston pumps are exceptionally precise and appropriate for accurate mixing in constant proportions of several stock solutions.

Variable speed motors and variable stroke length allow for a wide range of dosing from 0.5 to 300 Lh⁻¹ at the working pressure of 2 – 10 bars.

Fig. 39.3. Piston (left) and diaphragm (right) hydraulic pumps and no – drain hydraulic pump.

Fig. 39.4. Electric pump.

39.4 Dosing Patterns

Normally two types of dosing are practiced for chemicals and fertilizers injection. These are: i) quantitative and ii) proportional dosing.

I) Quantitative Dosing: A measured amount of fertilizer is injected into the irrigation system during each water application. Injection may be initiated and controlled automatically or manually.

ii) Proportional Dosing: It maintains a constant predetermined ratio between the irrigation water and the fertilizer solution. Pumps inject the fertilizer solution in a pulsating pattern. Venturi injectors apply the fertilizer continuously and in constant concentration.

39.5 Prevention and Precautions

Avoiding Corrosion Damage: Most fertilizer solutions are corrosive. Accessories exposed to the injected solution should be corrosion-resistant. The injection device and irrigation system must be thoroughly flushed after fertilizer injection.

Backflow Prevention: Whenever the irrigation system is connected to a potable water supply network, strict precautions should be taken to avoid backflow of fertilizer containing irrigation water. Fig. 39.5 shows back flow prevention valves.

Back – siphonage: Back siphonage occurs when low pressure in the supply line is created by an excessive hydraulic gradient in undersized pipes in the supply line. A break in the supply line, pump or power failure occurs.

Back – Pressure: It occurs when the pressure in the irrigation system is higher than in the water supply network. This happens when booster pumps are used for irrigation or when the area under irrigation is topographically higher than a local water supply tank.

Fig. 39.5. Tedem backflow preventer.
(Source: <http://www.amiad.com/products.asp>)

An atmospheric vacuum breaker installed beyond the last valve allows air to enter downstream when pressure falls. A pressure vacuum breaker has an atmospheric vent valve that is internally loaded by a

spring. This valve is unsuitable for fertigation system and it is operated by an external source of energy. Vacuum breakers are effective only against back-siphonage and do not prevent back-pressure.

Location of Fertigation Device: The fertigation devices should be installed between the sand filter, (if installed) and the screen or disc filter. It is essential that the fertigation devices be installed at the upstream end of the screen or disc filters to prevent any impurities in the fertiliser/chemical solution from entering the irrigation system.

39.6 Fertilizer Quantity Computation

The quantity of fertilizer to be injected in the system is calculated using the following formula given by Michael (2010).

in which,

= amount of fertilizer required in per setting, kg

= distance between sprinklers, m

= distance between laterals, m

number of sprinklers, and

= recommended fertilizer dose, kg/ha

Example 39.1: A sprinkler system is used apply fertilizer at the recommended dose of 60 kg/h at each setting. The sprinkler laterals are spaced at 20 m on the main line. Ten sprinklers are attached in a lateral and these are spaced at 12 m apart. Determine the amount of fertilizer to be applied in each setting.

Solution:

$D_s = 12 \text{ m}$, $D_m = 20 \text{ m}$, $N_s = 14$ and $Q_f = 60 \text{ kg/ha}$

= 14.4 kg



LESSON 40 Evaluation of Rotating Head Sprinklers and Operation of Sprinkler System

40.1 Evaluation of a Sprinkler Head

The sprinkler head is evaluated based on the water distribution pattern from the sprinkler nozzle, discharge of sprinkler nozzle, radius of throw, sprinkler rotation and precipitation or water application depth collected in a standard catch can under set of condition specified in the BIS (IS: 10802-1984).

40.1.1 Site Conditions and Test Equipment

i) Sprinkler site: The sprinkler should be located in an area where the surface is smooth or where vegetative growth is less than 150 mm in height. The surface grade should not exceed 2 percent within the wetted area of sprinkler under test.

ii) Collector Description and Location: The collectors or catch cans used for any one test should be such that the water does not splash in or out. The type of collector should be identified and recorded on the data sheet. If an evaporation suppressant is used its type and method of application should be identified and recorded on the data sheet. The spacing of the collectors depends on the radius of throw of the sprinklers and given in Table 40.1.

Table 40.1. Spacing of collectors

Sprinkler radius of throw, m	Maximum collector spacing center to center, m
0.3-3	0.30
3-6	0.60
6-12	0.75
>12	1.50

iii) Sprinkler mounting: The sprinkler nozzle height above the nearest collector(s) for test purposes is given in Table: 40.2.

Table 40.2. Nozzle heights

SL. No.	Sprinkler type	Maximum nozzle height above collector (mm)
1	Riser mounted, rotating sprinkler of not more than 30 mm nominal inlet size	915
2	Riser mounted, rotating sprinkler of not less than 30 mm nominal inlet size	1830
3	Riser mounted, non-rotating sprinkler	460
4	Grade mounted sprinkler	Sprinkler lid level with the collector in the non-operating position
5	Hose end base mounted sprinkler	Bottom of sprinkler base to be level with the collector inlet.

- iv) The sprinkler should remain vertical (within 2^o) throughout the duration of the test.
- v) The position of all collectors should be maintained such that the entrance portion is level.
- vi) The height of the top of any collector should be a maximum of 0.9 m above the ground.

40.1.2 Wind Measuring Equipment and Location for Outdoor Tests

The sprinkling pattern is influenced by wind; hence the measurement of wind velocity and direction are required to be known for sprinkler performance. Wind velocity should be measured with a rotating cup anemometer. The wind direction should be determined with a wind vane. Wind velocity sensing equipment should be located at a minimum height of 4.0 m. These equipments should be located outside the wetted area of the sprinkler and at a location that is representative of the wind conditions at the sprinkler location. The maximum distance of the sensor location should exceed 45 m from the wetted area of the sprinkler under test.

40.1.3 Measurements

i) Sprinkler Pressure: The sprinkler base pressure should not vary more than ± 3 percent during the test period. Pressure should be measured with pressure measuring device accurate within ± 3 percent of the sprinkler test pressure and recorded in kPa. The pitot tube is the commonly used pressure measuring device for measuring the pressure at the nozzle of the sprinkler.

ii) Sprinkler Flow: The flow through the sprinkler should be measured to an accuracy of ± 3 percent of the sprinkler flow rate and recorded in m³/h. Data rates up to 95 m³/h. Rates than 95 m³/h should be listed to at least the nearest 0.2 m³/h. Data rates up to 95 m³/h. Rates than 95 m³/h should be listed to at least the nearest 0.2 m³/h. The flow rate can be measured by connecting the tube to the nozzle and measuring the volume of water collected in a water tank for a specified time.

iii) Sprinkler Radius of Throw

- a) The radius for rotating sprinklers should be defined as the distance measured from the sprinkler centerline to the farthest point at which the sprinkler deposits water at the minimum rate of 0.25 mm/h over the inlet surface area of the collector.
- b) The radius for non-rotating sprinklers should be defined as the farthest distance measured from the sprinkler centerline to the point at which the sprinkler deposits water at the minimum rate of 0.25 mm/h typically measured at any arc of coverage except at the arc extremes of part circle sprinklers.
- c) The radius of throw for both full and part circle sprinklers should be reported to the nearest 0.3 m.
- iv) Sprinkler Rotation: The sprinkler rotation speed should be measured only while the sprinkler is rotating from its own drive mechanisms and should be recorded.
- v) Collector Readings: The amount of water in each collector should be accurately determined and recorded showing the location of the collectors relative to the sprinkler. For multi-leg tests, the reading for each leg should be recorded independently.
- vi) Test Records and Data Recording: The data outlined in this section should be recorded on appropriate forms. Supplemental data describing the conduct of the test may be included on the form.

40.2 Moisture Distribution Pattern and Uniformity of Coverage

The application efficiency of sprinkler depends upon the degree of uniformity of water application. The basic objective of sprinkler irrigation is to apply uniform depth of water at a given application rate. The uniformity of water application depends upon the water spray distribution characteristics of sprinkler nozzle and sprinkler spacing. The spray distribution characteristics change with nozzle size and operating pressure. The drops are larger and the water from the nozzle falls in a ring away from the sprinkler at lower pressures. For higher pressures, the water from the nozzle breaks up into very fine drops and falls close to the sprinkler. External factors such as wind also distort the application pattern. Higher the wind velocity, greater the distortion and this factor should be considered when selecting the sprinkler spacing under windy conditions. This distribution pattern from sprinklers for favorable wind conditions and optimum pressure is shown in Fig. 40.1. It can be seen that the depth of water applied surrounding the sprinkler decreases with increase in the distance from the sprinkler. Similar pattern of the water in the soil can be observed in figure. The figure clearly shows that the pattern of moisture distribution is not uniform with the single sprinkler. Therefore to obtain the uniformity in water application, it is necessary that the moisture distribution pattern of the adjacent sprinklers be overlapped properly. Fig. 40.2 shows the water distribution pattern of overlapped sprinklers. The wetted circles formed by adjacent sprinklers are overlapped so as to add water to areas of the adjoining sprinklers for obtaining the depth of water application. The aggregate depth of distribution obtained by overlapping thus becomes nearly uniform as shown in Fig. 40.2.

The Fig 40.1 also shows the moisture distribution pattern of a rotating head sprinkler under windy conditions and corresponding moisture distribution in soil.

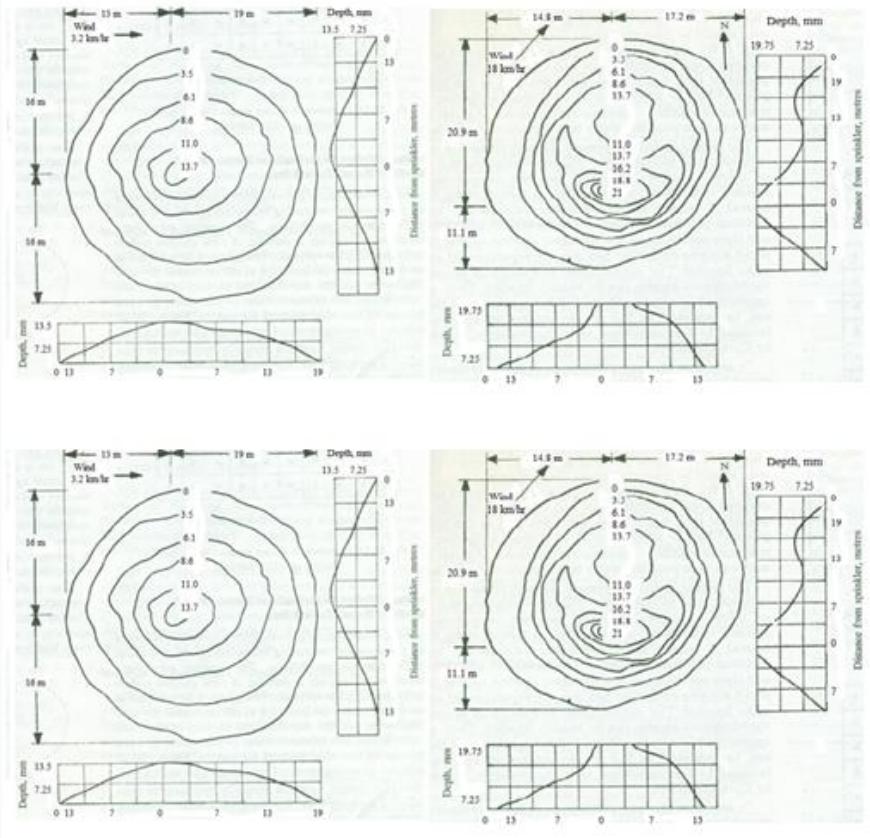

Fig. 40.1. Moisture distribution pattern from a rotating head sprinkler under favourable & windy conditions of pressure and wind.

(Source: Michael, 2010)

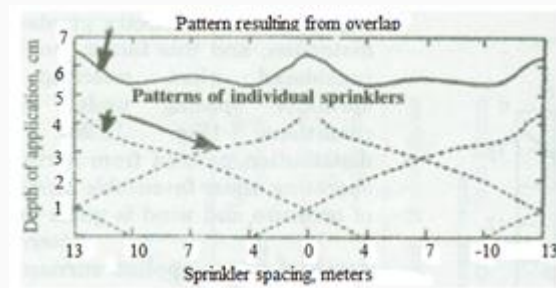

Fig. 40.2. Water distribution pattern from overlapped sprinklers.

(Source: Michael, 2010)

40.3 Uniformity of Coverage

Measuring Distributions: The distribution of sprinkler systems can be evaluated by measuring the patterns of individual sprinklers, and then by combining, as discussed in the previous section, or by sampling directly, ASAE Recommendations S330 (ASAE Yearbook, 1979) describes procedures for measuring the distribution of a single sprinkler including the format for presenting the data. According to ASAE measurements the test site should be nearly level and the minimum clean distance upwind should be positioned at least 60 cm above the collectors, and 90cm above the surface. Preferably, the sprinkler should be located in the center of the grid of the four adjacent central collectors. A minimum of 80 collectors should receive water during a test. Wind direction and total wind movement at the 4-m height should be recorded for interpretation of the data. The distribution of a typical sprinkler system can be evaluated with

a grid of catch cans or collectors. The grid should be located over a length equal to at least the sprinkler spacing on the lateral and over a width at least equal to lateral spacing. For linear moving systems, one or two lines of measuring devices perpendicular to the travel path may be more practical and meaningful than a grid system.

Uniformity Coefficients (C_u): It is a measurable index of the degree of uniformity obtainable for any size sprinkler operating under given conditions. This uniformity coefficient is affected by the pressure nozzle size relations, sprinkler spacing and by wind conditions. The coefficient is computed from field observations of the depths of water collected in catch cans or collectors placed at regular intervals within a sprinkled area as per procedure described in preceding sections. It is expressed by the equation developed by Christiansen (1942):

$$C_u = 100\left(1.0 - \frac{\sum X}{mn}\right) \quad (40.1)$$

in which

C_u = coefficient of uniformity

m = average value of all observations (average application rate), mm

n = total number of observation points

X = numerical deviation of individual observations from the average application rate, mm.

A uniformity coefficient of 100 per cent (obtained with overlapping sprinklers) is indicative of absolutely uniform application, whereas the water application is less uniform with a lower value of coefficient. A uniformity coefficient of 85 per cent or more is considered to be satisfactory.

Pattern Efficiency: The pattern efficiency (also known as distribution efficiency) is calculated with the total depths of water collected at each of the catch cans placed at the grid points. The minimum depth is calculated considering average of the lowest one fourth of the depths collected in catch cans used in a particular test. Pattern efficiency is given by

$$P_e = \frac{\text{min. depth}}{\text{average depth}} \times 100 \quad (40.2)$$

The pattern efficiency is useful in calculating the average depth to be applied for a certain minimum depth. The pattern efficiency is influenced by the wind conditions.

The application efficiency is given by

$$\text{Application efficiency} = \frac{\text{Min. rate caught}}{\text{Average rate applied}} \quad (40.3)$$

40.4 Operation and Maintenance

The operation mode for a solid-set or permanent sprinkler system depends upon the design and use of the system, available labor, water supply, and available capital. Either system can be designed on the lateral or area (block) design method. With the lateral design method, individual laterals are controlled by valves and each lateral may be operated as desired. Normally, more than one lateral is operated simultaneously, but the operating laterals usually are widely separated in the field. The lateral design method minimizes the main or supply line pipe size, but it increases the number of valves required and also the time to open

and close valves when a manually operated valve system is used. With the area (or block) design method, a contiguous portion of the field is irrigated at one time. Usually a sub-main is installed to supply water to that portion of the field.

For frost and snow protection, the entire system may be operated at one time. Depending upon the crop being protected, the application rate will be 2 to 5 mm (0.08 to 0.18 in.) per hour. Both undertree and overtree systems are used; however with saline water only undertree systems should be used. Single nozzle, medium pressure sprinklers should be used for frost and snow protection. For crop cooling and blossom delay, the entire system may be sequenced in alternate on-off modes as one portion of the system may be operated at a time and the operation can be switched to another portion of the system. Sequencing is best accomplished with electric controllers and automatic valves. If the system is being used strictly for irrigation, only a portion of the system is normally operated at one time. Where several hours are required for irrigation, control may be manual or automatic.

A sprinkler system like any other farm equipment needs maintenance to keep it operating at peak efficiency. Parts of the system subject to wear are the rotating sprinkler heads, the pumping set, the couplers and the pipeline. General principle regarding the maintenance of the pipes and fittings and sprinkler heads are given below:

1. Pipes and Fittings: The pipes and fittings require virtually no maintenance but attention must be given to the following procedures:

- (a) Occasionally clean any dirt or sand out of the groove in the coupler in which the rubber sealing ring fits. Any accumulation of dirt or sand will affect the performance of the rubber sealing ring.
- (b) Keep all nuts and bolt tight.
- (c) Do not lay pipes on new damp concrete or on piles of fertilizer. Do not lay fertilizer sacks on the pipe.

The pipes are automatically emptied and ready to be moved. When the pump is first started and before the pressure has built up in the system the seals may give a little leakage. With full pressure in the system the couplers and fittings will be effectively leak free. If however there is a leakage check the following:

- (a) There is no accumulation of dirt or sand in the groove in the coupler in which the sealing ring fits. Clean out any dirt or sand and refit the sealing ring.
- (b) The end of the pipe going inside the coupler is smooth clean and not distorted.
- (c) In the case of fittings such as bends, tees and reducers ensure that the fitting has been properly connected into the coupler.

2. Sprinkler Heads: The sprinkler heads should be given the following attention.

- (a) When moving the sprinkler lines make sure that the sprinklers are not damaged or pushed into the soil.
- (b) Do not apply oil, grease or any lubricant to the sprinklers. They are water lubricated and using oil, grease or any other lubricant may stop them from working.
- (c) Sprinkler usually have a sealed bearing and at the bottom of the bearing there are washers. Usually it is the washers that wear and not the more expensive metal parts. Check the washers for wear once a season or every six months this is especially important where water is sandy. Replace the washers if worn.

(d) After several seasons operation the swing arm spring may need tightening. This is done by pulling out the spring end at the top and rebending it. This will increase the spring tension. In general check all equipment at the end of the season and make any repairs and adjustment and order the spare parts immediately so that the equipment is in perfect condition to start in the next season.

Storage: The following points are to be observed while storing the sprinkler equipment during the off season:

- (a) Remove the sprinklers and store in a cool dry place.
- (b) Remove the rubber sealing rings from the couplers and fittings and store them in a cool, dark place.
- (c) The pipes can be stored outdoors in which cases they should be placed in racks with one end higher than the other. Do not store pipes along with fertilizer.
- (d) Disconnect the suction and delivery pipe work from the pump and pour in a small quantity of medium grade oil. Rotate the pump for a few minutes. Blank off the suction and delivery branches. This will prevent the pump from rusting. Grease the shaft.
- (e) Protect the electric motor from the ingress of dust, dampness and rodents.

40.5 Common Troubles and Remedies in Operation of Sprinkler System

The following are the general guidelines to identify and remove the common troubles in the sprinkler systems:

1) Pump does not Prime or Delivers Water

- i) The pump suction lift should be checked, if it is within the limits. If not lower the pump closer to the water.
- ii) Check the suction pipeline and all connections for air leaks. All connections and flanges should be air tight.
- iii) Check that the strainer on the foot valve is not blocked
- iv) Check that the flap in the foot valve is free to open fully.
- v) Check the pump gland (s) gently. If necessary repack the gland (s) using a thick grease to seal the gland satisfactorily.
- vi) Check that the gate valve on the delivery pipe is fully closed during priming and opens fully when the pump is running.
- vii) Check that the direction of rotation of the pump is correct.

2) Sprinklers do not Turn

- i) Check pressure.
- ii) Check that the nozzle is not blocked. Preferably unscrew the nozzle or use a small soft piece of wood to clear the blockage. Do not use a piece of wire or metal as this may damage the nozzle.

- iii) Check that the sprinkler can usually be pushed down towards the riser pipes so that the water pressure flushes out the bearing. If the bearing is still stiff dismantle and then clean it. Do not use oil, grease or any lubricant.
- iv) Check that the condition of washers at the bottom of the bearing and replace them if worn or damaged.
- v) Check that the swing arm moves freely and that the spoon which moves into the water stream is not bent by comparing it with a sprinkler which is operating correctly. If it is bent then very carefully bend it back into position.
- vi) Adjust the swing arm spring tension. Usually it should not be necessary to pull up the spring by more than about 6mm.

3) Leakage from Coupler or Fittings

The sealing rings in the couplers and fittings are usually designed to drain the water from the pipes when the pressure is turned off. This ensures that the pipes are automatically emptied and ready to be moved. When the pump is first started and before the pressure has built up in the system the seals may give a little leakage. With full pressure in the system the couplers and fittings will be effectively leak-free. If, however, there is a leakage, check the following:

- i) There is no accumulation of dirt or sand in the groove of the coupler in which the sealing ring fits. Clean out any dirt or sand and refit the sealing ring.
- ii) The end of the pipe going inside the coupler is smooth, clean and not distorted.
- iii) In the case of fittings such as bends, tees and reducers ensure that the fitting has been properly connected into the coupler.

Example 1: Determine the uniformity coefficient, Pattern and application efficiencies from the following data obtained from a field test on a square plot bounded by four sprinklers:

Sprinkler (S) - 4.76 x 3.2 mm nozzles at 2.8 kg/cm³

Spacing- 16 m x 12 m

Wind- 5 km/hr from south-west

Humidity- 49 percent

Time of test- 2 hour

S	9.4	8.1	7.1	S
8.6	8.1	10.4	10.7	8.8
9.4	9.6	9.6	9.9	9.4
9.9	8.4	9.6	9.1	9.6
S	8.4	7.1	7.3	S

Note: S indicates location of sprinklers.

Solution:

Observation	Frequency	Application rate x frequency	Numerical deviations	Frequency x deviations
10.7	1	10.7	1.6	1.6
10.4	1	10.4	1.3	1.3
9.9	2	19.8	0.8	1.6
9.6	4	38.4	0.5	2
9.4	3	28.2	0.3	0.9
9.1	1	9.1	0	0
8.8	1	8.8	0.3	0.3
8.6	1	8.6	0.5	0.5
8.4	2	16.8	0.7	1.4
8.1	2	16.2	1	2
7.3	1	7.3	1.8	1.8
7.1	2	14.2	2	4
	21	188.5		$\Sigma X=17.4$

Mean = = 8.97

$C_u = 100$

= 100

Total catch in 21 locations=188.5 mm in 2 hours

Average catch (188.5/21) = 8.97

Average of the lowest one fourth of the cans (5 out of 21)

$$= (37.7/5)=7.54 \text{ mm or } 3.77 \text{ mm/hr}$$

Pattern efficiency = (7.54/8.97) *100= 84 percent

Average rate applied =

$$= 0.45 \text{ cm/hr}$$

Application efficiency = (0.377/0.56) x 100= 83.77 percent

LESSON 41 Drip Irrigation

41.1 Introduction

Drip irrigation also called as trickle irrigation is the method of applying filtered water (and fertilizers soluble in water) at a low discharge through the emitters or drippers directly onto or in to the soil. The pressure that need to maintained at the emitters, also called as operating pressure, is usually small operating pressure (20 to 200 kPa or 1 to 2 kg/cm²) compared to the operating pressure required at the nozzle or sprinkler of the sprinkler irrigation system. The discharge of the emitter varies from 0.5 to 12 lph depending on the soil type, discharge available at the source and the area to be irrigated. The low discharge of the emitter results in partial wetting of soil root zone.

The drip irrigation is one of the micro irrigation methods. The micro irrigation method is the low pressure irrigation system that sprays, sprinkles, mists, delivers or drips the water frequently at low discharges onto or into the soil near the plant roots and causing only partial wetting of the soil surface. The other types of the micro irrigation methods are micro-sprinkler, micro-jet, bubbler. In micro irrigation methods water is conveyed through the network of the pipes directly in to the field and applied at or near the crop root zone. Micro irrigation differs from sprinkler irrigation by the fact the only part of the soil surface is wetted in micro irrigation methods and these methods operate on low pressure and deliver low discharge.

A precise amount of water equal to daily consumptive use or the depleted soil water that change with crop growth stages and weather conditions can be applied through drip irrigation methods. In this method the soil water can be maintained near to field capacity (or within allowable depletion range) or at low tensions during the entire crop growth period. Due to regulated flow in low volumes, deep percolation losses can be completely prevented and evaporation loss is also reduced. Therefore this method is preferable in arid regions where water is scarce compared to others methods. Due to the provision of frequent water application and possibility of maintaining the soil at low tension poor quality water in respect of salt concentration can also be used. It enables application of fertilizer along with irrigation water. Due to these facts, drip irrigation ensures optimum growth, better fruiting and early maturity of crops by assuring balanced soil water, air and nutrients throughout the crop period.

41.2 Advantages and Limitations of Drip Irrigation

Due to the possibility of applying water frequently in low volumes along with fertilizer and causing only partial wetting of soil, this method offers various advantages over the surface and sprinkler irrigation methods. However at the same time, this method involves high level of technology compared to the surface irrigation method and therefore for its successful operation, the method needs to be

used carefully. This section describes the advantage and disadvantages of drip irrigation method along with its adoptability.

41.2.1 Advantages

- **Water Savings:** In drip irrigation system, the water is not moved over the soil surface or through the air. Therefore the conveyance losses are totally eliminated. As water does not come in contact with the foliage, the interception losses are also eliminated. In addition to this as this method can wet only the desired soil root zone keeping other portion of the soil dry, the losses in application are also reduced. Due to regulated flow and application of water in low volumes, the deep percolation losses are also reduced to a great extent. All these utilities in drip irrigation method make this method to use water efficiently and reduce/eliminate the

water losses in the process of conveyance, distribution, application and storage. Therefore this method can save water to the extent of 40 to 60 % without compromising the crop growth.

- **Improved Plant Growth and Crop Yield:** As this method allows the efficient application of water in low volumes frequently, it is possible to maintain the water content in the soil root zone near to the field capacity or within allowable depletion soil moisture. At this level the soil moisture tension is low and the plant need not to exert much to extract water from the soil. Therefore the plants are not subjected to water stress during the entire crop growth period. This also maintains the favorable air and water ratio in the soil root zone and thus improving the plant growth and in the process obtaining the higher crop yield compared to other methods. It has been reported that drip irrigation increases the yield from 10 to 60% depending upon soils and crops over conventional methods of irrigation (INCID, 1994).
- **Labor & Saving:** There is considerable saving in labor, as the well-designed system needs labor only to start or stop the system. This method is also adaptable to automation of low to high level in water and fertilizer application. Therefore the expenses on the manual labourer can be reduced to a great extent.
- **Energy Saving:** Because of high irrigation efficiency, less amount of water is required to be applied and hence less time is required to supply the desired quantity of water and therefore this, method saves energy. In addition to this the low pressure is required to operate the emitters compared to sprinkler irrigation system, therefore there is a need of low horse power pump, further causing the saving in energy.
- **Suitability to Poor Soils:** Very light soils are difficult to irrigate by conventional methods due to deep percolation of water. Like-wise, very heavy soils with low infiltration rates are difficult to irrigate even by sprinkler method. However, drip irrigation has been found successful in both types of soils.
- **Weed Control:** In drip method, due to partial wetting of soil, weed infestation is very less in comparison to other methods of irrigation. This reduces the need of expensive and environmentally hazardous chemicals and laborers for the application of these chemicals.
- **Economy in Cultural Practices & Operations:** Besides achieving effective control of weeds, it also increases the efficiency of other operations like spraying, weeding, harvesting etc. due to the possibility of arranging the geometry of the plantation to suit to these operations. There by reducing the operational costs even upto the extent of 50%.
- **Use of Brackish/Saline Water:** In this method the soil moisture can be maintained at low tension and therefore best suited to the application of brackish/saline water which is otherwise not possible in surface irrigation method due to moisture at high tension because of prolonged interval between two irrigations. As the irrigation requirement of this method is almost reduced by more than 50%, the use of water with salt loads cause the less salt accumulation compared to surface irrigation methods.
- **Enhanced Fertilizer Application Efficiency:** In drip irrigation system, water soluble fertilizers can be applied. As water can be precisely applied in the root zone, fertilizer can also be applied in the root zone of the crop only. Therefore the losses of fertilizers in the process of deep percolation, leaching, runoff etc can be considerably eliminated enhancing the saving of precious fertilizer and causing the minimum hazards to the environment reducing the groundwater pollution.

- **No Soil Erosion:** As water is not moved over the land surface, there is no soil erosion due to drip irrigation.
- **No Land Preparation:** Preparation of leveled bed, bund and channels is not necessary as water is not required to move on the land surface. Only land smoothing will suffice.
- **Minimum Diseases and Pest Problems:** In drip system, because of less atmospheric humidity minimum diseases and pest problems are observed.
- **Adaptability to Application of Mulches:** In water scarce region, the mulching has been found very successful for saving water. The drip irrigation method wherein the drippers can be placed below the mulch cover is suitable for the situations where the mulches are required to be used. The drip irrigation method along with the mulching has been found a very formidable option in regions where water shortage is acute.

41.2.2 Limitations

The limitations of drip system are

- **Initial Heavy investment:** The drip irrigation method involves the use of several components to apply water as per its principle compared to surface and sprinkler irrigation methods. Therefore the initial cost required for the procurement of these components of the system and its installation is high. Often farmers may not afford this investment. However realizing the importance of this method in water saving and other factors, the Central and various State government agencies including National Horticulture Mission on Micro-irrigation bear the partial expenses on this system by offering the subsidy to the farmers on the procurement of this system. Though the initial cost is high, in long term the system is beneficial as it saves water, energy, fertilizers, labor and produces more crop produce.
- **Extensive Maintenance Requirement:** If the proper filtration system is not used emitter clogging could be the most serious problem in drip irrigation the remedial measures on which could be expensive. Apart from this, salt and chemical deposits can accumulate at openings of the emitters partially or fully plugging the them. Clogging can adversely affect the flow rate and uniformity of water application, increased maintenance costs as it becomes necessary to check, replace or reclaim the clogged emitters. As the water is not applied uniformly and as per the requirement due to partial and full clogging of the emitters, crop damage & decreased yield may occur, if not detected early & corrected timely. Other maintenance problems may include pipeline leaks and puncturing of the tubes. Rodents, rabbits, dogs, etc. can chew & damage drip line; and ants & other insects have occasionally enlarged opening in drip tubing. Drip lines can be cut or dug-up accidentally when weeding, replacing or repairing other pipelines or utilities in nearby areas. Filters, chemical injectors, pressure regulators, water meters and pumps are also subjected to malfunctioning and liable for maintenance.
- **Salinity Hazards:** Although drip system can be used under saline conditions, it must be managed properly. Otherwise reverse pressure gradients in the soil will cause flow of salts towards plant root with the resulting detrimental effects. It has also been found that the salts in irrigation water or soil are pushed to the fringes of the wetted area formed due to emitters, causing the accumulation of salts. This accumulation of salt could be harmful for the next seasons if not leached in rainy season or by applying water in excess of the irrigation requirement for leaching of the salts that are accumulated.

- **Economic and/or Technical Limitations:** Besides the initial heavy investment on the components of the drip irrigation system, the annual maintenance of these components, if not used properly, could be expensive. There are some specific requirements to operate and maintain the fertigation units, valves, pumps and filters. Often the technical limitations on the operation of these components may prohibit the proper use of the components, increasing the cost on the maintenance.
- **High Skill Requirements:** High skill is required for designing, installation and subsequent operation. The technical knowledge in the design of emitters, fittings, filters, etc. has been necessary. The procedures for preventing or correcting emitter clogging & rectifying equipment failure have been difficult. The use of proper methods for injection of fertilizers & other chemicals has sometimes been a problem. A higher level of design, management & maintenance is required with drip than other irrigation methods.

41.3 Critical Appraisal of the Adaptability of Drip Irrigation

The drip irrigation system is very popular in areas of acute water scarcity due to its advantages in terms of high water use efficiency. This method adoptable to almost all types of soil and topography of land. Drip irrigation has been found to irrigate marginal soils and terrain that otherwise not possible continently irrigate by other methods, Soils with high permeability and low water holding capacity, such as sands, desert pavement and least topical soils adopt poorly to surface or sprinkler irrigation but can be irrigated successfully with drip systems. Drip irrigation has been proven to be an efficient and effective technique for establishing vegetation on steep slopes of abandoned mines, road embankments etc. It is also suitable for irrigating slowly permeable soils and irregular plots.

Small irregularly shaped and narrow long and landscaped area are difficult to irrigate by sprinkler irrigation system resulting in over spray of paved surfaces and lack of uniformity. Drip irrigation enables water to be applied with high uniformity and may eliminate runoff and overspray. Sub surface drip on turf grass and sports fields does not interfere with the continuous use of area. Drip irrigation is adaptable for protected cultivation in green house, shade net and low tunnels. It provides control application of water and nutrients for each individual plant without foliage wetting, which is an important feature for high values crops such as flowers, potted plants and green house vegetables. Drip irrigation is also suitable for vegetables grown on plastic mulching under tunnels, such as strawberries and early seasons melons and other vegetable crops. Saline and poor quality water can be more safely used through drip irrigation than through any other method of irrigation. It is well adapted to variety of row crops from widely spaced fruit crops to closely spaced vegetable crops and places where commercial cultivation is in vogue of cash or horticultural crops. Numerous studies have been conducted in different parts of the country on various crops to quantify the benefits of the use of drip irrigation in terms of increased production and productivity as well as saving of water (Padmakumari and Sivanappan, 1989; Raman, 1999; Sivanappan, 1999). Kumar and Singh 2002 compiled multi locational research trial data on drip irrigation and these are reported in Table 41.1. The crops that gave relatively higher yield under drip irrigation are gherkins, mosambi, carrot, beans, mango, turmeric, popcorn, baby corn, papaya and capsicum (Table 41.1). On the other hand, chilli, coconut, radish, ridge gourd, tomato, guava, cabbage, banana, potato and beet root gave higher water use efficiency. High water saving was observed among beet root, bitter gourd, sweet potato, papaya, radish, sweet lime, mosambi, pomegranate, turmeric and cotton crops.

41.4 Scope and Status of Drip Irrigation in India

The drip method is an acceptable system of irrigation to many crops, yet drip irrigation should not be expected to replace other irrigation methods or in some cases to even compete with conventional irrigation methods. The potential for using less water per unit of production may provide the motivation for

changing irrigation methods whenever and wherever water costs have very significant effects on profit margins. The rapid expansion of drip irrigation in southern India such as Andhra Pradesh, Tamil Nadu, Karnataka and western part of country such as Maharashtra and Gujarat where water is scarce commodity and the costs are high illustrates this point. Since drip irrigation is not economical for some crops that are surface irrigated such as wheat and paddy in particular. Vast areas under these crops underestimate the acceptance of drip irrigation over the past decade.

Table 41.1. Average crop yield, percentage increase in yield, water use efficiency and water saving in drip over the conventional irrigation system for various crops.

Sl. No.	Crop	No. of references	Yield (tha ⁻¹)	Yield increases (%)	WUE (tha ⁻¹ cm ⁻¹)	Water saving (%)
1	Acid lime	1	78.00	56.00	1.30	50.00
2	Baby corn	1	9.88	72.40	0.48	43.80
3	Banana	7	71.52	29.27	2.95	42.50
4	Bean	1	10.25	81.80	0.37	36.90
5	Beet root	1	48.87	7.00	2.76	79.00
6	Ber	3	71.03	27.67	0.66	34.33
7	Bitter Ground	4	2.68	44.38	1.43	69.50
8	Bottle gourd	1	55.80	46.80	1.03	35.70
9	Brinjal	7	16.01	44.63	1.47	42.55
10	Cabbage	5	50.49	37.48	3.17	37.35
11	Capsicum	1	22.50	66.60	0.78	43.10
12	Carrot	1	26.26	92.30	0.81	33.60
13	Castor	2	7027	30.24	1.73	32.99

14	Cauliflower	3	19.50	39.73	0.68	37.10
15	Chickpea	1	3.80	66.60	1.60	42.60
16	Chilli	5	67.98	28.74	7.47	47.28
17	Coconut, No/plant	2	181.00	7.10	6.89	50.50
18	Cotton	3	36.00	40.00	0.86	51.10
19	Cucumber	1	22.50	45.10	0.94	37.80
20	Gherkins	1	4.88	100.60	2.30	36.10
21	Grain corn	1	6.50	52.90	2.20	45.00
Contd...						
S. No.	Crop	No. of references	Yield (tha ⁻¹)	Yield Increases (%)	WUE (tha ⁻¹ cm ⁻¹)	Water saving (%)
22	Grape	5	29.93	20.94	0.95	43.00
23	Groundnut	2	3.50	62.50	1.00	32.40
24	Guava	2	25.50	63.00	3.53	9.00
25	Mango	3	19.50	80.67	2.40	28.93
26	Mosambi, 1000 pcs	1	15.00	98.00	0.23	61.00
27	Oil palm	1	-	-	-	21.00
28	Okra	12	20.05	20.69	1.94	44.72

29	Onion	3	17.01	42.60	1.20	36.70
30	Papaya	5	56.64	71.97	0.91	67.97
31	Pomegranate, 100 pcs	3	44.67	55.67	0.53	57.33
32	Popcorn	1	5.50	75.40	2.10	42.00
33	Potato	5	28.66	50.02	2.80	24.62
34	Radish	2	17.00	27.50	5.04	64.00
35	Ridge gourd	3	17.39	14.50	4.36	43.39
36	Round gourd	1	36.60	24.00	0.46	0.00
37	Sapota	1	-	17.20	-	21.40
38	Sweet potato	1	50.00	39.00	1.98	68.00
39	Sugarcane	6	145.87	43.59	1.19	46.67
40	Sweet lime	1	15.00	50.00	2.30	61.40
41	Tapioca	2	54.60	12.60	0.55	23.40
42	Tomato	11	36.57	46.00	3.82	37.35
43	Turmeric	2	18.44	76.30	0.56	53.10
44	Watermelon	3	46.80	64.83	2.13	46.10

WUE = Water use efficiency

If the gross value per unit land area of the various crops that are drip irrigated are compared with those irrigated with conventional systems, the importance of drip irrigation may be seen. Most of the crops irrigated by the drip method yield higher cash returns per unit area compared to some of the crops under

conventional irrigation. Developments in the future will probably continue to be concentrated on high value crops. Extending limited water supplies and on the utilization of relatively low quality water.

Adoption of Drip Irrigation in India

In India, drip irrigation was introduced in the early seventies at the Agricultural Universities and research institutions. Significant development of drip irrigation has taken place since 1980s. The growth of micro-irrigation has gained momentum in recent years. From a mere 1500 ha in 1985, the area under drip irrigation has grown to 462,300 ha in 2003 (ICAR, 2003). These developments have taken place mainly in areas of acute water scarcity. As on in year 2003 the area-wise distributions of drip irrigation in different states of India are Maharashtra (1,94,000 ha), Andhra Pradesh (59,500 ha); Karnataka (58,500 ha); Tamil Nadu (46,500 ha); Rajasthan (41,500 ha); Gujarat (20,500 ha); Madhya Pradesh (8800 ha); Kerala (8500 ha); Uttar Pradesh (4500 ha); Orissa (3900, ha) Haryana (3400 ha); Punjab (2200 ha); West Bengal (800 ha); Assam (800 ha) and other (8900 ha). (Kumar and Singh, 2002)

During the year 2004, the area under drip irrigation in India increased to 5,40,000 ha covering majority of horticultural crops, coconut 19%, banana 11% ,grapes 10%, mango 9.4%,citrus 7.9% and pomegranate 6.2% (Rajput and Patel, 2004).

Efforts have been made at research level by Indian Council of Agricultural Research, Agricultural Universities, National Committee on Use of Plastics in Agriculture, Ministry of Water Resources of the Government of India to promote the use of drip irrigation method, Various State governments have sponsored promotional activities for adoption of drip irrigation.

Promotional Efforts by the Government

Many State governments facing water shortage for irrigation. Have been taking efforts to motivate farmers in adopting drip irrigation. In India, Ministry of Agriculture Govt. of India provides subsidies to the farmers of different social communities under the National Mission Micro Irrigation. The Government of India acknowledged the importance of micro-irrigation and announced subsidy schemes in a few selected states in year 1991. Encouraging results and positive response from farmers, the Govt. of India announced a subsidy scheme of Rs.250 cores during VIII plan (1992-1997). In the IXth plan, plasticulture got a major thrust with an outlay of Rs. 375 crores. Recognizing the importance of plasticulture in horticulture in particular, the Government of India reconstituted the National Committee on Plastics in Agriculture (NCPA) to National Committee on Plasticulture Application in Horticulture (NCPH) in May 2001. Till early 2005, the assistance of the Government of India under the "Centrally Sponsored Scheme" on development of horticulture through "Plasticulture interventions" was available for all types of micro-irrigation system. The assistance covers all farmers growing horticulture through "plasticulture interventions" and is available for all types of micro-irrigation systems. The assistance covers all farmers growing horticultural crops like fruits, vegetables including potato, onion and other root and tuber crops, spices and medical and aromatic plants- (Rajput and Patel, 2005). Fig. 41.1. shows the crop coverage under drip irrigation in India.

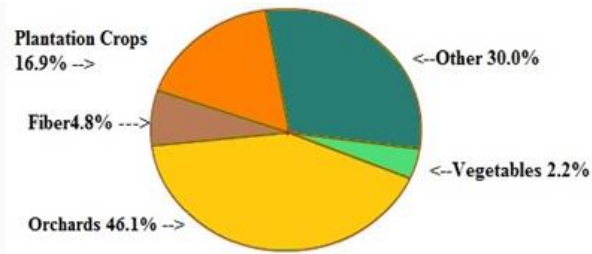

Fig. 41.1 Area of different crops under drip irrigation in India.



LESSON 42 Components of Drip Irrigation System-I

42.1 Introduction

Drip irrigation system applies water in low volumes uniformly along with the fertilizers onto or into the soil near the plant root zone. This involves several components. These are the network of pipes (main line, sub mains, laterals), emitting device called as drippers or emitters, control head consisting of pumps, filters and fertigation units; and other accessories such as valves, gages etc. The main line delivers water from water source with the help of pumping device or elevated water tank to the sub main and the sub mains to the laterals. The emitters which are attached to the laterals deliver water onto or into the soil for irrigation. Emitters are the end device of the drip irrigation system. The typical layout of the drip irrigation system with its components is shown in Figs. 42.1 and Fig 42.2. These figures show arrangement of pipe network (main, sub-main, lateral) and layout of drip irrigation system in the field.

The components of the drip irrigation system are classified into following principal categories:

- Pump and prime mover:** The pressure necessary to force water through the components of the system including fertilizer tank, filter unit, mainline, sub main, laterals and provide at the emitters at the desired pressure is obtained by a pump of suitable capacity or the overhead water tank located at suitable elevation.
- Water source:** Water sources such as river, lake, reservoir/tank, well, canal water supply or connection to a public commercial or cooperative water supply network can be used. Drip irrigation is a pressurized irrigation technology in which water is delivered from these sources by increasing its internal energy (pressure) by pumping.

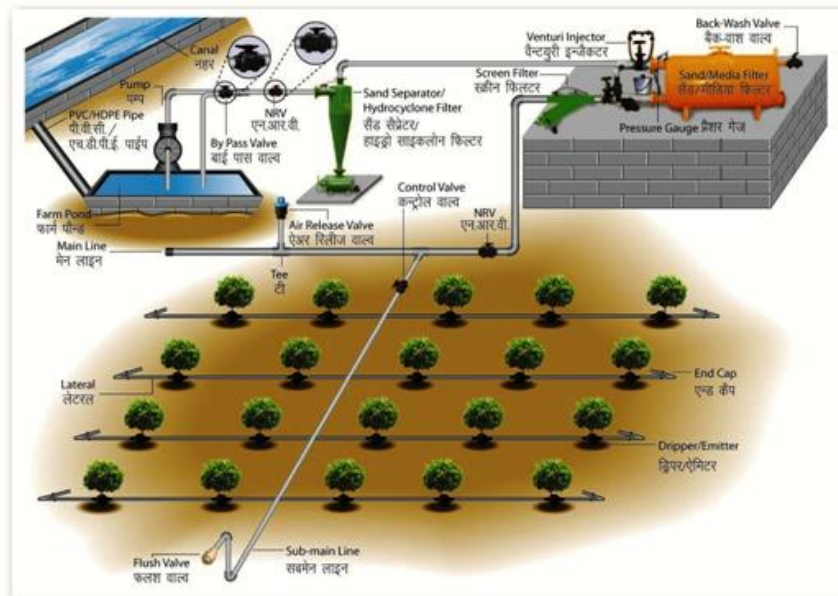

Fig. 42.1. Component and layout of drip irrigation system.

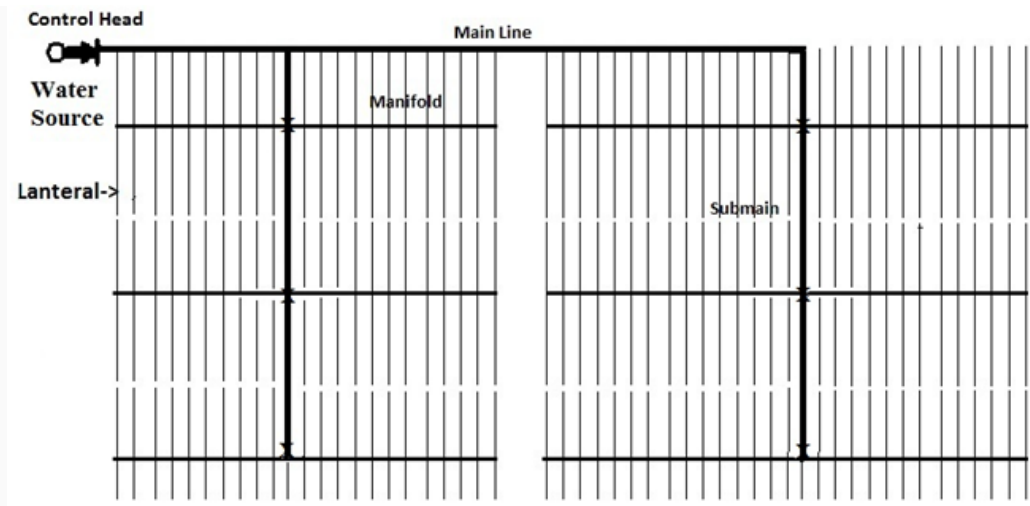

Fig. 42.2. Typical layout of drip irrigation system.

- c) Pipe network: Mainline, submains and manifolds (feeder pipes) and laterals.
- d) Emitting devices: Emitters or drippers or the laterals integrated with drippers/emitters and line source with drippers.
- e) Control devices: Valves, flow meters, pressure and flow regulators, automation equipment, backflow preventers, vacuum and air release valves, etc.
- f) Filtration devices: Removal of suspended materials in the water. Media, screen and disc filters.
- g) Chemical injectors: For application of plant nutrients and water treatment agents along with the irrigation water. Pressurized tank, venture injector, injection pump.

42.2 The Source

There are two alternative sources of water supply:

- a) Direct withdrawal from surface source (such as a river, stream, pond or dam reservoir) or from an underground sources (such as a well). The pumping devices need to be installed for the withdrawal.
- b) Connection to a commercial, public or co-operative supply network. If pumping is needed, the pump will be chosen according to the required flow rate and pressure in the irrigation system. When connected to a water supply network, the diameter of the connection, main valve and the delivering line should correspond with the planned flow rate and working pressure in the irrigated area.

42.3 The Pumping Devices

The pumping devices are required to provide the pressure to pass water through the control head, different accessories and pipe network and then to the emitting devices at desired pressure. The pressure can be developed by using the elevated tanks or pumps. The elevated tanks can provide the pressure to the small system with micro tubes as the emitting devices. Other systems need the pumps. The pumps to be used may be centrifugal pump, submersible pump, turbine pumps. They may be powered by the electric motor or the diesel pump.

42.4 The Pipe Network

42.4.1 Main

Pipes of mainlines are usually made of poly vinyl chloride (PVC) or high density polyethylene (HDPE). Ordinary PVC pipes have not UV protection and should be installed underground. Recently, unplasticized PVC (uPVC) pipes are manufactured with reduced sensitivity to ultra-violet (UV) rays and better endurance than ordinary PVC pipes. HDPE pipes can be installed inside or above ground, as they are impregnated with carbon black that provides protection against UV. The nominal working pressure of pipes has to be higher than that of the submain/drip laterals. The pipes of diameter 50 mm or above and the pressure rating of more than 4 kg/cm² are used for mainline. The exact diameter and pressure ratings are decided in the process of design and depend on the size of the area irrigated, emitter operating pressure, topography, static and delivery heads etc.

42.4.2 Submains

Submains are installed underground (PVC or HDPE) or above ground (HDPE only.) The pipes of diameter 32 mm or above and the pressure rating of more than 2.5 kg/cm² are used for sub mainline

42.4.3 Manifolds

In certain circumstances, when rows are very long or in rolling topography, sub-division of the plot by submains is insufficient. In these cases secondary partition is carried out by manifolds. Manifolds are used also to simplify operation and to lower accessories costs.

42.4.4 Laterals

Laterals are the tubes on which the emitters are mounted or within which they are integrated. They are usually made of low density polythene (LDPE) or linear low density polythene (LLDPE) (Fig. 42.3) with features such as flexibility, non corrosivity, resistance to solar radiation and temperature fluctuation and generally black in color. Laterals usually have inner diameters in the range of 12 to 20 mm with wall thickness varying from 1 to 3 mm. The wall thickness is made to withstand pressure more than 2 kg/cm² depending on the requirement. The laterals may be laid on the soil surface or underground. Laterals buried at 5-10 cm below soil surface is suitable to vegetables grown on hillocks or under plastic mulch. Laterals need to distribute the water uniformly along their length by means of drippers or emitters.

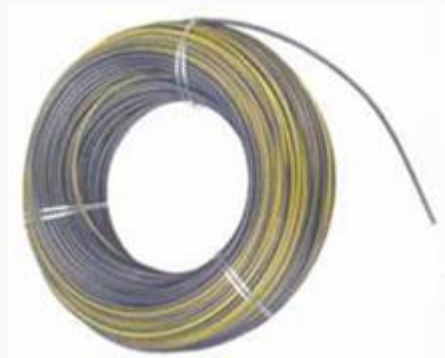

Fig. 42.3. Laterals pipe.

42.5 Control and Monitoring Devices

42.5.1 Valves

Flow and pressure control valves are required for controlling water distribution and regulating pressure in the pipeline. The valves used in drip irrigation systems include air release and vacuum relief valve, pressure regulating valves, flow regulation valves, non return valves and on hyphen and hyphen off valves.

- **Manual or Automatic Flow Regulating Valves:** Manual or automatic valves are used for the opening and shutdown of water and for splitting the irrigated area into subunits.
- **Pressure Regulators or Pressure Relief Valves:** These are used to prevent excessive pressure beyond the working pressure of the system. These are installed at any point where there is a possibility of existing excessively high pressure. Such kind of high pressure may be generated in the system from sudden opening and closing of the valves, starting and stopping of a pump.

Closing and opening of the flow regulating valves gradually and using the air vents/relief valves at the proper location may prevent to generate the excessive pressure in the system. By pass assembly to bypass the excess water and pressure right at the source and pump could be adequate instead of pressure regulators or pressure relief valves.

- **Check Valves and Backflow Preventers:** Check valves and backflow preventers are required when fertilizers or other chemicals are injected into the irrigation system, if the irrigation system is connected to potable water supply network.
- **Air-Release/Relief Valves:** Air-release/relief valves are installed at the higher elevation points of the system to prevent air flow in the pipes. These valves allow air to escape when filling pipelines with water and remove air pockets at high points in the system. High air content in the pipes may interfere with water flow, increase friction with pipe walls, distort water measurement and may cause water hammer and pipe burst.
- **Vacuum Breakers:** Vacuum breakers prevent the collapse of pipes in steep slopes and drip laterals in sub-surface drip irrigation (SDI) systems. In SDI they also eliminate the suction of soil particles into the drippers after shutdown of the water supply. Vacuum relief valves, which have orifices of size 25 to 200 mm in diameter, are designed to exhaust large volume of air during pipe filling and to close when the filling stops.

42.5.2 Gages

Pressure gauges monitor water pressure in the system and ensure operating pressure remains close to the recommended or desired values. Based on where the pressure gauge is installed, it will measure water pressure in a various ranges, from 0 to 10 kg/cm² near the pump to 0-2 kg/cm² at the end of drip lateral. Pressure gauges may be installed at set points (near the pump, before and after the filter, near the field). They can also be mounted as portable devices and installed temporarily at the end of a drip lateral.

42.5.3 Water Meters

Water meters monitor and record the amount of water moving through a pipe where the water meter is installed. When a stopwatch is used together with a water meter, it is possible to determine the discharge in the system.

42.6 Control Head

The main components of the control head are the filtration and chemigation units.

44.6.1 Filtration Systems

Filtration is the key to the success or failure of a drip irrigation system. The narrow water passage or pathways in the emitters of the drip irrigation system are susceptible to clogging by suspended matter and chemicals that precipitate from the irrigation water. The clogging of the emitters can be partial or full causing the reduction in the emission uniformity and rated discharge of the emitters. Clogging can be prevented or reduced by:

- a) Preliminary separation of suspended solid particles by settling ponds, settling tanks and sand separators.
- b) Complimentary chemical treatments for decomposition of suspended organic matter; to hinder the development of slime by microorganisms; to prevent chemical precipitates deposition and to dissolve previous deposited precipitates.
- c) Filtration of the irrigation water: The media filters usually called as sand filters, screen filters or disc filters are used.

Filtration devices are usually installed at the control head. If the irrigation water is heavily contaminated, secondary control filters are installed at the subunit valves. Filters should be flushed and cleaned routinely. Flushing can be done manually or automatically. The filters can be installed in arrays of two or more units. The installation of the filters causes the additional head loss in the system and need to be considered while designing the system. The details of the filters are explained in the next lesson.

42.6.2 Chemical Injectors

Three categories of chemicals viz. fertilizers, pesticides and anti-clogging agents need to be injected into irrigation systems depending on the need.

- i) Fertilizers are the most commonly injected chemicals. In drip irrigation system, it is possible to time the application of the fertilizers as per the requirement of crop growth stages. The fertilizers need to be water soluble.
- ii) Systemic pesticides are injected into drip irrigation systems to control insects and protect plants from a variety of diseases.
- iii) Chemicals that clean drippers or prevent dripper clogging: Chlorine is used to kill algae and different microorganisms and to decompose organic matter, while acids are used to reduce water pH and dissolve precipitates.

42.7 Emitters

Emitters, the core of micro irrigation system or made of plastic material. The design of production of high quality drippers is comprised of delicate and complicated process. Water passes through the emitters and need to be delivered at constant and low with the desired uniformity. The emitters are designed to dissipate pressure and yield low discharge which does not vary significantly because of minor differences in pressure head.

42.7.1 Requirements of Good Emitters

Emitters, being the heart of the drip system and the success of the system being dependent on the operation of the emitters, need to satisfy the following requirements (Karmeli and Keller, 1974).

- Give a relatively low but uniform and constant discharge, which does not vary significantly because of minor differences in pressure.
- Have a relatively large section in order to reduce clogging problem.
- Be in expensive and compact as emitters constitute more than 1/3rd cost of the system.

42.7.2 Classification of the Emitters

Emitters can be classified on the basis of various characteristics (Karmeli and Keller, 1974). These are:

- Flow regime
- Pressure dissipation
- Operating pressure
- Discharge
- Lateral connection
- Water distribution
- Flow cross section
- Cleaning characteristics
- Pressure compensation
- Material used for production

Different types of emitters are shown in Figs. 42.4 and 42.5.



Fig. 42.4. Online pressure compensating drippers.



Fig. 42.5. Online non-pressure compensating drippers.

- **Flow Regime:** The three main regimes into which the emitters are classified are: laminar flow, partially turbulent flow and fully turbulent flow. Laminar flow regimes exist in the emitters having long flow path and low discharges, whereas partially turbulent and turbulent flow exist in long path and multi exit emitters with relatively high discharges and in nozzle or vortex type emitters.
- **Pressure Dissipation:** Pressure dissipation is one of the important characteristics of the good emitters. Different forms of dissipation are used and accordingly the emitters are classified as: long path emitters, nozzle or orifice type emitters and leaking lateral type. In long path emitters, the pressure is dissipated during flow through a long and narrow path. In nozzle or orifice type of emitters, the pressure is dissipated as water discharges through a small opening. In leaking lateral type, pressure is dissipated as the water is delivered through a large number of very small pores and perforations in the lateral pipe wall instead of discharging through emitting devices.
- **Operating Pressure:** Based on the operating pressure, emitters may be grouped into (i) low pressure (5 to 8 m), (ii) medium pressure (8 to 12 m), and (iii) high pressure (12 to 15 m). The micro tubes are the examples of low pressure while the pressure compensating emitters need high operating pressure.
- **Flow Cross-Section:** Based on the relative sensitivity to clogging, emitters may be grouped into (i) low (below 0.7 mm), (ii) medium (0.7 to 1.5 mm), and (iii) wide (above 1.5 mm). Low flow cross section is very sensitive to clogging, medium is sensitive and wide are relatively insensitive to clogging.
- **Discharge:** Based on the discharge the emitters are classified as (i) low (0.5 to 2 L h^{-1}), (ii) medium (2 to 6 L h^{-1}), (iii) high (6 to 12 L h^{-1} or more). Considering the soil types, crops, average holding, the emitters having flow rate of 4 lph are suitable.
- **Lateral Connection:** Based on the connection of the emitters to lateral, the emitters can be classified as on line and integrated. The online emitters are mounted on the laterals whereas the integrated emitters are inserted in the laterals.
- **Water Distribution:** Based on the water distribution the emitters could be orifice and long path emitters which have a single exit point; orifice and long path emitters that have several water exit points with small spaghetti like tubing attached to distribute water to several points surrounding the emitter; and perforated pipes having continuous distribution along the lateral.
- **Cleaning Characteristics:** Some emitters are self-flushing types and some emitters need to be opened for cleaning.
- **Pressure Compensation:** On the basis of pressure compensation, the emitters are classified as the non-pressure compensating (NPC) and pressure compensating (PC). In case of NPC emitters, the discharge of the emitters increases with the operating pressure whereas in case of PC emitters, discharge is constant over a wide range of lateral operating pressure.
- **Material used for the Production:** Emitters are made from poly vinyl chloride (PVC), low density polyethylene (LDPE) and linear low density polyethylene (LLDPE)

42.7.3 Types of Drippers

- **Point Sources Dripper:** In this system drippers are mounted and inserted along the laterals at length intervals that create a discrete wetted soil volume by each emitter without overlapping.
- **Line Sources:** Drippers are densely spaced along the lateral, insuring overlapping of wetted soil volumes by emitters and drippers. This layout is typical end tape designed and is the favored choice of densely grown annual crops.
- **Compensating Emitter:** Several methods of pressure dissipation are employed in emitter or dripper manufacturing in order to overcome the opposing constraints imposed by energy dissipation and clogging. Pressure compensating emitters are designed to discharge water at a constant rate over a wide range of operating pressures (Fig. 42.4).
- **Continuous Flushing Emitter:** These are designed to continuously permit passage of large solid particles while operating at a drip flow thus reducing filter fineness requirements.
- **Flushing Emitter:** Water is discharged from closely spaced perforations, emitters, or porous wall along the tubing.

- Long Path Emitters: The water flows through a narrow, long micro tube. The micro tube may be long (spaghetti) or built in- spiral capsulation. Water flow is laminar in the spaghetti and the semi turbulent in the built in spiral. The flow laminar flow dripper is sensitive to change in pressure. The employ a long capillary-sized tube or channel to dissipate pressure.
- Multi-Outlet Emitters: Each emitter has to hyphen 12 outlets on to which small diameter micro tubes are connected. The drippers are used mostly in landscaping and irrigation of potted plants. Supplies water to two or more points through small diameter auxiliary tubing.
- Orifice Emitter: Employs a series of orifices to dissipate pressure. Pressure description occurs at a tinny inlet in the bottom of the dripper, rendering it proven to plugging.
- Vortex Emitter: In vortex drippers, water enters tangentially in to a circular chamber, creating a spiral whirlpool that generates high head losses along a relatively short path. This allows for a wide hyphen orated orifice that decreases clogging hazards. The desirable features of an emitter are low in cost, easy to manufacture and install, resistant to clogging, uniformity in discharge and reliable performance. Emitters are located at predetermined spacing on the lateral and are connected by various means. On the basis of their design, drippers are classified into three types, namely, point source, line source and disc source.



LESSON 43 Description of Drip System Components and their Selection-II

This lesson presents the important components of the control head of the drip irrigation system *viz.* Fertigation units and filtration system. Fertigation unit is required for the application of nutrients along with water to the crop root zone which is the main concept of drip irrigation system and responsible for achieving the maximum productivity along with the minimum losses of chemicals and fertilisers. Filtration unit is required to provide filtered water in to the system to prevent the small openings or narrow pathways of the emitting devices for improving the performance of the system.

43.1 Fertigation

Application of fertilizers and chemicals along with water through drip or sprinkler system is known as fertigation or chemigation. Fertilisers that are water soluble can be effectively and efficiently applied through drip irrigation system. Compared to the conventional methods of fertilizer and water application, fertigation offers several benefits such as reduced labour, equipment and energy costs and higher fertilizer use efficiency. The success of drip irrigation, to a good degree, is due to the improved supply of nutrients along with water at the desired location. Hence the use of appropriate fertigation equipment is necessary. Plant protection chemicals can also be applied effectively using the same equipments.

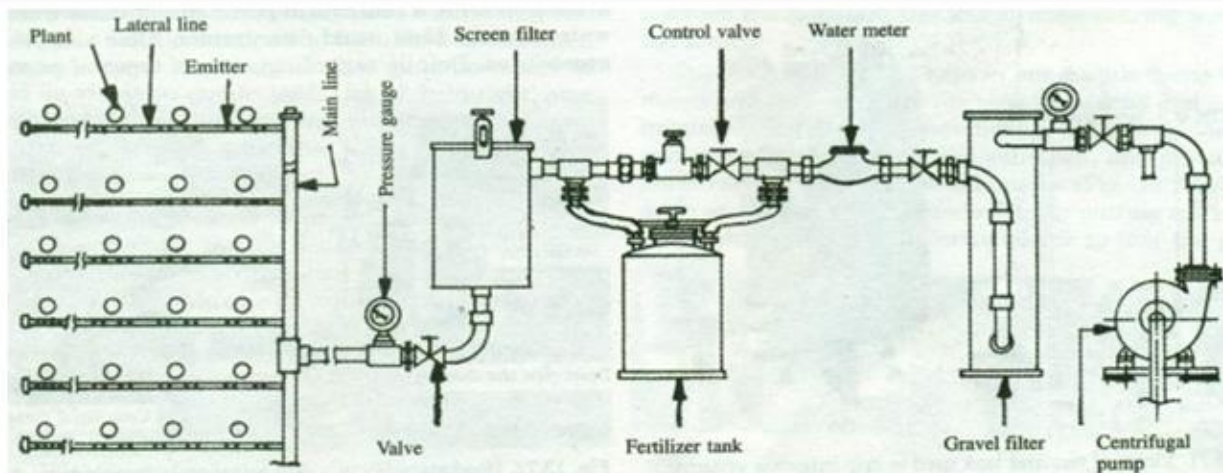

Fig. 43.1. The arrangement of different components of drip irrigation system with fertigation and filtration units. (Source: Michael, 2010, pp.641)

Fig. 43.1 illustrates the control head assembly in overall layout of different components of drip irrigation system. The control head assembly of a drip irrigation system consists of fertigation equipment, filters, control valves and other accessories.

43.1.1 Selection and Types of Fertigation Unit

The requirement of fertilizer application in terms of quantity and type of fertilisers to be injected, concentration and time schedule should be considered in deciding the types of fertigation equipment in drip irrigation system. Some of the fertilizers are not suitable for application through drip systems, because of volatilization of gaseous ammonia, low water solubility and problems with the chemical quality of irrigation water. Therefore, fertilizers that need to be used and the type of fertigation equipment should be decided with an understanding of the chemical composition of the fertilizers to be used. Nitrogen is

relatively problem free. The type of fertigation equipments that is chosen also depends on the crop grown and the farm management system.

43.1.2 Equipment and Methods for Fertilizer Injection

Fertilizers and other agrochemicals such as herbicides and pesticides into the drip irrigation system can be injected by:

- i) By pass pressure tank
- ii) Venturi system and
- iii) Direct injection system

i) By Pass Pressure Tank

This method consists of a tank into which the water soluble dry or liquid fertilizers are stored. The tank is connected to the main irrigation line by means of a bypass so that some of the irrigation water flows through the tank and dilutes the fertilizer solution. This by pass flow is brought about by a pressure gradient between the entrance and exit of the tank. This pressure difference between the entrance pipe to the fertiliser tank and the exit pipe is created by a gate valve, pressure regulator or permanent constriction in the line or by a control valve. Fig. 43.2 shows by- pass pressure tank.



Fig. 43.2. By- pass pressure tank. (Source: Tiwari, 2009, pp. 591)

ii) Venturi Injector

In case of the venturi injector, there is a constriction in the main water flow pipe that increases the water flow velocity thereby causing a pressure differential (vacuum) sufficient to suck fertilizer solution from an open reservoir/tank into the main water flow. The rate of injection can be regulated by means of valves. This is a simple and relatively inexpensive method of fertilizer application. Fig. 43.3 shows venturi injector.



Fig. 43.3. Venturi Injector.

iii) Direct Injection System

Direct injection system employs a pump to inject fertilizer solution into the irrigation line. The type of pump used depends on the power source. The pump may be driven by an internal combustion engine, an electric motor or hydraulic pressure. The electric pump can be automatically controlled and is thus the most convenient to use. However its use is constrained by the limited availability of electrical power. The use of a hydraulic pump, driven by the water pressure of the irrigation system, eliminates this limitation. The injection rate of fertilizer solution is proportional to the flow of water in the system. A high degree of control over the injection rate is possible, no serious head loss occurs and operating cost is low.

43.2 Filtration System

Irrigation water quality is defined by its physical, chemical and biological characteristics. The narrow water passageways in drippers and micro-emitters are particularly sensitive to irrigation water quality. Poor water quality if allowed to enter the system clogs the emitters. Narrow pathways in the emitters coupled with low velocity of water aggravate the clogging. The clogging of the emitters is the most difficult problem that can encounter in the operation of the drip irrigation system, if not dealt properly. The clogging that blocks the water pathways in the emitters fully or partially reduces the discharge in varying degrees affecting the performance of the system in terms of precise application of water to the soil root zone and uniformity in application. Thus the clogging tends to loss of precious water and fertilisers and reduction in crop yield. Keeping contaminants entering from the system or forming within the system is the best preventive measure against the clogging. Hence the appropriate filtration system is the important component of the drip irrigation system.

The relative clogging of drip emitters depends on the size of particulars suspended in irrigation water. Table 43.1 provides the relative clogging potential of drip irrigation systems by water contaminants.

Table 43.1. Relative clogging potential of drip irrigation systems by water contaminants

Water characteristic	Minor	Moderate	Severe
Suspended solids (ppm)	<50	50-100	>100
pH	<7.0	7.0-8.0	>8.0
Total dissolved solids (ppm)	<500	500-2000	>2000
Manganese (ppm)	<0.1	0.1-1.5	>1.5
Iron (ppm)	<0.2	0.2-1.5	>1.5
Hydrogen sulphide (ppm)	<0.2	0.2-2.0	>2.0
Bacteria population (per ml)	<10,000	10,000-50,000	>50,000

Filtration system should be able to filter or process all the water entering in to the system and should be able to remove

- i) Suspended solid mineral particles
- ii) Organic matter
- iii) Live zooplankton

The particles many times smaller than the size of the water pathways in the emitter should be removed by the filtration system as in the process of time many particles can group together to block the water pathways. In general following five types of the filters are used in combination or standalone depending on the need.

1. Screen filter
2. Disc filter
3. Media filter
4. Hydrocyclone filter
5. Settling ponds

43.2.1 Screen (Strainer) Filters

Screen filter and disc filters (described in the subsequent section) are considered as the primary filter. One of these two filters is essential even water is free of all kinds of impurities. Screen filter has five main parts. These are: Casing or basket, filter element or cylindrical screen, rubber seal or gasket, inlet and outlet. Screens are usually made from stainless steel or nylon. Screen filters are designated by filtration degree, filtration surface area and filtration ratio. Filtration degree is designated in microns or mesh number. The filtration degree in microns indicates the diameter of the biggest ball-shaped particle that can pass between the screen wires. The mesh number indicates the number of openings per inch with a standard wire size. The two concepts i.e. hole size and the mesh number are not fully inter-convertible. Perforation width may differ in two screens with the same mesh number due to different wire thickness. Conversion from one system to another is done by rule of thumb: mesh number = $\frac{15,000}{\text{microns}}$. The screen mesh number and corresponding hole size for typical wire size is given in Table 43.2.

Table 43.2. The screen mesh number and corresponding hole size for typical wire size

Screen mesh number	Hole size	
	Mm	inch
4	4.76	0.1874
10	2.00	0.0787
20	0.84	0.0331
40	0.42	0.0165
80	0.172	0.0068
140	0.105	0.0041

200	0.074	0.0029
-----	-------	--------

The screen mesh should be such so that the screen retains all particles larger than one sixth the size of smallest passage (openings) in the drip system (British Columbia, Ministry of Agriculture, 1982). The required filter screen area can be estimated by an empirical ratio between the open area in the filter basket (the sum of the holes) and the cross sectional area of the exit pipe of the filter. This ratio should be at least 2.0. When using fine screens, the wire mesh occupies approximately one half of the area. Figure 43.4 shows (a) Screen filter (b) Elements of a screen filter.

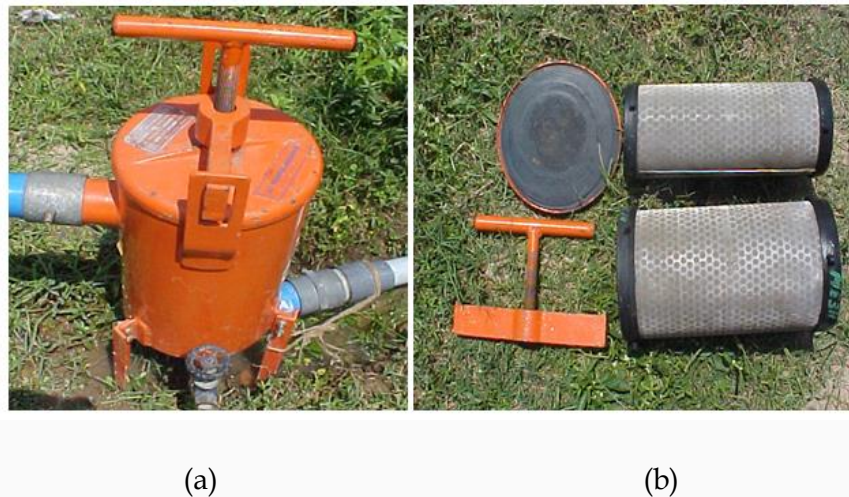

Fig. 43.4. (a) Screen filter, (b) Elements of a screen filter. (Image source: Report of the task force on Micro-Irrigation, Ministry of Agriculture, Department of Agriculture & Cooperation, Govt. of India, New Delhi, Jan, 2004)

In screen filters any impurities or dirt materials accumulated on the surface of the screen for long time causes increase in, the head loss across the filter. This, if not monitored properly, reduces the operating head available at the emitter and discharge affecting the performance of the emitters adversely. The pressure difference between the filter inlet and outlet is, therefore, monitored to know excessive dirt accumulation on the screen. The pressure difference between inlet and outlet should not exceed 0.5 bar (5m). Filters then need to be flushed manually i.e. by pulling out the filter element and cleaning it by washing or automatically which takes place during the filter operation either continuously, on a time schedule or whenever the pressure loss across the filter reaches a certain level. Extreme care needs to be taken to prevent the dirt from bypassing the filter in to the system during the cleaning.

43.2.2 Disc Filters

Disc filters are suitable for filtration of water containing mixed, inorganic and organic impurities such as algae. The casing is made of metal or plastic materials (Fig. 43.6). The filtering element is stack of grooved rings, tightened firmly by a screw on cap or by a spring that is compressed by a water-piston. The sizes of the grooves determine the of filtration grade. Water is filtered as it flows from the perimeter into the stack inner space through the grooves. The intersections of the grooves provide in-depth filtering. Coarse particles are trapped on the external surface of the stack whereas finer particles and organic debris stick to the inner grooves. Disc filters have a higher dirt-retention capacity than screen filters. Disk filters are available in different flow rates varying from 4 to 30 m³h⁻¹. Figure 43.5 shows (a) Disc filter (b) Elements of disc filter. The disc filters can also be manually or automatically washed. In case of manual washing, the stack of discs is loosened and water at high pressure is sprayed on the grooves of the disc to remove dirt accumulated in the grooves.



(a)

(b)

Fig. 43.5. (a) Disc filter, (b) Elements of a disc filter.

43.2.3 Media Filter

Sand or media filters consist of layered beds of graduated sand and/or fine gravel placed inside the cylindrical pressurized tank. As the water passes through the tank, the gravel and sand carry out the filtration process. Media filters are used to remove high organic load from open water bodies or reclaimed water and heavy loads of very fine sand. Normally tanks or media containers (0.5 m – 1.25 m in diameter) are made of epoxy-coated carbon steel, stainless steel or fiberglass. The filtering media is 1.5 mm – 4 mm size basalt, gravel, crushed granite particles or fine silica sand. The filter material be as coarse textured as possible but fine enough to retain all particles larger than one sixth the size of the smallest passage way in the drip system. Filter materials should be large enough, Such that it should not be removed by filter cleaning or backwashing process. The organic impurities adhere to the surface of the media particles. The accumulated dirt should be back-flushed routinely in order to eliminate excessive head losses. American Societies of Agricultural Engineers recommend pressure drop across the media filter not to exceed 70 kPa. Fig. 43.6 shows (a) Media filter (b) Elements of media filter. Screen filter/disc filter needs to be used invariably downstream of the media filter to pick up any particles which might escape the media filter in filtering or backwashing process.



(a)

(b)

Fig. 43.6. (a) Media filter (b) Elements of a media filter.

43.2.4 Hydro cyclone Filter or Centrifugal Sand Separators

High loads of sand or other solid particles if present in irrigation water needs to be removed before getting to the main filtration system. The media screen and disc filters cannot perform the filtering operations effectively in this case. The traditional practice of separation of heavy sand load is based on sedimentation of solid sand particles by slowing -down water flow in to the settling tanks or basins and then re-pump the treated water into the irrigation system. In centrifugal (vortex) sand separators, the water is introduced tangentially at the top of a cone creating a circular motion resulting in to centrifugal force which throws heavy suspended particles against the wall. The sand particles thrown against the container wall by the centrifugal force settle down and accumulate in a collecting chamber at the bottom (Fig.43.7). The collector is washed out manually or automatically. Clean water exits through an outlet at the top of the separator. A suitable sand separator can be designed for any flow rate ranging from $3\text{m}^3\text{h}^{-1}$ - $300\text{m}^3\text{h}^{-1}$ without excessive head-losses. Such filters are effective for primary filtration of river or canal waters. These filters are capable of removing up to 98% of the sand particles which would be contained by a 200 mesh screen.



(a)

(b)

Fig. 43.7. (a) Centrifugal sand separator, (b) Working pattern.

43.2.5 Settling Basins

Settling basins, ponds or reservoirs are used to remove large volumes of sand and silts from the irrigation water. However the water stored in open water bodies may develop algae growth and wind blown contaminants in the ponds may cause more filtration problems than before. In addition to this, water needs to be re-pumped in to the system.

43.3 Selection of Emitters

Emitter is a device used to dissipate water pressure and to discharge water at a constant flow rate at many points on a lateral as uniformly as possible. The objective of the water passageways of emitters is to maximize pressure dissipation to approach atmospheric pressure in the emitter outlet. The commonly used drippers are online pressure compensating or online non-pressure compensating, in-line dripper,

adjustable discharge type drippers, vortex type drippers and micro tubing of 1 to 4 mm diameter. These are manufactured from poly- propylene or LLDPE.

43.3.1 Online Pressure Compensating Drippers: A pressure compensating type dripper supplies water uniformly on long rows and on uneven slopes within prescribed variation in pressure. These emitters consist of high quality flexible rubber diaphragm or disc inside the emitter that changes shape according to operating pressure and delivers uniform discharge (Fig. 43.8). These are most suitable on sloping lands and difficult topographic terrains.



Fig. 43.8. Online Pressure Compensating Drippers.

43.3.2 Online Non-Pressure Compensating Drippers: In such type of drippers discharge tends to vary with operating pressure. They have simple thread type, labyrinth type, zigzag path, vortex type flow path or have float type arrangement to dissipate energy. However they are less expensive and available in affordable prices compared to pressure compensating emitters. Different types of on line non-pressure compensating types of drippers are shown in Fig. 43.9.



Fig.43.9. Online non-pressure compensating drippers.

43.3.3 Point Source Emitters

Point source emitters dissipate water pressure through a long narrow path and a vortex chamber or a small orifice before discharging into the air (Fig.42 .10). The emitters can take a predetermined water pressure at its inlet and reduce it to almost zero as the water exits. The typical flow rates range from 2 to 8 lph. The point source emitters can be on line or inline or integrated (Fig. 42.11), pressure compensating or non pressure compensating; surface or subsurface.



Fig. 43.10. Point source emitter.

43.3.4 Line Source Emitter

Line source emitters consist of the drip tubing having perforations continuously along its length. The pressure is dissipated as the water discharges through a large number of very small pores or perforations in the lateral pipe wall, instead of discharging through emitting devices. Twin wall type is more commonly used. In this case there is inner tubing which is known as main tubing. The outer tubing is known as auxiliary tubing. Both the tubings are concentric twin wall type. The main tubing of the pipe serves as the lateral. Inside this tubing major portion of water flows under relatively high pressure. A small number of widely spaced holes connect the main tubing to the auxiliary tubing. The auxiliary tubing is provided with five to ten types as many holes per unit of length as the main tubing. The water discharges through the numerous holes of the auxiliary tubing to the outside. The inner and outer holes are of the same size. The inner holes act as pressure dissipaters and outer holes distribute the water. The flow rate is typically expressed in Lh^{-1} meter length. Drip lines are either buried below the ground or laid on the surface. Burial of the drip line is preferred to avoid degradation from heat and ultraviolet rays and displacement from strong winds. However, some specialized equipment to install and extract the thin drip distribution line is required.



Fig. 42.11. Drip line with integrated emitters.

43.4 The Flow Characteristics of the Emitters

The flow characteristics of the emitters is presented by the following equation

$$q = kH^x$$

where

q = emitter discharge (Lh^{-1})

k = a constant of proportionality that characterise each emitter

H = working pressure head at the emitter (m)

x = the emitter discharge exponent that is characterised by the flow regime.

The lower the value of x , the less discharge will be affected by pressure variations. In fully turbulent flow $x=0.5$ and in laminar flow $x=1.0$. Non compensating orifice and nozzle emitters are always fully turbulent with $x = 0.5$ and $x = 0.0$ for fully compensating emitters. However the exponents of long path emitters may range anywhere between 0.5 and 1.0.



LESSON 44 Planning and Design of Drip Irrigation System

The planning and design of drip irrigation system is essential to supply the required quantity of irrigation water to the crop at a desired uniformity. The main purpose of the design of drip irrigation system is to decide the dimensions of various components of the system such that the system provides the required quantity of water at the desired uniformity in application while keeping the cost of the system to minimum. To apply the desired amount of water at nearly uniform rate to all the plants in the field, it is essential to design the irrigation system that maintains a desired hydraulic pressure in the pipe network and provide the desired operating pressure at the emitter. The design of drip irrigation system consists of selection of emission devices, size of laterals, manifolds, sub main, main pipeline, filter and pump. The system design depends on many factors, but the design will be constrained by several economic factors such as feasibility, initial investment, labour, return on investment and performance parameters such as the rated flow rate and desired emission uniformity. The steps to be followed for designing the drip irrigation system are given below:

1. Inventory of the resources and data collection.
2. Computation of peak crop water requirement
3. Deciding the appropriate layout of the drip irrigation system
4. Selection of emitters
5. Hydraulic design of the system in terms of lateral, sub main and main
6. Horse power requirement of pump

44.1 Inventory of the Resources and Data Collection

This step involves preparation of inventory of all the available resources and operating conditions. The resources involved include:

Water resources: Quantity (stream size, volume and duration for which the supply is available) and quality of water, the type of water resources i.e. bore/tube well; open dug well, reservoir/pond/tank or river and location of the water resource:

Land resources: The size and shape of the area to be irrigated, soil type for its texture and irrigation properties (field capacity, wilting point, bulk density, allowable depletion level) including infiltration rate, and topography of the land

Climate: The climatic data required for the computation of crop water requirement.

Crop: Crop type, sowing/planting and harvesting period, crop coefficient, fertilizer requirements, crop geometry. In general following guidelines can be used to ensure adequate quantity of available water for supply of irrigation water to the wide spaced (orchard) and close spaced (vegetable etc.) crops. However the area to be irrigated can be decided on the basis of the water availability and the crop water demand.

Essential parameters	Orchard crops	Vegetables and other closely spaced crops
Stream size	1L s ⁻¹ /ha ⁻¹ for 4hday ⁻¹	3Lp ⁻¹ ha ⁻¹ for 4 h day ⁻¹
Storage capacity	15m ³ ha ⁻¹	45m ³ ha ⁻¹
Power requirement	1hp ha ⁻¹	3hp ha ⁻¹

44.2. Peak Crop Water Requirement

The design of drip irrigation system needs the information on the peak water requirement, however while the system is in operation, the water requirement during the specified irrigation interval is required. This section describes the method to estimate the crop water requirement. Water requirement of crops is a function of plants, surface area covered by plant, evapotranspiration rate. Crop water requirement is calculated for each plant and the water requirement of the whole area is estimated based on the water requirement per plant and total number of plants. The crop water requirement which is maximum during any one of the three seasons is adopted for system design.

The daily water requirement for fully grown plants can be calculated as under:

$$V = ET_r \times K_c \times A \times W_p \quad (44.1)$$

Net volume of water to be applied

$$V_n = V - R_e \times A \times W_p \quad (44.2)$$

Number of daily operating hours of the system

$$(T) = \frac{V_n}{N_e \times N_p \times q} \quad (44.3)$$

where,

V =Volume of water required, L

ET_r= Reference crop evapotranspiration, mm day⁻¹

K_c = Crop coefficient

A = Area occupied by a plant (row to row spacing x plant to plant spacing), m²

R_e = Effective rainfall, mm

W_p = Wetting fraction (varies from 0.2 for wide spaced crops and 1.0 for close spaced crops)

N_e = Number of emitters per plant

N_p = Number of plants

q = Emitter discharge, $L\ h^{-1}$

The crop coefficient (K_c) varies with crop growth stage and season. The crop coefficient (K_c) should be considered for the maturity stage of crop while designing micro irrigation system and for the specified growth while operation of the system.

Water requirement of few crops are given in Table 44.1, which can be used as guideline for design of irrigation system. However it should be noted that this is only guideline and actual water requirement needs to be computed on the basis of crop, climate etc.

Table 44.1. Water requirements of few horticultural crops

Name of the Crop	Spacing (m)	Water requirement (l/plant/day)	
		Minimum	Maximum
Banana	2.0 × 2.0	4	18
Papaya	2.0 × 2.0	2	10
Guava	5.0 × 5.0	14	39
Mango	5.0 × 5.0	20	50
Pineapple	0.45 × 0.25	0.1	0.6
Cashew	7.5 × 7.5	25	60
Jujube	6.0 × 6.0	20	50
Sapheda	5.0 × 5.0	20	65
Pomegranate	5.0 × 5.0	15	40
Tomato	0.6 × 0.6	0.45	1.15
Cauliflower	0.6 × 0.45	0.7	1.4

Okra		0.3 × 0.3	0.6	1.8
Cabbage		0.6 × 0.45	0.7	1.6
Brinjal		0.9 × 0.6	0.8	3.3
Rose		0.75 × 0.75	0.5	2
Jasmine		1.5 × 1.5	1.5	5

44.3 Layout of the Drip Irrigation System

It is possible to apply water to the whole field by drip irrigation method at the same time. However this may result in the requirement of high discharge which may not be available, further large diameter of mains and sub main which could make the system more expensive and the high capacities of the fertigation and filtration units. Hence the whole field needs to be divided in to the convenient number of subunits. Each subunit is then designed separately and operated separately by having valve at the head of the subunit. The number of subunits is calculated as:

Number of subunits = Total time available for irrigation/ (time of operation for drip) system (Equation 44.3).

Total time available for irrigation depends on the hours of electricity available in the region, capacity of the farmers to supplement the electricity by other means such as diesel engine/generator etc.

The system requirement or discharge for the individual sub unit is then computed. If it is more than the available discharge from the water resources, the area under each subunit is then proportionally reduced to match the discharge requirement with the available discharge,

The layout of the micro irrigation system i.e. arrangement of main, sub mains and laterals is done considering the shape, size and slope of the field. As far as possible, the sub main should run along the slope of the field and lateral should be laid across the slope or along the contour lines of the field. Different layouts design of drip irrigation system are shown in Fig. 44.1.

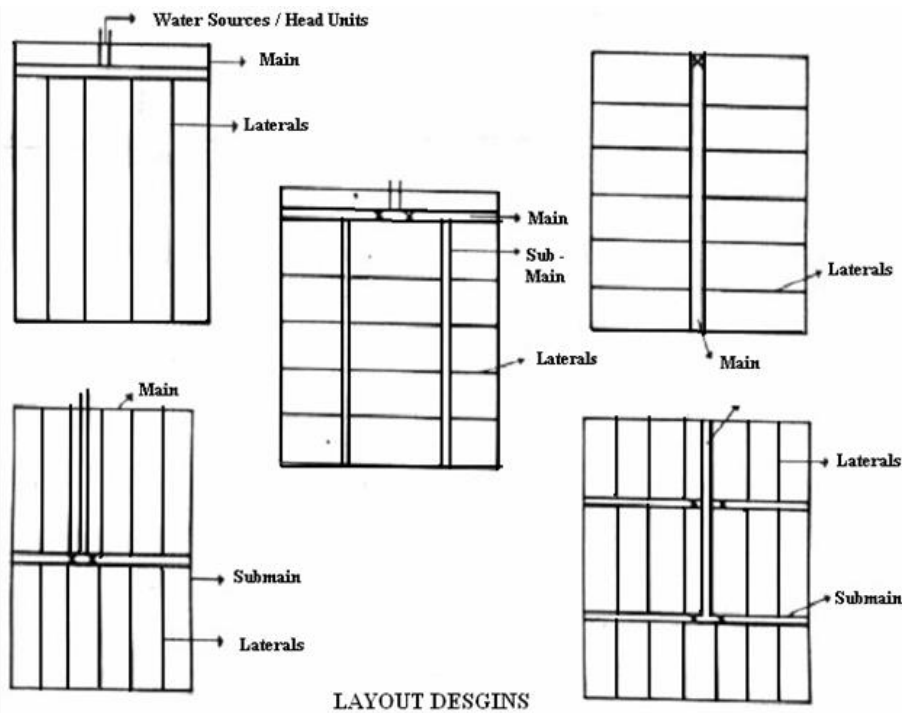

Fig. 44.1. Layout Design of Drip Irrigation System.

Once the layout is finalized, the diameter and the length of sub main and laterals for each subunit are decided on the basis of hydraulic design of the pipe which is explained in subsequent sections. The spacing between lateral depends on the crop geometry for the row crops. For the plantation or orchard crops, the spacing between laterals is equal to the row spacing. However depending on the age of tree, tree spacing and soil type, the two laterals per row of tree may be needed. The spacing between the emitters on laterals for row crops is governed by the soil type whereas in case of plantation or tree crops, the number of emitters per tree is governed by the spacing, age and soil type.

44.4 Selection of Emitters

The emitters are to be selected for its discharge, operating pressure, online/inline, pressure compensating/non pressure compensating, point source/line source, single exit/multi exit and surface/subsurface. The selection of particular type of emitter

depends on the soil, crop, topography, desired emission uniformity, available discharge and electricity/other sources for operation of the system, water quality, water use efficiency and the cost.

Soil: The discharge of the emitters should be less than the infiltration rate of the soil. Soil type also governs the spacing between emitters. Heavier the soils, more could be the spacing.

Crop: In case of row crops, emitters need to be spaced so as to wet the entire strip of the row. In case of close growing and row crops, inline/integrated emitters are preferred whereas for the plantation/orchards, online emitters are preferable. Single exit emitters are used for row crops while multi exit emitters are suitable for plantation crops.

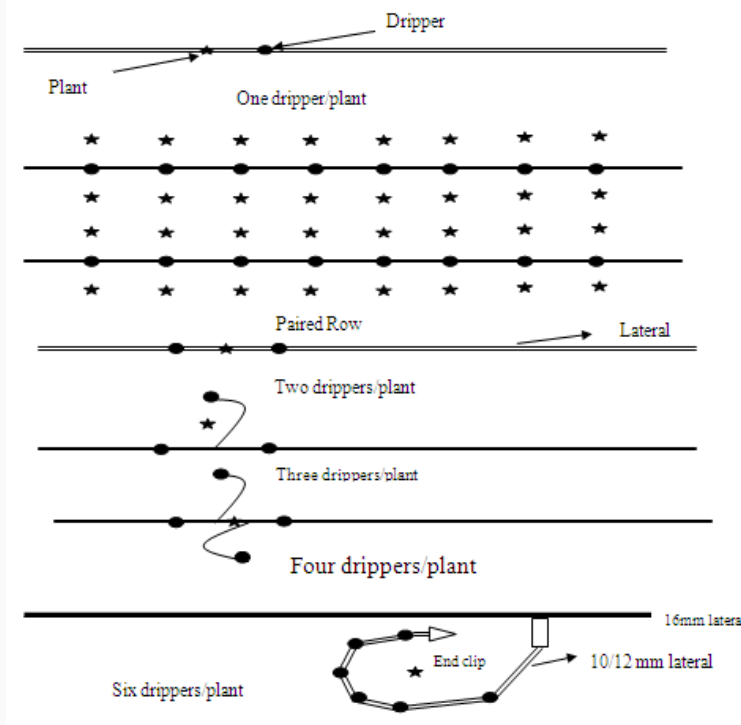

Fig. 44.2. Different arrangement of emitters along the laterals.

Topography: Non pressure compensating emitters could be used for relatively flat lands where as on the land with rolling or uneven topography, pressure compensating emitters are preferable.

Emission Uniformity: Pressure compensating emitters are capable of providing more uniformity compared to non pressure compensating emitters.

Discharge Available: When the discharge available is small, the emitters with low discharge need to be used. However these emitters may need more time of operation.

Water Use Efficiency: Subsurface drip irrigation reduces the evaporation losses compared to surface drip; thus resulting in to more water use efficiency

Water Quality: The emitters with more diameter or cross sectional area need to be used for the water with heavy load of suspended solids.

44.5 Hydraulic Design of Pipe Network

The pipe network in drip irrigation system consists of laterals, sub main and main. Water under pressure flows through these pipes and as a result the pressure in the pipes reduces creating the variation in pressure or pressure difference between any two points. The emitter discharge depends on the operating pressure available in the pipe at emitter connection and reduces with reducing pressure. Therefore there is variation in discharge obtained by the emitters in system; affecting the emission uniformity.

Ideally the emitters should give the same discharge at different operating pressure. However only pressure compensating emitters are capable of giving the same discharge over certain range of pressure variation. But these emitters are expensive. The alternative is to design the system with non-pressure compensating emitters such that the same discharge is available at all the points. From the practical point

of view, it is almost impossible to achieve this ideal performance. However, the flow variation of water pressure can be minimized by the appropriate hydraulic design.

As per the principle of hydraulics, the minimum pressure variation along the laterals/sub main can be obtained by keeping the diameter of the pipes as large as possible and length as minimum as possible. But doing this is expensive. On the other hand decreasing the diameter and increasing the length, though less expensive, reduces the performance of the system in terms of emission uniformity. In order to have tradeoff between the economy and efficiency, the criterion of allowing the variation in discharge of 10% amongst any two emitters in the subunit is adopted. This is equivalent to 20% variation in pressure for turbulent type of emitters and 10-15% variation for long path emitters. Of the total allowable head loss in the subunit 55% head loss is allowed in laterals and remaining 45% in the sub main.

The procedure of hydraulic design consists of:

1. Know the operating pressure of emitters
2. Find out the allowable head loss in lateral and sub main
3. Find out the lateral and sub main discharge
4. Find out the diameter and length of the lateral such that the head loss in the lateral is within allowable limits for the given layout. For this purpose find out the head loss by Hazen William or Darcy-Weisbach formula for different combinations of diameter and length and select the suitable combination by trial and error method
5. Repeat the procedure for the sub main
6. Find out the diameter of main so that the velocity is within the allowable limit or find out the head loss in main for the specified diameter of the main. The length of the main is the distance of the field from the water source.

Computation of Discharge of Lateral, Sub Main and Main

Flow carried by each lateral line

$$Q_1 = \text{Discharge of one emitter} \times \text{No. of emitters per lateral}$$

$$\text{Flow carried by each sub main line } Q = Q_1 \times \text{No. of lateral lines per sub main}$$

$$\text{Flow carried by main } Q = Q_1 \times \text{No. of sub main line}$$

The diameter of the main, sub main and laterals are chosen based on the hydraulics of pipe flow. The pressure drop due to friction can be evaluated with the help of Hazen William or Darcy-Weisbach equation as stated before.

i) Head Loss in Laterals

The pipes used in micro irrigation system are made of plastics (PVC, HDPE, LDPE or LLDPE) and considered as smooth pipe. The pressure drop due to friction or frictional head loss can be evaluated with the help of Hazen -William empirical equation as given below.

$$H_f(100) = K \left(\frac{Q}{C} \right)^{1.852} \times D^{-4.871} \times F \quad (44.4)$$

As the length of the pipe increases, the discharge in the pipe decreases due to emission outlets and hence the total energy drop is less than as estimated by the above equation. For this reason, a reduction factor F which is less than 1.0 is introduced in the equation.

Head loss for the specified length of pipe is

$$H_{fl} = H_f(L + L_e) / 100$$

where

$H_f(100)$ = head loss due to friction per 100 meter of pipe length, m/100m

H_{fl} = head loss in the specified length of lateral

Q = Flow of water in pipe, Ls^{-1}

D = Internal diameter of pipe, cm

L = Length of the pipe, m

C = Hazen-William constant (140 for PVC pipe)

$K = 1.22 \times 10^{12}$

L_e = equivalent length of the pipe

$= N_e \cdot f_e$

N_e = number of emitters on a lateral

f_e = equivalent length due to one emitter connection

$f_e = 1$ to 3 m for in line emitter with barbed connection

$f_e = 0.1$ to 0.6 for online emitters

F = Reduction factor due to multiple opening in pipe, which can be computed by following equation.

$$F = \frac{1}{m+1} + \frac{1}{2N} + \frac{\sqrt{m-1}}{6N^2}$$

$m = 1.852$

N = Number of outlets on the lateral

As stated before, the design criteria for lateral pipe is to keep pressure and discharge variations within the prescribed limit.

ii) Head Loss in Sub mains

The sub main line hydraulics of submains pipe is similar to that of the lateral hydraulics. The sub main hydraulics characteristics can be computed by assuming the laterals are analogous to emitters on lateral line, except for the fact that f_e is considered as zero in this case due to relatively smooth connection of laterals to submain. Hydraulics characteristics of sub main and mainline pipe for drip system are usually taken hydraulically smooth pipe due to PVC and HDPE pipe material. The Hazen Williams roughness coefficient (C) varies between 140 and 150. The energy loss in the sub main is computed in the same way as used for lateral.

iii) Head Loss in Main Line

Usually the pressure controls or adjustments are provided at the sub main inlet. Therefore energy loss in the mainline should not affect the system uniformity. In case of main line the value of reduction factor (F) is the unity (1). The frictional head loss in main pipeline is calculated by the same equation Darcy-Weisbach formula or Hazen-Williams.

44.6 Horsepower Requirement of Pump

The horsepower requirement of pump is computed by following equation

$$\text{Horsepower required (hp)} = \frac{H \times Q_m}{75 \times \eta_p \times \eta_m} \quad (44.5)$$

where,

H = total pumping head ($H_f + H_e + H_s$), m

H_f = Total head loss due to friction (Friction head loss in mains + Friction head loss in sub mains + Friction loss in laterals + Head loss in accessories, filters and fertigation unit), m

H_e = Operating pressure head required at the emitter, m

H_s = Total static head, m

Q_m = Discharge of main

η_p = Efficiency of pump

η_m = Efficiency of motor



LESSON 45 Evaluation of Drip Emitters and Design of Drip Irrigation System

This lesson presents procedure for evaluation and testing of drip emitters. Numerical problems related to testing and evaluation of drip emitters as well as design of drip irrigation system is also dealt in this chapter.

45.1 Performance Evaluation Drip Emitters

The different characteristics used for performance evaluation of emitters are as follows:

- a) Manufacturing Characteristics
- b) Hydraulic Characteristics
- c) Operational Characteristics

a) Manufacturing Characteristics

The variations in passage size, shape, surface and finish that occur are small in absolute magnitude but represent a relatively large percent variation. Although pressure compensating emitters use an elastomeric material to achieve consistent dimensions and characteristics. The amount of difference to be expected varies with the design of the emitter materials used in its construction and the care with which it is manufactured. The emitter coefficient of manufacturing variation (v) is used as a measure of the anticipated variations in discharge in a sample of new emitters. The value of C_v should be available from the manufacturer or it can be estimated from the measured discharges of a sample set of at least 50 emitters operated at a reference pressure head. It is estimated as

$$C_v = \text{Standard Deviation (s)} / \text{Average Flow rate (q)}$$

The system coefficient of manufacturing variation (v_s) is a useful concept because more than one emitter or emission points may be used per plant. In such a situation the variations in flow rate for each emitter around the plant partly compensate for one another.

The value of v_s can be computed by following equation (US Soil Cons. Service, 1984):

$$v_s = \frac{v}{\sqrt{e'}} \quad (45.1)$$

In which

v = emitter coefficient of manufacturing variation.

e' minimum number of emitters per plant or 1 if one emitter is shared by more than one plant.

Table 45.1 provides interpretation of drip emitters based on manufacturing coefficient of variation.

Table 45.1. ASAE Interpretation on Manufacturing Coefficient of Variation

Emitter type	C_v	Interpretation
Point Source	< 0.05	Excellent
	0.05 - 0.07	Average
	0.07 - 0.11	Marginal
	0.11- 0.15	Poor
	> 0.15	Unacceptable
Line Source	< 0.10	Good
	0.10 - 0.20	Average
	> 0.20	Marginal to Unacceptable

b) Hydraulic Characteristics

The relationship between changes in pressure head and discharge is an important characteristic of emitters. The pressure compensating emitters have a low value of the exponent. However since they have some physical part that responds to pressure their long range performance requires careful consideration. The compensating emitters usually have a high coefficient of manufacturing variation (v), and their performance may be affected by temperature, material fatigue or both. On undulating terrain the design of a highly uniform system is usually constrained by the pressure sensitivity of the average emitter. Compensating emitters provide the solution. Emitters of various sizes may be placed along the lateral to meet pressure variations resulting from changes in elevation. In laminar flow emitters which include the long path, low discharge devices the relation between the discharge and the operating pressure is linear, i.e., doubling the pressure doubles the discharge. Therefore the variations in operating pressure head within the system are often kept to within ± 5 percent of the desired average. In a turbulent flow emitter the change in discharge varies with the square root of the pressure head, i.e., $x = 0.5$, and the pressure is to be increased four times to double the flow. Therefore the pressure head in drip irrigation system with turbulent flow emitter is often allowed to vary by $\pm 10\%$ of the desired average (US Soil Cons. Service, 1984).

Depending upon the experimental values of x , flow regimes can be obtained. Based on the flow regime and exponent x the emitters can be classified (Table 45.2).

Table 45.2. Emission device classification

Flow Regime	x - Value	Emitter Type
Variable flow path	0.0	Pressure
	0.1	compensating
	0.2	
	0.3	
Vortex flow	0.4	Vortex
Fully turbulent flow	0.5	Orifice tortuous
Mostly turbulent flow	0.6	Long or
	0.7	spiral path
	0.8	
Mostly laminar flow	0.9	Micro tube
Fully laminar flow	1.0	Capillary

c) Operational Characteristics

The coefficient of uniformity proposed by Christiansen (1948) is widely accepted for estimating uniformity of water application through sprinkler irrigation systems. However this measure determines the uniformity of sprinkling pattern of one nozzles of sprinkler irrigation system. This is not required for the emitter of drip irrigation system. Hence the Christiansen formula is not used in drip systems are significantly different from those of sprinkler nozzles. The uniformity in water application of emitters (except of pressure compensating type emitters) is influenced by the operating pressure, emitter spacing, land slope, size of the pipe line, emitter discharge, and emitter discharge variability of specified emitters. The emitter discharge variability is due to the variation in operating pressure and temperature, manufacturing variability (coefficient of variation, C_v), clogging, and aging of the emitters.

Karmeli and Keller (1975) proposed the 'emission uniformiy' as the measure for the performance evaluation of the drip irrigation system. They proposed two measures viz. emission uniformity and absolute emission uniformity. These measures are now widely accepted to measure the performance of irrigation system when laid in the field.

Emission Uniformity (EU): The Primary objective of the good drip irrigation system is to provide sufficient water or discharge to adequately irrigate the least watered plant or area. Therefore the relation between

the minimum and average emitter discharge within the subunit of the system is most important factor and is designated by the emission uniformity.

The emitter discharge from minimum four emitters (in case of more than one emitters per plant, the discharges are taken from all the emitters at minimum four locations or plants and the discharges from each location are averaged) per lateral along four randomly selected laterals are measured. The minimum 16 measurement points so selected should include the extremes and uniformly spaced in the subunit. This can be achieved by selecting the first, one third point, two third point and the last emitter on a selected lateral.

The emission uniformity, EU, which is expressed as percentage is the ratio of the average emitter discharge from the lowest one fourth of the field data (obtained from arranging the emitter discharges in descending order) to the average discharge of all the data. EU is computed by:

$$EU = \left(\frac{q_n}{q_a} \right) \times 100$$

Where,

q_n = average of the lowest one fourth of the field data emitter discharges (Lh^{-1}),

q_a = average of all the field data emitted discharges (Lh^{-1}),

Absolute emission Uniformity: Crop quality and productivity may be affected by both excess watering and under watering. Therefore the uniformity measure needs to include the maximum and minimum emitter discharges and the uniformity. The measurements that need to undertake in the field is same as for the computation of the computation of the emission uniformity. The absolute emission uniformity is computed by the following formula.

$$EU_a = \frac{1}{2} \left[\left(\frac{q_n}{q_a} \right) + \left(\frac{q_n}{q_x} \right) \right] \times 100$$

where,

q_x = average of the highest one - eighth of the field data emitter discharges, (Lh^{-1})

The emission uniformity measures proposed above are used to measure the field performance of the already installed drip irrigation system and therefore these are also called as field emission uniformity and absolute field emission uniformity, respectively,

However the emission uniformity measures are also required at the time of design and need to be estimated before installing the system in the field. These are called as design emission uniformity and absolute design emission uniformity, respectively. In this case, the measurements for q_a , q_n and q_x are not available, These are estimated from the pressure - discharge relationship of the emitter. For example, q_n is the minimum emitter discharge computed with the minimum pressure using the pressure using the pressure discharge relationship. In this way q_a and q_x are estimated. The corresponding formulas are:

Emission Uniformity (EUd)

$$EU = 100 \left[1.0 - \frac{1.27C_v}{\sqrt{n}} \right] \frac{q_n}{q_a} \quad (45.2)$$

In which,

EU = design emission uniformity, %

n = (i) for point source emitter on a perennial tree crop, number of emitters per plant, (ii) for a line source emitters on a perennial tree crop, either the rooting diameter of the plants divided by the same unit length of lateral used to compute C_v or 1, whichever is greater.

C_v = the manufacture's coefficient of variation for point source or line source emitters,

q_n = the minimum emitter discharge at a minimum pressure in the section (sub unit), computed from pressure discharge relationship, Lh^{-1} .

q_a = the average or design emitter discharge for the section (sub- unit), Lh^{-1} .

The commonly recommended ranges for the design emission uniformity are as follows:

i) Point source emitters for tree crops with spacing larger than 4 m:

- a) Land slope less than 2% - (E_u 90 to 95%)
- b) Land slope greater than 2% - (E_u 85 to 90%)

ii) Point source emitters for tree crops with spacing larger than 4 m:

- a) Land slope less than 2% - (E_u 85 to 90%)
- b) Land slope greater than 2% - (E_u 80 to 90%)

iii) Line source emitters on annual or perennial crops:

- a) Land slope less than 2% - (E_u 80% to 90%)
- b) Land slope greater than 2% - (E_u 75 to 85%)

45.2 Evaluation of Emission Uniformity

Example 45.1: Determine the emission uniformity of a drip system section that uses drip emitter with coefficient of discharge (k_d) = 0.3, exponent (x) = 0.57 and coefficient of variation (C_v) = 0.06. Two emitters are used for each plant. The average pressure is 120 kP_a and minimum pressure is 90 kP_a .

Solution:

$$q_{min} = k_d \times p_{min}^x$$

$$= 0.3 \times (90)^{0.57}$$

$$= 0.3 \times 12.99$$

$$= 3.89 \text{ Lh}^{-1}$$

$$q_{av} = k_d (120)^{0.57}$$

$$= 0.3 \times 15.31$$

$$= 4.59 \text{ Lh}^{-1}$$

$$Eu = 100 \left[1 - \frac{1.27(0.06)}{\sqrt{2}} \right] \frac{3.89}{4.59}$$

$$= 100$$

$$= 80.1 \%$$

The value of EU in Example 45.1 is lower than the recommended value stated above. The EU could be improved by reducing the difference between q_{min} and q_a (by using the emitters with lower values of the discharge exponent) or by using an emitter with a lower C_v .

45.3 Design of Drip Irrigation System

Example 45.2: Design a drip irrigation system for a citrus orchard of 1 ha area with length and breadth of 100 m each. Citrus has been planted at a spacing of 5 m \times 5.5 m. The maximum pan evaporation during summer is 8 mm/day. The other relevant data are given below:

Land slope = 0.40 % upward slope from S - N direction,

Water source = A well located at the S-W corner of the field

Soil texture = Sandy loam, Clay content = 18.4 %, Silt = 22.6 %, Sand = 59.0%, Field capacity = 14.9 %, Wilting point = 8 %, Bulk density = 1.44 g/cc,

Effective root zone depth = 120 cm, Wetting Percentage = 40 %,

Pan coefficient = 0.7, Crop coefficient = 0.8

Solution:

Solution of this Example is taken from Tiwari (2009).

Step 1:

Estimation of Water Requirement

Evapotranspiration of the crop = Open pan evaporation \times Pan coefficient \times Crop coefficient

$$= 8 \times 0.7 \times 0.8$$

$$= 4.48 \text{ mm/day}$$

Volume of water to be applied = Area covered by each plant \times Wetting fraction \times Evapotranspiration of the crop

$$= (5 \times 5.5) \times 0.40 \times 4.48$$

$$= 49.28 \text{ L day}^{-1} \text{ or } 50 \text{ L day}^{-1}$$

Step 2:

Emitter Selection and Irrigation Time

Emitters are selected based on the soil texture and crop root zone system. Assuming three emitters of 4 L h⁻¹, placed on each plant in a triangular pattern are sufficient so as to wet the effective root zone of the crop.

Total discharge delivered in one hour = 4 \times 3 = 12 L h⁻¹

Irrigation time = 50 / 12 = 4 h 10 minutes

Step 3:

Discharge through Each Lateral

A well is located at one corner of the field. Sub mains will be laid from the centre of field (Fig. 45.1). Therefore, the length of main, sub mains, and lateral will be 50 m, 97.25 m, 47.5 m each respectively. The laterals will extend on both sides of the sub mains. Each lateral will supply water to 10 citrus plants.

Total number of laterals = (100/5.5) \times 2 = 36.36 (Considering only 36)

Discharge carried by each lateral, $Q_{\text{lateral}} = 10 \times 3 \times 4 = 120 \text{ L h}^{-1}$

Total discharge carried by 36 laterals = 120 \times 36 = 4320 L h⁻¹

Each plant is provided with three emitters, therefore total number of emitters will be 36 \times 10 \times 3 = 1080

Step 4:

Determination of Number of Manifolds

Assuming the pump discharge = 2.5 L s⁻¹ = 9000 L h⁻¹

Number of laterals that can be operated by each manifold = 9000/120 = 75

So only one manifold or sub mains can supply water to all the laterals at a time.

Step 5:

Size of Lateral

Once the discharge carried by each lateral is known, then size of the lateral can be determined by using the Hazen- Williams equation .(Equation 44.4)

The reduction factor (F) can be estimated as

$$F = \frac{1}{1.852+1} + \frac{1}{2 \times 30} + \frac{\sqrt{1.852-1}}{6(30)^2}$$
$$= 0.367$$

$$H_f(100) = 1.22 \times 10^{12} \frac{(0.033/130)^{1.852}}{(12)^{4.871}} \times 0.367 = 0.54 \text{ m}$$

$$H_f = 0.54 \times (47.5/100) = 0.26 \text{ m}$$

For D = 16 mm, = 0.063 m

The permissible head loss due to friction is 10% of head of 10 m (head required to operate 4 L h⁻¹ emitters) is 1 m, therefore 12 mm diameter. lateral size is selected.

Step 6:

Size of Sub Main

Total discharge through the sub mains = Q_{lateral} X Number of laterals

$$= 120 \times 36$$

$$= 4320 \text{ L h}^{-1} = 1.2 \text{ L s}^{-1}$$

Assuming the diameter of the sub mains as 50 mm. The values of parameter of the Hazen- Williams equation are

$$= 150$$

$$= 1.2 \text{ L s}^{-1}$$

$$= 50 \text{ mm}$$

$$= 1.22 \times 10^{12}$$

$$= 0.364$$

$$H_f(100) = 1.22 \times 10^{12} \times \frac{(1.2/150)^{1.852}}{50^{4.87}} \times 0.364$$

$$= 0.31 \text{ m}$$

$$H_f \text{ for } 97.25 \text{ m of pipe length} = 0.31 \cdot (97.25/100)$$

$$= 0.30 \text{ m}$$

Therefore, frictional head loss in the sub mains = 0.30 m

$$\text{Head at the inlet of the sub mains} = H_{\text{emitter}} + H_{f \text{ lateral}} + H_{f \text{ sub main}} + H_{\text{slope}}$$

$$= 10 + 0.26 + 0.30 + 0.40$$

$$= 10.96 \text{ m}$$

$$\text{Pressure head variation} = \frac{10.96 - 10.26}{10.96} \times 100$$

$$= 6.38 \%$$

Estimated head loss due to friction in the sub main is much less than the recommended 20% variation, hence reducing the pipe size from 50 to 35 mm will probably be a good option.

$$H_f (100) = 1.22 \times 10^{12} \times \frac{(1.2/150)^{1.852}}{35^{4.87}} \times 0.364$$

$$= 1.75 \text{ m}$$

$$H_f \text{ for } 97.25 \text{ m pipe} = 1.75 \cdot (97.25/100)$$

$$= 1.70 \text{ m}$$

$$\text{Head at the inlet of the sub main} = H_{\text{emitter}} + H_{f \text{ lateral}} + H_{f \text{ sub main}} + H_{\text{slope}}$$

$$= 10 + 0.26 + 1.70 + 0.40$$

$$= 12.36 \text{ m}$$

$$\text{Pressure head variation} = \frac{12.36 - 10.26}{12.36} \times 100$$

$$= 17\%$$

Pressure head variation lies within the acceptable limit, hence accepted.

Step 7:

Size of the main line

Assuming the diameter of main as 50 mm

Discharge of main, $Q_{\text{main}} = \text{Discharge of sub main, } Q_{\text{sub main}}$

The values of parameter of the Hazen- Williams equation are

$$C = 150$$

$$Q = 1.2 \text{ L s}^{-1}$$

$$D = 50 \text{ mm}$$

$$K = 1.22 \times 10^{12}$$

$$H_f(100) = 1.22 \times 10^{12} \frac{(1.2/150)^{1.852}}{(50)^{4.871}}$$

$$= 0.84 \text{ m}$$

$$\text{for 50 m main pipe} = 0.84 \times (50/100) = 0.42 \text{ m}$$

Step 8.

Determining the Horse Power of Pump

Assume head variation due to uneven field variations and the losses due to pump fittings, etc. as 10 % of all other losses.

$$H_{\text{local}} = 10 \% \text{ of all other loss}$$

$$\text{Total dynamic head} = (H_{\text{emitter}} + H_{f \text{ lateral}} + H_{f \text{ sub main}} + H_{f \text{ main}} + H_{\text{slope}}) + H_{\text{static}} + H_{\text{local}}$$

$$= 12.36 + 0.42 + 10 + 1.28$$

$$= 29.06 \text{ m}$$

$$\text{Pump Horse power } (hp) = \frac{H \times Q}{75 \times \eta_p}$$

where,

H = Total dynamic head, m

Q = Total discharge through main line, L s^{-1}

η_p = Efficiency of pump

$$hp = \frac{1.2 \times 29.06}{75 \times 0.60} = 0.64 @ 1.0$$

Hence 1 hp pump or the pump giving 1.2 L s^{-1} discharge at head of 30.0 m is adequate for operating the drip irrigation system to irrigate for 1 ha area of citrus crop.

The design details of components micro irrigation system are estimated as

Length of laterals = 47.5 m, Number of laterals = 36,

Diameter of lateral = 12 mm, Length of sub main = 97.25 m,

Number of sub main = 1, Diameter of sub main = 35 mm,

Length of main = 50 m, Number of main = 1,

Diameter of main = 50 mm, Total power required = 1 hp,

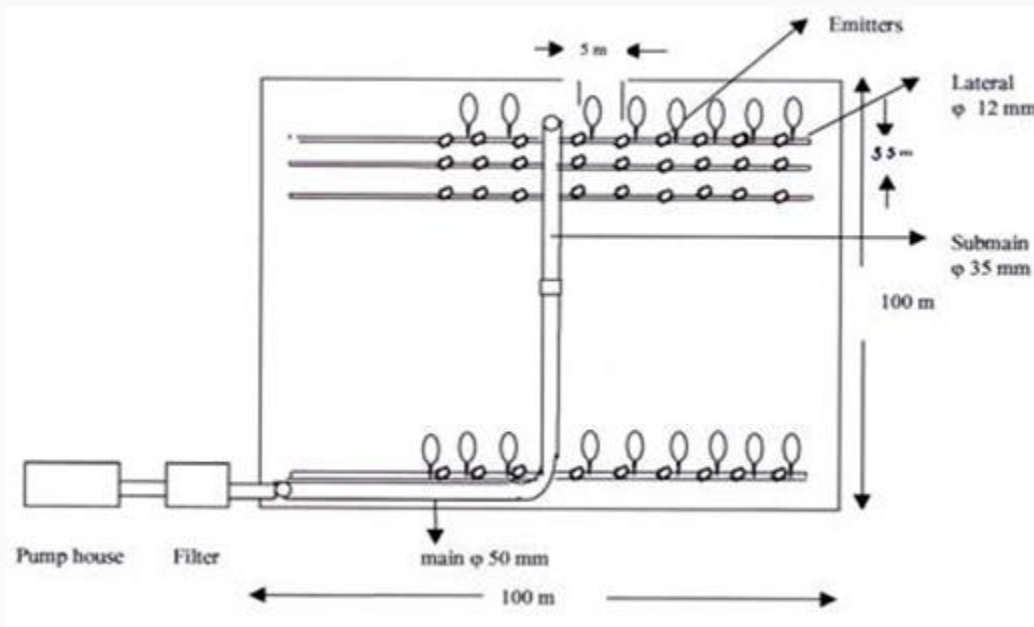

Fig. 45.1. Layout of designed drip irrigation system.



LESSON 46 Installation Operation and Maintenance of Drip Irrigation Systems

Drip irrigation system consists of various components. All these components are to be designed properly as per their specifications. After designing the components these are to be installed properly. Many of the problems in drip irrigation system result in due to poor installation of the drip irrigation system. The system needs to be maintained and operated properly for obtaining the longer or expected life of different components of the system and trouble free operation of the system. The points that need to be considered while installation, operation and maintenance of the drip irrigation system are described in this lesson.

46.1 Installation

The main items in the installation of drip irrigation system include installation of the head assembly (control head), comprising the pumping set, non-return valve, water meter, filters, fertilization equipment, flow control, air release and pressure release valves. The other items of installation include connecting mains, sub-mains, and laying of drip tape or lateral with drippers. While installing the control head or the pipe network, the minimum number of accessories such as elbows, reducers etc should be used. This is required for proper maintenance of the system and to reduce unnecessary head loss in the system due to these connections.

46.1.1 Installation of Filters and Fertigation Equipment

1. A strong support in the form of hard base or concrete base along with the GI fittings should be used for the installation of the sand and hydro cyclone filters to avoid any vibrations due to load.
2. The filter size should be in accordance with the capacity of the system. This should match with the pump discharge under size will lead to loss and over size will add cost.
3. The delivery pipe of the pump should be connected directly to the hydro cyclone or the media or sand filter followed by the fertilizer equipment and the screen filter. All of these components should be installed in the main pipe.
4. Once the sand/screen filter is essential requirement. Suitable arrangement to collect and dispose of the bypass material should be made.
5. In pressurized irrigation system the fertilizer injection unit is located, between the sand filter (if required) and the screen filter. The general recommendation is that the fertilizer solution pass through at least two 90-degree turns to ensure adequate time for thorough mixing and for any precipitate to come out in front of the screen filter. It is must that fertigation unit is installed at the upstream end of the screen filter so as to filter the under solved matter present in the fertilizer solution.

46.1.2 Installation of Mains and Sub-mains

1. Except for fully portable system, both mains and sub mains if made out from PVC must be installed underground at a minimum depth of about 0.5m such that they are unaffected by cultivation or by heavy harvesting machinery. Even for systems, which have portable laterals that are removed at the end of each season, it is common practice to install permanent underground mains and sub mains. Generally sub mains run across the direction of the rows.

The United States Soil Conservation Service has recommended the following minimum cover of earth over for various pipe sizes (Fred Hamish, 1977):

Pipe size	Depth of earth cover
1.2 to 6 cm diameter	45 cm
6 to 10 cm diameter	60 cm
Over 60 cm diameter	75 cm

2. If the mains and sub mains are made out of materials other than PVC such as HDPE or GI, these may not be the need to install them below the ground surface; however it is advisable to install them underground.

3. It is important to remove mud and other impurities in the pipe before fitting of mains and sub-mains and gate valves. A ball valve is provided at the inlet end of the sub-main. After the ball valve, the air release valve is provided. A flush valve facing the slope of the sub-mains is provided at the end of each sub-main to facilitate sub-main flushing.

46.1.3 Laying of Laterals

1. After the main and sub mains are installed, holes are drilled on the sub-main, according to the grommet take off (GTO) i.e., 11.9 mm dia drill for 8 mm ID GTO and 16.5 mm drill for 13 mm ID GTO.
2. Then grommet are fixed in it and theses take off are fixed.
3. Once the grommet take offs are fixed on the sub-mains, lateral/polytube laying is done as per the design.Lateral is fixed to one end of the take off.
4. 4.Lateral placement is done according to row distance, with sufficient shrinking allowance and extra lateral length is provided at the end.
5. The drippers are punched on the laterals as per the requirement.
6. Generally laterals are laid on the ground surface. Usually laterals are placed along contours on sloping field. Burying laterals underground might be necessary or at least have some advantages for some installations. Where this is done, the emission devices should be fixed above ground level. except for the subsurface drip lateral.
7. The downstream end of the lateral can be closed by simply folding back the pipe and closing it with a ring of larger diameter pipe, known as end plug. This can be easily slipped for flushing.

46.1.4 Punching of Laterals and Fixing of Emitters

1. Punching of laterals should start from sub-main. Water should be allowed to flow through lateral so as to get bulging in pipe which makes easy punching.
2. Punch the lateral sideways.

3. The dripper position is fixed as per the spacing requirement.
4. All the drippers should follow the same straight line.
5. Do not fix the drippers on lateral until complete lateral is punched
6. Drippers are fixed on laterals as per the arrows marked (if having arrow marks) and it should be towards the sub-mains.
7. While fixing the dripper, push it inside the lateral and pull it slightly. The end of lateral should be closed with end cap.

Once the system is completely installed, it needs to be tested by allowing water to flow in to the system. Before allowing the water in to the system, ensure that all the valves are open. After main, sub mains and laterals are flushed completely close the flushed completely close the flush valve and end caps. After closing of the valves and caps check the pressure at pressure gages and ensure that the pressure at the selected points is as per the design pressure. It is also required to check the working of filters, air release valves and the fertigation unit. Once it is ensured that all the components are functioning properly and the required pressure exists in the system, the system is ready for use.

46.2 Operation of Drip Irrigation System

When the system is in use, it is required to operate properly for long and trouble free use of the system. The following guidelines may be considered for this purpose.

- i) Keep all the design, evaluation and testing information from the designer, installer and dealer handy.
- ii) Computer the time of operation of different sub units based on the climatological data of previous day(s) or from the average historical data; prepare the time schedules for different valves and operate the valves accordingly to release the desired quantity of water, compute the volume of water to be applied for each setting/subunit and ensure that the desire quantity of water is applied.
- iii) Check the pressure at the pressure gages regularly.
- iv) For the se\system involving the operation of valves hydraulically, ensure proper setting of the hydraulic metering valve.
- v) Operating the head valve to begin irrigation.
- vi) Checking the system all components for proper operation, beginning with pressure readings at the control header.
- vii) Checking the emitters, randomly for its discharge.
- viii) Measure the emission uniformity of the system at least at the start of the irrigation season.
- ix) The chemical and fertilizer injection equipments to ensure the application of desired quantity and concentration (US Soil Cons. Service, 1984).

46.3 Maintenance of Drip Irrigation System

Periodic preventive maintenance of all the components of the drip irrigation system is required for successful operation of drip irrigation system.

46.3.1 Emitters

The emitter functioning, wetting pattern and leakage of pipes, valves, and fittings should be checked regularly. The placement of emitters should be ascertained. If the placement is disturbed, place them in proper position. If emitters do not give the rated pressure, they need to be cleaned manually either by flushing or provide manual or automatic chemical (acid or chlorine) treatments. The chemical treatment is described later in these lesson emitters not giving the rated discharge even after flushing or the chemical treatments should be replaced. Leakage through filter gaskets in the lids, flushing valves & fittings etc. are monitored regularly.

46.3.2 Filter Cleaning

Filter is the heart of a drip irrigation system and its failure will lead to clogging of the emitters and in turn the poor performance of the system. Pressure difference across the filter is used as the indicator for deciding the timing of cleaning of the filter.

i) Hydro Cyclone Filter

Hydro cyclone filter should be installed before sand and screen filter in case there is heavy load of sand in irrigation water. Hydro cyclone filter requires least maintenance; however the dirt or sand, inside the under flow chamber should be removed daily. Flush the chamber by opening flush valve/cap are or open the main valve for thorough cleaning.

ii) Sand Filter

The sand filter should be backwashed every day for five minutes to remove the silt other dirt or any other organic matter accumulated during the previous day's irrigation. Once in a week, while back washing, the backwash water should be allowed to pass through the lid instead of the backwash valves. The sand in the filter bed is stirred up to the filter candles without damaging them. Whatever dirt is accumulated deep inside the sand bed will get free and goes out with the water through the lid. The need of back washing can be detected by monitoring the pressure drop across the filter. When the pressure drops increased to a pre-determined level, the filter should be back-flushed. ASAE recommends that this pressure drop should not exceed 70 kPa. If there is heavy load of organic matter in irrigation water, the sand in the filter should be washed thoroughly with clean water. The sand filter should be filled with the sand if the level of sand in filter decreases. The sand may be lost in the process of backwashing or cleaning. It is advisable to procure 20% additional sand at the time of purchase of the sand filter.

iii) Screen/Disc Filter

Flushing at scheduled daily interval is necessary to maintain screen and disc filters. It is recommended to flush screen filter, if pressure drops more than 0.5 kg/cm². Before the start of drip irrigation system, the flushing valve of the filter link should be opened so that the dirt and silt will be flushed out. The filter element (screen or disc) is taken out from the filter and it is cleaned in flowing water. The rubber seals are taken out from both the sides and precaution should be taken while replacing the rubber seals, otherwise they may get damaged.

46.3.3 Maintenance of Fertigation Equipment

It is always advisable to allow clean water through ventury or other injectors for 10 to 15 minutes before and after fertilizer application for uniform application of fertilizers. It will also prevent clogging of suction port of ventury from clogging. It is important to note that equipment is resistant to acid. The lid of the fertilizer tank should be fully tightened while in operation. In order to check leaks between the body and bell housing in fertigation pump, clean the seal seating and put back the seal or change and keep the position of bell housing at upright.

46.3.4 Sub-main and Lateral / Flushing

It is possible that the silt or other dirt materials escapes through the filters and settles in sub mains and laterals. Also some algae and bacteria lead to the formation of slimes/pastes in the sub mains and laterals. The sub mains should be flushed by opening the flush valves to remove these formations. The lateral should be flushed by removing the end caps allowing water to pass through. Flushing also removes the traces of accumulated salts. The flushing process should be terminated once the water going out is cleaned.

46.3.5 Chemical Treatments

Clogging or plugging of emitters/orifices is due to precipitation and accumulation of certain dissolved salts like carbonates, bi-carbonates, iron, calcium and manganese salts. The clogging is also due to the presence of microorganisms and the related iron and sulphur slimes due to algae and bacteria. The clogging or plugging is usually removed by chemical treatment. Chemical treatments commonly used in drip irrigation systems include application of chloride and/or acid with water. The frequency of chemical treatment is decided on the degree of clogging and quality of water. Chlorine treatment is required to remove organic and any physical materials and acid treatment is required to remove the salt and any chemical precipitates from the system. As a general rule, acid treatment is performed once in ten days and chlorine treatment once in fifteen days.

i) Acid Treatment

Hydrochloric acid is injected into the drip irrigation system at the rate suggested in the water analysis report. The acid treatment is performed till a pH of 4 is observed at the end of pipe. After achieving a pH of 4 the system is shut off for 24 hours. The system is then flushed by opening the flush valve and lateral end caps.

ii) Chlorine Treatment

Chlorine treatment in the form of bleaching powder is performed to inhibit the growth of microorganisms like algae and bacteria. The bleaching powder is dissolved in water and this solution is injected into the system for about 30 minutes. Then the system is shut off for 24 hours. The lateral end caps and flush valves are opened to flush out the water with impurities. The recommended chlorine dosages are 0.5 to 1.0 ppm continuously or 20 ppm for 20 minutes at the end of each irrigation cycle for algae while for slimes, 1.0 ppm free residual chlorine is maintained at the end of each laterals. For iron precipitation, 0.64 times the Fe⁺⁺ content are used to maintain 1.0 ppm free residual chlorine at the end of each lateral. Efficiency of chlorine injection is related to pH of the water to be treated. More chlorine is required at a high pH. The rate of injection of liquid chlorine or acid depends on the system flow rate and can be determined by using the following expressions.

$$q_c = K \frac{u \times Q_s}{c} \quad (46.1)$$

where

q_c = Rate of injection of the chemical into the system,

K = Conversion constant, 6×10^{-3}

u = Desired concentration of chemical in irrigation water, ppm

Q_s = Supply flow rate, $L \text{min}^{-1}$

C = Concentration of chemical in the solution to be injected, per cent

LESSON 47 Project Planning and Financial Analysis of Irrigation Project

A project is a specific activity in which resources are used over a specified period of time with the expectation of a greater flow of benefits to an individual or a community. A common feature of all projects is that they can be planned, financed and implemented. During planning the costs and returns of a project are estimated.

Agricultural development is a process that involves changes in production techniques and methods on the different farming units including both which are large-scale and small-scale. Changes do not always bring positive benefits to the farmer. They have to be analyzed and measured against the prevailing situation. Choices should be made between alternative plans and ideas. Farmers, investors and society all need an objective way of making these analyses and choices. Resources are limited and all organizations and institutions have to make choices regarding the allocation and investment of human and financial resources in development of projects. Project appraisal helps to determine if the investment is viable, usually according to quantitative financial and economic criteria. Projects may be financed by the government, donor agencies, farmers, or a combination of these three.

47.1 Project Planning

This is a continuous process that involves sequential steps that form a kind of cycle, usually called the “project cycle”. The sequence is as follows

47.1.1 Identification

A project may be designed to address an identified constraint in the community or to exploit an opportunity. Ideas of pursuing an irrigation project may be prompted by the following

1. Low yields due to poor rainfall patterns
2. Low incomes from rain fed crop production
3. Presence of water resources and irrigable land
4. Market opportunities due to proximity to a large market (consumer and/or industrial, for example a processing factory).

Project identification aims at undertaking a preliminary assessment of a project idea before important planning resources, like money and skills, are utilized in detailed project design and appraisal. It involves the development of the concept and initial ideas. Project identification is initiated when farmers, extension workers, or NGO or donor agency staff recommend for a prospective project.

47.1.2 Project Preparation and Analysis

Once a project has been identified, the process of progressively more detailed preparation and analysis of project plan starts. This process includes all the work necessary to bring the project to the point at which a careful review or appraisal can be undertaken. Then, if it is determined to be a good project, implementation can begin. Typically, the first step in project preparation and analysis is to undertake a feasibility study that will provide enough information for deciding whether to begin more advanced planning. The feasibility study should clearly define the objectives of the project. It should explicitly address the question of whether alternative ways to achieve the same objectives may be preferable. This

stage is concerned with the study of a limited number of project alternatives and will enable project planners to exclude poor alternatives.

47.1.3 Project Appraisal

After the project preparation phase, a critical review of the project is conducted to re-examine every aspect of the project plan in order to assess whether proposal is appropriate and sound before financial commitment. Time frame is also checked for implementation feasibility. Appraisal process builds on the plan by gathering new information as required by the specialists.

47.1.4 Project Implementation

Implementation commences when appraisal and financial commitments have been approved. It involves

1. Preparation of an action plan and budget for the project
2. Mobilization of resources (human, material and financial) and assigning responsibilities
3. Mobilization of farmers to participate fully in the project right from the start
4. Initiation of fieldwork, for example laying out of engineering works, crop production, etc.

47.1.5 Project Monitoring and Evaluation

Monitoring takes place throughout project implementation and helps management keep track of the project progress. Monitoring can also be used to improve the management of the irrigated plot in terms of which agronomic technologies to use, the allocation of resources and decisions on what to produce. Evaluations consist of

1. Project objective deadlines.
2. Implementation of activities as planned.
3. Achievement of anticipated benefits.

Evaluation is not limited to completed projects. It is a most important managerial tool in ongoing projects and formalized evaluation might take place several times during the lifetime of the project.

47.2 Financial Analysis of an Irrigation Project

Analyzing the financial benefits of an irrigation project involves looking at the two levels: - i) farmer level and the ii) scheme level. At farmer level, we look at production levels, labour requirements and net income 'with' and 'without' the project. At scheme level, we look at costs incurred in constructing, operating and managing the whole scheme.

Financial Analysis of an irrigation project consists of the following:-

47.2.1 Farm Income Analysis

During project analysis, the underlying assumption made is that for farming community or for a farm, the objective will be maximization of income that the families will earn as a result of the participation in the project. The resources used are land, water, electricity and labour. The tools to evaluate these resources are: -

a. Cropping Patterns: When an irrigation project is introduced, the area of irrigation comes from the participating farmers' landholdings being used for rainfed cultivation.

If the farmers become full time irrigators, this will mean that income from cultivation is lost and income from irrigation is gained. In order to assess the impact of this, cropping patterns are analyzed and suitable decisions are taken.

b. Labour Requirements: Labour requirements are calculated on crop by crop basis and added to estimate the total requirements in any given situation. Where an exhaustive survey on the labour schemes has been carried out, this provides the data associated with various operations in the proposed scheme. When calculating the requirements for each crop, not only the total requirements but also the distribution over the cropping period will have to be established so that labour requirements in the peak periods can be determined.

c. Crop Budgets/Gross Margin Analysis: Crop Budgets contain the evaluation of gross margins per hectare for the different crops. Gross margin is the income generated from a production activity and is equal to the difference between the total gross income and the total variable costs.

47.2.2 Scheme Investment Analysis

The scheme investment analysis looks at the scheme income based on the gross margins, investment costs and the operations and maintenance costs. The analysis seeks to judge the likely incremental benefits project participants and the incentive for farmers to participate in the project, thus looking at the attractiveness of the project to the indulging farmers.

Scheme investment analysis depends on the following:-

- a. **Investment:** Investment refers to the amount put in a project irrespective of its type. Investment can also be termed as initial costs incurred to kick start a project.
- b. **Land:** Land for any irrigation project must appear in the investment analysis of the project. Similarly, rent should also appear as a cost in the investment analysis if the land has been rented.
- c. **Operating Costs:** The operating expenditure is calculated for the costs of equipment utilized in making the investment work functional and would include

- **Replacement Costs:** These are the costs incurred to replace specific items.
- **Energy Costs:** This depends on the elevation of the water source relative to the elevation of the scheme, which determines whether water should be pumped in order to reach the scheme and the irrigation system used.
- **Repair and Maintenance Costs:** These costs are usually assumed to depend on the cost of the equipment utilized. Thus a percentage of the cost of the equipment (generally between 1.5-5%) is taken as the repair and maintenance costs per year.
- **Water Charges:** These are the charges payable to whoever supplies the water, for example the national water authority. Where water is purchased, the water charges should be indicated as a cost.

- d. **Other Costs:** Following come under the other costs

- **Sunk Cost:** A cost incurred in the past projects that cannot be recovered again.
- **Residual Value:** This is the value of the asset remaining unused at the end of a project. The asset can be termed as an residual asset.

47.2.3 Setting Up the investment budget

Having assessed the costs and benefits, the budget of the irrigation project is set up.

47.2.4 Project Period

This is defined as the time duration for which the project will be carried out. If the project centers on only one major asset, say the irrigation system, then the usual project period is said to be 20 years. For external funding, the projects get wrapped up by 5-7 years.

47.2.5 Time Value of Money

When costs and benefits are spread over time, then the future income has to be reduced to its present worth. This is based on the principle that a dollar buys more today than it will buy tomorrow.

Determining the discount rate: The factor used to reduce projected future income or to accumulate loans now, is the discount rate or interest. There are two main explanations for interest namely, time preference and opportunity cost of capital.

47.2.6 Measuring the Project Worthiness

The viability or worthiness of the project that takes the timing of costs and benefits into account can be measured using the following indicators

a. Net Present Value (NPV): In financial terms, the net present value (NPV) or net present worth of a time series of cash flows, both incoming and outgoing, is defined as the sum of the present values (PVs) of the individual cash flows of the same entity. In the case when all future cash flows are incoming (such as coupons and principal of a bond) and the only outflow of cash is the purchase price, the NPV is simply the PV of future cash flows minus the purchase price (which is its own PV). NPV is a central tool in discounted cash flow (DCF) analysis and is a standard method for using the time value of money to appraise long-term projects. Used for capital budgeting and widely used throughout economics, finance, and accounting, it measures the excess or shortfall of cash flows, in present value terms, above the cost of funds.

Formula for NPV is

$$\frac{R_t}{(1 + i)^t}$$

where,

t – time of the cash flow

i – discount rate (the rate of return that could be earned on an investment in the financial markets with similar risk.)

R_t – the net cash flow i.e. cash inflow – cash outflow, at time t. For educational purposes

R_0 - is commonly placed to the left of the sum to emphasize its role as (minus) the investment.

The result of this formula is multiplied with the Annual Net cash in-flows and reduced by Initial Cash outlay the present value but in cases where the cash flows are not equal in amount, then the previous formula will be used to determine the present value of each cash flow separately. Any cash flow within 12 months will not be discounted for NPV purpose, nevertheless the usual initial investments during the first year R_0 are summed up a negative cash flow.

b. Benefit/Cost Ratio: A benefit-cost ratio (BCR) is an indicator, used in the formal discipline of cost-benefit analysis, that attempts to summarize the overall value for money of a project or proposal. A BCR is the ratio of the benefits of a project or proposal, expressed in monetary terms, relative to its costs, also expressed in monetary terms. All benefits and costs should be expressed in discounted present values. Benefit cost ratio (BCR) takes into account the amount of monetary gain realized by performing a project versus the amount it costs to execute the project. The higher the BCR the better the investment. General rule of thumb is that if the benefit is higher than the cost the project is a good investment.

c. Internal Rate of Return: The internal rate of return on an investment or project is the "annualized effective compounded return rate" or "rate of return" that makes the net present value (NPV as $NET \cdot 1 / (1 + IRR)^{\text{year}}$) of all cash flows (both positive and negative) from a particular investment equal to zero. It can also be defined as the discount rate at which the present value of all future cash flow is equal to the initial investment or in other words the rate at which an investment breaks even.

In more specific terms, the IRR of an investment is the discount rate at which the net present value of costs (negative cash flows) of the investment equals the net present value of the benefits (positive cash flows) of the investment.

IRR calculations are commonly used to evaluate the desirability of investments or projects. The higher a project's IRR, the more desirable it is to undertake the project. Assuming all projects require the same amount of up-front investment, the project with the highest IRR would be considered the best and undertaken first.

A firm (or individual) should, in theory, undertake all projects or investments available with IRRs that exceed the cost of capital. Investment may be limited by availability of funds to the firm and/or by the firm's capacity or ability to manage numerous projects.

Given a collection of pairs (time, cash flow) involved in a project, the internal rate of return follows from the net present value as a function of the rate of return. A rate of return for which this function is zero is an internal rate of return.

Given the (period, cash flow) pairs (t, C_n) where n is a positive integer, the total number of periods N , and the net present value NPV , the internal rate of return is given by r in:

$$NPV = \sum_{n=0}^N \frac{C_n}{(1+r)^n} = 0$$

The period is usually given in years, but the calculation may be made simpler if r is calculated using the period in which the majority of the problem is defined (e.g., using months if most of the cash flows occur at monthly intervals) and converted to a yearly period thereafter.

Any fixed time can be used in place of the present (e.g., the end of one interval of an annuity); the value obtained is zero if and only if the NPV is zero.

In the case that the cash flows are random variables, such as in the case of a life annuity, the expected values are put into the above formula.

Often, the value of r cannot be found analytically. In this case, numerical methods or graphical methods must be used.

47.3 Irrigation Project Costs

Irrigation project costs include all the expenditure made to establish, maintain and operate a project. Costs are estimated on an annual basis. The annual cost of a project includes both fixed and variable costs.

47.3.1 Fixed Costs

Fixed costs, also referred as investment or initial costs, include the following, as applicable:

- (a) Costs of obtaining water right and permits.

- (b) Planning and design costs.
- (c) Land purchase and rehabilitation of the population in the areas affected by the water resources project.
- (d) Cost of storage reservoirs, head regulator and canal water distribution system, including associated structures and controls.
- (e) Command area development surveying, land development operations and on-farm water conveyance and control.
- (f) Drainage system main drains, link drains, and on-farm drainage system surface and sub-surface.
- (g) Cost of wells, pumps, electric motors/engines and pumping plant accessories, and their installation.
- (h) Pump house
- (i) Electric Power connection, metering and recording equipment.
- (j) Automation equipment/remote control, if used.
- (k) Inspection and approach roads.
- (l) Equipment for water application, sprinkler/drip irrigation equipment, if used.

The above costs are incurred at the initial stages of the project, while others are paid annually. Annual fixed costs include the interest on the total investment on the project.

47.3.2 Variable costs

Variable costs are recurring in nature and computed on an annual basis. They are operation and maintenance costs as well as levies and charges on insurance and miscellaneous operating costs of recurring nature. The variable annual costs may be enumerated as follows:

- (a) Maintenance of structures and water distribution network.
- (b) Costs of fuel, namely, diesel or other fuels and electricity.
- (c) Lubricants, minor repairs, and painting.
- (d) Layout of field for surface irrigation renewal of borders, ridges and field channels.
- (e) Maintenance of drainage system desilting, weed control etc.
- (f) Operating manpower cost (Manpower costs include salaries, social benefits, housing, insurance, medical treatment, transportation and similar items). A simple procedure, commonly used for preliminary cost estimates is to calculate the interest on the average value of the installation at the prevailing interest rate:

$$\text{Annual interest cost} = \frac{(\text{Value of installation} - \text{salvage value}) \times \text{Interest rate}}{2}$$

47.3.3 Depreciation

It is a provision of funds over the life time of the project for its replacement. Depreciation is excluded from the economic appraisal of a project as it is only an accounting concept. Depreciation is the anticipated reduction in the value of an asset due to physical use of the equipment/structure or obsolescence. In the conventional analysis, the annual depreciation is computed as follows:

$$\text{Annual depreciation} = \frac{\text{Original cost} - \text{salvage value}}{\text{Useful life in years}}$$

Depreciation refers to the process of allocating a portion of the original cost of a fixed asset to each accounting period so that the value is gradually written off during the course of the estimated useful life of the asset. Allowance may be made for the asset's estimated resale value, if any, at the end of the useful life of the enterprise.

In discounted cash flow analysis, depreciation is not treated as a cost. The cost of an asset is shown in the year it is incurred and the benefits are shown in the year they are obtained. Since this is done over the entire life of the project, it is not necessary to show the value of the asset apportioned in any given year as depreciation. That would amount to double counting.

Service Period of Wells and Pumps Projects

In the case of ground water and lift irrigation projects, when the expected service period of wells and pumps is specified in hours of operation, same in years is calculated by dividing the total hours of operation by the average annual hours of operation.

Variable Costs of Irrigation Projects

If the electrical connection charges are paid in lump sum, the annualized cost may be estimated, assuming an expected service life of about 25 years. If the charges are to be paid annually, the same are to be added to the operation and maintenance cost, to arrive at the annual variable cost.

Variable costs of surface irrigation projects include the costs on regulation of the conveyance system as well as maintenance and repairs. In case of wells and pumps, they include the cost of power/fuel (electricity/diesel), cost of lubricants, labour charges for operating the pumping units and the expenditure on repairs and maintenance of the equipment and accessories.

The cost of power is often the most important component of variable costs in the case of pumping systems. The usual practice is to operation from the known discharge rate of the pumping plant, total operating head and its overall efficiency. The requirement of power is expressed in kilowatt-hour per hour for electricity and liters of diesel per hour of operation of engines.

The energy consumption of an electric motor is computed as follows:

$$\text{Energy Consumption} = \frac{\text{Brake horse Power}}{\text{Motor efficiency}} \times 0.746$$

Efficiencies of electric motor may be obtained from the performance data supplied by the manufacturers. Motor efficiencies usually vary from 75 to 90 per cent.

The demand of electrical power for hourly operation is multiplied by the annual hours of operation to arrive at the total annual energy consumption. The annual power cost is determined by multiplying the annual energy demand by the prevailing cost per unit of electrical energy.

In case of engine, the cost of fuel is computed as follows:

$$\text{Fuel cost} = \text{BHP} \times \text{Specific fuel consumption} \times \text{Cost of fuel per liter}$$

A realistic estimate of the rate of fuel consumption for a given engine can be made if the manufacturer's fuel consumption curve for the engine is available. Fuel consumption of diesel commonly used in irrigation pumping vary from 0.2 L to 0.29 L per bhp hour. An average value of 0.23 L/bhp-h can be assumed in the absence of better data.

The consumption of lubrication oil is usually assumed to be 4.5 L per 1000 bhp-h. Many manufacturers provide values for the consumption of lubricants of their products. From the cost of lubricants per hour of operation, the annual cost of lubricants is computed.

The repair and maintenance costs of the component parts of an irrigation system may be assumed as per the norms given in Table. 47.1. or an average value may be assumed on based on field evaluation studies or local experience.

Table 47.1. Guidelines for estimation of service life and annual maintenance and repair costs of irrigation structures and equipment

Component	Expected duration (operation hours)	Expected economic life in years	Annual maintenance and repair charge as % of initial investment
Dams	-	50-150	-
Masonry wells	-	50-170	0.2-0.5
Ponds and tanks	-	20-50	-
Tubewell screen and casing(mild steel)	-	20-50	0.5-1.5
Pump house and foundation	-	40-50	0.5-1.5
Bowls of turbine pumps (about 50% of the cost of the pump unit)	16000-20000	8-10	5-7
Columns of turbine pump	32000-40000	16-20	3-5
Centrifugal pump	32000-50000	15-20	3-5

Gear head	30000-36000	14-20	5-7
V-belt	6000	3	5-7
Flat belt (leather)	20000	10	5-7
Electric motor	50000-70000	25-35	1.5-2.5
Diesel engine	28000	15	5-8
Petrol engine	14000-18000	8-12	5-10
Galvanized iron pipes	-	25-50	1-2
Concrete pipes	-	20-60	2-4
Portable aluminum pipes	-	10-15	2-4
Plastic pipes (underground)	-	20-40	1.5-2.5
Asbestos cement pipes	-	20-40	1-1.5
Hydrants	-	20-40	1-2
Water meters	-	20-40	2-4
Sprinkler nozzle	-	5-10	2-3
Fittings of portable pipes	-	15	2-3

(Source: Michael, 2010)

47.4 Basic Concepts and Terminologies in Economic Analysis

i. Economic Rate of Return (ERR): The internal rate of return is calculated using economic values. Interest rate at which the cost and benefits of a project, discounted over its life, are equal. ERR differs from the financial rate of return. It takes into account the effects of factors such as price controls, subsidies, and tax breaks.

ii. Economic Analysis: A systematic approach to determining the optimum use of scarce resources, involving comparison of two or more alternatives in achieving a specific objective under the given assumptions and constraints. Economic analysis takes into account the opportunity costs of resources employed and attempts to measure in monetary terms the private and social costs and benefits of a project to the community or economy.

iii. Economic Value: It is the amount by which the return or output from a project changes the national income.

iv. Financial Rate of Return: The internal rate of return calculated using market values.

v. National Income: National Income is the money value of all goods and services produced by an economy in a given period of time for a country. National income measures the money value of the flow of output of goods and services produced within an economy over a period of time. The level and rate of growth of national income provide various purposes regarding economy, production, trade, consumption, policy formulation, etc.

vi. Gross Domestic Product (GDP): The monetary value of all the finished goods and services produced within a country's borders in a specific time period, though GDP is usually calculated on an annual basis. It includes all the private and public consumption, government outlays, investments and exports less imports that occur within a defined territory.

$$GDP = C + G + I + NX$$

where,

C is equal to all private consumption, or consumer spending, in a nation's economy

G is the sum of government spending

I is the sum of all the country's businesses spending on capital

NX is the nation's total net exports, calculated as total exports minus total imports. (NX = Exports - Imports)

vii. Net Benefit: The benefits from an irrigation project minus the costs. It is often calculated as the present value of benefits minus the present value of costs.

Gross Benefit: The incremental value of output from a project shows the gross benefit.

viii. Incremental Net Benefit: The increase in net benefit with the project is called its incremental net benefit. It shows the incremental cash flow.

xi. Indirect Benefit: The secondary benefits resulting from a project is called as indirect benefit.

xii. Opportunity cost: The opportunity cost is the benefit foregone by investing capital in a particular project, instead of its next best alternative use. It usually form the basis for selecting the discount rate for calculating the benefit cost ratio and the net present worth of the investment.

xiii. Discount rate: It is the interest rate used to determine the present worth of a future values in discounted cash flow analysis.

xiv. Efficiency Price: It is the economic value used in economic analysis. Efficiency prices reflect the opportunity cost or value of a good or services used or generated by a project. The price used may be the

market price adjusted for market distortions or shadow price. Efficiency price is used in economic analysis when the objective is to maximize the national income. Hence the procedure is also sometime called as efficiency analysis.

xv. Imputed Price: It is a price or economic values obtained by some computation rather than using an observed market price. It is better to avoid using an imputed price in project analysis, to the extent possible.

xvi. Inflation: The rate at which the general level of prices for goods and services is rising, and, subsequently, purchasing power is falling. Inflation occurs when the quantity of money in circulation rises relative to the quantity of goods and services which are available. Reserve Bank of India attempts to stop severe inflation, along with severe deflation, in an attempt to keep the excessive growth of prices to a minimum. In analysis, it is usual to consider constant prices rather than the current prices and to consider that inflation will affect prices of all costs and benefits equally. It is assumed that the prices will affect both the costs and benefits to the same extent, and hence the general relationship between costs and products and inputs and benefits will remain same.

xvii. Shadow Price: Shadow price is the value used in economic analysis for cost or benefits in a project when it is considered that the market price may not provide a realistic estimate of the economic value. Shadow price usually means the accounting price under such a situation. Shadow price usually is derived using the mathematical model such as linear programming.

xviii. Current ratio: The current ratio measures a company's ability to pay short-term obligations.

It is computed by the formula:

$$\text{Current Ratio} = \frac{\text{Current Assets}}{\text{Current Liabilities}}$$

It is also known as "liquidity ratio", "cash asset ratio" and "cash ratio".

xix. Current Price: It is the price or the value which includes the effect of change in the price of a commodity or service due to inflation. It could be a past value or price, as recorded, or a value or price which is expected to occur in normal conditions.

xx. Farm Gate Price: A cultivated product in agriculture or aquaculture is the net value of the product when it leaves the farm, after marketing costs have been subtracted. Since many farms do not have significant marketing costs, it is often understood as the price of the product at which it is sold by the farm (the farm gate price). The farm gate value is typically lower than the retail price consumers pay in a store as it does not include costs for shipping, handling, storage, marketing, and profit margins of the involved companies.

xxi. Cut-off Rate: It is the rate below which a project cannot be accepted as economically viable. The opportunity cost of the capital is usually taken as the cut off rate. It is the minimum acceptable internal rate of return.

xxii. Transfer Payment: It is a payment made without receiving any goods or services in return. In irrigation projects, the most common transfer payments are the taxes of different types and the subsidies received for growing specialized crops and adopting water-saving irrigation methods like sprinkler and drip irrigation systems.

xxiii. Economic Life: The period during which a fixed asset is capable of yielding services to its owner.

xxiv. **Grace Period:** In credit transactions during the grace period allowed, the holder need not repay principal, and sometimes the interest.

xxv. **Grants:** A payment made to an individual or a co-operative enterprise by a government or other agency without expectation of goods or services in return.

The purpose is to encourage a specific activity. A grant is a transfer payment in economic appraisal.

xxvi. **Work Day:** The time devoted to an activity by one person during one day. In developing countries, the duration in agricultural operations is usually taken as 8 hours per day.

xxvii. **Equity:** It is the ownership right in an enterprise. Equity capital is the residual amount left after deducting the total liabilities from the total assets.

Example 47.1: The opportunity cost of capital is 10 per cent per annum. Determine the discount rates for first, second, third and fourth years.

Solution:

$$\text{Discount factor} = \frac{1}{(1+i)^n}$$

$$\text{The discount rate for the first year} = \frac{1}{(1+0.1)^1} = 0.909$$

$$\text{Second year} = \frac{1}{(1+0.1)^2} = 0.826$$

$$\text{Third year} = \frac{1}{(1+0.1)^3} = 0.751$$

$$\text{Fourth year} = \frac{1}{(1+0.1)^4} = 0.683$$

Example 47.2: A project proposes to build a reserve fund by depositing Rs. 1500 million at the end of each year, by investing in suspense accounts available for 4 years. If the investment can earn at the rate of 7% per year, compounded annually, what would be the sum of annuities deposited at the time of fourth payment?

Solution:

The annuity at the end of n year can be given by

Where v = annuity = 15000 millions

n = no of annuity payment = 4

i = interest rate = 7%

$$Sn = V \left[\frac{(1+i)^n - 1}{i} \right]$$

$$Sn = 1500 \left[\frac{(1+0.07)^4 - 1}{0.07} \right]$$

$$= \text{Rs. } 6659.915 \text{ million}$$

Example 47.3: A 3 year annuity for Rs. 1000 has payments received at the end of each year. Determine the present value of annuity when discounted at 5 %.

Solution:

The present worth of annuity is given by

$$PV (A) = \frac{[V\{(1+i)^n - 1\}]}{i(1+i)^n}$$

In which, V=Rs. 1000, n=3, i=5%

$$PV (A) = \frac{[1000\{(1+0.05)^3 - 1\}]}{0.05(1+0.05)^3}$$

$$= \text{Rs. } 2723.25$$

Example 47.4: If the interest rate is 1 per cent for Rupee 1, compute the compounding factor for the first, second and subsequent years.

Solution:

The compounding factor is used to calculate the future worth of a present amount at the end of a particular period, using the following relationship:

$$Fv = P (1+i)^n$$

in which,

Fv = future worth

P = present amount

n = period

$$\text{Compounding factor for first year} = (1+0.1)^1$$

$$= 1.10$$

$$\text{Second yea} = (1+0.1)^2$$

$$=1.21$$

$$\text{Third year} = (1+0.1)^3$$

$$= 1.33$$

$$\text{Fourth year} = (1+0.1)^4$$

$$=1.46$$

Example 47.5: If an investible amount worth Rs. 25000 has an opportunity of earning at the rate of 10 per cent per annum, calculate the future value at the end of the tenth period.

Solution:

$$F_v = P (1+i)^n$$

$$= 25000 (1+0.1)^{10}$$

$$= \text{Rs. } 64843.56$$

Example 47.6: A loan of Rs. 100000 carrying an annual interest of 10% is to be amortized by equal installments over the next 10 years. Determine the value of annual installments.

Solution:

Amortization factor (D) is given by $D = \frac{i}{1-(1+i)^{-n}}$

in which, $i=10\%$, $n=10$

$$\text{The annual installment} = 100000 \times \frac{0.1}{1-(1+0.1)^{-10}}$$

$$= \text{Rs. } 16274.54$$



LESSON 48. National Water Policy and Participatory Irrigation Management

48.1 National Water Policy (NWP)

India has more than 17 percent of the world's population, but has only 4% of world's renewable water resources with 2.6% of world's land area. There are further limits on utilizable quantities of water owing to uneven distribution over time and space. In addition, there are challenges of frequent floods and droughts in one or the other part of the country.

Lack of understanding about scarcity of water, its life sustaining and economic value results in its mismanagement, pollution, wastage, reduction of flows below minimum ecological needs and inefficient use. In addition, there are inequities in distribution and lack of a unified perspective in planning, management and use of water resources.

The objective of the NWP is to take cognizance of the existing situation and create a system of laws and institutions, for plan of action in national perspective.

The main emphasis in the Draft of National Water Policy 2012 is conservation and efficient use of water. The policy also does away with the priorities for water allocation mentioned in 1987 and 2002 versions of the policy (Table 48.1). The other major recommendations are:

- i) to ensure access to a minimum quantity of potable water for essential health and hygiene to all citizens, available within easy reach of the household,
 - ii) to curtail subsidy to agricultural electricity users,
 - iii) setting up of water regulatory authority,
 - iv) to keep aside a portion of the river flow to meet the ecological needs and to ensure that the low and high flow releases correspond in time closely to the natural flow regime,
 - v) to give statutory powers to Water Users Associations to maintain the distribution system,
 - vi) project benefited families to bear part of the cost of resettlement & rehabilitation of project affected families,
 - vii) to remove the large disparity between stipulations for water supply in urban areas and in rural areas.
- (Source: Michael, 2010)

Planning, development and management of water resources need to be governed by common integrated perspective considering local, regional, State and national context, having an environmentally sound basis, keeping in view the human, social and economic needs. Water needs to be managed as a common pool community resource held, by the state, under public trust doctrine to achieve food security, support livelihood, and ensure equitable and sustainable development for all.

Water is essential for sustenance of eco-system, and therefore, minimum ecological needs should be given due consideration. Water, after meeting the pre-emptive needs for safe drinking water, sanitation and high priority allocation for other domestic needs (including needs of animals), achieving food security, supporting sustenance agriculture and minimum eco-system needs may be treated as economic good so as to promote its conservation and efficient use. Availability of utilizable water resources and increased

variability in supplies due to climate change, meeting the future needs will depend more on demand management, and hence, this needs to be given priority, especially through:

Table 48.1. National Water Policy during 1987 and 2002

Issue	National Water Policy (1987)	National Water Policy (2002)
Allocation priority	<p>1. Drinking water 2. Irrigation 3. Hydro-power 4. Navigation 5. Industrial and other uses</p> <p>“However these priorities might be modified if necessary in particular regions with reference to area specific considerations.”</p>	<p>1. Drinking water 2. Irrigation 3. Hydro-power 4. Ecology 5. Agro-industries and non- agricultural industries 6. Navigation and other uses</p>
Service provision	No mention.	<p>Private sector participation should be encouraged in planning, development and management of water resource projects for diverse uses, wherever feasible.</p> <p>Depending upon the specific situations, various combinations of private sector participation, in building, owning, operating, leasing and transferring of water resources facilities, may be considered.</p>

(Source: <http://www.downtoearth.org.in/content/national-water-policy-2012-silent-priorities>).

- (a) evolving an agricultural system which economizes on water use and maximizes value from water,
- (b) bringing in maximum efficiency in use of water and avoiding wastages,

48.2 Water Distribution in Canal Irrigation Systems

Different methods of water distribution are following in canal irrigation. These distribution systems are being practiced in India to ensure and to meet the crop demand. The commonly used distribution systems in irrigation canal are:

- i) Warabandi or Osrabandi
- ii) Shejpali
- iii) Zonal irrigation
- iv) Localized system

i) Warabandi or Osrabandi: It is a rotational method for distribution of irrigation water, with fixed time allocations based on the size of landholdings of individual water users within a water course command area. It presupposes an overall shortage of the water supply. The primary objective of the method is to distribute this restricted supply in an equitable manner over a large command area. This system has been successfully adopted in Indo-Gangetic plains.

ii) Shejpali: In this system estimate of expected water availability are made. Water is then sanctioned taking into account the total demand and the water availability. This system is practiced in Maharashtra, parts of Gujarat, and Karnataka.

iii) Zonal irrigation: In this system command area is divided into two halves. Water is made available continuously in one half of the area for one season for a period of four months in a year. The other half gets irrigation water sufficient for wet land crops the next year. This system is being practice in Tamilnadu.

iv) Localized system: This system is applicable in paddy grown areas in which irrigation flow below the canal outlet is allowed from one field to another through surface flooding. This practice usually results insufficient water distribution and low fertilizer use efficiency.

48.3 Participatory Irrigation Management (PIM)

As the name (PIM) indicates it is co-operation and involvement of farmers in operation, management, and maintenance of the irrigation systems at secondary and tertiary levels through forming “Water User’s Associations” (WUAs). It is a tool for improving irrigation management along with sustainability of the system. Participatory Irrigation Management (PIM) is conceived as panacea (remedy) for the ills of irrigated farming.

48.3.1 Objectives of PIM

Major objectives of PIM are stated below

1. To initiate participation of the farmers in water management, irrigation scheduling, distribution and maintenance of system at micro level.
2. To create a sense of ownership of water resources and the irrigation system among the users, so as to promote economy in water use and preservation of the system.
3. To achieve optimum utilization of available resources through sophisticated deliveries, precisely as per the crop needs.
4. To achieve equity in water distribution.

5. To increase production per unit of water, under both the circumstances of water scarce and adequate availability.
6. To make best use of natural precipitation and ground water in conjunction with flow irrigation for increasing irrigation and cropping intensity.
7. To facilitate a choice of better crops, cropping sequence, timing of water supply, and period of supply and frequency of supply depending on soil, climate and other infrastructure facilities available in commands such as roads, transportation, markets cold storages, etc., so as to maximize the incomes and returns.
8. To encourage collective and community responsibility on the farmers to collect water charges and payment to Irrigation Agency.
9. To create healthy atmosphere between the Irrigation Agency personnel and the users.
10. Coordinating post-harvest activities (grading, packaging, storage, marketing etc.) so as to derive maximum benefits.

48.3.2 Necessity of PIM

a) Need of Increase in Agricultural Production

The human as well as cattle population has been increasing all over the world and more so in India. As such the need for food, fiber, fuel, fodder etc. has also been increasing with growing demand. Aside from providing more food, increasing the productivity of farms affects the region's prospects for growth and competitiveness on the agricultural market, income distribution and savings, and labour migration. It is, hence, imperative to increase the agricultural production to match with the requirement.

Irrigation being lifeline of agriculture, its development and efficient management is the necessity of the day. Increasing the existing reservoirs capacity and taking up of new projects is causing serious financial and social problems. So far as ground water development is concerned, it has its own limitations and the most important being over exploitation of this resource at many places particularly in many parts of India. Hence proper management of already created water resources development structures is extremely essential at this juncture, in order to maintain the balance between need and the agricultural production. Since farmers are the real stakeholders, they have to come forward through their associations to look after their interest so that they get water from the system according to the predetermined time and space for planning their crops. It also helps in cost management.

b) Problem of Fiscal Availability

There is a severe budgetary competition at the government level under different sectors. The ratio of financial outlay for the irrigation sector to the total outlay is coming down year after year. Moreover there are many incomplete irrigation projects, where work is going on and there is demand of meeting the regional balance to provide irrigation facility almost all over. Under such circumstances, investment of more money by the Government on operation and maintenance of the old system appears difficult. Thus, farmers have to take up this responsibility themselves in order to avoid over burdening of the Government exchequer and to become self-dependent.

c) Recovery of operation and maintenance cost and recovery of irrigation charge

The Operation & Maintenance cost is much higher than the recoverable irrigation charges as per the present rate. Even these low rates are not being recovered in full. Often the cost of recovery of water charges by the Government is more than the amount recovered. This is causing severe budget constraints to

Government and consequently O&M could not be properly carried out resulting in system deficiency and unreliability of irrigation water to farmers. The Water Users' Associations could play this role in a better way.

Besides above aspects, there are other compulsions like non availability of water when it is needed, taking immediate problems like leakages, adopting flexibility in water distribution and taking many more initiatives by farmers' group to make their farm economy a sustainable proposition, PIM appears extremely necessary and worthwhile.

(Source:<http://wrmin.nic.in/writereaddata/mainlinkFile/File421.pdf>)

48.4 People's Participation in Managing Irrigation System in India

Public participation is needed at the planning, project concept, design, implementation and operation stage. Although decision making is the key part of management. However participation also involves a major role to play. People's participation in irrigation systems management can enhance agricultural production. People directly involved in irrigation fall into two categories:

Farmers: Peoples who make use of irrigation water for agricultural purposes on their own land.

System Managers: People who are employed to manage and make the irrigation system function work.

The Rajasthan Farmers Participation in Management of Irrigation Systems Act (2000) provides farmers participation in the Management of Irrigation System and for matters connected with or incidental to. The act provides to draw or trace the outline of water users' area and territorial constituencies. The Project Authority, by notification delineates every command area under each of the irrigation systems on a hydraulic basis which may be administratively viable and declare it to be a water user's area for the purpose of this Act. Every water users' area shall be divided into territorial constituencies which shall not be vary from four to ten, as may be prescribed.

The Andhra Pradesh Farmers Management of Irrigation Systems (APFMIS) Act, enacted in 1997 (Government of Andhra Pradesh, 1997), provides the basis for the take-over of the management and maintenance of irrigation systems by Water Users Associations (WUAs). This Act aims at reforms of irrigation management at both system and agency levels, and devolves powers to the water users.

The Water Users' Association shall perform the following functions, namely:

1. To prepare and implement a warabandi schedule for each irrigation season,
2. consistent with the operational plan, based upon the entitlement, area, soil and
3. cropping pattern;
4. To prepare a plan for the maintenance, extension, improvements, renovation and
5. modernization of irrigation system in the area of its operation and carry out
6. such works of both distributary system and field drains in its area of operation
7. with the funds of the association from time to time;
8. To regulate the use of water among the various outlets under its area of
9. operation according to the warabandi schedule of the system;

10. To promote economy in the use of water allocated;
11. To prepare demand and collect water charges;
12. To maintain a register of land owners as published by the revenue department;
13. To prepare and maintain an inventory of the irrigation system within the area of operation;
14. To monitor flow of water for irrigation;
16. To resolve the disputes, if any, between its Members and water users in its area of operation;
17. To raise resources;
18. To maintain accounts;
19. To cause annual audit of its accounts;
20. To assist in the conduct of elections to the Managing Committee;
21. To maintain such other records, as may be prescribed;
22. To abide by the decisions of the distributary and Project Committee;
23. To conduct General Body meeting in the manner, as may be prescribed;
24. To encourage avenue plantation on canal bunds and tank bunds by leasing
25. such bunds, and
26. To conduct regular water budgeting and also to conduct periodical social
27. audit in the manner, as may be prescribed.



***** 😊 *****

This Book Download From e-course of ICAR
**Visit for Other Agriculture books, News,
Recruitment, Information, and Events at**
WWW.AGRIMOON.COM

Give FeedBack & Suggestion at info@agrmoon.com

Send a Massage for daily Update of Agriculture on WhatsApp
+91-7900 900 676

DISCLAIMER:

The information on this website does not warrant or assume any legal liability or responsibility for the accuracy, completeness or usefulness of the courseware contents.

The contents are provided free for noncommercial purpose such as teaching, training, research, extension and self learning.

***** 😊 *****

Connect With Us:

